

Upstart Raising Patent Bar Simulator

U.S. DEPARTMENT OF COMMERCE  
U.S. Patent and Trademark Office  
P.O. Box 1450  
Alexandria, Virginia 22313-1450

**MANUAL OF PATENT EXAMINING PROCEDURE**  
**Eighth Edition**

**Instructions Regarding Revision No. 2**

This revision incorporates the changes necessitated by the following final rules:

- (1) "Correspondence With the United States Patent and Trademark Office," which became effective on May 1, 2003;
- (2) "Elimination of Continued Prosecution Application Practice as to Utility and Plant Patent Applications," which became effective on July 14, 2003;
- (3) "Changes To Implement Electronic Maintenance of Official Patent Application Records," which became effective on July 30, 2003;
- (4) "Reorganization of Correspondence and Other General Provisions," which became effective on September 12, 2003;
- (5) "Revision of Patent Fees for Fiscal Year 2004," which became effective on October 1, 2003;
- (6) "January 2004 Revision of Patent Cooperation Treaty Application Procedure," which became effective on January 1, 2004;
- (7) "Changes to Implement the 2002 *Inter Partes* Reexamination and Other Technical Amendments to the Patent Statute," which became effective on January 21, 2004; and
- (8) "Revision of Patent Term Extension and Patent Term Adjustment Provisions," which became effective on May 24, 2004.

It is noted that the discussion of 35 U.S.C. 102(e) in Chapters 800 and 900 has not yet been updated to incorporate revised 35 U.S.C. 102(e) (as amended by the Intellectual Property and High Technology Technical Amendments Act of 2002). When using Chapters 800 and 900 where 35 U.S.C. 102(e) has not yet been updated, users of the Manual should refer to Chapters 700 and 2100 for the revised 35 U.S.C. 102(e) as amended by the Intellectual Property and High Technology Technical Amendments Act of 2002.

This revision consists of replacement pages for the **Title Page, Foreword, Table of Contents, and Introduction** in the front of the Manual, **entire Chapters 100, 200, 500 - 700, 1000, 1100, 1300 - 1500, 1700, 1800, 2000 - 2200, 2500 and 2700, Appendices II – List of Decisions Cited, L – Patent Laws, R – Patent Rules, T – Patent Cooperation Treaty, and AI – Administrative Instructions Under the PCT, and entire Index**. A new **Chapter 2600** on *Inter Partes* Reexamination has been added.

Pages which have been printed in this revision are labeled as "**Rev. 2**" on the bottom. Sections of the Manual that have been changed by this revision are indicated by "[**R-2**]" after the section title. Additions to the text of the Manual are indicated by arrows (><) inserted in the text. Deletions are indicated by a single asterisk (\*) where a single word was deleted and by two asterisks (\*\*) where more than one word was deleted. The use of three or five asterisks in the body of the laws and rules indicates a portion of the law or rule that was not reproduced.

This revision of the Manual was prepared with the assistance of the Office of Patent Legal Administration. Their efforts are greatly appreciated.

Magdalen Y. C. Greenlief, Editor  
Manual of Patent Examining Procedure

Remove Pages

Title Page  
Foreword  
Table of Contents  
Introduction  
100-1 through 100-30  
200-1 through 200-108  
500-1 through 500-64  
600-1 through 600-140  
700-1 through 700-276  
1000-1 through 1000-14  
1100-1 through 1100-8  
1300-1 through 1300-24  
1400-1 through 1400-90  
1500-1 through 1500-52  
1700-1 through 1700-14  
1800-1 through 1800-168  
2000-1 through 2000-14  
2100-1 through 2100-226  
2200-1 through 2200-128  
2500-1 through 2500-16  
  
2700-1 through 2700-34  
  
A-7 through A-48  
L-1 through L-84  
R-1 through R-322  
T-1 through T-126  
AI-1 through AI-112  
I-1 through I-94

Insert Pages

Title Page  
Foreword  
Table of Contents  
Introduction  
100-1 through 100-36  
200-1 through 200-98  
500-1 through 500-60  
600-1 through 600-144  
700-1 through 700-298  
1000-1 through 1000-16  
1100-1 through 1100-36  
1300-1 through 1300-34  
1400-1 through 1400-106  
1500-1 through 1500-62  
1700-1 through 1700-16  
1800-1 through 1800-210  
2000-1 through 2000-14  
2100-1 through 2100-234  
2200-1 through 2200-146  
2500-1 through 2500-20  
2600-1 through 2600-160  
2700-1 through 2700-50  
  
A-7 through A-48  
L-1 through L-84  
R-1 through R-328  
T-1 through T-128  
AI-1 through AI-102  
I-1 through I-112

Particular attention is called to the changes in the following sections:

**CHAPTER 100:**

- 101 Revised to reflect amendments to 37 CFR 1.14. Added reference to Image File Wrapper (IFW) processing. References to particular PALM screens have been deleted.
- 102 Revised to reflect amendments to 37 CFR 1.14. Also revised to indicate that status information includes whether another application claims the benefit of the application for which status information is requested. Added reference to IFW processing.
- 103 Revised to reflect amendments to 37 CFR 1.11 and 1.14. The section has been rearranged to parallel 37 CFR 1.14 as amended and new subsection headings have been added. Added a subsection to discuss access to IFW applications. Revised to indicate that all reexamination files are available to the public in electronic format only. Regarding FOIA requests, 37 CFR 1.15, which was directed to requests for USPTO records, has been removed and supplanted by 37 CFR Part 102.
- 104 Revised to reflect amendments to 37 CFR 1.14. Revised to indicate that powers to inspect are not accepted in IFW applications. IFW applications are available through Private Patent Application Information Retrieval (PAIR) system.
- 110 Revised to reflect amendments to 37 CFR 1.14.
- 115 Added reference to IFW processing.
- 120 Revised to reflect amendments to 37 CFR 5.1, 5.2, and 5.3. Also revised to indicate that any petition for rescission or modification of a Secrecy Order or any appeal of a decision on petition should be addressed to Mail Stop L & R, Commissioner for Patents, P.O. Box 1450, Alexandria, VA 22313-1450.
- 140 Revised to reflect amendments to 37 CFR 5.11, and 5.18.
- 150 Revised to reflect amendments to 37 CFR 1.14.

**CHAPTER 200:**

- 201 Revised to indicate that effective July 14, 2003, a continued prosecution application (CPA) filed under 37 CFR 1.53(d) is only available for design applications.



- 201.03 Form paragraphs have been revised. Added reference to IFW processing. Revised to indicate that effective July 14, 2003, a continued prosecution application (CPA) filed under 37 CFR 1.53(d) is only available for design applications and that the CPA practice has been eliminated as to utility and plant applications.
- 201.04(b) Revised to indicate that an application filed under 37 CFR 1.53(b) may be converted to a provisional application provided a “request” for conversion and the fee are filed rather than a “petition” for conversion and the fee. Form PTO/SB/16 has been updated to reflect the current form that is available on the USPTO web site.
- 201.06 Revised to indicate that a divisional application is often filed as a result of a restriction requirement made by the examiner. Also revised to indicate that effective July 14, 2003, continued prosecution application (CPA) practice has been eliminated as to utility and plant applications. The reference to the deletion of 37 CFR 1.60 and 1.62 as of December 1, 1997 has been deleted.
- 201.06(a) Information regarding practice and procedure under former 37 CFR 1.60 has been deleted. Such information is available in the 8<sup>th</sup> edition, revision 1 of the MPEP posted on the USPTO web site.
- 201.06(b) Information regarding practice and procedure under former 37 CFR 1.62 has been deleted. Such information is available in the 8<sup>th</sup> edition, revision 1 of the MPEP posted on the USPTO web site.
- 201.06(c) Revised to indicate that a proceeding is terminated when the mandate is issued by the court rather than the date of receipt of the court’s certified copy of the decision by the USPTO. This change is consistent with a 1998 amendment to Rule 41 of the Federal Rules of Appellate Procedure. The commentary to the amendment to Rule 41 of the Federal Rules of Appellate Procedure indicated that the change is to make clear that the court’s mandate is effective upon issuance, and that its effectiveness is not delayed until receipt of the mandate by the trial court or agency.
- 201.06(d) Revised to reflect amendments to 37 CFR 1.53(d). Effective July 14, 2003, continued prosecution application (CPA) practice has been eliminated as to utility and plant applications. CPA practice is only available for design applications. CPAs filed prior to July 14, 2003 will continue to be processed and examined under the procedures set forth in prior 37 CFR 1.53(d). The forms have been updated to reflect the current forms that are available on the USPTO web site.

- 201.07 Revised to indicate that effective July 14, 2003, a continued prosecution application (CPA) filed under 37 CFR 1.53(d) is only available for design applications.
- 201.08 Revised to indicate that notations are to be put in the “file history” rather than referring to the file wrapper so as to cover applications maintained in paper and those that are maintained in IFW.
- 201.09 Revised to indicate that notations are to be put in the “file history” rather than referring to the file wrapper so as to cover applications maintained in paper and those that are maintained in IFW.
- 201.10 Form paragraph has been revised.
- 201.11 Form paragraphs have been revised. Added discussion to a Federal Circuit decision. Revised to indicate that a proceeding is terminated when the mandate is issued by the court rather than the date of receipt of the court’s certified copy of the decision by the USPTO. Revised to indicate that when a benefit claim is submitted after the filing of an application, the reference to the prior application cannot include an incorporation by reference statement of the prior application unless an incorporation by reference statement of the prior application was presented at the time of filing of the application. Also revised to indicate that a nonprovisional application which entered the national stage from an international application after compliance with 35 U.S.C. 371, the benefit claim must be made within the time period set forth in 37 CFR 1.78(a)(2)(ii) and (a)(5)(ii), as appropriate.
- 201.11(a) Added a new subsection to discuss delayed submission of benefit claim in an international application.
- 201.13 The list of countries to which the right of priority referred to in 35 U.S.C. 119(a)-(d) has been recognized has been updated.
- 201.14(a) Revised to reflect amendments to 37 CFR 1.55. Form paragraph has been revised.
- 201.14(b) Form paragraph has been revised.
- 201.14(c) Added reference to IFW processing.
- 202.02 The title of this section has been changed to read “Notation in File History Regarding Prior U.S. Application, Including Provisional Applications.” Added reference to IFW processing.
- 202.03 Added reference to IFW processing.

- 202.04 Revised to include the requirements of 37 CFR 1.63(c)(2).
- 203.08 Revised to indicate that applicants are encouraged to check Patent Application Information Retrieval (PAIR) for status information of their own patent applications. Also revised to indicate that for amended applications, if applicant files a reply to an Office action and six months have elapsed since the filing of the reply and no response from the Office is received, applicant should inquire as to the status of the application to avoid potential abandonment.
- 203.08(a) Revised to reflect that the name of the Office of Legislative and International Affairs has been changed to the Office of International Relations.

**CHAPTER 500:**

- 501 The title of this section has been changed to read “Filing Papers With the U.S. Patent and Trademark Office.” Revised to reflect amendments to 37 CFR 1.1 and 1.4. Revised to set forth the mailing addresses for certain types of correspondence. Also revised to indicate that patent-related papers, other than those that require immediate Office attention may be delivered to the Office and if hand-delivered, the correspondence must be delivered to the Customer Window.
- 502 Revised to reflect amendments to 37 CFR 1.5 and 1.6. Revised to indicate that effective December 1, 2003, all official patent application related correspondence for organizations reporting to the Commissioner for Patents that is hand-delivered to the Office must be delivered to the Customer Window with a few exceptions.
- 502.01 Revised to reflect amendments to 37 CFR 1.6. Revised to indicate that effective July 14, 2003, continued prosecution application (CPA) procedures are only available to design applications. Revised to indicate that effective December 1, 2003, all patent application related correspondence transmitted by fax must be directed to the central fax number with a few exceptions. Also revised to indicate that the Office has waived the prohibition in 37 CFR 1.6(d)(4) against the submission of drawings by fax when the drawings are facsimile transmitted with the issue fee.
- 502.02 Revised to reflect amendments to 37 CFR 1.4.
- 502.04 Revised to reflect amendments to 37 CFR 1.4.

- 503 Added reference to the “10” series code for patent applications and the “95” series code for *inter partes* reexamination proceedings. Revised to indicate that any return receipt postcard containing a dated meter postmark may not be delivered by the USPS to the address provided on the postcard.
- 505 Revised to reflect amendments to 37 CFR 1.6.
- 506 Revised to reflect amendments to 37 CFR 1.53. Revised to indicate that any preliminary amendment, regardless of when it is filed, must comply with the requirements of 37 CFR 1.121.
- 507 Revised to indicate that replacement drawings for inclusion in a patent application publication must be addressed to Mail Stop PGPUB Drawings.
- 508 Revised to indicate that all applications filed on or after June 30, 2003 are electronically scanned and loaded into the IFW system.
- 508.03 Revised to indicate that effective December 1, 2003, no official paper that relates to a pending application may be personally delivered to a TC except for papers that are directed to an application subject to a secrecy order or are national security classified.
- 509 Revised to reflect amendments to 37 CFR 1.22 and 1.26. Revised to indicate that the credit card payment form, PTO-2038, may be downloaded from the USPTO web site.
- 509.01 Revised to reflect amendments to 37 CFR 1.25. Revised to add information regarding deposit account replenishment.
- 509.02 Revised to include reference to 35 U.S.C. 41(h)(1). Information regarding the Small Business Administration has been updated. Added recent Federal Circuit decision regarding a grant of a non-exclusive license to a large entity which resulted in applicant being disqualified from claiming small entity status.
- 509.03 Added form paragraph 5.05 which may be used to notify applicant that he or she may qualify for small entity status. Address for submitting requests for refunds along with assertions under 37 CFR 1.27(c) has been updated.
- 511 The title of this section has been changed to read “Postal Service Interruptions and Emergencies.” Revised to indicate that in the event of a postal interruption or emergency, an announcement will be posted on the USPTO web site providing instructions on the filing of patent applications and other papers related to patent applications and patents. Information regarding depositing papers with U.S. Department of Commerce District Offices is no longer necessary and has been deleted.

- 512 Revised to reflect amendments to 37 CFR 1.8. Form paragraph has been revised.
- 513 Revised to reflect amendments to 37 CFR 1.6 and 1.10. Revised to indicate that the Express Mail procedures set forth in 37 CFR 1.10 is limited to correspondence deposited in the “Express Mail Post Office to Addressee” service of the USPS and that no similar benefit can be obtained for correspondence deposited in International Express Mail.

**CHAPTER 600:**

- 601 Revised to reflect amendments to 37 CFR 1.51. Added information regarding what constitutes a complete application filed under 35 U.S.C. 111(a). Revised to include a reference to new MPEP Chapter 2600, which is directed to *inter partes* reexamination.
- 601.01 Revised to reflect amendments to 37 CFR 1.53. Also revised to indicate that effective July 14, 2003, continued prosecution application (CPA) practice under 37 CFR 1.53(d) is only available for design applications.
- 601.01(a) The discussion regarding applications filed under former 37 CFR 1.62 has been deleted since 37 CFR 1.62 has been deleted since December 1, 1997.
- 601.01(c) Revised to indicate that the conversion of a nonprovisional application to a provisional application would not avoid publication of the nonprovisional application unless the request to convert is recognized in sufficient time to permit the Office to remove the nonprovisional application from the publication process. Requests to convert should be addressed to “Mail Stop Conversion.”
- 601.01(d) Added reference to IFW processing.
- 601.01(e) Added discussion of recent Federal Circuit decision on preliminary amendments that cancels all claims without presenting new claims.
- 601.01(g) Revised to replace the requirement of a separate letter renumbering the drawing figures consecutively with replacement sheets of drawings in compliance with 37 CFR 1.121(d).
- 601.02 The title of this section has been changed to read “Power of Attorney.” Reference to authorization of agent has been deleted. Form PTO/SB/81 has been updated to reflect the current form that is available on the USPTO web site.
- 601.03 Revised to reflect amendments to 37 CFR 1.33.

- 601.05 Revised to include an example to illustrate the reasons why the Office would prefer applicants to use an application data sheet. Reference to authorization of agent has been deleted. Added discussion on supplemental ADS submissions. Revised to indicate that the Office strongly encourages the filing of an ADS or a supplemental ADS to correct a typographical or transliteration error in the spelling of an inventor's name.
- 602 Revised to indicate that documents with seals cannot be adequately scanned for retention in the IFW, therefore, the Office strongly encourages the use of declarations rather than oaths. Also revised to indicate that 37 CFR 1.63 no longer requires the oath or declaration to state that the inventor is a sole or joint inventor of the invention claimed. Form paragraph has been revised. Form PTO/SB/01 has been updated to reflect the current form that is available on the USPTO web site.
- 602.02 The cross-reference to the MPEP has been corrected.
- 602.03 Form paragraphs have been revised. Added reference to IFW processing.
- 604.01 Revised to indicate that documents with seals cannot be adequately scanned for retention in the IFW, therefore, the Office strongly encourages the use of declarations rather than oaths.
- 604.04(a) Revised to indicate that the Office no longer returns improperly authenticated oaths for proper authentication. Form paragraph has been revised.
- 605 Revised to reflect amendments to 37 CFR 1.41.
- 605.02 Form paragraph has been revised.
- 605.03 Form paragraph has been revised.
- 605.04(a) Revised to indicate that applications filed through the EFS must also contain an oath or declaration personally signed by the inventor. Also revised to indicate that in situations where an inventor's full given name is a singular letter or a plurality of singular letters, it is acceptable to identify the inventor by his or her family name and the singular letter(s). In order to avoid an objection under 37 CFR 1.63(a)(2), applicant should point out in the oath or declaration that the singular lettering set forth is the inventor's given name. Revised to indicate that when a typographical or transliteration error in the spelling of an inventor's name is discovered during the pendency of the application, applicants are strongly encouraged

to use an ADS to provide the corrected spelling to ensure that any patent to issue will reflect the correct spelling of the inventor's name.

- 605.04(c) Added reference to IFW processing.
- 605.04(f) Revised to indicate that applicants are strongly encouraged to submit an ADS showing the new order of inventor names to ensure appropriate printing of the inventor names in any patent to issue. Also revised to indicate that when the Office of Petitions grants a petition to change the order of the names of the inventors, the Office of Petitions will change the order of the names in the Office computer records unless the application is an 08/ or earlier series, in which case, OIPE will correct the file wrapper and the PALM database.
- 605.04(g) The discussion regarding a typographical or transliteration error in the spelling of an inventor's name has been moved to MPEP § 605.04(a). Added reference to IFW processing.
- 606.01 Added reference to IFW processing.
- 607.02 Revised to reflect amendments to 37 CFR 1.26.
- 608.01 Revised to reflect amendments to 37 CFR 1.52, and 1.71. Revised to indicate that the specification must commence on a separate sheet and the text must be written in a nonscript type font. Also revised to indicate that examiners should not object to the specification and/or claims merely because applicants are using British English spellings rather than American English spellings. Regarding "Easily Erasable" paper, since application papers are now maintained in an IFW, the type of paper is unlikely to be an issue so long as the Office was able to scan and reproduce the papers that are filed. Also revised to clarify that where the hyperlinks themselves, rather than the content of the site to which the hyperlinks are directed, are part of applicant's invention and it is necessary to have them included to comply with 35 U.S.C. 112, first paragraph, and applicant does not intend to have these hyperlinks be active links, examiners should not object to these hyperlinks. Form paragraphs have been revised.
- 608.01(a) Form paragraphs have been revised.
- 608.01(b) Revised to reflect amendments to 37 CFR 1.72. Form paragraphs have been revised.
- 608.01(i) Revised to reflect amendments to 37 CFR 1.75.

- 608.01(m) Revised to indicate that the claim or claims must commence on a separate physical sheet or electronic page. Form paragraphs have been revised.
- 608.01(n) Added reference to forms PTO/SB/06 and PTO/SB/07. Revised to clarify the reason why a claim to a product set forth in claim 1 is an improper dependent claim where claim 1 recites a method of making a specified product.
- 608.01(o) Revised to indicate that if the examiner determines that the claims presented late in prosecution do not comply with the requirements of 37 CFR 1.75(d)(1), applicant will be required to make appropriate amendment to the description to provide clear support or antecedent basis for the terms appearing in the claims provided no new matter is introduced.
- 608.01(p) Added a reference to MPEP § 2181 regarding incorporation by reference, 35 U.S.C. 112, second paragraph, and 35 U.S.C. 112, sixth paragraph. Revised to indicate that as a safeguard against the omission of a portion of a prior application for which priority is claimed under 35 U.S.C. 119(a)-(d) or (f), or for which benefit is claimed under 35 U.S.C. 119(e) or 120, applicant may include a statement at the time of filing of the later application incorporating by reference the prior application. The inclusion of the incorporation by reference statement will permit applicant to include subject matter from the prior application into the later-filed application without the subject matter being considered as new matter.
- 608.01(q) Revised to reflect amendments to 37 CFR 1.125. Form paragraphs have been revised.
- 608.01(v) Revised to indicate that where a letter demonstrates a trademark misuse in a patent application publication, the Office should, where the application is still pending, ensure that the trademark is replaced by appropriate generic terminology.
- 608.02 Revised to indicate that facsimile copies of drawings are acceptable if included with application papers mailed or hand delivered to the Office or if submitted at the time of payment of the issue fee. Applicants should ensure that the facsimile transmission process does not unreasonably degrade the quality of the drawings. Also revised to indicate that the “Guide for the Preparation of Patent Drawings” is available on the USPTO web site. Also revised to indicate that photographs may be treated as artifacts when the patent application is an IFW application. Revised to add a reference to the American National Standards Institute (ANSI) publications that pertain to graphical symbols.



- 608.02(a) Deleted reference to “informal” drawings since the Office no longer considers drawings as formal or informal. Drawings are either acceptable or not acceptable.
- 608.02(b) Revised to indicate that drawings are now considered either acceptable or not acceptable rather than formal or informal. Form paragraphs have been revised.
- 608.02(c) Added reference to IFW processing.
- 608.02(d) Form paragraphs have been revised.
- 608.02(e) Form paragraphs have been revised.
- 608.02(f) Form paragraph has been revised.
- 608.02(g) Form paragraph has been revised.
- 608.02(h) The title of this section has been changed to read “Replacement Drawings.” The phrase “additional or substitute sheets of drawings” has been changed to “replacement sheets of drawings.” Form paragraph has been changed.
- 608.02(m) Added reference to IFW processing.
- 608.02(o) Revised to indicate that drawings are no longer endorsed with an application number or receipt date.
- 608.02(p) Revised to reflect amendments to 37 CFR 1.121(d). Form paragraphs have been revised.
- 608.02(r) This section on separate letter has been deleted.
- 608.02(t) Revised to indicate that if a drawing figure is canceled, a replacement sheet of drawing must be submitted with the figure. If the canceled figure was the only drawing on the sheet, then only a marked-up copy of the drawing including an annotation that the drawing has been canceled is required.
- 608.02(v) The title of this section has been changed to read “Drawing Changes Which Require Annotated Sheets.”
- 608.02(w) The title of this section has been changed to read “Drawing Changes Which May Be Made Without Applicant’s Annotated Sheets.”

- 608.02(x) The title of this section has been changed to read “Drawing Corrections or Changes Accepted Unless Notified Otherwise.” Revised to indicate that drawing corrections or changes will be entered at the time they are presented, unless applicant is notified to the contrary by the examiner in the action following the amended drawing submission.
- 608.02(z) Revised to indicate that if at allowance, the examiner determines that correction is required, the drawings requiring correction should be placed as the top papers in the center fold of the file wrapper if the application is maintained in paper.
- 608.03(a) Revised to reflect amendments to 37 CFR 1.94 and 1.95.
- 608.05 Added reference to IFW processing.
- 608.05(a) Form paragraphs have been revised. Revised to indicate that the Office provided for the continuation of prior microfiche appendix practice for computer listings until March 1, 2001. Added references to IFW processing.
- 608.05(b) Revised to indicate that if lengthy tables are submitted on a CD or in electronic format in response to a specific request from the Office of Publication, these lengthy tables will not be published as part of a patent document. The lengthy tables will be published separately on the sequence homepage of the USPTO Internet web site as an XML file and the patent document will include a standardized “Lengthy Table” statement. Form paragraph has been revised.
- 609 Revised to reflect amendments to 37 CFR 1.98. Revised to indicate that a third party, who is not covered by 37 CFR 1.56(c), cannot file an IDS under 37 CFR 1.97 and 1.98. Also revised to indicate that pursuant to 37 CFR 1.98(d), if the IDS submitted in the parent application complies with 37 CFR 1.98(a) to (c), applicant need not resubmit copies of the documents in the continuing application. Form paragraphs have been revised. Revised to include a discussion of e-IDS. Forms PTO/SB/08A and PTO/SB/08B have been updated to reflect the current forms that are available on the USPTO web site.
- 610 This section has been deleted and the subject matter has been moved to new MPEP § 1134.01.

## **CHAPTER 700:**

- 702 Added reference to IFW processing.
- 702.01 Form paragraph has been revised.

- 704.10 Added discussion of recent Federal Circuit decision.
- 704.12(a) Added discussion of recent Federal Circuit decision.
- 704.14(b) Added reference to IFW processing.
- 705.01 Added reference to IFW processing.
- 705.01(a) Added reference to IFW processing.
- 705.01(d) Added reference to IFW processing.
- 705.01(e) Added reference to IFW processing.
- 706.02 Added reference to MPEP § 2658, which is directed to *inter partes* reexamination.
- 706.02(b) Revised to indicate that where applicant is attempting to overcome a rejection under 35 U.S.C. 102(b) by perfecting priority claim under 35 U.S.C. 119(e), there has to be at least one intermediate application between the provisional application and the nonprovisional application under examination (chain of prior applications) since a provisional application could not have been filed more than one year prior to the filing of a nonprovisional application that claims benefit to the provisional application. In this situation, priority must be perfected for the chain of prior applications (35 U.S.C. 119(e) and 120 must be perfected).
- 706.02(f)(1) Revised to indicate that where the 35 U.S.C. 102(e) date of a reference is based on the filing date of an earlier-filed U.S. provisional or nonprovisional application or international application, the subject matter used in the rejection must be disclosed in the earlier-filed application in compliance with 35 U.S.C. 112, first paragraph, in order for that subject matter to be entitled to the earlier filing date under 35 U.S.C. 102(e).
- 706.02(l)(1) Revised to indicate that the fact that the reference and the application have the same assignee is not, by itself, sufficient evidence to disqualify the prior art under 35 U.S.C. 103(c). There must be a statement that the common ownership was “at the time the invention was made.”
- 706.02(l)(2) Added examples 7 and 8 to illustrated common ownership.
- 706.02(m) Form paragraphs have been revised.
- 706.03(a) Form paragraph has been revised.

- 706.03(c) Form paragraphs have been revised.
- 706.03(d) Form paragraph has been revised.
- 706.07 Revised to reflect amendments to 37 CFR 1.113.
- 706.07(f) Form paragraph has been revised.
- 706.07(h) Revised to indicate that applicants cannot file an RCE to obtain continued examination on the basis of claims that are independent and distinct from the claims previously claimed and examined. Any newly submitted claims that are directed to an invention that is independent and distinct from the invention previously claimed will be withdrawn from consideration and not entered. Revised to add a chart to illustrate what the submission must include based on the status of the application. Also revised to indicate that effective July 14, 2003, CPA practice has been eliminated as to utility and plant applications. If an applicant files a transmittal letter that is ambiguous as to whether it is a CPA or an RCE in an application filed on or after June 8, 1995, the Office will treat the transmittal letter as an RCE. If the application is a design application, the Office will treat the transmittal letter as a request for a CPA since RCE practice does not apply to design applications. Revised to indicate that all amendments filed as of the date the RCE is filed are entered in the order in which they are filed in the absence of any specific instructions for entry. Also revised to indicate that if a reply to a final Office action is outstanding and the submission is not fully responsive and is not a *bona fide* attempt to provide a complete reply, the RCE will be treated as an improper RCE and the improper RCE will not toll the period for reply to the final Office action. Form paragraphs have been revised. Forms have been updated to reflect current forms.
- 707 Form paragraphs have been revised. Form PTOL-326 has been updated.
- 707.05 Added reference to IFW processing.
- 707.05(a) Added reference to IFW processing.
- 707.05(e) Added reference to IFW processing.
- 707.05(g) Form paragraph has been revised.
- 707.07(a) Form paragraph has been revised.
- 707.07(i) Added reference to IFW processing.
- 707.07(j) Form paragraphs have been revised.

- 707.08 Form paragraphs have been revised.
- 707.10 Added reference to IFW processing.
- 707.12 Added reference to IFW processing.
- 707.13 Added reference to IFW processing.
- 708 Added reference to *inter partes* reexamination.
- 708.01 Revised to reflect amendments to 37 CFR 1.102.
- 708.02 Revised to reflect amendments to 37 CFR 1.102. Subsection VIII. has been revised to clarify that the pre-examination search must be directed to the invention as claimed in the application for which special status is requested. Also revised to clarify that a search made by a foreign patent office satisfies the requirement of a pre-examination search if the claims in the corresponding foreign application are of the same or similar scope to the claims in the U.S. application for which special status is requested. Added reference to IFW processing.
- 708.03 Added reference to IFW processing.
- 709 Revised to reflect amendments to 37 CFR 1.103. Revised to indicate that effective July 14, 2003, CPA practice is only available for design applications. Form PTO/SB/37 has been updated to reflect the current form that is available on the USPTO web site.
- 710.02 Added reference to MPEP Chapter 2600 for *inter partes* reexamination.
- 710.02(b) The discussion under the heading “Period For Reply Restarted” has been revised.
- 710.02(e) Revised to indicate that hand-carried requests for extension of time will no longer be accepted in the TCs. They may only be delivered to the Customer Window.
- 710.06 Added reference to IFW processing.
- 711.01 Form paragraph has been revised. Added discussion of recent Federal Circuit decision. Revised to indicate that applicants are strongly encouraged to hand-carry a petition to withdraw an application from issue to the Office of Petitions to allow sufficient time to process the petition and if the petition is granted, withdraw the application from issue. Also revised to indicate that a petition under 37 CFR 1.138(c) for express

abandonment to avoid publication may be (1) mailed to Mail Stop Express Abandonment, (2) faxed to the Pre-Grant Publication Division, or (3) hand-carried to the Pre-Grant Publication Division. Form PTO/SB/24 has been updated to reflect the current form that is available on the USPTO web site.

- 711.02 Form paragraph has been revised.
- 711.02(b) The reference to FWC applications filed under former 37 CFR 1.62 has been deleted.
- 711.03(c) Revised to reflect amendments to 37 CFR 1.137. Former subsections I and II directed to petitions to withdraw a holding of abandonment have been combined as a single subsection I. Added discussion regarding untimely petition to withdraw holding of abandonment. The discussion regarding reply requirement under the subsection directed to petitions to revive an abandoned application or accept late payment of issue fee has been clarified to indicate that a petition for extension of time under 37 CFR 1.136 and a fee for such an extension are not required to be included with the reply. The forms have been updated to reflect the current forms that are available on the USPTO web site.
- 711.03(d) Revised to reflect amendments to 37 CFR 1.181.
- 711.04 Revised the discussion to reflect amendments to 37 CFR 1.14.
- 711.04(b) Added reference to IFW processing.
- 713.01 Revised to reflect amendments to 37 CFR 1.133. Revised to indicate that applicants are encouraged to use form PTOL-413A, "Applicant Initiated Interview Request," however, the fact that applicants do not submit this form is not, by itself, grounds for the examiner to deny a request for an interview. Added reference to IFW processing.
- 713.04 Added reference to IFW processing.
- 713.05 Revised to indicate that a practitioner cannot authorize other registered practitioners to conduct interviews without the consent of the client after full disclosure (37 CFR 10.57(c)) and furthermore, a practitioner cannot authorize a nonpractitioner to conduct interviews since this would be contrary to 37 CFR 10.47.
- 713.08 Added reference to IFW processing.
- 714 The revised manner of making amendments which became effective on July 30, 2003 has been added.

- 714.01(e) Subsections added. Revised to indicate that a preliminary amendment must comply with the requirements of 37 CFR 1.121.
- 714.02 Revised to reflect amendments to 37 CFR 1.111.
- 714.03 Revised to indicate that if an amendment submitted on or after July 30, 2003 fails to comply with 37 CFR 1.121, applicant will be notified by a Notice of Non-Compliant Amendment. Applicant's reply to the notice should consist of a corrected version of only that portion of the amendment that previously failed to comply with 37 CFR 1.121. It is not necessary to resubmit the entire amendment document. Added discussion of recent Federal Circuit decision.
- 714.03(a) Revised to reflect amendments to 37 CFR 1.115.
- 714.13 Revised to indicate that effective July 14, 2003, CPA practice has been eliminated as to utility and plant applications. Form paragraph has been revised. Also revised to indicate that hand-carried papers for the TCs may only be delivered to the Customer Window. Added reference to IFW processing.
- 714.16 Revised to reflect amendments to 37 CFR 1.312. Revised to indicate that an amendment under 37 CFR 1.312 must be filed on or after the date the issue fee is paid, except where the amendment is required by the Office of Patent Publication.
- 714.16(d) Revised to indicate that hand-carried amendments are no longer accepted in the TC. The amendments may only be delivered to the Customer Window. Added discussion regarding IFW processing. Added a subsection to address amendments required by the Office of Patent Publication.
- 714.16(e) Added reference to IFW processing.
- 714.17 Added reference to IFW processing.
- 714.18 Revised to indicate that evaluation of the amendment after final rejection for compliance with 37 CFR 1.121 should be left to the examiner and not treated by the technical support staff before forwarding the amendment to the examiner. If the examiner determines that the amendment does not comply with 37 CFR 1.121, a Notice of Non-Compliant Amendment should be attached to the Advisory Action.
- 714.22 Revised to reflect amendments to 37 CFR 1.121.

- 714.23 Added reference to IFW processing.
- 714.24 Added discussion regarding a marked-up version of the replacement paragraph or section of the specification.
- 714.25 Revised to reflect amendments to 37 CFR 1.3.
- 715 Form paragraph has been revised.
- 715.04 Revised to clarify that if a petition under 37 CFR 1.47 was granted or the application was accepted under 37 CFR 1.42 or 1.43, the 37 CFR 1.131 affidavit may be signed by the 37 CFR 1.47 applicant or the legal representative of the deceased or incapacitated inventor, as appropriate.
- 715.05 Revised to indicate that if the reference is a U.S. application publication under 35 U.S.C. 122(b) which claims the same invention as the application being examined and its publication date is more than one year prior to the presentation of claims to that invention in the application under examination, a rejection of the claims in the application under examination under 35 U.S.C. 135(b)(2) should be made only if the application under examination was filed after the publication date of the reference.
- 719.01 Added reference to IFW processing.
- 719.01(a) Added reference to IFW processing.
- 719.01(b) Added reference to IFW processing.
- 719.02 Added reference to IFW processing.
- 719.02(b) Revised to indicate that for a patent application publication to be published with a new residence, the information must be entered into the Office electronic records at least nine weeks before the publication date of the application. For a patent to issue with the new residence, applicants are strongly encouraged to file an ADS showing the new residence information.
- 719.04 Added reference to IFW processing.
- 719.05 Added reference to IFW processing. Table 1 has been revised. The “Search Request Form” has been updated.
- 719.07 Added reference to IFW processing.



- 720 Revised to reflect amendments to 37 CFR 1.292. Added reference to IFW processing. Also revised to indicate that hand-carried petitions under 37 CFR 1.292 and replies may only be delivered to the Customer Window.
- 724.02 The examples of appropriate labels for envelope or container with trade secret, proprietary and/or protective order materials have been revised. Also revised to indicate that these envelope or container should be hand-carried to the Customer Window.
- 724.04 Revised to indicate that if the application file and contents are available to the public pursuant to 37 CFR 1.11 or 1.14, any material submitted under MPEP § 724.02 will only be released to the public with any other application papers if no petition to expunge was filed prior to the mailing of a notice of allowability or notice of abandonment, or if a petition to expunge was filed and the petition was denied.
- 724.04(a) Revised to indicate that if the application file and contents are available to the public pursuant to 37 CFR 1.11 or 1.14, any material submitted under MPEP § 724.02 will only be released to the public with any other application papers if no petition to expunge was filed prior to the mailing of a notice of allowability or notice of abandonment, or if a petition to expunge was filed and the petition was denied.
- 724.04(b) Revised to indicate that material submitted under MPEP § 724.02 will only be released to the public with any other application papers if no petition to expunge was filed prior to the mailing of a notice of allowability or notice of abandonment, or if a petition to expunge was filed and the petition was denied.
- 724.04(c) Revised to indicate that material submitted under MPEP § 724.02 will only be released to the public with any other application papers if no petition to expunge was filed prior to the mailing of a notice of allowability or notice of abandonment, or if a petition to expunge was filed and the petition was denied.
- 724.05 Revised to indicate that a petition to expunge should accompany the submission of the information and in any event, must be submitted in sufficient time that it can be acted on prior to the mailing of a notice of allowability or a notice of abandonment for original and reissue applications, or prior to the mailing of a NIRC for reexamination proceedings.
- 724.06 Revised to reflect amendments to 37 CFR 1.59. Form paragraphs have been revised.

## **CHAPTER 1000:**

- 1001 The title of this section has been changed to read “Statutory Authority of Director of the USPTO.” Revised to reflect amendments to 35 U.S.C. 2 and 3.
- 1001.01 Revised to change “Commissioner” to “Director.”
- 1002 The title of this section has been changed to read “Petitions to the Director of the USPTO.” Revised to reflect amendments to 37 CFR 1.181.
- 1002.02 Revised to change “Commissioner” to “Director of the USPTO.”
- 1002.02(b) The address for sending petitions decided by the Office of the Deputy Commissioner for Patent Examination Policy has been changed. Revised to add petitions to withdraw patent applications from issue after payment of the issue fee (item 33) and petitions to expunge papers from patent application or patent files where the papers were not submitted under MPEP § 724.02 or as part of the IDS (item 34).
- 1002.02(c) Added items 20 to 22.
- 1002.02(d) Revised to delete “requests for second or subsequent change of inventorship in application under 37 CFR 1.48” since all requests for correction of inventorship are decided by primary examiners as noted in MPEP § 1002.02(e).
- 1002.02(i) The title of this section has been changed to read “Petitions Decided by the Commissioner for Trademarks.”
- 1002.02(k)(1) The title of this section has been changed to read “Petitions and Matters Decided by the General Counsel.” Items 2 to 4 have been added since these petitions and matters have been delegated to the General Counsel.
- 1002.02(o) The title of this section has been changed to read “Petitions and Matters Decided by the Deputy Director of the USPTO.” Items 3 and 4 have been moved to MPEP § 1002.02(k)(1) and items 5 and 6 have been combined and moved to MPEP § 1002.02(k)(1).
- 1002.02(p) Revised to change “Commissioner” to “Director of the USPTO.” Reference to 37 CFR 1.44 in item 10 has been deleted since this rule has been removed and reserved.
- 1002.02(r) Added item 4.
- 1003 Added item 19.

1005 Revised to indicate that withdrawal of final rejection requires the signature of a primary examiner.

**CHAPTER 1100:**

1101 Added reference to MPEP § 1120 *et seq.* for information pertaining to eighteen months publication of patent applications. Form PTO/SB/94 has been updated to reflect the current form that is available on the USPTO web site.

1103 Revised to reflect the current SIR forms.

1105 Revised to reflect amendments to 37 CFR 1.295.

1107 Added reference to IFW processing.

1109 Revised to reflect the current SIR forms.

1120 New section added to discuss eighteen-month publication of patent applications.

1121 New section added to discuss content of a patent application publication.

1122 New section added to discuss requests for nonpublication.

1123 New section added to discuss rescission of a nonpublication request.

1124 New section added to discuss notice of foreign filing.

1125 New section added to discuss express abandonment to avoid publication.

1126 New section added to discuss publication fees.

1127 New section added to discuss notice of publication.

1128 New section added to discuss availability of published applications.

1129 New section added to discuss request for early publication.

1130 New section added to discuss republication and correction of patent application publications.

1132 New section added to discuss requests for redacted publication.

1133 New section added to discuss requests for voluntary publication.

- 1134 New section added to discuss third party inquiries and correspondence in a published application.
- 1134.01 The subject matter in former MPEP § 610 has been moved to this section.
- 1135 New section added to include PGPUB forms.

**CHAPTER 1300:**

- 1302.01 Revised to indicate that if an application is an IFW application, any changes made by the examiner to the specification must be by way of a formal examiner's amendment. Added a reference to MPEP § 1302.04 for changes to the abstract by examiner's amendment.
- 1302.03 Form PTOL-37 has been updated.
- 1302.04 Revised to indicate that informal examiner's amendments are not permitted if the application is an IFW application. Form paragraphs have been revised. Also revised to indicate that substantive changes made by the examiner to the abstract must be done by a formal examiner's amendment after first obtaining approval from the applicant. Furthermore, no examiner's amendment, whether formal or informal, may make substantive changes to the written portions of the specification without first obtaining applicant's approval. Also revised to indicate that effective July 14, 2003, CPA practice has been eliminated as to utility and plant applications.
- 1302.04(f) Revised to indicate that any changes made by the examiner to an IFW application must be by way of a formal examiner's amendment.
- 1302.05 Revised to indicate that if the corrected drawings submitted by the applicant in response to a Notice of Allowability are still not acceptable, the Publishing Division will mail a notice giving applicant a non-extendable period to file the corrected drawings.
- 1302.05(a) Revised to indicate that where the original drawings cannot be located and the replacement drawings are not acceptable for publishing, an attachment to the Notice of Allowability should explain the problem and require the corrected drawings. If the attachment is not included with the Notice of Allowability, the Publishing Division will mail a notice giving applicant a non-extendable period to file the corrected drawings.
- 1302.09 The title of this section has been changed to read "Classification, Print Figure, and other Notations." Revised to indicate that for an IFW application, an Issue Classification sheet is to be completed.

- 1302.10 Revised to indicate that if the application is an IFW application, the issue classification information should be put on the Issue Classification sheet.
- 1302.12 Added reference to form PTO/SB/08. Revised to indicate that when preparing an application for allowance, the technical support staff will also verify that each reference on the IDS has either been initialed by the examiner or lined-through by the examiner.
- 1302.14 Revised to indicate that it is improper to use a statement of reasons for allowance to attempt to narrow a claim by providing a special definition to a claim limitation which is argued by the applicant, but not supported by a special definition in the description in cases where the ordinary meaning of the term in the prior art demonstrates that the claim remains unpatentable for the reasons of record, and where such claim narrowing is only tangential to patentability. Added example (I) to show that a statement of reasons for allowance should be added to the record in this situation. Form paragraph has been revised. Also revised to indicate that the examiner's statement of reasons for allowance should not create an *estoppel*, only applicant's statements should create an *estoppel*. The failure of applicant to comment on the examiner's statement of reasons for allowance should not be treated as acquiescence to the examiner's statement.
- 1303 Revised to reflect amendments to 37 CFR 1.311. Revised to indicate that the Notice of Allowance and Issue Fee Due form (PTOI-85) has been revised and the revised form is entitled "Notice of Allowance and Fee(s) Due."
- 1303.01 Revised to indicate that any paper filed after receiving the Issue Notification should include the indicated patent number, unless the application has been withdrawn from issue.
- 1303.02 Revised to add discussion of IFW processing.
- 1306 Revised to indicate that the issue fee and any required publication fee are due 3 months from the date of the notice of allowance.
- 1306.02 Revised to indicate that any request for simultaneous issuance of patents must be addressed to Mail Stop Issue Fee, Commissioner for Patents, P.O. Box 1450, Alexandria, VA 22313-1450, Attention: Office of Patent Publication.
- 1306.03 Revised to indicate that duplicate filing of papers is not recommended and may be treated as a failure to engage in reasonable efforts to conclude prosecution pursuant to 37 CFR 1.704(c)(10).

1308 Revised to indicate that effective July 14, 2003, CPA practice is available only for design applications. Also revised to indicate that applicants are encouraged to hand-deliver a petition to withdraw an application from issue to the Office of Petitions to allow sufficient time to process the petition and if the petition can be granted, withdraw the application from issue. Form paragraph has been revised.

1308.01 Added reference to IFW processing.

1309 Revised to indicate that the Initial Data Capture (IDC) process takes approximately 5 weeks and during this time, the application (if in a paper file) is not available for purposes of making copies of the application. Also revised to indicate that recording of the assignment or submission of the assignment for recordation is required for a patent to issue to an assignee.

1309.02 Added reference to IFW processing.

#### **CHAPTER 1400:**

1400.01 Added reference to MPEP Chapter 2600 for *inter partes* reexamination.

1402 Revised to indicate that in the situation where it is necessary to submit for the first time both the claim for priority and the certified copy of the priority document in the reissue application and the patent to be reissued resulted from a utility or plant application that was filed on or after November 29, 2000, the reissue applicant must also file a petition for an unintentionally delayed priority claim under 37 CFR 1.55(c) in addition to filing a reissue application. Also revised to indicate that a reissue may be based on a drawing correction that is substantive in nature.

1404 Added reference to IFW processing.

1405 New section added to discuss reissue and patent term.

1406 New section added to discuss citation and consideration of references cited in the original patent.

1410 Revised to indicate that for expedited processing, new and continuing reissue application filings may be addressed to Mail Stop REISSUE, Commissioner for Patents, P.O. Box 1450, Alexandria, VA 22313-1450. Mail Stop REISSUE should only be used for the initial filing of reissue applications and should not be used for any subsequently filed correspondence in reissue applications.

- 1410.01 Revised to reflect amendments to 37 CFR 3.73. Revised to indicate who needs to sign a reissue oath or declaration where an inventor is to be added or where one or more inventors are being deleted. Also revised to indicate when a copy of the assignee consent from the parent reissue application should be accepted in a continuation reissue application. Form paragraphs have been revised.
- 1411 Revised to indicate that a full copy of the printed patent is used to provide the abstract, drawings, specification, and claims of the patent for the reissue application. Each page of the patent must appear on only one side of each individual page of the reissue application. A two-sided copy is improper.
- 1411.01 Revised to indicate that if the certificate of correction changes are too extensive, the examiner may request a clean copy of the specification. In order for the clean copy to be entered as a substitute specification, the reissue applicant must file a grantable petition under 37 CFR 1.183 for waiver of 37 CFR 1.125(d) and 1.173(a)(1). The examiner's request for the clean copy will generally serve as sufficient basis for granting the petition.
- 1412.01 A new subsection has been added to discuss the failure to timely file a divisional application prior to the issuance of the original patent.
- 1412.02 Revised to reflect updated reissue recapture guidelines. A new flow chart has been added. Form paragraph has been revised.
- 1412.03 Revised to add an example to illustrate new category of invention added in a reissue application is generally not broadening.
- 1412.04 Revised to clarify that where a reissue application seeks to correct inventorship in the patent and the inventors are required to sign the reissue oath or declaration due to a broadening of any claims of the original patent, the correct inventive entity must sign the reissue oath or declaration.
- 1413 Revised to reflect amendments to 37 CFR 1.173.
- 1414 Revised to add a discussion regarding copy of the reissue oath or declaration from the parent reissue application being filed in a continuation reissue application. Forms PTO/SB/51 and PTO/SB/52 have been updated to reflect the current forms that are available on the USPTO web site.
- 1414.01 Revised to indicate that a supplemental reissue oath or declaration will not be effective for any errors which are corrected by a filing made after the

execution of the supplemental reissue oath or declaration, unless it is clear from the record that the parties executing the document were aware of the nature of the correction when they executed the document. Form PTO/SB/51S has been updated to reflect the current form that is available on the USPTO web site.

- 1415 Form PTO/SB/56 has been updated to reflect the current form that is available on the USPTO web site.
- 1415.01 Revised the instructions for obtaining the history of maintenance fees. Also revised to indicate that the issuance of one or more reissue patents does not alter the schedule of payments of maintenance fees on the original patent.
- 1417 Added reference to IFW processing. Revised to indicate that reissue is also available to correct the “error” in failing to take any steps to obtain the right of foreign priority before the original patent was granted.
- 1418 Revised to indicate that the Office imposes no responsibility on a reissue applicant to resubmit, in the reissue application, all the references cited in the patent for which reissue is sought. Rather, applicant has a continuing duty under 37 CFR 1.56 to timely apprise the Office of any information which is material to the patentability of the claims under consideration in the reissue application. The text has been rearranged.
- 1430 Added reference to IFW processing.
- 1431 This section on notice to be placed in the patented file identifying the reissue application has been deleted.
- 1441.01 Revised to indicate that since reissue applications are not published under 35 U.S.C. 122, pursuant to 37 CFR 1.291(a)(1), a protest may be filed throughout the pendency of the reissue application prior to the date of mailing of a notice of allowance subject to the timing constraints of the examination. Added reference to IFW processing.
- 1442.02 Added reference to MPEP § 2686 directed to *inter partes* reexamination.
- 1442.05 The title of this section has been changed to read “Court Ordered Filing of Reissue Application.” Added discussion of Federal Circuit decision which held that a district court in an infringement case could not compel a patentee to seek reissue by the USPTO.
- 1442.05(a) This section has been deleted.
- 1442.05(b) This section has been deleted.



- 1443 Added reference to IFW processing.
- 1448 Form paragraph has been revised.
- 1449 Revised to indicate that after the reissue application has been reviewed by the OPLA, the reissue application with the protest will be returned to the examiner.
- 1449.01 New subsection headings have been added. Added discussion on reissue application and a reexamination proceeding that are pending concurrently on a patent.
- 1450 The title of this section has been changed to read “Restriction and Election of Species Made in Reissue Application.” Revised to indicate that where a restriction requirement is made by the examiner in the reissue application, applicant will be informed in the Office action that if the original claims are found allowable, and a divisional reissue application has been filed for the non-elected claims, further action in the application will be suspended, pending resolution of the divisional reissue application.
- 1451 Added reference to IFW processing. Revised to indicate that whenever a divisional reissue application is filed with a copy of the reissue oath or declaration and assignee consent from the parent reissue application, the copy of the assignee consent from the parent reissue application should not be accepted. Revised to add a discussion regarding copy of the reissue oath or declaration from the parent reissue application being filed in a continuation reissue application.
- 1453 Revised to reflect amendments to 37 CFR 1.121 and 1.173. Additional examples regarding amendments in reissue applications have been added.
- 1455 Added reference to IFW processing.
- 1456 Revised to indicate that TC SPREs monitor and review all reissue applications in the TC. TC QASs perform patentability review in a sample of reissue applications.
- 1457 New section added to discuss design reissue applications.
- 1460 Added a discussion regarding intervening rights.
- 1470 Added reference to IFW processing. Revised to indicate that requests for copies of papers in the reissue application file must be in writing and addressed to Mail Stop Document Services, Director of the U.S. Patent and Trademark Office, P.O. Box 1450, Alexandria, VA 22313-1450.

- 1480 Revised to reflect amendments to 37 CFR 1.322. The address of the Certificate of Correction Branch has been updated.
- 1480.01 New section added to discuss expedited issuance of certificate of correction – error attributable to the Office.
- 1481 The title of this section has been changed to read “Certificates of Correction – Applicant’s Mistake.” Added discussion of recent Federal Circuit decision. Revised to reflect amendments to 37 CFR 1.324. Form paragraphs have been revised.
- 1485 The address of the Certificate of Correction Branch has been updated. Added reference to IFW processing. Form PTO/SB/44 has been updated to reflect the current form that is available on the USPTO web site.
- 1490 Added reference to IFW processing. Form paragraphs have been revised. Form PTO/SB/43 has been updated to reflect the current form that is available on the USPTO web site.

#### **CHAPTER 1500:**

- 1502 Form paragraph has been revised.
- 1502.01 Revised to clarify that articles of manufacture may possess both functional and ornamental characteristics. Also revised to indicate that effective July 14, 2003, continued prosecution application (CPA) practice is only available for design applications.
- 1503.01 Added discussion of the form and content of a design claim. Revised to indicate that statements which describe or suggest another embodiment of the claimed design having a shape and appearance that would be evident from the one shown are permitted in the specification of an issued design patent. Form paragraphs have been revised.
- 1503.02 Revised to indicate that certain deficiencies in the drawings may render the design nonenabling and indefinite under 35 U.S.C. 112, first and second paragraphs. Also revised to indicate that a grantable petition to accept color photographs or color drawings must explain that they are necessary because color is an integral part of the claimed design. Form paragraphs have been revised.
- 1504 Revised to clarify that ornamentality, novelty, nonobviousness, enablement and definiteness are necessary prerequisites to the grant of a design patent. Also revised to indicate that if a reply to an Office action

overcomes a rejection, the rejection must be indicated as withdrawn in the next Office action, unless such action is a notice of allowability.

- 1504.01(c) Revised to rewrite explanation of the proper evidentiary basis for a rejection under 35 U.S.C. 171 that a claim is lacking in ornamentality. Also revised to explain that attorney's arguments are not a substitute for evidence to rebut a *prima facie* case of lack of ornamentality. Revised to clarify that the requirements for visibility of the design and creation for the purpose of ornamenting must be met for a rejection under 35 U.S.C. 171 to be overcome if the design would be hidden during its end use. Form paragraphs have been revised.
- 1504.02 Form paragraphs have been revised.
- 1504.03 Form paragraphs have been revised.
- 1504.04 Revised to clarify that claims must be analyzed to determine whether they comply with the requirements of both the first and second paragraphs of 35 U.S.C. 112, and to provide further guidance with respect to these analyses. Also revised to clarify that an amendment that changes the scope of a design by either reducing certain portions of the drawing to broken lines or converting broken line structure to solid lines is not a change in configuration. Form paragraphs have been revised.
- 1504.05 Revised to indicate that a clear admission on the record that embodiments are not patentably distinct will not overcome a requirement for restriction if the embodiments do not have the same basic overall appearances. Also revised to clarify that examiners must include a brief explanation of the differences between the embodiments that render them patentably distinct. Added guidance with respect to determining whether embodiments of different scope can be retained in a single application. Added discussion of traversal of a restriction requirement. Form paragraphs have been revised.
- 1504.06 Revised to clarify that an obviousness-type double patenting rejection is appropriate where the conflicting designs have overall appearances that are basically the same, and the differences between them must either be minor and patentably indistinct or obvious to a designer of ordinary skill in the art. Form paragraphs have been revised.
- 1504.10 Revised to indicate that the United States will recognize claims for the right of priority under 35 U.S.C. 119(a)-(d) based on applications filed under the "European Community Design." Form paragraphs have been revised.

- 1504.20 Revised to indicate that a later filed application that changes the scope of a design claimed in an earlier application by reducing certain portions of drawings to broken lines is not a change in configuration. Form paragraphs have been revised.
- 1504.30 Revised to update delivery and mailing information pertaining to requests for expedited examination under 37 CFR 1.155.
- 1509 Added discussion of drawing views with respect to design reissue applications.
- 1512 Form paragraphs have been revised.

#### **CHAPTER 1700:**

- 1701.01 Revised to reflect issuance of 37 CFR Part 104, Subpart C, which sets forth policies and procedures regarding employee testimony and production of documents in legal proceedings. Also revised to indicate that a request by a third party to take deposition testimony of a patent examiner in a pending *ex parte* reexamination proceeding will generally be denied.
- 1703 Revised to indicate that the *Official Gazette – Patents* (eOG:P) and the *Official Gazette – Trademarks* are published electronically, and to explain how the information in the eOG:P can be browsed. Also revised to indicate that special and regular notices of the Office are published in the *Official Gazette Notices*, both as part of the eOG:P and as a separate publication.
- 1705 Revised to reflect differences in procedures for reporting an examiner's action in applications maintained in paper form and in IFW applications.
- 1706 Revised to add a brief description of provisional patent applications, and to encourage inventors to file a provisional patent application instead of a Disclosure Document. Also revised to update the mailing address of the USPTO and to update the Patent and Trademark Depository Libraries (PTDLs) that are authorized to accept documents under the Disclosure Document Program.
- 1730 Revised to include additional information pertaining to Patent Application Information Retrieval (PAIR) and the Electronic Filing System (EFS). Also revised to update USPTO facility and contact information.

## **CHAPTER 1800:**

- 1801 Revised to reflect amendments to PCT rules and CFR Title 37 that took effect on January 1, 2004.
- 1805 Revised to include new mailing address for international applications and related papers: Mail Stop PCT, Commissioner for Patents, P.O. Box 1450, Alexandria, Virginia 22313-1450.
- 1807 Revised to reflect amendments to PCT Rule 90 and 37 CFR 1.455, and to indicate that the USPTO, when acting in its capacity as a receiving Office, International Searching Authority, or International Preliminary Examining Authority, will in most cases waive the requirement for a separate power of attorney and copy of the general power of attorney in international applications having an international filing date on or after January 1, 2004.
- 1808 Revised to reflect amendments to PCT Rule 90 and 37 CFR 1.455.
- 1810 Revised to reflect amendments to 37 CFR 1.431 and to expand discussion of PCT Rule 19.4 to include discussion of international applications filed with the USPTO that are not in the English language.
- 1812 Revised to refer to WIPO's web site ([www.wipo.int/pct/en/index.html](http://www.wipo.int/pct/en/index.html)) as a source of the PCT request (Form PCT/RO/101) and to replace discussion of PCT-EASY with discussion of PCT-SAFE.
- 1817 Revised to update list of PCT Contracting States and to indicate that a current listing is maintained on WIPO's web site ([www.wipo.int/pct/guide/en/gdvol1/annexes/annexa/ax\\_a.pdf](http://www.wipo.int/pct/guide/en/gdvol1/annexes/annexa/ax_a.pdf)).
- 1817.01 Revised to discuss international applications having an international filing date on or after January 1, 2004. Information regarding the designation of states and precautionary designations in applications filed before January 1, 2004 moved to newly added MPEP § 1817.01(a).
- 1817.01(a) Added new section. Includes the information formerly in MPEP § 1817.01.
- 1817.02 Revised to reflect treatment as a continuation or continuation-in-part now provided for in PCT Rule 4.11(a)(iv).
- 1819 Revised to reflect amendments to PCT Rule 4 and 37 CFR 1.445. Applicant is entitled to reduced search fee only if the prior nonprovisional application is identified as specified in 37 CFR 1.445(a)(2)(i).

- 1820 Revised to reflect amendments to PCT rules and CFR Title 37 regarding signature requirements on the international application and powers of attorney. Also revised to include the procedure for naming a legal representative of a deceased inventor as the applicant.
- 1821 Revised to reflect amendments to the PCT rules and CFR Title 37, to reflect the replacement of PCT-EASY with PCT-SAFE, to include WIPO's web site ([www.wipo.int/pct/en/forms/index.htm](http://www.wipo.int/pct/en/forms/index.htm)) as a source of the request form, and to include the date format now provided in Administrative Instructions Section 110.
- 1823 Revised to reflect amendments to Administrative Instructions Section 209.
- 1823.01 Revised to reflect amendments to Administrative Instructions Section 209.
- 1823.02 Revised to reflect amendments to Administrative Instructions Section 803 and to include Alexandria mailing address for submissions under PCT Administrative Instructions - Part 8.
- 1827 Revised to reflect amendments to the PCT rules eliminating designation fees for applications filed on or after January 1, 2004.
- 1830 Revised to update the list of submissions specifically covered by Form PTO-1382.
- 1840 Revised to reflect amendments to 37 CFR 1.413.
- 1840.01 Revised to reflect changes regarding when the EPO is a competent International Searching Authority for residents and nationals of the U.S.
- 1842 Revised to include time limits for applications filed on or after January 1, 2004.
- 1843 Revised to include a discussion of the written opinion of the International Searching Authority (PCT Rule 43*bis*).
- 1843.01 Material formerly in MPEP § 1843 moved to this added new section. Supplemented with information from the PCT Search and Examination Guidelines relating to conducting the international search, citing documents on the international search report, and establishing the written opinion of the International Searching Authority.
- 1843.02 Material formerly in MPEP § 1843 moved to this added new section.
- 1843.03 Material formerly in MPEP § 1843 moved to this added new section.

- 1843.04 Added new section to explain ISA procedure for claims not required to be searched and for claims that are unclear.
- 1843.05 Added new section. Includes subject matter formerly in MPEP § 1844.01.
- 1844 Revised for consistency with Form PCT/ISA/210 (January 2004).
- 1844.01 Revised to include information useful to the examiner preparing the international search report and to include a completed copy of updated Form PCT/ISA/210 (January 2004).
- 1845 Added new section explaining new PCT Rule 43*bis*, the written opinion of the International Searching Authority.
- 1845.01 Added new section useful to the examiner when preparing the written opinion of the International Searching Authority. Includes a completed copy of new Form PCT/ISA/237 (January 2004).
- 1845.02 Added new section useful to the examiner when preparing the Notification of Transmittal of the International Search Report and the Written Opinion of the International Searching Authority. Includes a completed copy of revised Form PCT/ISA/220 (January 2004).
- 1846 Revised to reflect the current status of PCT Rules and Administrative Instructions.
- 1847 Revised to reflect the revision of 37 CFR 1.446(c) to include “Director” and “Director’s” instead of the “Commissioner” and “Commissioner’s.”
- 1849 Section deleted. Subject matter moved to MPEP § 1843.02.
- 1850 Revised to include a more complete discussion of the requirement for unity of invention, the invitation to pay additional fees (PCT/ISA/206), and telephonic unity practice. Also revised to indicate that if a written invitation is required, the examiner should, if possible submit that written invitation to the TC for review and mailing within 7 days from the date the international application is charged to the examiner. Also revised to include the form paragraphs formerly reproduced in MPEP § 1875.01.
- 1851 Revised to cite documents using new date formats provided in Administrative Instructions Section 110 and to update information reproduced from WIPO Standard ST.16 and WIPO Standard ST.3.
- 1857 Updated to reference new rules and to include current information on electronic publication of international applications.

- 1859 Revised to include a more complete discussion of withdrawals under PCT Rule 90*bis*, with the exception of withdrawals under PCT Rule 90*bis*.4, which are discussed in MPEP § 1880.
- 1860 Revised to discuss international applications having an international filing date on or after January 1, 2004. Information regarding the international preliminary examination procedure applicable to applications filed before January 1, 2004 moved to newly added MPEP § 1860.01.
- 1861 Section deleted.
- 1860.01 Added new section. Includes the information formerly in MPEP § 1860.
- 1864 Revised to reflect amendments to 37 CFR 1.480.
- 1864.01 Revised to include an overview of amendments filed under PCT Article 34.
- 1864.03 Revised to indicate the filing of a demand after January 1, 2004 shall constitute the election of all Contracting States which are designated and bound by Chapter II of the Treaty on the international filing date (PCT Rule 53.7).
- 1865 Addresses for use when filing a demand in the USPTO updated. Demand (Form PCT/IPEA/401) was replaced with January 2004 version.
- 1865.01 Revised to reflect changes regarding when the EPO is a competent International Examining Authority for residents and nationals of the U.S.
- 1866 Reference to “14 digit” PCT application number eliminated in view of amendments to Administrative Instructions Section 307.
- 1867 Revised to reflect amendments to 37 CFR 1.481. For demands filed on or after January 1, 2004, 37 CFR 1.481(a) provides that the preliminary examination fee or handling fee payable is the preliminary examination fee or handling fee in effect on the date of payment.
- 1868 Revised to reflect amendments to PCT Rule 60.1 and deletion of PCT Rule 60.2.
- 1871 Revised to discuss international applications having an international filing date on or after January 1, 2004. Information regarding the processing of amendments at the start of international preliminary examination for applications filed before January 1, 2004 was moved to newly added MPEP § 1871.01.



- 1871.01 Added new section. Includes the information formerly in MPEP § 1871.
- 1873 Section deleted.
- 1875 Revised to include a discussion of treatment (permitted by national stage offices under PCT Article 34(3)(c)) of parts of the international application which do not relate to the main invention.
- 1875.01 Revised to indicate that if a written invitation is required, the examiner should, if possible, submit that written invitation to the TC for review and mailing within 7 days from the date the international application is charged to the examiner. Form paragraphs formerly in this section were moved to MPEP § 1850.
- 1878 Revised to discuss written opinions of the IPEA in international applications having an international filing date on or after January 1, 2004. Information relating to preparing a written opinion in an application filed before January 1, 2004 was moved to newly added MPEP § 1878.01.
- 1878.01 Added new section. Includes the information formerly in MPEP § 1878.
- 1878.01(a) Revised to discuss the “relevant date” for prior art purposes when there is insufficient time for the examiner to make a proper determination as to whether a priority claim is valid. The “relevant date” for the purposes of the written opinion of the ISA will be based on the claimed priority date.
- 1879 Revised to include information relating to the preparation of an IPER in international applications filed on or after January 1, 2004. Also revised to include completed examples of Forms PCT/IPEA/416 (January 2004) and PCT/IPEA/409 (January 2004).
- 1879.01 Revised to discuss the time limit for preparing the IPER in an application having an international filing date on or after January 1, 2004. Subject matter formerly in MPEP § 1879.01 moved to newly added MPEP § 1879.01(a).
- 1879.01(a) Added new section. Includes the information formerly in MPEP § 1879.01.
- 1879.04 Revised to include PCT Rule 44*ter* relating to the confidential nature of the written opinion of the ISA. Also revised to reflect amendments to 37 CFR 1.14.
- 1880 Updated in view of new rules effective for applications filed on or after January 1, 2004, to indicate that pursuant to PCT Rules 90.4(e) and

90.5(d), the requirement for a separate power of attorney or a copy of the general power of attorney shall not be waived in cases of withdrawal.

- 1881 Revised to reflect amendments to PCT Rule 61.2(b) and 61.3.
- 1890 Section deleted.
- 1891 Section deleted.
- 1893.01(a) Revised to reflect amendments to 37 CFR 1.495(c) and (g).
- 1893.01(a)(2) Revised to indicate that if applicant has requested early processing of the national stage application under 35 U.S.C. 371(f), the amendment(s) under PCT Article 19 and the English translation of the amendment(s) must be filed by the time applicant has submitted the basic national fee, an oath or declaration in compliance with 37 CFR 1.497(a)-(b), and any required translation of the international application if such time is earlier than 30 months from the priority date. Otherwise, the amendment(s) will be considered to be canceled.
- 1893.01(a)(3) Revised to indicate that if an amendment introducing “new matter” was entered during the international phase, the U.S. national stage examiner should require removal of the new matter and make any necessary rejections to the claims.
- 1893.01(c) Revised to include discussion of calculation of national stage fees under 37 CFR 1.492 when a preliminary amendment accompanies the initial national stage submission under 35 U.S.C. 371.
- 1893.01(d) Revised to provide additional guidance relating to translations that will not be accepted because they are not translations of the international application as filed or with any changes which have been properly accepted under PCT Rule 26 or any rectifications which have been properly accepted under PCT Rule 91.
- 1893.03 Revised to indicate the International Publication Number and the Publication Date MUST be in the national stage application if the application is allowed. (This requirement was formerly in MPEP § 1895.01).
- 1893.03(a) Revised to indicate that national stage applications transmitted using a “Utility Patent Application Transmittal” (Form PTO/SB/05) and national stage applications that include a benefit claim under 35 U.S.C. 120 to the international application include conflicting instructions as to whether the filing is under 35 U.S.C. 111(a) or 35 U.S.C. 371. Also revised to indicate that applications that have been processed under 35 U.S.C. 371 and later

found by the examiner to contain conflicting instructions should be forwarded to the Office of PCT Legal Administration for resolution.

- 1893.03(b) Revised to explain the relevance of the “Date of Completion of all 35 U.S.C. 371 Requirements” included on the Notification of Acceptance of Application under 35 U.S.C 371 and 37 CFR 1.495 (Form PCT/DO/EO/903) and to explain how the “Date of Completion of all 35 U.S.C. 371 Requirements” is determined.
- 1893.03(c) Regarding a right of priority under 35 U.S.C. 119(a) and 365(b), revised to indicate that the priority must have been timely claimed in the international stage of the international application (37 CFR 1.55(a)(1)(ii)). Regarding a benefit claim under 35 U.S.C. 119(e) or 120 and 365(c), revised to indicate that if the entire delay between the date the claim was due under 37 CFR 1.78(a)(5)(ii) and the date the claim was filed was unintentional, a petition under 37 CFR 1.78(a)(6) may be filed to accept the delayed claim.
- 1893.03(d) Revised to include the form paragraphs for restricting national stage applications where the claimed invention does not form a single general inventive concept under PCT Rule 13.1.
- 1893.03(e) Revised to indicate that applicants desiring to have the filing receipt reflect a title that is different than the English language title appearing on the cover page of the publication must submit either a preliminary amendment amending the title or an application data sheet (37 CFR 1.76) with the desired title. Also revised to include a discussion of how to use the IPER as a roadmap to determine which version of the application should be examined during its national stage.
- 1895.01 Revised to include a more complete discussion of continuations, divisions, and continuations-in-part of international applications designating the United States. Subsection I deleted as redundant to information provided in MPEP § 1896. Subject matter from subsection I, paragraph F moved to MPEP § 1893.03.
- 1896 Revised to indicate that if a copy of the foreign priority document is not in the national stage application file but applicant asserts that a certified copy of the priority document was timely furnished under PCT Rule 17 in the international phase, then the examiner should consult with a Special Program Examiner in his or her Technology Center.

## **CHAPTER 2000:**

- 2001.04 Revised to indicate that materiality is not limited to prior art but embraces any information, including information pertaining to enablement, that a

reasonable examiner would likely consider important in making a patentability determination. Also revised to indicate that the Office may order or conduct reexamination proceedings based on prior art that was cited/considered in any prior related Office proceeding.

- 2001.06 Added discussion of recent Federal Circuit decision.
- 2001.06(a) Revised to clarify when there is a strong inference that prior art or other information in any related foreign application brought to the attention of individuals covered by 37 CFR 1.56 is material to patentability.
- 2001.06(b) Added discussion of recent Federal Circuit decision. Also revised to indicate that if the application under examination is identified as a continuation, divisional, or continuation-in-part of an earlier application, the examiner will consider the prior art cited in the earlier application.
- 2001.06(c) Added discussion of where litigation papers that are filed with the Office and relate to a pending reissue application should be forwarded for processing.
- 2001.06(d) Deleted discussion pertaining to issuance of a requirement for information.
- 2003.01 Added cross-references to information pertaining to *inter partes* reexamination.
- 2004 Added discussion of recent Federal Circuit decisions.
- 2005 Added discussion of recent district court decision.
- 2010 Added discussion of when the Board of Patent Appeals and Interferences will consider issues of fraud and/or inequitable conduct in an interference proceeding.
- 2013 Revised to clarify that protest information indicating the presence of fraud, inequitable conduct or violation of the duty of disclosure will be entered in the application file without comment other than a statement that such information will not be considered.
- 2014 Revised to add cross-references to *inter partes* reexamination proceeding information.

#### **CHAPTER 2100:**

- 2106 Added discussion of recent Federal Circuit decisions. Also revised to clarify that in the absence of an express intent to impart a different

meaning, claims terms are presumed to have the ordinary and customary meanings attributed to them by those of ordinary skill in the art.

- 2111.01 Revised to add discussion of recent Federal Circuit decisions. Also revised to clarify that in the absence of an express intent to impart a different meaning, claims terms are presumed to have the ordinary and customary meanings attributed to them by those of ordinary skill in the art.
- 2111.02 Revised to add discussion of recent Federal Circuit decision.
- 2111.03 Revised to add discussion of recent Federal Circuit decisions.
- 2112 Revised to indicate that an inherent feature need not be recognized at the time of the invention. Also revised to add discussion of recent Federal Circuit decisions.
- 2112.01 Revised to indicate that where the only difference between a prior art product and a claimed product is printed matter that is not functionally related to the product, the content of the printed matter will not distinguish the claimed product from the prior art.
- 2116.01 Revised to add discussion of recent Federal Circuit decision.
- 2121.01 Revised to add discussion of recent Federal Circuit decision.
- 2128.01 Revised to indicate that while internal documents intended to be confidential are not “printed publications,” there must be an existing policy of confidentiality or agreement to remain confidential within the organization; mere intent to remain confidential is insufficient.
- 2129 Rewritten to clarify when admissions by applicant constitute prior art.
- 2131.03 Revised to indicate that prior art which teaches a value or range close to, but not overlapping or touching, a claimed range does not anticipate the claimed range.
- 2131.05 Revised to add discussion of recent Federal Circuit decision.
- 2133.03(b) Revised to add discussion of recent Federal Circuit decisions.
- 2133.03(c) Revised to indicate that the sale of a device embodying a claimed process may trigger the on-sale bar.
- 2133.03(e) Revised to add discussion of recent Federal Circuit decision.
- 2133.03(e)(3) Revised to add discussion of recent Federal Circuit decision.

- 2133.03(e)(6) Revised to add discussion of recent Federal Circuit decision.
- 2136.03 Revised to clarify that in order to give subject matter disclosed in a reference available under 35 U.S.C. 102(e) the benefit of an earlier filing date under 35 U.S.C. 119(e), 120, or 365(c), the subject matter must be disclosed in the earlier-filed application in compliance with 35 U.S.C. 112, first paragraph.
- 2137.01 Added discussion of recent Federal Circuit decision.
- 2141.01(a) Revised to add discussion of recent Federal Circuit decision and to clarify that the cross-references in the official search notes of the class definitions are some evidence of analogy.
- 2141.03 Revised to indicate that documents not available as prior art because they were not widely disseminated may be used to demonstrate the level of ordinary skill in the art.
- 2143.01 Added discussion of a recent Federal Circuit decision.
- 2145 Revised to indicate that there is no requirement for an express, written motivation to combine to appear in prior art references to support a finding of obviousness.
- 2163 Revised to add discussion of recent Federal Circuit decisions.
- 2163.05 Revised to add discussion of recent Federal Circuit decisions.
- 2164 Revised to indicate that to comply with 35 U.S.C. 112, first paragraph, it is not necessary to enable a skilled artisan to make and use a commercially viable embodiment in the absence of a limitation to that effect.
- 2164.03 Added discussion of recent Federal Circuit decision.
- 2164.05(a) Added discussion of recent Federal Circuit decision.
- 2164.08 Added discussion of recent Federal Circuit decision.
- 2173.01 Revised for consistency with MPEP § 2111.01 to indicate that any special meaning assigned to a claim term must be clearly set forth in the specification.
- 2173.05(a) Revised to add discussion of recent Federal Circuit decision.
- 2181 Revised to add discussion of recent Federal Circuit decisions.

2182 Revised to add discussion of recent Federal Circuit decision.

2184 Revised to add discussion of recent Federal Circuit decision.

#### **CHAPTER 2200:**

A number of the section titles have been revised to indicate that the sections are directed to *ex parte* reexamination.

2201 Added reference to Public Law 107-273 which amended the reexamination statute to expand the scope of what qualifies for a substantial new question of patentability upon which a reexamination may be based. Also added reference to new MPEP Chapter 2600 directed to *inter partes* reexamination. The flowchart has been revised and a new flowchart has been added to illustrate the procedure from time of appeal.

2202 Revised to reflect amendments to 37 CFR 1.502 and 1.902.

2204 Revised to add cross-references to 37 CFR 1.915 and 1.948 for *inter partes* reexamination.

2205 In the examples, the address for submitting prior art under 37 CFR 1.501 to the Office has been updated.

2206 Revised to add cross-references to the *inter partes* reexamination rules.

2207 Revised to add cross-references to *inter partes* reexamination.

2209 Revised to indicate that the paper reexamination file is not available to the public. All public access to and copying of the reexamination file may be made from the electronic format copy.

2211 Revised to clarify that any patent term extensions or adjustments under 35 U.S.C. 154 and any patent term extensions under 35 U.S.C. 156 are taken into account in determining the patent expiration date.

2212 Revised to reflect amendments to 37 CFR 1.510.

2214 Revised to indicate that a copy of the patent for which reexamination is requested should be provided with the specification and claims submitted in a double column format and that the printed patent is to be reproduced on only one side of the paper and that a two-sided copy of the patent is not proper. Form PTO/SB/57 has been updated to reflect the current form that is available on the USPTO web site.

- 2217 Revised to reflect amendment to 35 U.S.C. 102(e) (as amended by the Intellectual Property and High Technology Technical Amendments Act of 2002).
- 2222 Revised the mailing address for submitting change of correspondence address or power of attorney in the record of the patent. Added form PTO/SB/82.
- 2223 Added form PTO/SB/83.
- 2224 Revised to indicate that all requests for *ex parte* reexamination mailed to the Office should be additionally marked “Mail Stop *Ex Parte* Reexam” on the face of the outer envelope to distinguish such requests from *inter partes* reexamination requests. Added reference to MPEP § 2624 for *inter partes* reexamination.
- 2229 Revised to reflect amendments to 37 CFR 1.11. Also revised to indicate that notice of filing of all complete *ex parte* reexamination requests will be published in the *Official Gazette* approximately 4 - 5 weeks after filing.
- 2232 Revised to indicate that in an emergency when the Reexamination Processing System (REPS) terminal in the Patent Search Room is not operative, member of the public should be referred to the Central Reexamination Unit (CRU) as an alternative for viewing only of the reexamination files.
- 2234 Revised to reflect amendments to 37 CFR 1.121.
- 2235 Revised and updated the PALM related activities.
- 2236 Revised to indicate that in situations where a paper directed to the examiner assignment has no right of entry under the rules, the Office may waive the rules to the extent that the paper directed to the examiner assignment will be entered and considered.
- 2238 The project codes have been updated.
- 2239 The title of this section has been changed to read “Reexamination Ordered at the Director’s Initiative.” Revised to reflect amendments to 37 CFR 1.520.
- 2240 Revised to reflect amendments to 35 U.S.C. 303, and 37 CFR 1.515. Also revised to indicate that if a second or subsequent request for *ex parte* reexamination is filed while a first *ex parte* reexamination is pending and if the second or subsequent request includes prior art which raised a substantial new question of patentability in the pending first



reexamination, the second or subsequent request should be granted only if the prior art cited raises a substantial new question of patentability which is different than that raised in the pending first reexamination proceeding. If the same question of patentability is raised then the second or subsequent request should be denied.

- 2241 Revised to clarify that if the 3-month period under 37 CFR 1.515(a) ends on a Saturday, Sunday or Federal holiday within the District of Columbia, then the determination must be mailed by the preceding business day.
- 2242 The discussion of the *In re Portola Packaging* decision has been deleted in view of Public Law 107-273, which expanded the scope of what qualifies for a substantial new question of patentability upon which a reexamination may be based.
- 2246 Form paragraph has been revised.
- 2247 Revised to indicate the procedures to be followed after the mailing of a decision denying a request for reexamination.
- 2248 Revised to reflect amendments to 37 CFR 1.515.
- 2250 Revised to reflect amendments to 37 CFR 1.121 and 1.52. Form paragraph has been revised. Added reference to MPEP § 2666.01 for form paragraphs to use in *inter partes* reexamination. Added a subsection V. to discuss cross references to other areas.
- 2250.01 Added discussion regarding the procedures to handle new sheets of drawings.
- 2250.02 Revised to reflect amendments to 37 CFR 1.530.
- 2254 Revised to reflect amendments to 37 CFR 1.550.
- 2256 The title of this section has been changed to read “Prior Art Patents and Printed Publications Reviewed by Examiner in Reexamination.”
- 2257 Revised to add references to forms PTO/SB/08A, PTO/SB/08B and PTO/SB/42. Also revised to indicate that all citations listed on the form PTO-892 and all citations not lined-through on any form PTO-1449, PTO/SB/08A or 08B, or PTO/SB/42 will be printed on the reexamination certificate.
- 2258 Revised to reflect amendment to 35 U.S.C. 102(e) (as amended by the Intellectual Property and High Technology Technical Amendments Act of

- 2002). Form paragraphs have been revised. Also revised to add discussion on claiming foreign and domestic priority in reexamination.
- 2258.01 New section added to discuss use of previously cited/considered art in rejections. The discussion is directed to reexamination that was ordered on or after November 2, 2002 (date of enactment of Public Law 107-273, which expanded the scope of what qualifies for a substantial new question of patentability upon which a reexamination may be based) and reexamination that was ordered prior to November 2, 2002 (the decision in *In re Portola Packaging* would apply).
- 2259 The title of this section has been changed to read “*Res Judicata* and Collateral Estoppel in Reexamination Proceedings.” Revised to indicate that since claims finally held invalid by a Federal Court, after all appeals, will be withdrawn from consideration and not reexamined during a reexamination proceeding, a rejection on the grounds of *res judicata* will not be appropriate in reexamination.
- 2260 Form paragraph has been revised.
- 2266 Revised to reflect amendments to 37 CFR 1.111 and 1.550.
- 2266.01 Revised to indicate that where a patent owner’s submission contains a serious deficiency (i.e., omission) and the period for response has expired, or there is insufficient time remaining to take corrective action before the expiration of the period for response, the patent owner should be notified of the deficiency and given a new time period for response. The patent owner must supply the omission within the new time period for response to avoid termination of the proceeding. Form paragraph has been revised.
- 2266.03 Form paragraph has been revised.
- 2268 The title of this section has been changed to read “Petition for Entry of Late Papers for Revival of Reexamination Proceeding.” Revised to reflect amendments to 37 CFR 1.137.
- 2271 Form paragraphs have been revised.
- 2274 Revised to update the correct forms to be used to notify the patent owner that the appeal is dismissed and also to notify the patent owner that the appeal brief is defective.
- 2275 Revised to reflect amendments to 37 CFR 1.193.
- 2280 Revised to reflect amendments to 37 CFR 1.555.

- 2281 Revised to reflect amendments to 37 CFR 1.560.
- 2282 Form paragraphs added.
- 2283 Revised to indicate that the discussion in this section is directed to multiple copending reexamination requests which are filed on the same patent where none of the requests is an *inter partes* request. Added cross-reference to MPEP § 2686.01.
- 2285 Form paragraph has been revised. Added subsection on examiner assignment.
- 2286 Revised to reflect amendments to 37 CFR 1.565. Revised to indicate that if the examiner discovers, during the reexamination proceeding, that there is litigation on the patent, this fact will be brought to the attention of the TC SPRE (rather than the TC Director) prior to any further action by the examiner.
- 2287 Revised to indicate that an examiner's amendment can be made to change the abstract, where the patent owner's narrowing amendments during prosecution of the reexamination have changed the focus of the invention.
- 2288 Revised to reflect amendments to 37 CFR 1.570.
- 2290 Revised to indicate the two exceptions to issuing a reexamination certificate at the close of the *ex parte* reexamination proceeding.
- 2294 Section has been rewritten to identify the four ways that an *ex parte* reexamination proceeding may be terminated.
- 2295 Added a subsection to discuss the situation where the prior reexamination matures to a certificate while the later reexamination is pending.

#### **CHAPTER 2500:**

- 2501 Updated maintenance fee amounts and revised the mailing address for submitting requests to update post-issuance patent information.
- 2504 Revised to indicate that no payment of additional maintenance fees is required for second and subsequent reissue patents.
- 2506 Revised to indicate that maintenance fees cannot be paid in advance.
- 2510 Title revised to indicate that the section addresses submission of maintenance fee payments and documents. Section revised to indicate that maintenance fee payments can be made over the Internet by electronic

funds transfer (EFT), credit card, or deposit account payment methods. Also revised to add mailing address for maintenance fee payments not electronically submitted over the Internet.

- 2515 Revised to reflect amendment to 37 CFR 1.366(b).
- 2520 Revised to indicate that if the term of a patent is shortened, e.g., by a terminal disclaimer, the maintenance fee amount cannot be prorated to cover only the amount of time past the due date before the patent expires.
- 2522 Revised to indicate that money orders and checks must be made payable to the Director of the United States Patent and Trademark Office, but that checks made payable to the Commissioner of Patents and Trademarks will continue to be accepted.
- 2530 Rewritten to set forth guidelines for specially accepting maintenance fee payments containing informalities (inconsistent or missing patent number or application number information). Also revised to recommend that a maintenance fee submission include both a telephone number and a mailing address for the fee submitter in case the Office needs to confirm the patent to which the fee is to be applied. Information pertaining to late or insufficient payment of maintenance fees deleted from this section and moved to new section 2531.
- 2531 Information pertaining to late or insufficient payment of maintenance fees moved to this new section from section 2530, and revised to indicate that that if a payment is deemed insufficient because it was submitted in the small entity amount without a written assertion of entitlement to small entity status, a notice of non-acceptance of the maintenance fee will be mailed to the fee submitter.
- 2532 Added to explain Office treatment of a duplicate maintenance fee received from a second fee submitter.
- 2540 Revised to suggest the use of a current version of the “Fee Address” Indication Form (PTO/SB/47) and, if necessary, a Request for Customer Number (PTO/SB/125) when requesting establishment of a fee address, and to explain the importance of using a Form PTO/SB/47 having a revision date of March 2002 or later. Also revised to indicate that all fee addresses established at the Office will be represented by a customer number.
- 2550 Revised to indicate that if a payment is submitted that conflicts with the Office record of the patentee’s entity status, either a Notice of Overpayment of Maintenance Fee (PTO-211) or a Notice of Non-Acceptance of Small Entity Patent Maintenance Fee (PTO-2140) will be

sent as appropriate. Also revised to explain the time period for reply to each of these notices.

- 2570 Revised to indicate that maintenance fee status information can be requested by telephone, facsimile, or e-mail, or obtained over the Internet at [www.uspto.gov](http://www.uspto.gov).
- 2580 Revised to update mailing address for petitions under 37 CFR 1.377.
- 2590 Revised to update mailing address for petitions under 37 CFR 1.378.
- 2595 Revised to update forms reproduced therein.

#### **CHAPTER 2600:**

2601

- 2696 New Chapter 2600 added to set forth policies and procedures pertaining to optional *inter partes* reexamination pursuant to 35 U.S.C. 311-318 and 37 CFR 1.902 – 1.997. The subject matter appearing in each section of this chapter parallels the subject matter in the corresponding section of Chapter 2200 (Citation of Prior Art and *Ex Parte* Reexamination of Patents) to the extent practicable.

#### **CHAPTER 2700:**

- 2701 Revised to clarify that patents that issue from applications filed before June 8, 1995, are not eligible for patent term extension or patent term adjustment under 35 U.S.C. 154.
- 2710 Revised to clarify that utility and plant patents issuing on applications filed on or after June 8, 1995, but before May 29, 2000, are eligible for the patent term extension provisions of former 35 U.S.C. 154(b) and 37 CFR 1.701.
- 2720 Revised to indicate that if the patent issues with a different patent term extension value than that indicated on the Notice of Allowance or Office computer records, patentee may seek correction of the information by filing a request for a Certificate of Correction pursuant to 37 CFR 1.322. Also revised to update the mailing address for petitions and Certificates of Correction regarding patent term extension under former 35 U.S.C. 154(b).
- 2731 Added to discuss the period of adjustment of patent term due to examination delay pursuant to 37 CFR 1.703.
- 2732 Added to discuss reduction of the period of adjustment of patent term pursuant to 37 CFR 1.704.

- 2733 Added to discuss the notification of patent term adjustment determination as set forth in the notice of allowance pursuant to 37 CFR 1.705(a).
- 2734 Added to discuss requirements for an application for patent term adjustment pursuant to 37 CFR 1.705(b).
- 2735 Added to discuss requests for reconsideration of the patent term adjustment determination pursuant to 37 CFR 1.705(d).
- 2736 Added to discuss 37 CFR 1.705(f), which indicates that no submission or petition on behalf of a third party concerning patent term adjustment under 35 U.S.C. 154(b) will be considered by the Office.
- 2751 Revised to explain that terminally disclaimed patents are eligible for patent term extension under 35 U.S.C. 156.
- 2754 Revised to update mailing address for applications for patent term extension under 35 U.S.C. 156.



# **Manual of PATENT EXAMINING PROCEDURE**

Original Eighth Edition, August 2001

Latest Revision May 2004

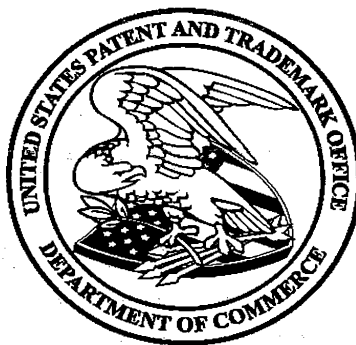

**U.S. DEPARTMENT OF COMMERCE**  
**United States Patent and Trademark Office**



The U.S. Patent and Trademark Office does not handle the sale of the Manual, distribution of notices and revisions, or change of address of those on the subscription list. Correspondence relating to existing subscriptions should be sent to the Superintendent of Documents at the following address:

Superintendent of Documents  
Mail List Section  
Washington, DC 20402

Telephone: 202-512-2267

Inquiries relating to purchasing the Manual should be directed to:

Superintendent of Documents  
United States Government Printing Office  
Washington, DC 20402

Telephone: 202-512-1800

Orders for reproduced copies of individual replacement pages or of previous revisions of the Manual should be sent to the following address:

Mail Stop Document Services  
Director of the U.S. Patent and Trademark Office  
P.O. Box 1450  
Alexandria, VA 22313-1450

Telephone: 1-800-972-6382 or 703-308-9726

Previous editions and revisions of the Manual are available on microfilm in the Patent Search Room.  
The Manual is available on CD-ROM and on diskette from:

U.S. Patent and Trademark Office  
Office of Electronic Information Products and Services  
P.O. Box 1450  
Alexandria, VA 22313-1450

Telephone: 703-306-2600

Employees of the U.S. Patent and Trademark Office should direct their requests for the Manual, replacement pages, notices, and revisions to the Patent Academy.

Telephone: 703-308-9660

Pursuant to the Patent and Trademark Office Efficiency Act (PTOEA) (Pub. L. 106-113, 113 Stat. 1501A-572), the head of the United States Patent and Trademark Office (USPTO) is the "Under Secretary of Commerce for Intellectual Property and Director of the United States Patent and Trademark Office." The Director is assisted by the "Deputy Under Secretary of Commerce for Intellectual Property and Deputy Director of the United States Patent and Trademark Office." The patent operations of the USPTO are now headed by the "Commissioner for Patents." The trademark operations of the USPTO are now headed by the "Commissioner for Trademarks." Under section 4741(b) of the PTOEA, any reference to the Commissioner of Patents and Trademarks, the Assistant Commissioner for Patents, or the Assistant Commissioner for Trademarks is deemed to refer to the Director, the Commissioner for Patents, or the Commissioner for Trademarks, respectively. See "Reestablishment of the Patent and Trademark Office as the United States Patent and Trademark Office" published in the *Federal Register* at 65 FR 17858 (Apr. 5, 2000), and in the *Official Gazette of the United States Patent and Trademark Office* at 1234 O.G. 41 (May 9, 2000).

Additions to the text of the Manual are indicated by arrows (><) inserted in the text. Deletions are indicated by a single asterisk (\*) where a single word was deleted and by two asterisks (\*\*) where more than one word was deleted. The use of three or five asterisks in the body of the laws, rules, treaties, and administrative instructions indicates a portion of the law, rule, treaty, or administrative instruction which was not reproduced.

First Edition, November 1949  
Second Edition, November 1953  
Third Edition, November 1961  
Fourth Edition, June 1979  
Fifth Edition, August 1983  
Sixth Edition, January 1995  
Seventh Edition, July 1998  
Eighth Edition, August 2001  
Revision 1, February 2003  
Revision 2, May 2004

# Foreword

This Manual is published to provide U.S. Patent and Trademark Office (USPTO) patent examiners, applicants, attorneys, agents, and representatives of applicants with a reference work on the practices and procedures relative to the prosecution of patent applications before the USPTO. It contains instructions to examiners, as well as other material in the nature of information and interpretation, and outlines the current procedures which the examiners are required or authorized to follow in appropriate cases in the normal examination of a patent application. The Manual does not have the force of law or the force of the rules in Title 37 of the Code of Federal Regulations.

A separate manual entitled "Trademark Manual of Examining Procedure" is published by the USPTO as a reference work for trademark cases.

Examiners will be governed by the applicable statutes, rules, decisions, and orders and instructions issued by the Director of the USPTO and other officials authorized by the Director of the USPTO. Orders and Notices still in force which relate to the subject matter included in this Manual are incorporated in the text. Orders and Notices, or portions thereof, relating to the examiners' duties and functions which have been omitted or not incorporated in the text may be considered obsolete. Interference procedure not directly involving the Primary Examiner are not included in this Manual and, therefore, Orders and Notices relating thereto remain in force.

Subsequent changes in practice and other revisions will be incorporated in the form of substitute or additional pages for the Manual.

Suggestions for improving the form and content of the Manual are always welcome. They should be addressed to:

Mail Stop MPEP  
Commissioner for Patents  
P.O. Box 1450  
Alexandria, Virginia 22313-1450

# Table of Contents

<i>Chapter</i>		<i>Page</i>
100	Secrecy, Access, National Security, and Foreign Filing . . . . .	100-1
200	Types, Cross-Noting, and Status of Application. . . . .	200-1
300	Ownership and Assignment . . . . .	300-1
400	Representative of Inventor or Owner . . . . .	400-1
500	Receipt and Handling of Mail and Papers . . . . .	500-1
600	Parts, Form, and Content of Application . . . . .	600-1
700	Examination of Applications . . . . .	700-1
800	Restriction in Applications Filed Under 35 U.S.C. 111; Double Patenting . . . . .	800-1
900	Prior Art, Classification, Search . . . . .	900-1
1000	Matters Decided by Various U.S. Patent and Trademark Office Officials . . . . .	1000-1
1100	Statutory Invention Registration (SIR) and Pre-Grant Publication (PG Pub) . . . . .	1100-1
1200	Appeal. . . . .	1200-1
1300	Allowance and Issue . . . . .	1300-1
1400	Correction of Patents . . . . .	1400-1
1500	Design Patents. . . . .	1500-1
1600	Plant Patents . . . . .	1600-1
1700	Miscellaneous . . . . .	1700-1
1800	Patent Cooperation Treaty . . . . .	1800-1
1900	Protest . . . . .	1900-1
2000	Duty of Disclosure . . . . .	2000-1
2100	Patentability . . . . .	2100-1
2200	Citation of Prior Art and <i>Ex Parte</i> Reexamination of Patents . . . . .	2200-1
2300	Interference Proceedings. . . . .	2300-1
2400	Biotechnology. . . . .	2400-1
2500	Maintenance Fees . . . . .	2500-1
2600	Optional <i>Inter Partes</i> Reexamination . . . . .	2600-1
2700	Patent Terms and Extensions . . . . .	2700-1
Appendix I	Partial List of Trademarks. . . . .	A-1
Appendix II	List of Decisions Cited . . . . .	A-7
Appendix L	Patent Laws . . . . .	L-1
Appendix R	Patent Rules. . . . .	R-1
Appendix T	Patent Cooperation Treaty. . . . .	T-1
Appendix AI	Administrative Instructions Under the PCT . . . . .	AI-1
Appendix P	Paris Convention . . . . .	P-1
Index . . . . .		I-1

# Introduction

## Constitutional Basis

The Constitution of the United States provides:

“Art. 1, Sec. 8. The Congress shall have power . . . To promote the progress of science and useful arts, by securing for limited times to authors and inventors the exclusive right to their respective writings and discoveries.”

## Statutes

Pursuant to the provision of the Constitution, Congress has over the years passed a number of statutes under which the U.S. Patent and Trademark Office (USPTO) is organized and our patent system is established. The provisions of the statutes can in no way be changed or waived by the USPTO.

Prior to January 1, 1953, the law relating to patents consisted of various sections of the Revised Statutes of 1874, derived from the Patent Act of 1870 and numerous amendatory and additional acts.

By an Act of Congress approved July 19, 1952, which came into effect on January 1, 1953, the patent laws were revised and codified into substantially its present form. The patent law is Title 35 of the United States Code which governs all cases in the USPTO. In referring to a particular section of the patent code the citation is given, for example, as, 35 U.S.C. 31. Title 35 of the United States Code is reproduced in Appendix L of the Manual of Patent Examining Procedure (MPEP).

### 35 U.S.C. 1. Establishment.

(a) ESTABLISHMENT.— The United States Patent and Trademark Office is established as an agency of the United States, within the Department of Commerce. In carrying out its functions, the United States Patent and Trademark Office shall be subject to the policy direction of the Secretary of Commerce, but otherwise shall retain responsibility for decisions regarding the management and administration of its operations and shall exercise independent control of its budget allocations and expenditures, personnel decisions and processes, procurements, and other administrative and management functions in accordance with this title and applicable provisions of law. Those operations designed to grant and issue patents and those operations which are designed to facilitate the registration of trademarks shall be treated as separate operating units within the Office.

(b) OFFICES.— The United States Patent and Trademark Office shall maintain its principal office in the metropolitan Washington, D.C., area, for the service of process and papers and for the purpose of carrying out its functions. The United States Patent and Trademark Office shall be deemed, for purposes of venue in civil actions, to be a resident of the district in which its principal office is located, except where jurisdiction is otherwise provided

by law. The United States Patent and Trademark Office may establish satellite offices in such other places in the United States as it considers necessary and appropriate in the conduct of its business.

(c) REFERENCE.— For purposes of this title, the United States Patent and Trademark Office shall also be referred to as the “Office” and the “Patent and Trademark Office”.

## Rules

One of the sections of the patent statute, namely, 35 U.S.C. 2, authorizes the USPTO, subject to the policy direction of the Secretary of Commerce, to establish regulations, not inconsistent with law, for the conduct of proceedings in the USPTO.

These regulations or rules and amendments thereto are published in the *Federal Register* and in the *Official Gazette*. In the *Federal Register* and in the Code of Federal Regulations the rules pertaining to patents are in Parts 1, 3, 4, 5, and 10 of Title 37, Patents, Trademarks, and Copyrights. In referring to a particular section of the rules the citation is given, for example, as 37 CFR 1.31. A booklet entitled “Code of Federal Regulations, Title 37, Patents, Trademarks, and Copyrights,” published by the Office of the Federal Register, contains all of the patent rules as well as trademark rules and copyright rules. Persons desiring a copy of this booklet should order a copy from the Superintendent of Documents.

The primary function of the rules is to advise the public of the rules which have been established in accordance with the statutes and which must be followed before the USPTO. The rules govern the examiners, as well as applicants and their attorneys and agents. The rules pertaining to patent practice appear in the MPEP as Appendix R.

## Director’s Orders and Notices

From time to time, the Director of the USPTO, formerly the Commissioner of Patents and Trademarks, has issued Orders and Notices relating to various specific situations that have arisen in operating the USPTO. Notices and circulars of information or instructions have also been issued by other USPTO officials under authority of the Director. Orders and Notices have served various purposes including giving examiners instruction, information, interpretations, and the like. Others have been for the information of the public, advising what the USPTO will do under specified circumstances.

### **Decisions**

In addition to the statutes and rules, the actions taken by the examiner in the examination of applications for patents are to a great extent governed by decisions on prior cases. Applicants dissatisfied with an examiner's action may have it reviewed. In general, that portion of the examiner's action pertaining to objections on formal matters may be reviewed by petition to the Director of the USPTO (see MPEP § 1002), and that portion of the examiner's action pertaining to the rejection of claims on the merits may be reviewed by appeal to the Board of Patent Appeals and Interferences (see MPEP § 1201). The distinction is set forth in 37 CFR 1.181 and 1.191. In citing decisions as authority for his or her actions, the examiner should cite the decision in the manner set forth in MPEP § 707.06.

### **Publications Available from the U.S. Government Printing Office**

For current price and availability information, visit the U.S. Government Printing Office (GPO) web site (<http://bookstore.gov>), call the GPO Order Desk (202-512-1800 or 1-866-512-1800), send a fax to 202-512-2250, or send an e-mail to [orders@gpo.gov](mailto:orders@gpo.gov).

### **Products and Services Available From the U.S. Patent and Trademark Office**

Patent and trademark related products and services available from the USPTO are described in the Products and Services Catalog, available on the USPTO's

web site ([www.uspto.gov/web/offices/ac/ido/oeip/catalog](http://www.uspto.gov/web/offices/ac/ido/oeip/catalog)).

Call 800-786-9199 or 703-308-4357 for information on Patent, Trademark, and General Products. Customer Service Representatives are available Monday through Friday (except Federal holidays) from 8:30 a.m. to 8:00 p.m.

For information on electronic information products, or to discuss system requirements for magnetic tape products, contact:

Office of Electronic Information Products  
Crystal Park 3, Suite 441  
P.O. Box 1450  
Alexandria VA 22313-1450  
Telephone: 703-306-2600  
Fax: 703-306-2737  
E-mail: [oeip@uspto.gov](mailto:oeip@uspto.gov).

For information on patent and trademark copy/document sales, contact:

Office of Public Records (OPR) Customer Service  
Telephone: 703-308-9726 or 800-972-6382  
Fax: 703-305-8759  
Email: [dsd@uspto.gov](mailto:dsd@uspto.gov). Web site: <http://ebiz1.uspto.gov/oems25p/index.html>

See MPEP § 1730 for additional information sources.

# Chapter 100 Secrecy, Access, National Security, and Foreign Filing

101	General
102	Information as to Status of an Application
103	Right of Public to Inspect Patent Files and Some Application Files
104	Power to Inspect Application
105	Suspended or Excluded Practitioner Cannot Inspect
106	Control of Inspection by Assignee
106.01	Rights of Assignee of Part Interest
110	Confidential Nature of International Applications
115	Review of Applications for National Security and Property Rights Issues
120	Secrecy Orders
121	Handling of Applications and Other Papers Bearing Security Markings
130	Examination of Secrecy Order Cases
140	Foreign Filing Licenses
150	Statements to DOE and NASA
151	Content of the Statements

## 101 General [R-2]

35 U.S.C. 122. *Confidential status of applications; publication of patent applications.*

(a) CONFIDENTIALITY.— Except as provided in subsection (b), applications for patents shall be kept in confidence by the Patent and Trademark Office and no information concerning the same given without authority of the applicant or owner unless necessary to carry out the provisions of an Act of Congress or in such special circumstances as may be determined by the Director.

(b) PUBLICATION.—

(1) IN GENERAL.—

(A) Subject to paragraph (2), each application for a patent shall be published, in accordance with procedures determined by the Director, promptly after the expiration of a period of 18 months from the earliest filing date for which a benefit is sought under this title. At the request of the applicant, an application may be published earlier than the end of such 18-month period.

(B) No information concerning published patent applications shall be made available to the public except as the Director determines.

(C) Notwithstanding any other provision of law, a determination by the Director to release or not to release information concerning a published patent application shall be final and nonreviewable.

(2) EXCEPTIONS.—

(A) An application shall not be published if that application is—

- (i) no longer pending;
- (ii) subject to a secrecy order under section 181 of

this title;

(iii) a provisional application filed under section 111(b) of this title; or

(iv) an application for a design patent filed under chapter 16 of this title.

(B)(i) If an applicant makes a request upon filing, certifying that the invention disclosed in the application has not and will not be the subject of an application filed in another country, or under a multilateral international agreement, that requires publication of applications 18 months after filing, the application shall not be published as provided in paragraph (1).

(ii) An applicant may rescind a request made under clause (i) at any time.

(iii) An applicant who has made a request under clause (i) but who subsequently files, in a foreign country or under a multilateral international agreement specified in clause (i), an application directed to the invention disclosed in the application filed in the Patent and Trademark Office, shall notify the Director of such filing not later than 45 days after the date of the filing of such foreign or international application. A failure of the applicant to provide such notice within the prescribed period shall result in the application being regarded as abandoned, unless it is shown to the satisfaction of the Director that the delay in submitting the notice was unintentional.

(iv) If an applicant rescinds a request made under clause (i) or notifies the Director that an application was filed in a foreign country or under a multilateral international agreement specified in clause (i), the application shall be published in accordance with the provisions of paragraph (1) on or as soon as is practical after the date that is specified in clause (i).

(v) If an applicant has filed applications in one or more foreign countries, directly or through a multilateral international agreement, and such foreign filed applications corresponding to an application filed in the Patent and Trademark Office or the description of the invention in such foreign filed applications is less extensive than the application or description of the invention in the application filed in the Patent and Trademark Office, the applicant may submit a redacted copy of the application filed in the Patent and Trademark Office eliminating any part or description of the invention in such application that is not also contained in any of the corresponding applications filed in a foreign country. The Director may only publish the redacted copy of the application unless the redacted copy of the application is not received within 16 months after the earliest effective filing date for which a benefit is sought under this title. The provisions of section 154(d) shall not apply to a claim if the description of the invention published in the redacted application filed under this clause with respect to the claim does not enable a person skilled in the art to make and use the subject matter of the claim.

(c) PROTEST AND PRE-ISSUANCE OPPOSITION.— The Director shall establish appropriate procedures to ensure that no protest or other form of pre-issuance opposition to the grant of a patent on an application may be initiated after publication of the application without the express written consent of the applicant.

(d) NATIONAL SECURITY.— No application for patent shall be published under subsection (b)(1) if the publication or disclosure of such invention would be detrimental to the national security. The Director shall establish appropriate procedures to

ensure that such applications are promptly identified and the secrecy of such inventions is maintained in accordance with chapter 17 of this title.

*18 U.S.C. 2071. Concealment, removal, or mutilation generally.*

(a) Whoever willfully and unlawfully conceals, removes, mutilates, obliterates, or destroys, or attempts to do so, or, with intent to do so takes and carries away any record, proceeding, map, book, paper, document, or other thing, filed or deposited with any clerk or officer of any court of the United States, or in any public office, or with any judicial or public officer of the United States, shall be fined under this title or imprisoned not more than three years, or both.

(b) Whoever, having the custody of any such record, proceeding, map, book, document, paper, or other thing, willfully and unlawfully conceals, removes, mutilates, obliterates, falsifies, or destroys the same, shall be fined under this title or imprisoned not more than three years, or both; and shall forfeit his office and be disqualified from holding any office under the United States. As used in this subsection, the term "office" does not include the office held by any person as a retired officer of the Armed Forces of the United States.

*37 CFR 1.14. Patent applications preserved in confidence.*

\*\*>

(a) *Confidentiality of patent application information.* Patent applications that have not been published under 35 U.S.C. 122(b) are generally preserved in confidence pursuant to 35 U.S.C. 122(a). Information concerning the filing, pendency, or subject matter of an application for patent, including status information, and access to the application, will only be given to the public as set forth in § 1.11 or in this section.

(1) Records associated with patent applications (see paragraph (g) for international applications) may be available in the following situations:

(i) *Patented applications and statutory invention registrations.* The file of an application that has issued as a patent or published as a statutory invention registration is available to the public as set forth in § 1.11(a). A copy of the patent application-as-filed, the file contents of the application, or a specific document in the file of such an application may be provided upon request and payment of the appropriate fee set forth in § 1.19(b).

(ii) *Published abandoned applications.* The file of an abandoned application that has been published as a patent application publication is available to the public as set forth in § 1.11(a). A copy of the application-as-filed, the file contents of the published application, or a specific document in the file of the published application may be provided to any person upon request, and payment of the appropriate fee set forth in § 1.19(b).

(iii) *Published pending applications.* A copy of the application-as-filed, the file contents of the application, or a specific document in the file of a pending application that has been published as a patent application publication may be provided to any person upon request, and payment of the appropriate fee set forth in § 1.19(b). If a redacted copy of the application was used for the patent application publication, the copy of the specification, drawings, and papers may be limited to a redacted copy. The

Office will not provide access to the paper file of a pending application that has been published, except as provided in paragraph (c) or (h) of this section.

(iv) *Unpublished abandoned applications (including provisional applications) that are identified or relied upon.* The file contents of an unpublished, abandoned application may be made available to the public if the application is identified in a U.S. patent, a statutory invention registration, a U.S. patent application publication, or an international patent application publication of an international application that was published in accordance with PCT Article 21(2). An application is considered to have been identified in a document, such as a patent, when the application number or serial number and filing date, first named inventor, title and filing date or other application specific information are provided in the text of the patent, but not when the same identification is made in a paper in the file contents of the patent and is not included in the printed patent. Also, the file contents may be made available to the public, upon a written request, if benefit of the abandoned application is claimed under 35 U.S.C. 119(e), 120, 121, or 365 in an application that has issued as a U.S. patent, or has published as a statutory invention registration, a U.S. patent application publication, or an international patent application that was published in accordance with PCT Article 21(2). A copy of the application-as-filed, the file contents of the application, or a specific document in the file of the application may be provided to any person upon written request, and payment of the appropriate fee (§ 1.19(b)).

(v) *Unpublished pending applications (including provisional applications) whose benefit is claimed.* A copy of the file contents of an unpublished pending application may be provided to any person, upon written request and payment of the appropriate fee (§ 1.19(b)), if the benefit of the application is claimed under 35 U.S.C. 119(e), 120, 121, or 365 in an application that has issued as a U.S. patent, an application that has published as a statutory invention registration, a U.S. patent application publication, or an international patent application publication that was published in accordance with PCT Article 21(2). A copy of the application-as-filed, or a specific document in the file of the pending application may also be provided to any person upon written request, and payment of the appropriate fee (§ 1.19(b)). The Office will not provide access to the paper file of a pending application, except as provided in paragraph (c) or (h) of this section.

(vi) *Unpublished pending applications (including provisional applications) that are incorporated by reference or otherwise identified.* A copy of the application as originally filed of an unpublished pending application may be provided to any person, upon written request and payment of the appropriate fee (§ 1.19(b)), if the application is incorporated by reference or otherwise identified in a U.S. patent, a statutory invention registration, a U.S. patent application publication, or an international patent application publication that was published in accordance with PCT Article 21(2). The Office will not provide access to the paper file of a pending application, except as provided in paragraph (c) or (h) of this section.

(vii) *When a petition for access or a power to inspect is required.* Applications that were not published or patented, that are not the subject of a benefit claim under 35 U.S.C. 119(e), 120,

121, or 365 in an application that has issued as a U.S. patent, an application that has published as a statutory invention registration, a U.S. patent application publication, or an international patent application publication that was published in accordance with PCT Article 21(2), or are not identified in a U.S. patent, a statutory invention registration, a U.S. patent application publication, or an international patent application that was published in accordance with PCT Article 21(2), are not available to the public. If an application is identified in the file contents of another application, but not the published patent application or patent itself, a granted petition for access (see paragraph (h)) or a power to inspect (see paragraph (c)) is necessary to obtain the application, or a copy of the application.

(2) Information concerning a patent application may be communicated to the public if the patent application is identified in paragraphs (a)(1)(i) through (a)(1)(vi) of this section. The information that may be communicated to the public (*i.e.*, status information) includes:

- (i) Whether the application is pending, abandoned, or patented;
- (ii) Whether the application has been published under 35 U.S.C. 122(b);
- (iii) The application "numerical identifier" which may be:
  - (A) The eight-digit application number (the two-digit series code plus the six-digit serial number); or
  - (B) The six-digit serial number plus any one of the filing date of the national application, the international filing date, or date of entry into the national stage; and
- (iv) Whether another application claims the benefit of the application (*i.e.*, whether there are any applications that claim the benefit of the filing date under 35 U.S.C. 119(e), 120, 121 or 365 of the application), and if there are any such applications, the numerical identifier of the application, the specified relationship between the applications (*e.g.*, continuation), whether the application is pending, abandoned or patented, and whether the application has been published under 35 U.S.C. 122(b).<

\*\*\*\*\*

All U.S. Patent and Trademark Office employees are legally obligated to preserve pending applications for patents in confidence until they are published or patented. 35 U.S.C. 122 and 18 U.S.C. 2071 impose statutory requirements which cover the handling of patent applications and related documents. Suspension, removal, and even criminal penalties may be imposed for violations of these statutes.

In order to provide prompt and orderly service to the public, application files must be readily available to authorized U.S. Patent and Trademark Office employees at all times. Accordingly, in carrying or transporting applications and related papers, care must be exercised by U.S. Patent and Trademark Office employees, especially in corridors and eleva-

tors, to ensure that applications and related papers are always under employee surveillance and control. Application files must not be displayed or handled so as to permit perusal or inspection by any unauthorized member of the public.

Interoffice mail must be sent in appropriate envelopes.

No part of any application or paper related thereto should be reproduced or copied except for official purposes.

No patent application or related document may be removed from the premises occupied by the U.S. Patent and Trademark Office, except for handling as required by the issue process, unless specifically authorized by the \*>Director<. If such authorization is given, the employee having custody will be responsible for maintaining confidentiality and otherwise conforming with the requirements of law.

Applications must not be placed in desk drawers or other locations where they might be easily overlooked or are not visible to authorized personnel.

Whenever an application>, or an artifact file in an Image File Wrapper (IFW) application,< is removed from the operating area having custody of the file, a charge on the PALM system must be properly and promptly made.

\*\*>Official papers are accepted only at a central delivery window, except for certain papers that have been specifically exempted from the central delivery policy. See MPEP § 502. Papers for non-Image File Wrapper (IFW) applications are forwarded to the Technology Center (TC) and< must be properly and promptly placed within the appropriate files. If papers are received with faulty identifications, this should be corrected at once. If papers are received at a destination for which they are not intended due to faulty identification or routing, appropriate corrective action should be taken at once to ensure the prompt receipt thereof at destination. See MPEP § 508.01 and § 508.03. >Similarly, for IFW messages with faulty identifications or incorrect routing, appropriate corrective action should be taken at once to ensure the prompt receipt thereof at the appropriate destination. For IFW processing, see the IFW Manual.<

All U.S. Patent and Trademark Office employees should bear in mind at all times the critical importance of ensuring the confidentiality and accessibility of patent application files and related documents, and



in addition to the specific procedures referred to above, should take all appropriate action to that end.

Examiners, classifiers, and other U.S. Patent and Trademark Office employees who assist public searchers by outlining or indicating a field of search, should also bear in mind the critical importance of ensuring the confidentiality of information revealed by a searcher when requesting field of search assistance. See MPEP § 1701. Statutory requirements and curbs regarding the use of information obtained by an employee through government employment are imposed by 15 U.S.C. 15(b) and 18 U.S.C. 1905.

Examiners, while holding interviews with attorneys and applicants, should be careful to prevent exposures of files and drawings of other applicants.

Extreme care should be taken to prevent inadvertent and/or inappropriate disclosure of the filing date or application number of any application. This applies not only to Office actions but also to notes (usually in pencil) in the file wrapper >or in the artifact folder of IFW applications<.

#### **TELEPHONE AND IN-PERSON REQUESTS FOR INFORMATION CONCERNING PENDING OR ABANDONED APPLICATIONS**

>

*37 CFR 1.14. Patent applications preserved in confidence.*

\*\*\*\*\*

(2) Information concerning a patent application may be communicated to the public if the patent application is identified in paragraphs (a)(1)(i) through (a)(1)(vi) of this section. The information that may be communicated to the public (i.e., status information) includes:

(i) Whether the application is pending, abandoned, or patented;

(ii) Whether the application has been published under 35 U.S.C. 122(b);

(iii) The application "numerical identifier" which may be:

(A) The eight-digit application number (the two-digit series code plus the six-digit serial number); or

(B) The six-digit serial number plus any one of the filing date of the national application, the international filing date, or date of entry into the national stage; and

(iv) Whether another application claims the benefit of the application (i.e., whether there are any applications that claim the benefit of the filing date under 35 U.S.C. 119(e), 120, 121 or 365 of the application), and if there are any such applications, the numerical identifier of the application, the specified relationship between the applications (e.g., continuation), whether the applica-

tion is pending, abandoned or patented, and whether the application has been published under 35 U.S.C. 122(b).

\*\*\*\*\*

<

Normally no information concerning pending or abandoned patent applications (except applications which have been published, reissue applications and reexamination proceedings) may be given to the public without the authorization of the applicant, the assignee of record, or the attorney or agent of record. See 35 U.S.C. 122 and 37 CFR 1.14. Other exceptions are specified in 37 CFR 1.14.

When handling an incoming telephone call or an in-person request for information regarding an unpublished pending or abandoned patent application, no information should be disclosed until the identity of the requester can be adequately verified as set forth below. Particular care must be exercised when a request is made for the publication date or publication number, or issue date and patent number assigned to a *pending* patent application. If the publication or issue date is later than the current date (i.e., the date of the request), such information may be given *only* to the applicant, or the assignee of record, or the attorney or agent of record.

The following procedure should be followed before any information about an unpublished pending or abandoned patent application is given over the telephone:

(A) Obtain the caller's full name, the application number, and the caller's telephone number. Ask the caller if there is an attorney or agent of record.

(1) If there is an attorney or agent of record, ask for his or her registration number. If the registration number is not known, ask for the name of the attorney or agent of record. Inform caller that an attorney or agent of record will be called after verification of his/her identity and that information concerning the application will be released to that attorney or agent.

(2) If there is no attorney or agent of record, ask the caller why he or she is entitled to information concerning the application. If the caller identifies himself or herself as an applicant or an authorized representative of the assignee of record, ask for the correspondence address of record and inform caller that his or her association with the application must be verified before any information concerning the

application can be released and that he or she will be called back. If the caller indicates that he or she is not an applicant or an authorized representative of the assignee of record then status information may only be given pursuant to MPEP § 102.

(B) Verify that information concerning the application can be released by checking PALM or the application file.

(1) If the caller stated there was an attorney or agent of record, PALM Intranet \*\* should be used to verify the registration number given or to obtain the registration number of an attorney or agent of record. Then PALM Intranet \*\* (using the registration number) should be used to obtain a telephone number for an attorney or agent of record.

(2) If the caller identified himself or herself as an applicant or an authorized representative of the assignee of record, PALM Intranet \*\* should be used to verify the correspondence address of record. PALM Intranet \*\* should be used to determine if there is an attorney or agent of record. If there is an attorney or agent of record, their telephone number can be obtained from PALM Intranet\*\*.

(C) Return the call using the telephone number as specified below.

(1) If an attorney or agent is of record in the application, information concerning the application should only be released by calling the attorney's or agent's telephone number obtained from PALM Intranet\*\*.

(2) If the applicant or an authorized representative of the assignee of record requests information, and there is no attorney or agent of record and the correspondence address of record has been verified, information concerning the application can be released to the caller using the telephone number given by the caller. If the caller's association with the application cannot be verified, no information concerning the application will be released. However, the caller should be informed that the caller's association with the application could not be verified.

In handling an in-person request, ask the requester to wait while verifying their identification as in (B) above.

## 102 Information as to Status of an Application [R-2]

*37 CFR 1.14. Patent applications preserved in confidence.*  
\*\*>

(a) *Confidentiality of patent application information.* Patent applications that have not been published under 35 U.S.C. 122(b) are generally preserved in confidence pursuant to 35 U.S.C. 122(a). Information concerning the filing, pendency, or subject matter of an application for patent, including status information, and access to the application, will only be given to the public as set forth in § 1.11 or in this section.

(1) Records associated with patent applications (see paragraph (g) for international applications) may be available in the following situations:

(i) *Patented applications and statutory invention registrations.* The file of an application that has issued as a patent or published as a statutory invention registration is available to the public as set forth in §1.11(a). A copy of the patent application-as-filed, the file contents of the application, or a specific document in the file of such an application may be provided upon request and payment of the appropriate fee set forth in § 1.19(b).

(ii) *Published abandoned applications.* The file of an abandoned application that has been published as a patent application publication is available to the public as set forth in § 1.11(a). A copy of the application-as-filed, the file contents of the published application, or a specific document in the file of the published application may be provided to any person upon request, and payment of the appropriate fee set forth in § 1.19(b).

(iii) *Published pending applications.* A copy of the application-as-filed, the file contents of the application, or a specific document in the file of a pending application that has been published as a patent application publication may be provided to any person upon request, and payment of the appropriate fee set forth in § 1.19(b). If a redacted copy of the application was used for the patent application publication, the copy of the specification, drawings, and papers may be limited to a redacted copy. The Office will not provide access to the paper file of a pending application that has been published, except as provided in paragraph (c) or (h) of this section.

(iv) *Unpublished abandoned applications (including provisional applications) that are identified or relied upon.* The file contents of an unpublished, abandoned application may be made available to the public if the application is identified in a U.S. patent, a statutory invention registration, a U.S. patent application publication, or an international patent application publication of an international application that was published in accordance with PCT Article 21(2). An application is considered to have been identified in a document, such as a patent, when the application number or serial number and filing date, first named inventor, title and filing date or other application specific information are provided in the text of the patent, but not when the same identification is made in a paper in the file contents of the patent and is not included in the printed patent. Also, the file contents may be made available to the public, upon a written request, if benefit of the abandoned application is claimed under 35 U.S.C. 119(e), 120, 121, or 365 in an application that has issued as a U.S.

patent, or has published as a statutory invention registration, a U.S. patent application publication, or an international patent application that was published in accordance with PCT Article 21(2). A copy of the application-as-filed, the file contents of the application, or a specific document in the file of the application may be provided to any person upon written request, and payment of the appropriate fee (§ 1.19(b)).

(v) *Unpublished pending applications (including provisional applications) whose benefit is claimed.* A copy of the file contents of an unpublished pending application may be provided to any person, upon written request and payment of the appropriate fee (§ 1.19(b)), if the benefit of the application is claimed under 35 U.S.C. 119(e), 120, 121, or 365 in an application that has issued as a U.S. patent, an application that has published as a statutory invention registration, a U.S. patent application publication, or an international patent application publication that was published in accordance with PCT Article 21(2). A copy of the application-as-filed, or a specific document in the file of the pending application may also be provided to any person upon written request, and payment of the appropriate fee (§ 1.19(b)). The Office will not provide access to the paper file of a pending application, except as provided in paragraph (c) or (h) of this section.

(vi) *Unpublished pending applications (including provisional applications) that are incorporated by reference or otherwise identified.* A copy of the application as originally filed of an unpublished pending application may be provided to any person, upon written request and payment of the appropriate fee (§ 1.19(b)), if the application is incorporated by reference or otherwise identified in a U.S. patent, a statutory invention registration, a U.S. patent application publication, or an international patent application publication that was published in accordance with PCT Article 21(2). The Office will not provide access to the paper file of a pending application, except as provided in paragraph (c) or (h) of this section.

(vii) *When a petition for access or a power to inspect is required.* Applications that were not published or patented, that are not the subject of a benefit claim under 35 U.S.C. 119(e), 120, 121, or 365 in an application that has issued as a U.S. patent, an application that has published as a statutory invention registration, a U.S. patent application publication, or an international patent application publication that was published in accordance with PCT Article 21(2), or are not identified in a U.S. patent, a statutory invention registration, a U.S. patent application publication, or an international patent application that was published in accordance with PCT Article 21(2), are not available to the public. If an application is identified in the file contents of another application, but not the published patent application or patent itself, a granted petition for access (see paragraph (h)) or a power to inspect (see paragraph (c)) is necessary to obtain the application, or a copy of the application.

(2) Information concerning a patent application may be communicated to the public if the patent application is identified in paragraphs (a)(1)(i) through (a)(1)(vi) of this section. The information that may be communicated to the public (*i.e.*, status information) includes:

(i) Whether the application is pending, abandoned, or patented;

(ii) Whether the application has been published under 35 U.S.C. 122(b);

(iii) The application “numerical identifier” which may be:

(A) The eight-digit application number (the two-digit series code plus the six-digit serial number); or

(B) The six-digit serial number plus any one of the filing date of the national application, the international filing date, or date of entry into the national stage; and

(iv) Whether another application claims the benefit of the application (*i.e.*, whether there are any applications that claim the benefit of the filing date under 35 U.S.C. 119(e), 120, 121 or 365 of the application), and if there are any such applications, the numerical identifier of the application, the specified relationship between the applications (*e.g.*, continuation), whether the application is pending, abandoned or patented, and whether the application has been published under 35 U.S.C. 122(b).<

\*\*\*\*\*

Status information of an application means only the following information:

(A) whether the application is pending, abandoned, or patented;

(B) whether the application has been published; \*

(C) the application number or the serial number plus any one of the filing date of the national application, the international filing date or the date of entry into the national stage\*>; and

(D) whether another application claims the benefit of the application (*i.e.*, whether there are any applications that claim the benefit of the filing date under 35 U.S.C. 119(e), 120, 121 or 365 of the application), and if there are any such applications, status information therefor as set forth in 37 CFR 1.14(a)(2)(iv).<

A requester seeking status information regarding an application should check the Patent Application Information Retrieval (PAIR) system on the U.S. Patent and Trademark Office (USPTO) website at <http://www.uspto.gov/ebc>. Alternatively, the requester may contact the File Information Unit (see MPEP § 1730). The File Information Unit (FIU) will check the relevant Office records and will inform the requester whether the application has been published or has issued as a patent. If the application has been published, the FIU will inform the requester of the publication number and publication date, and if the application has issued as a patent, the patent number, issue date and classification. If the application has not been published, but is pending or abandoned then the FIU should determine whether the requester is:

- (A) an inventor;
- (B) an attorney or agent of record in the application;
- (C) an assignee of record in the application; or
- (D) a person with written authority from (A), (B), or (C).

If the requester is (A), (B), (C), or (D), as set forth above, then the requester is entitled to status information. If the requester is inquiring about whether a reply was received or when an Office action can be expected, the requester should be directed to call the Technology Center (TC) to which the application is assigned. The assignment of an application to a TC can be determined from PALM Intranet \*\*.

If the requester is not (A), (B), (C), or (D), as set forth above, and the application is (1) identified by application number (or serial number and filing date) in a published patent document, or (2) an application claiming the benefit of the filing date of an application identified by application number (or serial number and filing date) in a published patent document, then a written request including a copy of a published patent document (United States or foreign) which refers to the specific application must be provided when requesting status information for the application. If the published patent document is not in English, then a translation of the pertinent part thereof must also be included. The published patent document may be presented in person to the FIU or in written correspondence to the U.S. Patent and Trademark Office, for example, by facsimile transmission. Any written correspondence must include a return address or facsimile number. If the application is referred to by application number or serial number and filing date in a published patent document (e.g., a U.S. patent, >a statutory invention registration,< a U.S. patent application publication, or an international application publication), or in a U.S. application open to public inspection, pursuant to 37 CFR \*>1.14(a)<, the requester is entitled to status information for the application. (The published patent document will at least identify the application from which the patent itself was issued.) PALM Intranet \*\* should be used to determine the status of the application. If the requester asks whether there are any applications on file which claim the benefit of the filing date of the identified application, pursuant to 37 CFR \*>1.14(a)(2)(iv)<, status information (application

number, filing date and whether the application is pending, abandoned or patented) for the applications claiming benefit of the identified application may be given to the requester as well. PALM Intranet \*\* should be used to determine the application number and filing date of any applications claiming the benefit of the filing date of the identified application. The requester should be informed of the national applications listed in the “child” section of the screen. If the child application is not shown to have been patented \*\*>, PALM Intranet< should be used to determine whether the application is pending or abandoned. Alternatively, \*\* PALM \*>Intranet< may be used with the patent number for continuity data for the patent. Other information contained on the screen, such as whether the application is a Continuation-in-Part (CIP), continuation or divisional application, the date of abandonment of the application, and the issue date, may be confidential information and should not be communicated. As to the extent of the chain of applications for which status information is available, the rule applies only to subsequent and not prior applications.

Furthermore, if the requester is not (A), (B), (C), or (D), as set forth above, but the application is a national stage application or any application claiming the benefit of the filing date of a published international application and the United States of America has been indicated as a Designated State in the international application, pursuant to 37 CFR \*>1.14(a)(2)(iv)<, the requester is entitled to status information for the national stage application as well as any application claiming the benefit of the filing date of the published international application. A copy of the first page of the published international application or of the corresponding page of the PCT Gazette must be supplied with the status request. \*\* The status request should be \*\*>made in writing to the Office of PCT Legal Administration< (see MPEP § 1730). Alternatively, inquiries relating to applications claiming the benefit of the filing date of a published international application may be directed to the PCT Help desk. Only the serial number and filing date, or application number, as well as whether the application is pending, abandoned, or patented may be given for the national stage application and for any applications claiming the benefit of the filing date of the referenced published international application. Other

information contained on the >continuity data< screen, such as whether the application is a CIP, continuation or divisional application, the date of abandonment of the application and issue date may be confidential information and should not be communicated.

### STATUS LOCATION INFORMATION FOR OFFICE PERSONNEL

When it is desired to determine the current location or status of an application, Office personnel should use PALM. >If the application is an Image File Wrapper (IFW) application, no location is associated with the file. For the location of any artifact file(s) associated with an IFW application, see the IFW Manual.<

\*\*Office personnel requesting status/location information on \* applications \*\* >prior to 07 series applications that are not< in the PALM system \*\*>should< contact the FIU (see MPEP § 1730) where the numerical index records of the above mentioned applications are maintained.

## 103 Right of Public To Inspect Patent Files and Some Application Files [R-2]

### 37 CFR 1.11. Files open to the public.

(a) The specification, drawings, and all papers relating to the file of an abandoned published application, except if a redacted copy of the application was used for the patent application publication, a patent, or a statutory invention registration are open to inspection by the public, and copies may be obtained upon the payment of the fee set forth in § 1.19(b)(2). See § 2.27 for trademark files.

(b) All reissue applications, all applications in which the Office has accepted a request to open the complete application to inspection by the public, and related papers in the application file, are open to inspection by the public, and copies may be furnished upon paying the fee therefor. The filing of reissue applications, other than continued prosecution applications under § 1.53(d) of reissue applications, will be announced in the *Official Gazette*. The announcement shall include at least the filing date, reissue application and original patent numbers, title, class and subclass, name of the inventor, name of the owner of record, name of the attorney or agent of record, and examining group to which the reissue application is assigned.

(c) \*\*>All requests for reexamination for which the fee under § 1.20(c) has been paid, will be announced in the *Official Gazette*. Any reexaminations at the initiative of the Director pursuant to § 1.520 will also be announced in the *Official Gazette*. The announcement shall include at least the date of the request, if any, the reexamination request control number or the Director ini-

tiated order control number, patent number, title, class and subclass, name of the inventor, name of the patent owner of record, and the examining group to which the reexamination is assigned.<

(d) All papers or copies thereof relating to a reexamination proceeding which have been entered of record in the patent or reexamination file are open to inspection by the general public, and copies may be furnished upon paying the fee therefor.

(e) The file of any interference involving a patent, a statutory invention registration, a reissue application, or an application on which a patent has been issued or which has been published as a statutory invention registration, is open to inspection by the public, and copies may be obtained upon paying the fee therefor, if:

- (1) The interference has terminated or
- (2) An award of priority or judgment has been entered as to all parties and all counts.

>

### 37 CFR 1.14. Patent applications preserved in confidence.

(a) *Confidentiality of patent application information.* Patent applications that have not been published under 35 U.S.C. 122(b) are generally preserved in confidence pursuant to 35 U.S.C. 122(a). Information concerning the filing, pendency, or subject matter of an application for patent, including status information, and access to the application, will only be given to the public as set forth in § 1.11 or in this section.

(1) Records associated with patent applications (see paragraph (g) for international applications) may be available in the following situations:

(i) *Patented applications and statutory invention registrations.* The file of an application that has issued as a patent or published as a statutory invention registration is available to the public as set forth in § 1.11(a). A copy of the patent application-as-filed, the file contents of the application, or a specific document in the file of such an application may be provided upon request and payment of the appropriate fee set forth in § 1.19(b).

(ii) *Published abandoned applications.* The file of an abandoned application that has been published as a patent application publication is available to the public as set forth in § 1.11(a). A copy of the application-as-filed, the file contents of the published application, or a specific document in the file of the published application may be provided to any person upon request, and payment of the appropriate fee set forth in § 1.19(b).

(iii) *Published pending applications.* A copy of the application-as-filed, the file contents of the application, or a specific document in the file of a pending application that has been published as a patent application publication may be provided to any person upon request, and payment of the appropriate fee set forth in § 1.19(b). If a redacted copy of the application was used for the patent application publication, the copy of the specification, drawings, and papers may be limited to a redacted copy. The Office will not provide access to the paper file of a pending application that has been published, except as provided in paragraph (c) or (h) of this section.

(iv) *Unpublished abandoned applications (including provisional applications) that are identified or relied upon.* The file contents of an unpublished, abandoned application may be made available to the public if the application is identified in a

U.S. patent, a statutory invention registration, a U.S. patent application publication, or an international patent application publication of an international application that was published in accordance with PCT Article 21(2). An application is considered to have been identified in a document, such as a patent, when the application number or serial number and filing date, first named inventor, title and filing date or other application specific information are provided in the text of the patent, but not when the same identification is made in a paper in the file contents of the patent and is not included in the printed patent. Also, the file contents may be made available to the public, upon a written request, if benefit of the abandoned application is claimed under 35 U.S.C. 119(e), 120, 121, or 365 in an application that has issued as a U.S. patent, or has published as a statutory invention registration, a U.S. patent application publication, or an international patent application that was published in accordance with PCT Article 21(2). A copy of the application-as-filed, the file contents of the application, or a specific document in the file of the application may be provided to any person upon written request, and payment of the appropriate fee (§ 1.19(b)).

(v) *Unpublished pending applications (including provisional applications) whose benefit is claimed.* A copy of the file contents of an unpublished pending application may be provided to any person, upon written request and payment of the appropriate fee (§ 1.19(b)), if the benefit of the application is claimed under 35 U.S.C. 119(e), 120, 121, or 365 in an application that has issued as a U.S. patent, an application that has published as a statutory invention registration, a U.S. patent application publication, or an international patent application publication that was published in accordance with PCT Article 21(2). A copy of the application-as-filed, or a specific document in the file of the pending application may also be provided to any person upon written request, and payment of the appropriate fee (§ 1.19(b)). The Office will not provide access to the paper file of a pending application, except as provided in paragraph (c) or (h) of this section.

(vi) *Unpublished pending applications (including provisional applications) that are incorporated by reference or otherwise identified.* A copy of the application as originally filed of an unpublished pending application may be provided to any person, upon written request and payment of the appropriate fee (§ 1.19(b)), if the application is incorporated by reference or otherwise identified in a U.S. patent, a statutory invention registration, a U.S. patent application publication, or an international patent application publication that was published in accordance with PCT Article 21(2). The Office will not provide access to the paper file of a pending application, except as provided in paragraph (c) or (h) of this section.

(vii) *When a petition for access or a power to inspect is required.* Applications that were not published or patented, that are not the subject of a benefit claim under 35 U.S.C. 119(e), 120, 121, or 365 in an application that has issued as a U.S. patent, an application that has published as a statutory invention registration, a U.S. patent application publication, or an international patent application publication that was published in accordance with PCT Article 21(2), or are not identified in a U.S. patent, a statutory invention registration, a U.S. patent application publication, or an international patent application that was published in accordance with PCT Article 21(2), are not available to the public. If an application is identified in the file contents of another application, but not the published patent application or patent itself, a granted petition for access (see paragraph (h)) or a power to inspect (see paragraph (c)) is necessary to obtain the application, or a copy of the application.

(2) Information concerning a patent application may be communicated to the public if the patent application is identified in paragraphs (a)(1)(i) through (a)(1)(vi) of this section. The information that may be communicated to the public (*i.e.*, status information) includes:

(i) Whether the application is pending, abandoned, or patented;

(ii) Whether the application has been published under 35 U.S.C. 122(b);

(iii) The application “numerical identifier” which may be:

- (A) The eight-digit application number (the two-digit series code plus the six-digit serial number); or
- (B) The six-digit serial number plus any one of the filing date of the national application, the international filing date, or date of entry into the national stage; and

(iv) Whether another application claims the benefit of the application (*i.e.*, whether there are any applications that claim the benefit of the filing date under 35 U.S.C. 119(e), 120, 121 or 365 of the application), and if there are any such applications, the numerical identifier of the application, the specified relationship between the applications (*e.g.*, continuation), whether the application is pending, abandoned or patented, and whether the application has been published under 35 U.S.C. 122(b).

\*\*\*\*\*

## I. ACCESS TO IMAGE FILE WRAPPER (IFW) APPLICATIONS

The USPTO adopted an electronic data processing system for the storage and maintenance of all records associated with patent applications. All new applications filed on or after June 30, 2003 are stored in this system as an Image File Wrapper (IFW), and the IFW is the official record of the application. Similarly, as earlier filed pending applications are loaded into the IFW system, the electronic record will be the official record of the application. There is no corresponding paper file wrapper for IFW applications. When access to IFW applications is available to the public in the File Information Unit (FIU) and/or over the Internet, the public will be able to access pending and abandoned published patent applications pursuant to 37 CFR 1.14(a)(1)(ii) and (iii). If an application is an IFW application and FIU/Internet access is not yet available for IFW applications, then the file itself will

not be available to the public for inspection. However, copies of the application file may be obtained pursuant to 37 CFR 1.14(a)(1)(ii) and (iii).

## II. < PUBLISHED U.S. PATENT APPLICATIONS

*37 CFR 1.14. Patent applications preserved in confidence.*  
\*\*>

(a) Confidentiality of patent application information. Patent applications that have not been published under 35 U.S.C. 122(b) are generally preserved in confidence pursuant to 35 U.S.C. 122(a). Information concerning the filing, pendency, or subject matter of an application for patent, including status information, and access to the application, will only be given to the public as set forth in § 1.11 or in this section.

(1) Records associated with patent applications (see paragraph (g) for international applications) may be available in the following situations:

\*\*\*\*\*

(ii) Published abandoned applications. The file of an abandoned application that has been published as a patent application publication is available to the public as set forth in § 1.11(a). A copy of the application-as-filed, the file contents of the published application, or a specific document in the file of the published application may be provided to any person upon request, and payment of the appropriate fee set forth in § 1.19(b).

(iii) Published pending applications. A copy of the application-as-filed, the file contents of the application, or a specific document in the file of a pending application that has been published as a patent application publication may be provided to any person upon request, and payment of the appropriate fee set forth in § 1.19(b). If a redacted copy of the application was used for the patent application publication, the copy of the specification, drawings, and papers may be limited to a redacted copy. The Office will not provide access to the paper file of a pending application that has been published, except as provided in paragraph (c) or (h) of this section.<

\*\*\*\*\*

If a patent application has been published pursuant to 35 U.S.C. 122(b), then a copy of the specification, drawings, and all papers relating to the file of that published application (whether abandoned or pending) may be provided to any person upon written request and payment of the fee set forth in 37 CFR 1.19(b)\*. >See 37 CFR 1.14(a)(1)(ii) and (iii).< If a redacted copy of the application was used for the patent application publication, the copy of the application will be limited to the redacted copy of the application and the redacted materials provided under 37 CFR 1.217(d).

>See paragraph I., above, for information pertaining to access to Image File Wrapper (IFW) applications.< If the published patent application is pending, the application file itself will not be available to the public for inspection. Only copies of the application file may be obtained pursuant to 37 CFR \*\*>1.14(a)(1)(iii)<. If the published patent application is abandoned, the entire application is available to the public for inspection and obtaining copies. See 37 CFR 1.11(a).

\*\*>

## III. UNPUBLISHED ABANDONED AND PENDING APPLICATIONS (INCLUDING PROVISIONAL APPLICATIONS) THAT ARE IDENTIFIED<

*37 CFR 1.14. Patent applications preserved in confidence.*

\*\*\*\*\*

\*\*>

(a) *Confidentiality of patent application information.* Patent applications that have not been published under 35 U.S.C. 122(b) are generally preserved in confidence pursuant to 35 U.S.C. 122(a). Information concerning the filing, pendency, or subject matter of an application for patent, including status information, and access to the application, will only be given to the public as set forth in § 1.11 or in this section.

(1) Records associated with patent applications (see paragraph (g) for international applications) may be available in the following situations:

\*\*\*\*\*

(iv) *Unpublished abandoned applications (including provisional applications) that are identified or relied upon.* The file contents of an unpublished, abandoned application may be made available to the public if the application is identified in a U.S. patent, a statutory invention registration, a U.S. patent application publication, or an international patent application publication of an international application that was published in accordance with PCT Article 21(2). An application is considered to have been identified in a document, such as a patent, when the application number or serial number and filing date, first named inventor, title and filing date or other application specific information are provided in the text of the patent, but not when the same identification is made in a paper in the file contents of the patent and is not included in the printed patent. Also, the file contents may be made available to the public, upon a written request, if benefit of the abandoned application is claimed under 35 U.S.C. 119(e), 120, 121, or 365 in an application that has issued as a U.S. patent, or has published as a statutory invention registration, a U.S. patent application publication, or an international patent application that was published in accordance with PCT Article 21(2). A copy of the application-as-filed, the file contents of the application, or a specific document in the file of the application may be provided to

any person upon written request, and payment of the appropriate fee (§ 1.19(b)).

\*\*\*\*\*

(vi) *Unpublished pending applications (including provisional applications) that are incorporated by reference or otherwise identified.* A copy of the application as originally filed of an unpublished pending application may be provided to any person, upon written request and payment of the appropriate fee (§ 1.19(b)), if the application is incorporated by reference or otherwise identified in a U.S. patent, a statutory invention registration, a U.S. patent application publication, or an international patent application publication that was published in accordance with PCT Article 21(2). The Office will not provide access to the paper file of a pending application, except as provided in paragraph (c) or (h) of this section.

\*\*\*\*\*

Abandoned applications meeting the requirements of 37 CFR 1.14(a)(1)(iv) and any application that is open to the public under 37 CFR 1.11 may be obtained by any person upon written request to the FIU without the specific written authority of the applicant, assignee, attorney or agent of record or Director. The following abandoned applications are available from the FIU: (A) An abandoned application referred to in a U.S. patent application publication or U.S. patent; and (B) a pending File Wrapper Continuation application (FWC) filed under former 37 CFR 1.62 of an abandoned application that meets the requirements of 37 CFR 1.14(a)(1)(iv). Under former 37 CFR 1.62(f), where access is permitted to an application within the file wrapper of a FWC application, the applicant has waived the right to keep all earlier filed applications in the same file wrapper in confidence.

37 CFR 1.14(a)(1)(i) relates only to United States applications that are open to public inspection. See 37 CFR 1.14(g)(3)-(5) for access to international applications where the U.S. is designated. See also MPEP § 110. If an abandoned application is referred to in an international application that is published in accordance with PCT Article 21(2), access to the abandoned application is available under 37 CFR 1.14(a)(1)(iv).

An abandoned non-IFW application identified in a U.S. patent application publication, U.S. patent or a U.S. application that is open to public inspection may be ordered for inspection by any member of the public through the FIU. An abandoned file received by a member of the public must be returned to the charge

counter in the FIU before closing the same day it is received. If the abandoned application is contained within a pending FWC application, the requester will generally be directed to the appropriate Technology Center (TC) to inquire as to the availability of the pending FWC application. If the pending FWC application is available, it will be forwarded to the FIU for the requester to pick-up. See paragraph I., above, for information pertaining to access to IFW applications.

The incorporation by reference of a pending application in a U.S. patent application publication, a U.S. patent, a published international application published in accordance with PCT Article 21(2), or a statutory invention registration constitutes a special circumstance under 35 U.S.C. 122 warranting that a copy of the application-as-filed be provided upon written request as provided in 37 CFR 1.14(a)(1)(iv). In addition, if a U.S. patent application publication, a U.S. patent, or a published international application claims benefit under 35 U.S.C. 119(e), 120, 121, or 365 to a U.S. patent application, a copy of that application-as-filed may be provided upon written request. A benefit claim in an international application that does not designate the United States is not a claim under 35 U.S.C. 119(e), 120, 121 or 365. The written request, including a copy of the page of the patent application publication, U.S. patent, or published international application including the incorporation by reference or specific reference under 35 U.S.C. 119(e), 120, 121, or 365, and the requisite fee set forth in 37 CFR 1.19(b)(1), should be directed to the Certification Division. However, an incorporation by reference that is made as part of a transmittal letter for the application, or that is a part of the text of the application that has been canceled and which does not appear as part of the printed patent, may not be relied upon to obtain a copy of the application as originally filed. A petition for access with an explanation of special circumstances other than the not-printed incorporation by reference will be required. See 37 CFR 1.14(a)(1)(vii).

Copies of a patent application-as-filed and the contents of a patent application file wrapper may be ordered from the Certification Division with a facsimile request and payment of the appropriate fee under 37 CFR 1.19(b) by USPTO Deposit Account, American Express®, Discover®, MasterCard®, or Visa® by any person having a right to access to the



originally filed application or patent. The Office does not provide for access to non-United States applications.

Form PTO/SB/68 may be used to request access.

PTO/SB/68 (08-03)

Approved for use through 7/31/2006. OMB 0651-0031  
U.S. Patent and Trademark Office; U.S. DEPARTMENT OF COMMERCE

Under the Paperwork Reduction Act of 1995, no persons are required to respond to a collection of information unless it displays a valid OMB control number.

**REQUEST FOR ACCESS TO AN ABANDONED APPLICATION UNDER 37 CFR 1.14**

Bring completed form to:  
File Information Unit  
Crystal Plaza Three, Room 1D01  
2021 South Clark Place  
Arlington, VA  
Telephone: (703) 308-2733

In re Application of _____	
Application Number _____	Filed _____

Paper No. \_\_\_\_\_

**I hereby request access under 37 CFR 1.14(a)(1)(iv) to the application file record of the above-identified ABANDONED application, which is identified in, or to which a benefit is claimed, in the following document (as shown in the attachment):**

United States Patent Application Publication No. \_\_\_\_\_, page, \_\_\_\_\_ line \_\_\_\_\_,  
United States Patent Number \_\_\_\_\_, column \_\_\_\_\_, line, \_\_\_\_\_ or  
WIPO Pub. No. \_\_\_\_\_, page \_\_\_\_\_, line \_\_\_\_\_.

**Related Information about Access to Pending Applications (37 CFR 1.14):**

**Direct access to pending applications is not available to the public (see 37 CFR 1.14(c) if applicant) but copies may be available and may be purchased from the Office of Public Records upon payment of the appropriate fee (37 CFR 1.19(b)), as follows:**

**For published applications that are still pending,** a member of the public may obtain a copy of:  
the file contents;  
the pending application as originally filed; or  
any document in the file of the pending application.

**For unpublished applications that are still pending:**

- (1) If the benefit of the pending application is claimed under 35 U.S.C. 119(e), 120, 121, or 365 in another application that has: (a) issued as a U.S. patent, or (b) published as a statutory invention registration, a U.S. patent application publication, or an international patent application publication in accordance with PCT Article 21(2), a member of the public may obtain a copy of:  
the file contents;  
the pending application as originally filed; or  
any document in the file of the pending application.
- (2) If the application is incorporated by reference or otherwise identified in a U.S. patent, a statutory invention registration, a U.S. patent application publication, or an international patent application publication in accordance with PCT Article 21(2), a member of the public may obtain a copy of:  
the pending application as originally filed.

_____ Signature	_____ Date
_____ Typed or printed name	FOR PTO USE ONLY  Approved by: _____ (initials)  Unit: _____
_____ Registration Number, if applicable	
_____ Telephone Number	

This collection of information is required by 37 CFR 1.14. The information is required to obtain or retain a benefit by the public which is to file (and by the USPTO to process) an application. Confidentiality is governed by 35 U.S.C. 122 and 37 CFR 1.14. This collection is estimated to take 12 minutes to complete, including gathering, preparing, and submitting the completed application form to the USPTO. Time will vary depending upon the individual case. Any comments on the amount of time you require to complete this form and/or suggestions for reducing this burden, should be sent to the Chief Information Officer, U.S. Patent and Trademark Office, U.S. Department of Commerce, P.O. Box 1450, Alexandria, VA 22313-1450. DO NOT SEND FEES OR COMPLETED FORMS TO THIS ADDRESS. **BRING TO: File Information Unit, Crystal Plaza Three, Room 1D01, 2021 South Clark Place, Arlington, VA.**

*If you need assistance in completing the form, call 1-800-PTO-9199 and select option 2.*

#### IV. ACCESS WHERE PART OF AN APPLICATION IS INCORPORATED BY REFERENCE IN A U.S. PATENT APPLICATION PUBLICATION OR A U.S. PATENT

37 CFR 1.14(a)(1)(vi) permits a member of the public, without a petition for access, to obtain a copy of a pending application as originally filed, when the application is incorporated by reference in a U.S. patent application publication or a U.S. patent, upon the filing of an appropriate request and the payment of the required fee. However, if only part of the application is incorporated by reference, for example, where an application states, “the disclosure of a valve on page 5, lines 5-35, of application No. XX/YYY,YYY, is hereby incorporated by reference,” then a petition for access is required to obtain access to or a copy of the incorporated material. Incorporation by reference of part of an application in a U.S. patent application publication or a U.S. patent constitutes a special circumstances under 35 U.S.C. 122(a) warranting that access to that part of the original disclosure of the application be granted on petition. The incorporation by reference will be interpreted as a waiver of confidentiality of only that part of the original disclosure as filed, and not the entire application file. *In re Gallo*, 231 USPQ 496 (Comm’r Pat. 1986). If applicant objects to access to the entire application file, applicant must file two copies of the information incorporated by reference along with the objection. In the example given, applicant would be required to provide two copies of page 5, lines 5-35 of the XX/YYY,YYY application. Failure to provide the material within the time period provided will result in the entire application content (including prosecution history) being made available to the petitioner. The Office will not attempt to separate the noted materials from the remainder of the application. Compare *In re Marsh Eng’g. Co.*, 1913 C.D. 183 (Comm’r Pat. 1913).

#### V. < PETITION FOR ACCESS

37 CFR 1.14. Patent applications preserved in confidence.

\*\*\*\*\*

\*\*>

(vii) When a petition for access or a power to inspect is required. Applications that were not published or patented, that are not the subject of a benefit claim under 35 U.S.C. 119(e), 120,

121, or 365 in an application that has issued as a U.S. patent, an application that has published as a statutory invention registration, a U.S. patent application publication, or an international patent application publication that was published in accordance with PCT Article 21(2), or are not identified in a U.S. patent, a statutory invention registration, a U.S. patent application publication, or an international patent application that was published in accordance with PCT Article 21(2), are not available to the public. If an application is identified in the file contents of another application, but not the published patent application or patent itself, a granted petition for access (see paragraph (h)) or a power to inspect (see paragraph (c)) is necessary to obtain the application, or a copy of the application.

\*\*\*\*\*

(h) *Access or copies in other circumstances.* The Office, either *sua sponte* or on petition, may also provide access or copies of all or part of an application if necessary to carry out an Act of Congress or if warranted by other special circumstances. Any petition by a member of the public seeking access to, or copies of, all or part of any pending or abandoned application preserved in confidence pursuant to paragraph (a) of this section, or any related papers, must include:

- (1) The fee set forth in § 1.17(h); and
- (2) A showing that access to the application is necessary to carry out an Act of Congress or that special circumstances exist which warrant petitioner being granted access to all or part of the application.<

Any interested party may file a petition, accompanied by the petition fee, to the \*>Director< for access to an application. Inasmuch as the post office address is necessary for the complete identification of the petitioner, it should always be included complete with ZIP Code number. In addition, telephone and facsimile numbers should be provided to expedite handling of the petition. Petitions for access are handled in the Office of Patent Legal Administration, unless the application is involved in an interference. See MPEP § 1002.02(b).

The petition may be filed either with proof of service of copy upon the applicant, assignee of record, or attorney or agent of record in the application to which access is sought, or the petition may be filed in duplicate, in which case the duplicate copy will be sent by the Office to the applicant, assignee of record, or attorney or agent of record in the application (hereinafter “applicant”). A separate petition, with fee, must be filed for each application file to which access is desired. Each petition should show not only why access is desired, but also why petitioner believes he or she is entitled to access. The applicant will normally be given a limited period such as 3 weeks

within which to state any objection to the granting of the petition for access and reasons why it should be denied. If applicant states that he or she has no objection to the requested access, the petition will be granted. If objection is raised or applicant does not respond, the petition will be decided on the record. If access is granted to the application, any objections filed by the applicant will be available to the petitioner since these papers are in the application file. If access to the application is denied, petitioner will not receive copies of any objections filed by the applicant. A determination will be made whether "special circumstances" are present which warrant a grant of access under 35 U.S.C. 122. See below when the application is the basis of a claim for benefit of an earlier filing date under 35 U.S.C. 120 or part of the application is incorporated by reference in a United States patent. "Special circumstances" could be found where an applicant has relied upon his or her application as a means to interfere with a competitor's business or customers. See *In re Crossman*, 187 USPQ 367 (PTO Solicitor 1975); *In re Trimless Cabinets*, 128 USPQ 95 (Comm'r Pat. 1960); and *Ex parte Bonnie-B Co.*, 1923 C.D. 42, 313 O.G. 453 (Comm'r Pat. 1922). Furthermore, "special circumstances" could be found where an attorney or agent of record in an application in which a provisional double patenting rejection is made does not have power of attorney in the copending application having a common assignee or inventor. However, a more expeditious means of obtaining access would be to obtain power to inspect from an assignee or inventor. See MPEP § 104 and § 106.01.

>

**VI. < ACCESS WHERE PATENT CLAIMS 35 U.S.C. >119(e)<, 120>, 121, or 365< BENEFIT**

37 CFR 1.14. Patent applications preserved in confidence.

\*\*>

(a) Confidentiality of patent application information. Patent applications that have not been published under 35 U.S.C. 122(b) are generally preserved in confidence pursuant to 35 U.S.C. 122(a). Information concerning the filing, pendency, or subject matter of an application for patent, including status information, and access to the application, will only be given to the public as set forth in § 1.11 or in this section.

(1) Records associated with patent applications (see paragraph (g) for international applications) may be available in the following situations:

\*\*\*\*\*

(iv) Unpublished abandoned applications (including provisional applications) that are identified or relied upon. The file contents of an unpublished, abandoned application may be made available to the public if the application is identified in a U.S. patent, a statutory invention registration, a U.S. patent application publication, or an international patent application publication of an international application that was published in accordance with PCT Article 21(2). An application is considered to have been identified in a document, such as a patent, when the application number or serial number and filing date, first named inventor, title and filing date or other application specific information are provided in the text of the patent, but not when the same identification is made in a paper in the file contents of the patent and is not included in the printed patent. Also, the file contents may be made available to the public, upon a written request, if benefit of the abandoned application is claimed under 35 U.S.C. 119(e), 120, 121, or 365 in an application that has issued as a U.S. patent, or has published as a statutory invention registration, a U.S. patent application publication, or an international patent application that was published in accordance with PCT Article 21(2). A copy of the application-as-filed, the file contents of the application, or a specific document in the file of the application may be provided to any person upon written request, and payment of the appropriate fee (§ 1.19(b)).

(v) Unpublished pending applications (including provisional applications) whose benefit is claimed. A copy of the file contents of an unpublished pending application may be provided to any person, upon written request and payment of the appropriate fee (§ 1.19(b)), if the benefit of the application is claimed under 35 U.S.C. 119(e), 120, 121, or 365 in an application that has issued as a U.S. patent, an application that has published as a statutory invention registration, a U.S. patent application publication, or an international patent application publication that was published in accordance with PCT Article 21(2). A copy of the application-as-filed, or a specific document in the file of the pending application may also be provided to any person upon written request, and payment of the appropriate fee (§ 1.19(b)). The Office will not provide access to the paper file of a pending application, except as provided in paragraph (c) or (h) of this section.

(vi) Unpublished pending applications (including provisional applications) that are incorporated by reference or otherwise identified. A copy of the application as originally filed of an unpublished pending application may be provided to any person, upon written request and payment of the appropriate fee (§ 1.19(b)), if the application is incorporated by reference or otherwise identified in a U.S. patent, a statutory invention registration, a U.S. patent application publication, or an international patent application publication that was published in accordance with PCT Article 21(2). The Office will not provide access to the paper file of a pending application, except as provided in paragraph (c) or (h) of this section.

<

Whenever a patent relies on the filing date of an earlier but still pending application, \*\*>the Office

permits an applicant to obtain a copy of the prior application, either as originally filed or of the pending file history, upon written request (to the Office of Public Records) and payment of the appropriate fee. Furthermore, after publication of an international application that was published in accordance with PCT Article 21(2), a U.S. patent, a U.S. patent application publication, or a statutory invention registration, the file contents of any abandoned application identified or relied upon in such a publication are available pursuant to 37 CFR 1.14(a)(1)(iv). If the application is pending and benefit of the application is claimed pursuant to 35 U.S.C. 119(e), 120, 121 or 365 in such a patent document, then the file contents of the application are available pursuant to 37 CFR 1.14(a)(1)(v).

#### VII. < ACCESS TO PROVISIONAL APPLICATIONS

In provisional applications, access or certified copies will only be given to parties with written authority from a named inventor, the assignee of record, or the attorney or agent of record. Since provisional applications do not require an oath or declaration, there may be no power of attorney in the application. If there is no power of attorney in the provisional application, a certified copy requested by the registered attorney or agent named in the papers accompanying the provisional application papers will be supplied to the correspondence address of the provisional application. Provisional applications are also available in the same manner as any other application. For example, an application that is relied upon for priority in a U.S. patent and is abandoned is available under 37 CFR 1.14(a)(1)(iv).

>

#### VIII. < APPLICATION AT BOARD OF PATENT APPEALS AND INTERFERENCES

The Board of Patent Appeals and Interferences handles all petitions for access to applications involved in an interference. See 37 CFR 1.612.

>

#### IX. < DEFENSIVE PUBLICATIONS

If a defensive publication has been published, the entire application is available to the public for inspection and obtaining copies. See MPEP § 711.06.

>

#### X. < REISSUE APPLICATIONS

37 CFR 1.11(b) opens all reissue applications filed after March 1, 1977 to inspection by the general public. 37 CFR 1.11(b) also provides for announcement of the filings of reissue applications in the *Official Gazette* (except for continued prosecution applications filed under 37 CFR 1.53(d)). This announcement will give interested members of the public an opportunity to submit to the examiner information pertinent to patentability of the reissue application.

\*\*

37 CFR 1.11(b) is applicable only to those reissue applications filed on or after March 1, 1977. Those reissue applications previously on file will not be automatically open to inspection but a liberal policy will be followed by the Special Program Examiner in granting petitions for access to such applications. >See Paragraph I. above for information pertaining to access to IFW applications.<

For those reissue applications filed on or after March 1, 1977, the following procedure will be observed\*:><

(A) The filing of reissue applications will be announced in the *Official Gazette* (except for continued prosecution applications filed under 37 CFR 1.53(d)) and will include certain identifying data as specified in 37 CFR 1.11(b). Any member of the general public may request access to a particular reissue application filed after March 1, 1977. \*\*

(B) \*>Following the announcement in the *Official Gazette*, the< pending reissue application files will be maintained in the TCs and inspection thereof will be supervised by TC personnel. Although no general limit is placed on the amount of time spent reviewing the files, the Office may impose limitations, if necessary. No access will be permitted while the application is actively being processed.

(C) Where the reissue application has left the TC for administrative processing, requests for access should be directed to the appropriate supervisory personnel in the division or branch where the application is currently located.

(D) The reissue application file is not available to the public once the reissue application file has been released and forwarded by the TC for publication of the reissue patent. This would include any reissue

application files which have been selected for a post-allowance screening in the Office of Patent Legal Administration. Unless prosecution is reopened pursuant to the screening, the reissue application files are not available to the public until the reissue patent issues. This is because the reissue application file is put into a special format for printing purposes upon forwarding the application file for publication, and its release to the public would constitute a disruption of the publication process.

(E) Requests for copies of papers in the reissue application file must be in writing addressed to Mail Stop Document Services, Director of the United States Patent and Trademark Office, P.O. Box 1450, Alexandria, Virginia 22313-1450 and may be either mailed or delivered to the Customer Service Window. The price for a copy of an application as filed is set forth in 37 CFR 1.19(b)(1). Since no useful purpose is seen for retaining such written request for copies of papers in reissue applications, they should be destroyed after the order has been completed.

>

**XI. < REQUEST FOR REEXAMINATION**

>An announcement of the filing of each request for reexamination in which the entire fee has been paid, and of each reexamination ordered at the initiative of the Director under 37 CFR 1.520, will be published in the *Official Gazette*. A reexamination file is normally NOT open to inspection by the general public until the file has been scanned into the reexamination database in the Central Reexamination Unit (CRU), at which point an electronic copy of the file is made available to the public. A Reexamination Processing System (REPS) terminal is available to the public in the Patent Search Room for accessing/copying reexamination files from the reexamination database. Access is free, and copies are 25 cents per page. All reexamination files are available to the public in electronic format only. See also MPEP § 2232.

>

**XII. <DECISIONS OF U.S. PATENT AND TRADEMARK OFFICE**

37 CFR 1.14. Patent applications preserved in confidence.

\*\*\*\*\*

\*\*>

(e) *Decisions by the Director or the Board of Patent Appeals and Interferences.* Any decision by the Director or the Board of Patent Appeals and Interferences which would not otherwise be open to public inspection may be published or made available for public inspection if:

(1) The Director believes the decision involves an interpretation of patent laws or regulations that would be of precedential value; and

(2) The applicant, or a party involved in an interference for which a decision was rendered, is given notice and an opportunity to object in writing within two months on the ground that the decision discloses a trade secret or other confidential information. Any objection must identify the deletions in the text of the decision considered necessary to protect the information, or explain why the entire decision must be withheld from the public to protect such information. An applicant or party will be given time, not less than twenty days, to request reconsideration and seek court review before any portions of a decision are made public under this paragraph over his or her objection.

\*\*\*\*\*

37 CFR 1.14(e) states the conditions under which significant decisions of the U.S. Patent and Trademark Office that would not otherwise be open to public inspection will be made available to the public. 37 CFR 1.14(e) includes decisions of the Board of Patent Appeals and Interferences and the Director. The section is applicable to decisions deemed by the Director to involve an interpretation of patent laws or regulation that would be of significant precedential value, where such decisions are contained in either pending or abandoned applications or in interference files not otherwise open to the public. It is applicable whether or not the decision is a final decision of the U.S. Patent and Trademark Office.

37 CFR 1.14(e) is considered to place a duty on the U.S. Patent and Trademark Office to identify significant decisions and to take the steps necessary to inform the public of such decisions, by publication of such decisions, in whole or in part. It is anticipated, however, that no more than a few dozen decisions per year will be deemed of sufficient importance to warrant publication under the authority of this section.

>

### XIII. <FOIA REQUESTS

\*\*>

#### 37 CFR 102.4. Requirements for making requests.

(a) A request for USPTO records that are not customarily made available to the public as part of USPTO's regular informational services must be in writing, and shall be processed under FOIA, regardless of whether FOIA is mentioned in the request. Requests should be sent to the USPTO FOIA Officer, United States Patent and Trademark Office, P.O. Box 1450, Alexandria, Virginia 22313-1450 (records FOIA requires to be made regularly available for public inspection and copying are addressed in § 102.2(c)). For the quickest handling, the request letter and envelope should be marked "Freedom of Information Act Request." For requests for records about oneself, § 102.24 contains additional requirements. For requests for records about another individual, either a written authorization signed by that individual permitting disclosure of those records to the requester or proof that individual is deceased (for example, a copy of a death certificate or an obituary) facilitates processing the request.

(b) The records requested must be described in enough detail to enable USPTO personnel to locate them with a reasonable amount of effort. Whenever possible, a request should include specific information about each record sought, such as the date, title or name, author, recipient, and subject matter of the record, and the name and location of the office where the record is located. Also, if records about a court case are sought, the title of the case, the court in which the case was filed, and the nature of the case should be included. If known, any file designations or descriptions for the requested records should be included. In general, the more specifically the request describes the records sought, the greater the likelihood that USPTO will locate those records. If the FOIA Officer determines that a request does not reasonably describe records, the FOIA Officer will inform the requester what additional information is needed or why the request is otherwise insufficient. The FOIA Officer also may give the requester an opportunity to discuss the request so that it may be modified to meet the requirements of this section.<

Many decisions of the Office are available on the FOIA section of the U.S. Patent and Trademark Office website at [www.uspto.gov/web/offices/com/sol/foia/index.html](http://www.uspto.gov/web/offices/com/sol/foia/index.html). >See 37 CFR Part 102, Subpart A, "Freedom of Information Act," for rules pertaining to FOIA requests.<

### 104 Power to Inspect Application [R-2]

#### 37 CFR 1.14. Patent applications preserved in confidence.

\*\*\*\*\*

\*\*>

(c) *Power to inspect a pending or abandoned application.* Access to an application may be provided to any person if the application file is available, and the application contains written

authority (*e.g.*, a power to inspect) granting access to such person. The written authority must be signed by:

- (1) An applicant;
- (2) An attorney or agent of record;
- (3) An authorized official of an assignee of record (made of record pursuant to § 3.71 of this chapter); or
- (4) A registered attorney or agent named in the papers accompanying the application papers filed under § 1.53 or the national stage documents filed under § 1.495, if an executed oath or declaration pursuant to § 1.63 or § 1.497 has not been filed.

<

\*\*\*\*\*

If an executed oath or declaration pursuant to 37 CFR 1.63 or 1.497 has been filed, no person but the applicant (any one of joint applicants), an attorney or agent of record >(if a power of attorney was filed)<, or an assignee whose assignment is of record, will be permitted to have access to the file of any pending application, except as provided for under 37 CFR 1.11(b), former 37 CFR 1.62(f), or under the interference rules, unless written authority from one of the above indicated parties, identifying the application to be inspected and the name of the person authorized to have access, is made of record, or upon the written order of the \*>Director<, which will also become a part of the record of the application.

A person acting in a representative capacity under 37 CFR 1.34(a) may execute a power to inspect an application only if the attorney or agent was named in the application transmittal papers filed under 37 CFR 1.53 or the national stage documents filed under 37 CFR \*\* 1.495 and an executed oath or declaration has not been filed. Once an executed oath or declaration has been filed, any previously filed power to inspect signed by an registered attorney or agent who \*\*>does not have a power of attorney< will cease to have effect. For a discussion of power of attorney in an application, see MPEP § 402.

Approval by the primary examiner of a power to inspect is *not* required. The technical support staff of the Technology Center (TC) to which the application is assigned ascertains that the power is properly signed by one of the above indicated parties, and if acceptable, enters it into the file. If the power to inspect is unacceptable, notification of nonentry is written by the technical support staff to the person who signed the power.

When a power to inspect is received while a file is under the jurisdiction of a service branch, such as the

Customer Services Division, the Service Branch of the Board of Patent Appeals and Interferences, and the Publishing Division of the Office of Patent Publication, the question of permission to inspect is decided by the head of the branch who, if he or she approves, indicates the approval directly on the power (in the "Office use only" section).

Powers to inspect are not accepted in Image File Wrapper (IFW) applications. IFW applications are available through the Private Patent Application Information Retrieval (PAIR) system, and *pro se* applicants and attorneys of record have direct access to the IFW through Private PAIR (when a Customer Number is associated with the correspondence address for the application, and the applicant or attorney has access to Private PAIR for the customer number). In the future, IFW application files of published applications or patents will be available at least through Public PAIR. If for some reason an applicant, assignee, or attorney or agent of record cannot view an IFW application through PAIR, then a copy of the application must be purchased from the Office of Public Records.

A "power to inspect" is, in effect, the same as a "power to inspect and make copies."

Where an applicant relied on his or her application as a means to interfere with a competitor's business or customers, permission to inspect the application may be given the competitor by the Director. *Ex parte Bonnie-B Co.*, 1923 C.D. 42, 313 O.G. 453, (Comm'r Pat. 1922). Such permission is via petition for access under 37 CFR 1.14(h).

An unrestricted power to inspect given by an applicant is, under existing practice, recognized as in effect until and unless rescinded. The same is true in the case of one given by the attorney or agent of record, or assignee so long as such attorney or agent, or assignee retains his or her connection with the application.

Permission to inspect given by the Director, however, is not of a continuing nature, since the conditions that justified the permission to inspect when given may not apply at a later date.

**ACCESS TO PATENT APPLICATIONS AND INTERFERENCE FILES**

In order to ensure that access to patent applications, other than \* applications that are available pursuant to 37 CFR 1.11 or 1.14, and interference files is given only to persons who are entitled thereto or who are specially authorized to have access under 37 CFR 1.14 and to ensure also that the file record identifies any such specially authorized person who has been given access to a file, the following practice will be observed by all personnel of the U.S. Patent and Trademark Office:

(A) Access, as provided for in the rules, will be given on *oral request* to any applicant, patentee, assignee, or attorney or agent of record in an application or patent only upon *proof of identity* or upon recognition based on personal acquaintance.

(B) Where a power of attorney or authorization of agent was given to a registered firm prior to July 2, 1971, access will be given upon oral request as in paragraph (A) above to any registered member or employee of the firm who has signatory power for the firm.

(C) Unregistered employees of attorneys or agents, public stenographers, and all other persons not within the provisions of paragraphs (A) and (B) above will be given access only upon presentation of a *written authorization for access* (power to inspect) signed by a person specified in paragraph (A) above, which authorization will be entered as a part of the official file. The power to inspect must *specifically* name the person who is entitled to inspect and copy the application. An associate or representative of the named person is not entitled to access to the application on behalf of the authorized person. Further, the power to inspect must specifically identify the application by application number and be limited to a single application. Form PTO/SB/67 may be used for this purpose.

(D) In provisional applications, access or certified copies may only be requested by parties with written authority from a named inventor, the assignee of record, or the attorney or agent of record, unless the application is available pursuant to 37 CFR 1.14(a)(1)(iv)-(vi). Since provisional applications do not require an oath or declaration, there may be no



power of attorney in the application. If the person requesting a certified copy is not a named inventor, assignee of record, or an attorney or agent of record, the requested certified copy will be supplied to the correspondence address of the provisional application.

### **105 Suspended or Excluded Practitioner Cannot Inspect [R-2]**

U.S. Patent and Trademark Office (USPTO) employees are forbidden to hold either oral or written communication with an attorney or agent who has been suspended or excluded from practice by the USPTO regarding an application unless it is one in which said attorney or agent is the applicant. Power to inspect given to such an attorney or agent will not be accepted.

### **106 Control of Inspection by Assignee [R-2]**

The assignee of record of the entire interest in an application may intervene in the prosecution of the application, appointing an attorney or agent of his or her own choice. See 37 CFR 3.71. Such intervention, however, does not exclude the applicant from access to the application to see that it is being prosecuted properly, unless the assignee makes specific request to that effect. Any request to prevent the inventor from obtaining access to the file should be filed as a separate paper, 37 CFR 1.4(c), and should be directed to the Office of Petitions. If the request is granted, the inventor will be informed that he or she will only be permitted to inspect the application on sufficient showing why such inspection is necessary to conserve his or her rights, *In re The Kellogg Switchboard & Supply Company*, 1906 C.D. 274 (Comm'r Pat. 1906), or after the application has published pursuant to 35 U.S.C. 122(b).

#### **106.01 Rights of Assignee of Part Interest**

While it is only the assignee of record of the entire interest who can intervene in the prosecution of an application or interference to the exclusion of the applicant, an assignee of a part interest or a licensee of exclusive right is entitled to inspect the application.

See also MPEP § 402.10 for applications accorded status under 37 CFR 1.47.

### **110 Confidential Nature of International Applications [R-2]**

*PCT Article 30.*

*Confidential Nature of the International Application.*

(1)(a) Subject to the provisions of subparagraph (b), the International Bureau and the International Searching Authorities shall not allow access by any person or authority to the international application before the international publication of that application, unless requested or authorized by the applicant.

(b) The provisions of subparagraph (a) shall not apply to any transmittal to the competent International Searching Authority, to transmittals provided for under Article 13, and to communications provided for under Article 20.

(2)(a) No national Office shall allow access to the international application by third parties unless requested or authorized by the applicant, before the earliest of the following dates:

(i) date of the international publication of the international application,

(ii) date of receipt of the communication of the international application under Article 20,

(iii) date of receipt of a copy of the international application under Article 22.

(b) The provisions of subparagraph (a) shall not prevent any national Office from informing third parties that it has been designated, or from publishing that fact. Such information or publication may, however, contain only the following data: identification of the receiving Office, name of the applicant, international filing date, international application number, and title of the invention.

(c) The provisions of subparagraph (a) shall not prevent any designated Office from allowing access to the international application for the purposes of the judicial authorities.

(3) The provisions of paragraph (2)(a) shall apply to any receiving Office except as so far as transmittals provided for under Article 12(1) are concerned.

(4) For the purposes of this Article, the term "access" covers any means by which third parties may acquire cognizance, including individual communication and general publication, provided, however, that no national Office shall generally publish an international application or its translation before the international publication or, if international publication has not taken place by the expiration of 20 months from the priority date, before the expiration of 20 months from the said priority date.

*PCT Article 38.*

*Confidential Nature of the International Preliminary Examination.*

(1) Neither the International Bureau nor the International Preliminary Examining Authority shall, unless requested or authorized by the applicant, allow access within the meaning, and with the proviso, of Article 30(4) to the file of the international

preliminary examination by any person or authority at any time, except by the elected Offices once the international preliminary examination report has been established.

(2) Subject to the provisions of paragraph (1) and Articles 36(1) and (3) and 37(3)(b), neither the International Bureau nor the International Preliminary Examining Authority shall, unless requested or authorized by the applicant, give information on the issuance or non-issuance of an international preliminary examination report and on the withdrawal or non-withdrawal of the demand or of any election.

*35 U.S.C. 368. Secrecy of certain inventions; filing international applications in foreign countries.*

(a) International applications filed in the Patent and Trademark Office shall be subject to the provisions of chapter 17 of this title.

(b) In accordance with article 27 (8) of the treaty, the filing of an international application in a country other than the United States on the invention made in this country shall be considered to constitute the filing of an application in a foreign country within the meaning of chapter 17 of this title, whether or not the United States is designated in that international application.

(c) If a license to file in a foreign country is refused or if an international application is ordered to be kept secret and a permit refused, the Patent and Trademark Office when acting as a Receiving Office, International Searching Authority, or International Preliminary Examining Authority, may not disclose the contents of such application to anyone not authorized to receive such disclosure.

Although most international applications are published soon after the expiration of 18 months from the priority date, PCT Article 21(2)(a), such publication does not open up the Home Copy or Search Copy to the public for inspection, except as provided in 37 CFR 1.14(g).

*37 CFR 1.14. Patent applications preserved in confidence.*

\*\*\*\*\*

\*\*>

(g) *International applications.*

(1) Copies of international application files for international applications which designate the U.S. and which have been published in accordance with PCT Article 21(2), or copies of a document in such application files, will be furnished in accordance with PCT Articles 30 and 38 and PCT Rules 94.2 and 94.3, upon written request including a showing that the publication of the application has occurred and that the U.S. was designated, and upon payment of the appropriate fee (see § 1.19(b)), if:

(i) With respect to the Home Copy (the copy of the international application kept by the Office in its capacity as the Receiving Office, see PCT Article 12(1)), the international application was filed with the U.S. Receiving Office;

(ii) With respect to the Search Copy (the copy of an international application kept by the Office in its capacity as the International Searching Authority, see PCT Article 12(1)), the

U.S. acted as the International Searching Authority, except for the written opinion of the International Searching Authority which shall not be available until the expiration of thirty months from the priority date; or

(iii) With respect to the Examination Copy (the copy of an international application kept by the Office in its capacity as the International Preliminary Examining Authority), the United States acted as the International Preliminary Examining Authority, an International Preliminary Examination Report has issued, and the United States was elected.

(2) A copy of an English language translation of a publication of an international application which has been filed in the United States Patent and Trademark Office pursuant to 35 U.S.C. 154(d)(4) will be furnished upon written request including a showing that the publication of the application in accordance with PCT Article 21(2) has occurred and that the U.S. was designated, and upon payment of the appropriate fee (§ 1.19(b)(4)).

(3) Access to international application files for international applications which designate the U.S. and which have been published in accordance with PCT Article 21(2), or copies of a document in such application files, will be permitted in accordance with PCT Articles 30 and 38 and PCT Rules 44<sup>ter</sup>.1, 94.2 and 94.3, upon written request including a showing that the publication of the application has occurred and that the U.S. was designated.

(4) In accordance with PCT Article 30, copies of an international application-as-filed under paragraph (a) of this section will not be provided prior to the international publication of the application pursuant to PCT Article 21(2).

(5) Access to international application files under paragraphs (a)(1)(i) through (a)(1)(vi) and (g)(3) of this section will not be permitted with respect to the Examination Copy in accordance with PCT Article 38.<

\*\*\*\*\*

Effective \*\*>July 30, 2003<, 37 CFR 1.14(g)< was amended to provide greater access to international application files kept by the U.S. Patent and Trademark Office (USPTO). 37 CFR 1.14(g)< as amended applies to international applications having an international filing date on or after November 29, 2000. \*\* After publication of an application under 35 U.S.C. 122(b), the USPTO will make available copies of the application files and also allow for access to those files in accordance with 37 CFR 1.14(a)<. Therefore, after publication of an international application designating the U.S. under PCT Article 21, the USPTO will make available copies of, and allow access to, those international application files which are kept in the USPTO (see 37 CFR 1.14(g)<).

37 CFR 1.14(g)(1)< sets forth those conditions upon which copies of international application files may be provided to the public. 37 CFR

\*>1.14(g)(1)(i) and (ii)< address the situation where the U.S. acted as the receiving Office and the International Searching Authority, respectively. Under these provisions, copies of the Home and Search Copies of the international file will be provided upon request. >However, the written opinion established by the International Searching Authority will not be available until the expiration of 30 months from the priority date.< 37 \*>CFR 1.14(g)(1)(iii)< addresses the situation in which the U.S. acted as the International Preliminary Examining Authority (IPEA), the U.S. was elected, and the international preliminary examination report (IPER) has issued. PCT Rule 94.2 provides that after issuance of the IPER, the IPEA shall provide copies of any documents in the examination file to the elected Offices upon request. PCT Rule 94.3 permits the elected Offices to provide access to any documents in its files after international publication has occurred. Therefore, the USPTO acting in its capacity as an elected Office, will provide a copy of the examination file in an international application to a third party upon submission of a request complying with the requirements of 37 CFR \*>1.14(g)(1)(iii)<. Requests for copies of an international application file under 37 CFR \*>CFR 1.14(g)(1)< must be in the form of a written request >sent to the Office of PCT Legal Administration< and must include a showing that the international application has been published and that the U.S. was designated. Such a showing should preferably be in the form of the submission of a copy of the front page of the published international application. Additionally, requests for copies of international application files must also be accompanied by the appropriate fee (37 CFR 1.19(b)\*\*).

37 CFR \*>1.14(g)(2)< provides that copies of English language translations of international applications, which were published in a non-English language and which designated the U.S., and which have been submitted to the Office pursuant to 35 U.S.C. 154(d)(4), will also be available to the public. The USPTO will not provide general notification to the public of the filing of English language translations under 35 U.S.C. 154. Under 35 U.S.C. 154, it is the responsibility of the applicant to notify any possible infringers for the purposes of obtaining provisional rights.

37 CFR \*>1.14(g)(3)< addresses access to the Home Copy and the Search Copy of the international application. Access to the Examination Copy of the international application is prohibited under 37 CFR \*>1.14(g)(5)< as required by PCT Article 38.

## 115 Review of Applications for National Security and Property Rights Issues [R-2]

All provisional applications filed under 35 U.S.C. 111(b), nonprovisional applications filed under 35 U.S.C. 111(a), and international applications filed under the PCT, in the U.S. Patent and Trademark Office (USPTO) are reviewed for the purposes of issuance of a foreign filing license pursuant to 35 U.S.C. 184. See also 37 CFR 5.1(b). These applications are screened upon receipt in the USPTO for subject matter that, if disclosed, might impact the national security. Such applications are referred to the appropriate agencies for consideration of restrictions on disclosure of the subject matter. Authority for this referral can be found in 35 U.S.C. 181 which provides, in part:

Whenever the publication or disclosure of an invention by the publication of an application or by the granting of a patent, in which the Government does not have a property interest, might, in the opinion of the Commissioner of Patents, be detrimental to the national security, he shall make the application for patent in which such invention is disclosed available for inspection to the Atomic Energy Commission, the Secretary of Defense, and the chief officer of any other department or agency of the Government designated by the President as a defense agency of the United States.

If the agency concludes that disclosure of the invention would be detrimental to the national security, a secrecy order is recommended to the Commissioner >for Patents<. The Commissioner then issues a Secrecy Order and withholds the publication of the application or the grant of a patent for such period as the national interest requires.

Applications on inventions made outside the U.S. and on inventions in which a U.S. Government defense agency has a property interest will not be made available to defense agencies (see 37 CFR 5.1(f)). While 35 U.S.C. 181 does not expressly limit security review to applications made in the U.S., the licensing requirement of 35 U.S.C. 184, which limits

the need for a license only to inventions made in this country, has been interpreted to limit review under 35 U.S.C. 181 to inventions made in the U.S.

For those applications in which the Government has a property interest (including applications indicating national security classified subject matter), responsibility for notifying the Commissioner of Patents of the need for a Secrecy Order resides with the agency having that interest. Applications that are national security classified (see 37 CFR 1.9(i)) may be so indicated by use of authorized national security markings (e.g., “Confidential,” “Secret,” or “Top Secret”). National security classified documents filed in the USPTO must be either hand-carried to Licensing and Review or mailed to the Office in compliance with 37 CFR 5.1(a) and Executive Order 12958 of April 17, 1995 and Executive Order 13292 of March 25, 2003. As set forth in 37 CFR 5.1(d), the applicant in a national security classified patent application must obtain a secrecy order or provide authority to cancel the markings.

A second purpose for the screening of all applications is to identify inventions in which DOE or NASA might have property rights. See 42 U.S.C. 2182 and 42 U.S.C. 2457 and MPEP § 150.

A third function of the screening procedure is to process foreign filing license petitions under 37 CFR 5.12(a). See MPEP § 140.

Some applications have a label (Form PTO-1305) on the upper right hand corner of the face of the file wrapper. A Notice of Allowance and Fee(s) Due may not be mailed for those applications if the “REV” on the label is circled (although the examiner may be given credit for a disposal). Such cases must be forwarded to Licensing and Review to have the security review completed before the Notice of Allowance can be mailed. Cases in which only “DOE” and/or “NASA” is circled should be counted for allowance and the notice of allowance mailed before being sent to Licensing and Review for processing under the Atomic Energy and Space Acts. For Image File Wrapper (IFW) processing, see the IFW Manual.

All applications should be cleared from secrecy review before forwarding to issue. If the L&R code on the general information display does not equal 1, then an E-mail message should be sent to the supervisor of Licensing and Review, or in the case of an IFW appli-

cation, a message should be sent to LREVINCOM-INGDOCS.

Applications will be deleted from IFW upon the imposition of a secrecy order.

While the initial screening is performed only by designated personnel, all examiners have a responsibility to be alert for obviously sensitive subject matter either in the original disclosure or subsequently introduced, for example, by amendment. Applications that may disclose sensitive subject matter must be forwarded to Licensing & Review with the significant subject matter identified by a check mark in the margin of the paper or by some equivalent marking.

## 120 Secrecy Orders [R-2]

### 37 CFR 5.1. Correspondence.

\*\*>

(a) All correspondence in connection with this part, including petitions, should be addressed to: Commissioner for Patents (Attention Licensing and Review), P.O. Box 1450, Alexandria, Virginia 22313-1450.

(b) Application as used in this part includes provisional applications filed under 35 U.S.C. 111(b) (§ 1.9(a)(2) of this chapter), nonprovisional applications filed under 35 U.S.C. 111(a) or entering the national stage from an international application after compliance with 35 U.S.C. 371 (§ 1.9(a)(3)), or international applications filed under the Patent Cooperation Treaty prior to entering the national stage of processing (§ 1.9(b)).

(c) Patent applications and documents relating thereto that are national security classified (see § 1.9(i) of this chapter) and contain authorized national security markings (e.g., “Confidential,” “Secret” or “Top Secret”) are accepted by the Office. National security classified documents filed in the Office must be either hand-carried to Licensing and Review or mailed to the Office in compliance with paragraph (a) of this section.

(d) The applicant in a national security classified patent application must obtain a secrecy order pursuant to § 5.2(a). If a national security classified patent application is filed without a notification pursuant to § 5.2(a), the Office will set a time period within which either the application must be declassified, or the application must be placed under a secrecy order pursuant to § 5.2(a), or the applicant must submit evidence of a good faith effort to obtain a secrecy order pursuant to § 5.2(a) from the relevant department or agency in order to prevent abandonment of the application. If evidence of a good faith effort to obtain a secrecy order pursuant to § 5.2(a) from the relevant department or agency is submitted by the applicant within the time period set by the Office, but the application has not been declassified or placed under a secrecy order pursuant to § 5.2(a), the Office will again set a time period within which either the application must be declassified, or the application must be placed under a secrecy order pursuant to § 5.2(a), or the applicant must submit evidence of a good faith effort to again obtain a secrecy order pursuant to

§ 5.2(a) from the relevant department or agency in order to prevent abandonment of the application.

(e) An application will not be published under § 1.211 of this chapter or allowed under § 1.311 of this chapter if publication or disclosure of the application would be detrimental to national security. An application under national security review will not be published at least until six months from its filing date or three months from the date the application was referred to a defense agency, whichever is later. A national security classified patent application will not be published under § 1.211 of this chapter or allowed under § 1.311 of this chapter until the application is declassified and any secrecy order under § 5.2(a) has been rescinded.

(f) Applications on inventions made outside the United States and on inventions in which a U.S. Government defense agency has a property interest will not be made available to defense agencies.

### *37 CFR 5.2. Secrecy order.*

\*\*>

(a) When notified by the chief officer of a defense agency that publication or disclosure of the invention by the granting of a patent would be detrimental to the national security, an order that the invention be kept secret will be issued by the Commissioner for Patents.<

(b) Any request for compensation as provided in 35 U.S.C. 183 must not be made to the Patent and Trademark Office, but directly to the department or agency which caused the secrecy order to be issued.

(c) An application disclosing any significant part of the subject matter of an application under a secrecy order pursuant to paragraph (a) of this section also falls within the scope of such secrecy order. Any such application that is pending before the Office must be promptly brought to the attention of Licensing and Review, unless such application is itself under a secrecy order pursuant to paragraph (a) of this section. Any subsequently filed application containing any significant part of the subject matter of an application under a secrecy order pursuant to paragraph (a) of this section must either be hand-carried to Licensing and Review or mailed to the Office in compliance with § 5.1(a).

### *37 CFR 5.3. Prosecution of application under secrecy orders; withholding patent.*

Unless specifically ordered otherwise, action on the application by the Office and prosecution by the applicant will proceed during the time an application is under secrecy order to the point indicated in this section:

\*\*>

(a) National applications under secrecy order which come to a final rejection must be appealed or otherwise prosecuted to avoid abandonment. Appeals in such cases must be completed by the applicant but unless otherwise specifically ordered by the Commissioner for Patents will not be set for hearing until the secrecy order is removed.<

(b) An interference will not be declared involving national applications under secrecy order. However, if an applicant whose application is under secrecy order seeks to provoke an interfer-

ence with an issued patent, a notice of that fact will be placed in the file wrapper of the patent. (See § 1.607(d)).

(c) When the national application is found to be in condition for allowance except for the secrecy order the applicant and the agency which caused the secrecy order to be issued will be notified. This notice (which is not a notice of allowance under § 1.311 of this chapter) does not require reply by the applicant and places the national application in a condition of suspension until the secrecy order is removed. When the secrecy order is removed the Patent and Trademark Office will issue a notice of allowance under § 1.311 of this chapter, or take such other action as may then be warranted.

(d) International applications under secrecy order will not be mailed, delivered or otherwise transmitted to the international authorities or the applicant. International applications under secrecy order will be processed up to the point where, if it were not for the secrecy order, record and search copies would be transmitted to the international authorities or the applicant.

### *37 CFR 5.4. Petition for rescission of secrecy order.*

(a) A petition for rescission or removal of a secrecy order may be filed by, or on behalf of, any principal affected thereby. Such petition may be in letter form, and it must be in duplicate.

(b) The petition must recite any and all facts that purport to render the order ineffectual or futile if this is the basis of the petition. When prior publications or patents are alleged the petition must give complete data as to such publications or patents and should be accompanied by copies thereof.

(c) The petition must identify any contract between the Government and any of the principals, under which the subject matter of the application or any significant part thereof was developed, or to which the subject matter is otherwise related. If there is no such contract, the petition must so state.

(d) Appeal to the Secretary of Commerce, as provided by 35 U.S.C. 181, from a secrecy order cannot be taken until after a petition for rescission of the secrecy order has been made and denied. Appeal must be taken within sixty days from the date of the denial, and the party appealing, as well as the department or agency which caused the order to be issued, will be notified of the time and place of hearing.

### *37 CFR 5.5. Permit to disclose or modification of secrecy order.*

(a) Consent to disclosure, or to the filing of an application abroad, as provided in 35 U.S.C. 182, shall be made by a "permit" or "modification" of the secrecy order.

(b) Petitions for a permit or modification must fully recite the reason or purpose for the proposed disclosure. Where any proposed disclosee is known to be cleared by a defense agency to receive classified information, adequate explanation of such clearance should be made in the petition including the name of the agency or department granting the clearance and the date and degree thereof. The petition must be filed in duplicate.

(c) In a petition for modification of a secrecy order to permit filing abroad, all countries in which it is proposed to file must be made known, as well as all attorneys, agents and others to whom the material will be consigned prior to being lodged in the foreign patent office. The petition should include a statement vouching for

the loyalty and integrity of the proposed disclosees and where their clearance status in this or the foreign country is known all details should be given.

(d) Consent to the disclosure of subject matter from one application under secrecy order may be deemed to be consent to the disclosure of common subject matter in other applications under secrecy order so long as not taken out of context in a manner disclosing material beyond the modification granted in the first application.

(e) Organizations requiring consent for disclosure of applications under secrecy order to persons or organizations in connection with repeated routine operation may petition for such consent in the form of a general permit. To be successful such petitions must ordinarily recite the security clearance status of the disclosees as sufficient for the highest classification of material that may be involved.

>

**I. < SECRETY ORDER TYPES**

Three types of Secrecy Orders, each of a different scope, are issued as follows:

(A) Secrecy Order and Permit for Foreign Filing in Certain Countries — to be used for those patent applications that contain technical data whose export is controlled by the guidelines contained in DoD Directive 5230.25 dated November 6, 1984 which reviews export control under 10 U.S.C. 140(c) and the Militarily Critical Technology List (MCTL).

(B) Secrecy Order and Permit for Disclosing Classified Information — to be used for those patent applications which contain technical data that is properly classified or classifiable (no Government interest) under a security guideline where the patent application owner has a current DoD Security Agreement, DD Form 441. If the application is classifiable, this secrecy order allows disclosure of the technical information as if it were classified as prescribed in the Industrial Security Manual (ISM).

(C) Secrecy Order — to be used for those patent applications that contain technical data properly classifiable under a security guideline where the patent application owner does not have a DoD Security Agreement. The order prevents disclosure of the subject matter to anyone without an express written consent from the Commissioner >for Patents<. However, quite often this type of secrecy order includes a permit “Permit A” which relaxes the disclosure restrictions as set forth in the permit.

The first Secrecy Order is intended to permit the widest utilization of the technical data in the patent application while still controlling any publication or disclosure which would result in an unlawful exportation. This type of Secrecy Order is based on the applicable export controls in either the Commodity Control List (CCL) or the Munitions Lists of the International Traffic in Arms Regulation (ITAR), and identifies the countries where corresponding patent applications may be filed. Countries with which the United States has reciprocal security agreements are: Australia, Belgium, Canada, Denmark, France, Germany, Greece, Italy, Japan, Luxembourg, Netherlands, Norway, Portugal, Spain, Sweden, Turkey and the United Kingdom. Please note that applications subject to a secrecy order cannot be filed directly with the European Patent Office since no reciprocal security agreement with this organization exists. Applications must be filed in the individual EPO member countries identified above.

The intent of the second Secrecy Order is to treat classified technical data presented as a patent application in the same manner as any other classified material. Accordingly, this Secrecy Order will include a notification of the classification level of the technical data in the application.

The third type of Secrecy Order is used where the other types of Orders do not apply, including Orders issued by direction of agencies other than the Department of Defense.

A Secrecy Order should not be construed in any way to mean that the Government has adopted or contemplates adoption of the alleged invention disclosed in an application; nor is it any indication of the value of such invention.

>

**II. < RELATED SUBJECT MATTER**

The Secrecy Orders apply to the subject matter of the invention, not just to the patent application itself. Thus, the Secrecy Order restricts disclosure or publication of the invention in any form. Furthermore, other patent applications already filed or later filed which contain any significant part of the subject matter of the application also fall within the scope of the Order and must be brought to the attention of Licensing & Review if such applications are not already under Secrecy Order by the Commissioner.

The effects of a Secrecy Order are detailed in the notifying letter and include restrictions on disclosure of the invention and delay of any patent grant until the Order is rescinded.

>

### III. < CORRESPONDENCE

When the Secrecy Order issues, the law specifies that the subject matter or any material information relevant to the application, including unpublished details of the invention, shall not be published or disclosed to any person not aware of the invention prior to the date of the Order, including any employee of the principals except as permitted by the Secrecy Order. The law also requires that all information material to the subject matter of the application be kept in confidence, unless written permission to disclose is first obtained from the Commissioner >for Patents \*\* except as provided by the Secrecy Order. Therefore, all correspondence to be filed in an application which is subject to a secrecy order and which is directly related to the subject matter covered by the Secrecy Order must be transmitted to the Office in a manner which would preclude disclosure to unauthorized individuals and addressed as set forth in 37 CFR 5.1(a). Use of facsimile transmission is not permitted. 37 CFR 1.6(d)(6).

Subject matter under Secrecy Order must be safeguarded under conditions that will provide adequate protection and prevent access by unauthorized persons.

When applicants desire to change the Power of Attorney in an application under Secrecy Order, the name, date of birth and Social Security number of the new attorney(s) should be included in the change notice so that Licensing and Review may conduct the necessary access security clearance checks.

Applicants should also ensure that the correspondence address (37 CFR 1.33) of any application under Secrecy Order represents a location suitable for the receipt of security information.

>

### IV. < PCT APPLICATIONS

If the Secrecy Order is applied to an international application, the application will not be forwarded to the International Bureau as long as the Secrecy Order remains in effect. If the Secrecy Order remains in

effect at the end of the time limit under PCT Rule 22.3, the international application will be considered withdrawn (abandoned) because the Record Copy of the international application was not received in time by the International Bureau. 37 CFR 5.3(d), PCT Article 12(3), and PCT Rule 22.3. If the United States of America has been designated, however, it is possible to save the U.S. filing date, by fulfilling the requirements of 35 U.S.C. 371(c) prior to the withdrawal.

>

### V. < CHANGES IN SECRECY ORDERS

Applicants may petition for rescission or modification of the Secrecy Order. For example, if the applicant believes that certain existing facts or circumstances would render the Secrecy Order ineffectual, he or she may informally contact the sponsoring agency to discuss these facts or formally petition the Commissioner >for Patents< to rescind the Order. Rescission of a Secrecy Order may also be effected in some circumstances by expunging the sensitive subject matter from the disclosure, provided the sensitive subject matter is not necessary for an enabling disclosure under 35 U.S.C. 112, first paragraph. See MPEP § 724.05. The defense agency identified with the Secrecy Order as sponsoring the Order should be contacted directly for assistance in determining what subject matter in the application is sensitive, and whether the agency would agree to rescind the Order upon expunging this subject matter. The applicant may also petition the Commissioner >for Patents< for a permit to disclose the invention to another or to modify the Secrecy Order stating fully the reason or purpose for disclosure or modification. An example of such a situation would be a request to file the application in a foreign country. The requirements for petitions are described in 37 CFR 5.4 and 5.5. The law also provides that if an appeal is necessary, it may be taken to the Secretary of Commerce. Any petition or appeal should be addressed to the \*\*>Mail Stop L&R, Commissioner for Patents, P.O. Box 1450, Alexandria, Virginia, 22313-1450.

### VI. < IMPROPER OR INADVERTENT DISCLOSURE

If, prior to or after the issuance of the Secrecy Order, any significant part of the subject matter or material information relevant to the application has

been or is revealed to any U.S. citizen in the United States, the principals must promptly inform such person of the Secrecy Order and the penalties for improper disclosure. If such part of the subject matter was or is disclosed to any person in a foreign country or foreign national in the U.S., the principals must not inform such person of the Secrecy Order, but instead must promptly furnish to **>Mail Stop L&R, Commissioner for Patents, P.O. Box 1450, Alexandria, Virginia, 22313-1450<** the following information to the extent not already furnished: date of disclosure; name and address of the disclosee; identification of such subject matter; and any authorization by a U.S. government agency to export such subject matter. If the subject matter is included in any foreign patent application or patent, this should be identified.

>

**VII. < EXPIRATION**

Under the provision of 35 U.S.C. 181, a Secrecy Order remains in effect for a period of 1 year from its date of issuance. A Secrecy Order may be renewed for additional periods of not more than 1 year upon notice by a government agency that the national interest so requires. The applicant is notified of any such renewal.

The expiration of or failure to renew a Secrecy Order does not lessen in any way the responsibility of the principals for the security of the subject matter if it is subject to the provisions of Exec. Order No. 12958 or the Atomic Energy Act of 1954, as amended, 42 U.S.C. 141 *et. seq.* and 42 U.S.C. 2181 *et. seq.* or other applicable law unless the principals have been expressly notified that the subject patent application has been declassified by the proper authorities and the security markings have been authorized to be canceled or removed.

**121 Handling of Applications and Other Papers Bearing Security Markings [R-2]**

Under Executive Order for Classified National Security Information (Exec. Order No. 12958, 60 FR 19825 (April 20, 1995)) **>and Executive Order 13292 of March 25, 2003<** standards are prescribed for the marking, handling, and care of official information which requires safeguarding in the interest of security.

Papers marked as prescribed in the Executive **>Orders<** and showing that such marking is applied by, or at the direction of, a government agency, are accepted in patent applications. All applications or papers in the U.S. Patent and Trademark Office bearing words such as “Secret” or “Confidential” must be promptly referred to Technology Center (TC) Working Group 3640 for clarification or security treatment. Under no circumstances can any such application, drawing, exhibit, or other paper be placed in public records, such as the patented files, until all security markings have been considered and declassified or otherwise explained.

Authorized security markings may be placed on the patent application drawings when filed provided that such markings are outside the illustrations and that they are removed when the material is declassified. 37 CFR 1.84(v).

**130 Examination of Secrecy Order Cases [R-2]**

All applications in which a Secrecy Order has been imposed are examined in Technology Center (TC) Working Group 3640 and Art Unit 3662. If the Order is imposed subsequent to the docketing of an application in another TC, the application will be transferred to TC Working Group 3640.

Secrecy Order cases are examined for patentability as in other cases, but may not be passed to issue; nor will an interference be declared where one or more of the conflicting cases is classified or under Secrecy Order. See MPEP § 2309.06. When requested to do so by examiners outside TC Working Group 3640 and Art Unit 3662, examiners in TC Working Group 3640 or, if appropriate, examiners of Art Unit 3662, will conduct the interference searches of those interference files containing briefcards from classified or Secrecy Order cases.

In case of a final rejection, while such action must be properly replied to, and an appeal, if filed, must be completed by the applicant to prevent abandonment, such appeal will not be set for hearing by the Board of Patent Appeals and Interferences until the Secrecy Order is removed, unless specifically ordered by the Commissioner **>for Patents<**.

When a Secrecy Order case is in condition for allowance, a notice of allowability (Form D-10) is issued, thus closing the prosecution. Any amendments



received thereafter are not entered or responded to until such time as the Secrecy Order is rescinded. At such time, amendments which are free from objection will be entered; otherwise they are denied entry.

Due to the additional administrative burdens associated with handling papers in Secrecy Order cases, the full statutory period for reply will ordinarily be set for all Office actions issued on such cases.

Sometimes applications bearing national security markings but no Secrecy Order come up for examination. In this case, the examiner should require the applicant to seek imposition of a Secrecy Order or authority to cancel the markings. This should preferably be done with the first action and, in any event, prior to final disposition of the application. Pursuant to 37 CFR 5.1(d), if no Secrecy Order has issued in a national security classified patent application, the Office will set a time period within which the applicant must take one of the following three actions in order to prevent abandonment of the application:

- (A) obtain a Secrecy Order;
- (B) declassify the application; or
- (C) submit evidence of a good faith effort to obtain a Secrecy Order pursuant to 37 CFR 5.2(a).

Pursuant to 37 CFR 5.1(e), a national security classified patent application will not be allowed until the application is declassified and any Secrecy Order pursuant to 37 CFR 5.2(a) has been rescinded.

## 140 Foreign Filing Licenses [R-2]

### *35 U.S.C. 184. Filing of application in foreign country.*

Except when authorized by a license obtained from the Commissioner of Patents a person shall not file or cause or authorize to be filed in any foreign country prior to six months after filing in the United States an application for patent or for the registration of a utility model, industrial design, or model in respect of an invention made in this country. A license shall not be granted with respect to an invention subject to an order issued by the Commissioner of Patents pursuant to section 181 of this title without the concurrence of the head of the departments and the chief officers of the agencies who caused the order to be issued. The license may be granted retroactively where an application has been filed abroad through error and without deceptive intent and the application does not disclose an invention within the scope of section 181 of this title.

The term "application" when used in this chapter includes applications and any modifications, amendments, or supplements thereto, or divisions thereof.

The scope of a license shall permit subsequent modifications, amendments, and supplements containing additional subject matter if the application upon which the request for the license is

based is not, or was not, required to be made available for inspection under section 181 of this title and if such modifications, amendments, and supplements do not change the general nature of the invention in a manner which would require such application to be made available for inspection under such section 181. In any case in which a license is not, or was not, required in order to file an application in any foreign country, such subsequent modifications, amendments, and supplements may be made, without a license, to the application filed in the foreign country if the United States application was not required to be made available for inspection under section 181 and if such modifications, amendments, and supplements do not, or did not, change the general nature of the invention in a manner which would require the United States application to have been made available for inspection under such section 181.

### *35 U.S.C. 185. Patent barred for filing without license.*

Notwithstanding any other provisions of law any person, and his successors, assigns, or legal representatives, shall not receive a United States patent for an invention if that person, or his successors, assigns, or legal representatives shall, without procuring the license prescribed in section 184 of this title, have made, or consented to or assisted another's making, application in a foreign country for a patent or for the registration of a utility model, industrial design, or model in respect of the invention. A United States patent issued to such person, his successors, assigns, or legal representatives shall be invalid, unless the failure to procure such license was through error and without deceptive intent, and the patent does not disclose subject matter within the scope of section 181 of this title.

### *35 U.S.C. 186. Penalty.*

Whoever, during the period or periods of time an invention has been ordered to be kept secret and the grant of a patent thereon withheld pursuant to section 181 of this title, shall, with knowledge of such order and without due authorization, willfully publish or disclose or authorize or cause to be published or disclosed the invention, or material information with respect thereto, or whoever willfully, in violation of the provisions of section 184 of this title, shall file or cause or authorize to be filed in any foreign country an application for patent or for the registration of a utility model, industrial design, or model in respect of any invention made in the United States, shall, upon conviction, be fined not more than \$10,000 or imprisoned for not more than two years, or both.

The amendments made to 35 U.S.C. 184, 185, and 186 by Public Law 100-418 apply to all United States patents granted before, on, or after August 23, 1988, to all applications for United States patents pending on or filed after August 23, 1988, and to all licenses under 35 U.S.C. 184 granted before, on, or after August 23, 1988.

More specifically, paragraphs (c) and (d) of section 9101 of Public Law 100-418 read as follows:

Sec. 9101. INCREASED EFFECTIVENESS OF PATENT LAW

\*\*\*\*\*

(c)REGULATIONS.-- The Commissioner of Patents and Trademarks shall prescribe such regulations as may be necessary to implement the amendments made by this section.

(d)EFFECTIVE DATE.-- (1) Subject to paragraphs (2), (3), and (4) of this subsection, the amendments made by this section shall apply to all United States patents granted before, on, or after the date of enactment of this section, to all applications for United States patents pending on or filed after such date of enactment, and to all licenses under section 184 granted before, on, or after the date of enactment of this section.

(2)The amendments made by this section shall not affect any final decision made by a court or the Patent and Trademark Office before the date of enactment of this section with respect to a patent or application for patent, if no appeal from such decision is pending and the time for filing an appeal has expired.

(3)No United States patent granted before the date of enactment of this section shall abridge or affect the right of any person or his successors in business who made, purchased, or used, prior to such date of enactment, anything protected by the patent, to continue the use of, or sell to others to be used or sold, the specific thing so made, purchased, or used, if the patent claims were invalid or otherwise unenforceable on a ground obviated by this section and the person made, purchased, or used the specific thing in reasonable reliance on such invalidity or unenforceability. If a person reasonably relied on such invalidity or unenforceability, the court before which such matter is in question may provide for the continued manufacture, use, or sale of the thing made, purchased, or used as specified, or for the manufacture, use, or sale of which substantial preparation was made before the date of enactment of this section, and it may also provide for the continued practice of any process practiced, or for the practice of which substantial preparation was made, prior to the date of enactment of this section, to the extent and under such terms as the court deems equitable for the protection of investments made or business commenced before such date of enactment.

(4)The amendments made by this section shall not affect the right of any party in any case pending in court on the date of enactment of this section to have its rights or liabilities --

(A)under any patent before the court, or

(B)under any patent granted after such date of enactment which is related to the patent before the court by deriving priority right under section 120 or 121 of title 35, United States Code, from a patent or an application for patent common to both patents, determined on the basis of the substantive law in effect before the date of enactment of this section.

*35 U.S.C. 187. Nonapplicability to certain persons*

The prohibitions and penalties of this chapter shall not apply to any officer or agent of the United States acting within the scope of his authority, nor to any person acting upon his written instructions or permission.

*35 U.S.C. 188. Rules and regulations, delegation of power.*

The Atomic Energy Commission, the Secretary of a defense department, the chief officer of any department or agency of the Government designated by the President as a defense agency of the United States, and the Secretary of Commerce, may separately issue rules and regulations to enable the respective department or agency to carry out the provisions of this chapter, and may delegate any power conferred by this chapter.

*37 CFR 5.11. License for filing in a foreign country an application on an invention made in the United States or for transmitting an international application.*

\*\*>

(a) A license from the Commissioner for Patents under 35 U.S.C. 184 is required before filing any application for patent including any modifications, amendments, or supplements thereto or divisions thereof or for the registration of a utility model, industrial design, or model, in a foreign patent office or any foreign patent agency or any international agency other than the United States Receiving Office, if the invention was made in the United States and:

(1) An application on the invention has been filed in the United States less than six months prior to the date on which the application is to be filed, or

(2) No application on the invention has been filed in the United States.

(b) The license from the Commissioner for Patents referred to in paragraph (a) would also authorize the export of technical data abroad for purposes relating to the preparation, filing or possible filing and prosecution of a foreign patent application without separately complying with the regulations contained in 22 CFR parts 121 through 130 (International Traffic in Arms Regulations of the Department of State), 15 CFR part 779 (Regulations of the Office of Export Administration, International Trade Administration, Department of Commerce) and 10 CFR part 810 (Foreign Atomic Energy Programs of the Department of Energy).

(c) Where technical data in the form of a patent application, or in any form, is being exported for purposes related to the preparation, filing or possible filing and prosecution of a foreign patent application, without the license from the Commissioner for Patents referred to in paragraphs (a) or (b) of this section, or on an invention not made in the United States, the export regulations contained in 22 CFR parts 120 through 130 (International Traffic

in Arms Regulations of the Department of State), 15 CFR parts 768-799 (Export Administration Regulations of the Department of Commerce) and 10 CFR part 810 (Assistance to Foreign Atomic Energy Activities Regulations of the Department of Energy) must be complied with unless a license is not required because a United States application was on file at the time of export for at least six months without a secrecy order under § 5.2 being placed thereon. The term “exported” means export as it is defined in 22 CFR part 120, 15 CFR part 779 and activities covered by 10 CFR part 810.<

(d) If a secrecy order has been issued under § 5.2, an application cannot be exported to, or filed in, a foreign country (including an international agency in a foreign country), except in accordance with § 5.5.

(e) No license pursuant to paragraph (a) of this section is required:

(1) If the invention was not made in the United States, or

(2) If the corresponding United States application is not subject to a secrecy order under § 5.2, and was filed at least six months prior to the date on which the application is filed in a foreign country, or

(3) For subsequent modifications, amendments and supplements containing additional subject matter to, or divisions of, a foreign patent application if:

(i) A license is not, or was not, required under paragraph (e)(2) of this section for the foreign patent application;

(ii) The corresponding United States application was not required to be made available for inspection under 35 U.S.C. 181; and

(iii) Such modifications, amendments, and supplements do not, or did not, change the general nature of the invention in a manner which would require any corresponding United States application to be or have been available for inspection under 35 U.S.C. 181.

(f) A license pursuant to paragraph (a) of this section can be revoked at any time upon written notification by the Patent and Trademark Office. An authorization to file a foreign patent application resulting from the passage of six months from the date of filing of a United States patent application may be revoked by the imposition of a secrecy order.

### *37 CFR 5.12. Petition for license.*

(a) Filing of an application for patent for inventions made in the United States will be considered to include a petition for license under 35 U.S.C. 184 for the subject matter of the application. The filing receipt will indicate if a license is granted. If the initial automatic petition is not granted, a subsequent petition may be filed under paragraph (b) of this section.

(b) A petition for license must include the fee set forth in § 1.17(h) of this chapter, the petitioner’s address, and full instructions for delivery of the requested license when it is to be delivered to other than the petitioner. The petition should be presented in letter form.

### *37 CFR 5.13. Petition for license; no corresponding application.*

If no corresponding national or international application has been filed in the United States, the petition for license under § 5.12(b) must also be accompanied by a legible copy of the mate-

rial upon which a license is desired. This copy will be retained as a measure of the license granted.

### *37 CFR 5.14. Petition for license; corresponding U.S. application.*

(a) When there is a corresponding United States application on file, a petition for license under § 5.12(b) must also identify this application by application number, filing date, inventor, and title, but a copy of the material upon which the license is desired is not required. The subject matter licensed will be measured by the disclosure of the United States application.

(b) Two or more United States applications should not be referred to in the same petition for license unless they are to be combined in the foreign or international application, in which event the petition should so state and the identification of each United States application should be in separate paragraphs.

(c) Where the application to be filed or exported abroad contains matter not disclosed in the United States application or applications, including the case where the combining of two or more United States applications introduces subject matter not disclosed in any of them, a copy of the application as it is to be filed in the foreign country or international application which is to be transmitted to a foreign international or national agency for filing in the Receiving Office, must be furnished with the petition. If however, all new matter in the foreign or international application to be filed is readily identifiable, the new matter may be submitted in detail and the remainder by reference to the pertinent United States application or applications.

### *37 CFR 5.15. Scope of license.*

(a) Applications or other materials reviewed pursuant to §§ 5.12 through 5.14, which were not required to be made available for inspection by defense agencies under 35 U.S.C. 181, will be eligible for a license of the scope provided in this paragraph. This license permits subsequent modifications, amendments, and supplements containing additional subject matter to, or divisions of, a foreign patent application, if such changes to the application do not alter the general nature of the invention in a manner which would require the United States application to have been made available for inspection under 35 U.S.C. 181. Grant of this license authorizing the export and filing of an application in a foreign country or the transmitting of an international application to any foreign patent agency or international patent agency when the subject matter of the foreign or international application corresponds to that of the domestic application. This license includes authority:

(1) To export and file all duplicate and formal application papers in foreign countries or with international agencies;

(2) To make amendments, modifications, and supplements, including divisions, changes or supporting matter consisting of the illustration, exemplification, comparison, or explanation of subject matter disclosed in the application; and

(3) To take any action in the prosecution of the foreign or international application provided that the adding of subject matter or taking of any action under paragraphs (a)(1) or (2) of this section does not change the general nature of the invention disclosed in the application in a manner which would require such

application to have been made available for inspection under 35 U.S.C. 181 by including technical data pertaining to:

(i) Defense services or articles designated in the United States Munitions List applicable at the time of foreign filing, the unlicensed exportation of which is prohibited pursuant to the Arms Export Control Act, as amended, and 22 CFR parts 121 through 130; or

(ii) Restricted Data, sensitive nuclear technology or technology useful in the production or utilization of special nuclear material or atomic energy, dissemination of which is subject to restrictions of the Atomic Energy Act of 1954, as amended, and the Nuclear Non-Proliferation Act of 1978, as implemented by the regulations for Unclassified Activities in Foreign Atomic Energy Programs, 10 CFR part 810, in effect at the time of foreign filing.

(b) Applications or other materials which were required to be made available for inspection under 35 U.S.C. 181 will be eligible for a license of the scope provided in this paragraph. Grant of this license authorizes the export and filing of an application in a foreign country or the transmitting of an international application to any foreign patent agency or international patent agency. Further, this license includes authority to export and file all duplicate and formal papers in foreign countries or with foreign and international patent agencies and to make amendments, modifications, and supplements to, file divisions of, and take any action in the prosecution of the foreign or international application, provided subject matter additional to that covered by the license is not involved.

(c) A license granted under § 5.12(b) pursuant to § 5.13 or § 5.14 shall have the scope indicated in paragraph (a) of this section, if it is so specified in the license. A petition, accompanied by the required fee (§ 1.17(h)), may also be filed to change a license having the scope indicated in paragraph (b) of this section to a license having the scope indicated in paragraph (a) of this section. No such petition will be granted if the copy of the material filed pursuant to § 5.13 or any corresponding United States application was required to be made available for inspection under 35 U.S.C. 181. The change in the scope of a license will be effective as of the date of the grant of the petition.

(d) In those cases in which no license is required to file the foreign application or transmit the international application, no license is required to file papers in connection with the prosecution of the foreign or international application not involving the disclosure of additional subject matter.

(e) Any paper filed abroad or transmitted to an international patent agency following the filing of a foreign or international application which changes the general nature of the subject matter disclosed at the time of filing in a manner which would require such application to have been made available for inspection under 35 U.S.C. 181 or which involves the disclosure of subject matter listed in paragraphs (a)(3)(i) or (ii) of this section must be separately licensed in the same manner as a foreign or international application. Further, if no license has been granted under § 5.12(a) on filing the corresponding United States application, any paper filed abroad or with an international patent agency which involves the disclosure of additional subject matter must be licensed in the same manner as a foreign or international application.

(f) Licenses separately granted in connection with two or more United States applications may be exercised by combining or dividing the disclosures, as desired, provided:

(1) Subject matter which changes the general nature of the subject matter disclosed at the time of filing or which involves subject matter listed in paragraphs (a)(3) (i) or (ii) of this section is not introduced and,

(2) In the case where at least one of the licenses was obtained under § 5.12(b), additional subject matter is not introduced.

(g) A license does not apply to acts done before the license was granted. See § 5.25 for petitions for retroactive licenses.

*37 CFR 5.18. Arms, ammunition, and implements of war.*

\*\*>

(a) The exportation of technical data relating to arms, ammunition, and implements of war generally is subject to the International Traffic in Arms Regulations of the Department of State (22 CFR parts 120 through 130); the articles designated as arms, ammunitions, and implements of war are enumerated in the U.S. Munitions List (22 CFR part 121). However, if a patent applicant complies with regulations issued by the Commissioner for Patents under 35 U.S.C. 184, no separate approval from the Department of State is required unless the applicant seeks to export technical data exceeding that used to support a patent application in a foreign country. This exemption from Department of State regulations is applicable regardless of whether a license from the Commissioner for Patents is required by the provisions of §§ 5.11 and 5.12 (22 CFR part 125).<

(b) When a patent application containing subject matter on the Munitions List (22 CFR part 121) is subject to a secrecy order under § 5.2 and a petition is made under § 5.5 for a modification of the secrecy order to permit filing abroad, a separate request to the Department of State for authority to export classified information is not required (22 CFR part 125).

*37 CFR 5.19. Export of technical data.*

(a) Under regulations (15 CFR 770.10(j)) established by the Department of Commerce, a license is not required in any case to file a patent application or part thereof in a foreign country if the foreign filing is in accordance with the regulations (§§ 5.11 through 5.25) of the Patent and Trademark Office.

(b) An export license is not required for data contained in a patent application prepared wholly from foreign-origin technical data where such application is being sent to the foreign inventor to be executed and returned to the United States for subsequent filing in the U.S. Patent and Trademark Office (15 CFR 779A.3(e)).

*37 CFR 5.20. Export of technical data relating to sensitive nuclear technology.*

Under regulations (10 CFR 810.7) established by the United States Department of Energy, an application filed in accordance with the regulations (§§ 5.11 through 5.25) of the Patent and Trademark Office and eligible for foreign filing under 35 U.S.C. 184, is considered to be information available to the public in published form and a generally authorized activity for the purposes of the Department of Energy regulations.

*37 CFR 5.25. Petition for retroactive license.*

(a) A petition for retroactive license under 35 U.S.C. 184 shall be presented in accordance with § 5.13 or § 5.14(a), and shall include:

- (1) A listing of each of the foreign countries in which the unlicensed patent application material was filed,
- (2) The dates on which the material was filed in each country,
- (3) A verified statement (oath or declaration) containing:
  - (i) An averment that the subject matter in question was not under a secrecy order at the time it was filed abroad, and that it is not currently under a secrecy order,
  - (ii) A showing that the license has been diligently sought after discovery of the proscribed foreign filing, and
  - (iii) An explanation of why the material was filed abroad through error and without deceptive intent without the required license under § 5.11 first having been obtained, and
- (4) The required fee (§ 1.17(h)).

In the interests of national security, the United States government imposes restrictions on the export of technical information. These restrictions are administered by the Departments of Commerce, State, and/or Energy depending on the subject matter involved. For the filing of patent applications in foreign countries, the authority for export control has been delegated to the Commissioner \*>for< Patents \*\*>(note that the term “Commissioner of Patents” is used in Chapter 17 of title 35 of the U.S. Code, but “Commissioner for Patents” is used in the remainder of the statute and in title 37 of the Code of Federal Regulations; both titles are understood to represent the same individual)<.

There are two ways in which permission to file a patent application abroad may be obtained: either a petition for a foreign filing license may be granted (37 CFR 5.12) or an applicant may wait 6 months after filing a patent application in the USPTO (35 U.S.C. 184) at which time a license on that subject matter is no longer required as long as no Secrecy Order has been imposed. 37 CFR 5.11(e)(2).

There are several means by which a foreign filing license may be issued. First, every U.S. origin application filed in the USPTO is considered to include an implicit petition for a foreign filing license. The grant of a license is not immediate or even ensured. If the application is not marked by the security screeners, the petition is granted. This is indicated to the applicant by the presence on the filing receipt of the phrase “Foreign Filing License Granted” and a date. The license becomes effective on the date shown. Further, grant of this license is made of record in the

application file by means of a similar notation on the file wrapper of the application below the “Foreign/PCT Applications” data or on the PALM bib-data sheet. The scope of this license is quite broad as set forth in 37 CFR 5.15(a).

Explicit petitions for foreign filing licenses will also be accepted in accordance with 37 CFR 5.12(b)>, and may be faxed to Licensing and Review. See MPEP § 502.01<. Applicants may be interested in such petitions in cases:

- (A) in which the filing receipt license is not granted;
- (B) in which the filing receipt has not yet been issued (37 CFR 5.14(a) or (b));
- (C) in which there is no corresponding U.S. application (37 CFR 5.13);
- (D) in which subject matter additional to that already licensed is sought to be licensed (37 CFR 5.14(c) and 5.15(e)); or
- (E) in which expedited handling is requested.

The scope of any license granted on these petitions is indicated on the license.

Petitions under 37 CFR 5.14(a) or (b) as well as any license granted on the petition are given paper numbers and endorsed on the file wrapper. Petitions under 37 CFR 5.14(c) are not ordinarily made of record in the file.

Applicants granted a license under 37 CFR 5.12(b) having the relatively narrow scope indicated in 37 CFR 5.15(b) may petition under 37 CFR 5.15(c) to convert the license to the broad scope of 37 CFR 5.15(a). A fee is charged for such a petition. See 37 CFR 1.17(h). If the petition is granted, the change in the scope of the license is effective as of that day.

Finally, a retroactive license may be sought if an unlicensed foreign filing has occurred through error and without deceptive intent. However, the requirements of 37 CFR 5.25 must be fulfilled in order for such a petition to be granted. Note that licenses under 37 CFR 5.25 are only made retroactive with respect to specific acts of foreign filing, and therefore the countries, the actual dates of filing and the establishing of the nature of the error must be provided for each act of proscribed foreign filing for which a retroactive license is sought. Also, the required verified statement must be in oath or declaration form.

Upon written notification from the U.S. Patent and Trademark Office, any foreign filing license required by 37 CFR 5.11(a) may be revoked. Ordinarily, revocation indicates that additional review of the licensed subject matter revealed the need for referral of the application to the appropriate defense agencies. Revocation of a filing receipt license (37 CFR 5.12(a)) does not necessarily mean that a petition under 37 CFR 5.12(b) for a license of narrower scope will not be granted. The revocation becomes effective on the date on which the notice is mailed. Foreign filings which occurred prior to revocation need not be abandoned or otherwise specially treated; however, additional filings without a license are not permitted unless 6 months have elapsed from the filing of any corresponding U.S. application. Papers and other documents needed in support of prosecution of foreign applications may be sent abroad if they comply with any pertinent export regulations. Of course, if and once a Secrecy Order is issued, the restrictions thereof must immediately be observed.

Only the imposition of a Secrecy Order will cause revocation of the authority which arises from 35 U.S.C. 184 to file a foreign patent application 6 months or later after the date of filing of a corresponding U.S. patent application.

The penalties for failing to obtain any necessary license to file a patent application abroad are set forth in 35 U.S.C. 182, 35 U.S.C. 185, and 35 U.S.C. 186 and include loss of patenting rights in addition to possible fine or imprisonment.

## 150 Statements to DOE and NASA [R-2]

37 CFR 1.14. *Patent applications preserved in confidence.*

\*\*\*\*\*

\*\*>

(d) *Applications reported to Department of Energy.* Applications for patents which appear to disclose, purport to disclose or do disclose inventions or discoveries relating to atomic energy are reported to the Department of Energy, which Department will be given access to the applications. Such reporting does not constitute a determination that the subject matter of each application so reported is in fact useful or is an invention or discovery, or that such application in fact discloses subject matter in categories specified by 42 U.S.C. 2181(c) and (d).<

\*\*\*\*\*

Title 42 United States Code, Section 2182 reads in part:

No patent for any invention or discovery, useful in the production or utilization of special nuclear material or atomic energy, shall be issued unless the applicant files with the application, or within thirty days after request therefor by the Under Secretary of Commerce for Intellectual Property and Director of the United States Patent and Trademark Office (unless the Commission advises the Under Secretary of Commerce for Intellectual Property and Director of the United States Patent and Trademark Office that its rights have been determined and that accordingly no statement is necessary) a statement under oath setting forth the full facts surrounding the making or conception of the invention or discovery described in the application and whether the invention or discovery was made or conceived in the course of or under any contract, subcontract, or arrangement entered into with or for the benefit of the Commission, regardless of whether the contract, subcontract, or arrangement involved the expenditure of funds by the Commission. The Under Secretary of Commerce for Intellectual Property and Director of the United States Patent and Trademark Office shall as soon as the application is otherwise in condition for allowance forward copies of the application and the statement to the Commission.

Similarly, 42 U.S.C. 2457 provides in part:

(c) *Patent application.* No patent may be issued to any applicant other than the Administrator for any invention which appears to the Under Secretary of Commerce for Intellectual Property and Director of the United States Patent and Trademark Office (hereafter in this section referred to as the "Director") to have significant utility in the conduct of aeronautical and space activities unless the applicant files with the Director, with the application or within thirty days after request therefor by the Director, a written statement executed under oath setting forth the full facts concerning the circumstances under which such invention was made and stating the relationship (if any) of such invention to the performance of any work under any contract of the Administration. Copies of each statement and application to which it relates shall be transmitted forthwith by the \*>Director< to the Administrator.

Property rights statements to DOE or NASA may be filed at any time but should be updated if necessary to accurately reflect property rights at the time the application is allowed.

Shortly after filing, an informal request for a property rights statement will be mailed to those applicants whose nonprovisional applications have been marked by the USPTO security screeners as being of interest to DOE or NASA. Provisional applications

are not subject to DOE or NASA property rights review. While no formal time period is set, a response by applicants within 45 days will expedite processing. If the statement submitted during this period is defective, another letter is sent from Licensing and Review detailing the deficiencies and giving applicant another opportunity to respond during this period of informal correspondence.

If no response to the initial so called 45-Day Letter is received or if repeated efforts to correct a defective statement evidence an absence of cooperation on the part of the applicant, a formal request for a statement in accordance with the statutes will be made. A 30-day statutory period for response is then set. There is no provision for an extension of this time period. If no proper and timely statement is received, the application will be held abandoned and the applicant so notified. Such applications may be revived under the provisions of 37 CFR 1.137. *In re Rutan*, 231 USPQ 864 (Comm'r Pat. 1986).

Any papers pertaining to property rights under section 152 of the Atomic Energy Act, 42 U.S.C. 2182, (DOE), or section 305(c) of the National Aeronautics and Space Act, 42 U.S.C. 2457, (NASA), that have not been associated with the application file, or have not been made of record in the file and processed by the Licensing and Review section, must be sent to the Licensing and Review section immediately.

## 151 Content of the Statements

The law requires the statement to set forth "the full facts" surrounding the conception and making of the invention. These facts should include those which are unique to that invention. The use of form paragraphs or printed forms which set forth only broad generalized statements of fact is not ordinarily regarded as meeting the requirements of these statutes.

The word "applicant" in both of these statutes has been construed to mean the inventor or joint inventors in person. Accordingly, in the ordinary situation, the statements must be signed by the inventor or the joint inventors, if available. This construction is consistent with the fact that no other person could normally be more knowledgeable of the "full facts concerning the circumstances under which such invention was made," (42 U.S.C. 2457) or, "full facts surrounding the making or conception of the invention or discovery" (42 U.S.C. 2182). If a request under 37 CFR 1.48

for correction of inventorship is granted during pendency of an application in which a property rights statement has been filed, a supplemental statement executed by any added inventor(s) is required and should promptly be filed with the Licensing and Review section.

In instances where an applicant does not have first-hand knowledge whether the invention involved work under any contract, subcontract, or arrangement with or for the benefit of the Atomic Energy Commission, or had any relationship to any work under any contract of the National Aeronautics and Space Administration, and includes in his or her statement information of this nature derived from others, his or her statement should identify the source of his or her information. Alternatively, the statement by the applicant could be accompanied by a supplemental declaration or oath, as to the contractual matters, by the assignee or other person, e.g., an employee thereof, who has the requisite knowledge.

When an applicant is deceased or incompetent, or where it is shown to the satisfaction of this Office that he or she refuses to furnish a statement or cannot be reached after diligent efforts, declarations or statements under oath setting forth the information required by the statutes may be accepted from an officer or employee of the assignee who has sufficient knowledge of the facts. The offer of such substitute statements should be based on the actual unavailability of or refusal by the applicant, rather than mere inconvenience. Where it is shown that one of the joint inventors is deceased or unavailable, a statement by all of the other inventor(s) may be accepted.

The following is an acceptable format for statements to DOE or NASA assuming that no government funds or other considerations were involved in the making or conception of the invention. It is important that the information provided in the statement be an accurate reflection of the fact situation at the time the statement is made. While the sample below is in the form of a declaration, a sworn oath is equally acceptable.

Note that the statement must be in the form of an oath or declaration. Further note that the statement must be signed by all the inventors. See also the notice entitled "Statements Filed Under Atomic Energy Act and NASA Act" published in 914 O.G. 1 (Sept. 4, 1973) for further information.

I (We) \_\_\_\_\_ citizens of residing at declare: That I (we) made and conceived the invention described and claimed in patent application number filed in the United States of America on titled.

I (We) \_\_\_\_\_ citizens of \_\_\_\_\_ residing at \_\_\_\_\_ declare: That I (we) made and conceived the invention described and claimed in patent application number \_\_\_\_\_ filed in the United States of America on \_\_\_\_\_ titled \_\_\_\_\_.

(Include completed I. or II. below)

I. (for Inventors Employed by an Organization)

That I (we) made and conceived this invention while employed by \_\_\_\_\_.

That the invention is related to the work I am (we are) employed to perform and was made within the scope of my (our) employment duties;

That the invention was made during working hours and with the use of facilities, equipment, materials, funds, information and services of \_\_\_\_\_.

Other relevant facts are: \_\_\_\_\_.

That to the best of my (our) knowledge and belief based upon information provided by \_\_\_\_\_ of \_\_\_\_\_:

-OR-

II. (For Self-Employed Inventors)

That I (we) made and conceived this invention on my (our) own time using only my (our) own facilities, equipment, materials, funds, information and services.

Other relevant facts are \_\_\_\_\_

That to the best of my (our) knowledge and belief:

(Include III. and/or IV. below as appropriate)

III. The invention or discovery was not made or conceived in the course of, or in connection with, or under the terms of any contract, subcontract or arrangement entered into with or for the benefit of the United States Atomic Energy Commission or its successors Energy Research and Development Administration or the Department of Energy.

-AND/OR-

IV. The invention was not made under nor is there any relationship of the invention to the performance of any work under any contract of the National Aeronautics and Space Administration.

V. The undersigned inventor(s) declare(s) further that all statements made herein of his or her (their)own knowledge are true and that all statements made on information and belief are believed to be true and further that these statements were made with the knowledge that willful false statements and the like so made are punishable by fine or imprisonment, or both, under Section 1001 of Title 18 of the United States Code and that such willful false statements may jeopardize the validity of the application or any patent issuing thereon.

Inventor's Signature \_\_\_\_\_

Post Office Address \_\_\_\_\_

Date \_\_\_\_\_

Inventor's Signature \_\_\_\_\_

Post Office Address \_\_\_\_\_

Date \_\_\_\_\_





MANUAL OF PATENT EXAMINING PROCEDURE

# Chapter 200 Types, Cross-Noting, and Status of Application

<b>201</b>	<b>Types of Applications</b>
201.01	Sole
201.02	Joint
201.03	Correction of Inventorship in an Application
201.04	Parent Application
201.04(a)	Original Application
201.04(b)	Provisional Application
201.05	Reissue Application
201.06	Divisional Application
201.06(a)	Former 37 CFR 1.60 Divisional-Continuation Procedure
201.06(b)	Former 37 CFR 1.62 File Wrapper Continuing Procedure
201.06(c)	37 CFR 1.53(b) and 37 CFR 1.63(d) Divisional-Continuation Procedure
201.06(d)	37 CFR 1.53(d) Continued Prosecution Application (CPA) Practice
201.07	Continuation Application
201.08	Continuation-in-Part Application
201.09	Substitute Application
201.10	Refile
201.11	Continuity Between Applications: the Benefit of an Earlier Filing Date
201.11(a)	Filing of Continuation or Continuation-in-Part Application During Pendency of International Application Designating the United States
201.12	Assignment Carries Title
201.13	Right of Priority of Foreign Application
201.13(a)	Right of Priority Based Upon an Application for an Inventor's Certificate
201.13(b)	Right of Priority Based Upon an International Application Filed Under the Patent Cooperation Treaty
201.14	Right of Priority, Formal Requirements
201.14(a)	Right of Priority, Time for Filing Papers
201.14(b)	Right of Priority, Papers Required
201.14(c)	Right of Priority, Practice
201.14(d)	Proper Identification of Priority Application
201.15	Right of Priority, Overcoming a Reference
201.16	Using Certificate of Correction to Perfect Claim for Priority Under 35 U.S.C. 119(a)-(d) or (f)
<b>202</b>	<b>Cross-Noting</b>
202.01	In Specification
202.02	Notation <i>*&gt;in&lt;</i> File <i>*&gt;History&lt;</i> Regarding Prior U.S. Applications, Including Provisional Applications
202.03	Notation <i>*&gt;in&lt;</i> File <i>*&gt;History&lt;</i> When Priority Is Claimed for Foreign Application
202.04	In Oath or Declaration

202.05	In Case of Reissues
<b>203</b>	<b>Status of Applications</b>
203.01	New
203.02	Rejected
203.03	Amended
203.04	Allowed or in Issue
203.05	Abandoned
203.06	Incomplete
203.07	Abandonment for Failure to Pay Issue Fee
203.08	Status Inquiries
203.08(a)	Congressional and Other Official Inquiries

## 201 Types of Applications [R-2]

### 35 U.S.C. 111. Application.

#### (a) IN GENERAL.—

(1) WRITTEN APPLICATION.—An application for patent shall be made, or authorized to be made, by the inventor, except as otherwise provided in this title, in writing to the Director.

#### (2) CONTENTS.—Such application shall include—

(A) a specification as prescribed by section 112 of this title;

(B) a drawing as prescribed by section 113 of this title; and

(C) an oath by the applicant as prescribed by section 115 of this title.

(3) FEE AND OATH.—The application must be accompanied by the fee required by law. The fee and oath may be submitted after the specification and any required drawing are submitted, within such period and under such conditions, including the payment of a surcharge, as may be prescribed by the Director.

(4) FAILURE TO SUBMIT.—Upon failure to submit the fee and oath within such prescribed period, the application shall be regarded as abandoned, unless it is shown to the satisfaction of the Director that the delay in submitting the fee and oath was unavoidable or unintentional. The filing date of an application shall be the date on which the specification and any required drawing are received in the Patent and Trademark Office.

#### (b) PROVISIONAL APPLICATION.—

(1) AUTHORIZATION.—A provisional application for patent shall be made or authorized to be made by the inventor, except as otherwise provided in this title, in writing to the Director. Such application shall include—

(A) a specification as prescribed by the first paragraph of section 112 of this title; and

(B) a drawing as prescribed by section 113 of this title.

(2) CLAIM.—A claim, as required by the second through fifth paragraphs of section 112, shall not be required in a provisional application.

#### (3) FEE.—

(A) The application must be accompanied by the fee required by law.

(B) The fee may be submitted after the specification and any required drawing are submitted, within such period and

under such conditions, including the payment of a surcharge, as may be prescribed by the Director.

(C) Upon failure to submit the fee within such prescribed period, the application shall be regarded as abandoned, unless it is shown to the satisfaction of the Director that the delay in submitting the fee was unavoidable or unintentional.

(4) **FILING DATE.**—The filing date of a provisional application shall be the date on which the specification and any required drawing are received in the Patent and Trademark Office.

(5) **ABANDONMENT.**—Notwithstanding the absence of a claim, upon timely request and as prescribed by the Director, a provisional application may be treated as an application filed under subsection (a). Subject to section 119(e)(3) of this title, if no such request is made, the provisional application shall be regarded as abandoned 12 months after the filing date of such application and shall not be subject to revival after such 12-month period.

(6) **OTHER BASIS FOR PROVISIONAL APPLICATION.**—Subject to all the conditions in this subsection and section 119(e) of this title, and as prescribed by the Director, an application for patent filed under subsection (a) may be treated as a provisional application for patent.

(7) **NO RIGHT OF PRIORITY OR BENEFIT OF EARLIEST FILING DATE.**—A provisional application shall not be entitled to the right of priority of any other application under section 119 or 365(a) of this title or to the benefit of an earlier filing date in the United States under section 120, 121, or 365(c) of this title.

(8) **APPLICABLE PROVISIONS.**—The provisions of this title relating to applications for patent shall apply to provisional applications for patent, except as otherwise provided, and except that provisional applications for patent shall not be subject to sections 115, 131, 135, and 157 of this title.

(Amended Aug. 27, 1982, Public Law 97-247, sec. 5, 96 Stat. 319; Dec. 8, 1994, Public Law 103-465, sec. 532(b)(3), 108 Stat. 4986; Nov. 29, 1999, Public Law 106-113, sec. 1000(a)(9), 113 Stat. 1501A-582, 588 (S. 1948 secs. 4732(a)(10)(A), 4801(a).))

### 37 CFR 1.9. Definitions.

(a)(1) A national application as used in this chapter means a U.S. application for patent which was either filed in the Office under 35 U.S.C. 111, or which entered the national stage from an international application after compliance with 35 U.S.C. 371.

(2) A provisional application as used in this chapter means a U.S. national application for patent filed in the Office under 35 U.S.C. 111(b).

(3) A nonprovisional application as used in this chapter means a U.S. national application for patent which was either filed in the Office under 35 U.S.C. 111(a), or which entered the national stage from an international application after compliance with 35 U.S.C. 371.

(b) An international application as used in this chapter means an international application for patent filed under the Patent Cooperation Treaty prior to entering national processing at the Designated Office stage.

\*\*\*\*\*

## **NATIONAL APPLICATIONS (35 U.S.C. 111) VS. NATIONAL STAGE APPLICATIONS (35 U.S.C. 371)**

Nonprovisional and provisional applications are national applications. Treatment of a national application under 35 U.S.C. 111 and a national stage application (a national application which entered the national stage from an international application after compliance with 35 U.S.C. 371) are similar but not identical. Note the following examples:

(A) Restriction practice under MPEP § 806+ is applied to national applications under 35 U.S.C. 111(a) while unity of invention practice under MPEP Chapter 1800 is applied to national stage applications.

(B) National nonprovisional applications filed under 35 U.S.C. 111(a) without an executed oath or declaration or filing fee are governed by the notification practice set forth in 37 CFR 1.53(f) while national stage applications filed without an oath or declaration or national stage fee are governed by the notification practice set forth in 37 CFR 1.495.

37 CFR 1.9(a)(1) defines a national application as a U.S. application which was either filed in the Office under 35 U.S.C. 111, or which entered the national stage from an international application after compliance with 35 U.S.C. 371. Domestic national patent applications fall under three broad types:

(A) applications for patent under 35 U.S.C. 101 relating to a “new and useful process, machine, manufacture, or composition of matter, etc.”;

(B) applications for plant patents under 35 U.S.C. 161; and

(C) applications for design patents under 35 U.S.C. 171.

The first type of patents are sometimes referred to as “utility” patents \*\* when being contrasted with plant or design patents. The specialized procedure which pertains to the examination of applications for design and plant patents are treated in detail in Chapters 1500 and 1600, respectively. Domestic national applications include original (nonprovisional), provisional, plant, design, reissue, divisional, and continuation applications (which may be filed under 37 CFR 1.53(b)), continued prosecution applications (CPA) (filed under 37 CFR 1.53(d)), only applicable if the application is for a design patent<) and continuation-

in-part applications (which may be filed under 37 CFR 1.53(b)).

### **201.01 Sole**

An application wherein the invention is presented as that of a single person is termed a sole application.

### **201.02 Joint**

A joint application is one in which the invention is presented as that of two or more persons. See MPEP § 605.07.

### **201.03 Correction of Inventorship in an Application [R-2]**

Correction of inventorship in an application is permitted by amendment under 35 U.S.C. 116, which is implemented by 37 CFR 1.48. The utilization of a request under 37 CFR 1.48 will generally correct the inventorship in the application in which it is filed. 37 CFR 1.48(a) is directed at correcting the inventorship in an application where the inventorship was improperly set forth in the executed oath or declaration filed in the application. 37 CFR 1.48(b) is directed at correcting the inventorship where the executed oath or declaration had correctly set forth the inventorship but due to prosecution of the application, e.g., claim cancellation or amendment, fewer than all of the currently named inventors are the actual inventors of the remaining claims. 37 CFR 1.48(c) is directed at correcting the inventorship where the executed oath or declaration had correctly set forth the inventorship but due to amendment of the claims to include previously unclaimed but disclosed subject matter, one or more inventors of the amended subject matter must be added to the current inventorship. 37 CFR 1.48(d) is directed at provisional applications where an inventor is to be added. 37 CFR 1.48(e) is directed at provisional applications where an inventor is to be deleted. 37 CFR 1.48(f) operates to automatically correct the inventorship upon filing of a first executed oath or declaration under 37 CFR 1.63 by any of the inventors in a nonprovisional application or upon filing of a cover sheet in a provisional application.

Correction of inventorship may also be obtained by the filing of a continuing application under 37 CFR 1.53 without the need for filing a request under

37 CFR 1.48, either in the application containing the inventorship error (to be abandoned) or in the continuing application. The continuing application must be filed with the correct inventorship named therein. The filing of a continuing application to correct the inventorship is appropriate if at least one of the correct inventors has been named in the prior application (35 U.S.C. 120 and 37 CFR 1.78(a)(1)). That is, at least one of the correct inventors must be named in the executed oath or declaration filed in the prior application, or where no executed oath or declaration has been submitted in the prior application, the name of at least one correct inventor must be set forth in the application papers pursuant to 37 CFR 1.41(a)(1). Where the name of at least one inventor is to be added, correction of inventorship can be accomplished by filing a continuing application under 37 CFR 1.53(b) with a newly executed oath or declaration under 37 CFR 1.63(a). Where the name of an inventor(s) is to be deleted, applicant can file a continuing application with a request for deletion of the name of the inventor(s). The continuing application may be filed under 37 CFR 1.53(b) or, if the application is for a design patent, under 37 CFR 1.53(d). Note the requirements of 37 CFR 1.78 (a)(1)(ii)-(iv).

In certain instances where the statement of the lack of deceptive intent of the inventor to be added or deleted cannot be obtained, a petition under 37 CFR 1.183 requesting waiver of that requirement may be possible.

For provisional applications, it may not be necessary to correct the inventorship under 37 CFR 1.48 (d) and (e) unless there would be no overlap of inventors upon the filing of the nonprovisional application with the correct inventorship. See this MPEP section, headings “37 CFR 1.48(d)” and “37 CFR 1.48(e).”

The need to correct the inventorship in any U.S. nonprovisional or provisional application may in part be dependent upon whether a foreign filing under the Paris Convention will occur subsequent to the U.S. filing. See MPEP § 201.13.

37 CFR 1.48 does not apply to reissue applications as is noted in its title, whether correcting an inventorship error in the patent to be reissued or in the reissue application itself. Where an error in inventorship in a patent is to be corrected via a reissue application, see MPEP § 1412.04. Where such an error is to

be corrected via a certificate of correction under 37 CFR 1.324, see MPEP § 1481.

Where a request under 37 CFR 1.48 is denied in a final agency action, the examiner must determine whether a rejection under 35 U.S.C. 102(f) or (g) is appropriate. Where the request under 37 CFR 1.48 has been entered (for a decision thereon) and is dismissed (due to a defect that can be corrected) consideration under 35 U.S.C. 102(f) or (g) would be premature.

Although 37 CFR 1.48 does not contain a diligence requirement for filing the request, once an inventorship error is discovered, timeliness requirements under 37 CFR 1.116 and 37 CFR 1.312 apply. For allowed applications where the issue fee has been paid prior to the entry of a request under 37 CFR 1.48, if the request under 37 CFR 1.48 is dismissed or denied in an Office action, the application must be withdrawn from issue so that applicant would be given time to correct the defect(s). If the request under 37 CFR 1.48 is granted, then it would not be necessary to withdraw the application from issue.

Requests under 37 CFR 1.48 are generally decided by the primary examiner except:

(A) When the application is involved in an interference (decided by the Board of Patent Appeals and Interferences);

(B) When the application is a national stage application filed under 35 U.S.C. 371 which, as of the date of filing of the request, has not been accepted as satisfying the requirements for entry into the national stage (decided in the PCT Legal Office); and

(C) When accompanied by a petition under 37 CFR 1.183 requesting waiver of a requirement under 37 CFR 1.48(a) or (c), e.g., waiver of the statement of lack of deceptive intent by an inventor to be added or deleted, or waiver of the reexecution of the declaration by all of the inventors (decided in the Office of Petitions).

When any request for correction of inventorship under 37 CFR 1.48(a)-(c) is granted, the examiner will acknowledge any addition or deletion of the names of inventors by using either form paragraph 2.14 or form paragraph 2.14.01 in the next Office communication to applicant or his/her attorney. It will be necessary to revise the PALM records, issue a corrected filing receipt, and change the bib-data sheet \*\*.

The correction should be noted on the original oath or declaration by writing in \* ink in the left column "See Paper No. \_\_\_ for inventorship corrections." See MPEP § 605.04(g). >For Image File Wrapper (IFW) processing, see the IFW Manual.<

\*\*>

*¶ 2.14 Correction of Inventorship Under 37 CFR 1.48(a) or (c), Sufficient*

In view of the papers filed [1], it has been found that this non-provisional application, as filed, through error and without deceptive intent, improperly set forth the inventorship, and accordingly, this application has been corrected in compliance with 37 CFR 1.48 ([2]). The inventorship of this application has been changed by [3].

The application will be forwarded to the Office of Initial Patent Examination (OIPE) for issuance of a corrected filing receipt, and correction of Office records to reflect the inventorship as corrected.

**Examiner Note:**

1. In bracket 2, insert --a-- or --c--, as appropriate.
2. In bracket 3, insert explanation of correction made, including addition or deletion of appropriate names.

*¶ 2.14.01 Correction of Inventorship Under 37 CFR 1.48(b), Sufficient*

In view of the papers filed [1], the inventorship of this non-provisional application has been changed by the deletion of [2].

The application will be forwarded to the Office of Initial Patent Examination (OIPE) for issuance of a corrected filing receipt, and correction of Office records to reflect the inventorship as corrected.

**Examiner Note:**

1. This form paragraph is to be used only for 37 CFR 1.48(b) corrections.
2. In bracket 2, insert the names of the deleted inventor(s).

<

The grant or denial of a request under 37 CFR 1.48(a) may result in the lack of inventorship overlap between a parent application and a continuing application and the consequent inability to claim benefit in the continuing application of the parent application's filing date under 35 U.S.C. 120. Intervening references must then be considered.

For correction of inventorship in a patent, see 37 CFR 1.324 and MPEP § 1481.

A request under 37 CFR 1.48 will not be required:

(A) Where an application is to issue with the correct inventorship based on the allowed claims even though the application may have been filed with an

incorrect inventorship based on the claims as originally submitted;

(B) Where a typographical or transliteration error in the spelling of an inventor's name is discovered, the Office should simply be notified of the error. A new oath or declaration is not required. >See MPEP § 605.04(g).< Reference to the notification will be made on the previously filed oath or declaration;

(C) Where an inventor's name has been changed after the application has been filed, see MPEP § 605.04(c);

(D) Where a court has issued an order under 35 U.S.C. 256 for correction of the inventorship of a patent, it should be submitted directly to the Certificate of Correction Division along with the Office's certificate of correction form, PTO-1050. A new oath or declaration under 37 CFR 1.63 is not required;

(E) Where there is no change of individual but an incorrect name was given, \*\*>a petition under 37 CFR 1.182 should be filed requesting correction of applicant's name<;

(F) In a nonprovisional application filed under 35 U.S.C. 111(a), where the first-filed executed oath or declaration was filed on or after December 1, 1997 and names the correct inventors, but the inventive entity on the executed oath or declaration differs from that which was set forth on filing of the application, e.g., the application transmittal letter or an unexecuted oath or declaration. See 37 CFR 1.48(f)(1);

(G) In a provisional application filed under 35 U.S.C. 111(b), where the cover sheet was filed on or after December 1, 1997 which names the correct inventors, but the inventive entity on the cover sheet differs from that which was set forth on filing of the provisional application without a cover sheet. See 37 CFR 1.48(f)(2).

>

## **I. <APPLICATIONS FILED UNDER 37 CFR 1.53(f) - NO OATH/DECLARATION**

The Office will issue a filing receipt listing the inventors identified at the time of filing of the application even if the application was filed under 37 CFR 1.53(f) without an executed oath or declaration. Where the first-filed executed oath or declaration was filed on or after December 1, 1997 and sets forth an inventive entity which is different from the inventive

entity initially set forth at the time of filing of the application, the actual inventorship of the application will be taken from the executed oath or declaration. See 37 CFR 1.41(a)(1). A request under 37 CFR 1.48(a) >, (b), or (c)< will not be necessary. See 37 CFR 1.48(f).

Where the first-filed executed oath or declaration was submitted prior to December 1, 1997 in an application filed without an executed oath or declaration, if the inventive entity identified on the executed oath or declaration differs from the inventive entity identified at the time of filing of the application, a request under 37 CFR 1.48(a) or (c) must also be submitted. \*\*

The original named inventors should not execute or submit an oath or declaration under 37 CFR 1.63 merely to timely complete the filing requirements in reply to a "Notice to File Missing Parts of Application" where the possibility of an error in inventorship has been discovered >\*, nor should the oath or declaration be< signed by someone who cannot properly make the averments therein. Additional time to reply to the Notice is available under 37 CFR 1.136(a) and possibly under 37 CFR 1.136(b). See MPEP § 710.02(d).

### **Example**

A nonprovisional application is filed (either prior to, on or after December 1, 1997) naming A as the sole inventor without an executed declaration under 37 CFR 1.63. Only claim 1 is presented.

A "Notice to File Missing Parts of Application" is mailed prior to December 1, 1997. In timely reply thereto after December 1, 1997, a preliminary amendment adding claim 2, and a declaration under 37 CFR 1.63 executed by inventors A and B are submitted with B being added in view of claim 2. A request under 37 CFR 1.48(c) is not required, in that 37 CFR 1.48(f)(1) will act to set forth an inventorship of A and B.

Similarly, where a preliminary amendment canceling or amending claims concomitantly requires the deletion of an inventor, such deletion may be accomplished by the submission of a first-filed executed oath or declaration on or after December 1, 1997 naming the actual inventive entity. A request under 37 CFR 1.48(b) would not be necessary.

&gt;

**II. < 37 CFR 1.48(a)**

37 CFR 1.48. *Correction of inventorship in a patent application, other than a reissue application, pursuant to 35 U.S.C. 116.*

(a) *Nonprovisional application after oath/declaration filed.*

If the inventive entity is set forth in error in an executed § 1.63 oath or declaration in a nonprovisional application, and such error arose without any deceptive intention on the part of the person named as an inventor in error or on the part of the person who through error was not named as an inventor, the inventorship of the nonprovisional application may be amended to name only the actual inventor or inventors. If the nonprovisional application is involved in an interference, the amendment must comply with the requirements of this section and must be accompanied by a motion under § 1.634. Amendment of the inventorship requires:

(1) A request to correct the inventorship that sets forth the desired inventorship change;

(2) A statement from each person being added as an inventor and from each person being deleted as an inventor that the error in inventorship occurred without deceptive intention on his or her part;

(3) An oath or declaration by the actual inventor or inventors as required by § 1.63 or as permitted by §§ 1.42, 1.43 or § 1.47;

(4) The processing fee set forth in § 1.17(i); and

(5) If an assignment has been executed by any of the original named inventors, the written consent of the assignee (see § 3.73(b) of this chapter).

\*\*\*\*\*

Under 37 CFR 1.48(a), if the correct inventor or inventors are not named in an executed oath or declaration under 37 CFR 1.63 in a nonprovisional application for patent, the application can be amended to name only the actual inventor or inventors so long as the error in the naming of the inventor or inventors occurred without any deceptive intention on the part of the person named as an inventor in error or the person who through error was not named as an inventor.

37 CFR 1.48(a) requires that the amendment be accompanied by: (1) a request to correct the inventorship that sets forth the desired inventorship change; (2) a statement from each person being added and from each person being deleted as an inventor that the error occurred without deceptive intention on his or her part; (3) an oath or declaration by each actual inventor or inventors as required by 37 CFR 1.63 or as permitted by 37 CFR 1.42, 1.43 or 1.47; (4) the fee set forth in 37 CFR 1.17 (i); and (5) the written consent of

any existing assignee, if any of the originally named inventors has executed an assignment.

Correction may be requested in cases where the person originally named as inventor was in fact not an inventor or the sole inventor of the subject matter being claimed. If such error occurred without any deceptive intention on the part of the inventor named and/or not named in error, the Office has the authority to substitute the true inventive entity for the erroneously named inventive entity. Instances where corrections can be made include changes from: a mistaken sole inventor to a different but actual sole inventor; a mistakenly identified sole inventor to different, but actual, joint inventors; a sole inventor to joint inventors to include the original sole inventor; erroneously identified joint inventors to different but actual joint inventors; erroneously identified joint inventors to a different, but actual, sole inventor. (Note that 35 U.S.C. 120 and 37 CFR 1.78 require an overlap of inventorship, hence, refiling, rather than requesting under 37 CFR 1.48, to change inventorship where the change would not result in an inventorship overlap may result in the loss of a priority claim.)

**A. *Statement of Lack of Deceptive Intention***

Where a similar inventorship error has occurred in more than one application for which correction is requested wherein petitioner seeks to rely on identical statements, only one original set need be supplied if copies are submitted in all other applications with a reference to the application containing the originals (original oaths or declarations under 37 CFR 1.63 and written consent of assignees along with separate processing fees must be filed in each application).

The statement required from each inventor being added or deleted may simply state that the inventorship error occurred without deceptive intention. The statement need not be a verified statement (see MPEP § 410).

On very infrequent occasions, the requirements of 37 CFR 1.48(a) have been waived upon the filing of a request and fee under 37 CFR 1.183 (along with the request and fee under 37 CFR 1.48(a)) to permit the filing of a statement by less than all the parties required to submit a statement. *In re Cooper*, 230 USPQ 638, 639 (Dep. Assist. Comm'r Pat. 1986). However, such a waiver will not be considered unless the facts of record unequivocally support the correc-

tion sought. *In re Hardee*, 223 USPQ 1122, 1123 (Comm'r Pat. 1984). As 37 CFR 1.48(a) is intended as a simple procedural remedy and does not represent a substantive determination as to inventorship, issues relating to the inventors' or alleged inventors' actual contributions to conception and reduction to practice are not appropriate for consideration in determining whether the record unequivocally supports the correction sought.

In those situations where an inventor to be added refuses to submit a statement supporting the addition or such party cannot be reached, waiver under 37 CFR 1.183 of the requirement for a statement from that party would be appropriate upon a showing of such refusal or inability to reach the inventor. Every existing assignee of the original named inventors must give its consent to the requested correction. Where there is more than one assignee giving its consent, the extent of that interest (percentage) should be shown. Where no assignment has been executed by the inventors, or if deletion of a refusing inventor is requested, waiver will not be granted absent unequivocal support for the correction sought. Petitions under 37 CFR 1.47 are not applicable to the requirement for statements from each originally named inventor.

An available remedy to obtain correction of inventorship where waiver of a required statement is not available to correct the inventorship in a particular application is to refile the application naming the correct inventive entity. A request under 37 CFR 1.48(a) would not then be required in the newly filed application as no correction would be needed. Furthermore, a request under 37 CFR 1.48(a) would also not be required in the prior application that was refiled, since the prior application will be abandoned. Benefit of the parent application's filing date would be available under 35 U.S.C. 120 provided there is at least one inventor overlap between the two applications. (Note: a sole-to-sole correction would not obtain benefit under 35 U.S.C. 120).

### **B. Oath or Declaration**

An oath or declaration under 37 CFR 1.63 by each actual inventor must be presented. While each inventor need not execute the same oath or declaration, each oath or declaration executed by an inventor must contain a complete listing of all inventors so as to

clearly indicate what each inventor believes to be the appropriate inventive entity. Where individual declarations are executed, they must be submitted as individual declarations rather than combined into one declaration. For example, where the inventive entity is A and B, a declaration may not be executed only by A naming only A as the inventor and a different declaration may not be executed only by B naming only B as the inventor, which two declarations are then combined into one declaration with a first page of boiler plate, a second page with A's signature, and a second page with B's signature (so that it appears that the declaration was executed with the entire inventive entity appearing in the declaration when it did not).

**Conflicting oaths or declarations filed:** If the first executed oaths or declarations that are submitted name different inventive entities (e.g., one declaration names A, B, and C as inventors and a second declaration names D as the inventor) and are filed on the same day, the application will be considered to name the inventors named in both declarations (A, B, C, and D) and a new oath or declaration in compliance with 37 CFR 1.63 including the entire inventive entity will be required. Where an application is filed with an executed declaration under 37 CFR 1.63 naming an inventive entity that is in conflict with another paper filed in the application, such as the transmittal letter, the executed declaration will govern. However, where an executed declaration is never submitted and the application papers are in conflict as to the inventorship, each party identified as an inventor on filing will be considered to have been named as part of the inventive entity. See 37 CFR 1.41(a)(1).

37 CFR 1.47 is available to meet the requirement for an oath or declaration under 37 CFR 1.63 as for example where A, B, and C were originally named as inventors and D who refuses to cooperate is to be later added as an inventor. The oath or declaration under 37 CFR 1.63 of inventor D may be supplied pursuant to 37 CFR 1.47(a), but note that the required 37 CFR 1.48(a)(2) statement must still be supplied by inventor D (an unlikely event in view of the inability to obtain the executed oath or declaration under 37 CFR 1.63), or waiver thereof petitioned under 37 CFR 1.183. Alternatively, where D is to be added as an inventor (where inventors A, B, and C have previously executed the application under 37 CFR 1.63) and it is original inventor A who refuses to cooperate, the



statement under 37 CFR 1.48(a)(2) is only required to be signed by inventor D. Originally named inventor A is merely required to reexecute an oath or declaration in compliance with 37 CFR 1.63. Petitions under 37 CFR 1.47 are only applicable to an original oath or declaration and are not applicable to the reexecution of another oath or declaration by A. In such circumstances, a petition under 37 CFR 1.183 should be considered requesting waiver of the requirement of 37 CFR 1.64 that each of the actual inventors, i.e., inventor A, execute the oath or declaration, particularly where assignee consent is given to the requested correction. Absent assignee consent, the petition under 37 CFR 1.183 requesting waiver of the reexecution of the oath or declaration will be evaluated as to whether the nonsigning inventor was actually given the opportunity to reexecute the oath or declaration, or whether the nonsigning inventor could not be reached.

Applications filed with a petition under 37 CFR 1.47 and a request under 1.48(a) will be forwarded to the Office of Petitions, after mailing the filing receipt by the Office of Initial Patent Examination, for consideration of the petition and the request. In those instances wherein a request under 37 CFR 1.48(a) and a petition under 37 CFR 1.47 have both been filed in an application, the Office of Petitions may first issue a decision on the request under 37 CFR 1.48(a) so as to determine the appropriate oath or declaration under 37 CFR 1.63 required for the petition under 37 CFR 1.47.

The oath or declaration submitted subsequent to the filing date (37 CFR 1.53(f)) of an application filed under 37 CFR 1.53(b) must clearly identify the previously filed specification it is intended to execute. See MPEP § 601.01(a).

### **C. Fee**

Where waiver under 37 CFR 1.183 is requested in relation to a requirement under 37 CFR 1.48(a), a processing fee under 37 CFR 1.48(a) and a petition fee under 37 CFR 1.183 are required. Similarly, where in addition to a request under 37 CFR 1.48, two petitions under 37 CFR 1.183 are presented, e.g., one requesting waiver of a requirement under 37 CFR 1.48 and the other requesting waiver of the reexecution of an oath or declaration under 37 CFR 1.64, three fees are required (one for the request filed under 37 CFR 1.48 and two for the petitions filed under 37 CFR 1.183).

Where a similar error has occurred in more than one application a separate processing fee must be submitted in each application in which correction is requested.

If the processing fee has not been submitted or authorized the request will be dismissed.

### **D. Written Consent of Assignee**

The written consent of every existing assignee of the original named inventors must be submitted. 37 CFR 1.48(a)(5). 37 CFR 1.48(a) does not limit assignees to those who are recorded in the U.S. Patent and Trademark Office records. The Office employee deciding the request should check the file record for any indication of the existence of an assignee (e.g., a small entity assertion from an assignee.)

Where no assignee exists requester should affirmatively state that fact. If the file record including the request is silent as to the existence of an assignee it will be presumed that no assignee exists. Such presumption should be set forth in the decision to alert requesters to the requirement.

The individual signing on behalf of the assignee giving its consent to the requested inventorship correction, should specifically state that he or she has the authority to act on behalf of the assignee. In the absence of such a statement, the consent will be accepted if it is signed by an appropriate official of the assignee (e.g., president, vice president, secretary, treasurer, or derivative thereof) if the official's title has been made of record. A general statement of authority to act for the assignee, or on the specific matter of consent, or the appropriate title of the party signing on behalf of the assignee should be made of record in the consent. However, if it appears in another paper of record, e.g., small entity assertion, it is also acceptable. Further, the assignee must establish its ownership of the application in accordance with 37 CFR 3.73. MPEP § 324.

### **E. Continuing Applications**

35 U.S.C. 120 permits a continuing application to claim the benefit of the filing date of a copending, previously filed, parent application provided there is inventorship overlap between the continuing application and the parent application. If the inventive entity of a continuing application includes an inventor

named in the parent application, the inventorship overlap required by 35 U.S.C. 120 is met.

### Example

The parent application names inventors A and B and claims inventions 1 and 2. Inventor A contributes only to invention 1 and inventor B contributes only to invention 2. A restriction requirement is made and invention 1 was elected. Upon allowance of claims directed to invention 1 and cancellation of claims directed to invention 2, a request under 37 CFR 1.48(b) was filed requesting deletion of inventor B. The request under 37 CFR 1.48(b) was granted by the primary examiner. Prior to the issuance of the parent application, a divisional application claiming benefit under 35 U.S.C. 120 to the parent application, is filed claiming only invention 2 and naming only inventor B. The inventorship overlap required by 35 U.S.C. 120 is met in this instance even though at the time of filing of the divisional application, the inventorship overlap was lost as a result of the deletion of an inventor in the parent application. The overlap of inventorship need not be present on the date the continuing application is filed nor present when the parent application issues or becomes abandoned.

On filing a continuing application under 37 CFR 1.53(b) \*\* it should not be assumed that an error in inventorship made in a parent application was in fact corrected therein in response to a request under 37 CFR 1.48(a) unless a decision from the U.S. Patent and Trademark Office to that effect was received by the requester. \*\* A continuing application naming the additional inventor can be filed under 35 U.S.C. 111(a) and 37 CFR 1.53(b) with a newly executed oath or declaration by the new inventive entity along with a request for priority under 35 U.S.C. 120 without the need for a decision on the request under 37 CFR 1.48 filed in the parent application.

Should an error in inventorship in a parent application be discovered, whether it is the need to add and/or to delete inventors, when preparing to file a continuing application, the continuing application may be filed under 37 CFR 1.53(b) with the correct inventive entity without the need for a request under 37 CFR 1.48(a) in the parent or continuing application provided the parent application is to be abandoned on fil-

ing of the continuing application. In filing the continuing application under 37 CFR 1.53(b), a copy of an oath or declaration from the prior application can only be used where inventors are to be deleted (37 CFR 1.53(b)(1) and 37 CFR 1.63(d)(1)(ii)), but not where inventors are to be added. Where inventors are to be added, a newly executed oath or declaration must be submitted. See 37 CFR 1.63(d)(5).

>In a continued prosecution application (CPA) filed under 37 CFR 1.53(d), a request under 37 CFR 1.48(a) or (c) to add an inventor to a parent application that was not acted on (e.g., filed after final rejection) will be automatically considered in the CPA. Until the request is granted, the inventorship remains the same as the prior application. Note, however, that effective July 14, 2003, CPA practice has been eliminated as to utility and plant applications. If the application is a design application, after< discovery of an inventorship error, the application can also be refiled under 37 CFR 1.53(d)(4) as a CPA where inventors are only to be deleted.

In filing a continuing application to correct the inventorship, \*\* it is important to recognize that 37 CFR 1.78 requires for priority purposes that the prior application must either have had the filing fee, or the retention fee as set forth in 37 CFR 1.21(l), paid within the period set forth in 37 CFR 1.53(f) so as to establish copendency. See 37 CFR 1.78(a)(1)(iii) and 37 CFR 1.78(a)(1)(iv).

Should a continuing application be filed \* under 37 CFR 1.53(b)(1) where a copy of the oath or declaration from the prior application is utilized\* >(or under 37 CFR 1.53(d) as a CPA \*\* >if the prior application is a design application) purporting< to add an inventor, the inventorship of the prior application will be retained in the continuing application as addition of an inventor is not permitted in these instances. The absence of a request to correct the inventorship submitted with the continuing application will not affect the filing date of the continuing application. However, the retained inventorship must then be corrected by the filing of a request under 37 CFR 1.48(a) in the continuing application stating that the error in failing to name the additional inventor in the prior application was without deceptive intention. Where an inventor is to be added, it is recommended that a continuing application be filed under 37 CFR 1.53(b) with a newly executed oath or declaration and not be filed

with a copy of the oath or declaration from the prior application. This procedure eliminates the need for a request under 37 CFR 1.48.

An inventorship error discovered while prosecuting a continuing application that occurred in both an abandoned parent application and the continuing application can be corrected in both applications by filing a single request in the continuing application (e.g., A + B named in parent, B + C named in continuing application, actual inventorship is C + D thereby eliminating inventorship overlap and resulting loss of priority claim under 35 U.S.C. 120 if the error is not corrected in abandoned parent application as well as in continuation application). Absent such loss of inventorship overlap, correction need not be made in the abandoned application.

When entering the national stage under 35 U.S.C. 371, correction of inventorship is via the provisions of **\*\*>37 CFR 1.497(d)**. See MPEP § 1893.01(e).<

**¶ 2.13 Correction of Inventorship Under 37 CFR 1.48(a), Insufficient**

The request to correct the inventorship of this nonprovisional application under 37 CFR 1.48(a) is deficient because:

**Examiner Note:**

1. This form paragraph should only be used in response to requests to correct an error in the naming of the prior inventors in nonprovisional applications. If the request is merely to delete an inventor because claims were canceled or amended such that the deleted inventor is no longer an actual inventor of any claim in the application, use form paragraph 2.13.01 instead of this form paragraph.

Potential rejections

A rejection under 35 U.S.C. 102(f) or (g) must be considered if the request is denied.

The grant or denial of the request may result in the loss of inventorship overlap between a parent application and a continuing application and an inability to claim benefit in the continuing application of the parent application's filing date under 35 U.S.C. 120. Intervening references must then be considered.

2. A primary examiner may not decide the request if the request is also accompanied by a petition under 37 CFR 1.183 requesting waiver of one of the requirements explicitly set forth in 37 CFR 1.48(a) (typically a refusal of one of the inventors to be added or deleted to execute the required statement of facts) – the request for correction of inventorship and request for waiver of the rules should be forwarded to the Office of Petitions.

3. One or more of form paragraphs 2.13a - 2.13e should follow this form paragraph, as applicable.

4. Where it appears that: 1) the inventor(s) to be added or deleted may be hostile and will not execute a required statement of facts; and 2) the actual inventorship would overlap the original inventorship (37 CFR 1.78), follow this form paragraph with form paragraph 2.13f.

5. Requests under 37 CFR 1.41 to change inventorship where an executed oath or declaration has not been filed are to be acted upon by OIPE.

6. Where there is a correction in a person's name, e.g., due to misspelling, or marriage, a request under 37 CFR 1.48 is inappropriate. See MPEP § 605.04(b) and (c) for name changes.

7. An initial executed oath or declaration under 37 CFR 1.63 may change the inventorship as originally set forth when the application is filed without an executed oath or declaration without request for correction of inventorship (37 CFR 1.48(f)).

**¶ 2.13a Statement of Facts Problem (for Use Following FP 2.13, If Applicable)**

The statement of facts by an inventor or inventors to be added or deleted does not explicitly state that the inventorship error occurred without deceptive intent on his or her part or cannot be construed to so state.

**¶ 2.13b No New Oath or Declaration (for Use Following FP 2.13 or 2.13.02, If Applicable)**

An oath or declaration by each actual inventor or inventors listing the entire inventive entity has not been submitted.

**¶ 2.13c Required Fee Not Submitted (for Use Following FP 2.13, 2.13.01 or 2.13.02, If Applicable)**

It lacks the required fee under 37 CFR 1.17(i).

**¶ 2.13d Written Consent Missing (for Use Following FP 2.13 or 2.13.02, If Applicable)**

It lacks the written consent of any assignee of one of the originally named inventors.

**¶ 2.13e 37 CFR 3.73(b) Submission (for Use Following FP 2.13 or 2.13.02, If Applicable)**

A 37 CFR 3.73(b) submission has not been received to support action by the assignee.

**\*\*>**

**¶ 2.13f Hostile Inventor(s)/Inventorship Overlap (for Use Following FP 2.13, If Applicable)**

As it appears that a party required by 37 CFR 1.48(a)(2) to submit a statement of facts may not be willing to submit such statement, applicant should consider either: a) submission of a petition under 37 CFR 1.183 to waive that requirement if the original named inventor(s) has assigned the entire right and interest to an assignee who has given its consent to the requested inventorship correction, MPEP § 201.03, Statement of Lack of Deceptive Intention, or b) refiling the application (where addition is needed under 37 CFR 1.53(b) with a new oath or declaration and any necessary petition under 37 CFR 1.47, or where only deletion is needed, either under 37 CFR 1.53(b) utilizing a copy of a prior oath or declaration under 37 CFR 1.63(d)(1)(iv), or under 37 CFR

1.53(d)) (design applications only), thereby eliminating the need for a 37 CFR 1.48 request.

<

¶ 2.13.01 *Correction of Inventorship Under 37 CFR 1.48(b), Insufficient*

The request for the deletion of an inventor in this nonprovisional application under 37 CFR 1.48(b) is deficient because:

**Examiner Note:**

1. This form paragraph should only be used when the inventorship was previously correct when originally executed but an inventor is being deleted because claims have been amended or canceled such that he or she is no longer an inventor of any remaining claim in the non-provisional application. If the inventorship is being corrected because of an error in naming the correct inventors, use form paragraph 2.13 instead of this form paragraph.
2. Follow this form paragraph with one or both of form paragraphs 2.13c and 2.13g.
3. See note 1 of form paragraph 2.13, Potential rejections.

¶ 2.13g *Statement Under 37 CFR 1.48(b)(2) Problem (for Use Following FP 2.13.01, If Applicable)*

The request was not accompanied by the statement required under 37 CFR 1.48 (b)(2).

¶ 2.13.02 *Correction of Inventorship Under 37 CFR 1.48(c), Insufficient*

The request to correct the inventorship in this nonprovisional application under 37 CFR 1.48(c) requesting addition of an inventor(s) is deficient because:

**Examiner Note:**

1. This form paragraph should only be used when the inventorship was previously correct when the application was originally executed, but the inventorship now needs to be changed due to subsequent addition of subject matter from the specification to the claims, which subject matter was contributed by a party not originally named as an inventor.
2. See note 2 of form paragraph 2.13.
3. Follow this form paragraph with any of form paragraphs 2.13b-2.13e or 2.13h.
4. See note 1 of form paragraph 2.13, Potential rejections.
5. See notes 4-7 of form paragraph 2.13.

¶ 2.13h *Statement of Facts, Added Inventor (for Use Following FP 2.13.02, If Applicable)*

The statement of facts by the inventor(s) to be added does not explicitly state that the amendment of the inventorship is necessitated by amendment of the claims and that the inventorship error occurred without deceptive intent on the part of the inventor(s) to be added, or cannot be construed to so state.

\*\*>

¶ 2.14 *Correction of Inventorship Under 37 CFR 1.48(a) or (c), Sufficient*

In view of the papers filed [1], it has been found that this nonprovisional application, as filed, through error and without deceptive intent, improperly set forth the inventorship, and accordingly, this application has been corrected in compliance with 37 CFR 1.48 ([2]). The inventorship of this application has been changed by [3].

The application will be forwarded to the Office of Initial Patent Examination (OIPE) for issuance of a corrected filing receipt, and correction of Office records to reflect the inventorship as corrected.

**Examiner Note:**

1. In bracket 2, insert --a-- or --c--, as appropriate.
2. In bracket 3, insert explanation of correction made, including addition or deletion of appropriate names.

¶ 2.14.01 *Correction of Inventorship Under 37 CFR 1.48(b), Sufficient*

In view of the papers filed [1], the inventorship of this nonprovisional application has been changed by the deletion of [2].

The application will be forwarded to the Office of Initial Patent Examination (OIPE) for issuance of a corrected filing receipt, and correction of Office records to reflect the inventorship as corrected.

**Examiner Note:**

1. This form paragraph is to be used only for 37 CFR 1.48(b) corrections.
2. In bracket 2, insert the names of the deleted inventor(s).

**III. < 37 CFR 1.48(b)**

37 CFR 1.48. *Correction of inventorship in a patent application, other than a reissue application, pursuant to 35. U.S.C. 116.*

\*\*\*\*\*

(b) *Nonprovisional application—fewer inventors due to amendment or cancellation of claims.* If the correct inventors are named in a nonprovisional application, and the prosecution of the nonprovisional application results in the amendment or cancellation of claims so that fewer than all of the currently named inventors are the actual inventors of the invention being claimed in the nonprovisional application, an amendment must be filed requesting deletion of the name or names of the person or persons who are not inventors of the invention being claimed. If the application is involved in an interference, the amendment must comply with the requirements of this section and must be accompanied by a motion under § 1.634. Amendment of the inventorship requires:

(1) A request, signed by a party set forth in § 1.33(b), to correct the inventorship that identifies the named inventor or inventor's being deleted and acknowledges that the inventor's invention is no longer being claimed in the nonprovisional application; and

- (2) The processing fee set forth in § 1.17(i).

\*\*\*\*\*

37 CFR 1.48(b) provides for deleting the names of persons originally properly included as inventors, but whose invention is no longer being claimed in a nonprovisional application. Such a situation would arise where claims have been amended or deleted during prosecution because they are unpatentable or as a result of a requirement for restriction of the application to one invention, or for other reasons. A request under 37 CFR 1.48(b) to delete an inventor would be appropriate prior to an action by the TC where it is decided not to pursue particular aspects of an invention attributable to some of the original named inventors.

37 CFR 1.48(b) requires that the amendment be accompanied by: (1) a request including a statement identifying each named inventor who is being deleted and acknowledging that the inventor's invention is no longer being claimed in the application; and (2) a fee under 37 CFR 1.17(i). The statement may be signed by applicant's registered attorney or agent who then takes full responsibility for ensuring that the inventor is not being improperly deleted from the application. Written consent of any assignee is not required for requests filed under 37 CFR 1.48(b).

>

#### IV. < 37 CFR 1.48(c)

*37 CFR 1.48. Correction of inventorship in a patent application, other than a reissue application, pursuant to 35. U.S.C. 116.*

\*\*\*\*\*

(c) *Nonprovisional application—inventors added for claims to previously unclaimed subject matter.* If a nonprovisional application discloses unclaimed subject matter by an inventor or inventors not named in the application, the application may be amended to add claims to the subject matter and name the correct inventors for the application. If the application is involved in an interference, the amendment must comply with the requirements of this section and must be accompanied by a motion under § 1.634. Amendment of the inventorship requires:

(1) A request to correct the inventorship that sets forth the desired inventorship change;

(2) A statement from each person being added as an inventor that the addition is necessitated by amendment of the claims and that the inventorship error occurred without deceptive intention on his or her part;

(3) An oath or declaration by the actual inventors as required by § 1.63 or as permitted by §§ 1.42, 1.43, or § 1.47;

- (4) The processing fee set forth in § 1.17(i); and

(5) If an assignment has been executed by any of the original named inventors, the written consent of the assignee (see § 3.73(b) of this chapter).

\*\*\*\*\*

37 CFR 1.48(c) provides for the situation where a nonprovisional application discloses unclaimed subject matter by an inventor or inventors not named in the application when an executed declaration under 37 CFR 1.63 was first filed. In such a situation, the nonprovisional application may be amended pursuant to 37 CFR 1.48(c) to add claims directed to the originally unclaimed but disclosed subject matter and also to name the correct inventors for the application based on the newly added claims. Any claims added to the application must be supported by the disclosure as filed and cannot add new matter.

37 CFR 1.48(c) requires that the amendment must be accompanied by: (1) a request to correct the inventorship that sets forth the desired inventorship change; (2) a statement from each person being added as an inventor that the amendment is necessitated by an amendment to the claims and that the inventorship error occurred without deceptive intention on his or her part; (3) an oath or declaration by each actual inventor; (4) the fee under 37 CFR 1.17(i); and (5) the written consent of any assignee of the original named inventors.

>

#### V. < 37 CFR 1.48(d)

*37 CFR 1.48. Correction of inventorship in a patent application, other than a reissue application, pursuant to 35. U.S.C. 116.*

\*\*\*\*\*

(d) *Provisional application—adding omitted inventors.* If the name or names of an inventor or inventors were omitted in a provisional application through error without any deceptive intention on the part of the omitted inventor or inventors, the provisional application may be amended to add the name or names of the omitted inventor or inventors. Amendment of the inventorship requires:

(1) A request, signed by a party set forth in § 1.33(b), to correct the inventorship that identifies the inventor or inventors being added and states that the inventorship error occurred without deceptive intention on the part of the omitted inventor or inventors; and

- (2) The processing fee set forth in § 1.17(q).

\*\*\*\*\*

37 CFR 1.48(d) provides a procedure for adding the name of an inventor in a provisional application, where the name was originally omitted without deceptive intent.

37 CFR 1.48(d) requires that the amendment be accompanied by: (1) a request to correct the inventorship that sets forth the desired inventorship change; (2) a statement that the inventorship error occurred without deceptive intention on the part of the omitted inventor or inventors; and (3) the fee set forth in 37 CFR 1.17(q). The statement of lack of deceptive intent may be included in the request and may be signed by a registered attorney or agent. A statement of lack of deceptive intent is not required from any of the original or to be added inventors.

See also discussion below regarding requests filed under 37 CFR 1.48(e).

>

## VI. < 37 CFR 1.48(e)

*37 CFR 1.48. Correction of inventorship in a patent application, other than a reissue application, pursuant to 35 U.S.C. 116.*

\*\*\*\*\*

(e) *Provisional application—deleting the name or names of the inventor or inventors.* If a person or persons were named as an inventor or inventors in a provisional application through error without any deceptive intention on the part of such person or persons, an amendment may be filed in the provisional application deleting the name or names of the person or persons who were erroneously named. Amendment of the inventorship requires:

(1) A request to correct the inventorship that sets forth the desired inventorship change;

(2) A statement by the person or persons whose name or names are being deleted that the inventorship error occurred without deceptive intention on the part of such person or persons;

(3) The processing fee set forth in § 1.17(q); and

(4) If an assignment has been executed by any of the original named inventors, the written consent of the assignee (see § 3.73(b) of this chapter).

\*\*\*\*\*

37 CFR 1.48(e) provides a procedure for deleting the name of a person who was erroneously named as an inventor in a provisional application.

37 CFR 1.48(e) requires that the amendment be accompanied by: (1) a request to correct the inventor-

ship that sets forth the desired inventorship change; (2) a statement of lack of deceptive intent by the person whose name is being deleted establishing that the error occurred without deceptive intention on his or her part; (3) the fee set forth in 37 CFR 1.17(q); and (4) the written consent of any assignee.

Under 35 U.S.C. 119(e), as contained in Public Law 103-465, a later filed nonprovisional application under 35 U.S.C. 111(a) that is filed within twelve months of an earlier provisional application may claim priority benefits based on the earlier filed provisional application so long as both applications have at least one inventor in common. An error in not naming or in naming a person as an inventor in a provisional application would not require correction under either 37 CFR 1.48(d) (to add an inventor) or 37 CFR 1.48(e) (to delete an inventor) in the provisional application so long as the nonprovisional application naming the correct inventorship would contain an overlap of at least one inventor with the provisional application. The existence of inventorship overlap would prevent the original inventorship error from having any effect upon the ability of the provisional application to serve as a basis for a priority claim under 35 U.S.C. 119(e) with the U.S. Patent and Trademark Office.

If, however, applicant chooses to correct the inventive entity of a provisional application, for example, to permit the provisional application to serve as the basis of a priority claim in a foreign country, 37 CFR 1.48(d) and (e) set forth the procedures for adding one or more actual inventors and for deleting one or more erroneously named inventors respectively.

In the situation where an inventor was not named in a provisional application and an inventor was also erroneously named in the same provisional application and correction is desired, a request under 37 CFR 1.48(d) and a request under 37 CFR 1.48(e) would be required.

Where an inventorship error in a provisional application is desired to be corrected after expiration of twelve months from the filing date of the provisional application, a request under 37 CFR 1.48(d) and/or 37 CFR 1.48(e) may still be filed with OIPE, which handles requests under 37 CFR 1.48(d) and (e), to correct the inventorship in provisional applications.

&gt;

**VII. < 37 CFR 1.48(f)**

*37 CFR 1.48. Correction of inventorship in a patent application, other than a reissue application, pursuant to 35 U.S.C. 116.*

\*\*\*\*\*

(f)(1) *Nonprovisional application—filing executed oath/declaration corrects inventorship.* If the correct inventor or inventors are not named on filing a nonprovisional application under § 1.53(b) without an executed oath or declaration under § 1.63 by any of the inventors, the first submission of an executed oath or declaration under § 1.63 by any of the inventors during the pendency of the application will act to correct the earlier identification of inventorship. See §§ 1.41(a)(4) and 1.497(d) and (f) for submission of an executed oath or declaration to enter the national stage under 35 U.S.C. 371 naming an inventive entity different from the inventive entity set forth in the international stage.

(2) *Provisional application filing cover sheet corrects inventorship.* If the correct inventor or inventors are not named on filing a provisional application without a cover sheet under § 1.51(c)(1), the later submission of a cover sheet under § 1.51(c)(1) during the pendency of the application will act to correct the earlier identification of inventorship.

\*\*\*\*\*

37 CFR 1.48(f)(1) and (f)(2) will act to automatically correct an earlier identification of inventorship in a nonprovisional application by the filing of an initial executed oath or declaration and in a provisional application by the filing of an initial cover sheet. A request and fee is not required for the inventorship correction to occur.

The provision in 37 CFR 1.48(f)(1) for changing the inventorship only applies if an executed oath or declaration under 37 CFR 1.63 has not been submitted by any of the inventors. In this situation, the submission of an executed oath or declaration under 37 CFR 1.63 by any of the inventors is sufficient to correct an earlier identification of inventorship. A first-filed oath or declaration under 37 CFR 1.63 executed by less than all of the inventors initially identified will, under 37 CFR 1.48(f)(1), determine the inventorship in the application. Any subsequent oath or declaration filed by a different inventive entity will not be effective under 37 CFR 1.48(f)(1) to correct the inventorship that was specified in the first-filed oath or declaration.

37 CFR 1.48(f)(1) is not applicable for national stage applications filed under 35 U.S.C. 371 where the inventorship has been erroneously named in the

international application. Accordingly, if the inventorship set forth in the oath or declaration filed in the national stage application differs from the inventorship specified in the international application, the oath or declaration must be accompanied by a request under 37 CFR 1.48(a).

&gt;

**VIII. < 37 CFR 1.48(g)**

*37 CFR 1.48. Correction of inventorship in a patent application, other than a reissue application, pursuant to 35 U.S.C. 116.*

\*\*\*\*\*

(g) *Additional information may be required.* The Office may require such other information as may be deemed appropriate under the particular circumstances surrounding the correction of inventorship.

**201.04 Parent Application**

The term “parent” is applied to an earlier application of an inventor disclosing a given invention. Such invention may or may not be claimed in the first application. Benefit of the filing date of copending parent application may be claimed under 35 U.S.C. 120. The term parent will not be used to describe a provisional application.

**201.04(a) Original Application**

“Original” is used in the patent statute and rules to refer to an application which is not a reissue application. An original application may be a first filing or a continuing application.

**201.04(b) Provisional Application [R-2]**

*35 U.S.C. 111. Application.*

\*\*\*\*\*

**(b) PROVISIONAL APPLICATION.—**

(1) **AUTHORIZATION.**—A provisional application for patent shall be made or authorized to be made by the inventor, except as otherwise provided in this title, in writing to the Director. Such application shall include—

(A) a specification as prescribed by the first paragraph of section 112 of this title; and

(B) a drawing as prescribed by section 113 of this title.

(2) **CLAIM.**—A claim, as required by the second through fifth paragraphs of section 112, shall not be required in a provisional application.

(3) **FEE.**—

(A) The application must be accompanied by the fee required by law.

(B) The fee may be submitted after the specification and any required drawing are submitted, within such period and under such conditions, including the payment of a surcharge, as may be prescribed by the Director.

(C) Upon failure to submit the fee within such prescribed period, the application shall be regarded as abandoned, unless it is shown to the satisfaction of the Director that the delay in submitting the fee was unavoidable or unintentional.

(4) FILING DATE.—The filing date of a provisional application shall be the date on which the specification and any required drawing are received in the Patent and Trademark Office.

(5) ABANDONMENT.—Notwithstanding the absence of a claim, upon timely request and as prescribed by the Director, a provisional application may be treated as an application filed under subsection (a). Subject to section 119(e)(3) of this title, if no such request is made, the provisional application shall be regarded as abandoned 12 months after the filing date of such application and shall not be subject to revival after such 12-month period.

(6) OTHER BASIS FOR PROVISIONAL APPLICATION.—Subject to all the conditions in this subsection and section 119(e) of this title, and as prescribed by the Director, an application for patent filed under subsection (a) may be treated as a provisional application for patent.

(7) NO RIGHT OF PRIORITY OR BENEFIT OF EARLIEST FILING DATE.—A provisional application shall not be entitled to the right of priority of any other application under section 119 or 365(a) of this title or to the benefit of an earlier filing date in the United States under section 120, 121, or 365(c) of this title.

(8) APPLICABLE PROVISIONS.—The provisions of this title relating to applications for patent shall apply to provisional applications for patent, except as otherwise provided, and except that provisional applications for patent shall not be subject to sections 115, 131, 135, and 157 of this title.

### 37 CFR 1.9. Definitions.

(a)(1) A national application as used in this chapter means a U.S. application for patent which was either filed in the Office under 35 U.S.C. 111, or which entered the national stage from an international application after compliance with 35 U.S.C. 371.

(2) A provisional application as used in this chapter means a U.S. national application for patent filed in the Office under 35 U.S.C. 111(b).

(3) A nonprovisional application as used in this chapter means a U.S. national application for patent which was either filed in the Office under 35 U.S.C. 111(a), or which entered the national stage from an international application after compliance with 35 U.S.C. 371.

\*\*\*\*\*

37 CFR 1.53. *Application number, filing date, and completion of application.*

\*\*\*\*\*

(c) *Application filing requirements - Provisional application.* The filing date of a provisional application is the date on which a specification as prescribed by the first paragraph of 35 U.S.C. 112, and any drawing required by § 1.81(a) are filed in the Patent and Trademark Office. No amendment, other than to make the provisional application comply with the patent statute and all applicable regulations, may be made to the provisional application after the filing date of the provisional application.

(1) A provisional application must also include the cover sheet required by § 1.51(c)(1), which may be an application data sheet (§ 1.76), or a cover letter identifying the application as a provisional application. Otherwise, the application will be treated as an application filed under paragraph (b) of this section.

(2) An application for patent filed under paragraph (b) of this section may be converted to a provisional application and be accorded the original filing date of the application filed under paragraph (b) of this section. The grant of such a request for conversion will not entitle applicant to a refund of the fees that were properly paid in the application filed under paragraph (b) of this section. Such a request for conversion must be accompanied by the processing fee set forth in § 1.17(q) and be filed prior to the earliest of:

- (i) Abandonment of the application filed under paragraph (b) of this section;
- (ii) Payment of the issue fee on the application filed under paragraph (b) of this section;
- (iii) Expiration of twelve months after the filing date of the application filed under paragraph (b) of this section; or
- (iv) The filing of a request for a statutory invention registration under § 1.293 in the application filed under paragraph (b) of this section.

(3) A provisional application filed under paragraph (c) of this section may be converted to a nonprovisional application filed under paragraph (b) of this section and accorded the original filing date of the provisional application. The conversion of a provisional application to a nonprovisional application will not result in either the refund of any fee properly paid in the provisional application or the application of any such fee to the filing fee, or any other fee, for the nonprovisional application. Conversion of a provisional application to a nonprovisional application under this paragraph will result in the term of any patent to issue from the application being measured from at least the filing date of the provisional application for which conversion is requested. Thus, applicants should consider avoiding this adverse patent term impact by filing a nonprovisional application claiming the benefit of the provisional application under 35 U.S.C. 119(e) (rather than converting the provisional application into a nonprovisional application pursuant to this paragraph). A request to convert a provisional application to a nonprovisional application must be accompanied by the fee set forth in § 1.17(i) and an amendment including at least one claim as prescribed by the second paragraph of 35 U.S.C. 112, unless the provisional application under paragraph (c) of this section otherwise contains at least one claim as



prescribed by the second paragraph of 35 U.S.C.112. The nonprovisional application resulting from conversion of a provisional application must also include the filing fee for a nonprovisional application, an oath or declaration by the applicant pursuant to §§ 1.63, 1.162, or 1.175, and the surcharge required by § 1.16(e) if either the basic filing fee for a nonprovisional application or the oath or declaration was not present on the filing date accorded the resulting nonprovisional application (*i.e.*, the filing date of the original provisional application). A request to convert a provisional application to a nonprovisional application must also be filed prior to the earliest of:

(i) Abandonment of the provisional application filed under paragraph (c) of this section; or

(ii) Expiration of twelve months after the filing date of the provisional application filed under this paragraph (c).

(4) A provisional application is not entitled to the right of priority under 35 U.S.C. 119 or 365(a) or § 1.55, or to the benefit of an earlier filing date under 35 U.S.C. 120, 121 or 365(c) or § 1.78 of any other application. No claim for priority under 35 U.S.C. 119(e) or § 1.78(a)(4) may be made in a design application based on a provisional application. No request under § 1.293 for a statutory invention registration may be filed in a provisional application. The requirements of §§ 1.821 through 1.825 regarding application disclosures containing nucleotide and/or amino acid sequences are not mandatory for provisional applications.

\*\*\*\*\*

One of the provisions of the Uruguay Round Agreements Act \*\* >(effective as of June 8, 1995)><, is the establishment of a domestic priority system. The Act provides a mechanism to enable domestic applicants to quickly and inexpensively file provisional applications. Under the provisions of 35 U.S.C. 119(e), applicants are entitled to claim the benefit of priority in a given application in the United States. The domestic priority period will not count in the measurement of the 20-year patent term. See 35 U.S.C. 154(a)(3). Thus, domestic applicants are placed on equal footing with foreign applicants with respect to the patent term.

The parts of a provisional application that are required are set forth in 37 CFR 1.51(c) and MPEP § 601.01(b). The filing date of a provisional application is the date on which (1) a specification which complies with 35 U.S.C. 112, first paragraph, and (2) any drawing required by 37 CFR 1.81(a) are filed. A provisional application must also include a cover sheet or cover letter identifying the application as a provisional application. Otherwise, the application will be treated as an application filed under 37 CFR 1.53(b). The filing fee is set forth in 37 CFR 1.16(k).

#### NOTE:

(A) No claim is required in a provisional application.

(B) No oath or declaration is required in a provisional application.

(C) Provisional applications will not be examined for patentability, placed in an interference, or made the subject of a statutory invention registration.

A provisional application will automatically be abandoned 12 months after its filing date and will not be subject to revival to restore it to pending status thereafter. See 35 U.S.C. 111(b)(5). Public Law 106-113 amended 35 U.S.C. 119(e)(3) to extend the period of pendency of a provisional application to the next succeeding business day if the day that is 12 months after the filing date of a provisional application falls on a Saturday, Sunday, or Federal holiday within the District of Columbia. See also 37 CFR 1.7(b). 35 U.S.C. 119(e)(3) as amended by Public Law 106-113 is effective as of November 29, 1999 and applies to any provisional applications filed on or after June 8, 1995 but has no effect on any patent which is the subject of litigation in an action commenced before November 29, 1999.

For example, if a provisional application was filed on January 15, 1999, the last day of pendency of the provisional application under 35 U.S.C. 111(b)(5) and 35 U.S.C. 119(e)(3) is extended to January 18, 2000 (January 15, 2000 is a Saturday and Monday, January 17, 2000 is a Federal holiday and therefore, the next succeeding business day is Tuesday, January 18, 2000). A nonprovisional application claiming the benefit of the provisional application must be filed no later than January 18, 2000.

A provisional application is not entitled to claim priority benefits based on any other application under 35 U.S.C. 119, 120, 121, or 365. If applicant attempts to claim the benefit of an earlier U.S. or foreign application in a provisional application, the filing receipt will not reflect the improper priority claim. Moreover, if a nonprovisional application claims the benefit of the filing date of a provisional application, and states that the provisional application relies upon the filing date of an earlier application, the claim for priority earlier than the filing date of the provisional application will be disregarded.

An application filed under 37 CFR 1.53(b) may be converted to a provisional application provided a request for conversion is submitted along with the fee as set forth in 37 CFR 1.17(q). The request and fee must be submitted prior to the earlier of the abandonment of the nonprovisional application, the payment of the issue fee, the expiration of 12 months after the filing date of the nonprovisional application, or the filing of a request for statutory invention registration. The grant of any such request will not entitle applicant to a refund of the fees which were properly paid in the application filed under 37 CFR 1.53(b). See MPEP § 601.01(c)

Public Law 106-113 amended 35 U.S.C. 111(b)(5) to permit a provisional application filed under 37 CFR 1.53(c) be converted to a nonprovisional application filed under 37 CFR 1.53(b). 35 U.S.C. 111(b)(5) as amended by Public Law 106-113 is effective as of November 29, 1999 and applies to any provisional applications filed on or after June 8, 1995. A request to convert a provisional application to a nonprovisional application must be accompanied by the fee set forth in 37 CFR 1.17(i) and an amendment including at least one claim as prescribed by 35 U.S.C. 112,

unless the provisional application otherwise contains at least one such claim. The request must be filed prior to the earliest of the abandonment of the provisional application or the expiration of twelve months after the filing date of the provisional application. The filing fee for a nonprovisional application, an executed oath or declaration under 37 CFR 1.63, and the surcharge under 37 CFR 1.16(e), if appropriate, are also required. The grant of any such request will not entitle applicant to a refund of the fees which were properly paid in the application filed under 37 CFR 1.53(c). Conversion of a provisional application to a nonprovisional application will result in the term of any patent issuing from the application being measured from at least the filing date of the provisional application. This adverse patent term impact can be avoided by filing a nonprovisional application claiming the benefit of the provisional application under 35 U.S.C. 119(e), rather than requesting conversion of the provisional application to a nonprovisional application. See 37 CFR 1.53(c)(3).

Design applications may not make a claim for priority of a provisional application under 35 U.S.C. 119(e). See 35 U.S.C. 172 and 37 CFR 1.78(a)(4).

\*\*>

PTO/SB/16 (04-04)

Approved for use through 07/31/2008, OMB 0651-0032  
 U.S. Patent and Trademark Office; U.S. DEPARTMENT OF COMMERCE

Under the Paperwork Reduction Act of 1995, no persons are required to respond to a collection of information unless it displays a valid OMB control number.

**PROVISIONAL APPLICATION FOR PATENT COVER SHEET**

This is a request for filing a PROVISIONAL APPLICATION FOR PATENT under 37 CFR 1.53(c).

Express Mail Label No.

INVENTOR(S)				
Given Name (first and middle [if any])	Family Name or Surname	Residence (City and either State or Foreign Country)		
Additional inventors are being named on the _____ separately numbered sheets attached hereto				
<b>TITLE OF THE INVENTION (500 characters max)</b>				
Direct all correspondence to: <b>CORRESPONDENCE ADDRESS</b>				
<input type="checkbox"/> Customer Number:				
<b>OR</b>				
<input type="checkbox"/> Firm or Individual Name				
Address				
Address				
City	State	Zip		
Country	Telephone	Fax		
<b>ENCLOSED APPLICATION PARTS (check all that apply)</b>				
<input type="checkbox"/> Specification Number of Pages _____	<input type="checkbox"/> CD(s), Number _____			
<input type="checkbox"/> Drawing(s) Number of Sheets _____	<input type="checkbox"/> Other (specify) _____			
<input type="checkbox"/> Application Data Sheet. See 37 CFR 1.76				
<b>METHOD OF PAYMENT OF FILING FEES FOR THIS PROVISIONAL APPLICATION FOR PATENT</b>				
<input type="checkbox"/> Applicant claims small entity status. See 37 CFR 1.27.			FILING FEE Amount (\$)	
<input type="checkbox"/> A check or money order is enclosed to cover the filing fees.				
<input type="checkbox"/> The Director is hereby authorized to charge filing fees or credit any overpayment to Deposit Account Number: _____				
<input type="checkbox"/> Payment by credit card. Form PTO-2038 is attached.				
The invention was made by an agency of the United States Government or under a contract with an agency of the United States Government.				
<input type="checkbox"/> No.				
<input type="checkbox"/> Yes, the name of the U.S. Government agency and the Government contract number are: _____				

[Page 1 of 2]

Respectfully submitted,

Date \_\_\_\_\_

SIGNATURE \_\_\_\_\_

REGISTRATION NO. \_\_\_\_\_

TYPED or PRINTED NAME \_\_\_\_\_

(if appropriate)

Docket Number: \_\_\_\_\_

TELEPHONE \_\_\_\_\_

**USE ONLY FOR FILING A PROVISIONAL APPLICATION FOR PATENT**

This collection of information is required by 37 CFR 1.51. The information is required to obtain or retain a benefit by the public which is to file (and by the USPTO to process) an application. Confidentiality is governed by 35 U.S.C. 122 and 37 CFR 1.14. This collection is estimated to take 8 hours to complete, including gathering, preparing, and submitting the completed application form to the USPTO. Time will vary depending upon the individual case. Any comments on the amount of time you require to complete this form and/or suggestions for reducing this burden, should be sent to the Chief Information Officer, U.S. Patent and Trademark Office, U.S. Department of Commerce, P.O. Box 1450, Alexandria, VA 22313-1450. DO NOT SEND FEES OR COMPLETED FORMS TO THIS ADDRESS. SEND TO: **Commissioner for Patents, P.O. Box 1450, Alexandria, VA 22313-1450.**

If you need assistance in completing the form, call 1-800-PTO-9199 and select option 2.

**PROVISIONAL APPLICATION COVER SHEET**  
*Additional Page*

PTO/SB/16 (04-04)  
 Approved for use through 07/31/2006. OMB 0651-0032  
 U.S. Patent and Trademark Office; U.S. DEPARTMENT OF COMMERCE

Under the Paperwork Reduction Act of 1995, no persons are required to respond to a collection of information unless it displays a valid OMB control number.

Docket Number		
INVENTOR(S)/APPLICANT(S)		
Given Name (first and middle [if any] )	Family or Surname	Residence (City and either State or Foreign Country)

[Page 2 of 2]

Number \_\_\_\_\_ of \_\_\_\_\_

**WARNING:** Information on this form may become public. Credit card information should not be included on this form. Provide credit card information and authorization on PTO-2038.

<

## 201.05 Reissue Application

A reissue application is an application for a patent to take the place of an unexpired patent that is defective in some one or more particulars. A detailed treatment of reissues will be found in Chapter 1400.

## 201.06 Divisional Application [R-2]

A later application for an independent or distinct invention, carved out of a pending application and disclosing and claiming only subject matter disclosed in the earlier or parent application, is known as a divisional application or “division.” >A divisional application is often filed as a result of a restriction requirement made by the examiner.< The divisional application must claim the benefit of the prior nonprovisional application under 35 U.S.C. 121 or 365(c). \*>See MPEP § 201.11 for the conditions for receiving the benefit of the filing date of the prior application. The divisional application should set forth at least the portion of the earlier disclosure that is germane to the invention as claimed in the divisional application.

Divisional applications of utility or plant applications must be filed under 37 CFR 1.53(b). Divisional applications of design applications< may be filed pursuant to 37 CFR 1.53(b) or 1.53(d). 37 CFR 1.60 and 1.62 have been deleted as of December 1, 1997.

\*>Effective July 14, 2003, continued prosecution application (CPA) practice set forth in 37 CFR 1.53(d) has been eliminated as to utility and plant applications.< An application claiming the benefits of a provisional application under 35 U.S.C. 119(e) should not be called a “division” of the provisional application since the application will have its patent term calculated from its filing date, whereas an application filed under 35 U.S.C. 120, 121, or 365(c) will have its patent term calculated from the date on which the earliest application was filed, provided a specific reference is made to the earlier filed application(s). 35 U.S.C. 154(a)(2) and (a)(3).

In the interest of expediting the processing of newly filed divisional applications filed as a result of a restriction requirement, applicants are requested to include the appropriate U.S. Patent and Trademark Office classification of the divisional application and the status and \*>assigned art unit< of the parent application on the papers submitted. The appropriate classification for the divisional application may be found

in the Office communication of the parent application wherein the >restriction< requirement was made. It is suggested that this classification designation be placed in the upper right hand corner of the letter of transmittal accompanying these divisional applications or in an application data sheet as set forth in 37 CFR 1.76(b)(3).

Use form paragraph 2.01 to remind applicant of possible divisional status.

\*->

### ¶ 2.01 Definition of Division

This application appears to be a division of Application No. [1], filed [2]. A later application for a distinct or independent invention, carved out of a pending application and disclosing and claiming only subject matter disclosed in the earlier or parent application, is known as a divisional application or “division.” The divisional application should set forth the portion of the earlier disclosure that is germane to the invention as claimed in the divisional application.

### Examiner Note:

1. In bracket 1, insert the Application No.(series code and serial no.) of the parent application.
2. In bracket 2, insert the filing date of the parent application.
3. An application claiming the benefits of a provisional application under 35 U.S.C. 119(e) should not be called a “division” of the provisional application since the application will have its patent term calculated from its filing date, whereas an application filed under 35 U.S.C. 120, 121, or 365(c) will have its term calculated from the date on which the earliest application was filed, provided a specific reference is made to the earlier filed application(s), 35 U.S.C. 154(a)(2) and (a)(3).

<

A design application may be considered to be a division of a utility application (but not of a provisional application), and is entitled to the filing date thereof if the drawings of the earlier filed utility application show the same article as that in the design application sufficiently to comply with 35 U.S.C. 112, first paragraph. However, such a divisional design application may only be filed under the procedure set forth in 37 CFR 1.53(b) not under 37 CFR 1.53(d). \*\* See MPEP § 1504.20.

While a divisional application may depart from the phraseology used in the parent application there may be no departure therefrom in substance or variation in the disclosure that would amount to “new matter” if introduced by amendment into the parent application. Compare MPEP § 201.08 and § 201.11.

For notation to be put *>*in< the file *>*history< by the examiner in the case of a divisional application, see MPEP § 202.02.

### **201.06(a) Former 37 CFR 1.60 Divisional-Continuation Procedure [R-2]**

\* 37 CFR 1.60 was deleted effective December 1, 1997. See 1203 O.G. 63, October 21, 1997. A continuation or divisional application filed under 37 CFR 1.60 on or after December 1, 1997, will automatically be treated as an application filed under 37 CFR 1.53(b). All continuation and divisional applications filed under 37 CFR 1.60 prior to December 1, 1997 will continue to be processed and examined under the procedures set forth in former 37 CFR 1.60. *>*For more information pertaining to practice and procedure under former 37 CFR 1.60, see MPEP § 201.06(a) in the MPEP 8th Edition, Rev. 1 (February 2003)(available on the USPTO web site at [www.uspto.gov/web/offices/pac/mpep/mpep.htm](http://www.uspto.gov/web/offices/pac/mpep/mpep.htm)).<

### **201.06(b) Former 37 CFR 1.62 File Wrapper Continuing Procedure [R-2]**

\* 37 CFR 1.62 was deleted effective December 1, 1997. See 1203 O.G. 63, October 21, 1997. A *>*request for a< continuation or divisional application filed under former 37 CFR 1.62 on or after December 1, 1997, *>*, in an application that was filed on or after June 8, 1995,< will be treated as *>*a request for continued examination (RCE) under 37 CFR *>*1.114<, see MPEP 706.07(h), paragraph IV. *>*A request< filed on or after December 1, 1997, under former 37 CFR 1.62 *>*for< a continuation-in-part (CIP) application, *>*, or for a continuation or divisional of an application having a filing date before June 8, 1995,< will be treated as an improper application.

\*\*

All continuation, divisional and CIP applications filed under former 37 CFR 1.62 prior to December 1, 1997, will continue to be processed and examined under the procedures set forth in former 37 CFR 1.62. *>*For more information

**pertaining to practice and procedure under former 37 CFR 1.62, see MPEP § 201.06(b) in the MPEP 8th Edition, Rev. 1 (February 2003)(available on the USPTO web site at [www.uspto.gov/web/offices/pac/mpep/mpep.htm](http://www.uspto.gov/web/offices/pac/mpep/mpep.htm)).<**

### **201.06(c) 37 CFR 1.53(b) and 37 CFR 1.63(d) Divisional-Continuation Procedure [R-2]**

*37 CFR 1.53. Application number, filing date, and completion of application.*

\*\*\*\*\*

(b) *Application filing requirements - Nonprovisional application.* The filing date of an application for patent filed under this section, except for a provisional application under paragraph (c) of this section or a continued prosecution application under paragraph (d) of this section, is the date on which a specification as prescribed by 35 U.S.C. 112 containing a description pursuant to § 1.71 and at least one claim pursuant to § 1.75, and any drawing required by § 1.81(a) are filed in the Patent and Trademark Office. No new matter may be introduced into an application after its filing date. A continuing application, which may be a continuation, divisional, or continuation-in-part application, may be filed under the conditions specified in 35 U.S.C. 120, 121 or 365(c) and § 1.78(a).

(1) A continuation or divisional application that names as inventors the same or fewer than all of the inventors named in the prior application may be filed under this paragraph or paragraph (d) of this section.

(2) A continuation-in-part application (which may disclose and claim subject matter not disclosed in the prior application) or a continuation or divisional application naming an inventor not named in the prior application must be filed under this paragraph.

\*\*\*\*\*

*37 CFR 1.63. Oath or Declaration.*

\*\*\*\*\*

(d)(1) A newly executed oath or declaration is not required under § 1.51(b)(2) and § 1.53(f) in a continuation or divisional application, provided that:

(i) The prior nonprovisional application contained an oath or declaration as prescribed by paragraphs (a) through (c) of this section;

(ii) The continuation or divisional application was filed by all or by fewer than all of the inventors named in the prior application;

(iii) The specification and drawings filed in the continuation or divisional application contain no matter that would have been new matter in the prior application; and

(iv) A copy of the executed oath or declaration filed in the prior application, showing the signature or an indication thereon

that it was signed, is submitted for the continuation or divisional application.

(2) The copy of the executed oath or declaration submitted under this paragraph for a continuation or divisional application must be accompanied by a statement requesting the deletion of the name or names of the person or persons who are not inventors in the continuation or divisional application.

(3) Where the executed oath or declaration of which a copy is submitted for a continuation or divisional application was originally filed in a prior application accorded status under § 1.47, the copy of the executed oath or declaration for such prior application must be accompanied by:

(i) A copy of the decision granting a petition to accord § 1.47 status to the prior application, unless all inventors or legal representatives have filed an oath or declaration to join in an application accorded status under § 1.47 of which the continuation or divisional application claims a benefit under 35 U.S.C. 120, 121, or 365(c); and

(ii) If one or more inventor(s) or legal representative(s) who refused to join in the prior application or could not be found or reached has subsequently joined in the prior application or another application of which the continuation or divisional application claims a benefit under 35 U.S.C. 120, 121, or 365(c), a copy of the subsequently executed oath(s) or declaration(s) filed by the inventor or legal representative to join in the application.

(4) Where the power of attorney (or authorization of agent) or correspondence address was changed during the prosecution of the prior application, the change in power of attorney (or authorization of agent) or correspondence address must be identified in the continuation or divisional application. Otherwise, the Office may not recognize in the continuation or divisional application the change of power of attorney (or authorization of agent) or correspondence address during the prosecution of the prior application.

(5) A newly executed oath or declaration must be filed in a continuation or divisional application naming an inventor not named in the prior application.

\*\*\*\*\*

>

## I. < IN GENERAL

37 CFR 1.53(b) is the section under which all applications are filed EXCEPT: (A) an application resulting from entry of an international application into the national stage under 35 U.S.C. 371 and 37 CFR 1.495; (B) a provisional application under 35 U.S.C. 111(b) and 37 CFR 1.53(c); or (C) a continued prosecution application (CPA) >of a design application< under 37 CFR 1.53(d). Applications submitted under 37 CFR 1.53(b), as well as CPAs submitted under 37 CFR 1.53(d), are applications filed under 35 U.S.C. 111(a). An application filed under 37 CFR 1.53(b) may be an original, a continuation, a divisional, a con-

tinuation-in-part, or a substitute. (See MPEP § 201.09 for substitute application.) The application may be for a “utility” patent under 35 U.S.C. 101, a design patent under 35 U.S.C. 171, a plant patent under 35 U.S.C. 161, or a reissue under 35 U.S.C. 251.

37 CFR 1.53(b) is the “default” application. An application that is not (A) the result of the entry of an international application into the national stage after compliance with 35 U.S.C. 371 and 37 CFR 1.495, (B) a provisional application under 37 CFR 1.53(c), or (C) a CPA >of a design application filed< under 37 CFR 1.53(d), is an application filed under 37 CFR 1.53(b). An application will be treated as one filed under 37 CFR 1.53(b) unless otherwise designated.

In order to be complete for filing date purposes, all applications filed under 37 CFR 1.53(b) must include a specification as prescribed by 35 U.S.C. 112 containing a description pursuant to 37 CFR 1.71 and at least one claim pursuant to 37 CFR 1.75, and any drawing required by 37 CFR 1.81(a). The statutory filing fee and an oath or declaration in compliance with 37 CFR 1.63 (and 37 CFR 1.175 (if a reissue) or 37 CFR 1.162 (if for a plant patent)) are also required by 37 CFR 1.51(b) for a complete application, but the filing fee and oath or declaration may be filed after the application filing date upon payment of the surcharge set forth in 37 CFR 1.16(e). See 37 CFR 1.53(f).

Any application filed on or after December 1, 1997, which is identified by the applicant as an application filed under 37 CFR 1.60 will be processed as an application under 37 CFR 1.53(b) (using the copy of the specification, drawings and signed oath/declaration filed in the prior application supplied by the applicant). Any submission of an application including or relying on a copy of an oath or declaration that would have been proper under 37 CFR 1.60 will be a proper filing under 37 CFR 1.53(b).

A new application containing a copy of an oath or declaration under 37 CFR 1.63 referring to an attached specification is indistinguishable from a continuation or divisional application containing a copy of an oath or declaration from a prior application submitted pursuant to 37 CFR 1.63(d). Unless an application is submitted with a statement that the application is a continuation or divisional application, see 37 CFR 1.78(a)(2), the Office will process the application as a

new non-continuing application. Applicants are advised to clearly designate any continuation, divisional, or continuation-in-part application as such to avoid the need for a petition to accept an unintentionally delayed claim under 37 CFR 1.78(a) and the surcharge set forth in 37 CFR 1.17(t), and the issuance of a filing receipt that does not indicate that the application is a continuation, divisional, or continuation-in-part.

>

## II. < OATH/DECLARATION

37 CFR 1.63(d) provides that a newly executed oath or declaration is not required in a continuation or divisional application filed by all or by fewer than all of the inventors named in a prior nonprovisional application containing a signed oath or declaration as required by 37 CFR 1.63, provided that a copy of the signed oath or declaration filed in the prior application is submitted for the continuation or divisional application and the specification and drawings filed in the continuation or divisional application do not contain any subject matter that would have been new matter in the prior application. The copy of the oath or declaration must show the signature of the inventor(s) or contain an indication thereon that the oath or declaration was signed (e.g., the notation “/s/” on the line provided for the signature).

It is not necessary to have the inventor sign a new oath or declaration merely to include a reference to the duty of disclosure if the parent application was filed prior to January 1, 1978, to indicate that the inventor has reviewed and understands the contents of the application if the parent application was filed prior to October 1, 1983, or to indicate the inventor's post office address if the parent application was filed prior to December 1, 1997, and the inventor's mailing or post office address is identified elsewhere in the application.

When a copy of an oath or declaration from a prior application is filed in a continuation or divisional application under 37 CFR 1.53(b), special care should be taken by the applicant to ensure that the copy is matched with the correct application file. Applicant should file the copy of the oath or declaration with a cover letter explaining that the copy of the oath or declaration is for the attached application or for a previously-filed 37 CFR 1.53(b) application (identified

by application number which consists of a two-digit series code, e.g., 08/, and a six-digit serial number, e.g., 123,456). An adhesive label may be attached to the front of the copy of the oath or declaration. The label should clearly state that the copy of the oath or declaration is intended for the attached application submitted therewith or for Application No. XX/YYYY,YYY. During initial processing, attachments (e.g., a cover letter) to application papers may be separated. Therefore, applicant should not rely solely upon a cover letter. Note: 37 CFR 1.5(a) states that no correspondence relating to an application should be filed prior to receipt of the application number information from the Patent and Trademark Office.

37 CFR 1.63(d) requires a copy of the signed oath or declaration from the prior application. In instances in which the oath or declaration filed in the prior application is itself a copy of an oath or declaration from a prior application, either a copy of the copy of the oath or declaration in the prior application or a direct copy of the original oath or declaration is acceptable, as both are a copy of the oath or declaration in the prior application, see 37 CFR 1.4(d)(1)(ii).

The patent statute and rules of practice do not require that an oath or declaration include a date of execution, and no objection should be made to an oath or declaration because it lacks either a recent date of execution or any date of execution. The applicant's duty of candor and good faith including compliance with the duty of disclosure requirements of 37 CFR 1.56 is continuous and applies to the continuing application.

A newly executed oath or declaration is required in a continuation or divisional application filed under 37 CFR 1.53(b) naming an inventor not named in the prior application, and in a continuation-in-part application.

>

## III. < SPECIFICATION AND DRAWINGS

A continuation or divisional application may be filed under 35 U.S.C. 111(a) using the procedures set forth in 37 CFR 1.53(b), by providing: (A) a copy of the prior application, including a copy of the signed oath or declaration in such prior application, as filed; (B) a new specification and drawings and a copy of the signed oath or declaration as filed in the prior application provided the new specification and draw-



ings do not contain any subject matter that would have been new matter in the prior application; or (C) a new specification and drawings and a newly executed oath or declaration provided the new specification and drawings do not contain any subject matter that would have been new matter in the prior application. If a continuation or divisional application filed with a newly executed oath or declaration contains subject matter that would have been new matter in the prior application, the application will have to be amended to indicate that it is a continuation-in-part application rather than a continuation or a divisional application. The specification and drawings of a continuation or divisional application filed under 37 CFR 1.53(b) are not limited to a reproduction or “true copy” of the prior application, i.e., the applicant may revise the specification for clarity or contextual purposes *vis-à-vis* the specification originally filed in the prior application in the manner that an applicant may file a substitute specification, see 37 CFR 1.125, or amend the drawings of an application so long as it does not result in the introduction of new matter. It is the applicant’s responsibility to review any new specification or drawings submitted for a continuation or divisional application under 37 CFR 1.53(b) and 37 CFR 1.63(d) to determine that it contains no new matter. An applicant is advised to simply file a continuing application with a newly executed oath or declaration when it is questionable as to whether the continuing application adds material that would have been new matter if presented in the prior application. If one or more claims are allowed in the continuation or divisional application which are directed to matter shown and described in the prior nonprovisional application but not claimed in the prior application, the applicant should be required to file a supplemental oath or declaration under 37 CFR 1.67(b).

Where a copy of the oath or declaration from a prior application was filed in a continuation or divisional application, if the examiner determines that new matter is present relative to the prior application, the examiner should so notify the applicant in the next Office action (preferably the first Office action). The examiner should require: (A) a new oath or declaration along with the surcharge set forth in 37 CFR 1.16(e); and (B) that the application be redesignated as a continuation-in-part.

Any utility or plant patent application, including any continuing application, that will be published pursuant to 35 U.S.C. 122(b) should be filed under 37 CFR 1.53(b) with a specification (including the claims), and drawings, that the applicant would like to have published. This is important because the Office will generally publish the specification (including the claims) and drawings as filed and, under 35 U.S.C. 154(d), a patentee may obtain provisional rights if the invention claimed in a patent is substantially identical to the invention claimed in the application publication. Filing a continuing application under 37 CFR 1.53(b) with a preliminary amendment (which makes all the desired changes to the specification, including adding, deleting or amending claims) is NOT recommended because the changes made by the preliminary amendment will generally not be reflected in the patent application publication even if the preliminary amendment is referred to in an oath or declaration. As noted above, a continuation or divisional application filed under 37 CFR 1.53(b) may be filed with a new specification and corrected drawings, along with a copy of an oath or declaration from a prior (parent) application, provided the new specification and drawings do not contain any subject matter that would have been new matter in the prior application. Thus, the new specification and corrected drawings may include some or all of the amendments entered during the prosecution of the prior application(s), as well as additional amendments submitted for clarity or contextual purposes, and a new set of claims. In order to have a patent application publication of a continuation or divisional application contain only a desired set of claims, rather than the set of claims in the prior application, it is strongly recommended that the continuation or divisional application be filed under 37 CFR 1.53(b) with a new specification containing only the desired set of claims. If the continuation or divisional application is filed with a copy of the specification from the prior application along with a preliminary amendment which cancels, amends and/or adds new claims, publication of the application, as amended, would only occur if a copy of the specification (with the amended set of claims) was also submitted through the Office’s Electronic Filing System (EFS).

>

#### IV. < INCORPORATION BY REFERENCE

In a continuation or divisional application, the safeguard (petition and fee under former 37 CFR 1.60(b)) concerning the filing of an application lacking all of the pages of the specification or sheets of drawings of the prior application has not been retained in 37 CFR 1.53(b) since the specification and drawings of a continuation or divisional application are not limited to a reproduction or a “true copy” of the prior application. As a safeguard, however, an applicant may incorporate by reference the prior application by including, in the continuation or divisional application-as-filed, a statement that such specifically enumerated prior application or applications are “hereby incorporated herein by reference.” The statement may appear in the specification or in the application transmittal letter. The incorporation by reference statement can only be relied upon to permit the entering of a portion of the prior application into the continuation or divisional application when the portion of the prior application has been inadvertently omitted from the submitted application papers in the continuation or divisional application>.< The inclusion of this incorporation by reference of the prior application(s) will permit an applicant to amend the continuation or divisional application to include any subject matter in such prior application(s), without the need for a petition provided the continuation or divisional application is entitled to a filing date notwithstanding the incorporation by reference.

A priority claim under 35 U.S.C. 120 in a continuation or divisional application does not amount to an incorporation by reference of the application(s) to which priority is claimed.

For the incorporation by reference to be effective as a proper safeguard against the omission of a portion of a prior application, the incorporation by reference statement must be included in the specification-as-filed, or transmittal letter-as-filed, or in an amendment specifically referred to in an oath or declaration executing the application. An incorporation by reference statement added after an application’s filing date is not effective because no new matter can be added to an application after its filing date (see 35 U.S.C. 132(a)). If an incorporation by reference statement is included in an amendment to the specification to add a benefit claim under 35 U.S.C. 120 after the filing date of the application, the amendment would not be

proper. When a benefit claim under 35 U.S.C. 120 is submitted after the filing of an application, the reference to the prior application cannot include an incorporation by reference statement of the prior application. See *Dart Indus. v. Banner*, 636 F.2d 684, 207 USPQ 273 (C.A.D.C. 1980).

Mere reference to another application, patent, or publication is not an incorporation of anything therein into the application containing such reference for the purpose of the disclosure required by 35 U.S.C. 112, first paragraph. *In re de Seversky*, 474 F.2d 671, 177 USPQ 144 (CCPA 1973). See MPEP § 608.01(p).

##### A. *Application NOT Entitled to a Filing Date*

Material needed to accord an application a filing date may not be incorporated by reference. Therefore, if a continuation or divisional application as originally filed incorporates by reference material omitted from the application papers, which is needed to accord the application a filing date, the application will **not** be entitled to a filing date. A petition under 37 CFR 1.182 and the required petition fee, including an amendment submitting the necessary omitted material, requesting that the necessary omitted material contained in the prior application and submitted in the amendment, be included in the continuation or divisional application based upon the incorporation by reference statement, is required in order to accord the application a filing date as of the date of deposit of the continuation or divisional application. An amendment submitting the omitted material and relying upon the incorporation by reference will not be entered in the continuation or divisional application unless a decision granting the petition states that the application is accorded a filing date and that the amendment will be entered.

##### B. *Application Entitled to a Filing Date*

If a continuation or divisional application as originally filed is entitled to a filing date despite the omission of a portion of the prior application(s), applicant will be permitted to add the omitted material by way of an amendment provided a statement was included in the application as originally filed that incorporates by reference the prior application(s). If the application as originally filed includes a proper incorporation by reference of the prior application(s), an omitted specification page(s) and/or drawing figure(s) identified in

a “Notice of Omitted Item(s)” may be added by amendment provided the omitted item(s) contains only subject matter in common with such prior application(s). In such case, applicant need **not** respond to the “Notice of Omitted Item(s).” Applicant should submit the amendment adding the omitted material prior to the first Office action to avoid delays in the prosecution of the application. See MPEP § 601.01(d) and § 601.01(g).

&gt;

## V. < INVENTORSHIP

To continue the practice in former 37 CFR 1.60(b)(4) of permitting the filing of a continuation or divisional application by all or by fewer than all of the inventors named in a prior application without a newly executed oath or declaration, 37 CFR 1.63(d)(2) provides that the copy of the oath or declaration submitted for a continuation or divisional application under 1.53(b) and 37 CFR 1.63(d) must be accompanied by a statement from applicant, applicant's representative or other authorized party requesting the deletion of the names of the person or persons who are not inventors in the continuation or divisional application. Where the continuation or divisional application and a copy of the oath or declaration from the prior application are filed without a statement from an authorized party requesting deletion of the names of any person or persons named in the prior application, the continuation or divisional application will be treated as naming as inventors the person or persons named in the copy of the executed oath or declaration from the prior application. Accordingly, if a petition or request under 37 CFR 1.48(a) or (c) was granted in the prior application, the oath or declaration filed in a continuation or divisional application pursuant to 37 CFR 1.53(b) and 37 CFR 1.63(d) should be a copy of the oath or declaration executed by the added inventor(s) filed in the prior application. The statement requesting the deletion of the names of the person or persons who are not inventors in the continuation or divisional application must be signed by person(s) authorized pursuant to 37 CFR 1.33(b) to sign an amendment in the continuation or divisional application.

A newly signed oath or declaration in compliance with 37 CFR 1.63 is required where an inventor who was not named as an inventor in the signed oath or

declaration filed in the prior application is to be named in a continuation or divisional application filed under 37 CFR 1.53(b). The newly signed oath or declaration must be signed by all the inventors.

&gt;

## VI. < RULE 47 ISSUES

37 CFR 1.63(d)(3) provides for the situation in which the executed oath or declaration, of which a copy is submitted for a continuation or divisional application, was originally filed in a prior application accorded status under 37 CFR 1.47. 37 CFR 1.63(d)(3)(i) requires a copy of any decision granting a petition to accord 37 CFR 1.47 status to such application, unless all nonsigning inventor(s) or legal representative (pursuant to 37 CFR 1.42 or 1.43) have filed an oath or declaration to join in an application of which the continuation or divisional application claims a benefit under 35 U.S.C. 120, 121 or 365(c). Where one or more, but not all, nonsigning inventor or legal representative (pursuant to 37 CFR 1.42 or 1.43) subsequently joins in any application of which the continuation or divisional application claims a benefit under 35 U.S.C. 120, 121 or 365(c), 37 CFR 1.63(d)(3)(ii) also requires a copy of any oath or declaration filed by the inventor or legal representative who subsequently joined in such application.

New continuation or divisional applications filed under 37 CFR 1.53(b) which contain a copy of an oath or declaration that is not signed by one of the inventors and a copy of the decision according 37 CFR 1.47 status in the prior application, should be forwarded by the Office of Initial Patent Examination (OIPE) to the Office of Petitions before being forwarded to the Technology Center (TC). The Office of Petitions will mail applicant a letter stating that “Rule 47” status has been accorded to the continuation or divisional application, but will not repeat the notice to the nonsigning inventor nor the announcement in the *Official Gazette*. See 37 CFR 1.47(c).

&gt;

## VII. < CHANGE OF ATTORNEY/CORRESPONDENCE ADDRESS

37 CFR 1.63(d)(4) provides that where the power of attorney (or authorization of agent) or correspondence address was changed during the prosecution of the prior application, the change in power of attorney

(or authorization of agent) or correspondence address must be identified in the continuation or divisional application. Otherwise, the Office may not recognize in the continuation or divisional application the change of power of attorney (or authorization of agent) or correspondence address which occurred during the prosecution of the prior application.

>

### VIII. < SMALL ENTITY STATUS

If small entity status has been established in a parent application and is still proper and desired in a continuation or divisional application filed under 37 CFR 1.53(b), a new assertion as to the continued entitlement to small entity status under 37 CFR 1.27 is required. >See MPEP § 509.03.<

>

### IX. < COPIES OF AFFIDAVITS

Affidavits or declarations, such as those submitted under 37 CFR 1.130, 1.131 and 1.132 filed during the prosecution of the prior nonprovisional application do not automatically become a part of a continuation or divisional application filed under 37 CFR 1.53(b). Where it is desired to rely on an earlier filed affidavit or declaration, the applicant should make such remarks of record in the 37 CFR 1.53(b) application and include a copy of the original affidavit or declaration filed in the prior nonprovisional application.

Use form paragraph 2.03 for instructions to applicant concerning affidavits or declarations filed in the parent application.

#### *¶ 2.03 Affidavits or Declarations in Parent Application*

Applicant refers to an affidavit or declaration filed in the parent application. Affidavits or declarations, such as those submitted under 37 CFR 1.131 and 37 CFR 1.132, filed during the prosecution of the parent application do not automatically become a part of this application. Where it is desired to rely on an earlier filed affidavit or declaration, the applicant should make the remarks of record in the later application and include a copy of the original affidavit or declaration filed in the parent application.

#### **Examiner Note:**

This form paragraph is to be used in applications filed under 37 CFR 1.53(b) and former 37 CFR 1.60. Do not use this form paragraph in applications filed under 37 CFR 1.53(d) and former 37 CFR 1.62 applications, since affidavits and/or declarations, such as those submitted under 37 CFR 1.131 and 37 CFR 1.132 filed during the prosecution of the parent nonprovisional application

automatically become a part of the 37 CFR 1.53(d) and former 37 CFR 1.62 applications.

>

### X. < EXTENSIONS OF TIME

If an extension of time is necessary to establish continuity between the prior application and the continuing application filed under 37 CFR 1.53(b), the petition for an extension of time must be filed as a separate paper directed to the prior nonprovisional application. Under 37 CFR 1.136(a)(3), an authorization to charge all required fees, fees under 37 CFR 1.17, or all required extension of time fees will be treated as a constructive petition for an extension of time in any concurrent or future reply requiring a petition for an extension of time for its timely submission. A continuing application filed under 37 CFR 1.53(b) is a new application which is assigned a new application number and filing date and is \*\* maintained separately from the file of the prior application. The filing of a continuing application is not a paper directed or placed in the file of the prior application and is not a “reply” to the last Office action in the prior application. Thus, a petition for an extension of time and the fee set forth in 37 CFR 1.17 are required to be filed as a separate paper in the prior application. Any petition for an extension of time directed to the prior application must be accompanied by its own certificate of mailing under 37 CFR 1.8 (if mailed by first class mail) or under 37 CFR 1.10 (if mailed by Express Mail), if the benefits of those rules are desired.

>

### XI. < ABANDONMENT OF THE PRIOR NONPROVISIONAL APPLICATION

Under 37 CFR 1.53(b) and 37 CFR 1.63(d) practice, the prior nonprovisional application is not automatically abandoned upon filing of the continuing application. If the prior nonprovisional application is to be expressly abandoned, such a paper must be signed in accordance with 37 CFR 1.138. A registered attorney or agent not of record acting in a representative capacity under 37 CFR 1.34(a) may also expressly abandon a prior nonprovisional application as of the filing date granted to a continuing application when filing such a continuing application.

If the prior nonprovisional application which is to be expressly abandoned has a notice of allowance

issued therein, the prior nonprovisional application can become abandoned by the nonpayment of the issue fee. However, once an issue fee has been paid in the prior application, even if the payment occurs following the filing of a continuing application under 37 CFR 1.53(b) and 37 CFR 1.63(d), a petition to withdraw the prior nonprovisional application from issue must be filed before the prior nonprovisional application can be abandoned (37 CFR 1.313).

If the prior nonprovisional application which is to be expressly abandoned is before the Board of Patent Appeals and Interferences, a separate notice should be forwarded by the appellant to the Board, giving them notice thereof.

After a decision by the Court of Appeals for the Federal Circuit (CAFC) in which the rejection of all claims is affirmed, \*\*>the proceeding is terminated when the mandate is issued by the Court.

## XII. < EXAMINATION

The practice relating to making first action rejections final also applies to continuation and divisional applications filed under 37 CFR 1.53(b) and 37 CFR 1.63(d). See MPEP § 706.07(b).

Any preliminary amendment filed with a 37 CFR 1.53(b) application which is to be entered after granting of the filing date should be entered by the technical support personnel of the TC where the application is finally assigned to be examined. Any errors in the numbering of claims in preliminary amendment(s) can be corrected in the TCs. Accordingly, these applications should be classified and assigned to the proper TC by taking into consideration the claims that will be before the examiner upon entry of such a preliminary amendment.

Where a copy of the oath or declaration from a prior application was filed in a continuation or divisional application, if the examiner determines that new matter is present relative to the prior application, the examiner should so notify the applicant in the next Office action (preferably the first Office action). The examiner should require: (A) a new oath or declaration along with the surcharge set forth in 37 CFR 1.16(e); and (B) that the application be redesignated as a continuation-in-part. See MPEP § 608.04(b)

when new matter is contained in a preliminary amendment.

If the examiner finds that pages of the specification or drawings figures described in the specification are missing and the application is a continuation or divisional application filed under 37 CFR 1.53(b) using a copy of the oath or declaration filed in the prior application under 37 CFR 1.63(d), the examiner must check to determine whether the continuation or divisional application, as originally filed, includes a statement incorporating by reference the prior application(s). The statement may appear in the specification or in the application transmittal letter. The inclusion of this incorporation by reference of the prior application(s) will permit applicant to amend the continuation or divisional application to include subject matter in the prior application(s) without the need for a petition. See also the subsection above regarding "Incorporation by Reference." If the continuation or divisional application filed under 37 CFR 1.53(b) and 37 CFR 1.63(d) does not include the incorporation by reference statement in the application papers as originally filed and applicant has not been informed of the omitted items, the application should be returned to OIPE for mailing of a "Notice of Omitted Item(s)."

### 201.06(d) 37 CFR 1.53(d) Continued Prosecution Application (CPA) Practice [R-2]

*37 CFR 1.53. Application number, filing date, and completion of application.*

\*\*\*\*\*

(d) *Application filing requirements - Continued prosecution (nonprovisional) application.\*\*>*

(1) A continuation or divisional application (but not a continuation-in-part) of a prior nonprovisional application may be filed as a continued prosecution application under this paragraph, provided that:

(i) The application is for a design patent:

(ii) The prior nonprovisional application is a design application that is complete as defined by § 1.51(b); and

(ii) The application under this paragraph is filed before the earliest of:

(A) Payment of the issue fee on the prior application, unless a petition under § 1.313(c) is granted in the prior application;

(B) Abandonment of the prior application; or

(C) Termination of proceedings on the prior application.<

(2) The filing date of a continued prosecution application is the date on which a request on a separate paper for an application under this paragraph is filed. An application filed under this paragraph:

(i) Must identify the prior application;

(ii) Discloses and claims only subject matter disclosed in the prior application;

(iii) Names as inventors the same inventors named in the prior application on the date the application under this paragraph was filed, except as provided in paragraph (d)(4) of this section;

(iv) Includes the request for an application under this paragraph, will utilize the file jacket and contents of the prior application, including the specification, drawings and oath or declaration from the prior application, to constitute the new application, and will be assigned the application number of the prior application for identification purposes; and

(v) Is a request to expressly abandon the prior application as of the filing date of the request for an application under this paragraph.

\*\*>

(3) The filing fee for a continued prosecution application filed under this paragraph is the basic filing fee as set forth in § 1.16(f).<

(4) An application filed under this paragraph may be filed by fewer than all the inventors named in the prior application, provided that the request for an application under this paragraph when filed is accompanied by a statement requesting deletion of the name or names of the person or persons who are not inventors of the invention being claimed in the new application. No person may be named as an inventor in an application filed under this paragraph who was not named as an inventor in the prior application on the date the application under this paragraph was filed, except by way of correction of inventorship under § 1.48.

(5) Any new change must be made in the form of an amendment to the prior application as it existed prior to the filing of an application under this paragraph. No amendment in an application under this paragraph (a continued prosecution application) may introduce new matter or matter that would have been new matter in the prior application. Any new specification filed with the request for an application under this paragraph will not be considered part of the original application papers, but will be treated as a substitute specification in accordance with § 1.125.

(6) The filing of a continued prosecution application under this paragraph will be construed to include a waiver of confidentiality by the applicant under 35 U.S.C. 122 to the extent that any member of the public, who is entitled under the provisions of § 1.14 to access to, copies of, or information concerning either the prior application or any continuing application filed under the provisions of this paragraph, may be given similar access to, copies of, or similar information concerning the other application or applications in the file jacket.

(7) A request for an application under this paragraph is the specific reference required by 35 U.S.C. 120 to every application assigned the application number identified in such request. No amendment in an application under this paragraph may delete this specific reference to any prior application.

(8) In addition to identifying the application number of the prior application, applicant should furnish in the request for an application under this paragraph the following information relating to the prior application to the best of his or her ability:

(i) Title of invention;

(ii) Name of applicant(s); and

(iii) Correspondence address.

\*\*>

(9) Envelopes containing only requests and fees for filing an application under this paragraph should be marked "Mail Stop CPA." Requests for an application under this paragraph filed by facsimile transmission should be clearly marked "Mail Stop CPA."

<

(10) See § 1.103(b) for requesting a limited suspension of action in an application filed under this paragraph.

\*\*\*\*\*

>

**I. CPA PRACTICE HAS BEEN ELIMINATED AS TO UTILITY AND PLANT APPLICATIONS**

Effective July 14, 2003, continued prosecution application (CPA) practice has been eliminated as to utility and plant applications. Applicants who wish to continue examination of the same claimed invention after the prosecution of a utility or plant application is closed should consider filing a request for continued examination (RCE) under 37 CFR 1.114. For more information on RCE practice, see MPEP § 706.07(h). Applicants who wish to file a continuation, divisional, or continuation-in-part application should file an application under 37 CFR 1.53(b). See MPEP § 201.06(c). CPAs filed prior to July 14, 2003 will continue to be processed and examined under the procedures set forth in prior 37 CFR 1.53(d). Any request for a CPA filed on or after July 14, 2003 in a utility or plant application is improper, regardless of the filing date of the utility or plant application in which the CPA is filed.

The Office will not convert an improper CPA into an application under 37 CFR 1.53(b) unless the applicant shows that there are extenuating circumstances that warrant the burdensome process of such conversion.

If an examiner discovers that an improper or incomplete CPA has been processed as a proper CPA in error, the examiner should immediately notify a supervisory applications examiner (SAE) or other technical support staff within the Technology Center (TC) who will reprocess the CPA and correct the application records as appropriate.

#### **A. Applications Filed on or After June 8, 1995**

If a utility or plant application has a filing date on or after June 8, 1995, an improper CPA filed on or after July 14, 2003 will be treated as a request for continued examination (RCE) under 37 CFR 1.114. See MPEP § 706.07(h) and form paragraph . If the improper CPA does not satisfy the requirements of 37 CFR 1.114 (e.g., the request lacks a submission or the fee under 37 CFR 1.17(e), or the prosecution of the application is not closed), the Office will treat the improper CPA as an improper RCE, and the time period set in the last Office action (or notice) will continue to run. The Office will send the applicant a Notice of Improper Request for Continued Examination (RCE), PTO-2051. If the time period for reply to the last Office action (or notice) has expired, the application is abandoned and the applicant must file a petition under 37 CFR 1.137 and the required petition fee to revive the abandoned application. Unless prosecution in the application was not closed, the petition must be accompanied by a submission as defined by 37 CFR 1.114(c) and the fee set forth in 37 CFR 1.17(e), unless previously filed. If the last Office action is a notice of allowance, the issue fee must also be paid at the time of filing the petition to revive. If prosecution in the application was not closed, the petition must be accompanied by a reply to the non-final Office action.

Applicants cannot, as a matter of right, obtain continued examination on claims that are independent and distinct from the invention previously claimed (i.e., applicants cannot switch inventions when filing an RCE). See 37 CFR 1.145. Therefore, if applicants file a request for a divisional CPA on or after July 14, 2003 and the request satisfies all the requirements in 37 CFR 1.114 (e.g., the request is accompanied by the fee as set forth in 37 CFR 1.17(e) and a submission), the Office will treat the improper divisional CPA as a proper RCE. However, any amendment canceling all claims drawn to the elected invention and presenting

only claims drawn to the nonelected invention will be treated as nonresponsive. See MPEP § 821.03. Any newly submitted claims that are directed to an invention distinct from and independent of the invention previously claimed will be withdrawn from consideration. Applicants should be notified by using form paragraph 8.26 or 8.27.

#### **B. Applications Filed Before June 8, 1995**

If a utility or plant application has a filing date before June 8, 1995, the Office cannot treat an improper CPA filed on or after July 14, 2003 as an RCE because RCE practice does not apply to applications filed before June 8, 1995. The Office will notify the applicant of the improper CPA by mailing a Notice of Improper CPA (or FWC) Filing For Utility or Plant Applications Filed Before June 8, 1995, PTO-2011 (Rev. 7/03 or later). The time period for reply set in the last Office action (or notice) will continue to run. Applicant may file a continuing application under 37 CFR 1.53(b). If the time period for reply has expired, the application is abandoned. If the application in which the improper CPA is filed is abandoned when a continuing application is filed, applicant would need to file a petition under 37 CFR 1.137 to revive the prior application to establish copendency with the continuing application under 37 CFR 1.53(b).

## **II. FILING AND INITIAL PROCESSING OF CPAs FOR DESIGN APPLICATIONS**

### **A. < In General**

In addition to the provisions of 37 CFR 1.53(b), a continuation or divisional (but not a continuation-in-part) application may be filed under 37 CFR 1.53(d) if the prior application is \*\* a design application that is complete as defined by 37 CFR 1.51(b)\*\*. A continuation or divisional application filed under 37 CFR 1.53(d) is called a “Continued Prosecution Application” or “CPA.” A CPA has a number of advantages compared to a continuation or divisional application filed under 37 CFR 1.53(b). For example, the papers required to be filed in the U.S. Patent and Trademark Office in order to secure a filing date under 37 CFR 1.53(d) are minimal compared to 37 CFR 1.53(b). In addition, the Office will not normally issue a new filing receipt for a CPA. See 37 CFR 1.54(b). The \*\*

time delay between the filing date and the first Office action should be less for a CPA than for an application filed under 37 CFR 1.53(b). For examination priority purposes only, the USPTO will treat continuation CPAs as if they were “amended” applications (as of the CPA filing date) and not as “new” applications. This treatment is limited to CPAs in which the prior application has an Office action issued by the examiner. If no Office action has been issued in the prior application, the CPA will be treated, for examination purposes, like a “new” application unless a petition to make special under 37 CFR 1.102 or a request for expedited examination under 37 CFR 1.155 is filed in the CPA. As “amended” applications generally have a shorter time frame for being acted on by examiners than “new” applications, the treatment of a CPA as an “amended” application will result in a first Office action being mailed in the CPA much sooner than if it had been filed as a continuation application under 37 CFR 1.53(b) (or under former 37 CFR 1.60 or 1.62). Therefore, applicants are strongly encouraged to file any preliminary amendment in a CPA at the time the CPA is filed. See 37 CFR 1.115 and MPEP § 714.03(a).

A request for a CPA expressly abandons the prior application as of the filing date of the request for the CPA. See 37 CFR 1.53(d)(2)(v). Therefore, where the prior application is not to be abandoned, any continuation or divisional application must be filed under 37 CFR 1.53(b). If applicant wants the USPTO to disregard a previously filed request for a CPA >filed in a design application< (and not recognize its inherent request to expressly abandon the prior application) and to treat the paper as the filing of an application under 37 CFR 1.53(b), the applicant must file a petition under 37 CFR 1.182. A request to expressly abandon an application is not effective until the abandonment is acknowledged, including the express abandonment of the prior application of a CPA that occurs by operation of 37 CFR 1.53(d)(2)(v). The express abandonment of the prior application is acknowledged and becomes effective upon processing and entry of the CPA into the file of the prior application. Thus, such a petition under 37 CFR 1.182 should be filed expeditiously since the petition will not be granted once the request for a CPA has been entered into the prior application (and the inherent request to expressly abandon the prior application has been

acknowledged). If the request for a CPA has been entered into the prior application by the time the petition under 37 CFR 1.182 and the application file are before the deciding official for a decision on the petition, the petition will be denied. It is noted, however, that if the applicant intended to file a second application (either a continuation or a divisional) without abandoning the prior application, applicant can still achieve that result without loss of the benefit of the original filing date by: (A) continuing the prosecution of the original application via the CPA; and (B) filing a new continuation/divisional under 37 CFR 1.53(b) claiming benefit of the CPA and its parent applications under 35 U.S.C. 120 during the pendency of the CPA.

\*\* Since no new matter may be introduced in a CPA, the procedure set forth in 37 CFR 1.53(d) is not available for filing a continuation-in-part application. All continuation-in-part applications must be filed under 37 CFR 1.53(b) and a newly executed oath or declaration is required.

Under the CPA procedure, the continuation or divisional application will utilize the file wrapper and contents of the prior nonprovisional application, including the specification, drawings and oath or declaration from the prior nonprovisional application, and will be assigned the same application number as the prior nonprovisional application. Any changes to the continuation or divisional application desired when filing the CPA must be made in the form of an amendment to the prior application as it existed prior to filing the CPA, see 37 CFR 1.53(d)(5). Any new specification filed with the CPA request will not be considered part of the original application papers, but will be treated as a substitute specification in accordance with 37 CFR 1.125. However, the applicant must comply with the requirements of 37 CFR 1.125(b) before the substitute specification will be entered into the CPA. Since 37 CFR 1.125(b) requires that a substitute specification be accompanied by, *inter alia*, a statement that the substitute specification includes no new matter, any substitute specification containing new matter will be denied entry by the examiner. Any preliminary amendment to the written description and claims, other than a substitute specification, filed with a CPA request will ordinarily be entered. Any new matter which is entered, however, will be required to be canceled



pursuant to 35 U.S.C. 132 from the descriptive portion of the specification. Further, any claim(s) which relies upon such new matter for support will be rejected under 35 U.S.C. 112, first paragraph. See MPEP § 2163.06. In the event that a substitute specification or preliminary amendment containing new matter was filed with a request for a CPA, applicant may file a petition under 37 CFR 1.182 requesting that the substitute specification or preliminary amendment be removed from the CPA application file, and be accorded the status as a separate application by being placed in a new file wrapper and assigned a new application number, with the new application being accorded a filing date as of the date the request for a CPA and substitute specification/preliminary amendment were filed. Of course, a request for a CPA is not improper simply because the request is accompanied by a substitute specification or preliminary amendment containing new matter. Thus, an applicant will not be entitled to a refund of the filing fee paid in a proper CPA as a result of the granting of a petition under 37 CFR 1.182 requesting that the substitute specification or preliminary amendment be removed from the CPA application file.

A CPA may be based on a prior CPA so long as the prior CPA is complete under 37 CFR 1.51(b) and \*\* is a design application. There is no other limit to the number of CPAs that may be filed in a chain of continuing applications. However, only one CPA may be pending at one time based on the same prior nonprovisional application.

Under 37 CFR 1.53(d), the specification, claims, and drawings, and any amendments entered in the prior nonprovisional application are used in the CPA. A new filing fee is required in accordance with 35 U.S.C. 41 and 37 CFR 1.16. The only other statutory requirement under 35 U.S.C. 111(a) is a signed oath or declaration. Since a CPA cannot contain new matter, the oath or declaration filed in the prior nonprovisional application would supply all the information required under the statute and rules to have a complete application and to obtain a filing date. Accordingly, the previously filed oath or declaration

will be considered to be the oath or declaration of the CPA.

The original disclosure of a CPA is the same as the original disclosure of the parent non-continued prosecution application and amendments entered in the parent application(s). However, any subject matter added by amendment in the parent application which is deemed to be new matter in the parent application will also be considered new matter in the CPA. No amendment filed in a CPA, even if filed on the filing date of the CPA, may include new matter.

If application papers >for a design application< are in any way designated as a CPA filing under 37 CFR 1.53(d) (e.g., contain a reference to 37 CFR 1.53(d), CPA, or continued prosecution application), the application papers will be treated by the Office as a CPA filed under 37 CFR 1.53(d), even if the application papers also contain other inconsistent designations (e.g., if the papers are also designated as an application filed under 37 CFR 1.53(b) or include a reference to a “continuation-in-part CPA”). \*\*>If application papers for a utility or plant application are in any way designated as a CPA filing under 37 CFR 1.53(d), the application papers will be treated as a request for continued examination (RCE) under 37 CFR 1.114. See I. CPA PRACTICE HAS BEEN ELIMINATED AS TO UTILITY AND PLANT APPLICATIONS, above.

#### **B. < Conditions for Filing a CPA**

A continuation or divisional application may be filed under 37 CFR 1.53(d), if the prior nonprovisional application is \*\* a design application that is complete as defined by 37 CFR 1.51(b)\*\*. The term “prior nonprovisional application” in 37 CFR 1.53(d)(1) means the nonprovisional application immediately prior to the CPA. A complete application as defined by 37 CFR 1.51(b) \*\* must \* contain, *inter alia*, the appropriate filing fee and a signed oath or declaration under 37 CFR 1.63.

In addition, a continuation or divisional application filed under 37 CFR 1.53(d) must be filed before the earliest of: (A) payment of the issue fee on the prior application, unless a petition under 37 CFR 1.313(c) is granted in the prior application; (B) abandonment of the prior application; or (C) termination of proceedings on the prior application.

>Note that request for continued examination (RCE) practice under 37 CFR 1.114 is not available in design applications. Any improper RCE filed in a design application will not be treated as a CPA. An improper RCE filed in a design application will not toll the running of any time period for reply.

### **C. < Initial Processing**

A CPA request will be initially processed by the TC assigned the prior application. The TC will verify that (A) the prior application is \*\* a design application, (B) the correct application number of the prior nonprovisional application is identified in the request, (C) the request is properly signed, (D) the prior nonprovisional application was pending on, and that the issue fee has not been paid in the prior nonprovisional application on or prior to, the filing date of the CPA request, (E) the prior nonprovisional application was complete under 37 CFR 1.51(b) (e.g., the filing fee has been paid and a signed oath or declaration under 37 CFR 1.63 has been filed in the prior application), and (F) the proper filing fee has been paid in the CPA. \*\* If one or more other conditions for filing a CPA have not been satisfied or the proper filing fee has not been paid, the applicant will be so notified and no examination will be made in the CPA until the filing error has been corrected or the proper filing fee submitted. See 37 CFR 1.53(h). If an examiner discovers that an improper or incomplete CPA has been \*\* >processed as a proper CPA in error, the examiner should immediately notify a supervisory applications examiner (SAE) or other technical support staff within the TC who will reprocess the CPA and correct the application records.

### **D. < Incorrect Patent Application Number Identified**

A request for a CPA must identify the prior nonprovisional application (37 CFR 1.53(d)(2)(i)) by application number (series code and serial number) or by serial number and filing date. Where a paper requesting a CPA is filed which does not properly identify the prior nonprovisional application number, the TC should attempt to identify the proper application number by reference to other identifying information provided in the CPA papers, e.g., name of the inventor, filing date, title of the invention, and attorney's docket number of the prior application. If the TC is

able to identify the correct application number of the prior application, the correct application number should be entered in red ink on the paper requesting the CPA and the entry should be dated and initialed. >For Image File Wrapper (IFW) processing, see IFW Manual.< If the TC is unable to identify the application number of the prior application and the party submitting the CPA papers is a registered practitioner, the practitioner may be requested by telephone to supply a letter signed by the practitioner providing the correct application number. If all attempts to obtain the correct application number are unsuccessful, the paper requesting the CPA should be returned by the TC to the sender where a return address is available. The returned CPA request must be accompanied by a cover letter which will indicate to the sender that if the returned CPA request is resubmitted to the U.S. Patent and Trademark Office with the correct application number within two weeks of the mail date on the cover letter, the original date of receipt of the CPA request will be considered by the U.S. Patent and Trademark Office as the date of receipt of the CPA request. See 37 CFR 1.5(a). A copy of the returned CPA request and a copy of the date-stamped cover letter should be retained by the TC. Applicants may use either the Certificate of Mailing or Transmission procedure under 37 CFR 1.8 or the "Express Mail" procedure under 37 CFR 1.10 for resubmissions of returned CPA requests if they desire to have the benefit of the date of deposit in the United States Postal Service. If the returned CPA request is not resubmitted within the two-week period with the correct application number, the TC should cancel the original "Office Date" stamp on the CPA request and re-stamp the returned CPA request with the date of receipt of the resubmission or with the date of deposit as "Express Mail" with the United States Postal Service, if the CPA request is resubmitted under 37 CFR 1.10. Where the CPA request is resubmitted later than two weeks after the return mailing by the U.S. Patent and Trademark Office, the later date of receipt or date of deposit as "Express Mail" of the resubmission will be considered to be the filing date of the CPA request. The two-week period to resubmit the returned CPA request is not extendible. See 37 CFR 1.5(a).

In addition to identifying the application number of the prior application, applicant is urged to furnish in the request for a CPA the following information

relating to the prior application to the best of his or her ability: (A) title of invention; (B) name of applicant(s); and (C) correspondence address. See 37 CFR 1.53(d)(8).

>

### **E** < *Signature Requirement*

A CPA is a request to expressly abandon the prior application (37 CFR 1.53(d)(2)(v)) and, therefore, must be properly signed. For a listing of the individuals who may properly sign a CPA request, see 37 CFR 1.33(b). In a joint application with no attorney or agent, all applicants must sign the CPA request in order for the CPA request to be considered properly signed. An unsigned or improperly signed CPA request will be placed in the file of the prior application, and is entitled to an application filing date, but is ineffective to abandon the prior application. A CPA will NOT be examined until the CPA request is properly signed.

A request for a CPA may be signed by a registered practitioner acting in a representative capacity under 37 CFR 1.34(a). However, correspondence concerning the CPA will be sent by the Office to the correspondence address as it appears in the prior nonprovisional application until a new power of attorney, or change of correspondence address signed by an attorney or agent of record in the prior application, is filed in the CPA.

A request for a CPA may also be signed by the assignee or assignees of the entire interest. However, the request must be accompanied by papers establishing the assignee's ownership under 37 CFR 3.73(b), unless such papers were filed in the prior application and ownership has not changed.

>

### **F** < *Filing Date*

The filing date of a CPA is the date on which a request on a separate paper for a CPA is filed. A request for a CPA cannot be submitted as a part of papers filed for another purpose, see 37 CFR 1.53(d)(2), (e.g., the filing of a request for a CPA within an amendment after final for the prior application is an improper request for a CPA).

A paper requesting a CPA may be sent to the U.S. Patent and Trademark Office by mail (see MPEP § 501), by facsimile transmission (see MPEP

§ 502.01) or it may be filed directly at the \*>Customer< Window located in Room 1B03 of Crystal Plaza 2, 2011 South Clark Place, Arlington, VA.

The date of receipt accorded to a CPA request sent by facsimile transmission is the date the complete transmission is received by an Office facsimile unit, unless the transmission is completed on a Saturday, Sunday, or Federal holiday within the District of Columbia. Correspondence for which transmission was completed on a Saturday, Sunday, or Federal holiday within the District of Columbia, will be accorded a receipt date of the next succeeding day which is not a Saturday, Sunday, or Federal holiday within the District of Columbia. \*\*

Applicants filing a CPA by facsimile transmission may include a "Receipt for Facsimile Transmitted CPA" (PTO/SB/29A) containing a mailing address and identifying information (e.g., the prior application number, filing date, title, first named inventor) with the request for a CPA. The USPTO will: (A) separate the "Receipt for Facsimile Transmitted CPA" from the CPA request papers; (B) date-stamp the "Receipt for Facsimile Transmitted CPA"; (C) verify that the identifying information provided by the applicant on the "Receipt for Facsimile Transmitted CPA" is the same information provided on the accompanying request for a CPA; and (D) mail the "Receipt for Facsimile Transmitted CPA" to the mailing address provided on the "Receipt for Facsimile Transmitted CPA." The "Receipt for Facsimile Transmitted CPA" cannot be used to acknowledge receipt of any paper(s) other than the request for a CPA. A returned "Receipt for Facsimile Transmitted CPA" may be used as *prima facie* evidence that a request for a CPA containing the identifying information provided on the "Receipt for Facsimile Transmitted CPA" was filed by facsimile transmission on the date stamped thereon by the USPTO. As the USPTO will verify only the identifying information contained on the request for a CPA, and will not verify whether the CPA was accompanied by other papers (e.g., a preliminary amendment), the "Receipt for Facsimile Transmitted CPA" cannot be used as evidence that papers other than a CPA were filed by facsimile transmission in the USPTO. Likewise, applicant-created "receipts" for acknowledgment of facsimile transmitted papers (whether created for the acknowledgment of a CPA or other papers) cannot be used as evidence that papers

were filed by facsimile in the USPTO. Applicants are cautioned not to include information on a "Receipt for Facsimile Transmitted CPA" that is intended for retention in the application file, as the USPTO does not plan on retaining a copy of such receipts in the file of the application.

An applicant filing a CPA by facsimile must include an authorization to charge the basic filing fee to a deposit account or to a credit card using PTO-2038 (See MPEP § 509), or the application will be treated under 37 CFR 1.53(f) as having been filed without the basic filing fee (as fees cannot otherwise be transmitted by facsimile).

37 CFR 1.6(f) provides for the situation in which the Office has no evidence of receipt of a CPA transmitted to the Office by facsimile transmission. 37 CFR 1.6(f) requires that a showing thereunder include, *inter alia*, a copy of the sending unit's report confirming transmission of the application or evidence that came into being after the complete transmission of the application and within one business day of the complete transmission of the application.

The Certificate of Mailing Procedure under 37 CFR 1.8 does not apply to filing a request for a CPA, since the filing of such a request is considered to be a filing of national application papers for the purpose of obtaining an application filing date (37 CFR 1.8(a)(2)(i)(A)). Thus, if (A) the Patent and Trademark Office mails a final Office action on July 2, 1997 (Wednesday), with a shortened statutory period of 3 months to reply and (B) a petition for a three-month extension of time (and the fee) and a CPA are received in the U.S. Patent and Trademark Office on January 5, 1998 (Monday), accompanied by a certificate of mailing under 37 CFR 1.8 dated January 2, 1998 (Friday), then the prior application was abandoned on January 3, 1998, and the CPA is improper because the CPA was not filed before the abandonment of the prior application. As a further example, if (A) the U.S. Patent and Trademark Office mails a final Office action on July 2, 1997 (Wednesday), with a shortened statutory period of 3 months to reply and (B) applicant submits a petition for a three-month extension of time (and the fee) and a CPA request via facsimile transmission accompanied by a certificate of transmission under 37 CFR 1.8 at 9:00 PM (PST) on January 2, 1998 (Friday), but the U.S. Patent and Trademark Office does not receive the complete

transmission until 12:01 AM (EST) on January 3, 1998 (Saturday), then the CPA is improper because the CPA request was not filed until January 5, 1998, see 37 CFR 1.6(a)(3), which is after the abandonment (midnight on Friday, January 2, 1998) of the prior application.

>

### G < Filing Fee

The filing fee for a CPA is \*\* the basic filing fee as set forth in 37 CFR 1.16>(f)<\*\*. See 37 CFR 1.53(d)(3).

A general authorization to charge fees to a deposit account which was filed in the prior application carries over from the prior nonprovisional application to a CPA. Thus, where a general authorization to charge fees to a deposit account was filed in the prior application the TC should charge the necessary filing fee of the CPA to the deposit account. \*\*

Where a general authorization to charge fees to a deposit account was filed in the prior application and applicant desires to file a CPA without paying the filing fee on the filing date of the application, applicant may file the CPA with specific instructions revoking the general authorization filed in the prior application.

Where a filing date has been assigned to a CPA, but the basic filing fee is insufficient or has been omitted, applicant will be so notified by the TC and given a period of time in which to file the missing fee and to pay the surcharge set forth in 37 CFR 1.16(e) in order to prevent abandonment of the application. The time period usually set is 2 months from the date of notification. This time period is subject to the provisions of 37 CFR 1.136(a). A CPA will not be placed upon the files for examination until all of its required parts, including the filing fee and surcharge, if necessary, are received. See 37 CFR 1.53(h). Thus, it would be inappropriate to conduct an interview or to issue an action on the merits in the CPA until the filing fee and surcharge, if necessary, are received.

### Small Entity Status

Small entity status established in the parent application does not automatically carry over to a CPA. Status as a small entity must be specifically established in every application in which the status is available and desired. 37 CFR 1.27(c)(4) provides that the refiling of an application as a continued prosecution appli-

cation under 37 CFR 1.53(d) requires a new assertion of continued entitlement to small entity status.

Because small entity status does not automatically carry over from the prior application to the CPA, unless the request for a CPA specifically indicates that the filing fee is to be charged in the small entity amount or otherwise includes an assertion of entitlement to small entity status, the large entity filing fee should be charged.

#### **H. < Extensions of Time**

If an extension of time is necessary to establish continuity between the prior application and the CPA, the petition for extension of time should be filed as a separate paper directed to the prior nonprovisional application. However, a CPA is not improper simply because the request for a CPA is combined in a single paper with a petition for extension of time. The “separate paper” requirement of 37 CFR 1.53(d)(2) is intended to preclude an applicant from burying a request for a CPA in a paper submitted primarily for another purpose, e.g., within an amendment after final for the prior application.

While the filing of a CPA is not strictly a reply to an Office action mailed in a prior application, a request for a CPA is a paper directed to and placed in the file of the prior application, and seeks to take action in (i.e., expressly abandon) the prior application. Thus, it will be considered a “reply” for purposes of 37 CFR 1.136(a)(3). As a result, an authorization in the prior application to charge all required fees, fees under 37 CFR 1.17, or all required extension of time fees to a deposit account or to a credit card (See MPEP § 509) will be treated as a constructive petition for an extension of time in the prior application for the purpose of establishing continuity with the CPA. The correct extension fee to be charged in the prior application would be the extension fee necessary to establish continuity between the prior application and the CPA on the filing date of the CPA.

If an extension of time directed to the prior application is filed as a separate paper, it must be accompanied by its own certificate of mailing under 37 CFR 1.8 (if mailed by first class mail) or under 37 CFR 1.10 (if mailed by Express Mail), if the benefits of those rules are desired.

>

#### **I. < Notice of CPA Filing**

Since a “Notice of Abandonment” is not mailed in the prior application as a result of the filing of a CPA nor is a filing receipt normally mailed for a CPA \*\*, the examiner should advise the applicant that a request for a CPA has been granted by including form paragraph 2.30 in the first Office action of the CPA.

\*\*>

##### *¶ 2.30 CPA Status Acceptable (for Design Applications)*

The request filed on [1] for a Continued Prosecution Application (CPA) under 37 CFR 1.53(d) based on parent Application No. [2] is acceptable and a CPA has been established. An action on the CPA follows.

#### **Examiner Note:**

1. Use this form paragraph in the first Office action of a CPA to advise the applicant that a request for a CPA is acceptable and that a CPA has been established. This notice should be given, since applicant is not notified of the abandonment of the parent nor is a filing receipt normally sent for a CPA. If the request for a CPA in a utility or plant application is improper and the CPA has been treated as an RCE, do not use this form paragraph (use form paragraph 7.24.15 instead). See MPEP § 706.07(h).
2. In bracket 1 insert the filing date of the request for a CPA.
3. In bracket 2 insert the Application Number of the parent application.

<

A “conditional” request for a CPA will not be permitted. Any “conditional” request for a CPA submitted as a separate paper with an amendment after final in an application will be treated as an unconditional request for a CPA of the application. This will result (by operation of 37 CFR 1.53(d)(2)(v)) in the abandonment of the prior application, and (if so instructed in the request for a CPA) the amendment after final in the prior application will be treated as a preliminary amendment in the CPA. The examiner should advise the applicant that a “conditional” request for a CPA has been treated as an unconditional request for a CPA and has been accepted by including form paragraph 2.35 in the first Office action of the CPA.

\*\*>

##### *¶ 2.35 CPA Status Acceptable - Conditional Request (for Design Applications)*

Receipt is acknowledged of the “conditional” request for a Continued Prosecution Application (CPA) filed on [1] under 37 CFR 1.53(d) based on prior Application No. [2]. Any “condi-

tional” request for a CPA submitted as a separate paper is treated as an unconditional request for a CPA. Accordingly, the request for a CPA application is acceptable and a CPA has been established. An action on the CPA follows.

**Examiner Note:**

1. Use this form paragraph in the first Office action of a CPA to advise the applicant that a “conditional” request for a CPA is treated as an unconditional request and the CPA is acceptable and that a CPA has been established. This notice should be given, since applicant is not notified of the abandonment of the parent nor is a filing receipt normally sent for a CPA. If the request for a CPA in a utility or plant application is improper and the CPA has been treated as an RCE, do not use this form paragraph (use form paragraph 7.24.15 instead). See MPEP § 706.07(h).
2. In bracket 1 insert the filing date of the request for a CPA.
3. In bracket 2 insert the Application Number identified in the CPA request.

<

Where the examiner recognizes that a paper filed in the prior application contains a request for a CPA, but the request is not in a separate paper, the examiner should, if possible, contact applicant by telephone to notify applicant that the request for a CPA is ineffective or notify the applicant in the next Office action that the CPA request is ineffective by using form paragraph 2.31.

\*\*>

*¶ 2.31 CPA Status Not Acceptable - Request Not on Separate Paper*

Receipt is acknowledged of the request for a Continued Prosecution Application (CPA) filed on [1] under 37 CFR 1.53(d) based on Application No. [2]. However, because the request was not submitted on a separate paper as required by 37 CFR 1.53(d)(2), the request is not acceptable and no CPA has been established.

**Examiner Note:**

1. Use this form paragraph to inform applicant that a request for a CPA in a design application is not in compliance with 37 CFR 1.53(d)(2) and, therefore, no CPA has been established.
2. In bracket 1 insert the filing date of the paper containing the request for a CPA.
3. In bracket 2 insert the Application Number identified in the CPA request.

**J. < Inventorship**

The inventive entity set forth in the prior nonprovisional application automatically carries over into the CPA UNLESS the request for a CPA is accompanied by or includes on filing a statement requesting the

deletion of the name or names of the person or persons who are not inventors of the invention being claimed in the CPA. 37 CFR 1.53(d)(4). The statement requesting the deletion of the names of the person or persons who are not inventors in the continuation or divisional application must be signed by person(s) authorized pursuant to 37 CFR 1.33(b) to sign an amendment in the continuation or divisional application. The examiner should acknowledge receipt of a statement filed with a CPA requesting the deletion of the name or names of the person or persons who are not inventors of the invention being claimed in the CPA in the first Office action in the CPA by using form paragraph 2.32.

*¶ 2.32 Request To Delete a Named Inventor*

Receipt is acknowledged of the statement requesting that [1] be deleted as a named inventor which was filed with the Continued Prosecution Application (CPA) on [2]. The inventorship has been corrected as requested.

**Examiner Note:**

1. Use this form paragraph where a Continued Prosecution Application (CPA) is filed accompanied by a statement requesting deletion of the name or names of the person or persons who are not inventors of the invention being claimed in the new application. Any request to delete a named inventor in a CPA filed after the CPA is filed must be accompanied by a request under 37 CFR 1.48.
2. In bracket 1 insert the name or names of the inventor(s) requested to be deleted.
3. In bracket 2 insert the filing date of the CPA.

After the first Office action is mailed, the application file should be sent to OIPE for revision of its records to reflect the change of inventorship. The examiner should note the change of inventorship on the original oath or declaration by writing in red ink in the left column “See Paper No. \_\_ for inventorship changes.” See MPEP § 201.03 and § 605.04(g). >For Image File Wrapper (IFW) processing, see the IFW Manual.< Any request by applicant for a corrected filing receipt to show the change in inventorship should not be submitted until after the examiner has acknowledged the change in inventorship in an Office action. Otherwise, the “corrected” filing receipt may not show the change in inventorship.

The inventive entity of the CPA will be the same as the inventive entity of the prior application even if the CPA papers include a transmittal letter or a new oath or declaration naming an inventor not named in the prior application. However, the new oath or declara-

tion will be placed in the application file. Upon review of the application, the examiner will notify the applicant in the first Office action using form paragraph 2.33 that the inventive entity of the prior application has been carried over into the CPA. If the inventive entity set forth in the transmittal letter of the new oath or declaration is desired, then a request under 37 CFR 1.48 along with the required fee set forth in 37 CFR 1.17(i) must be filed. No new oath or declaration need be filed with the later-filed request under 37 CFR 1.48 if such was submitted on filing of the CPA. If a request under 37 CFR 1.48 is not filed, it should be noted that the filing in a CPA of a transmittal letter or a new oath or declaration containing an inventor not named in the prior nonprovisional application may result in the claims in the CPA being rejected under 35 U.S.C. 102(f).

#### ¶ 2.33 *New Inventor Identified*

It is noted that [1] identified as a named inventor in the Continued Prosecution Application (CPA) filed under 37 CFR 1.53(d) on [2], but no request under 37 CFR 1.48, as is required, was filed to correct the inventorship. Any request to add an inventor must be in the form of a request under 37 CFR 1.48. Otherwise, the inventorship in the CPA shall be the same as in the prior application.

#### **Examiner Note:**

1. Use this form paragraph where a request for a Continued Prosecution Application (CPA) identifies one or more inventors who were not named as inventors in the prior application on the filing date of the CPA.
2. In bracket 1 insert the name or names of the inventor(s) requested to be added followed by either --was-- or --were--, as appropriate.
3. In bracket 2 insert the filing date of the CPA.

>

### **III. EXAMINATION OF CPAs**

#### **A. < Benefit of Earlier Filing Date**

A request for a CPA is a specific reference under 35 U.S.C. 120 to every application assigned the application number identified in the request, and 37 CFR 1.78(a)(2) provides that a request for a CPA is the specific reference under 35 U.S.C. 120 to the prior application. That is, the CPA includes the request for an application under 37 CFR 1.53(d) and the recitation of the application number of the prior application in such request is the “specific reference to the earlier

filed application” required by 35 U.S.C. 120. No further amendment to the specification of the CPA nor a reference in the CPA’s application data sheet is required by 35 U.S.C. 120 or 37 CFR 1.78(a) to identify or reference the prior application, as well as any other application assigned the application number of the prior application (e.g., in instances in which a CPA is the last in a chain of CPAs).

Where an application claims a benefit under 35 U.S.C. 120 of a chain of applications, the application must make a reference to the first (earliest) application and every intermediate application. See *Sampson v. Ampex Corp.*, 463 F.2d 1042, 1044-45, 174 USPQ 417, 418-19 (2d Cir. 1972); *Sticker Indus. Supply Corp. v. Blaw-Knox Co.*, 405 F.2d 90, 93, 160 USPQ 177, 179 (7th Cir. 1968); *Hovlid v. Asari*, 305 F.2d 747, 751, 134 USPQ 162, 165 (9th Cir. 1962). See also MPEP § 201.11. In addition, every intermediate application must also make a reference to the first (earliest) application and every application after the first application and before such intermediate application.

In the situation in which there is a chain of CPAs, each CPA in the chain will, by operation of 37 CFR 1.53(d)(7), contain the required specific reference to its immediate prior application, as well as every other application assigned the application number identified in such request. Put simply, a specific reference to a CPA by application number and filing date will constitute a specific reference to: (A) the non-continued prosecution application originally assigned such application number (the prior application as to the first CPA in the chain); and (B) every CPA assigned the application number of such non-continued prosecution application.

Where the non-continued prosecution application originally assigned such application number itself claims the benefit of a prior application or applications under 35 U.S.C. 119(e), 120, 121, or 365(c), 37 CFR 1.78(a)(2) and (a)(5) continue to require that such application contain a reference to any such prior application(s). The reference(s) can be in an application data sheet (37 CFR 1.76) or in the first sentence of the specification. See 37 CFR 1.78(a)(2) and (a)(5). As a CPA uses the application file of the prior application, a specific reference in the prior application (as to the CPA) will constitute a specific reference in the

CPA, as well as every CPA in the event that there is a chain of CPAs.

Where an applicant in an application filed under 37 CFR 1.53(b) seeks to claim the benefit of a CPA under 35 U.S.C. 120 or 121 (as a continuation, divisional, or continuation-in-part), 37 CFR 1.78(a)(2) requires a reference to the CPA by application number in the first sentence of such application unless such reference is made in an application data sheet. 37 CFR 1.78(a)(2) provides that “[t]he identification of an application by application number under this section is the specific reference required by 35 U.S.C. 120 to every application assigned that application number.” Thus, where a referenced CPA is in a chain of CPAs, this reference will constitute a reference under 35 U.S.C. 120 and 37 CFR 1.78(a)(2) to every CPA in the chain as well as the non-continued prosecution application originally assigned such application number.

Therefore, regardless of whether an application is filed under 37 CFR 1.53(b) or (d), a claim under 35 U.S.C. 120 to the benefit of a CPA is, by operation of 37 CFR 1.53(d)(7) and 37 CFR 1.78(a)(2), a claim to every application assigned the application number of such CPA. In addition, applicants will not be permitted to choose to delete such a claim as to certain applications assigned that application number (e.g., for patent term purposes). See 37 CFR 1.53(d)(7).

Further, an applicant in a CPA is not permitted to amend the first sentence of the specification to provide the specific reference to the prior application, or to provide such a reference in an application data sheet. Any such amendment will not be entered. The applicant should be advised in the next Office action that any such amendment to the specification or reference in the application data sheet has not been entered by using form paragraph 2.34 or 2.36. See 37 CFR 1.78(a)(2). \*\*.

¶ 2.34 *Reference in CPA to Prior Application (by Amendment to the Specification)*

The amendment filed [1] requesting that the specification be amended to refer to the present Continued Prosecution Application (CPA) as a [2] application of Application No. [3] has not been entered. As set forth in 37 CFR 1.53(d)(7), a request for a CPA is the specific reference required by 35 U.S.C. 120 to every application assigned the application number identified in such request. Thus, there is no need to amend the first sentence of the specification to refer back to the prior application and any such amendment shall be denied entry.

**Examiner Note:**

1. Use this form paragraph to inform the applicant that an amendment to the first sentence of the specification referring to the CPA as a continuing application of the prior application has not been entered and will not be entered if submitted again.
2. In bracket 1, insert the filing date of the amendment.
3. In bracket 2, insert either --continuation-- or --divisional--.
4. In bracket 3, insert the Application Number of the prior non-provisional application.

Claims under 35 U.S.C. 119(a)-(d) and (e) for the benefit of the filing dates of earlier applications in a parent application will automatically carry over to a CPA.

\*\*

>

**B. < Terminal Disclaimer**

A terminal disclaimer filed in the parent application carries over to a CPA. The terminal disclaimer filed in the parent application carries over because the CPA retains the same application number as the parent application, i.e., the application number to which the previously filed terminal disclaimer is directed. If applicant does not want the terminal disclaimer to carry over to the CPA, applicant must file a petition under 37 CFR 1.182 along with the required petition fee, requesting the terminal disclaimer filed in the parent application not be carried over to the CPA. See MPEP § 1490, “Withdrawing a Terminal Disclaimer,” subheading entitled “A. Before Issuance of Patent.”

>

**C. < Prior Election**

An election made in the prior application carries over to the CPA only if all of the following conditions are met: (A) the CPA is designated as a continuation or is not designated at all (i.e., the CPA is **NOT** designated as a divisional); (B) there was an express election by the applicant in reply to a restriction requirement in the prior application; (C) the CPA presents claim(s) drawn only to invention(s) claimed in the prior application; and (D) the CPA does not contain an indication that a shift in election is desired.

Where all of the conditions are met, the examiner’s first action should repeat the restriction requirement made in the prior application to the extent it is still applicable in the CPA and include a statement that prosecution is being continued on the invention



elected and prosecuted by applicant in the prior application.

>

#### ***D. < Information Disclosure Statements and Preliminary Amendments***

All information disclosure statements filed in the prior application that comply with the content requirements of 37 CFR 1.98 will be considered in a CPA by the examiner. No specific request that the previously submitted information be considered in a CPA is required.

In addition, all information disclosure statements that comply with the content requirements of 37 CFR 1.98 and are filed before the mailing of a first Office action on the merits will be considered by the examiner, regardless of whatever else has occurred in the examination process up to that point in time. The submission of an information disclosure statement after the first Office action is mailed could delay prosecution\*\*. Therefore, applicants are encouraged to file any information disclosure statement in a CPA as early as possible, preferably at the time of filing the CPA. For further discussion of information disclosure statements, see MPEP § 609.

Applicants are also encouraged to file all preliminary amendments at the time of filing a CPA because the entry of any preliminary amendment filed after the filing date of the CPA could be denied under 37 CFR 1.115 if the preliminary amendment unduly interferes with the preparation of a first Office action. See MPEP § 714.03(a). In a situation where the applicant needs more time to prepare a preliminary amendment or to file an information disclosure statement, applicant can request a three-month suspension of action under 37 CFR 1.103(b). The three-month suspension of action under 37 CFR 1.103(b) must be filed at the time of filing a CPA. See MPEP § 709 .

#### ***E. Copies of Affidavits***

Affidavits and declarations, such as those under 37 CFR 1.130, 1.131 and 1.132 filed during the prosecution of the parent nonprovisional application, automatically become a part of the CPA. Therefore, no copy of the original affidavit or declaration filed in the parent nonprovisional application need be filed in the CPA.

>

### **IV. PUBLIC ACCESS TO CPAs**

#### ***A. Waiver of Confidentiality***

A CPA is construed to include a waiver of confidentiality by the applicant under 35 U.S.C. 122 to the extent that any member of the public who is entitled under the provisions of 37 CFR 1.14 to obtain access to, copies of, or information concerning either the prior application or any continuing application filed under the provisions of 37 CFR 1.53(d) may be given similar access to, copies of, or similar information concerning, the other application(s) in the application file. 37 CFR 1.53(d)(6). However, all applications in the file jacket of a pending CPA are treated as pending, rather than abandoned, in determining whether copies of, and access to, such applications will be granted. See, e.g., 37 CFR 1.14(e)(2). For Image File Wrapper (IFW) processing, see IFW Manual. See MPEP § 103 for further discussion of access to an abandoned application contained in the file of a pending CPA.

#### ***B. Certified Copy***

A certified copy of a CPA will be prepared by the Certification Branch upon request. The certified copy will consist of a copy of the most recent non-continued prosecution application in the chain of CPAs. The filing date of the CPA will be shown in the certified copy as the filing date of the most recent non-continued prosecution application in the chain of CPAs.

### **V. < FORMS**

Form PTO/SB/29, “>For Design Applications Only:< Continued Prosecution Application (CPA) Request Transmittal” and Form PTO/SB/29A, “>For Design Applications Only:< Receipt For Facsimile Transmitted CPA” may be used by applicant for filing a CPA under 37 CFR 1.53(d). The forms used by the TCs to notify applicants of defects regarding applications filed under 37 CFR 1.53(d) are shown below. “Notice of Improper \*\*>CPA (or FWC) Filing For Utility or Plant Applications Filed Before June 8, 1995<” Form PTO-2011; “Notice of Improper CPA \*\*>For Design Applications<” Form PTO-2012; “Notice To File Missing Parts Of Application (CPA), \*\*>For Design Applications<” Form PTO-2021;

TYPES, CROSS-NOTING, AND STATUS OF APPLICATION

**201.06(d)**

“Notice Of Incomplete Reply (CPA) \*\*>For Design Applications<” Form PTO-2018; and “Notice Of Abandonment Under 37 CFR 1.53(f) (CPA) \*\*>For Design Applications<” Form PTO-2019.

\*\*>

PTO/SB/29 (04-04)

Approved for use through 07/31/2006. OMB 0651-0032  
U.S. Patent and Trademark Office; U.S. DEPARTMENT OF COMMERCE

Under the Paperwork Reduction Act of 1995, no persons are required to respond to a collection of information unless it displays a valid OMB control number.

**FOR DESIGN APPLICATIONS ONLY:  
CONTINUED PROSECUTION APPLICATION (CPA) REQUEST TRANSMITTAL**

*Submit an original, and a duplicate for fee processing*  
*(Only for Continuation or Divisional applications under 37 CFR 1.53(d))*

CHECK BOX, if applicable:  
 DUPLICATE

Address to:  <b>Commissioner for Patents P.O. Box 1450 Alexandria, VA 22313-1450</b>	Attorney Docket No. of Prior Application	
	First Named Inventor	
	Examiner Name	
	Art Unit	
	Express Mail Label No.	

This is a request for a  continuation or  Divisional application under 37 CFR 1.53(d), (continued prosecution application (CPA)) of prior application number \_\_\_\_\_ filed on \_\_\_\_\_, entitled \_\_\_\_\_

**NOTES**

A CPA may only be filed in a design application. A CPA cannot be filed in a utility or plant application. See "Elimination of Continued Prosecution Application Practice as to Utility and Plant Applications; Final Rule," 68 FR 32376 (May 30, 2003). Applicant may consider filing a Request for Continued Examination (RCE) under 37 CFR 1.114 in utility or plant applications. See MPEP 706.07(h) and form PTO/SB/30.

**Filing Qualifications:** The prior application identified above must be a design application that is complete as defined by 37 CFR 1.51(b).

**C-I-P NOT PERMITTED:** A continuation-in-part application cannot be filed as a CPA under 37 CFR 1.53(d), but must be filed under 37 CFR 1.53(b).

**EXPRESS ABANDONMENT OF PRIOR APPLICATION:** The filing of this CPA is a request to expressly abandon the prior application as of the filing date of the request for a CPA. 37 CFR 1.53(b) must be used to file a continuation, divisional, or continuation-in-part of an application that is not to be abandoned.

**ACCESS TO PRIOR APPLICATION:** The filing of this CPA will be construed to include a waiver of confidentiality by the applicant under 35 U.S.C. 122 to the extent that any member of the public who is entitled under the provisions of 37 CFR 1.14 to access to, copies of, or information concerning, the prior application may be given similar access to, copies of, or similar information concerning, the other application or applications in the file.

**35 U.S.C. 120 STATEMENT:** In a CPA, no reference to the prior application is needed in the first sentence of the specification and none should be submitted. If a sentence referencing the prior application is submitted, it will not be entered. A request for a CPA is the specific reference required by 35 U.S.C. 120 and to every application assigned the application number identified in such request, 37 CFR 1.78(a).

**WARNING: Information on this form may become public. Credit card information should not be included on this form. Provide credit card information and authorization on PTO-2038.**

1.  Enter the unentered amendment previously filed on \_\_\_\_\_ under 37 CFR 1.116 in the prior design application.
2.  A preliminary amendment is enclosed.
3. This application is filed by fewer than all the inventor(s) named in the prior application, 37 CFR 1.53(d)(4).
  - a.  DELETE the following inventor(s) named in the prior design application:  
\_\_\_\_\_
  - b.  The inventor(s) to be deleted are set forth on a separate sheet attached hereto.
4.  A new power of attorney (PTO/SB/81) is enclosed.
5. Information Disclosure Statement (IDS) is enclosed;
  - a.  PTO-1449 (PTO/SB/08 or equivalent)
  - b.  Copies of IDS Citations

Page 1 of 2

This collection of information is required by 37 CFR 1.53(d). The information is required to obtain or retain a benefit by the public which is to file (and by the USPTO to process) an application. Confidentiality is governed by 35 U.S.C. 122 and 37 CFR 1.14. This collection is estimated to take 24 minutes to complete, including gathering, preparing, and submitting the completed application form to the USPTO. Time will vary depending upon the individual case. Any comments on the amount of time you require to complete this form and/or suggestions for reducing this burden, should be sent to the Chief Information Officer, U.S. Patent and Trademark Office, U.S. Department of Commerce, P.O. Box 1450, Alexandria, VA 22313-1450. DO NOT SEND FEES OR COMPLETED FORMS TO THIS ADDRESS. SEND TO: Commissioner for Patents, P. O. Box 1450, Alexandria, VA 22313-1450.

If you need assistance in completing the form, call 1-800-PTO-9199 (1-800-786-9199) and select option 2.

TYPES, CROSS-NOTING, AND STATUS OF APPLICATION

201.06(d)

PTO/SB/29 (04-04)  
 Approved for use through 07/31/2006. OMB 0651-0032  
 U.S. Patent and Trademark Office; U.S. DEPARTMENT OF COMMERCE

Under the Paperwork Reduction Act of 1995, no persons are required to respond to a collection of information unless it displays a valid OMB control number.

6.  Small entity status: Applicant claims small entity status. See 37 CFR 1.27.

7. The Director is hereby authorized to credit overpayments or charge the following fees to Deposit Account No. \_\_\_\_\_:

a.  Fees required under 37 CFR 1.16.

b.  Fees required under 37 CFR 1.17.

c.  Fees required under 37 CFR 1.18.

8.  A check in the amount of \$ \_\_\_\_\_ is enclosed.

9.  Payment by credit card. Form PTO-2038 is attached.

10.  Applicant requests suspension of action under 37 CFR 1.103(b) for a period of \_\_\_\_\_ months (not to exceed 3 months) and the fee under 37 CFR 1.17(i) is enclosed.

11.  New Attorney Docket Number, if desired \_\_\_\_\_  
 [Prior application Attorney Docket Number will carryover to this CPA unless a new Attorney Docket Number has been provided herein.]

12. a.  Receipt For Facsimile Transmitted CPA (PTO/SB/29A)

b.  Return Receipt Postcard (Should be specifically itemized. See MPEP 503)

13.  Other:

**NOTE:** The prior application's correspondence address will carry over to this CPA **UNLESS** a new correspondence address is provided below.

**14. NEW CORRESPONDENCE ADDRESS**

Customer Number  OR  New correspondence address below

Name	
Address	
City	
Country	

**15. SIGNATURE OF APPLICANT, ATTORNEY, OR AGENT REQUIRED**

Name (Print Type)	
Signature	
Registration No. (Attorney Agent)	
Date	

PTO/SB/29A (09-03)  
 Approved for use through 07/31/2006. OMB 0651-0032  
 Patent and Trademark Office, U.S. DEPARTMENT OF COMMERCE

Under the Paperwork Reduction Act of 1995, no persons are required to respond to a collection of information unless it displays a valid OMB control number.

<p><b>If this RECEIPT is included with a request for a CPA filed by facsimile transmission, it will be date stamped and mailed to the ADDRESS in item 1.</b></p>		<p><b>FOR DESIGN APPLICATIONS ONLY</b></p> <p><b>RECEIPT</b></p> <p><b>FOR</b></p> <p><b>FACSIMILE TRANSMITTED</b></p> <p><b>CPA</b></p> <p><i>(To accompany a request for a Continued Prosecution Application (CPA) under 37 CFR 1.53(d) filed by facsimile transmission)</i></p>
<b>1. ADDRESS</b>	<p><i>Applicant's Mailing Address for this receipt must be CLEARLY PRINTED or TYPED in the box below.</i></p>	
<p><b>NOTE:</b> By this receipt, the USPTO (a) acknowledges that a request for a CPA in a design application was filed by facsimile the date stamped below by the USPTO and (b) verifies only that the application number provided by the applicant on this receipt is the same as the application number provided on the accompanying request for a CPA. This receipt CANNOT be used to acknowledge receipt of any paper(s) other than the request for a CPA.</p>		
<p><b>2. APPLICATION IDENTIFICATION:</b>  <i>(Provide at least enough information to identify the application)</i></p> <p><b>a. For prior application</b></p> <p>Application No: .....</p> <p>Filing Date: .....</p> <p>Title: .....</p> <p>Attorney Docket No: .....</p> <p>First Named Inventor: .....</p> <p><b>b. For instant CPA application</b></p> <p>New Attorney Docket No: .....  <i>(if applicable)</i></p>		
<p>The USPTO date stamp, which appears in the box to the right, is an acknowledgement by the USPTO of receipt of a request for a CPA filed by facsimile transmission on the date indicated below.</p>		<p><i>(THIS AREA FOR PTO DATE STAMP USE)</i></p>
<p><u>USPTO HANDLING INSTRUCTIONS:</u>  <i>Please stamp area to the right with the date the complete transmission of the request for a CPA was received in the USPTO and also include the USPTO organization name that provided the date stamp (stamp may include both items). Verify that the application number provided by applicant on this receipt is the same as the application number provided by applicant on the request for a CPA accompanying this receipt. If there is an inconsistency between the application number provided on this receipt and the request for a CPA, strike through the inconsistent application number provided on this receipt and insert the correct application number, if possible. Then place in a window envelope and mail.</i></p>		

This collection of information is required by 37 CFR 1.8. The information is required to obtain or retain a benefit by the public which is to file (and by the USPTO to process) an application. Confidentiality is governed by 35 U.S.C. 122 and 37 CFR 1.14. This collection is estimated to take 24 minutes to complete, including gathering, preparing, and submitting the completed application form to the USPTO. Time will vary depending upon the individual case. Any comments on the amount of time you require to complete this form and/or suggestions for reducing this burden, should be sent to the Chief Information Officer, U.S. Patent and Trademark Office, U.S. Department of Commerce, P.O. Box 1450, Alexandria, VA 22313-1450. DO NOT SEND FEES OR COMPLETED FORMS TO THIS ADDRESS. SEND TO: Commissioner for Patents, P.O. Box 1450, Alexandria, VA 22313-1450.  
 If you need assistance in completing the form, call 1-800-PTO-9199 (1-800-786-9199) and select option 2.



UNITED STATES PATENT AND TRADEMARK OFFICE

COMMISSIONER FOR PATENTS  
 UNITED STATES PATENT AND TRADEMARK OFFICE  
 P.O. Box 1450  
 ALEXANDRIA, VA 22313-1450  
 www.uspto.gov

DATE MAILED:

**Notice of Improper CPA (or FWC) Filing  
 For Utility or Plant Applications Filed Before June 8, 1995  
 No Filing Date Granted**

Applicant filed a request for a continued prosecution application (CPA) under 37 CFR 1.53(d) (or a file wrapper continuing (FWC) application under 37 CFR 1.62) on \_\_\_\_\_ in the above-identified application which is a utility or plant application filed before June 8, 1995. Effective July 14, 2003, CPA Practice under 37 CFR 1.53(d) is no longer available for utility and plant applications. See *Elimination of Continued Prosecution Application Practice as to Utility and Plant Patent Applications*, Final Rule, 68 Fed. Reg. 32376 (May 30, 2003). FWC practice also has been eliminated as of December 1, 1997. See 1203 O.G. 63 (October 21, 1997).

The time period for reply set in the last Office action (or notice) of the application in which the improper CPA (or FWC) is filed (hereafter "prior application") continues to run from the mailing date of the Office action or notice. Applicant may wish to file a continuing application under 37 CFR 1.53(b). If, however, the prior application is abandoned (e.g., the time period for reply has expired), applicant would need to file a petition to revive the prior application to establish copendency with the continuing application under 37 CFR 1.53(b).

Any petition to revive under 37 CFR 1.137 should be directed to the attention of the Office of Petitions and may be addressed to: Mail Stop Petition  
 Commissioner for Patents  
 P.O. Box 1450  
 Alexandria, VA 22313-1450

Alternatively, if no application is desired, applicant may file a request for refund of any CPA (or FWC) filing fee paid (less the handling fee set forth in 37 CFR 1.21(n)).

**A copy of this notice MUST be returned with the reply.**

Direct the reply and any questions concerning this notice to

\_\_\_\_\_, Technology Center \_\_\_\_\_

(703) \_\_\_\_\_



UNITED STATES PATENT AND TRADEMARK OFFICE

COMMISSIONER FOR PATENTS  
 UNITED STATES PATENT AND TRADEMARK OFFICE  
 P.O. Box 1450  
 ALEXANDRIA, VA 22313-1450  
 www.uspto.gov

DATE MAILED:

**NOTICE OF IMPROPER CPA  
 FOR DESIGN APPLICATIONS  
 No Filing Date Granted**

The Continued Prosecution Application (CPA) request deposited on \_\_\_\_\_ is improper under 37 CFR 1.53(d) and has **not** been granted a filing date for reason(s) indicated below.

1. The prior application is not a complete (37 CFR 1.51(b)) application.
2. The request for a CPA was not filed before the payment of issue fee on the prior application. The issue fee was paid on \_\_\_\_\_.
3. The request for a CPA was not filed before the abandonment of, or termination of proceedings on, the prior application. The prior application was abandoned, or proceedings terminated, on \_\_\_\_\_.
4. A petition under 37 CFR 1.136(a) and appropriate fee are necessary to establish copendency between this CPA and the prior application.
5. Other: \_\_\_\_\_.

Any assertions that the above-identified CPA request is proper under 37 CFR 1.53(d) must be by way of petition directed to the attention of the Office of Petitions, and may be addressed to:

Mail Stop Petition  
 Commissioner for Patents  
 P.O. Box 1450  
 Alexandria, VA 22313-1450

Any such petition must be accompanied by the \$130.00 petition fee (37 CFR 1.17(h)). If the petition alleges that no defect exists, a request for refund of the petition fee may be included in the petition.

Any petition **must be** submitted within **TWO MONTHS** of the mailing date of this notice (37 CFR 1.181(f)) or the application may be returned or otherwise disposed of and the filing fee, if submitted, will be refunded less the \$130.00 handling fee (37 CFR 1.21(n)). **THIS TIME LIMIT MAY NOT BE EXTENDED PURSUANT TO 37 CFR 1.136.**

***A copy of this Notice MUST be returned with the reply.***

Direct any questions concerning this notice to

\_\_\_\_\_, Technology Center 2900  
 (703)\_\_\_\_\_

Form PTO-2012 (Rev. 7/03)



UNITED STATES PATENT AND TRADEMARK OFFICE

COMMISSIONER FOR PATENTS  
 UNITED STATES PATENT AND TRADEMARK OFFICE  
 P.O. Box 1450  
 ALEXANDRIA, VA 22313-1450  
 www.uspto.gov

DATE MAILED:

**NOTICE TO FILE MISSING PARTS OF APPLICATION (CPA)  
 FOR DESIGN APPLICATIONS  
 Filing Date Granted**

The Continued Prosecution Application (CPA) request filed on \_\_\_\_\_ is entitled to a filing date under 37 CFR 1.53(d)(1). The CPA request, however, lacks the filing fee(s) and/or items indicated below.

Applicant is given **TWO MONTHS FROM THE DATE OF THIS NOTICE** within which to file the fee(s), and any surcharge required below to avoid abandonment of this CPA. Extensions of time may be obtained by filing a petition accompanied by the extension fee under the provisions of 37 CFR 1.136(a).

*The total amount owed by applicant is the sum of items 1(a) or 1(b), and 2 (if checked) below.*

- 1. The statutory basic filing fee is:
  - Missing.
  - Insufficient.
  - a. Applicant must submit \$ \_\_\_\_\_ to complete the basic filing fee and the \$130.00 surcharge set forth in 37 CFR 1.16(e) (non-small entity), or \$ \_\_\_\_\_ to complete the basic filing fee as a small entity and the \$65.00 surcharge set forth in 37 CFR 1.16(e) and file a written assertion of small entity status under 37 CFR 1.27.
  - b. Applicant must submit \$ \_\_\_\_\_ to complete the basic filing fee as a small entity and the \$65.00 surcharge set forth in 37 CFR 1.16(e).
- 2. A \$50.00 processing fee is required since your check was returned without payment (37 CFR 1.21(m)).
- 3. The CPA request is unsigned. Applicant must file a signed duplicate or ratification of the CPA request.
- 4. Other: \_\_\_\_\_

***A copy of this notice MUST be returned with the reply.***

Any reply may be addressed to: Commissioner for Patents  
 P.O. Box 1450  
 Alexandria, VA 22313-1450

Direct any questions concerning this notice to  
 \_\_\_\_\_, Technology Center 2900  
 (703) \_\_\_\_\_





UNITED STATES PATENT AND TRADEMARK OFFICE

COMMISSIONER FOR PATENTS  
 UNITED STATES PATENT AND TRADEMARK OFFICE  
 P.O. Box 1450  
 ALEXANDRIA, VA 22313-1450  
 www.uspto.gov

DATE MAILED:

**NOTICE OF INCOMPLETE REPLY (CPA)  
 FOR DESIGN APPLICATIONS  
 Filing Date Granted**

The reply filed on \_\_\_\_\_ to the Notice to File Missing Parts of Application (CPA) (Notice) mailed on \_\_\_\_\_ has been entered into the application. The reply, however, is incomplete for the following reason(s):

- 1. The filing fee required by the Notice has not been received. The amount of \$\_\_\_\_\_ is due.
- 2. The surcharge of \$\_\_\_\_\_ has not been received.
- 3. The reply does not include \_\_\_\_\_ as required by the Notice.

A complete reply must be timely filed to prevent **ABANDONMENT** of the above-identified application and may be addressed to:

Commissioner for Patents  
 P.O. Box 1450  
 Alexandria, VA 22313-1450

The period for reply set forth in the Notice continues to run from the mailing date of the Notice. Applicant may obtain an **EXTENSION OF TIME** under the provisions of 37 CFR 1.136(a) by filing a petition accompanied by the appropriate fee (37 CFR 1.17(a)).

***A copy of this notice MUST be returned with the reply.***

Direct any questions concerning this notice to

\_\_\_\_\_, Technology Center 2900

(703) \_\_\_\_\_

Form PTO-2018 (Rev. 7/03)



UNITED STATES PATENT AND TRADEMARK OFFICE

COMMISSIONER FOR PATENTS  
 UNITED STATES PATENT AND TRADEMARK OFFICE  
 P.O. BOX 1450  
 ALEXANDRIA, VA 22313-1450  
 www.uspto.gov

DATE MAILED:

**NOTICE OF ABANDONMENT UNDER 37 CFR 1.53(f) (CPA)  
 For Design Applications**

The above-identified Continued Prosecution Application (CPA) is abandoned for failure to timely or completely reply to the Notice to File Missing Parts of Application (CPA) (Notice) mailed on \_\_\_\_\_.

- No reply was received.
- The reply received on \_\_\_\_\_ was untimely.
- The reply received on \_\_\_\_\_ was incomplete. The reply did not include:
  - 1. The surcharge required for filing the basic filing fee on a date later than the filing date of a nonprovisional application (37 CFR 1.16(e)).
  - 2. The basic filing fee required by the Notice (37 CFR 1.16(f)).  
 (Note: A nonprovisional application may not be relied on for benefits under 35 U.S.C. 120 and 37 CFR 1.78 unless the processing and retention fee set forth in 37 CFR 1.21(l) is paid within the period set forth in 37 CFR 1.53(f)).
- The letter of Express Abandonment filed on \_\_\_\_\_ is acknowledged; however, the application is abandoned for failure to timely or completely reply to the Notice as indicated above.

A petition to the Director under 37 CFR 1.137 may be filed requesting that the application be revived.

Under 37 CFR 1.137(a), a petition requesting the application be revived on the grounds of **UNAVOIDABLE DELAY** must be filed promptly after the applicant becomes aware of the abandonment and such petition must be accompanied by: (1) an adequate showing of the cause of unavoidable delay; (2) the required reply to the above-identified Notice; (3) the petition fee set forth in 37 CFR 1.17(l), and (4) a terminal disclaimer if required by 37 CFR 1.137(d).

Under 37 CFR 1.137(b), a petition requesting the application be revived on the grounds of **UNINTENTIONAL DELAY** must be filed promptly after applicant becomes aware of the abandonment and such petition must be accompanied by: (1) a statement that the entire delay was unintentional; (2) the required reply to the above-identified Notice; (3) the petition fee set forth in 37 CFR 1.17(m); and (4) a terminal disclaimer if required by 37 CFR 1.137(d).

Any questions concerning petitions to revive should be directed to Office of Petitions at (703) 305-9282. Any petitions to revive may be addressed to: Mail Stop Petition  
 Commissioner for Patents  
 P.O. Box 1450  
 Alexandria, VA 22313-1450

Direct any questions concerning this notice to

\_\_\_\_\_, Technology Center 2900  
 (703) \_\_\_\_\_

## 201.07 Continuation Application [R-2]

A continuation is a second application for the same invention claimed in a prior nonprovisional application and filed before the original prior application becomes abandoned or patented. The continuation application may be filed under 37 CFR 1.53(b) >(or 1.53(d) >if the application is a design application)<. The applicant in the continuation application must include at least one inventor named in the prior nonprovisional application. The disclosure presented in the continuation must be the same as that of the original application; i.e., the continuation should not include anything which would constitute new matter if inserted in the original application. The continuation application must claim the benefit of the prior nonprovisional application under 35 U.S.C. 120 or 365(c).

An application claiming the benefits of a provisional application under 35 U.S.C. 119(e) should not be called a “continuation” of the provisional application since an application that claims benefit of a provisional application is a nonprovisional application of a provisional application, not a continuation, division, or continuation-in-part of the provisional application.

At any time before the patenting or abandonment of or termination of proceedings on his or her earlier nonprovisional application, an applicant may have recourse to filing a continuation in order to introduce into the application a new set of claims and to establish a right to further examination by the primary examiner. An application under 37 CFR 1.53(d), however, must be filed prior to payment of the issue fee unless a petition under 37 CFR 1.313(c) is granted in the prior application. In addition, a continuation or divisional application may only be filed under 37 CFR 1.53(d) if the prior nonprovisional application is \*\* a design application that is complete as defined by 37 CFR 1.51(b)\*\*.

For notation to be put \*>in< the file \*>history< by the examiner in the case of a continuation application, see MPEP § 202.02.

Use form paragraph 2.05 to remind applicant of possible continuation status.

### ¶ 2.05 Possible Status as Continuation

This application discloses and claims only subject matter disclosed in prior application no [1], filed [2], and names an inventor or inventors named in the prior application. Accordingly, this application may constitute a continuation or division. Should

applicant desire to obtain the benefit of the filing date of the prior application, attention is directed to 35 U.S.C. 120 and 37 CFR 1.78.

### Examiner Note:

1. This form paragraph should only be used if it appears that the application may be a continuation, but priority has not been properly established.
2. An application claiming the benefits of a provisional application under 35 U.S.C. 119(e) should not be called a “continuation” of the provisional application since an application that claims benefit of a provisional application is a nonprovisional application of a provisional application, not a continuation, division, or continuation-in-part of the provisional application.

## 201.08 Continuation-in-Part Application [R-2]

A continuation-in-part is an application filed during the lifetime of an earlier nonprovisional application, repeating some substantial portion or all of the earlier nonprovisional application and *adding matter not disclosed* in the said earlier nonprovisional application. (*In re Klein*, 1930 C.D. 2, 393 O.G. 519 (Comm’r Pat. 1930)). The continuation-in-part application may only be filed under 37 CFR 1.53(b). The continuation-in-part application must claim the benefit of the prior nonprovisional application under 35 U.S.C. 120 or 365(c).

A continuation-in-part application CANNOT be filed as a continued prosecution application (CPA) under 37 CFR 1.53(d).

An application claiming the benefit of a provisional application under 35 U.S.C. 119(e) should not be called a “continuation-in-part” of the provisional application since an application that claims benefit of a provisional application is a nonprovisional application of a provisional application, not a continuation, division, or continuation-in-part of the provisional application.

The mere filing of a continuation-in-part does not itself create a presumption that the applicant acquiesces in any rejections which may be outstanding in the copending national nonprovisional application or applications upon which the continuation-in-part application relies for benefit.

A continuation-in-part filed by a sole applicant may also derive from an earlier joint application showing a portion only of the subject matter of the later application, subject to the conditions set forth in 35 U.S.C. 120 and 37 CFR 1.78. Subject to the same conditions,

a joint continuation-in-part application may derive from an earlier sole application.

Unless the filing date of the earlier nonprovisional application is actually needed, for example, in the case of an interference or to overcome a reference, there is no need for the Office to make a determination as to whether the requirement of 35 U.S.C. 120, that the earlier nonprovisional application discloses the invention of the second application in the manner provided by the first paragraph of 35 U.S.C. 112, is met and whether a substantial portion of all of the earlier nonprovisional application is repeated in the second application in a continuation-in-part situation. Accordingly, an alleged continuation-in-part application should be permitted to claim the benefit of the filing date of an earlier nonprovisional application if the alleged continuation-in-part application complies with the following formal requirements of 35 U.S.C. 120:

(A) The first application and the alleged continuation-in-part application were filed with at least one common inventor;

(B) The alleged continuation-in-part application was “filed before the patenting or abandonment of or termination of proceedings on the first application or an application similarly entitled to the benefit of the filing date of the first application”; and

(C) The alleged continuation-in-part application “contains or is amended to contain a specific reference to the earlier filed application.” (The specific reference may be in an application data sheet. See 37 CFR 1.76.)

For notation to be put *>in<* the file *>history<* by the examiner in the case of a continuation-in-part application see MPEP § 202.02. See MPEP § 708 for order of examination.

Use form paragraph 2.06 to remind applicant of possible continuation-in-part status.

#### ¶ 2.06 Possible Status as Continuation-in-Part

This application repeats a substantial portion of prior Application No. [1], filed [2], and adds and claims additional disclosure not presented in the prior application. Since this application names an inventor or inventors named in the prior application, it may constitute a continuation-in-part of the prior application. Should applicant desire to obtain the benefit of the filing date of the prior application, attention is directed to 35 U.S.C. 120 and 37 CFR 1.78.

#### Examiner Note:

1. This form paragraph should only be used when it appears that the application may qualify as a continuation-in-part, but no priority claim has been perfected.

2. An application claiming the benefits of a provisional application under 35 U.S.C. 119(e) should not be called a “continuation-in-part” of the provisional application since an application that claims benefit of a provisional application is a nonprovisional application of a provisional application, not a continuation, division, or continuation-in-part of the provisional application.

### 201.09 Substitute Application [R-2]

The use of the term “Substitute” to designate any application which is in essence the duplicate of an application by the same applicant abandoned before the filing of the later application, finds official recognition in the decision *Ex parte Komenak*, 1940 C.D. 1, 512 O.G. 739 (Comm'r Pat. 1940). Current practice does not require applicant to insert in the specification reference to the earlier application; however, attention should be called to the earlier application. The notation *>in<* the file *>history<* (see MPEP § 202.02) that one application is a “Substitute” for another is printed in the heading of the patent copies. See MPEP § 202.02.

As is explained in MPEP § 201.11, a “Substitute” does not obtain the benefit of the filing date of the prior application.

Use form paragraph 2.07 to remind applicant of possible substitute status.

#### ¶ 2.07 Definition of a Substitute

Applicant refers to this application as a “substitute” of Application No. [1], filed [2]. The use of the term “substitute” to designate an application which is in essence the duplicate of an application by the same applicant abandoned before the filing of the later case finds official recognition in the decision, *Ex parte Komenak*, 1940 C.D. 1, 512 O.G. 739 (Comm'r Pat. 1940). The notation on the file wrapper (See MPEP § 202.02) that one case is a “substitute” for another is printed in the heading of the patent copies. A “substitute” does not obtain the benefit of the filing date of the prior application.

### 201.10 Refile [R-2]

No official definition has been given the term “Refile,” though it is sometimes used as an alternative for the term “Substitute.”

If the applicant designates his or her application as “Refile” and the examiner finds that the application is in fact a duplicate of a former application by the same party which was abandoned prior to the filing of the

second application, the examiner should require the substitution of the word “substitute” for “refile”, since the former term has official recognition.

Use form paragraph 2.08 to remind applicant of possible refile status.

\*\*>

#### ¶ 2.08 Definition of a Refile

It is noted that applicant refers to this application as a “refile.” No official definition has been given the term “refile,” though it is sometimes used as an alternative for the term “substitute.” Since this application appears to be in fact a duplicate of a former application which was abandoned prior to the filing of the second case, the substitution of the word “substitute” for “refile” is required since the term “substitute” has official recognition. Applicant is required to make appropriate corrections.

<

### 201.11 Continuity Between Applications: The Benefit of an Earlier Filing Date [R-2]

Under certain circumstances an application for patent is entitled to the benefit of the filing date of a prior nonprovisional application or provisional application which has at least one common inventor. The conditions are specified in 35 U.S.C. 120 for the benefit claim of a prior nonprovisional application and 35 U.S.C. 119(e) for the priority claim of a prior provisional application.

#### 35 U.S.C. 120. Benefit of earlier filing date in the United States.

An application for patent for an invention disclosed in the manner provided by the first paragraph of section 112 of this title in an application previously filed in the United States, or as provided by section 363 of this title, which is filed by an inventor or inventors named in the previously filed application shall have the same effect, as to such invention, as though filed on the date of the prior application, if filed before the patenting or abandonment of or termination of proceedings on the first application or on an application similarly entitled to the benefit of the filing date of the first application and if it contains or is amended to contain a specific reference to the earlier filed application. No application shall be entitled to the benefit of an earlier filed application under this section unless an amendment containing the specific reference to the earlier filed application is submitted at such time during the pendency of the application as required by the Director. The Director may consider the failure to submit such an amendment within that time period as a waiver of any benefit under this section. The Director may establish procedures, including the payment of a

surcharge, to accept an unintentionally delayed submission of an amendment under this section.

#### 35 U.S.C. 119. Benefit of earlier filing date; right of priority.

\*\*\*\*\*

(e)(1) An application for patent filed under section 111(a) or section 363 of this title for an invention disclosed in the manner provided by the first paragraph of section 112 of this title in a provisional application filed under section 111(b) of this title, by an inventor or inventors named in the provisional application, shall have the same effect, as to such invention, as though filed on the date of the provisional application filed under section 111(b) of this title, if the application for patent filed under section 111(a) or section 363 of this title is filed not later than 12 months after the date on which the provisional application was filed and if it contains or is amended to contain a specific reference to the provisional application. No application shall be entitled to the benefit of an earlier filed provisional application under this subsection unless an amendment containing the specific reference to the earlier filed provisional application is submitted at such time during the pendency of the application as required by the Director. The Director may consider the failure to submit such an amendment within that time period as a waiver of any benefit under this subsection. The Director may establish procedures, including the payment of a surcharge, to accept an unintentionally delayed submission of an amendment under this subsection during the pendency of the application

(2) A provisional application filed under section 111(b) of this title may not be relied upon in any proceeding in the Patent and Trademark Office unless the fee set forth in subparagraph (A) or (C) of section 41(a)(1) of this title has been paid.

(3) If the day that is 12 months after the filing date of a provisional application falls on a Saturday, Sunday, or Federal holiday within the District of Columbia, the period of pendency of the provisional application shall be extended to the next succeeding secular or business day.

There are six conditions for receiving the benefit of an earlier filing date under 35 U.S.C. 120, 121, or 365(c) or under 35 U.S.C. 119(e).

(A) The later-filed application must be an application for a patent for an invention which is also disclosed in the prior application (the parent or original nonprovisional application or provisional application); the disclosure of the invention in the prior application and in the later-filed application must be sufficient to comply with the requirements of the first paragraph of 35 U.S.C. 112. See *Transco Prods., Inc. v. Performance Contracting, Inc.*, 38 F.3d 551, 32 USPQ2d 1077 (Fed. Cir. 1994). See subsection I. “WRITTEN DESCRIPTION” below.

Form paragraphs 2.09 and 2.10 should be used where the disclosure of the later-filed application is not for an invention disclosed in the prior application.

*¶ 2.09 Heading for Conditions for Domestic Priority Under 35 U.S.C. 119(e) or 120*

Applicant has not complied with one or more conditions for receiving the benefit of an earlier filing date under 35 U.S.C. [1] as follows:

**Examiner Note:**

1. In bracket 1, insert either or both --119(e)-- or --120--.
2. One or more of the following form paragraphs 2.10 to 2.12 must follow depending upon the circumstances.

*¶ 2.10 Disclosure Must Be the Same*

The later-filed application must be an application for a patent for an invention which is also disclosed in the prior application (the parent or original nonprovisional application or provisional application); the disclosure of the invention in the parent application and in the later-filed application must be sufficient to comply with the requirements of the first paragraph of 35 U.S.C. 112. See *Transco Products, Inc. v. Performance Contracting, Inc.*, 38 F.3d 551, 32 USPQ2d 1077 (Fed. Cir. 1994).

**Examiner Note:**

1. This form paragraph must be preceded by heading form paragraph 2.09.
2. Form paragraph 2.29 should be used where the claim(s) of the nonprovisional application lack(s) support in the disclosure of the provisional application.

*¶ 2.29 Domestic Priority Not Granted*

Applicant's claim for domestic priority under 35 U.S.C. 119(e) is acknowledged. However, the provisional application upon which priority is claimed fails to provide adequate support under 35 U.S.C. 112 for claim [1] of this application. [2]

**Examiner Note:**

1. This form paragraph may be used when there is lack of support in the provisional application for the pending claims in the nonprovisional application.
2. In bracket 2, provide an explanation of lack of support.

(B) With respect to claiming benefit under 35 U.S.C. 120, 121, or 365(c), the later-filed application must be copending with the prior application or with an application similarly entitled to the benefit of the filing date of the prior application. See subsection II. "COPENDENCY" below. With respect to claiming benefit under 35 U.S.C. 119(e) to provisional applications, effective November 29, 1999, Public Law 106-113 amended 35 U.S.C. 119(e)(2) to eliminate the copendency requirement for a nonprovisional application claiming benefit of a provisional application. However, pursuant to 35 U.S.C. 119(e)(1), the non-

provisional application must be filed not later than 12 months after the date on which the provisional application was filed. If the day that is 12 months after the filing date of a provisional application falls on a Saturday, Sunday, or Federal holiday within the District of Columbia, \*\* the nonprovisional application may be filed on that next succeeding business day. See 35 U.S.C. >21(b)<, 37 CFR 1.7(b), and MPEP § 201.04(b) and § 505.

(C) The later-filed application must contain a specific reference to the prior application(s) in the specification or in an application data sheet. If benefit is claimed under 35 U.S.C. 120, 121, or 365(c), the specific reference required by 35 U.S.C. 120 and 37 CFR 1.78(a)(2) to a prior nonprovisional application must include the relationship (i.e., continuation, divisional, or continuation-in-part) between the applications except when the reference is to a prior application of a continued prosecution application (CPA) assigned the same application number. See subsection III. "REFERENCE TO PRIOR APPLICATION(S)" below.

A request for a CPA filed under 37 CFR 1.53(d) is itself the specific reference required by 35 U.S.C. 120 and 37 CFR 1.78(a)(2) to every application assigned the same application number identified in the request. (Note: The CPA is assigned the same application number as the prior application.) >See MPEP § 201.06(d).< In a CPA, a specific reference in the first sentence of the specification following the title, or in an application data sheet, to a prior application assigned the same application number is not required and should not be made. No amendment in a CPA may delete the specific reference to the prior application assigned the same application number. A specific reference to an application not assigned the same application number, but relied on for benefit under 35 U.S.C. 120 and 37 CFR 1.78(a)(2) is required. Cross references to other related applications not assigned the same application >number< as the CPA may be made when appropriate.

Form paragraphs 2.09 and 2.12 should be used to indicate reference to the prior application.

\*\*>

*¶ 2.12 Application Must Contain a Reference to an Earlier Application*

An application in which the benefits of an earlier application are desired must contain a specific reference to the prior application(s) in the first sentence of the specification or in an application

data sheet (37 CFR 1.78(a)(2) and (a)(5)). The specific reference to any prior nonprovisional application must include the relationship (i.e., continuation, divisional, or continuation-in-part) between the applications except when the reference is to a prior application of a CPA assigned the same application number.

**Examiner Note:**

1. This form paragraph must be preceded by heading form paragraph 2.09.
2. This form paragraph should not be used for a continued prosecution application (CPA). In a continued prosecution application (CPA) filed under 37 CFR 1.53(d), a specific reference in the first sentence of the specification or in an application data sheet to the prior application is not required and should not be made. The specific reference requirement of 35 U.S.C. 120 is met by the request for the CPA which is considered to be part of the CPA (37 CFR 1.53(d)(2)(iv) and (d)(7)).
3. This form paragraph should not be used where priority is claimed under 35 U.S.C. 119(e) to a prior provisional application.

<

(D) The later-filed application must be filed by an inventor or inventors named in the previously filed application.

(E) For utility or plant applications (including reissues) filed on or after November 29, 2000, benefit claims under 35 U.S.C. 119(e), 120, 121 and 365(c) must be made during the pendency of the application and within the time period set forth in 37 CFR 1.78(a)(2)(ii) and (a)(5)(ii). If the application is an application filed under 35 U.S.C. 111(a), the benefit claim must be made within the later of four months from the actual filing date of the application or sixteen months from the filing date of the prior application. If the application is a nonprovisional application which entered the national stage from an international application after compliance with 35 U.S.C. 371, the benefit claim must be made within the later of four months from the date on which the national stage commenced under 35 U.S.C. 371(b) or (f) or sixteen months from the filing date of the prior application. See 37 CFR 1.78(a)(2)(ii) and (a)(5)(ii). This time period is not extendable and a failure to submit the reference required by 35 U.S.C. 119(e) and/or 120, where applicable, within this time period is considered a waiver of any benefit of such prior application under 35

U.S.C. 119(e), 120, 121 and 365(c). For a more detailed explanation, see subsection V. “TIME PERIOD FOR MAKING A CLAIM FOR BENEFIT (37 CFR 1.78(a)(2) and (a)(5))” below.

(F) If benefit is being claimed to a provisional application which was filed in a language other than English, (1) an English language translation of the provisional application, and (2) a statement that the translation is accurate, are required to be filed either in the provisional application or in each nonprovisional application that claims the benefit of the provisional application. If the translation and statement were not previously filed in the provisional application or the nonprovisional application, the applicant will be notified in the nonprovisional application and given a period of time within which to file the translation and statement. In a pending nonprovisional application, failure to timely reply to such notice will result in the abandonment of the nonprovisional application.

Form paragraph 2.38 may be used to notify applicant that an English translation of the non-English language provisional application is required.

*¶ 2.38 Reference to a Non-English Language Provisional Application*

This application claims benefit to a provisional application No. [1], filed on [2], in a language other than English. Applications that claim benefit of a provisional application filed in a non-English language must include an English translation of the non-English language provisional application and a statement that the translation is accurate. See 37 CFR 1.78(a)(5). The [3] as required by 37 CFR 1.78(a)(5) is missing. Applicant must supply the missing [4] in the reply to this Office action prior to the expiration of the time period set in this Office action.

**Examiner Note:**

1. Use this form paragraph to notify applicant that an English translation of the non-English language provisional application and/or a statement that the translation is accurate is required.
2. In bracket 1, insert the application number of the non-English language provisional application.
3. In bracket 2, insert the filing date of the prior provisional application.
4. In brackets 3 and 4, insert --English translation and a statement that the translation is accurate-- or --statement that the translation is accurate--, where appropriate.

## I. WRITTEN DESCRIPTION

Under 35 U.S.C. 120, a claim in a U.S. application is entitled to the benefit of the filing date of an earlier filed U.S. application if the subject matter of the claim is disclosed in the manner provided by 35 U.S.C. 112, first paragraph, in the earlier filed application. See, e.g., *Tronzo v. Biomet, Inc.*, 156 F.3d 1154, 47 USPQ2d 1829 (Fed. Cir. 1998); *In re Scheiber*, 587 F.2d 59, 199 USPQ 782 (CCPA 1978). >A claim in a subsequently filed application that relies on a combination of prior applications may not be entitled to the benefit of an earlier filing date under 35 U.S.C. 120 since 35 U.S.C. 120 requires that the earlier filed application contain a disclosure which complies with 35 U.S.C. 112, first paragraph for each claim in the subsequently filed application. *Studiengesellschaft Kohle m.b.H. v. Shell Oil Co.*, 112 F.3d 1561, 1564, 42 USPQ2d 1674, 1677 (Fed. Cir. 1997).<

Under 35 U.S.C. 119(e), the written description and drawing(s) (if any) of the provisional application must adequately support and enable the subject matter claimed in the nonprovisional application that claims the benefit of the provisional application. In *New Railhead Mfg., L.L.C. v. Vermeer Mfg. Co.*, 298 F.3d 1290, 1294, 63 USPQ2d 1843, 1846 (Fed. Cir. 2002), the court held that for a nonprovisional application to be afforded the priority date of the provisional application, “the specification of the provisional must ‘contain a written description of the invention and the manner and process of making and using it, in such full, clear, concise, and exact terms,’ 35 U.S.C. § 112 ¶1, to enable an ordinarily skilled artisan to practice the invention claimed in the nonprovisional application.”

In *New Railhead*, the patented drill bit was the subject of a commercial offer for sale. A provisional application was filed after the sale offer, but well within the one year grace period of 35 U.S.C. 102(b). A nonprovisional application, which issued as Patent No. 5,899,283, was filed within one year of the filing of the provisional application but more than one year after the sale offer. If the ‘283 patent was not afforded the priority date of the provisional application, the patent would be invalid under 35 U.S.C. 102(b) since it was filed more than one year after the commercial offer for sale. The court looked at claim 1 of the ‘283 patent which recites a bit body being angled with respect to the sonde housing. The court then reviewed

the provisional application and concluded that nowhere in the provisional application is the bit body expressly described as “being angled with respect to the sonde housing” as recited in claim 1 of the ‘283 patent. The court held that the disclosure of the provisional application does not adequately support the invention claimed in the ‘283 patent as to the angle limitation and therefore, the ‘283 patent is not entitled to the filing date of the provisional application under 35 U.S.C. 119(e)(1) and the ‘283 patent is invalid under 35 U.S.C. 102(b).

A claim is not required in a provisional application. However, for a claim in a later filed nonprovisional application to be entitled to the benefit of the filing date of the provisional application, the written description and drawing(s) (if any) of the provisional application must adequately support and enable the subject matter of the claim in the later filed nonprovisional application. If a claim in the nonprovisional application is not adequately supported by the written description and drawing(s) (if any) of the provisional application (as in *New Railhead*), that claim in the nonprovisional application is not entitled to the benefit of the filing date of the provisional application. If the filing date of the earlier provisional application is necessary, for example, in the case of an interference or to overcome a reference, care must be taken to ensure that the disclosure filed as the provisional application adequately provides (1) a written description of the subject matter of the claim(s) at issue in the later filed nonprovisional application, and (2) an enabling disclosure to permit one of ordinary skill in the art to make and use the claimed invention in the later filed nonprovisional application without undue experimentation.

## II. COPENDENCY

Copendency is defined in the clause which requires that the later-filed application must be filed before (1) the patenting, or (2) the abandonment of, or (3) the termination of proceedings in the prior application. With respect to provisional applications, Public Law 106-113 amended 35 U.S.C. 119(e)(2) to eliminate the copendency requirement for a nonprovisional application claiming benefit of a provisional application. 35 U.S.C. 119(e)(2) as amended by Public Law 106-113 is effective as of November 29, 1999 and applies to any provisional applications filed on or



after June 8, 1995 but has no effect on any patent which is the subject of litigation in an action commenced before November 29, 1999.

Use form paragraphs 2.09 and 2.11 to indicate copendency is required.

*¶ 2.11 Application Must Be Copending With Parent*

This application is claiming the benefit of a prior filed nonprovisional application under 35 U.S.C. 120, 121, or 365(c). Copendency between the current application and the prior application is required.

**Examiner Note:**

1. This form paragraph must be preceded by heading form paragraph 2.09.
2. Do not use this form paragraph for priority claims under 35 U.S.C. 119(e) to provisional applications.

>Use form paragraphs 2.09 and 2.11.01 and to indicate that the later-filed application must be filed not later than 12 months after the filing date of the provisional application for which a benefit is sought.

*¶ 2.11.01 Application Must Be Filed Within 12 Months From the Provisional Application*

This application is claiming the benefit of a provisional application under 35 U.S.C. 119(e). However, this application was not filed within twelve months from the filing date of the provisional application, and there is no indication of an intermediate nonprovisional application that is directly claiming the benefit of the provisional application and filed within 12 months of the filing date of the provisional application.

Note: If the day that is 12 months after the filing date of the provisional application falls on a Saturday, Sunday, or Federal holiday within the District of Columbia, the nonprovisional application claiming the benefit of the provisional application may be filed on that next succeeding business day.

**Examiner Note:**

1. This form paragraph must be preceded by heading form paragraph 2.09.

<

If the prior application issues as a patent, it is sufficient for the later-filed application to be copending with it if the later-filed application is filed on the same date, or before the date that the patent issues on the prior application. Thus, the later-filed application may be filed under 37 CFR 1.53(b) while the prior >application< is still pending before the examiner, or is in issue, or even between the time the issue fee is paid and the patent issues. **\*\*>Patents usually<** will be published within four weeks of payment of the issue fee. Applicants are encouraged to file any continuing applications no later than the date the issue fee is paid,

to avoid issuance of the prior application before the continuing application is filed.

If the prior application is abandoned, the later-filed application must be filed before the abandonment in order for it to be copending with the prior application. The term “abandoned,” refers to abandonment for failure to prosecute (MPEP § 711.02), express abandonment (MPEP § 711.01), and abandonment for failure to pay the issue fee (37 CFR 1.316).

The expression “termination of proceedings” includes the situations when an application is abandoned or when a patent has been issued, and hence this expression is the broadest of the three.

After a decision by the Court of Appeals for the Federal Circuit in which the rejection of all claims is affirmed, **\*\*>the proceeding is terminated when the mandate is issued by the Court.<** There are several other situations in which proceedings are terminated as is explained in MPEP § 711.02(c).

When proceedings in an application are terminated, the application is treated in the same manner as an abandoned application, and the term “abandoned application” may be used broadly to include such applications.

The term “continuity” is used to express the relationship of copendency of the same subject matter in two different applications of the same inventor. The later-filed application may be referred to as a continuing application when the prior application is not a provisional application. Continuing applications include those applications which are called divisions, continuations, and continuations-in-part. The statute is so worded that the prior application may contain more than the later-filed application, or the later-filed application may contain more than the prior application, and in either case the later-filed application is entitled to the benefit of the filing date of the prior application as to the common subject matter.

A later-filed application which is not copending with the prior application (which includes those called “substitute” applications as set forth in MPEP § 201.09) is not entitled to the benefit of the filing date of the prior application. Therefore, prior art against the claims of the later-filed application is determined based on the filing date of the later-filed application. An applicant is not required to refer to such prior application(s) in an application data sheet or in the specification of the later-filed application, but is

required to otherwise call the examiner's attention to the prior application if it or its contents or prosecution is material to patentability of the later-filed application as defined in 37 CFR 1.56(b).

### III. REFERENCE TO PRIOR APPLICATION(S)

The third requirement of the statute is that the later-filed application must contain a specific reference to the prior application. This should appear as the first sentence of the specification following the title preferably as a separate paragraph (37 CFR 1.78(a)) and/or in an application data sheet (37 CFR 1.76). If the specific reference is only contained in the application data sheet, then the benefit claim information will be included on the front page of any patent or patent application publication, but will not be included in the first sentence of the specification. When a benefit claim is submitted after the filing of an application, the reference to the prior application cannot include an incorporation by reference statement of the prior application, unless an incorporation by reference statement of the prior application was presented upon filing of the application. See *Dart Indus. v. Banner*, 636 F.2d 684, 207 USPQ 273 (C.A.D.C. 1980).

#### A. Reference to Prior Nonprovisional Applications

Except for benefit claims to the prior application in a continued prosecution application (CPA), benefit claims under 35 U.S.C. 120, 121, and 365(c) must identify the prior application by application number, or by international application number and international filing date, and indicate the relationship between the applications. The relationship between the applications is whether the instant application is a continuation, divisional, or continuation-in-part of the prior nonprovisional application. An example of a proper benefit claim is "this application is a continuation of prior Application No. ---, filed ---." A benefit claim that merely states that "this application claims the benefit of Application No. ---, filed ---" does not comply with 35 U.S.C. 120 and 37 CFR 1.78(a)(2)(i), since the relationship between the applications is not stated. In addition, a benefit claim that merely states that "this application is a continuing application of Application No. ---, filed ---" does not comply with 35 U.S.C. 120 and 37 CFR 1.78(a)(2)(i) since the

proper relationship, which includes the type of continuing (i.e., continuation, divisional, or continuation-in-part) application, is not stated.

A request for a CPA filed under 37 CFR 1.53(d) is itself the specific reference required by 35 U.S.C. 120 and 37 CFR 1.78(a)(2) to every application assigned the same application number identified in the request. (Note: The CPA is assigned the same application number as the prior application.) In a CPA, a specific reference in the first sentence of the specification following the title, or in an application data sheet, to a prior application assigned the same application number is not required and may not be made. Any such reference should be deleted. No amendment in a CPA may delete the specific reference to the prior application assigned the same application number. A specific reference to an application not assigned the same application number, but relied on for benefit under 35 U.S.C. 120 and 37 CFR 1.78(a)(2) is required. Cross references to other related applications not assigned the same application as the CPA may be made when appropriate.

When a nonprovisional application (other than a CPA) is entitled under 35 U.S.C. 120 to an earlier U.S. effective filing date, a statement such as "This is a divisional (or continuation, or continuation-in-part), as appropriate) application of Application No. ---, filed ---" should appear as the first sentence of the description or in an application data sheet, except in the case of design applications where it should appear as set forth in MPEP § 1504.20. In the case of an application filed under 37 CFR 1.53(b) as a divisional, continuation or continuation-in-part of a CPA, there should be only one reference to the series of applications assigned the same application number, with the filing date cited being that of the original noncontinued application. Where a nonprovisional application is claiming the benefit under 35 U.S.C. 120 of a prior national stage application under 35 U.S.C. 371, a suitable reference would read "This application is a continuation of U.S. Application No. 08/---, \*\* which was the National Stage of International Application No. PCT/DE95/---, filed ---."

Any benefit claim that does not both identify a prior application by its application number and specify a relationship between the applications will not be considered to contain a specific reference to a prior application as required by 35 U.S.C. 120. Such benefit

claim may not be recognized by the Office and may not be included on the filing receipt even if the claim appears in the first sentence of the specification or an application data sheet. As a result, publication of the application may not be scheduled as a function of the prior application's filing date. If the Office does not recognize a benefit claim under 35 U.S.C. 120 because it does not contain the required reference and the time period set forth in 37 CFR 1.78(a)(2)(ii) for submitting the required reference has expired, applicant must submit a petition under 37 CFR 1.78(a)(3) and the surcharge set forth in 37 CFR 1.17(t) in order for the Office to accept the unintentionally delayed claim under 35 U.S.C. 120 since the application will not have been scheduled for publication on the basis of the prior application's filing date.

To specify the relationship between the applications, applicant must specify whether the application is a continuation, divisional, or continuation-in-part of the prior application. Note that the terms are exclusive. An application cannot be, for example, both a continuation and a divisional or a continuation and a continuation-in-part of the same application. Moreover, if the benefit of more than one nonprovisional application is claimed, then the relationship between each application (i.e., continuation, divisional, or continuation-in-part) must be specified in order to establish copendency throughout the entire chain of prior-filed applications. For example, a statement that "this application claims the benefit of Application Nos. C, B, and A" or "this application is a continuing application of Application Nos. C, B, and A" is improper. Applicant instead must state, for example, that "this application is a continuation of Application No. C, filed ---, which is a continuation of Application No. B, filed ---, which is a continuation of Application No. A, filed ---.

### ***B. Reference to Prior Provisional Applications***

When the nonprovisional application is entitled to an earlier U.S. effective filing date of one or more provisional applications under 35 U.S.C. 119(e), a statement such as "This application claims the benefit of U.S. Provisional Application No. 60/---, filed ---, and U.S. Provisional Application No. 60/ ---, filed ---." should appear as the first sentence of the description or in an application data sheet. In addition, for an application which is claiming the benefit under 35

U.S.C. 120 of a prior application, which in turn claims the benefit of a provisional application under 35 U.S.C. 119(e), a suitable reference would read, "This application is a continuation of U.S. Application No. 08/---, filed ---, now abandoned, which claims the benefit of U.S. Provisional Application No. 60/---, filed ---." Status of nonprovisional parent applications (whether it is patented or abandoned) should also be included. If a parent application has become a patent, the expression, "Patent No. \_\_" should follow the filing date of the parent application. If a parent application has become abandoned, the expression "abandoned" should follow the filing date of the parent application. In the case of design applications, it should appear as set forth in MPEP § 1504.20.

The relationship (i.e., continuation, divisional, or continuation-in-part) is not required and should not be specified when a prior provisional application is being claimed under 35 U.S.C. 119(e). No relationship should be specified because whenever a priority claim to a provisional application under 35 U.S.C. 119(e) is made, it is implicit that the relationship is "nonprovisional application of a provisional application." If a relationship between a prior provisional application and the nonprovisional application is submitted, it may be unclear whether the applicant wishes to claim the benefit of the filing date of the provisional application under 35 U.S.C. 119(e) or 120. Thus, applicants seeking to claim the priority to a provisional application under 35 U.S.C. 119(e) should not state that the application is a "continuation" of a provisional application or that the application claims 35 U.S.C. 120 benefit to a provisional application. Although 35 U.S.C. 120 does not preclude a benefit claim to a provisional application, it is not recommended that applicants claim the benefit to a provisional application under 35 U.S.C. 120 since such a claim could have the effect of reducing the patent term, as the term of a patent issuing from such an application may be measured from the filing date of the provisional application pursuant to 35 U.S.C. 154(a)(2).

### ***C. Benefit Claims to Multiple Prior Applications***

Sometimes a pending application is one of a series of applications wherein the pending application is not copending with the first filed application but is copending with an intermediate application entitled to

the benefit of the filing date of the first application. If applicant wishes that the pending application have the benefit of the filing date of the first filed application, applicant must, besides making reference to the intermediate application, also make reference to the first application. See *Sticker Indus. Supply Corp. v. Blaw-Knox Co.*, 405 F.2d 90, 160 USPQ 177 (7th Cir. 1968) and *Hovlid v. Asari*, 305 F. 2d 747, 134 USPQ 162 (9th Cir. 1962). The reference to the prior applications must identify all of the prior applications and indicate the relationship (i.e., continuation, divisional, or continuation-in-part) between each nonprovisional application in order to establish copendency throughout the entire chain of prior applications. Appropriate references must be made in each intermediate application in the chain of prior applications. If an applicant desires, for example, the following benefit claim: “this application is a continuation of Application No. C, filed ---, which is a continuation of Application No. B, filed ---, which claims the benefit of provisional Application No. A, filed ---,” then Application No. C must have a reference to Application No. B and provisional Application No. A, and Application No. B must have a reference to provisional Application No. A.

There is no limit to the number of prior applications through which a chain of copendency may be traced to obtain the benefit of the filing date of the earliest of a chain of prior copending applications. See *In re Henriksen*, 399 F.2d 253, 158 USPQ 224 (CCPA 1968).

A nonprovisional application that directly claims the benefit of a provisional application under 35 U.S.C. 119(e) must be filed within 12 months from the filing date of the provisional application. Although an application that itself directly claims the benefit of a provisional application is not required to specify the relationship to the provisional application, if the instant nonprovisional application is not filed within the 12 month period, but claims the benefit of an intermediate nonprovisional application under 35 U.S.C. 120 that was filed within 12 months from the filing date of the provisional application and claimed the benefit of the provisional application, the intermediate application must be clearly identified as claiming the benefit of the provisional application so that the Office can determine whether the intermediate nonprovisional application was filed within 12 months of the provisional application and thus,

whether the claim is proper. Applicant must state, for example, “this application is a continuation of Application No. C, filed ---, which is a continuation of Application No. B, filed ---, which claims the benefit of provisional Application No. A, filed ---.” A benefit claim that merely states “this application claims the benefit of nonprovisional Application Nos. C and B, and provisional Application No. A” would be improper. Where the benefit of more than one provisional application is being claimed, the intermediate nonprovisional application(s) claiming the benefit of each provisional application must be indicated. Applicant must state, for example, “this application is continuation of Application No. D, filed ---, which is a continuation-in-part of Application No. C, filed ---, Application No. D claims the benefit of provisional Application No. B, filed ---, and Application No. C claims the benefit of provisional Application No. A, filed ---.” If a benefit claim to a provisional application is submitted without an indication that an intermediate application directly claims the benefit of the provisional application and the instant nonprovisional application is not filed within the 12 month period or the relationship between each nonprovisional application is not indicated, the Office will not recognize such benefit claim and will not include the benefit claim on the filing receipt. Therefore, a petition under 37 CFR 1.78(a) and the surcharge set forth in 37 CFR 1.17(t) will be required if the intermediate application and the relationship of each nonprovisional application are not indicated within the period set forth in 37 CFR 1.78(a).

**D. Reference Must Be Included in the Specification or an Application Data Sheet (ADS)**

The reference required by 37 CFR 1.78(a)(2) or (a)(5) must be included in an ADS or the specification must contain or be amended to contain such reference in the first sentence following the title. If an applicant includes a benefit claim in the application but not in the manner specified by 37 CFR 1.78(a) (e.g., if the claim is included in an oath or declaration or the application transmittal letter) within the time period set forth in 37 CFR 1.78(a), the Office will not require a petition under 37 CFR 1.78(a) and the surcharge under 37 CFR 1.17(t) to correct the claim if the information concerning the claim was recognized by the Office as shown by its inclusion on the filing receipt.

If, however, a claim is not included in the first sentence of the specification or in an ADS and is not recognized by the Office as shown by its absence on the filing receipt, the Office will require a petition under 37 CFR 1.78(a) and the surcharge to correct the claim. The Office may not recognize any benefit claim where there is no indication of the relationship between the nonprovisional applications or no indication of the intermediate nonprovisional application that is directly claiming the benefit of the provisional application. Even if the Office has recognized a benefit claim by entering it into the Office's database and including it on applicant's filing receipt, the benefit claim is not a proper benefit claim under 35 U.S.C. 119(e) or 35 U.S.C. 120 and 37 CFR 1.78 unless the reference is included in an ADS or in the first sentence of the specification and all other requirements are met.

### ***E. Examiners Should Require the Reference if Missing***

In view of this requirement, the right to rely on a prior application may be waived or refused by an applicant by refraining from inserting a reference to the prior application in the specification of the later one. If the examiner is aware of the fact that an application is a continuing application of a prior one, he or she should merely call attention to this in an Office action by using the wording of form paragraphs 2.15 or 2.16.

\*\*>

#### ***¶ 2.15 Reference to Prior Application, 35 U.S.C. 119(e) or 120 Benefit***

If applicant desires priority under 35 U.S.C. [1] based upon a previously filed application, specific reference to the earlier filed application must be made in the instant application. For benefit claims under 35 U.S.C. 120, 121 or 365(c), the reference must include the relationship (i.e., continuation, divisional, or continuation-in-part) of the applications. This should appear as the first sentence of the specification following the title, preferably as a separate paragraph unless it appears in an application data sheet. The status of nonprovisional parent application(s) (whether patented or abandoned) should also be included. If a parent application has become a patent, the expression "now Patent No. \_\_\_\_\_" should follow the filing date of the parent application. If a parent application has become abandoned, the expression "now abandoned" should follow the filing date of the parent application.

If the application is a utility or plant application filed under 35 U.S.C. 111(a) on or after November 29, 2000, the specific reference must be submitted during the pendency of the application and within the later of four months from the actual filing date of

the application or sixteen months from the filing date of the prior application. If the application is a utility or plant application which entered the national stage from an international application filed on or after November 29, 2000, after compliance with 35 U.S.C. 371, the specific reference must be submitted during the pendency of the application and within the later of four months from the date on which the national stage commenced under 35 U.S.C. 371(b) or (f) or sixteen months from the filing date of the prior application. See 37 CFR 1.78(a)(2)(ii) and (a)(5)(ii). This time period is not extendable and a failure to submit the reference required by 35 U.S.C. 119(e) and/or 120, where applicable, within this time period is considered a waiver of any benefit of such prior application(s) under 35 U.S.C. 119(e), 120, 121 and 365(c). A priority claim filed after the required time period may be accepted if it is accompanied by a grantable petition to accept an unintentionally delayed claim for priority under 35 U.S.C. 119(e), 120, 121 and 365(c). The petition must be accompanied by (1) the reference required by 35 U.S.C. 120 or 119(e) and 37 CFR 1.78(a)(2) or (a)(5) to the prior application (unless previously submitted), (2) a surcharge under 37 CFR 1.17(t), and (3) a statement that the entire delay between the date the claim was due under 37 CFR 1.78(a)(2) or (a)(5) and the date the claim was filed was unintentional. The Director may require additional information where there is a question whether the delay was unintentional. The petition should be addressed to: Mail Stop Petition, Commissioner for Patents, P.O. Box 1450, Alexandria, Virginia 22313-1450.

#### **Examiner Note:**

1. In bracket 1, insert --119(e)-- or --120--.
2. In a continued prosecution application (CPA) filed under 37 CFR 1.53(d), a specific reference in the first sentence of the specification, or in an application data sheet, to the prior application is not required and may not be made. The specific reference requirement of 35 U.S.C. 120 is met by the transmittal request for the CPA which is considered to be part of the CPA. 37 CFR 1.53(d)(2)(iv) and (d)(7).

#### ***¶ 2.16 Reference to a Prior Application***

It is noted that this application appears to claim subject matter disclosed in prior Application No. [1], filed [2]. A reference to the prior application must be inserted as the first sentence of the specification of this application or in an application data sheet (37 CFR 1.76), if applicant intends to rely on the filing date of the prior application under 35 U.S.C. 119(e) or 120. See 37 CFR 1.78(a). For benefit claims under 35 U.S.C. 120, the reference must include the relationship (i.e., continuation, divisional, or continuation-in-part) of all nonprovisional applications. Also, the current status of all nonprovisional parent applications referenced should be included.

If the application is a utility or plant application filed under 35 U.S.C. 111(a) on or after November 29, 2000, the specific reference to the prior application must be submitted during the pendency of the application and within the later of four months from the actual filing date of the application or sixteen months from the filing date of the prior application. If the application is a utility or plant application which entered the national stage from an international application filed on or after November 29, 2000, after compliance with 35 U.S.C. 371, the specific reference must be

submitted during the pendency of the application and within the later of four months from the date on which the national stage commenced under 35 U.S.C. 371(b) or (f) or sixteen months from the filing date of the prior application. See 37 CFR 1.78(a)(2)(ii) and (a)(5)(ii). This time period is not extendable and a failure to submit the reference required by 35 U.S.C. 119(e) and/or 120, where applicable, within this time period is considered a waiver of any benefit of such prior application(s) under 35 U.S.C. 119(e), 120, 121 and 365(c). A priority claim filed after the required time period may be accepted if it is accompanied by a grantable petition to accept an unintentionally delayed claim for priority under 35 U.S.C. 119(e), 120, 121 and 365(c). The petition must be accompanied by (1) the reference required by 35 U.S.C. 120 or 119(e) and 37 CFR 1.78(a)(2) or (a)(5) to the prior application (unless previously submitted), (2) a surcharge under 37 CFR 1.17(t), and (3) a statement that the entire delay between the date the claim was due under 37 CFR 1.78(a)(2) or (a)(5) and the date the claim was filed was unintentional. The Director may require additional information where there is a question whether the delay was unintentional. The petition should be addressed to: Mail Stop Petition, Commissioner for Patents, P.O. Box 1450, Alexandria, Virginia 22313-1450.

#### Examiner Note:

In a continued prosecution application (CPA) filed under 37 CFR 1.53(d), a specific reference in the first sentence of the specification, or in an application data sheet, to the prior application is not required and may not be made. The specific reference requirement of 35 U.S.C. 120 is met by the transmittal request for the CPA which is considered to be part of the CPA. 37 CFR 1.53(d)(2)(iv) and (d)(7).

<

If the examiner is aware of a prior application he or she should note it in an Office action, as indicated above, but should not require the applicant to call attention to the prior application.

In an application filed under former 37 CFR 1.60 applicant, in the amendment canceling the nonelected claims, should include directions to enter "This is a divisional (continuation) of application No. ...., filed ....." as the first sentence. Where the applicant has inadvertently failed to do this the wording of form paragraph 2.17 should be used. Where the application filed under former 37 CFR 1.60 is otherwise ready for allowance, the examiner should insert the quoted sentence by examiner's amendment.

Applications are sometimes filed with a division, continuation, or continuation-in-part oath or declaration, in which the oath or declaration refers back to a prior application. If there is no reference in the specification of an application filed under former 37 CFR

1.60, in such cases, the examiner should merely call attention to this fact in his or her Office action, utilizing the wording of form paragraph 2.17.

#### ¶ 2.17 Reference in Continuation/Divisional Applications Under Former 37 CFR 1.60

This application filed under former 37 CFR 1.60 lacks the necessary reference to the prior application. A statement reading "This is a [1] of Application No. [2], filed [3]." should be entered following the title of the invention or as the first sentence of the specification. Also, the current status of all nonprovisional parent applications referenced should be included.

#### Examiner Note:

1. In bracket 1, insert either --division-- or --continuation--.
2. Use only in former 37 CFR 1.60 applications. For File Wrapper Continuing applications under former 37 CFR 1.62, use form paragraph 2.24.
3. Do not use if the prior application is a provisional application.
4. Do not use if the application is a continued prosecution application (CPA) filed under 37 CFR 1.53(d).

>Form paragraph may be used to remind applicant to insert parent application data in an application filed under former 37 CFR 1.62.

#### ¶ 2.28 Reference in Former 37 CFR 1.62 Continuing Applications

This application filed under former 37 CFR 1.62 lacks the necessary reference to the prior application. A statement reading "This is a [1] of Application No. [2], filed [3]." should be entered following the title of the invention or as the first sentence of the specification. Also, the current status of the nonprovisional parent application(s) should be included.

#### Examiner Note:

1. In bracket 1, insert --division--, --continuation--, or --continuation-in-part--.
2. Use only in "file wrapper continuing" applications under former 37 CFR 1.62.

<

Where the applicant has inadvertently failed to make a reference to the parent application in an application filed under former 37 CFR 1.60 or 1.62 which is otherwise ready for issue, the examiner should insert the required reference by a formal examiner's amendment.

For notations to be placed on the file wrapper in the case of continuing applications, see MPEP § 202.02 and § 1302.09.

### **F. Correcting or Adding a Benefit Claim After Filing**

The Office will not grant a request for a corrected filing receipt to include a benefit claim unless the proper reference to the prior application is included in the first sentence of the specification or an ADS within the time period required by 37 CFR 1.78(a). If the proper reference was previously submitted, a copy of the amendment, the first page of the specification, or the ADS containing the benefit claim should be included with the request for a corrected filing receipt. The Office plans to notify applicants on or with the filing receipt that a benefit claim may not have been recognized because the benefit claim was improper but applicants are advised that only the benefit claims that are listed on the filing receipt have been recognized by the Office. Therefore, applicants should carefully and promptly review their filing receipts in order to avoid the need for a petition (37 CFR 1.78(a)(3) or (a)((6)) and the surcharge.

If a benefit claim is added after the time period required by 37 CFR 1.78(a), a petition and the surcharge are required. See subsection V. "TIME PERIOD FOR MAKING A CLAIM FOR BENEFIT 37 CFR 1.78(a)(2) AND (a)(5)." Any petition under 37 CFR 1.78(a)(3) or (a)(\*)(>6<) must be accompanied by an amendment to the specification or an ADS unless the proper reference was previously submitted. >In addition to the petition under 37 CFR 1.78 and the amendment or ADS, to add a benefit claim it may be necessary for applicant to file one of the following, depending on the status of the application:

(A) a request for continued examination (RCE) under 37 CFR 1.114, if the application is under a final rejection or has been allowed (see MPEP §706.07(h)). An amendment or ADS filed after final rejection or allowance is not entered as a matter of right and must be filed in compliance with 37 CFR 1.116 or 1.312, respectively; or

(B) a reissue application or a request for a certificate of correction under 37 CFR 1.323, if appropriate (see MPEP §§ 1402 and 1481), if the application has issued as a patent.<

An incorporation by reference statement added after an application's filing date is not effective because no new matter can be added to an application after its filing date (see 35 U.S.C. 132(a)). If an incor-

poration by reference statement is included in an amendment to the specification to add a benefit claim after the filing date of the application, the amendment would not be proper. When a benefit claim is submitted after the filing of an application, the reference to the prior application cannot include an incorporation by reference statement of the prior application>unless an incorporation by reference statement of the prior application was presented upon filing of the application<. See *Dart Indus. v. Banner*, 636 F.2d 684, 207 USPQ 273 (C.A.D.C. 1980).

### **G. Deleting Benefit Claims**

Effective June 8, 1995, Public Law 103-465 amended 35 U.S.C. 154 to change the term of a patent to 20 years measured from the filing date of the earliest U.S. application for which benefit under 35 U.S.C. 120, 121, or 365(c) is claimed. The 20-year patent term applies to all utility and plant patents issued on applications filed on or after June 8, 1995. As a result of the 20-year patent term, it is expected, in certain circumstances, that applicants may cancel their claim to priority by amending the specification or submitting a new application data sheet (no supplemental declaration is necessary) to delete any references to prior applications.

The examiner should consider whether any new prior art may now be available if a benefit claim is deleted. If an applicant is submitting an amendment to the specification or an ADS to delete a benefit claim after final rejection or action, the amendment or ADS will be treated under 37 CFR 1.116 (see MPEP § 714.12 and § 714.13). If the amendment or ADS to delete a benefit claim is submitted after the application has been allowed, the amendment or ADS will be treated under 37 CFR 1.312 (see MPEP § 714.16). A deletion of a benefit claim will not delay the publication of the application unless the amendment or ADS is recognized by the Office within nine weeks prior to the projected publication date that was originally calculated based on the benefit claim.

A cancelation of a benefit claim to a prior application may be considered as a showing that the applicant is intentionally waiving the benefit claim to the prior application in the instant application. If the applicant later files a petition to accept an unintentionally delayed claim to add the benefit claim to the prior application in the same application from which

the benefit claim was canceled, the Office may refuse to accept such benefit claim because the delay was not unintentional.

In a continued prosecution application (CPA) filed under 37 CFR 1.53(d), no amendment may delete the specific reference to a prior application assigned the same application number. (Note: In the CPA, the request is the specific reference required by 35 U.S.C. 120 and 37 CFR 1.78(a)(2) to every application assigned the same application number identified in the request. Further, in a CPA, a specific reference in the first sentence of the specification following the title, or in an application data sheet, to a prior application assigned the same application number is not required and should not be made.) Upon entry of the amendment, the examiner must return the application to the Office of Initial Patent Examination (OIPE), accompanied by a completed OIPE Data Base Routing Slip, for correction of the file wrapper label and for updating the PALM data base. >For Image File Wrapper (IFW) processing, see the IFW Manual.< For 09/ or later series applications, it will not be necessary to forward the application to OIPE for correction of the parent application data in PALM. The correction or entry of the data in the PALM data base can be made by technical support staff of the TC. Upon entry of the data, a new PALM bib-data sheet should be printed and placed in the file \*. See also MPEP § 707.05 and § 1302.09.

#### IV. SAME INVENTOR OR INVENTORS

The statute also requires that the applications claiming benefit of the earlier filing date under 35 U.S.C. 119(e) or 120 be filed by an inventor or inventors named in the previously filed application or provisional application.

#### V. TIME PERIOD FOR MAKING A CLAIM FOR BENEFIT >UNDER< 37 CFR 1.78(a)(2) AND (a)(5)

**The time period requirement under 37 CFR 1.78(a)(2) and (a)(5) is only applicable to utility or plant applications filed on or after November 29, 2000.**

The American Inventors Protection Act of 1999 (AIPA), Public Law 106-113, amended 35 U.S.C. 119 and 120 to provide that the Office may set a time period for the filing of benefit claims and establish

procedures to accept an unintentionally delayed benefit claim. The Office has implemented these statutory changes, in part, by amending 37 CFR 1.78 to include: (A) a time period within which a benefit claim to a prior nonprovisional or provisional application must be stated or it is considered waived; and (B) provisions for the acceptance of the unintentionally delayed submission of a claim to the benefit of a prior nonprovisional or provisional application.

If the application is an application filed under 35 U.S.C. 111(a) on or after November 29, 2000, the benefit claim of the prior application must be made during the pendency of the application and within the later of four months from the actual filing date of the application or sixteen months from the filing date of the prior application. \*\*>If the application is a non-provisional application which entered the national stage from an international application after compliance with 35 U.S.C. 371, the benefit claim must be made within the later of: (1) four months from the date on which the national stage commenced under 37 U.S.C. 371(b) or (f); or (2) sixteen months from the filing date of the prior application.< See 37 CFR 1.78(a)(2)(ii) and (a)(5)(ii). This time period is not extendable and a failure to submit the reference required by 35 U.S.C. 119(e) and/or 120, where applicable, within this time period is considered a waiver of any benefit of such prior application(s) under 35 U.S.C. 119(e), 120, 121 and 365(c).

If the reference required by 35 U.S.C. 120 and 37 CFR 1.78(a)(2) is not submitted within the required time period, a petition for an unintentionally delayed claim may be filed. The petition must be accompanied by: (A) the reference required by 35 U.S.C. 120 and 37 CFR 1.78(a)(2) to the prior application (unless previously submitted); (B) a surcharge under 37 CFR 1.17(t); and (C) a statement that the entire delay between the date the claim was due under 37 CFR 1.78(a)(2) and the date the claim was filed was unintentional. The \*>Director< may require additional information where there is a question whether the delay was unintentional. See 37 CFR 1.78(a)(3).

Likewise, if the reference required by 35 U.S.C. 119(e) and 37 CFR 1.78(a)(5) is not submitted within the required time period, a petition for an unintentionally delayed claim may be filed. The petition for an unintentionally delayed benefit claim must be submitted during the pendency of the nonprovisional appli-



cation. The petition must be accompanied by: (A) the reference required by 35 U.S.C. 119(e) and 37 CFR 1.78(a)(5) to the prior provisional application (unless previously submitted); (B) a surcharge under 37 CFR 1.17(t); and (C) a statement that the entire delay between the date the claim was due under 37 CFR 1.78(a)(5) and the date the claim was filed was unintentional. The \*>Director< may require additional information where there is a question whether the delay was unintentional. See 37 CFR 1.78(a)(6).

Petitions for an unintentionally delayed benefit claim should be forwarded to the Office of Petitions. See MPEP § 1002.02(b).

If a benefit claim is filed after the required time period and without a petition as required by 37 CFR 1.78(a)(3) or (a)(6), the applicant should be informed that the benefit claim was not entered and that a petition needs to be filed using form paragraph 2.39.

\*\*>

¶ 2.39 35 U.S.C. 119(e), 120, 121 or 365(c) Benefit Claim is Untimely

The benefit claim filed on [1] was not entered because the required reference was not timely filed within the time period set forth in 37 CFR 1.78(a)(2) or (a)(5). If the application is an application filed under 35 U.S.C. 111(a) on or after November 29, 2000, the reference to the prior application must be submitted during the pendency of the application and within the later of four months from the actual filing date of the application or sixteen months from the filing date of the prior application. If the application is a nonprovisional application which entered the national stage from an international application filed on or after November 29, 2000, after compliance with 35 U.S.C. 371, the reference to the prior application must be made during the pendency of the application and within the later of four months from the date on which the national stage commenced under 35 U.S.C. 371(b) or (f) or sixteen months from the filing date of the prior application. See 37 CFR 1.78(a)(2)(ii) and (a)(5)(ii). If applicant desires priority under 35 U.S.C. [2] based upon a previously filed application, applicant must file a petition for an unintentionally delayed benefit claim under 37 CFR 1.78(a)(3) or (a)(6). The petition must be accompanied by: (1) the reference required by 35 U.S.C. 120 or 119(e) and 37 CFR 1.78(a)(2) or (a)(5) to the prior application (unless previously submitted); (2) a surcharge under 37 CFR 1.17(t); and (3) a statement that the entire delay between the date the claim was due under 37 CFR 1.78(a)(2) or (a)(5) and the date the claim was filed was unintentional. The Director may require additional information where there is a question whether the delay was unintentional. The petition should be addressed to: Mail Stop Petition, Commissioner for Patents, P.O. Box 1450, Alexandria, Virginia 22313-1450.

**Examiner Note:**

1. Use this form paragraph only for utility or plant applications filed on or after November 29, 2000.
2. In bracket 1, insert the filing date of the amendment or paper containing the benefit claim.
3. In bracket 2, insert --119(e)--, --120--, --121--, or --365(c)--.

<

If an applicant includes a claim to the benefit of a prior application elsewhere in the application but not in the manner specified in 37 CFR 1.78(a)(2)(i) and (a)(2)(iii) or 37 CFR 1.78(a)(5)(i) and (a)(5)(iii) (e.g., if the benefit claim is included in an unexecuted oath or declaration or the application transmittal letter) within the time period set forth in 37 CFR 1.78(a)(2)(ii) or (a)(5)(ii), the Office will not require a petition and the surcharge under 37 CFR 1.17(t) to correct the benefit claim if the information concerning the benefit claim contained elsewhere in the application was recognized by the Office as shown by its inclusion on a filing receipt. This is because the application will have been scheduled for publication on the basis of such information concerning the benefit claim. Applicant must still submit the benefit claim in the manner specified in 37 CFR 1.78(a)(2)(i) and (a)(2)(iii) or 37 CFR 1.78(a)(5)(i) and (a)(5)(iii) (i.e., by an amendment in the first sentence of the specification or in an ADS) to have a proper claim under 35 U.S.C. 120 or 119(e) and 37 CFR 1.78 to the benefit of a prior application. If, however, an applicant includes a benefit claim elsewhere in the application and not in the manner specified in 37 CFR 1.78(a), and the claim is not recognized by the Office as shown by its absence on a filing receipt (e.g., if the benefit claim is in a part of the application where benefit claims are not conventionally located, such as the body of the specification), the Office will require a petition and the surcharge under 37 CFR 1.17(t) to correct the benefit claim. This is because the application will not have been scheduled for publication on the basis of the information concerning the benefit claim contained elsewhere in the application.

**VI. WHEN NOT ENTITLED TO BENEFIT  
>OF< EARLIER \* FILING DATE**

Where the prior application (a nonprovisional application) is found to be fatally defective because of insufficient disclosure to support allowable claims, a later-filed application filed as a “continuation-in-part”

of the first application to supply the deficiency is not entitled to the benefit of the filing date of the first application. *Hunt Co. v. Mallinckrodt Chemical Works*, 177 F.2d 583, 587, 83 USPQ 277, 281 (2d Cir. 1949) and cases cited therein.

Any claim in a continuation-in-part application which is directed *solely* to subject matter adequately disclosed under 35 U.S.C. 112 in the parent nonprovisional application is entitled to the benefit of the filing date of the parent nonprovisional application. However, if a claim in a continuation-in-part application recites a feature which was not disclosed or adequately supported by a proper disclosure under 35 U.S.C. 112 in the parent nonprovisional application, but which was first introduced or adequately supported in the continuation-in-part application such a claim is entitled only to the filing date of the continuation-in-part application; *In re Chu*, 66 F.3d 292, 36 USPQ2d 1089 (Fed. Cir. 1995); *Transco Products, Inc. v. Performance Contracting Inc.*, 38 F.3d 551, 32 USPQ2d 1077 (Fed. Cir. 1994); *In re Von Lagenhoven*, 458 F.2d 132, 136, 173 USPQ 426, 429 (CCPA 1972); and *Chromalloy American Corp. v. Alloy Surfaces Co., Inc.*, 339 F. Supp. 859, 874, 173 USPQ 295, 306 (D. Del. 1972).

By way of further illustration, if the claims of a continuation-in-part application which are only entitled to the continuation-in-part filing date, “read on” such published, publicly used or sold, or patented subject matter (e.g., as in a genus- species relationship) a rejection under 35 U.S.C. 102 would be proper. Cases of interest in this regard are as follows: *Mendenhall v. Cedarapids Inc.*, 5 F.3d 1557, 28 USPQ2d 1081 (Fed. Cir. 1993); *In re Lukach*, 442 F.2d 967, 169 USPQ 795 (CCPA 1971); *In re Hafner*, 410 F.2d 1403, 161 USPQ 783 (CCPA 1969); *In re Ruscetta*, 255 F.2d 687, 118 USPQ 101 (CCPA 1958); *In re Steenbock*, 83 F.2d 912, 30 USPQ 45 (CCPA 1936); *Ex parte Hageman*, 179 USPQ 747 (Bd. App. 1971).

### **201.11(a) Filing of Continuation or Continuation-in-Part Application During Pendency of International Application Designating the United States [R-2]**

It is possible to file a U.S. national application under 35 U.S.C. 111(a) and 37 CFR 1.53(b) during

the pendency (prior to the abandonment) of an international application which designates the United States without completing the requirements for entering the national stage under 35 U.S.C. 371(c). See MPEP §1895. The ability to take such action is based on provisions of the United States patent law. 35 U.S.C. 363 provides that “An international application designating the United States shall have the effect from its international filing date under article 11 of the treaty, of a national application for patent regularly filed in the Patent and Trademark Office...”. 35 U.S.C. 371(d) indicates that failure to timely comply with the requirements of 35 U.S.C. 371(c) “shall be regarded as abandonment by the parties thereof...”. It is therefore clear that an international application which designates the United States has the effect of a pending U.S. application from the international application filing date until its abandonment as to the United States. The first sentence of 35 U.S.C. 365(c) specifically provides that “In accordance with the conditions and requirements of section 120 of this title,... a national application shall be entitled to the benefit of the filing date of a prior international application designating the United States.” The condition of 35 U.S.C. 120 relating to the time of filing requires the later application to be “filed before the patenting or abandonment of or termination of proceedings on the first application...”.

### **\*\*>DELAYED SUBMISSION OF BENEFIT CLAIM IN INTERNATIONAL APPLICATION**

A petition under 37 CFR 1.78(a)(3) for accepting an unintentionally delayed benefit claim and the surcharge under 37 CFR 1.17(t) are required to add a benefit claim under 35 U.S.C. 120 in an abandoned international application filed on or after November 29, 2000, even when the international application did not enter the national stage under 35 U.S.C. 371. For example, when filing a “bypass” continuation application under 35 U.S.C. 111(a) that claims the benefit of an international application with a filing date on or after November 29, 2000 that could have but did not claim the benefit of an earlier U.S. application, and the benefit claim is to be added to the international application, a petition under 37 CFR 1.78(a)(3) must be filed in the international application.<

## 201.12 Assignment Carries Title

Assignment of an original application carries title to any divisional, continuation, or reissue application stemming from the original application and filed after the date of assignment. See MPEP § 306. When the assignment is in a provisional application, see MPEP § 306.01.

## 201.13 Right of Priority of Foreign Application [R-2]

Under certain conditions and on fulfilling certain requirements, an application for patent filed in the United States may be entitled to the benefit of the filing date of a prior application filed in a foreign country, to overcome an intervening reference or for similar purposes. The conditions are specified in 35 U.S.C. 119(a)-(d) and (f).

*35 U.S.C. 119. Benefit of earlier filing date; right of priority.*

(a) An application for patent for an invention filed in this country by any person who has, or whose legal representatives or assigns have, previously regularly filed an application for a patent for the same invention in a foreign country which affords similar privileges in the case of applications filed in the United States or to citizens of the United States, or in a WTO member country, shall have the same effect as the same application would have if filed in this country on the date on which the application for patent for the same invention was first filed in such foreign country, if the application in this country is filed within twelve months from the earliest date on which such foreign application was filed; but no patent shall be granted on any application for patent for an invention which had been patented or described in a printed publication in any country more than one year before the date of the actual filing of the application in this country, or which had been in public use or on sale in this country more than one year prior to such filing.

(b)(1) No application for patent shall be entitled to this right of priority unless a claim is filed in the Patent and Trademark Office, identifying the foreign application by specifying the application number on that foreign application, the intellectual property authority or country in or for which the application was filed, and the date of filing the application, at such time during the pendency of the application as required by the Director.

(2) The Director may consider the failure of the applicant to file a timely claim for priority as a waiver of any such claim. The Director may establish procedures, including the payment of a surcharge, to accept an unintentionally delayed claim under this section.

(3) The Director may require a certified copy of the original foreign application, specification, and drawings upon which it is based, a translation if not in the English language, and such other information as the Director considers necessary. Any such

certification shall be made by the foreign intellectual property authority in which the foreign application was filed and show the date of the application and of the filing of the specification and other papers.

(c) In like manner and subject to the same conditions and requirements, the right provided in this section may be based upon a subsequent regularly filed application in the same foreign country instead of the first filed foreign application, provided that any foreign application filed prior to such subsequent application has been withdrawn, abandoned, or otherwise disposed of, without having been laid open to public inspection and without leaving any rights outstanding, and has not served, nor thereafter shall serve, as a basis for claiming a right of priority.

(d) Applications for inventors' certificates filed in a foreign country in which applicants have a right to apply, at their discretion, either for a patent or for an inventor's certificate shall be treated in this country in the same manner and have the same effect for purpose of the right of priority under this section as applications for patents, subject to the same conditions and requirements of this section as apply to applications for patents, provided such applicants are entitled to the benefits of the Stockholm Revision of the Paris Convention at the time of such filing.

\*\*\*\*\*

(f) Applications for plant breeder's rights filed in a WTO member country (or in a foreign UPOV Contracting Party) shall have the same effect for the purpose of the right of priority under subsections (a) through (c) of this section as applications for patents, subject to the same conditions and requirements of this section as apply to applications for patents.

\*\*\*\*\*

### *37 CFR 1.55. Claim for foreign priority.*

(a) An applicant in a nonprovisional application may claim the benefit of the filing date of one or more prior foreign applications under the conditions specified in 35 U.S.C. 119(a) through (d) and (f), 172, and 365(a) and (b).

(1)(i) In an original application filed under 35 U.S.C. 111(a), the claim for priority must be presented during the pendency of the application, and within the later of four months from the actual filing date of the application or sixteen months from the filing date of the prior foreign application. This time period is not extendable. The claim must identify the foreign application for which priority is claimed, as well as any foreign application for the same subject matter and having a filing date before that of the application for which priority is claimed, by specifying the application number, country (or intellectual property authority), day, month, and year of its filing. The time periods in this paragraph do not apply in an application under 35 U.S.C. 111(a) if the application is:

(A) A design application; or

(B) An application filed before November 29, 2000.

(ii) In an application that entered the national stage from an international application after compliance with 35 U.S.C. 371, the claim for priority must be made during the pendency of the application and within the time limit set forth in the PCT and the Regulations under the PCT.

(2) The claim for priority and the certified copy of the foreign application specified in 35 U.S.C. 119(b) or PCT Rule 17 must, in any event, be filed before the patent is granted. If the claim for priority or the certified copy of the foreign application is filed after the date the issue fee is paid, it must be accompanied by the processing fee set forth in § 1.17(i), but the patent will not include the priority claim unless corrected by a certificate of correction under 35 U.S.C. 255 and § 1.323

(3) When the application becomes involved in an interference (§ 1.630), when necessary to overcome the date of a reference relied upon by the examiner, or when deemed necessary by the examiner, the Office may require that the claim for priority and the certified copy of the foreign application be filed earlier than provided in paragraphs (a)(1) or (a)(2) of this section.

(4) An English language translation of a non-English language foreign application is not required except when the application is involved in an interference (§ 1.630), when necessary to overcome the date of a reference relied upon by the examiner, or when specifically required by the examiner. If an English language translation is required, it must be filed together with a statement that the translation of the certified copy is accurate.

\*\*\*\*\*

The period of 12 months specified in this section is 6 months in the case of designs, 35 U.S.C. 172. See MPEP § 1504.10.

The conditions, for benefit of the filing date of a prior application filed in a foreign country, may be listed as follows:

(A) The foreign application must be one filed in “a foreign country which affords similar privileges in the case of applications filed in the United States or to citizens of the United States or in a WTO member country.”

(B) The foreign application must have been filed by the same applicant (inventor) as the applicant in the United States, or by his or her legal representatives or assigns.

(C) The application, or its earliest parent United States application under 35 U.S.C. 120, must have been filed within 12 months from the date of the earliest foreign filing in a “recognized” country as explained below.

(D) The foreign application must be for the same invention as the application in the United States.

(E) For an original application filed under 35 U.S.C. 111(a) (other than a design application) on or after November 29, 2000, the claim for priority must be presented during the pendency of the application, and within the later of four months from the actual filing date of the application or sixteen months

from the filing date of the prior foreign application. This time period is not extendable.

(F) For applications that entered the national stage from an international application filed on or after November 29, 2000, after compliance with 35 U.S.C. 371, the claim for priority must be made during the pendency of the application and within the time limit set forth in the PCT Article and Regulations.

(G) In the case where the basis of the claim is an application for an inventor's certificate, the requirements of 37 CFR 1.55(b) must also be met.

Applicant may be informed of possible priority rights under 35 U.S.C. 119(a)-(d) and (f) by using the wording of form paragraph 2.18.

¶ 2.18 *Right of Priority Under 35 U.S.C. 119(a)-(d) and (f)*

Applicant is advised of possible benefits under 35 U.S.C. 119(a)-(d) and (f), wherein an application for patent filed in the United States may be entitled to the benefit of the filing date of a prior application filed in a foreign country.

>

## I. < RECOGNIZED COUNTRIES OF FOREIGN FILING

The right to rely on a foreign application is known as the right of priority in international patent law and this phrase has been adopted in the U.S. statute. The right of priority originated in a multilateral treaty of 1883, to which the United States adhered in 1887, known as the Paris Convention for the Protection of Industrial Property (Paris Convention). The treaty is administered by the World Intellectual Property Organization (WIPO) at Geneva, Switzerland. This treaty has been revised several times, the latest revision in effect being written in Stockholm in July 1967 (copy at Appendix P of this Manual). Articles 13-30 of the Stockholm Revision became effective on September 5, 1970. Articles 1-12 of the Stockholm Revision became effective on August 25, 1973. One of the many provisions of the treaty requires each of the adhering countries to accord the right of priority to the nationals of the other countries and the first United States statute relating to this subject was enacted to carry out this obligation. There is another treaty between the United States and some Latin American countries which also provides for the right of priority.

A foreign country may also provide for this right by reciprocal legislation.

The United States and Taiwan signed an agreement on priority for patent and trademark applications on April 10, 1996, and Taiwan is now a country for which the right of priority is recognized in the United States. Applicants seeking patent protection in the United States may avail themselves of the right of priority based on patent applications filed in Taiwan, on or after April 10, 1996.

An application for patent filed in the United States on or after January 1, 1996, by any person who has, or whose legal representatives or assigns have, previously filed an application for patent in Thailand shall have the benefit of the filing date in Thailand in accordance with 35 U.S.C. 119 and 172.

**NOTE:** Following is a list of countries with respect to which the right of priority referred to in 35 U.S.C. 119(a)-(d) has been recognized. The letter “I” following the name of the country indicates that the basis for priority in the case of these countries is the Paris Convention for the Protection of Industrial Property (613 O.G. 23, 53 Stat. 1748). The letter “P” after the name of the country indicates the basis for priority of these countries is the Inter-American Convention relating to Inventions, Patents, Designs, and Industrial Models, signed at Buenos Aires, August 20, 1910 (207 O.G. 935, 38 Stat. 1811). The letter “L” following the name of the country indicates the basis for priority is reciprocal legislation in the particular country. The letter “W” following the name of the country indicates the basis for priority is membership in the World Trade Organization (WTO). See 35 U.S.C. 119(a). The letter “W<sup>o</sup>” indicates that the country became a WTO member after January 1, 1996. See [http://www.wto.org/english/thewto\\_e/whatis\\_e/tif\\_e/org6\\_e.htm](http://www.wto.org/english/thewto_e/whatis_e/tif_e/org6_e.htm) for a current list of WTO member countries along with their dates of membership. Applications for plant breeder’s rights filed in WTO member countries and foreign UPOV contracting parties may be relied upon for priority pursuant to 35 U.S.C. 119(f) and MPEP Chapter 1600.

Albania (I, W<sup>o</sup>),

Algeria (I),

Angola (W<sup>o</sup>),

Antigua and Barbuda (I, W),

Argentina (I, W),

Armenia (I),

Australia (I, W),

Austria (I, W),

Azerbaijan (I),

Bahamas (I),

Bahrain (I, W),

Bangladesh (I, W),

Barbados (I, W),

Belarus (I),

Belgium (I, W),

Belize (I, W),

Benin (I, W<sup>o</sup>),

Bhutan (I),

Bolivia (I, P, W),

Bosnia and Herzegovina (I),

Botswana (I, W),

Brazil (I, P, W),

Brunei Darussalam (W),

Bulgaria (I, W<sup>o</sup>),

Burkina Faso (I, W),

Burundi (I, W),

Cambodia (I),

Cameroon (I, W),

Canada (I, W),

Central African Republic (I, W),

Chad (I, W<sup>o</sup>),

Chile (I, W),

China (I, W<sup>o</sup>),

Colombia (I, W),

Congo (I, W<sup>o</sup>),

Costa Rica (I, P, W),

Cote d’Ivoire (I, W),

Croatia (I, W<sup>o</sup>),

Cuba (I, P, W),

Cyprus (I, W),  
Czech Republic (I, W),  
Democratic People's Republic of Korea (I),  
Democratic Republic of the Congo (I, W°),  
Denmark (I, W),  
Djibouti (I, W),  
Dominica (I, W),  
Dominican Republic (I, P, W),  
Ecuador (I, P, W°),  
Egypt (I, W),  
El Salvador (I, W),  
Equatorial Guinea (I),  
Estonia (I, W°),  
European Community (W),  
Fiji (W°),  
Finland (I, W),  
France (I, W),  
Gabon (I, W),  
Gambia (I, W°),  
Georgia (I, W°),  
Germany (I, W),  
Ghana (I, W),  
Greece (I, W),  
Grenada (I, W°),  
Guatemala (I, P, W),  
Guinea (I, W),  
Guinea-Bissau (I, W),  
Guyana (I, W),  
Haiti (I, P, W°),  
Holy See (I),  
Honduras (I, P, W),  
Hong Kong Special Administrative Region of China (I, W),  
Hungary (I, W),  
Iceland (I, W),  
India (I, W),  
Indonesia (I, W),  
Iran (Islamic Republic of) (I),  
Iraq (I),  
Ireland (I, W),  
Israel (I, W),  
Italy (I, W),  
Jamaica (I, W),  
Japan (I, W),  
Jordan (I, W°),  
Kazakstan (I),  
Kenya (I, W),  
Kuwait (W),  
Kyrgyzstan (I, W°),  
Lao People's Democratic Republic (I),  
Latvia (I, W°),  
Lebanon (I),  
Lesotho (I, W),  
Liberia (I),  
Libya (I),  
Libyan Arab Jamahiriya (I),  
Liechtenstein (I, W),  
Lithuania (I, W°),  
Luxembourg (I, W),  
Macau Special Administrative Region of China (I, W),  
Madagascar (I, W),  
Malawi (I, W),  
Malaysia (I, W),  
Maldives (W),  
Mali (I, W),  
Malta (I, W),  
Mauritania (I, W),  
Mauritius (I, W),  
Mexico (I, W),

Monaco (I),  
 Mongolia (I, W<sup>o</sup>),  
 Morocco (I, W),  
 Mozambique (I, W),  
 Myanmar (W),  
 Namibia (>I,< W),  
 Nepal (I),  
 Netherlands (I, W),  
 New Zealand (I, W),  
 Nicaragua (I, P, W),  
 Niger (I, W<sup>o</sup>),  
 Nigeria (I, W),  
 Norway (I, W),  
 Oman (I, PW<sup>o</sup>),  
 Pakistan (W),  
 Panama (I, W<sup>o</sup>),  
 Papua New Guinea (I, W<sup>o</sup>),  
 Paraguay (I, P, W),  
 Peru (I, W),  
 Philippines (I, W),  
 Poland (I, W),  
 Portugal (I, W),  
 Qatar (I, W<sup>o</sup>),  
 Republic of Korea (I, W),  
 Republic of Moldova (I, W<sup>o</sup>),  
 Romania (I, W),  
 Russian Federation (I),  
 Rwanda (I, W<sup>o</sup>),  
 Saint Kitts and Nevis (I, W<sup>o</sup>),  
 Saint Lucia (I, W),  
 Saint Vincent and the Grenadines (I, W),  
 San Marino (I),  
 Sao Tome and Principe (I),  
 >Saudi Arabia (I)<  
 Senegal (I, W),  
 >Serbia and Montenegro (I)<  
 Seychelles (I)  
 Sierra Leone (I, W),  
 Singapore (I, W),  
 Slovakia (I, W),  
 Slovenia (I, W),  
 Solomon Islands (W<sup>o</sup>),  
 South Africa (I, W),  
 Spain (I, W),  
 Sri Lanka (I, W),  
 Sudan (I),  
 Suriname (I, W),  
 Swaziland (I, W),  
 Sweden (I, W),  
 Switzerland (I, W),  
 Syrian Arab Republic (I),  
 Taiwan (L, W<sup>o</sup>),  
 Tajikistan (I),  
 Tanzania, United Republic of (I, W),  
 Thailand (L, W),  
 The former Yugoslav Republic of Macedonia (I,> W<sup>o</sup><),  
 Togo (I, W),  
 Tonga (I),  
 Trinidad and Tobago (I, W),  
 Tunisia (I, W),  
 Turkey (I, W),  
 Turkmenistan (I),  
 Uganda (I, W),  
 Ukraine (I),  
 United Arab Emirates (I, W<sup>o</sup>),  
 United Kingdom (I, W),  
 Uruguay (I, P, W),  
 Uzbekistan (I),  
 Venezuela (I, W),

Viet Nam (I),  
\*\*

Zambia (I, W),

Zimbabwe (I, W).

Sixteen African Countries have joined together to create a common patent office and to promulgate a common law for the protection of inventions, trademarks, and designs. The common patent office is called "Organisation Africain de la Propriete Intellectuelle" (OAPI) and is located in Yaounde, Cameroon. The English title is "African Intellectual Property Organization." The member countries using the OAPI Patent Office are Benin, Cameroon, Central African Republic, Chad, Congo, Gabon, Cote d'Ivoire, Mauritania, Niger, Senegal, Republic of Togo, Burkina Faso Guinea, Guinea-Bissau, Mali and Equatorial Guinea. Since all these countries adhere to the Paris Convention for the Protection of Industrial Property, priority under 35 U.S.C. 119(a)-(d) may be claimed of an application filed in the OAPI Patent Office.

If any applicant asserts the benefit of the filing date of an application filed in a country not on this list, the examiner should \*\*>contact< the Office of \*\*>International Relations< to determine if there has been any change in the status of that country. It should be noted that the right is based on the *country* of the foreign filing and not upon the citizenship of the applicant.

>

## II. < RIGHT OF PRIORITY (35 U.S.C. 119(a)-(d) AND 365) BASED ON A FOREIGN APPLICATION FILED UNDER A BILATERAL OR MULTILATERAL TREATY

Under Article 4A of the Paris Convention for the Protection of Industrial Property a right of priority may be based either on an application filed under the national law of a foreign country adhering to the Convention or on a foreign application filed under a bilateral or multilateral treaty concluded between two or more such countries. Examples of such treaties are The Hague Agreement Concerning the International Deposit of Industrial Designs, the Benelux Designs Convention, and the Libreville Agreement of September 13, 1962, relating to the creation of an African Intellectual Property Office. The Convention on the Grant of European Patents \*>< the Patent Cooperation Treaty (MPEP § 201.13(b))>, the Office for Har-

monization in the Internal Market (OHIM), and the Community Plant Variety Office (CPVO)< are further examples of such treaties.

### A. *The Priority Claim*

A priority claim need not be in any special form and may be a statement signed by a registered attorney or agent. A priority claim can be made on filing: (A) by including a copy of an unexecuted or executed oath or declaration specifying a foreign priority claim (see 37 CFR 1.63(c)(2)); or (B) by submitting an application data sheet specifying a foreign priority claim (see 37 CFR 1.76).

In claiming priority of a foreign application previously filed under such a treaty, certain information must be supplied to the U.S. Patent and Trademark Office. In addition to the application number and the date of the filing of the application, the following information is required: (A) the name of the treaty under which the application was filed; and (B) the name and location of the national or intergovernmental authority which received such application.

### B. *Certification of the Priority Papers*

35 U.S.C. 119(b)(3) authorizes the Office to require the applicant to furnish a certified copy of priority papers. Applicants are required to submit the certified copy of the foreign application specified in 35 U.S.C. 119(b) or PCT Rule 17 before the patent is granted. If the claim for priority or the certified copy of the foreign application is filed after the date the issue fee is paid, it must be accompanied by the processing fee set forth in 37 CFR 1.17(i), but the patent will not include the priority claim unless corrected by a certificate of correction under 35 U.S.C. 255 and 37 CFR 1.323. See 37 CFR 1.55(a)(2). Certification by the authority empowered under a bilateral or multilateral treaty to receive applications which give rise to a right of priority under Article 4A(2) of the Paris Convention will be deemed to satisfy the certification requirement.

### C. *Identity of Inventors*

The inventors of the U.S. nonprovisional application and of the foreign application must be the same, for a right of priority does not exist in the case of an application of inventor A in the foreign country and inventor B in the United States, even though the two applications may be owned by the same party. How-



ever, the application in the foreign country may have been filed by the assignee, or by the legal representative or agent of the inventor which is permitted in some foreign countries, rather than by the inventor himself, but in such cases the name of the inventor is usually given in the foreign application on a paper filed therein. An indication of the identity of inventors made in the oath or declaration accompanying the U.S. nonprovisional application by identifying the foreign application and stating that the foreign application had been filed by the assignee, or the legal representative, or agent, of the inventor, or on behalf of the inventor, as the case may be, is acceptable. Joint inventors A and B in a nonprovisional application filed in the United States Patent and Trademark Office may properly claim the benefit of an application filed in a foreign country by A and another application filed in a foreign country by B, i.e., A and B may each claim the benefit of their foreign filed applications. See MPEP § 605.07.

#### **D. Time for Filing U.S. Nonprovisional Application**

The United States nonprovisional application, or its earliest parent nonprovisional application under 35 U.S.C. 120, must have been filed within 12 months of the earliest foreign filing. In computing this 12 months, the first day is not counted; thus, if an application was filed in Canada on January 3, 1983, the U.S. nonprovisional application may be filed on January 3, 1984. The Convention specifies in Article 4C(2) that “the day of filing is not counted in this period.” (This is the usual method of computing periods, for example a 6-month period for reply to an Office action dated January 2 does not expire on July 1, but the reply may be made on July 2.) If the last day of the 12 months is a Saturday, Sunday, or Federal holiday within the District of Columbia, the U.S. nonprovisional application is in time if filed on the next succeeding business day; thus, if the foreign application was filed on September 4, 1981, the U.S. nonprovisional application is in time if filed on September 7, 1982, since September 4, 1982, was a Saturday and September 5, 1982 was a Sunday and September 6, 1982 was a Federal holiday. Since January 1, 1953, the Office has not received applications on Saturdays and, in view of 35 U.S.C. 21, and the Convention which provides “if the last day of the period is an offi-

cial holiday, or a day on which the Office is not open for the filing of applications in the country where protection is claimed, the period shall be extended until the first following working day” (Article 4C(3)><, if the 12 months expires on Saturday, the U.S. application may be filed on the following Monday. Note *Ex parte Olah*, 131 USPQ 41 (Bd. App. 1960). See, e.g., *Dubost v. U.S. Patent and Trademark Office*, 777 F.2d 1561, 1562, 227 USPQ 977, 977 (Fed. Cir. 1985).

#### **E. Filing of Papers During Unscheduled Closings of the U.S. Patent and Trademark Office**

37 CFR 1.9(h) provides that the definition of “Federal holiday within the District of Columbia” includes an official closing of the Office. When the entire U.S. Patent and Trademark Office is officially closed for business for an entire day, for reasons due to adverse weather or other causes, the Office will consider each such day a “Federal holiday within the District of Columbia” under 35 U.S.C. 21. Any action or fee due on such a day may be taken, or fee paid, on the next succeeding business day the Office is open. In addition, 37 CFR 1.6(a)(1) provides “[t]he U.S. Patent and Trademark Office is not open for the filing of correspondence on any day that is a Saturday, Sunday or Federal holiday within the District of Columbia” to clarify that any day that is a Saturday, Sunday or Federal holiday within the District of Columbia is a day that the U.S. Patent and Trademark Office is not open for the filing of applications within the meaning of Article 4C(3) of the Paris Convention. Note further that in accordance with 37 CFR 1.6(a)(2), even when the Office is not open for the filing of correspondence on any day that is a Saturday, Sunday or Federal holiday within the District of Columbia, correspondence deposited as Express Mail with the USPS in accordance with 37 CFR 1.10 will be considered filed on the date of its deposit, regardless of whether that date is a Saturday, Sunday or Federal holiday within the District of Columbia (under 35 U.S.C. 21(b) or \*>37< CFR 1.7).

When the U.S. Patent and Trademark Office is open for business during any part of a business day between 8:30 a.m. and 5:00 p.m., papers are due on that day even though the Office may be officially closed for some period of time during the business

day because of an unscheduled event. The procedures of 37 CFR 1.10 may be used for filing applications.

Information regarding whether or not the Office is officially closed on any particular day may be obtained by calling (703) 308-4357 which transposes to (703) 308-HELP.

### F. *First Foreign Application*

The 12 months is from earliest foreign filing except as provided in 35 U.S.C. 119(c). If an inventor has filed an application in France on January 4, 1982, and an identical application in the United Kingdom on March 3, 1982, and then files in the United States on February 2, 1983, the inventor is not entitled to the right of priority at all; the inventor would not be entitled to the benefit of the date of the French application since this application was filed more than twelve months before the U.S. application, and the inventor would not be entitled to the benefit of the date of the United Kingdom application since this application is not the first one filed. *Ahrens v. Gray*, 1931 C.D. 9, 402 O.G. 261 (Bd. App. 1929). If the first foreign application was filed in a country which is not recognized with respect to the right of priority, it is disregarded for this purpose.

Public Law 87-333 modified 35 U.S.C. 119(c) to extend the right of priority to "subsequent" foreign applications if one earlier filed had been withdrawn, abandoned, or otherwise disposed of, under certain conditions.

The United Kingdom and a few other countries have a system of "post-dating" whereby the filing date of an application is changed to a later date. This "post-dating" of the filing date of the application does not affect the status of the application with respect to the right of priority; if the original filing date is more than one year prior to the U.S. filing no right of priority can be based upon the application. See *In re Clamp*, 151 USPQ 423 (Comm'r Pat. 1966).

If an applicant has filed two foreign applications in recognized countries, one outside the year and one within the year, and the later application discloses additional subject matter, a claim in the U.S. application specifically limited to the additional disclosure would be entitled to the date of the second foreign application since this would be the first foreign application for that subject matter.

>

### G. *Incorporation by Reference*

Applicant may incorporate by reference the foreign priority application by including a statement in the U.S. application-as-filed that such specifically enumerated foreign priority application is "hereby incorporated by reference." The statement may appear in the transmittal letter. The inclusion of the incorporation by reference of the foreign priority application will permit an applicant to amend the U.S. application to include any subject in the foreign priority application without raising the issue of new matter. Thus the incorporation by reference statement can be relied upon to permit the entering of a portion of the foreign priority application into the U.S. application when a portion of the foreign priority application has been inadvertently omitted from the U.S. application, or to permit the correction of translation error in the U.S. application where the foreign priority application is in a non-English language.

## III. < EFFECT OF RIGHT OF PRIORITY

The right to rely on the foreign filing extends to overcoming the effects of intervening references or uses, but there are certain restrictions. For example, the 1 year bar of 35 U.S.C. 102(b) dates from the U.S. filing date and not from the foreign filing date; thus if an invention was described in a printed publication, or was in public use in this country, in November 1981, a foreign application filed in January 1982, and a U.S. application filed in December 1982, granting a patent on the U.S. application is barred by the printed publication or public use occurring more than one year prior to its actual filing in the United States.

The right of priority can be based upon an application in a foreign country for a so-called "utility model," called Gebrauchsmuster in Germany.

### 201.13(a) Right of Priority Based Upon an Application for an Inventor's Certificate

37 CFR 1.55. *Claim for foreign priority.*

\*\*\*\*\*

(b) An applicant in a nonprovisional application may under certain circumstances claim priority on the basis of one or more applications for an inventor's certificate in a country granting both

inventor's certificates and patents. To claim the right of priority on the basis of an application for an inventor's certificate in such a country under 35 U.S.C. 119(d), the applicant when submitting a claim for such right as specified in paragraph (a) of this section, shall include an affidavit or declaration. The affidavit or declaration must include a specific statement that, upon an investigation, he or she is satisfied that to the best of his or her knowledge, the applicant, when filing the application for the inventor's certificate, had the option to file an application for either a patent or an inventor's certificate as to the subject matter of the identified claim or claims forming the basis for the claim of priority.

\*\*\*\*\*

An inventor's certificate may form the basis for rights of priority under 35 U.S.C. 119(d) only when the country in which they are filed gives to applicants, at their discretion, the right to apply, on the same invention, either for a patent or for an inventor's certificate. The affidavit or declaration specified under 37 CFR 1.55(b) is only required for the purpose of ascertaining whether, in the country where the application for an inventor's certificate originated, this option generally existed for applicants with respect to the particular subject matter of the invention involved. The requirements of 35 U.S.C. 119(d) and 37 CFR 1.55(b) are not intended, however, to probe into the eligibility of the particular applicant to exercise the option in the particular priority application involved.

It is recognized that certain countries that grant inventors' certificates also provide by law that their own nationals who are employed in state enterprises may only receive inventors' certificates and not patents on inventions made in connection with their employment. This will not impair their right to be granted priority in the United States based on the filing of the inventor's certificate.

Accordingly, affidavits or declarations filed pursuant to 37 CFR 1.55(b) need only show that in the country in which the original inventor's certificate was filed, applicants generally have the right to apply at their own option either for a patent or an inventor's certificate as to the particular subject matter of the invention.

Priority rights on the basis of an inventor's certificate application will be honored only if the applicant had the option or discretion to file for either an inventor's certificate or a patent on his or her invention in his or her home country. Certain countries which grant both patents and inventor's certificates issue

only inventor's certificates on certain subject matter, generally pharmaceuticals, foodstuffs, and cosmetics.

To ensure compliance with the treaty and statute, 37 CFR 1.55(b) provides that at the time of claiming the benefit of priority for an inventor's certificate, the applicant or his or her attorney must submit an affidavit or declaration stating that the applicant when filing his or her application for the inventor's certificate had the option either to file for a patent or an inventor's certificate as to the subject matter forming the basis for the claim of priority.

### Effective Date

37 CFR 1.55(b) originally went into effect on August 25, 1973, which is the date on which the international treaty entered into force with respect to the United States. The rights of priority based on an earlier filed inventor's certificate shall be granted only with respect to U.S. patent applications where *both* the earlier application and the U.S. patent application were filed in their respective countries following this effective date.

### 201.13(b) Right of Priority Based Upon an International Application Filed Under the Patent Cooperation Treaty [R-2]

*35 U.S.C. 365. Right of priority; benefit of the filing date of a prior application.*

(a) In accordance with the conditions and requirements of subsections (a) through (d) of section 119 of this title, a national application shall be entitled to the right of priority based on a prior filed international application which designated at least one country other than the United States.

(b) In accordance with the conditions and requirements of section 119(a) of this title and the treaty and the Regulations, an international application designating the United States shall be entitled to the right of priority based on a prior foreign application, or a prior international application designating at least one country other than the United States.

(c) In accordance with the conditions and requirements of section 120 of this title, an international application designating the United States shall be entitled to the benefit of the filing date of a prior national application or a prior international application designating the United States, and a national application shall be entitled to the benefit of the filing date of a prior international application designating the United States. If any claim for the benefit of an earlier filing date is based on a prior international application which designated but did not originate in the United States, the Director may require the filing in the Patent and Trademark Office of a certified copy of such application together with a

translation thereof into the English language, if it was filed in another language.

35 U.S.C. 365(a) provides that a national application shall be entitled to the right of priority based on a prior international application of whatever origin, which designated any country other than, or in addition to, the United States. Of course, the conditions prescribed by section 119(a)-(d) of title 35 U.S.C., which deals with the right of priority based on earlier filed foreign applications, must be complied with.

35 U.S.C. 365(b) provides that an international application designating the United States shall be entitled to the right of priority of a prior foreign application which may either be another international application or a regularly filed foreign application. The international application upon which the claim of priority is based can either have been filed in the United States or a foreign country; however, it must contain the designation of at least one country other than, or in addition to, the United States.

As far as the actual place of filing is concerned, for the purpose of 35 U.S.C. 365(a) and (b) and 35 U.S.C. 119(a)-(d) and (f), an international application designating a country is considered to be a national application regularly filed in that country on the international filing date irrespective of whether it was physically filed in that country, in another country, or in an intergovernmental organization acting as Receiving Office for a country.

An international application which seeks to establish the right of priority will have to comply with the conditions and requirements as prescribed by the Treaty and the PCT Regulations, in order to avoid rejection of the claim to the right of priority. Reference is especially made to the requirement of making a declaration of the claim of priority at the time of filing of the international application (Article 8(1) of the Treaty and Rule 4.10 of the PCT Regulations) and the requirement of either filing a certified copy of the priority document with the international application, or submitting a certified copy of the priority document to the International Bureau at a certain time (Rule 17 of the PCT Regulations). The submission of the priority document to the International Bureau is only required in those instances where priority is based on an earlier filed foreign *national* application.

Thus, if the priority document is an earlier national application and did not accompany the international

application when filed with the Receiving Office, an applicant must submit such document to the International Bureau not later than 16 months after the priority date. However, should an applicant request early processing of his or her international application in accordance with Article 23(2) of the Treaty, the priority document would have to be submitted to the International Bureau at that time (Rule 17.1(a) of the PCT Regulations). If priority is based on an earlier international application, a copy does not have to be filed, either with the Receiving Office or the International Bureau, since the latter is already in possession of such international application.

The formal requirements for obtaining the right of priority under 35 U.S.C. 365 differ somewhat from those imposed by 35 U.S.C. 119(a)-(d) and (f), although the 1-year bar of 35 U.S.C. 102(b), as required by the last clause of section 119(a) is the same. However, the substantive right of priority is the same, in that it is derived from Article 4 of the Paris Convention for the Protection of Industrial Property (Article 8(2) of the Treaty).

35 U.S.C. 365(c) recognizes the benefit of the filing date of an earlier application under 35 U.S.C. 120. Any international application designating the United States, whether filed with a Receiving Office in this country or abroad, and even though other countries may have also been designated, has the effect of a regular national application in the United States, as of the international filing date. As such, any later filed national application, or international application designating the United States, may claim the benefit of the filing date of an earlier international application designating the United States, if the requirements and conditions of section 120 of title 35 U.S.C. are fulfilled. Under the same circumstances, the benefit of the earlier filing date of a national application may be obtained in a later filed international application designating the United States. In those instances, where the applicant relies on an international application designating, but not originating in, the United States the \*>Director< may require submission of a copy of such application together with an English translation, since in some instances, and for various reasons, a copy of that international application or its translation may not otherwise be filed in the U.S. Patent and Trademark Office.

*PCT Rule 17.**The Priority Document**17.1. Obligation to Submit Copy of Earlier National or International Application*

\*\*&gt;

(a) Where the priority of an earlier national or international application is claimed under Article 8, a copy of that earlier application, certified by the authority with which it was filed (“the priority document”), shall, unless that priority document has already been filed with the receiving Office together with the international application in which the priority claim is made, and subject to paragraphs (b) and (b<sup>bis</sup>), be submitted by the applicant to the International Bureau or to the receiving Office not later than 16 months after the priority date, provided that any copy of the said earlier application which is received by the International Bureau after the expiration of that time limit shall be considered to have been received by that Bureau on the last day of that time limit if it reaches it before the date of international publication of the international application.

(b) Where the priority document is issued by the receiving Office, the applicant may, instead of submitting the priority document, request the receiving Office to prepare and transmit the priority document to the International Bureau. Such request shall be made not later than 16 months after the priority date and may be subjected by the receiving Office to the payment of a fee.

(b<sup>bis</sup>) Where the priority document is, in accordance with the Administrative Instructions, available to the receiving Office or to the International Bureau from a digital library, the applicant may, as the case may be, instead of submitting the priority document:

(i) request the receiving Office to obtain the priority document from such digital library and transmit it to the International Bureau; or

(ii) request the International Bureau to obtain the priority document from such digital library.

Such request shall be made not later than 16 months after the priority date and may be subjected by the receiving Office or the International Bureau to the payment of a fee.

(c) If the requirements of none of the three preceding paragraphs are complied with, any designated Office may, subject to paragraph (d), disregard the priority claim, provided that no designated Office shall disregard the priority claim before giving the applicant an opportunity to furnish the priority document within a time limit which shall be reasonable under the circumstances.

(d) No designated Office shall disregard the priority claim under paragraph (c) if the earlier application referred to in paragraph (a) was filed with it in its capacity as national Office or if the priority document is, in accordance with the Administrative Instructions, available to it from a digital library.<

*17.2. Availability of Copies*

\*\*&gt;

(a) Where the applicant has complied with Rule 17.1(a), (b) or (b<sup>bis</sup>), the International Bureau shall, at the specific request of the designated Office, promptly but not prior to the international publication of the international application, furnish a copy of the priority document to that Office. No such Office shall ask the applicant himself to furnish it with a copy. The applicant shall not be required to furnish a translation to the designated Office before the expiration of the applicable time limit under Article 22. Where the applicant makes an express request to the designated Office under Article 23(2) prior to the international publication of the international application, the International Bureau shall, at the specific request of the designated Office, furnish a copy of the priority document to that Office promptly after receiving it.<

(b) The International Bureau shall not make copies of the priority document available to the public prior to the international publication of the international application.

(c) Where the international application has been published under Article 21, the International Bureau shall furnish a copy of the priority document to any person upon request and subject to reimbursement of the cost unless, prior to that publication:

(i) the international application was withdrawn,

(ii) the relevant priority claim was withdrawn or considered, under Rule 26<sup>bis</sup>.2(b), not to have been made.

(iii) [Deleted]

(d) [Deleted]

*37 CFR 1.451. The priority claim and priority document in an international application.*

(a) The claim for priority must, subject to paragraph (d) of this section, be made on the Request (PCT Rule 4.10) in a manner complying with sections 110 and 115 of the Administrative Instructions.

(b) Whenever the priority of an earlier United States national application or international application filed with the United States Receiving Office is claimed in an international application, the applicant may request in a letter of transmittal accompanying the international application upon filing with the United States Receiving Office or in a separate letter filed in the United States Receiving Office not later than 16 months after the priority date, that the United States Patent and Trademark Office prepare a certified copy of the prior application for transmittal to the International Bureau (PCT Article 8 and PCT Rule 17). The fee for preparing a certified copy is set forth in § 1.19(b)(1).

(c) If a certified copy of the priority document is not submitted together with the international application on filing, or, if the priority application was filed in the United States and a request and appropriate payment for preparation of such a certified copy do not accompany the international application on filing or are not filed within 16 months of the priority date, the certified copy of the priority document must be furnished by the applicant to the International Bureau or to the United States Receiving Office within the time limit specified in PCT Rule 17.1(a).

(d) The applicant may correct or add a priority claim in accordance with PCT Rule 26<sup>bis</sup>.1.

## 201.14 Right of Priority, Formal Requirements [R-2]

Under the statute (35 U.S.C. 119(b)), an applicant who wishes to secure the right of priority must comply with certain formal requirements within a time specified. If these requirements are not complied with the right of priority is lost and cannot thereafter be asserted.

For nonprovisional applications filed prior to November 29, 2000, the requirements of the statute are (a) that the applicant must file a claim for the right and (b) he or she must also file a certified copy of the original foreign application; these papers must be filed within a certain time limit. The maximum time limit specified in the statute is that the claim for priority and the priority papers must be filed before the patent is granted, but the statute gives the \*>Director< authority to set this time limit at an earlier time during the pendency of the application. Where a claim for priority under 35 U.S.C. 119(b) has not been made in the parent application, the claim for priority may be made in a continued prosecution application (CPA) filed under 37 CFR 1.53(d) or FWC application filed under former 37 CFR 1.62, provided the parent application has been filed within 12 months from the date of the earliest foreign filing. If the required papers are not filed within the time limit set the right of priority is lost. A reissue was granted in *Brenner v. State of Israel*, 400 F.2d 789, 158 USPQ 584 (D.C. Cir. 1968), where the only ground urged was failure to file a certified copy of the original foreign application to obtain the right of foreign priority under 35 U.S.C. 119 before the patent was granted.

It should be particularly noted that these papers must be filed in all cases even though they may not be necessary during the pendency of the application to overcome the date of any reference. The statute also gives the \*>Director< authority to require a translation of the foreign documents if not in the English language and such other information as the \*>Director< may deem necessary.

For original applications filed under 35 U.S.C.111(a) (other than a design application ) on or after November 29, 2000, the requirements of the statute are that the applicant must (a) file a claim for the right of priority and (b) identify the original foreign application by specifying the application number

of the foreign application, the intellectual property authority or country in which the application was filed and the date of filing of the application. These papers must be filed within a certain time limit. The time limit specified in 35 U.S.C.119(b)(1) is that the claim for priority and the required identification information must be filed at such time during the pendency of the application as set by the \*>Director<. The \*>Director< has by rule set this time limit as the later of four months from the actual filing date of the application or sixteen months from the filing date of the prior foreign application. See 37 CFR 1.55(a)(1)(i). This time period is not extendable. In an application that entered the national stage from an international application after compliance with 35 U.S.C. 371, the claim for priority must be made during the pendency of the application and within the time limit set forth in the PCT and the Regulations under the PCT. See 37 CFR 1.55(a)(1)(ii). Claims for foreign priority not presented within the time period specified in 37 CFR 1.55(a)(1)(i) are considered to have been waived. If a claim for priority under 35 U.S.C.119(a) - (d) or (f), or 365(a) is presented after the time period set in 37 CFR 1.55(a)(1)(i), the claim may be accepted if it includes the required identification information and is accompanied by a grantable petition to accept the unintentionally delayed claim for priority. See 37 CFR 1.55(c). In addition, 35 U.S.C. 119(b)(3) gives the \*>Director< authority to require a certified copy of the foreign application and an English translation if the foreign application is not in the English language and such other information as the \*>Director< may deem necessary. The \*>Director< has by rule, 37 CFR 1.55(a)(2), required a certified copy of the foreign application to be submitted before the patent is granted. If the certified copy of the foreign application is submitted after the payment of the issue fee, it must be accompanied by the processing fee set forth in 37 CFR 1.17(i). See MPEP § 201.14(a).

Unless provided in an application data sheet, 37 CFR 1.63 requires that the oath or declaration must identify the foreign application for patent or inventor's certificate for which priority is claimed under 37 CFR 1.55, and any foreign applications having a filing date before that of the application on which priority is claimed, by specifying the application number, country, day, month, and year of its filing.

## 201.14(a) Right of Priority, Time for Filing Papers [R-2]

The time for filing the priority papers required by the statute is specified in 37 CFR 1.55(a).

### 37 CFR 1.55. Claim for foreign priority.

(a) An applicant in a nonprovisional application may claim the benefit of the filing date of one or more prior foreign applications under the conditions specified in 35 U.S.C. 119(a) through (d) and (f), 172, and 365(a) and (b).

(1)(i) In an original application filed under 35 U.S.C. 111(a), the claim for priority must be presented during the pendency of the application, and within the later of four months from the actual filing date of the application or sixteen months from the filing date of the prior foreign application. This time period is not extendable. The claim must identify the foreign application for which priority is claimed, as well as any foreign application for the same subject matter and having a filing date before that of the application for which priority is claimed, by specifying the application number, country (or intellectual property authority), day, month, and year of its filing. The time periods in this paragraph do not apply in an application under 35 U.S.C. 111(a) if the application is:

- (A) A design application; or
- (B) An application filed before November 29, 2000.

(ii) In an application that entered the national stage from an international application after compliance with 35 U.S.C. 371, the claim for priority must be made during the pendency of the application and within the time limit set forth in the PCT and the Regulations under the PCT.

(2) The claim for priority and the certified copy of the foreign application specified in 35 U.S.C. 119(b) or PCT Rule 17 must, in any event, be filed before the patent is granted. If the claim for priority or the certified copy of the foreign application is filed after the date the issue fee is paid, it must be accompanied by the processing fee set forth in § 1.17(i), but the patent will not include the priority claim unless corrected by a certificate of correction under 35 U.S.C. 255 and § 1.323

(3) When the application becomes involved in an interference (§ 1.630), when necessary to overcome the date of a reference relied upon by the examiner, or when deemed necessary by the examiner, the Office may require that the claim for priority and the certified copy of the foreign application be filed earlier than provided in paragraphs (a)(1) or (a)(2) of this section.

(4) An English language translation of a non-English language foreign application is not required except when the application is involved in an interference (§ 1.630), when necessary to overcome the date of a reference relied upon by the examiner, or when specifically required by the examiner. If an English language translation is required, it must be filed together with a statement that the translation of the certified copy is accurate.

\*\*\*\*\*

(c) Unless such claim is accepted in accordance with the provisions of this paragraph, any claim for priority under 35 U.S.C. 119(a)-(d) or 365(a) not presented within the time period

provided by paragraph (a) of this section is considered to have been waived. If a claim for priority under 35 U.S.C. 119(a)-(d) or 365(a) is presented after the time period provided by paragraph (a) of this section, the claim may be accepted if the claim identifying the prior foreign application by specifying its application number, country (or intellectual property authority), and the day, month, and year of its filing was unintentionally delayed. A petition to accept a delayed claim for priority under 35 U.S.C. 119(a)-(d) or 365(a) must be accompanied by:

(1) The claim under 35 U.S.C. 119(a)-(d) or 365(a) and this section to the prior foreign application, unless previously submitted;

(2) The surcharge set forth in § 1.17(t); and

\*\*>

(3) A statement that the entire delay between the date the claim was due under paragraph (a)(1) of this section and the date the claim was filed was unintentional. The Director may require additional information where there is a question whether the delay was unintentional.<

It should first be noted that the \*>Director< has by rule specified an earlier ultimate date than the date the patent is granted for filing a claim and a certified copy. For original applications filed under 35 U.S.C. 111(a) (other than a design application) on or after November 29, 2000, a claim for foreign priority must be presented during the pendency of the application, and within the later of four months from the actual filing date of the application or sixteen months from the filing date of the prior foreign application. See 37 CFR 1.55(a)(1)(i). This time period is not extendable. For applications that entered the national stage from an international application filed on or after November 29, 2000, after compliance with 35 U.S.C. 371, the claim for priority must be made during the pendency of the application and within the time limit set forth in the PCT and the Regulations under the PCT. Any foreign priority claim not presented within the time period set in 37 CFR 1.55(a)(1)(i) is considered to have been waived. If a claim for foreign priority is presented after the time period set in 37 CFR 1.55(a)(1)(i), the claim may be accepted if the claim properly identifies the prior foreign application and is accompanied by a grantable petition to accept an unintentionally delayed claim for priority. A grantable petition to accept an unintentionally delayed claim for priority must include: (1) the claim (i.e., the claim required by 35 U.S.C. 119(a)-(d) and (f) and 37 CFR 1.55) for priority to the prior foreign application, unless previously submitted; (2) the surcharge set forth in 37 CFR 1.17(t); and (3) a statement that the entire delay between the date the claim was due under

37 CFR 1.55(a)(1) and the date the claim was filed was unintentional. The \*>Director< may require additional information where there is a question whether the delay was unintentional. See 37 CFR 1.55(c).

For nonprovisional applications filed prior to November 29, 2000 and for design applications, a claim for foreign priority may be made up until the time when the patent is granted. Priority claims and certified copies of foreign applications filed after payment of the issue fee will be placed in the application file but will not be reviewed, as explained in further detail below.

For all applications, assuming the claim for foreign priority has been made, the latest time at which the papers may be filed without a processing fee (37 CFR 1.17(i)) is the date of the payment of the issue fee, except that, under certain circumstances, they are required at an earlier date. These circumstances are specified in the rule as:

(A) in the case of interferences in which event the papers must be filed within the time specified in the interference rules;

(B) when necessary to overcome the date of a reference relied on by the examiner; and

(C) when specifically required by the examiner.

The claim for foreign priority and the certified copy of the foreign application specified in 35 U.S.C. 119(b) or PCT Rule 17 must, in any event, be filed before the patent is granted. If the claim for foreign priority or the certified copy of the foreign application is filed after the date of payment of the issue fee but prior to the date of grant of the patent, the priority claim or certified copy must be accompanied by a processing fee set forth in 37 CFR 1.17(i). The priority claim or certified copy will be placed in the file record but there will be no review of the papers and the patent when published will not include the priority claim. A certificate of correction under 35 U.S.C. 255 and 37 CFR 1.323 can be filed to have the priority claim or certified copy considered after publication of the patent. In addition, for original applications filed under 35 U.S.C. 111(a) (other than a design application) on or after November 29, 2000, a grantable petition to accept an unintentionally delayed claim for priority under 37 CFR 1.55(c) must also be filed with the certificate of correction.

In view of the shortened periods for prosecution leading to allowances, it is recommended that priority papers be filed as early as possible. Although 37 CFR 1.55(a)(2) permits the filing of priority papers up to and including the date for payment of the issue fee, it is advisable that such papers be filed promptly after filing the application. Frequently, priority papers are found to be deficient in material respects, such as for example, the failure to include the correct certified copy, and there is not sufficient time to remedy the defect. Occasionally, a new oath or declaration may be necessary where the original oath or declaration omits the reference to the foreign filing date for which the benefit is claimed. The early filing of priority papers would thus be advantageous to applicants in that it would afford time to explain any inconsistencies that exist or to supply any additional documents that may be necessary.

It is also suggested that a pencil notation of the application number of the corresponding U.S. application be placed on the priority papers. Such notation should be placed directly on the priority papers themselves even where a cover letter is attached bearing the U.S. application data. Experience indicates that cover letters and priority papers occasionally become separated, and without the suggested pencil notations on the priority papers, correlating them with the corresponding U.S. application becomes exceedingly difficult, frequently resulting in severe problems for both the Office and applicant. Adherence to the foregoing suggestion for making a pencil notation on the priority document of the U.S. application data will result in a substantial lessening of the problem.

If the priority claim in an original application filed under 35 U.S.C. 111(a) (other than a design application) on or after November 29, 2000 is submitted after the time period set forth in 37 CFR 1.55(a)(1) and without the required petition (37 CFR 1.55(c)), the examiner may use the following form paragraph to inform applicant that the foreign priority claim will not be entered.

\*\*>

*¶ 2.21.01 35 U.S.C. 119(a)-(d) or (f) or 365(a) Foreign Priority Claim is Untimely*

The foreign priority claim filed on [1] was not entered because the foreign priority claim was not filed during the time period set forth in 37 CFR 1.55(a)(1). For original applications filed under 35 U.S.C. 111(a) (other than a design application) on or after November 29, 2000, the time period is during the pendency of the



application and within the later of four months from the actual filing date of the application or sixteen months from the filing date of the prior foreign application. For applications that have entered national stage from an international application filed on or after November 29, 2000, after compliance with 35 U.S.C. 371, the claim for priority must be made during the pendency of the application and within the time limit set forth in the PCT and the Regulations under the PCT. See 37 CFR 1.55(a)(1)(ii). If applicant desires priority under 35 U.S.C. 119(a)-(d), (f) or 365(a) based upon a prior foreign application, applicant must file a petition for an unintentionally delayed priority claim (37 CFR 1.55(c)). The petition must be accompanied by (1) the claim (i.e., the claim required by 35 U.S.C. 119(a)-(d) and (f) and 37 CFR 1.55) for priority to the prior foreign application, unless previously submitted; (2) a surcharge under 37 CFR 1.17(t); and (3) a statement that the entire delay between the date the claim was due under 37 CFR 1.55(a)(1) and the date the claim was filed was unintentional. The Director may require additional information where there is a question whether the delay was unintentional. The petition should be addressed to: Mail Stop Petition, Commissioner for Patents, P.O. Box 1450, Alexandria, Virginia 22313-1450.

**Examiner Note:**

1. Use this form paragraph only for original applications filed under 35 U.S.C. 111(a) on or after November 29, 2000. DO NOT use for design applications.
2. In bracket 1, insert the date the amendment or paper containing the foreign priority claim was filed.

&lt;

**201.14(b) Right of Priority, Papers Required [R-2]**

The filing of the priority papers under 35 U.S.C. 119(a)-(d) makes the record of the file of the United States patent complete. The U.S. Patent and Trademark Office does not normally examine the papers to determine whether the applicant is in fact entitled to the right of priority and does not grant or refuse the right of priority, except as described in MPEP § 201.15 and in cases of interferences.

The papers required are the claim for priority and the certified copy of the foreign application. For original applications filed under 35 U.S.C. 111(a) (other than design applications) on or after November 29, 2000, the claim for foreign priority must identify the foreign application for which priority is claimed by specifying the application number, country (or intellectual property authority), day, month, and year of its filing. In addition, the claim for priority must also identify any foreign application for the same subject matter having a filing date before that of the foreign application for which priority is claimed.

For all applications, the claim to priority need be in no special form, and may be made by a person authorized to sign correspondence under 37 CFR 1.33(b). No special language is required in making the claim for priority, and any expression which can be reasonably interpreted as claiming the benefit of the foreign application is accepted as the claim for priority. The claim for priority may appear in the oath or declaration, an application data sheet (37 CFR 1.76), or the application transmittal letter with the recitation of the foreign application. See MPEP § 201.13, paragraph A.

The certified copy which must be filed is a copy of the original foreign application with a certification by the patent office of the foreign country in which it was filed. Certified copies ordinarily consist of a copy of the specification and drawings of the applications as filed with a certificate of the foreign patent office giving certain information. "Application" in this connection is not considered to include formal papers such as a petition. A copy of the foreign patent as issued does not comply since the application as filed is required; however, a copy of the printed specification and drawing of the foreign patent is sufficient if the certification indicates that it corresponds to the application as filed. A French patent stamped "Service De La Propriete Industrielle - Conforme Aux Pieces Deposees A L' Appui de La Demande" and additionally bearing a signed seal is also acceptable in lieu of a certified copy of the French application.

When the claim to priority and the certified copy of the foreign application are received while the application is pending before the examiner, the examiner should make no examination of the papers except to see that they correspond in number, date and country to the application identified in the oath or declaration and contain no obvious formal defects. The subject matter of the application is not examined to determine whether the applicant is actually entitled to the benefit of the foreign filing date on the basis of the disclosure thereof. In addition, for original applications filed under 35 U.S.C. 111(a) (other than design applications) on or after November 29, 2000, the examiner should make sure that the claim for foreign priority is timely. Examiners may use form paragraph 2.21.01 to notify applicant that the foreign priority claim is untimely.

&gt;

**I. < DURING INTERFERENCE**

If priority papers are filed in an interference, it is not necessary to file an additional certified copy in the application file. The administrative patent judge will \*->associate< them \*->with< the application \*.

&gt;

**II. < LATER FILED APPLICATIONS, REISSUES**

Where the benefit of a foreign filing date based on a foreign application is claimed in a later filed application (i.e., continuation, continuation-in-part, division) or in a reissue application and a certified copy of the foreign application as filed, has been filed in a parent or related application, it is not necessary to file an additional certified copy in the later application. A reminder of this provision is found in form paragraph 2.20. The applicant when making such claim for priority may simply identify the application containing the certified copy. In such cases, the examiner should acknowledge the claim on form PTOL-326. Note copy in MPEP § 707.

If the applicant fails to call attention to the fact that the certified copy is in the parent or related application and the examiner is aware of the fact that a claim for priority under 35 U.S.C. 119(a)-(d) or (f) was made in the parent application, the examiner should call applicant's attention to these facts in an Office action, so that if a patent issues on the later or reissue application, the priority data will appear in the patent. In such cases, the language of form paragraph 2.20 should be used.

\*\*&gt;

**¶ 2.20 Priority Papers in Parent or Related (Reissue Situation) - Application**

Applicant is reminded that in order for a patent issuing on the instant application to obtain the benefit of priority based on priority papers filed in parent or related Application No. [1] under 35 U.S.C. 119(a)-(d) or (f), a claim for such foreign priority must be timely made in this application. To satisfy the requirement of 37 CFR 1.55(a)(2) for a certified copy of the foreign application, applicant may simply identify the application containing the certified copy.

&lt;

Where the benefit of a foreign filing date, based on a foreign application, is claimed in a later filed appli-

cation or in a reissue application and a certified copy of the foreign application, as filed, has not been filed in a parent or related application, a claim for priority may be made in the later application. *In re Tangsrud*, 184 USPQ 746 (Comm'r Pat. 1973). When such a claim is made in the later application and a certified copy of the foreign application is placed therein, the examiner should acknowledge the claim on form PTOL-326. Note copy in MPEP § 707.

&gt;

**III. < WHERE AN ACTUAL MODEL WAS ORIGINALLY FILED IN GERMANY**

The German design statute does not permit an applicant having an establishment or domicile in the Federal Republic of Germany to file design patent applications with the German Patent Office. These German applicants can only obtain design protection by filing papers or an actual deposit of a model with the judicial authority ("Amtsgericht") of their principal establishment or domicile. Filing with the German Patent Office is exclusively reserved for applicants who have neither an establishment or domicile in the Federal Republic of Germany. The deposit in an "Amtsgericht" has the same effect as if deposited at the German Patent Office and results in a "Geschmacksmuster" which is effective throughout Germany.

In implementing the Paris Convention, 35 U.S.C. 119(a)-(d) and (f) requires that a copy of the original foreign application, specification, and drawings certified by the patent office of the foreign country in which filed, shall be submitted to the U.S. Patent and Trademark Office, in order for an applicant to be entitled to the right of priority in the United States.

Article 4, section A(2) of the Paris Convention however states that "(a)ny filing that is equivalent to a regular national filing under the domestic legislation of any country of the Union . . . shall be recognized as giving rise to the right of priority." Article 4D(3) of the Convention further provides that countries of the Union may require any person making a declaration of priority to produce a copy of the previously filed application (description, drawings, etc.) certified as correct by the authority which received this application.

As far as the physical production of a copy of the earlier filed paper application is concerned, an appli-

cant should have no difficulty in providing a copy, certified by the authority which received it, if the earlier filed application contained drawings illustrating the design. A problem, however, arises when the only prior “regular national filing” consisted of the deposit of an actual model of the design. 35 U.S.C. 119 is silent on this subject.

Therefore, the U.S. Patent and Trademark Office will receive as evidence of an earlier filed German design application under 35 U.S.C. 119(a)-(d), drawings or acceptable clear photographs of the deposited model faithfully reproducing the design embodied therein together with other required information, certified as being a true copy by an official of the court with which the model was originally deposited.

35 U.S.C. 119(a)-(d), prior to amendment by the American Inventors Protection Act of 1999 (AIPA), Public Law 106-113, provides for the certification of the earlier filed application by the patent office of the foreign country in which it was filed. Because Article 4D(3) of the Paris Convention which 35 U.S.C. 119(a)-(d) implements refers to certification “. . . by the authority which received such application . . .”, the reference to “patent office” in the statute is construed to extend also to the authority which is in charge of the design register, i.e., the applicable German court. As a consequence, an additional certification by the German Patent Office will not be necessary especially since Article 4D(3) of the Paris Convention provides that authentication shall not be required. Effective November 29, 2000, the AIPA amended 35 U.S.C. 119(b)(3) to state that certification “. . . shall be made by the foreign intellectual property authority in which the foreign application was filed.” 35 U.S.C. 119(b)(3) as amended by the AIPA applies to applications filed under 35 U.S.C. 111(a) and international applications complying with 35 U.S.C. 371, with filing dates on or after November 29, 2000.

Although, as stated above, a “regular national filing” gives rise to the right of priority, the mere submission of a certified copy of the earlier filed foreign application, however, may not be sufficient to perfect that right in this country. For example, among other things, an application filed in a foreign country must contain a disclosure of the invention adequate to satisfy the requirements of 35 U.S.C. 112, in order to

form the basis for the right of priority in a later filed United States application.

## **201.14(c) Right of Priority, Practice [R-2]**

Before going into the practice with respect to those instances in which the priority papers are used to overcome a reference, there will first be described the practice when there is no occasion to use the papers, which will be in the majority of cases. In what follows in this section it is assumed that no reference has been cited which requires the priority date to be overcome.

>

### **I. < UNTIMELY CLAIM FOR PRIORITY**

If the foreign priority claim in an original application filed under 35 U.S.C. 111(a) (other than a design application) on or after November 29, 2000 is submitted after the time period set in 37 CFR 1.55(a)(1)(i) and without a petition under 37 CFR 1.55(c), the examiner may use form paragraph 2.21.01 to notify applicant that the foreign priority claim will not be entered.

>

### **II. < NO IRREGULARITIES AND PRIORITY CLAIM TIMELY**

When the papers under 35 U.S.C. 119(a)-(d) are received within the time period set forth in 37 CFR 1.55(a)(1), if applicable, they are to be endorsed on the contents page of the file as “Letter (or amendment) and foreign application”. Assuming that the papers are timely and regular in form and that there are no irregularities in dates, the examiner in the next Office action will advise the applicant that the papers have been received on form PTOL-326 or by use of form paragraph 2.26. >For Image File Wrapper (IFW) processing, see the IFW Manual.<

#### *¶ 2.26 Claimed Foreign Priority - Papers Filed*

Receipt is acknowledged of papers submitted under 35 U.S.C. 119(a)-(d), which papers have been placed of record in the file.

Where the priority papers have been filed in another application, use form paragraph 2.27.

*¶ 2.27 Acknowledge Foreign Priority Paper in Parent*

Acknowledgment is made of applicant's claim for foreign priority under 35 U.S.C. 119 (a)-(d). The certified copy has been filed in parent Application No. [1], filed on [2].

**Examiner Note:**

1. For problems with foreign priority, see form paragraphs 2.18 to 2.24.
2. In bracket 1, insert series code and serial no. of parent.

The examiner will enter the information specified in MPEP § 202.03 on the face of the file wrapper or on the PALM bib-data sheet for \*\*>as appropriate<.

&gt;

**III. < PAPERS INCONSISTENT WITH A TIMELY PRIORITY CLAIM**

If the certified copy filed does not correspond to the foreign application identified in the application oath or declaration or an application data sheet, or if the application oath or declaration or an application data sheet does not refer to the particular foreign application, the applicant has not complied with the requirements of the rule relating to the oath or declaration. In such instances, the Office action, after acknowledging receipt of the papers, should require the applicant to explain the inconsistency and to file a new oath or declaration or an application data sheet stating correctly the facts concerning foreign applications required by 37 CFR 1.63 by using form paragraph 2.21.

*¶ 2.21 Oath, Declaration, or Application Data Sheet Does Not Contain Reference to Foreign Filing*

Receipt is acknowledged of papers filed under 35 U.S.C. 119(a)-(d) based on an application filed in [1] on [2]. Applicant has not complied with the requirements of 37 CFR 1.63(c), since the oath, declaration, or application data sheet does not acknowledge the filing of any foreign application. A new oath, declaration, or application data sheet is required in the body of which the present application should be identified by application number and filing date.

Other situations requiring some action by the examiner are exemplified by other form paragraphs.

&gt;

**IV. < NO CLAIM FOR PRIORITY**

Where applicant has filed a certified copy but has not made a claim for priority, use form paragraph 2.22.

*¶ 2.22 Certified Copy Filed, But No Claim Made*

Receipt is acknowledged of a certified copy of the [1] application referred to in the oath or declaration or in an application data sheet. If this copy is being filed to obtain the benefits of the foreign filing date under 35 U.S.C. 119(a)-(d), applicant should also file a claim for such priority as required by 35 U.S.C. 119(b). If the application being examined is an original application filed under 35 U.S.C. 111(a) (other than a design application) on or after November 29, 2000, the claim for priority must be presented during the pendency of the application, and within the later of four months from the actual filing date of the application or sixteen months from the filing date of the prior foreign application. See 37 CFR 1.55(a)(1)(i). If the application being examined has entered the national stage from an international application filed on or after November 29, 2000, after compliance with 35 U.S.C. 371, the claim for priority must be made during the pendency of the application and within the time limit set forth in the PCT and Regulations of the PCT. See 37 CFR 1.55(a)(1)(ii). Any claim for priority under 35 U.S.C. 119(a)-(d) or (f) or 365(a) or (b) not presented within the time period set forth in 37 CFR 1.55(a)(1) is considered to have been waived. If a claim for foreign priority is presented after the time period set forth in 37 CFR 1.55(a)(1), the claim may be accepted if the claim properly identifies the prior foreign application and is accompanied by a grantable petition to accept an unintentionally delayed claim for priority. See 37 CFR 1.55(c).

**Examiner Note:**

In bracket 1, insert the application number of the foreign application.

**NOTE:** Where the applicant's accompanying letter states that the certified copy is filed for priority purposes or for the convention date, it is accepted as a claim for priority.

&gt;

**V. < FOREIGN APPLICATIONS ALL FILED MORE THAN A YEAR BEFORE EARLIEST EFFECTIVE U.S. FILING**

Where the earlier foreign application was filed more than 12 months prior to the U.S. application, use form paragraph 2.23.

*¶ 2.23 Foreign Filing More Than 12 Months Earlier*

Acknowledgment is made of applicant's claim for priority under 35 U.S.C. 119(a)-(d) based upon an application filed in [1] on [2]. A claim for priority under 35 U.S.C. 119(a)-(d) cannot be based on said application, since the United States application was filed more than twelve months thereafter.

**Examiner Note:**

1. In bracket 1, insert the country name.
2. In bracket 2, insert the filing date of the foreign application.

&gt;

## VI. < SOME FOREIGN APPLICATIONS FILED MORE THAN A YEAR BEFORE U.S. FILING

For example, where a British provisional specification was filed more than a year before a U.S. application, but the British complete application was filed within the year, and certified copies of both were submitted, language similar to the following should be used: "Receipt is acknowledged of papers filed on September 18, 1979, purporting to comply with the requirements of 35 U.S.C. 119(a)-(d). It is not seen how the claim for priority can be based on the British specification filed January 23, 1978, because the instant application was filed more than one year thereafter. However, the printed heading of the patent will note the claimed priority date based on the complete specification; i.e., November 1, 1978, for such subject matter as was not disclosed in the provisional specification."

&gt;

## VII. < CERTIFIED COPY NOT THE FIRST FOREIGN APPLICATION

Form paragraph 2.24 may be used to notify applicant that the date for which foreign priority is claimed is not the date of the first filed foreign application acknowledged in the oath or declaration.

### ¶ 2.24 Claimed Foreign Priority Date Not the Earliest Date

Receipt is acknowledged of papers filed on [1] purporting to comply with the requirements of 35 U.S.C. 119(a)-(d) and they have been placed of record in the file. Attention is directed to the fact that the date for which foreign priority is claimed is not the date of the first filed foreign application acknowledged in the oath or declaration.

&gt;

## VIII. < NO CERTIFIED COPY

Where priority is claimed but no certified copy of the foreign application has been filed, use form paragraph 2.25.

### ¶ 2.25 Claimed Foreign Priority, No Papers Filed

Acknowledgment is made of applicant's claim for foreign priority based on an application filed in [1] on [2]. It is noted, however, that applicant has not filed a certified copy of the [3] application as required by 35 U.S.C. 119(b).

### Examiner Note:

1. In bracket 1, insert the country name.
2. In bracket 2, insert the filing date of the foreign application.
3. In bracket 3, insert the application number of the foreign application.

Any unusual situation may be referred to the Technology Center (TC) Director.

&gt;

## IX. < APPLICATION IN ISSUE

When priority papers for applications which have been sent to the Publishing Division are received, the priority papers should be sent to the Publishing Division. >For Image File Wrapper (IFW) processing, see the IFW Manual.<

When the claim for foreign priority or the certified copy of the foreign application is filed after the date of payment of the issue fee but prior to the date of grant of the patent, the priority claim or certified copy must be accompanied by a processing fee set forth in 37 CFR 1.17(i). The priority claim or certified copy will be placed in the file record but there will be no review of the papers and the patent when published will not include the priority claim. A certificate of correction under 35 U.S.C. 255 and 37 CFR 1.323 can be filed to have the priority claim or certified copy considered after publication of the patent. In addition, for original applications filed under 35 U.S.C.111(a) (other than design applications) on or after November 29, 2000, a grantable petition to accept an unintentionally delayed claim for priority under 37 CFR 1.55(c) must be filed with the certificate of correction.

&gt;

## X. < RETURN OF PAPERS

>For Image File Wrapper (IFW) processing, see the IFW Manual.< It is sometimes necessary for the examiner to return papers filed under 35 U.S.C. 119(a)-(d) either upon request of the applicant, for example, to obtain a translation of the certified copy of the foreign application, or because they fail to meet a basic requirement of the statute, such as where all foreign applications were filed more than a year prior to the U.S. filing date.

When the papers have not been given a paper number and endorsed on the file wrapper, it is not necessary to secure approval of the >Director of the United States Patent and Trademark Office< for their return

but they should be sent to the TC Director for cancellation of the Office stamps. Where the papers have been made of record in the file (given a paper number and endorsed on the file wrapper), a request for permission to return the papers should be addressed to the \*\*>Director of the United States Patent and Trademark Office< and forwarded to the TC Director for approval. Where the return is approved, the written approval should be placed in the file wrapper. Any questions relating to the return of papers filed under 35 U.S.C. 119(a)-(d) should be directed to the Office of the \* Commissioner for Patents.

>

#### **XI. < FILLING OUT THE FOREIGN PRIORITY SECTION OF THE FILE WRAPPER LABEL (PTO-436L)**

>For Image File Wrapper (IFW) processing, see the IFW Manual.< Where foreign applications are listed on the 37 CFR 1.63 oath or declaration or application data sheet, the examiner should check that such foreign applications are properly listed on the file wrapper, correcting errors of typography or format as necessary, and initialing the “verified” line when the information on the file wrapper, matches the oath or declaration or application data sheet. See MPEP § 202.03. Should there be an error on the oath or declaration, or application data sheet itself, the examiner should require a new oath or declaration, or application data sheet, where appropriate. If a foreign application listed on the oath or declaration, or application data sheet is not listed on the file wrapper, the examiner should print in black ink the country, application number, and filing date under “Foreign/PCT Applications” on the file wrapper or on the PALM bib-data sheet. Applications listed on the file wrapper but filed in countries not qualifying for benefits under 35 U.S.C. 119(a)-(d) should be lined through in red ink. A listing of countries qualifying for benefits under 35 U.S.C. 119(a)-(d) appears at MPEP § 201.13.

Below the “Foreign/PCT applications” portion, the “yes” box for “Foreign priority claimed” should be checked only when priority has been properly claimed as provided in 37 CFR 1.55. Otherwise, the Examiner should check “no”. Where a claim is made for one or more listed foreign applications and not for one or

more other listed foreign applications, the data on the file wrapper concerning the unclaimed applications should be lined through in pencil and the “yes” box checked.

The “yes” box for “35 U.S.C. 119 conditions met” should be checked when there are any foreign applications listed that meet all of the requirements of 35 U.S.C. 119(a)-(d). In such cases, any listed foreign application that does not meet all of the requirements of 35 U.S.C. 119(a)-(d) should be lined through in pencil.

#### **201.14(d) Proper Identification of Priority Application**

In order to help overcome problems in determining the proper identification of priority applications for patent documentation and printing purposes, the following tables have been prepared which set out for various countries the forms of acceptable presentation of application numbers.

The tables should enable applicants, examiners and others to extract from the various formats the minimum required data which comprises a proper citation.

Proper identification of priority applications is essential to establishing accurate and complete relationships among various patent documents which reflect the same invention. Knowledge of these relationships is essential to search file management, technology documentation and various other purposes.

The tables show the forms of presentation of application numbers as used in the records of the source or originating patent office. They also show, under the heading “Minimum Significant Part of the Number,” the simplified form of presentation which should be used in United States Patent and Trademark Office records.

Note particularly that in the simplified format that:

(A) Alpha symbols preceding numerals are eliminated in all cases except Hungary.

(B) A decimal character and numerical subset as part of a number is eliminated in all cases except France.

(C) Use of the dash (—) is reduced, but is still an essential element of application numbers, in the case of Czechoslovakia and Japan.

MINIMUM SIGNIFICANT PART OF AN APPLICATION NUMBER PROVIDING UNIQUE IDENTIFICATION OF AN APPLICATION
---

**Table I—Countries Using Annual Application Number Series**

Country #	Example of application number at source	Minimum significant part of the number	Remarks
Austria [AT]	A 12116/69	12116/69	The letter A is common to all patent applications.
Czechoslovakia [CS]	PV3628-72	3628-72	PV is an abbreviation meaning “application of invention.”
Denmark [DK]	68/2986	68/2986	
Egypt [EG]	487-1968	487-1968	
Country #	Example of application number at source	Minimum significant part of the number	Remarks
Finland [FI]	3032/69 (old numbering system) 752032 (new numbering system)	3032/69 752032	New numbering system introduced on January 1, 1975. First two digits indicate year of application.
France [FR]	69.38066 7319346	68.38066 7319346	Deletion of the intermediary full stop from this number onwards.
Note: All French applications are numbered in a single annual series, e.g., demande de brevet, demande de certificate d’addition (first addition, second addition, etc.)			Annual series of numbers is used for all applications of patent documents. The number allotted to an application at its filing (national registration number) is also the number of the granted patent.

Country #	Example of application number at source	Minimum significant part of the number	Remarks
Germany, Fed. Rep. of [DE]	P 1940738//6-24 G6947580.5	1940738 D6947580	P=Patent. The first two digits of the number represent the last two digits of the year of application less 50 (e.g., 1969 less 50=19; 1973 less 50=23). The first digit after the slash is an error control digit. The two digits following the dash indicate the examining division. G= Gebrauchsmuster. The first two digits of the number represent the last two digits of the year of application. The difference in numbering scheme of the first two digits affords unique identification of this type of application. However, see note below (D). The digit after the period is for error control.
Ireland	1152/69	1152/69	
Italy [IT]	28039-A/70	28039/70	Application numbers are not presented on published patent documents or given in an official gazette. An exclusive block of application numbers is given annually to each of 93 provincial bureaus where patent applications may be filed. In 1973, 90,000 numbers were allotted, wherein an estimated total of 30,000 applications were expected to be filed. While, as a consequence, gaps will exist in the ultimately used numbers, each application has a unique number. For this purpose, neither the dash nor the letter identifying the receiving bureau, which follows the application number, is needed.
Japan [JP]	46-69807 46-81861	46-69807 D46-81861	The two digits before the dash indicate the year (1925 or 1988) of the Emperor's reign in which the application was filed (46=1971). Patent and utility model applications are numbered in separate series.
Netherlands [NL]	7015038	7015038	First two digits indicate year of application.
Norway [NO]	1748/70 (old numbering system) 74001 (new numbering system)	1748/70 74001	New numbering system introduced on January 1, 1974. First two digits indicate year of application.
South Africa [ZA]	70/4865	70/4865	



Country #	Example of application number at source	Minimum significant part of the number	Remarks
Sweden [SE]	16414/70 7300001-0 (new system)	16414/70 7300001	The new numbering system was introduced January 1, 1973. First two digits indicate year of application. The digit after the dash is used for computer control.
Switzerland [CH]	15978/70	15978/70	
United Kingdom [GB]	41352/70	41352/70	
Yugoslavia [YU]	P1135/66	1135/66	
Zambia [ZM]	142/70	142/70	
Argentina [AR]	231790	231790	
Australia [AU]	59195/69	59195/69	Long series spread over several years. New series started in 1970.
Belgium [BE]	96469	96469	Application numbers are not presented on published patent documents or given in an official gazette. A series of parallel numbers is provided to each of 10 offices which, respectively, may receive applications (control office + 9 provincial bureaus) and assign application numbers. Series was started in 1958. Since an application number does not uniquely identify a BE document, the patent number is often cited as the "priority application number."
Brazil [BR]	222986	222986	
Bulgaria [BG]	11572	11572	
Canada [CA]	103828	103828	
Colombia [CO]	126050	126050	

**Table II—Countries Using Other Than Application Number Series**

Country #	Example of application number at source	Minimum significant part of the number	Remarks
Brazil [BR]	222986	222986	
Bulgaria [BG]	11572	11572	
Canada [CA]	103828	103828	
Colombia [CO]	126050	126050	
Cuba [CU]	33384	33384	
German (Dem. Rep.) [DD]	AP84c/ 137355 WP135b/ 147203	137355 147203	AP=Ausschliessungspatent; WP=Wirtschaftspatent. The other symbols before the slash are classification symbols. A single numbering series covers both AP and WP applications.
Greece [GR]	44114	44114	
Hungary [HU]	OE 107	OE 107	The letters preceding the number are essential for identifying the application. They are the first letter and the first following vowel of the applicant's name. There is a separate numbering sequence for each pair of letters.
Israel [IL]	35691	35691	
Luxembourg [LU]	60093	60093	
Mexico [MX]	123723	123723	
Monaco [MC]	908	908	
New Zealand [NZ]	161732	161732	
OAPI [OA]	52118	52118	
Philippines [PH]	11929	11929	
Poland [PO]	P144826 44987	144826 D44987	

Country #	Example of application number at source	Minimum significant part of the number	Remarks
Portugal [PT]	P52-555-5607	52555 D5607	
Romania [RO]	65211	65211	
Soviet Union	1397205-15	1397205	The numbers following the slash denote the examination division and a processing division.
United States [US]	889877	889877	The highest number assigned in the series of numbers started in January 1960. New series started in January 1970, January 1979, D January 1987, January 1993, and January 1998.

# ICIREPAT Country Code is indicated in brackets, e.g., [AR].

D In order to distinguish utility model applications from patent applications, it is necessary to identify them as to type of application in citations or references. This may be done by using the name of the application type in conjunction with the number or by using the symbol "U" in brackets or other enclosure following the number.

## 201.15 Right of Priority, Overcoming a Reference

The only times during *ex parte* prosecution that the examiner considers the merits of an applicant's claim of priority is when a reference is found with an effective date between the date of the foreign filing and the date of filing in the United States and when an interference situation is under consideration. If at the time of making an action the examiner has found such an intervening reference, he or she simply rejects whatever claims may be considered unpatentable thereover, without paying any attention to the priority date (assuming the papers have not yet been filed). The applicant in his or her reply may argue the rejection if it is of such a nature that it can be argued, or present the foreign papers for the purpose of overcoming the date of the reference. If the applicant argues the reference, the examiner, in the next action in the application, may specifically require the foreign papers to be filed in addition to repeating the rejection if it is still considered applicable, or he or she may merely continue the rejection.

Form paragraph 2.19 may be used in this instance.

### ¶ 2.19 Overcome Rejection by Translation

Applicant cannot rely upon the foreign priority papers to overcome this rejection because a translation of said papers has not been made of record in accordance with 37 CFR 1.55. See MPEP § 201.15.

### Examiner Note:

This paragraph should follow a rejection based on an intervening reference.

In those cases where the applicant files the foreign papers for the purpose of overcoming the effective date of a reference, a translation is required if the foreign papers are not in the English language. When the examiner requires the filing of the papers, the translation should also be required at the same time. This translation must be filed together with a statement that the translation of the certified copy is accurate. When the necessary papers are filed to overcome the date of the reference, the examiner's action, if he or she determines that the applicant is not entitled to the priority date, is to repeat the rejection on the reference, stating the reasons why the applicant is not considered entitled to the date. If it is determined that the applicant is entitled to the date, the rejection is withdrawn in view of the priority date.

If the priority papers are already in the file when the examiner finds a reference with the intervening effective date, the examiner will study the papers, if they are in the English language, to determine if the applicant is entitled to their date. If the applicant is found to be entitled to the date, the reference is simply not used but may be cited to applicant on form PTO-892. If the applicant is found not entitled to the date, the unpatentable claims are rejected on the reference with an explanation. If the papers are not in the English language and there is no translation, the examiner may reject the unpatentable claims and at the same time require an English translation for the purpose of determining the applicant's right to rely on the foreign filing date.

The foreign application may have been filed by and in the name of the assignee or legal representative or agent of the inventor, as applicant. In such cases, if the certified copy of the foreign application corresponds with the one identified in the oath or declaration as required by 37 CFR 1.63 and no discrepancies appear, it may be assumed that the inventors are entitled to the claim for priority. If there is disagreement as to inventors on the certified copy, the priority date should be refused until the inconsistency or disagreement is resolved.

The most important aspect of the examiner's action pertaining to a right of priority is the determination of the identity of invention between the U.S. and the foreign applications. The foreign application may be considered in the same manner as if it had been filed in this country on the same date that it was filed in the foreign country, and the applicant is ordinarily entitled to any claims based on such foreign application that he or she would be entitled to under our laws and practice. The foreign application must be examined for the question of sufficiency of the disclosure under 35 U.S.C. 112, as well as to determine if there is a basis for the claims sought.

In applications filed from the United Kingdom there may be submitted a certified copy of the "provisional specification," which may also in some cases be accompanied by a copy of the "complete specification." The nature and function of the United Kingdom provisional specification is described in an article in the Journal of the Patent Office Society of November 1936, pages 770-774. According to United Kingdom law the provisional specification need not contain a

complete disclosure of the invention in the sense of 35 U.S.C. 112, but need only describe the general nature of the invention, and neither claims nor drawings are required. Consequently, in considering such provisional specifications, the question of completeness of disclosure is important. If it is found that the United Kingdom provisional specification is insufficient for lack of disclosure, reliance may then be had on the complete specification and its date, if one has been presented, the complete specification then being treated as a different application and disregarded as to the requirement to file within 1 year.

In some instances, the specification and drawing of the foreign application may have been filed at a date subsequent to the filing of the petition in the foreign country. Even though the petition is called the application and the filing date of this petition is the filing date of the application in a particular country, the date accorded here is the date on which the specification and drawing were filed.

It may occasionally happen that the U.S. application will be found entitled to the filing date of the foreign application with respect to some claims and not with respect to others. Occasionally a sole or joint applicant may rely on two or more different foreign applications and may be entitled to the filing date of one of them with respect to certain claims and to another with respect to other claims.

### **201.16 Using Certificate of Correction to Perfect Claim for Priority Under 35 U.S.C. 119(a)-(d) or (f) [R-1]**

*35 U.S.C. 119. Benefit of Earlier Filing Date; Right of Priority.*

\*\*\*\*\*

(b)(1) No application for patent shall be entitled to this right of priority unless a claim is filed in the Patent and Trademark Office, identifying the foreign application by specifying the application number on that foreign application, the intellectual property authority or country in or for which the application was filed, and the date of filing the application, at such time during the pendency of the application as required by the Director.

(2) The Director may consider the failure of the applicant to file a timely claim for priority as a waiver of any such claim. The Director may establish procedures, including the payment of a surcharge, to accept an unintentionally delayed claim under this section.

(3) The Director may require a certified copy of the original foreign application, specification, and drawings upon which it is based, a translation if not in the English language, and such other information as the Director considers necessary. Any such certification shall be made by the foreign intellectual property authority in which the foreign application was filed and show the date of the application and of the filing of the specification and other papers.

\*\*\*\*\*

The failure to perfect a claim to foreign priority benefit prior to issuance of the patent may be cured by filing a reissue application. *Brenner v. State of Israel*, 400 F.2d 789, 158 USPQ 584 (D.C. Cir. 1968).

However, under certain conditions, this failure may also be cured by filing a certificate of correction request under 35 U.S.C. 255 and 37 CFR 1.323. For example, in the case of *In re Van Esdonk*, 187 USPQ 671 (Comm'r Pat. 1975), the Commissioner granted a request to issue a certificate of correction in order to perfect a claim to foreign priority benefits. In that case, a claim to foreign priority benefits had not been filed in the application prior to issuance of the patent. However, the application was a continuation of an earlier application in which the requirements of 35 U.S.C. 119(a)-(d) or (f) had been satisfied. Accordingly, the Commissioner held that the "applicants' perfection of a priority claim under 35 U.S.C. 119 in the parent application will satisfy the statute with respect to their continuation application."

Although *In re Van Esdonk* involved the patent of a continuation application filed under former 37 CFR 1.60, it is proper to apply the holding of that case in similar factual circumstances to any patented application having benefits under 35 U.S.C. 120. This is primarily because a claim to foreign priority benefits in a continuing application, where the claim has been perfected in the parent application, constitutes in essence a mere affirmation of the applicant's previously expressed desire to receive benefits under 35 U.S.C. 119(a)-(d) or (f) for subject matter common to the foreign, parent, and continuing applications.

In summary, a certificate of correction under 35 U.S.C. 255 and 37 CFR 1.323 may be requested and issued in order to perfect a claim for foreign priority benefit in a patented continuing application if the requirements of 35 U.S.C. 119(a)-(d) or (f) had been satisfied in the parent application prior to issuance of the patent and the requirements of 37 CFR 1.55(a) are met. Furthermore, if the continuing application (other

than a design application), which issued as a patent, was filed on or after November 29, 2000 \*\*, in addition to the filing of a certificate of correction request, patentee must also file a petition for an unintentionally delayed foreign priority claim under 37 CFR 1.55(c).

However, a claim to foreign priority benefits cannot be perfected via a certificate of correction if the requirements of 35 U.S.C. 119(a)-(d) or (f) had not been satisfied in the patented application, or its parent, prior to issuance and the requirements of 37 CFR 1.55(a) are not met. In this latter circumstance, the claim to foreign priority benefits can be perfected only by way of a reissue application in accordance with the rationale set forth in *Brenner v. State of Israel*, 158 USPQ 584.

\*>If the original application, which issued as the patent, was filed under 35 U.S.C. 111(a) (other than a design application) on or after November 29, 2000, a claim for priority under 35 U.S.C. 119(a)-(d) or (f) for the benefit of a prior foreign application may be added (or corrected) in \*the< issued patent by reissue or certificate of correction (assuming the conditions for reissue or certificate of correction are otherwise met)\*\*. In addition to the filing of a reissue application or a request for a certificate of correction, a petition to accept a delayed claim for priority under 35 U.S.C. 119(a)-(d) or (f) along with the surcharge as set forth in 37 CFR 1.17(t) and a statement that the entire delay between the date the claim was due under 37 CFR 1.55(a)(1) and the date the claim was filed was unintentional must be submitted. See 37 CFR 1.55(c).

## 202 Cross-Noting

### 202.01 In Specification [R-1]

37 CFR 1.78. *Claiming benefit of earlier filing date and cross references to other applications.*

\*\*>

(a)(1) A nonprovisional application or international application designating the United States of America may claim an invention disclosed in one or more prior-filed copending nonprovisional applications or international applications designating the United States of America. In order for an application to claim the benefit of a prior-filed copending nonprovisional application or international application designating the United States of America, each prior-filed application must name as an inventor at least one inventor named in the later-filed application and disclose the named inventor's invention claimed in at least one claim of the

later-filed application in the manner provided by the first paragraph of 35 U.S.C. 112. In addition, each prior-filed application must be:

(i) An international application entitled to a filing date in accordance with PCT Article 11 and designating the United States of America; or

(ii) Complete as set forth in § 1.51(b); or

(iii) Entitled to a filing date as set forth in § 1.53(b) or § 1.53(d) and include the basic filing fee set forth in § 1.16; or

(iv) Entitled to a filing date as set forth in § 1.53(b) and have paid therein the processing and retention fee set forth in § 1.21(l) within the time period set forth in § 1.53(f).

(2)(i) Except for a continued prosecution application filed under § 1.53(d), any nonprovisional application claiming the benefit of one or more prior-filed copending nonprovisional applications or international applications designating the United States of America must contain or be amended to contain a reference to each such prior-filed application, identifying it by application number (consisting of the series code and serial number) or international application number and international filing date and indicating the relationship of the applications. Cross references to other related applications may be made when appropriate (see § 1.14).

(ii) This reference must be submitted during the pendency of the later-filed application. If the later-filed application is an application filed under 35 U.S.C. 111(a), this reference must also be submitted within the later of four months from the actual filing date of the later-filed application or sixteen months from the filing date of the prior-filed application. If the later-filed application is a nonprovisional application which entered the national stage from an international application after compliance with 35 U.S.C. 371, this reference must also be submitted within the later of four months from the date on which the national stage commenced under 35 U.S.C. 371 (b) or (f) in the later-filed international application or sixteen months from the filing date of the prior-filed application. These time periods are not extendable. Except as provided in paragraph (a)(3) of this section, the failure to timely submit the reference required by 35 U.S.C. 120 and paragraph (a)(2)(i) of this section is considered a waiver of any benefit under 35 U.S.C. 120, 121, or 365(c) to such prior-filed application. The time periods in this paragraph do not apply if the later-filed application is:

(A) An application for a design patent;

(B) An application filed under 35 U.S.C. 111 (a) before November 29, 2000; or

(C) A nonprovisional application which entered the national stage after compliance with 35 U.S.C. 371 from an international application filed under 35 U.S.C. 363 before November 29, 2000.

(iii) If the later-filed application is a nonprovisional application, the reference required by this paragraph must be included in an application data sheet (§ 1.76), or the specification must contain or be amended to contain such reference in the first sentence following the title.

(iv) The request for a continued prosecution application under § 1.53(d) is the specific reference required by 35 U.S.C. 120 to the prior-filed application. The identification of an

application by application number under this section is the identification of every application assigned that application number necessary for a specific reference required by 35 U.S.C. 120 to every such application assigned that application number.<

\*\*\*\*\*

Where an applicant in a nonprovisional application filed under 37 CFR 1.53(b) prior to November 29, 2000 seeks to claim the benefit under 35 U.S.C. 120 or 121 of a continued prosecution application (CPA) filed under 37 CFR 1.53(d), 37 CFR 1.78(a)(2) requires a reference to the CPA by application number in the first sentence of the specification of such application. For a nonprovisional application filed on or after November 29, 2000, unless the reference required by 37 CFR 1.78(a)(2) is included in an application data sheet (37 CFR 1.76), the specification must contain or be amended to contain such reference in the first sentence of the specification. 37 CFR 1.78(a)(2) also provides that “[t]he identification of an application by application number under this section is the specific reference required by 35 U.S.C. 120 to every application assigned that application number.” Thus, where a referenced CPA is in a chain of CPAs, this reference will constitute a reference under 35 U.S.C. 120 and 37 CFR 1.78(a)(2) to every CPA in the chain as well as the noncontinued prosecution application originally assigned such application number. Applicants are not permitted to delete such a claim for benefit under 35 U.S.C. 120 as to certain applications assigned that application number (e.g., for patent term purposes).

\*\*

There is seldom a reason for one application to refer to another application with no common applicant where the applications are not assigned to a common assignee. Such reference ordinarily should not be permitted.

See also 37 CFR 1.78 and MPEP § 201.11.

## **202.02 Notation \*>in< File \*>History< Regarding Prior U.S. Applications, Including Provisional Applications [R-2]**

>For Image File Wrapper (IFW) processing, see the IFW Manual.< The heading of a printed patent includes all identifying parent data of continuation-in-part, continuation, divisional, substitute, and reissue

applications, as well as any provisional application from which priority is claimed. Therefore, the identifying data of all parent or prior applications, when given in the specification>,< must be inserted by the examiner in black ink on the file wrapper \*>or< for applications with the 09/ series >or IFW applications<, on the PALM bib-data sheet\* in the case of a DIVISION, a CONTINUATION, a CONTINUATION-IN-PART and, whether given in the specification or not, in the case of a SUBSTITUTE application. >Only these terms should be used to specify the relationship between applications.< Similarly, the application number of any provisional application from which priority is claimed should be printed on the file wrapper or on the PALM bib-data sheet for 09/ series >or IFW< applications.

The heading of a printed patent issuing on a continued prosecution application (CPA) filed under 37 CFR 1.53(d) will identify the application number and filing date of the most recent noncontinued prosecution application (but not the filing date of the CPA) as well as all parent application data from which priority was claimed in the most recent noncontinued prosecution application.

Where parent or prior application data, including provisional application data, is preprinted on the file wrapper or on the PALM bib-data sheet for 09/ series >or IFW< applications, the examiner should check that data for accuracy, including whether the application is, in fact, copending with the parent nonprovisional application or applications of which priority is claimed. If applicant claims benefit under 35 U.S.C.119(e) to a prior provisional application, and states that the provisional application claims priority to earlier domestic or foreign application(s), the earlier application(s) should not be reflected on the file wrapper or PALM bib-data sheet because a provisional application is not entitled to the right of priority of any other application. See 35 U.S.C. 111(b)(7).

Where the data is correct, the examiner should initial the file wrapper or the PALM bib-data sheet \*\*>as appropriate< in the provided space. Should there be error in the preprinted parent application data, the application should be forwarded to the Office of Initial Patent Examination (OIPE) Customer Corrections for correction or entry of the data in the PALM data base, accompanied by a completed OIPE Data Base Routing Slip. For 09/ series >or IFW<

applications, it will not be necessary to forward the application to OIPE for correction of the parent application data in PALM. The correction or entry of the data in the PALM data base can be made by technical support staff of the Technology Center. Upon entry of the data, a new PALM bib-data sheet should be printed and placed in the file\*\*>.<

>The examiner should check the< status of the parent application, but not a provisional application, >and< should \*\*>indicate< if it has been patented\*> or< abandoned\*\*. Note MPEP § 1302.04(f). The “None” boxes must be marked when no parent or prior application information is present on the file wrappers containing such boxes. This should be done no later than the first action.

The inclusion of parent or prior application information in the heading does not necessarily indicate that the claims are entitled to the benefit of the earlier filing date.

See MPEP § 306 for work done by the Assignment Division pertaining to these particular types of applications.

In the situation in which there has been no reference to a parent application because the benefit of its filing date is not desired, no notation as to the parent application is made on the face of the file wrapper or on the PALM bib-data sheet for 09/ series >or IFW< applications.

### **202.03 Notation on File Wrapper When Priority Is Claimed for Foreign Application [R-2]**

\*\*>For Image File Wrapper (IFW) processing, see the IFW Manual. A pre-printed< file wrapper \*\*>label< or PALM bib-data sheet (for 09/ series >or IFW< applications) >should< include \*\*>the application number, country (or intellectual property authority), day, month, and year of each foreign application that the U.S. application is claiming the benefit of<. The examiner should check this information for accuracy. Should there be error, the examiner should make the appropriate corrections directly on the file wrapper or on the PALM bib-data sheet \*\*>, and have the information corrected in the Office computer systems by forwarding the information either to the Office of Initial Patent Examination Customer Corrections, accompanied by a completed Application Branch Data Base Routing Slip (if the application has a com-

puter printed label and is an 08/ or earlier series application), or to the examiner’s Legal Instrument Examiner, with an explanation of the correction to be made<. The examiner should initial the file wrapper or the PALM bib-data sheet in the “VERIFIED” space provided when the information is correct or has been amended to be correct. However, the examiner must still indicate on the Office action and on the file wrapper or on the PALM bib-data sheet whether the conditions of 35 U.S.C. 119(a)-(d) or (f) have been met.

If the filing dates of several foreign applications are claimed (see MPEP § 201.15, last paragraph) and satisfactory papers have been received for each, information respecting each of the foreign applications is to be entered on the face of the file wrapper or on the PALM bib-data sheet.

The front page of the patent when it is issued, and the listing in the *Official Gazette*, will refer to the claim of priority, giving the country, the filing date, and the number of the foreign application in those applications in which the face of the file or the PALM bib-data sheet has been endorsed.

### **202.04 In Oath or Declaration [R-2]**

As will be noted by reference to MPEP § 201.14, 37 CFR 1.63 requires that the oath or declaration \*\*>must identify any foreign application for patent (or inventor’s certificate) for which a claim for priority is made pursuant to 37 CFR 1.55, and any foreign application having a filing date before that of the application on which priority is claimed, by specifying the application number, country, day, month, and year of its filing, unless such information is supplied on an application data sheet in accordance with 37 CFR 1.76.<

### **202.05 In Case of Reissues**

37 CFR 1.179 requires that a notice be placed in the file of an original patent for which an application for reissue has been filed. See MPEP § 1431.

## **203 Status of Applications**

### **203.01 New [R-2]**

A “new” application is a nonprovisional \*>application< that has not yet received an action by the examiner. An amendment filed prior to the first Office



Action does not alter the status of a “new” application.

### **203.02 Rejected**

A nonprovisional application which, during its prosecution in the examining group and before allowance, contains an unanswered examiner’s action is designated as a “rejected” application. Its status as a “rejected” application continues as such until acted upon by the applicant in reply to the examiner’s action (within the allotted reply period), or until it becomes abandoned.

### **203.03 Amended [R-2]**

An “amended” \*\* nonprovisional application is one that having been acted on by the examiner, has in turn been acted on by the applicant in reply to the examiner’s action. The applicant’s reply may be confined to an election, a traverse of the action taken by the examiner or may include an amendment of the application.

### **203.04 Allowed or in Issue [R-2]**

An “allowed” nonprovisional application or an application “in issue” is one which, having been examined, is passed to issue as a patent, subject to payment of the issue fee. Its status as an “allowed” application continues from the date of the notice of allowance until it is withdrawn from issue or until it issues as a patent or becomes abandoned, as provided in 37 CFR 1.316.

The files of allowed applications are kept in the \*\*>Office of Patent Publication. For Image File Wrapper (IFW) processing, see the IFW Manual<.

### **203.05 Abandoned**

An abandoned application is, *inter alia*, one which is removed from the Office docket of pending applications:

(A) through formal abandonment by the applicant (acquiesced in by the assignee if there is one) or by the attorney or agent of record;

(B) through failure of applicant to take appropriate action at some stage in the prosecution of a non-provisional application;

(C) for failure to pay the issue fee (MPEP § 203.07, § 711 to § 711.05); or

(D) in the case of a provisional application, no later than 12 months after the filing date of the provisional application (see MPEP § 711.03(c) and 35 U.S.C. 111 (b) (5)).

### **203.06 Incomplete**

An application lacking some of the essential parts and not accepted for filing is termed an incomplete application. (MPEP § 506, § 506.01 and § 601.01(d)-(g)).

### **203.07 Abandonment for Failure to Pay Issue Fee [R-2]**

An allowed application in which the Issue Fee is not paid within 3 months after the Notice of Allowance in accordance with 35 U.S.C. 151 is abandoned for that reason (37 CFR 1.316). The issue fee may, however, be accepted by the \*>Director< if on petition it is shown that the delay in payment was unavoidable and >upon< payment of the fee for delayed payment of the issue fee under 37 CFR 1.17(l), in which case the patent will issue as though no abandonment had occurred (MPEP § 711.03(c)). (37 CFR 1.137(a)). The issue fee may also be accepted if on petition it is shown that the delay in payment was unintentional and upon payment of the fee for delayed payment of the issue fee under 37 CFR 1.17(m) (37 CFR 1.137(b)).

### **203.08 Status Inquiries [R-2]**

>

#### **I. < NEW APPLICATION**

Current examining procedures now provide for the routine mailing from the Technology Centers (TCs) of Form PTOL-37 in *every* case of allowance of an application. Thus, the mailing of a form PTOL-37 in addition to a formal Notice of Allowance (PTOL-85) in all allowed applications would seem to obviate the need for status inquiries even as a precautionary measure where the applicant may believe his or her new application may have been passed to issue on the first examination. However, as an exception, a status inquiry would be appropriate where a Notice of Allowance is not received within three months from receipt of form PTOL-37.

Current examining procedures also aim to minimize the spread in dates among the various examiner

dockets of each art unit and TC with respect to actions on new applications. Accordingly, the dates of the “oldest new applications” appearing in the *Official Gazette* are fairly reliable guides as to the expected time frames of when the examiners reach the applications or action.

Therefore, it should be rarely necessary to query the status of a new application.

>

## II. < AMENDED APPLICATIONS

Amended applications are expected to be taken up by the examiner and an action completed within two months of the date the examiner receives the application. Accordingly, a status inquiry is not in order after reply by the attorney until 5 or 6 months have elapsed with no response from the Office.> However, in the event that a six month period has elapsed, and no response from the Office is received, applicant should inquire as to the status of the application to avoid potential abandonment. Applicants are encouraged to use PAIR to make status inquiries. See subsection III below.< A >stamped< postcard receipt for replies to Office actions, adequately and specifically identifying the papers filed, will be considered *prima facie* proof of receipt of such papers. >See MPEP § 503.< Where such proof indicates the timely filing of a reply, the submission of a copy of the postcard with a copy of the reply will ordinarily obviate the need for a petition to revive. Proof of receipt of a timely reply to a final action will obviate the need for a petition to revive only if the reply was in compliance with 37 CFR 1.113.

>

## III. < IN GENERAL

>Applicants are encouraged, where appropriate, to check Patent Application Information Retrieval (PAIR) (<http://pair.uspto.gov>) which provides applicants direct secure access to their own patent application status information, as well as to general patent information publicly available. See MPEP § 1730.< Inquiries as to the status of applications, by persons entitled to the information, should be answered promptly. Simple letters of inquiry regarding the status of applications will be transmitted from the Office of Initial Patent Examination\* to the TCs for direct action. Such letters will be stamped “Status Letters.”

If the correspondent is not entitled to the information, in view of 37 CFR 1.14, he or she should be so informed. For Congressional and other official inquiries, see MPEP § 203.08(a).

Telephone inquiries regarding the status of applications, by persons entitled to the information, should be directed to the TC technical support personnel and not to the examiners \*\*>, since< the technical support personnel can readily provide status information without contacting the examiners.

See also MPEP § 102 regarding status information.

### *Processing Status Letters by the TCs*

(A) All status letters sent to a TC will be delivered to a designated location (e.g., Customer Service Office) within the TC for action. Status requests with respect to PCT applications are to be processed by the PCT Legal Division and should be forwarded to that office for reply. Status information regarding an application identified in a published patent document should be forwarded to the File Information Unit for reply. See MPEP § 102.

(B) A designated representative of the TC will review the status letter to determine the nature of the request and whether the requester is entitled to receive the requested information. PALM Intranet should be used to determine whether the requester is entitled to the information. If after reviewing the information in PALM it is not clear whether the requester is entitled to receive the information requested, the TC representative should review the application file to resolve the issue.

(C) The TC representative will determine the appropriate reply to the status letter by

- (1) using PALM Intranet to determine the status of the application,
- (2) reviewing the new application dates within the TC,
- (3) reviewing any tracking system for the particular item or action at issue,
- (4) discussing the matter with the supervisory patent examiner or the examiner in charge of the application, or
- (5) when necessary, reviewing the application file.

The TC representative should discuss the matter with an appropriate resource person in the TC if it is not clear what the reply should be.

(D) The TC representative may reply to a status letter, other than an inquiry directed to an abandoned application, by placing a telephone call to the attorney or agent of record. If the status letter requests a date of expected action, the reply should make clear that the date provided is only an "expected" date of when the examiner will take action on the application. If the requester requests that the Office provide a written reply to the status letter, the reply may be faxed (preferable) or mailed (only if requested) to the correspondence address.

(E) The TC representative will note the reply to the status inquiry on the status letter with the initials of the TC representative and the date that the reply was completed.

(F) All TCs will employ the Status Letter Database to track the progress of the status letters. The TC will retain a record of the reply to the status letter. The record includes the entry of the information concerning the status letter and the reply into the Status Letter Database.

(G) After the information has been entered into the Status Letter Database, the status letter along with the reply must be associated with the application file (including abandoned applications).

**203.08(a) Congressional and Other Official Inquiries [R-2]**

Correspondence and inquiries from the White House, Members of Congress, embassies, and heads

of Executive departments and agencies normally are cleared through the Office of International Relations and/or the Office of Congressional Relations.

When persons from the designated official sources request services from the Office, or information regarding the business of the Office, they should, under long-standing instructions, be referred, at least initially, to a staff member in the appropriate office.

This procedure is used so that there will be uniformity in the handling of contacts from the indicated sources, and also so that compliance with directives of the Department of Commerce is attained.

Inquiries referred to in this section such as correspondence from embassies, the Office of the U.S. Trade Representative, and the Department of State should immediately be transmitted to the Director of the Office of International Relations by messenger, and a staff member of that office should be notified by phone that such correspondence has been received. Inquiries referred to in this section, such as correspondence from Congress or the White House, should immediately be transmitted to the Director of the Office of Congressional Relations by messenger, and the a staff member of that office should be notified by phone that such correspondence has been received.



# Chapter 300 Ownership and Assignment

- 301 Ownership/Assignability of Patents and Applications**
  - 301.01 Accessibility of Assignment Records
- 302 Recording of Assignment Documents**
  - 302.01 Assignment Document Must Be Original or True Copy for Recording
  - 302.02 Translation of Assignment Document
  - 302.03 Identifying Patent or Application
  - 302.04 Foreign Assignee May Designate Domestic Representative
  - 302.05 Address of Assignee
  - 302.06 Fee for Recording
  - 302.07 Assignment Document Must Be Accompanied by a Cover Sheet
  - 302.08 Mailing Address for Submitting Assignment Documents
  - 302.09 Facsimile Submission of Assignment Documents
- 303 Assignment Documents Not Endorsed on Pending Applications**
- 306 Assignment of Division, Continuation, Substitute, and Continuation-in-Part in Relation to Parent Application**
  - 306.01 Assignment of an Application Claiming the Benefits of a Provisional Application
- 307 Issue to Assignee**
- 309 Restrictions Upon Employees of Patent and Trademark Office**
- 310 Government License Rights to Contractor-Owned Inventions Made Under Federally Sponsored Research and Development**
- 311 Filing of Notice of Arbitration Awards**
- 313 Recording of Licenses, Security Interests, and Other Documents Other Than Assignments**
- 314 Certificates of Change of Name or of Merger**
- 315 Indexing Against a Recorded Certificate**
- 317 Handling of Documents in the Assignment Division**
  - 317.01 Recording Date
  - 317.02 Correction of Returned Documents and Cover Sheets
  - 317.03 Effect of Recording
- 318 Documents Not to be Placed in Files**
- 320 Title Reports**
- 323 Procedures for Correcting Errors in Recorded Assignment Document**
  - 323.01 Correction of Error in Recorded Cover Sheet
- 324 Establishing Right of Assignee to Take Action**

## 301 Ownership/Assignability of Patents and Applications

### 35 U.S.C. 261. *Ownership; assignment.*

Subject to the provisions of this title, patents shall have the attributes of personal property.

Applications for patent, patents, or any interest therein, shall be assignable in law by an instrument in writing. The applicant, patentee, or his assigns or legal representatives may in like manner grant and convey an exclusive right under his application for patent, or patents, to the whole or any specified part of the United States.

A certificate of acknowledgment under the hand and official seal of a person authorized to administer oaths within the United States, or, in a foreign country, of a diplomatic or consular officer of the United States or an officer authorized to administer oaths whose authority is proved by a certificate of a diplomatic or consular officer of the United States, or apostille of an official designated by a foreign country which, by treaty or convention, accords like effect to apostilles of designated officials in the United States, shall be prima facie evidence of the execution of an assignment, grant, or conveyance of a patent or application for patent.

An assignment, grant, or conveyance shall be void as against any subsequent purchaser or mortgagee for valuable consideration, without notice, unless it is recorded in the Patent and Trademark Office within three months from its date or prior to the date of such subsequent purchase or mortgage.

### 35 U.S.C. 262. *Joint owners.*

In the absence of any agreement to the contrary, each of the joint owners of a patent may make, use, offer to sell, or sell the patented invention within the United States, or import the patented invention into the United States, without the consent of and without accounting to the other owners.

### 37 CFR 3.1. *Definitions.*

For purposes of this part, the following definitions shall apply:

*Application* means a national application for patent, an international application that designates the United States of America, or an application to register a trademark unless otherwise indicated.

*Assignment* means a transfer by a party of all or part of its right, title and interest in a patent or patent application, or a transfer of its entire right, title and interest in a registered mark or a mark for which an application to register has been filed.

*Document* means a document which a party requests to be recorded in the Office pursuant to § 3.11 and which affects some interest in an application, patent, or registration.

*Office* means the Patent and Trademark Office.

*Recorded document* means a document which has been recorded in the Office pursuant to § 3.11.

*Registration* means a trademark registration issued by the Office.

## OWNERSHIP

Ownership of a patent gives the patent owner the right to exclude others from making, using, offering

for sale, selling, or importing into the United States the invention claimed in the patent. 35 U.S.C. 154(a)(1). Ownership of the patent does not furnish the owner with the **right** to make, use, offer for sale, sell, or import the claimed invention because there may be other legal considerations precluding same (e.g., existence of another patent owner with a dominant patent, failure to obtain FDA approval of the patented invention, an injunction by a court against making the product of the invention, or a national security related issue).

The ownership of the patent (or the application for the patent) initially vests in the named inventors of the invention of the patent. See *Beech Aircraft Corp. v. EDO Corp.*, 990 F.2d 1237, 1248, 26 USPQ2d 1572, 1582 (Fed. Cir. 1993). The patent (or patent application) is then assignable by an instrument in writing, and the assignment of the patent, or patent application, transfers to the assignee(s) an alienable (transferable) ownership interest in the patent or application. 35 U.S.C. 261.

## ASSIGNMENT

“Assignment,” in general, is the act of transferring to another the ownership of one’s property, i.e., the interest and rights to the property. In 37 CFR 3.1, assignment of patent rights is defined as “a transfer by a party of all or part of its right, title and interest in a patent or patent application...” An assignment of a patent, or patent application, is the transfer to another of a party’s **entire** ownership interest or a percentage of that party’s ownership interest in the patent or application. In order for an assignment to take place, the transfer to another must include the entirety of the bundle of rights that is associated with the ownership interest, i.e., all of the bundle of rights that are inherent in the right, title and interest in the patent or patent application.

## LICENSING

As compared to assignment of patent rights, the licensing of a patent transfers a bundle of rights which is less than the entire ownership interest, e.g., rights that may be limited as to time, geographical area, or field of use. A patent license is, in effect, a contractual agreement that the patent owner will not sue the licensee for patent infringement if the licensee makes, uses, offers for sale, sells, or imports the claimed

invention, as long as the licensee fulfills its obligations and operates within the bounds delineated by the license agreement.

An exclusive license may be granted by the patent owner to a licensee. The exclusive license prevents the patent owner (or any other party to whom the patent owner might wish to sell a license) from competing with the exclusive licensee, as to the geographic region, the length of time, and/or the field of use, set forth in the license agreement.

A license is not an assignment of the patent. Even if the license is an exclusive license, it is **not** an assignment of patent rights in the patent or application.

## INDIVIDUAL AND JOINT OWNERSHIP

Individual ownership - An individual entity may own the entire right, title and interest of the patent property. This occurs where there is only one inventor, and the inventor has not assigned the patent property. Alternatively, it occurs where all parties having ownership interest (all inventors and assignees) assign the patent property to one party.

Joint ownership - Multiple parties may **together** own the entire right, title and interest of the patent property. This occurs when any of the following cases exist:

- (A) Multiple partial assignees of the patent property;
- (B) Multiple inventors who have not assigned their right, title and interest; or
- (C) A combination of partial assignee(s), and inventor(s) who have not assigned their right, title and interest.

Each individual inventor may only assign the interest he or she holds; thus, assignment by one joint inventor renders the assignee a partial assignee. A partial assignee likewise may only assign the interest it holds; thus, assignment by a partial assignee renders a subsequent assignee a partial assignee. All parties having any portion of the ownership in the patent property must act **together** as a composite entity in patent matters before the Office.

## MAKING THE ASSIGNMENT OF RECORD

An assignment can be made of record in the United States Patent and Trademark Office (Office) in two

different ways, for two different purposes. The differences are important to note:

(A) An assignment can be made of record in the assignment records of the Office. Recordation of the assignment provides legal notice to the public of the assignment. It should be noted that recording of the assignment is merely a ministerial act; it is not an Office determination of the validity of the assignment document nor the effect of the assignment document on the ownership of the patent property. See 37 CFR 3.54 and MPEP § 317.03; and

(B) An assignment can be made of record in the file of a patent application, patent, or other patent proceeding (e.g., reexamination proceeding). This step is necessary to permit the assignee to “take action” in the application, patent, or other patent proceeding under the conditions set forth in 37 CFR 3.73 and MPEP § 324. Recordation of an assignment in the assignment records of the Office does **not**, by itself, permit the assignee to take action in the application, patent, or other patent proceeding.

### 301.01 Accessibility of Assignment Records

*37 CFR 1.12. Assignment records open to public inspection.*

(a)(1) Separate assignment records are maintained in the United States Patent and Trademark Office for patents and trademarks. The assignment records, relating to original or reissue patents, including digests and indexes (for assignments recorded on or after May 1, 1957), published patent applications, and assignment records relating to pending or abandoned trademark applications and to trademark registrations (for assignments recorded on or after January 1, 1955), are open to public inspection at the United States Patent and Trademark Office, and copies of those assignment records may be obtained upon request and payment of the fee set forth in § 1.19 and § 2.6 of this chapter.

(2) All records of assignments of patents recorded before May 1, 1957, and all records of trademark assignments recorded before January 1, 1955, are maintained by the National Archives and Records Administration (NARA). The records are open to public inspection. Certified and uncertified copies of those assignment records are provided by NARA upon request and payment of the fees required by NARA.

(b) Assignment records, digests, and indexes relating to any pending or abandoned patent application which has not been published under 35 U.S.C. 122(b) are not available to the public. Copies of any such assignment records and related information shall be obtainable only upon written authority of the applicant or applicant’s assignee or attorney or agent or upon a showing that the person seeking such information is a bona fide prospective or

actual purchaser, mortgagee, or licensee of such application, unless it shall be necessary to the proper conduct of business before the Office or as provided in this part.

(c) Any request by a member of the public seeking copies of any assignment records of any pending or abandoned patent application preserved in confidence under § 1.14, or any information with respect thereto, must:

(1) Be in the form of a petition including the fee set forth in § 1.17 (h); or

(2) Include written authority granting access to the member of the public to the particular assignment records from the applicant or applicant’s assignee or attorney or agent of record.

(d) An order for a copy of an assignment or other document should identify the reel and frame number where the assignment or document is recorded. If a document is identified without specifying its correct reel and frame, an extra charge as set forth in § 1.21(j) will be made for the time consumed in making a search for such assignment.

Assignment documents relating to patents, published patent applications, registrations of trademarks, and applications for registration of trademarks are open to public inspection.

The Office will not open only certain parts of an assignment document to public inspection. If such a document contains two or more items, any one of which, if alone, would be open to such inspection, then the entire document will be open. Thus, if a document covers either a trademark or a patent in addition to one or more patent applications, it will be available to the public *ab initio*; and if it covers a number of patent applications, it will be so available as soon as any one of them is published or patented. Documents relating only to one or more pending applications for patent which have not been published under 35 U.S.C. 122(b) will not be open to public inspection.

Copies of assignment records relating to pending or abandoned patent applications not published under 35 U.S.C. 122(b) and information related thereto are obtainable upon a showing of written authority from the applicant or applicant’s assignee or from the attorney or agent of either, or upon a showing that the person seeking such information is a *bona fide* prospective or actual purchaser, mortgagee, or licensee of such application.

If the application on which a patent was granted is a division or continuation of an earlier application, the assignment records of that earlier application will be open to public inspection; similar situations involving continuation-in-part applications will be considered

on their individual merits upon petition to the Office of Petitions.

Assignment records relating to reissue applications are open to public inspection.

Requests for abstracts of title for assignments of patents recorded after May 1, 1957, are provided by the Certification Division upon request and payment of fee required in 37 CFR 1.19. Requests for copies of pre-1957 records for patents should be directed to the National Archives and Records Administration (NARA). Since these records are maintained by NARA, it is more expeditious to request copies directly from NARA, rather than from the Office, which would then have to route the requests to NARA. Payment of the fees required by NARA should accompany all requests for copies.

All assignment records from 1837 to April 30, 1957 for patents are now maintained and are open for public inspection in the National Archives Research Room located at the Washington National Records Center Building, 4205 Suitland Road, Suitland, Maryland 20746. Assignment documents recorded before 1837 are maintained at the National Archives and Records Administration, 841 South Pickett Street, Alexandria, Virginia 22304.

### **302 Recording of Assignment Documents**

*37 CFR 3.11. Documents which will be recorded.*

(a) Assignments of applications, patents, and registrations, accompanied by completed cover sheets as specified in §§ 3.28 and 3.31, will be recorded in the Office. Other documents, accompanied by completed cover sheets as specified in §§ 3.28 and 3.31, affecting title to applications, patents, or registrations, will be recorded as provided in this part or at the discretion of the Commissioner.

(b) Executive Order 9424 of February 18, 1944 (9 FR 1959, 3 CFR 1943-1948 Comp., p. 303) requires the several departments and other executive agencies of the Government, including Government-owned or Government-controlled corporations, to forward promptly to the Commissioner of Patents and Trademarks for recording all licenses, assignments, or other interests of the Government in or under patents or patent applications. Assignments and other documents affecting title to patents or patent applications and documents not affecting title to patents or patent applications required by Executive Order 9424 to be filed will be recorded as provided in this part.

*37 CFR 3.58. Governmental registers.*

(a) The Office will maintain a Departmental Register to record governmental interests required to be recorded by Executive Order 9424. This Departmental Register will not be open to

public inspection but will be available for examination and inspection by duly authorized representatives of the Government. Governmental interests recorded on the Departmental Register will be available for public inspection as provided in § 1.12.

(b) The Office will maintain a Secret Register to record governmental interests required to be recorded by Executive Order 9424. Any instrument to be recorded will be placed on this Secret Register at the request of the department or agency submitting the same. No information will be given concerning any instrument in such record or register, and no examination or inspection thereof or of the index thereto will be permitted, except on the written authority of the head of the department or agency which submitted the instrument and requested secrecy, and the approval of such authority by the Commissioner of Patents and Trademarks. No instrument or record other than the one specified may be examined, and the examination must take place in the presence of a designated official of the Patent and Trademark Office. When the department or agency which submitted an instrument no longer requires secrecy with respect to that instrument, it must be recorded anew in the Departmental Register.

Effective September 4, 1992, Part 3 has been added to 37 CFR to set forth Office rules on recording assignments and other documents and the rights of an assignee.

#### **302.01 Assignment Document Must Be Original or True Copy for Recording**

*37 CFR 3.24. Requirements for documents and cover sheets relating to patents and patent applications.*

The document and cover sheet must be legible. Either the original document or a true copy of the original document, may be submitted for recording. Only one side of each page shall be used. The paper used should be flexible, strong, white, non-shiny, durable, and preferably no larger than 21.6 x 33.1 cm. (8 1/2 x 14 inches) with a 2.5 cm. (one-inch) margin on all sides.

The United States Patent and Trademark Office will accept and record only an original, or a true copy of an original assignment or other document. See MPEP § 317.

Certification shall be made by the person submitting a copy of an original document that the document submitted is a true copy of the original. The certification is not required to be in oath or declaration form.

#### **302.02 Translation of Assignment Document**

*37 CFR 3.26. English language requirement.*

The Office will accept and record non-English language documents only if accompanied by an English translation signed by the individual making the translation.

The assignment document, if not in the English language, will not be recorded unless accompanied by an English translation signed by the translator.

### **302.03 Identifying Patent or Application**

*37 CFR 3.21. Identification of patents and patent applications.*

An assignment relating to a patent must identify the patent by the patent number. An assignment relating to a national patent application must identify the national patent application by the application number (consisting of the series code and the serial number, *e.g.*, 07/123,456). An assignment relating to an international patent application which designates the United States of America must identify the international application by the international application number (*e.g.*, PCT/US90/01234). If an assignment of a patent application filed under § 1.53(b) is executed concurrently with, or subsequent to, the execution of the patent application, but before the patent application is filed, it must identify the patent application by its date of execution, name of each inventor, and title of the invention so that there can be no mistake as to the patent application intended. If an assignment of a provisional application under § 1.53(c) is executed before the provisional application is filed, it must identify the provisional application by name of each inventor and title of the invention so that there can be no mistake as to the provisional application intended.

The patent or patent application to which an assignment relates must be identified by patent number or application number unless the assignment is executed concurrently with or subsequent to the execution of the application but before the application is filed. Then, the application must be identified by the date of execution, the name(s) of the inventors, and the title of the invention. If an assignment of a provisional application is executed before the provisional application is filed, it must identify the provisional application by name(s) of the inventors and the title of the invention.

The Office makes every effort to provide applicants with the application numbers for newly filed patent applications as soon as possible. It is suggested, however, that an assignment be written to allow entry of the identifying number after the execution of the assignment. An example of acceptable wording is:

“I hereby authorize and request my attorney, (Insert name), of (Insert address), to insert here in parentheses (Application number \_\_\_\_\_, filed \_\_\_\_\_) the filing date and application number of said application when known.”

### **302.04 Foreign Assignee May Designate Domestic Representative**

*35 U.S.C. 293. Nonresident patentee; service and notice.*

Every patentee not residing in the United States may file in the Patent and Trademark Office a written designation stating the name and address of a person residing within the United States on whom may be served process or notice of proceedings affecting the patent or rights thereunder. If the person designated cannot be found at the address given in the last designation, or if no person has been designated, the United States District Court for the District of Columbia shall have jurisdiction and summons shall be served by publication or otherwise as the court directs. The court shall have the same jurisdiction to take any action respecting the patent or rights thereunder that it would have if the patentee were personally within the jurisdiction of the court.

*37 CFR 3.61. Domestic representative.*

If the assignee of a trademark application or registration is not domiciled in the United States, the assignee must designate, in writing to the Office, a domestic representative. An assignee of a patent application or patent may designate a domestic representative if the assignee is not residing in the United States. The designation shall state the name and address of a person residing within the United States on whom may be served process or notice of proceedings affecting the application, patent or registration or rights thereunder.

An assignee not domiciled in the United States may, by written document signed by such assignee, designate a domestic representative. The designation of domestic representative should always be a paper separate from any assignment document, in order that the paper of designation can be retained in the appropriate application or patent file. Also, there should be a separate paper of designation of representative for each patent or application, so that a designation paper can be placed in each file. The designation of a domestic representative should be directed to the Office of Public Records for processing.

### **302.05 Address of Assignee**

The address of the assignee may be recited in the assignment document and must be given in the required cover sheet. See MPEP § 302.07.

### **302.06 Fee for Recording**

*37 CFR 3.41. Recording fees.*

(a) All requests to record documents must be accompanied by the appropriate fee. Except as provided in paragraph (b) of this section, a fee is required for each application, patent and registration against which the document is recorded as identified in the



cover sheet. The recording fee is set in § 1.21(h) of this chapter for patents and in § 2.6(b)(6) of this chapter for trademarks.

(b) No fee is required for each patent application and patent against which a document required by Executive Order 9424 is to be filed if:

(1) The document does not affect title and is so identified in the cover sheet (see § 3.31(c)(2)); and

(2) The document and cover sheet are mailed to the Office in compliance with § 3.27(b).

The recording fee set forth in 37 CFR 1.21(h) is charged for each patent application and patent identified in the required cover sheet except as provided in 37 CFR 3.41(b).

### **302.07 Assignment Document Must Be Accompanied by a Cover Sheet**

#### *37 CFR 3.28. Requests for recording.*

Each document submitted to the Office for recording must include at least one cover sheet as specified in § 3.31 referring either to those patent applications and patents, or to those trademark applications and registrations, against which the document is to be recorded. If a document to be recorded includes interests in, or transactions involving, both patents and trademarks, separate patent and trademark cover sheets should be submitted. Only one set of documents and cover sheets to be recorded should be filed. If a document to be recorded is not accompanied by a completed cover sheet, the document and the incomplete cover sheet will be returned pursuant to § 3.51 for proper completion. The document and a completed cover sheet should be resubmitted.

#### *37 CFR 3.31. Cover sheet content.*

(a) Each patent or trademark cover sheet required by § 3.28 must contain:

(1) The name of the party conveying the interest;  
 (2) The name and address of the party receiving the interest;

(3) A description of the interest conveyed or transaction to be recorded;

(4) Identification of the interests involved:

(i) For trademark assignments and trademark name changes: Each trademark registration number and each trademark application number, if known, against which the Office is to record the document. If the trademark application number is not known, a copy of the application or a reproduction of the trademark must be submitted, along with an estimate of the date that the Office received the application; or

(ii) For any other document affecting title to a trademark or patent application, registration or patent: Each trademark or patent application number or each trademark registration number or patent against which the document is to be recorded, or an indication that the document is filed together with a patent application;

(5) The name and address of the party to whom correspondence concerning the request to record the document should be mailed;

(6) The date the document was executed;

(7) An indication that the assignee of a trademark application or registration who is not domiciled in the United States has designated a domestic representative (see § 3.61); and

(8) The signature of the party submitting the document.

(b) A cover sheet should not refer to both patents and trademarks, since any information, including information about pending patent applications, submitted with a request for recordation of a document against a trademark application or trademark registration will become public record upon recordation.

(c) Each patent cover sheet required by § 3.28 seeking to record a governmental interest as provided by § 3.11(b) must:

(1) Indicate that the document is to be recorded on the Governmental Register, and, if applicable, that the document is to be recorded on the Secret Register (see § 3.58); and

(2) Indicate, if applicable, that the document to be recorded is not a document affecting title (see § 3.41(b)).

(d) Each trademark cover sheet required by § 3.28 seeking to record a document against a trademark application or registration should include, in addition to the serial number or registration number of the trademark, identification of the trademark or a description of the trademark, against which the Office is to record the document.

(e) Each patent or trademark cover sheet required by § 3.28 should contain the number of applications, patents or registrations identified in the cover sheet and the total fee.

Each assignment document submitted to the Office for recording must be accompanied by a cover sheet as required by 37 CFR 3.28. The cover sheet for patents or patent applications must contain:

(A) The name of the party conveying the interest;  
 (B) The name and address of the party receiving the interest;

(C) A description of the interest conveyed or transaction to be recorded;

(D) Each patent application number or patent number against which the document is to be recorded, or an indication that the document is filed together with a patent application;

(E) The name and address of the party to whom correspondence concerning the request to record the document should be mailed;

(F) The date the document was executed; and

(G) The signature of the party submitting the document.

Each patent cover sheet should contain the number of patent applications or patents identified in the cover sheet and the total fee.

Examples of the type of descriptions of the interest conveyed or transaction to be recorded that can be identified are:

- (A) assignment;
- (B) security agreement;
- (C) merger;
- (D) change of name;
- (E) license;
- (F) foreclosure;
- (G) lien; and
- (H) contract.

Cover sheets required by 37 CFR 3.28 seeking to record a governmental interest must also (1) indicate that the document is to be recorded on the Governmental Register, and, if applicable, that the document is to be recorded on the Secret Register (see 37 CFR 3.58); and (2) indicate, if applicable, that the document to be recorded is not a document affecting title.

A patent cover sheet may not refer to trademark applications or registrations.

Form PTO-1595, Recordation Form Cover Sheet, may be used as the cover sheet for recording documents relating to patent(s) and/or patent application(s) in the Office.

Form PTO-1595 (Rev. 03/01) OMB No. 0651-0027 (exp. 5/31/2002) Tab settings ⇌ ⇌ ⇌	<b>RECORDATION FORM COVER SHEET</b> <b>PATENTS ONLY</b>	U.S. DEPARTMENT OF COMMERCE U.S. Patent and Trademark Office
To the Honorable Commissioner of Patents and Trademarks: Please record the attached original documents or copy thereof.		
1. Name of conveying party(ies):  Additional name(s) of conveying party(ies) attached? <input type="checkbox"/> Yes <input type="checkbox"/> No	2. Name and address of receiving party(ies) Name: _____ Internal Address: _____ _____ _____ Street Address: _____ _____ City: _____ State: _____ Zip: _____ Additional name(s) & address(es) attached? <input type="checkbox"/> Yes <input type="checkbox"/> No	
3. Nature of conveyance: <input type="checkbox"/> Assignment <input type="checkbox"/> Merger <input type="checkbox"/> Security Agreement <input type="checkbox"/> Change of Name <input type="checkbox"/> Other _____ Execution Date: _____		
4. Application number(s) or patent number(s): If this document is being filed together with a new application, the execution date of the application is: _____ A. Patent Application No.(s)                      B. Patent No.(s) Additional numbers attached? <input type="checkbox"/> Yes <input type="checkbox"/> No		
5. Name and address of party to whom correspondence concerning document should be mailed: Name: _____ Internal Address: _____ _____ _____ Street Address: _____ _____ City: _____ State: _____ Zip: _____	6. Total number of applications and patents involved: <input type="text"/> 7. Total fee (37 CFR 3.41).....\$ _____ <input type="checkbox"/> Enclosed <input type="checkbox"/> Authorized to be charged to deposit account 8. Deposit account number: _____ (Attach duplicate copy of this page if paying by deposit account)	
<b>DO NOT USE THIS SPACE</b>		
9. Statement and signature. <i>To the best of my knowledge and belief, the foregoing information is true and correct and any attached copy is a true copy of the original document.</i> _____ Name of Person Signing                      Signature                      Date		
Total number of pages including cover sheet, attachments, and documents: <input type="text"/>		

Mail documents to be recorded with required cover sheet information to:  
 Commissioner of Patents & Trademarks, Box Assignments  
 Washington, D.C. 20231

## Guidelines for Completing Patents Cover Sheets

Cover Sheet information must be submitted with each document to be recorded. If the document to be recorded concerns both patents and trademarks separate patent and trademark cover sheets, including any attached pages for continuing information, must accompany the document. All pages of the cover sheet should be numbered consecutively, for example, if both a patent and trademark cover sheet is used, and information is continued on one additional page for both patents and trademarks, the pages of the cover sheet would be numbered form 1 to 4.

### Item 1. Name of Conveying Party(ies).

Enter the full name of the party(ies) conveying the interest. If there is insufficient space, enter a check mark in the "Yes" box to indicate that additional information is attached. The name of the additional conveying party(ies) should be placed on an attached page clearly identified as a continuation of the information Item 1. Enter a check mark in the "No" box, if no information is contained on an attached page.

### Item 2. Name and Address of Receiving Party(ies).

Enter the name and full address of the first party receiving the interest. If there is more than one party receiving the interest, enter a check mark in the "Yes" box to indicate that additional information is attached. Enter a check mark in the "No" box, if no information is contained on an attached page.

### Item 3. Nature of Conveyance.

Place a check mark in the appropriate box describing the nature of the conveying document. If the "Other" box is checked, specify the nature of the conveyance. Enter the execution date of the document. It is preferable to use the name of the month, or an abbreviation of that name, in order that confusion over dates is minimized.

### Item 4. Application Number(s) or Patent Number(s).

Indicate the application number(s), and/or patent number(s) against which the document is to be recorded. National application numbers must include both the series code and a six-digit number; and international application numbers must be complete, e.g., 07/123,456 for national application numbers, and PCTUS91/12345 for international application numbers. Enter a check mark in the appropriate box: "Yes" or "No" if additional numbers appear on attached pages. Be sure to identify numbers included on attached pages as the continuation of Item 4.

### Item 5. Name and Address of Party to whom correspondence concerning the document should be mailed.

Enter the name and full address of the party to whom correspondence is to be mailed.

### Item 6. Total Applications and Patents involved.

Enter the total number of applications and patents identified for recordation. Be sure to include all applications and patents identified on the cover sheet and on additional pages.

### Block 7. Total Fee Enclosed.

Enter the total fee enclosed or authorized to be charged. A fee is required for each application and patent against which the document is recorded.

### Item 8. Deposit Account Number.

Enter the deposit account number to authorize charges. Attach a duplicate copy of cover sheet to be used for the deposit charge account transaction.

### Item 9. Statement and Signature.

Enter the name of the person submitting the document. The submitter must sign and date the cover sheet, confirming that to the best of the persons knowledge and belief, the information contained on the cover sheet is correct and that any copy of the document is a true copy of the original document. Enter the total number of pages including the cover sheet, attachments, and document.

This collection of information is required by 35 USC 261 and 262 and 15 USC 1057 and 1060. The information is used by the public to submit (and by the USPTO to process) patent and trademark assignment requests. After the USPTO records the information, the records for patent and trademarks, assignments, and other associated documents can be inspected by the public. To view documents recorded under secrecy orders or documents recorded due to the interest of the federal government, a written authorization must be submitted. This collection is estimated to take 30 minutes to complete, including gathering, preparing, and submitting the form to the USPTO. Any comments on the amount of time you require to complete this form and/or suggestions for reducing this burden, should be sent to the Manager of the Assignment Division, Crystal Gateway 4, Room 310, 1213 Jefferson Davis Highway, Arlington, Va. 22202. DO NOT SEND FEES OR COMPLETED FORMS TO THIS ADDRESS. SEND TO: Commissioner of Patents and Trademarks, Box Assignments, Washington, D.C., 20231.

### 302.08 Mailing Address for Submitting Assignment Documents

*37 CFR 3.27. Mailing address for submitting documents to be recorded.*

Documents and cover sheets to be recorded should be addressed to the Commissioner, United States Patent and Trademark Office, Box Assignment, Washington, D.C. 20231, unless they are filed together with new applications or with a request under § 3.81.

37 CFR 3.27 sets out how documents submitted for recording should be addressed to the Office. In order to ensure prompt and proper processing, documents and their cover sheets should be addressed to the Commissioner, United States Patent and Trademark Office, Box Assignment, Washington, D.C. 20231, unless they are filed together with new applications or with a request under 37 CFR 3.81. Requests for recording documents which accompany new applications should be addressed to the Assistant Commissioner for Patents, Washington, D.C. 20231. Requests under 37 CFR 3.81 will be processed by the Office of Patent Publications. Therefore, such requests should be marked to the attention of the Office of Patent Publications and addressed to the Assistant Commissioner for Patents, Washington, D.C. 20231.

### 302.09 Facsimile Submission of Assignment Documents

Assignments and other documents affecting title may be submitted to the Office via facsimile (fax). See MPEP § 1730 for the facsimile number. This process allows customers to submit their documents directly into the automated Patent and Trademark Assignment System and receive the resulting recordation notice at their fax machine. The customer's fax machine must be connected to a dedicated line because recordation notices will be returned automatically to the sending fax number through the Patent and Trademark Assignment System. If the Office system is unable to complete transmission of the recordation notice, the notice will be printed and mailed to the sender by U.S. Postal Service first class mail. Recorded documents will not be returned with the "Notice of Recordation."

Any assignment-related document submitted by facsimile must include:

- (A) an identified application or patent number;
- (B) one cover sheet to record a single transaction; and
- (C) payment of the recordation fee by a USPTO Deposit Account.

The following documents **cannot** be submitted via facsimile:

- (A) Assignments submitted concurrently with newly filed patent applications;
- (B) Documents with two or more cover sheets (e.g., a single document with one cover sheet to record an assignment, and a separate cover sheet to record separately a license relating to the same property);
- (C) Requests for corrections to documents recorded previously;
- (D) Requests for "at cost" recordation services;
- (E) Documents with payment of the recordation fee by credit card; and
- (F) Resubmission of a non-recorded assignment.

The date of receipt accorded to an assignment document sent to the Office by facsimile transmission is the date the complete transmission is received in the Office. See MPEP § 502.01. The benefits of a certificate of transmission under 37 CFR 1.8 are available.

If a document submitted by fax is determined not to be recordable, the entire document, with its associated cover sheet, and the Office "Notice of Non-Recordation" will be transmitted via fax back to the sender. Once corrections are made, the initial submission, amended, may then be resubmitted by mailing the corrected submission to the address set forth in 37 CFR 3.27. Timely resubmission will provide the sender with the benefit of the initial receipt date as the recordation date in accordance with 37 CFR 3.51.

The Patent and Trademark Assignment System assigns reel and frame numbers and superimposes recordation stampings on the processed and stored electronic images. Accordingly, copies of all recorded documents will have the reel and frame numbers and recordation stampings.

### 303 Assignment Documents Not Endorsed on Pending Applications

Certified copies of patent applications as filed do not include an indication of assignment documents.

Applicants desiring an indication of assignment documents of record should request separately certified copies of assignment documents and submit the fees required by 37 CFR 1.19.

When the assignment condition of an application is significant, such as when applications of different inventors contain conflicting claims or there is a question as to who should direct prosecution, it is necessary for the examiner to obtain assignment information from PALM. See MPEP § 320.

### **306 Assignment of Division, Continuation, Substitute, and Continuation-in-Part in Relation to Parent Application**

In the case of a division or continuation application, a prior assignment recorded against the original application is applied to the division or continuation application because the assignment recorded against the original application gives the assignee rights to the subject matter common to both applications.

In the case of a substitute or continuation-in-part application, a prior assignment of the original application is not applied to the substitute or continuation-in-part application because the assignment recorded against the original application gives the assignee rights to only the subject matter common to both applications. Substitute or continuation-in-part applications require a new assignment if they are to be issued to an assignee.

The front page of the printed patent includes all identifying parent data of continuation-in-part, continuation, divisional, and reissue applications. It should be noted, however, that inclusion of this information does not necessarily indicate that the claims are entitled to the benefit of the earlier filing date.

#### **306.01 Assignment of an Application Claiming the Benefits of a Provisional Application**

If an application which claims the earlier filing date of a provisional application under 35 U.S.C. 119(e) includes only subject matter which formed a part of the provisional application, an assignment recorded against the provisional application will be effective in the later application, similar to the practice with

respect to continuations and divisions filed under 35 U.S.C. 120. See MPEP § 306. If an application claiming the earlier filing date of a provisional application includes subject matter that is not common with subject matter of the provisional application, new assignment papers must be submitted in the later application, similar to the practice with respect to continuations-in-part filed under 35 U.S.C. 120. See MPEP § 306.

### **307 Issue to Assignee**

*35 U.S.C. 152. Issue of patent to assignee.*

Patents may be granted to the assignee of the inventor of record in the Patent and Trademark Office, upon the application made and the specification sworn to by the inventor, except as otherwise provided in this title.

*37 CFR 3.81. Issue of patent to assignee.*

(a) *With payment of the issue fee:* An application may issue in the name(s) of the assignee(s) consistent with the application's assignment where a request for such issuance is submitted with payment of the issue fee, provided the assignment has been previously recorded in the Office. If the assignment has not been previously recorded, the request should be accompanied by the assignment and either a direction to record the assignment in the Office pursuant to § 3.28, or a statement under § 3.73(b).

(b) *After payment of the issue fee:* An application may issue in the name(s) of the assignee(s) consistent with the application's assignment where a request for such issuance along with the processing fee set forth in § 1.17(i) of this chapter is submitted after the date of payment of the issue fee, but prior to issuance of the patent, provided the assignment has been previously recorded in the Office. If the assignment has not been previously recorded, the request should be accompanied by the assignment and either a direction to record the assignment in the Office pursuant to § 3.28, or a statement under § 3.73(b).

(c) *Partial assignees.*

(1) If one or more assignee(s) together with one or more inventor(s) hold the entire right, title, and interest in the application, the patent may issue in the names of the assignee(s) and the inventor(s).

(2) If multiple assignees hold the entire right, title, and interest to the exclusion of all the inventors, the patent may issue in the names of the multiple assignees.

Normally, for a patent to issue to an assignee, a request for issuance of the application in the name(s) of the assignee(s) must be filed in the United States Patent and Trademark Office (Office) at a date not later than the day on which the issue fee is paid. If the request for such issuance is submitted after the day on which the issue fee is paid, the patent may issue to an assignee upon submission of a request under 37 CFR 3.81(b) along with the processing fee set forth in

37 CFR 1.17(i). The extent to which the Office can comply with such a request will depend upon when the request is filed, the time it takes to match the request with the file, and whether there is sufficient time for the appropriate Office official to act on the request before the date of issue.

37 CFR 3.81 permits proof of the application's assignment to be submitted so that a patent may issue in the name(s) of the assignee(s) consistent with the application's assignment. The prior requirement for submitting a copy of an actual assignment for recording (in the assignment records of the Office) has been replaced with a requirement that proof of the assignment be submitted pursuant to 37 CFR 3.73(b) (which may include a copy of the assignment, or alternatively, may make reference to a reel and frame number if the assignment is recorded in the Office assignment records). Recording of the assignment is not required; only proof of its existence is required. Reliance may be had on a 37 CFR 3.73(b) statement already of record in the application, if the statement is still accurate at the time the request for issue of the application in the name(s) of the assignee(s) is submitted.

Only the first appearing name of an assignee will be printed on the patent where multiple names for the same party are identified on the Issue Fee Transmittal form, PTOL-85B. Such multiple names may occur when both a legal name and an "also known as" or "doing business as" name is also included. This printing practice will not, however, affect the existing practice of recording assignments with the Office in the Assignment Division. The assignee entry on form PTOL-85B should still be completed to indicate the assignment data as recorded in the Office. For example, the assignment filed in the Office and, therefore, the PTOL-85B assignee entry might read "Smith Company doing business as (d.b.a.) Jones Company." The assignee entry on the printed patent will read "Smith Company."

Irrespective of whether the assignee participates in the prosecution of the application, the patent issues to the assignee if so indicated on the Issue Fee Transmittal form PTOL-85B. Unless an assignee's name and address are identified in item 3 of the Issue Fee Transmittal form PTOL-85B, the patent will issue to the applicant. Assignment data printed on the patent will be based solely on the information so supplied.

A request for a certificate of correction under 37 CFR 1.323 (see MPEP § 1481 and § 1485) arising from incomplete or erroneous assignee's name furnished in item 3 of PTOL-85B will not be granted unless a petition under 37 CFR 1.183 has been granted. Any such petition under 37 CFR 1.183 should be directed to the Office of Petitions and should include:

- (A) the petition fee required by 37 CFR 1.17(h);
- (B) a request that 37 CFR 3.81(a) be waived to permit the correct name of the assignee to be provided after issuance of the patent;
- (C) a statement that the failure to include the correct assignee name on the PTOL-85B was inadvertent; and
- (D) a copy of the Notice of Recordation of Assignment Document.

### **309 Restrictions Upon Employees of Patent and Trademark Office**

*35 U.S.C. 4. Restrictions on officers and employees as to interests in patents.*

Officers and employees of the Patent and Trademark Office shall be incapable, during the period of their appointments and for one year thereafter, of applying for a patent and of acquiring, directly or indirectly, except by inheritance or bequest, any patent or any right or interest in any patent, issued or to be issued by the Office. In patents applied for thereafter they shall not be entitled to any priority date earlier than one year after the termination of their appointment.

### **310 Government License Rights to Contractor-Owned Inventions Made Under Federally Sponsored Research and Development**

Where a Government contractor retains U.S. domestic patent rights, the contractor is under an obligation by virtue of 35 U.S.C. 202(c)(6) to include the following statement at the beginning of the application and any patents issued thereon:

"The U.S. Government has a paid-up license in this invention and the right in limited circumstances to require the patent owner to license others on reasonable terms as provided for by the terms of (contract No. or Grant No.) awarded by (Agency)."

If reference is made in the first sentence of the application to prior copending applications of the applicant, such prior applications must be referred to

in the first sentence of the specification (37 CFR 1.78(a) and MPEP § 201.11), and in this case the above “Government License Rights” statement should follow immediately as the second paragraph of the specification.

If there is no reference to an earlier application, the “Government License Rights” statement should appear as the first paragraph of the specification. See 37 CFR 1.77.

### **311 Filing of Notice of Arbitration Awards**

#### *35 U.S.C. 294. Voluntary arbitration.*

(a) A contract involving a patent or any right under a patent may contain a provision requiring arbitration of any dispute relating to patent validity or infringement arising under the contract. In the absence of such a provision, the parties to an existing patent validity or infringement dispute may agree in writing to settle such dispute by arbitration. Any such provision or agreement shall be valid, irrevocable, and enforceable, except for any grounds that exist at law or in equity for revocation of a contract.

(b) Arbitration of such disputes, awards by arbitrators, and confirmation of awards shall be governed by title 9, United States Code, to the extent such title is not inconsistent with this section. In any such arbitration proceeding, the defenses provided for under section 282 of this title shall be considered by the arbitrator if raised by any party to the proceeding.

(c) An award by an arbitrator shall be final and binding between the parties to the arbitration but shall have no force or effect on any other person. The parties to an arbitration may agree that in the event a patent which is the subject matter of an award is subsequently determined to be invalid or unenforceable in a judgment rendered by a court to competent jurisdiction from which no appeal can or has been taken, such award may be modified by any court of competent jurisdiction upon application by any party to the arbitration. Any such modification shall govern the rights and obligations between such parties from the date of such modification.

(d) When an award is made by an arbitrator, the patentee, his assignee or licensee shall give notice thereof in writing to the Director. There shall be a separate notice prepared for each patent involved in such proceeding. Such notice shall set forth the names and addresses of the parties, the name of the inventor, and the name of the patent owner, shall designate the number of the patent, and shall contain a copy of the award. If an award is modified by a court, the party requesting such modification shall give notice of such modification to the Director. The Director shall, upon receipt of either notice, enter the same in the record of the prosecution of such patent. If the required notice is not filed with the Director, any party to the proceeding may provide such notice to the Director.

(e) The award shall be unenforceable until the notice required by subsection (d) is received by the Director.

#### *37 CFR 1.335. Filing of notice of arbitration awards.*

(a) Written notice of any award by an arbitrator pursuant to 35 U.S.C. 294 must be filed in the Patent and Trademark Office by the patentee, or the patentee’s assignee or licensee. If the award involves more than one patent a separate notice must be filed for placement in the file of each patent. The notice must set forth the patent number, the names of the inventor and patent owner, and the names and addresses of the parties to the arbitration. The notice must also include a copy of the award.

(b) If an award by an arbitrator pursuant to 35 U.S.C. 294 is modified by a court, the party requesting the modification must file in the Patent and Trademark Office, a notice of the modification for placement in the file of each patent to which the modification applies. The notice must set forth the patent number, the names of the inventor and patent owner, and the names and addresses of the parties to the arbitration. The notice must also include a copy of the court’s order modifying the award.

(c) Any award by an arbitrator pursuant to 35 U.S.C. 294 shall be unenforceable until any notices required by paragraph (a) or (b) of this section are filed in the Patent and Trademark Office. If any required notice is not filed by the party designated in paragraph (a) or (b) of this section, any party to the arbitration proceeding may file such a notice.

The written notices required by this section should be directed to the attention of the Office of the Solicitor. The Office of the Solicitor will be responsible for processing such notices.

### **313 Recording of Licenses, Security Interests, and Other Documents Other Than Assignments**

In addition to assignments and documents required to be recorded by Executive Order 9424, documents affecting title to a patent or application will be recorded in the Assignment Division of the United States Patent and Trademark Office (Office). Other documents not affecting title may be recorded at the discretion of the Commissioner. 37 CFR 3.11(a).

Thus, some documents which relate to patents or applications will be recorded, although they do not constitute a transfer or change of title. Typical of these documents which are accepted for recording are license agreements and agreements which convey a security interest. Such documents are recorded in the public interest in order to give third parties notification of equitable interests or other matters relevant to the ownership of a patent or application.

Any document returned unrecorded, which the sender nevertheless believes represents an unusual case which justifies recordation, may be submitted to



the Office of Petitions with a petition under 37 CFR 1.181 requesting recordation of the document.

The recordation of a document is not a determination of the effect of the document on the chain of title. The determination of what, if any, effect a document has on title will be made by the Office at such times as ownership must be established to permit action to be taken by the Office in connection with a patent or an application. See MPEP § 324.

### **314 Certificates of Change of Name or of Merger**

Certificates issued by appropriate authorities showing a change of name of a business or a merger of businesses are recordable. Although a mere change of name does not constitute a change in legal entity, it is properly a link in the chain of title. Documents of merger are also proper links in the chain of title. They may represent a change of entity as well as a change of name.

### **315 Indexing Against a Recorded Certificate**

Prior to amendment of the Rules of Practice to add Part 3 to 37 CFR, it had been the practice of the United States Patent and Trademark Office (Office) to process requests for “indexing” or “cross-referencing” additional patent numbers or application numbers against a document, other than an assignment, previously recorded in the Assignment Division, upon submission of a transmittal letter and recording fee. The Office no longer processes such indexing requests. Such requests do not comply with 37 CFR 3.11, 3.28, and 3.31, which require that each request for recordation include the document to be recorded and a cover sheet.

Therefore, even where a document has already been recorded in the Assignment Division in connection with a patent or patent application, a party that wishes recordation of that document with respect to additional patents and/or patent applications must submit the following to the Assignment Division:

(A) the original document, or a true copy of the original document (which may consist of the previously recorded papers on which the Assignment Division has stamped the reel and frame numbers at which they are recorded, or a copy of such papers);

(B) a completed cover sheet (see 37 CFR 3.31 and MPEP § 302.07); and

(C) the appropriate recording fee (see 37 CFR 1.21(h) and 3.41).

The Office will assign a new recording date to that submission, update the assignment database, and microfilm the cover sheet and document, which shall become part of the official record.

### **317 Handling of Documents in the Assignment Division**

All documents and cover sheets submitted for recording are examined for formal requirements in the Assignment Division in order to separate documents which are recordable from those which are not recordable.

Documents and cover sheets that are considered not to be recordable are returned to the sender by the Assignment Division with an explanation. If the sender disagrees or believes that the document represents an unusual case which justifies recordation, the sender may present the question to the Commissioner by way of petition under 37 CFR 1.181, filed with the Office of Petitions.

After an assignment and cover sheet have been recorded, they will be returned to the name and address indicated on the cover sheet to receive correspondence, showing the reel and frame number.

#### **317.01 Recording Date**

*37 CFR 3.51. Recording date.*

The date of recording of a document is the date the document meeting the requirements for recording set forth in this part is filed in the Office. A document which does not comply with the identification requirements of § 3.21 will not be recorded. Documents not meeting the other requirements for recording, for example, a document submitted without a completed cover sheet or without the required fee, will be returned for correction to the sender where a correspondence address is available. The returned papers, stamped with the original date of receipt by the Office, will be accompanied by a letter which will indicate that if the returned papers are corrected and resubmitted to the Office within the time specified in the letter, the Office will consider the original date of filing of the papers as the date of recording of the document. The procedure set forth in § 1.8 or § 1.10 of this chapter may be used for resubmissions of returned papers to have the benefit of the date of deposit in the United States Postal Service. If the returned papers are not corrected and resubmitted within the specified period, the date of filing of the corrected papers will be con-

sidered to be the date of recording of the document. The specified period to resubmit the returned papers will not be extended.

The date of recording of a document is the date the document meeting the requirements for recording set forth in the regulations is filed in the Office. A document which does not comply with the identification requirements of 37 CFR 3.21 will not be recorded. Documents not meeting the other requirements for recording, for example, a document submitted without a completed cover sheet or without the required fee, will be returned for correction to the sender when a correspondence address is available.

### **317.02 Correction of Returned Documents and Cover Sheets**

Assignment documents and cover sheets which are returned by Assignment Division will be stamped with the original date of receipt by the Office and will be accompanied by a letter which will indicate that if the returned papers are corrected and resubmitted to the Office within the time specified in the letter, the Office will consider the original date of receipt of the papers as the date of recording of the document. See 37 CFR 3.51. The certification procedure under 37 CFR 1.8 or the "Express Mail" procedure under 37 CFR 1.10 may be used for resubmissions of returned papers to obtain the benefit of the date of deposit in the United States Postal Service. If the returned papers are not corrected and resubmitted within the specified period, the date of receipt of the corrected papers will be considered to be the date of recording of the document. The specified period to resubmit the returned papers will not be extended.

### **317.03 Effect of Recording**

#### *37 CFR 3.54. Effect of recording.*

The recording of a document pursuant to § 3.11 is not a determination by the Office of the validity of the document or the effect that document has on the title to an application, a patent, or a registration. When necessary, the Office will determine what effect a document has, including whether a party has the authority to take an action in a matter pending before the Office.

#### *37 CFR 3.56. Conditional assignments.*

Assignments which are made conditional on the performance of certain acts or events, such as the payment of money or other condition subsequent, if recorded in the Office, are regarded as absolute assignments for Office purposes until canceled with the written consent of all parties or by the decree of a court of compe-

tent jurisdiction. The Office does not determine whether such conditions have been fulfilled.

The recording of a document is not a determination by the Office of the validity of the document or the effect that document has on the title to an application or patent. When necessary, the Office will determine what effect a document has, including whether a party has the authority to take an action in a matter pending before the Office. See MPEP § 324.

37 CFR 3.56 provides that an assignment, which at the time of its execution is conditional on a given act or event, will be treated by the Office as an absolute assignment. This rule serves as notification as to how a conditional assignment will be treated by the Office in any proceeding requiring a determination of the owner of an application, patent, or registration. Since the Office will not determine whether a condition has been fulfilled, the Office will treat the submission of such an assignment for recordation as signifying that the act or event has occurred. A security agreement that does not convey the right, title, and interest of a patent property is not a conditional assignment.

### **318 Documents Not to be Placed in Files**

Assignment documents submitted for recording should not be placed directly in application or patent files, but should be forwarded to Assignment Division for recording.

### **320 Title Reports**

The "title report" is a form which can be used under certain circumstances by the Assignment Division to report to someone within the Office the name of the owner of an application or patent as shown by the Assignment Division records on the date the title report is made. For example, a title report is requested by the Reexamination Preprocessing Staff when a request for reexamination is filed. Title reports may not be ordered by applicants or attorneys.

Information as to the title is not normally required by the examiner to examine an application. It is only in limited circumstances when the ownership becomes an issue and an examiner needs a title report. See MPEP § 303. Examiners may obtain a title report using the PALM Intranet, Patent Assignment Information (either link to the Assignments home page from the OASIS home page or go to [HTTP://A16/ASGN/OBJECT/ASNINFO](http://A16/ASGN/OBJECT/ASNINFO)). The screen resulting from the

search may be printed to yield the copy of the title report.

**NOTE:** The public can request a certified abstract of title. The fee for this service is set forth at 37 CFR 1.19(b)(5). See MPEP § 301.01 for a discussion of which assignment records are publicly available.

### 323 Procedures for Correcting Errors in Recorded Assignment Document

An error in a recorded assignment document will be corrected by Assignment Division provided a “corrective document” is submitted. The “corrective document” must include the following:

(A) The original assignment document with the corrections made therein. The corrections must be initialed and dated by the party conveying the interest; and

(B) A new Recordation Form Cover Sheet (form PTO-1619) (See MPEP § 302.07).

The new recordation form cover sheet must identify the submission as a “corrective document” submission and indicate the reel and frame number where the incorrectly recorded assignment document appears. The person signing the new recordation form cover sheet must state that the information provided on the new cover sheet is true and correct and that any copy submitted is a true copy of the original document. The original cover sheet should be submitted with the corrective document. The corrective document will be recorded and given a new reel and frame number and recording date. The recording fee set forth in 37 CFR 1.21(h) is required for each patent application and patent against which the corrective document is being recorded. See MPEP § 302.06.

Corrections may be made on the original assignment document, for example, by lining out an incorrect patent or application number in a merger or change of name (see MPEP § 314).

Office policy regarding recordation of assignment documents is directed toward maintaining a complete history of claimed interests in property and, therefore, recorded assignment documents will not be expunged even if subsequently found to be invalid. See *In re Ratny*, 24 USPQ2d 1713 (Comm’r Pat. 1992).

### 323.01 Correction of Error in Recorded Cover Sheet

37 CFR 3.34. *Correction of cover sheet errors.*

(a) An error in a cover sheet recorded pursuant to § 3.11 will be corrected only if:

(1) The error is apparent when the cover sheet is compared with the recorded document to which it pertains and

(2) A corrected cover sheet is filed for recordation.

(b) The corrected cover sheet must be accompanied by the originally recorded document or a copy of the originally recorded document and by the recording fee as set forth in § 3.41.

Any alleged error in a recorded cover sheet will only be corrected if the error is apparent from a comparison with the recorded assignment document. The corrected cover sheet should be directed to Assignment Division.

### 324 Establishing Right of Assignee To Take Action

37 CFR 3.71. *Prosecution by assignee.*

(a) Patents — conducting of prosecution. One or more assignees as defined in paragraph (b) of this section may, after becoming of record pursuant to paragraph (c) of this section, conduct prosecution of a national patent application or a reexamination proceeding to the exclusion of either the inventive entity, or the assignee(s) previously entitled to conduct prosecution.

(b) Patents — assignee(s) who can prosecute. The assignee(s) who may conduct either the prosecution of a national application for patent or a reexamination proceeding are:

(1) A single assignee. An assignee of the entire right, title and interest in the application or patent being reexamined who is of record, or

(2) Partial assignee(s) together or with inventor(s). All partial assignees, or all partial assignees and inventors who have not assigned their right, title and interest in the application or patent being reexamined, who together own the entire right, title and interest in the application or patent being reexamined. A partial assignee is any assignee of record having less than the entire right, title and interest in the application or patent being reexamined.

(c) Patents — Becoming of record. An assignee becomes of record either in a national patent application or a reexamination proceeding by filing a statement in compliance with § 3.73(b) that is signed by a party who is authorized to act on behalf of the assignee.

(d) Trademarks. The assignee of a trademark application or registration may prosecute a trademark application, submit documents to maintain a trademark registration, or file papers against a third party in reliance on the assignee’s trademark application or registration, to the exclusion of the original applicant or previous assignee. The assignee must establish ownership in compliance with § 3.73(b).

*37 CFR 3.73. Establishing right of assignee to take action.*

(a) The inventor is presumed to be the owner of a patent application, and any patent that may issue therefrom, unless there is an assignment. The original applicant is presumed to be the owner of a trademark application or registration, unless there is an assignment.

(b)(1) In order to request or take action in a patent or trademark matter, the assignee must establish its ownership of the patent or trademark property of paragraph (a) of this section to the satisfaction of the Commissioner. The establishment of ownership by the assignee may be combined with the paper that requests or takes the action. Ownership is established by submitting to the Office a signed statement identifying the assignee, accompanied by either:

(i) Documentary evidence of a chain of title from the original owner to the assignee (*e.g.*, copy of an executed assignment). The documents submitted to establish ownership may be required to be recorded pursuant to § 3.11 in the assignment records of the Office as a condition to permitting the assignee to take action in a matter pending before the Office; or

(ii) A statement specifying where documentary evidence of a chain of title from the original owner to the assignee is recorded in the assignment records of the Office (*e.g.*, reel and frame number).

(2) The submission establishing ownership must show that the person signing the submission is a person authorized to act on behalf of the assignee by:

(i) Including a statement that the person signing the submission is authorized to act on behalf of the assignee; or

(ii) Being signed by a person having apparent authority to sign on behalf of the assignee, *e.g.*, an officer of the assignee.

(c) For patent matters only:

(1) Establishment of ownership by the assignee must be submitted prior to, or at the same time as, the paper requesting or taking action is submitted.

(2) If the submission under this section is by an assignee of less than the entire right, title and interest, such assignee must indicate the extent (by percentage) of its ownership interest, or the Office may refuse to accept the submission as an establishment of ownership.

The owner or assignee of a patent property can take action in a patent application or patent proceeding in numerous instances. The owner or assignee can sign a reply to an Office action (37 CFR 1.33(b)(3) and (4)), a request for a continued prosecution application under 37 CFR 1.53(d) (MPEP § 201.06(d)), a terminal disclaimer (MPEP § 1490), an Issue Fee Transmittal (PTOL-85B) (MPEP § 1306), or a request for status of an application (MPEP § 102). The owner or assignee can file an application under 37 CFR 1.47(b) (MPEP § 409.03(b)) or 37 CFR 1.425, appoint its own registered attorney or agent to prosecute an application (37 CFR 3.71 and MPEP

§ 402.07), grant a power to inspect an application (MPEP § 104), and acquiesce to express abandonment of an application (MPEP § 711.01). The owner or assignee consents to the filing of a reissue application (MPEP § 1410.01), and to the correction of inventorship (MPEP § 201.03 or § 1481).

## I. THE ASSIGNEE/OWNER THAT CAN TAKE ACTION IN PATENT MATTERS

The provisions of 37 CFR 3.71(b)(1) and (2) identify the owner or assignee that can take action in patent matters, *e.g.*, the assignee which may conduct the prosecution of a U.S. national application for a patent (35 U.S.C. 111(a)), or any other patent proceeding (*e.g.*, a reexamination proceeding, an interference proceeding). A national patent application is owned by one of the following individual or composite entities:

(A) the inventor(s);

(B) an assignee or multiple assignees of the inventor(s); or

(C) some combination of the assignee(s), and inventor(s) who have not assigned away their right, title and interest in the application.

Pursuant to 37 CFR 3.73(b), a party must be established as the assignee by satisfying the requirements of that subsection, in order to be recognized as an owner or part owner, for purposes of taking action in patent matters before the Office.

As discussed in subsection II below, all parties having any portion of the ownership must join in “taking action” (*i.e.*, act together as a composite entity) in order to be entitled to conduct the prosecution in patent matters.

### *Individual and Partial Assignees*

If there is a single assignee of the **entire** right, title and interest in the patent application, 37 CFR 3.71(b)(1) provides that the single assignee (*i.e.*, individual assignee) may act alone to conduct the prosecution of an application or other patent proceeding (upon complying with 37 CFR 3.73(b)).

If there is no assignee of the **entire** right, title and interest of the patent application, then two possibilities exist:

(A) The application has not been assigned, and ownership resides solely in the inventor(s) (i.e., the applicant(s)). In this situation, 37 CFR 3.71 does not apply, since there is no assignee, and the combination of all inventors is needed to conduct the prosecution of an application.

(B) The application has been assigned by at least one of the inventors, and there is thus at least one “partial assignee.” As defined in 37 CFR 3.71(b)(2), a partial assignee is any assignee of record who has less than the entire right, title and interest in the application. The application is owned by the combination of all partial assignees and all inventors who have not assigned away their right, title and interest in the application.

Where at least one inventor retains an ownership interest together with the partial assignee(s), the combination of all partial assignees and inventors retaining ownership interest is needed to conduct the prosecution of an application. Where no inventor retains an ownership interest, the combination of all partial assignees is needed to conduct the prosecution of an application.

### ***Example***

Inventors A and B invent a process and file their application. Inventors A and B together may conduct prosecution. Inventor A then assigns all his/her rights in the application to Corporation X. As soon as Corporation X (now a partial assignee) is made of record in the application as a partial assignee (by filing a statement pursuant to 37 CFR 3.73(b) stating fifty percent ownership), Corporation X and Inventor B together may conduct prosecution. Corporation X and Inventor B then both assign their rights in the application to Corporation Y. As soon as Corporation Y (now an assignee of the entire right, title and interest) is made of record in the application as the assignee (by filing a statement pursuant to 37 CFR 3.73(b) stating one-hundred percent ownership), Corporation Y may, by itself, conduct prosecution.

## **II. ESTABLISHING OWNERSHIP**

When an assignee first seeks to take action in a matter before the Office with respect to a patent application, patent, or reexamination proceeding, the assignee must establish its ownership of the property

to the satisfaction of the Commissioner. 37 CFR 3.73(b). The assignee’s ownership may be established under 37 CFR 3.73(b) by submitting to the Office, in the Office file related to the matter in which action is sought to be taken:

(A) documentary evidence of a chain of title from the original owner to the assignee (e.g., copy of an executed assignment submitted for recording); or

(B) a statement specifying, by reel and frame number, where such evidence is recorded in the Office.

Documents submitted to establish ownership may be required to be recorded as a condition to permitting the assignee to take action in a matter pending before the Office.

The action taken by the assignee, and the 37 CFR 3.73(b) submission establishing that the assignee is the appropriate assignee to take such action, can be combined in one paper.

The establishment of ownership by the assignee must be submitted prior to, or at the same time as, the paper requesting or taking action is submitted. 37 CFR 3.73(c). If the submission establishing ownership is not present, the action sought to be taken will not be given effect. If the submission establishing ownership is submitted at a later date, that date will be the date of the request for action or the date of the assignee’s action taken.

The submission establishing ownership by the assignee must be signed by a party who is authorized to act on behalf of the assignee. See discussion below. Once 37 CFR 3.73(b) is complied with by an assignee, that assignee may continue to take action in that application, patent, or reexamination proceeding without filing a 37 CFR 3.73(b) submission each time, provided that ownership has not changed.

The submission establishing ownership by the assignee pursuant to 37 CFR 3.73(b) is generally referred to as the “statement under 37 CFR 3.73(b)” or the “37 CFR 3.73(b) statement.” A duplicate copy of the 37 CFR 3.73(b) statement is not required and should not be submitted. See 37 CFR 1.4(b) and MPEP § 502.04.

## **CONTINUING APPLICATIONS**

When an assignee files a continuation or divisional application under 37 CFR 1.53, other than a continued

prosecution application (CPA) under 37 CFR 1.53(d), the application papers must:

(A) refer to a statement filed under 37 CFR 3.73(b) in the parent application;

(B) contain a copy of a statement filed under 37 CFR 3.73(b) in the parent application; or

(C) contain a newly executed statement under 37 CFR 3.73(b).

When a continuation-in-part application is filed by an assignee, a newly executed statement under 37 CFR 3.73(b) must be filed. When a CPA under 37 CFR 1.53(d) is filed, the statement filed under 37 CFR 3.73(b) in the parent application will serve as the statement for the CPA.

### **REQUESTS FOR CONTINUED EXAMINATION**

Where a Request for Continued Examination of an application is filed under 37 CFR 1.114 (which can be filed on or after May 29, 2000 for an application filed on or after June 8, 1995), the application is not considered to be abandoned; rather the finality of the Office action is withdrawn and the prosecution continues. Thus, the statement under 37 CFR 3.73(b) in the application will continue to serve as the statement establishing ownership.

### **PARTY WHO MUST SIGN**

The submission establishing ownership must be signed by a party authorized to act on behalf of the assignee. The submission under 37 CFR 3.73(b) may be signed on behalf of the assignee in the following manner if the assignee is an organization (e.g., corporation, partnership, university, government agency, etc.):

(A) The submission may be signed by a person in the organization having apparent authority to sign on behalf of the organization. 37 CFR 3.73(b)(2)(ii). An officer (chief executive officer, president, vice-president, secretary, or treasurer) is presumed to have authority to sign on behalf of the organization. The signature of the chairman of the board of directors is acceptable, but not the signature of an individual director. Modifications of these basic titles are acceptable, such as vice-president for sales, executive vice-president, assistant treasurer, vice-chairman of the

board of directors. A person having a title (manager, director, administrator, general counsel) that does not clearly set forth that person as an officer of the assignee is not presumed to have authority to sign the submission on behalf of the assignee. A power of attorney (37 CFR 1.34(b)) from the inventors or the assignee to a patent practitioner to prosecute a patent application does not make the practitioner an official of an assignee or empower the practitioner to sign the submission on behalf of the assignee.

(B) The submission may be signed by any person, if the submission sets forth that the person signing is authorized (or empowered) to act on behalf of the assignee, i.e., to sign the submission on behalf of the assignee. 37 CFR 3.73(b)(2)(i).

(C) The submission may be signed by a person empowered by an organizational resolution (e.g., corporate resolution, partnership resolution) to sign the submission on behalf of the assignee, if a copy of the resolution is, or was previously, submitted in the record.

Where a submission does not comply with (A), (B), or (C) above, evidence of the person's authority to sign will be required.

### **WHEN OWNERSHIP MUST BE ESTABLISHED**

Examples of situations where ownership must be established under 37 CFR 3.73(b) are when the assignee: signs a request for a continued prosecution application under 37 CFR 1.53(d), unless papers establishing ownership under 37 CFR 3.73(b) were filed in the prior application and ownership has not changed (MPEP § 201.06(d)); signs a request for status of an application or gives a power to inspect an application (MPEP § 102 and § 104); acquiesces to express abandonment of an application (MPEP § 711.01); appoints its own registered attorney or agent to prosecute an application (37 CFR 3.71 and MPEP § 402.07); signs a terminal disclaimer (MPEP § 1490); consents to the filing of a reissue application (MPEP § 1410.01); consents to the correction of inventorship (MPEP § 201.03 or § 1481); files an application under 37 CFR 1.47(b) (MPEP § 409.03(b)) or 37 CFR 1.425; signs an Issue Fee Transmittal (PTOL-85B) (MPEP § 1306); or signs a reply to an Office action.

**WHEN OWNERSHIP NEED NOT BE ESTABLISHED**

Examples of situations where ownership need not be established under 37 CFR 3.73(b) are when the assignee: signs a request for a continued prosecution application under 37 CFR 1.53(d), where papers establishing ownership under 37 CFR 3.73(b) were filed in the prior application and ownership has not changed (MPEP § 201.06(d)); signs a small entity statement (MPEP § 509.03); signs a statement of common ownership of two inventions (MPEP § 706.02(1)(2)); signs a NASA or DOE property rights statement (MPEP § 151); signs an affidavit under 37 CFR 1.131 where the inventor is unavailable (MPEP § 715.04); signs a certificate under 37 CFR 1.8 (MPEP § 512); or files a request for reexamination of a patent under 37 CFR 1.510 (MPEP § 2210).

**MULTIPLE ASSIGNEES**

When an assignee seeks to take action in a matter before the Office with respect to a patent application, patent, or reexamination proceeding and the right, title, and interest therein is held by more than one assignee, each partial assignee must provide a submission under 37 CFR 3.73(b). In each submission, the extent of each assignee's interest must be set forth so

that the Office can determine whether it has obtained action by the entirety of the right, title and interest holders (owners). 37 CFR 3.73(c)(2). If the extent of the partial assignee's ownership interest is not set forth in the submission under 37 CFR 3.73(b), the Office may refuse to accept the submission as an establishment of ownership interest.

**CONFLICTING 37 CFR 3.73(b) STATEMENTS**

Where there are two or more conflicting 37 CFR 3.73(b) statements in an application or other Office proceeding, the statement with the latest date of submission to the Office will normally control as to establishment of the assignee. If, however, the ownership established as controlling is contested on the record by another party who has submitted a conflicting 37 CFR 3.73(b) statement, then the application or other proceeding shall be forwarded by the Office official in charge of the application or other proceeding to the Office of Patent Legal Administration for resolution of the ownership question.

**FORMS**

Form PTO/SB/96 may be used to establish ownership under 37 CFR 3.73(b).

PTO/SB/96 (08-00)  
 Approved for use through 10/31/2002. OMB 0651-0031  
 U.S. Patent and Trademark Office; U.S. DEPARTMENT OF COMMERCE

Under the Paperwork Reduction Act of 1995, no persons are required to respond to a collection of information unless it displays a valid OMB control number.

**STATEMENT UNDER 37 CFR 3.73(b)**

Applicant/Patent Owner: \_\_\_\_\_

Application No./Patent No.: \_\_\_\_\_ Filed/Issue Date: \_\_\_\_\_

Entitled: \_\_\_\_\_

\_\_\_\_\_, a \_\_\_\_\_,

(Name of Assignee)

(Type of Assignee, e.g., corporation, partnership, university, government agency, etc.)

states that it is:

1.  the assignee of the entire right, title, and interest; or
2.  an assignee of less than the entire right, title and interest.  
 The extent (by, percentage) of its ownership interest is \_\_\_\_\_ %

in the patent application/patent identified above by virtue of either:

A.  An assignment from the inventor(s) of the patent application/patent identified above. The assignment was recorded in the United States Patent and Trademark Office at Reel \_\_\_\_\_, Frame \_\_\_\_\_, or for which a copy thereof is attached.

OR

B.  A chain of title from the inventor(s), of the patent application/patent identified above, to the current assignee as shown below:

1. From: \_\_\_\_\_ To: \_\_\_\_\_  
 The document was recorded in the United States Patent and Trademark Office at Reel \_\_\_\_\_, Frame \_\_\_\_\_, or for which a copy thereof is attached.

2. From: \_\_\_\_\_ To: \_\_\_\_\_  
 The document was recorded in the United States Patent and Trademark Office at Reel \_\_\_\_\_, Frame \_\_\_\_\_, or for which a copy thereof is attached.

3. From: \_\_\_\_\_ To: \_\_\_\_\_  
 The document was recorded in the United States Patent and Trademark Office at Reel \_\_\_\_\_, Frame \_\_\_\_\_, or for which a copy thereof is attached.

Additional documents in the chain of title are listed on a supplemental sheet.

Copies of assignments or other documents in the chain of title are attached.  
 [NOTE: A separate copy (i.e., the original assignment document or a true copy of the original document) must be submitted to Assignment Division in accordance with 37 CFR Part 3, if the assignment is to be recorded in the records of the USPTO. See MPEP 302.08]

The undersigned (whose title is supplied below) is authorized to act on behalf of the assignee.

\_\_\_\_\_ Date

\_\_\_\_\_ Typed or printed name

\_\_\_\_\_ Signature

\_\_\_\_\_ Title

Burden Hour Statement: This form is estimated to take 0.2 hours to complete. Time will vary depending upon the needs of the individual case. Any comments on the amount of time you are required to complete this form should be sent to the Chief Information Officer, U.S. Patent and Trademark Office, Washington, DC 20231. DO NOT SEND FEES OR COMPLETED FORMS TO THIS ADDRESS. SEND TO: Assistant Commissioner for Patents, Washington, DC 20231.



MANUAL OF PATENT EXAMINING PROCEDURE

# Chapter 400 Representative of Inventor or Owner

- 401 U.S. Patent and Trademark Office Cannot Aid in Selection of Attorney**
- 402 Power of Attorney**
  - 402.01 Exceptions as to Registration
  - 402.02 Appointment of Associate Attorney or Agent
  - 402.05 Revocation
  - 402.06 Attorney or Agent Withdraws
  - 402.07 Assignee Can Revoke Power of Attorney of Applicant
  - 402.08 Application in Interference
  - 402.09 International Application
  - 402.10 Appointment/Revocation by Less Than All Applicants or Owners
- 403 Correspondence — With Whom Held**
  - 403.01 Correspondence Held With Associate Attorney
  - 403.02 Two Attorneys for Same Application
- 404 Conflicting Parties Having Same Attorney**
- 405 Attorney Not of Record**
- 406 Death of Attorney**
- 407 Suspended or Excluded Practitioner**
- 408 Telephoning Attorney**
- 409 Death, Legal Incapacity, or Unavailability of Inventor**
  - 409.01 Death of Inventor
    - 409.01(a) Prosecution by Administrator or Executor
    - 409.01(b) Proof of Authority of Administrator or Executor
    - 409.01(c) After Administrator or Executor Has Been Discharged
    - 409.01(d) Exception in Some Foreign Countries
    - 409.01(e) If Applicant of Assigned Application Dies
    - 409.01(f) Intervention of Executor Not Compulsory
  - 409.02 Insanity or Other Legal Incapacity
  - 409.03 Unavailability of Inventor
    - 409.03(a) At Least One Joint Inventor Available
    - 409.03(b) No Inventor Available
    - 409.03(c) Legal Representatives of Deceased Inventor Not Available
    - 409.03(d) Proof of Unavailability or Refusal
    - 409.03(e) Statement of Last Known Address
    - 409.03(f) Proof of Proprietary Interest
    - 409.03(g) Proof of Irreparable Damage
    - 409.03(h) Processing and Acceptance of a 37 CFR 1.47 Application
    - 409.03(i) Rights of the Nonsigning Inventor
    - 409.03(j) Action Following Acceptance of a 37 CFR 1.47 Application
- 410 Representations to the U.S. Patent and Trademark Office**

## 401 U.S. Patent and Trademark Office Cannot Aid in Selection of Attorney

37 CFR 1.31. Applicants may be represented by a registered attorney or agent.

An applicant for patent may file and prosecute his or her own case, or he or she may be represented by a registered attorney, registered agent, or other individual authorized to practice before the Patent and Trademark Office in patent cases. See §§ 10.6 and 10.9 of this subchapter. The Patent and Trademark Office cannot aid in the selection of a registered attorney or agent.

An applicant for patent may file and prosecute his or her own application, and thus act as his or her own representative (*pro se*) before the Office. See 37 CFR 1.31. In presenting (whether by signing, filing, submitting, or later advocating) papers to the Office, a *pro se* applicant is making the certifications under 37 CFR 10.18(b), and may be subject to sanctions under 37 CFR 10.18(c) for violations of 37 CFR 10.18(b)(2). See 37 CFR 1.4(d)(2). See also MPEP § 410.

If patentable subject matter appears to be disclosed in a *pro se* application and it is apparent that the applicant is unfamiliar with the proper preparation and prosecution of patent applications, the examiner may suggest to the applicant that it may be desirable to employ a registered patent attorney or agent. It is suggested that form paragraph 4.10 be incorporated in an Office action if the use of an attorney or agent is considered desirable and if patentable subject matter exists in the application.

### ¶ 4.10 Employ Services of Attorney or Agent

An examination of this application reveals that applicant is unfamiliar with patent prosecution procedure. While an inventor may prosecute the application, lack of skill in this field usually acts as a liability in affording the maximum protection for the invention disclosed. Applicant is advised to secure the services of a registered patent attorney or agent to prosecute the application, since the value of a patent is largely dependent upon skilled preparation and prosecution. The Office cannot aid in selecting an attorney or agent.

Applicant is advised of the availability of the publication “Attorneys and Agents Registered to Practice Before the U.S. Patent and Trademark Office.” This publication is for sale by the Superintendent of Documents, U.S. Government Printing Office, Washington, D.C. 20402.

### Examiner Note:

The examiner should not suggest that applicant employ an attorney or agent if the application appears to contain no patentable subject matter.

## 402 Power of Attorney

### *37 CFR 1.34. Recognition for representation.*

(a) When a registered attorney or agent acting in a representative capacity appears in person or signs a paper in practice before the Patent and Trademark Office in a patent case, his or her personal appearance or signature shall constitute a representation to the Patent and Trademark Office that under the provisions of this Subchapter and the law, he or she is authorized to represent the particular party in whose behalf he or she acts. In filing such a paper, the registered attorney or agent should specify his or her registration number with his or her signature. Further proof of authority to act in a representative capacity may be required.

(b) When an attorney or agent shall have filed his or her power of attorney, or authorization, duly executed by the person or persons entitled to prosecute an application or a patent involved in a reexamination proceeding, he or she is a principal attorney of record in the case. A principal attorney or agent, so appointed, may appoint an associate attorney or agent who shall also then be of record.

Powers of attorney or authorizations of agent naming firms of attorneys or agents filed in patent applications will not be recognized. However, the U.S. Patent and Trademark Office will construe any such powers or authorizations as a direction to consider the address of the firm as the correspondence address for the application.

Powers of attorney and authorizations of agent under 37 CFR 1.34(b) naming one or more registered individuals, or all registered practitioners associated with a Customer Number, may be made. See MPEP § 403 for Customer Number practice.

For a power of attorney or authorization of agent to be valid, the attorney or agent appointed must be registered to practice before the U.S. Patent and Trademark Office in accordance with 37 CFR 10.6. Form PTO/SB/81 may be used to appoint a registered practitioner.

Please type a plus sign (+) inside this box

PTO/SB/81 (02-01)

Approved for use through 10/31/2002. OMB 0651-0035  
U.S. Patent and Trademark Office; U.S. DEPARTMENT OF COMMERCE

Under the Paperwork Reduction Act of 1995, no persons are required to respond to a collection of information unless it display a valid OMB control number.

<b>POWER OF ATTORNEY OR AUTHORIZATION OF AGENT</b>	<b>Application Number</b>	
	<b>Filing Date</b>	
	<b>First Named Inventor</b>	
	<b>Title</b>	
	<b>Group Art Unit</b>	
	<b>Examiner Name</b>	
	<b>Attorney Docket Number</b>	

I hereby appoint:

Practitioners at Customer Number  Place Customer Number Bar Code Label here

**OR**

Practitioner(s) named below:

Name	Registration Number

as my/our attorney(s) or agent(s) to prosecute the application identified above, and to transact all business in the United States Patent and Trademark Office connected therewith.

Please change the correspondence address for the above-identified application to:

The above-mentioned Customer Number.

**OR**

Practitioners at Customer Number  Place Customer Number Bar Code Label here

**OR**

<input type="checkbox"/> Firm or Individual Name			
Address			
Address			
City	State	Zip	
Country			
Telephone	Fax		

I am the:

Applicant/Inventor.

Assignee of record of the entire interest. See 37 CFR 3.71. *Statement under 37 CFR 3.73(b) is enclosed. (Form PTO/SB/96).*

**SIGNATURE of Applicant or Assignee of Record**

Name	
Signature	
Date	

NOTE: Signatures of all the inventors or assignees of record of the entire interest or their representative(s) are required. Submit multiple forms if more than one signature is required, see below\*.

\*Total of \_\_\_\_\_ forms are submitted.

Burden Hour Statement: This form is estimated to take 3 minutes to complete. Time will vary depending upon the needs of the individual case. Any comments on the amount of time you are required to complete this form should be sent to the Chief Information Officer, U.S. Patent and Trademark Office, Washington, DC 20231. DO NOT SEND FEES OR COMPLETED FORMS TO THIS ADDRESS. SEND TO: Assistant Commissioner for Patents, Washington, DC 20231.

In accordance with 37 CFR 1.34(a), a paper filed by a registered patent attorney or agent in an application in which he or she is not of record should include both his or her signature and registration number. Acceptance of papers filed in patent applications and reexamination proceedings by registered attorneys and agents upon a representation that the attorney or agent is authorized to act in a representative capacity is for the purpose of facilitating replies on behalf of applicants in patent applications and, further, to obviate the need for filing powers of attorney or authorizations of agent in individual applications or patents when there has been a change in composition of law firms or corporate patent staffs. Interviews with a registered attorney or agent not of record will, in view of 35 U.S.C. 122, be conducted only on the basis of information and files supplied by the attorney or agent. A person acting in a representative capacity may not sign a power of attorney or a document granting access to an application.

A power of attorney or authorization given to a registered Canadian patent agent, to be valid, must be given by the applicants, all of whom are located in Canada. See 37 CFR 10.6(c).

When an application for patent is filed accompanied by a power of attorney or authorization of agent to a person not registered to practice before the United States Patent and Trademark Office, the Office of Initial Patent Examination will send the official filing receipt directly to the applicant, together with an explanatory letter. A copy of the letter will be sent to the person named in the power or authorization and a copy placed in the file without being given a paper number. The name of the unregistered person will not be placed on either the face of the file or the PALM bib-data sheet and the examiner will communicate only with the applicant directly at the correspondence address specified by the applicant unless and until the applicant appoints a recognized practitioner. An associate power of attorney or authorization from the unregistered person will not be recognized or accepted.

Form paragraph 4.09 may be used to notify applicant that the attorney or agent is not registered.

#### ¶ 4.09 Unregistered Attorney or Agent

An examination of this application reveals that applicant has attempted to appoint an attorney or agent who is not registered to practice before the U.S. Patent and Trademark Office, contrary to the Code of Federal Regulations, 37 CFR 1.31. Therefore, the

appointment is void, *ab initio*. We will not recognize the appointment and all correspondence concerning this application must be signed by: 1) all named applicants (inventors), 2) all the owners of the rights to the invention, or 3) a registered attorney or agent duly appointed by the inventor(s) or the owner(s). Furthermore, all communications from the Office will be addressed to the first named inventor, unless specific instructions to the contrary are supplied by the named inventor(s) or owner(s).

While an applicant may prosecute the application, lack of skill in this field usually acts as a liability in affording the maximum protection for the invention disclosed. Applicant is, therefore, encouraged to secure the services of a registered patent attorney or agent (i.e., registered to practice before the U.S. Patent and Trademark Office) to prosecute the application, since the value of a patent is largely dependent upon skillful preparation and prosecution.

The Office cannot aid you in selecting a registered attorney or agent, however, we do have a publication which lists all the patent attorneys and agents who are registered to practice before the Office. The publication, "Attorneys and Agents Registered to Practice Before the U.S. Patent and Trademark Office," may be purchased from the Superintendent of Documents, U.S. Government Printing Office, Washington, D.C. 20402. In addition, applicant may obtain this information: from the USPTO Internet Web Site [<http://www.uspto.gov/>]; by writing to the Commissioner of Patents and Trademarks, Box OED, Washington, DC 20231; by calling the Office of Enrollment and Discipline at (703) 306-4097; or, through the Patent Assistance Center toll free number, 1(800)786-9199.

#### Examiner Note:

This form paragraph is to be used ONLY after ensuring that the named representative is not registered with the Office. A PALM inquiry should be first made and if no listing is given, the Office of Enrollment and Discipline should be contacted to determine the current "recognition" status of the individual named by the applicant in a "power of attorney." If the named individual is NOT registered or otherwise recognized by the Office, the correspondence address on the face of the file should be promptly changed to that of the first named inventor unless applicant specifically provides a different "correspondence address." A copy of the Office communication incorporating this form paragraph should also be mailed to the unregistered individual named by the applicant in the "power of attorney." If desired, you may include with your communication, a list of the registered practitioners from applicant's Zip Code copied from the above noted publication which should be available in the TC Director's Office.

See MPEP § 601.03 for change of correspondence address. See MPEP § 201.06(c) for change in the power of attorney in continuation or divisional applications filed under 37 CFR 1.53(b). See MPEP § 403 for the addition and/or deletion of a practitioner from the list of practitioners associated with a Customer Number. For a representative of a requester of reexamination, see MPEP § 2213.

*37 CFR 10.18. Signature and certificate for correspondence filed in the Patent and Trademark Office.*

(a) For all documents filed in the Office in patent, trademark, and other non-patent matters, except for correspondence that is required to be signed by the applicant or party, each piece of correspondence filed by a practitioner in the Patent and Trademark Office must bear a signature, personally signed by such practitioner, in compliance with § 1.4(d)(1) of this chapter.

(b) By presenting to the Office (whether by signing, filing, submitting, or later advocating) any paper, the party presenting such paper, whether a practitioner or non-practitioner, is certifying that—

(1) All statements made therein of the party's own knowledge are true, all statements made therein on information and belief are believed to be true, and all statements made therein are made with the knowledge that whoever, in any matter within the jurisdiction of the Patent and Trademark Office, knowingly and willfully falsifies, conceals, or covers up by any trick, scheme, or device a material fact, or makes any false, fictitious or fraudulent statements or representations, or makes or uses any false writing or document knowing the same to contain any false, fictitious or fraudulent statement or entry, shall be subject to the penalties set forth under 18 U.S.C. 1001, and that violations of this paragraph may jeopardize the validity of the application or document, or the validity or enforceability of any patent, trademark registration, or certificate resulting therefrom; and

(2) To the best of the party's knowledge, information and belief, formed after an inquiry reasonable under the circumstances, that —

(i) The paper is not being presented for any improper purpose, such as to harass someone or to cause unnecessary delay or needless increase in the cost of prosecution before the Office;

(ii) The claims and other legal contentions therein are warranted by existing law or by a nonfrivolous argument for the extension, modification, or reversal of existing law or the establishment of new law;

(iii) The allegations and other factual contentions have evidentiary support or, if specifically so identified, are likely to have evidentiary support after a reasonable opportunity for further investigation or discovery; and

(iv) The denials of factual contentions are warranted on the evidence, or if specifically so identified, are reasonably based on a lack of information or belief.

(c) Violations of paragraph (b)(1) of this section by a practitioner or non-practitioner may jeopardize the validity of the application or document, or the validity or enforceability of any patent, trademark registration, or certificate resulting therefrom. Violations of any of paragraphs (b)(2)(i) through (iv) of this section are, after notice and reasonable opportunity to respond, subject to such sanctions as deemed appropriate by the Commissioner, or the Commissioner's designee, which may include, but are not limited to, any combination of —

(1) Holding certain facts to have been established;

(2) Returning papers;

(3) Precluding a party from filing a paper, or presenting or contesting an issue;

(4) Imposing a monetary sanction;

(5) Requiring a terminal disclaimer for the period of the delay; or

(6) Terminating the proceedings in the Patent and Trademark Office.

(d) Any practitioner violating the provisions of this section may also be subject to disciplinary action. See § 10.23(c)(15).

37 CFR 10.18(a) emphasizes that every paper filed by a practitioner must be personally signed by the practitioner, except those required to be signed by the applicant or party. 37 CFR 10.18(b) provides that, by presenting any paper to the Office, the party presenting such paper (whether a practitioner or nonpractitioner) is: (1) certifying that the statements made therein are subject to the declaration clause of 37 CFR 1.68; and (2) making the certifications required for papers filed in a federal court under Rule 11(b) of the Federal Rules of Civil Procedure. See MPEP § 410. 37 CFR 10.18(d) provides that any practitioner violating the provisions of 37 CFR 10.18 may also be subject to disciplinary action (see 37 CFR 10.23(c)(15)), thus clarifying that a practitioner may be subject to disciplinary action in lieu of, or in addition to, the sanctions set forth in 37 CFR 10.18(c) for violations of 37 CFR 10.18. See also 37 CFR 1.4(d)(2).

The certifications in 37 CFR 10.18(b) apply to all papers filed in the Office, including allegations of improper conduct made by a registered practitioner in any Office proceeding.

*37 CFR 10.11. Removing names from registers.*

(a) Registered attorneys and agents shall notify the Director of any change of address. Any notification to the Director of any change of address shall be separate from any notice of change of address filed in individual applications.

(b) A letter may be addressed to any individual on the register, at the address of which separate notice was last received by the Director, for the purpose of ascertaining whether such individual desires to remain on the register. The name of any individual failing to reply and give any information requested by the Director within a time limit specified will be removed from the register and the names of individuals so removed will be published in the Official Gazette. The name of any individual so removed may be reinstated on the register as may be appropriate and upon payment of the fee set forth in § 1.21(a)(3) of this subchapter.

See also MPEP § 1702.

## 402.01 Exceptions as to Registration

*37 CFR 10.9. Limited recognition in patent cases.*

(a) Any individual not registered under § 10.6 may, upon a showing of circumstances which render it necessary or justifiable,

be given limited recognition by the Director to prosecute as attorney or agent a specified application or specified applications, but limited recognition under this paragraph shall not extend further than the application or applications specified.

(b) When registration of a resident alien under paragraphs (a) or (b) of § 10.6 is not appropriate, the resident alien may be given limited recognition as may be appropriate under paragraph (a) of this section.

\*\*\*\*\*

Sometimes in a joint application one of the coinventors gives to the other the power of attorney in the application. Such power will be recognized even though the one to whom it is given is not registered.

If a request for special recognition accompanies the application, the Office of Initial Patent Examination will forward the file to the Director of the Office of Enrollment and Discipline.

#### **402.02 Appointment of Associate Attorney or Agent**

The principal attorney or agent may appoint an associate attorney or agent as provided in 37 CFR 1.34. The associate attorney may not appoint another attorney. See also MPEP § 406.

#### **402.05 Revocation**

*37 CFR 1.36. Revocation of power of attorney or authorization; withdrawal of attorney or agent.*

A power of attorney or authorization of agent, pursuant to § 1.31, may be revoked at any stage in the proceedings of a case, and a registered attorney or agent may withdraw, upon application to and approval by the Commissioner. A registered attorney or agent, except an associate registered attorney or agent whose address is the same as that of the principal registered attorney or agent, will be notified of the revocation of the power of attorney or authorization, and the applicant or patent owner will be notified of the withdrawal of the registered attorney or agent. An assignment will not of itself operate as a revocation of a power or authorization previously given, but the assignee of the entire interest may revoke previous powers and be represented by a registered attorney or agent of the assignee's own selection. See § 1.613(d) for withdrawal in an interference.

Upon revocation of the power of attorney, appropriate notification is sent by the technical support staff of the Technology Center.

Revocation of the power of the principal attorney revokes powers granted by him or her to other attorneys.

Revocation of the power of attorney becomes effective on the date that the revocation is RECEIVED in the Office (not on the date of ACCEPTANCE).

#### **402.06 Attorney or Agent Withdraws**

See 37 CFR 1.36 in MPEP § 402.05. See also 37 CFR 10.40.

In the event that a notice of withdrawal is filed by the attorney or agent of record, the file will be forwarded to the Technology Center Director where the application is assigned where appropriate procedure will be followed pertaining to the withdrawal. The **withdrawal is effective when approved** rather than when received.

To expedite the handling of requests for permission to withdraw as attorney or agent, under 37 CFR 1.36, Form PTO/SB/83 may be used. Because the Office does not recognize law firms, each attorney of record must sign the notice of withdrawal, or the notice of withdrawal must contain a clear indication of one attorney signing on behalf of another.

The Commissioner of Patents and Trademarks usually requires that there be at least 30 days between *approval* of withdrawal and the later of the expiration date of a time period for reply or the expiration date of the period which can be obtained by a petition and fee for extension of time under 37 CFR 1.136(a). This is so that the applicant will have sufficient time to obtain other representation or take other action. If a period has been set for reply and the period may be extended without a showing of cause pursuant to 37 CFR 1.136(a) by filing a petition for extension of time and fee, the practitioner will not be required to seek such extension of time for withdrawal to be approved. In such a situation, however, withdrawal will not be approved unless at least 30 days would remain between the date of approval and the last date on which such a petition for extension of time and fee could properly be filed.

For withdrawal during reexamination proceedings, see MPEP § 2223.

Please type a plus sign (+) inside this box  $\rightarrow$

PTO/SB/83 (08-00)

Approved for use through 10/31/2002. OMB 0651-0035

U.S. Patent and Trademark Office; U.S. DEPARTMENT OF COMMERCE

Under the Paperwork Reduction Act of 1995, no persons are required to respond to a collection of information unless it displays a valid OMB control number.

<b>REQUEST FOR WITHDRAWAL AS ATTORNEY OR AGENT</b>	<b>Application Number</b>	
	<b>Filing Date</b>	
	<b>First Named Inventor</b>	
	Group Art Unit	
	Examiner Name	
	Attorney Docket Number	

To: Assistant Commissioner for Patents  
Washington, DC 20231

I hereby apply to withdraw as attorney or agent for the above identified patent application.

The reasons for this request are:

1.  The correspondence address is NOT affected by this withdrawal.

2.  Change the correspondence address and direct all future correspondence to:

**CORRESPONDENCE ADDRESS**

Customer Number   $\rightarrow$  Place Customer Number  
Bar Code Label here

OR

Firm or Individual Name

Address

Address

City	State	ZIP
------	-------	-----

Country

Telephone	Fax
-----------	-----

This request is enclosed in triplicate.

Name	
Signature	
Date	

*NOTE: Withdrawal is effective when approved rather than when received.  
Unless there are at least 30 days between approval of withdrawal and the expiration date of a time period for response or possible extension period, the request to withdraw is normally disapproved.*

Burden Hour Statement: This form is estimated to take 0.2 hours to complete. Time will vary depending upon the needs of the individual case. Any comments on the amount of time you are required to complete this form should be sent to the Chief Information Officer, U.S. Patent and Trademark Office, Washington, DC 20231. DO NOT SEND FEES OR COMPLETED FORMS TO THIS ADDRESS. SEND TO: Assistant Commissioner for Patents, Washington, DC 20231.



## 402.07 Assignee Can Revoke Power of Attorney of Applicant

The assignee of record of the entire interest can revoke the power of attorney of the applicant unless an “irrevocable” right to prosecute the application had been given as in some government owned applications.

*37 CFR 3.71. Prosecution by assignee.*

(a) Patents — conducting of prosecution. One or more assignees as defined in paragraph (b) of this section may, after becoming of record pursuant to paragraph (c) of this section, conduct prosecution of a national patent application or a reexamination proceeding to the exclusion of either the inventive entity, or the assignee(s) previously entitled to conduct prosecution.

(b) Patents — assignee(s) who can prosecute. The assignee(s) who may conduct either the prosecution of a national application for patent or a reexamination proceeding are:

(1) A single assignee. An assignee of the entire right, title and interest in the application or patent being reexamined who is of record, or

(2) Partial assignee(s) together or with inventor(s). All partial assignees, or all partial assignees and inventors who have not assigned their right, title and interest in the application or patent being reexamined, who together own the entire right, title and interest in the application or patent being reexamined. A partial assignee is any assignee of record having less than the entire right, title and interest in the application or patent being reexamined.

(c) Patents — Becoming of record. An assignee becomes of record either in a national patent application or a reexamination proceeding by filing a statement in compliance with § 3.73(b) that is signed by a party who is authorized to act on behalf of the assignee.

(d) Trademarks. The assignee of a trademark application or registration may prosecute a trademark application, submit documents to maintain a trademark registration, or file papers against a third party in reliance on the assignee’s trademark application or registration, to the exclusion of the original applicant or previous assignee. The assignee must establish ownership in compliance with § 3.73(b).

See 37 CFR 1.36 in MPEP § 402.05.

A power of attorney by the assignee of the entire interest revokes all powers given by the applicant and prior assignees if the assignee establishes their right to take action as provided in 37 CFR 3.73(b). See MPEP § 324. Ordinarily, the applicant will still have access to the application (MPEP § 106).

In an application that has been accorded status under 37 CFR 1.47(a), or for which status under 37 CFR 1.47(a) has been requested, a power of attorney given by the inventors who have signed the declara-

tion (available inventors) may be revoked by an assignee of the entire interest of the available inventors. Rights of the assignee to take action may be established as provided in 37 CFR 3.73(b) and MPEP § 324.

## 402.08 Application in Interference

While an application is involved in an interference, no power of attorney of any kind should be entered in such application by the technical support staff of the Technology Center.

If a power of attorney or revocation is received for an application which is in interference, it should be forwarded to the Service Branch of the Board of Patent Appeals and Interferences because all parties to the interference must be notified.

## 402.09 International Application

*37 CFR 1.455. Representation in international applications.*

(a) Applicants of international applications may be represented by attorneys or agents registered to practice before the Patent and Trademark Office or by an applicant appointed as a common representative (PCT Art. 49, Rules 4, 8 and 90 and § 10.10). If applicants have not appointed an attorney or agent or one of the applicants to represent them, and there is more than one applicant, the applicant first named in the request and who is entitled to file in the U.S. Receiving Office shall be considered to be the common representative of all the applicants. An attorney or agent having the right to practice before a national office with which an international application is filed and for which the United States is an International Searching Authority or International Preliminary Examining Authority may be appointed to represent the applicants in the international application before that authority. An attorney or agent may appoint an associate attorney or agent who shall also then be of record (PCT Rule 90.1(d)). The appointment of an attorney or agent, or of a common representative, revokes any earlier appointment unless otherwise indicated (PCT Rule 90.6(b) and (c)).

(b) Appointment of an agent, attorney or common representative (PCT Rule 4.8) must be effected either in the Request form, signed by all applicants, or in a separate power of attorney submitted either to the United States Receiving Office or to the International Bureau.

(c) Powers of attorney and revocations thereof should be submitted to the United States Receiving Office until the issuance of the international search report.

(d) The addressee for correspondence will be as indicated in section 108 of the Administrative Instructions.

For representation in international applications, see MPEP § 1807.

#### **402.10 Appointment/Revocation by Less Than All Applicants or Owners**

Papers giving or revoking a power of attorney in an application generally require signature by all the applicants or owners of the application. Papers revoking a power of attorney in an application (or giving a power of attorney) will not be accepted by the Office when signed by less than all of the applicants or owners of the application unless they are accompanied by a petition and fee under 37 CFR 1.182 giving good and sufficient reasons as to why such papers should be accepted. The petition should be directed to the Office of Petitions. The acceptance of such papers by petition under 37 CFR 1.182 will result in more than one attorney, agent, applicant, or owner prosecuting the application at the same time. Therefore, each of these parties must sign all subsequent replies submitted to the Office. See *In re Goldstein*, 16 USPQ2d 1963 (Dep. Assist. Comm'r Pat. 1988). In an application filed under 37 CFR 1.47(a), an assignee of the entire interest of the available inventors who have signed the declaration may appoint or revoke a power of attorney without a petition under 37 CFR 1.182. See MPEP § 402.07. However, in applications accepted under 37 CFR 1.47, such a petition under 37 CFR 1.182 submitted by a previously nonsigning inventor who has now joined in the application will not be granted. See MPEP § 409.03(i). Upon accepting papers appointing and/or revoking a power of attorney that are signed by less than all of the applicants or owners, the Office will indicate to applicants who must sign subsequent replies. An indication will be placed on the file wrapper as to the number of signatures necessary for accepting subsequent replies and the paper number(s) where the split powers of attorney appear. Dual correspondence will still not be permitted. Accordingly, when the acceptance of such papers results in an attorney or agent and at least one applicant or owner prosecuting the application, correspondence will be mailed to the attorney or agent. When the acceptance of such papers results in more than one attorney or agent prosecuting the application, the correspondence address will continue to be that of the attorney or agent first named in the application, unless all parties agree. Each attorney or agent signing sub-

sequent papers must indicate whom he or she represents.

The following are examples of who must sign replies when there is more than one person responsible for prosecuting the application:

(A) If coinventor A has given a power of attorney and coinventor B has not, replies must be signed by the attorney of A and by coinventor B.

(B) If coinventors A and B have each appointed their own attorney, replies must be signed by both attorneys.

#### **403 Correspondence —With Whom Held**

*37 CFR 1.33. Correspondence respecting patent applications, reexamination proceedings, and other proceedings.*

(a) *Correspondence address and daytime telephone number.* When filing an application, a correspondence address must be set forth in either an application data sheet (§ 1.76), or elsewhere, in a clearly identifiable manner, in any paper submitted with an application filing. If no correspondence address is specified, the Office may treat the mailing address of the first named inventor (if provided, see §§ 1.76(b)(1) and 1.63(c)(2)) as the correspondence address. The Office will direct all notices, official letters, and other communications relating to the application to the correspondence address. The Office will not engage in double correspondence with an applicant and a registered attorney or agent, or with more than one registered attorney or agent except as deemed necessary by the Commissioner. If more than one correspondence address is specified, the Office will establish one as the correspondence address. For the party to whom correspondence is to be addressed, a daytime telephone number should be supplied in a clearly identifiable manner and may be changed by any party who may change the correspondence address. The correspondence address may be changed as follows:

(1) *Prior to filing of § 1.63 oath or declaration by any of the inventors.* If a § 1.63 oath or declaration has not been filed by any of the inventors, the correspondence address may be changed by the party who filed the application. If the application was filed by a registered attorney or agent, any other registered practitioner named in the transmittal papers may also change the correspondence address. Thus, the inventor(s), any registered practitioner named in the transmittal papers accompanying the original application, or a party that will be the assignee who filed the application, may change the correspondence address in that application under this paragraph.

(2) *Where a § 1.63 oath or declaration has been filed by any of the inventors.* If a § 1.63 oath or declaration has been filed, or is filed concurrent with the filing of an application, by any of the inventors, the correspondence address may be changed by the parties set forth in paragraph (b) of this section, except for paragraph (b)(2).

(b) *Amendments and other papers.* Amendments and other papers, except for written assertions pursuant to § 1.27(c)(2)(ii) of this part, filed in the application must be signed by:

(1) A registered attorney or agent of record appointed in compliance with § 1.34(b);

(2) A registered attorney or agent not of record who acts in a representative capacity under the provisions of § 1.34(a);

(3) An assignee as provided for under § 3.71(b) of this chapter; or

(4) All of the applicants (§ 1.41(b)) for patent, unless there is an assignee of the entire interest and such assignee has taken action in the application in accordance with § 3.71 of this chapter.

(c) All notices, official letters, and other communications for the patent owner or owners in a reexamination proceeding will be directed to the attorney or agent of record (see § 1.34(b)) in the patent file at the address listed on the register of patent attorneys and agents maintained pursuant to §§ 10.5 and 10.11 or, if no attorney or agent is of record, to the patent owner or owners at the address or addresses of record. Amendments and other papers filed in a reexamination proceeding on behalf of the patent owner must be signed by the patent owner, or if there is more than one owner by all the owners, or by an attorney or agent of record in the patent file, or by a registered attorney or agent not of record who acts in a representative capacity under the provisions of § 1.34(a). Double correspondence with the patent owner or owners and the patent owner's attorney or agent, or with more than one attorney or agent, will not be undertaken. If more than one attorney or agent is of record and a correspondence address has not been specified, correspondence will be held with the last attorney or agent made of record.

(d) A "correspondence address" or change thereto may be filed with the Patent and Trademark Office during the enforceable life of the patent. The "correspondence address" will be used in any correspondence relating to maintenance fees unless a separate "fee address" has been specified. See § 1.363 for "fee address" used solely for maintenance fee purposes.

37 CFR 1.33(a) provides for an applicant to supply an address to receive correspondence from the U.S. Patent and Trademark Office so that the Office may direct mail to any address of applicant's selection, such as a corporate patent department, a firm of attorneys or agents, or an individual attorney, agent, or other person.

37 CFR 1.33(a) provides that in a patent application the applicant must specify a correspondence address to which the Office will send notices, letters and other communications relating to the application. The correspondence address must appear either in an application data sheet (37 CFR 1.76) or in a clearly identifiable manner elsewhere in any papers submitted with an application filing. Where more than one correspondence address is specified, the Office will determine which one to establish as the correspon-

dence address. This is intended to cover the situation where an application is submitted with multiple addresses, such as one correspondence address being given in the application transmittal letter, and a different one in an accompanying 37 CFR 1.63 oath or declaration, or other similar situations. The determination of which of the correspondence addresses to use will be made on a case-by-case basis, considering such factors as the earliest correspondence address submitted, and the first listed correspondence address if conflicting addresses appear in the same declaration.

37 CFR 1.33(a) requests the submission of a daytime telephone number of the party to whom correspondence is to be addressed. While business is to be conducted on the written record (37 CFR 1.2), a daytime telephone number would be useful in initiating contact that could later be reduced to writing. The telephone number would be changeable by any party who could change the correspondence address.

37 CFR 1.33(a)(1) provides that any party filing the application and setting forth a correspondence address could later change the correspondence address provided that a 37 CFR 1.63 oath/declaration by any of the inventors has not been submitted. If one joint inventor filed an application, the person who may change the correspondence address would include only the one inventor who filed the application, even if another inventor was identified on the application transmittal letter. If two of three inventors filed the application, the two inventors filing the application would be needed to change the correspondence address. Additionally, any registered practitioner named in the application transmittal letter, or a person who has the authority to act on behalf of the party that will be the assignee (if the application was filed by the party that will be the assignee), could change the correspondence address. A registered practitioner named in a letterhead would not be sufficient, but rather a clear identification of the individual as being a representative would be required. A company (to whom the invention has been assigned, or to whom there is an obligation to assign the invention) who files an application, is permitted to designate the correspondence address, and to change the correspondence address, until such time as a (first) 37 CFR 1.63 oath/declaration is filed. The mere filing of a 37 CFR 1.63 oath/declaration that does not include a correspondence address does not affect any correspondence address

previously established on the filing of the application, or changed per 37 CFR 1.63(a)(1), even if the application was filed by a company that is only a partial assignee. The expression “party that will be the assignee,” rather than assignee, is used in that until a declaration is submitted, inventors have only been identified, and any attempted assignment, or partial assignment, cannot operate for Office purposes until the declaration is supplied. Hence, if the application transmittal letter indicates that the application is being filed on behalf of XYZ company, with an assignment to be filed later, XYZ company would be allowed to change the correspondence address without resort to 37 CFR 3.73(b) until an executed oath or declaration is filed, and with resort to 37 CFR 3.73(b) after the oath or declaration is filed.

Where a correspondence address was set forth or changed pursuant to 37 CFR 1.33(a)(1) (prior to the filing of a 37 CFR 1.63 oath or declaration), that correspondence address remains in effect upon filing of a 37 CFR 1.63 declaration and can then only be changed pursuant to 37 CFR 1.33(a)(2).

37 CFR 1.33 states that when an attorney has been duly appointed to prosecute an application correspondence will be held with the attorney unless some other correspondence address has been given. Double correspondence with an applicant and his or her attorney, or with two representatives, will not be undertaken. See MPEP § 403.01, § 403.02, and § 714.01(d).

If double correspondence is attempted, form paragraph 4.01 should be included in the next Office action.

#### ¶ 4.01 Dual Correspondence

Applicant has appointed an attorney or agent to conduct all business before the Patent and Trademark Office. Double correspondence with an applicant and applicant’s attorney or agent will not be undertaken. Accordingly, applicant is required to conduct all future correspondence with this Office through the attorney or agent of record. See 37 CFR 1.33.

#### Examiner Note:

1. The first time a reply is received directly from applicant, include this paragraph in the Office action and send a copy of the action to the applicant. See MPEP §§ 403 and 714.01.
2. Should applicant file additional replies, do not send copies of subsequent Office actions to the applicant.
3. Status letters from the applicant may be acknowledged in isolated instances.

In a joint application with no attorney or agent, the applicant whose name first appears in the papers

receives the correspondence, unless other instructions are given. All applicants must sign the replies. See MPEP § 714.01(a). If the assignee of the entire interest is prosecuting the application (MPEP § 402.07), the assignee may specify a correspondence address.

37 CFR 1.33(c) relates to which address communications for the patent owner will be sent in reexamination proceedings. See also MPEP § 2224.

Powers of attorney to firms are not recognized by the U.S. Patent and Trademark Office. See MPEP § 204. However, the firm’s address will be considered to be the correspondence address. The address should appear as follows:

John Doe (inventor)  
In care of Able, Baker, and Charlie (firm)  
1234 Jefferson Davis Highway  
Arlington, Virginia 22202

See MPEP § 601.03 for change of correspondence address.

See MPEP § 201.06(c) regarding change of correspondence address in continuation or divisional applications filed under 37 CFR 1.53(b).

#### CUSTOMER NUMBER PRACTICE

A Customer Number (previously a “Payor Number”) may be used to:

(A) designate the correspondence address of a patent application by a Customer Number such that the correspondence address for the patent application would be the address associated with the Customer Number;

(B) designate the fee address (37 CFR 1.363) of a patent by a Customer Number such that the fee address for the patent would be the address associated with the Customer Number; and

(C) submit a list of practitioners by Customer Number such that an applicant may in a Power of Attorney appoint those practitioners associated with the Customer Number.

Thus, a Customer Number may be used to designate the address associated with the Customer Number as the correspondence address of an application (or patent) or the fee address of a patent, and may also be used to submit a power of attorney in the application (or patent) to the registered practitioners associated with the Customer Number.

Applicant may use either the same or different customer number(s) for the correspondence address, the fee address and/or a list of practitioners. The customer number associated with the correspondence address is the customer number used to obtain access to the Patent Application Information Retrieval (PAIR) system at <http://pair.uspto.gov>. See MPEP § 1730 for additional information regarding PAIR.

The following forms are suggested for use with the Customer Number practice:

(A) the “Request for Customer Number” (PTO/SB/125) to request a Customer Number;

(B) the “Request for Customer Number Data Change” (PTO/SB/124) to request a change in the data (address or list of practitioners) associated with an existing Customer Number;

(C) the “Change of Correspondence Address, Application” (PTO/SB/122) to change the correspondence address of an individual application to the address associated with a Customer Number;

(D) the “Change of Correspondence Address, Patent” (PTO/SB/123) to change the correspondence address of an individual patent to the address associated with a Customer Number; and

(E) the “Correspondence Address Indication Form” (PTO/SB/121) to change the correspondence address of a list of applications or patents to the address associated with a Customer Number.

The Office will also accept requests submitted electronically *via* a computer-readable diskette to:

(A) change the correspondence address of a list of applications or patents or the fee address for a list of patents to the address associated with a Customer Number; and

(B) submit a power of attorney in a list of applications or patents to the registered practitioners associated with the Customer Number.

Such electronic requests must be submitted in the manner set forth in the Notice entitled “Extension of the Payor Number Practice (through “Customer Numbers”) to Matters Involving Pending Patent Applications,” published in the *Federal Register* at 61 FR 54622, 54623-24 (October 21, 1996), and in the *Official Gazette* at 1191 O. G. 187, 188-89 (October 29, 1996).

The Customer Number practice does not affect the current practice of permitting a patentee to provide a “fee address” for the receipt of maintenance fee correspondence. A patentee will be able to designate a “fee address” for the receipt of maintenance fee correspondence, and a different address for the receipt of all other correspondence. The designation of a “fee address” by reference to a Customer Number will not affect or be affected by the designation of a correspondence address by reference to another Customer Number, in that the Office will send maintenance fee correspondence to the address associated with the Customer Number designated as the “fee address” and will send all other correspondence to the address associated with the Customer Number designated as the correspondence address.

The association of a list of practitioners with a Customer Number will permit an applicant to appoint all of the practitioners associated with the Customer Number merely by reference to the Customer Number in the Power of Attorney (i.e., without individually listing the practitioners in the Power of Attorney). The addition and/or deletion of a practitioner from the list of practitioners associated with a Customer Number will result in the addition or deletion of such practitioner from the list of persons authorized to represent any applicant who appointed all of the practitioners associated with such Customer Number. This will avoid the necessity for the filing of additional papers in each patent application affected by a change in the practitioners of the law firm prosecuting the application. The appointment of practitioners associated with a Customer Number will be optional, in that any applicant may continue to individually name those practitioners to represent the applicant in a patent application.

The Customer Number practice does not affect the prohibition against, and does not amount to, an appointment of a law firm (rather than specified practitioners). The Office prohibits an appointment of a specified law firm because the Office cannot ascertain from its records whether a particular practitioner submitting a paper to the Office is associated with the law firm specified in an appointment. The Office will permit an appointment of all of the practitioners associated with a specified Customer Number because the Office can ascertain from its records for the specified

Customer Number whether a particular practitioner is associated with that Customer Number.

As the Office will not recognize more than one correspondence address (37 CFR 1.33(a)), any inconsistencies between the correspondence address resulting from a Customer Number being provided in an application for the correspondence address and any other correspondence address provided in that application would be resolved in favor of the address of the Customer Number. Due to the prohibition against dual correspondence in an application (37 CFR 1.33(a)), an applicant will be permitted to provide only a single number at a time as the Customer Number for the correspondence address.

Where an applicant appoints all of the practitioners associated with a Customer Number as well as a list of individually named practitioners, such action would be treated as only an appointment of all of the practitioners associated with a Customer Number due to the potential for confusion and data entry errors in entering registration numbers from plural sources.

Although Customer Numbers are designed to designate both a correspondence address and to associate one or more patent attorneys or agents with an application, one Customer Number may be used for the correspondence address, and another Customer Number may be used for the power of attorney.

Applicants are strongly cautioned not to attempt to appoint more than one Customer Number for a particular purpose (e.g., correspondence address) in a single communication, as such action will **not** have a cumulative effect.

The Office has created a box designation for correspondence related to a Customer Number (“Box CN”), and all correspondence related to a Customer Number (e.g., requests for a Customer Number) should be addressed to this box designation.

The following persons are authorized to change the information associated with an established Customer Number: (1) a registered practitioner associated with the Customer Number; and (2) the person who requested the Customer Number (signed the Request for Customer Number, Form PTO/SB/125).

Please type a plus sign (+) inside this box 

PTO/SB/121 (10-00)  
Approved for use through 10/31/2002. OMB 0651-0035  
U.S. Patent and Trademark Office; U.S. DEPARTMENT OF COMMERCE

Under the Paperwork Reduction Act of 1995, no persons are required to respond to a collection of information unless it displays a valid OMB control number.

<p><b>CORRESPONDENCE ADDRESS INDICATION FORM</b></p>	<p><b>Address to:</b></p> <p>Assistant Commissioner for Patents Box CN Washington, DC 20231</p>
--	---

Please recognize the following address as the correspondence address:

Customer Number   Place Customer Number  
Bar Code Label here

*OR* *Type Customer Number here*

Request for Customer Number (PTO/SB/125) submitted herewith.

**in the following listed application(s) or patent(s) :**

Patent Number (if appropriate)	Application Number	Patent Date (if appropriate)	U.S. Filing Date

Typed or Printed Name		<p><b>(check one)</b></p> <p><input type="checkbox"/> Applicant or Patentee</p> <p><input type="checkbox"/> Assignee of record of the entire interest. Statement under 37 CFR 3.73(b) is enclosed. (Form PTO/SB/96)</p> <p><input type="checkbox"/> Attorney or Agent of record</p> <p style="text-align: center;">----- (Reg. No.)</p>
Signature		
Date		
Address of signer:		

NOTE: Signatures of all the inventors or assignees of record of the entire interest or their representative(s) are required. Submit multiple forms if more than one signature is required, see below \*.

\*Total of \_\_\_\_\_ forms are submitted.

Burden Hour Statement: This form is estimated to take 0.2 hours to complete. Time will vary depending upon the needs of the individual case. Any comments on the amount of time you are required to complete this form should be sent to the Chief Information Officer, U.S. Patent and Trademark Office, Washington, DC 20231. DO NOT SEND FEES OR COMPLETED FORMS TO THIS ADDRESS. SEND TO: Assistant Commissioner for Patents, Box CN, Washington, DC 20231.

Please type a plus sign (+) inside this box  PTO/SB/122 (10-00)  
Approved for use through 10/31/2002. OMB 0651-0035  
U.S. Patent and Trademark Office: U.S. DEPARTMENT OF COMMERCE  
Under the Paperwork Reduction Act of 1995, no persons are required to respond to a collection of information unless it displays a valid OMB control number.

<p><b>CHANGE OF CORRESPONDENCE ADDRESS</b> <i>Application</i></p> <p>Address to: Assistant Commissioner for Patents Washington, D.C. 20231</p>	<table border="1" style="width: 100%; border-collapse: collapse;"> <tr><td style="width: 80%;">Application Number</td><td></td></tr> <tr><td>Filing Date</td><td></td></tr> <tr><td>First Named Inventor</td><td></td></tr> <tr><td>Group Art Unit</td><td></td></tr> <tr><td>Examiner Name</td><td></td></tr> <tr><td>Attorney Docket Number</td><td></td></tr> </table>	Application Number		Filing Date		First Named Inventor		Group Art Unit		Examiner Name		Attorney Docket Number	
Application Number													
Filing Date													
First Named Inventor													
Group Art Unit													
Examiner Name													
Attorney Docket Number													

<p>Please change the Correspondence Address for the above-identified application to:</p> <p><input type="checkbox"/> Customer Number <input style="width: 100px;" type="text"/> <span style="float: right;">→</span> <div style="border: 1px solid black; padding: 5px; width: fit-content; margin-left: auto;">Place Customer Number Bar Code Label here</div></p> <p style="text-align: center;"><i>Type Customer Number here</i></p> <p><b>OR</b></p> <p><input type="checkbox"/> Firm or Individual Name</p>	
Address	
Address	
City	State
Country	ZIP
Telephone	Fax

This form cannot be used to change the data associated with a Customer Number. To change the data associated with an existing Customer Number use "Request for Customer Number Data Change" (PTO/SB/124).

I am the :

- Applicant/Inventor.
- Assignee of record of the entire interest. Statement under 37 CFR 3.73(b) is enclosed. (Form PTO/SB/96).
- Attorney or Agent of record.
- Registered practitioner named in the application transmittal letter in an application without an executed oath or declaration. See 37 CFR 1.33(a)(1). Registration Number \_\_\_\_\_

Typed or Printed Name	
Signature	
Date	
<p>NOTE: Signatures of all the inventors or assignees of record of the entire interest or their representative(s) are required. Submit multiple forms if more than one signature is required, see below*.</p>	

\*Total of \_\_\_\_\_ forms are submitted.

Burden Hour Statement: This form is estimated to take 3 minutes to complete. Time will vary depending upon the needs of the individual case. Any comments on the amount of time you are required to complete this form should be sent to the Chief Information Officer, U.S. Patent and Trademark Office, Washington, DC 20231. DO NOT SEND FEES OR COMPLETED FORMS TO THIS ADDRESS. SEND TO: Assistant Commissioner for Patents, Washington, DC 20231.



Please type a plus sign (+) inside this box

PTO/SB/123 (10-00)  
 Approved for use through 10/31/2002. OMB 0651-0035  
 U.S. Patent and Trademark Office; U.S. DEPARTMENT OF COMMERCE  
 Under the Paperwork Reduction Act of 1995, no persons are required to respond to a collection of information unless it displays a valid OMB control number.

<p><b>CHANGE OF CORRESPONDENCE ADDRESS</b> <i>Patent</i></p> <p>Address to: Assistant Commissioner for Patents Washington, D.C. 20231</p>	<table border="1" style="width: 100%; border-collapse: collapse;"> <tr><td style="padding: 2px;">Patent Number</td><td style="width: 100px;"></td></tr> <tr><td style="padding: 2px;">Issue Date</td><td></td></tr> <tr><td style="padding: 2px;">Application Number</td><td></td></tr> <tr><td style="padding: 2px;">Filing Date</td><td></td></tr> <tr><td style="padding: 2px;">First Named Inventor</td><td></td></tr> </table>	Patent Number		Issue Date		Application Number		Filing Date		First Named Inventor	
Patent Number											
Issue Date											
Application Number											
Filing Date											
First Named Inventor											

Please change the Correspondence Address for the above-identified patent to:

Customer Number  →

Place Customer Number Bar Code Label here

*Type Customer Number here*

**OR**

<b>Firm or Individual Name</b>			
<b>Address</b>			
<b>Address</b>			
<b>City</b>	<b>State</b>	<b>ZIP</b>	
<b>Country</b>			
<b>Telephone</b>		<b>Fax</b>	

This form cannot be used to change the data associated with a Customer Number. To change the data associated with an existing Customer Number use "Request for Customer Number Data Change" (PTO/SB/124).

This form will not affect any "fee address" provided for the above-identified patent. To change a "fee address" use the "Fee Address Indication Form" (PTO/SB/47).

I am the :

Patentee.

Assignee of record of the entire interest. See 37 CFR 3.71. Statement under 37 CFR 3.73(b) is enclosed. (Form PTO/SB/96).

Attorney or agent of record.

<b>Typed or Printed Name</b>	
<b>Signature</b>	
<b>Date</b>	

NOTE: Signatures of all the inventors or assignees of record of the entire interest or their representative(s) are required. Submit multiple forms if more than one signature is required, see below\*.

\*Total of \_\_\_\_\_ forms are submitted.

Burden Hour Statement: This form is estimated to take 3 minutes to complete. Time will vary depending upon the needs of the individual case. Any comments on the amount of time you are required to complete this form should be sent to the Chief Information Officer, U.S. Patent and Trademark Office, Washington, DC 20231. DO NOT SEND FEES OR COMPLETED FORMS TO THIS ADDRESS. SEND TO: Assistant Commissioner for Patents, Washington, DC 20231.

Please type a plus sign (+) inside this box →

PTO/SB/124A (08-00)  
 Approved for use through 10/31/2002. OMB 0651-0035  
 U.S. Patent and Trademark Office; U.S. DEPARTMENT OF COMMERCE

Under the Paperwork Reduction Act of 1995, no persons are required to respond to a collection of information unless it displays a valid OMB control number.

<h2 style="margin: 0;">Request for Customer Number Data Change</h2>	<p><b>Address to:</b></p> <p>Assistant Commissioner for Patents                  Box CN                  Washington, DC 20231</p>
---	---

To the Commissioner of Patents and Trademarks: Please record the following data changes to <b>Customer Number</b> :		Place Customer Number Bar Code Label here
Type Customer Number here <input style="width: 150px;" type="text"/>	→	
<input type="checkbox"/> Please change Correspondence Address to:		
<b>Firm or Individual Name</b>	<input style="width: 98%;" type="text"/>	
<b>Address</b>	<input style="width: 98%;" type="text"/>	
<b>Address</b>	<input style="width: 98%;" type="text"/>	
<b>City</b>	<b>State</b>	<b>ZIP</b>
<b>Country</b>	<input style="width: 98%;" type="text"/>	
<b>Telephone</b>	<b>Fax</b>	<input style="width: 98%;" type="text"/>
<input type="checkbox"/> Please <b>delete</b> the following practitioner registration number(s) from the Customer Number indicated above:		
<input style="width: 80px;" type="text"/>	<input style="width: 80px;" type="text"/>	<input style="width: 80px;" type="text"/>
<input style="width: 80px;" type="text"/>	<input style="width: 80px;" type="text"/>	<input style="width: 80px;" type="text"/>
<input style="width: 80px;" type="text"/>	<input style="width: 80px;" type="text"/>	<input style="width: 80px;" type="text"/>
<input type="checkbox"/> Please <b>add</b> the following practitioner registration number(s) to the Customer Number indicated above:		
<input style="width: 80px;" type="text"/>	<input style="width: 80px;" type="text"/>	<input style="width: 80px;" type="text"/>
<input style="width: 80px;" type="text"/>	<input style="width: 80px;" type="text"/>	<input style="width: 80px;" type="text"/>
<input type="checkbox"/> Additional practitioner registration numbers are listed on supplemental sheet(s) attached hereto		
<b>Request Submitted by:</b>		
Firm Name (if applicable)	<input style="width: 98%;" type="text"/>	
Name of Person submitting request	<input style="width: 98%;" type="text"/>	
Signature	<input style="width: 98%;" type="text"/>	
Telephone Number	<input style="width: 80%;" type="text"/>	Date <input style="width: 150px;" type="text"/>

Burden Hour Statement: This form is estimated to take 0.2 hours to complete. Time will vary depending upon the needs of the individual case. Any comments on the amount of time you are required to complete this form should be sent to the Chief Information Officer, U.S. Patent and Trademark Office, Washington, DC 20231. DO NOT SEND FEES OR COMPLETED FORMS TO THIS ADDRESS. SEND TO: Assistant Commissioner for Patents, Box CN, Washington, DC 20231.

PTO/SB/124B (08-00)  
 Approved for use through 10/31/2002. OMB 0651-0035  
 U.S. Patent and Trademark Office: U.S. DEPARTMENT OF COMMERCE

Under the Paperwork Reduction Act of 1995, no persons are required to respond to a collection of information unless it displays a valid OMB control number.

<b>Request for Customer Number Data Change</b>	<b>Practitioner Registration Number Supplemental Sheet</b>
	Page                      of                      Pages

To the Commissioner of Patents and Trademarks:

Please record the following data changes to **Customer Number**:  → Place Customer Number  
Bar Code Label here

Please **delete** the following practitioner registration number(s) from the Customer Number indicated above:

<input style="width: 90%;" type="text"/>	<input style="width: 90%;" type="text"/>	<input style="width: 90%;" type="text"/>	<input style="width: 90%;" type="text"/>	<input style="width: 90%;" type="text"/>
<input style="width: 90%;" type="text"/>	<input style="width: 90%;" type="text"/>	<input style="width: 90%;" type="text"/>	<input style="width: 90%;" type="text"/>	<input style="width: 90%;" type="text"/>
<input style="width: 90%;" type="text"/>	<input style="width: 90%;" type="text"/>	<input style="width: 90%;" type="text"/>	<input style="width: 90%;" type="text"/>	<input style="width: 90%;" type="text"/>
<input style="width: 90%;" type="text"/>	<input style="width: 90%;" type="text"/>	<input style="width: 90%;" type="text"/>	<input style="width: 90%;" type="text"/>	<input style="width: 90%;" type="text"/>
<input style="width: 90%;" type="text"/>	<input style="width: 90%;" type="text"/>	<input style="width: 90%;" type="text"/>	<input style="width: 90%;" type="text"/>	<input style="width: 90%;" type="text"/>
<input style="width: 90%;" type="text"/>	<input style="width: 90%;" type="text"/>	<input style="width: 90%;" type="text"/>	<input style="width: 90%;" type="text"/>	<input style="width: 90%;" type="text"/>
<input style="width: 90%;" type="text"/>	<input style="width: 90%;" type="text"/>	<input style="width: 90%;" type="text"/>	<input style="width: 90%;" type="text"/>	<input style="width: 90%;" type="text"/>

Please **add** the following practitioner registration number(s) to the Customer Number indicated above:

<input style="width: 90%;" type="text"/>	<input style="width: 90%;" type="text"/>	<input style="width: 90%;" type="text"/>	<input style="width: 90%;" type="text"/>	<input style="width: 90%;" type="text"/>
<input style="width: 90%;" type="text"/>	<input style="width: 90%;" type="text"/>	<input style="width: 90%;" type="text"/>	<input style="width: 90%;" type="text"/>	<input style="width: 90%;" type="text"/>
<input style="width: 90%;" type="text"/>	<input style="width: 90%;" type="text"/>	<input style="width: 90%;" type="text"/>	<input style="width: 90%;" type="text"/>	<input style="width: 90%;" type="text"/>
<input style="width: 90%;" type="text"/>	<input style="width: 90%;" type="text"/>	<input style="width: 90%;" type="text"/>	<input style="width: 90%;" type="text"/>	<input style="width: 90%;" type="text"/>
<input style="width: 90%;" type="text"/>	<input style="width: 90%;" type="text"/>	<input style="width: 90%;" type="text"/>	<input style="width: 90%;" type="text"/>	<input style="width: 90%;" type="text"/>
<input style="width: 90%;" type="text"/>	<input style="width: 90%;" type="text"/>	<input style="width: 90%;" type="text"/>	<input style="width: 90%;" type="text"/>	<input style="width: 90%;" type="text"/>
<input style="width: 90%;" type="text"/>	<input style="width: 90%;" type="text"/>	<input style="width: 90%;" type="text"/>	<input style="width: 90%;" type="text"/>	<input style="width: 90%;" type="text"/>

Firm Name	
Date	
<input type="checkbox"/> Additional supplemental sheet(s) attached hereto	

Burden Hour Statement: This form is estimated to take 0.2 hours to complete. Time will vary depending upon the needs of the individual case. Any comments on the amount of time you are required to complete this form should be sent to the Chief Information Officer, U.S. Patent and Trademark Office, Washington, DC 20231. DO NOT SEND FEES OR COMPLETED FORMS TO THIS ADDRESS. SEND TO: Assistant Commissioner for Patents, Box CN, Washington, DC 20231.

REPRESENTATIVE OF INVENTOR OR OWNER

403

Please type a plus sign (+) inside this box →

PTO/SB/125A (08-00)

Approved for use through 10/31/2002. OMB 0651-0035

U.S. Patent and Trademark Office; U.S. DEPARTMENT OF COMMERCE

Under the Paperwork Reduction Act of 1995, no persons are required to respond to a collection of information unless it displays a valid OMB control number.

<h2 style="margin: 0;">Request for Customer Number</h2>	<p><b>Address to:</b></p> <p>Assistant Commissioner for Patents                  Box CN                  Washington, DC 20231</p>
---	---

<p>To the Commissioner of Patents and Trademarks:                  Please assign a Customer Number to the Correspondence Address indicated below.</p>				
Firm or Individual Name				
Address				
Address				
City		State		ZIP
Country				
Telephone		Fax		
<p>Please associate the following practitioner registration number(s) with the Customer Number assigned to the Correspondence Address cited above.</p>				
<input type="text"/>	<input type="text"/>	<input type="text"/>	<input type="text"/>	<input type="text"/>
<input type="text"/>	<input type="text"/>	<input type="text"/>	<input type="text"/>	<input type="text"/>
<input type="text"/>	<input type="text"/>	<input type="text"/>	<input type="text"/>	<input type="text"/>
<input type="text"/>	<input type="text"/>	<input type="text"/>	<input type="text"/>	<input type="text"/>
<input type="text"/>	<input type="text"/>	<input type="text"/>	<input type="text"/>	<input type="text"/>
<input type="text"/>	<input type="text"/>	<input type="text"/>	<input type="text"/>	<input type="text"/>
<input type="checkbox"/> Additional practitioner registration numbers are listed on supplemental sheet(s) attached hereto				
<b>Request Submitted by:</b>				
Firm Name (if applicable)				
Name of person submitting request				
Signature				
Telephone Number		Date		

Burden Hour Statement: This form is estimated to take 0.2 hours to complete. Time will vary depending upon the needs of the individual case. Any comments on the amount of time you are required to complete this form should be sent to the Chief Information Officer, U.S. Patent and Trademark Office, Washington, DC 20231. DO NOT SEND FEES OR COMPLETED FORMS TO THIS ADDRESS. SEND TO: Assistant Commissioner for Patents, Box CN, Washington, DC 20231.



**PATENT APPLICATION FILED WITHOUT CORRESPONDENCE ADDRESS**

In accordance with the provisions of 35 U.S.C. 111(a) and 37 CFR 1.53, a filing date is granted to a nonprovisional application for patent filed in the U.S. Patent and Trademark Office, if it includes at least a specification containing a description pursuant to 37 CFR 1.71 and at least one claim pursuant to 37 CFR 1.75, and any drawing referred to in the specification or required by 37 CFR 1.81(a). If a nonprovisional application which has been accorded a filing date does not include the appropriate filing fee, or oath or declaration, the applicant will be so notified and given a period of time within which to file the missing parts to complete the application and to pay the surcharge as set forth in 37 CFR 1.16(e) in order to prevent abandonment of the application. If a provisional application which has been accorded a filing date does not include the appropriate filing fee, or the cover sheet, the applicant will be so notified and given a period of time within which to file the missing parts to complete the application and to pay the surcharge as set forth in 37 CFR 1.16(l) in order to prevent abandonment of the application.

In order for the Office to so notify the applicant, a correspondence address must also be provided by the applicant. The address may be different from the post office address of the applicant. For example, the address of the applicant's registered attorney or agent may be used as the correspondence address. If the applicant fails to provide the Office with a correspondence address, the Office will be unable to provide the applicant with notification to complete the application and to pay the surcharge as set forth in 37 CFR 1.16(e) for nonprovisional applications and 37 CFR 1.16(l) for provisional applications. In such a case, the applicant will be considered to have constructive notice as of the filing date that the application must be completed and the applicant will have 2 months from the filing date in which to do so before abandonment occurs.

The periods of time within which the applicant must complete the application may be extended under the provisions of 37 CFR 1.136. Applications which are not completed in a timely manner will be abandoned.

**403.01 Correspondence Held With Associate Attorney**

Where the attorneys bear relation of principal attorney and associate attorney, the correspondence will be had with the associate attorney unless the principal attorney directs otherwise. *Ex parte Eggan*, 1911 C.D. 213, 172 O.G. 1091 (Comm'r Pat. 1911). The associate attorney may specify or change the correspondence address to which communications about the application are to be directed.

**403.02 Two Attorneys for Same Application**

If the applicant simultaneously appoints two principal attorneys, he or she should indicate with whom correspondence is to be conducted. If one is a local Washington metropolitan area attorney and the applicant fails to indicate either attorney, correspondence will be conducted with the local attorney.

If, after one attorney is appointed, a second attorney is later appointed without revocation of the power of the first attorney, the name of the second attorney is entered on either the face of the file or the PALM bibdata sheet (*Ex parte Eggan*, 1911 C.D. 213, 172 O.G. 1091 (Comm'r Pat. 1911)), with notation that the Office letters are to be sent to him or her. This applies also to associate attorneys.

**404 Conflicting Parties Having Same Attorney**

See 37 CFR 10.66.

**405 Attorney Not of Record**

Papers may be filed in patent applications by registered attorneys or agents not of record under 37 CFR 1.34(a). Filing of such papers is considered to be a representation that the attorney or agent is authorized to act in a representative capacity on behalf of applicant. However, interviews with a registered attorney or agent not of record will be conducted based only on the information and files supplied by the attorney or agent in view of 35 U.S.C. 122. Powers of attorney may not be signed by an attorney or agent not of record.

A change of correspondence address or a document granting access (i.e., a power to inspect) may only be signed by an attorney or agent who is not of record if an executed oath or declaration has not been filed in the application. See 37 CFR 1.33(a) (correspondence address) and 1.14(d)(4)

## 406 Death of Attorney

The power of a principal attorney will be revoked or terminated by his or her death. Such a revocation or termination of the power of the principal attorney will also terminate the power of those appointed by him or her. Thus, a principal attorney may appoint an associate attorney but such a power terminates with that of the principal. The principal attorney may not appoint a “substitute” and any attempt by the principal to appoint a “substitute” attorney whose power is intended to survive his or her own will not be recognized by the Office.

If notification is received from the applicant or assignee of the death of the sole principal attorney and the application is up for action by the examiner, correspondence is held with the applicant or assignee who originally appointed the deceased attorney.

If notification is received from the office of the deceased attorney and the application is up for action, the examiner when preparing the Office action should add form paragraph 4.02.

### ¶ 4.02 *Death of Attorney, Notice Received from Attorney's Office*

In view of the notification of the death of the attorney or agent of record, the power of attorney is terminated. A new registered attorney or agent may be appointed.

#### **Examiner Note:**

As the power of attorney has been terminated, Office correspondence is sent to the applicant or the assignee who originally appointed the deceased attorney or agent.

If notification of the death of the sole principal attorney is received from the Office of Enrollment and Discipline or some other source, there will be no paper of record in the file wrapper to indicate that the attorney is deceased. Correspondence therefore continues to be held with the office of the deceased attorney but a copy of the Office action is also mailed to the person who originally appointed the attorney. In such an Office action where the application is not ready for allowance, the examiner should add form paragraph 4.03.

### ¶ 4.03 *Death of Attorney, Notice from Other Source*

Notice of the death of the attorney or agent of record has come to the attention of this Office. Since the power of attorney is therefore terminated, a copy of this action is being mailed to the [1].

#### **Examiner Note:**

In bracket 1, insert --applicant-- or --assignee-- if the assignee originally appointed the deceased attorney or agent.

If notification of the death of the sole principal attorney is received from the Office of Enrollment and Discipline or some other source and the application is ready for allowance, the examiner prepares the application for allowance and writes a letter to the office of the deceased attorney with a copy to the person who originally appointed the deceased attorney including the wording of form paragraph 4.04.

### ¶ 4.04 *Death of Attorney, Application Is Ready for Allowance*

Notice of the death of the attorney or agent of record has come to the attention of this Office. Since the power of attorney is thus terminated, and this application is now ready for allowance, the Notice of Allowance will be mailed to the office of the deceased attorney or agent in the absence of a new power of attorney.

#### **Examiner Note:**

A copy should also be mailed to the applicant or the assignee who originally appointed the attorney or agent.

Note MPEP § 405.

## 407 Suspended or Excluded Practitioner

See MPEP § 105.

Form paragraphs 4.06, 4.07, and 4.08 should be used where power of attorney is given to an attorney or agent who has been suspended from practice before the Office.

### ¶ 4.06 *Attorney/Agent Suspended (Sole Practitioner, Sole Inventor)*

The instant application contains a power of attorney to [1] who has been [2] from practice before the Patent and Trademark Office (Office). The Office does not communicate with attorneys or agents who have been suspended or excluded from practice. Accordingly, the Office action is being mailed to you as the inventor.

Applicant may, of course, file a new power of attorney in the application to have a registered attorney or agent represent you before the Office. In the absence of an attorney or agent of record, all amendments and other papers filed in the application must be signed: (1) by you; or (2) if there is an assignee of record of an undivided part interest, by you and such assignee; or (3) if there is

an assignee of the entire interest, by such assignee; or (4) by a registered patent attorney or agent, not of record, who acts in a representative capacity under the provisions of 37 CFR 1.34(a). The Office will not hold telephone interviews with or send communications to a registered patent attorney or agent, acting in a representative capacity under 37 CFR 1.34, i.e., who is not of record in the application.

Applicant may obtain a list of registered patent attorneys and agents located in your area by writing to the Commissioner of Patents and Trademarks, Box OED, Washington, DC 20231, or by calling the Office of Enrollment and Discipline at (703) 306-4097.

#### **Examiner Note:**

1. In bracket 1, insert name of suspended or excluded practitioner.
2. In bracket 2, insert either --suspended-- or --excluded--.
3. This form paragraph should be used when a suspended or excluded practitioner is the only practitioner of record and there is only a single inventor. Use form paragraph 4.07 if there are joint inventors.
4. The Office action is to be mailed only to the inventor at his/her current address of record.

#### **¶ 4.07 Attorney/Agent Suspended (Sole Practitioner, Joint Inventors)**

The instant application contains a power of attorney to [1] who has been [2] from practice before the Patent and Trademark Office (Office). The Office does not communicate with attorneys or agents who have been suspended or excluded from practice. Accordingly, the Office action is being mailed to the address of the inventor first named in the application.

Applicants may, of course, file a new power of attorney in the application to have a registered attorney or agent represent them before the Office. In the absence of an attorney or agent of record, all amendments and other papers filed in the application must be signed: (1) by all named applicants unless one named applicant has been given a power of attorney to sign on behalf of the remaining applicants, and the power of attorney is of record in the application; or (2) if there is an assignee of record of an undivided part interest, by all named applicants retaining an interest and such assignee; or (3) if there is an assignee of the entire interest, by such assignee; or (4) by a registered patent attorney or agent not of record who acts in a representative capacity under the provisions of 37 CFR 1.34(a). The Office will not hold telephone interviews with or send communications to a registered patent attorney or agent, acting in a representative capacity under 37 CFR 1.34, i.e., who is not of record in the application.

Applicants may obtain a list of registered patent attorneys and agents located in their area by writing to the Commissioner of Patents and Trademarks, Box OED, Washington, DC 20231, or by calling the Office of Enrollment and Discipline at (703) 306-4097.

#### **Examiner Note:**

1. In bracket 1, insert the name of the suspended or excluded practitioner.
2. In bracket 2, insert either --suspended-- or --excluded--.
3. This form paragraph should be used when the suspended or excluded practitioner is the only practitioner of record and there

are joint inventors. Use form paragraph 4.06 if there is a single inventor.

4. The Office action is to be mailed only to the inventor first named in the declaration at his or her current post office address of record.

#### **¶ 4.08 Attorney/Agent Suspended (Plural Practitioners)**

The present application was filed containing a power of attorney to [1] and [2]. A correspondence address was supplied for [3]. No address was supplied for [4].

[5] was [6] from practice before the Patent and Trademark Office (Office). The Office does not communicate with attorneys or agents who have been suspended or excluded from practice.

As a correspondence address, other than to [7], is not of record, this Office action is being mailed to [8] at his/her last known address as listed on the register of patent attorneys and agents. To ensure that a copy of this Office action is received in a timely manner to allow for a timely reply, a copy of the Office action is being mailed directly to the address of the inventor first named in the declaration or oath. Any reply by applicant(s) should be by way of the remaining practitioner(s) of record and should include a new correspondence address.

#### **Examiner Note:**

1. In brackets 1, 3, 5 and 7 insert the name of the suspended or excluded practitioner.
2. In brackets 2, 4 and 8, insert the name of the first named unsuspended (unexcluded) registered practitioner of record.
3. In bracket 6, insert either --suspended-- or --excluded--.
4. This form paragraph should be used when there is at least one registered practitioner still of record who has not been suspended or excluded from practice. Use one of form paragraphs 4.06 or 4.07 if there are no remaining registered attorneys or agents of record.
5. The Office action is to be mailed both to the first named registered attorney or agent of record (who is not suspended or excluded) at the address currently listed in the Attorney's Roster, and to the inventor first named in the declaration at his or her current post office address of record.

## **408 Telephoning Attorney**

Present Office policy places great emphasis on telephone interviews initiated by the examiner. For this reason, it is not necessary for an attorney to request a telephone interview. Examiners are not required to note or acknowledge requests for telephone calls or state reasons why such proposed telephone interviews would not be considered effective to advance prosecution. However, it is desirable for an attorney to call the examiner if the attorney feels the call will be beneficial to advance prosecution of the application. See MPEP § 713.01 and § 713.05.



Many attorneys have offices or representatives in the Washington area and it sometimes expedites business to interview them concerning an application. When the examiner believes the progress of the application would be advanced by an interview, he or she may call the attorney in the application by telephone and ask the attorney to come to the Office.

Registered attorneys or agents not of record in a patent application and acting in a representative capacity under 37 CFR 1.34(a) should not be telephoned for restriction requirements, approval of examiner's amendments, or given any information relative to such patent application by telephone unless the telephone number of such attorney or agent appears in a paper signed by the applicant or an attorney or agent of record.

Examiners should place all long distance telephone calls through the FTS (Federal Telecommunications System), even though collect calls may have been authorized by the attorney.

To facilitate any telephone calls that may become necessary, it is strongly recommended that amendments, letters of transmittal, and powers of attorney include the complete telephone number, with area code and extension, of the person with whom the interview should be held, preferably near the signature.

In new applications, the telephone number may appear on the letter of transmittal or in the power of attorney, oath, or declaration, next to the attorney's name and address.

#### **SPECIFIC TELEPHONE INTERVIEW SITUATIONS**

For restriction of invention, see MPEP § 812.01.

For multiplicity, see MPEP § 2173.05(n).

#### **409 Death, Legal Incapacity, or Unavailability of Inventor**

If the inventor is dead, insane, or otherwise legally incapacitated, refuses to execute an application, or cannot be found, an application may be made by someone other than the inventor, as specified in 37 CFR 1.42-1.47, and 37 CFR 1.423, MPEP § 409.01 - § 409.03(j).

A minor (under age 18) inventor may execute an oath or declaration under 37 CFR 1.63 as long as the person is competent to sign (i.e., understands the doc-

ument that he or she is signing); a legal representative is not required to execute an oath or declaration on the minor's behalf. See 37 CFR 1.63(a)(1).

#### **409.01 Death of Inventor**

Unless a power of attorney is coupled with an interest (i.e., an attorney is assignee or part-assignee), the death of the inventor (or one of the joint inventors) terminates the power of attorney given by the deceased inventor. A new power from the heirs, administrators, executors, or assignees is necessary if the deceased inventor is the sole inventor or all powers of attorney in the application have been terminated (but see MPEP § 409.01(f)). See also 37 CFR 1.422.

#### **409.01(a) Prosecution by Administrator or Executor**

*35 U.S.C. 117. Death or incapacity of inventor*

Legal representatives of deceased inventors and of those under legal incapacity may make application for patent upon compliance with the requirements and on the same terms and conditions applicable to the inventor.

*37 CFR 1.42. When the inventor is dead.*

In case of the death of the inventor, the legal representative (executor, administrator, etc.) of the deceased inventor may make the necessary oath or declaration, and apply for and obtain the patent. Where the inventor dies during the time intervening between the filing of the application and the granting of a patent thereon, the letters patent may be issued to the legal representative upon proper intervention.

One who has reason to believe that he or she will be appointed legal representative of a deceased inventor may apply for a patent as legal representative in accordance with 37 CFR 1.42.

Application may be made by the heirs of the inventor, as such, if there is no will or the will did not appoint an executor and the estate was under the sum required by state law for the appointment of an administrator. The heirs should identify themselves as the legal representative of the deceased inventor in the oath or declaration submitted pursuant to 37 CFR 1.63 and 1.64.

#### **409.01(b) Proof of Authority of Administrator or Executor**

The Office no longer requires proof of authority of the legal representative of a deceased or incapacitated

inventor. Although the Office does not require proof of authority to be filed, any person acting as a legal representative of a deceased or incapacitated inventor should ensure that he or she is properly acting in such a capacity.

#### **409.01(c) After Administrator or Executor Has Been Discharged**

When an administrator or executor has performed his or her functions and has been discharged and it is desired to make an application for an invention of the deceased, it is necessary for the administrator or executor to take out new letters of administration in order that he or she may file a new application for an invention of the deceased inventor.

#### **409.01(d) Exception in Some Foreign Countries**

The terms “Executor” and “Administrator” do not have exact counterparts in all foreign countries, and therefore, those terms must be construed to fit the circumstances of the case. Hence, the person or persons having authority corresponding to that of executor or administrator are permitted to make application as, for example, the heirs in the Federal Republic of Germany where no existing executor or administrator has been or will be appointed.

#### **409.01(e) If Applicant of Assigned Application Dies**

When an applicant who has prosecuted an application after assignment, dies, the administrator of the deceased applicant’s estate may carry on the prosecution upon filing letters of administration unless and until the assignee intervenes (MPEP § 402.07).

#### **409.01(f) Intervention of Executor Not Compulsory**

When an inventor dies after filing an application and executing the oath or declaration required by 37 CFR 1.63, the executor or administrator should intervene, but the allowance of the application will not be withheld nor the application withdrawn from issue if the executor or administrator does not intervene.

This practice is applicable to an application which has been placed in condition for allowance or passed

to issue prior to notification of the death of the inventor. See MPEP § 409.01.

When a joint inventor of a *pro se* application dies after filing the application, the living joint inventor(s) must submit proof that the other joint inventor is dead. Upon submission of such proof, only the signatures of the living joint inventors are required on the papers filed with the USPTO if the legal representative of the deceased inventor does not intervene. If the legal representative of the deceased inventor wishes to intervene, the legal representative must submit an oath or declaration in compliance with 37 CFR 1.63 and 1.64 (e.g., stating that he or she is the legal representative of the deceased inventor and his or her residence, citizenship and post office address). Once the legal representative of the deceased inventor intervenes in the *pro se* application, the signatures of the living joint inventors and the legal representative are required on the papers filed with the USPTO.

#### **409.02 Insanity or Other Legal Incapacity**

*37 CFR 1.43. When the inventor is insane or legally incapacitated.*

In case an inventor is insane or otherwise legally incapacitated, the legal representative (guardian, conservator, etc.) of such inventor may make the necessary oath or declaration, and apply for and obtain the patent.

When an inventor dies prior to the filing of an application and prior to executing the oath or declaration required by 37 CFR 1.63 and no legal representative has been appointed, one must be appointed by a court of competent jurisdiction for the purpose of execution of the oath or declaration of the application.

#### **409.03 Unavailability of Inventor**

*35 U.S.C. 116. Inventors*

When an invention is made by two or more persons jointly, they shall apply for patent jointly and each make the required oath, except as otherwise provided in this title. Inventors may apply for a patent jointly even though (1) they did not physically work together or at the same time, (2) each did not make the same type or amount of contribution, or (3) each did not make a contribution to the subject matter of every claim of the patent.

If a joint inventor refuses to join in an application for patent or cannot be found or reached after diligent effort, the application may be made by the other inventor on behalf of himself and the omitted inventor. The Director, on proof of the pertinent facts and after such notice to the omitted inventor as he prescribes, may grant a patent to the inventor making the application, subject to

the same rights which the omitted inventor would have had if he had been joined. The omitted inventor may subsequently join in the application.

Whenever through error a person is named in an application for patent as the inventor, or through an error an inventor is not named in an application, and such error arose without any deceptive intention on his part, the Director may permit the application to be amended accordingly, under such terms as he prescribes.

#### 35 U.S.C. 118. *Filing by other than inventor*

Whenever an inventor refuses to execute an application for patent, or cannot be found or reached after diligent effort, a person to whom the inventor has assigned or agreed in writing to assign the invention or who otherwise shows sufficient proprietary interest in the matter justifying such action, may make application for patent on behalf of and as agent for the inventor on proof of the pertinent facts and a showing that such action is necessary to preserve the rights of the parties or to prevent irreparable damage; and the Director may grant a patent to such inventor upon such notice to him as the Director deems sufficient, and on compliance with such regulations as he prescribes.

#### 37 CFR 1.47. *Filing when an inventor refuses to sign or cannot be reached.*

(a) If a joint inventor refuses to join in an application for patent or cannot be found or reached after diligent effort, the application may be made by the other inventor on behalf of himself or herself and the nonsigning inventor. The oath or declaration in such an application must be accompanied by a petition including proof of the pertinent facts, the fee set forth in § 1.17(h), and the last known address of the nonsigning inventor. The nonsigning inventor may subsequently join in the application by filing an oath or declaration complying with § 1.63.

(b) Whenever all of the inventors refuse to execute an application for patent, or cannot be found or reached after diligent effort, a person to whom an inventor has assigned or agreed in writing to assign the invention, or who otherwise shows sufficient proprietary interest in the matter justifying such action, may make application for patent on behalf of and as agent for all the inventors. The oath or declaration in such an application must be accompanied by a petition including proof of the pertinent facts, a showing that such action is necessary to preserve the rights of the parties or to prevent irreparable damage, the fee set forth in § 1.17(h), and the last known address of all of the inventors. An inventor may subsequently join in the application by filing an oath or declaration complying with § 1.63.

(c) The Office will send notice of the filing of the application to all inventors who have not joined in the application at the address(es) provided in the petition under this section, and publish notice of the filing of the application in the *Official Gazette*. The Office may dispense with this notice provision in a continuation or divisional application, if notice regarding the filing of the prior application was given to the nonsigning inventor(s).

Application papers submitted pursuant to 37 CFR 1.47 are forwarded by the Office of Initial Patent Examination (OIPE) to the Office of Petitions for a

determination of whether the papers are proper, complete, and acceptable under 37 CFR 1.47 and for a decision on the petition under 37 CFR 1.47 before the application is sent to the Technology Center. Since an application without an oath or declaration executed by all of the inventors may be an incomplete application, an examiner should not mail an Office action in an application without a fully executed oath or declaration under 37 CFR 1.63 unless the application has been accorded status under 37 CFR 1.47 in a written decision on the petition.

A *bona fide* attempt must be made to comply with the provisions of 37 CFR 1.47 at the time the oath or declaration is first submitted. If the oath or declaration, and evidence submitted with the oath or declaration, are not acceptable, the 37 CFR 1.47 applicant will be notified of the reasons why the papers are not acceptable. The 37 CFR 1.47 applicant may request reconsideration and file supplemental evidence in a case where a *bona fide* attempt was made to comply with 37 CFR 1.47 from the outset.

A decision granting a petition under 37 CFR 1.47 does not alter the ownership interest or title of the application. If the nonsigning inventor has not signed an assignment document which has been recorded in the USPTO, then the 37 CFR 1.47 applicant (the company that files the petition under 37 CFR 1.47(b) and establishes proprietary interest in the application) is NOT the assignee of the entire interest of the application.

### 409.03(a) At Least One Joint Inventor Available

37 CFR 1.47(a) and 35 U.S.C. 116, second paragraph, requires all available joint inventors to file an application “on behalf of” themselves and on behalf of a joint inventor who “cannot be found or reached after diligent effort” or who refuses to “join in an application.”

In addition to other requirements of law (35 U.S.C. 111(a) and 115), an application deposited in the U.S. Patent and Trademark Office pursuant to 37 CFR 1.47(a) must meet the following requirements:

(A) All the available joint inventors must (1) make oath or declaration on their own behalf as required by 37 CFR 1.63 or 1.175 (see MPEP § 602, § 605.01, and § 1414) and (2) make oath or declara-

tion on behalf of the nonsigning joint inventor as required by 37 CFR 1.64. An oath or declaration signed by all the available joint inventors with the signature block of the nonsigning inventor(s) left blank may be treated as having been signed by all the available joint inventors on behalf of the nonsigning inventor(s), unless otherwise indicated.

(B) The application must be accompanied by proof that the nonsigning inventor (1) cannot be found or reached after diligent effort or (2) refuses to execute the application papers. See MPEP § 409.03(d).

(C) The last known address of the nonsigning joint inventor must be stated. See MPEP § 409.03(e).

### 409.03(b) No Inventor Available

Filing under 37 CFR 1.47(b) and 35 U.S.C. 118 is permitted only when no inventor is available to make application. These provisions allow a “person” with a demonstrated proprietary interest to make application “on behalf of and as agent for” an inventor who “cannot be found or reached after diligent effort” or who refuses to sign the application oath or declaration. The word “person” has been construed by the U.S. Patent and Trademark Office to include juristic entities, such as a corporation. Where 37 CFR 1.47(a) is available, application cannot be made under 37 CFR 1.47(b).

In addition to other requirements of law (35 U.S.C. 111(a) and 115), an application deposited pursuant to 37 CFR 1.47(b) must meet the following requirements:

(A) The 37 CFR 1.47(b) applicant must make the oath required by 37 CFR 1.63 and 1.64 or 1.175. Where a corporation is the 37 CFR 1.47(b) applicant, an officer (President, Vice-President, Secretary, Treasurer, or Chief Executive Officer) thereof should normally sign the necessary oath or declaration. A corporation may authorize any person, including an attorney or agent registered to practice before the U.S. Patent and Trademark Office, to sign the application oath or declaration on its behalf. Where an oath or declaration is signed by a registered attorney or agent on behalf of a corporation, either proof of the attorney's or agent's authority in the form of a statement signed by an appropriate corporate officer must be submitted, or the attorney or agent may simply state that he or she is authorized to sign on behalf of the corporation. Where the oath or declaration is being signed on behalf of an assignee, see MPEP § 324. An

inventor may not authorize another individual to act as his or her agent to sign the application oath or declaration on his or her behalf. *Staeger v. Commissioner*, 189 USPQ 272 (D.D.C. 1976), *In re Striker*, 182 USPQ 507 (Comm'r Pat. 1973). Where an application is executed by one other than the inventor, the declaration required by 37 CFR 1.63 must state the full name, residence, post office address, and citizenship of the nonsigning inventor. Also, the title or position of the person signing must be stated if signing on behalf of a corporation under 37 CFR 1.47(b).

(B) The 37 CFR 1.47(b) applicant must state his or her relationship to the inventor as required by 37 CFR 1.64.

(C) The application must be accompanied by proof that the inventor (1) cannot be found or reached after a diligent effort or (2) refuses to execute the application papers. See MPEP § 409.03(d).

(D) The last known address of the inventor must be stated. See MPEP § 409.03(e).

(E) The 37 CFR 1.47(b) applicant must make out a *prima facie* case (1) that the invention has been assigned to him or her or (2) that the inventor has agreed in writing to assign the invention to him or her or (3) otherwise demonstrate a proprietary interest in the subject matter of the application. See MPEP § 409.03(f).

(F) The 37 CFR 1.47(b) applicant must prove that the filing of the application is necessary (1) to preserve the rights of the parties or (2) to prevent irreparable damage. See MPEP § 409.03(g).

### 409.03(c) Legal Representatives of Deceased Inventor Not Available

37 CFR 1.47 should not be considered an alternative to 37 CFR 1.42 or 35 U.S.C. 117 since the language “cannot be found or reached after diligent effort” has no reasonable application to a deceased inventor. *In re Application Papers Filed September 10, 1954*, 108 USPQ 340 (Comm'r Pat. 1955). See 37 CFR 1.42 and MPEP § 409.01. However, 37 CFR 1.47 does apply where a known legal representative of a deceased inventor cannot be found or reached after diligent effort, or refuses to make application. In such cases, the last known address of the legal representative must be given (see MPEP § 409.03(e)).

## 409.03(d) Proof of Unavailability or Refusal

### INVENTOR CANNOT BE REACHED

Where inability to find or reach a nonsigning inventor “after diligent effort” is the reason for filing under 37 CFR 1.47, a statement of facts should be submitted that fully describes the exact facts which are relied on to establish that a diligent effort was made.

The fact that a nonsigning inventor is on vacation or out of town and is therefore temporarily unavailable to sign the declaration is not an acceptable reason for filing under 37 CFR 1.47.

Furthermore, the fact that an inventor is hospitalized and/or is not conscious is not an acceptable reason for filing under 37 CFR 1.47. 37 CFR 1.43 may be available under these circumstances. See MPEP § 409.02. Such a petition under 37 CFR 1.47 will be dismissed as inappropriate.

The statement of facts must be signed, where at all possible, by a person having firsthand knowledge of the facts recited therein. Statements based on hearsay will not normally be accepted. Copies of documentary evidence such as internet searches, certified mail return receipts, cover letters of instructions, telegrams, that support a finding that the nonsigning inventor could not be found or reached should be made part of the statement. The steps taken to locate the whereabouts of the nonsigning inventor should be included statement of facts. It is important that the statement contain facts as opposed to conclusions.

### REFUSAL TO JOIN

A refusal by an inventor to sign an oath or declaration when the inventor has not been presented with the application papers does not itself suggest that the inventor is refusing to join the application unless it is clear that the inventor understands exactly what he or she is being asked to sign and refuses to accept the application papers. A copy of the application papers should be sent to the last known address of the nonsigning inventor, or, if the nonsigning inventor is represented by counsel, to the address of the nonsigning inventor’s attorney. The fact that an application may contain proprietary information does not relieve the

37 CFR 1.47 applicant of the responsibility to present the application papers to the inventor if the inventor is willing to receive the papers in order to sign the oath or declaration. It is noted that the inventor may obtain a complete copy of the application, unless the inventor has assigned his or her interest in the application, and the assignee has requested that the inventor not be permitted access. See MPEP § 106. It is reasonable to require that the inventor be presented with the application papers before a petition under 37 CFR 1.47 is granted since such a procedure ensures that the inventor is apprised of the application to which the oath or declaration is directed. *In re Gray*, 115 USPQ 80 (Comm’r Pat. 1956).

Where a refusal of the inventor to sign the application papers is alleged, the circumstances of the presentation of the application papers and of the refusal must be specified in a statement of facts by the person who presented the inventor with the application papers and/or to whom the refusal was made. Statements by a party not present when an oral refusal is made will not be accepted.

Proof that a *bona fide* attempt was made to present a copy of the application papers (specification, including claims, drawings, and oath or declaration) to the nonsigning inventor for signature, but the inventor refused to accept delivery of the papers or expressly stated that the application papers should not be sent, may be sufficient. When there is an express oral refusal, that fact along with the time and place of the refusal must be stated in the statement of facts. When there is an express written refusal, a copy of the document evidencing that refusal must be made part of the statement of facts. The document may be redacted to remove material not related to the inventor’s reasons for refusal.

When it is concluded by the 37 CFR 1.47 applicant that a nonsigning inventor’s conduct constitutes a refusal, all facts upon which that conclusion is based should be stated in the statement of facts in support of the petition or directly in the petition. If there is documentary evidence to support facts alleged in the petition or in any statement of facts, such evidence should be submitted. Whenever a nonsigning inventor gives a reason for refusing to sign the application oath or declaration, that reason should be stated in the petition.

### **409.03(e) Statement of Last Known Address**

An application filed pursuant to 37 CFR 1.47 must state the last known address of the nonsigning inventor.

That address should be the last known address at which the inventor customarily receives mail. See MPEP § 605.03. Ordinarily, the last known address will be the last known residence of the nonsigning inventor.

Inasmuch as a nonsigning inventor is notified that an application pursuant to 37 CFR 1.47 has been filed on his or her behalf, other addresses at which the nonsigning inventor may be reached should also be given.

### **409.03(f) Proof of Proprietary Interest**

When an application is deposited pursuant to 37 CFR 1.47(b), the 37 CFR 1.47(b) applicant must prove that

(A) the invention has been assigned to the applicant, or

(B) the inventor has agreed in writing to assign the invention to the applicant, or

(C) the applicant otherwise has sufficient proprietary interest in the subject matter to justify the filing of the application.

If the application has been assigned, a copy of the assignment (in the English language) must be submitted. The assignment must clearly indicate that the invention described in the 37 CFR 1.47(b) application was assigned to the 37 CFR 1.47(b) applicant. A statement under 37 CFR 3.73(b) by the assignee must also be submitted (see MPEP § 324). An assignment of an application and any “reissue, division, or continuation of said application” does not itself establish an assignment of a continuation-in-part application. *In re Gray*, 115 USPQ 80 (Comm’r Pat. 1956). An assignment to a 37 CFR 1.47(b) applicant for the sole purpose of obtaining a filing date for a 37 CFR 1.47(b) application is not considered an assignment within the meaning of 35 U.S.C. 118 and 37 CFR 1.47(b).

When an inventor has agreed in writing to assign an invention described in an application deposited pursuant to 37 CFR 1.47(b), a copy of that agreement should be submitted. If an agreement to assign is dependent on certain specified conditions being met,

it must be established by a statement of facts by someone with first hand knowledge of the circumstances in which those conditions have been met. A typical agreement to assign is an employment agreement where an employee (nonsigning inventor) agrees to assign to his or her employer (37 CFR 1.47(b) applicant) all inventions made during employment. When such an agreement is relied on, it must be established by a statement of a person having firsthand knowledge of the facts that the invention was made by the employee while employed by the 37 CFR 1.47(b) applicant.

If the invention has not been assigned, or if there is no written agreement to assign, the 37 CFR 1.47(b) applicant must demonstrate that he or she otherwise has a sufficient proprietary interest in the matter.

A proprietary interest obtained other than by assignment or agreement to assign may be demonstrated by an appropriate legal memorandum to the effect that a court of competent jurisdiction (federal, state, or foreign) would by the weight of authority in that jurisdiction award title of the invention to the 37 CFR 1.47(b) applicant. The facts in support of any conclusion that a court would award title to the 37 CFR 1.47(b) applicant should be made of record by way of an affidavit or declaration of the person having firsthand knowledge of same. The legal memorandum should be prepared and signed by an attorney at law familiar with the law of the jurisdiction involved. A copy (in the English language) of a statute (if other than the United States statute) or a court decision (if other than a reported decision of a federal court or a decision reported in the United States Patents Quarterly) relied on to demonstrate a proprietary interest should be made of record.

### **409.03(g) Proof of Irreparable Damage**

Irreparable damage may be established by a showing (a statement) that a filing date is necessary to preserve the rights of the party or to prevent irreparable damage.

### **409.03(h) Processing and Acceptance of a 37 CFR 1.47 Application**

A filing date is assigned to an application deposited pursuant to 37 CFR 1.47 provided the requirements of 37 CFR 1.53(b) are met. A filing receipt will be sent to the applicant and the application will be forwarded

to the Office of Petitions, for consideration of the petition filed under 37 CFR 1.47.

When papers deposited pursuant to 37 CFR 1.47 are found acceptable, the Office of Petitions enters a decision to that effect in the file. A notice will be published in the *Official Gazette* identifying the application number, filing date, the title of the invention and the name(s) of the nonsigning inventor(s). The U.S. Patent and Trademark Office will notify the nonsigning inventor(s) or, if the inventor is deceased, the legal representative(s), of the filing of an application under 37 CFR 1.47 by sending a letter to the last known address of the nonsigning inventor(s) or legal representative(s). In a continuation or divisional application filed under 37 CFR 1.53(b) of an application accorded status under 37 CFR 1.47, if a copy of a declaration from a prior application and a copy of a decision according status under 37 CFR 1.47 are filed as permitted by 37 CFR 1.63(d)(3)(i), the notice will not be repeated. See 37 CFR 1.47(c). In addition, the notice is not repeated in continued prosecution applications filed under 37 CFR 1.53(d).

#### **409.03(i) Rights of the Nonsigning Inventor**

The nonsigning inventor (also referred to as an “inventor designee”) may protest his or her designation as an inventor. The nonsigning inventor is entitled to inspect any paper in the application, order copies thereof at the price set forth in 37 CFR 1.19, and make his or her position of record in the file wrapper of the application. Alternatively, the nonsigning inventor may arrange to do any of the preceding through a registered patent attorney or agent.

While the U.S. Patent and Trademark Office will grant the nonsigning inventor access to the application, *inter partes* proceedings will not be instituted in 37 CFR 1.47 case. *In re Hough*, 108 USPQ 89 (Comm'r Pat. 1955). A nonsigning inventor is not entitled to a hearing (*Cogar v. Schuyler*, 464 F.2d 747, 173 USPQ 389 (D.C. Cir. 1972)), and is not entitled to prosecute the application if status under 37 CFR 1.47 has been accorded, or if proprietary interest of the 37 CFR 1.47(b) applicant has been shown to the satisfaction of the U.S. Patent and Trademark Office.

A nonsigning inventor may join in a 37 CFR 1.47 application. To join in the application, the nonsigning inventor must file an appropriate 37 CFR 1.63 oath or

declaration. Even if the nonsigning inventor joins in the application, he or she cannot revoke or give a power of attorney without agreement of the 37 CFR 1.47 applicant.

The rights of a nonsigning inventor are protected by the fact that the patent resulting from an application filed under 37 CFR 1.47(b) and 35 U.S.C. 118 must issue to the inventor, and in an application filed under 37 CFR 1.47(a) and 35 U.S.C. 116, the inventor has the same rights that he or she would have if he or she had joined in the application. *In re Hough*, 108 USPQ 89 (Comm'r Pat. 1955).

If a nonsigning inventor feels that he or she is the sole inventor of an invention claimed in a 37 CFR 1.47 application naming him or her as a joint inventor, the nonsigning inventor may file his or her own application and request that his or her application be placed in interference with the 37 CFR 1.47 application. If the claims in both the nonsigning inventor's application and the 37 CFR 1.47 application are otherwise found allowable, an interference may be declared.

#### **409.03(j) Action Following Acceptance of a 37 CFR 1.47 Application**

After an application deposited pursuant to 37 CFR 1.47 is found acceptable by the Office, the examiner will act on the application in the usual manner. Papers filed by an inventor who did not originally join in the application, and papers relating to its 37 CFR 1.47 status, will be placed in the file wrapper.

In the event the previously nonsigning inventor decides to join in the application by filing an executed oath or declaration complying with 37 CFR 1.63, the oath or declaration will be placed in the application file.

When the examiner determines that an application in which a petition under 37 CFR 1.47 has been granted, or either a continued prosecution application (CPA) filed under 37 CFR 1.53(d) or a file wrapper continuing application filed under former 37 CFR 1.62 thereof is allowable, he or she must check the file wrapper or the PALM bib-data sheet to make sure that the phrase “Rule 47” appears under the filing date. If the phrase “Rule 47” does not appear under the filing date, the examiner should write in black ink the phrase “Rule 47” under the filing date. The examiner will then prepare the application for allowance in accordance with MPEP Chapter 1300. It will not be

necessary to forward the application to the Office of Petitions.

A patent granted on an application accepted under 37 CFR 1.47 will have an indication on the face of the patent that the application was filed under 37 CFR 1.47, regardless of whether proper joinder of the previously nonsigning inventor has been made.

An application filed under 37 CFR 1.47 can be published as a Statutory Invention Registration.

## 410 Representations to the U.S. Patent and Trademark Office

*37 CFR 1.4. Nature of correspondence and signature requirements.*

\*\*\*\*\*

(2) The presentation to the Office (whether by signing, filing, submitting, or later advocating) of any paper by a party, whether a practitioner or non-practitioner, constitutes a certification under § 10.18(b) of this chapter. Violations of § 10.18(b)(2) of this chapter by a party, whether a practitioner or non-practitioner, may result in the imposition of sanctions under § 10.18(c) of this chapter. Any practitioner violating § 10.18(b) may also be subject to disciplinary action. See §§ 10.18(d) and 10.23(c)(15).

\*\*\*\*\*

*37 CFR 10.18. Signature and certificate for correspondence filed in the Patent and Trademark Office.*

(a) For all documents filed in the Office in patent, trademark, and other non-patent matters, except for correspondence that is required to be signed by the applicant or party, each piece of correspondence filed by a practitioner in the Patent and Trademark Office must bear a signature, personally signed by such practitioner, in compliance with § 1.4(d)(1) of this chapter.

(b) By presenting to the Office (whether by signing, filing, submitting, or later advocating) any paper, the party presenting such paper, whether a practitioner or non-practitioner, is certifying that—

(1) All statements made therein of the party's own knowledge are true, all statements made therein on information and belief are believed to be true, and all statements made therein are made with the knowledge that whoever, in any matter within the jurisdiction of the Patent and Trademark Office, knowingly and willfully falsifies, conceals, or covers up by any trick, scheme, or device a material fact, or makes any false, fictitious or fraudulent statements or representations, or makes or uses any false writing or document knowing the same to contain any false, fictitious or fraudulent statement or entry, shall be subject to the penalties set forth under 18 U.S.C. 1001, and that violations of this paragraph may jeopardize the validity of the application or document, or the validity or enforceability of any patent, trademark registration, or certificate resulting therefrom; and

(2) To the best of the party's knowledge, information and belief, formed after an inquiry reasonable under the circumstances, that —

(i) The paper is not being presented for any improper purpose, such as to harass someone or to cause unnecessary delay or needless increase in the cost of prosecution before the Office;

(ii) The claims and other legal contentions therein are warranted by existing law or by a nonfrivolous argument for the extension, modification, or reversal of existing law or the establishment of new law;

(iii) The allegations and other factual contentions have evidentiary support or, if specifically so identified, are likely to have evidentiary support after a reasonable opportunity for further investigation or discovery; and

(iv) The denials of factual contentions are warranted on the evidence, or if specifically so identified, are reasonably based on a lack of information or belief.

(c) Violations of paragraph (b)(1) of this section by a practitioner or non-practitioner may jeopardize the validity of the application or document, or the validity or enforceability of any patent, trademark registration, or certificate resulting therefrom. Violations of any of paragraphs (b)(2)(i) through (iv) of this section are, after notice and reasonable opportunity to respond, subject to such sanctions as deemed appropriate by the Commissioner, or the Commissioner's designee, which may include, but are not limited to, any combination of —

(1) Holding certain facts to have been established;

(2) Returning papers;

(3) Precluding a party from filing a paper, or presenting or contesting an issue;

(4) Imposing a monetary sanction;

(5) Requiring a terminal disclaimer for the period of the delay; or

(6) Terminating the proceedings in the Patent and Trademark Office.

(d) Any practitioner violating the provisions of this section may also be subject to disciplinary action. See § 10.23(c)(15).

37 CFR 1.4(d)(2) provides that the presentation to the Office (whether by signing, filing, submitting, or later advocating) of any paper by a party, whether a practitioner or nonpractitioner, constitutes a certification under 37 CFR 10.18(b), and that violations of 37 CFR 10.18(b)(2) may subject the party to sanctions under 37 CFR 10.18(c). Thus, by presenting a paper to the Office, the party is making the certifications set forth in 37 CFR 10.18(b), and is subject to sanctions under 37 CFR 10.18(c) for violations of 37 CFR 10.18(b)(2), regardless of whether the party is a practitioner or nonpractitioner. A practitioner violating 37 CFR 10.18(b) may also be subject to disciplinary action in lieu of or in addition to sanctions under 37 CFR 10.18(c) for violations of 37 CFR 10.18(b).



37 CFR 10.18(b) provides that, by presenting any paper to the USPTO, the party presenting such paper is making two certifications: (1) the first certification is that the statements made therein are subject to the declaration clause of 37 CFR 1.68; (2) the second certification is the certification required for papers filed in a federal court under Rule 11(b) of the Federal Rules of Civil Procedure.

The first certification has permitted the USPTO to eliminate the separate verification requirement previously contained in 37 CFR 1.6, 1.8, 1.10, 1.27, 1.28, 1.47, 1.48, 1.52, 1.55, 1.69, 1.102, 1.125, 1.137, 1.377, 1.378, 1.740, 1.804, 1.805, 3.26, and 5.4 for statements of facts by persons who are not registered to practice before the USPTO. As statements submitted to the USPTO by any person are now, by operation of 37 CFR 10.18(b)(1), verified statements, a separate verification requirement is no longer necessary. The USPTO, however, has retained the verification requirement for a statement to be submitted under oath or declaration (37 CFR 1.68) in a number of sections (e.g., 37 CFR 1.63, 1.130, 1.131, 1.132, 1.494(e), 1.495(f), and 5.25).

The second certification is based upon Rule 11(b) of the Federal Rules of Civil Procedure (1993). This provision is promulgated pursuant to the Commissioner's authority under 35 U.S.C. 6(a) to establish regulations for the conduct of proceedings in the USPTO, and is intended to discourage the filing of frivolous papers by practitioners or non-practitioners in the USPTO. Rule 11(b) of the Federal Rules of Civil Procedure provides:

**Representations to Court.** By presenting to the court (whether by signing, filing, submitting, or later advocating) a pleading, written motion, or other paper, an attorney or unrepresented party is certifying that to the best of the person's knowledge, information and belief, formed after an inquiry reasonable under the circumstances, --

(1) it is not being presented for any improper purpose, such as to harass or to cause unnecessary delay or needless increase in the cost of litigation;

(2) the claims, defenses, and other legal contentions therein are warranted by existing law or by a nonfrivolous argument for the extension, modification, or reversal of existing law or the establishment of new law;

(3) the allegations and other factual contentions have evidentiary support or, if specifically so identified, are

likely to have evidentiary support after a reasonable opportunity for further investigation or discovery; and

(4) the denials of factual contentions are warranted on the evidence or, if specifically so identified, are reasonably based on a lack of information or belief.

Fed. R. Civ. P. 11(b)(1993).

37 CFR 10.18(b)(2) tracks the language of Fed. R. Civ. P. 11(b). The advisory committee notes to Fed. R. Civ. P. 11(b) provide, in part, that:

[Fed. R. Civ. P. 11(b) and (c)] restate the provisions requiring attorneys and *pro se* litigants to conduct a reasonable inquiry into the law and facts before signing pleadings, written motions, and other documents, and prescribing sanctions for violations of these obligations. The [1993] revision in part expands the responsibilities of litigants to the court, while providing greater constraints and flexibility in dealing with infractions of the rule. The rule continues to require litigants to "stop-and-think" before initially making legal or factual contentions. It also, however, emphasizes the duty of candor by subjecting litigants to potential sanctions for insisting upon a position after it is no longer tenable and by generally providing protection against sanctions if they withdraw or correct contentions after a potential violation is called to their attention.

The rule applies only to assertions contained in papers filed with or submitted to the court. It does not cover matters arising for the first time during oral presentations to the court, when counsel may make statements that would not have been made if there had been more time for study and reflection. However, a litigant's obligations with respect to the contents of these papers are not measured solely as of the time they are filed with or submitted to the court, but include reaffirming to the court and advocating positions contained in those pleadings and motions after learning that they cease to have any merit. For example, an attorney who during a pretrial conference insists on a claim or defense should be viewed as "presenting to the court" that contention and would be subject to the obligations of [Rule 11(b)] measured at that time. Similarly, if after a notice of removal is filed, a party urges in federal court the allegations of a pleading filed in state court (whether as claims, defenses, or in disputes regarding removal or remand), it would be viewed as "presenting" -- and hence certifying to the district court under Rule 11 -- those allegations.

The certification with respect to allegations and other factual contentions is revised in recognition that sometimes a litigant may have good reason to believe that a fact is true or false but may need discovery, formal or informal, from opposing parties or third persons to gather and confirm the evidentiary basis for the allegation. Tolerance of factual contentions in initial pleadings by plaintiffs or defen-

dants when specifically identified as made on information and belief does not relieve litigants from the obligation to conduct an appropriate investigation into the facts that is reasonable under the circumstances; it is not a license to join parties, make claims, or present defenses without any factual basis or justification. Moreover, if evidentiary support is not obtained after a reasonable opportunity for further investigation or discovery, the party has a duty under the rule not to persist with that contention. [Rule 11(b)] does not require a formal amendment to pleadings for which evidentiary support is not obtained, but rather calls upon a litigant not thereafter to advocate such claims or defenses.

The certification is that there is (or likely will be) “evidentiary support” for the allegation, not that the party will prevail with respect to its contention regarding the fact. That summary judgment is rendered against a party does not necessarily mean, for purposes of this certification, that it had no evidentiary support for its position. On the other hand, if a party has evidence with respect to a contention that would be sufficient to defeat a motion for summary judgment based thereon, it would have sufficient “evidentiary support” for purposes of Rule 11.

Denials of factual contentions involve somewhat different considerations. Often, of course, a denial is premised upon the existence of evidence contradicting the alleged fact. At other times a denial is permissible because, after an appropriate investigation, a party has no information concerning the matter or, indeed, has a reasonable basis for doubting the credibility of the only evidence relevant to the matter. A party should not deny an allegation it knows to be true; but it is not required, simply because it lacks contradictory evidence, to admit an allegation that it believes is not true.

The changes in [Rule 11(b)(3) and (4)] will serve to equalize the burden of the rule upon plaintiffs and defendants, who under Rule 8(b) are in effect allowed to deny allegations by stating that from their initial investigation they lack sufficient information to form a belief as to the truth of the allegation. If, after further investigation or discovery, a denial is no longer warranted, the defendant should not continue to insist on that denial. While sometimes helpful, formal amendment of the pleadings to withdraw an allegation or denial is not required by [Rule 11(b)].

Arguments for extensions, modifications, or reversals of existing law or for creation of new law do not violate [Rule 11(b)(2)] provided they are “nonfrivolous.” This establishes an objective standard, intended to eliminate any “empty-head pure-heart” justification for patently frivolous arguments. However, to the extent to which a litigant has researched the issues and found some support for its theories even in minority opinions, in law review articles, or through consultation with other attorneys

should certainly be taken into account in determining whether [Rule 11(b)(2)] has been violated. Although arguments for a change in law are not required to be specifically so identified, a contention that is so identified should be viewed with greater tolerance under [Rule 11].

*Amendments to the Federal Rules of Civil Procedure at 50-53 (1993), reprinted in 146 F.R.D. 401, 584-87.* An “inquiry reasonable under the circumstances” requirement of 37 CFR 10.18(b)(2) is identical to that in Fed. R. Civ. P. 11(b). The Federal courts have stated in regard to the “reasonable inquiry” requirement of Fed. R. Civ. P. 11:

In requiring reasonable inquiry before the filing of any pleading in a civil case in federal district court, Rule 11 demands “an objective determination of whether a sanctioned party’s conduct was reasonable under the circumstances.” In effect it imposes a negligence standard, for negligence is a failure to use reasonable care. The equation between negligence and failure to conduct a reasonable precomplaint inquiry is . . . that “the amount of investigation required by Rule 11 depends on both the time available to investigate and on the probability that more investigation will turn up important evidence; the Rule does not require steps that are not cost-justified.”

*Hays v. Sony Corp. of Am.*, 847 F.2d 412, 418, 7 USPQ2d 1043, 1048 (7th Cir. 1988) (citations omitted) (decided prior to the 1993 amendment to Fed. R. Civ. P. 11, but discussing a “reasonable under the circumstances” standard).

37 CFR 1.4(d)(2) and 10.18 do not require a practitioner to advise the client (or third party) providing information of this certification effect (or the sanctions applicable to noncompliance), or question the client (or third party) when such information or instructions are provided. When a practitioner is submitting information (e.g., a statement of fact) from the applicant or a third party, or relying upon information from the applicant or a third party in his/her arguments, the Office will consider a practitioner’s “inquiry reasonable under the circumstances” duty under 37 CFR 10.18 met so long as the practitioner has no knowledge of information that is contrary to the information provided by the applicant or third party or would otherwise indicate that the information provided by the applicant or third party was so provided for the purpose of a violation of 37 CFR 10.18 (e.g., was submitted to cause unnecessary delay).

Nevertheless, it is highly advisable for a practitioner to advise a client or third party that any informa-

tion so provided must be reliable and not misleading. The submission by an applicant of misleading or inaccurate statements of facts during the prosecution of applications for patent has resulted in the patents issuing on such applications being held unenforceable. See, e.g., *Refac Int'l Ltd. v. Lotus Development Corp.*, 81 F.3d 1576, 38 USPQ2d 1665 (Fed. Cir. 1996); *Paragon Podiatry Laboratory, Inc. v. KLM Laboratories, Inc.*, 984 F.2d 1182, 25 USPQ2d 1561 (Fed. Cir. 1993); *Rohm & Haas Co. v. Crystal Chem. Co.*, 722 F.2d 1556, 200 USPQ 289 (Fed. Cir. 1983), *cert. denied*, 469 U.S. 851 (1984); *Ott v. Goodpasture*, 40 USPQ2d 1831 (D.N. Tex. 1996); *Herman v. William Brooks Shoe Co.*, 39 USPQ2d 1773 (S.D.N.Y. 1996); *Golden Valley Microwave Food Inc. v. Weaver Popcorn Co.*, 837 F. Supp. 1444, 24 USPQ2d 1801 (N.D. Ind. 1992), *aff'd*, 11 F.3d 1072 (Fed. Cir. 1993)(table), *cert. denied*, 511 U.S. 1128 (1994). Likewise, false statements by a practitioner in a paper submitted to the Office during the prosecution of an application for patent have resulted in the patent issuing on such application also being held unenforceable. See *General Electro Music Corp. v. Samick Music Corp.*, 19 F.3d 1405, 30 USPQ2d 1149 (Fed. Cir. 1994)(false statement in a petition to make an application special constitutes inequitable conduct, and renders the patent issuing on such application unenforceable).

An applicant has no duty to conduct a prior art search as a prerequisite to filing an application for patent. See *Nordberg, Inc. v. Telsmith, Inc.*, 82 F.3d 394, 397, 38 USPQ2d 1593, 1595-96 (Fed. Cir. 1996); *FMC Corp. v. Hennessy Indus., Inc.*, 836 F.2d 521, 526 n.6, 5 USPQ2d 1272, 1275-76 n.6 (Fed. Cir. 1987); *FMC Corp. v. Manitowoc Co.*, 835 F.2d 1411, 1415, 5 USPQ2d 1112, 1115 (Fed. Cir. 1987); *American Hoist & Derrick Co. v. Sowa & Sons, Inc.*, 725 F.2d 1350, 1362, 220 USPQ 763, 772 (Fed. Cir.), *cert. denied*, 469 U.S. 821, 224 USPQ 520 (1984). Thus, the “inquiry reasonable under the circumstances” requirement of 37 CFR 10.18 does not create any new duty on the part of an applicant for patent to conduct a prior art search. See MPEP § 609; cf. *Judin v. United States*, 110 F.3d 780, 42 USPQ2d 1300 (Fed. Cir. 1997)(the failure to obtain and examine the accused infringing device prior to bringing a civil action for infringement violates the 1983 version of Fed. R. Civ. P. 11). The “inquiry reasonable under the circum-

stances” requirement of 37 CFR 10.18, however, will require an inquiry into the underlying facts and circumstances when a practitioner provides conclusive statements to the Office (e.g., a statement that the entire delay in filing the required reply from the due date for the reply until the filing of a grantable petition pursuant to 37 CFR 1.137(b) was unintentional).

37 CFR 10.18(c) specifically provides that violations of 37 CFR 10.18(b)(1) may jeopardize the validity of the application or document, or the validity or enforceability of any patent, trademark registration, or certificate resulting therefrom, and that violations of any of 37 CFR 10.18(b)(2)(i) through (iv) are, after notice and reasonable opportunity to respond, subject to such sanctions as deemed appropriate by the Commissioner, or the Commissioner's designee, which may include, but are not limited to, any combination of:

- (A) holding certain facts to have been established;
- (B) returning papers;
- (C) precluding a party from filing a paper, or presenting or contesting an issue;
- (D) imposing a monetary sanction;
- (E) requiring a terminal disclaimer for the period of the delay; or
- (F) terminating the proceedings in the U.S. Patent and Trademark Office.

The Office has amended 37 CFR 1.4(d)(2) and 10.18 with the objective of discouraging the filing of frivolous or clearly unwarranted correspondence in the Office, not to routinely review correspondence for compliance with 37 CFR 10.18(b)(2) and impose sanctions under 37 CFR 10.18(c).

Where the circumstances of an application or other proceeding warrant a determination of whether there has been a violation of 37 CFR 10.18(b), the file or the application or other proceeding will be forwarded to the Office of Enrollment and Discipline (OED) for a determination of whether there has been a violation of 37 CFR 10.18(b). In the event that OED determines that a provision of 37 CFR 10.18(b) has been violated, the Commissioner, or the Commissioner's designee, will determine what (if any) sanction(s) under 37 CFR 10.18(c) is to be imposed in the application or other proceeding. In addition, if OED determines that a provision of 37 CFR 10.18(b) has been violated by a practitioner, OED will determine whether such practi-

tioner is to be subject to disciplinary action (see 37 CFR 1.4(d)(2) and 10.18(d)). That is, OED will provide a determination of whether there has been a violation of 37 CFR 10.18(b), and if such violation is by a practitioner, whether such practitioner is to be subject to disciplinary action; however, OED will not be responsible for imposing sanctions under 37 CFR 10.18(c) in an application or other proceeding.

37 CFR 10.18(d) provides that any practitioner violating the provisions of this section may also be subject to disciplinary action. 37 CFR 10.18(d) (and the corresponding provision of 37 CFR 1.4(d)(2)) clarifies that a practitioner may be subject to disciplinary action in lieu of, or in addition to, the sanctions set forth in 37 CFR 10.18(c) for violations of 37 CFR 10.18.



MANUAL OF PATENT EXAMINING PROCEDURE

# Chapter 500 Receipt and Handling of Mail and Papers

- 501   \*\*>Filing Papers With the U.S. Patent and Trademark Office<**
- 502   Depositing Correspondence**
  - 502.01   Correspondence Transmitted by Facsimile
  - 502.02   Correspondence Signature Requirements
  - 502.03   Communications via the Internet
  - 502.04   Duplicate Copies of Correspondence
- 503   Application Number and Filing Receipt**
- 504   Assignment of Application for Examination**
- 505   “Office Date” Stamp of Receipt**
- 506   Completeness of Original Application**
- \*\*
- 506.02   Review of Refusal To Accord Filing Date
- 507   Drawing Review in the Office of Initial Patent Examination**
- 508   Distribution**
  - 508.01   Papers Sent to Wrong Technology Center (TC)
  - 508.02   Papers Received After Patenting or Abandonment
  - 508.03   Unmatched Papers
  - 508.04   Unlocatable Patent or Application Files
- 509   Payment of Fees**
  - 509.01   Deposit Accounts
  - 509.02   Small Entity Status — Definitions
  - 509.03   Claiming Small Entity Status
- 510   U.S. Patent and Trademark Office Business Hours**
- 511   Postal Service \*\*>Interruptions and Emergencies<**
- 512   Certificate of Mailing or Transmission**
- 513   Deposit as Express Mail with U.S. Postal Service**
  
- 501   \*\*>Filing Papers With the U.S. Patent and Trademark Office< [R-2]**

\*\*>

37 CFR 1.1. Addresses for non-trademark correspondence with the United States Patent and Trademark Office.

(a) *In general.* Except as provided in paragraphs (a)(3)(i), (a)(3)(ii) and (d)(1) of this section, all correspondence intended for the United States Patent and Trademark Office must be addressed to either “Director of the United States Patent and Trademark Office, P.O. Box 1450, Alexandria, Virginia 22313-1450” or to specific areas within the Office as set out in para-

graphs (a)(1) and (a)(3)(iii) of this section. When appropriate, correspondence should also be marked for the attention of a particular office or individual.

(1) *Patent correspondence.*

(i) *In general.* All correspondence concerning patent matters processed by organizations reporting to the Commissioner for Patents should be addressed to: Commissioner for Patents, PO Box 1450, Alexandria, Virginia 22313-1450.

(ii) *Board of Patent Appeals and Interferences: Appeals.* All correspondence in an application involved in an appeal to the Board of Patent Appeals and Interferences during the period beginning when an appeal docketing notice is issued and ending when a decision has been rendered by the Board of Patent Appeals and Interferences, as well as any request for rehearing of a decision by the Board of Patent Appeals and Interferences, should be mailed to: Board of Patent Appeals and Interferences, United States Patent and Trademark Office, PO Box 1450, Alexandria, Virginia 22313-1450. Notices of appeal, appeal briefs, reply briefs, requests for oral hearing, as well as all other correspondence in an application involved in an appeal to the Board of Patent Appeals and Interferences for which an address is not otherwise specified, should be addressed as set out in paragraph (a)(1)(i) of this section.

(iii) *Board of Patent Appeals and Interferences: Interferences.* Except as an administrative patent judge or the Board may otherwise direct, all correspondence relating to patent interferences, or relating to patent applications or patents involved in an interference, should be mailed to: Mail Stop INTERFERENCE, Board of Patent Appeals and Interferences, United States Patent and Trademark Office, PO Box 1450, Alexandria, Virginia 22313-1450.

(2) [Reserved]

(3) *Office of General Counsel correspondence.—*

(i) *Litigation and service.* Correspondence relating to pending litigation or otherwise within the scope of part 104 of this title shall be addressed as provided in § 104.2.

(ii) *Disciplinary proceedings.* Correspondence to counsel for the Director of the Office of Enrollment and Discipline relating to disciplinary proceedings pending before an Administrative Law Judge or the Director shall be mailed to: Office of the Solicitor, PO Box 16116, Arlington, Virginia 22215.

(iii) *Solicitor, in general.* Correspondence to the Office of the Solicitor not otherwise provided for shall be addressed to: Mail Stop 8, Director of the United States Patent and Trademark Office, PO Box 1450, Alexandria, Virginia 22313-1450.

(iv) *General Counsel.* Correspondence to the Office of the General Counsel not otherwise provided for, including correspondence to the General Counsel relating to disciplinary proceedings, shall be addressed to: General Counsel, United States Patent and Trademark Office, PO Box 1450, Alexandria, Virginia 22313-1450.

(v) *Improper correspondence.* Correspondence improperly addressed to a Post Office Box specified in paragraphs (a)(3)(i) and (a)(3)(ii) of this section will not be filed elsewhere in the United States Patent and Trademark Office, and may be returned.

(4) *Office of Public Records correspondence.*—

(i) *Assignments.* All patent-related documents to be recorded by the Assignment Services Division, except for documents filed together with a new application or under § 3.81 of this chapter, should be addressed to: Mail Stop Assignment Recordation Services, Director of the United States Patent and Trademark Office, P.O. Box 1450, Alexandria, Virginia 22313-1450. See § 3.27.

(ii) *Documents.* All requests for certified or uncertified copies of patent documents should be addressed to: Mail Stop Document Services, Director of the United States Patent and Trademark Office, P.O. Box 1450, Alexandria, Virginia 22313-1450.

(b) *Patent Cooperation Treaty.* Letters and other communications relating to international applications during the international stage and prior to the assignment of a national serial number should be additionally marked “Mail Stop PCT.”

(c) *For reexamination proceedings.*

(1) Requests for *ex parte* reexamination (*original* request papers only) should be additionally marked “Mail Stop *Ex parte* Reexam.”

(2) Requests for *inter partes* reexamination (*original* request papers) and all subsequent *inter partes* reexamination correspondence filed in the Office, other than correspondence to the Office of the General Counsel pursuant to § 1.1(a)(3) and § 1.302(c), should be additionally marked “Mail Stop *Inter partes* Reexam.”

(d) *Maintenance fee correspondence.*—

(1) *Payments.* Payments of maintenance fees in patents not submitted electronically should be mailed to: United States Patent and Trademark Office, P.O. Box 371611, Pittsburgh, Pennsylvania 15250-1611.

(2) *Other correspondence.* Correspondence related to maintenance fees other than payments of maintenance fees in patents is not to be mailed to P.O. Box 371611, Pittsburgh, Pennsylvania 15250-1611, but must be mailed to: Mail Stop M Correspondence, Director of the United States Patent and Trademark Office, P.O. Box 1450, Alexandria, Virginia 22313-1450.

(e) *Patent term extension.* All applications for extension of patent term under 35 U.S.C. 156 and any communications relating thereto intended for the United States Patent and Trademark Office should be additionally marked “Mail Stop Patent Ext.” When appropriate, the communication should also be marked to the attention of a particular individual, as where a decision has been rendered.

(f) *Provisional applications.* The filing of all provisional applications and any communications relating thereto should be additionally marked “Mail Stop Provisional Patent Application.”<

37 CFR 1.4. *Nature of correspondence and signature requirements.*

\*\*>

(a) Correspondence with the Patent and Trademark Office comprises:

(1) Correspondence relating to services and facilities of the Office, such as general inquiries, requests for publications supplied by the Office, orders for printed copies of patents, orders for copies of records, transmission of assignments for recording, and the like, and

(2) Correspondence in and relating to a particular application or other proceeding in the Office. See particularly the rules relating to the filing, processing, or other proceedings of national applications in subpart B, §§ 1.31 to 1.378; of international applications in subpart C, §§ 1.401 to 1.499; of *ex parte* reexaminations of patents in subpart D, §§ 1.501 to 1.570; of interferences in subpart E, §§ 1.601 to 1.690; of extension of patent term in subpart F, §§ 1.710 to 1.785; and of *inter partes* reexaminations of patents in subpart H, §§ 1.902 to 1.997.

(b) Since each file must be complete in itself, a separate copy of every paper to be filed in a patent, patent file, or other proceeding must be furnished for each file to which the paper pertains, even though the contents of the papers filed in two or more files may be identical. The filing of duplicate copies of correspondence in the file of an application, patent, or other proceeding should be avoided, except in situations in which the Office requires the filing of duplicate copies. The Office may dispose of duplicate copies of correspondence in the file of an application, patent, or other proceeding.

(c) Since different matters may be considered by different branches or sections of the United States Patent and Trademark Office, each distinct subject, inquiry or order must be contained in a separate paper to avoid confusion and delay in answering papers dealing with different subjects.

(d)(1) Each piece of correspondence, except as provided in paragraphs (e) and (f) of this section, filed in an application, patent file, or other proceeding in the Office which requires a person's signature, must:

(i) Be an original, that is, have an original signature personally signed in permanent ink by that person; or

(ii) Be a direct or indirect copy, such as a photocopy or facsimile transmission (§ 1.6(d)), of an original. In the event that a copy of the original is filed, the original should be retained as evidence of authenticity. If a question of authenticity arises, the Office may require submission of the original.

(iii) [Reserved]

(2) The presentation to the Office (whether by signing, filing, submitting, or later advocating) of any paper by a party, whether a practitioner or non-practitioner, constitutes a certification under § 10.18(b) of this chapter. Violations of § 10.18(b)(2) of this chapter by a party, whether a practitioner or non-practitioner, may result in the imposition of sanctions under § 10.18(c) of this chapter. Any practitioner violating § 10.18(b) may also be subject to disciplinary action. See §§ 10.18(d) and 10.23(c)(15).<

(e) Correspondence requiring person's signature and relating to registration practice before the Patent and Trademark Office in patent cases, enrollment and disciplinary investigations, or disciplinary proceedings must be submitted with an original signature personally signed in permanent ink by that person.

(f) When a document that is required by statute to be certified must be filed, a copy, including a photocopy or facsimile transmission, of the certification is not acceptable.

(g) An applicant who has not made of record a registered attorney or agent may be required to state whether assistance was received in the preparation or prosecution of the patent application, for which any compensation or consideration was given or charged, and if so, to disclose the name or names of the person or persons providing such assistance. Assistance includes the preparation for the applicant of the specification and amendments or other papers to be filed in the Patent and Trademark Office, as well as other assistance in such matters, but does not include merely making drawings by draftsmen or stenographic services in typing papers.

\*\*>

## I. GENERAL MAILING ADDRESSES

The U.S. Patent and Trademark Office (Office) has three separate general mailing addresses. The addresses are as follows:

### A. *For Patent Applications and Patent-Related Papers*<

Correspondence in patent-related matters under the direction of the \* Commissioner for Patents should be addressed to:

\*\*>Commissioner for Patents  
P.O. Box 1450  
Alexandria, Virginia 22313-1450<

Such correspondence includes: patent applications, replies to notices of informality, requests for extension of time, notices of appeal to the Board of Patent Appeals and Interferences (the Board), briefs in support of an appeal to the Board, requests for oral hearing before the Board, extensions of term of patent, requests for publication of Statutory Invention Registration (SIR), requests for reexamination, statutory disclaimers, certificates of correction, petitions to the \* Commissioner for Patents, submission of information disclosure statements, petitions to institute a public use proceeding, petitions to revive abandoned patent applications, and other correspondence related to patent applications and patents which is processed by organizations reporting to the \* Commissioner for Patents.

>Certain patent-related correspondence requires immediate Office attention. Examples are:

(A) Petitions for express abandonment to avoid publication under 37 CFR 1.138(c);

(B) Petitions to withdraw an application from issue under 37 CFR 1.313(c);

(C) Request for expedited examination of a design application (rocket docket); and

(D) Papers required by the Office of Patent Publication to be hand-carried or faxed to the Office of Patent Publication.

Applicants are encouraged to transmit these types of correspondence by facsimile transmission or hand-carry them to the appropriate area of the Office for processing. See MPEP § 502.

### B. *For Trademark Applications and Trademark-Related Papers*<

Correspondence in trademark-related matters under the direction of the \* Commissioner for Trademarks >or the Trademark Trial and Appeal Board< should be addressed to:

\*\*>Commissioner for Trademarks  
2900 Crystal Drive  
Arlington, VA 22202-3514<

Such correspondence includes all trademark applications and other trademark-related mail, except for trademark documents sent to the Assignment Division for recordation, requests for certified and uncertified copies of trademark documents, and filings submitted electronically. See 37 CFR \*> 2.190<.

>

### C. *For Other Correspondence*

Patent and trademark documents sent to the Assignment Division for recordation, requests for certified or uncertified copies of patent and trademark documents, and for correspondence for which an address is not otherwise specified in 37 CFR 1.1, should be addressed to:

Director of the United States Patent and Trademark Office  
P.O. Box 1450  
Alexandria, VA 22313-1450

## II. SEPARATE MAILING ADDRESSES FOR CERTAIN CORRESPONDENCE

The Office has separate mailing addresses for certain correspondence:



(A) Certain court-related correspondence (e.g., summons and complaint) being delivered to the Office via the U.S. Postal Service (USPS) must be addressed:

General Counsel  
United States Patent and Trademark Office  
P.O. Box 15667  
Arlington, VA 22215

(B) Correspondence directed to the Office of Enrollment and Discipline (OED) Director relating to disciplinary proceedings pending before an Administrative Law Judge or the Director must be addressed:

Office of the Solicitor  
P.O. Box 16116  
Arlington, Virginia 22215

(C) Payments of maintenance fees in patents being delivered to the Office via the USPS should be addressed:

United States Patent and Trademark Office  
P.O. Box 371611  
Pittsburgh, Pennsylvania 15250-1611

(D) A deposit account replenishment being delivered to the Office via the USPS should be addressed:

Director of the United States Patent and Trademark Office  
P.O. Box 70541  
Chicago, Illinois 60673

Persons filing correspondence with the Office should check the rules of practice, the *Official Gazette*, or the Office's Internet Web site (<http://www.uspto.gov>) to determine the appropriate mailing address for such correspondence.

### III. HAND-DELIVERY OF PAPERS

Patent-related papers, other than those that require immediate Office attention, may be hand-carried to the Office. If the correspondence is hand-carried to the Office, it must be delivered to the Customer Window located at:

U.S. Patent and Trademark Office  
2011 South Clark Place  
Customer Window  
Crystal Plaza Two, Lobby, Room 1B03  
Arlington, Virginia 22202

See MPEP § 502.<

Trademark-related papers may also be filed at the "walk-up" window located on the third floor of the South Tower Building, 2900 Crystal Drive, Arlington, VA >22202<. Hand delivery of trademark papers and fees directly to the South Tower Building will expedite processing.

As provided in 37 CFR 1.4(c), matters that are to be considered by different branches or sections of the USPTO must be contained in separate papers. The following form paragraph may be used to notify the applicant of this requirement when the applicant has filed a single paper containing distinct subjects, inquiries, or orders.

#### ¶ 5.01.01 Separate Paper Required

The [1] submitted [2] should have been submitted as a separate paper as required by 37 CFR 1.4(c). The paper has been entered. However, all future correspondence must comply with 37 CFR 1.4.

#### Examiner Note:

1. In bracket 1, indicate the item required to be separately submitted, such as an affidavit, petition, or other appropriate document.
2. If the applicant is a *pro se* inventor, include a copy of the rule.

Those who correspond with the USPTO are strongly encouraged not to include correspondence which will have to be directed to different areas (e.g., Patents and Trademarks) of the Office in a single envelope. Including multiple papers in a single envelope increases the likelihood that one or more of the papers will be delayed before reaching the appropriate area. Placing the papers in separately addressed envelopes will reduce the number of actions being performed by the USPTO unnecessarily or inappropriately. At the present time, use of the wrong mailing address will not affect the filing date assigned to any application or correspondence received in the USPTO, except as specified in **\*\*>37 CFR 1.1(a)(3)(v).<**

Except for certain mail addressed incorrectly to the Office of the Solicitor, there will be no penalty for addressing a document to the wrong area within the

Office, as long as one of the approved addresses is used. Use of the specific addresses listed within 37 CFR 1.1 is strongly encouraged because it will facilitate the process both for the Office and the filer. Accordingly, a new application incorrectly addressed to the \*>Director< will be treated the same as if the application was addressed to the specific \* Commissioner.

All mailed communications are received by the Incoming-Mail Section of the Office of Initial Patent Examination (OIPE), which opens and distributes all official mail.

Special \*>mail stops< have been established to allow the forwarding of particular types of mail to appropriate areas of the Office as quickly as possible. A list of these \*>mail stops< is published weekly in the *Official Gazette*. Only the specified type of document for a particular \*>mail stop< should be placed in an envelope addressed to that \*>mail stop<.

If any documents other than the specified type identified for each department are addressed to that department, they will be significantly delayed in reaching the appropriate area for which they were intended.

## 502 Depositing Correspondence [R-2]

\*\*>

### *37 CFR 1.5. Identification of patent, patent application, or patent-related proceeding.<*

(a) No correspondence relating to an application should be filed prior to receipt of the application number from the Patent and Trademark Office. When a letter directed to the Patent and Trademark Office concerns a previously filed application for a patent, it must identify on the top page in a conspicuous location, the application number (consisting of the series code and the serial number; e.g., 07/123,456), or the serial number and filing date assigned to that application by the Patent and Trademark Office, or the international application number of the international application. Any correspondence not containing such identification will be returned to the sender where a return address is available. The returned correspondence will be accompanied with a cover letter which will indicate to the sender that if the returned correspondence is resubmitted to the Patent and Trademark Office within two weeks of the mail date on the cover letter, the original date of receipt of the correspondence will be considered by the Patent and Trademark Office as the date of receipt of the correspondence. Applicants may use either the Certificate of Mailing or Transmission procedure under § 1.8 or the Express Mail procedure under § 1.10 for resubmissions of returned correspondence if they desire to have the benefit of the date of deposit in the United States Postal Service. If the returned correspondence is not resub-

mitted within the two-week period, the date of receipt of the resubmission will be considered to be the date of receipt of the correspondence. The two-week period to resubmit the returned correspondence will not be extended. In addition to the application number, all letters directed to the Patent and Trademark Office concerning applications for patent should also state the name of the applicant, the title of the invention, the date of filing the same, and, if known, the group art unit or other unit within the Patent and Trademark Office responsible for considering the letter and the name of the examiner or other person to which it has been assigned.

(b) When the letter concerns a patent other than for purposes of paying a maintenance fee, it should state the number and date of issue of the patent, the name of the patentee, and the title of the invention. For letters concerning payment of a maintenance fee in a patent, see the provisions of § 1.366(c).

(c) \*\*>[Reserved]<

(d) A letter relating to a reexamination proceeding should identify it as such by the number of the patent undergoing reexamination, the reexamination request control number assigned to such proceeding, and, if known, the group art unit and name of the examiner to which it been assigned.

(e) When a paper concerns an interference, it should state the names of the parties and the number of the interference. The name of the examiner-in-chief assigned to the interference (§ 1.610) and the name of the party filing the paper should appear conspicuously on the first page of the paper.

(f) When a paper concerns a provisional application, it should identify the application as such and include the application number.

\*\*>

### *37 CFR 1.6. Receipt of correspondence.*

(a) *Date of receipt and Express Mail date of deposit.* Correspondence received in the Patent and Trademark Office is stamped with the date of receipt except as follows:

(1) The Patent and Trademark Office is not open for the filing of correspondence on any day that is a Saturday, Sunday, or Federal holiday within the District of Columbia. Except for correspondence transmitted by facsimile under paragraph (a)(3) of this section, or filed electronically under paragraph (a)(4) of this section, no correspondence is received in the Office on Saturdays, Sundays, or Federal holidays within the District of Columbia.

(2) Correspondence filed in accordance with § 1.10 will be stamped with the date of deposit as “Express Mail” with the United States Postal Service.

(3) Correspondence transmitted by facsimile to the Patent and Trademark Office will be stamped with the date on which the complete transmission is received in the Patent and Trademark Office unless that date is a Saturday, Sunday, or Federal holiday within the District of Columbia, in which case the date stamped will be the next succeeding day which is not a Saturday, Sunday, or Federal holiday within the District of Columbia.

(4) [Reserved]

(b) [Reserved]

(c) *Correspondence delivered by hand.* In addition to being mailed, correspondence may be delivered by hand during hours the Office is open to receive correspondence.

(d) *Facsimile transmission.* Except in the cases enumerated below, correspondence, including authorizations to charge a deposit account, may be transmitted by facsimile. The receipt date accorded to the correspondence will be the date on which the complete transmission is received in the United States Patent and Trademark Office, unless that date is a Saturday, Sunday, or Federal holiday within the District of Columbia. See § 1.6(a)(3). To facilitate proper processing, each transmission session should be limited to correspondence to be filed in a single application or other proceeding before the United States Patent and Trademark Office. The application number of a patent application, the control number of a reexamination proceeding, the interference number of an interference proceeding, or the patent number of a patent should be entered as a part of the sender's identification on a facsimile cover sheet. Facsimile transmissions are not permitted and, if submitted, will not be accorded a date of receipt in the following situations:

- (1) Correspondence as specified in § 1.4(e), requiring an original signature;
- (2) Certified documents as specified in § 1.4(f);
- (3) Correspondence which cannot receive the benefit of the certificate of mailing or transmission as specified in § 1.8(a)(2)(i)(A) through (D) and (F), and § 1.8(a)(2)(iii)(A), except that a continued prosecution application under § 1.53(d) may be transmitted to the Office by facsimile;
- (4) Drawings submitted under §§ 1.81, 1.83 through 1.85, 1.152, 1.165, 1.174, or 1.437;
- (5) A request for reexamination under § 1.510 or § 1.913;
- (6) Correspondence to be filed in a patent application subject to a secrecy order under §§ 5.1 through 5.5 of this chapter and directly related to the secrecy order content of the application;
- (7) [Reserved]
- (8) [Reserved]
- (9) Correspondence to be filed in an interference proceeding which consists of a preliminary statement under § 1.621; a transcript of a deposition under § 1.676 or of interrogatories, or cross-interrogatories; or an evidentiary record and exhibits under § 1.653.

(e) *Interruptions in U.S. Postal Service.* If interruptions or emergencies in the United States Postal Service which have been so designated by the Director occur, the Patent and Trademark Office will consider as filed on a particular date in the Office any correspondence which is:

- (1) Promptly filed after the ending of the designated interruption or emergency; and
- (2) Accompanied by a statement indicating that such correspondence would have been filed on that particular date if it were not for the designated interruption or emergency in the United States Postal Service.

(f) *Facsimile transmission of a patent application under § 1.53(d).* In the event that the Office has no evidence of receipt of an application under § 1.53(d) (a continued prosecution application) transmitted to the Office by facsimile transmission, the party

who transmitted the application under § 1.53(d) may petition the Director to accord the application under § 1.53(d) a filing date as of the date the application under § 1.53(d) is shown to have been transmitted to and received in the Office.

(1) Provided that the party who transmitted such application under § 1.53(d):

(i) Informs the Office of the previous transmission of the application under § 1.53(d) promptly after becoming aware that the Office has no evidence of receipt of the application under § 1.53(d);

(ii) Supplies an additional copy of the previously transmitted application under § 1.53(d); and

(iii) Includes a statement which attests on a personal knowledge basis or to the satisfaction of the Director to the previous transmission of the application under § 1.53(d) and is accompanied by a copy of the sending unit's report confirming transmission of the application under § 1.53(d) or evidence that came into being after the complete transmission and within one business day of the complete transmission of the application under § 1.53(d).

(2) The Office may require additional evidence to determine if the application under § 1.53(d) was transmitted to and received in the Office on the date in question.<

All applications (provisional and nonprovisional) may be sent to the U.S. Patent and Trademark Office by mail (see MPEP § 501), or they may be \*\*>hand-carried to the Customer Window<. A continued prosecution application (CPA) filed under 37 CFR 1.53(d) >(available for design applications only)<, amendments, and other papers may be sent to the U.S. Patent and Trademark Office by mail (see MPEP § 501), by facsimile (see MPEP § 502.01) or \*\*>hand-carried to the Customer Window<. Any correspondence sent to the U.S. Patent and Trademark Office should include the sender's return address and ZIP Code designation.\*\*>For correspondence hand-delivered to the Office, see subsection II. below.<

Trademark-related papers may also be filed or delivered by private courier to the "walk-up" window located on the third floor of the South Tower Building, 2900 Crystal Drive, Arlington, VA >22202<. Hand delivery of trademark papers and fees directly to the South Tower Building is recommended, to expedite processing.

All correspondence related to a national patent application already filed with the U.S. Patent and Trademark Office must include the identification of the application number or the serial number and the filing date assigned to the application by the Office. Any correspondence not containing the proper identification set forth in 37 CFR 1.5(a) \*\*>will be returned

to the sender by OIPE<. Each paper should be inspected to assure that the papers being returned contain either an "Office Date" stamp or a TC date stamp. A minor error in the identification of the application can be corrected by the \*>Office< provided the correct identification can be quickly discovered. Examples of minor errors are transposed numbers, typographical errors, and listing the parent application number. The failure to give any application number is not a minor error. The Office often experiences difficulty in matching incoming papers with the application file to which they pertain because insufficient or erroneous information is given. This applies especially to amendments, powers of attorney, changes of address, status letters, petitions for extension of time, and other petitions.

Frequently, there are errors in the application number or in the art unit number, or the incoming paper uses the old art unit number where an application has been transferred and acted on by a different art unit.

Where the art unit number is entirely omitted, the routine operations of OIPE must be interrupted solely for the purpose of determining the location of the application so that the communication can be properly routed. Under these circumstances, the efficiency of OIPE is impaired and the incoming paper is delayed in reaching its proper destination. Where such papers are not essential to compliance with a statutory period or time limit for reply, they may be returned for completion to identify the location of the files. >For Image File Wrapper (IFW) processing, see IFW Manual.<

It would be of great assistance to the Office if *all* incoming papers pertaining to a filed application carried the following items:

- (A) Application number (checked for accuracy, including series code and serial no.).
- (B) Art Unit number (copied from most recent Office communication).
- (C) Filing date.
- (D) Name of the examiner who prepared the most recent Office action.
- (E) Title of invention.
- (F) Confirmation number (see MPEP § 503).

Applicants may be reminded of this provision by including form paragraph 5.01.

#### ¶ 5.01 *Proper Heading for Incoming Papers*

It would be of great assistance to the Office if all incoming papers pertaining to a filed application carried the following items:

- 1. Application number (checked for accuracy, including series code and serial no.).
- 2. Art Unit number (copied from most recent Office communication).
- 3. Filing date.
- 4. Name of the examiner who prepared the most recent Office action.
- 5. Title of invention.
- 6. Confirmation number (see MPEP § 503).

The Office prefers identifying indicia to be provided on the drawings. If such identifying indicia is provided, it must be placed on the front of each sheet of drawings and centered within the top margin. See 37 CFR 1.84(c). The identifying indicia should include the title of the invention, inventor's name, application number, and confirmation number (see MPEP § 503). If the Office has not yet assigned an application number and confirmation number to the application, the docket number (if any) used by the applicant to track the application should be provided.

When the Office receives \*\*>replacement sheets of< drawings for patent applications after the application has been filed, a cover letter identifying the drawings by application number should accompany them. The application number and other identifying indicia should be placed on each sheet of drawings in accordance with 37 CFR 1.84(c).

It is requested that the submission of additional or supplemental papers on a newly filed application be deferred until an application number has been received. \*\*

Documents which have no particular time or sequence requirements should be filed in the Office with materials submitted in reply to the statutory or regulatory requirements. Examples are certified copies of foreign documents to support priority in patent applications, changes of power of attorney, or changes in mailing address following first action.

All letters relating to a reexamination proceeding should identify the proceeding involved by patent number and reexamination request control number.

&gt;

## I. < POST ALLOWANCE CORRESPONDENCE

All post allowance correspondence, except for petitions under 37 CFR 1.313(c), should be \*\* addressed “\*\*>Mail Stop< Issue Fee.” Any petition filed under 37 CFR 1.313(c) to withdraw an application from issue after payment of the issue fee should be clearly marked “Petition under 37 CFR 1.313(c)” and be either hand-carried >to the Office of Petitions, Crystal Plaza 4, 2201 South Clark Place, Room 3C23, Arlington, Virginia 22202< or submitted by facsimile to the \*\*>Central Facsimile Number (703) 872-9306<.

Any paper filed after receiving the Issue \*>notification< should include the indicated patent number.

Since an allowed application \*>may< be issued as a patent within about \*>four< weeks of payment of the issue fee, all post allowance correspondence should be filed prior to the date of issue fee payment to ensure the papers reach the appropriate USPTO official for consideration before the date the application issues as a patent. >See MPEP § 2732 for a discussion of the patent term adjustment impact of submitting amendments or other papers after a notice of allowance has been mailed.<

If the above suggestions are adopted, the processing of both new and allowed applications could proceed more efficiently and promptly through the U.S. Patent and Trademark Office.

&gt;

## II. < HAND-DELIVERY OF PAPERS

\*\*>No official paper which relates to a pending application may be personally delivered to a TC except papers that are directed to an application subject to a secrecy order pursuant to 35 U.S.C. 181, or are national security classified and that are directed to Licensing and Review. Effective December 1, 2003, all official patent application related correspondence for organizations reporting to the Commissioner for Patents (e.g., TCs, the Office of Patent Publication, and the Office of Petitions) that is hand-carried (or delivered by other delivery services) must be delivered to the Customer Window, with a few exceptions.

### *Correspondence for Which Centralized Delivery of Hand-Carried Papers is Not Required*

The following types of patent application related correspondence may be delivered to the specific location where they are processed instead of the Customer Window. Any such correspondence carried by error to the Customer Window will be accepted but then re-routed to the appropriate office, thereby incurring a delay before being processed. Non-patent application related papers (e.g., correspondence for the Office of Enrollment and Discipline (OED), questions on employment, correspondence for the Office of General Counsel, correspondence relating to PCT international applications prior to national stage entry) may continue to be hand-carried to the current designated locations depending on the substance of the correspondence.

(A) Petitions for express abandonment under 37 CFR 1.138(c) to avoid publication may be hand-carried to the Pre-Grant Publication Division, 2231 Crystal Drive, Room 905, Arlington, VA 22202.

(B) Petitions to withdraw from issue under 37 CFR 1.313(c) may be hand-carried to the Office of Petitions, Crystal Plaza 4, 2201 South Clark Place, Room 3C23, Arlington, VA 22202.

(C) Requests for expedited examination of a design application may be hand-carried to the Design TC Director’s Office (TC 2900). Applicants should check the USPTO web site at [www.uspto.gov](http://www.uspto.gov) for the current telephone and room number of the Design TC Director.

(D) Papers required by the Office of Patent Publication may be hand-carried to the Office of Patent Publication, 2231 Crystal Drive, Room 907, Arlington, VA 22202.

(E) Applications subject to a secrecy order pursuant to 35 U.S.C. 181, or are national security classified, and correspondence to be filed in such an application, may be hand-carried to Licensing and Review, Office of TC 3600 Director, Crystal Park 5, 2451 Crystal Drive, Room 3D07, Arlington, VA 22202.

## III. < “EXPRESS MAIL” SERVICE

There are two types of “Express Mail” delivery offered by the U.S. Postal Service — “Post Office to Addressee” and “Post Office to Post Office.” The only

type of service which can be used for “Express Mail” directed to the U.S. Patent and Trademark Office is the “Post Office to Addressee” service of the U.S. Postal Service. 37 CFR 1.10. This service provides for the use of a mailing label which clearly indicates the date on which a particular paper or fee was deposited.

The addresses that should be used for “Express Mail” sent to the U.S. Patent and Trademark Office are set forth in 37 CFR 1.1 (see MPEP § 501).

“Post Office to Post Office” Express Mail *does not* provide for delivery but instead is retained at the postal facility of the addressee for pickup. The Postal Service *does not* notify the addressee that this type of Express Mail has been received and is awaiting pickup. If not picked up, this mail is held for 15 days and then returned to the sender.

Therefore, since the U.S. Patent and Trademark Office does not have resources for picking up any mail, including Express Mail, the “Post Office to Post Office” Express Mail will not reach the U.S. Patent and Trademark Office.

See MPEP § 513 for the use of the Express Mail Mailing procedure of 37 CFR 1.10.

## 502.01 Correspondence Transmitted by Facsimile [R-2]

37 CFR 1.6. Receipt of correspondence.

\*\*\*\*\*

\*\*

>

(d) *Facsimile transmission.* Except in the cases enumerated below, correspondence, including authorizations to charge a deposit account, may be transmitted by facsimile. The receipt date accorded to the correspondence will be the date on which the complete transmission is received in the United States Patent and Trademark Office, unless that date is a Saturday, Sunday, or Federal holiday within the District of Columbia. See § 1.6(a)(3). To facilitate proper processing, each transmission session should be limited to correspondence to be filed in a single application or other proceeding before the United States Patent and Trademark Office. The application number of a patent application, the control number of a reexamination proceeding, the interference number of an interference proceeding, or the patent number of a patent should be entered as a part of the sender’s identification on a facsimile cover sheet. Facsimile transmissions are not permitted and, if submitted, will not be accorded a date of receipt in the following situations:

- (1) Correspondence as specified in § 1.4(e), requiring an original signature;
- (2) Certified documents as specified in § 1.4(f);

(3) Correspondence which cannot receive the benefit of the certificate of mailing or transmission as specified in § 1.8(a)(2)(i)(A) through (D) and (F), and § 1.8(a)(2)(iii)(A), except that a continued prosecution application under § 1.53(d) may be transmitted to the Office by facsimile;

(4) Drawings submitted under §§ 1.81, 1.83 through 1.85, 1.152, 1.165, 1.174, or 1.437;

(5) A request for reexamination under § 1.510 or § 1.913;

(6) Correspondence to be filed in a patent application subject to a secrecy order under §§ 5.1 through 5.5 of this chapter and directly related to the secrecy order content of the application;

(7) [Reserved]

(8) [Reserved]

(9) Correspondence to be filed in an interference proceeding which consists of a preliminary statement under § 1.621; a transcript of a deposition under § 1.676 or of interrogatories, or cross-interrogatories; or an evidentiary record and exhibits under § 1.653.<

\*\*\*\*\*

The date of receipt accorded to any correspondence permitted to be sent by facsimile transmission, including a continued prosecution application (CPA) filed under 37 CFR 1.53(d) >(for design applications only)<, is the date the complete transmission is received by an Office facsimile unit, unless the transmission is completed on a Saturday, Sunday, or Federal holiday within the District of Columbia. Correspondence for which transmission was completed on a Saturday, Sunday, or Federal holiday within the District of Columbia, will be accorded a receipt date of the next succeeding day which is not a Saturday, Sunday, or Federal holiday within the District of Columbia. For example, a facsimile transmission to the Office from California starting on a Friday at 8:45 p.m. Pacific time and taking 20 minutes, would be completed at 9:05 p.m. Pacific time. The complete transmission would be received in the Office around 12:05 a.m. Eastern time on Saturday. The receipt date accorded to the correspondence is the date of the following business day, which in this case, would be Monday (assuming that Monday was not a Federal holiday within the District of Columbia). Note however, that if the Certificate of Transmission is available (for documents not proscribed by 37 CFR 1.8(a)(2)), then the above facsimile may be considered timely filed on Friday if it contains a Certificate of Transmission and is in compliance with 37 CFR 1.8(a)(1)(i)(B) and (ii).

37 CFR 1.6(d) specifies the types of correspondence which may be transmitted by facsimile. These would include CPAs filed under 37 CFR 1.53(d) >(available for design applications only)<, amendments, declarations, petitions, >information disclosure statements (IDS), terminal disclaimers, notices of appeal and appeal briefs, requests for continued examination (RCEs) under 37 CFR 1.114, assignment documents,< issue fee transmittals and authorizations to charge deposit accounts. The situations where transmissions by facsimile are prohibited are identified in 37 CFR 1.6(d)(1)-(9). Prohibitions cover situations where originals are required as specified in 37 CFR 1.4(e) and (f), and situations where accepting a facsimile transmission would be unduly burdensome on the Office. As a courtesy, the Office will attempt to notify senders whenever correspondence is sent to the Office by facsimile transmission that falls within one of these prohibitions. Senders are cautioned against submitting correspondence by facsimile transmission which is not permitted under 37 CFR 1.6(d) since such correspondence will not be accorded a receipt date.

An applicant filing a CPA >for a design application only< by facsimile transmission must include an authorization to charge the basic filing fee to a deposit account or to a credit card, or the application will be treated under 37 CFR 1.53(f) as having been filed without the basic filing fee (as fees cannot otherwise be transmitted by facsimile).

There is a special receipt procedure for filing a CPA by fax, whereby the Office will fax back a receipt of the CPA filing if applicant submits the Office receipt form along with the CPA filing.

*37 CFR 1.6. Receipt of correspondence.*

\*\*\*\*\*

\*\*>

(f) *Facsimile transmission of a patent application under § 1.53(d).* In the event that the Office has no evidence of receipt of an application under § 1.53(d) (a continued prosecution application) transmitted to the Office by facsimile transmission, the party who transmitted the application under § 1.53(d) may petition the Director to accord the application under § 1.53(d) a filing date as of the date the application under § 1.53(d) is shown to have been transmitted to and received in the Office,

(1) Provided that the party who transmitted such application under § 1.53(d):

(i) Informs the Office of the previous transmission of the application under § 1.53(d) promptly after becoming aware

that the Office has no evidence of receipt of the application under § 1.53(d);

(ii) Supplies an additional copy of the previously transmitted application under § 1.53(d); and

(iii) Includes a statement which attests on a personal knowledge basis or to the satisfaction of the Director to the previous transmission of the application under § 1.53(d) and is accompanied by a copy of the sending unit's report confirming transmission of the application under § 1.53(d) or evidence that came into being after the complete transmission and within one business day of the complete transmission of the application under § 1.53(d).

(2) The Office may require additional evidence to determine if the application under § 1.53(d) was transmitted to and received in the Office on the date in question.<

37 CFR 1.6(f) provides for the situation in which the Office has no evidence of receipt of a CPA transmitted to the Office by facsimile transmission. 37 CFR 1.6(f) requires a petition be filed requesting that the CPA be accorded a filing date as of the date the CPA is shown to have been transmitted to and received in the Office. The showing must include, *inter alia*, a copy of the sending unit's report confirming transmission of the application or evidence that came into being after the complete transmission of the application and within one business day of the complete transmission of the application.

\*\*>

## **I. CENTRALIZED FACSIMILE NUMBER FOR OFFICIAL PATENT APPLICATION RELATED CORRESPONDENCE**

### **A. Central Number**

Effective December 1, 2003, all patent application related correspondence transmitted by facsimile must be directed to the central facsimile number, (703) 872-9306, with a few exceptions below. Replies to Office actions including after-final amendments that are transmitted by facsimile must be directed to the central facsimile number. Unofficial correspondence such as draft proposed amendments for interviews may continue to be transmitted by facsimile to the Technology Centers (TCs). Office personnel should not use their personal facsimile numbers for official application related correspondence. Office personnel that inadvertently receive official application related correspondence on a personal facsimile number must either route (do not forward) the correspondence to the official central number or they may, with appli-

cant's (or applicant's representative) permission, make the facsimile amendment part of an examiner's amendment.

**B. Correspondence Which May Be Sent by Facsimile to Other Than the Central Facsimile Number**

The correspondence items below may be sent by facsimile to specific facsimile numbers as indicated (they are exceptions to facsimile transmission to the central facsimile number).

(1) Facsimile transmissions of Assignment Documents.

Facsimile transmission to record an assignment or other documents affecting title is permitted. This process allows customers to submit their documents directly into the Automated Patent and Trademark Assignment System and receive the resulting recordation notice at their facsimile machine. Credit card payments to record assignment documents are now accepted, and use of the Credit Card form (PTO-2038) is required for the credit card information to be separated from the assignment records. Only documents with an identified patent application or patent number, a single cover sheet to record a single type of transaction, and the fee paid by an authorization to charge a USPTO deposit account or credit card may be submitted via facsimile. Consult the USPTO web site at <http://www.uspto.gov/web/offices/ac/ido/oprptas-fax.pdf> for more information regarding the submission of assignment documents via facsimile. The facsimile number for the Automated Patent and Trademark Assignment System is (703) 306-5995.

(2) Petitions for a foreign filing license pursuant to 37 CFR 5.12(b) and 5.13 may be transmitted by facsimile to Licensing and Review at (703) 305-7658.

(3) Petitions for express abandonment to avoid publication under 37 CFR 1.138(c) may be transmitted by facsimile directly to the Pre-Grant Publication Division at (703) 305-8568.

(4) Papers required by the Office of Patent Publication may be transmitted by facsimile directly to (703) 746-4000.

**II. < CORRESPONDENCE RELATIVE TO PATENTS AND PATENT APPLICATIONS WHERE FILING BY FACSIMILE TRANSMISSION IS NOT PERMITTED**

(A) A document that is required by statute to be certified;

(B) A national patent application specification and drawing (provisional or nonprovisional) or other correspondence for the purpose of obtaining an application filing date, other than a continued prosecution application filed under 37 CFR 1.53(d);

(C) Drawings submitted under 37 CFR 1.81, 1.83-1.85, 1.152, 1.165, \* or 1.437 >except when submitted with the issue fee<;

(D) Correspondence in an interference which an Administrative Patent Judge orders to be filed by hand or "Express Mail";

(E) Agreements between parties to an interference under 35 U.S.C. 135(c);

(F) Correspondence to be filed in an interference proceeding which consists of a preliminary statement under 37 CFR 1.621; a transcript of a deposition under 37 CFR 1.676; or of interrogatories, or cross-interrogatories, or an evidentiary record and exhibits under 37 CFR 1.653;

(G) Correspondence to be filed in a patent application subject to a secrecy order under 37 CFR 5.1-5.5 and directly related to the secrecy order content of the application;

(H) An international application for patent;

(I) A copy of the international application and the basic national fee necessary to enter the national stage, as specified in \*\* 37 CFR 1.495(b);

(J) A request for reexamination under 37 CFR 1.510 or 37 CFR 1.913.

Under 37 CFR 1.6(d)(4), drawings submitted under \*\* 37 CFR 1.81, 1.83-1.85, 1.152, 1.165, \* or 1.437 may not be filed by facsimile transmission in patent applications. However, \*\*>the Office has waived the prohibition in 37 CFR 1.6(d)(4) against the submission of drawings by facsimile when drawings are facsimile transmitted with the issue fee. See Payment of the Issue Fee and Filing Related Correspondence by Facsimile, 1254 *Off. Gaz. Pat. Office* (January 15, 2002). Applicants are reminded that the facsimile process may reduce the quality of the drawings, and the Office will generally print the drawings as received<.



See MPEP § 1834.01 for a discussion concerning facsimile transmissions in PCT applications.

## 502.02 Correspondence Signature Requirements [R-2]

37 CFR 1.4. *Nature of correspondence and signature requirements.*

\*\*\*\*\*

\*\*>

(d)(1) Each piece of correspondence, except as provided in paragraphs (e) and (f) of this section, filed in an application, patent file, or other proceeding in the Office which requires a person's signature, must:

(i) Be an original, that is, have an original signature personally signed in permanent ink by that person; or

(ii) Be a direct or indirect copy, such as a photocopy or facsimile transmission (§ 1.6(d)), of an original. In the event that a copy of the original is filed, the original should be retained as evidence of authenticity. If a question of authenticity arises, the Office may require submission of the original.

(iii) [Reserved]<

(2) The presentation to the Office (whether by signing, filing, submitting, or later advocating) of any paper by a party, whether a practitioner or non-practitioner, constitutes a certification under § 10.18(b) of this chapter. Violations of § 10.18(b)(2) of this chapter by a party, whether a practitioner or non-practitioner, may result in the imposition of sanctions under § 10.18(c) of this chapter. Any practitioner violating § 10.18(b) may also be subject to disciplinary action. See §§ 10.18(d) and 10.23(c)(15).

(e) Correspondence requiring person's signature and relating to registration practice before the Patent and Trademark Office in patent cases, enrollment and disciplinary investigations, or disciplinary proceedings must be submitted with an original signature personally signed in permanent ink by that person.

(f) When a document that is required by statute to be certified must be filed, a copy, including a photocopy or facsimile transmission, of the certification is not acceptable.

\*\*\*\*\*

Correspondence filed in the Office, which requires a person's signature, may be an original, or a copy thereof. The word original, as used herein, is defined as correspondence which is personally signed in permanent ink by the person whose signature appears thereon. Where copies of correspondence are acceptable, photocopies or facsimile transmissions may be filed. For example, a photocopy or facsimile transmission of an original of an amendment, declaration (e.g., under 37 CFR 1.63 or 1.67), petition, issue fee transmittal form, authorization to charge a deposit account or a credit card, may be submitted in a patent application. Where copies are permitted, second and further

generation copies (i.e., copy of a copy) are acceptable. For example, a client may fax a paper to an attorney and the attorney may then fax the paper to the Office, provided the paper is eligible to be faxed (see MPEP § 502.01). The original, if not submitted to the Office, should be retained as evidence of proper execution in the event that questions arise as to the authenticity of the signature reproduced on the photocopy or facsimile-transmitted correspondence. If a question of authenticity arises, the Office may require submission of the original.

When a document that is required by statute to be certified must be filed (such as a certified copy of a foreign patent application pursuant to 35 U.S.C. 119 or a certified copy of an international application pursuant to 35 U.S.C. 365) a copy of the certification, including a photocopy or facsimile transmission, will not be acceptable. The requirement for an original certification does not apply to certifications such as required under 37 CFR 1.8 since these certifications are not required by statute.

## 502.03 Communications via the Internet [R-2]

The Office published a Patent Internet Usage Policy to

(A) establish a policy for use of the Internet by the Patent Examining Corps and other organizations within the USPTO,

(B) address use of the Internet to conduct interview-like communications and other forms of formal and informal communications,

(C) publish guidelines for locating, retrieving, citing, and properly documenting scientific and technical information sources on the Internet,

(D) inform the public how the USPTO intends to use the Internet, and

(E) establish a flexible Internet policy framework which can be modified, enhanced, and corrected as the USPTO, the public, and customers learn to use, and subsequently integrate, new and emerging Internet technology into existing business infrastructures and everyday activities to improve the patent application, examining, and granting functions.

See *Internet Usage Policy*, 64 \*>FR< 33056 (June 21, 1999). The Articles of the Patent Internet Usage Policy pertinent to communications via electronic

mail are summarized below. See MPEP § 904.02(c) for information pertinent to Internet searching, and MPEP § 707.05(e) for information pertaining to the citation of electronic documents. See also MPEP § 713.04 for recordation of e-mail interviews.

>

## **I. < CONFIDENTIALITY OF PROPRIETARY INFORMATION (ARTICLE 4)**

If security and confidentiality cannot be attained for a specific use, transaction, or activity, then that specific use, transaction, or activity shall NOT be undertaken/conducted.

All use of the Internet by Patent Organization employees, contractors, and consultants shall be conducted in a manner that ensures compliance with confidentiality requirements in statutes, including 35 U.S.C. 122, and regulations. Where a written authorization is given by the applicant for the USPTO to communicate with the applicant via Internet e-mail, communications via Internet e-mail may be used.

Backup, archiving, and recovery of information sent or received via the Internet is the responsibility of individual users. The OCIO does not, and will not, as a normal practice, provide backup and recovery services for information produced, retrieved, stored, or transmitted to/from the Internet.

>

## **II. < COMMUNICATIONS VIA THE INTERNET AND AUTHORIZATION (ARTICLE 5)**

Communications via Internet e-mail are at the discretion of the applicant.

Without a written authorization by applicant in place, the USPTO will not respond via Internet e-mail to any Internet correspondence which contains information subject to the confidentiality requirement as set forth in 35 U.S.C. 122. A paper copy of such correspondence will be placed in the appropriate patent application.

The following is a sample authorization form which may be used by applicant:

“Recognizing that Internet communications are not secure, I hereby authorize the USPTO to communicate with me concerning any subject matter of this application by electronic mail. I understand that a copy of these communications will be made of record in the application file.”

A written authorization may be withdrawn by filing a signed paper clearly identifying the original authorization. The following is a sample form which may be used by applicant to withdraw the authorization:

“The authorization given on\_\_\_\_\_, to the USPTO to communicate with me via the Internet is hereby withdrawn. I understand that the withdrawal is effective when approved rather than when received.”

Where a written authorization is given by the applicant, communications via Internet e-mail, other than those under 35 U.S.C. 132 or which otherwise require a signature, may be used. In such case, a printed copy of the Internet e-mail communications MUST be given a paper number, entered into the Patent Application Locating and Monitoring System (PALM) and entered in the patent application file. A reply to an Office action may NOT be communicated by applicant to the USPTO via Internet e-mail. If such a reply is submitted by applicant via Internet e-mail, a paper copy will be placed in the appropriate patent application file with an indication that the reply is NOT ENTERED. >For Image File Wrapper (IFW) processing, see IFW Manual.<

USPTO employees are NOT permitted to initiate communications with applicants via Internet e-mail unless there is a written authorization of record in the patent application by the applicant.

All reissue applications are open to public inspection under 37 CFR 1.11(a) and all papers relating to a reexamination proceeding which have been entered of record in the patent or reexamination file are open to public inspection under 37 CFR 1.11(d). USPTO employees are NOT permitted to initiate communications with applicant in a reissue application or a patentee of a reexamination proceeding via Internet e-mail unless written authorization is given by the applicant or patentee.

&gt;

### III. < AUTHENTICATION OF SENDER BY A PATENT ORGANIZATION RECIPIENT (ARTICLE 6)

The misrepresentation of a sender's identity (i.e., spoofing) is a known risk when using electronic communications. Therefore, Patent Organization users have an obligation to be aware of this risk and conduct their Internet activities in compliance with established procedures.

Internet e-mail must be initiated by a registered practitioner, or an applicant in a pro se application, and sufficient information must be provided to show representative capacity in compliance with 37 CFR 1.34. Examples of such information include the attorney registration number, attorney docket number, and patent application number.

&gt;

### IV. < USE OF ELECTRONIC MAIL SERVICES (ARTICLE 7)

Once e-mail correspondence has been received from the applicant, as set forth in Patent Internet Usage Policy Article 4, such correspondence must be responded to appropriately. The Patent Examiner may respond to an applicant's e-mail correspondence by telephone, fax, or other appropriate means.

&gt;

### V. < INTERVIEWS (ARTICLE 8)

Internet e-mail shall NOT be used to conduct an exchange of communications similar to those exchanged during telephone or personal interviews unless a written authorization has been given under Patent Internet Usage Policy Article 5 to use Internet e-mail. In such cases, a paper copy of the Internet e-mail contents MUST be made and placed in the patent application file, as required by the Federal Records Act, in the same manner as an Examiner Interview Summary Form is entered.

&gt;

### VI. < POLICY GUIDANCE AND CLARIFICATIONS (ARTICLE 13)

Within the Patent Organization, any questions regarding Internet usage policy should be directed to

the user's immediate supervisor. Non-USPTO personnel should direct their questions to the Office of the Deputy Commissioner for Patent Examination Policy.

## 502.04 Duplicate Copies of Correspondence [R-2]

*37 CFR 1.4. Nature of correspondence and signature requirements.*

\*\*>

(b) Since each file must be complete in itself, a separate copy of every paper to be filed in a patent, patent file, or other proceeding must be furnished for each file to which the paper pertains, even though the contents of the papers filed in two or more files may be identical. The filing of duplicate copies of correspondence in the file of an application, patent, or other proceeding should be avoided, except in situations in which the Office requires the filing of duplicate copies. The Office may dispose of duplicate copies of correspondence in the file of an application, patent, or other proceeding.<

\*\*\*\*\*

When the Office does not require duplicate copies of a paper, the filing of multiple copies may cause a delay in processing by the Office. Accordingly, the Office may discard duplicate copies of correspondence filed in an application or patent file.

## 503 Application Number and Filing Receipt [R-2]

*37 CFR 1.54. Parts of application to be filed together; filing receipt.*

(a) It is desirable that all parts of the complete application be deposited in the Office together; otherwise, a letter must accompany each part, accurately and clearly connecting it with the other parts of the application. See § 1.53(f) and (g) with regard to completion of an application.

(b) Applicant will be informed of the application number and filing date by a filing receipt, unless the application is an application filed under § 1.53(d).

Application numbers consisting of a series code and a serial number are assigned by the Office of Initial Patent Examination (OIPE) immediately after mail has been opened.

The following series codes are assigned to the applications identified below:

(A) 01/ - \*>10</ - for nonprovisional applications (utility, plant, and reissue),

- The 01 series code was used from year 1925 to 1934,

- 02 – 1935 to 1947,
- 03 – 1948 to 1959,
- 04 – 1960 to 1969,
- 05 – 1970 to 1978,
- 06 – 1979 to 1986,
- 07 – 1987 to 1992,
- 08 – 1993 to 1997, \*
- 09 – 1998 to \*>Nov. 2001, and<

>10 – Dec. 2001 to present.<

(B) 29/ - for design applications;

(C) 60/ - for provisional applications; \*

(D) 90/ - for >*ex parte* reexamination proceedings; and

(E) 95/ - for *inter partes*< reexamination proceedings.

If a self-addressed postcard is submitted with a patent application, that postcard will be provided with both the receipt date and application number prior to returning it to the addressee. The application number identified on such a postcard receipt is merely the preliminary assignment of an application number to the application, and should not be relied upon (e.g., with respect to foreign filings) as necessarily representing the application number assigned to such application. See 37 CFR 1.53(b).

The identifying data on the postcard should include:

(A) applicant's name(s);

(B) title of invention;

(C) number of pages of specification, claims (for nonprovisional applications), and sheets of drawing;

(D) whether oath or declaration is included;

(E) a list of any additional forms included with the application (e.g., application transmittal form, application data sheet, fee transmittal form, and/or provisional application cover sheet); and

(F) amount and manner of paying the fee.

A return postcard should be attached to *each* patent application for which a receipt is desired.

It is important that the return postcard itemize all of the components of the application. If the postcard does not itemize each of the components of the application, it will not serve as evidence that any component which was not itemized was received by the United States Patent and Trademark Office (USPTO).

It should be recognized that the identification of an application by application number does not necessar-

ily signify that the USPTO has accepted the application as complete (37 CFR 1.53(a)).

OIPE mails a filing receipt to the attorney or agent, if any, otherwise to the applicant, for each application filed which meets the minimum requirements to receive a filing date. The filing receipt includes the application number, filing date, a confirmation number, a suggested class in the U.S. Patent Classification System (see MPEP § 902.01), and the number of an art unit where the application is likely to be examined. The filing receipt also includes other information about the application as applicable, such as continuing data, national stage data, foreign priority data, foreign filing license data, entity status information, and the date the Office anticipates publishing the application under 35 U.S.C. 122(b). The filing receipt represents the official assignment by the USPTO of a specific application number and confirmation number to a particular application. See 37 CFR 1.54(b). The application number officially assigned to an application on the filing receipt may differ from the application number identified on a postcard receipt submitted with such application, and, as between inconsistent filing receipts and postcard receipts, the application number on the filing receipt is controlling.

The confirmation number is a four-digit number that is assigned to each newly filed application. The confirmation number, in combination with the application number, is used to verify the accuracy of the application number placed on correspondence filed with the Office to avoid misidentification of an application due to a transposition error in the application number. The confirmation number may be found in the upper left-hand corner of the filing receipt. The confirmation number will also be available through the Patent Application Information Retrieval (PAIR) system (<http://pair.uspto.gov>). The Office eventually plans to include the application's confirmation number (in addition to the application number) on all Office actions and notices concerning the application. The confirmation number must be used when submitting an electronic filing system (EFS) copy of the application for publication to verify that the application number correctly identifies the application for which a copy is being submitted for publication. The Office also recommends that applicants include the application's confirmation number (in addition to the application number) on all

correspondence submitted to the Office concerning the application.

A continued prosecution application (CPA) filed under 37 CFR 1.53(d) >(design applications only)< will be assigned the application number of the prior application for identification purposes.

A nonprovisional application, other than a CPA filed under 37 CFR 1.53(d), is entitled to a filing date as of the date of receipt of the specification, including claims, and any required drawing. See 37 CFR 1.53(b). The filing receipt will be mailed at the time a determination is made that the application meets the minimum requirements to receive a filing date. The oath or declaration and filing fee may be filed later than the remaining application papers, but if so, they must be accompanied by the required surcharge. See 37 CFR 1.53(f). If the oath or declaration, and/or filing fee, and appropriate surcharge are not timely filed, the application will be abandoned.

A provisional application is entitled to a filing date as of the date of receipt of the specification and any required drawing(s). See 37 CFR 1.53(c). A cover sheet (37 CFR 1.51(c)(1)), which may be an application data sheet (37 CFR 1.76) or a cover letter, identifying the application as a provisional application is required to prevent the provisional application from being treated as a nonprovisional application. 37 CFR 1.53(c)(1).

Each application which meets the minimum requirements to receive a filing date is given a filing date. It is important, when referring to application files, to identify them by their filing dates and confirmation numbers as well as by application numbers.

Attorney docket numbers must be limited to a maximum of 12 characters to prevent truncation. The Patent Application Locating and Monitoring (PALM) system data base allows a maximum of 12 characters for the attorney docket numbers. Spaces, slashes, and hyphens will no longer be included in the entered docket number on the official filing receipt. In an application where CASE or NAVY-CASE appears before the first character in the docket number, only the characters after CASE or NAVY-CASE will be entered on the official filing receipt.

The application papers are placed in a file wrapper and certain data placed thereon by OIPE. >For Image File Wrapper (IFW) processing, see IFW Manual.<

Applications which are entitled to a filing date and are filed, whether by regular mail or “Express Mail” under 37 CFR 1.10, by hand-delivery or otherwise, will not be returned to applicant even if requested. See 37 CFR 1.59. Accordingly, applicants must be careful not to file applications which are not intended to be filed, e.g., duplicates of applications already filed. >Note that 37 CFR 1.26(a) provides that a change of purpose after the payment of a fee, as when a party desires to withdraw the filing of a patent application for which the fee was paid, will not entitle the party to a refund of such fee. See MPEP § 607.02.<

## RETURN POSTCARD

If a receipt >for< any item (e.g., paper or fee) filed in the USPTO is desired, it may be obtained by enclosing with the paper a self-addressed postcard specifically identifying the item. >To ensure the receipt of return receipt postcards, users must either: (A) purchase already stamped postcards from the United States Postal Service (USPS) or affix postage stamps to their postcards; or (B) if a postage meter is used, ensure that the meter postmark does not show the date. Any return receipt postcard containing a dated meter postmark may not be delivered by the USPS to the address provided on the postcard.< The USPTO will stamp the receipt date on the postcard and place it in the outgoing mail. A postcard receipt which itemizes and properly identifies the items which are being filed serves as *prima facie* evidence of receipt in the USPTO of all the items listed thereon on the date stamped thereon by the USPTO.

The identifying data on the postcard should be so complete as to clearly identify the item for which >a< receipt is requested. For example, the postcard should identify the applicant’s name, application number (if known), confirmation number (if known), filing date, interference number, title of the invention, etc. The postcard should also identify the type of paper being filed, e.g., new application, affidavit, amendment, notice of appeal, appeal brief, drawings, fees, motions, supplemental oath or declaration, petition, etc., and the number of pages being submitted. If a new application is being filed, all parts of the application being submitted should be separately listed on the postcard, e.g., the number of pages of specification (including written description, claims and abstract), number of claims, number of sheets of drawings,

number of pages of oath/declaration, number of pages of cover sheet (provisional application).

The postcard receipt will not serve as *prima facie* evidence of receipt of any item which is not adequately itemized on the postcard. For example, merely listing on the postcard “a complete application” or “patent application” will not serve as a proper receipt for each of the required components of an application (e.g., specification (including claims), drawings (if necessary), oath or declaration and the application filing fee) or missing portions (e.g., pages, sheets of drawings) of an application if one of the components or portion of a component is found to be missing by the USPTO. Each separate component should be specifically and properly itemized on the postcard. Furthermore, merely incorporating by reference in the postcard receipt, the items listed in a transmittal letter will not serve as *prima facie* evidence of receipt of those items.

The person receiving the item(s) in the USPTO will check the listing on the postcard against the item(s) being filed to be sure they are properly identified and that all the items listed on the postcard are presently being submitted to the USPTO. If any of the items listed on the postcard are not being submitted to the USPTO, those items will be crossed off and the postcard initialed by the person receiving the items.

Upon return of a postcard receipt from the USPTO, the postcard receipt should be promptly reviewed by the person who filed the items to ensure that every item specifically denoted on the postcard was received by the USPTO. If the postcard receipt has been annotated to indicate that a particular item denoted on the postcard was not received by the USPTO, the postcard receipt will not serve as *prima facie* evidence of receipt of that item in the USPTO.

## 504 Assignment of Application for Examination

The Office of Initial Patent Examination assigns a nonprovisional application to the art unit to which it appears to belong. Provisional applications will not be examined.

## 505 “Office Date” Stamp of Receipt [R-2]

37 CFR 1.6. Receipt of correspondence.

(a) *Date of receipt and Express Mail date of deposit.* Correspondence received in the Patent and Trademark Office is stamped with the date of receipt except as follows:

(1) The Patent and Trademark Office is not open for the filing of \*->correspondence< on any day that is a Saturday, Sunday, or Federal holiday within the District of Columbia. Except for correspondence transmitted by facsimile under paragraph (a)(3) of this section, or filed electronically under paragraph (a)(4) of this section, no correspondence is received in the Office on Saturdays, Sundays, or Federal holidays within the District of Columbia.

(2) Correspondence filed in accordance with § 1.10 will be stamped with the date of deposit as “Express Mail” with the United States Postal Service.

(3) Correspondence transmitted by facsimile to the Patent and Trademark Office will be stamped with the date on which the complete transmission is received in the Patent and Trademark Office unless that date is a Saturday, Sunday, or Federal holiday within the District of Columbia, in which case the date stamped will be the next succeeding day which is not a Saturday, Sunday, or Federal holiday within the District of Columbia.

(4) \*\*>[Reserved]<

\*\*\*\*\*

The United States Patent and Trademark Office (Office) stamps papers and fees with the date of their receipt in the Office. The stamp is referred to as the “Office Date” stamp.

When the last day for taking any action or paying any fee in the Office falls on a Saturday, Sunday, or a Federal holiday within the District of Columbia, the action or the fee is considered timely if the action is taken or the fee is paid on the next succeeding business day.

Effective November 29, 1999, Public Law 106-113 amended 35 U.S.C. 119(e)(3) to extend the period of pendency of a provisional application to the next succeeding business day if the day that is 12 months after the filing date of a provisional application falls on a Saturday, Sunday, or Federal holiday within the District of Columbia. See also 37 CFR 1.7(b). 35 U.S.C. 119(e)(3) as amended by Public Law 106-113 applies to any provisional application filed on or after June 8, 1995 but has no effect on any patent which is the subject of litigation in an action commenced before November 29, 1999.

New patent applications filed in accordance with 37 CFR 1.10 will be stamped by the Office with the

date of deposit as “Express Mail” with the United States Postal Service. For example, if a new patent application is deposited in “Express Mail” in accordance with 37 CFR 1.10 on a Saturday and the United States Postal Service gives it a date of deposit of Saturday, the Office will accord and stamp the correspondence with the Saturday date. 37 CFR 1.6(a)(2).

If an application includes the necessary components for a filing date (see 37 CFR 1.53(b)-(d) and MPEP § 506), the “Office Date” stamp establishes the “filing date.” Applications will not be accepted and stamped in the Technology Centers. They must be date stamped at the Customer Window. See MPEP § 502<.

## 506 Completeness of Original Application [R-2]

*37 CFR 1.53. Application number, filing date, and completion of application.*

(a) *Application number.* Any papers received in the Patent and Trademark Office which purport to be an application for a patent will be assigned an application number for identification purposes.

(b) *Application filing requirements - Nonprovisional application.* The filing date of an application for patent filed under this section, except for a provisional application under paragraph (c) of this section or a continued prosecution application under paragraph (d) of this section, is the date on which a specification as prescribed by 35 U.S.C. 112 containing a description pursuant to § 1.71 and at least one claim pursuant to § 1.75, and any drawing required by § 1.81(a) are filed in the Patent and Trademark Office. No new matter may be introduced into an application after its filing date. A continuing application, which may be a continuation, divisional, or continuation-in-part application, may be filed under the conditions specified in 35 U.S.C. 120, 121 or 365(c) and § 1.78(a).

(1) A continuation or divisional application that names as inventors the same or fewer than all of the inventors named in the prior application may be filed under this paragraph or paragraph (d) of this section.

(2) A continuation-in-part application (which may disclose and claim subject matter not disclosed in the prior application) or a continuation or divisional application naming an inventor not named in the prior application must be filed under this paragraph.

(c) *Application filing requirements - Provisional application.* The filing date of a provisional application is the date on which a specification as prescribed by the first paragraph of 35 U.S.C. 112, and any drawing required by § 1.81(a) are filed in the Patent and Trademark Office. No amendment, other than to make the provisional application comply with the patent statute and all applicable regulations, may be made to the provisional application after the filing date of the provisional application.

(1) A provisional application must also include the cover sheet required by § 1.51(c)(1), which may be an application data sheet (§ 1.76), or a cover letter identifying the application as a provisional application. Otherwise, the application will be treated as an application filed under paragraph (b) of this section.

(2) An application for patent filed under paragraph (b) of this section may be converted to a provisional application and be accorded the original filing date of the application filed under paragraph (b) of this section. The grant of such a request for conversion will not entitle applicant to a refund of the fees that were properly paid in the application filed under paragraph (b) of this section. Such a request for conversion must be accompanied by the processing fee set forth in § 1.17(q) and be filed prior to the earliest of:

(i) Abandonment of the application filed under paragraph (b) of this section;

(ii) Payment of the issue fee on the application filed under paragraph (b) of this section;

(iii) Expiration of twelve months after the filing date of the application filed under paragraph (b) of this section; or

(iv) The filing of a request for a statutory invention registration under § 1.293 in the application filed under paragraph (b) of this section.

(3) A provisional application filed under paragraph (c) of this section may be converted to a nonprovisional application filed under paragraph (b) of this section and accorded the original filing date of the provisional application. The conversion of a provisional application to a nonprovisional application will not result in either the refund of any fee properly paid in the provisional application or the application of any such fee to the filing fee, or any other fee, for the nonprovisional application. Conversion of a provisional application to a nonprovisional application under this paragraph will result in the term of any patent to issue from the application being measured from at least the filing date of the provisional application for which conversion is requested. Thus, applicants should consider avoiding this adverse patent term impact by filing a nonprovisional application claiming the benefit of the provisional application under 35 U.S.C. 119(e) (rather than converting the provisional application into a nonprovisional application pursuant to this paragraph). A request to convert a provisional application to a nonprovisional application must be accompanied by the fee set forth in § 1.17(i) and an amendment including at least one claim as prescribed by the second paragraph of 35 U.S.C. 112, unless the provisional application under paragraph (c) of this section otherwise contains at least one claim as prescribed by the second paragraph of 35 U.S.C.112. The nonprovisional application resulting from conversion of a provisional application must also include the filing fee for a nonprovisional application, an oath or declaration by the applicant pursuant to §§ 1.63, 1.162, or 1.175, and the surcharge required by § 1.16(e) if either the basic filing fee for a nonprovisional application or the oath or declaration was not present on the filing date accorded the resulting nonprovisional application (*i.e.*, the filing date of the original provisional application). A request to convert a provisional application to a nonprovisional application must also be filed prior to the earliest of:

(i) Abandonment of the provisional application filed under paragraph (c) of this section; or

(ii) Expiration of twelve months after the filing date of the provisional application filed under this paragraph (c).

(4) A provisional application is not entitled to the right of priority under 35 U.S.C. 119 or 365(a) or § 1.55, or to the benefit of an earlier filing date under 35 U.S.C. 120, 121 or 365(c) or § 1.78 of any other application. No claim for priority under 35 U.S.C. 119(e) or § 1.78(a)(4) may be made in a design application based on a provisional application. No request under § 1.293 for a statutory invention registration may be filed in a provisional application. The requirements of §§ 1.821 through 1.825 regarding application disclosures containing nucleotide and/or amino acid sequences are not mandatory for provisional applications.

(d) *Application filing requirements - Continued prosecution (nonprovisional) application.*

\*\*>

(1) A continuation or divisional application (but not a continuation-in-part) of a prior nonprovisional application may be filed as a continued prosecution application under this paragraph, provided that:

(i) The application is for a design patent;

(ii) The prior nonprovisional application is a design application that is complete as defined by § 1.51(b); and

(iii) The application under this paragraph is filed before the earliest of:

(A) Payment of the issue fee on the prior application, unless a petition under § 1.313(c) is granted in the prior application;

(B) Abandonment of the prior application; or

(C) Termination of proceedings on the prior application.<

(2) The filing date of a continued prosecution application is the date on which a request on a separate paper for an application under this paragraph is filed. An application filed under this paragraph:

(i) Must identify the prior application;

(ii) Discloses and claims only subject matter disclosed in the prior application;

(iii) Names as inventors the same inventors named in the prior application on the date the application under this paragraph was filed, except as provided in paragraph (d)(4) of this section;

(iv) Includes the request for an application under this paragraph, will utilize the file jacket and contents of the prior application, including the specification, drawings and oath or declaration from the prior application, to constitute the new application, and will be assigned the application number of the prior application for identification purposes; and

(v) Is a request to expressly abandon the prior application as of the filing date of the request for an application under this paragraph.

\*\*>

(3) The filing fee for a continued prosecution application filed under this paragraph is the basic filing fee as set forth in § 1.16(f).<

(4) An application filed under this paragraph may be filed by fewer than all the inventors named in the prior application, provided that the request for an application under this paragraph when filed is accompanied by a statement requesting deletion of the name or names of the person or persons who are not inventors of the invention being claimed in the new application. No person may be named as an inventor in an application filed under this paragraph who was not named as an inventor in the prior application on the date the application under this paragraph was filed, except by way of correction of inventorship under § 1.48.

(5) Any new change must be made in the form of an amendment to the prior application as it existed prior to the filing of an application under this paragraph. No amendment in an application under this paragraph (a continued prosecution application) may introduce new matter or matter that would have been new matter in the prior application. Any new specification filed with the request for an application under this paragraph will not be considered part of the original application papers, but will be treated as a substitute specification in accordance with § 1.125.

(6) The filing of a continued prosecution application under this paragraph will be construed to include a waiver of confidentiality by the applicant under 35 U.S.C. 122 to the extent that any member of the public, who is entitled under the provisions of § 1.14 to access to, copies of, or information concerning either the prior application or any continuing application filed under the provisions of this paragraph, may be given similar access to, copies of, or similar information concerning the other application or applications in the file jacket.

(7) A request for an application under this paragraph is the specific reference required by 35 U.S.C. 120 to every application assigned the application number identified in such request. No amendment in an application under this paragraph may delete this specific reference to any prior application.

(8) In addition to identifying the application number of the prior application, applicant should furnish in the request for an application under this paragraph the following information relating to the prior application to the best of his or her ability:

(i) Title of invention;

(ii) Name of applicant(s); and

(iii) Correspondence address.

\*\*>

(9) Envelopes containing only requests and fees for filing an application under this paragraph should be marked "Mail Stop CPA." Requests for an application under this paragraph filed by facsimile transmission should be clearly marked "Mail Stop CPA."<

(10) See § 1.103(b) for requesting a limited suspension of action in an application filed under this paragraph.

(e) *Failure to meet filing date requirements.*

\*\*>

(1) If an application deposited under paragraph (b), (c), or (d) of this section does not meet the requirements of such paragraph to be entitled to a filing date, applicant will be so notified, if



a correspondence address has been provided, and given a period of time within which to correct the filing error. If, however, a request for an application under paragraph (d) of this section does not meet the requirements of that paragraph because the application in which the request was filed is not a design application, and if the application in which the request was filed was itself filed on or after June 8, 1995, the request for an application under paragraph (d) of this section will be treated as a request for continued examination under § 1.114.<

(2) Any request for review of a notification pursuant to paragraph (e)(1) of this section, or a notification that the original application papers lack a portion of the specification or drawing(s), must be by way of a petition pursuant to this paragraph accompanied by the fee set forth in § 1.17(h). In the absence of a timely (§ 1.181(f)) petition pursuant to this paragraph, the filing date of an application in which the applicant was notified of a filing error pursuant to paragraph (e)(1) of this section will be the date the filing error is corrected.

(3) If an applicant is notified of a filing error pursuant to paragraph (e)(1) of this section, but fails to correct the filing error within the given time period or otherwise timely (§ 1.181(f)) take action pursuant to this paragraph, proceedings in the application will be considered terminated. Where proceedings in an application are terminated pursuant to this paragraph, the application may be disposed of, and any filing fees, less the handling fee set forth in § 1.21(n), will be refunded.

(f) *Completion of application subsequent to filing—nonprovisional (including continued prosecution or reissue) application.*

(1) If an application which has been accorded a filing date pursuant to paragraph (b) or (d) of this section does not include the basic filing fee, or if an application which has been accorded a filing date pursuant to paragraph (b) of this section does not include an oath or declaration by the applicant pursuant to §§ 1.63, 1.162 or § 1.175, and applicant has provided a correspondence address (§ 1.33(a)), applicant will be notified and given a period of time within which to pay the filing fee, file an oath or declaration in an application under paragraph (b) of this section, and pay the surcharge required by § 1.16(e) to avoid abandonment.

(2) If an application which has been accorded a filing date pursuant to paragraph (b) of this section does not include the basic filing fee or an oath or declaration by the applicant pursuant to §§ 1.63, 1.162 or § 1.175, and applicant has not provided a correspondence address (§ 1.33(a)), applicant has two months from the filing date of the application within which to pay the basic filing fee, file an oath or declaration, and pay the surcharge required by § 1.16(e) to avoid abandonment.

(3) This paragraph applies to continuation or divisional applications under paragraphs (b) or (d) of this section and to continuation-in-part applications under paragraph (b) of this section.

(4) See § 1.63(d) concerning the submission of a copy of the oath or declaration from the prior application for a continuation or divisional application under paragraph (b) of this section.

(5) If applicant does not pay one of the basic filing or the processing and retention fees (§ 1.21(l)) during the pendency of the application, the Office may dispose of the application.

(g) *Completion of application subsequent to filing—provisional application.*

(1) If a provisional application which has been accorded a filing date pursuant to paragraph (c) of this section does not include the cover sheet required by § 1.51(c)(1) or the basic filing fee (§ 1.16(k)), and applicant has provided a correspondence address (§ 1.33(a)), applicant will be notified and given a period of time within which to pay the basic filing fee, file a cover sheet (§ 1.51(c)(1)), and pay the surcharge required by § 1.16(l) to avoid abandonment.

(2) If a provisional application which has been accorded a filing date pursuant to paragraph (c) of this section does not include the cover sheet required by § 1.51(c)(1) or the basic filing fee (§ 1.16(k)), and applicant has not provided a correspondence address (§ 1.33(a)), applicant has two months from the filing date of the application within which to pay the basic filing fee, file a cover sheet (§ 1.51(c)(1)), and pay the surcharge required by § 1.16(l) to avoid abandonment.

(3) If applicant does not pay the basic filing fee during the pendency of the application, the Office may dispose of the application.

(h) *Subsequent treatment of application - Nonprovisional (including continued prosecution) application.* An application for a patent filed under paragraphs (b) or (d) of this section will not be placed on the files for examination until all its required parts, complying with the rules relating thereto, are received, except that certain minor informalities may be waived subject to subsequent correction whenever required.

(i) *Subsequent treatment of application - Provisional application.* A provisional application for a patent filed under paragraph (c) of this section will not be placed on the files for examination and will become abandoned no later than twelve months after its filing date pursuant to 35 U.S.C. 111(b)(1).

(j) *Filing date of international application.* The filing date of an international application designating the United States of America is treated as the filing date in the United States of America under PCT Article 11(3), except as provided in 35 U.S.C. 102(e).

>

## **I. < INCOMPLETE NONPROVISIONAL APPLICATIONS FILED UNDER 37 CFR 1.53(b)**

If the nonprovisional application papers filed under 37 CFR 1.53(b) do not include at least a specification containing a description and at least one claim and a drawing, if necessary under 35 U.S.C. 113 (first sentence), or if the submitted application papers are too informal to be given a filing date, the case is held in the Office of Initial Patent Examination (OIPE) as an incomplete application and the applicant is informed of the shortcomings of the papers. No filing date is granted until the incompleteness is corrected.

A Notice of Incomplete Application is prepared and mailed by OIPE when nonprovisional application papers filed under 37 CFR 1.53(b) are deemed incomplete under 35 U.S.C. 111(a).

Such incompleteness may consist of the omission of any one of the following parts of an application. The component parts of a nonprovisional application filed under 37 CFR 1.53(b) necessary to obtain a filing date are:

A specification as prescribed by 35 U.S.C. 112 and 37 CFR 1.71.

A claim as prescribed by 35 U.S.C. 112 and 37 CFR 1.75.

A drawing, if necessary under 35 U.S.C. 113 (first sentence) and 37 CFR 1.81(a).

See 37 CFR 1.53(b).

Even though an application purports to include the component parts necessary to obtain a filing date, the application will still be held to be incomplete and a filing date will be refused if the component parts fail to satisfy the requirements set forth above.

For example, if the documents purporting to be a specification are so obviously informal and incoherent that they clearly do not constitute a specification as required by 35 U.S.C. 112 and 37 CFR 1.71, the application is not acceptable for examination and it will not be accorded a filing date until corrections are made. The filing date of the application will be the date the corrections are made.

Filing dates are accorded to nonprovisional applications filed under 37 CFR 1.53(b) submitted without the names of all the inventors, the basic filing fee and/or the oath or declaration. In such cases, a notice is mailed by OIPE requiring that at least the basic filing fee and the oath or declaration (which must include the names of all the inventors) be filed, accompanied by a surcharge (37 CFR 1.16(e)). In addition to the basic filing fee required under 37 CFR 1.16(a), the prescribed filing fee (37 CFR 1.51(b)(4)) may include additional fees for filing more than 3 independent claims (37 CFR 1.16(b)), for filing a total of more than 20 claims (37 CFR 1.16(c)), or for filing a multiple dependent claim (37 CFR 1.16(d)). In those cases where the basic filing fee is paid, but additional fees are required, under 37 CFR 1.16, a notice is mailed by OIPE or the Technology Center (TC), requiring that the balance of the prescribed fee be paid.

Occasionally, nonprovisional applications filed under 37 CFR 1.53(b) which have already been signed by the inventors contain informal claims that the attorney or agent feels should not be present in the application upon filing. However, since alteration after execution by the inventor and before filing is prohibited, such applications must be filed by the attorney or agent in the form in which they were executed by the inventors. A nonprovisional application filed under 37 CFR 1.53(b) may be filed with a preliminary amendment which is limited to the cancellation of claims. Any preliminary amendment, regardless of when it is filed, must be in compliance with 37 CFR 1.121, e.g., it must include a complete listing of all of the claims. Therefore, the Office strongly recommends that applicants file their applications with a specification containing only the desired set of claims, rather than filing the application with a preliminary amendment canceling claims. If such a preliminary amendment canceling claims is filed, it will diminish the number of claims to be considered for calculation of the filing fee. Any other changes to the application should be the subject of a separate amendment which may be entered after the filing fee has been calculated and the filing date granted. If a preliminary amendment which cancels claims does not accompany the application at the time the application is filed, the notification of insufficient fee will inform the inventor, attorney, or agent of the possibility of correcting the insufficient payment by either (1) paying the additional required fee amount, or (2) filing an amendment which cancels claims so that the remaining claims are covered by the fee submitted upon filing. However, no refund will be made once the fee for claims is properly paid, even though claims are later canceled.

In the past, OIPE has reviewed the claimed subject matter of newly filed nonprovisional applications to determine whether a filing date should be granted. Such applications included those drawn to perpetual motion devices and methods of doing business and applications for reissue signed by assignees or filed more than 2 years after the grant of the patent which appear to contain broadened reissue claims.

Under the current practice, a filing date is normally granted in such cases if the nonprovisional application filed under 37 CFR 1.53(b) is otherwise sufficient and

then forwarded to the examiner for consideration and decision during the regular course of examination.

>

## II. < INCOMPLETE PROVISIONAL APPLICATIONS

If the provisional application papers do not include at least a specification containing a description and a drawing, if necessary under 35 U.S.C. 113 (first sentence) or if the submitted application papers are too informal to be given a filing date, the case is held in OIPE as an incomplete application and the applicant is informed of the shortcomings of the papers. No filing date is granted until the incompleteness is corrected.

Such incompleteness may consist of the omission of any one of the following parts of an application. The component parts of a provisional application necessary to obtain a filing date are:

A specification as prescribed by 35 U.S.C. 112, first paragraph, and 37 CFR 1.71.

A drawing, if necessary under 35 U.S.C. 113 (first sentence) and 37 CFR 1.81(a).

Even though an application purports to include the component parts necessary to obtain a filing date, the application will still be held to be incomplete and a filing date will be refused if the component parts fail to satisfy the requirements set forth above. For example, if the documents purporting to be a specification are so obviously informal and incoherent that they would clearly not constitute a specification as required by 35 U.S.C. 112, first paragraph, and 37 CFR 1.71, the application would not be acceptable and would not be accorded a filing date until corrections are made. The filing date of the application would be the date the corrections were made. A provisional application will not be examined. However, a provisional application which does not include a cover sheet (37 CFR 1.51(c)(1)), which may be an application data sheet (37 CFR 1.76) or a cover letter, identifying the application as a provisional application, will be treated as a nonprovisional application filed under 37 CFR 1.53(b). See 37 CFR 1.53(c)(1).

NOTE: No amendment, other than to make the provisional application comply with the patent statute and all applicable regulations, may be made to the

provisional application after the filing date of the provisional application. See 37 CFR 1.53(c).

>

## III. < INFORMAL APPLICATIONS

An application is informal if it is typed on both sides of the paper, or is not permanent, legible, or reproducible. If such informalities are timely corrected, the application is given the filing date on which the original informal papers were filed.

OIPE accords a filing date, as of the date indicated by the "Office Date" stamp (see MPEP § 505), to application papers which include a specification containing a description and at least one claim (nonprovisional applications filed under 37 CFR 1.53(b)), and a drawing, if necessary under 35 U.S.C. 113 (first sentence) but are informal because they do not comply with the rules or notices. In such applications, OIPE prepares a Notice of Informal Application indicating the informality and places it in the file wrapper. The TC mails the letter to applicant. Failure to correct the informality within the specified time results in abandonment of the application.

The letter of transmittal accompanying the filing of continuing applications should include such additional information as the identification by application number of a provisional or parent application, its status, and location (if known) in the U.S. Patent and Trademark Office. The supplying of this information will simplify the processing of these applications.

\*\*

## 506.02 Review of Refusal To Accord Filing Date

The filing date of the provisional or nonprovisional application is the date of receipt in the Office of the application which includes a specification containing description pursuant to 37 CFR 1.71 and at least one claim (required for nonprovisional applications only) pursuant to 37 CFR 1.75, and any drawings required by 37 CFR 1.81(a). See 37 CFR 1.53(b) and (c).

If any of these items are missing, applicant will be notified to file them and the filing date will be the date of receipt of the missing part(s). If the oath or declaration for a nonprovisional application was executed and filed with the application, a supplemental oath or declaration by the inventor is required in some circumstances, e.g., where the missing item is the claim,

specification, or a drawing. The supplemental declaration must identify the missing item and indicate, as appropriate, that it accurately claims, describes, or illustrates applicant's invention. See MPEP § 601.01(d)-(g) where the application is filed without all the pages of the specification, without at least one claim (nonprovisional application), without drawings, or without all the figures of the drawings. An error in or failure to identify inventorship does not raise a filing date issue.

Any review of the refusal to grant a filing date as of the date of deposit of the application would be by way of petition, accompanied by the petition fee (37 CFR 1.17(h)). Petitioner should provide any arguments that he or she has that the items noted were not missing or that a filing date should be assigned in the absence of such items if they are believed to be unnecessary. If petitioner alleges that no defect exists, a request for refund of the petition fee may be included in the petition.

For applications properly filed under 37 CFR 1.10, the filing date is the date that the application was deposited as "Express Mail" in the U.S. Postal Service. For example, if a new patent application is deposited in "Express Mail" in accordance with 37 CFR 1.10 on a Saturday and the United States Postal Service gives it a date of deposit of Saturday, the Office will accord and stamp the correspondence with the Saturday date. 37 CFR 1.6(a)(2). If the proper procedures were not followed, the application will receive a filing date as of the date it was received in the Office. Any review of these matters would be by way of petition, accompanied by the petition fee (37 CFR 1.17(h)), providing whatever arguments and evidence petitioner has that the application is entitled to a filing date as of the date it was deposited as "Express Mail."

Petitions relating to the filing date accorded to patent applications under 37 CFR 1.53 are decided in the Office of the Deputy Commissioner for Patent Examination Policy (See MPEP § 1002.02(b)), with the exception of petitions relating to the filing date accorded to a design application, which are decided by the Director of Technology Center 2900. See MPEP § 1002.02(c)(3).

Any petition under this section should be marked to the attention of the Office of Patent Legal Administration.

## 507 Drawing Review in the Office of Initial Patent Examination [R-2]

The Office has revised the drawing review process to implement the eighteen-month publication of patent applications. Under the revised drawing review process, the Office of Initial Patent Examination (OIPE) performs an initial review of drawings in new utility and plant patent applications filed on or after November 29, 2000 to see if the drawings can be effectively scanned for publication purposes. Design applications are not published. Therefore, drawings filed in design patent applications (whether filed before, on or after November 29, 2000) will be reviewed but not for publication purposes. The standard of review employed by OIPE is such that most drawings, including those that have been indicated by applicant to be informal drawings, will be accepted.

OIPE inspects the drawings to see if they can be effectively scanned and adequately reproduced. If the drawings are not acceptable, OIPE will object to the drawings and notify applicant that a timely submission of acceptable drawings (e.g., drawings which can be scanned) is required. This initial review process in OIPE is necessary in order to ensure that applications can be timely published.

Under the OIPE review process, OIPE may object to and require corrected drawings within a set time period, if the drawings:

(A) have a line quality that is too light to be reproduced (weight of all lines and letters must be heavy enough to permit adequate reproduction) or text that is illegible (reference characters, sheet numbers, and view numbers must be plain and legible). See 37 CFR 1.84(l) and (p)(1);

(B) have missing lead lines. See 37 CFR 1.84(q). Lead lines are those lines between the reference characters and the details referred to;

(C) contain excessive text or text that is not in English (including, for example, a flow chart that was originally not in English that has been marked up to include the English text). See 37 CFR 1.84(o) and (p)(2) and 37 CFR 1.52(d)(1);

(D) do not have the appropriate margin or are not on the correct size paper. See 37 CFR 1.84(f) and (g). Each sheet must include a top margin of at least 2.5 cm. (1 inch), a left size margin of at least 2.5 cm. (1 inch), a right size margin of at least 1.5 cm. (5/8 inch),

and a bottom margin of at least 1.0 cm. (3/8 inch). The size of the sheets on which drawings are made must be either 21.0 cm. by 29.7 cm. (DIN size A4) or 21.6 cm. by 27.9 cm. (8-1/2 by 11 inches);

(E) have more than one figure and each figure is not labeled "Fig." With a consecutive Arabic numeral (1, 2, etc.) or an Arabic numeral and capital letter in the English alphabet (A, B, etc.). See 37 CFR 1.84(u)(1);

(F) include photographs of the claimed invention which are capable of illustration by other medium such as ink drawings, and which are illegible after scanning. See 37 CFR 1.84(b); and

(G) contain color drawings or color photographs, but not a petition to accept color drawings/photographs. Note that the requirement under 37 CFR 1.84(a)(2)(iii) and 37 CFR 1.165(b) for a black and white photocopy of any color drawings/photographs has been waived. See 1246 O.G. 106 (May 22, 2001).

If OIPE objects to the drawings and sends applicant a Notice requiring submission of corrected drawings within a set time period (usually two months), corrected drawings must be filed, in paper, to the mailing address set forth in the Notice, along with any other items required by OIPE, to avoid abandonment of the application. No fee will be necessary for filing corrected drawings which are required by OIPE. Otherwise, in most situations, patent application publications and patents will reflect the quality of the drawings that are included with a patent application on filing unless applicant voluntarily submits better quality drawings as set forth below.

>

#### **I. < VOLUNTARY SUBMISSION OF REPLACEMENT DRAWINGS FOR PURPOSES OF PATENT APPLICATION PUBLICATION**

As noted above, for the vast majority of applications, corrected or new drawings will not be required, and the application will be published with the originally filed drawings. Although the initial submission of high quality drawings is certainly encouraged, the USPTO will not require applicant to submit "formal drawings" for purposes of publication of the application.

>

#### **II. < REPLACEMENT DRAWINGS SUBMITTED ON PAPER**

Applicant may submit replacement drawings within the later of one month from the filing date of the application, or fourteen months from the earliest filing date for which a benefit is sought under Title 35, United States Code. The replacement paper drawings must be filed in an envelope addressed to \*\*>Mail Stop PGPUB Drawings, Commissioner for Patents, P.O. BOX 1450, Alexandria, Virginia 22313-1450<, with a petition under 37 CFR 1.182 requesting entry of the drawings, and the petition fee set forth in 37 CFR 1.17(h). If such replacement drawings are properly and timely submitted, the patent application publication shall include the replacement drawings. Replacement drawings that are received later than this date may still be included in the patent application publication, where practicable, if the USPTO has not started the patent application publication process when the paper drawings and the appropriate fee are received.

\*\*>Mail Stop PGPUB Drawings< should only be used for filing replacement drawings for inclusion in a patent application publication. The replacement drawings should be accompanied by a transmittal letter identifying the application to which the replacement drawings are directed and either an authorization to charge the petition fee or other payment of the petition fee. Replacement drawings received in this special \*>mail stop< will be scanned and included in the electronic document which will be used for the patent application publication. After the replacement drawings are scanned for the patent application publication, they will be made of record in the application file. Replacement drawings that are not mailed to the special \*>mail stop<, or are filed without the appropriate petition fee, or are untimely submitted, will be routed to, and made of record in the application file \*\* and will not be included in the patent application publication. Other papers, such as amendments to the application, amended titles or status inquiries should not be included with the replacement drawings addressed to \*\*>Mail Stop PGPUB Drawings<. By including any such other items with the replacement drawings may result in the replacement drawings not being scanned for purposes of the patent application

publication. Replacement drawings for unrelated applications must be submitted in separate envelopes to ensure that the replacement drawings are associated with the proper application file prior to publication.

>

### III. < REPLACEMENT DRAWINGS SUBMITTED WITH A SPECIFICATION THROUGH THE ELECTRONIC FILING SYSTEM

Applicant may also submit replacement drawings in electronic form by submitting the drawings with a copy of the application, as amended during prosecution, for publication via the Electronic Filing System (EFS). Pursuant to 37 CFR 1.215(c), the EFS submission must be filed within the later of one month from the filing date of the application, or fourteen months from the earliest filing date for which a benefit is sought under Title 35, United States Code. A paper copy of the replacement drawings must also be filed in the application within the time period noted above. The paper replacement drawings must be placed in an envelope addressed to \*\*>Mail Stop PGPUB Drawings, Commissioner for Patents, P.O. Box 1450, Alexandria, Virginia 22313-1450<. Since the replacement drawings was also submitted via EFS, a petition under 37 CFR 1.182 requesting entry of the drawings, and the petition fee set forth in 37 CFR 1.17(h) will not be required with the submission of the paper copy of the replacement drawings. The replacement drawings submitted via EFS should be submitted in accordance with the instructions for EFS submissions. Information on EFS submissions can be obtained at <http://www.uspto.gov/ebc/efs/>. If such paper or EFS replacement drawings are properly and timely submitted, the patent application publication shall include the replacement drawings. Replacement drawings that are received later than this date may be included in the patent application publication, where practicable, if the USPTO has not started the patent application publication process when the EFS replacement drawings are received. See 37 CFR 1.215(c).

## 508 Distribution [R-2]

\*\*>All applications filed on or after June 30, 2003, are electronically scanned and loaded into the Image File Wrapper (IFW) system. Once documents are

loaded into the IFW system, examiners, technical support staff, and other Office personnel will perform further processing and examination using the IFW system.

For handling of models, exhibits, and specimen,< see MPEP § 608.03 and § 608.03(a).

### 508.01 Papers Sent to Wrong Technology Center (TC) [R-2]

If drawings, amendments, or other papers are delivered to the wrong TC, the TC to which this application is assigned should be obtained from PALM and be placed on the paper and then forwarded to the appropriate TC. The TC to which the application is assigned as indicated by PALM may be verified by calling the TC as indicated before forwarding the paper. >For Image File Wrapper (IFW) processing, see IFW Manual.<

### 508.02 Papers Received After Patenting or Abandonment [R-2]

After an application is patented or abandoned, any incoming communication which is not to become part of the record will be returned to the sender by the Technology Center. >For Image File Wrapper (IFW) processing, see IFW Manual.<

### 508.03 Unmatched Papers [R-2]

>For Image File Wrapper (IFW) processing, see IFW Manual. Effective December 1, 2003, no official paper which relates to a pending application may be personally delivered to a Technology Center (TC) except papers that are directed to an application subject to a secrecy order pursuant to 35 U.S.C. 181, or are national security classified and that are directed to Licensing and Review. See MPEP § 502.< Unmatched papers for nonprovisional applications >(maintained in paper application files)< within a \*\*>TC< should be frequently reviewed to determine which should be sent to the Paper Correlating Office (PCO).

Item I below treats the papers in the “Application number too high” category. Items II-VI below are directed to all other unmatched papers not in the “Application number too high” category.

### **I. UNMATCHED PAPERS IN THE “APPLICATION NUMBER TOO HIGH” CATEGORY**

This collection of papers being held by the TC should be reviewed *at least* once a week. Any paper having an application number which clearly should have already been received by the TC should be removed from this collection. Where the TC does not have a corresponding application for any of these papers, inquiry should be made of the Office of Initial Patent Examination (OIPE) to determine the TC of record. If another TC number is indicated, the paper should be forwarded to that TC. If OIPE does not yield a new TC number for the indicated application number, the paper should be sent to the PCO.

### **II. UNMATCHED PAPERS HAVING AN APPLICATION NUMBER**

It can be assumed that either the TC number or the application number on these papers is incorrect. Inquiry should be made of the OIPE and PALM to determine the TC of record and the procedure set out in paragraph I above followed. An exception to this practice should be made where the paper has thereon the name of an examiner in the TC. In these situations, a careful check of the TC records and files as well as consultation with the indicated examiner should be made to determine the correct application number. If this does not yield a new application number, the paper should be sent to the PCO.

### **III. UNMATCHED PAPERS RELATING TO APPLICATIONS ABANDONED FROM TC**

The application file should be ordered from Files Repository. If the file is not received therefrom, the paper should be forwarded to the PCO.

### **IV. PAPERS FOR APPLICATIONS WHICH HAVE BEEN SENT TO PUBLISHING DIVISION**

All papers for applications which PALM indicates to be located in any of the locations 7400 through 7650 should be forwarded to the Publishing Division.

The instructions of this paragraph (IV) apply to all files in issue including those which have been assigned a patent number and issue date. Papers

requiring examiner review and action will be returned to the TC after Publishing Division personnel have matched the paper to the appropriate file.

### **V. PAPERS FOR APPLICATIONS WHICH HAVE BEEN SENT TO THE FILE INFORMATION UNIT (RECORD ROOM)**

If PALM indicates that the application to which a paper relates is in the File Information Unit (Record Room) (location code 9210), the paper should be forwarded to the PCO for response.

### **VI. UNMATCHED PAPERS FOR APPLICATIONS WHICH ARE KNOWN TO BE PENDING IN THE TC BUT CANNOT BE LOCATED**

Generally, these are applications which PALM indicates are present in the TC, but the file is not available. These papers should be retained in the TC for processing.

*Each* paper sent to the PCO must have a PCO Transmittal Form *stapled* thereto. Each form attached to a paper should be filled out as completely as possible. Transmittal Forms attached to papers of the type described in paragraph I and paragraph II above must have an indication of the information obtained from *both* OIPE and PALM. The PALM information should be inserted in the large space at the bottom of the form. This will help eliminate duplication of effort by PCO personnel. Papers received without transmittal forms or with incompletely filled out transmittal forms may be returned to the originating TC.

## **508.04 Unlocatable Patent or Application Files [R-2]**

*37 CFR 1.251. Unlocatable file.*

(a) In the event that the Office cannot locate the file of an application, patent, or other patent-related proceeding after a reasonable search, the Office will notify the applicant or patentee and set a time period within which the applicant or patentee must comply with the notice in accordance with one of paragraphs (a)(1), (a)(2), or (a)(3) of this section.

(1) Applicant or patentee may comply with a notice under this section by providing:

(i) A copy of the applicant's or patentee's record (if any) of all of the correspondence between the Office and the applicant or patentee for such application, patent, or other proceeding (except for U.S. patent documents);

(ii) A list of such correspondence; and

(iii) A statement that the copy is a complete and accurate copy of the applicant's or patentee's record of all of the correspondence between the Office and the applicant or patentee for such application, patent, or other proceeding (except for U.S. patent documents), and whether applicant or patentee is aware of any correspondence between the Office and the applicant or patentee for such application, patent, or other proceeding that is not among applicant's or patentee's records.

(2) Applicant or patentee may comply with a notice under this section by:

(i) Producing the applicant's or patentee's record (if any) of all of the correspondence between the Office and the applicant or patentee for such application, patent, or other proceeding for the Office to copy (except for U.S. patent documents); and

(ii) Providing a statement that the papers produced by applicant or patentee are applicant's or patentee's complete record of all of the correspondence between the Office and the applicant or patentee for such application, patent, or other proceeding (except for U.S. patent documents), and whether applicant or patentee is aware of any correspondence between the Office and the applicant or patentee for such application, patent, or other proceeding that is not among applicant's or patentee's records.

(3) If applicant or patentee does not possess any record of the correspondence between the Office and the applicant or patentee for such application, patent, or other proceeding, applicant or patentee must comply with a notice under this section by providing a statement that applicant or patentee does not possess any record of the correspondence between the Office and the applicant or patentee for such application, patent, or other proceeding.

(b) With regard to a pending application, failure to comply with one of paragraphs (a)(1), (a)(2), or (a)(3) of this section within the time period set in the notice will result in abandonment of the application.

37 CFR 1.251 sets forth a procedure for the reconstruction of the file of a patent application, patent, or any other patent-related proceeding that cannot be located after a reasonable search. The phrase "an application" in 37 CFR 1.251 applies to any type of application (national or international), and regardless of the status (pending or abandoned) of the application

37 CFR 1.251(a) provides that in the event the Office cannot locate the file of an application, patent, or any other patent-related proceeding after a reasonable search, the Office will notify the applicant or patentee and set a time period within which the applicant or patentee must comply with the notice. The applicant or patentee may comply with a notice under 37 CFR 1.251 by providing: (1) a copy of his or her record (if any) of all of the correspondence between the Office and the applicant or patentee for such appli-

cation, patent, or other proceeding (except for U.S. patent documents); (2) a list of such correspondence; and (3) a statement that the copy is a complete and accurate copy of the applicant's or patentee's record of all of the correspondence between the Office and the applicant or patentee for such application, patent, or other proceeding (except for U.S. patent documents), and whether applicant or patentee is aware of any correspondence between the Office and the applicant or patentee for such application, patent, or other proceeding that is not among applicant's or patentee's records (37 CFR 1.251(a)(1)). The applicant or patentee may also comply with a notice under 37 CFR 1.251 by: (1) producing his or her record (if any) of all of the correspondence between the Office and the applicant or patentee for such application, patent, or other proceeding for the Office to copy (except for U.S. patent documents); and (2) providing a statement that the papers produced by applicant or patentee are applicant's or patentee's complete record of all of the correspondence between the Office and the applicant or patentee for such application, patent, or other proceeding (except for U.S. patent documents), and whether applicant or patentee is aware of any correspondence between the Office and the applicant or patentee for such application, patent, or other proceeding that is not among applicant's or patentee's records (37 CFR 1.251(a)(2)). If applicant or patentee does not possess any record of the correspondence between the Office and the applicant or patentee for such application, patent, or other proceeding, the applicant or patentee must comply with a notice under 37 CFR 1.251 by providing a statement that applicant or patentee does not possess any record of the correspondence between the Office and the applicant or patentee for such application, patent, or other proceeding (37 CFR 1.251(a)(3)).

According to 37 CFR 1.251(a), if the applicant or patentee possesses all or just some of the correspondence between the Office and the applicant or patentee for such application, patent, or other proceeding, the applicant or patentee is to reply by providing a copy of (or producing) his or her record of all of the correspondence between the Office and the applicant or patentee for such application, patent, or other proceeding (37 CFR 1.251(a)(1) or (a)(2)). If applicant or patentee does not possess any record of the correspondence between the Office and the applicant



or patentee for such application, patent, or other proceeding, the applicant or patentee is to reply with a statement to that effect (37 CFR 1.251(a)(3)).

If an applicant or patentee decides to produce his or her record of the correspondence between the Office and the applicant or patentee for the application, patent, or other proceeding for copying by the Office under 37 CFR 1.251(a)(2) (rather than provide a copy under 37 CFR 1.251(a)(1)), the record should be brought to the Customer Service Center in the Office of Initial Patent Examination (Crystal Plaza 2, 2011 South Clark Place, Arlington, VA 22202).

The Office will set a time period of three months for reply in a notice under 37 CFR 1.251 in an application. The time period will be extendable under 37 CFR 1.136(a) (unless the notice indicates otherwise) by three months up to a maximum period for reply of six months in an application. See 35 U.S.C. 133. If, however, an applicant fails to reply to a notice under 37 CFR 1.251 within three months of its mailing date, any patent term adjustment under 35 U.S.C. 154(b) will be reduced by a period equal to the number of days (if any) beginning on the day after the date that is three months after the mailing date of the notice under 37 CFR 1.251 and ending on the date the reply to the notice under 37 CFR 1.251 was filed. See 35 U.S.C. 154(b)(2)(C)(ii) and 37 CFR 1.704(b). The Office will set a time period of six months for reply in a notice under 37 CFR 1.251 in a patent. The time period will **not** be extendable under 37 CFR 1.136(a) in a patent because 35 U.S.C. 41(a)(8) only authorizes the Office to charge fees for extensions of time in proceedings involving an application.

37 CFR 1.251 generally applies only to situations in which the file of an application or patent (not just certain documents) is unlocatable. When a document is missing from an application, Office practice is to call the applicant's representative and request submission (generally by facsimile) of a copy of the missing document. While the Office will generally treat missing documents in this relatively informal manner (rather than issuing a notice under 37 CFR 1.251), the Office may issue a notice under 37 CFR 1.251 to obtain a copy of a missing document if the Office's informal attempts to obtain a copy of the document are unsuccessful. The notice under 37 CFR 1.251 will include a printout of the contents entries from the Office's PALM system.

Any appendix or information disclosure statement submitted with an application is not contained in the Office's PACR database. Therefore, the applicant or patentee must also provide a copy of any appendix or information disclosure statement (except in the limited circumstance discussed below) submitted with the application. Since the Office can obtain copies of U.S. patent documents (U.S. patent application publications and patents) from its internal databases, the Office is not requiring applicants or patentees to provide copies of U.S. patent application publications and patents that are among the applicant's or patentee's record of the correspondence between the Office and the applicant or patentee for the application, patent, or other proceeding.

37 CFR 1.251(b) provides that with regard to a pending application, the **failure** to provide a reply to such a notice within the time period set in the notice will result in **abandonment** of the application. While abandonment (or expiration or lapse) of a patent is not an issue if a patentee fails to timely comply with a notice under 37 CFR 1.251, in such a situation the only certified copy of the patent file that the Office will be able to produce will be a copy of the patent and a copy of the application-as-filed (which may have an adverse impact during attempts to enforce the patent). In addition, if the patent is involved in a proceeding before the Office, the Office may take action under 37 CFR 1.616 or 37 CFR 10.18.

## 509 Payment of Fees [R-2]

The latest fee schedule is available by contacting the USPTO at 1-800-PTO(786)-9199 or (703) 308-HELP(4357), or on the USPTO webpage at <http://www.uspto.gov>.

*37 CFR 1.22. Fees payable in advance.*

\*\*>

(a) Patent fees and charges payable to the United States Patent and Trademark Office are required to be paid in advance; that is, at the time of requesting any action by the Office for which a fee or charge is payable with the exception that under § 1.53 applications for patent may be assigned a filing date without payment of the basic filing fee.

(b) All fees paid to the United States Patent and Trademark Office must be itemized in each individual application, patent, or other proceeding in such a manner that it is clear for which purpose the fees are paid. The Office may return fees that are not itemized as required by this paragraph. The provisions of

§ 1.5(a) do not apply to the resubmission of fees returned pursuant to this paragraph.<

### 37 CFR 1.23. Method of payment.

(a) All payments of money required for United States Patent and Trademark Office fees, including fees for the processing of international applications (§ 1.445), shall be made in U.S. dollars and in the form of a cashier's or certified check, Treasury note, national bank notes, or United States Postal Service money order. If sent in any other form, the Office may delay or cancel the credit until collection is made. Checks and money orders must be made payable to the Director of the United States Patent and Trademark Office. (Checks made payable to the Commissioner of Patents and Trademarks will continue to be accepted.) Payments from foreign countries must be payable and immediately negotiable in the United States for the full amount of the fee required. Money sent to the Office by mail will be at the risk of the sender, and letters containing money should be registered with the United States Postal Service.

(b) Payments of money required for United States Patent and Trademark Office fees may also be made by credit card. Payment of a fee by credit card must specify the amount to be charged to the credit card and such other information as is necessary to process the charge, and is subject to collection of the fee. The Office will not accept a general authorization to charge fees to a credit card. If credit card information is provided on a form or document other than a form provided by the Office for the payment of fees by credit card, the Office will not be liable if the credit card number becomes public knowledge.

### 37 CFR 1.26. Refunds.

\*\*>

(a) The Director may refund any fee paid by mistake or in excess of that required. A change of purpose after the payment of a fee, such as when a party desires to withdraw a patent filing for which the fee was paid, including an application, an appeal, or a request for an oral hearing, will not entitle a party to a refund of such fee. The Office will not refund amounts of twenty-five dollars or less unless a refund is specifically requested, and will not notify the payor of such amounts. If a party paying a fee or requesting a refund does not provide the banking information necessary for making refunds by electronic funds transfer (31 U.S.C. 3332 and 31 CFR part 208), or instruct the Office that refunds are to be credited to a deposit account, the Director may require such information, or use the banking information on the payment instrument to make a refund. Any refund of a fee paid by credit card will be by a credit to the credit card account to which the fee was charged.<

(b) Any request for refund must be filed within two years from the date the fee was paid, except as otherwise provided in this paragraph or in § 1.28(a). If the Office charges a deposit account by an amount other than an amount specifically indicated in an authorization (§ 1.25(b)), any request for refund based upon such charge must be filed within two years from the date of the deposit account statement indicating such charge, and include a copy of that deposit account statement. The time periods set forth in this paragraph are not extendable.

\*\*>

(c) If the Director decides not to institute a reexamination proceeding, for *ex parte* reexaminations filed under § 1.510, a refund of \$1,690 will be made to the reexamination requester. For *inter partes* reexaminations filed under § 1.913, a refund of \$7,970 will be made to the reexamination requester. The reexamination requester should indicate the form in which any refund should be made (*e.g.*, by check, electronic funds transfer, credit to a deposit account, etc.). Generally, reexamination refunds will be issued in the form that the original payment was provided.<

Where the Office has notified an applicant, in writing, that a fee is due and has specified a particular dollar amount for that fee, if the applicant timely submits the specified fee amount in response to the notice, the applicant should be considered to have complied with the notice so as to avoid abandonment of the application. If the fee paid by the applicant is insufficient, either because the notice specified an incorrect dollar amount for the fee or because of a fee increase effective after the mailing of the notice and before payment of the fee by the applicant, the applicant should be notified in writing by the Office of the fee insufficiency and given a new time period in which to submit the remaining balance. The written notification of the fee insufficiency should set forth the reason (*i.e.*, the fee amount indicated by the Office in the earlier notice was incorrect or the fees have increased since the earlier notice was mailed) why applicant is being required to submit an additional fee.

37 CFR 1.22(b) sets forth that fees must be itemized in such a manner that it is clear for which purpose fees are paid. The Office may return fees that are not itemized. The intent of the fee itemization requirement is to encourage a better explanation by applicants of how fees being paid are to be applied by the Office. This will allow Office employees to properly account for the fees being paid by applicants. It should be noted that the language of 37 CFR 1.22 is not intended to create a problem when it is clear what fee is needed. A reference to "filing fee(s)" would be sufficient to cover filing fees of all different types of applications and all types of claims. Further, in a paper submitted on a date later than the actual filing date, the reference to "filing fee(s)" would also be sufficient to cover the surcharge under 37 CFR 1.16, as the surcharge is also required to make the application complete. A reference to "any corresponding fee under 37 CFR 1.16" would be sufficient to cover any fee (*e.g.*, surcharge, excess claims fees) under

37 CFR 1.16. In a petition for an extension of time filed without a specifically itemized fee, but with a general authorization to charge a deposit account, it is clear that a fee for an extension of time is needed and the deposit account should be charged the appropriate extension of time fee.

### PAYMENT BY CREDIT CARD

Effective June 5, 2000, 37 CFR 1.23 was amended to permit payment of any patent process fee, trademark process fee, or information product fee by credit card, subject to actual collection of the fee. The Office currently accepts charges to the following credit cards: AMERICAN EXPRESS®, DISCOVER®, MASTER CARD®, and VISA®.

Credit Card Payment Form (PTO-2038) should be used when paying a patent process or trademark process fee (or the fee for an information product) by credit card. >Form PTO-2038 may be downloaded at <http://www.uspto.gov/web/forms/2038.pdf>.< The Office will not include the Credit Card Payment Form (PTO-2038) among the records open to public inspection in the file of a patent, trademark registration, or other proceeding. The Office does **not** require customers to use this form when paying a patent process or trademark process fee by credit card. If a customer provides a credit card charge authorization in another form or document (e.g., a communication relating to the patent or trademark), the credit card information may become part of the record of an Office file that is

open to public inspection. Thus, failure to use the Credit Card Payment Form (PTO-2038) when submitting a credit card payment may result in your credit card information becoming part of the record of an Office file that is open to public inspection.

Credit card payments by facsimile are permitted, except in situations in which facsimile submission of correspondence is not permitted in 37 CFR 1.6(d).

35 U.S.C. 42(d) and 37 CFR 1.26 (which concern refund of patent and trademark fees) also apply to requests for refund of fees paid by credit card. Any refund of a fee paid by credit card will be by a credit to the credit card account to which the fee was charged. See 37 CFR 1.26(a).

Any payment of a patent process or trademark process fee by credit card must be in writing (see 37 CFR 1.2), preferably on the Credit Card Payment Form (PTO-2038). If a Credit Card Payment Form or other document authorizing the Office to charge a patent process or trademark process fee to a credit card does not contain the information necessary to charge the fee to the credit card, the customer must submit a revised Credit Card Payment Form or document containing the necessary information. Office employees will **not** accept oral (telephonic) instructions to complete the Credit Card Payment Form or otherwise charge a patent process or trademark process fee (as opposed to information product or service fees) to a credit card.

\*>

PTO-2038 (02-2003)

Approved for use through 02/28/2006. OMB 0651-0043

United States Patent and Trademark Office; U.S. DEPARTMENT OF COMMERCE

Under the Paperwork Reduction Act of 1995, no persons are required to respond to a collection of information unless it displays a valid OMB control number.

**United States Patent and Trademark Office**  
**Credit Card Payment Form**  
**Please Read Instructions before Completing this Form**

Credit Card Information			
<b>Credit Card Type:</b> <input type="checkbox"/> Visa <input type="checkbox"/> MasterCard <input type="checkbox"/> American Express <input type="checkbox"/> Discover			
Credit Card Account #:			
Credit Card Expiration Date:			
Name as it Appears on Credit Card:			
Payment Amount: \$ (US Dollars):			
Cardholder Signature:		Date:	
<small><b>Refund Policy:</b> The Office may refund a fee paid by mistake or in excess of that required. A change of purpose after the payment of a fee will not entitle a party to a refund of such fee. The office will not refund amounts of \$25.00 or less unless a refund is specifically requested, and will not notify the payor of such amounts (37 CFR § 1.26). Refund of a fee paid by credit card will be issued as a credit to the credit card account to which the fee was charged.</small>			
<small><b>Service Charge:</b> There is a \$50.00 service charge for processing each payment refused (including a check returned "unpaid") or charged back by a financial institution (37 CFR § 1.21 (m)).</small>			
Street Address 1:			
Street Address 2:			
City:			
State/Province:		Zip/Postal Code:	
Country:			
Daytime Phone #:		Fax #:	
Request and Payment Information			
Description of Request and Payment Information:			
<input type="checkbox"/> Patent Fee	<input type="checkbox"/> Patent Maintenance Fee	<input type="checkbox"/> Trademark Fee	<input type="checkbox"/> Other Fee
Application No.	Application No.	Application No.	IDON Customer No.
Patent No.	Patent No.	Registration No.	
Attorney Docket No.		Identify or Describe Mark	

*If the cardholder includes a credit card number on any form or document other than the Credit Card Payment Form, the United States Patent and Trademark Office will not be liable in the event that the credit card number becomes public knowledge.*

<

## 509.01 Deposit Accounts [R-2]

### 37 CFR 1.25. Deposit accounts.

(a) For the convenience of attorneys, and the general public in paying any fees due, in ordering services offered by the Office, copies of records, etc. deposit accounts may be established in the Patent and Trademark Office upon payment of the fee for establishing a deposit account § 1.21(b)(1)). A minimum deposit of \$1,000 is required for paying any fee due or in ordering any services offered by the Office. However, a minimum deposit of \$300 may be paid to establish a restricted subscription deposit account used exclusively for subscription order of patent copies as issued. At the end of each month, a deposit account statement will be rendered. A remittance must be made promptly upon receipt of the statement to cover the value of items or services charged to the account and thus restore the account to its established normal deposit value. An amount sufficient to cover all fees, services, copies, etc., requested must always be on deposit. Charges to accounts with insufficient funds will not be accepted. A service charge (§ 1.21(b)(2)) will be assessed for each month that the balance at the end of the month is below \$1,000. For restricted subscription deposit accounts, a service charge (§ 1.21(b)(3)) will be assessed for each month that the balance at the end of the month is below \$300.

\*\*>

(b) Any request for refund must be filed within two years from the date the fee was paid, except as otherwise provided in this paragraph or in § 1.28(a). If the Office charges a deposit account by an amount other than an amount specifically indicated in an authorization (§ 1.25(b)), any request for refund based upon such charge must be filed within two years from the date of the deposit account statement indicating such charge, and include a copy of that deposit account statement. The time periods set forth in this paragraph are not extendable.

(c) If the Director decides not to institute a reexamination proceeding, for *ex parte* reexaminations filed under § 1.510, a refund of \$1,690 will be made to the reexamination requester. For *inter partes* reexaminations filed under § 1.913, a refund of \$7,970 will be made to the reexamination requester. The reexamination requester should indicate the form in which any refund should be made (*e.g.*, by check, electronic funds transfer, credit to a deposit account, etc.). Generally, reexamination refunds will be issued in the form that the original payment was provided.<

An overdrawn account will be immediately suspended and no charges will be accepted against it until a proper balance is restored, together with a payment of \$10 (37 CFR 1.21(b)(1)) to cover the work done by the U.S. Patent and Trademark Office incident to suspending and reinstating the account and dealing with charges which may have been made in the meantime.

If there is an authorization to charge the filing fee to a deposit account which is overdrawn or has insufficient funds, a surcharge (37 CFR 1.16(e)) is required in addition to payment of the filing fee. Failure to

timely pay the filing fee and surcharge will result in abandonment of the application.

It is expected, however, that reasonable precautions will be taken in all cases to avoid overdrafts, and if an account is suspended repeatedly it will be closed.

Similarly, because of the burden placed on the U.S. Patent and Trademark Office incident to the operation of deposit accounts, a charge of \$10 (37 CFR 1.21(b)(1)) will be made for opening each new account.

>

### I. < DEPOSIT ACCOUNT AUTHORIZATIONS

The rules of practice were amended effective Oct. 1, 1982, at 37 CFR 1.25(b) to state that:

A general authorization to charge all fees, or only certain fees, set forth in §§ 1.16 to 1.18 to a deposit account containing sufficient funds may be filed in an individual application, either for the entire pendency of the application or with respect to a particular paper filed.

As provided in 37 CFR 1.311(b), an authorization to charge the issue fee (37 CFR 1.18) to a deposit account may be filed in an individual application only after the mailing of the notice of allowance. 37 CFR 1.25(b) also makes clear that a general authorization made prior to the mailing of a notice of allowance does not apply to issue fees under 37 CFR 1.18.

In addition, a general authorization does not apply to document supply fees under 37 CFR 1.19, such as those required for certified copies, to post issuance fees under 37 CFR 1.20, such as those required for maintenance fees, >or< to miscellaneous fees and charges under 37 CFR 1.21, such as assignment recording fees\*\*.

Many applications contain broad language authorizing any additional fees which might have been due to be charged to a deposit account. The U.S. Patent and Trademark Office will interpret such broad authorizations to include authorization to charge to a deposit account fees set forth in 37 CFR 1.16, and 1.17. Fees under 37 CFR 1.19, 1.20, and 1.21 will not be charged as a result of a general authorization under 37 CFR 1.25. Effective November 7, 2000, fees under 37 CFR 1.18 will not be charged as a result of a preauthorization of issue fee payment.

Authorizations to charge fees relating only to a specific paper, the authorization could read “The \*>Director< is hereby authorized to charge any fees under 37 CFR 1.16 and 1.17 which may be required by this paper to Deposit Account No.———.” Such authorizations would cover situations in which a check to cover a filing and/or a processing fee under 37 CFR 1.16 and 1.17 was omitted or was for an amount less than the amount required.

It is extremely important that the authorization be clear and unambiguous. If applicants file authorizations which are ambiguous and deviate from the usual forms of authorizations, the Office may not interpret the authorizations in the manner applicants intend and may return the fees. As a result, applicants could be subject to further expenses, petitions, etc. in order to have a particular fee charged to a deposit account (which was not charged as intended) or to resubmit a fee(s) due to an ambiguous authorization.

When statutory fees are to be charged to a deposit account, the processing of the application can be facilitated by submitting the applicant’s transmittal letter or other correspondence specifying the account to be charged in duplicate. Submission of these documents in duplicate will eliminate the need for the Mail Center to photocopy the document and will thereby reduce the processing time of incoming mail.

37 CFR 1.25(b) further provides that an authorization to charge fees under 37 CFR 1.16 (which relates to national application filing fees) in an application filed under 35 U.S.C. 371 will be treated as an authorization to charge fees under 37 CFR 1.492 (which relates to national stage fees). Papers filed for the purpose of entering the national stage under 35 U.S.C. 371 and 37 CFR \*\* 1.495 that include an authorization to charge fees under 37 CFR 1.16 are treated by the Office as an authorization to charge fees under 37 CFR 1.492 since: (1) timely payment of the appropriate national fee under 37 CFR 1.492 is necessary to avoid abandonment of the application as to the United States; and (2) the basic filing fee under 37 CFR 1.16 is not applicable to such papers or applications.

&gt;

## II. DEPOSIT ACCOUNT REPLENISHMENTS

37 CFR 1.25(c) specifies how a deposit account holder may submit a payment to the Office to replenish the deposit account. A payment to replenish a deposit account may be submitted by:

(A) making the payment by electronic funds transfer through the Federal Reserve Fedwire System. Deposit account holders who use the Federal Reserve Fedwire System must provide the following information to their bank or financial institution: (1) Name of the Bank, which is Treas NYC (Treasury New York City); (2) Bank Routing Code, which is 021030004; (3) United States Patent and Trademark Office account number with the Department of Treasury, which is 13100001; and (4) the deposit account holder’s company name and deposit account number. The deposit account holder should inform his or her bank or financial institution to use due care to ensure that all pertinent account numbers are listed on the transaction because the failure to include the proper deposit account number will delay the processing of the replenishment;

(B) credit card or electronic funds transfer over the Office’s Internet web site ([www.uspto.gov](http://www.uspto.gov));

(C) mailing the payment with the United States Postal Service (USPS) to: Director of the United States Patent and Trademark Office, P.O. Box 70541, Chicago, Illinois 60673; or

(D) mailing the payment with a private delivery service or hand-carrying the payment to: Director of the United States Patent and Trademark Office, Deposit Accounts, One Crystal Park, 2011 Crystal Drive, Suite 307, Arlington, Virginia 22202.

Further information on deposit account replenishment may be obtained from the Office’s Internet web site or by contacting the Deposit Account Division at (703) 305-4631.<

## 509.02 Small Entity Status — Definitions [R-2]

\*\*>Under 35 U.S.C. 41(h)(1), fees charged under 35 U.S.C. 41(a) or (b) shall be reduced by 50 percent with respect to their application to any small business concern as defined under section 3 of the

Small Business Act, and to any independent inventor or nonprofit organization as defined in regulations issued by the Director.<

The fees which are reduced include patent application filing fees (37 CFR 1.16), extension of time, revival, and appeal fees (37 CFR 1.17), patent issue fees (37 CFR 1.18), statutory disclaimer fee (37 CFR 1.20(d)), and maintenance fees on patents (37 CFR 1.20). Other fees, established under section 41 (c) or (d) of Title 35, United States Code, are not reduced for small entities since such a reduction is not permitted or authorized by \*\*>35 U.S.C. 41(h)(1)<

Fees which are not reduced include petition and processing fees (other than revival), 37 CFR 1.17(h)-(k), document supply fees, 37 CFR 1.19, certificate of correction fees, 37 CFR 1.20(a), request for reexamination fees, 37 CFR 1.20(c), miscellaneous fees and charges, 37 CFR 1.21, and international application fees, 37 CFR 1.445.

\*\*>35 U.S.C. 41(h)(1) gives the Director the< authority to establish regulations defining independent inventors and nonprofit organizations. The Small Business Administration was given authority to establish the definition of a small business concern. A small entity for purposes of paying reduced fees is defined in 37 CFR 1.27(a) as a person, a small business concern, or a nonprofit organization. The term “person” rather than “independent inventor” is used since individuals who are not inventors but who have received some rights in the invention are intended to be covered by 37 CFR 1.27.

*37 CFR 1.27. Definition of small entities and establishing status as a small entity to permit payment of small entity fees; when a determination of entitlement to small entity status and notification of loss of entitlement to small entity status are required; fraud on the Office.*

(a) *Definition of small entities.* A small entity as used in this chapter means any party (person, small business concern, or nonprofit organization) under paragraphs (a)(1) through (a)(3) of this section.

(1) *Person.* A person, as used in paragraph (c) of this section, means any inventor or other individual (*e.g.*, an individual to whom an inventor has transferred some rights in the invention), who has not assigned, granted, conveyed, or licensed, and is under no obligation under contract or law to assign, grant, convey, or license, any rights in the invention. An inventor or other individual who has transferred some rights, or is under an obligation to transfer some rights in the invention to one or more parties, can

also qualify for small entity status if all the parties who have had rights in the invention transferred to them also qualify for small entity status either as a person, small business concern, or nonprofit organization under this section.

(2) *Small business concern.* A small business concern, as used in paragraph (c) of this section, means any business concern that:

(i) Has not assigned, granted, conveyed, or licensed, and is under no obligation under contract or law to assign, grant, convey, or license, any rights in the invention to any person, concern, or organization which would not qualify for small entity status as a person, small business concern, or nonprofit organization.

(ii) Meets the standards set forth in 13 CFR part 121 to be eligible for reduced patent fees. Questions related to standards for a small business concern may be directed to: Small Business Administration, Size Standards Staff, 409 Third Street, S.W., Washington, D.C. 20416.

(3) *Nonprofit Organization.* A nonprofit organization, as used in paragraph (c) of this section, means any nonprofit organization that:

(i) Has not assigned, granted, conveyed, or licensed, and is under no obligation under contract or law to assign, grant, convey, or license, any rights in the invention to any person, concern, or organization which would not qualify as a person, small business concern, or a nonprofit organization, and

(ii) Is either:

(A) A university or other institution of higher education located in any country;

(B) An organization of the type described in section 501(c)(3) of the Internal Revenue Code of 1986 (26 U.S.C. 501(c)(3)) and exempt from taxation under section 501(a) of the Internal Revenue Code (26 U.S.C. 501(a));

(C) Any nonprofit scientific or educational organization qualified under a nonprofit organization statute of a state of this country (35 U.S.C. 201(i)); or

(D) Any nonprofit organization located in a foreign country which would qualify as a nonprofit organization under paragraphs (a)(3)(ii)(B) of this section or (a)(3)(ii)(C) of this section if it were located in this country.

(4) *License to a Federal agency.* (i) For persons under paragraph (a)(1) of this section, a license to the Government resulting from a rights determination under Executive Order 10096 does not constitute a license so as to prohibit claiming small entity status.

(i) For persons under paragraph (a)(1) of this section, a license to the Government resulting from a rights determination under Executive Order 10096 does not constitute a license so as to prohibit claiming small entity status.

(ii) For small business concerns and nonprofit organizations under paragraphs (a)(2) and (a)(3) of this section, a license to a Federal agency resulting from a funding agreement with that agency pursuant to 35 U.S.C. 202(c)(4) does not constitute a license for the purposes of paragraphs (a)(2)(i) and (a)(3)(i) of this section.

&gt;

**I. < PERSON**

37 CFR 1.27(a)(1) defines a person as any inventor or other individual (e.g., an individual to whom an inventor has transferred some rights in the invention), who has not assigned, granted, conveyed, or licensed, and is under no obligation under contract or law to assign, grant, convey, or license, any rights in the invention. An inventor or other individual who has transferred some rights, or is under an obligation to transfer some rights in the invention to one or more parties, can also qualify for small entity status if all the parties who have had rights in the invention transferred to them also qualify for small entity status either as a person, small business concern, or non-profit organization.

&gt;

**II. < SMALL BUSINESS CONCERN**

In order to be eligible for reduced patent fees as a “small business concern” under 37 CFR 1.27(a)(2), a business concern must meet the standards set forth in 13 CFR Part 121. Questions relating to standards for a small business concern may be directed to:

Small Business Administration  
 \*\*>Office of Size Standards<  
 409 Third Street, S.W.  
 Washington, DC 20416  
 (202)205-6618  
 >E-mail: sizestandards@sba.gov

**III. < NONPROFIT ORGANIZATIONS**

37 CFR 1.27(a)(3) defines a nonprofit organization by utilizing and interpreting the definition contained in 35 U.S.C. 201(i). The term “university or other institution of higher education” as used in 37 CFR 1.27(a)(3)(ii)(A) means an educational institution which

(A) admits as regular students only persons having a certificate of graduation from a school providing secondary education, or the recognized equivalent of such a certificate,

(B) is legally authorized within the jurisdiction in which it operates to provide a program of education beyond secondary education,

(C) provides an educational program for which it awards a bachelor’s degree or provides not less than a 2-year program which is acceptable for full credit toward such a degree,

(D) is a public or other nonprofit institution, and

(E) is accredited by a nationally recognized accrediting agency or association>, or if not so accredited, is an institution that has been granted pre-accreditation status by such agency or association that has been recognized by the Secretary for the granting of preaccreditation status, and the Secretary has determined that there is satisfactory assurance that the institution will meet the accreditation standards of such an agency or association within a reasonable time<.

The definition of “university or other institution of higher education” as set forth herein essentially follows the definition of “institution of higher education” contained in 20 U.S.C. \*>1000<. Institutions which are strictly research facilities, manufacturing facilities, service organizations, etc., are not intended to be included within the term “other institution of higher education” even though such institutions may perform an educational function or publish the results of their work.

Nonprofit organizations also include organizations of the type described in section 501(c)(3) of the Internal Revenue Code of 1986 (26 U.S.C. 501(c)(3)) and which are exempt from taxation under 26 U.S.C. 501(a). Organizations described in 26 U.S.C. 501(c)(3) include corporations, and any community chest, fund, or foundation, organized and operated exclusively for religious, charitable, scientific, testing for public safety, literary, or educational purposes, or to foster national or international amateur sports competition (but only if no part of its activities involve the provision of athletic facilities or equipment), or for the prevention of cruelty to children or animals, no part of the net earnings of which inures to the benefit of any private shareholder or individual, no substantial part of the activities of which is carrying on propaganda, or otherwise attempting to influence legislation >(limited exceptions may apply under 26 U.S.C. 501(h)< and which does not participate in, or intervene in (including the publishing or distributing of statements), any political campaign on behalf of >(or in opposition to)< any candidate for public office.



&gt;

**IV. < LOCATION OF SMALL ENTITY**

Small entities may claim reduced fees regardless of the country in which they are located. There is no restriction requiring that the person, small business concern, or nonprofit organization be located in the United States. The same definitions apply to all applicants equally in accordance with the Paris Convention for the Protection of Industrial Property.

&gt;

**V. < RIGHTS IN THE INVENTION AND TRANSFER OF RIGHTS**

The “rights in the invention” under 37 CFR 1.27(a)(1), (a)(2)(i), and (a)(3)(i) are the rights in the United States. Rights in the invention include the right to exclude others from making, using, offering for sale, or selling the invention throughout the United States or importing the invention into the United States. Therefore, for example, status as a small entity is lost by an inventor who has transferred or has an obligation to transfer a shop right to an employer who could not qualify as a small entity.

Individual inventors (37 CFR 1.27(a)(1)), small business concerns (37 CFR 1.27(a)(2)), and nonprofit organizations (37 CFR 1.27(a)(3)) can make an assignment, grant, conveyance, or license of partial rights in the invention to another individual(s), small business concern, or nonprofit organization who could qualify as a person (37 CFR 1.27(a)(1)), small business concern, or nonprofit organization. Under the circumstances described, the individual inventor, small business concern, or nonprofit organization could still qualify for small entity status. However, if the individual inventor, small business concern, or nonprofit organization assigned, granted, conveyed, or licensed, or came under an obligation to assign, grant, convey, or license, any rights to the invention to any individual, small business concern, or nonprofit organization which would not qualify as a small entity (37 CFR 1.27(a)), then the inventor, small business concern, or nonprofit organization would no longer qualify for small entity status.

With regard to transfer of rights in the invention, the rights in question are those in the United States to be covered by an application or patent. Transfer of rights to a Japanese patent, for example, would not

affect small entity status if no rights in the United States to a corresponding patent were likewise transferred.

The payment of reduced fees under 35 U.S.C. 41 is limited to those situations in which all of the rights in the invention are owned by small entities, i.e., persons, small business concerns, or nonprofit organizations. To do otherwise would be clearly contrary to the intended purpose of the legislation which contains no indication that fees are to be reduced in circumstances where rights are owned by non-small entities. For example, a non-small entity is not permitted to transfer patent rights to a small business concern which would pay the reduced fees and grant a license to the entity.

If rights transferred to a non-small entity are later returned to a small entity so that all rights are held by small entities, reduced fees may be claimed.

The term “license” in the definitions includes non-exclusive as well as exclusive licenses and royalty free as well as royalty generating licenses. Implied licenses to use and resell patented articles purchased from a small entity, however, will not preclude the proper claiming of small entity status. Likewise, an order by an applicant to a firm to build a prototype machine or product for the applicant’s own use is not considered to constitute a license for purposes of the definitions. >A grant of a non-exclusive license to a large entity will disqualify applicant from claiming small entity status. See *Ulead Systems, Inc. v. Lex Computer & Management Corp.*, 351 F.3d 1139, 1142, 69 USPQ2d 1097, 1099 (Fed. Cir. 2003).

**VI. < RIGHTS HELD BY GOVERNMENT ORGANIZATIONS**

Also, although the Federal government agencies do not qualify as nonprofit organizations for paying reduced fees under the rules, a license to a Federal agency resulting from a funding agreement with the agency pursuant to 35 U.S.C. 202(c)(4) will not preclude the proper claiming of small entity status. Furthermore, a license to the Government resulting from a rights determination under Executive Order 10096 does not constitute a license so as to prohibit claiming small entity status by a person under 37 CFR 1.27(a)(1).

Public Law 96-517 added a new chapter 18 of Title 35 of the United States Code entitled “Patent Rights in

Inventions Made With Federal Assistance.” Under the provisions of the statute, each funding agreement between a Federal agency and an individual, small business firm, or nonprofit organization must provide, *inter alia*, that “. . . the Federal agency shall have a nonexclusive, nontransferable, irrevocable, paid-up license to practice or have practiced for or on behalf of the United States any subject invention . . .” See 35 U.S.C. 202(c)(4). The Federal agencies do not qualify as nonprofit organizations for paying reduced patent fees under the rules. Applying this construction to the licensing of an invention to a Federal agency by a person, small business concern, or nonprofit organization pursuant to a funding agreement under 35 U.S.C. 202(c)(4) would preclude their qualifying for paying reduced fees. This, however, would frustrate the intent of Public Law 97-247 and Public Law 96-517 when taken together.

Government organizations as such, whether domestic or foreign, cannot qualify as nonprofit organizations as defined in 37 CFR 1.27(a)(3). Thus, for example, a government research facility or other government-owned corporation could not qualify. 37 CFR 1.27(a)(3) was based upon 35 U.S.C. 201(i), as established by Public Law 96-517. The limitation to “an organization of the type described in section 501(c)(3) of the Internal Revenue Code of 1986 (26 U.S.C. 501(c)(3)) and exempt from taxation under section 501(a) of the Internal Revenue Code (26 U.S.C. 501(a))” would by its nature exclude the U.S. government and its agencies and facilities, including research facilities and government corporations. State and foreign governments and governmental agencies and facilities would be similarly excluded. 37 CFR 1.27(a)(3) is not intended to include within the definition of a nonprofit organization government organizations of any kind located in any country. A university or other institution of higher education located in any country would qualify, however, as a “nonprofit organization” under 37 CFR 1.27(a)(3) even though it has some government affiliation since such institutions are specifically included.

A wholly owned subsidiary of a nonprofit organization or of a university is considered a part of the nonprofit organization or university and is not precluded from qualifying for small entity status.

## 509.03 Claiming Small Entity Status [R-2]

*37 CFR 1.27. Definition of small entities and establishing status as a small entity to permit payment of small entity fees; when a determination of entitlement to small entity status and notification of loss of entitlement to small entity status are required; fraud on the Office.*

\*\*\*\*\*

(b) *Establishment of small entity status permits payment of reduced fees.* A small entity, as defined in paragraph (a) of this section, who has properly asserted entitlement to small entity status pursuant to paragraph (c) of this section will be accorded small entity status by the Office in the particular application or patent in which entitlement to small entity status was asserted. Establishment of small entity status allows the payment of certain reduced patent fees pursuant to 35 U.S.C. 41(h).

(c) *Assertion of small entity status.* Any party (person, small business concern or nonprofit organization) should make a determination, pursuant to paragraph (f) of this section, of entitlement to be accorded small entity status based on the definitions set forth in paragraph (a) of this section, and must, in order to establish small entity status for the purpose of paying small entity fees, actually make an assertion of entitlement to small entity status, in the manner set forth in paragraphs (c)(1) or (c)(3) of this section, in the application or patent in which such small entity fees are to be paid.

(1) *Assertion by writing.* Small entity status may be established by a written assertion of entitlement to small entity status. A written assertion must:

- (i) Be clearly identifiable;
- (ii) Be signed (see paragraph (c)(2) of this section);

and

(iii) Convey the concept of entitlement to small entity status, such as by stating that applicant is a small entity, or that small entity status is entitled to be asserted for the application or patent. While no specific words or wording are required to assert small entity status, the intent to assert small entity status must be clearly indicated in order to comply with the assertion requirement.

(2) *Parties who can sign and file the written assertion.* The written assertion can be signed by:

(i) One of the parties identified in § 1.33(b) (*e.g.*, an attorney or agent registered with the Office), § 3.73(b) of this chapter notwithstanding, who can also file the written assertion;

(ii) At least one of the individuals identified as an inventor (even though a § 1.63 executed oath or declaration has not been submitted), notwithstanding § 1.33(b)(4), who can also file the written assertion pursuant to the exception under § 1.33(b) of this part; or

(iii) An assignee of an undivided part interest, notwithstanding §§ 1.33(b)(3) and 3.73(b) of this chapter, but the partial assignee cannot file the assertion without resort to a party identified under § 1.33(b) of this part.

(3) *Assertion by payment of the small entity basic filing or basic national fee.* The payment, by any party, of the exact amount of one of the small entity basic filing fees set forth in §§ 1.16(a), (f), (g), (h), or (k), or one of the small entity basic national fees set forth in §§ 1.492(a)(1), (a)(2), (a)(3), (a)(4), or (a)(5), will be treated as a written assertion of entitlement to small entity status even if the type of basic filing or basic national fee is inadvertently selected in error.

(i) If the Office accords small entity status based on payment of a small entity basic filing or basic national fee under paragraph (c)(3) of this section that is not applicable to that application, any balance of the small entity fee that is applicable to that application will be due along with the appropriate surcharge set forth in § 1.16(e), or § 1.16(l).

(ii) The payment of any small entity fee other than those set forth in paragraph (c)(3) of this section (whether in the exact fee amount or not) will not be treated as a written assertion of entitlement to small entity status and will not be sufficient to establish small entity status in an application or a patent.

(4) *Assertion required in related, continuing, and reissue applications.* Status as a small entity must be specifically established by an assertion in each related, continuing and reissue application in which status is appropriate and desired. Status as a small entity in one application or patent does not affect the status of any other application or patent, regardless of the relationship of the applications or patents. The refiling of an application under § 1.53 as a continuation, divisional, or continuation-in-part application (including a continued prosecution application under § 1.53(d)), or the filing of a reissue application, requires a new assertion as to continued entitlement to small entity status for the continuing or reissue application.

(d) *When small entity fees can be paid.* Any fee, other than the small entity basic filing fees and the small entity national fees of paragraph (c)(3) of this section, can be paid in the small entity amount only if it is submitted with, or subsequent to, the submission of a written assertion of entitlement to small entity status, except when refunds are permitted by § 1.28(a).

(e) *Only one assertion required.*

(1) An assertion of small entity status need only be filed once in an application or patent. Small entity status, once established, remains in effect until changed pursuant to paragraph (g)(1) of this section. Where an assignment of rights or an obligation to assign rights to other parties who are small entities occurs subsequent to an assertion of small entity status, a second assertion is not required.

(2) Once small entity status is withdrawn pursuant to paragraph (g)(2) of this section, a new written assertion is required to again obtain small entity status.

(f) *Assertion requires a determination of entitlement to pay small entity fees.* Prior to submitting an assertion of entitlement to small entity status in an application, including a related, continuing, or reissue application, a determination of such entitlement should be made pursuant to the requirements of paragraph (a) of this section. It should be determined that all parties holding rights in the invention qualify for small entity status. The Office will generally not question any assertion of small entity status that is

made in accordance with the requirements of this section, but note paragraph (h) of this section.

(g)(1) *New determination of entitlement to small entity status is needed when issue and maintenance fees are due.* Once status as a small entity has been established in an application or patent, fees as a small entity may thereafter be paid in that application or patent without regard to a change in status until the issue fee is due or any maintenance fee is due.

(2) *Notification of loss of entitlement to small entity status is required when issue and maintenance fees are due.* Notification of a loss of entitlement to small entity status must be filed in the application or patent prior to paying, or at the time of paying, the earliest of the issue fee or any maintenance fee due after the date on which status as a small entity as defined in paragraph (a) of this section is no longer appropriate. The notification that small entity status is no longer appropriate must be signed by a party identified in § 1.33(b). Payment of a fee in other than the small entity amount is not sufficient notification that small entity status is no longer appropriate.

(h) *Fraud attempted or practiced on the Office.*

(1) Any attempt to fraudulently establish status as a small entity, or pay fees as a small entity, shall be considered as a fraud practiced or attempted on the Office.

(2) Improperly, and with intent to deceive, establishing status as a small entity, or paying fees as a small entity, shall be considered as a fraud practiced or attempted on the Office.

#### 37 CFR 1.4. Nature of correspondence and signature requirements.

\*\*\*\*\*

(d)(2) The presentation to the Office (whether by signing, filing, submitting, or later advocating) of any paper by a party, whether a practitioner or non-practitioner, constitutes a certification under § 10.18(b) of this chapter. Violations of § 10.18(b)(2) of this chapter by a party, whether a practitioner or non-practitioner, may result in the imposition of sanctions under § 10.18(c) of this chapter. Any practitioner violating § 10.18(b) may also be subject to disciplinary action. See §§ 10.18(d) and 10.23(c)(15).

\*\*\*\*\*

#### 37 CFR 10.18. Signature and certificate for correspondence filed in the Patent and Trademark Office.

\*\*\*\*\*

(b) By presenting to the Office (whether by signing, filing, submitting, or later advocating) any paper, the party presenting such paper, whether a practitioner or non-practitioner, is certifying that—

(1) All statements made therein of the party's own knowledge are true, all statements made therein on information and belief are believed to be true, and all statements made therein are made with the knowledge that whoever, in any matter within the jurisdiction of the Patent and Trademark Office, knowingly and willfully falsifies, conceals, or covers up by any trick, scheme, or device a material fact, or makes any false, fictitious or fraudulent statements or representations, or makes or uses any false writing

or document knowing the same to contain any false, fictitious or fraudulent statement or entry, shall be subject to the penalties set forth under 18 U.S.C. 1001, and that violations of this paragraph may jeopardize the validity of the application or document, or the validity or enforceability of any patent, trademark registration, or certificate resulting therefrom; and

(2) To the best of the party's knowledge, information and belief, formed after an inquiry reasonable under the circumstances, that —

(i) The paper is not being presented for any improper purpose, such as to harass someone or to cause unnecessary delay or needless increase in the cost of prosecution before the Office;

(ii) The claims and other legal contentions therein are warranted by existing law or by a nonfrivolous argument for the extension, modification, or reversal of existing law or the establishment of new law;

(iii) The allegations and other factual contentions have evidentiary support or, if specifically so identified, are likely to have evidentiary support after a reasonable opportunity for further investigation or discovery; and

(iv) The denials of factual contentions are warranted on the evidence, or if specifically so identified, are reasonably based on a lack of information or belief.

\*\*\*\*\*

In order to establish small entity status for the purpose of paying small entity fees, any party (person, small business concern or nonprofit organization) must make an assertion of entitlement to small entity status in the manner set forth in 37 CFR 1.27(c)(1) or (c)(3), in the application or patent in which such small entity fees are to be paid. Under 37 CFR 1.27, as long as all of the rights remain in small entities, the fees established for a small entity can be paid. This includes circumstances where the rights were divided between a person, a small business concern, and a nonprofit organization, or any combination thereof.

Under 37 CFR 1.4(d)(2), an assertion of entitlement to small entity status, including the mere payment of an exact small entity basic filing fee, inherently contains a certification under 37 CFR 10.18(b). It is not required that an assertion of entitlement to small entity status be filed with each fee paid. Rather, once status as a small entity has been established in an application or patent, fees as a small entity may thereafter be paid in that application or patent without regard to a change in status until the issue fee is due or any maintenance fee is due. 37 CFR 1.27(g)(1). Notification of a loss of entitlement to small entity status must be filed in the application or patent prior to paying, or at the time of paying, the earliest of the issue fee or any maintenance fee due after the date on

which status as a small entity is no longer appropriate. 37 CFR 1.27(g)(2).

Status as a small entity may be established in a provisional application by complying with 37 CFR 1.27.

Status as a small entity must be specifically established in each application or patent in which the status is available and desired. Status as a small entity in one application or patent does not affect any other application or patent, including applications or patents which are directly or indirectly dependent upon the application or patent in which the status has been established. The filing of an application under 37 CFR 1.53 as a continuation-in-part, continuation or division (including a continued prosecution application under 37 CFR 1.53(d)), or the filing of a reissue application requires a new assertion as to continued entitlement to small entity status for the continuing or reissue application. Submission of a request for continued examination (RCE) under 37 CFR 1.114 does not require a new determination or assertion of entitlement to small entity status since it is not a new application.

>Examiners may use the following form paragraph to notify applicant that he or she may qualify for small entity status.

#### ¶ 5.05 *Small Entity Status*

This application may qualify for "Small Entity Status" and, therefore, applicant may be entitled to the payment of reduced fees. In order to establish small entity status for the purpose of paying small entity fees, applicant must make a determination of entitlement to small entity status under 37 CFR 1.27(f) and make an assertion of entitlement to small entity status in the manner set forth in 37 CFR 1.27(c)(1) or 37 CFR 1.27(c)(3). Accordingly, if applicant meets the requirements of 37 CFR 1.27(a), applicant must submit a written assertion of entitlement to small entity status under 37 CFR 1.27(c) before fees can be paid in the small entity amount. See 37 CFR 1.27(d). The assertion must be signed, clearly identifiable, and convey the concept of entitlement to small entity status. See 37 CFR 1.27(c)(1). No particular form is required.

<

### I. ASSERTION BY WRITING

Small entity status may be established by the submission of a simple written assertion of entitlement to small entity status. The assertion must be signed, clearly identifiable, and convey the concept of entitlement to small entity status. 37 CFR 1.27(c)(1). The written assertion is not required to be presented in any particular form. Written assertions of small entity

status or references to small entity fees will be liberally interpreted to represent the required assertion. The written assertion can be made in any paper filed in or with the application and need be no more than a simple sentence or a box checked on an application transmittal letter.

Practitioners may continue to use former USPTO forms or similar forms if they believe such small entity forms serve an educational purpose for their clients.

## **II. PARTIES WHO CAN ASSERT AND SIGN AN ENTITLEMENT TO SMALL ENTITY STATUS BY WRITING**

The parties who can assert entitlement to small entity status by writing include all parties permitted by 37 CFR 1.33(b) to file a paper in an application, including a registered practitioner. 37 CFR 1.27(c)(2)(i). Additionally, one of the individuals identified as an inventor, or a partial assignee, can also sign the written assertion. 37 CFR 1.27(c)(2)(ii) and (iii). By way of example, in the case of three *pro se* inventors for a particular application, one of the three inventors upon filing the application can submit a written assertion of entitlement to small entity status and thereby establish small entity status for the application, (but see paragraph VI. below). Where rights are divided between a person, small business concern, and nonprofit organization, or any combination thereof, only one party is required to assert small entity status. For example, where one of two inventors has assigned his or her rights in the invention, it is sufficient if either of the two inventors or the assignee asserts entitlement to small entity status.

Any inventor is permitted to submit a written assertion of small entity status, including individuals identified as inventors but who are not officially named of record as an executed oath or declaration under 37 CFR 1.63 has not yet been submitted. See 37 CFR 1.41(a)(1). Where an application is filed without an executed oath or declaration pursuant to 37 CFR 1.53(f), the Office will accept the written assertion of an individual who has merely been identified as an inventor on filing of the application (e.g., application transmittal letter) as opposed to having to be named as an inventor by the filing of an executed oath or declaration under 37 CFR 1.63 (37 CFR 1.41(a)(1)). 37 CFR 1.4(d)(2) and 37 CFR 10.18(b)

are seen as sufficient basis to permit any individual to provide a written assertion so long as the individual identifies himself or herself as an inventor. An actual inventor who has not been identified as an inventor (e.g., by way of application transmittal letter) or named as an inventor (i.e., executed 37 CFR 1.63 oath or declaration) in the file record may not file a written assertion as to small entity entitlement.

Where an oath or declaration under 37 CFR 1.63 is later filed, any original written assertion as to small entity status (which has been previously appropriately submitted to the Office) will remain unless changed by an appropriate party under 37 CFR 1.27(g)(2). Where a later-filed oath or declaration under 37 CFR 1.63 sets forth an inventive entity that does not include the person who initially was identified as an inventor and who asserted small entity status, small entity status will also remain.

An assignee asserting small entity status is not required to submit a 37 CFR 3.73(b) certification whether the assignee is a partial assignee or an assignee of the entire right, title, and interest, (but see paragraph III. below).

## **III. PARTIES WHO CAN FILE THE WRITTEN ASSERTION ONCE SIGNED**

A distinction exists as to who can file a written assertion of entitlement to small entity status once the written assertion is signed. 37 CFR 1.27(c)(2)(ii) and 37 CFR 1.33(b) permit one of several inventors to file as well as to sign a written assertion. The same is not true for a partial assignee. 37 CFR 1.27(c)(2)(iii). While a partial assignee may sign a written assertion, the written assertion must be filed by an appropriate party under 37 CFR 1.33(b).

## **IV. ASSERTION BY PAYMENT OF SMALL ENTITY BASIC FILING OR BASIC NATIONAL FEE**

The payment of an exact small entity basic filing (37 CFR 1.16(a), (f), (g), (h), or (k)) or basic national fee (37 CFR 1.492(a)(1), (a)(2), (a)(3), (a)(4), or (a)(5)) is also considered to be a sufficient assertion of entitlement to small entity status. 37 CFR 1.27(c)(3). An applicant filing a patent application and paying an exact small entity basic filing or basic national fee automatically establishes small entity status for the application even without any other assertion of small

entity status. This is so even if an applicant inadvertently selects the wrong type of small entity basic filing or basic national fee for the application being filed (e.g., the exact small entity basic filing fee for a design application is selected but the application is a utility application). If small entity status was not established when the basic filing or basic national fee was paid, such as by payment of a large entity basic filing or basic national fee, a later claim to small entity status requires a written assertion under 37 CFR 1.27(c)(1). Payment of a small entity fee other than a small entity basic filing or basic national fee (e.g., extension of time fee, or issue fee) without inclusion of a written assertion is not sufficient.

Even though applicants can assert small entity status only by payment of an exact small entity basic filing or basic national fee, the Office encourages applicants to also file a written assertion of small entity status as well as to pay the exact amount of the small entity basic filing or basic national fee. The Office's application transmittal forms include a check box that can be used to submit a written assertion of small entity status. A written assertion will provide small entity status should applicant fail to pay the exact small entity basic filing or basic national fee. The provision providing for small entity status by payment of an exact small entity basic filing or basic national fee is intended to act as a safety net to avoid possible financial loss to inventors or small businesses that qualify for small entity status.

Even though small entity status is accorded where the wrong type of small entity basic filing fee or basic national fee is selected but the exact amount of the fee is paid, applicant still needs to pay the correct small entity amount for the basic filing or basic national fee where selection of the wrong type of fee results in a deficiency. While an accompanying general authorization to charge any additional fees suffices to pay the balance due of the proper small entity basic filing or basic national fee, specific authorizations to charge fees under 37 CFR 1.17 or extension of time fees do not suffice to pay any balance due of the proper small entity basic filing or basic national fee because they do not actually authorize payment of small entity amounts. If payment is attempted of the proper type of basic filing or basic national fee (applicant correctly identifies the type of fee for the type of application being filed), but the amount of the fee paid is not the

exact small entity fee required (an incorrect fee amount is supplied) and a written assertion of small entity status is not present, small entity status will not be accorded. The Office will mail a notice of insufficient basic filing or basic national fee with a surcharge due if an authorization to charge the basic filing or basic national fee is not present. The Office does not consider a basic filing or basic national fee submitted in an amount above the correct fee amount, but below the non-small entity fee amount, as a request to establish small entity status unless an additional written assertion is also present. The submission of a basic filing or basic national fee below the correct fee amount also does not serve to establish small entity status.

Where an application is originally filed by a party, who is in fact a small entity, with an authorization to charge fees (including basic filing or national fees) and there is no indication (assertion) of entitlement to small entity status present, that authorization is not sufficient to establish small entity status unless the authorization is specifically directed to small entity basic filing or basic national fees. The general authorization to charge fees will continue to be acted upon immediately and the full (not small entity) basic filing or basic national fees will be charged. Applicant will have three months under 37 CFR 1.28 to request a refund by asserting entitlement to small entity status. This is so even if the application is a continuing application where small entity status had been established in the prior application.

#### **V. PARTIES WHO CAN ASSERT AND FILE SMALL ENTITY STATUS BY PAYMENT**

Where small entity status is sought by way of payment of the basic filing or basic national fee, any party (including a third party), may submit payment, such as by check, and small entity status will be accorded.

#### **VI. CONTINUED OBLIGATIONS FOR THOROUGH INVESTIGATION OF SMALL ENTITY STATUS**

While small entity status is not difficult to obtain, it should be clearly understood that applicants need to do a complete and thorough investigation of all facts and circumstances before making a determination of actual entitlement to small entity status. 37 CFR 1.27(f). Where entitlement to small entity status is uncertain, it should not be claimed.

The assertion of small entity status (even by mere payment of the exact small entity basic filing fee) is not appropriate until such an investigation has been completed. For example, where there are three *pro se* inventors, before one of the inventors pays the small entity basic filing or basic national fee to establish small entity status, the single inventor asserting entitlement to small entity status should check with the other two inventors to determine whether small entity status is appropriate.

If small entity status is desired on the basis that the entity is a small business concern, the investigation should include a review of whether the business is a small business concern as defined by section 3 of the Small Business Act (Public Law 85-536 as amended by Public Law 106-50). Review of whether the business concern meets the standards set forth in 13 CFR part 121 to be eligible for reduced patent fees is also appropriate. Additionally, if the business has assigned, granted, conveyed or licensed (or is under an obligation to do so) any rights in the invention to others directly or indirectly, the same review for each other entity would also be appropriate.

Furthermore, once status as a small entity has been established in an application, a new determination of entitlement to small entity status is needed (1) when the issue fee is due and (2) when any maintenance fee is due. It should be appreciated that the costs incurred in appropriately conducting the initial and subsequent investigations may outweigh the benefit of claiming small entity status. For some applicants it may be desirable to file as a large entity (by not filing a written assertion of small entity status and by submitting large entity fees) rather than undertaking the appropriate investigations which may be both difficult and time-consuming and which may be cost effective only where several applications are involved.

The intent of 37 CFR 1.27 is that the person making the assertion of entitlement to small entity status is the person in a position to know the facts about whether or not status as a small entity can be properly established. That person, thus, has a duty to investigate the circumstances surrounding entitlement to small entity status to the fullest extent. It is important to note that small entity status must not be claimed unless the person or persons can unequivocally make the required self-certification.

The U.S. Patent and Trademark Office does not give advisory opinions as to whether or not a specific individual or organization qualifies as a small entity. In establishing reduced fees for persons, small business concerns, and nonprofit organizations, the Congressional consideration of the legislation which became Public Law 97-247 indicated an intent that the U.S. Patent and Trademark Office rely exclusively on a self-certification that a patent applicant qualifies as an independent inventor (now person), small business concern, or nonprofit organization. In addition, it was also stated during Congressional consideration of the legislation that no additional resources would be required to administer the system whereby fees would be reduced for small entities.

In view of the intent expressed during Congressional consideration of the legislation, it would be inappropriate for the U.S. Patent and Trademark Office to give advisory opinions as to entitlement to small entity status. Accordingly, any individual seeking to establish status as a small entity for purposes of paying the fee in an application or patent must file the assertion required by 37 CFR 1.27 and in so doing is self-certifying entitlement to small entity status.

Consistent with 37 CFR 1.4(d)(2), the payment of a small entity basic filing or national fee constitutes a certification under 37 CFR 10.18(b). Thus, a simple payment of the small entity basic filing or basic national fee, without a specific written assertion, activates the provisions of 37 CFR 1.4(d)(2) and, by that, invokes the self-certification requirement set forth in 37 CFR 10.18(b), regardless of whether the party is a practitioner or non-practitioner.

## VII>.< REMOVAL OF STATUS

Once small entity status is established in an application or patent, fees as a small entity may thereafter be paid in that application or patent without regard to a change in status until the issue fee is due or any maintenance fee is due. 37 CFR 1.27(g)(1). 37 CFR 1.27(g)(2) requires that notification of any change in status resulting in loss of entitlement to small entity status be filed in the application or patent prior to paying, or at the time of paying, the earliest of the issue fee or any maintenance fee due after the date on which status as a small entity is no longer appropriate. 37 CFR 1.27(g)(2) also requires that the notification of loss of entitlement to small entity status be in the

form of a specific written assertion to that extent, rather than only payment of a large entity fee. For example, when paying the issue fee in an application that has previously been accorded small entity status and the required new determination of continued entitlement to small entity status reveals that status has been lost, applicant should not just simply pay the large issue fee or cross out the recitation of small entity status on **\*\*>**Part B of the Notice of Allowance and Fee(s) Due (PTOL-85)**<**, but should submit a separate paper requesting removal of small entity status pursuant to 37 CFR 1.27(g)(2).

For correcting errors in small entity status, see paragraph X below.

### VIII. IMPROPERLY ESTABLISHING SMALL ENTITY STATUS

37 CFR 1.27(h) indicates that any attempt to fraudulently establish status as a small entity or pay fees as a small entity will be considered as a fraud practiced or attempted on the Office. Applicants should not rely on any oral advice inadvertently given by an Office employee as to entitlement to small entity status. In addition, improperly and with intent to deceive establishing status as a small entity or paying fees as a small entity will be considered as a fraud practiced or attempted on the Office. Normally, the Office will not question a claim to status as a small entity.

### IX. REFUNDS BASED ON LATER ESTABLISHMENT OF SMALL ENTITY STATUS

*37 CFR 1.28(a). Refunds when small entity status is later established; how errors in small entity status are excused..*

(a) *Refunds based on later establishment of small entity status.* A refund pursuant to § 1.26, based on establishment of small entity status, of a portion of fees timely paid in full prior to establishing status as a small entity may only be obtained if an assertion under § 1.27(c) and a request for a refund of the excess amount are filed within three months of the date of the timely payment of the full fee. The three-month time period is not extendable under § 1.136. Status as a small entity is waived for any fee by the failure to establish the status prior to paying, at the time of paying, or within three months of the date of payment of, the full fee.

(b) *Date of payment.*

(1) The three-month period for requesting a refund, pursuant to paragraph (a) of this section, starts on the date that a full fee has been paid;

(2) The date when a deficiency payment is paid in full determines the amount of deficiency that is due, pursuant to paragraph (c) of this section.

\*\*\*\*\*

37 CFR 1.28(a) provides a three-month time period for requesting a refund of a portion of a large entity fee based on later establishment of small entity status. The start date of the three-month refund period of 37 CFR 1.28(a) is the date the full fee has been paid. See 37 CFR 1.28(b)(1). Payment by authorization to charge a deposit account is treated for refund purposes the same as payments by other means (e.g., check or credit card authorizations), with each being treated as paid (for refund purposes) on the date of receipt in the Office as defined by 37 CFR 1.6. Thus, the date of receipt of an authorization to charge fees starts the three-month period for refunds under 37 CFR 1.28(a), not the date of debit of the fee to a deposit account. If a payment is mailed with a Certificate of Mailing under 37 CFR 1.8, the three month period for requesting a refund will start on the actual date of receipt of the payment in the Office, and not the Certificate of Mailing date. If a payment is filed by Express Mail under 37 CFR 1.10, the date of deposit with the United States Postal Service (shown by the “date-in” on the Express Mail mailing label or other official USPS notation) is the date of receipt of the payment by the Office under 37 CFR 1.10(a) and the three month period for requesting a refund starts on the date shown by the “date-in” on the Express Mail mailing label rather than the date when the payment actually reaches the Office.

Request for refunds, along with the assertions under 37 CFR 1.27(c), should be addressed to **\*\*>**Mail Stop 16, Director of the U.S. Patent and Trademark Office, P.O. Box 1450, Alexandria, VA 22313-1450**<**.

### X. CORRECTING ERRORS IN SMALL ENTITY STATUS

*37 CFR 1.28(c). Refunds when small entity status is later established; how errors in small entity status are excused*

\*\*\*\*\*

(c) *How errors in small entity status are excused.* If status as a small entity is established in good faith, and fees as a small entity are paid in good faith, in any application or patent, and it is later discovered that such status as a small entity was established in error, or that through error the Office was not notified of a loss of entitlement to small entity status as required by § 1.27(g)(2), the error will be excused upon: compliance with the separate submission and itemization requirements of paragraphs (c)(1) and



(c)(2) of this section, and the deficiency payment requirement of paragraph (c)(2) of this section:

(1) *Separate submission required for each application or patent.* Any paper submitted under this paragraph must be limited to the deficiency payment (all fees paid in error), required by paragraph (c)(2) of this section, for one application or one patent. Where more than one application or patent is involved, separate submissions of deficiency payments (e.g., checks) and itemizations are required for each application or patent. See § 1.4(b).

(2) *Payment of deficiency owed.* The deficiency owed, resulting from the previous erroneous payment of small entity fees, must be paid.

(i) *Calculation of the deficiency owed.* The deficiency owed for each previous fee erroneously paid as a small entity is the difference between the current fee amount (for other than a small entity) on the date the deficiency is paid in full and the amount of the previous erroneous (small entity) fee payment. The total deficiency payment owed is the sum of the individual deficiency owed amounts for each fee amount previously erroneously paid as a small entity. Where a fee paid in error as a small entity was subject to a fee decrease between the time the fee was paid in error and the time the deficiency is paid in full, the deficiency owed is equal to the amount (previously) paid in error;

(ii) *Itemization of the deficiency payment.* An itemization of the total deficiency payment is required. The itemization must include the following information:

(A) Each particular type of fee that was erroneously paid as a small entity, (e.g., basic statutory filing fee, two-month extension of time fee) along with the current fee amount for a non-small entity;

(B) The small entity fee actually paid, and when. This will permit the Office to differentiate, for example, between two one-month extension of time fees erroneously paid as a small entity but on different dates;

(C) The deficiency owed amount (for each fee erroneously paid); and

(D) The total deficiency payment owed, which is the sum or total of the individual deficiency owed amounts set forth in paragraph (c)(2)(ii)(C) of this section.

(3) *Failure to comply with requirements.* If the requirements of paragraphs (c)(1) and (c)(2) of this section are not complied with, such failure will either: be treated as an authorization for the Office to process the deficiency payment and charge the processing fee set forth in § 1.17(i), or result in a requirement for compliance within a one-month non-extendable time period under § 1.136(a) to avoid the return of the fee deficiency paper, at the option of the Office.

(d) *Payment of deficiency operates as notification of loss of status.* Any deficiency payment (based on a previous erroneous payment of a small entity fee) submitted under paragraph (c) of this section will be treated under § 1.27(g)(2) as a notification of a loss of entitlement to small entity status.

\*\*\*\*\*

37 CFR 1.28(c) provides that if small entity status is established in good faith and the small entity fees are paid in good faith, and it is later discovered that

such status as a small entity was established in error or through error the Office was not notified of a change of status, the error will be excused upon compliance with the separate submission and itemization requirements of 37 CFR 1.28(c)(1) and (c)(2), and the deficiency payment requirement of 37 CFR 1.28(c)(2). The deficiency amount owed under 37 CFR 1.28(c) is calculated using the date on which the deficiency was paid in full. See 37 CFR 1.28(b)(2).

37 CFR 1.28(c)(1) requires that a deficiency paper be limited to one application or patent file. Where, for example, the same set of facts has caused errors in payment in more than one application and/or patent file, a separate paper must be submitted in each file for which an error is to be excused.

37 CFR 1.28(c)(2) requires that for each fee that was erroneously paid as a small entity, the deficiencies owed must be paid, and the payment of the deficiencies must be itemized. The deficiency owed for each previous fee erroneously paid as a small entity is the difference between the current fee amount (for other than a small entity) on the date the deficiency is paid in full and the amount of the previous erroneous (small entity) fee payment. Where there has been a fee decrease, the deficiency owed is equal to the amount (previously) paid in error, not the difference between the amount (previously) paid in error and the new lower large entity fee. 37 CFR 1.28(c)(2)(ii) requires the following itemizations: (A) the particular fee involved (e.g., basic filing fee, extension of time fee); (B) the small entity fee amount actually paid and when (for example, distinguishing between two one-month extension of time fees erroneously paid on two different dates); (C) the actual deficiency owed for each fee previously paid in error; and (D) the total deficiency owed (i.e., the sum of the individual deficiencies owed).

Under 37 CFR 1.28(c)(3), the failure to comply with the requirements of 37 CFR 1.28(c)(1) and (c)(2) permits the Office at its option to either charge a processing fee (37 CFR 1.17(i)) to process the paper or require compliance within a one-month non-extendable time period to avoid return of the paper.

Any paper submitted under 37 CFR 1.28(c) is treated as a notification of loss of small entity status under 37 CFR 1.27(g)(2). See 37 CFR 1.28(d).

A maintenance fee improperly paid as a small entity where small entity status has been established but is no longer appropriate will be treated as a matter under 37 CFR 1.28(c) and will not be considered to involve expiration of the patent under 37 CFR 1.378. On the other hand, payment of a maintenance fee in the small entity amount where small entity status has not been established would result in the expiration of the patent under 37 CFR 1.378 unless the full maintenance fee due or a written assertion of small entity status is timely filed.

## **510 U.S. Patent and Trademark Office Business Hours**

The U.S. Patent and Trademark Office working hours are 8:30 a.m. to 5:00 p.m., Monday through Friday, excluding Federal holidays in the District of Columbia. Outside these hours, only U.S. Patent and Trademark Office employees are authorized to be in areas of the U.S. Patent and Trademark Office other than the Public Search Rooms.

The hours for the Patent Search Room are 8:00 a.m. to 8:00 p.m., and the hours for the Trademark Search Room are 8:00 a.m. to 6:00 p.m., Monday through Friday, excluding Federal holidays in the District of Columbia.

During working hours, all applicants, attorneys, and other members of the public should announce their presence to the Office personnel in the area of their visit. In the Technology Centers (TCs), visitors should inform the TC receptionist of their presence before visiting other areas of the TC.

### **FILING OF PAPERS DURING UNSCHEDULED CLOSINGS OF THE U.S. PATENT AND TRADEMARK OFFICE**

37 CFR 1.9(h) provides that the definition of “Federal holiday within the District of Columbia” includes an official closing of the Office. When the entire U.S. Patent and Trademark Office is officially closed for business for an entire day, for reasons due to adverse weather or other causes, the Office will consider each such day a “Federal holiday within the District of Columbia” under 35 U.S.C. 21. Any action or fee due on such a day may be taken, or fee paid, on the next succeeding business day the Office is open. In addition, 37 CFR 1.6(a)(1) provides “[t]he Patent and Trademark Office is not open for the filing of corre-

spondence on any day that is a Saturday, Sunday or Federal holiday within the District of Columbia” to clarify that any day that is a Saturday, Sunday or Federal holiday within the District of Columbia is a day that the U.S. Patent and Trademark Office is not open for the filing of applications within the meaning of Article 4(C)(3) of the Paris Convention. Note further that in accordance with 37 CFR 1.6(a)(2), even when the Office is not open for the filing of correspondence on any day that is a Saturday, Sunday or Federal holiday within the District of Columbia, correspondence deposited as Express Mail with the United States Postal Service in accordance with 37 CFR 1.10 will be considered filed on the date of its deposit, regardless of whether that date is a Saturday, Sunday or Federal holiday within the District of Columbia (under 35 U.S.C. 21(b) or 37 CFR 1.7).

When the U.S. Patent and Trademark Office is open for business during any part of a business day between 8:30 a.m. and 5:00 p.m., papers are due on that day even though the Office may be officially closed for some period of time during the business day because of an unscheduled event. The procedures of 37 CFR 1.10 may be used for filing applications.

Information regarding whether or not the Office is officially closed on any particular day may be obtained by calling (703) 308-4357 which transposes to (703) 308-HELP.

Effective November 29, 1999, Public Law 106-113 amended 35 U.S.C. 119(e)(3) to extend the period of pendency of a provisional application to the next succeeding business day if the day that is 12 months after the filing date of a provisional application falls on a Saturday, Sunday, or Federal holiday within the District of Columbia. 35 U.S.C. 119(e)(3) as amended by Public Law 106-113 applies to any provisional applications filed on or after June 8, 1995 but has no effect on any patent which is the subject of litigation in an action commenced before November 29, 1999. See also 37 CFR 1.7(b).

New patent applications filed in accordance with 37 CFR 1.10 will be stamped by the Office with the date of deposit as “Express Mail” with the United States Postal Service. For example, if a new patent application is deposited in “Express Mail” in accordance with 37 CFR 1.10 on a Saturday and the United States Postal Service gives it a date of deposit of Saturday, the Office will accord and stamp the cor-

respondence with the Saturday date. 37 CFR 1.6(a)(2).

### **REGULATIONS FOR THE PUBLIC USE OF RECORDS IN THE PATENT SEARCH ROOM OF THE U.S. PATENT AND TRADEMARK OFFICE**

The U.S. Patent and Trademark Office has established procedures and regulations for using the facilities of the Patent Search Room. The procedures for the Search Room include the requirement that users obtain and show, prior to entering the Search Room facilities, a User Pass. This pass can be obtained at the receptionist's desk in the lobby of Crystal Plaza Building 3, 2021 South Clark Place, Arlington, VA. User Passes will be issued to persons not under prohibition from using the search facilities who sign an application form and acknowledge receipt of a copy of the noted regulations. User Passes are nontransferable and are valid until reissue or revocation for cause. Office employees must show their building pass in order to enter the Patent Search Room.

Persons exiting the Search Room will automatically pass electronic sensing equipment designed to detect any marked documents or materials being removed from the Search Room. The sensing equipment is capable of detecting marked documents and materials in briefcases and parcels and under clothing. The equipment does not use X-ray or other high energy radiation and is, therefore, completely safe and harmless to persons, photographic film, magnetic tape, and electronic or mechanical devices such as wrist watches.

Whenever a marked document is transported past the sensing equipment, U.S. Patent and Trademark Office officials and the security guards will be alerted to the removal of the document. Persons triggering the alarm will be asked to cooperate in identifying the source for the alarm. Failure to cooperate when the alarm is triggered could result in detention of the person, seizure of any briefcase or the like, or other legal measures deemed necessary and appropriate in the specific case.

The regulations for the Search Room are reprinted in a regulation brochure. It is available in the Search Room. In order to maintain an environment conducive to search, the regulations will be strictly enforced.

Although these procedures and regulations may cause some inconvenience, it is hoped that with understanding and cooperation they will result in improvement in search facilities which will benefit all participants in the U.S. patent system.

Persons violating the regulations may be denied the use of the facilities in the Patent Search Room, and may further be subjected to prosecution under the Criminal Code. Additionally, the name of any person violating these regulations who is registered to practice before the U.S. Patent and Trademark Office may be forwarded to the Office of Enrollment and Discipline for appropriate action under 37 CFR Part 10.

### **USE OF TECHNOLOGY CENTER FACILITIES**

The primary function of the U.S. Patent and Trademark Office is the examination of nonprovisional applications for patents and the issuance of valid patents based upon a search and consideration of the best available prior art. This can be accomplished only through maintaining strict search file integrity within the Technology Center (TC) facilities.

Therefore, the regulations appearing below were established for those authorized members of the public using the facilities of the TCs.

Although these regulations may cause some inconvenience, it is believed that with the cooperation and understanding of the public, a more efficient and reliable examination system within the patent examining groups will result.

A copy of the following "Regulations for Users of the Technology Center Search Facilities," is posted in each of the TCs and the Patent Search Room:

### **REGULATIONS FOR USERS OF THE TECHNOLOGY CENTER SEARCH FACILITIES**

(A) TC facilities are defined as those areas in Crystal City (Arlington, VA) where the TCs are located.

(B) The use of the TC facilities for search purposes by members of the public is strictly limited to the search of materials not available in the Patent Search Room or the Scientific and Technical Information Center (STIC) and when it does not conflict with the regular business of U.S. Patent and Trademark personnel and only between the hours of 8:45 a.m. and 4:45 p.m. on regular business days.

(C) Authorized Officials, under these regulations, include Supervisory Patent Examiners and TC Directors.

(D) Under applicable statutes and regulations, including 40 U.S.C. 486(c); 41 CFR Subpart 101-20.3; and appropriate Sections of Department Organization Orders 30-3A and 30-3B of the Department of Commerce, the regulations appearing below are established for those members of the public using the TC Facilities.

(1) All persons using these facilities are subject to the Regulations Governing Conduct on Federal Property, as specified in 41 CFR Subpart 101-20.3.

(2) All posted Official Notices are to be complied with.

(3) A valid User Pass must be prominently displayed when searching in the TC Facilities. User Passes are nontransferable and must be surrendered upon request to authorized officials.

(4) All persons holding User Passes must register with the TC Receptionist, unless otherwise directed, in each TC where they search and must sign a log (e.g., indicating time-in, time-out, name, User Pass number, class(es) and subclass(es) searched).

(5) No patents, records, or other documents of the U.S. Patent and Trademark Office shall be removed from the TC Facilities except by express written authorization by an authorized official in the TC where the material resides. Such authorization will not be given for U.S. patents and other material readily available through the Scientific and Technical Information Center.

(6) Smoking is not permitted except in designated areas.

(7) No food or beverages in any form are to be consumed except in designated areas.

(8) Loud talking, use of radios, and any other form of activity which may disturb other members of the public or U.S. Patent and Trademark Office personnel are forbidden.

(9) Children brought into the TC Facilities must not be allowed to disturb others.

(10) The presence or use of equipment such as dictation equipment, reproducing machines, typewriters, and photographic equipment is prohibited without prior permission from an authorized official in the TC where the use is intended and then is permitted where its use does not conflict with regulation (8) above.

(11) Patents and other documents must not be removed from their shoes for any reason other than for cursory study thereof while kept in close proximate association with the shoe and must not be moved out of their normal sequence.

(12) All patent shoes must be promptly replaced in their proper location in the shoe case.

(13) All textbooks, journals, and the like must be returned to their proper location.

(14) The reserving of seats and/or working areas is prohibited.

(15) All packages, briefcases, or other personal effects brought into the TC Facilities are subject to search by authorized officials upon request and must be removed when leaving the TC Facilities.

(16) All verbal requests for compliance with these regulations or other posted U.S. Patent and Trademark Office Notices pertaining to activity in the TC Facilities, when made by authorized officials, must be promptly complied with.

(E) Persons violating these regulations may be denied the use of the facilities in the TC and Patent Search Room, and may further be subject to prosecution under the Criminal Code. Additionally, the name of any person violating these regulations who is registered to practice before the U.S. Patent and Trademark Office may be forwarded to the Office of Enrollment and Discipline for appropriate action under 37 CFR Part 10.

If any individual is observed in violation of any of the regulations, immediate compliance should be courteously requested. If a verbal request is not complied with, a note should be made of the individual's name and User's Pass number, if possible (the User's Pass is required to be prominently displayed) and a report of the incident should be made to the Supervisory Patent Examiner, Supervisory Applications Examiner, or other appropriate supervisor who will take further action.

In addition, if any individual in a search area appears to be a stranger and is not wearing a User's Pass, some identification, such as a Building or User's Pass, should be requested. If the individual refuses, notify a supervisor. Consequently, all Office employees are expected to carry their Building Pass with them at all times, especially when searching outside of their assigned TCs.

Supervisors, when aware of violations of the posted regulations, should prepare a memorandum detailing the facts of the incident and forward this memorandum to the Deputy Commissioner for Patent Operations via their TC Director. Supervisory Patent Examiners and TC Directors are authorized to demand surrender of User Passes on-the-spot. If the Supervisory Patent Examiner exercises this function, the TC Director should be immediately notified, followed up by a memorandum as previously set forth.

## 511 Postal Service **\*\*>**Interruptions and Emergencies< [R-2]

*35 U.S.C. 21. Filing date and day for taking action.*

(a) The Director may by rule prescribe that any paper or fee required to be filed in the Patent and Trademark Office will be considered filed in the Office on the date on which it was deposited with the United States Postal Service or would have been deposited with the United States Postal Service but for postal service interruptions or emergencies designated by the Director.

\*\*\*\*\*

*37 CFR 1.6. Receipt of letters and papers.*

\*\*\*\*\*

(e) *Interruptions in U.S. Postal Service.*

If interruptions or emergencies in the United States Postal Service which have been so designated by the Commissioner occur, the Patent and Trademark Office will consider as filed on a particular date in the Office any correspondence which is:

- (1) Promptly filed after the ending of the designated interruption or emergency; and
- (2) Accompanied by a statement indicating that such correspondence would have been filed on that particular date if it were not for the designated interruption or emergency in the United States Postal Service.

\*\*\*\*\*

>In the event of a postal interruption or emergency, an announcement will be placed on the USPTO web site at [www.uspto.gov](http://www.uspto.gov), providing instructions about the filing of patent applications, and other papers related to patent applications and patents.<

37 CFR 1.6(e) provides a procedure under which correspondence (papers and fees) which could not be filed on a particular date because of an interruption or emergency in the United States Postal Service >(USPS)< which is so designated by the **\*\*>**Director<, may be promptly filed after the ending of such a designated interruption or emergency and be considered

as having been filed on that particular date. Authority for such a practice is found in 35 U.S.C. 21(a), as amended by Public Law 97-247.

**\*\*>**Applicants are cautioned that the provisions of 35 U.S.C. 21(a) and 37 CFR 1.6(e) only apply to postal interruptions and emergencies. The provisions of 35 U.S.C. 21(a) and 37 CFR 1.6(e) do not provide for granting of a filing date to correspondence as of the date on which it would have been filed but for other exigencies, such as the unavailability of a computer or word processing equipment, or the inaccessibility of an office or building other than a USPS facility. 35 U.S.C. 21(a) requires, in part, that “any paper or fee required to be filed in the Patent and Trademark Office...would have been deposited with the United States Postal Service but for postal service interruptions or emergencies designated by the Director.” The statute requires that the correspondence was complete and ready to be deposited with the USPS on the filing date requested (e.g., complete application papers have been prepared and printed) and that the correspondence could not have been deposited with the USPS on the requested filing date for the sole reason that the postal service was not available due to the interruption or emergency designated by the Office.

In general, applicants should consider filing correspondence by facsimile when permitted. See 37 CFR 1.6(d) and MPEP § 502.01. Applicants should also consider filing correspondence with a Certificate of Mailing or a Certificate of Transmission under 37 CFR 1.8 when permitted. See MPEP § 512. Even if the post office is closed due to an emergency, applicants should ordinarily be able to deposit correspondence in a mailbox for first class mail. New applications **cannot** be transmitted by facsimile and are **not** entitled to the benefit of a Certificate of Transmission under 37 CFR 1.8. A request for a continued prosecution application (CPA) filed under 37 CFR 1.53(d) (available only for design applications) may be transmitted to the Office by facsimile (37 CFR 1.6(d)(3)); however, it is not entitled to the benefit of a Certificate of Transmission (see 37 CFR 1.8(a)(2)(i)(A)). The Office strongly recommends that applicants file new applications by “Express Mail” in accordance with 37 CFR 1.10 since such correspondence will be accorded the date of deposit in “Express Mail” with the USPS as the filing date. See 37 CFR 1.6(a) and MPEP § 513. Applications that are not

filed by “Express Mail” can only be accorded the date of receipt in the Office as the filing date (unless there is a postal interruption or emergency designated by the Office and applicants are instructed to file their applications in a manner other than by “Express Mail”). Any applicant who files an application by first class mail bears the risk of any delay in the delivery of the application to the Office, even if the delay is unusually significant due to some unforeseen event. New patent applications, computer readable format (CRF) biosequence listings, pre-grant publication submissions, and electronic information disclosure statements (e-IDS) may also be submitted to the USPTO via the Internet by using the Electronic Filing System (EFS). Information regarding EFS may be obtained via the USPTO web site at [www.uspto.gov/ebs/efs/index.html](http://www.uspto.gov/ebs/efs/index.html).

## 512 Certificate of Mailing or Transmission [R-2]

### 37 CFR 1.8. Certificate of mailing or transmission.

(a) Except in the cases enumerated in paragraph (a)(2) of this section, correspondence required to be filed in the Patent and Trademark Office within a set period of time will be considered as being timely filed if the procedure described in this section is followed. The actual date of receipt will be used for all other purposes.

(1) Correspondence will be considered as being timely filed if:

(i) The correspondence is mailed or transmitted prior to expiration of the set period of time by being:

(A) Addressed as set out in § 1.1(a) and deposited with the U.S. Postal Service with sufficient postage as first class mail; or

(B) Transmitted by facsimile to the Patent and Trademark Office in accordance with § 1.6(d); and

(ii) The correspondence includes a certificate for each piece of correspondence stating the date of deposit or transmission. The person signing the certificate should have reasonable basis to expect that the correspondence would be mailed or transmitted on or before the date indicated.

(2) The procedure described in paragraph (a)(1) of this section does not apply to, and no benefit will be given to a Certificate of Mailing or Transmission on, the following:

(i) *Relative to Patents and Patent Applications*—

(A) The filing of a national patent application specification and drawing or other correspondence for the purpose of obtaining an application filing date, including a request for a continued prosecution application under § 1.53(d);

(B) The filing of correspondence in an interference which an examiner-in-chief orders to be filed by hand or “Express Mail”;

(C) The filing of agreements between parties to an interference under 35 U.S.C. 135(c);

(D) The filing of an international application for patent;

(E) The filing of correspondence in an international application before the U.S. Receiving Office, the U.S. International Searching Authority, or the U.S. International Preliminary Examining Authority;

(F) The filing of a copy of the international application and the basic national fee necessary to enter the national stage, as specified in § 1.495(b).

(ii) *\*\*>[Reserved]<*

(iii) *Relative to Disciplinary Proceedings*—

(A) Correspondence filed in connection with a disciplinary proceeding under part 10 of this chapter.

(B) *[Reserved]*

(b) In the event that correspondence is considered timely filed by being mailed or transmitted in accordance with paragraph (a) of this section, but not received in the Patent and Trademark Office, and the application is held to be abandoned or the proceeding is dismissed, terminated, or decided with prejudice, the correspondence will be considered timely if the party who forwarded such correspondence:

(1) Informs the Office of the previous mailing or transmission of the correspondence promptly after becoming aware that the Office has no evidence of receipt of the correspondence;

(2) Supplies an additional copy of the previously mailed or transmitted correspondence and certificate; and

*\*\*>*

(3) Includes a statement which attests on a personal knowledge basis or to the satisfaction of the Director to the previous timely mailing or transmission. If the correspondence was sent by facsimile transmission, a copy of the sending unit’s report confirming transmission may be used to support this statement.<

(c) The Office may require additional evidence to determine if the correspondence was timely filed.

A suggested format for a Certificate of Mailing and a Certificate of Transmission under 37 CFR 1.8 to be included with the correspondence is reproduced below.

### Certificate of Mailing

I hereby certify that this correspondence is being deposited with the United States Postal Service with sufficient postage as first class mail in an envelope addressed to:

*\*\*>*Commissioner for Patents  
P.O. Box 1450  
Alexandria, Virginia 22313-1450<

on \_\_\_\_\_.

(Date)

Typed or printed name of person signing this certificate

\_\_\_\_\_

Signature \_\_\_\_\_

**Certificate of Transmission**

I hereby certify that this correspondence is being facsimile transmitted to the U.S. Patent and Trademark Office (Fax No. (703)\_\_\_\_-\_\_\_\_)

on \_\_\_\_\_.  
(Date)

Typed or printed name of person signing this certificate

\_\_\_\_\_

Signature \_\_\_\_\_

\*\*>

*¶ 5.02 Format of Certificate of Mailing or Transmission*

The following are suggested formats for either a Certificate of Mailing or Certificate of Transmission under 37 CFR 1.8(a). The certification may be included with all correspondence concerning this application or proceeding to establish a date of mailing or transmission under 37 CFR 1.8(a). Proper use of this procedure will result in such communication being considered as timely if the established date is within the required period for reply. The Certificate should be signed by the individual actually depositing or transmitting the correspondence or by an individual who, upon information and belief, expects the correspondence to be mailed or transmitted in the normal course of business by another no later than the date indicated.

**Certificate of Mailing**

I hereby certify that this correspondence is being deposited with the United States Postal Service with sufficient postage as first class mail in an envelope addressed to:

Commissioner for Patents  
P.O. Box 1450  
Alexandria, VA 22313-1450

on \_\_\_\_\_.

(Date)

Typed or printed name of person signing this certificate:

\_\_\_\_\_

Signature: \_\_\_\_\_

**Certificate of Transmission**

I hereby certify that this correspondence is being facsimile transmitted to the United States Patent and Trademark Office, Fax No. (703)\_\_\_\_-\_\_\_\_ on \_\_\_\_\_ (Date)

Typed or printed name of person signing this certificate:

\_\_\_\_\_

Signature:

\_\_\_\_\_

Please refer to 37 CFR 1.6(d) and 1.8(a)(2) for filing limitations concerning facsimile transmissions and mailing, respectively.

<

Under 37 CFR 1.8, a person may state on certain papers directed to the Office (exceptions are stated in 37 CFR 1.8), the date on which the paper will be deposited in the United States Postal Service or transmitted by facsimile. If the date stated is within the period for reply, the reply in most instances will be considered to be timely. This is true even if the paper does not actually reach the Office until after the end of the period for reply. The Certificate of Mailing procedure does not apply to papers mailed in a foreign country.

The Certificate of Transmission procedure, however, also applies to papers transmitted to the Office from a foreign country provided that the correspondence being transmitted is not prohibited from being transmitted by facsimile and is not otherwise precluded from receiving the benefits under 37 CFR 1.8.

It should be noted, however, that the Office will continue its normal practice of stamping the date of receipt ("Office Date" Stamp) on all papers received through the mail or by facsimile except those filed under 37 CFR 1.10 (See MPEP § 513). The date stamped will also be the date which is entered on Office records and from which any subsequent periods are calculated. For example, 37 CFR 1.192 gives an appellant 2 months from the date of the appeal to file an appeal brief. For example, if the last day to reply to a final rejection was November 10, 1997, and applicant deposited a Notice of Appeal with fee in the U.S. mail on November 10, 1997, and so certified, that appeal is timely even if it was not received in the U.S. Patent and Trademark Office until November 16, 1997. Since the date of receipt will be used to calculate the time at which the brief is due, the brief was

due on January 16, 1998. This is 2 months after the Mail Center date.

37 CFR 1.8(a)(2)(i)(A) specifically refers to a request for a continued prosecution application (CPA) filed under 37 CFR 1.53(d) >(available only for design applications)< as a correspondence filed for the purposes of obtaining an application filing date and the procedures and benefit set forth in 37 CFR 1.8(a)(1) are not applicable to a request for a CPA. The date on a certificate of mailing or transmission (37 CFR 1.8(a)) of a CPA is not controlling or even relevant. A CPA filed by facsimile transmission will not be accorded a filing date as of the date on the certificate of transmission unless Office records indicate, or applicant otherwise establishes pursuant to 37 CFR 1.6(f), receipt in the Office of the complete CPA on the date on the certificate of transmission and that date is not a Saturday, Sunday, or Federal holiday within the District of Columbia.

>

## I. < PROCEDURE BY APPLICANT

(A) The certification requires a signature. Specifically, if the certification appears on a paper that requires a signature, two signatures are required, one for the paper and one for the certification. Although not specifically required by 37 CFR 1.8, it is preferred that the certificate be signed by the applicant, assignee, or registered practitioner.

(B) When possible, the certification should appear on a portion of the paper being submitted. However, if there is insufficient space to make the certification on the same paper, the certification should be on a separate sheet securely attached to the paper.

(C) When the certification is presented on a separate sheet, that sheet must (1) be signed and (2) fully identify and be securely attached to the paper it accompanies. The required identification should include the application number and filing date of the application as well as the type of paper being filed, e.g., reply to rejection or refusal, Notice of Appeal, etc. An unsigned certification will not be considered acceptable.

Moreover, without the proper identifying data, a certification presented on a separate sheet will not be considered acceptable if there is any question or doubt

concerning the connection between the sheet and the paper filed.

If the sheet should become detached from the paper and thereafter not associated with the appropriate file, evidence that this sheet was received in the Office can be supported by submitting a copy of a postcard receipt specifically identifying this sheet and the paper and by submitting a copy of the sheet as originally mailed. Attention is directed to MPEP § 503 relative to the use of postcards as receipts.

(D) In situations wherein the correspondence includes papers for more than one application (e.g., a single envelope containing separate papers responding to Office actions in different applications) or papers for various parts of the Office (e.g., a patent issue fee transmittal form PTOL-85B and an assignment), each paper must have its own certification as a part thereof or attached thereto.

Although **\*\*>Part B of Form PTOL-85, Notice of Allowance and Fee(s) Due<**, may contain a Certificate of Mailing thereon, a separate Certificate of Mailing is required for all papers included with this form, including formal drawings**\*\***. Checks submitted with the papers do not require certification.

(E) In situations wherein the correspondence includes several papers directed to the same area of the Office for the same application (for example, a proposed reply under 37 CFR 1.116 and a Notice of Appeal), each paper should have its own certification as a part thereof or attached thereto.

(F) For the purposes of 37 CFR 1.8(a)(1)(i)(A), first class mail is interpreted as including "Express Mail" and "Priority Mail" deposited with the U.S. Postal Service.

Alternatively, the correspondence may be submitted with a cover or transmittal letter which itemizes the papers and on which is placed the certificate under 37 CFR 1.8.

>

## II. < USE OF STAMPED CERTIFICATION

Some practitioners place the certification language on the first page of a paper with an inked stamp. Such a practice is encouraged because the certification is not only readily visible but also forms an integral part of the paper.



&gt;

**III. < OFFICE PROCEDURE****A. Mail Center of the Office of Initial Patent Examination**

The Mail Center of the Office of Initial Patent Examination will continue to date stamp the actual date of receipt of all papers received by mail in the Office. No attempt will be made to retain the envelopes in which the papers are received or to indicate on the papers the postal cancellation date (postmark).

However, the benefits of 37 CFR 1.8 or 37 CFR 1.10 apply only to documents delivered to the Office by the U.S. Postal Service. A number of instances have been uncovered where individuals are certifying that documents were deposited with the U.S. Postal Service when, in fact, the documents were hand-carried or delivered to the Office via commercial couriers, e.g., "Federal Express," "DHL," "Purolator," "Air Borne," "UPS." In those instances where documents include a Certificate of Mailing under 37 CFR 1.8 or "Express Mail" mailing label (commonly used to comply with 37 CFR 1.10) but were delivered to the Office by other than the U.S. Postal Service, Mail Center personnel are placing a notice indicating that fact on the correspondence involved to alert Office personnel that the benefits of 37 CFR 1.8 or 37 CFR 1.10 do not apply.

**B. Processing Areas**

When papers are received in a \*\*>specific location of the Office (e.g., Pre-Grant Publication Division, Office of Patent Publication, Office of Petitions - see MPEP § 502 and § 502.01)<, the date of receipt in the \*>Office< is stamped on the papers in accordance with 37 CFR 1.6(a).

The date indicated on the Certificate of Mailing or of Transmission will be used by the Office only to determine if the paper was deposited in the United States Postal Service or transmitted by facsimile within the period for reply. If the paper was actually received in the Office within the period for reply, there is no need to refer to the Certificate. Note however, that 37 CFR 1.6(a)(3) provides that "[c]orrespondence transmitted by facsimile to the Patent and Trademark Office will be stamped with the date on which the complete transmission is received in the

Patent and Trademark Office unless that date is a Saturday, Sunday, or Federal holiday within the District of Columbia, in which case the date stamped will be the next succeeding day which is not a Saturday, Sunday, or Federal holiday within the District of Columbia."

If, however, the paper was received in the U.S. Patent and Trademark Office after the end of the period for reply, the paper should be inspected to determine if a Certificate of Mailing or of Transmission has been included. Where no such Certificate is found, the paper is untimely since applicant did not reply within the period for reply. This may result in abandonment of the application or other loss of rights.

In those instances where a Certificate of Mailing or of Transmission does appear in the paper or a cover letter thereto, a check should be made to determine whether the indicated date of deposit or transmission is within the period for reply. If the date indicated in the Certificate is after the end of the period for reply, the paper is untimely and no notation of the date need be made. Where the date indicated on the Certificate is within the period for reply, the paper should be considered to be timely filed. A notation should be made adjacent to the Office stamp indicating the date of receipt ("Office Date" Stamp) which notes the date stated on the Certificate. This notation should be "C of Mail" or "C of Fax" followed by the date. A paper with a certificate dated November 10, 1997, would be noted next to the "Office Date" Stamp "(C of Mail. 11/10/97)." This notation should also appear on the "Contents" portion of the file wrapper. >For Image File Wrapper (IFW) processing, see IFW Manual.<

If the period set for taking an action in the U.S. Patent and Trademark Office ends on a Saturday, Sunday, or Federal holiday within the District of Columbia (37 CFR 1.7), the action will be considered to be timely if deposited in the United States mail or transmitted by facsimile and certified under 37 CFR 1.8(a) on the next succeeding day which is not a Saturday, Sunday, or a Federal holiday.

It should be noted that the filing of a paper for the purpose of obtaining a continuation or division application under 37 CFR 1.53(d) >(available only for design applications)< and former 37 CFR 1.60 or 1.62 is excluded from the Certificate practice under 37 CFR 1.8(a)(2)(i)(A) since it is considered to be the filing of a national patent application.

Effective November 29, 1999, Public Law 106-113 amended 35 U.S.C. 119(e)(3) to extend the period of pendency of a provisional application to the next succeeding business day if the day that is 12 months after the filing date of a provisional application falls on a Saturday, Sunday, or Federal holiday within the District of Columbia. See also 37 CFR 1.7(b). 35 U.S.C. 119(e)(3) as amended by Public Law 106-113 applies to any provisional applications filed on or after June 8, 1995 but has no effect on any patent which is the subject of litigation in an action commenced before November 29, 1999.

No benefit will be given to a Certificate of Mailing or Transmission relative to the filing of a national patent application specification and drawing or other correspondence for the purpose of obtaining an application filing date. However, note that new patent applications filed in accordance with 37 CFR 1.10 will be stamped by the Office with the date of deposit as "Express Mail" with the United States Postal Service. For example, if a new patent application is deposited as "Express Mail" in accordance with 37 CFR 1.10 on a Saturday and the United States Postal Service gives it a date of deposit of Saturday, the Office will accord and stamp the correspondence with the Saturday date. 37 CFR 1.6(a)(2).

All Certificates of Mailing or Transmission filed in applications should be placed in the file wrappers directly below the papers to which they refer. >For Image File Wrapper (IFW) processing, see IFW Manual.<

\*>Office< personnel receiving a hand-delivered paper from other than U.S. Postal Service personnel should inspect the paper to ensure that the benefits of 37 CFR 1.8 or "Express Mail" benefits under 37 CFR 1.10 are not accorded in error. If the paper contains a certificate of mailing under 37 CFR 1.8 or "Express Mail" mailing label (commonly used to comply with 37 CFR 1.10), the words "HAND DELIVERED" should be written adjacent to the \* date stamp.

Applicant should be notified in the next Office action when a paper containing a Certificate of Mailing has been denied the benefits under 37 CFR 1.8 or a paper containing an "Express Mail" mailing label (commonly used to comply with 37 CFR 1.10) is denied benefits under 37 CFR 1.10 by including, for example, form paragraph 5.04.

#### *¶ 5.04 Benefit of Certificate of Mailing Denied*

The [1] filed [2] is not entitled to the benefits of 37 CFR 1.[3] since it was not deposited with the U. S. Postal Service for delivery to the U.S. Patent and Trademark Office. Therefore, the date of receipt in the U.S. Patent and Trademark Office has been used to determine the timeliness of the paper.

#### **Examiner Note:**

1. This form paragraph is to be used in those situations where correspondence contains a Certificate of Mailing under 37 CFR 1.8 or requests the benefit of "Express Mail" under 37 CFR 1.10, but the correspondence was not actually deposited with the U. S. Postal Service.

2. In bracket 3, insert --8-- or --10--, as appropriate.

Misuse of a Certificate of Mailing under 37 CFR 1.8 or improperly claiming the benefit of 37 CFR 1.10 which appears to be more than a one-time, inadvertent error should be brought to the attention of the Office of Enrollment and Discipline.

>

#### **IV. < ORIGINAL MAILED PAPER NOT DELIVERED**

Paragraphs (b) and (c) of 37 CFR 1.8 concern the situation where a paper containing a Certificate was timely deposited in the U.S. mail or transmitted by facsimile, but never received by the U.S. Patent and Trademark Office. In the TCs, all submissions under these paragraphs should be considered and the sufficiency thereof determined by the TC Director. The statement required by 37 CFR 1.8(b)(3) is no longer required to be verified.

#### **513 Deposit as Express Mail with U.S. Postal Service [R-2]**

*35 U.S.C. 21. Filing date and day for taking action.*

(a) The Director may by rule prescribe that any paper or fee required to be filed in the Patent and Trademark Office will be considered filed in the Office on the date on which it was deposited with the United States Postal Service or would have been deposited with the United States Postal Service but for postal service interruptions or emergencies designated by the Director.

\*\*\*\*\*

*37 CFR 1.6. Receipt of correspondence.*

(a) *Date of receipt and Express Mail date of deposit.* Correspondence received in the Patent and Trademark Office is stamped with the date of receipt except as follows:

(1) The Patent and Trademark Office is not open for the filing of correspondence on any day that is a Saturday, Sunday, or Federal holiday within the District of Columbia. Except for

correspondence transmitted by facsimile under paragraph (a)(3) of this section, or filed electronically under paragraph (a)(4) of this section, no correspondence is received in the Office on Saturdays, Sundays, or Federal holidays within the District of Columbia.

(2) Correspondence filed in accordance with § 1.10 will be stamped with the date of deposit as “Express Mail” with the United States Postal Service.

(3) Correspondence transmitted by facsimile to the Patent and Trademark Office will be stamped with the date on which the complete transmission is received in the Patent and Trademark Office unless that date is a Saturday, Sunday, or Federal holiday within the District of Columbia, in which case the date stamped will be the next succeeding day which is not a Saturday, Sunday, or Federal holiday within the District of Columbia.

(4) \*\*>[Reserved]<

\*\*\*\*\*

*37 CFR 1.10. Filing of correspondence by “Express Mail”.*

\*\*>

(a)(1) Any correspondence received by the U.S. Patent and Trademark Office (USPTO) that was delivered by the “Express Mail Post Office to Addressee” service of the United States Postal Service (USPS) will be considered filed with the USPTO on the date of deposit with the USPS.

(2) The date of deposit with USPS is shown by the “date in” on the “Express Mail” label or other official USPS notation. If the USPS deposit date cannot be determined, the correspondence will be accorded the USPTO receipt date as the filing date. See § 1.6(a).<

(b) Correspondence should be deposited directly with an employee of the USPS to ensure that the person depositing the correspondence receives a legible copy of the “Express Mail” mailing label with the “date-in” clearly marked. Persons dealing indirectly with the employees of the USPS (such as by deposit in an “Express Mail” drop box) do so at the risk of not receiving a copy of the “Express Mail” mailing label with the desired “date-in” clearly marked. The paper(s) or fee(s) that constitute the correspondence should also include the “Express Mail” mailing label number thereon. See paragraphs (c), (d) and (e) of this section.

\*\*>

(c) Any person filing correspondence under this section that was received by the Office and delivered by the “Express Mail Post Office to Addressee” service of the USPS, who can show that there is a discrepancy between the filing date accorded by the Office to the correspondence and the date of deposit as shown by the “date-in” on the “Express Mail” mailing label or other official USPS notation, may petition the Director to accord the correspondence a filing date as of the “date-in” on the “Express Mail” mailing label or other official USPS notation, provided that:<

(1) The petition is filed promptly after the person becomes aware that the Office has accorded, or will accord, a filing date other than the USPS deposit date;

(2) The number of the “Express Mail” mailing label was placed on the paper(s) or fee(s) that constitute the correspondence prior to the original mailing by “Express Mail;” and

(3) The petition includes a true copy of the “Express Mail” mailing label showing the “date-in,” and of any other official notation by the USPS relied upon to show the date of deposit.

\*\*>

(d) Any person filing correspondence under this section that was received by the Office and delivered by the “Express Mail Post Office to Addressee” service of the USPS, who can show that the “date-in” on the “Express Mail” mailing label or other official notation entered by the USPS was incorrectly entered or omitted by the USPS, may petition the Director to accord the correspondence a filing date as of the date the correspondence is shown to have been deposited with the USPS, provided that:<

(1) The petition is filed promptly after the person becomes aware that the Office has accorded, or will accord, a filing date based upon an incorrect entry by the USPS;

(2) The number of the “Express Mail” mailing label was placed on the paper(s) or fee(s) that constitute the correspondence prior to the original mailing by “Express Mail;” and

\*\*>

(3) The petition includes a showing which establishes, to the satisfaction of the Director, that the requested filing date was the date the correspondence was deposited in the “Express Mail Post Office to Addressee” service prior to the last scheduled pickup for that day. Any showing pursuant to this paragraph must be corroborated by evidence from the USPS or that came into being after deposit and within one business day of the deposit of the correspondence in the “Express Mail Post Office to Addressee” service of the USPS.

(e) Any person mailing correspondence addressed as set out in § 1.1(a) to the Office with sufficient postage utilizing the “Express Mail Post Office to Addressee” service of the USPS but not received by the Office, may petition the Director to consider such correspondence filed in the Office on the USPS deposit date, provided that:<

(1) The petition is filed promptly after the person becomes aware that the Office has no evidence of receipt of the correspondence;

(2) The number of the “Express Mail” mailing label was placed on the paper(s) or fee(s) that constitute the correspondence prior to the original mailing by “Express Mail;”

(3) The petition includes a copy of the originally deposited paper(s) or fee(s) that constitute the correspondence showing the number of the “Express Mail” mailing label thereon, a copy of any returned postcard receipt, a copy of the “Express Mail” mailing label showing the “date-in,” a copy of any other official notation by the USPS relied upon to show the date of deposit, and, if the requested filing date is a date other than the “date-in” on the “Express Mail” mailing label or other official notation entered by the USPS, a showing pursuant to paragraph (d)(3) of this section that the requested filing date was the date the correspondence was deposited in the “Express Mail Post Office to Addressee” service prior to the last scheduled pickup for that day; and

\*\*>

(4) The petition includes a statement which establishes, to the satisfaction of the Director, the original deposit of the correspondence and that the copies of the correspondence, the copy of the “Express Mail” mailing label, the copy of any returned

postcard receipt, and any official notation entered by the USPS are true copies of the originally mailed correspondence, original "Express Mail" mailing label, returned postcard receipt, and official notation entered by the USPS.<

(f) The Office may require additional evidence to determine if the correspondence was deposited as "Express Mail" with the USPS on the date in question.

The statutory authority for the granting of a filing date based on the date of deposit for correspondence sent by "Express Mail" and received by the Office is found in section 21(a) of Title 35 of the United States Code.

The specific rule for obtaining a filing date as of the date of deposit in "Express Mail" (rather than the date of receipt at the Office) is 37 CFR 1.10 \*\*.

>35 U.S.C. 21(a) is limited to correspondence deposited with the United States Postal Service (USPS). The procedure in 37 CFR 1.10 is limited to correspondence deposited in the "Express Mail Post Office to Addressee" service of the USPS. There are no similar provisions and no similar benefit can be obtained for correspondence deposited in International Express Mail.

## **I. < EFFECTIVE DATE, WEEKENDS & HOLIDAYS**

Effective December 2, 1996, 37 CFR 1.6(a)(2) provides that correspondence deposited as "Express Mail" in accordance with 37 CFR 1.10 will be stamped, and, therefore, considered as filed on the date of its deposit, regardless of whether that date is a Saturday, Sunday or Federal holiday within the District of Columbia. 37 CFR 1.10 provides a procedure for assigning the date on which any paper or fee is deposited as "Express Mail" with the \*\*>USPS< as the filing date of the paper or fee in the U.S. Patent and Trademark Office (Office). The date of deposit with the USPS is shown by the "date-in" on the "Express Mail" mailing label or other official USPS notation. This holds true for any day that the correspondence may be accepted as "Express Mail" by the USPS, even when the paper or fee is deposited and accepted on a Saturday, Sunday or Federal holiday within the District of Columbia. For example, if a person files a patent application by "Express Mail" with the USPS on a Saturday in compliance with 37 CFR 1.10, he or she will receive the benefit of the Saturday date, even though the Office is closed on Saturdays and, therefore, the person could not have filed the

application by depositing it directly at the Office on that Saturday. See 37 CFR 1.6(a)(1). In those cases where the procedure of 37 CFR 1.10(a) has not been properly followed, e.g., the "date-in" is illegible, the filing date of the correspondence will be the date of actual receipt in the Office. An applicant may file a petition under the conditions specified in 37 CFR 1.10(c), (d) or (e) (discussed below) presenting whatever arguments and evidence that the paper or fee is entitled to a filing date other than the filing date accorded by the Office.

>

## **II. < DATE-IN, DIRECT DEPOSIT, "EXPRESS MAIL" BOX RECEPTACLES & LOG BOOKS**

The procedure in 37 CFR 1.10(a) requires the use of the "Express Mail Post Office to Addressee" service of the USPS. This service provides for the use of a mailing label on which the USPS clearly indicates the date on which it was deposited. Correspondence sent by the "Express Mail Post Office to Addressee" service is considered filed in the Office on the "date-in" entered by the USPS. The "date-in" on the "Express Mail" mailing label must be completed by the USPS, not by the applicant. For correspondence filed in accordance with 37 CFR 1.10, Office personnel will routinely look to the "Express Mail" mailing label, and stamp the "date-in" or other official USPS notation as the filing date of the correspondence. Accordingly, if the USPS enters the deposit date as its "date-in," the correspondence will receive the deposit date as its filing date. If the USPS deposit date cannot be determined, the correspondence will be accorded the date of receipt in the Office as the filing date. An applicant may file a petition under the conditions specified in 37 CFR 1.10(c), (d), or (e) (discussed below) presenting whatever arguments and evidence that the paper or fee is entitled to a filing date other than the filing date accorded by the Office.

37 CFR 1.10(b) further provides that correspondence should be deposited directly with an employee of the USPS to ensure that the person depositing the correspondence receives a legible copy of the "Express Mail" mailing label with the "date-in" clearly marked, and that persons dealing indirectly with the employees of the USPS (such as by deposit-

ing correspondence in an “Express Mail” drop box) do so at the risk of not receiving a copy of the “Express Mail” mailing label with the desired “date-in” clearly marked. On petition, the failure to obtain an “Express Mail” receipt with the “date-in” clearly marked may be considered an omission that could have been avoided by the exercise of due care, as discussed below. While the Office strongly urges direct deposit of “Express Mail” correspondence in order to obtain a legible copy of the “Express Mail” mailing label, parties are not precluded from using “Express Mail” drop boxes, but do so at their own risk.

A paper or fee placed in an “Express Mail” box receptacle after the box has been cleared for the last time on a given day will be considered to be deposited as of the date of receipt (“date-in”) indicated on the “Express Mail” mailing label by the Postal Service “Express Mail” acceptance clerk. 37 CFR 1.10(d) permits the Office to correct a USPS “date-in” error when the correspondence is deposited in an “Express Mail” drop box prior to last scheduled pick up of the day, that is, the time clearly marked on the “Express Mail” drop box indicating when the box will be cleared for the last time on the date of deposit. 37 CFR 1.10(d) sets forth the procedures to be followed to be entitled to such a correction.

Parties who do use drop boxes can protect themselves from uncertainty due to illegible mailing labels by routinely maintaining a log of “Express Mail” deposits in which notations are entered by the person who deposited the correspondence as “Express Mail” within one business day after deposit with the USPS. Such evidence could be useful to later support a petition filed under 37 CFR 1.10(c), (d) or (e). Evidence that came into being after deposit and within one day after the deposit of the correspondence as “Express Mail” may be in the form of a log book which contains information such as the “Express Mail” number; the application number, attorney docket number or other such file identification number; the place, date and time of deposit; the time of the last scheduled pick-up for that date and place of deposit; the depositor’s initials or signature; and the date and time of entry in the log.

&gt;

### III. < “EXPRESS MAIL” MAILING LABEL NUMBER

Effective December 2, 1996, 37 CFR 1.10(b) no longer requires a certificate of mailing by “Express Mail” or that the “Express Mail” mailing label number be placed on the correspondence prior to mailing. Correspondence deposited with the USPS on or after December 2, 1996, and which is actually received by the Office will not be denied a filing date as of the “date-in” appearing on the “Express Mail” mailing label because the number of the “Express Mail” mailing label was not placed on the correspondence prior to the original mailing. However, if the number of the mailing label did not appear on the correspondence as originally filed, relief will not be granted on petition under 37 CFR 1.10(c) through (e), even if the party who filed the correspondence satisfies the other requirements of 37 CFR 1.10(c), 1.10(d) or 1.10(e). To be effective, the number must be placed on each separate paper and each fee transmittal either directly on the document or by a separate paper firmly and securely attached thereto. In situations wherein the correspondence includes several papers directed to the same application (for example, the specification, drawings, and declaration for a new application), the correspondence may be submitted with a cover or transmittal letter which should itemize the papers. It is not necessary that the number be placed on each page of a particular paper or fee transmittal. Merely placing the number in one prominent location on each separate paper or fee transmittal (or cover sheet or transmittal letter which should itemize the separate papers and fees) will be sufficient.

Since the filing of correspondence under 37 CFR 1.10 without the number of the “Express Mail” mailing label thereon is an oversight that can be avoided by the exercise of reasonable care, requests for waiver of this requirement will not be granted on petition. A party’s inadvertent failure to comply with the requirements of a rule is not deemed to be an extraordinary situation that would warrant waiver of a rule under 37 CFR 1.183, 2.146(a)(5) or 2.148, nor is such an inadvertent omission considered “unavoidable,” within the meaning of 15 U.S.C. 1062(b), 35 U.S.C. 133, 37 CFR 1.137(a) or 37 CFR 2.66(a). See *Honigsbaum v. Lehman*, 903 F. Supp. 8, 37 USPQ2d 1799

(D.D.C. 1995) (Commissioner did not abuse his discretion in refusing to waive requirements of 37 CFR 1.10(c) in order to grant filing date to patent application, where applicant failed to produce “Express Mail” customer receipt or any other evidence that application was actually deposited with USPS as “Express Mail.”), *aff’d without opinion*, 95 F.3d 1166 (Fed. Cir. 1996); *Nitto Chemical Industry Co., Ltd. v. Comer*, 39 USPQ2d 1778, 1782 (D.D.C. 1994) (Commissioner’s refusal to waive requirements of 37 CFR 1.10 in order to grant priority filing date to patent application not arbitrary and capricious, because failure to comply with the requirements of 37 CFR 1.10 is an “avoidable” oversight that could have been prevented by the exercise of ordinary care or diligence, and thus not an extraordinary situation under 37 CFR 1.183.); *Vincent v. Mossinghoff*, 230 USPQ 621 (D.D.C. 1985) (misunderstanding of 37 CFR 1.8 not unavoidable delay in responding to Office Action); *Gustafson v. Strange*, 227 USPQ 174 (Comm’r Pat. 1985) (counsel’s unawareness of 37 CFR 1.8 not extraordinary situation warranting waiver of a rule); *In re Chicago Historical Antique Automobile Museum, Inc.*, 197 USPQ 289 (Comm’r Pat. 1978) (since certificate of mailing procedure under 37 CFR 1.8 was available to petitioner, lateness due to mail delay not deemed to be extraordinary situation).

>

#### IV. < PETITIONS

37 CFR 1.10(c) through 1.10(e) set forth procedures for petitioning the \*>Director< to accord a filing date as of the date of deposit as “Express Mail.” Briefly, 37 CFR 1.10(c) applies where there is a discrepancy between the filing date accorded by the Office and the “date-in” entered by the USPS on the “Express Mail” mailing label or other official USPS notation; 37 CFR 1.10(d) applies where the “date-in” is incorrectly entered by the USPS; and 37 CFR 1.10(e) applies where correspondence deposited with the USPS as “Express Mail” is not received by the Office.

>

#### V. < PETITION TO CORRECT FILING DATE AND DATE-IN DISCREPANCY

37 CFR 1.10(c) sets forth procedures for filing a petition to the \*>Director< for a filing date as of the date of deposit with the USPS, where there is a discrepancy between the filing date initially accorded by the Office and the “date-in” entered by the USPS or other official USPS notation. Such a petition should:

(A) be filed promptly after the person becomes aware that the Office has accorded, or will accord, a filing date other than the USPS deposit date;

(B) include a showing that the number of the “Express Mail” mailing label was placed on each piece of correspondence prior to the original mailing; and

(C) include a true copy of the “Express Mail” mailing label showing the “date-in” or other official notation by the USPS.

>

#### VI. < PETITION TO CORRECT INCORRECTLY ENTERED DATE-IN

37 CFR 1.10(d) sets forth procedures for filing a petition to the \*>Director< to accord a filing date as of the actual date of deposit with the USPS, where the “date-in” or other official notation is incorrectly entered by the USPS. Such a petition should:

(A) be filed promptly after the person becomes aware that the Office has accorded, or will accord, a filing date based upon an incorrect entry by the USPS;

(B) include a showing that the number of the “Express Mail” mailing label was placed on each piece of correspondence prior to the original mailing; and

(C) include a showing that the correspondence was deposited as “Express Mail” prior to the last scheduled pickup on the requested filing date.

The showing under 37 CFR 1.10(d) must be corroborated by (1) evidence from the USPS, or (2) evidence that came into being after deposit and within one business day of the deposit of the correspondence as “Express Mail.” Evidence from the USPS may be the “Express Mail” Corporate Account Mailing Statement. Evidence that came into being within one day

after the deposit of the correspondence as “Express Mail” may be in the form of a log book which contains information such as the “Express Mail” number; the application number, attorney docket number or other such file identification number; the place, date and time of deposit; the time of the last scheduled pick-up for that date and place of deposit; the depositor’s initials or signature; and the date and time of entry in the log.

The reason the Office considers correspondence to have been filed as of the date of deposit as “Express Mail” is that this date has been verified by a disinterested USPS employee, through the insertion of a “date-in,” or other official USPS notation, on the “Express Mail” mailing label. Due to the questionable reliability of evidence from a party other than the USPS that did not come into being contemporaneously with the deposit of the correspondence with the USPS, 37 CFR 1.10(d) specifically requires that any petition under 37 CFR 1.10(d) be corroborated either by evidence from the USPS, or by evidence that came into being after deposit and within one business day after the deposit of the correspondence as “Express Mail.”

A petition alleging that the USPS erred in entering the “date-in” will be denied if it is supported only by evidence (other than from the USPS) which was:

(A) created prior to the deposit of the correspondence as “Express Mail” with the USPS (e.g., an application transmittal cover letter, or a client letter prepared prior to the deposit of the correspondence); or

(B) created more than one business day after the deposit of the correspondence as “Express Mail” (e.g., an affidavit or declaration prepared more than one business day after the correspondence was deposited with the USPS as “Express Mail”).

On the other hand, a notation in a log book, entered after deposit by the person who deposited the correspondence as “Express Mail” within one business day of such deposit, setting forth the items indicated above, would be deemed on petition to be an adequate showing of the date of deposit under 37 CFR 1.10(d)(3).

37 CFR 1.10(d)(3) further provides that a party must show that correspondence was deposited as “Express Mail” before the last scheduled pickup on

the requested filing date in order to obtain a filing date as of that date.

>

## VII. < PETITION FOR CORRESPONDENCE NEVER RECEIVED

37 CFR 1.10(e) sets forth procedures for filing a petition to the \*>Director< to accord a filing date as of the date of deposit with the USPS, where correspondence deposited as “Express Mail” is never received by the Office. Such a petition should:

(A) be filed promptly after the person becomes aware that the Office has no evidence of receipt of the correspondence;

(B) include a showing that the number of the “Express Mail” mailing label was placed on each piece of correspondence prior to the original mailing;

(C) include a true copy of the originally deposited correspondence showing the number of the “Express Mail” mailing label thereon, a copy of any returned postcard receipt, a copy of the “Express Mail” mailing label showing the “date-in” or other official notation entered by the USPS; and

(D) include a statement, signed by the person who deposited the documents as “Express Mail” with the USPS, setting forth the date and time of deposit, and declaring that the copies of the correspondence, “Express Mail” mailing label, and returned postcard receipt accompanying the petition are true copies of the correspondence, mailing label and returned postcard receipt originally mailed or received.

37 CFR 1.10(e) provides for the filing of a petition to accord correspondence a filing date as of the date of deposit with the USPS as “Express Mail” only where the correspondence was mailed with sufficient postage and addressed as set out in 37 CFR 1.1(a). There is no corresponding provision that correspondence be properly addressed and mailed with sufficient postage in 37 CFR 1.10(a), (c) and (d), because these sections apply only to correspondence that is actually received by the Office. Correspondence mailed by “Express Mail” that is actually received by the Office will not be denied a filing date as of the date of deposit as “Express Mail” simply because the correspondence was not mailed with sufficient postage or not addressed as set out in 37 CFR 1.1(a).

37 CFR 1.10(e)(3) provides that if the requested filing date is a date other than the “date-in” on the “Express Mail” mailing label, the petition should include a showing under 37 CFR 1.10(d)(3), as discussed above, that the correspondence was deposited as “Express Mail” before the last scheduled pickup on the requested filing date in order to obtain a filing date as of that date. 37 CFR 1.10(e) applies only in those situations in which the correspondence at issue was lost *in toto* (i.e., the entire correspondence was not delivered to the Office). Where there is a dispute as to the contents of correspondence submitted to the Office (e.g., an applicant asserts that three sheets of drawings were submitted under 37 CFR 1.10 with an application, but the Office records indicate receipt of only two sheets of drawings with the application), an applicant may not rely upon the provisions of 37 CFR 1.10(e) to establish what document(s) and/or fee(s) were filed in the Office with such correspondence. Rather, where the records of the Office (e.g., the file of the application) contain any document(s) or fee(s)

corresponding to the contents of the correspondence at issue, the Office will rely upon its official record of the contents of such correspondence in absence of convincing evidence (e.g., a postcard receipt under MPEP § 503 containing specific itemization of the document(s) or fee(s) purported to have been filed with the correspondence at issue) that the Office received and misplaced any document(s) or fee(s) that is not among the official records of the Office.

>

**VIII. < ADDITIONAL EVIDENCE MAY BE REQUIRED**

37 CFR 1.10(f) provides that the Office may require additional evidence to determine whether the correspondence was deposited as “Express Mail” with the USPS on the date in question.





MANUAL OF PATENT EXAMINING PROCEDURE

# Chapter 600 Parts, Form, and Content of Application

<b>601</b>	<b>Content of Provisional and Nonprovisional Applications</b>	605.04(b)	One Full Given Name Required
601.01	Complete Application	605.04(c)	Inventor Changes Name
601.01(a)	Nonprovisional Applications Filed Under 35 U.S.C. 111(a)	605.04(d)	Applicant Unable to Write
601.01(b)	Provisional Applications Filed Under 35 U.S.C. 111(b)	605.04(e)	May Use Title With Signature
601.01(c)	Conversion to or from a Provisional Application	605.04(f)	Signature on Joint Applications - Order of Names
601.01(d)	Application Filed Without All Pages of Specification	605.04(g)	Correction of Inventorship
601.01(e)	Nonprovisional Application Filed Without At Least One Claim	605.05	Administrator, Executor, or Other Legal Representative
601.01(f)	Applications Filed Without Drawings	605.07	Joint Inventors
601.01(g)	Applications Filed Without All Figures of Drawings	<b>606</b>	<b>Title of Invention</b>
601.01(h)	Forms	606.01	Examiner May Require Change in Title
601.02	Power of Attorney **	<b>607</b>	<b>Filing Fee</b>
601.03	Change of Correspondence Address	607.02	Returnability of Fees
601.04	National Stage Requirements of the United States as a Designated Office	<b>608</b>	<b>Disclosure</b>
601.05	Bibliographic Information — Application Data Sheet (ADS)	608.01	Specification
<b>602</b>	<b>Original Oath or Declaration</b>	608.01(a)	Arrangement of Application
602.01	Oath Cannot Be Amended	608.01(b)	Abstract of the Disclosure
602.02	New Oath or Substitute for Original	608.01(c)	Background of the Invention
602.03	Defective Oath or Declaration	608.01(d)	Brief Summary of Invention
602.04	Foreign Executed Oath	608.01(e)	Reservation Clauses Not Permitted
602.04(a)	Foreign Executed Oath Is Ribbioned to Other Application Papers	608.01(f)	Brief Description of Drawings
602.05	Oath or Declaration — Date of Execution	608.01(g)	Detailed Description of Invention
602.05(a)	Oath or Declaration in Continuation and Divisional Applications	608.01(h)	Mode of Operation of Invention
602.06	Non-English Oath or Declaration	608.01(i)	Claims
602.07	Oath or Declaration Filed in United States as a Designated Office	608.01(j)	Numbering of Claims
<b>603</b>	<b>Supplemental Oath or Declaration</b>	608.01(k)	Statutory Requirement of Claims
603.01	Supplemental Oath or Declaration Filed After Allowance	608.01(l)	Original Claims
<b>604</b>	<b>Administration or Execution of Oath</b>	608.01(m)	Form of Claims
604.01	Seal	608.01(n)	Dependent Claims
604.02	Venue	608.01(o)	Basis for Claim Terminology in Description
604.03(a)	Notarial Powers of Some Military Officers	608.01(p)	Completeness
604.04	Consul	608.01(q)	Substitute or Rewritten Specification
604.04(a)	Consul – Omission of Certificate	608.01(r)	Derogatory Remarks About Prior Art in Specification
604.06	By Attorney in Application	608.01(s)	Restoration of Canceled Matter
<b>605</b>	<b>Applicant</b>	608.01(t)	Use in Subsequent Application
605.01	Applicant's Citizenship	608.01(u)	Use of Formerly Filed Incomplete Application
605.02	Applicant's Residence	608.01(v)	Trademarks and Names Used in Trade
605.03	Applicant's Mailing or Post Office Address	608.02	Drawing
605.04(a)	Applicant's Signature and Name	608.02(a)	New Drawing — When Replacement is Required Before Examination
		608.02(b)	Informal Drawings
		608.02(c)	Drawing Print Kept in File Wrapper
		608.02(d)	Complete Illustration in Drawings
		608.02(e)	Examiner Determines Completeness and Consistency of Drawings
		608.02(f)	Modifications in Drawings
		608.02(g)	Illustration of Prior Art
		608.02(h)	**>Replacement< Drawings
		608.02(i)	Transfer of Drawings From Prior Applications
		608.02(m)	Drawing Prints

- 608.02(n) Duplicate Prints in Patentability Report Applications
- 608.02(o) Notations Entered on Drawing
- 608.02(p) Correction of Drawings
- 608.02(q) Conditions Precedent to Amendment of Drawing
- \*\*
- 608.02(t) Cancellation of Figures
- 608.02(v) Drawing Changes Which Require \*>Annotated Sheets<
- 608.02(w) Drawing Changes Which May Be Made Without Applicant's \*>Annotated Sheets<
- 608.02(x) \*\* Drawing Corrections >or Changes Accepted Unless Notified Otherwise<
- 608.02(y) Return of Drawing
- 608.02(z) Allowable Applications Needing Drawing Corrections or Corrected Drawings
- 608.03 Models, Exhibits, Specimens
- 608.03(a) Handling of Models, Exhibits, and Specimens
- 608.04 New Matter
- 608.04(a) Matter Not in Original Specification, Claims, or Drawings
- 608.04(b) New Matter by Preliminary Amendment
- 608.04(c) Review of Examiner's Holding of New Matter
- 608.05 Sequence Listing Table, or Computer Program Listing Appendix Submitted on a Compact Disc
- 608.05(a) Deposit of Computer Program Listings
- 608.05(b) Compact Disc Submissions of Large Tables
- 608.05(c) Compact Disc Submissions of Biosequences

## 609 Information Disclosure Statement

\*\*

## 601 Content of Provisional and Non-provisional Applications [R-2]

### 35 U.S.C. 111. Application

#### (a) IN GENERAL.—

(1) WRITTEN APPLICATION.—An application for patent shall be made, or authorized to be made, by the inventor, except as otherwise provided in this title, in writing to the Director.

#### (2) CONTENTS.—Such application shall include—

- (A) a specification as prescribed by section 112 of this title;
- (B) a drawing as prescribed by section 113 of this title; and
- (C) an oath by the applicant as prescribed by section 115 of this title.

(3) FEE AND OATH.—The application must be accompanied by the fee required by law. The fee and oath may be submitted after the specification and any required drawing are submitted, within such period and under such conditions, includ-

ing the payment of a surcharge, as may be prescribed by the Director.

(4) FAILURE TO SUBMIT.—Upon failure to submit the fee and oath within such prescribed period, the application shall be regarded as abandoned, unless it is shown to the satisfaction of the Director that the delay in submitting the fee and oath was unavoidable or unintentional. The filing date of an application shall be the date on which the specification and any required drawing are received in the Patent and Trademark Office.

#### (b) PROVISIONAL APPLICATION.—

(1) AUTHORIZATION.—A provisional application for patent shall be made or authorized to be made by the inventor, except as otherwise provided in this title, in writing to the Director. Such application shall include—

(A) a specification as prescribed by the first paragraph of section 112 of this title; and

(B) a drawing as prescribed by section 113 of this title.

(2) CLAIM.—A claim, as required by the second through fifth paragraphs of section 112, shall not be required in a provisional application.

#### (3) FEE.—

(A) The application must be accompanied by the fee required by law.

(B) The fee may be submitted after the specification and any required drawing are submitted, within such period and under such conditions, including the payment of a surcharge, as may be prescribed by the Director.

(C) Upon failure to submit the fee within such prescribed period, the application shall be regarded as abandoned, unless it is shown to the satisfaction of the Director that the delay in submitting the fee was unavoidable or unintentional.

(4) FILING DATE.—The filing date of a provisional application shall be the date on which the specification and any required drawing are received in the Patent and Trademark Office.

(5) ABANDONMENT.—Notwithstanding the absence of a claim, upon timely request and as prescribed by the Director, a provisional application may be treated as an application filed under subsection (a). Subject to section 119(e)(3) of this title, if no such request is made, the provisional application shall be regarded as abandoned 12 months after the filing date of such application and shall not be subject to revival after such 12-month period.

(6) OTHER BASIS FOR PROVISIONAL APPLICATION.—Subject to all the conditions in this subsection and section 119(e) of this title, and as prescribed by the Director, an application for patent filed under subsection (a) may be treated as a provisional application for patent.

(7) NO RIGHT OF PRIORITY OR BENEFIT OF EARLIEST FILING DATE.—A provisional application shall not be entitled to the right of priority of any other application under section 119 or 365(a) of this title or to the benefit of an earlier filing date in the United States under section 120, 121, or 365(c) of this title.

(8) APPLICABLE PROVISIONS.—The provisions of this title relating to applications for patent shall apply to provisional applications for patent, except as otherwise provided, and except that provisional applications for patent shall not be subject to sections 115, 131, 135, and 157 of this title.

*37 CFR 1.51. General requisites of an application.*

\*\*&gt;

(a) Applications for patents must be made to the Director of the United States Patent and Trademark Office.<

(b) A complete application filed under § 1.53(b) or § 1.53(d) comprises:

(1) A specification as prescribed by 35 U.S.C. 112, including a claim or claims, see §§ 1.71 to 1.77;

(2) An oath or declaration, see §§ 1.63 and 1.68;

(3) Drawings, when necessary, see §§ 1.81 to 1.85; and

(4) The prescribed filing fee, see § 1.16.

(c) A complete provisional application filed under § 1.53(c) comprises:

(1) A cover sheet identifying:

(i) The application as a provisional application,

(ii) The name or names of the inventor or inventors, (see § 1.41(a)(2)),

(iii) The residence of each named inventor,

(iv) The title of the invention,

(v) The name and registration number of the attorney or agent (if applicable),

(vi) The docket number used by the person filing the application to identify the application (if applicable),

(vii) The correspondence address, and

(viii) The name of the U.S. Government agency and Government contract number (if the invention was made by an agency of the U.S. Government or under a contract with an agency of the U.S. Government);

(2) A specification as prescribed by the first paragraph of 35 U.S.C. 112, see § 1.71;

(3) Drawings, when necessary, see §§ 1.81 to 1.85; and

(4) The prescribed filing fee, see § 1.16.

(d) Applicants are encouraged to file an information disclosure statement in nonprovisional applications. See § 1.97 and § 1.98. No information disclosure statement may be filed in a provisional application.

&gt;

## **I. < GUIDELINES FOR DRAFTING A NON-PROVISIONAL PATENT APPLICATION UNDER 35 U.S.C. 111(a)**

The following guidelines illustrate the preferred layout and content of patent applications filed under 35 U.S.C. 111(a). These guidelines are suggested for the applicant's use. See also 37 CFR 1.77 and MPEP § 608.01(a). If an application data sheet (37 CFR 1.76) is used, data supplied in the application data sheet need not be provided elsewhere in the application except that the citizenship of each inventor must be provided in the oath or declaration under 37 CFR 1.63 even if this information is provided in the application data sheet (see 37 CFR 1.76(b)). If there is a discrepancy between the information submitted in an

application data sheet and the information submitted elsewhere in the application, the application data sheet will control except for the naming of the inventors and the citizenship of the inventors. See MPEP § 601.05.

>A complete application filed under 35 U.S.C. 111(a) comprises a specification, including claims, as prescribed by 35 U.S.C. 112, drawings as prescribed by 35 U.S.C. 113, an oath or declaration as prescribed by 35 U.S.C. 115, and the prescribed filing fee.<

### ***Arrangement and Contents of the Specification***

The following order of arrangement is preferable in framing the specification. See also MPEP § 608.01(a). Each of the lettered items should appear in upper case, without underlining or bold type, as section headings.

(A) Title of the invention. (See MPEP § 606).

(B) Cross-reference to related applications. (See MPEP § 201.11).

(C) Statement regarding federally sponsored research or development. (See MPEP § 310).

(D) Reference to a "Sequence Listing," a table, or a computer program listing appendix submitted on compact disc and an incorporation-by-reference of the material on the compact disc. For computer listings filed on or prior to March 1, 2001, reference to a "Microfiche appendix" (see former 37 CFR 1.96(c) for Microfiche appendix).

(E) Background of the invention. (See MPEP § 608.01(c)).

(1) Field of the invention.

(2) Description of related art including information disclosed under 37 CFR 1.97 and 37 CFR 1.98.

(F) Brief summary of the invention. (See MPEP § 608.01(d)).

(G) Brief description of the several views of the drawing. (See MPEP § 608.01(f)).

(H) Detailed description of the invention. (See MPEP § 608.01(g)).

(I) Claim(s) (commencing on a separate sheet). (See MPEP § 608.01(i)-(p)).

(J) Abstract of the Disclosure (commencing on a separate sheet). (See MPEP § 608.01(b)).

(K) \*\* Sequence Listing, if on paper (See 37 CFR 1.821 through 1.825).

&gt;

## II. < GUIDELINES FOR DRAFTING A PROVISIONAL APPLICATION UNDER 35 U.S.C. 111(b)

A provisional application should preferably conform to the arrangement guidelines for nonprovisional applications. The specification must, however, comply with the first paragraph of 35 U.S.C. 112 and refer to drawings, where necessary for an understanding of the invention. Unlike an application filed under 35 U.S.C. 111(a), a provisional application does not need claims. Furthermore, no oath or declaration is required. See MPEP § 201.04(b).

A cover sheet providing identifying information is required for a complete provisional application. In accordance with 37 CFR 1.51(c)(1) the cover sheet must state that it is for a provisional application, it must identify and give the residence of the inventor or inventors, and it must give a title of the invention. The cover sheet must also give the name and registration number of the attorney or agent (if applicable), the docket number used by the person filing the application (if applicable) and the correspondence address. If there is a governmental interest, the cover sheet must include a statement as to rights to inventions made under Federally sponsored research and development (See MPEP § 310). 37 CFR 1.51(c)(1)(viii) requires the name of the Government agency and the contract number, if the invention was developed by or while under contract with an agency of the U.S. Government.

Unlike applications filed under 35 U.S.C. 111(a), provisional applications should not include an information disclosure statement. See 37 CFR 1.51(d). Since no substantive examination is made, such statements are unnecessary. The Office will not accept an information disclosure statement in a provisional application. Any such statement received, will be returned or disposed of at the convenience of the Office.

This cover sheet information enables the Office to prepare a proper filing receipt and provides the Office of Initial Patent Examining (OIPE) with most of the information needed to process the provisional application. See MPEP § 201.04(b) for a sample cover sheet.

&gt;

## III. < THE APPLICATION

The parts of the application may be included in a single document.

The paper standard requirements for papers submitted as part of the record of a patent application is covered in MPEP § 608.01 under the heading “Paper Requirement.”

Determination of completeness of an application is covered in MPEP § 506 and § 601.01 - § 601.01(g).

The elements of the application are secured together in a file wrapper, bearing appropriate identifying data including the application number and filing date (MPEP § 719).

### Note

Provisional applications, MPEP § 201.04(b).

Divisional applications, MPEP § 201.06.

Continuation applications, MPEP § 201.07.

Continued prosecution applications, MPEP § 201.06(d).

Reissue applications, MPEP § 1401.

Design applications, MPEP Chapter 1500.

Plant applications, MPEP Chapter 1600.

>Ex Parte< Reexamination, MPEP Chapter 2200.

>Inter Partes Reexamination, MPEP Chapter 2600.<

A model, exhibit, or specimen is normally not admitted as part of the application, although it may be required in the prosecution of the application (37 CFR 1.91 and 1.93, MPEP § 608.03).

Copies of an application will be provided by the USPTO upon request and payment of the fee set forth in 37 CFR 1.19(b) unless the application has been disposed of (see 37 CFR 1.53(e), (f) and (g)).

All applicants are requested to include a preliminary classification on newly filed patent applications. The preliminary classification, preferably class and subclass designations, should be identified in the upper right-hand corner of the letter of transmittal accompanying the application papers, or in the application data sheet after the title of the invention (see 37 CFR 1.76(b)(3)), for example “Proposed Class 2, subclass 129.”

## 601.01 Complete Application [R-2]

37 CFR 1.53. *Application number, filing date, and completion of application.*

(a) *Application number.* Any papers received in the Patent and Trademark Office which purport to be an application for a patent will be assigned an application number for identification purposes.

(b) *Application filing requirements - Nonprovisional application.* The filing date of an application for patent filed under this section, except for a provisional application under paragraph (c) of this section or a continued prosecution application under paragraph (d) of this section, is the date on which a specification as prescribed by 35 U.S.C. 112 containing a description pursuant to § 1.71 and at least one claim pursuant to § 1.75, and any drawing required by § 1.81(a) are filed in the Patent and Trademark Office. No new matter may be introduced into an application after its filing date. A continuing application, which may be a continuation, divisional, or continuation-in-part application, may be filed under the conditions specified in 35 U.S.C. 120, 121 or 365(c) and § 1.78(a).

(1) A continuation or divisional application that names as inventors the same or fewer than all of the inventors named in the prior application may be filed under this paragraph or paragraph (d) of this section.

(2) A continuation-in-part application (which may disclose and claim subject matter not disclosed in the prior application) or a continuation or divisional application naming an inventor not named in the prior application must be filed under this paragraph.

(c) *Application filing requirements - Provisional application.* The filing date of a provisional application is the date on which a specification as prescribed by the first paragraph of 35 U.S.C. 112, and any drawing required by § 1.81(a) are filed in the Patent and Trademark Office. No amendment, other than to make the provisional application comply with the patent statute and all applicable regulations, may be made to the provisional application after the filing date of the provisional application.

(1) A provisional application must also include the cover sheet required by § 1.51(c)(1), which may be an application data sheet (§ 1.76), or a cover letter identifying the application as a provisional application. Otherwise, the application will be treated as an application filed under paragraph (b) of this section.

(2) An application for patent filed under paragraph (b) of this section may be converted to a provisional application and be accorded the original filing date of the application filed under paragraph (b) of this section. The grant of such a request for conversion will not entitle applicant to a refund of the fees that were properly paid in the application filed under paragraph (b) of this section. Such a request for conversion must be accompanied by the processing fee set forth in § 1.17(q) and be filed prior to the earliest of:

(i) Abandonment of the application filed under paragraph (b) of this section;

(ii) Payment of the issue fee on the application filed under paragraph (b) of this section;

(iii) Expiration of twelve months after the filing date of the application filed under paragraph (b) of this section; or

(iv) The filing of a request for a statutory invention registration under § 1.293 in the application filed under paragraph (b) of this section.

(3) A provisional application filed under paragraph (c) of this section may be converted to a nonprovisional application filed under paragraph (b) of this section and accorded the original filing date of the provisional application. The conversion of a provisional application to a nonprovisional application will not result in either the refund of any fee properly paid in the provisional application or the application of any such fee to the filing fee, or any other fee, for the nonprovisional application. Conversion of a provisional application to a nonprovisional application under this paragraph will result in the term of any patent to issue from the application being measured from at least the filing date of the provisional application for which conversion is requested. Thus, applicants should consider avoiding this adverse patent term impact by filing a nonprovisional application claiming the benefit of the provisional application under 35 U.S.C. 119(e) (rather than converting the provisional application into a nonprovisional application pursuant to this paragraph). A request to convert a provisional application to a nonprovisional application must be accompanied by the fee set forth in § 1.17(i) and an amendment including at least one claim as prescribed by the second paragraph of 35 U.S.C. 112, unless the provisional application under paragraph (c) of this section otherwise contains at least one claim as prescribed by the second paragraph of 35 U.S.C. 112. The nonprovisional application resulting from conversion of a provisional application must also include the filing fee for a nonprovisional application, an oath or declaration by the applicant pursuant to §§ 1.63, 1.162, or 1.175, and the surcharge required by § 1.16(e) if either the basic filing fee for a nonprovisional application or the oath or declaration was not present on the filing date accorded the resulting nonprovisional application (*i.e.*, the filing date of the original provisional application). A request to convert a provisional application to a nonprovisional application must also be filed prior to the earliest of:

(i) Abandonment of the provisional application filed under paragraph (c) of this section; or

(ii) Expiration of twelve months after the filing date of the provisional application filed under this paragraph (c).

(4) A provisional application is not entitled to the right of priority under 35 U.S.C. 119 or 365(a) or § 1.55, or to the benefit of an earlier filing date under 35 U.S.C. 120, 121 or 365(c) or § 1.78 of any other application. No claim for priority under 35 U.S.C. 119(e) or § 1.78(a)(4) may be made in a design application based on a provisional application. No request under § 1.293 for a statutory invention registration may be filed in a provisional application. The requirements of §§ 1.821 through 1.825 regarding application disclosures containing nucleotide and/or amino acid sequences are not mandatory for provisional applications.

(d) *Application filing requirements - Continued prosecution (nonprovisional) application.*

\*\*>

(1) A continuation or divisional application (but not a continuation-in-part) of a prior nonprovisional application may be filed as a continued prosecution application under this paragraph, provided that:

- (i) The application is for a design patent;
- (ii) The prior nonprovisional application is a design application that is complete as defined by § 1.51(b); and
- (iii) The application under this paragraph is filed before the earliest of:
  - (A) Payment of the issue fee on the prior application, unless a petition under § 1.313(c) is granted in the prior application;
  - (B) Abandonment of the prior application; or
  - (C) Termination of proceedings on the prior application.<

(2) The filing date of a continued prosecution application is the date on which a request on a separate paper for an application under this paragraph is filed. An application filed under this paragraph:

- (i) Must identify the prior application;
- (ii) Discloses and claims only subject matter disclosed in the prior application;
- (iii) Names as inventors the same inventors named in the prior application on the date the application under this paragraph was filed, except as provided in paragraph (d)(4) of this section;
- (iv) Includes the request for an application under this paragraph, will utilize the file jacket and contents of the prior application, including the specification, drawings and oath or declaration from the prior application, to constitute the new application, and will be assigned the application number of the prior application for identification purposes; and
- (v) Is a request to expressly abandon the prior application as of the filing date of the request for an application under this paragraph.

\*\*>

(3) The filing fee for a continued prosecution application filed under this paragraph is the basic filing fee as set forth in § 1.16(f).

(4) An application filed under this paragraph may be filed by fewer than all the inventors named in the prior application, provided that the request for an application under this paragraph when filed is accompanied by a statement requesting deletion of the name or names of the person or persons who are not inventors of the invention being claimed in the new application. No person may be named as an inventor in an application filed under this paragraph who was not named as an inventor in the prior application on the date the application under this paragraph was filed, except by way of correction of inventorship under § 1.48.

(5) Any new change must be made in the form of an amendment to the prior application as it existed prior to the filing of an application under this paragraph. No amendment in an application under this paragraph (a continued prosecution application) may introduce new matter or matter that would have been new

matter in the prior application. Any new specification filed with the request for an application under this paragraph will not be considered part of the original application papers, but will be treated as a substitute specification in accordance with § 1.125.

(6) The filing of a continued prosecution application under this paragraph will be construed to include a waiver of confidentiality by the applicant under 35 U.S.C. 122 to the extent that any member of the public, who is entitled under the provisions of § 1.14 to access to, copies of, or information concerning either the prior application or any continuing application filed under the provisions of this paragraph, may be given similar access to, copies of, or similar information concerning the other application or applications in the file jacket.

(7) A request for an application under this paragraph is the specific reference required by 35 U.S.C. 120 to every application assigned the application number identified in such request. No amendment in an application under this paragraph may delete this specific reference to any prior application.

(8) In addition to identifying the application number of the prior application, applicant should furnish in the request for an application under this paragraph the following information relating to the prior application to the best of his or her ability:

- (i) Title of invention;
- (ii) Name of applicant(s); and
- (iii) Correspondence address.

\*\*>

(9) Envelopes containing only requests and fees for filing an application under this paragraph should be marked "Box CPA." Requests for an application under this paragraph filed by facsimile transmission should be clearly marked "Box CPA."<

(10) See § 1.103(b) for requesting a limited suspension of action in an application filed under this paragraph.

(e) *Failure to meet filing date requirements.*

\*\*>

(1) If an application deposited under paragraph (b), (c), or (d) of this section does not meet the requirements of such paragraph to be entitled to a filing date, applicant will be so notified, if a correspondence address has been provided, and given a period of time within which to correct the filing error. If, however, a request for an application under paragraph (d) of this section does not meet the requirements of that paragraph because the application in which the request was filed is not a design application, and if the application in which the request was filed was itself filed on or after June 8, 1995, the request for an application under paragraph (d) of this section will be treated as a request for continued examination under § 1.114.

(2) Any request for review of a notification pursuant to paragraph (e)(1) of this section, or a notification that the original application papers lack a portion of the specification or drawing(s), must be by way of a petition pursuant to this paragraph accompanied by the fee set forth in § 1.17(h). In the absence of a timely (§ 1.181(f)) petition pursuant to this paragraph, the filing date of an application in which the applicant was notified of a filing error pursuant to paragraph (e)(1) of this section will be the date the filing error is corrected.

(3) If an applicant is notified of a filing error pursuant to paragraph (e)(1) of this section, but fails to correct the filing error

within the given time period or otherwise timely (§ 1.181(f)) take action pursuant to this paragraph, proceedings in the application will be considered terminated. Where proceedings in an application are terminated pursuant to this paragraph, the application may be disposed of, and any filing fees, less the handling fee set forth in § 1.21(n), will be refunded.

(f) *Completion of application subsequent to filing—nonprovisional (including continued prosecution or reissue) application.*

(1) If an application which has been accorded a filing date pursuant to paragraph (b) or (d) of this section does not include the basic filing fee, or if an application which has been accorded a filing date pursuant to paragraph (b) of this section does not include an oath or declaration by the applicant pursuant to §§ 1.63, 1.162 or § 1.175, and applicant has provided a correspondence address (§ 1.33(a)), applicant will be notified and given a period of time within which to pay the filing fee, file an oath or declaration in an application under paragraph (b) of this section, and pay the surcharge required by § 1.16(e) to avoid abandonment.

(2) If an application which has been accorded a filing date pursuant to paragraph (b) of this section does not include the basic filing fee or an oath or declaration by the applicant pursuant to §§ 1.63, 1.162 or § 1.175, and applicant has not provided a correspondence address (§ 1.33(a)), applicant has two months from the filing date of the application within which to pay the basic filing fee, file an oath or declaration, and pay the surcharge required by § 1.16(e) to avoid abandonment.

(3) This paragraph applies to continuation or divisional applications under paragraphs (b) or (d) of this section and to continuation-in-part applications under paragraph (b) of this section.

(4) See § 1.63(d) concerning the submission of a copy of the oath or declaration from the prior application for a continuation or divisional application under paragraph (b) of this section.

(5) If applicant does not pay one of the basic filing or the processing and retention fees (§ 1.21(l)) during the pendency of the application, the Office may dispose of the application.

(g) *Completion of application subsequent to filing—provisional application.*

(1) If a provisional application which has been accorded a filing date pursuant to paragraph (c) of this section does not include the cover sheet required by § 1.51(c)(1) or the basic filing fee (§ 1.16(k)), and applicant has provided a correspondence address (§ 1.33(a)), applicant will be notified and given a period of time within which to pay the basic filing fee, file a cover sheet (§ 1.51(c)(1)), and pay the surcharge required by § 1.16(l) to avoid abandonment.

(2) If a provisional application which has been accorded a filing date pursuant to paragraph (c) of this section does not include the cover sheet required by § 1.51(c)(1) or the basic filing fee (§ 1.16(k)), and applicant has not provided a correspondence address (§ 1.33(a)), applicant has two months from the filing date of the application within which to pay the basic filing fee, file a cover sheet (§ 1.51(c)(1)), and pay the surcharge required by § 1.16(l) to avoid abandonment.

(3) If applicant does not pay the basic filing fee during the pendency of the application, the Office may dispose of the application.

(h) *Subsequent treatment of application - Nonprovisional (including continued prosecution) application.* An application for a patent filed under paragraphs (b) or (d) of this section will not be placed on the files for examination until all its required parts, complying with the rules relating thereto, are received, except that certain minor informalities may be waived subject to subsequent correction whenever required.

(i) *Subsequent treatment of application - Provisional application.* A provisional application for a patent filed under paragraph (c) of this section will not be placed on the files for examination and will become abandoned no later than twelve months after its filing date pursuant to 35 U.S.C. 111(b)(1).

(j) *Filing date of international application.* The filing date of an international application designating the United States of America is treated as the filing date in the United States of America under PCT Article 11(3), except as provided in 35 U.S.C. 102(e).

37 CFR 1.53 relates to application numbers, filing dates, and completion of applications. 37 CFR 1.53(a) indicates that an application number is assigned for identification purposes to any paper which purports to be an application for a patent, even if the application is incomplete or informal. The remaining sections of 37 CFR 1.53 treat nonprovisional applications filed under 35 U.S.C. 111(a) separately from provisional applications filed under 35 U.S.C. 111(b).

37 CFR 1.53(d) sets forth the filing date requirements for a continued prosecution application (CPA). A CPA is a nonprovisional application which must be filed on or after December 1, 1997. Only a continuation or divisional application (but not a continuation-in-part) may be filed as a CPA. See MPEP § 201.06(d). \*\* >Effective July 14, 2003, CPA practice under 37 CFR 1.53(d) does not apply to utility and plant applications. CPAs can only be filed in design applications.<

## **601.01(a) Nonprovisional Applications Filed Under 35 U.S.C. 111(a) [R-2]**

The procedure for filing a nonprovisional application under 35 U.S.C. 111(a) is set forth in 37 CFR 1.53(b) and 37 CFR 1.53(d). 37 CFR 1.53(b) may be used to file any original, reissue, or substitute nonprovisional application and any continuing application, i.e., continuation, divisional, or continuation-in-part. Under 37 CFR 1.53(b), a filing date is assigned to a nonprovisional application as of the date a specification containing a description and claim and any necessary drawings are filed in the U.S. Patent and



Trademark Office (USPTO). Failure to meet any of the requirements in 37 CFR 1.53(b) will result in the application being denied a filing date. The filing date to be accorded such an application is the date on which all of the requirements of 37 CFR 1.53(b) are met.

37 CFR 1.53(d) may be used to file either a continuation or a divisional application (but not a continuation-in-part) of a design application. The prior nonprovisional application must be a design application that is complete as defined by 37 CFR 1.51(b). Any application filed under 37 CFR 1.53(d) must disclose and claim only subject matter disclosed in the prior nonprovisional application and must name as inventors the same or less than all of the inventors named in the prior nonprovisional application. Under 37 CFR 1.53(d), the filing date assigned is the date on which a request, on a separate paper, for an application under 37 CFR 1.53(d) is filed. An application filed under 37 CFR 1.53(d) must be filed before the earliest of:

- (A) payment of the issue fee on the prior application, unless a petition under 37 CFR 1.313(c) is granted in the prior application;
- (B) abandonment of the prior application; or
- (C) termination of proceedings on the prior application.

The filing fee for an application filed under 37 CFR 1.53(b) or 37 CFR 1.53(d) and the oath or declaration for an application filed under 37 CFR 1.53(b) can be submitted after the filing date. However, no amendment may introduce new matter into the disclosure of an application after its filing date.

37 CFR 1.53(e) provides for notifying applicant of any application which is incomplete under 37 CFR 1.53(b) or 37 CFR 1.53(d) and giving the applicant a time period to correct any omission. If the omission is not corrected within the time period given, the application will be returned or otherwise disposed of and a handling fee set forth in 37 CFR 1.21(n) will be retained from any refund of a filing fee.

37 CFR 1.53(f) provides that, where a filing date has been assigned to an application filed under 37 CFR 1.53(b) or 37 CFR 1.53(d), the applicant will be notified if a correspondence address has been provided and be given a period of time in which to file the missing fee, oath or declaration, and to pay the

surcharge due in order to prevent abandonment of the application. The time period usually set is 2 months from the mailing date of notification by the USPTO. This time period may be extended under 37 CFR 1.136(a).

If the required basic filing fee is not timely paid, or the processing and retention fee set forth in 37 CFR 1.21(l) is not paid during the pendency of the application, the application will be disposed of. The notification under 37 CFR 1.53(f) may be made simultaneously with any notification pursuant to 37 CFR 1.53(e). If no correspondence address is included in the application, applicant has 2 months from the filing date to file the fee, oath or declaration and to pay the surcharge as set forth in 37 CFR 1.16(e) in order to prevent abandonment of the application.

Copies of an application will be provided by the USPTO upon request and payment of the fee set forth in 37 CFR 1.19(b) unless the application has been disposed of (see 37 CFR 1.53(e) and (f)). The basic filing fee or the processing and retention fee must be paid in a nonprovisional application, if any claim for benefits under 35 U.S.C. 120, 121, or 365(c) based on that application is made in a subsequently filed copending nonprovisional application. 37 CFR 1.78(a)(1).

37 CFR 1.53(h) indicates that a patent application will not be forwarded for examination on the merits until all required parts have been received. 37 CFR 1.53(j) indicates that international applications filed under the Patent Cooperation Treaty which designate the United States of America are considered to have a United States filing date under PCT Article 11(3), except as provided in 35 U.S.C. 102(e), on the date the requirements of PCT Article 11(1) (i) to (iii) are met.

In accordance with the provisions of 35 U.S.C. 111(a) and 37 CFR 1.53(b), a filing date is granted to a nonprovisional application for patent, which includes at least a specification containing a description pursuant to 37 CFR 1.71 and at least one claim pursuant to 37 CFR 1.75, and any drawing referred to in the specification or required by 37 CFR 1.81(a), which is filed in the U.S. Patent and Trademark Office. If an application which has been accorded a filing date does not include the appropriate filing fee or oath or declaration, applicant will be so notified and given a period of time within which to file the missing parts to complete the application and to pay

the surcharge as set forth in 37 CFR 1.16(e) in order to prevent abandonment of the application.

Applicants should submit a copy of the notice(s) to file missing parts and the notice(s) of incomplete applications with the reply submitted to the U.S. Patent and Trademark Office. Applicants should also include the application number on all correspondence to the Office. These measures will aid the Office in matching papers to applications, thereby expediting the processing of applications.

In order for the Office to so notify the applicant, a correspondence address must also be provided in the application. The \*>correspondence< address may be different from the mailing (post office) address of the applicant. For example, the address of applicant's registered attorney or agent may be used as the correspondence address. If applicant fails to provide the Office with a correspondence address, the Office will be unable to provide applicant with notification to complete the application and to pay the surcharge as set forth in 37 CFR 1.16(e). In such a case, applicant will be considered to have constructive notice as of the filing date that the application must be completed within 2 months from the filing date before abandonment occurs per 37 CFR 1.53(f). This time period may be extended pursuant to 37 CFR 1.136.

The oath or declaration filed in reply to such a notice under 37 CFR 1.53(f) must be executed by the inventors and must identify the specification and any amendment filed with the specification which is intended to be part of the original disclosure. See MPEP § 602. If an amendment is filed with the oath or declaration filed after the filing date of the application, it may be identified in the oath or declaration but may not include new matter. No new matter may be included after the filing date of the application. See MPEP § 608.04(b). If the oath or declaration improperly refers to an amendment containing new matter, a supplemental oath or declaration will be required pursuant to 37 CFR 1.67(b), deleting the reference to the amendment containing new matter. If an amendment is filed on the same day that the application filed under 37 CFR 1.53(b) is filed and is referred to in the original oath or declaration filed with or after the application, it constitutes a part of the original application papers and the question of new matter is not considered. Similarly, if the application papers are altered prior to execution of the oath or declaration

and the filing of the application, new matter is not a consideration since the alteration is considered as part of the original disclosure.

\*\*

### **601.01(b) Provisional Applications Filed Under 35 U.S.C. 111(b)**

A provisional application will be given a filing date in accordance with 37 CFR 1.53(c) as of the date the written description and any necessary drawings are filed in the Office. The filing date requirements for a provisional application set forth in 37 CFR 1.53(c) parallel the requirements for a nonprovisional application set forth in 37 CFR 1.53(b), except that no claim is required. Amendments, other than those required to make the provisional application comply with applicable regulations, are not permitted after the filing date of the provisional application.

When the specification or drawing are omitted, 37 CFR 1.53(e) requires that the applicant be notified and given a time period in which to submit the missing element to complete the filing. See MPEP § 601.01(f) and § 601.01(g) for treatment of applications filed without drawings, or filed without all figures of drawings, respectively.

37 CFR 1.53(c)(1) requires all provisional applications be filed with a cover sheet, which may be an application data sheet (37 CFR 1.76) or a cover letter identifying the application as a provisional application. The Office will treat an application as having been filed under paragraph (b), unless the application is clearly identified as a provisional application. A provisional application, which is identified as such, but which does not have a complete cover sheet as required by 37 CFR 1.51(c)(1) will be treated as a provisional application. However, the complete cover sheet and a surcharge will be required to be submitted at a later date in conformance with 37 CFR 1.53(g).

When the provisional application does not have a complete cover sheet or the appropriate fee, the applicant will be notified pursuant to 37 CFR 1.53(g) and given a time period in which to provide the necessary fee or cover sheet and to pay the surcharge as set forth in 37 CFR 1.16(l) in order to avoid abandonment of the application. The time period will usually be set at 2 months from the date of notification. This time period may be extended under 37 CFR 1.136(a). If the filing fee is not timely paid, the Office may dispose of

the provisional application. If no correspondence address has been provided, applicant has 2 months from the filing date to file the basic filing fee, cover sheet, and to pay the surcharge as set forth in 37 CFR 1.16(l) in order to avoid abandonment of the provisional application. Copies of a provisional application will be provided by the USPTO upon request and payment of the fee set forth in 37 CFR 1.19(b) unless the provisional application has been disposed of (see 37 CFR 1.53(e) and (g)).

The basic filing fee must be paid in a provisional application on filing or within the time period set forth in 37 CFR 1.53(g), and the provisional application must be entitled to a filing date under 37 CFR 1.53(c), if any claim for benefits under 35 U.S.C. 119(e) based on that application is made in a subsequently filed nonprovisional application. 37 CFR 1.78(a)(4).

37 CFR 1.53(e)(2) requires that any request for review of a refusal to accord an application a filing date be made by way of a petition accompanied by the fee set forth in 37 CFR 1.17(h) (see MPEP § 506.02).

### **601.01(c) Conversion to or From a Provisional Application [R-2]**

>

#### **I. < CONVERSION FROM A NONPROVISIONAL APPLICATION TO A PROVISIONAL APPLICATION**

*37 CFR 1.53. Application number, filing date, and completion of application.*

\*\*\*\*\*

(c)(2)An application for patent filed under paragraph (b) of this section may be converted to a provisional application and be accorded the original filing date of the application filed under paragraph (b) of this section. The grant of such a request for conversion will not entitle applicant to a refund of the fees that were properly paid in the application filed under paragraph (b) of this section. Such a request for conversion must be accompanied by the processing fee set forth in § 1.17(q) and be filed prior to the earliest of:

- (i) Abandonment of the application filed under paragraph (b) of this section;
- (ii) Payment of the issue fee on the application filed under paragraph (b) of this section;

(iii) Expiration of twelve months after the filing date of the application filed under paragraph (b) of this section; or

(iv) The filing of a request for a statutory invention registration under § 1.293 in the application filed under paragraph (b) of this section.

\*\*\*\*\*

An application filed under 37 CFR 1.53(b) may be converted to a provisional application in accordance with the procedure described in 37 CFR 1.53(c)(2). The procedure requires the filing of a request for conversion and the processing fee set forth in 37 CFR 1.17(q). Filing of the request in the nonprovisional application is required prior to the abandonment of the 37 CFR 1.53(b) application, the payment of the issue fee, the expiration of 12 months after the filing date of the 37 CFR 1.53(b) application, or the filing of a request for a statutory invention registration under 37 CFR 1.293, whichever event is earlier. The grant of any such request does not entitle applicant to a refund of the fees properly paid in the application filed under 37 CFR 1.53(b).

>Converting a nonprovisional application to a provisional application will not avoid the publication of the nonprovisional application unless the request to convert is recognized in sufficient time to permit the appropriate officials to remove the nonprovisional application from the publication process. The Office cannot ensure that it can remove an application from publication or avoid publication of application information any time after the publication process for the application has been initiated. For information on procedures for removing an application from publication, see MPEP § 1120.

A provisional application is not entitled to claim priority to or benefit of a prior-filed application under 35 U.S.C. 119, 120, 121, or 365. See MPEP § 201.04(b). After the nonprovisional application has been converted to a provisional application, any priority or benefit claims submitted in the nonprovisional application will be disregarded.

Applicants who wish to file a request for conversion under 37 CFR 1.53(c)(2) by mail should designate "Mail Stop Conversion" as part of the U. S. Patent and Trademark Office address.

## II. < CONVERSION FROM A PROVISIONAL APPLICATION TO A NONPROVISIONAL APPLICATION

37 CFR 1.53. *Application number, filing date, and completion of application.*

\*\*\*\*\*

(c)(3) A provisional application filed under paragraph (c) of this section may be converted to a nonprovisional application filed under paragraph (b) of this section and accorded the original filing date of the provisional application. The conversion of a provisional application to a nonprovisional application will not result in either the refund of any fee properly paid in the provisional application or the application of any such fee to the filing fee, or any other fee, for the nonprovisional application. Conversion of a provisional application to a nonprovisional application under this paragraph will result in the term of any patent to issue from the application being measured from at least the filing date of the provisional application for which conversion is requested. Thus, applicants should consider avoiding this adverse patent term impact by filing a nonprovisional application claiming the benefit of the provisional application under 35 U.S.C. 119(e) (rather than converting the provisional application into a nonprovisional application pursuant to this paragraph). A request to convert a provisional application to a nonprovisional application must be accompanied by the fee set forth in § 1.17(i) and an amendment including at least one claim as prescribed by the second paragraph of 35 U.S.C. 112, unless the provisional application under paragraph (c) of this section otherwise contains at least one claim as prescribed by the second paragraph of 35 U.S.C. 112. The nonprovisional application resulting from conversion of a provisional application must also include the filing fee for a nonprovisional application, an oath or declaration by the applicant pursuant to §§ 1.63, 1.162, or 1.175, and the surcharge required by § 1.16(e) if either the basic filing fee for a nonprovisional application or the oath or declaration was not present on the filing date accorded the resulting nonprovisional application (*i.e.*, the filing date of the original provisional application). A request to convert a provisional application to a nonprovisional application must also be filed prior to the earliest of:

- (i) Abandonment of the provisional application filed under paragraph (c) of this section; or
- (ii) Expiration of twelve months after the filing date of the provisional application filed under this paragraph (c).

\*\*\*\*\*

An application filed under 37 CFR 1.53(c) may be converted to a nonprovisional application in accordance with the procedure described in 37 CFR 1.53(c)(3). Applicants should carefully consider the patent term consequences of requesting conversion rather than simply filing a nonprovisional application claiming the benefit of the filing date of the provisional application under 35 U.S.C. 119(e). Claiming

priority is less expensive and will result in a longer patent term. The procedure requires the filing of a request for the conversion of the provisional application to a nonprovisional application and the fee set forth in 37 CFR 1.17(i) as well as the basic filing fee for the nonprovisional application. In addition, if the provisional application was not filed with an executed oath or declaration and the filing fee for a non-provisional application, the surcharge set forth in 37 CFR 1.16(e) is required. Filing of the request for conversion in the provisional application is required prior to the abandonment of the provisional application or the expiration of 12 months after the filing date of the 37 CFR 1.53(c) application, whichever event is earlier. The grant of any such request does not entitle applicant to a refund of the fees properly paid in the application filed under 37 CFR 1.53(c).

>Applicants who wish to file a request for conversion under 37 CFR 1.53(c)(3) by mail should designate “Mail Stop Conversion” as part of the U. S. Patent and Trademark Office address.<

### 601.01(d) Application Filed Without All Pages of Specification [R-2]

The Office of Initial Patent Examination (OIPE) reviews application papers to determine whether all of the pages of specification are present in the application. If the application is filed without all of the page(s) of the specification, but containing something that can be construed as a written description, at least one drawing figure, if necessary under 35 U.S.C. 113 (first sentence), and, in a nonprovisional application, at least one claim, OIPE will mail a “Notice of Omitted Items” indicating that the application papers so deposited have been accorded a filing date, but are lacking some page(s) of the specification.

The mailing of a “Notice of Omitted Items” will permit the applicant to either: (1) promptly establish prior receipt in the USPTO of the page(s) at issue (generally by way of a date-stamped >itized< postcard receipt (MPEP § 503)); or (2) promptly submit the omitted page(s) in a nonprovisional application and accept the date of such submission as the application filing date. An applicant asserting that the page(s) was in fact deposited in the USPTO with the application papers must, within 2 months from the date of the “Notice of Omitted Item(s)”, file a petition under 37 CFR 1.53(e) with the petition fee set forth in 37 CFR

1.17(h), along with evidence of such deposit (37 CFR 1.181(f)). The petition fee will be refunded if it is determined that the page(s) was in fact received by the USPTO with the application papers deposited on filing. An applicant desiring to submit the omitted page(s) in a nonprovisional application and accept the date of such submission as the application filing date must, within 2 months from the date of the “Notice of Omitted Item(s),” file any omitted page(s) with an oath or declaration in compliance with 37 CFR 1.63 and 37 CFR 1.64 referring to such page(s) and a petition under 37 CFR 1.182 with the petition fee set forth in 37 CFR 1.17(h), requesting the later filing date (37 CFR 1.181(f)).

An applicant willing to accept the application as deposited in the USPTO need not respond to the “Notice of Omitted Items,” and the failure to file a petition under 37 CFR 1.53(e) or 37 CFR 1.182 (and the required petition fee) as discussed above within 2 months of the date of the “Notice of Omitted Item(s)” (37 CFR 1.181(f)) will be treated as constructive acceptance by applicant of the application as deposited in the USPTO. Amendment of the specification is required in a nonprovisional application to renumber the pages consecutively and cancel any incomplete sentences caused by the absence of the omitted page(s). Such amendment should be by way of preliminary amendment submitted prior to the first Office action to avoid delays in the prosecution of the application.

If the application does not contain anything that can be construed as a written description, OIPE will mail a Notice of Incomplete Application (PTO-1123) indicating that the application lacks the specification required by 35 U.S.C. 112. Applicant may file a petition under 37 CFR 1.53(e) with the petition fee set forth in 37 CFR 1.17(h), asserting that: (1) the missing specification was submitted; or (2) the application papers as deposited contain an adequate written description under 35 U.S.C. 112. The petition under 37 CFR 1.53(e) must be accompanied by sufficient evidence (37 CFR 1.181(b)) to establish applicant’s entitlement to the requested filing date (e.g., a date-stamped postcard receipt (MPEP § 503) to establish prior receipt in the USPTO of the missing specification). Alternatively, applicant may submit the omitted specification, including at least one claim in a nonprovisional application, accompanied by an oath or dec-

laration in compliance with 37 CFR 1.63 and 37 CFR 1.64 referring to the specification being submitted and accept the date of such submission as the application filing date.

Original claims form part of the original disclosure and provide their own written description. See *In re Anderson*, 471 F.2d 1237, 176 USPQ 331 (CCPA 1973). As such, an application that contains at least one claim, but does not contain anything which can be construed as a written description of such claim(s), would be unusual.

In instances in which a “Notice of Incomplete Application” has been mailed, further action by applicant is necessary for the application to be accorded a filing date. As such, the application will be retained in OIPE to await such action. Unless applicant either completes the application or files a petition under 37 CFR 1.53(e) with the petition fee set forth in 37 CFR 1.17(h), within the period set in the “Notice of Incomplete Application,” the application will be processed as an incomplete application under 37 CFR 1.53(e).

In instances in which a “Notice of Omitted Items” has been mailed, the application will be retained in OIPE for a period of 2 months from the mailing date of “Notice of Omitted Items” to permit applicant to either: (1) establish prior receipt in the USPTO of the page(s) or drawing(s) at issue; or (2) promptly submit the omitted page(s) or drawing(s) in a nonprovisional application and accept the date of such submission as the application filing date. As an applicant may, but is not required to, reply to such a “Notice of Omitted Items,” extensions of time under 37 CFR 1.136 will not be applicable to this 2-month time period.

Unless applicant timely files a petition under 37 CFR 1.53(e) or 37 CFR 1.182 with the required petition fee, the application will maintain the filing date as of the date of deposit of the application papers in the USPTO, and the original application papers (i.e., the original disclosure of the invention) will include only those application papers present in the USPTO on the date of deposit. Nonprovisional applications that are complete under 37 CFR 1.51(b) will then be forwarded to the appropriate Technology Center for examination of the application. Provisional applications that are complete under 37 CFR 1.51(c) will then be forwarded to Files Repository. The current practice for treating applications that are not complete

under 37 CFR 1.51(b) and (c) will remain unchanged (37 CFR 1.53(f) and (g)).

Any petition under 37 CFR 1.53(e) or 37 CFR 1.182 not filed within the 2-month period set in the “Notice of Omitted Item(s)” may be dismissed as untimely. 37 CFR 1.181(f). Under the adopted procedure, the USPTO may strictly adhere to the 2-month period set forth in 37 CFR 1.181(f), and dismiss as untimely any petition not filed within the 2-month period. This strict adherence to the 2-month period set forth in 37 CFR 1.181(f) is justified as such applications will now be forwarded for examination at the end of the 2-month period. It is further justified in instances in which applicant seeks to submit the omitted page(s) or drawing(s) in a nonprovisional application and request the date of such submission as the application filing date as: (1) according the application a filing date later than the date of deposit may affect the date of expiration of any patent issuing on the application due to the changes to 35 U.S.C. 154 contained in Public Law 103-465, § 532, 108 Stat. 4809 (1994); and (2) the filing of a continuation-in-part application is a sufficiently equivalent mechanism for adding additional subject matter to avoid the loss of patent rights.

The submission of omitted page(s) or drawing(s) in a nonprovisional application and acceptance of the date of such submission as the application filing date is tantamount to simply filing a new application. Thus, applicants should consider filing a new application as an alternative to submitting a petition under 37 CFR 1.182 (with the petition fee under 37 CFR 1.17(h)) with any omitted page(s) or drawing(s), which is a cost effective alternative in instances in which a nonprovisional application is deposited without filing fees. Likewise, in view of the relatively low filing fee for provisional applications, and the USPTO’s desire to minimize the processing of provisional applications, the USPTO will not grant petitions under 37 CFR 1.182 to accept omitted page(s) or drawing(s) and accord an application filing date as of the date of such submission in provisional applications. The applicant should simply file a new completed provisional application.

## **APPLICATION LOCATED IN A TECHNOLOGY CENTER**

If it is discovered that an application, located in a Technology Center (TC), was filed without all of the page(s) of the specification, and a Notice of Omitted Items has not been mailed by OIPE, the examiner should review the application to determine whether the application is entitled to a filing date. An application is entitled to a filing date if the application contains something that can be construed as a written description, at least one drawing figure (if necessary under 35 U.S.C. 113, first sentence), and at least one claim.

### ***Application Entitled to a Filing Date***

If the application is entitled to a filing date, the examiner should notify applicant of the omission in the next Office action and require applicant to do one of the following:

(A) accept the application, as filed, without all of the page(s) of the specification;

(B) file any omitted page(s) with an oath or declaration in compliance with 37 CFR 1.63 and 37 CFR 1.64 referring to the omitted page(s) and a petition under 37 CFR 1.182 with the petition fee set forth in 37 CFR 1.17(h), requesting the date of submission of the omitted page(s) as the application filing date; or

(C) file a petition under 37 CFR 1.53(e) with the petition fee set forth in 37 CFR 1.17(h) alleging that the page(s) indicated as omitted was in fact deposited with the USPTO with the application papers, including any and all evidence supporting the allegation. See MPEP § 503. The petition fee will be refunded if it is determined that the page(s) was in fact received by the USPTO with the application papers deposited on filing.

If applicant is willing to accept the application, as filed, without all of the page(s) of the application (item A above), an amendment of the specification is required to renumber the pages of the application consecutively and to cancel any incomplete sentences caused by the absence of the omitted page(s). The amendment should be submitted in response to the Office action.

Any petition filed in accordance with item B or C above should be filed with the TC. The TC will match the petition with the application file and forward the

application file with the petition to the Office of Petitions, along with a brief explanation as to the page(s) of the specification that has been omitted on filing, for consideration of the petition in due course. >For Image File Wrapper (IFW) processing, see IFW Manual section 5.3.<

### ***Application NOT Entitled to a Filing Date***

If upon review of the application, the examiner determines that the application is NOT entitled to a filing date, the examiner should forward the application to OIPE for mailing of a “Notice of Incomplete Application.”

### **601.01(e) Nonprovisional Application Filed Without At Least One Claim [R-2]**

35 U.S.C. 111(a)(2) requires that an application for patent include, *inter alia*, “a specification as prescribed by section 112 of this title,” and 35 U.S.C. 111(a)(4) provides that the “filing date of an application shall be the date on which the specification and any required drawing are received in the Patent and Trademark Office.” 35 U.S.C. 112, first paragraph, provides, in part, that “[t]he specification shall contain a written description of the invention,” and 35 U.S.C. 112, second paragraph, provides that “[t]he specification shall conclude with one or more claims particularly pointing out and distinctly claiming the subject matter which the applicant regards as his invention.” Also, the Court of Appeals for the Federal Circuit stated in *Litton Systems, Inc. v. Whirlpool Corp.*:

Both statute, 35 U.S.C. 111 [(a)], and federal regulations, 37 CFR 1.51 [(b)], make clear the requirement that an application for a patent *must* include. . . a specification and claims. . . . The omission of any *one* of these component parts makes a patent application incomplete and thus not entitled to a filing date.

728 F.2d 1423, 1437, 221 USPQ 97, 105 (Fed. Cir. 1984)(citing *Gearon v. United States*, 121 F. Supp 652, 654, 101 USPQ 460, 461 (Ct. Cl. 1954), *cert. denied*, 348 U.S. 942, 104 USPQ 409 (1955))(emphasis in the original).

Therefore, in an application filed under 35 U.S.C. 111(a), a claim is a statutory requirement for accord- ing a filing date to the application. 35 U.S.C. 162 and

35 U.S.C. 171 make 35 U.S.C. 112 applicable to plant and design applications, and 35 U.S.C. 162 specifically requires the specification in a plant patent application to contain a claim. 35 U.S.C. 111(b)(2), however, provides that “[a] claim, as required by the second through fifth paragraphs of section 112, shall not be required in a provisional application.” Thus, with the exception of provisional applications filed under 35 U.S.C. 111(b), any application filed without at least one claim is incomplete and not entitled to a filing date.

If a nonprovisional application does not contain at least one claim, \*\* a “Notice of Incomplete Application” will be mailed to the applicant(s) indicating that no filing date has been granted and setting a period for submitting a claim. The filing date will be the date of receipt of at least one claim. See \*\* *In re Mattson*, 208 USPQ 168 (Comm’r Pat. 1980). An oath or declaration in compliance with 37 CFR 1.63 and 37 CFR 1.64 referring to the claim being submitted is also required.

>If a nonprovisional application is accompanied by a preliminary amendment which cancels all claims without presenting any new claims, the Office will not enter such an amendment. See *Exxon Corp. v. Phillips Petroleum Co.*, 265 F.3d 1249, 60 USPQ2d 1368 (Fed. Cir. 2001). Thus, the application will not be denied a filing date merely because such a preliminary amendment was submitted on filing. For fee calculation purposes, the Office will treat such an application as containing only a single claim.<

As 37 CFR 1.53(c)(2) permits the conversion of an application filed under 35 U.S.C. 111(a) to an application under 35 U.S.C. 111(b), an applicant in an application, other than for a design patent, filed under 35 U.S.C. 111(a) on or after June 8, 1995, without at least one claim has the alternative of filing a petition under 37 CFR 1.53(c)(2) to convert such application into an application under 35 U.S.C. 111(b), which does not require a claim to be entitled to its date of deposit as a filing date. Such a petition, however, must be filed prior to the expiration of 12 months after the date of deposit of the application under 35 U.S.C. 111(a), and comply with the other requirements of 37 CFR 1.53(c)(2). See MPEP § 601.01(c).

The treatment of an application subsequent to the mailing of a “Notice of Incomplete Application” is discussed in MPEP § 601.01(d).

## 601.01(f) Applications Filed Without Drawings

35 U.S.C. 111(a)(2)(B) and 35 U.S.C. 111(b)(1)(B) each provide, in part, that an “application shall include . . . a drawing as prescribed by section 113 of this title” and 35 U.S.C. 111(a)(4) and 35 U.S.C. 111(b)(4) each provide, in part, that the “filing date. . . shall be the date on which . . . any required drawing are received in the Patent and Trademark Office.” 35 U.S.C. 113 (first sentence) in turn provides that an “applicant shall furnish a drawing where necessary for the understanding of the subject matter sought to be patented.”

Applications filed without drawings are initially inspected to determine whether a drawing is referred to in the specification, and if not, whether a drawing is necessary for the understanding of the invention. 35 U.S.C. 113 (first sentence).

It has been USPTO practice to treat an application that contains at least one process or method claim as an application for which a drawing is not necessary for an understanding of the invention under 35 U.S.C. 113 (first sentence). The same practice has been followed in composition applications. Other situations in which drawings are usually not considered necessary for the understanding of the invention under 35 U.S.C. 113 (first sentence) are:

(A) *Coated articles or products*: where the invention resides solely in coating or impregnating a conventional sheet (*e.g.*, paper or cloth, or an article of known and conventional character with a particular composition), unless significant details of structure or arrangement are involved in the article claims;

(B) *Articles made from a particular material or composition*: where the invention consists in making an article of a particular material or composition, unless significant details of structure or arrangement are involved in the article claims;

(C) *Laminated structures*: where the claimed invention involves only laminations of sheets (and coatings) of specified material unless significant details of structure or arrangement (other than the mere order of the layers) are involved in the article claims; or

(D) *Articles, apparatus, or systems where sole distinguishing feature is presence of a particular material*: where the invention resides solely in the use

of a particular material in an otherwise old article, apparatus or system recited broadly in the claims, for example:

(1) A hydraulic system distinguished solely by the use therein of a particular hydraulic fluid;

(2) Packaged sutures wherein the structure and arrangement of the package are conventional and the only distinguishing feature is the use of a particular material.

A nonprovisional application having at least one claim, or a provisional application having at least some disclosure, directed to the subject matter discussed above for which a drawing is usually not considered essential for a filing date, not describing drawing figures in the specification, and filed without drawings will simply be processed for examination, so long as the application contains something that can be construed as a written description. A nonprovisional application having at least one claim, or a provisional application having at least some disclosure, directed to the subject matter discussed above for which a drawing is usually not considered essential for a filing date, describing drawing figure(s) in the specification, but filed without drawings will be treated as an application filed without all of the drawing figures referred to in the specification as discussed in MPEP § 601.01(g), so long as the application contains something that can be construed as a written description. In a situation in which the appropriate Technology Center (TC) determines that drawings are necessary under 35 U.S.C. 113 (first sentence) the filing date issue will be reconsidered by the USPTO. The application will be returned to the Office of Initial Patent Examination (OIPE) for mailing of a “Notice of Incomplete Application.”

If a nonprovisional application does not have at least one claim directed to the subject matter discussed above for which a drawing is usually not considered essential for a filing date, or a provisional application does not have at least some disclosure directed to the subject matter discussed above for which a drawing is usually not considered essential for a filing date, and is filed without drawings, OIPE will mail a “Notice of Incomplete Application” indicating that the application lacks drawings and that 35 U.S.C. 113 (first sentence) requires a drawing where necessary for the understanding of the subject matter sought to be patented.



Applicant may file a petition under 37 CFR 1.53(e) with the petition fee set forth in 37 CFR 1.17(h), asserting that (1) the drawing(s) at issue was submitted, or (2) the drawing(s) is not necessary under 35 U.S.C. 113 (first sentence) for a filing date. The petition must be accompanied by sufficient evidence to establish applicant's entitlement to the requested filing date (e.g., a date-stamped postcard receipt (MPEP § 503) to establish prior receipt in the USPTO of the drawing(s) at issue). Alternatively, applicant may submit drawing(s) accompanied by an oath or declaration in compliance with 37 CFR 1.63 and 1.64 referring to the drawing(s) being submitted and accept the date of such submission as the application filing date.

In design applications, OIPE will mail a "Notice of Incomplete Application" indicating that the application lacks the drawings required under 35 U.S.C. 113 (first sentence). The applicant may: (1) promptly file a petition under 37 CFR 1.53(e) with the petition fee set forth in 37 CFR 1.17(h), asserting that the missing drawing(s) was submitted; or (2) promptly submit drawing(s) accompanied by an oath or declaration in compliance with 37 CFR 1.63 and 37 CFR 1.64 and accept the date of such submission as the application filing date. 37 CFR 1.153(a) provides that the claim in a design application "shall be in formal terms to the ornamental design for the article (specifying name) as shown, or as shown and described." As such, petitions under 37 CFR 1.53(e) asserting that drawings are unnecessary under 35 U.S.C. 113 (first sentence) for a filing date in a design application will not be found persuasive.

The treatment of an application subsequent to the mailing of a "Notice of Incomplete Application" is discussed in MPEP § 601.01(d).

### **601.01(g) Applications Filed Without All Figures of Drawings [R-2]**

The Office of Initial Patent Examination (OIPE) reviews application papers to determine whether all of the figures of the drawings that are mentioned in the specification are present in the application. If the application is filed without all of the drawing figure(s) referred to in the specification, and the application contains something that can be construed as a written description, at least one drawing, if necessary under 35 U.S.C. 113 (first sentence), and, in a nonprovisional application, at least one claim, OIPE will mail a

"Notice of Omitted Item(s)" indicating that the application papers so deposited have been accorded a filing date, but are lacking some of the figures of drawings described in the specification.

The mailing of a "Notice of Omitted Item(s)" will permit the applicant to either: (1) promptly establish prior receipt in the USPTO of the drawing(s) at issue (generally by way of a date-stamped >itemized< postcard receipt (MPEP § 503)); or (2) promptly submit the omitted drawing(s) in a nonprovisional application and accept the date of such submission as the application filing date. An applicant asserting that the drawing(s) was in fact deposited in the USPTO with the application papers must, within 2 months from the date of the "Notice of Omitted Item(s)," file a petition under 37 CFR 1.53(e) with the petition fee set forth in 37 CFR 1.17(h), along with evidence of such deposit (37 CFR 1.181(f)). The petition fee will be refunded if it is determined that the drawing(s) was in fact received by the USPTO with the application papers deposited on filing. An applicant desiring to submit the omitted drawings in a nonprovisional application and accept the date of such submission as the application filing date must, within 2 months from the date of the "Notice of Omitted Item(s)," file any omitted drawing(s) with an oath or declaration in compliance with 37 CFR 1.63 and 37 CFR 1.64 referring to such drawing(s) and a petition under 37 CFR 1.182 with the petition fee set forth in 37 CFR 1.17(h), requesting the later filing date (37 CFR 1.181(f)).

An applicant willing to accept the application as deposited in the USPTO need not respond to the "Notice of Omitted Item(s)," and the failure to file a petition under 37 CFR 1.53(e) or 37 CFR 1.182 with the required petition fee as discussed above within 2 months of the date of the "Notice of Omitted Item(s)" (37 CFR 1.181(f)) will be treated as constructive acceptance by applicant of the application as deposited in the USPTO. Amendment of the specification is required in a nonprovisional application to cancel all references to the omitted drawing, both in the brief and detailed descriptions of the drawings and including any reference numerals shown only in the omitted drawings. In addition, **\*\*>**an amendment with replacement sheets of drawings in compliance with 37 CFR 1.121(d)**<** is required in a nonprovisional application to renumber the drawing figures consecutively **\*\***, if necessary, and amendment of the specification

is required to correct the references to the drawing figures to correspond with any relabeled drawing figures, both in the brief and detailed descriptions of the drawings. Such amendment \*\* should be \*\* >submitted as a preliminary amendment \* prior to the first Office action to avoid delays in the prosecution of the application.

The treatment of an application subsequent to the mailing of a “Notice of Omitted Item(s)” is discussed in MPEP § 601.01(d).

Applications are often filed with drawings with several views of the invention where the views are labeled using a number-letter combination, e.g., Fig. 1A, Fig. 1B, and Fig. 1C. OIPE will not mail a “Notice of Omitted Item(s)” if a figure which is referred to in the specification by a particular number cannot be located among the drawings, if the drawings include at least one figure labeled with that particular number in combination with a letter. For example, if the drawings show Figures 1A, 1B, and 1C and the brief description of the drawings refers only to Figure 1, this is an error in the specification which must be corrected, rather than an application filed without all figures of drawings.

#### **APPLICATION LOCATED IN A TECHNOLOGY CENTER**

If it is discovered that an application, located in a Technology Center (TC), was filed without all of the drawing figure(s) referred to in the specification, and a Notice of Omitted Items has not been mailed by the OIPE, the examiner should review the application to determine whether the application is entitled to a filing date. An application is entitled to a filing date if the application contains something that can be construed as a written description, at least one drawing figure (if necessary under 35 U.S.C. 113, first sentence), and at least one claim.

##### ***Application Entitled to a Filing Date***

If the application is entitled to a filing date, the examiner should notify applicant of the omission in the next Office action and require applicant to do one of the following:

(A) accept the application, as filed, without all of the drawing figure(s) referred to in the specification;

(B) file any omitted drawing figure(s) with an oath or declaration in compliance with 37 CFR 1.63 and 37 CFR 1.64 referring to the omitted drawing figure(s) and a petition under 37 CFR 1.182 with the petition fee set forth in 37 CFR 1.17(h), requesting the date of submission of the omitted drawing figure(s) as the application filing date; or

(C) file a petition under 37 CFR 1.53(e) with the petition fee set forth in 37 CFR 1.17(h) alleging that the drawing figure(s) indicated as omitted was in fact deposited with the USPTO with the application papers, including any and all evidence supporting the allegation. See MPEP § 503. The petition fee will be refunded if it is determined that the drawing figure(s) was in fact received by the USPTO with the application papers deposited on filing.

If applicant is willing to accept the application, as filed, without all of the drawing figure(s) referred to in the application (item A above), applicant is required to submit (1) an amendment to the specification canceling all references to the omitted drawing figure(s) including any reference numerals shown only in the omitted drawing figure(s), (2) \*\*>an amendment with replacement sheets of drawings in compliance with 37 CFR 1.121(d)< renumbering the drawing figure(s) submitted on filing consecutively, \*\* and (3) a further amendment to the specification correcting references to drawing figure(s) to correspond with the relabeled drawing figure(s), both in the brief and detailed descriptions of the drawings. The amendment \*\*should be submitted in response to the Office action.

Any petition filed in accordance with item B or C above should be filed with the TC. The TC will match the petition with the application file and forward the application file with the petition to the Office of Petitions, along with a brief explanation as to the drawing figure(s) that has been omitted on filing, for consideration of the petition in due course.

##### ***Application NOT Entitled to a Filing Date***

If upon review of the application, the examiner determines that the application is NOT entitled to a filing date because the application does not contain any drawing figure, and at least one drawing figure is necessary under 35 U.S.C. 113, first sentence, the examiner should forward the application to OIPE for mailing of a “Notice of Incomplete Application.”

**601.01(h) Forms**

The Office of Initial Patent Examination (OIPE) is no longer using pre-printed forms and is instead using individualized notices generated by a computer to notify applicants of defects.

**601.02 Power of Attorney\*\* [R-2]**

The attorney's or agent's full mailing (post office) address (including ZIP Code) must be given in every

power of attorney \*\*. The telephone and fax numbers of the attorney or agent should also be included in the power. The prompt delivery of communications will thereby be facilitated.

A power of attorney \*\* may be incorporated in the oath or declaration form when the power of attorney \*\* is given by inventors. Otherwise, a separate power of attorney \*\* (e.g., PTO/SB/81) should be used. (See MPEP § 402.)

PARTS, FORM, AND CONTENT OF APPLICATION

601.02

\*\*>

PTO/SB/81 (09-03)

Approved for use through 11/30/2005. OMB 0651-0035

U.S. Patent and Trademark Office; U.S. DEPARTMENT OF COMMERCE

Under the Paperwork Reduction Act of 1995, no persons are required to respond to a collection of information unless it displays a valid OMB control number.

<b>POWER OF ATTORNEY and CORRESPONDENCE ADDRESS INDICATION FORM</b>	<b>Application Number</b>	
	<b>Filing Date</b>	
	<b>First Named Inventor</b>	
	<b>Title</b>	
	<b>Art Unit</b>	
	<b>Examiner Name</b>	
	<b>Attorney Docket Number</b>	

I hereby appoint:

Practitioners associated with the Customer Number:

**OR**

Practitioner(s) named below:

Name	Registration Number

as my/our attorney(s) or agent(s) to prosecute the application identified above, and to transact all business in the United States Patent and Trademark Office connected therewith.

Please recognize or change the correspondence address for the above-identified application to:

The address associated with the above-mentioned Customer Number:

**OR**

The address associated with Customer Number:

**OR**

<input type="checkbox"/> Firm or Individual Name			
Address			
Address			
City	State	Zip	
Country			
Telephone	Fax		

I am the:

Applicant/Inventor.

Assignee of record of the entire interest. See 37 CFR 3.71.  
*Statement under 37 CFR 3.73(b) is enclosed. (Form PTO/SB/96)*

**SIGNATURE of Applicant or Assignee of Record**

Name			
Signature			
Date	Telephone		

NOTE: Signatures of all the inventors or assignees of record of the entire interest or their representative(s) are required. Submit multiple forms if more than one signature is required, see below\*.

\*Total of \_\_\_\_\_ forms are submitted.

This collection of information is required by 37 CFR 1.31 and 1.33. The information is required to obtain or retain a benefit by the public which is to file (and by the USPTO to process) an application. Confidentiality is governed by 35 U.S.C. 122 and 37 CFR 1.14. This collection is estimated to take 3 minutes to complete, including gathering, preparing, and submitting the completed application form to the USPTO. Time will vary depending upon the individual case. Any comments on the amount of time you require to complete this form and/or suggestions for reducing this burden, should be sent to the Chief Information Officer, U.S. Patent and Trademark Office, U.S. Department of Commerce, P.O. Box 1450, Alexandria, VA 22313-1450. DO NOT SEND FEES OR COMPLETED FORMS TO THIS ADDRESS. SEND TO: **Commissioner for Patents, P.O. Box 1450, Alexandria, VA 22313-1450.**

If you need assistance in completing the form, call 1-800-PTO-9199 and select option 2.

<

### 601.03 Change of Correspondence Address [R-2]

*37 CFR 1.33. Correspondence respecting patent applications, reexamination proceedings, and other proceedings.*

\*\*>

(a) *Correspondence address and daytime telephone number.*

When filing an application, a correspondence address must be set forth in either an application data sheet (§ 1.76), or elsewhere, in a clearly identifiable manner, in any paper submitted with an application filing. If no correspondence address is specified, the Office may treat the mailing address of the first named inventor (if provided, see §§ 1.76(b)(1) and 1.63(c)(2)) as the correspondence address. The Office will direct all notices, official letters, and other communications relating to the application to the correspondence address. The Office will not engage in double correspondence with an applicant and a registered attorney or agent, or with more than one registered attorney or agent except as deemed necessary by the Director. If more than one correspondence address is specified, the Office will establish one as the correspondence address. For the party to whom correspondence is to be addressed, a daytime telephone number should be supplied in a clearly identifiable manner and may be changed by any party who may change the correspondence address. The correspondence address may be changed as follows:<

(1) *Prior to filing of § 1.63 oath or declaration by any of the inventors.* If a § 1.63 oath or declaration has not been filed by any of the inventors, the correspondence address may be changed by the party who filed the application. If the application was filed by a registered attorney or agent, any other registered practitioner named in the transmittal papers may also change the correspondence address. Thus, the inventor(s), any registered practitioner named in the transmittal papers accompanying the original application, or a party that will be the assignee who filed the application, may change the correspondence address in that application under this paragraph.

(2) *Where a § 1.63 oath or declaration has been filed by any of the inventors.* If a § 1.63 oath or declaration has been filed, or is filed concurrent with the filing of an application, by any of the inventors, the correspondence address may be changed by the parties set forth in paragraph (b) of this section, except for paragraph (b)(2).

\*\*\*\*\*

37 CFR 1.33(a) provides that the application must specify a correspondence address to which the Office will send notice, letters, and other communications relating to an application. The correspondence address must either be in an application data sheet (37 CFR 1.76) or in a clearly identifiable manner elsewhere in any papers submitted with the application filing. Where more than one correspondence address is specified, the Office will determine which one to establish as the correspondence address. This is

intended to cover the situation where an unexecuted application is submitted with multiple addresses, such as one correspondence address being given in the application transmittal letter, and a different one in an accompanying unexecuted 37 CFR 1.63 declaration, or other similar situations. The Office will determine which of the different addresses to use as the correspondence address on a case-by-case basis.

The submission of a daytime telephone number of the party to whom correspondence is to be addressed is requested pursuant to 37 CFR 1.33(a). While business is to be conducted on the written record (37 CFR 1.2), a daytime telephone number would be useful in initiating contact that could later be reduced to a writing. Any party who could change the correspondence address could also change the telephone number.

37 CFR 1.33(a)(1) provides that the party filing the application and setting forth a correspondence address may later change the correspondence address provided that an executed oath or declaration under 37 CFR 1.63 by any of the inventors has not been filed. If a registered attorney or agent filed the application, any other registered practitioners named in the transmittal letter may change the correspondence address. A registered practitioner named in a letterhead would not be considered as being named in the transmittal letter for purposes of changing the correspondence address. A clear identification of the individual as a representative would be required. If an application is filed by a company to whom the invention has been assigned or to whom there is an obligation to assign the invention, a person who has the authority to act on behalf of the company may change the correspondence address. Thus, the inventor(s), any registered practitioner named in the transmittal papers accompanying the original application, or a party that will be the assignee who filed the application, may change the correspondence address pursuant to 37 CFR 1.33(a)(1). The filing of an executed oath or declaration that does not include a correspondence address does not affect any correspondence address previously established on filing of the application, or changed pursuant to 37 CFR 1.33(a)(1).

Where a correspondence address has been established on filing of the application or changed pursuant to 37 CFR 1.33(a)(1) (prior to the filing of an executed oath or declaration under 37 CFR 1.63 by any of the inventors), that correspondence address remains in

effect upon filing of an executed oath or declaration under 37 CFR 1.63 and can only be subsequently changed pursuant to 37 CFR 1.33(a)(2). Under 37 CFR 1.33(a)(2), where an executed oath or declaration under 37 CFR 1.63 has been filed by any of the inventors, the correspondence address may be changed by (A) a registered attorney or agent of record \*\*, (B) an assignee as provided for under 37 CFR 3.73(b), or (C) all of the applicants (37 CFR 1.41(b)) for patent, unless there is an assignee of the entire interest and such assignee has taken action in the application in accordance with 37 CFR 3.71. See 37 CFR 1.33(a)(2).

Where an attorney or agent of record (or applicant, if he or she is prosecuting the application *pro se*) changes his or her correspondence address, he or she is responsible for promptly notifying the U.S. Patent and Trademark Office of the new correspondence address (including ZIP Code). The notification should also include his or her telephone number. A change of correspondence address may not be signed by an attorney or agent not of record (see MPEP § 405).

Unless the correspondence address is designated as the address associated with a Customer Number, a separate notification must be filed in each application for which a person is intended to receive communications from the Office. See MPEP § 403 for Customer Number Practice. In those instances where a change in the correspondence address of a registered attorney or agent is necessary in a plurality of applications, the notification filed in each application may be a reproduction of a properly executed, original notification. The original notice may either be sent to the Office of Enrollment and Discipline as notification to the Attorney's Roster of the change of address, or may be retained by applicant. See MPEP § 502.02.

Special care should be taken in continuation or divisional applications to ensure that any change of correspondence address in a prior application is reflected in the continuation or divisional application. For example, where a copy of the oath or declaration from the prior application is submitted for a continuation or divisional application filed under 37 CFR 1.53(b) and the copy of the oath or declaration from the prior application designates an old correspondence address, the Office may not recognize, in the continuation or divisional application, the change of correspondence address made during the prosecution of the

prior application. Applicant is required to identify the change of correspondence address in the continuation or divisional application to ensure that communications from the Office are mailed to the current correspondence address. 37 CFR 1.63(d)(4).

See MPEP § 711.03(c) for treatment of petitions to revive applications abandoned as a consequence of failure to timely receive an Office action addressed to the old correspondence address.

The required notification of change of correspondence address need take no particular form. However, it should be provided in a manner calling attention to the fact that a change of address is being made. Thus, the mere inclusion, in a paper being filed for another purpose, of an address which is different from the previously provided correspondence address, without mention of the fact that an address change is being made would not ordinarily be recognized or deemed as instructions to change the correspondence address on the file record.

The obligation (see 37 CFR 10.11) of a registered attorney or agent to notify the Attorney's Roster by letter of any change of his or her address for entry on the register is separate from the obligation to file a notice of change of address filed in individual applications. See MPEP § 402.

#### **601.04 National Stage Requirements of the United States as a Designated Office**

See MPEP Chapter 1800, especially MPEP § 1893.01 for requirements for entry into the national stage before the Designated Office or Elected Office under the Patent Cooperation Treaty (PCT).

#### **601.05 Bibliographic Information - Application Data Sheet (ADS) [R-2]**

*37 CFR 1.76. Application Data Sheet*

(a) *Application data sheet.* An application data sheet is a sheet or sheets that may be voluntarily submitted in either provisional or nonprovisional applications, which contains bibliographic data, arranged in a format specified by the Office. If an application data sheet is provided, the application data sheet is part of the provisional or nonprovisional application for which it has been submitted.

(b) *Bibliographic data.* Bibliographic data as used in paragraph (a) of this section includes:

(1) *Applicant information.* This information includes the name, residence, mailing address, and citizenship of each appli-

cant (§ 1.41(b)). The name of each applicant must include the family name, and at least one given name without abbreviation together with any other given name or initial. If the applicant is not an inventor, this information also includes the applicant's authority (§§ 1.42, 1.43, and 1.47) to apply for the patent on behalf of the inventor.

(2) *Correspondence information.* This information includes the correspondence address, which may be indicated by reference to a customer number, to which correspondence is to be directed (see § 1.33(a)).

(3) *Application information.* This information includes the title of the invention, a suggested classification, by class and subclass, the Technology Center to which the subject matter of the invention is assigned, the total number of drawing sheets, a suggested drawing figure for publication (in a nonprovisional application), any docket number assigned to the application, the type of application (e.g., utility, plant, design, reissue, provisional), whether the application discloses any significant part of the subject matter of an application under a secrecy order pursuant to § 5.2 of this chapter (see § 5.2(c)), and, for plant applications, the Latin name of the genus and species of the plant claimed, as well as the variety denomination. The suggested classification and Technology Center information should be supplied for provisional applications whether or not claims are present. If claims are not present in a provisional application, the suggested classification and Technology Center should be based upon the disclosure.

(4) *Representative information.* This information includes the registration number of each practitioner having a power of attorney or authorization of agent in the application (preferably by reference to a customer number). Providing this information in the application data sheet does not constitute a power of attorney or authorization of agent in the application (see § 1.34(b)).

(5) *Domestic priority information.* This information includes the application number, the filing date, the status (including patent number if available), and relationship of each application for which a benefit is claimed under 35 U.S.C. 119(e), 120, 121, or 365(c). Providing this information in the application data sheet constitutes the specific reference required by 35 U.S.C. 119(e) or 120, and § 1.78(a)(2) or § 1.78(a)(4), and need not otherwise be made part of the specification.

(6) *Foreign priority information.* This information includes the application number, country, and filing date of each foreign application for which priority is claimed, as well as any foreign application having a filing date before that of the application for which priority is claimed. Providing this information in the application data sheet constitutes the claim for priority as required by 35 U.S.C. 119(b) and § 1.55(a).

(7) *Assignee information.* This information includes the name (either person or juristic entity) and address of the assignee of the entire right, title, and interest in an application. Providing this information in the application data sheet does not substitute for compliance with any requirement of part 3 of this chapter to have an assignment recorded by the Office.

(c) *Supplemental application data sheets.* Supplemental application data sheets:

(1) May be subsequently supplied prior to payment of the issue fee either to correct or update information in a previously

submitted application data sheet, or an oath or declaration under § 1.63 or § 1.67, except that inventorship changes are governed by § 1.48, correspondence changes are governed by § 1.33(a), and citizenship changes are governed by § 1.63 or § 1.67; and

(2) Should identify the information that is being changed (added, deleted, or modified) and therefore need not contain all the previously submitted information that has not changed.

(d) *Inconsistencies between application data sheet and oath or declaration.* For inconsistencies between information that is supplied by both an application data sheet under this section and by an oath or declaration under §§ 1.63 and 1.67:

(1) The latest submitted information will govern notwithstanding whether supplied by an application data sheet, or by a § 1.63 or § 1.67 oath or declaration, except as provided by paragraph (d)(3) of this section;

(2) The information in the application data sheet will govern when the inconsistent information is supplied at the same time by a § 1.63 or § 1.67 oath or declaration, except as provided by paragraph (d)(3) of this section;

(3) The oath or declaration under § 1.63 or § 1.67 governs inconsistencies with the application data sheet in the naming of inventors (§ 1.41(a)(1)) and setting forth their citizenship (35 U.S.C. 115);

(4) The Office will initially capture bibliographic information from the application data sheet (notwithstanding whether an oath or declaration governs the information). Thus, the Office shall generally not look to an oath or declaration under § 1.63 to see if the bibliographic information contained therein is consistent with the bibliographic information captured from an application data sheet (whether the oath or declaration is submitted prior to or subsequent to the application data sheet). Captured bibliographic information derived from an application data sheet containing errors may be recaptured by a request therefor and the submission of a supplemental application data sheet, an oath or declaration under § 1.63 or § 1.67, or a letter pursuant to § 1.33(b).

37 CFR 1.76 provides for the voluntary inclusion of an application data sheet in provisional and nonprovisional applications. A guide to preparing an application data sheet (Patent Application Bibliographic Data Entry Format) can be found on the U.S. Patent and Trademark Office (Office) Web site "<http://www.uspto.gov>" \*\*.

An application data sheet is a sheet or set of sheets containing bibliographic data, which is arranged in a format specified by the Office. When an application data sheet is provided in a provisional or nonprovisional application, the application data sheet becomes part of the provisional or nonprovisional application. While the use of an application data sheet is optional, the Office prefers its use to help facilitate the electronic capturing of this important data. >For example, in a national stage application filed under 35 U.S.C. 371, the Office could look to the publication of the

international application for the title (see MPEP § 1893.03(e)) and to other documents for the listing of inventors and the correspondence address, but it is more desirable for the Office to only refer to a single document, i.e., an application data sheet. The data that is suggested to be supplied by way of an application data sheet can also be provided elsewhere in the application papers, but it is to applicant's advantage to submit the data via an application data sheet. To help ensure that the Office can, in fact, efficiently capture the data, the Office specifies a particular format to be used. The Office does not, however, provide an application data sheet paper form because of the variability in the data submitted (e.g., one application may have no domestic priority data and a single inventor, and others may have domestic priority data to a number of prior U.S. applications and have multiple joint inventors).

Bibliographic data under 37 CFR 1.76(a) includes: (1) applicant information; (2) correspondence information; (3) application information; (4) representative information; (5) domestic priority information; (6) foreign priority information; and (7) assignee information. The naming of the inventors and the setting forth of the citizenship of each inventor must be provided in the oath or declaration under 37 CFR 1.63 (as is required by 35 U.S.C 115) even if this information is provided in the application data sheet.

Applicant information includes the name, residence, mailing address, and citizenship of each applicant (37 CFR 1.41(b)). The name of each applicant must include the family name, and at least one given name without abbreviation together with any other given name or initial. If the applicant is not an inventor, this information also includes the applicant's authority (37 CFR 1.42, 1.43, and 1.47) to apply for the patent on behalf of the inventor. The "mailing address" is the address where applicant customarily receives mail.

Correspondence information includes the correspondence address, which may be indicated by reference to a customer number, to which correspondence is to be directed (see 37 CFR 1.33(a)).

Application information includes the title of the invention, a suggested classification by class and subclass, the Technology Center (TC) to which the subject matter of the invention is assigned, the total number of drawing sheets, a suggested drawing figure

for publication (in a nonprovisional application), any docket number assigned to the application, and the type of application (e.g., utility, plant, design, reissue, provisional). Application information also includes whether the application discloses any significant part of the subject matter of an application under a secrecy order pursuant to 37 CFR 5.2(c).

Although the submission of the information related to a suggested classification and TC is desired for both provisional and nonprovisional applications, the Office will not be bound to follow such information if submitted, as the Office will continue to follow its present procedures for classifying and assigning new applications. Similarly for the suggested drawing figure, the Office may decide to print another figure on the front page of any patent issuing from the application.

Application information also includes information about provisional applications, particularly their class and subclass, and the TC. Provisional applications are not examined or even processed (e.g., having a class and subclass assigned or being forwarded to a TC). Even though provisional applications are not examined, the TC and the class and subclass, if known to applicants, would be of benefit to the Office in giving an indication of where nonprovisional applications may be eventually received in the Office and their technologies so that the Office will be better able to plan for future workloads.

37 CFR 1.76(b)(3) also requests that the plant patent applicant state the Latin name and the variety denomination for the plant claimed. The Latin name and the variety denomination of the claimed plant are usually included in the specification of the plant patent application, and will be included in any plant patent or plant patent application publication if included in an application data sheet or patent application. The Office, pursuant to the "International Convention for the Protection of New Varieties of Plants" (generally known by its French acronym as the UPOV convention), has been asked to compile a database of the plants patented and the database must include the Latin name and the variety denomination of each patented plant. Having this information in separate sections of the plant patent will make the process of compiling this database more efficient.

Representative information includes the registration number appointed with a power of attorney in



the application (preferably by reference to a customer number). 37 CFR 1.76(b)(4) states that providing this information in the application data sheet does not constitute a power of attorney \*\* in the application (see 37 CFR 1.34\*). This is because the Office does not expect the application data sheet to be executed by the party (applicant or assignee) who may appoint a power of attorney \*\* in the application.

Domestic priority information includes the application number (series code and serial number), the filing date, the status (including patent number if available), and relationship of each application for which a benefit is claimed under 35 U.S.C. 119(e), 120, 121, or 365(c). 37 CFR 1.76(b)(5) states that providing this information in the application data sheet constitutes the specific reference required by 35 U.S.C. 119(e) or 120. While the patent rules of practice (37 CFR 1.78(a)(2) or (a)(4)) formerly required that this claim or specific reference be in the first sentence of the specification, the relevant patent statute is broader and only requires that a claim to the benefit of (specific reference to) a prior provisional (35 U.S.C. 119(e)(1)) or a prior nonprovisional (35 U.S.C. 120) application be in the application which is making the priority claim. Since the application data sheet, if provided, is considered part of the application, the specific reference to an earlier filed provisional or nonprovisional application in the application data sheet satisfies the “specific reference” requirement of 35 U.S.C. 119(e)(1) or 120, and it also complies with 37 CFR 1.78(a)(2) or (a)(4). Thus, a specific reference does not otherwise have to be made in the specification, such as in the first sentence of the specification. If continuity data is included in an application data sheet, but not in the first sentence of the specification, the continuity data for the patent front page will be taken from the application data sheet. No continuity data will be included in the first sentence of the specification if applicant does not provide it there. 37 CFR 1.76(b)(5) does not apply to provisional applications.

Foreign priority information includes the application number, country, and filing date of each foreign application for which priority is claimed, as well as any foreign application having a filing date before that of the application for which priority is claimed. 37 CFR 1.76(b)(6) states that providing this information in the application data sheet constitutes the claim

for priority as required by 35 U.S.C. 119(b) and 37 CFR 1.55(a). The patent statute, 35 U.S.C. 119(b), does not require that a claim to the benefit of a prior foreign application take any particular form. 37 CFR 1.76(b)(6) does not apply to provisional applications.

37 CFR 1.76(b)(7) provides that the assignee information includes the name (either person or juristic entity) and address of the assignee of the entire right, title, and interest in an application. The inclusion of this information in the application data sheet does not substitute for compliance with any requirement of 37 CFR part 3 to have an assignment recorded by the Office. Providing assignee information in the application data sheet is considered a request to include such information on the patent application publication, since there is no other reason for including such information in the application data sheet. Assignment information must be recorded to have legal effect.

Supplemental application data sheets may be subsequently supplied prior to payment of the issue fee to either correct or update information in a previously submitted application data sheet, or an oath or declaration under 37 CFR 1.63 or 1.67. See 37 CFR 1.76(c)(1). A supplemental data sheet cannot be used to correct the following \*: (1) inventorship changes (37 CFR 1.48); (2) correspondence changes (37 CFR 1.33(a)); and (3) citizenship changes (37 CFR 1.63 or 37 CFR 1.67). Supplemental application data sheets should \*\* contain information previously supplied that has not changed \*\*>, as well as any new information, with the information being deleted indicated with strike-through or brackets and the information being added shown with underlining. Although 37 CFR 1.76(c)(2) states that a supplemental application data sheet may contain only information that is changed and added and that all the previously submitted information that has not changed need not be submitted, a supplemental application data sheet containing only new or changed information is likely to confuse the record, creates unnecessary work for the Office, and therefore, is not recommended.

## SUPPLEMENTAL ADS SUBMISSIONS

When submitting an application data sheet supplemental to the initial filing of the application, to correct, modify, or augment the original application data sheet, the following applies:

(A) the supplemental application data sheet should be labeled “Supplemental Application Data Sheet;”

(B) a full replacement copy of the original application data sheet should be submitted with any changes or additions underlined. For deletions without replacement data, use strike-through;

(C) the footer information should include the word “Supplemental” in place of “Initial” and should also contain the Application Number and Filing Date.<

Resolution of inconsistent information supplied by both an application data sheet and the oath or declaration under 37 CFR 1.63, or 37 CFR 1.67 are addressed in 37 CFR 1.76(d). 37 CFR 1.76(d)(1) provides that the latest submitted information will govern notwithstanding whether supplied by an application data sheet or by an oath or declaration under 37 CFR 1.63, or 37 CFR 1.67. 37 CFR 1.76(d)(2) provides that the information in the application data sheet will govern when the inconsistent information is supplied at the same time by a 37 CFR 1.63 or 37 CFR 1.67 oath or declaration. This is because the application data sheet (and not the oath or declaration) is intended as the means by which applicants will provide most information to the Office \*\*. In the small number of instances where an oath or declaration under 37 CFR 1.63 or 37 CFR 1.67 has more accurate information than a concurrently supplied application data sheet (37 CFR 1.76(d)(2)), a supplemental application data sheet should be submitted to conform the information presented by the application data sheets with the correct information in the oath or declaration (37 CFR 1.76(d)(1)).

If an application is filed with an application data sheet improperly identifying the residence of one of the inventors, inventor B, and an executed 37 CFR 1.63 declaration setting forth the correct but different residence of inventor B, the Office will capture the residence of inventor B found in the application data sheet as the residence of B, and include that information in the filing receipt. If applicant desires correction of the residence, applicant should submit a supplemental application data sheet under 37 CFR 1.76(c), with the name of inventor B and the corrected residence for inventor B.

Pursuant to 37 CFR 1.76(d)(3), the oath or declaration under 37 CFR 1.63 or 37 CFR 1.67 governs

inconsistencies with the application data sheet in the naming of inventors and setting forth their citizenship. If different inventors are listed in the application data sheet than are named in the oath or declaration for the application, the inventors named in the oath or declaration are considered to be the inventors named in the patent application. See 37 CFR 1.76(d)(3). Any change in the inventorship set forth in the oath or declaration under 37 CFR 1.63 must be by way of petition under 37 CFR 1.48(a) notwithstanding identification of the correct inventive entity in an application data sheet or supplemental application data sheet. Similarly, if the oath or declaration under 37 CFR 1.63 incorrectly sets forth the citizenship of one of the inventors, that inventor must submit a supplemental oath or declaration under 37 CFR 1.67 with the correct citizenship notwithstanding the correct identification of the citizenship in an application data sheet or supplemental application data sheet. >If the spelling of the inventor’s name is incorrect, however, only a supplemental application data sheet is required. See MPEP § 605.04(b).<

The Office will rely upon information supplied in the application data sheet over an oath or declaration to \* capture the data even where the type of information supplied (citizenship, inventorship) is governed by the oath or declaration according to statute (35 U.S.C. 115) or other rule (37 CFR 1.41(a)(1)). Where the oath or declaration under 37 CFR 1.63 or 37 CFR 1.67 contains the correct information regarding inventors or their citizenship and the application data sheet does not, even though the oath or declaration governs pursuant to 37 CFR 1.76(d)(3), the information in the application data sheet must be corrected by submission of a request \*\*>for correction< and a supplemental application data sheet \*\*. >If the spelling of the inventor’s name is incorrect, however, only a supplemental application data sheet is required. See MPEP § 605.04(b).<

If an application is filed with an application data sheet correctly setting forth the citizenship of inventor B, and an executed 37 CFR 1.63 declaration setting forth a different incorrect citizenship of inventor B, the Office will capture the citizenship of inventor B found in the application data sheet. Applicant, however, must submit a supplemental oath or declaration under 37 CFR 1.67 by inventor B setting forth the correct citizenship even though it appears correctly in

the application data sheet. A supplemental application data sheet \*\* cannot be used to correct the citizenship error in the oath or declaration. If, however, the error is one of residence, no change would be required (37 CFR 1.76(d)(2)).

\*\*>Although< 37 CFR 1.76 \*\*>does not< change the practice in MPEP § 201.03 >and § 605.04(b)< regarding correction of a typographical or transliteration error in the spelling of an inventor's name whereby all that is required is notification of the error to the Office \*\*>, the Office strongly encourages the filing of an application data sheet or a supplemental application data sheet to correct a typographical or transliteration error in the spelling of an inventor's name. A< supplemental oath or declaration is not required.

>If applicant merely files a statement notifying the Office of the typographical or transliteration error in the spelling of an inventor's name without submitting an application data sheet or a supplemental application data sheet, any patent to issue is less likely to reflect the correct spelling since the spelling of the inventor's name is taken from the oath or declaration, or any subsequently filed application data sheet.<

As to the submission of class/subclass information in the application data sheet, the Office notes that there is a distinction between permitting applicants to aid in the identification of the appropriate Art Unit to examine the application and requiring the Office to always honor such identification/request, which could lead to misuse by some applicants of forum shopping. Even when an applicant's identification of an Art Unit is appropriate, internal staffing/workload requirements may dictate that the application be handled by another Art Unit qualified to do so, particularly when the art or claims encompass the areas of expertise of more than one Art Unit.

An application data sheet >must be labeled "Application Data Sheet" and< should provide the following information:

#### **Inventor Information**

Inventor One Given Name:  
 Family Name:  
 Name Suffix:  
 Mailing Address Line One:  
 Mailing Address Line Two:  
 City:  
 State or Province:

Postal or Zip Code:

City of Residence:

State or Prov. of Residence:

Country of Residence:

Citizenship Country:

[repeat for additional inventors]

If the inventor is deceased or \*>incapacitated<, if a petition under 37 CFR 1.47(b) is filed, or if the application is filed by the Administrator of NASA, the application data sheet should also include information for the applicant:

Given or Company Name of Applicant:

Family Name, if any:

Name Suffix:

Authority Code:

Mailing Address Line One:

Mailing Address Line Two:

City:

State or Province:

Postal or Zip Code:

City of Residence:

State or Prov. of Residence:

County of Residence:

Citizenship Country

#### **Correspondence Information**

Name Line One:

Name Line Two:

Address Line One:

Address Line Two:

City:

State or Province:

Country:

Postal or Zip Code:

Telephone:

Fax:

Electronic Mail:

#### **Application Information**

Title Line One:

Title Line Two:

[Repeat for any additional lines]

Suggested classification:

\*>Suggested< Tech. Center:

Total Drawing Sheets:

Suggested Dwg. Figure for Pub.:

Docket Number:

Application Type: [Utility]

Licensed US Govt. Agency:

Contract or Grant Numbers One:

Contract or Grant Numbers Two:

Secrecy Order in Parent Appl.?

If plant patent app.,

Latin name of genus and species of plant claimed:

### Representative Information

Registration Number One:

Registration Number Two:

[Repeat for extra registration numbers]

### Domestic Priority Information

This application is a: [Continuation of]

Application One:

Filing Date:

which is a:

Application Two:

Filing Date:

[repeat as necessary]

### Foreign Application Information

Foreign Application One:

Filing Date:

Country:

Priority Claimed: [Yes or No]

### Assignee Information

Name of assignee:

Address Line One:

Address Line Two:

City:

State or Province:

Country:

Postal or Zip Code:

## 602 Original Oath or Declaration [R-2]

*35 U.S.C. 25. Declaration in lieu of oath.*

(a) The Director may by rule prescribe that any document to be filed in the Patent and Trademark Office and which is required by any law, rule, or other regulation to be under oath may be subscribed to by a written declaration in such form as the Director may prescribe, such declaration to be in lieu of the oath otherwise required.

(b) Whenever such written declaration is used, the document must warn the declarant that willful false statements and the like are punishable by fine or imprisonment, or both (18 U.S.C. 1001).

*35 U.S.C. 26. Effect of defective execution.*

Any document to be filed in the Patent and Trademark Office and which is required by any law, rule, or other regulation to be executed in a specified manner may be provisionally accepted by the Director despite a defective execution, provided a properly executed document is submitted within such time as may be prescribed.

*35 U.S.C. 115. Oath of applicant.*

The applicant shall make oath that he believes himself to be the original and first inventor of the process, machine, manufacture, or composition of matter, or improvement thereof, for which he solicits a patent; and shall state of what country he is a citizen. Such oath may be made before any person within the United States authorized by law to administer oaths, or, when made in a foreign country, before any diplomatic or consular officer of the United States authorized to administer oaths, or before any officer having an official seal and authorized to administer oaths in the foreign country in which the applicant may be, whose authority is proved by certificate of a diplomatic or consular officer of the United States, or apostille of an official designated by a foreign country which, by treaty or convention, accords like effect to apostilles of designated officials in the United States. Such oath is valid if it complies with the laws of the state or country where made. When the application is made as provided in this title by a person other than the inventor, the oath may be so varied in form that it can be made by him. For purposes of this section, a consular officer shall include any United States citizen serving overseas, authorized to perform notarial functions pursuant to section 1750 of the Revised Statutes, as amended (22 U.S.C. 4221).

*37 CFR 1.63. Oath or declaration.*

(a) An oath or declaration filed under § 1.51(b)(2) as a part of a nonprovisional application must:

(1) Be executed, *i.e.*, signed, in accordance with either § 1.66 or § 1.68. There is no minimum age for a person to be qualified to sign, but the person must be competent to sign, *i.e.*, understand the document that the person is signing;

(2) Identify each inventor by full name, including the family name, and at least one given name without abbreviation together with any other given name or initial;

(3) Identify the country of citizenship of each inventor; and

(4) State that the person making the oath or declaration believes the named inventor or inventors to be the original and first inventor or inventors of the subject matter which is claimed and for which a patent is sought.

(b) In addition to meeting the requirements of paragraph (a) of this section, the oath or declaration must also:

(1) Identify the application to which it is directed;

(2) State that the person making the oath or declaration has reviewed and understands the contents of the application, including the claims, as amended by any amendment specifically referred to in the oath or declaration; and

(3) State that the person making the oath or declaration acknowledges the duty to disclose to the Office all information known to the person to be material to patentability as defined in § 1.56.

(c) Unless such information is supplied on an application data sheet in accordance with § 1.76, the oath or declaration must also identify:

(1) The mailing address, and the residence if an inventor lives at a location which is different from where the inventor customarily receives mail, of each inventor; and

(2) Any foreign application for patent (or inventor's certificate) for which a claim for priority is made pursuant to § 1.55, and any foreign application having a filing date before that of the application on which priority is claimed, by specifying the application number, country, day, month, and year of its filing.

(d)(1) A newly executed oath or declaration is not required under § 1.51(b)(2) and § 1.53(f) in a continuation or divisional application, provided that:

(i) The prior nonprovisional application contained an oath or declaration as prescribed by paragraphs (a) through (c) of this section;

(ii) The continuation or divisional application was filed by all or by fewer than all of the inventors named in the prior application;

(iii) The specification and drawings filed in the continuation or divisional application contain no matter that would have been new matter in the prior application; and

(iv) A copy of the executed oath or declaration filed in the prior application, showing the signature or an indication thereon that it was signed, is submitted for the continuation or divisional application.

(2) The copy of the executed oath or declaration submitted under this paragraph for a continuation or divisional application must be accompanied by a statement requesting the deletion of the name or names of the person or persons who are not inventors in the continuation or divisional application.

(3) Where the executed oath or declaration of which a copy is submitted for a continuation or divisional application was originally filed in a prior application accorded status under § 1.47, the copy of the executed oath or declaration for such prior application must be accompanied by:

(i) A copy of the decision granting a petition to accord § 1.47 status to the prior application, unless all inventors or legal representatives have filed an oath or declaration to join in an application accorded status under § 1.47 of which the continuation or divisional application claims a benefit under 35 U.S.C. 120, 121, or 365(c); and

(ii) If one or more inventor(s) or legal representative(s) who refused to join in the prior application or could not be found or reached has subsequently joined in the prior application or another application of which the continuation or divisional application claims a benefit under 35 U.S.C. 120, 121, or 365(c), a copy of the subsequently executed oath(s) or declaration(s) filed by the inventor or legal representative to join in the application.

(4) Where the power of attorney (or authorization of agent) or correspondence address was changed during the prosecution of the prior application, the change in power of attorney (or

authorization of agent) or correspondence address must be identified in the continuation or divisional application. Otherwise, the Office may not recognize in the continuation or divisional application the change of power of attorney (or authorization of agent) or correspondence address during the prosecution of the prior application.

(5) A newly executed oath or declaration must be filed in a continuation or divisional application naming an inventor not named in the prior application.

(e) A newly executed oath or declaration must be filed in any continuation-in-part application, which application may name all, more, or fewer than all of the inventors named in the prior application.

#### *37 CFR 1.68. Declaration in lieu of oath.*

Any document to be filed in the Patent and Trademark Office and which is required by any law, rule, or other regulation to be under oath may be subscribed to by a written declaration. Such declaration may be used in lieu of the oath otherwise required, if, and only if, the declarant is on the same document, warned that willful false statements and the like are punishable by fine or imprisonment, or both (18 U.S.C. 1001) and may jeopardize the validity of the application or any patent issuing thereon. The declarant must set forth in the body of the declaration that all statements made of the declarant's own knowledge are true and that all statements made on information and belief are believed to be true.

#### *18 U.S.C. 1001. Statements or entries generally.*

Whoever, in any matter within the jurisdiction of any department or agency of the United States knowingly and willfully falsifies, conceals, or covers up by any trick, scheme, or device a material fact, or makes any false, fictitious or fraudulent statements or representations, or makes or uses any false writing or document knowing the same to contain any false, fictitious or fraudulent statement or entry, shall be fined not more than \$10,000 or imprisoned not more than five years, or both.

A provisional application does not require an oath or declaration to be complete. See 37 CFR 1.51(c).

>

## **I. < OATH**

A seal is usually impressed on an oath. See 37 CFR 1.66, MPEP § 604 and § 604.01. >Documents with seals cannot be adequately scanned for retention in an Image File Wrapper, and since the Office maintains patent applications in an image form as much as possible, the Office strongly encourages the use of declarations rather than oaths.< However, oaths executed in many states including Alabama, Louisiana, Maryland, Massachusetts, New Jersey, New York, Rhode Island, South Carolina, and Virginia need not be impressed with a seal. See MPEP § 604 for execu-

tion of an oath, and MPEP § 604.01 and § 604.02 for information regarding seals and venue.

>

## II. < STATUTORY DECLARATIONS

U.S. Patent and Trademark Office personnel are authorized to accept a statutory declaration under 28 U.S.C. 1746 filed in the U.S. Patent and Trademark Office in lieu of an “oath” or declaration under 35 U.S.C. 25 and 37 CFR 1.68, provided that the statutory declaration otherwise complies with the requirements of law.

Section 1746 of Title 28 of the United States Code provides:

Whenever, under any law of the United States or under any rule, regulation, order, or requirement made pursuant to law, any matter is required to be supported, evidenced, established, or proved by sworn declaration, verification, certificate, statement, oath or affidavit, in writing of the person making the same (other than a deposition, or an oath of office, or an oath required to be taken before a specified official other than notary public), such matter may, with like force and effect, be supported, evidenced, established, or proved by the unsworn declaration, certificate, verification, or statement, in writing of such person which is subscribed by him, as true under penalty of perjury, and dated, in substantially the following form:

[1]If executed without the United States:

“I declare (or certify, verify, or state) under penalty of perjury under the laws of the United States of America that the foregoing is true and correct. Executed on (date).

(Signature).”

[2]If executed within the United States its territories, possessions, or commonwealths:

“I declare (or certify, verify, or state) under penalty of perjury that the foregoing is true and correct. Executed on (date).

(Signature).”

A 37 CFR 1.68 declaration need not be ribboned to the other papers, even if signed in a country foreign to the United States. When a declaration is used, it is unnecessary to appear before any official in connection with the making of the declaration. It must, however, since it is an integral part of the application, be maintained together therewith.

By statute, 35 U.S.C. 25, the \*>Director< has been empowered to prescribe instances when a written declaration may be accepted in lieu of the oath for “any document to be filed in the Patent and Trademark Office.”

The filing of a written declaration is acceptable in lieu of an original application oath that is informal.

The following form paragraphs may be used to notify applicant that the oath or declaration is defective because it was not properly executed.

### ¶ 6.05 Oath or Declaration Defective, Heading

The oath or declaration is defective. A new oath or declaration in compliance with 37 CFR 1.67(a) identifying this application by application number and filing date is required. See MPEP §§ 602.01 and 602.02.

The oath or declaration is defective because:

#### Examiner Note:

1. One or more of the appropriate form paragraphs 6.05.01 to 6.05.20 must follow this paragraph.
2. If none of the form paragraphs apply, then an appropriate explanation of the defect should be given immediately following this paragraph.

#### ¶ 6.05.01 Improper Execution

It was not executed in accordance with either 37 CFR 1.66 or 1.68.

#### Examiner Note:

This paragraph must be preceded by form paragraph 6.05.

#### ¶ 6.05.17 Declaration Clause Omitted

The clause regarding “willful false statements ...” required by 37 CFR 1.68 has been omitted.

#### Examiner Note:

This paragraph must be preceded by form paragraph 6.05.

>

## III. < EARLIER FOREIGN APPLICATIONS

Oaths and declarations must make reference to any foreign application for patent (or inventor’s certificate) for which priority is claimed and any foreign application filed prior to the filing date of an application on which priority is claimed, unless such information is included in an application data sheet. See 37 CFR 1.63(c)(2).

If all foreign applications have been filed within 12 months of the U.S. filing date, applicant is required only to recite the first such foreign application of which priority is claimed, and it should be clear that the foreign application referred to is the first filed for-

foreign application. The applicant is required to recite all foreign applications filed prior to the application on which priority is claimed. It is required to give the foreign application number and name of the country or office in which filed, as well as the filing date of the first filed foreign application.

If the information regarding the foreign application has not been included in an application data sheet, or in an oath or declaration, form paragraphs 6.05 and 6.05.08 may be used to notify applicant that the oath or declaration is defective because the prior foreign application has not been identified.

*¶ 6.05.08 Identification of Foreign Applications Omitted*

It does not identify the foreign application for patent or inventor's certificate on which priority is claimed pursuant to 37 CFR 1.55, and any foreign application having a filing date before that of the application on which priority is claimed, by specifying the application number, country, day, month and year of its filing.

**Examiner Note:**

This paragraph must be preceded by form paragraph 6.05.

>

**IV. < SOLE OR JOINT DESIGNATION**

\*\*>37 CFR 1.63 no longer requires the oath or declaration to state that the inventor is a sole or joint inventor of the invention claimed.<

When joint inventors execute separate oaths or declarations, each oath or declaration should make reference to the fact that the affiant is a joint inventor together with each of the other inventors indicating them by name. This may be done by stating that he or she does verily believe himself or herself to be the original, first and joint inventor together with "A" or "A & B, etc." as the facts may be.

\*\*

>

**V. < NEW MATTER ISSUES**

If the oath or declaration improperly refers to an amendment containing new matter, a supplemental oath or declaration will be required pursuant to 37 CFR 1.67(b), deleting the reference to the amendment containing new matter. If an amendment is filed on the same day that the application under 37 CFR 1.53(b) is filed and is referred to in the original oath or declaration filed with or after the application, the amendment constitutes a part of the original applica-

tion papers and the question of new matter is not considered. Similarly, if the application papers are altered prior to the execution of the oath or declaration and the filing of the application, new matter is not a consideration since the alteration is considered as part of the original disclosure.

See MPEP § 602.05(a) where a continuation application under 37 CFR 1.53(b) is filed with a copy of a declaration from a prior application, but the continuation application is filed with a rewritten specification.

If a claim is presented for matter not originally claimed or embraced in the original statement of invention in the specification a supplemental oath or declaration is required, 37 CFR 1.67, MPEP § 603.

>

**VI. < IDENTIFICATION OF APPLICATION**

37 CFR 1.63 requires that an oath or declaration identify the specification to which it is directed. The declaration form suggested by the Office includes spaces for filling in the names of the inventors, title of the invention, application number, filing date, and foreign priority application information. While this information should be provided, it is not essential that all of these spaces be \*\*>completed< in order to adequately identify the specification in compliance with 37 CFR 1.63(b)(1).

The following combination of information supplied in an oath or declaration filed on the application filing date with a specification are acceptable as minimums for identifying a specification and compliance with any one of the items below will be accepted as complying with the identification requirement of 37 CFR 1.63:

(A) name of inventor(s), and reference to an attached specification which is both attached to the oath or declaration at the time of execution and submitted with the oath or declaration on filing;

(B) name of inventor(s), and attorney docket number which was on the specification as filed; or

(C) name of inventor(s), and title of the invention which was on the specification as filed.

Filing dates are granted on applications filed without an oath or declaration in compliance with 37 CFR 1.63, the oath or declaration being filed later with a surcharge. The following combinations of informa-

tion supplied in an oath or declaration filed after the filing date of the application are acceptable as minimums for identifying a specification and compliance with any one of the items below will be accepted as complying with the identification requirement of 37 CFR 1.63:

(A) application number (consisting of the series code and the serial number, e.g., 08/123,456);

(B) serial number and filing date;

(C) attorney docket number which was on the specification as filed;

(D) title of the invention which was on the specification as filed and reference to an attached specification which is both attached to the oath or declaration at the time of execution and submitted with the oath or declaration; or

(E) title of the invention which was on the specification as filed and accompanied by a cover letter accurately identifying the application for which it was intended by either the application number (consisting of the series code and the serial number, e.g., 08/123,456), or serial number and filing date. Absent any statement(s) to the contrary, it will be presumed that the application filed in the USPTO is the application which the inventor(s) executed by signing the oath or declaration.

Form paragraphs 6.05 and 6.05.20 may be used to notify applicant that the oath or declaration is defective because the specification has not been adequately identified.

\*\*>

*¶ 6.05.20 Specification Not Identified*

The specification to which the oath or declaration is directed has not been adequately identified. See MPEP § 602.

**Examiner Note:**

This paragraph must be preceded by form paragraph 6.05.

<

Any specification that is filed attached to an oath or declaration on a date later than the application filing date will not be compared with the specification submitted on filing. Absent any statement(s) to the contrary, the “attached” specification will be presumed to be a copy of the specification and any amendments thereto, which were filed in the USPTO in order to obtain a filing date for the application.

Any variance from the above guidelines will only be considered upon the filing of a petition for waiver of the rules under 37 CFR 1.183 accompanied by a petition fee (37 CFR 1.17(h)).

Further an oath or declaration attached to a cover letter referencing an incorrect application may not become associated with the correct application and, therefore, could result in the abandonment of the correct application.

Supplemental oaths or declarations in accordance with 37 CFR 1.67 will be required in applications in which the oaths or declarations are not in compliance with the other requirements of 37 CFR 1.63 but contain sufficient information to identify the specifications to which they apply as detailed above.

See MPEP § 1896 for the identification requirements for a declaration filed in a U.S. national stage application filed under 35 U.S.C. 371.

>

**VII. < COPIES OF OATHS OR DECLARATIONS ARE \*>ENCOURAGED<**

A copy, such as a photocopy or facsimile transmission, of an originally executed oath or declaration is \*\*>encouraged to< be filed (see MPEP § 502.01 \*\*>), especially since applications are maintained in electronic form, not paper. The< original should be retained >by applicant, or his or her representative< as evidence of authenticity. If a question of authenticity arises, the U.S. Patent and Trademark Office may require submission of the original. See 37 CFR 1.4(d)(1)(ii).

**Note**

See MPEP § 602.03 for other defects in the oath or declaration.



\*\*>

PTO/SB/01 (08-03)

Approved for use through 07/31/2006. OMB 0651-0032  
 U.S. Patent and Trademark Office, U.S. DEPARTMENT OF COMMERCE  
 Under the Paperwork Reduction Act of 1995, no persons are required to respond to a collection of information unless it contains a valid OMB control number.

<p><b>DECLARATION FOR UTILITY OR DESIGN PATENT APPLICATION (37 CFR 1.63)</b></p> <p><input type="checkbox"/> Declaration Submitted With Initial Filing      <b>OR</b>      <input type="checkbox"/> Declaration Submitted after Initial Filing (surcharge (37 CFR 1.16 (e)) required)</p>	Attorney Docket Number	
	First Named Inventor	
	<i>COMPLETE IF KNOWN</i>	
	Application Number	
	Filing Date	
	Art Unit	
	Examiner Name	

**I hereby declare that:**

Each inventor's residence, mailing address, and citizenship are as stated below next to their name.

I believe the inventor(s) named below to be the original and first inventor(s) of the subject matter which is claimed and for which a patent is sought on the invention entitled:

*(Title of the Invention)*

the specification of which

is attached hereto

**OR**

was filed on (MM/DD/YYYY)  as United States Application Number or PCT International Application Number  and was amended on (MM/DD/YYYY)  (if applicable).

I hereby state that I have reviewed and understand the contents of the above identified specification, including the claims, as amended by any amendment specifically referred to above.

I acknowledge the duty to disclose information which is material to patentability as defined in 37 CFR 1.56, including for continuation-in-part applications, material information which became available between the filing date of the prior application and the national or PCT international filing date of the continuation-in-part application.

I hereby claim foreign priority benefits under 35 U.S.C. 119(a)-(d) or (f), or 365(b) of any foreign application(s) for patent, inventor's or plant breeder's rights certificate(s), or 365(a) of any PCT international application which designated at least one country other than the United States of America, listed below and have also identified below, by checking the box, any foreign application for patent, inventor's or plant breeder's rights certificate(s), or any PCT international application having a filing date before that of the application on which priority is claimed.

Prior Foreign Application Number(s)	Country	Foreign Filing Date (MM/DD/YYYY)	Priority Not Claimed	Certified Copy Attached?	
				Yes	No
			<input type="checkbox"/>	<input type="checkbox"/>	<input type="checkbox"/>
			<input type="checkbox"/>	<input type="checkbox"/>	<input type="checkbox"/>
			<input type="checkbox"/>	<input type="checkbox"/>	<input type="checkbox"/>
			<input type="checkbox"/>	<input type="checkbox"/>	<input type="checkbox"/>

Additional foreign application numbers are listed on a supplemental priority data sheet PTO/SB/02B attached hereto.

[Page 1 of 2]

This collection of information is required by 35 U.S.C. 115 and 37 CFR 1.63. The information is required to obtain or retain a benefit by the public which is to file (and by the USPTO to process) an application. Confidentiality is governed by 35 U.S.C. 122 and 37 CFR 1.14. This collection is estimated to take 21 minutes to complete, including gathering, preparing, and submitting the completed application form to the USPTO. Time will vary depending upon the individual case. Any comments on the amount of time you require to complete this form and/or suggestions for reducing this burden, should be sent to the Chief Information Officer, U.S. Patent and Trademark Office, U.S. Department of Commerce, P.O. Box 1450, Alexandria, VA 22313-1450. DO NOT SEND FEES OR COMPLETED FORMS TO THIS ADDRESS. SEND TO: **Commissioner for Patents, P.O. Box 1450, Alexandria, VA 22313-1450.**

*If you need assistance in completing the form, call 1-800-PTO-9199 and select option 2.*

PTO/SB/01 (08-03)

Approved for use through 07/31/2006. OMB 0651-0032

U.S. Patent and Trademark Office; U.S. DEPARTMENT OF COMMERCE

Under the Paperwork Reduction Act of 1995, no persons are required to respond to a collection of information unless it contains a valid OMB control number.

**DECLARATION — Utility or Design Patent Application**

Direct all correspondence to: <input type="checkbox"/> Customer Number: <input type="text"/> <b>OR</b> <input type="checkbox"/> Correspondence address below			
Name			
Address			
City		State	ZIP
Country	Telephone	Fax	
I hereby declare that all statements made herein of my own knowledge are true and that all statements made on information and belief are believed to be true; and further that these statements were made with the knowledge that willful false statements and the like so made are punishable by fine or imprisonment, or both, under 18 U.S.C. 1001 and that such willful false statements may jeopardize the validity of the application or any patent issued thereon.			
<b>NAME OF SOLE OR FIRST INVENTOR:</b>		<input type="checkbox"/> A petition has been filed for this unsigned inventor	
Given Name (first and middle [if any])		Family Name or Surname	
Inventor's Signature			Date
Residence: City	State	Country	Citizenship
Mailing Address			
City	State	ZIP	Country
<b>NAME OF SECOND INVENTOR:</b>		<input type="checkbox"/> A petition has been filed for this unsigned inventor	
Given Name (first and middle [if any])		Family Name or Surname	
Inventor's Signature			Date
Residence: City	State	Country	Citizenship
Mailing Address			
City	State	ZIP	Country
<input type="checkbox"/> Additional inventors or a legal representative are being named on the _____ supplemental sheet(s) PTO/SB/02A or 02LR attached hereto.			

[Page 2 of 2]

## 602.01 Oath Cannot Be Amended

The wording of an oath or declaration cannot be amended, altered or changed in any manner after it has been signed. If the wording is not correct or if all of the required affirmations have not been made, or if it has not been properly subscribed to, a new oath or declaration must be required. However, in some cases, a deficiency in the oath or declaration can be corrected by a supplemental paper such as an application data sheet (see 37 CFR 1.76 and MPEP § 601.05) and a new oath or declaration is not necessary. See 37 CFR 1.63(c)(1) and (c)(2).

For example, if the oath does not set forth evidence that the notary was acting within his or her jurisdiction at the time he or she administered the oath, a certificate of the notary that the oath was taken within his or her jurisdiction will correct the deficiency. See MPEP § 602 and § 604.02.

Applicant may be so advised by using form paragraph 6.03.

### ¶ 6.03 Oath, Declaration Cannot Be Amended

A new oath or declaration is required because [1]. The wording of an oath or declaration cannot be amended. If the wording is not correct or if all of the required affirmations have not been made or if it has not been properly subscribed to, a new oath or declaration is required. The new oath or declaration must properly identify the application of which it is to form a part, preferably by application number and filing date in the body of the oath or declaration. See MPEP §§ 602.01 and 602.02.

#### Examiner Note:

1. This form paragraph is intended primarily for use in *pro se* applications.
2. Use form paragraph 6.05 and one or more of form paragraphs 6.05.01 to 6.05.20 for a defective oath or declaration in a case where there is a power of attorney.
3. Some corrections may be made by an application data sheet. If the error is correctable by an application data sheet, applicant should be informed of the requirements of an application data sheet. See 37 CFR 1.76 and MPEP § 601.05.

### ¶ 6.05.16 Non-Initialed/Non-Dated Alterations

Non-initialed and/or non - dated alterations have been made to the oath or declaration. See 37 CFR 1.52(c).

#### Examiner Note:

This paragraph must be preceded by form paragraph 6.05.

## 602.02 New Oath or Substitute for Original [R-2]

In requiring a new oath or declaration, the examiner should always give the reason for the requirement and call attention to the fact that the application of which it is to form a part must be properly identified in the body of the new oath or declaration, preferably by giving the application number and the date of filing. Any one of the combinations of information identified in MPEP § \* >602< as acceptable for an oath or declaration filed after the filing date may be used.

Where neither the original oath or declaration, nor the substitute oath or declaration is complete in itself, but each oath or declaration names all of the inventors and the two taken together give all the required data, no further oath or declaration is needed.

## 602.03 Defective Oath or Declaration [R-2]

In the first Office action the examiner must point out every deficiency in a declaration or oath and require that the same be remedied. Applicant may be informed of deficiencies in the declaration or oath by form paragraphs 6.05 and 6.05.01 - 6.05.20.

The following form paragraph 6.05 must be used to introduce one or more of Form Paragraphs 6.05.01 - 6.05.20, which explain errors in the oath or declaration. One or more of the following form paragraphs may be used to notify applicant of the objections to the oath or declaration due to a missing “reviewed and understands” statement, “original and first” statement, duty to disclose statement, or if the oath or declaration is not in permanent ink. See MPEP § 602 for defects in the execution of the oath or declaration, failure to properly reference to an earlier foreign application, \*\* or a failure to properly identify the application papers. See MPEP § 602.04 for a defective foreign executed oath and MPEP § 602.04(a) for an oath with an improperly attached ribbon.

### ¶ 6.05 Oath or Declaration Defective, Heading

The oath or declaration is defective. A new oath or declaration in compliance with 37 CFR 1.67(a) identifying this application by application number and filing date is required. See MPEP §§ 602.01 and 602.02.

The oath or declaration is defective because:

**Examiner Note:**

1. One or more of the appropriate form paragraphs 6.05.01 to 6.05.20 must follow this paragraph.
2. If none of the form paragraphs apply, then an appropriate explanation of the defect should be given immediately following this paragraph.

¶ 6.05.05 “Reviewed and Understands” Statement Omitted

It does not state that the person making the oath or declaration has reviewed and understands the contents of the specification, including the claims, as amended by any amendment specifically referred to in the oath or declaration.

**Examiner Note:**

This paragraph must be preceded by form paragraph 6.05.

¶ 6.05.06 Original and First Omitted

It does not state that the person making the oath or declaration believes the named inventor or inventors to be the original and first inventor or inventors of the subject matter which is claimed and for which a patent is sought.

**Examiner Note:**

This paragraph must be preceded by form paragraph 6.05.

¶ 6.05.07 Duty To Disclose Omitted

It does not state that the person making the oath or declaration acknowledges the duty to disclose to the Office all information known to the person to be material to patentability as defined in 37 CFR 1.56.

**Examiner Note:**

This paragraph must be preceded by form paragraph 6.05.

\*\*>

¶ 6.05.15 Not in Permanent Ink

The [1] is not in permanent ink, or its equivalent in quality, as required under 37 CFR 1.52(a)(1)(iv).

**Examiner Note:**

1. In bracket 1, insert either signature or oath/declaration.
2. This paragraph must be preceded by form paragraph 6.05.
3. If other portions of the disclosure are not in permanent ink, use form paragraph 6.32.

<

When an application is otherwise ready for issue, an examiner with full signatory authority may waive the following minor deficiencies:

Minor deficiencies in the body of the oath or declaration where the deficiencies are self-evidently cured in the rest of the oath or declaration\*\*. *In re Searles*, 422 F.2d 431, 437, 164 USPQ 623, 628 (CCPA 1970).

If \*\* >such a deficiency< is waived, the examiner with full signatory authority should write in the mar-

gin of the declaration or oath a notation \*\*>why the deficiency was waived, indicate that the application is ready for issue, and provide his or her initials and the date. For Image File Wrapper (IFW) processing, see IFW Manual.<

Of course, requirements of the statute, e.g., that the applicant state his or her citizenship or believes himself or herself to be the original and first inventor or that the oath be administered before a person authorized to administer oaths or that a declaration pursuant to 35 U.S.C. 25 or 28 U.S.C. 1746 contain the language required therein, cannot be waived.

If the defect cannot be waived, form paragraph 6.46 should be used when the application is allowable.

\*\*>

¶ 6.46 Application Allowed, Substitute Declaration Needed

Applicant is now required to submit a substitute declaration or oath to correct the deficiencies set forth [1]. The substitute oath or declaration must be filed within the THREE MONTH shortened statutory period set for reply in the “Notice of Allowability” (PTO-37). Extensions of time may NOT be obtained under the provisions of 37 CFR 1.136. Failure to timely file the substitute declaration (or oath) will result in **ABANDONMENT** of the application. The transmittal letter accompanying the declaration (or oath) should indicate the date of the “Notice of Allowance” (PTOL-85) and the application number in the upper right hand corner.

**Examiner Note:**

In the bracket, insert appropriate information, e.g., --in this communication--, --in the Office action mailed \_\_\_\_\_--, or --in the PTO-152 mailed on\_\_\_\_\_--.

<

## 602.04 Foreign Executed Oath

An oath executed in a foreign country must be properly authenticated. See 37 CFR 1.66 and MPEP § 604.

Where the authority of the foreign officer is not certified, form paragraphs 6.05 (reproduced in MPEP § 602.03) and 6.05.13 may be used.

¶ 6.05.13 Authority of Foreign Officer Not Certified

It does not include an apostille, a consular certificate, or the position of authority of the officer signing an apostille or consular certificate, see 37 CFR 1.66(a).

**Examiner Note:**

This paragraph applies only to foreign executed oaths and must be preceded by form paragraph 6.05.

### 602.04(a) Foreign Executed Oath Is Ribbed to Other Application Papers

37 CFR 1.66. *Officers authorized to administer oaths.*

\*\*\*\*\*

(b) When the oath is taken before an officer in a country foreign to the United States, any accompanying application papers, except the drawings, must be attached together with the oath and a ribbon passed one or more times through all the sheets of the application, except the drawings, and the ends of said ribbon brought together under the seal before the latter is affixed and impressed, or each sheet must be impressed with the official seal of the officer before whom the oath is taken. If the papers as filed are not properly ribboned or each sheet impressed with the seal, the case will be accepted for examination, but before it is allowed, duplicate papers, prepared in compliance with the foregoing sentence, must be filed.

Where the papers are not properly ribboned, use form paragraphs 6.05 (reproduced in MPEP § 602.03) and 6.05.14.

#### ¶ 6.05.14 *No Ribbon Properly Attached*

It does not have a ribbon properly attached.

#### **Examiner Note:**

This paragraph applies only to foreign executed oaths and must be preceded by form paragraph 6.05.

### **U.S. ACCESSION TO HAGUE CONVENTION ABOLISHING THE REQUIREMENT OF LEGALIZATION FOR FOREIGN PUBLIC DOCUMENTS**

On Oct. 15, 1981, the Hague "Convention Abolishing the Requirement of Legalization for Foreign Public Documents" entered into force between the United States and 28 foreign countries as parties to the Convention. Subsequently, additional countries have become parties to the Convention. The Convention applies to any document submitted to the United States Patent and Trademark Office for filing or recording, which is sworn to or acknowledged by a notary public in any one of the member countries. The Convention abolishes the certification of the authority of the notary public in a member country by a diplomatic or consular officer of the United States and substitutes certification by a special certificate, or

apostille, executed by an officer of the member country. Accordingly, the Office will accept for filing or recording a document sworn to or acknowledged before a notary public in a member country if the document bears, or has appended to it, an apostille certifying the notary's authority. The requirement for a diplomatic or consular certificate, specified in 37 CFR 1.66, will not apply to a document sworn to or acknowledged before a notary public in a member country if an apostille is used.

The member countries that are parties to the Convention are:

Andorra, Angola<sup>1</sup>, Anguilla, Antigua and Barbuda, Argentina, Armenia<sup>2</sup>, Aruba, Australia, Austria, Bahamas, Barbados, Belarus<sup>2</sup>, Belgium, Belize, Bermuda, Bosnia-Herzegovina<sup>3</sup>, Botswana, British Antarctic Territory, British Virgin Islands, Brunei, Cayman Islands, Comoros Islands (formerly Moroni)<sup>1</sup>, Croatia<sup>3</sup>, Cyprus, Djibouti (formerly Affars and Issas)<sup>1</sup>, Dominica<sup>1</sup>, El Salvador, Falkland Islands, Fiji, Finland, France, French Guiana, French Polynesia, Guadeloupe, Germany, Gibraltar, Greece, Grenada<sup>1</sup>, Guernsey (Bailiwick of), Hong Kong, Hungary, Isle of Man, Israel, Italy, Japan, Jersey (Bailiwick of), Kiribati (formerly Gilbert Islands)<sup>1</sup>, Latvia, Lesotho, Liechtenstein, Luxembourg, Macedonia<sup>3</sup>, Malawi, Malta, Marshall Islands, Martinique, Mauritius, Mexico, Montserrat, Mozambique<sup>1</sup>, Netherlands, Netherlands Antilles (Curacao, Bonaire, St. Martin, St. Eustatius and Saba), New Caledonia, Norway, Panama, Portugal, Reunion, Russian Federation<sup>2</sup>, St. Christopher (Kitts) and Nevis, St. Georgia and South Sandwich Islands, St. Helena, St. Lucia, St. Pierre and Miquelon, St. Vincent and the Grenadines, San Marino, Seychelles, Slovenia<sup>3</sup>, Solomon Islands (formerly British Solomon Islands)<sup>1</sup>, South Africa, Spain, Suriname, Swaziland, Switzerland, Tonga, Turkey, Turks and Caicos, Tuvalu (formerly Ellice Islands)<sup>1</sup>, United Kingdom, United States, Vanuatu (formerly New Hebrides)<sup>1</sup>, Wallis and Futuna.<sup>123</sup>

The Convention prescribes the following form for the apostille:

<sup>1</sup>This country achieved independence. No declaration has been made on the continuation in force of the Convention.

**Model of Certificate**

The certificate will be in the form of a square with sides at least 9 centimeters long.

<b>APOSTILLE</b> (Convention de La Haye du Oct. 5, 1961)	
1. Country .....	
This public document	
2. has been signed by .....	
3. acting in the capacity of .....	
4. bears the seal/stamp of .....	
Certified	
5. at .....	
6. the .....	
7. by .....	
8. No. ....	
9. Seal/stamp: .....	10. Signature: .....

Note that a declaration in lieu of application oath (37 CFR 1.68) need not be ribboned to the other papers. It must, however, be maintained together therewith.

**602.05 Oath or Declaration — Date of Execution**

The Office no longer checks the date of execution of the oath or declaration and the Office will no longer require a newly executed oath or declaration based on an oath or declaration being stale (that is when the date of execution is more than 3 months prior to the filing date of the application) or where the date of execution has been omitted. However, applicants are reminded that they have a continuing duty of disclosure under 37 CFR 1.56.

**602.05(a) Oath or Declaration in Continuation and Divisional Applications**

A continuation or divisional application filed under 37 CFR 1.53(b) (other than a continuation-in-part (CIP)) may be filed with a copy of the oath or declaration from the prior nonprovisional application. See 37 CFR 1.63(d)(1)(iv).

A copy of an oath or declaration from a prior application may be submitted with a continuation or divisional application even if the oath or declaration identifies the application number of the prior application. However, if such a copy of the oath or declaration is filed after the filing date of the continuation or divisional application and an application number has been assigned to the continuation or divisional application (see 37 CFR 1.5(a)), the cover letter accompanying the oath or declaration should identify the application number of the continuation or divisional application. The cover letter should also indicate that the oath or declaration submitted is a copy of the oath or declaration from a prior application to avoid the oath or declaration being incorrectly matched with the prior application file. Furthermore, applicant should also label the copy of the oath or declaration with the application number of the continuation or divisional application in the event that the cover letter is separated from the copy of the oath or declaration.

A copy of the oath or declaration from a prior nonprovisional application may be filed in a continuation or divisional application even if the specification for the continuation or divisional application is different from that of the prior application, in that revisions have been made to clarify the text to incorporate amendments made in the prior application, or to make other changes provided the changes do not constitute new matter relative to the prior application. See 37 CFR 1.52(c)(3). If the examiner determines that the continuation or divisional application contains new

<sup>2</sup>On September 4, 1991, the Union of Soviet Socialist Republics (USSR) deposited an instrument of accession to the Convention. The Convention was to have entered into force for the USSR on April 1, 1992. Prior to that date, the USSR dissolved. Three members of the Newly Independent States (NIS), the Russian Federation, the Belarus Republic and Armenia have informed the depositary for the Convention that the Convention applies in those jurisdiction. It is not clear whether other NIS countries are applying the Convention. Even if other NIS countries were to consider the Convention to apply, it may not be operational. Each jurisdiction must designate an authority competent to issue the Convention certificate (apostille) before the Convention can be operational.

<sup>3</sup>Former Yugoslavia was a party to the Convention. Slovenia, Macedonia, Bosnia-Herzegovina and Croatia have informed the depositary that they consider the Convention to apply and have designated a competent authority to issue the Convention certificate (apostille).

matter relative to the prior application, the examiner should so notify the applicant in the next Office action. The examiner should also (1) require a new oath or declaration along with the surcharge set forth in 37 CFR 1.16(e); and (2) indicate that the application should be redesignated as a continuation-in-part.

A continuation or divisional application of a prior application accorded status under 37 CFR 1.47 will be accorded status under 37 CFR 1.47 if a copy of the decision according 37 CFR 1.47 status in the prior application is filed in the continuation or divisional application, unless an oath or declaration signed by all of the inventors is included upon filing the continuation or divisional application. An oath or declaration in an application accorded status under 37 CFR 1.47 is generally not signed by all of the inventors. Accordingly, if a copy of an oath or declaration of a prior application is submitted in a continuation or divisional application filed under 37 CFR 1.53(b) and the copy of the oath or declaration omits the signature of one or more inventors, the Office of Initial Patent Examination (OIPE) should send a “Notice to File Missing Parts” requiring the signature of the nonsigning inventor, unless a copy of the decision according status under 37 CFR 1.47 is also included at the time of filing of the continuation or divisional application. If OIPE mails such a Notice, a copy of the decision according status under 37 CFR 1.47, together with a surcharge under 37 CFR 1.16(e) for its late filing, will be an acceptable reply to the Notice. Alternatively, applicant may submit an oath or declaration signed by the previously nonsigning inventor together with the surcharge set forth in 37 CFR 1.16(e) in reply to the Notice.

If an inventor named in a prior application is not an inventor in a continuation or divisional application filed under 37 CFR 1.53(b), the continuation or divisional application may either be filed (1) with a copy of an oath or declaration from a prior application and a statement requesting the deletion of the name or names of the person or persons who are not inventors of the invention being claimed in the continuation or divisional application (see 37 CFR 1.63(d)), or (2) a newly executed oath or declaration naming the correct inventive entity. If an inventor named in a prior application is not an inventor in a continuation or divisional application filed under 37 CFR 1.53(d), the request for filing the continuation or divisional appli-

cation must be accompanied by a statement requesting the deletion of the name or names of the person or persons who are not inventors of the invention being claimed in the continuation or divisional application (see 37 CFR 1.53(d)(4)).

A continuation or divisional application filed under 37 CFR 1.53(b) of a prior application in which a petition (or request) under 37 CFR 1.48 to add an inventor was filed should be filed with a copy of the executed declaration naming the correct inventive entity from the prior application or a newly executed declaration naming the correct inventive entity. A copy of any decision under 37 CFR 1.48 from the prior application is not required to be filed in the continuation or divisional application.

## **602.06 Non-English Oath or Declaration**

*37 CFR 1.69. Foreign language oaths and declarations.*

(a) Whenever an individual making an oath or declaration cannot understand English, the oath or declaration must be in a language that such individual can understand and shall state that such individual understands the content of any documents to which the oath or declaration relates.

(b) Unless the text of any oath or declaration in a language other than English is a form provided or approved by the Patent and Trademark Office, it must be accompanied by an English translation together with a statement that the translation is accurate, except that in the case of an oath or declaration filed under § 1.63, the translation may be filed in the Office no later than two months from the date applicant is notified to file the translation.

37 CFR 1.69 requires that oaths and declarations be in a language which is understood by the individual making the oath or declaration, i.e., a language which the individual comprehends. If the individual comprehends the English language, he or she should preferably use it. If the individual cannot comprehend the English language, any oath or declaration must be in a language which the individual can comprehend. If an individual uses a language other than English for an oath or declaration, the oath or declaration must include a statement that the individual understands the content of any documents to which the oath or declaration relates. If the documents are in a language the individual cannot comprehend, the documents may be explained to him or her so that he or she is able to understand them.

The Office will accept a single non-English language oath or declaration where there are joint inventors, of which only some understand English but all understand the non-English language of the oath or declaration.

## 602.07 Oath or Declaration Filed in United States as a Designated Office

See MPEP § 1893.01.

## 603 Supplemental Oath or Declaration

*37 CFR 1.67. Supplemental oath or declaration.*

(a) The Office may require, or inventors and applicants may submit, a supplemental oath or declaration meeting the requirements of § 1.63 or § 1.162 to correct any deficiencies or inaccuracies present in the earlier filed oath or declaration.

(1) Deficiencies or inaccuracies relating to all the inventors or applicants (§§ 1.42, 1.43, or § 1.47) may be corrected with a supplemental oath or declaration signed by all the inventors or applicants.

(2) Deficiencies or inaccuracies relating to fewer than all of the inventor(s) or applicant(s) (§§ 1.42, 1.43 or § 1.47) may be corrected with a supplemental oath or declaration identifying the entire inventive entity but signed only by the inventor(s) or applicant(s) to whom the error or deficiency relates.

(3) Deficiencies or inaccuracies due to the failure to meet the requirements of § 1.63(c) (*e.g.*, to correct the omission of a mailing address of an inventor) in an oath or declaration may be corrected with an application data sheet in accordance with § 1.76.

(4) Submission of a supplemental oath or declaration or an application data sheet (§ 1.76), as opposed to who must sign the supplemental oath or declaration or an application data sheet, is governed by § 1.33(a)(2) and paragraph (b) of this section.

(b) A supplemental oath or declaration meeting the requirements of § 1.63 must be filed when a claim is presented for matter originally shown or described but not substantially embraced in the statement of invention or claims originally presented or when an oath or declaration submitted in accordance with § 1.53(f) after the filing of the specification and any required drawings specifically and improperly refers to an amendment which includes new matter. No new matter may be introduced into a nonprovisional application after its filing date even if a supplemental oath or declaration is filed. In proper situations, the oath or declaration here required may be made on information and belief by an applicant other than the inventor.

(c) [Reserved]

37 CFR 1.67 requires in the supplemental oath or declaration substantially all the data called for in 37 CFR 1.63 for the original oath or declaration. As to the purpose to be served by the supplemental oath or declaration, the examiner should bear in mind that it

cannot be availed of to introduce new matter into an application.

Deficiencies or inaccuracies in an oath or declaration may be corrected by a supplemental oath or declaration. The supplemental oath or declaration must (1) identify the entire inventive entity, and (2) be signed by all the inventors when the correction relates to all the inventors or applicants (37 CFR 1.42, 1.43, or 1.47), or by only those inventor(s) or applicants (37 CFR 1.42, 1.43, or 1.47) to whom the corrections relates. See 37 CFR 1.67(a). A deficiency or inaccuracy relating to information required by 37 CFR 1.63(c) may also be corrected with an application data sheet (37 CFR 1.67(a)(3)). The following examples illustrate how certain deficiencies or inaccuracies in an oath or declaration may be corrected:

Example 1: An application was filed with a declaration under 37 CFR 1.63 executed by inventors A, B, and C. If it is later determined that the citizenship of inventor C was in error, a supplemental declaration identifying inventors A, B, and C may be signed by inventor C alone correcting C's citizenship.

Example 2: An application was filed with a declaration under 37 CFR 1.63 executed by inventors A, B, and C. If it is later determined that the duty to disclose clause was omitted, a supplemental declaration identifying inventors A, B, and C must be signed by inventors A, B, and C. If separate declarations had been executed by each of the inventors and the duty to disclose clause had been omitted only in the declaration by inventor B, then only inventor B would need to execute a supplemental declaration identifying the entire inventive entity.

Example 3: An application was filed with a declaration under 37 CFR 1.63 executed by inventors A, and B, and the legal representative of deceased inventor C. It is later determined that an error was made in the citizenship of deceased inventor C. A supplemental declaration identifying A, B, and C as the inventors would be required to be signed by the legal representative of deceased inventor C alone correcting C's citizenship.

Example 4: An application was filed with a declaration under 37 CFR 1.63 executed by inventors A and B. If it is later determined that an error exists in the mailing address of inventor B, the mailing address of inventor B may be corrected by a supplemental declaration identifying the entire inventive entity and



signed by inventor B alone, or an application data sheet under 37 CFR 1.76 containing only a change in inventor B's mailing address.

When an inventor who executed the original declaration is refusing or cannot be found to execute a required supplemental declaration, the requirement for that inventor to sign the supplemental declaration may be suspended or waived in accordance with 37 CFR 1.183. All available joint inventor(s) must sign the supplemental declaration on behalf of themselves, if appropriate, and on behalf of the nonsigning inventor. See MPEP § 409.03(a). If there are no joint inventor(s), then the party with sufficient proprietary interest must sign the supplemental declaration on behalf of the nonsigning inventor. See MPEP § 409.03(b).

A new oath may be required by using form paragraph 6.06.

¶ 6.06 *New Oath for Subject Matter Not Originally Claimed*

This application presents a claim for subject matter not originally claimed or embraced in the statement of the invention. [1]. A supplemental oath or declaration is required under 37 CFR 1.67. The new oath or declaration must properly identify the application of which it is to form a part, preferably by application number and filing date in the body of the oath or declaration. See MPEP §§ 602.01 and 602.02.

**Examiner Note:**

Explain new claimed matter in bracket 1. The brief summary of the invention must be commensurate with the claimed invention and may be required to be modified. See MPEP § 608.01(d) and 1302, and 37 CFR 1.73.

### 603.01 Supplemental Oath or Declaration Filed After Allowance

Since the decision in *Cutter Co. v. Metropolitan Electric Mfg. Co.*, 275 F. 158 (2d Cir. 1921), many supplemental oaths and declarations covering the claims in the application have been filed after the applications were allowed. Such oaths and declarations may be filed as a matter of right and when received they will be placed in the file by the Office of Patent Publication, but their receipt will not be acknowledged to the party filing them. They should not be filed or considered as amendments under 37 CFR 1.312, since they make no change in the wording of the papers on file. See MPEP § 714.16.

## 604 Administration or Execution of Oath

37 CFR 1.66. *Officers authorized to administer oaths.*

(a) The oath or affirmation may be made before any person within the United States authorized by law to administer oaths. An oath made in a foreign country, may be made before any diplomatic or consular officer of the United States authorized to administer oaths, or before any officer having an official seal and authorized to administer oaths in the foreign country in which the applicant may be, whose authority shall be proved by a certificate of a diplomatic or consular officer of the United States, or by an apostille of an official designated by a foreign country which, by treaty or convention, accords like effect to apostilles of designated officials in the United States. The oath shall be attested in all cases in this and other countries, by the proper official seal of the officer before whom the oath or affirmation is made. Such oath or affirmation shall be valid as to execution if it complies with the laws of the State or country where made. When the person before whom the oath or affirmation is made in this country is not provided with a seal, his official character shall be established by competent evidence, as by a certificate from a clerk of a court of record or other proper officer having a seal.

\*\*\*\*\*

See MPEP § 602.04(a) for foreign executed oath.

### 604.01 Seal [R-2]

>Documents with seals cannot be adequately scanned for retention in an Image File Wrapper, and since the Office maintains patent applications in an image form as much as possible, the Office strongly encourages the use of declarations rather than oaths.< When the person before whom the oath or affirmation is made in this country is not provided with a seal, his or her official character shall be established by competent evidence, as by a certificate from a clerk of a court of record or other proper officer having a seal, except as noted in MPEP § 604.03(a), in which situations no seal is necessary. When the issue concerns the authority of the person administering the oath, the examiner should require proof of authority. Depending on the jurisdiction, the seal may be either embossed or rubber stamped. The latter should not be confused with a stamped legend indicating only the date of expiration of the notary's commission.

See also MPEP § 602.04(a) on foreign executed oath and seal. In some jurisdictions, the seal of the notary is not required but the official title of the officer must be on the oath. This applies to Alabama, California (certain notaries), Louisiana, Maryland,

Massachusetts, New Jersey, New York, Ohio, Puerto Rico, Rhode Island, South Carolina, and Virginia.

¶ 6.06 *New Oath for Subject Matter Not Originally Claimed*

This application presents a claim for subject matter not originally claimed or embraced in the statement of the invention. [1]. A supplemental oath or declaration is required under 37 CFR 1.67. The new oath or declaration must properly identify the application of which it is to form a part, preferably by application number and filing date in the body of the oath or declaration. See MPEP §§ 602.01 and 602.02.

**Examiner Note:**

Explain new claimed matter in bracket 1. The brief summary of the invention must be commensurate with the claimed invention and may be required to be modified. See MPEP § 608.01(d) and 1302, and 37 CFR 1.73.

¶ 6.05.11 *Notary Signature*

It does not include the notary's signature, or the notary's signature is in the wrong place.

**Examiner Note:**

This paragraph must be preceded by form paragraph 6.05.

¶ 6.05.12 *Notary Seal and Venue Omitted*

It does not include the notary's seal and venue.

**Examiner Note:**

This paragraph must be preceded by form paragraph 6.05.

## 604.02 Venue

That portion of an oath or affidavit indicating where the oath is taken is known as the venue. Where the county and state in the venue agree with the county and state in the seal, no problem arises. If the venue and seal do not correspond in county and state, the jurisdiction of the notary must be determined from statements by the notary appearing on the oath. Venue and notary jurisdiction must correspond or the oath is improper. The oath should show on its face that it was taken within the jurisdiction of the certifying officer or notary. This may be given either in the venue or in the body of the jurat. Otherwise, a new oath or declaration, or a certificate of the notary that the oath was taken within his or her jurisdiction, must be required. *Ex parte Delavoye*, 1906 C.D. 320, 124 O.G. 626 (Comm'r Pat. 1906); *Ex parte Irwin*, 1928 C.D. 13, 367 O.G. 701 (Comm'r Pat. 1928).

Form paragraph 6.07 may be used where the venue is not shown.

¶ 6.07 *Lack of Venue*

The oath lacks the statement of venue. Applicant is required to furnish either a new oath or declaration in proper form, identifying the application by application number and filing date, or a certificate by the officer before whom the original oath was taken stating that the oath was executed within the jurisdiction of the officer before whom the oath was taken when the oath was administered. The new oath or declaration must properly identify the application of which it is to form a part, preferably by application number and filing date in the body of the oath or declaration. See MPEP §§ 602.01 and 602.02.

Where the seal and venue differ, applicant should be notified by using the "Notice of Informal Application" form.

## 604.03(a) Notarial Powers of Some Military Officers

Public Law 506 (81st Congress, Second Session) Article 136: (a) The following persons on active duty in the armed forces . . . shall have the general powers of a notary public and of a consul of the United States, in the performance of all notarial acts to be executed by members of any of the armed forces, wherever they may be, and by other persons subject to this code [Uniform Code of Military Justice] outside the continental limits of the United States:

- (A) All judge advocates of the Army and Air Force;
- (B) All law specialists;
- (C) All summary courts-martial;
- (D) All adjutants, assistant adjutants, acting adjutants, and personnel adjutants;
- (E) All commanding officers of the Navy and Coast Guard;
- (F) All staff judge advocates and legal officers, and acting or assistant staff judge advocates and legal officers; and
- (G) All other persons designated by regulations of the armed forces or by statute.
- (H) The signature without seal of any such person acting as notary, together with the title of his office, shall be *prima facie* evidence of his authority.

## 604.04 Consul

On Oct. 15, 1981, the "Hague Convention Abolishing the Requirement of Legalization for Foreign Public Documents" entered into force between the United States and 28 foreign countries as parties to the Con-

vention. Subsequently, additional countries have become parties to the conventions. See MPEP § 604.04(a).

When the oath is made in a foreign country not a member of the Hague Convention Abolishing the Requirement of Legalization for Foreign Public Documents, the authority of any officer other than a diplomatic or consular officer of the United States authorized to administer oaths must be proved by certificate of a diplomatic or consular officer of the United States. See 37 CFR 1.66, MPEP § 604. This proof may be through an intermediary, e.g., the consul may certify as to the authority and jurisdiction of another official who, in turn, may certify as to the authority and jurisdiction of the officer before whom the oath is taken.

#### **604.04(a) Consul – Omission of Certificate [R-2]**

Where the oath is taken before an officer in a foreign country other than a diplomatic or consular officer of the United States and whose authority is not authenticated or accompanied with an apostille certifying the notary's authority (see MPEP § 602.04(a)), the application is nevertheless accepted for purposes of examination. The examiner, in the first Office action, should note this informality and require **\*\*>a new properly authenticated< oath by an appropriate diplomatic or consular officer, the filing of proper apostille, or a declaration (37 CFR 1.68). >The Office no longer returns improperly authenticated oaths for proper authentication.<**

Form paragraph 6.08 may be used to notify applicant.

**\*\*>**

#### *¶ 6.08 Consul-Omission of Certificate*

The oath is objected to as being informal. It lacks authentication by a diplomatic or consular officer of the United States; 37 CFR 1.66(a). This informality can be overcome by filing either a declaration under 37 CFR 1.68, or a new properly authenticated oath under 37 CFR 1.66. The new oath or declaration must properly identify the application of which it is to form a part, preferably by application number and filing date in the body of the oath or declaration. See MPEP §§ 602.01 and 602.02.

<

#### **604.06 By Attorney in Application**

The language of 37 CFR 1.66 and 35 U.S.C. 115 is such that an attorney in the application is not barred from administering the oath as notary. The Office presumes that an attorney acting as notary is cognizant of the extent of his or her authority and jurisdiction and will not knowingly jeopardize his or her client's rights by performing an illegal act. If such practice is permissible under the law of the jurisdiction where the oath is administered, then the oath is a valid oath.

The law of the District of Columbia prohibits the administering of oaths by the attorney in the case. If the oath is known to be void because of being administered by the attorney in a jurisdiction where the law holds this to be invalid, the proper action is to require a new oath or declaration and refer the file to the Office of Enrollment and Discipline. (*Riegger v. Beierl*, 1910 C.D. 12, 150 O.G. 826 (Comm'r Pat. 1910)). See 37 CFR 1.66 and MPEP § 604.

#### **605 Applicant [R-2]**

*37 CFR 1.41. Applicant for patent.*

(a) A patent is applied for in the name or names of the actual inventor or inventors.

(1) The inventorship of a nonprovisional application is that inventorship set forth in the oath or declaration as prescribed by § 1.63, except as provided for in §§ 1.53(d)(4) and 1.63(d). If an oath or declaration as prescribed by § 1.63 is not filed during the pendency of a nonprovisional application, the inventorship is that inventorship set forth in the application papers filed pursuant to § 1.53(b), unless applicant files a paper, including the processing fee set forth in § 1.17(i), supplying or changing the name or names of the inventor or inventors.

(2) The inventorship of a provisional application is that inventorship set forth in the cover sheet as prescribed by § 1.51(c)(1). If a cover sheet as prescribed by § 1.51(c)(1) is not filed during the pendency of a provisional application, the inventorship is that inventorship set forth in the application papers filed pursuant to § 1.53(c), unless applicant files a paper including the processing fee set forth in § 1.17(q), supplying or changing the name or names of the inventor or inventors.

(3) In a nonprovisional application filed without an oath or declaration as prescribed by § 1.63 or a provisional application filed without a cover sheet as prescribed by § 1.51(c)(1), the name, residence, and citizenship of each person believed to be an actual inventor should be provided when the application papers pursuant to § 1.53(b) or § 1.53(c) are filed.

\*\*>

(4) The inventorship of an international application entering the national stage under 35 U.S.C. 371 is that inventorship set forth in the international application, which includes any change effected under PCT Rule 92bis. See § 1.497(d) and (f) for filing an oath or declaration naming an inventive entity different from the inventive entity named in the international application, or if a change to the inventive entity has been effected under PCT Rule 92bis subsequent to the execution of any declaration filed under PCT Rule 4.17(iv) (§ 1.48(f)(1) does not apply to an international application entering the national stage under 35 U.S.C. 371).<

(b) Unless the contrary is indicated the word “applicant” when used in these sections refers to the inventor or joint inventors who are applying for a patent, or to the person mentioned in §§ 1.42, 1.43 or 1.47 who is applying for a patent in place of the inventor.

(c) Any person authorized by the applicant may physically or electronically deliver an application for patent to the Office on behalf of the inventor or inventors, but an oath or declaration for the application (§ 1.63) can only be made in accordance with § 1.64.

(d) A showing may be required from the person filing the application that the filing was authorized where such authorization comes into question.

#### 37 CFR 1.45. *Joint inventors.*

(a) Joint inventors must apply for a patent jointly and each must make the required oath or declaration; neither of them alone, nor less than the entire number, can apply for a patent for an invention invented by them jointly, except as provided in § 1.47.

(b) Inventors may apply for a patent jointly even though

(1) They did not physically work together or at the same time,

(2) Each inventor did not make the same type or amount of contribution, or

(3) Each inventor did not make a contribution to the subject matter of every claim of the application.

(c) If multiple inventors are named in a nonprovisional application, each named inventor must have made a contribution, individually or jointly, to the subject matter of at least one claim of the application and the application will be considered to be a joint application under 35 U.S.C. 116. If multiple inventors are named in a provisional application, each named inventor must have made a contribution, individually or jointly, to the subject matter disclosed in the provisional application and the provisional application will be considered to be a joint application under 35 U.S.C. 116.

37 CFR 1.41 and 37 CFR 1.53 were amended effective December 1, 1997, to remove the requirement that the name(s) of the inventor(s) be identified in the application papers in order to accord the application a filing date. 37 CFR 1.41(a)(1) now defines the inventorship of a nonprovisional application as that inventorship set forth in the oath or declaration filed to

comply with the requirements of 37 CFR 1.63, except as provided for in 37 CFR 1.53(d)(4) and 37 CFR 1.63(d). The oath or declaration may be filed on the filing date of the application or on a later date. If an oath or declaration is not filed during the pendency of a nonprovisional application, the inventorship is that inventorship set forth in the application papers filed pursuant to 37 CFR 1.53(b), unless an applicant files a paper under 37 CFR 1.41(a)(\*)>1<) accompanied by the processing fee set forth in 37 CFR 1.17(i) supplying or changing the name or names of the inventor or inventors.

The name, residence, and citizenship of each person believed to be an actual inventor should be provided as an application identifier when application papers under 37 CFR 1.53(b) are filed without an oath or declaration, or application papers under 37 CFR 1.53(c) are filed without a cover sheet. See 37 CFR 1.41(a)(3). Naming the individuals known to be inventors or the persons believed to be the inventors may enable the Office to identify the application, if applicant does not know the application number. Where no inventor(s) is known and applicant cannot name a person believed to be an inventor on filing, the Office requests that an alphanumeric identifier be submitted for the application. The use of very short identifiers should be avoided to prevent confusion. Without supplying at least a unique identifying name the Office may have no ability or only a delayed ability to match any papers submitted after filing of the application and before issuance of an identifying application number with the application file. Any identifier used that is not an inventor’s name should be specific, alphanumeric characters of reasonable length, and should be presented in such a manner that it is clear to application processing personnel what the identifier is and where it is to be found. Failure to apprise the Office of an application identifier such as the names of the inventors or the alphanumeric identifier being used may result in applicants having to resubmit papers that could not be matched with the application and proof of the earlier receipt of such papers where submission was time dependent.

For correction of inventorship, see MPEP § 201.03.

This section concerns filing by the actual inventor. If the application is filed by another, see MPEP § 409.03.

For assignments of application by inventor, see MPEP § 301. For an inventor who is dead or insane, see MPEP § 409.

### 605.01 Applicant's Citizenship

The statute (35 U.S.C. 115) requires an applicant, in a nonprovisional application, to state his or her citizenship. Where an applicant is not a citizen of any country, a statement to this effect is accepted as satisfying the statutory requirement, but a statement as to citizenship applied for or first papers taken out looking to future citizenship in this (or any other) country does not meet the requirement.

Form paragraphs 6.05 and 6.05.03 may be used to notify applicant that the applicant's citizenship is omitted.

#### ¶ 6.05 Oath or Declaration Defective, Heading

The oath or declaration is defective. A new oath or declaration in compliance with 37 CFR 1.67(a) identifying this application by application number and filing date is required. See MPEP §§ 602.01 and 602.02.

The oath or declaration is defective because:

#### Examiner Note:

1. One or more of the appropriate form paragraphs 6.05.01 to 6.05.20 must follow this paragraph.
2. If none of the form paragraphs apply, then an appropriate explanation of the defect should be given immediately following this paragraph.

#### ¶ 6.05.03 Citizenship Omitted

It does not identify the citizenship of each inventor.

#### Examiner Note:

This paragraph must be preceded by form paragraph 6.05

### 605.02 Applicant's Residence [R-2]

Applicant's place of residence, that is, the city and either state or foreign country, is required to be included in the oath or declaration in a nonprovisional application for compliance with 37 CFR 1.63 unless it is included in an application data sheet (37 CFR 1.76). In the case of an applicant who is in one of the U.S. Armed Services, a statement to that effect is sufficient as to residence. For change of residence, see MPEP § 719.02(b). Applicant's residence must be included on the cover sheet for a provisional application unless it is included in an application data sheet (37 CFR 1.76).

If the residence is not included in the executed oath or declaration filed under 37 CFR 1.63, the Office of Initial Patent Examination (OIPE) will normally so

indicate on a form PTO-152, "Notice of Informal Application," so as to require the submission of the residence information within a set period for reply. If the examiner notes that the residence has not been included in the oath or declaration or in an application data sheet, form paragraphs 6.05 (reproduced in MPEP § 605.01) and 6.05.02 should be used.

\*\*>

#### ¶ 6.05.02 Residence Omitted

It does not identify the city and either state or foreign country of residence of each inventor. The residence information may be provided on either an application data sheet or a supplemental oath or declaration.

#### Examiner Note:

This paragraph must be preceded by form paragraph 6.05.

<

### 605.03 Applicant's Mailing or Post Office Address [R-2]

Each applicant's mailing or post office address is required to be supplied on the oath or declaration, if not stated in an application data sheet. Applicant's mailing address means that address at which he or she customarily receives his or her mail. Either applicant's home or business address is acceptable as the mailing address. The mailing address should include the ZIP Code designation. Since the term "post office address" as previously used in 37 CFR 1.63 may be confusing, effective November 7, 2000, 37 CFR 1.63 was amended to use the term "mailing address" instead.

The object of requiring each applicant's mailing address is to enable the Office to communicate directly with the applicant if desired; hence, the address of the attorney with instruction to send communications to applicant in care of the attorney is not sufficient.

In situations where an inventor does not execute the oath or declaration and the inventor is not deceased, such as in an application filed under 37 CFR 1.47, the inventor's most recent home address must be given to enable the Office to communicate directly with the inventor as necessary.

If an oath or declaration was filed prior to December 1, 1997 and the post office address was incomplete or omitted from the oath or declaration, \*\* "Notice of Informal Application" or form paragraph

6.09.01 may be used to notify applicant of the deficiency of the post office address.

*¶ 6.09.01 Post Office Address Omitted, Residence Given*

Applicant has not given a post office address anywhere in the application papers as required by 37 CFR 1.33(a), which was in effect at the time of filing of the oath or declaration. A statement over applicant's signature providing a complete post office address is required.

**Examiner Note:**

1. This form paragraph should only be used where the Post Office address has been omitted in an oath or declaration filed prior to December 1, 1997. Use form paragraphs 6.05 and 6.05.19 if the oath or declaration was filed on or after December 1, 1997.
2. If both the post office address and residence are incomplete, not uniform or omitted, use form paragraphs 6.05 and 6.05.02.

Oaths or declarations filed on or after December 1, 1997 must include the mailing or post office address of each inventor. Effective November 7, 2000 the mailing address of each inventor may be provided in an application data sheet. See 37 CFR 1.63(c) and 37 CFR 1.76. In an application filed before November 29, 2000, the Office of Initial Patent Examination (OIPE) will normally indicate the omission of an inventor's mailing address on \*\*>a< "Notice of Informal Application," requiring a new oath or declaration when the form is sent out with an Office action. For utility and plant applications filed on or after November 29, 2000, applicant's mailing address may be needed for any patent application publication. If the mailing address of any inventor has been omitted, OIPE will notify applicant of the omission and require the omitted mailing address in response to the notice. If the examiner notes that the mailing or post office address has not been included in an oath or declaration filed on or after December 1, 1997, \*\* and the mailing address is not provided in an application data sheet, form paragraphs 6.05 (reproduced in MPEP § 605.01) and 6.05.19 may be used to notify applicant that the mailing or post office address has been omitted from the oath or declaration.

\*\*>

*¶ 6.05.19 Mailing Address Omitted*

It does not identify the mailing address of each inventor. A mailing address is an address at which an inventor customarily receives his or her mail and may be either a home or business address. The mailing address should include the ZIP Code designation. The mailing address may be provided in an application data sheet or a supplemental oath or declaration. See 37 CFR 1.63(c) and 37 CFR 1.76.

**Examiner Note:**

This paragraph must be preceded by form paragraph 6.05.

<

**605.04(a) Applicant's Signature and Name [R-2]**

*37 CFR 1.64. Person making oath or declaration.*

(a) The oath or declaration (§ 1.63), including any supplemental oath or declaration (§ 1.67), must be made by all of the actual inventors except as provided for in §§ 1.42, 1.43, 1.47, or § 1.67.

(b) If the person making the oath or declaration or any supplemental oath or declaration is not the inventor (§§ 1.42, 1.43, 1.47, or § 1.67), the oath or declaration shall state the relationship of the person to the inventor, and, upon information and belief, the facts which the inventor is required to state. If the person signing the oath or declaration is the legal representative of a deceased inventor, the oath or declaration shall also state that the person is a legal representative and the citizenship, residence, and mailing address of the legal representative.

>

**I. < EXECUTION OF OATHS OR DECLARATIONS OF PATENT APPLICATIONS**

United States patent applications which have not been prepared and executed in accordance with the requirements of Title 35 of the United States Code and Title 37 of the Code of Federal Regulations may be abandoned. Although the statute and the rules have been in existence for many years, the Office continues to receive a number of applications which have been improperly executed and/or filed. Since the improper execution and/or filing of patent applications can ultimately result in a loss of rights, it is appropriate to emphasize the importance of proper execution and filing.

There is no requirement that a signature be made in any particular manner. See MPEP § 605.04(d). If applicant signs his or her name using non-English characters, then such a signature will be accepted.

>Applications filed through the Electronic Filing System must also contain an oath or declaration personally signed by the inventor.<

It is improper for an applicant to sign an oath or declaration which is not attached to or does not identify a specification and/or claims.

Attached does not necessarily mean that all the papers must be literally fastened. It is sufficient that the specification, including the claims, and the oath or

declaration are physically located together at the time of execution. Physical connection is not required. Copies of declarations are \*>>encouraged<. See MPEP § 502.01 \*>,< § 502.02 >, § 602, and § 602.05(a)<.

The provisions of 35 U.S.C. 363 for filing an international application under the Patent Cooperation Treaty (PCT) which designates the United States and thereby has the effect of a regularly filed United States national application, except as provided in 35 U.S.C. 102(e), are somewhat different than the provisions of 35 U.S.C. 111. The oath or declaration requirements for an international application before the Patent and Trademark Office are set forth in 35 U.S.C. 371(c)(4) and 37 CFR 1.497.

37 CFR 1.52(c)(1) states that “[a]ny interlineation, erasure, cancellation or other alteration of the application papers filed must be made before the signing of any accompanying oath or declaration pursuant to § 1.63 referring to those application papers and should be dated and initialed or signed by the applicant on the same sheet of paper. Application papers containing alterations made after the signing of an oath or declaration referring to those application papers must be supported by a supplemental oath or declaration under § 1.67. In either situation, a substitute specification (§ 1.125) is required if the application papers do not comply with paragraphs (a) and (b) of this section.” 37 CFR 1.52(c)(2) states that after the signing of the oath or declaration referring to the application papers, amendments may only be made in the manner provided by 37 CFR 1.121. An application submitted through the electronic filing system (EFS) may include scanned images of a declaration executed by the inventor. The reformatting of an application in submitting the specification of the application using EFS, is not an “alteration of the application papers” requiring a substitute oath or declaration. It is acceptable to print out a copy of the specification prepared using traditional word processing software for the inventor to review as he or she signs the oath or declaration, and then cut and paste from the electronic document to prepare the EFS version of the specification and to submit a scanned copy of the declaration with the EFS submission.

In summary, it is emphasized that the application filed must be the application executed by the applicant and it is improper for anyone, including counsel, to alter, rewrite, or partly fill in any part of the appli-

cation, including the oath or declaration, after execution of the oath or declaration by the applicant. This provision should particularly be brought to the attention of foreign applicants by their United States counsel since the United States law and practice in this area may differ from that in other countries.

Any changes made in ink in the application or oath prior to signing should be initialed and dated by the applicants prior to execution of the oath or declaration. The Office will not consider whether noninitialed and/or nondated alterations were made before or after signing of the oath or declaration but will require a new oath or declaration. Form paragraph 6.02.01 may be used to call noninitialed and/or nondated alterations to applicant's attention.

#### *¶ 6.02.01 Non-Initialed and/or Non-Dated Alterations in Application Papers*

The application is objected to because of alterations which have not been initialed and/or dated as is required by 37 CFR 1.52(c). A properly executed oath or declaration which complies with 37 CFR 1.67(a) and identifies the application by application number and filing date is required.

The signing and execution by the applicant of oaths or declarations in certain continuation or divisional applications may be omitted. See MPEP § 201.06, § 201.07, and § 602.05(a).

For the signature on a reply, see MPEP § 714.01(a) to § 714.01(d).

>

## **II. < EXECUTION OF OATH OR DECLARATION ON BEHALF OF INVENTOR**

The oath or declaration required by 35 U.S.C. 115 must be signed by all of the actual inventors, except under limited circumstances. 35 U.S.C. 116 provides that joint inventors can sign on behalf of an inventor who cannot be reached or refuses to join. See MPEP § 409.03(a). 35 U.S.C. 117 provides that the legal representative of a deceased or incapacitated inventor can sign on behalf of the inventor. If a legal representative executes an oath or declaration on behalf of a deceased inventor, the legal representative must state that the person is a legal representative and provide the citizenship, residence, and mailing address of the legal representative. See 37 CFR 1.64, MPEP § 409.01 and § 409.02. 35 U.S.C. 118 provides that a party with proprietary interest in the invention claimed in an application can sign on behalf of the

inventor, if the inventor cannot be reached or refuses to join in the filing of the application. See MPEP § 409.03(b) and § 409.03(f). The oath or declaration may not be signed by an attorney on behalf of the inventor, even if the attorney has been given a power of attorney to do so. *Opinion of Hon. Edward Bates*, 10 Op. Atty. Gen. 137 (1861). See also *Staeger v. Commissioner of Patents and Trademarks*, 189 USPQ 272 (D.D.C. 1976) and *In re Striker*, 182 USPQ 507 (PTO Solicitor 1973) (In each case, an oath or declaration signed by the attorney on behalf of the inventor was defective because the attorney did not have a proprietary interest in the invention.).

### 605.04(b) One Full Given Name Required [R-2]

37 CFR 1.63(a)(2) requires that each inventor be identified by full name, including the family name, and at least one given name without abbreviation together with any other given name or initial in the oath or declaration. For example, if the applicant's full name is "John Paul Doe," either "John P. Doe" or "J. Paul Doe" is acceptable.

Form paragraphs 6.05 (reproduced in MPEP § 602.03) and 6.05.18 may be used to notify applicant that the oath or declaration is defective because the full given name of each inventor has not been adequately stated.

#### ¶ 6.05.18 Full Given Name Is Not Set Forth

The full name of each inventor (family name and at least one given name together with any initial) has not been set forth.

#### Examiner Note:

This paragraph must be preceded by paragraph 6.05.

>A situation may arise where an inventor's full given name is a singular letter, or is a plurality of singular letters. For example, an inventor's full given name may be 'J. Doe' or 'J.P. Doe,' i.e., the 'J' and the 'P' are not initials. In such a situation, identifying the inventor by his or her family name and the singular letter(s) is acceptable, since that is the inventor's full given name. In order to avoid an objection under 37 CFR 1.63(a)(2), applicant should point out in the oath or declaration that the singular lettering set forth is the inventor's given name. A statement to this effect, accompanying the filing of the oath or declaration, will also be acceptable. Without such a statement, the examiner should treat the singular letter(s) as an

abbreviation of the inventor's given name and should object to the oath or declaration using the appropriate form paragraphs. Applicant may overcome this objection by filing a responsive statement that the singular letter(s) is/are the inventor's given name(s).<

In an application where the name is typewritten with a *middle name* or *initial*, but the signature \*\*>does not contain< such middle name or initial, the typewritten version of the name will be used >as the inventor's name for the purposes of the application and any patent that may issue from the application. No objection should be made in this instance, since the inventor's signature may differ from his or her legal name.< Except for correction of a typographical or transliteration error in the spelling of an inventor's name, a request to have the name changed >from the typewritten version< to the signed version or any other corrections in the name of the inventor(s) will not be entertained, unless accompanied by a petition under 37 CFR 1.182 together with an appropriate petition fee. The petition should be directed to the attention of the Office of Petitions. Upon granting of the petition, >if the application is maintained in paper, the left margin of the original oath or declaration should be marked in red ink "See paper No. \_\_\_ for correction of the inventor's name," and< the application should be sent to the Office of Initial Patent Examination (OIPE) for correction of its records, unless the application is an application with an application data sheet (e.g., an 09/ series application), in which case the Office of Petitions \*>will< correct the Office computer records and print a new bibliographic data sheet. If the application is assigned, it will be forwarded by OIPE or the Office of Petitions to the Assignment Division for a change in the assignment record.

When a typographical or transliteration error in the spelling of an inventor's name is discovered during pendency of an application, a petition is not required, nor is a new oath or declaration under 37 CFR 1.63 needed. \*\*>However, applicants are strongly encouraged to use an application data sheet such that any patent to issue will reflect the correct spelling of the inventor's name. Without an application data sheet with the corrected spelling, any patent to issue is less likely to reflect the correct spelling since the spelling of the inventor's name is taken from the oath or decla-



ration, or any subsequently filed application data sheet.<

When any correction or change is effected, the Office computer records must be changed. If the application is maintained in paper, the change should be noted on the original oath or declaration by writing in red ink in the left column "See Paper No. \_\_\_ for inventorship changes." See MPEP §§ 201.03 and 605.04(g). If the application is an Image File Wrapper (IFW) application, after the Office records are corrected, a new bib-data sheet must be printed and added to the IFW.<

### **605.04(c) Inventor Changes Name [R-2]**

In cases where an inventor's name has been changed after the application has been filed and the inventor desires to change his or her name on the application, he or she must submit a petition under 37 CFR 1.182. Applicants are also strongly encouraged to submit an application data sheet (37 CFR 1.76) showing the new name.< The petition should be directed to the attention of the Office of Petitions. The petition must include an appropriate petition fee and an affidavit signed with both names and setting forth the procedure whereby the change of name was effected, or a certified copy of the court order.

If an application data sheet is not submitted, the petition may still be granted, but the patent may not reflect the correct spelling of the inventor's name.<

If the petition is granted, if the application is maintained in paper with a file jacket label (i.e., the application is an 08/ or earlier series application), the original declaration must be marked in red ink, in the left margin "See paper No. \_ for correction of inventor name" and the application should be sent to the Office of Initial Patent Examination (OIPE) for change of name on the file wrapper and in the PALM database \*. If the petition is granted in an Image File Wrapper (IFW) application or if the application is an 09/ or later series application, the spelling of the inventor's name should be changed in the Office computer records and a new PALM bib-data sheet should be printed.< If the application is assigned, applicant should submit a corrected assignment document along with a cover sheet and the recording fee as set forth in 37 CFR 1.21(h) to the Assignment Division for a change in the assignment record.

### **605.04(d) Applicant Unable to Write**

If the applicant is unable to write, his or her mark as affixed to the oath or declaration must be attested to by a witness. In the case of the oath, the notary's signature to the jurat is sufficient to authenticate the mark.

### **605.04(e) May Use Title With Signature**

It is permissible for an applicant to use a title of nobility or other title, such as "Dr.," in connection with his or her signature. The title will not appear in the printed patent.

### **605.04(f) Signature on Joint Applications - Order of Names [R-2]**

The order of names of joint patentees in the heading of the patent is taken from the order in which the typewritten names appear in the original oath or declaration. Care should therefore be exercised in selecting the preferred order of the typewritten names of the joint inventors, before filing, as requests for subsequent shifting of the names would entail changing numerous records in the Office. Since the particular order in which the names appear is of no consequence insofar as the legal rights of the joint applicants are concerned, no changes will be made except when a petition under 37 CFR 1.182 is granted. The petition should be directed to the attention of the Office of Petitions. The petition to change the order of names must be signed by either the attorney or agent of record or all the applicants. Applicants are strongly encouraged to submit an application data sheet showing the new order of inventor names to ensure appropriate printing of the inventor names in any patent to issue.< It is suggested that all typewritten and signed names appearing in the application papers should be in the same order as the typewritten names in the oath or declaration. When the Office of Petitions grants a petition to change the order of the names of the inventors, the Office of Petitions will change the order of the names in the Office computer records and print a new bib-data sheet, unless the application is an 08/ or earlier series application, in which case, the application should be sent to the Office of Initial Patent Examination (OIPE) for correction on the file wrapper label and the PALM database.<

In those instances where the joint applicants file separate oaths or declarations, the order of names is taken from the order in which the several oaths or declarations appear in the application papers unless a different order is requested at the time of filing.

### **605.04(g) Correction of Inventorship [R-2]**

When the request is granted to add or delete inventors under 37 CFR 1.48, the change should be noted in red ink in the left margin of the original oath or declaration, if the application is maintained in paper. The notation should read “See Paper No. \_\_\_\_\_ for inventorship changes.” For Image File Wrapper (IFW) processing, see IFW Manual. The application (other than original or later series applications) should be sent to the Office of Initial Patent Examination (OIPE) for correction on the file wrapper label and the PALM database regarding the inventorship. A brief explanation on an “Application Division Data Base Routing Slip” (available from the Technology Center (TC) technical support staff) should accompany the application file to OIPE. For original or later series applications, the examiner should have the TC’s technical support staff enter the correction in the PALM database and print a new PALM bib-data sheet, which will then be placed in the file wrapper, if correction of the database and printing of a new PALM bib-data sheet was not already done by the Office of Petitions.

### **605.05 Administrator, Executor, or Other Legal Representative**

In an application filed by a legal representative of the inventor, the specification should not be written in the first person.

For prosecution by administrator or executor, see MPEP § 409.01(a).

For prosecution by heirs, see MPEP § 409.01(a) and § 409.01(d).

For prosecution by representative of legally incapacitated inventor, see MPEP § 409.02.

For prosecution by other than inventor, see MPEP § 409.03.

### **605.07 Joint Inventors**

#### *35 U.S.C. 116. Inventors*

When an invention is made by two or more persons jointly, they shall apply for patent jointly and each make the required oath, except as otherwise provided in this title. Inventors may apply for a patent jointly even though (1) they did not physically work together or at the same time, (2) each did not make the same type or amount of contribution, or (3) each did not make a contribution to the subject matter of every claim of the patent.

\*\*\*\*\*

35 U.S.C. 116, as amended by Public Law 98-622, recognizes the realities of modern team research. A research project may include many inventions. Some inventions may have contributions made by individuals who are not involved in other, related inventions.

35 U.S.C. 116 allows inventors to apply for a patent jointly even though

(A) they did not physically work together or at the same time,

(B) each did not make the same type or amount of contribution, or

(C) each did not make a contribution to the subject matter of every claim of the patent.

Items (A) and (B) adopt the rationale stated in decisions such as *Monsanto Co. v. Kamp*, 269 F. Supp. 818, 824, 154 USPQ 259, 262 (D.D.C. 1967).

Item (C) adopts the rationale of cases such as *SAB Industrie AB v. Bendix Corp.*, 199 USPQ 95 (E.D. Va. 1978).

With regard to item (A), see *Kimberly-Clark Corp. v. Procter & Gamble Distributing Co.*, 973 F.2d 911, 916-17, 23 USPQ 2d 1921, 1925-26 (Fed. Cir. 1992) (some quantum of collaboration or connection is required in order for persons to be “joint” inventors under 35 U.S.C. 116, and thus individuals who are completely ignorant of what each other has done until years after their individual independent efforts cannot be considered joint inventors).

Like other patent applications, jointly filed applications are subject to the requirements of 35 U.S.C. 121 that an application be directed to only a single invention. If more than one invention is included in the application, the examiner may require the application to be restricted to one of the inventions. In such a case, a “divisional” application complying with 35 U.S.C. 120 would be entitled to the benefit of the earlier filing date of the original application.

It is possible that different claims of an application or patent may have different dates of inventions even though the patent covers only one independent and distinct invention within the meaning of 35 U.S.C. 121. When necessary, the U.S. Patent and Trademark Office or a court may inquire of the patent applicant or owner concerning the inventors and the invention dates for the subject matter of the various claims.

## GUIDELINES

37 CFR 1.45. *Joint inventors.*

\*\*\*\*\*

(b) Inventors may apply for a patent jointly even though

(1) They did not physically work together or at the same time,

(2) Each inventor did not make the same type or amount of contribution, or

(3) Each inventor did not make a contribution to the subject matter of every claim of the application.

(c) If multiple inventors are named in a nonprovisional application, each named inventor must have made a contribution, individually or jointly, to the subject matter of at least one claim of the application and the application will be considered to be a joint application under 35 U.S.C. 116. If multiple inventors are named in a provisional application, each named inventor must have made a contribution, individually or jointly, to the subject matter disclosed in the provisional application and the provisional application will be considered to be a joint application under 35 U.S.C. 116.

Since provisional applications may be filed without claims, 37 CFR 1.45(c) states that each inventor named in a joint provisional application must have made a contribution to the subject matter disclosed in the application.

The significant features resulting from the amendments to 35 U.S.C. 116 by Public Law 98-622 are the following:

(A) The joint inventors do not have to separately “sign the application,” but only need apply for the patent jointly and make the required oath or declaration by signing the same; this is a clarification, but not a change in current practice.

(B) Inventors may apply for a patent jointly even though “they did not work together or at the same time,” thereby clarifying (a) that it is not necessary that the inventors physically work together on a project, and (b) that one inventor may “take a step at one time, the other an approach at different times.”

(*Monsanto Co. v. Kamp*, 269 F. Supp. 818, 824, 154 USPQ 259, 262 (D.D.C. 1967)).

(C) Inventors may apply for a patent jointly even though “each did not make the same type or amount of contribution,” thereby clarifying the “fact that each of the inventors play a different role and that the contribution of one may not be as great as that of another does not detract from the fact that the invention is joint, if each makes some original contribution, though partial, to the final solution of the problem.” *Monsanto Co. v. Kamp*, 269 F. Supp. at 824, 154 USPQ at 262.

(D) Inventors may apply for a patent jointly even though “each did not make a contribution to the subject matter of every claim of the patent.”

(E) Inventors may apply for a patent jointly as long as each inventor made a contribution, i.e., was an inventor or joint inventor, of the subject matter of at least one claim of the patent; there is no requirement that all the inventors be joint inventors of the subject matter of any one claim.

(F) If an application by joint inventors includes more than one independent and distinct invention, restriction may be required with the possible result of a necessity to change the inventorship named in the application if the elected invention was not the invention of all the originally named inventors.

(G) The amendment to 35 U.S.C. 116 increases the likelihood that different claims of an application or patent may have different dates of invention; when necessary the Office or court may inquire of the patent applicant or owner concerning the inventors and the invention dates for the subject matter of the various claims.

Pending nonprovisional applications will be permitted to be amended by complying with 37 CFR 1.48 to add claims to inventions by inventors not named when the application was filed as long as such inventions were disclosed in the application as filed since 37 CFR 1.48 permits correction of inventorship where the correct inventor or inventors are not named in an application for patent through error without any deceptive intention on the part of the person being added as an inventor. This is specially covered in 37 CFR 1.48(c).

Under 35 U.S.C. 116, an examiner may reject claims under 35 U.S.C. 102(f) only in circumstances where a named inventor is not the inventor of at least

one claim in the application; no rejection under 35 U.S.C. 102(f) is appropriate if a named inventor made a contribution to the invention defined in any claim of the application.

Under 35 U.S.C. 116, considered in conjunction with 35 U.S.C. 103(c), a rejection may be appropriate under 35 U.S.C. 102(f)/103 where the subject matter, i.e., prior art, and the claimed invention were not owned by, or subject to an obligation of assignment to, the same person at the time the invention was made.

Applicants are responsible for correcting, and are required to correct, the inventorship in compliance with 37 CFR 1.48 when the application is amended to change the claims so that one (or more) of the named inventors is no longer an inventor of the subject matter of a claim remaining in the application.

In requiring restriction in an application filed by joint inventors, the examiner should remind applicants of the necessity to correct the inventorship pursuant to 37 CFR 1.48 if an invention is elected and the claims to the invention of one or more inventors are canceled.

The examiner should not inquire of the patent applicant concerning the inventors and the invention dates for the subject matter of the various claims until *it becomes necessary* to do so in order to properly examine the application.

If an application is filed with joint inventors, the examiner should assume that the subject matter of the various claims was commonly owned at the time the inventions covered therein were made, unless there is evidence to the contrary. If inventors of subject matter, not commonly owned at the time of the later invention, file a joint application, applicants have an obligation pursuant to 37 CFR 1.56 to point out the inventor and invention dates of each claim and the lack of common ownership at the time the later invention was made in order that the examiner may consider the applicability of 35 U.S.C. 102(e)/103, 35 U.S.C. 102(f)/103 or 35 U.S.C. 102(g)/103. The examiner should assume, unless there is evidence to the contrary, that applicants are complying with their duty of disclosure. It should be pointed out that 35 U.S.C. 119(a) benefit may be claimed to any foreign application as long as the U.S. named inventor was the inventor of the foreign application invention and 35 U.S.C. 119(a)-(d) requirements are met. Where

two or more foreign applications are combined in a single U.S. application, to take advantage of the changes to 35 U.S.C. 103 or 35 U.S.C. 116, the U.S. application may claim benefit under 35 U.S.C. 119(a) to each of the foreign applications provided all the requirements of 35 U.S.C. 119(a)-(d) are met. One of the conditions for benefit under 35 U.S.C. 119(a) is that the foreign application must be for “the same invention” as the application in the United States. Therefore, a claim in the U.S. application which relies on the combination of prior foreign applications may not be entitled to the benefit under 35 U.S.C. 119(a) if the subject matter of the claim is not sufficiently disclosed in the prior foreign application. *Cf. Studiengesellschaft Kohle m.b.H. v. Shell Oil Co.*, 112 F.3d 1561, 42 USPQ2d 1674 (Fed. Cir. 1997). For example:

If foreign applicant A invents X and files a foreign application; foreign applicant B invents Y and files separate foreign application. A+B combine inventions X+Y and A and B are proper joint inventors under 35 U.S.C. 116 and file U.S. application to X+Y. The U.S. application may claim benefit under 35 U.S.C. 119(a) to each of the foreign applications provided the requirements of 35 U.S.C. 119(a)-(d) are met.

## 606 Title of Invention

*37 CFR 1.72. Title and abstract.*

(a) The title of the invention may not exceed 500 characters in length and must be as short and specific as possible. Characters that cannot be captured and recorded in the Office’s automated information systems may not be reflected in the Office’s records in such systems or in documents created by the Office. Unless the title is supplied in an application data sheet (§ 1.76), the title of the invention should appear as a heading on the first page of the specification.

\*\*\*\*\*

The title of the invention should be placed at the top of the first page of the specification unless it is provided in the application data sheet (see 37 CFR 1.76). The title should be brief but technically accurate and descriptive and should contain fewer than 500 characters. Inasmuch as the words “improved,” “improvement of,” and “improvement in” are not considered as part of the title of an invention, these words should not be included at the beginning of the title of the invention and will be deleted when the Office enters the title into the Office’s computer records, and when any patent issues.

## 606.01 Examiner May Require Change in Title [R-2]

Where the title is not descriptive of the invention claimed, the examiner should require the substitution of a new title that is clearly indicative of the invention to which the claims are directed. Form paragraphs 6.11 and 6.11.01 may be used.

### ¶ 6.11 Title of Invention Is Not Descriptive

The title of the invention is not descriptive. A new title is required that is clearly indicative of the invention to which the claims are directed.

#### Examiner Note:

If a change in the title of the invention is being suggested by the examiner, follow with form paragraph 6.11.01.

### ¶ 6.11.01 Title of Invention, Suggested Change

The following title is suggested: “[1]”

This may result in slightly longer titles, but the loss in brevity of title will be more than offset by the gain in its informative value in indexing, classifying, searching, etc. If a satisfactory title is not supplied by the applicant, the examiner may, at the time of allowance, change the title by examiner’s amendment. If the change in the title is the only change being made by the examiner at the time of allowance, and the application is maintained in paper, a separate examiner’s amendment need not be prepared. The examiner is to indicate the change in the title on the file label (or bib-data sheet in 09/ series applications) using BLACK ink and place his or her initials and the date in the margin. For Image File Wrapper (IFW) applications, informal examiner’s amendments are not permitted and a separate examiner’s amendment must be prepared, and a copy of the bib-data sheet must be added to the IFW. When the Technology Center (TC) technical support staff prepares the application for issue and sees that the title has been changed, the TC technical support staff will make the required change in the Office computer record systems.

## 607 Filing Fee [R-2]

Patent application filing fees are set in accordance with 35 U.S.C. 41 and are listed in 37 CFR 1.16.

See MPEP § 608.01(n) for multiple dependent claims.

When filing a nonprovisional application, a basic fee entitles applicant to present 20 claims including not more than 3 claims in independent form. If claims in excess of the above are included at the time of filing, an additional fee is required for each independent claim in excess of three, and a fee is required for each claim in excess of 20 claims (whether independent or dependent). Fees for a proper multiple dependent claim are calculated based on the number of claims to which the multiple dependent claim refers, 37 CFR 1.75(c), and a separate fee is required in each application containing a proper multiple dependent claim. For an improper multiple dependent claim, the fee charged is that charged for a single dependent claim.

Upon submission of an amendment (whether entered or not) affecting the claims, payment of fees for those claims in excess of the number previously paid for is required.

The Office of Initial Patent Examination (OIPE) has been authorized to accept all applications, otherwise acceptable, if the basic fee is submitted, and to require payment of the deficiency within a stated period upon notification of the deficiency.

Amendments before the first action, or not filed in reply to an Office action, presenting additional claims in excess of the number already paid for, not accompanied by the full additional fee due, will not be entered in whole or in part and applicant will be so advised. Such amendments filed in reply to an Office action will be regarded as not responsive thereto and the practice set forth in MPEP § 714.03 will be followed.

The additional fees, if any, due with an amendment are calculated on the basis of the claims (total and independent) which would be present, if the amendment were entered. The amendment of a claim, unless it changes a dependent claim to an independent claim or adds to the number of claims referred to in a multiple dependent claim, and the replacement of a claim by a claim of the same type, unless it is a multiple dependent claim which refers to more prior claims, do not require any additional fees.

For purposes of determining the fee due the U.S. Patent and Trademark Office, a claim will be treated as dependent if it contains reference to one or more other claims in the application. A claim determined to be dependent by this test will be entered if the fee paid reflects this determination.

Any claim which is in dependent form but which is so worded that it, in fact, is not a proper dependent claim, as for example it does not include every limitation of the claim on which it depends, will be required to be canceled as not being a proper dependent claim; and \*>cancellation< of any further claim depending on such a dependent claim will be similarly required. The applicant may thereupon amend the claims to place them in proper dependent form, or may redraft them as independent claims, upon payment of any necessary additional fee.

After a requirement for restriction, nonelected claims will be included in determining the fees due in connection with a subsequent amendment unless such claims are canceled.

An amendment canceling claims accompanying the papers constituting the application will be effective to diminish the number of claims to be considered in calculating the filing fees to be paid. A preliminary amendment filed concurrently with a response to a Notice To File Missing Parts of Application that required the filing fees, which preliminary amendment cancels or adds claims, will be taken into account in determining the appropriate filing fees due in response to the Notice To File Missing Parts of Application. No refund will be made for claims being canceled in the response that have already been paid for.

The additional fees, if any, due with an amendment are required prior to any consideration of the amendment by the examiner.

Money paid in connection with the filing of a proposed amendment will not be refunded by reason of the nonentry of the amendment. However, unentered claims will not be counted when calculating the fee due in subsequent amendments.

Amendments affecting the claims cannot serve as the basis for granting any refund.

See MPEP § 1415 for reissue application fees.

## 607.02 Returnability of Fees [R-2]

35 U.S.C. 42. Patent and Trademark Office funding

\*\*\*\*\*

(d) The Director may refund any fee paid by mistake or any amount paid in excess of that required.

\*\*\*\*\*

37 CFR 1.26. Refunds.

\*\*>

(a) The Director may refund any fee paid by mistake or in excess of that required. A change of purpose after the payment of a fee, such as when a party desires to withdraw a patent filing for which the fee was paid, including an application, an appeal, or a request for an oral hearing, will not entitle a party to a refund of such fee. The Office will not refund amounts of twenty-five dollars or less unless a refund is specifically requested, and will not notify the payor of such amounts. If a party paying a fee or requesting a refund does not provide the banking information necessary for making refunds by electronic funds transfer (31 U.S.C. 3332 and 31 CFR part 208), or instruct the Office that refunds are to be credited to a deposit account, the Director may require such information, or use the banking information on the payment instrument to make a refund. Any refund of a fee paid by credit card will be by a credit to the credit card account to which the fee was charged.<

(b) Any request for refund must be filed within two years from the date the fee was paid, except as otherwise provided in this paragraph or in § 1.28(a). If the Office charges a deposit account by an amount other than an amount specifically indicated in an authorization (§ 1.25(b)), any request for refund based upon such charge must be filed within two years from the date of the deposit account statement indicating such charge, and include a copy of that deposit account statement. The time periods set forth in this paragraph are not extendable.

\*\*>

(c) If the Director decides not to institute a reexamination proceeding, for *ex parte* reexaminations filed under § 1.510, a refund of \$1,690 will be made to the reexamination requester. For *inter partes* reexaminations filed under § 1.913, a refund of \$7,970 will be made to the reexamination requester. The reexamination requester should indicate the form in which any refund should be made (*e.g.*, by check, electronic funds transfer, credit to a deposit account, etc.). Generally, reexamination refunds will be issued in the form that the original payment was provided.<

Under 35 U.S.C. 42(d) and 37 CFR 1.26, the Office may refund: (1) a fee paid by mistake (*e.g.*, fee paid when no fee is required); or (2) any fee paid in excess of the amount of fee that is required. See *Ex parte Grady*, 59 USPQ 276, 277 (Comm' r Pat. 1943) (the statutory authorization for the refund of fees under the "by mistake" clause is applicable only to a mistake relating to the fee payment).

When an applicant or patentee takes an action "by mistake" (*e.g.*, files an application or maintains a patent in force "by mistake"), the submission of fees required to take that action (*e.g.*, a filing fee submitted with such application or a maintenance fee submitted for such patent) is not a "fee paid by mistake" within the meaning of 35 U.S.C. \*>42<(d).

37 CFR 1.26(a) also provides that a change of purpose after the payment of a fee, as when a party desires to withdraw the filing of a patent application for which the fee was paid, will not entitle the party to a refund of such fee.

All questions pertaining to the return of fees are referred to the Refunds Section of the Receipts Division of the Office of Finance. No opinions should be expressed to attorneys or applicants as to whether or not fees are returnable in particular cases. Such questions may also be treated, to the extent appropriate, in decisions on petition decided by various U.S. Patent and Trademark Office officials.

>

### **I. < MANNER OF MAKING A REFUND**

Effective November 7, 2000, 37 CFR 1.26(a) was amended to authorize the Office to obtain the banking information necessary for making refunds by electronic funds transfer, or obtain the deposit account information to make the refund to the deposit account. If a party paying a fee or requesting a refund does not instruct the refund to be credited to a deposit account, the Office will attempt to make the refund by electronic fund transfer. The Office may (1) use the banking information on a payment instrument (e.g., a personal check) to refund an amount paid by the payment instrument in excess of that required, or (2) in other situations, require the banking information necessary for electronic funds transfer or require instructions to credit a deposit account. If it is not cost effective to require the banking information, the Office may obtain the deposit account information or simply issue any refund by treasury check.

37 CFR 1.26(a) further provides that any refund of a fee paid by credit card will be by a credit to the credit card account to which the fee was charged. The Office will not refund a fee paid by credit card by treasury check, electronic funds transfer, or credit to a deposit account.

>

### **II. < TIME PERIOD FOR REQUESTING A REFUND**

Any request for a refund which is not based upon subsequent entitlement to small entity status (see 37

CFR 1.28(a)) must be filed within the two-year non-extendable time limit set forth in 37 CFR 1.26(b).

>

### **III. < FEES PAID BY DEPOSIT ACCOUNT**

Effective November 7, 2000, the Office no longer treats authorizations to charge a deposit account as being received by the Office on the date the deposit account is actually debited for purposes of refund payments under 37 CFR 1.26 and 37 CFR 1.28. Payment by authorization to charge a deposit account will be treated for refund purposes the same as payments by other means (e.g., check or credit card charge authorization), with each being treated as paid on the date of receipt in the Office as defined by 37 CFR 1.6. Accordingly, the time period for requesting a refund of any fee paid by a deposit account begins on the date the charge authorization is received in the Office. For refund purposes: where a 37 CFR 1.8 certificate is used, the refund period will begin on the date of actual receipt (not the 37 CFR 1.8 date of mailing); where Express Mail under 37 CFR 1.10 is used, the “date-in” on the Express Mail label will control (not the actual date of receipt by the Office). The use of payment receipt date for refund purposes has no effect on the certificate of mailing practice under 37 CFR 1.8 for making a timely reply to an Office action.

Notwithstanding the foregoing, if the Office charges a deposit account by an amount other than an amount specifically indicated on the charge authorization, any request for refund based upon such charge must be filed within two years from the date of the deposit account statement indicating such charge, and must include a copy of that deposit account statement. This provision of 37 CFR 1.26(b) applies, for example, in the following types of situations: (1) a deposit account charged for an extension of time pursuant to 37 CFR 1.136(a)(3) as a result of there being a prior general authorization in the application; or (2) a deposit account charged for the outstanding balance of a fee as a result of an insufficient fee submitted with an authorization to charge the deposit account for any additional fees that are due. In these situations, the party providing the charge authorization is not in a position to know the exact amount by which the deposit account will be charged until the date of the deposit account statement indicating the amount of the charge. Therefore, the two-year time period set

forth in 37 CFR 1.26(b) does not begin until the date of the deposit account statement indicating the amount of the charge.

>

#### IV. < LATER ESTABLISHMENT OF SMALL ENTITY STATUS

Effective November 7, 2000, 37 CFR 1.28(a) was amended to provide a three-month period (instead of the former two-month period) for requesting a refund based on later establishment of small entity status. As the Office now treats the receipt date of a deposit account charge authorization as the fee payment date (for refund purposes), any request for a refund under 37 CFR 1.28(a) must be made within three months from the date the charge authorization is received in the Office.

### 608 Disclosure [R-2]

In return for a patent, the inventor gives as consideration a complete revelation or disclosure of the invention for which protection is sought. All amendments or claims must find descriptive basis in the original disclosure, or they involve new matter. Applicant may rely for disclosure upon the specification with original claims and drawings, as filed. See also \*\*>37 CFR 1.121(f)< and MPEP § 608.04.

If during the course of examination of a patent application, an examiner notes the use of language that could be deemed offensive to any race, religion, sex, ethnic group, or nationality, he or she should object to the use of the language as failing to comply with the Rules of Practice. 37 CFR 1.3 proscribes the presentation of papers which are lacking in decorum and courtesy. There is a further basis for objection in that the inclusion of such proscribed language in a Federal Government publication would not be in the public interest. Also, the inclusion in application drawings of any depictions or caricatures that might reasonably be considered offensive to any group should be similarly objected to, on like authority.

\*>An application should not be classified for publication under 35 U.S.C. 122(b) and an< examiner should not pass the application to issue until such language or drawings have been deleted, or questions relating to the propriety thereof fully resolved.

For design application practice, see MPEP § 1504.

### 608.01 Specification [R-2]

35 U.S.C. 22. *Printing of papers filed.*

The Director may require papers filed in the Patent and Trademark Office to be printed, typewritten, or on an electronic medium.

37 CFR 1.71. *Detailed description and specification of the invention.*

(a) The specification must include a written description of the invention or discovery and of the manner and process of making and using the same, and is required to be in such full, clear, concise, and exact terms as to enable any person skilled in the art or science to which the invention or discovery appertains, or with which it is most nearly connected, to make and use the same.

(b) The specification must set forth the precise invention for which a patent is solicited, in such manner as to distinguish it from other inventions and from what is old. It must describe completely a specific embodiment of the process, machine, manufacture, composition of matter or improvement invented, and must explain the mode of operation or principle whenever applicable. The best mode contemplated by the inventor of carrying out his invention must be set forth.

(c) In the case of an improvement, the specification must particularly point out the part or parts of the process, machine, manufacture, or composition of matter to which the improvement relates, and the description should be confined to the specific improvement and to such parts as necessarily cooperate with it or as may be necessary to a complete understanding or description of it.

\*\*>

(d) A copyright or mask work notice may be placed in a design or utility patent application adjacent to copyright and mask work material contained therein. The notice may appear at any appropriate portion of the patent application disclosure. For notices in drawings, see § 1.84(s). The content of the notice must be limited to only those elements provided for by law. For example, “©1983 John Doe”(17 U.S.C. 401) and “\*M\* John Doe” (17 U.S.C. 909) would be properly limited and, under current statutes, legally sufficient notices of copyright and mask work, respectively. Inclusion of a copyright or mask work notice will be permitted only if the authorization language set forth in paragraph (e) of this section is included at the beginning (preferably as the first paragraph) of the specification.

(e) The authorization shall read as follows:

A portion of the disclosure of this patent document contains material which is subject to (copyright or mask work) protection. The (copyright or mask work) owner has no objection to the facsimile reproduction by anyone of the patent document or the patent disclosure, as it appears in the Patent and Trademark Office patent file or records, but otherwise reserves all (copyright or mask work) rights whatsoever.

(f) The specification must commence on a separate sheet. Each sheet including part of the specification may not include other parts of the application or other information. The claim(s),



abstract and sequence listing (if any) should not be included on a sheet including any other part of the application.<

The specification is a written description of the invention and of the manner and process of making and using the same. The specification must be in such full, clear, concise, and exact terms as to enable any person skilled in the art or science to which the invention pertains to make and use the same. See 35 U.S.C. 112 and 37 CFR 1.71. If a newly filed application obviously fails to disclose an invention with the clarity required by 35 U.S.C. 112, revision of the application should be required. See MPEP § 702.01. >The specification must commence on a separate sheet. Each sheet including part of the specification may not include other parts of the application or other information. The claim(s), abstract and sequence listing (if any) should not be included on a sheet including any other part of the application (37 CFR 1.71(f)). That is, the claim(s), abstract and sequence listings (if any) should each begin on a new page since each of these sections (specification, abstract, claims, sequence listings) of the disclosure are separately indexed in the Image File Wrapper (IFW). There should be no overlap on a single page of more than one section of the disclosure.<

The specification does not require a date.

Certain cross >references< to other related applications may be made. References to foreign applications or to applications identified only by the attorney's docket number should be required to be canceled >, or amended to properly identify the earlier application(s)<. See 37 CFR 1.78 and MPEP § 202.01.

As the specification is never returned to applicant under any circumstances, the applicant should retain >an accurate copy thereof<. In amending >the specification<, the attorney or the applicant >must comply with 37 CFR 1.121 (see MPEP § 714).

Examiners should not object to the specification and/or claims in patent applications merely because applicants are using British English spellings (e.g., colour) rather than American English spellings. It is not necessary to replace the British English spellings with the equivalent American English spellings in the U.S. patent applications. Note that 37 CFR 1.52(b)(1)(ii) only requires the application to be in the English language. There is no additional requirement that the English must be American English.<

Form paragraph 7.29 may be used where the disclosure contains minor informalities.

#### ¶ 7.29 *Disclosure Objected to, Minor Informalities*

The disclosure is objected to because of the following informalities: [1]. Appropriate correction is required.

#### **Examiner Note:**

Use this paragraph to point out minor informalities such as spelling errors, inconsistent terminology, numbering of elements, etc., which should be corrected. See form paragraphs 6.28 to 6.32 for specific informalities.

Form paragraphs 6.29-6.31 should be used where appropriate.

#### ¶ 6.29 *Specification, Spacing of Lines*

The spacing of the lines of the specification is such as to make reading and entry of amendments difficult. New application papers with lines double spaced on good quality paper are required.

#### ¶ 6.30 *Numerous Errors in Specification*

35 U.S.C. 112, first paragraph, requires the specification to be written in "full, clear, concise, and exact terms." The specification is replete with terms which are not clear, concise and exact. The specification should be revised carefully in order to comply with 35 U.S.C. 112, first paragraph. Examples of some unclear, inexact or verbose terms used in the specification are: [1].

#### ¶ 6.31 *Lengthy Specification, Jumbo Application*

The lengthy specification has not been checked to the extent necessary to determine the presence of all possible minor errors. Applicant's cooperation is requested in correcting any errors of which applicant may become aware in the specification.

#### **Examiner Note:**

This paragraph is applicable in so-called "Jumbo Applications" (more than 20 pages, exclusive of claims).

>

## I. < PAPER REQUIREMENTS

37 CFR 1.52. *Language, paper, writing, margins, compact disc specifications.*

>>

(a) *Papers that are to become a part of the permanent United States Patent and Trademark Office records in the file of a patent application or a reexamination proceeding.*

(1) All papers, other than drawings, that are submitted on paper or by facsimile transmission, and are to become a part of the permanent United States Patent and Trademark Office records in the file of a patent application or reexamination proceeding, must be on sheets of paper that are the same size, not permanently bound together, and:

(i) Flexible, strong, smooth, non-shiny, durable, and white;

(ii) Either 21.0 cm by 29.7 cm (DIN size A4) or 21.6 cm by 27.9 cm (8 1/2 by 11 inches), with each sheet including a top margin of at least 2.0 cm (3/4 inch), a left side margin of at least 2.5 cm (1 inch), a right side margin of at least 2.0 cm (3/4 inch), and a bottom margin of at least 2.0 cm (3/4 inch);

(iii) Written on only one side in portrait orientation;

(iv) Plainly and legibly written either by a typewriter or machine printer in permanent dark ink or its equivalent; and

(v) Presented in a form having sufficient clarity and contrast between the paper and the writing thereon to permit the direct reproduction of readily legible copies in any number by use of photographic, electrostatic, photo-offset, and microfilming processes and electronic capture by use of digital imaging and optical character recognition.

(2) All papers that are submitted on paper or by facsimile transmission and are to become a part of the permanent records of the United States Patent and Trademark Office should have no holes in the sheets as submitted.

(3) The provisions of this paragraph and paragraph (b) of this section do not apply to the pre-printed information on paper forms provided by the Office, or to the copy of the patent submitted on paper in double column format as the specification in a reissue application or request for reexamination.

(4) *See* § 1.58 for chemical and mathematical formulae and tables, and § 1.84 for drawings.

(5) If papers that are submitted on paper or by facsimile transmission do not comply with paragraph (a)(1) of this section and are submitted as part of the permanent record, other than the drawings, applicant, or the patent owner, or the requester in a reexamination proceeding, will be notified and given a period of time within which to provide substitute papers that comply with paragraph (a)(1) of this section in order to avoid abandonment of the application in the case of an applicant for patent, termination of proceedings in the case of a patent owner in a reexamination proceeding, or refusal of consideration of the papers in the case of a third party requester in a reexamination proceeding.

(6) Papers that are submitted electronically to the Office must be formatted and transmitted in compliance with the Office's electronic filing system requirements.

(7) If the papers that are submitted electronically to the Office do not comply with paragraph (a)(6) of this section, the applicant, or the patent owner, or the requester in a reexamination proceeding, will be notified and given a period of time within which to provide substitute papers that comply with paragraph (a)(6) of this section in order to avoid abandonment of the application in the case of an applicant for patent, termination of proceedings in the case of a patent owner in a reexamination proceeding, or refusal of consideration of the papers in the case of a third party requester in a reexamination proceeding.

(b) *The application (specification, including the claims, drawings, and oath or declaration) or reexamination proceeding and any amendments or corrections to the application or reexamination proceeding.*

(1) The application or proceeding and any amendments or corrections to the application (including any translation submitted pursuant to paragraph (d) of this section) or proceeding, except as provided for in § 1.69 and paragraph (d) of this section, must:

(i) Comply with the requirements of paragraph (a) of this section; and

(ii) Be in the English language or be accompanied by a translation of the application and a translation of any corrections or amendments into the English language together with a statement that the translation is accurate.

(2) The specification (including the abstract and claims) for other than reissue applications and reexamination proceedings, and any amendments for applications (including reissue applications) and reexamination proceedings to the specification, except as provided for in §§ 1.821 through 1.825, must have:

(i) Lines that are 1 1/2 or double spaced;

(ii) Text written in a nonscript type font (*e.g.*, Arial, Times Roman, or Courier) lettering style having capital letters which are at least 0.21 cm (0.08 inch) high; and

(iii) Only a single column of text.

(3) The claim or claims must commence on a separate physical sheet or electronic page (§ 1.75(h)).

(4) The abstract must commence on a separate physical sheet or electronic page or be submitted as the first page of the patent in a reissue application or reexamination proceeding (§ 1.72(b)).

(5) Other than in a reissue application or reexamination proceeding, the pages of the specification including claims and abstract must be numbered consecutively, starting with 1, the numbers being centrally located above or preferably below, the text.

(6) Other than in a reissue application or reexamination proceeding, the paragraphs of the specification, other than in the claims or abstract, may be numbered at the time the application is filed, and should be individually and consecutively numbered using Arabic numerals, so as to unambiguously identify each paragraph. The number should consist of at least four numerals enclosed in square brackets, including leading zeros (*e.g.*, [0001]). The numbers and enclosing brackets should appear to the right of the left margin as the first item in each paragraph, before the first word of the paragraph, and should be highlighted in bold. A gap, equivalent to approximately four spaces, should follow the number. Nontext elements (*e.g.*, tables, mathematical or chemical formulae, chemical structures, and sequence data) are considered part of the numbered paragraph around or above the elements, and should not be independently numbered. If a nontext element extends to the left margin, it should not be numbered as a separate and independent paragraph. A list is also treated as part of the paragraph around or above the list, and should not be independently numbered. Paragraph or section headers (titles), whether abutting the left margin or centered on the page, are not considered paragraphs and should not be numbered.

(7) If papers that do not comply with paragraphs (b)(1) through (b)(5) of this section are submitted as part of the application, the applicant, or patent owner, or requester in a reexamination proceeding, will be notified and given a period of time within which to provide substitute papers that comply with paragraphs (b)(1) through (b)(5) of this section in order to avoid abandonment of the application in the case of an applicant for patent, termination of proceedings in the case of a patent owner in a reexamination proceeding.

tion proceeding, or refusal of consideration of the papers in the case of a third party requester in a reexamination proceeding.<

(c)(1) Any interlineation, erasure, cancellation or other alteration of the application papers filed must be made before the signing of any accompanying oath or declaration pursuant to § 1.63 referring to those application papers and should be dated and initialed or signed by the applicant on the same sheet of paper. Application papers containing alterations made after the signing of an oath or declaration referring to those application papers must be supported by a supplemental oath or declaration under § 1.67. In either situation, a substitute specification (§ 1.125) is required if the application papers do not comply with paragraphs (a) and (b) of this section.

(2) After the signing of the oath or declaration referring to the application papers, amendments may only be made in the manner provided by § 1.121.

(3) Notwithstanding the provisions of this paragraph, if an oath or declaration is a copy of the oath or declaration from a prior application, the application for which such copy is submitted may contain alterations that do not introduce matter that would have been new matter in the prior application.

(d) A nonprovisional or provisional application may be in a language other than English.

(1) *Nonprovisional application.* If a nonprovisional application is filed in a language other than English, an English language translation of the non-English language application, a statement that the translation is accurate, and the processing fee set forth in § 1.17(i) are required. If these items are not filed with the application, applicant will be notified and given a period of time within which they must be filed in order to avoid abandonment.

(2) *Provisional application.* If a provisional application is filed in a language other than English, an English language translation of the non-English language provisional application will not be required in the provisional application. See § 1.78(a) for the requirements for claiming the benefit of such provisional application in a nonprovisional application.

(e) *Electronic documents that are to become part of the permanent United States Patent and Trademark Office records in the file of a patent application or reexamination proceeding.*

(1) The following documents may be submitted to the Office on a compact disc in compliance with this paragraph:

- (i) A computer program listing (see § 1.96);
- (ii) A "Sequence Listing" (submitted under § 1.821(c)); or
- (iii) A table (see § 1.58) that has more than 50 pages of text.

(2) A compact disc as used in this part means a Compact Disc-Read Only Memory (CD-ROM) or a Compact Disc-Recordable (CD-R) in compliance with this paragraph. A CD-ROM is a "read-only" medium on which the data is pressed into the disc so that it cannot be changed or erased. A CD-R is a "write once" medium on which once the data is recorded, it is permanent and cannot be changed or erased.

(3)(i) Each compact disc must conform to the International Standards Organization (ISO) 9660 standard, and the con-

tents of each compact disc must be in compliance with the American Standard Code for Information Interchange (ASCII).

(ii) Each compact disc must be enclosed in a hard compact disc case within an unsealed padded and protective mailing envelope and accompanied by a transmittal letter on paper in accordance with paragraph (a) of this section. The transmittal letter must list for each compact disc the machine format (*e.g.*, IBM-PC, Macintosh), the operating system compatibility (*e.g.*, MS-DOS, MS-Windows, Macintosh, Unix), a list of files contained on the compact disc including their names, sizes in bytes, and dates of creation, plus any other special information that is necessary to identify, maintain, and interpret the information on the compact disc. Compact discs submitted to the Office will not be returned to the applicant.

(4) Any compact disc must be submitted in duplicate unless it contains only the "Sequence Listing" in computer readable form required by § 1.821(e). The compact disc and duplicate copy must be labeled "Copy 1" and "Copy 2," respectively. The transmittal letter which accompanies the compact disc must include a statement that the two compact discs are identical. In the event that the two compact discs are not identical, the Office will use the compact disc labeled "Copy 1" for further processing. Any amendment to the information on a compact disc must be by way of a replacement compact disc in compliance with this paragraph containing the substitute information, and must be accompanied by a statement that the replacement compact disc contains no new matter. The compact disc and copy must be labeled "COPY 1 REPLACEMENT MM/DD/YYYY" (with the month, day and year of creation indicated), and "COPY 2 REPLACEMENT MM/DD/YYYY," respectively.

(5) The specification must contain an incorporation-by-reference of the material on the compact disc in a separate paragraph (§ 1.77(b)(4)), identifying each compact disc by the names of the files contained on each of the compact discs, their date of creation and their sizes in bytes. The Office may require applicant to amend the specification to include in the paper portion any part of the specification previously submitted on compact disc.

(6) A compact disc must also be labeled with the following information:

- (i) The name of each inventor (if known);
- (ii) Title of the invention;
- (iii) The docket number, or application number if known, used by the person filing the application to identify the application; and
- (iv) A creation date of the compact disc.
- (v) If multiple compact discs are submitted, the label shall indicate their order (*e.g.* "1 of X").
- (vi) An indication that the disk is "Copy 1" or "Copy 2" of the submission. See paragraph (b)(4) of this section.

(7) If a file is unreadable on both copies of the disc, the unreadable file will be treated as not having been submitted. A file is unreadable if, for example, it is of a format that does not comply with the requirements of paragraph (e)(3) of this section, it is corrupted by a computer virus, or it is written onto a defective compact disc.

37 CFR 1.58. *Chemical and mathematical formulae and tables.*

(a) The specification, including the claims, may contain chemical and mathematical formulas, but shall not contain drawings or flow diagrams. The description portion of the specification may contain tables; claims may contain tables either if necessary to conform to 35 U.S.C. 112 or if otherwise found to be desirable.

(b) Tables that are submitted in electronic form (§§ 1.96(c) and 1.821(c)) must maintain the spatial relationships (*e.g.*, columns and rows) of the table elements and preserve the information they convey. Chemical and mathematical formulae must be encoded to maintain the proper positioning of their characters when displayed in order to preserve their intended meaning.

(c) Chemical and mathematical formulae and tables must be presented in compliance with § 1.52(a) and (b), except that chemical and mathematical formulae or tables may be placed in a landscape orientation if they cannot be presented satisfactorily in a portrait orientation. Typewritten characters used in such formulae and tables must be chosen from a block (nonscript) type font or lettering style having capital letters which are at least 0.21 cm. (0.08 inch) high (*e.g.*, elite type). A space at least 0.64 cm. (1/4 inch) high should be provided between complex formulae and tables and the text. Tables should have the lines and columns of data closely spaced to conserve space, consistent with a high degree of legibility.

The pages of the specification including claims and abstract must be numbered consecutively, starting with 1, the numbers being centrally located above or preferably, below, the text. The lines of the specification, and any amendments to the specification, must be 1 1/2 or double spaced. The text must be written in a nonscript type font (*e.g.*, Arial, Times Roman, or Courier) lettering style having capital letters which are at least 0.21 cm (0.08 inch) high (37 CFR 1.52(b)(2)(ii)). The text may not be written solely in capital letters.

All application papers (specification, including claims, abstract, any drawings, oath or declaration, and other papers), and also papers subsequently filed, must have each page plainly written on only one side of a sheet of paper. The specification must commence on a separate sheet. Each sheet including part of the specification may not include other parts of the application or other information. The claim(s), abstract and sequence listing (if any) should not be included on a sheet including any other part of the application (37 CFR 1.71(f)). The claim or claims must commence on a separate sheet or electronic page and any sheet including a claim or portion of a claim may not contain any other parts of the application or other material (37 CFR 1.75(h)). The abstract must commence on a separate sheet and any

sheet including an abstract or portion of an abstract may not contain any other parts of the application or other material (37 CFR 1.72(b)).

All application papers that are submitted on paper or by facsimile transmission which are to become a part of the permanent record of the U.S. Patent and Trademark Office must be on sheets of paper which are the same size (for example, an amendment should not have two different sizes of paper, but the specification can have one size of paper and the drawings a different size) and are either 21.0 cm. by 29.7 cm. (DIN size A4) or 21.6 cm. by 27.9 cm. (8 1/2 by 11 inches). See 37 CFR 1.52(a)(1) and 37 CFR 1.84(f). Application papers submitted by the Office Electronic Filing System (EFS) must conform with the user instructions for EFS. Each sheet, other than the drawings, must include a top margin of at least 2.0 cm. (3/4 inch), a left side margin of at least 2.5 cm. (1 inch), a right side margin of at least 2.0 cm. (3/4 inch), and a bottom margin of at least 2.0 cm. (3/4 inch). No holes should be made in the sheets as submitted.

Applicants must make every effort to file patent applications in a form that is clear and reproducible. If the papers are not of the required quality, substitute typewritten or mechanically printed papers of suitable quality will be required. See 37 CFR 1.125 for filing substitute typewritten or mechanically printed papers constituting a substitute specification required by the Office. See also MPEP § 608.01(q). All papers which are to become a part of the permanent records of the U.S. Patent and Trademark Office must be legibly written either by a typewriter or mechanical printer in permanent dark ink or its equivalent in portrait orientation on flexible, strong, smooth, nonshiny, durable, and white paper. Typed, mimeographed, xeroprinted, multigraphed or nonsmearing carbon copy forms of reproduction are acceptable.

Where an application is filed with papers that do not comply with 37 CFR 1.52, the Office of Initial Patent Examination will mail a "Notice to File Corrected Application Papers" indicating the deficiency and setting a time period within which the applicant must correct the deficiencies to avoid abandonment. The failure to submit application papers in compliance with 37 CFR 1.52 does not effect the grant of a filing date, and original application papers that do not comply with 37 CFR 1.52 will be retained in the application file as the original disclosure of the

invention. The USPTO will not return papers simply because they do not comply with 37 CFR 1.52.

Legibility includes ability to be photocopied and photomicrographed so that suitable reprints can be made and ability to be electronically reproduced by use of digital imaging and optical character recognition. This requires a high contrast, with black lines and a white background. Gray lines and/or a gray background sharply reduce photo reproduction quality. Legibility of some application papers may become impaired due to abrasion or aging of the printed material during examination and ordinary handling of the file. It may be necessary to require that legible and permanent copies be furnished at later stages after filing, particularly when preparing for issue.

Some of the patent application papers received by the U.S. Patent and Trademark Office are copies of the original, ribbon copy. These are acceptable if, in the opinion of the Office, they are legible and permanent.

The paper used must have a surface such that amendments may be written thereon in ink. So-called "Easily Erasable" paper having a special coating so that erasures can be made more easily may not provide a "permanent" copy, 37 CFR 1.52(a)(1)(iv). If a light pressure of an ordinary (pencil) eraser removes the imprint, the examiner should, as soon as this becomes evident, notify applicant by use of Form paragraph 6.32 that it will be necessary for applicant to order a copy of the specification and claims to be made by the U.S. Patent and Trademark Office at the applicant's expense for incorporation in the file. It is not necessary to return this copy to applicant for signature. >Since application papers are now maintained in an Image File Wrapper, the type of paper is unlikely to be an issue so long as the Office was able to scan and reproduce the papers that were filed.<

\*\*>

¶ 6.32 *Application on Easily Erasable Paper or Erasable Ink*

The application papers are objected to because they are not a permanent copy as required by 37 CFR 1.52(a)(1)(iv). Reference is made to [1].

Applicant is required either (1) to submit permanent copies of the identified parts or (2) to order a photocopy of the above identified parts to be made by the U.S. Patent and Trademark Office at applicant's expense for incorporation in the file. See MPEP § 608.01.

**Examiner Note:**

In the bracket, identify: 1) all of the specification; 2) certain pages of the specification; 3) particular claim(s); 4) the oath or declaration; 5) etc.

<

See *In re Benson*, 1959 C.D. 5, 744 O.G. 353 (Comm'r Pat. 1959). Reproductions prepared by heat-sensitive, hectographic, or spirit duplication processes are also not satisfactory.

>

**II. < ALTERATION OF APPLICATION PAPERS**

37 CFR 1.52(c) relating to interlineations and other alterations is strictly enforced. See *In re Swanberg*, 129 USPQ 364 (Comm'r Pat. 1960). See also MPEP § 605.04(a).

>

**III. < CERTIFIED COPIES OF AN APPLICATION-AS-FILED**

If an application-as-filed does not meet the sheet size/margin and quality requirements of 37 CFR 1.52 and 1.84(f) and (g), certified copies of such application may be illegible and/or ineffective as priority documents. When an applicant requests that the USPTO provide a certified copy of an application-as-filed and pays the fee set forth in 37 CFR 1.19(b)(1), the USPTO will make a copy of the application-as-filed from the records in the \*\*>IFW< database (or the microfilm database). If papers submitted in the application-as-filed are not legible, certified copies of the application as originally filed will not be legible.

The USPTO performs exception processing when scanning application papers that do not comply with the sheet size/margin and quality requirements. If papers submitted in the application-as-filed (including any transmittal letter or cover sheet) do not meet the sheet size requirement of 37 CFR 1.52 and 1.84(f) (e.g., the papers are legal size (8 1/2 by 14 inches)), the USPTO must reduce such papers to be able to image-scan the entire application and record it in the \*>IFW< database. In addition, if papers submitted in the application-as-filed do not meet the quality requirements of 37 CFR 1.52 (e.g., the papers are shiny or non-white), the USPTO will attempt to enhance such papers before scanning to make the resulting electronic record in the \*>IFW< database

more readable. However, if exception processing is required to make the \*>IFW< copy, certified copies of the application as originally filed may not be legible.

If application papers are filed that do not meet sheet size/margin and quality requirements, the USPTO will require the applicant to file substitute papers that do comply with the requirements of 37 CFR 1.52 and 1.84 >(e),< (f) and (g). The substitute papers submitted in reply to the above-mentioned requirement will provide the USPTO with an image- and OCR-scannable copy of the application for printing the application as a >patent publication or< patent. However, the USPTO will not treat application papers submitted after the filing date of an application as the original disclosure of the application for making a certified copy of the application-as-filed or any other purpose. That is, even if an applicant subsequently files substitute application papers that comply with 37 CFR 1.52 and then requests that the USPTO provide a certified copy of an application-as-filed, paying the fee set forth in 37 CFR 1.19(b)(1), the USPTO will still make a copy of the application-as-filed \*\*>rather than a copy of< the subsequently filed substitute papers.

\*\*>

#### IV. < USE OF METRIC SYSTEM OF MEASUREMENTS IN PATENT APPLICATIONS

In order to minimize the necessity in the future for converting dimensions given in the English system of measurements to the metric system of measurements when using printed patents as research and prior art search documents, all patent applicants should use the metric (S.I.) units followed by the equivalent English units when describing their inventions in the specifications of patent applications.

The initials S.I. stand for “Le Système International d’ Unités,” the French name for the International System of Units, a modernized metric system adopted in 1960 by the International General Conference of Weights and Measures based on precise unit measurements made possible by modern technology.

>

#### V. < FILING OF NON-ENGLISH LANGUAGE APPLICATIONS

37 CFR 1.52. *Language, Paper, Writing, Margins, Compact Disc Specifications.*

\*\*\*\*\*

(d) A nonprovisional or provisional application may be in a language other than English.

(1) *Nonprovisional application.* If a nonprovisional application is filed in a language other than English, an English language translation of the non-English language application, a statement that the translation is accurate, and the processing fee set forth in § 1.17(i) are required. If these items are not filed with the application, applicant will be notified and given a period of time within which they must be filed in order to avoid abandonment.

(2) *Provisional application.* If a provisional application is filed in a language other than English, an English language translation of the non-English language provisional application will not be required in the provisional application. See § 1.78(a) for the requirements for claiming the benefit of such provisional application in a nonprovisional application.

\*\*\*\*\*

The U.S. Patent and Trademark Office will accord a filing date to an application meeting the requirements of 35 U.S.C. 111(a), or a provisional application in accordance with 35 U.S.C. 111(b), even though some or all of the application papers, including the written description and the claims, is in a language other than English and hence does not comply with 37 CFR 1.52.

An English translation of the non-English language papers, a statement that the translation is accurate, the filing fee, the oath or declaration (if necessary) and fee set forth in 37 CFR 1.17(i) should either accompany the nonprovisional application papers or be filed in the Office within the time set by the Office. If a provisional application is filed in a language other than English, an English translation of the non-English language provisional application \*\*>and a statement that the translation is accurate must be submitted if benefit of the provisional application is claimed in a later-filed nonprovisional application (see 37 CFR 1.78(a)(5)). If the translation and statement were not previously filed in the provisional application, applicant will be notified in the nonprovisional application that claims the benefit of the provisional application and be given a period of time

within which to file the translation and statement. Failure to timely reply to such notice will result in the abandonment of the nonprovisional application.<

A subsequently filed English translation must contain the complete identifying data for the application in order to permit prompt association with the papers initially filed. Accordingly, it is strongly recommended that the original application papers be accompanied by a cover letter and a self-addressed return postcard, each containing the following identifying data in English: (a) applicant's name(s); (b) title of invention; (c) number of pages of specification, claims, and sheets of drawings; (d) whether >an< oath or declaration was filed and (e) amount and manner of paying the filing fee.

The translation must be a literal translation and must be accompanied by a statement that the translation is accurate. The translation must also be accompanied by a signed request from the applicant, his or her attorney or agent, asking that the English translation be used as the copy for examination purposes in the Office. If the English translation does not conform to idiomatic English and United States practice, it should be accompanied by a preliminary amendment making the necessary changes without the introduction of new matter prohibited by 35 U.S.C. 132. **\*\*>**If such an application is published as a patent application publication, the document that is published is the translation. See 37 CFR 1.215(a) and MPEP § 1121 regarding the content of the application publication. In the event that the English translation and the statement are not timely filed in the nonprovisional application, the nonprovisional application will be regarded as abandoned.<

It should be recognized that this practice is intended for emergency situations to prevent loss of valuable rights and should not be routinely used for filing applications. There are at least two reasons why this should not be used on a routine basis. First, there are obvious dangers to applicant and the public if he or she fails to obtain a correct literal translation. Second, the filing of a large number of applications under the procedure will create significant administrative burdens on the Office.

&gt;

## VI. < ILLUSTRATIONS IN THE SPECIFICATION

Graphical illustrations, diagrammatic views, flowcharts, and diagrams in the descriptive portion of the specification do not come within the purview of 37 CFR 1.58(a), which permits tables, chemical and mathematical formulas in the specification in lieu of formal drawings. The examiner should object to such descriptive illustrations in the specification and request formal drawings in accordance with 37 CFR 1.81 when an application contains graphs >, drawings, or flow charts< in the specification.

The specification, including any claims, may contain chemical formulas and mathematical equations, but may not contain drawings or flow diagrams. The description portion of the specification may contain tables; claims may contain tables **\*>**either< if necessary to conform to 35 U.S.C. 112 >or if otherwise found to be desirable. When such a patent is printed, however, the table will not be included as part of the claim, and instead the claim will contain a reference to the table number<.

See MPEP § 601.01(d) for treatment of applications filed without all pages of the specification.

&gt;

## VII. < HYPERLINKS AND OTHER FORMS OF BROWSER-EXECUTABLE CODE IN THE SPECIFICATION

Examiners must review patent applications to make certain that hyperlinks and other forms of browser-executable code, especially commercial site URLs, are not included in a patent application. Examples of a hyperlink or a browser-executable code are a URL placed between these symbols "< >" and http:// followed by a URL address. When a patent application with embedded hyperlinks and/or other forms of browser-executable code issues as a patent (or is published as a patent application publication) and the patent document is placed on the USPTO web page, when the patent document is retrieved and viewed via a web browser, the URL is interpreted as a valid HTML code and it becomes a live web link. When a user clicks on the link with a mouse, the user will be transferred to another web page identified by the URL, if it exists, which could be a commercial web

site. USPTO policy does not permit the USPTO to link to any commercial sites since the USPTO exercises no control over the organization, views or accuracy of the information contained on these outside sites.

If hyperlinks and/or other forms of browser-executable code are embedded in the text of the patent application, examiners should object to the specification and indicate to applicants that the embedded hyperlinks and/or other forms of browser-executable code are impermissible and require deletion. This requirement does not apply to electronic documents listed on forms PTO-892 and \*>PTO/SB/08< where the electronic document is identified by reference to a URL.

The attempt to incorporate subject matter into the patent application by reference to a hyperlink and/or other forms of browser-executable code is considered to be an improper incorporation by reference. See MPEP § 608.01(p), paragraph I regarding incorporation by reference. Where the hyperlinks and/or other forms of browser-executable codes >themselves rather than the contents of the site to which the hyperlinks are directed< are part of applicant's invention and it is necessary to have them included in the patent application in order to comply with the requirements of 35 U.S.C. 112, first paragraph, and applicant does not intend to have these hyperlinks be active links, examiners should not object to these hyperlinks. The Office will disable these hyperlinks when preparing the text to be loaded onto the USPTO web database.

Note that nucleotide and/or amino acid sequence data placed between the symbols "< >" are not considered to be hyperlinks and/or browser-executable code and therefore should not be objected to as being an improper incorporation by reference (see 37 CFR 1.821 – 1.825).

\*\*>

#### ¶ 7.29.04 Disclosure Objected To, Embedded Hyperlinks or Other Forms of Browser-Executable Code

The disclosure is objected to because it contains an embedded hyperlink and/or other form of browser-executable code. Applicant is required to delete the embedded hyperlink and/or other form of browser-executable code. See MPEP § 608.01.

#### Examiner Note:

1. Examples of a hyperlink or a browser-executable code are a URL placed between these symbols "< >" and http://followed by a URL address. Nucleotide and/or amino acid sequence data placed

between the symbols "< >" are not considered to be hyperlinks and/or browser-executable code.

2. If the application attempts to incorporate essential or nonessential subject matter into the patent application by reference to the contents of the site to which a hyperlink and/or other form of browser-executable code is directed, use form paragraph 6.19 or 6.19.01 instead. See also MPEP § 608.01(p).

3. The requirement to delete an embedded hyperlink or other form of browser-executable code does not apply to electronic documents listed on forms PTO-892 and PTO-1449 where the electronic document is identified by reference to a URL.

4. Examiners should not object to hyperlinks where the hyperlinks and/or browser-executable codes themselves (rather than the contents of the site to which the hyperlinks are directed) are necessary to be included in the patent application in order to meet the requirements of 35 U.S.C. 112, first paragraph, and applicant does not intend to have those hyperlinks be active links.

<

## 608.01(a) Arrangement of Application [R-2]

### 37 CFR 1.77. Arrangement of application elements.

(a) The elements of the application, if applicable, should appear in the following order:

- (1) Utility application transmittal form.
- (2) Fee transmittal form.
- (3) Application data sheet (see § 1.76).
- (4) Specification.
- (5) Drawings.
- (6) Executed oath or declaration.

(b) The specification should include the following sections in order:

(1) Title of the invention, which may be accompanied by an introductory portion stating the name, citizenship, and residence of the applicant (unless included in the application data sheet).

(2) Cross-reference to related applications (unless included in the application data sheet).

(3) Statement regarding federally sponsored research or development.

(4) Reference to a "Sequence Listing," a table, or a computer program listing appendix submitted on a compact disc and an incorporation-by-reference of the material on the compact disc (see § 1.52(e)(5)). The total number of compact discs including duplicates and the files on each compact disc shall be specified.

(5) Background of the invention.

(6) Brief summary of the invention.

(7) Brief description of the several views of the drawing.

(8) Detailed description of the invention.

(9) A claim or claims.

(10) Abstract of the disclosure.

(11) "Sequence Listing," if on paper (see §§ 1.821 through 1.825).



(c) The text of the specification sections defined in paragraphs (b)(1) through (b)(11) of this section, if applicable, should be preceded by a section heading in uppercase and without underlining or bold type.

For design patent specification, see MPEP § 1503.01.

For plant patent specification, see MPEP § 1605.

For reissue patent specification, see MPEP § 1411.

The following order of arrangement of specification elements is preferable in framing the nonprovisional specification and \*\* each of the lettered items should appear in upper case, without underlining or bold type, as section headings. If no text follows the section heading, the phrase “Not Applicable” should follow the section heading. It is recommended that provisional applications follow the same general format, although claims are not required. If an application data sheet (37 CFR 1.76) is used, data supplied in the application data sheet need not be provided elsewhere in the application except that the citizenship of each inventor must be provided in the oath or declaration under 37 CFR 1.63 even if this information is provided in the application data sheet (see 37 CFR \*>1.76(b)<). If there is a discrepancy between the information submitted in an application data sheet and the information submitted elsewhere in the application, the application data sheet will control except for the naming of the inventors and the citizenship of the inventors. See MPEP § 601.05.

(A) Title of the Invention.

(B) Cross-References to Related Applications.

(C) Statement Regarding Federally Sponsored Research or Development.

(D) Reference to a “\*>Sequence< Listing,” a table, or a computer program listing appendix submitted on a compact disc >and an incorporation-by-reference of the material on the compact disc< (See 37 CFR 1.52(e)(5).)

(E) Background of the Invention.

(1) Field of the Invention.

(2) Description of the related art including information disclosed under 37 CFR 1.97 and 1.98.

(F) Brief Summary of the Invention.

(G) Brief Description of the Several Views of the Drawings.

(H) Detailed Description of the Invention.

(I) Claim or Claims.

(J) Abstract of the Disclosure.

(K) \*\* “Sequence Listing,” if on paper (See 37 CFR 1.821-1.825).

Applicant (typically a *pro se*) may be advised of the proper arrangement by using Form Paragraph 6.01 or 6.02.

\*\*>

#### ¶ 6.01 Arrangement of the Sections of the Specification in a Utility Application

The following guidelines illustrate the preferred layout for the specification of a utility application. These guidelines are suggested for the applicant’s use.

#### Arrangement of the Specification

As provided in 37 CFR 1.77(b), the specification of a utility application should include the following sections in order. Each of the lettered items should appear in upper case, without underlining or bold type, as a section heading. If no text follows the section heading, the phrase “Not Applicable” should follow the section heading:

(a) TITLE OF THE INVENTION.

(b) CROSS-REFERENCE TO RELATED APPLICATIONS.

(c) STATEMENT REGARDING FEDERALLY SPONSORED RESEARCH OR DEVELOPMENT.

(d) INCORPORATION-BY-REFERENCE OF MATERIAL SUBMITTED ON A COMPACT DISC. (See 37 CFR 1.52(e)(5) and MPEP § 608.05. Computer program listings (37 CFR 1.96(c)), “Sequence Listings” (37 CFR 1.821(c)), and tables having more than 50 pages of text are permitted to be submitted on compact discs.) or

REFERENCE TO A “MICROFICHE APPENDIX”. (See MPEP § 608.05(a). “Microfiche Appendices” were accepted by the Office until March 1, 2001.)

(e) BACKGROUND OF THE INVENTION.

(1) Field of the Invention.

(2) Description of Related Art including information disclosed under 37 CFR 1.97 and 1.98.

(f) BRIEF SUMMARY OF THE INVENTION.

(g) BRIEF DESCRIPTION OF THE SEVERAL VIEWS OF THE DRAWING(S).

(h) DETAILED DESCRIPTION OF THE INVENTION.

(i) CLAIM OR CLAIMS (commencing on a separate sheet).

(j) ABSTRACT OF THE DISCLOSURE (commencing on a separate sheet).

(k) SEQUENCE LISTING. (See MPEP § 2424 and 37 CFR 1.821-1.825. A “Sequence Listing” is required on paper if the application discloses a nucleotide or amino acid sequence as defined in 37 CFR 1.821(a) and if the required “Sequence Listing” is not submitted as an electronic document on compact disc.)

#### Examiner Note:

For the arrangement of the sections of the specification in a design application, see 37 CFR 1.154(b). Form paragraph 15.05 may be used for a design application. For the arrangement of the sections of the specification in a plant application, see 37 CFR

1.163(c). For the requirements of the specification in a reissue application, see 37 CFR 1.173(a)(1).

## ¶ 6.02 Content of Specification

### Content of Specification

(a) TITLE OF THE INVENTION: See 37 CFR 1.72(a) and MPEP § 606. The title of the invention should be placed at the top of the first page of the specification unless the title is provided in an application data sheet. The title of the invention should be brief but technically accurate and descriptive, preferably from two to seven words. It may not contain more than 500 characters.

(b) CROSS-REFERENCES TO RELATED APPLICATIONS: See 37 CFR 1.78 and MPEP § 201.11.

(c) STATEMENT REGARDING FEDERALLY SPONSORED RESEARCH OR DEVELOPMENT: See MPEP § 310.

(d) INCORPORATION-BY-REFERENCE OF MATERIAL SUBMITTED ON A COMPACT DISC: The specification is required to include an incorporation-by-reference of electronic documents that are to become part of the permanent United States Patent and Trademark Office records in the file of a patent application. See 37 CFR 1.52(e) and MPEP § 608.05. Computer program listings (37 CFR 1.96(c)), "Sequence Listings" (37 CFR 1.821(c)), and tables having more than 50 pages of text were permitted as electronic documents on compact discs beginning on September 8, 2000.

Or alternatively, REFERENCE TO A "MICROFICHE APPENDIX": See MPEP § 608.05(a). "Microfiche Appendices" were accepted by the Office until March 1, 2001.

(e) BACKGROUND OF THE INVENTION: See MPEP § 608.01(c). The specification should set forth the Background of the Invention in two parts:

(1) Field of the Invention: A statement of the field of art to which the invention pertains. This statement may include a paraphrasing of the applicable U.S. patent classification definitions of the subject matter of the claimed invention. This item may also be titled "Technical Field."

(2) Description of the Related Art including information disclosed under 37 CFR 1.97 and 37 CFR 1.98: A description of the related art known to the applicant and including, if applicable, references to specific related art and problems involved in the prior art which are solved by the applicant's invention. This item may also be titled "Background Art."

(f) BRIEF SUMMARY OF THE INVENTION: See MPEP § 608.01(d). A brief summary or general statement of the invention as set forth in 37 CFR 1.73. The summary is separate and distinct from the abstract and is directed toward the invention rather than the disclosure as a whole. The summary may point out the advantages of the invention or how it solves problems previously existent in the prior art (and preferably indicated in the Background of the Invention). In chemical cases it should point out in general

terms the utility of the invention. If possible, the nature and gist of the invention or the inventive concept should be set forth. Objects of the invention should be treated briefly and only to the extent that they contribute to an understanding of the invention.

(g) BRIEF DESCRIPTION OF THE SEVERAL VIEWS OF THE DRAWING(S): See MPEP § 608.01(f). A reference to and brief description of the drawing(s) as set forth in 37 CFR 1.74.

(h) DETAILED DESCRIPTION OF THE INVENTION: See MPEP § 608.01(g). A description of the preferred embodiment(s) of the invention as required in 37 CFR 1.71. The description should be as short and specific as is necessary to describe the invention adequately and accurately. Where elements or groups of elements, compounds, and processes, which are conventional and generally widely known in the field of the invention described, and their exact nature or type is not necessary for an understanding and use of the invention by a person skilled in the art, they should not be described in detail. However, where particularly complicated subject matter is involved or where the elements, compounds, or processes may not be commonly or widely known in the field, the specification should refer to another patent or readily available publication which adequately describes the subject matter.

(i) CLAIM OR CLAIMS: See 37 CFR 1.75 and MPEP § 608.01(m). The claim or claims must commence on a separate sheet or electronic page (37 CFR 1.52(b)(3)). Where a claim sets forth a plurality of elements or steps, each element or step of the claim should be separated by a line indentation. There may be plural indentations to further segregate subcombinations or related steps. See 37 CFR 1.75 and MPEP 608.01(i)-(p).

(j) ABSTRACT OF THE DISCLOSURE: See 37 CFR 1.72(b) and MPEP § 608.01(b). A brief narrative of the disclosure as a whole in a single paragraph of 150 words or less commencing on a separate sheet following the claims. In an international application which has entered the national stage (37 CFR 1.491(b)), the applicant need not submit an abstract commencing on a separate sheet if an abstract was published with the international application under PCT Article 21. The abstract that appears on the cover page of the pamphlet published by the International Bureau (IB) of the World Intellectual Property Organization (WIPO) is the abstract that will be used by the USPTO. See MPEP § 1893.03(e).

(k) SEQUENCE LISTING: See 37 CFR 1.821-1.825 and MPEP § § 2421-2431. The requirement for a sequence listing applies to all sequences disclosed in a given application, whether the sequences are claimed or not. See MPEP § 2421.02.

### Examiner Note:

In this paragraph an introductory sentence will be necessary. This paragraph is intended primarily for use in *pro se* applications.

<

**608.01(b) Abstract of the Disclosure [R-2]**

37 CFR 1.72. *Title and abstract.*

\*\*\*\*\*

\*\*>

(b) A brief abstract of the technical disclosure in the specification must commence on a separate sheet, preferably following the claims, under the heading "Abstract" or "Abstract of the Disclosure." The sheet or sheets presenting the abstract may not include other parts of the application or other material. The abstract in an application filed under 35 U.S.C. 111 may not exceed 150 words in length. The purpose of the abstract is to enable the United States Patent and Trademark Office and the public generally to determine quickly from a cursory inspection the nature and gist of the technical disclosure.<

The Office of Initial Patent Examination (OIPE) will review all applications filed under 35 U.S.C. 111(a) for compliance with 37 CFR 1.72 and will require an abstract, if one has not been filed. In all other applications which lack an abstract, the examiner in the first Office action should require the submission of an abstract directed to the technical disclosure in the specification. See Form Paragraph 6.12 (below). Applicants may use either "Abstract" or "Abstract of the Disclosure" as a heading.

If the abstract contained in the application does not comply with the guidelines, the examiner should point out the defect to the applicant in the first Office action, or at the earliest point in the prosecution that the defect is noted, and require compliance with the guidelines. Since the abstract of the disclosure has been interpreted to be a part of the specification for the purpose of compliance with paragraph 1 of 35 U.S.C. 112 (*In re Armbruster*, 512 F.2d 676, 678-79, 185 USPQ 152, 154 (CCPA 1975)), it would ordinarily be preferable that the applicant make the necessary changes to the abstract to bring it into compliance with the guidelines. See Form Paragraphs 6.13-6.16 (below).

Replies to such actions requiring either a new abstract or amendment to bring the abstract into compliance with the guidelines should be treated under 37 CFR 1.111(b) practice like any other formal matter. Any submission of a new abstract or amendment to an existing abstract should be carefully reviewed for introduction of new matter, 35 U.S.C. 132, MPEP § 608.04.

Upon passing the application to issue, the examiner should make certain that the abstract is an adequate

and clear statement of the contents of the disclosure and generally in line with the guidelines. \*\*>If< the application is otherwise in condition for allowance except that the abstract does not comply with the guidelines, the examiner generally should make any necessary revisions by >a formal< examiner's amendment >after obtaining applicant's authorization (see MPEP § 1302.04< rather than issuing an *Ex parte Quayle* action requiring applicant to make the necessary revisions.

Under current practice, in all instances where the application contains an abstract when sent to issue, the abstract will be printed on the patent.

**GUIDELINES FOR THE PREPARATION OF PATENT ABSTRACTS**

>

**A. < Background**

The Rules of Practice in Patent Cases require that each application for patent include an abstract of the disclosure, 37 CFR 1.72(b).

The content of a patent abstract should be such as to enable the reader thereof, regardless of his or her degree of familiarity with patent documents, to \*\*>determine quickly from a cursory inspection of the nature and gist of< the technical disclosure and should include that which is new in the art to which the invention pertains.

\*\*>

**B. < Content**

A patent abstract is a concise statement of the technical disclosure of the patent and should include that which is new in the art to which the invention pertains.

If the patent is of a basic nature, the entire technical disclosure may be new in the art, and the abstract should be directed to the entire disclosure.

If the patent is in the nature of an improvement in old apparatus, process, product, or composition, the abstract should include the technical disclosure of the improvement.

In certain patents, particularly those for compounds and compositions, wherein the process for making and/or the use thereof are not obvious, the abstract should set forth a process for making and/or a use thereof.

If the new technical disclosure involves modifications or alternatives, the abstract should mention by way of example the preferred modification or alternative.

The abstract should not refer to purported merits or speculative applications of the invention and should not compare the invention with the prior art.

Where applicable, the abstract should include the following: (1) if a machine or apparatus, its organization and operation; (2) if an article, its method of making; (3) if a chemical compound, its identity and use; (4) if a mixture, its ingredients; (5) if a process, the steps. Extensive mechanical and design details of apparatus should not be given.

With regard particularly to chemical patents, for compounds or compositions, the general nature of the compound or composition should be given as well as the use thereof, e.g., "The compounds are of the class of alkyl benzene sulfonyl ureas, useful as oral anti-diabetics." Exemplification of a species could be illustrative of members of the class. For processes, the type reaction, reagents and process conditions should be stated, generally illustrated by a single example unless variations are necessary.

>

### C. < *Language and Format*

The abstract must commence on a separate sheet, preferably following the claims, under the heading > "Abstract" or < "Abstract of the Disclosure." >The sheet or sheets presenting the abstract may not include other parts of the application or other material.< Form paragraph 6.16.01 (below) may be used if the abstract does not commence on a separate sheet. Note that the abstract for a national stage application filed under 35 U.S.C. 371 may be found on the front page of the Patent Cooperation Treaty publication (i.e., pamphlet). See MPEP § 1893.03(e).

The abstract should be in narrative form and generally limited to a single paragraph within the range of 50 to 150 words. The abstract should not exceed 25 lines of text. Abstracts exceeding 25 lines of text should be checked to see that it does not exceed 150 words in length since the space provided for the abstract on the computer tape by the printer is limited. If the abstract cannot be placed on the computer tape because of its excessive length, the application will be returned to the examiner for preparation of a shorter

abstract. The form and legal phraseology often used in patent claims, such as "means" and "said," should be avoided. The abstract should sufficiently describe the disclosure to assist readers in deciding whether there is a need for consulting the full patent text for details.

The language should be clear and concise and should not repeat information given in the title. It should avoid using phrases which can be implied, such as, "This disclosure concerns," "The disclosure defined by this invention," "This disclosure describes," etc.

>

### D. < *Responsibility*

Preparation of the abstract is the responsibility of the applicant. Background knowledge of the art and an appreciation of the applicant's contribution to the art are most important in the preparation of the abstract. The review of the abstract for compliance with these guidelines, with any necessary editing and revision on allowance of the application, is the responsibility of the examiner.

>

### E. < *Sample Abstracts*

(1) A heart valve which has an annular valve body defining an orifice and a plurality of struts forming a pair of cages on opposite sides of the orifice. A spherical closure member is captively held within the cages and is moved by blood flow between open and closed positions in check valve fashion. A slight leak or backflow is provided in the closed position by making the orifice slightly larger than the closure member. Blood flow is maximized in the open position of the valve by providing an inwardly convex contour on the orifice-defining surfaces of the body. An annular rib is formed in a channel around the periphery of the valve body to anchor a suture ring used to secure the valve within a heart.

(2) A method for sealing whereby heat is applied to seal, overlapping closure panels of a folding box made from paperboard having an extremely thin coating of moisture-proofing thermoplastic material on opposite surfaces. Heated air is directed at the surfaces to be bonded, the temperature of the air at the point of impact on the surfaces being above the char point of the board. The duration of

application of heat is made so brief, by a corresponding high rate of advance of the boxes through the air stream, that the coating on the reverse side of the panels remains substantially non-tacky. The bond is formed immediately after heating within a period of time for any one surface point less than the total time of exposure to heated air of that point. Under such conditions the heat applied to soften the thermoplastic coating is dissipated after completion of the bond by absorption into the board acting as a heat sink without the need for cooling devices.

(3) Amides are produced by reacting an ester of a carbonized acid with an amine, using as catalyst an dioxide of an alkali metal. The ester is first heated to at least 75°C under a pressure of no more than 500 mm. of mercury to remove moisture and acid gases which would prevent the reaction, and then converted to an amide without heating to initiate the reaction.

\*\*>

#### ¶ 6.12 Abstract Missing (Background)

This application does not contain an abstract of the disclosure as required by 37 CFR 1.72(b). An abstract on a separate sheet is required.

#### Examiner Note:

1. For *pro se* applicant, consider form paragraphs 6.14 to 6.16.
2. This form paragraph should not be used during the national stage prosecution of international applications (“371 applications”) if an abstract was published with the international application under PCT Article 21.

<

#### ¶ 6.13 Abstract Objected To: Minor Informalities

The abstract of the disclosure is objected to because [1]. Correction is required. See MPEP § 608.01(b).

#### Examiner Note:

In bracket 1, indicate the informalities that should be corrected. Use this paragraph for minor informalities such as the inclusion of legal phraseology, undue length, etc.

#### ¶ 6.14 Abstract of the Disclosure: Content

Applicant is reminded of the proper content of an abstract of the disclosure.

A patent abstract is a concise statement of the technical disclosure of the patent and should include that which is new in the art to which the invention pertains. If the patent is of a basic nature, the entire technical disclosure may be new in the art, and the abstract should be directed to the entire disclosure. If the patent is in the nature of an improvement in an old apparatus, process,

product, or composition, the abstract should include the technical disclosure of the improvement. In certain patents, particularly those for compounds and compositions, wherein the process for making and/or the use thereof are not obvious, the abstract should set forth a process for making and/or use thereof. If the new technical disclosure involves modifications or alternatives, the abstract should mention by way of example the preferred modification or alternative.

The abstract should not refer to purported merits or speculative applications of the invention and should not compare the invention with the prior art.

Where applicable, the abstract should include the following:

- (1) if a machine or apparatus, its organization and operation;
- (2) if an article, its method of making;
- (3) if a chemical compound, its identity and use;
- (4) if a mixture, its ingredients;
- (5) if a process, the steps.

Extensive mechanical and design details of an apparatus should not be included in the abstract.

#### Examiner Note:

See form paragraph 6.16.

#### ¶ 6.15 Abstract of the Disclosure: Chemical Cases

Applicant is reminded of the proper content of an abstract of the disclosure.

In chemical patent abstracts for compounds or compositions, the general nature of the compound or composition should be given as well as its use, *e.g.*, “The compounds are of the class of alkyl benzene sulfonyl ureas, useful as oral anti-diabetics.” Exemplification of a species could be illustrative of members of the class. For processes, the type reaction, reagents and process conditions should be stated, generally illustrated by a single example unless variations are necessary.

Complete revision of the content of the abstract is required on a separate sheet.

#### ¶ 6.16 Abstract of the Disclosure: Language

Applicant is reminded of the proper language and format for an abstract of the disclosure.

The abstract should be in narrative form and generally limited to a single paragraph on a separate sheet within the range of 50 to 150 words. It is important that the abstract not exceed 150 words in length since the space provided for the abstract on the computer tape used by the printer is limited. The form and legal phraseology often used in patent claims, such as “means” and “said,” should be avoided. The abstract should describe the disclosure sufficiently to assist readers in deciding whether there is a need for consulting the full patent text for details.

The language should be clear and concise and should not repeat information given in the title. It should avoid using phrases which can be implied, such as, “The disclosure concerns,” “The disclosure defined by this invention,” “The disclosure describes,” etc.

#### Examiner Note:

See also form paragraph 6.14.

\*\*>

#### ¶ 6.16.01 Abstract of the Disclosure: Placement

The abstract of the disclosure does not commence on a separate sheet in accordance with 37 CFR 1.52(b)(4). A new abstract of the disclosure is required and must be presented on a separate sheet, apart from any other text.

#### Examiner Note:

1. This paragraph should only be used for applications filed on or after September 23, 1996.
2. 37 CFR 1.72(b) requires that the abstract be set forth on a separate sheet. This requirement applies to amendments to the abstract as well as to the initial filing of the application.
3. This form paragraph should not be used during the national stage prosecution of international applications ("371 applications") if an abstract was published with the international application under PCT Article 21.

<

### 608.01(c) Background of the Invention

The Background of the Invention ordinarily comprises two parts:

(1) **Field of the Invention:** A statement of the field of art to which the invention pertains. This statement may include a paraphrasing of the applicable U.S. patent classification definitions. The statement should be directed to the subject matter of the claimed invention.

(2) **Description of the related art** including information disclosed under 37 CFR 1.97 and 37 CFR 1.98: A paragraph(s) describing to the extent practical the state of the prior art or other information disclosed known to the applicant, including references to specific prior art or other information where appropriate. Where applicable, the problems involved in the prior art or other information disclosed which are solved by the applicant's invention should be indicated. See also MPEP § 608.01(a), § 608.01(p) and § 707.05(b).

### 608.01(d) Brief Summary of Invention

37 CFR 1.73. *Summary of the invention.*

A brief summary of the invention indicating its nature and substance, which may include a statement of the object of the invention, should precede the detailed description. Such summary should, when set forth, be commensurate with the invention as claimed and any object recited should be that of the invention as claimed.

Since the purpose of the brief summary of invention is to apprise the public, and more especially those interested in the particular art to which the invention

relates, of the nature of the invention, the summary should be directed to the specific invention being claimed, in contradistinction to mere generalities which would be equally applicable to numerous preceding patents. That is, the subject matter of the invention should be described in one or more clear, concise sentences or paragraphs. Stereotyped general statements that would fit one application as well as another serve no useful purpose and may well be required to be canceled as surplusage, and, in the absence of any illuminating statement, replaced by statements that are directly on point as applicable exclusively to the case at hand.

The brief summary, if properly written to set out the exact nature, operation, and purpose of the invention, will be of material assistance in aiding ready understanding of the patent in future searches. The brief summary should be more than a mere statement of the objects of the invention, which statement is also permissible under 37 CFR 1.73.

The brief summary of invention should be consistent with the subject matter of the claims. Note final review of application and preparation for issue, MPEP § 1302.

### 608.01(e) Reservation Clauses Not Permitted

37 CFR 1.79. *Reservation clauses not permitted.*

A reservation for a future application of subject matter disclosed but not claimed in a pending application will not be permitted in the pending application, but an application disclosing unclaimed subject matter may contain a reference to a later filed application of the same applicant or owned by a common assignee disclosing and claiming that subject matter.

### 608.01(f) Brief Description of Drawings

37 CFR 1.74. *Reference to drawings.*

When there are drawings, there shall be a brief description of the several views of the drawings and the detailed description of the invention shall refer to the different views by specifying the numbers of the figures, and to the different parts by use of reference letters or numerals (preferably the latter).

The Office of Initial Patent Examination (OIPE) will review the specification, including the brief description, to determine whether all of the figures of drawings described in the specification are present. If the specification describes a figure which is not present in the drawings, the application will be treated as an application filed without all figures of drawings

in accordance with MPEP § 601.01(g), unless the application lacks any drawings, in which case the application will be treated as an application filed without drawings in accordance with MPEP § 601.01(f).

The examiner should see to it that the figures are correctly described in the brief description of the drawing, that all section lines used are referred to, and that all needed section lines are used. If a figure contains several parts, for example, figure 1A, 1B, and 1C, the figure may be described as figure 1. If only figure 1A is described in the brief description, the examiner should object to the brief description, and require applicant to either add a brief description of figure 1B and 1C or describe the figure as “figure 1.”

The specification must contain or be amended to contain proper reference to the existence of drawings executed in color as required by 37 CFR 1.84.

#### *37 CFR 1.84. Standards for drawings.*

(a) *Drawings.* There are two acceptable categories for presenting drawings in utility and design patent applications.

(1) *Black ink.* Black and white drawings are normally required. India ink, or its equivalent that secures solid black lines, must be used for drawings; or

(2) *Color.* On rare occasions, color drawings may be necessary as the only practical medium by which to disclose the subject matter sought to be patented in a utility or design patent application or the subject matter of a statutory invention registration. The color drawings must be of sufficient quality such that all details in the drawings are reproducible in black and white in the printed patent. Color drawings are not permitted in international applications (see PCT Rule 11.13), or in an application, or copy thereof, submitted under the Office electronic filing system. The Office will accept color drawings in utility or design patent applications and statutory invention registrations only after granting a petition filed under this paragraph explaining why the color drawings are necessary. Any such petition must include the following:

- (i) The fee set forth in § 1.17(h);
- (ii) Three (3) sets of color drawings;

(iii) A black and white photocopy that accurately depicts, to the extent possible, the subject matter shown in the color drawing; and

(iv) An amendment to the specification to insert (unless the specification contains or has been previously amended to contain) the following language as the first paragraph of the brief description of the drawings:

The patent or application file contains at least one drawing executed in color. Copies of this patent or patent application publication with color drawing(s) will be provided by the Office upon request and payment of the necessary fee.

(b) *Photographs.*—

(1) *Black and white.* Photographs, including photocopies of photographs, are not ordinarily permitted in utility and design patent applications. The Office will accept photographs in utility and design patent applications, however, if photographs are the only practicable medium for illustrating the claimed invention. For example, photographs or photomicrographs of: electrophoresis gels, blots (*e.g.*, immunological, western, Southern, and northern), auto- radiographs, cell cultures (stained and unstained), histological tissue cross sections (stained and unstained), animals, plants, in vivo imaging, thin layer chromatography plates, crystalline structures, and, in a design patent application, ornamental effects, are acceptable. If the subject matter of the application admits of illustration by a drawing, the examiner may require a drawing in place of the photograph. The photographs must be of sufficient quality so that all details in the photographs are reproducible in the printed patent.

(2) *Color photographs.* Color photographs will be accepted in utility and design patent applications if the conditions for accepting color drawings and black and white photographs have been satisfied. See paragraphs (a)(2) and (b)(1) of this section.

\*\*\*\*\*

## **608.01(g) Detailed Description of Invention**

A detailed description of the invention and drawings follows the general statement of invention and brief description of the drawings. This detailed description, required by 37 CFR 1.71, MPEP § 608.01, must be in such particularity as to enable any person skilled in the pertinent art or science to make and use the invention without involving extensive experimentation. An applicant is ordinarily permitted to use his or her own terminology, as long as it can be understood. Necessary grammatical corrections, however, should be required by the examiner, but it must be remembered that an examination is not made for the purpose of securing grammatical perfection.

The reference characters must be properly applied, no single reference character being used for two different parts or for a given part and a modification of such part. In the latter case, the reference character, applied to the given part, with a prime affixed may advantageously be applied to the modification. Every feature specified in the claims must be illustrated, but there should be no superfluous illustrations.

The description is a dictionary for the claims and should provide clear support or antecedent basis for all terms used in the claims. See 37 CFR 1.75, MPEP § 608.01(i), § 608.01(o), and § 1302.01.

For completeness, see MPEP § 608.01(p).

## USE OF SYMBOL “Phi” IN PATENT APPLICATION

The Greek letter “Phi” has long been used as a symbol in equations in all technical disciplines. It further has special uses which include the indication of an electrical phase or clocking signal as well as an angular measurement. The recognized symbols for the upper and lower case Greek Phi characters, however, do not appear on most typewriters. This apparently has led to the use of a symbol composed by first striking a zero key and then backspacing and striking the “cancel” or “slash” key to result in an approximation of accepted symbols for the Greek character Phi. In other instances, the symbol is composed using the upper or lower case letter “O” with the “cancel” or “slash” superimposed thereon by backspacing, or it is simply handwritten in a variety of styles. These expedients result in confusion because of the variety of type sizes and styles available on modern typewriters.

In recent years, the growth of data processing has seen the increasing use of this symbol (“Ø”) as the standard representation of zero. The “slashed” or “canceled” zero is used to indicate zero and avoid confusion with the upper case letter “O” in both text and drawings.

Thus, when the symbol “Ø” in one of its many variations, as discussed above, appears in patent applications being prepared for printing, confusion as to the intended meaning of the symbol arises. Those (such as examiners, attorneys, and applicants) working in the art can usually determine the intended meaning of this symbol because of their knowledge of the subject matter involved, but editors preparing these applications for printing have no such specialized knowledge and confusion arises as to which symbol to print. The result, at the very least, is delay until the intended meaning of the symbol can be ascertained.

Since the Office does not have the resources to conduct a technical editorial review of each application before printing, and in order to eliminate the problem of printing delays associated with the usage of these symbols, any question about the intended symbol will be resolved by the editorial staff of the Office of Patent Publication by printing the symbol Ø whenever that symbol is used by the applicant. Any Certificate of Correction necessitated by the above practice will

be at the patentee’s expense (37 CFR 1.323) because the intended symbol was not accurately presented by the Greek upper or lower case Phi letters in the patent application.

## 608.01(h) Mode of Operation of Invention

The best mode contemplated by the inventor of carrying out his or her invention must be set forth in the description. See 35 U.S.C. 112. There is no statutory requirement for the disclosure of a specific example. A patent specification is not intended nor required to be a production specification. *Spectra-Physics, Inc. v. Coherent, Inc.*, 827 F.2d 1524, 1536, 3 USPQ2d 1737, 1745 (Fed. Cir. 1987); *In re Gay*, 309 F.2d 768, 135 USPQ 311 (CCPA 1962). The absence of a specific working example is not necessarily evidence that the best mode has not been disclosed, nor is the presence of one evidence that it has. *In re Honn*, 364 F.2d 454, 150 USPQ 652 (CCPA 1966). In determining the adequacy of a best mode disclosure, only evidence of concealment (accidental or intentional) is to be considered. That evidence must tend to show that the quality of an applicant’s best mode disclosure is so poor as to effectively result in concealment. *Spectra-Physics, Inc. v. Coherent, Inc.*, 827 F.2d 1524, 1536, 3 USPQ2d 1737, 1745 (Fed. Cir. 1987); *In re Sherwood*, 613 F.2d 809, 204 USPQ 537 (CCPA 1980).

The question of whether an inventor has or has not disclosed what he or she feels is his or her best mode is a question separate and distinct from the question of sufficiency of the disclosure. *Spectra-Physics, Inc. v. Coherent, Inc.*, 827 F.2d 1524, 1532, 3 USPQ2d 1737, 1742 (Fed. Cir. 1987); *In re Glass*, 492 F.2d 1228, 181 USPQ 31 (CCPA 1974); *In re Gay*, 309 F.2d 708, 135 USPQ 311 (CCPA 1962). See 35 U.S.C. 112 and 37 CFR 1.71(b).

If the best mode contemplated by the inventor at the time of filing the application is not disclosed, such defect cannot be cured by submitting an amendment seeking to put into the specification something required to be there when the application was originally filed. *In re Hay*, 534 F.2d 917, 189 USPQ 790 (CCPA 1976). Any proposed amendment of this type should be treated as new matter.

Patents have been held invalid in cases where the patentee did not disclose the best mode known to him or her. See *Chemcast Corp. v. Arco Indus. Corp.*, 913 F.2d 923, 16 USPQ2d 1033 (Fed. Cir. 1990); *Dana*



*Corp. v. IPC Ltd. Partnership*, 860 F.2d 415, 8 USPQ2d 1692 (Fed. Cir. 1988); *Spectra-Physics, Inc. v. Coherent, Inc.*, 821 F.2d 1524, 3 USPQ2d 1737 (Fed. Cir. 1987).

For completeness, see MPEP § 608.01(p) and § 2165 to § 2165.04.

## 608.01(i) Claims [R-2]

### 37 CFR 1.75. Claims

(a) The specification must conclude with a claim particularly pointing out and distinctly claiming the subject matter which the applicant regards as his invention or discovery.

(b) More than one claim may be presented provided they differ substantially from each other and are not unduly multiplied.

(c) One or more claims may be presented in dependent form, referring back to and further limiting another claim or claims in the same application. Any dependent claim which refers to more than one other claim ("multiple dependent claim") shall refer to such other claims in the alternative only. A multiple dependent claim shall not serve as a basis for any other multiple dependent claim. For fee calculation purposes under § 1.16, a multiple dependent claim will be considered to be that number of claims to which direct reference is made therein. For fee calculation purposes, also, any claim depending from a multiple dependent claim will be considered to be that number of claims to which direct reference is made in that multiple dependent claim. In addition to the other filing fees, any original application which is filed with, or is amended to include, multiple dependent claims must have paid therein the fee set forth in § 1.16(d). Claims in dependent form shall be construed to include all the limitations of the claim incorporated by reference into the dependent claim. A multiple dependent claim shall be construed to incorporate by reference all the limitations of each of the particular claims in relation to which it is being considered.

(d)(1) The claim or claims must conform to the invention as set forth in the remainder of the specification and the terms and phrases used in the claims must find clear support or antecedent basis in the description so that the meaning of the terms in the claims may be ascertainable by reference to the description (See § 1.58(a).)

(2) See §§ 1.141 to 1.146 as to claiming different inventions in one application.

(e) Where the nature of the case admits, as in the case of an improvement, any independent claim should contain in the following order, (1) a preamble comprising a general description of all the elements or steps of the claimed combination which are conventional or known, (2) a phrase such as "wherein the improvement comprises," and (3) those elements, steps and/or relationships which constitute that portion of the claimed combination which the applicant considers as the new or improved portion.

(f) If there are several claims, they shall be numbered consecutively in Arabic numerals.

(g) The least restrictive claim should be presented as claim number 1, and all dependent claims should be grouped together

with the claim or claims to which they refer to the extent practicable.

\*\*>

(h) The claim or claims must commence on a separate physical sheet or electronic page. Any sheet including a claim or portion of a claim may not contain any other parts of the application or other material.<

(i) Where a claim sets forth a plurality of elements or steps, each element or step of the claim should be separated by a line indentation.

For numbering of claims, see MPEP § 608.01(j).

For form of claims, see MPEP § 608.01(m).

For dependent claims, see MPEP § 608.01(n).

For examination of claims, see MPEP § 706.

For claims in excess of fee, see MPEP § 714.10.

## 608.01(j) Numbering of Claims

### 37 CFR 1.126. Numbering of claims.

The original numbering of the claims must be preserved throughout the prosecution. When claims are canceled the remaining claims must not be renumbered. When claims are added, they must be numbered by the applicant consecutively beginning with the number next following the highest numbered claim previously presented (whether entered or not). When the application is ready for allowance, the examiner, if necessary, will renumber the claims consecutively in the order in which they appear or in such order as may have been requested by applicant.

In a single claim case, the claim is not numbered.

Form paragraph 6.17 may be used to notify applicant.

### ¶ 6.17 Numbering of Claims, 37 CFR 1.126

The numbering of claims is not accordance with 37 CFR 1.126, which requires the original numbering of the claims to be preserved throughout the prosecution. When claims are canceled, the remaining claims must not be renumbered. When new claims are presented, they must be numbered consecutively beginning with the number next following the highest numbered claims previously presented (whether entered or not).

Misnumbered claim [1] been renumbered [2].

### Examiner Note:

1. In bracket 1, insert appropriate claim number(s) and --has-- or -- have --.
2. In bracket 2, insert correct claim number(s) and --, respectively -- if more than one claim is involved.

## 608.01(k) Statutory Requirement of Claims

35 U.S.C. 112 requires that the applicant shall particularly point out and distinctly claim the subject matter which he or she regards as his or her invention.

The portion of the application in which he or she does this forms the claim or claims. This is an important part of the application, as it is the definition of that for which protection is granted.

### 608.01(l) Original Claims

In establishing a disclosure, applicant may rely not only on the description and drawing as filed but also on the original claims if their content justifies it.

Where subject matter not shown in the drawing or described in the description is claimed in the application as filed, and such original claim itself constitutes a clear disclosure of this subject matter, then the claim should be treated on its merits, and requirement made to amend the drawing and description to show this subject matter. The claim should not be attacked either by objection or rejection because this subject matter is lacking in the drawing and description. It is the drawing and description that are defective, not the claim.

It is, of course, to be understood that this disclosure in the claim must be sufficiently specific and detailed to support the necessary amendment of the drawing and description.

### 608.01(m) Form of Claims [R-2]

The claim or claims must commence on a separate physical sheet or electronic page and should appear after the detailed description of the invention. Any sheet including a claim or portion of a claim may not contain any other parts of the application or other material. While there is no set statutory form for claims, the present Office practice is to insist that each claim must be the object of a sentence starting with "I (or we) claim," "The invention claimed is" (or the equivalent). If, at the time of allowance, the quoted terminology is not present, it is inserted by the Office of Patent Publication. Each claim begins with a capital letter and ends with a period. Periods may not be used elsewhere in the claims except for abbreviations. See *Fressola v. Manbeck*, 36 USPQ2d 1211 (D.D.C. 1995). Where a claim sets forth a plurality of elements or steps, each element or step of the claim should be separated by a line indentation, 37 CFR 1.75(i).

There may be plural indentations to further segregate subcombinations or related steps. In general, the printed patent copies will follow the format used but

printing difficulties or expense may prevent the duplication of unduly complex claim formats.

Reference characters corresponding to elements recited in the detailed description and the drawings may be used in conjunction with the recitation of the same element or group of elements in the claims. The reference characters, however, should be enclosed within parentheses so as to avoid confusion with other numbers or characters which may appear in the claims. The use of reference characters is to be considered as having no effect on the scope of the claims.

Many of the difficulties encountered in the prosecution of patent applications after final rejection may be alleviated if each applicant includes, at the time of filing or no later than the first reply, claims varying from the broadest to which he or she believes he or she is entitled to the most detailed that he or she is willing to accept.

Claims should preferably be arranged in order of scope so that the first claim presented is the least restrictive. All dependent claims should be grouped together with the claim or claims to which they refer to the extent practicable. Where separate species are claimed, the claims of like species should be grouped together where possible. Similarly, product and process claims should be separately grouped. Such arrangements are for the purpose of facilitating classification and examination.

The form of claim required in 37 CFR 1.75(e) is particularly adapted for the description of improvement-type inventions. It is to be considered a combination claim. The preamble of this form of claim is considered to positively and clearly include all the elements or steps recited therein as a part of the claimed combination.

For rejections not based on prior art, see MPEP § 706.03.

The following form paragraphs may be used to object to the form of the claims.

\*\*>

#### ¶ 6.18.01 Claims: Placement

The claims in this application do not commence on a separate sheet or electronic page in accordance with 37 CFR 1.52(b)(3). Appropriate correction is required in response to this action.

#### Examiner Note:

This paragraph should only be used for applications filed on or after September 23, 1996.

<

¶ 7.29.01 *Claims Objected to, Minor Informalities*

Claim[1] objected to because of the following informalities:  
[2]. Appropriate correction is required.

**Examiner Note:**

1. Use this form paragraph to point out minor informalities such as spelling errors, inconsistent terminology, etc., which should be corrected.
2. If the informalities render the claim(s) indefinite, use form paragraph 7.34.01 instead to reject the claim(s) under 35 U.S.C. 112, second paragraph.

¶ 7.29.02 *Claims Objected to, Reference Characters Not Enclosed Within Parentheses*

The claims are objected to because they include reference characters which are not enclosed within parentheses.

Reference characters corresponding to elements recited in the detailed description of the drawings and used in conjunction with the recitation of the same element or group of elements in the claims should be enclosed within parentheses so as to avoid confusion with other numbers or characters which may appear in the claims. See MPEP § 608.01(m).

**Examiner Note:**

1. Use of this paragraph is optional. You may instead choose to correct the error yourself at time of allowance by informal examiner's amendment.
2. If the lack of parentheses renders the claim(s) indefinite, use form paragraph 7.34.01 instead to reject the claim(s) under 35 U.S.C. 112, second paragraph.

¶ 7.29.03 *Claims Objected to, Spacing of Lines*

The claims are objected to because the lines are crowded too closely together, making reading and entry of amendments difficult. Substitute claims with lines one and one-half or double spaced on good quality paper are required. See 37 CFR 1.52(b).

Amendments to the claims must be in compliance with 37 CFR 1.121(c). Form paragraphs 6.33 and 6.34 may be used to inform applicant of nonentry of amendments to the claims.

\*\*>

¶ 6.33 *Amendment to the Claims, 37 CFR 1.121*

The amendment to the claims filed on [1] does not comply with the requirements of 37 CFR 1.121(c) because [2]. Amendments to the claims filed on or after July 30, 2003 must comply with 37 CFR 1.121(c) which states:

(c) *Claims.* Amendments to a claim must be made by rewriting the entire claim with all changes (e.g., additions and deletions) as indicated in this subsection, except when the claim is being canceled. Each amendment document that includes a change to an existing claim, cancellation of an existing claim or addition of a new claim, must include a complete listing of all claims ever presented, including the text of all pending and withdrawn claims, in the application. The claim listing, including the text of the claims, in the

amendment document will serve to replace all prior versions of the claims, in the application. In the claim listing, the status of every claim must be indicated after its claim number by using one of the following identifiers in a parenthetical expression: (Original), (Currently amended), (Canceled), (Withdrawn), (Previously presented), (New), and (Not entered)

(1) *Claim listing.* All of the claims presented in a claim listing shall be presented in ascending numerical order. Consecutive claims having the same status of “canceled” or “not entered” may be aggregated into one statement (e.g., Claims 1–5 (canceled)). The claim listing shall commence on a separate sheet of the amendment document and the sheet(s) that contain the text of any part of the claims shall not contain any other part of the amendment.

(2) *When claim text with markings is required.* All claims being currently amended in an amendment paper shall be presented in the claim listing, indicate a status of “currently amended,” and be submitted with markings to indicate the changes that have been made relative to the immediate prior version of the claims. The text of any added subject matter must be shown by underlining the added text. The text of any deleted matter must be shown by strike-through except that double brackets placed before and after the deleted characters may be used to show deletion of five or fewer consecutive characters. The text of any deleted subject matter must be shown by being placed within double brackets if strike-through cannot be easily perceived. Only claims having the status of “currently amended,” or “withdrawn” if also being amended, shall include markings. If a withdrawn claim is currently amended, its status in the claim listing may be identified as “withdrawn— currently amended.”

(3) *When claim text in clean version is required.* The text of all pending claims not being currently amended shall be presented in the claim listing in clean version, i.e., without any markings in the presentation of text. The presentation of a clean version of any claim having the status of “original,” “withdrawn” or “previously presented” will constitute an assertion that it has not been changed relative to the immediate prior version, except to omit markings that may have been present in the immediate prior version of the claims of the status of “withdrawn” or “previously presented.” Any claim added by amendment must be indicated with the status of “new” and presented in clean version, i.e., without any underlining.

(4) *When claim text shall not be presented; canceling a claim.*

(i) No claim text shall be presented for any claim in the claim listing with the status of “canceled” or “not entered.”

(ii) Cancellation of a claim shall be effected by an instruction to cancel a particular claim number. Identifying the status of a claim in the claim listing as “canceled” will constitute an instruction to cancel the claim.

(5) *Reinstatement of previously canceled claim.* A claim which was previously canceled may be reinstated

only by adding the claim as a “new” claim with a new claim number.

Since the reply filed on [3] appears to be *bona fide*, applicant is given a TIME PERIOD of **ONE (1) MONTH** or **THIRTY (30) DAYS** from the mailing date of this notice, whichever is longer, within which to submit an amendment in compliance with 37 CFR 1.121 in order to avoid abandonment. **EXTENSIONS OF THIS TIME PERIOD MAY BE GRANTED UNDER 37 CFR 1.136(a)**

**Examiner Note:**

1. In brackets 1 and 3, insert the filing date of the reply.
2. In bracket 2, insert the reason for non-compliance, *e.g.*, failure to provide a clean copy of an amended claim, failure to provide a marked up version of the amended claim.

<

**608.01(n) Dependent Claims [R-2]**

**I. MULTIPLE DEPENDENT CLAIMS**

37 CFR 1.75. Claim(s).

\*\*\*\*\*

(c) One or more claims may be presented in dependent form, referring back to and further limiting another claim or claims in the same application. Any dependent claim which refers to more than one other claim (“multiple dependent claim”) shall refer to such other claims in the alternative only. A multiple dependent claim shall not serve as a basis for any other multiple dependent claim. For fee calculation purposes under § 1.16, a multiple dependent claim will be considered to be that number of claims to which direct reference is made therein. For fee calculation purposes, also, any claim depending from a multiple dependent claim will be considered to be that number of claims to which direct reference is made in that multiple dependent claim. In addition to the other filing fees, any original application which is filed with, or is amended to include, multiple dependent claims must have paid therein the fee set forth in § 1.16(d). Claims in dependent form shall be construed to include all the limitations of the claim incorporated by reference into the dependent claim. A multiple dependent claim shall be construed to incorporate by reference all the limitations of each of the particular claims in relation to which it is being considered.

\*\*\*\*\*

Generally, a multiple dependent claim is a dependent claim which refers back in the alternative to more than one preceding independent or dependent claim.

The second paragraph of 35 U.S.C. 112 has been revised in view of the multiple dependent claim practice introduced by the Patent Cooperation Treaty. Thus 35 U.S.C. 112 authorizes multiple dependent claims in applications filed on and after January 24,

1978, as long as they are in the alternative form (*e.g.*, “A machine according to claims 3 or 4, further comprising ---”). Cumulative claiming (*e.g.*, “A machine according to claims 3 and 4, further comprising ---”) is not permitted. A multiple dependent claim may refer in the alternative to only one set of claims. A claim such as “A device as in claims 1, 2, 3, or 4, made by a process of claims 5, 6, 7, or 8” is improper. 35 U.S.C. 112 allows reference to only a particular claim. Furthermore, a multiple dependent claim may not serve as a basis for any other multiple dependent claim, either directly or indirectly. These limitations help to avoid undue confusion in determining how many prior claims are actually referred to in a multiple dependent claim.

A multiple dependent claim which depends from another multiple dependent claim should be objected to by using form paragraph 7.45.

*¶ 7.45 Improper Multiple Dependent Claims*

Claim [1] objected to under 37 CFR 1.75(c) as being in improper form because a multiple dependent claim [2]. See MPEP § 608.01(n). Accordingly, the claim [3] not been further treated on the merits.

**Examiner Note:**

1. In bracket 2, insert --should refer to other claims in the alternative only--, and/or, --cannot depend from any other multiple dependent claim--.
2. Use this paragraph rather than 35 U.S.C. 112, fifth paragraph.
3. In bracket 3, insert --has-- or --s have--.

Assume each claim example given below is from a different application.

**A. Acceptable Multiple Dependent Claim Word-  
ing**

Claim 5. A gadget according to claims 3 or 4, further comprising ---

Claim 5. A gadget as in any one of the preceding claims, in which ---

Claim 5. A gadget as in any one of claims 1, 2, and 3, in which ---

Claim 3. A gadget as in either claim 1 or claim 2, further comprising ---

Claim 4. A gadget as in claim 2 or 3, further comprising ---

Claim 16. A gadget as in claims 1, 7, 12, or 15, further comprising ---

Claim 5. A gadget as in any of the preceding claims, in which ---

Claim 8. A gadget as in one of claims 4-7, in which ---

Claim 5. A gadget as in any preceding claim, in which ---

Claim 10. A gadget as in any of claims 1-3 or 7-9, in which ---

Claim 11. A gadget as in any one of claims 1, 2, or 7-10 inclusive, in which ---

### ***B. Unacceptable Multiple Dependent Claim Wording***

#### **1. Claim Does Not Refer Back in the Alternative Only**

Claim 5. A gadget according to claim 3 and 4, further comprising ---

Claim 9. A gadget according to claims 1-3, in which ---

Claim 9. A gadget as in claims 1 or 2 and 7 or 8, which ---

Claim 6. A gadget as in the preceding claims in which ---

Claim 6. A gadget as in claims 1, 2, 3, 4 and/or 5, in which ---

Claim 10. A gadget as in claims 1-3 or 7-9, in which ---

#### **2. Claim Does Not Refer to a Preceding Claim**

Claim 3. A gadget as in any of the following claims, in which ---

Claim 5. A gadget as in either claim 6 or claim 8, in which ---

#### **3. Reference to Two Sets of Claims to Different Features**

Claim 9. A gadget as in claim 1 or 4 made by the process of claims 5, 6, 7, or 8, in which ---

#### **4. Reference Back to Another Multiple Dependent Claim**

Claim 8. A gadget as in claim 5 (claim 5 is a multiple dependent claim) or claim 7, in which ---

35 U.S.C. 112 indicates that the limitations or elements of each claim incorporated by reference into a multiple dependent claim must be considered sepa-

ately. Thus, a multiple dependent claim, as such, does not contain all the limitations of all the alternative claims to which it refers, but rather contains in any one embodiment only those limitations of the particular claim referred to for the embodiment under consideration. Hence, a multiple dependent claim must be considered in the same manner as a plurality of single dependent claims.

### ***C. Restriction Practice***

For restriction purposes, each embodiment of a multiple dependent claim is considered in the same manner as a single dependent claim. Therefore, restriction may be required between the embodiments of a multiple dependent claim. Also, some embodiments of a multiple dependent claim may be held withdrawn while other embodiments are considered on their merits.

### ***D. Handling of Multiple Dependent Claims by the Office of Initial Patent Examination***

The Office of Initial Patent Examination (OIPE) is responsible for verifying whether multiple dependent claims filed with the application are in proper alternative form, that they depend only upon prior independent or single dependent claims and also for calculating the amount of the filing fee. \*\*>Form< PTO-1360 >or PTO/SB/07< has been designed to be used in conjunction with the current fee calculation form PTO-875 >or PTO/SB/06<.

### ***E. Handling of Multiple Dependent Claims by the Technology Center Technical Support Staff***

The Technology Center (TC) technical support staff is responsible for verifying compliance with the statute and rules of multiple dependent claims added by amendment and for calculating the amount of any additional fees required. This calculation should be performed on form PTO-1360 >or PTO/SB/07<.

*There is no need for a TC technical support staff to check the accuracy of the initial filing fee since this has already been verified by the Office of Initial Patent Examination when granting the filing date.*

If a multiple dependent claim (or claims) is added in an amendment without the proper fee, either by adding references to prior claims or by adding a new multiple dependent claim, the amendment should not be entered until the fee has been received. In view of

the requirements for multiple dependent claims, no amendment containing new claims or changing the dependency of claims should be entered before checking whether the paid fees cover the costs of the amended claims. The applicant, or his or her attorney or agent, should be contacted to pay the additional fee. Where a letter is written in an insufficient fee situation, a copy of the multiple dependent claim fee calculation, form PTO-1360 >or PTO/SB/07< should be included for applicant's information.

Where the TC technical support staff notes that the reference to the prior claims is improper in an added or amended multiple dependent claim, a notation should be made in the left margin next to the claim itself and the number 1, which is inserted in the "Dep. Claim" column of that amendment on form PTO-1360 >or PTO/SB/07< should be circled in order to call this matter to the examiner's attention.

#### ***F. Handling of Multiple Dependent Claims by the Examiner***

Public Law 94-131, the implementing legislation for the Patent Cooperation Treaty amended 35 U.S.C. 112 to state that "a claim in dependent form shall contain a reference to a claim *previously set forth*." The requirement to refer to a previous claim had existed only in 37 CFR 1.75(c) before.

The following procedures are to be followed by examiners when faced with claims which refer to numerically succeeding claims:

If any series of dependent claims contains a claim with an improper reference to a numerically following claim which cannot be understood, the claim referring to a following claim should normally be objected to and not treated on the merits.

However, in situations where a claim refers to a numerically following claim and the dependency is clear, both as presented and as it will be renumbered at issue, all claims should be examined on the merits and no objection as to form need be made. In such cases, the examiner will renumber the claims into proper order at the time the application is allowed. (See Example B, below.)

Any unusual problems should be brought to the supervisor's attention.

#### **Example A**

(Claims 4 and 6 should be objected to as not being understood and should not be treated on the merits.)

1. Independent
2. Dependent on claim 5
3. Dependent on claim 2
4. ". . . as in any preceding claim"
5. Independent
6. Dependent on claim 4

#### **Example B**

Note: Parenthetical numerals represent the claim numbering for issue should all claims be allowed.

(All claims should be examined.)

1. (1) Independent
2. (5) Dependent on claim 5 (4)
3. (2) Dependent on claim 1 (1)
4. (3) Dependent on claim 3 (2)
5. (4) Dependent on either claim 1 (1) or claim 3 (2)

The following practice is followed by patent examiners when making reference to a dependent claim either singular or multiple:

(A) When identifying a singular dependent claim which does not include a reference to a multiple dependent claim, either directly or indirectly, reference should be made only to the number of the dependent claim.

(B) When identifying the embodiments included within a multiple dependent claim, or a singular dependent claim which includes a reference to a multiple dependent claim, either directly or indirectly, each embodiment should be identified by using the number of the claims involved, starting with the highest, *to the extent necessary* to specifically identify each embodiment.

(C) When all embodiments included within a multiple dependent claim or a singular dependent claim which includes a reference to a multiple dependent claim, either directly or indirectly, are subject to a common rejection, objection, or requirement, reference may be made only to the number of the dependent claim.

The following table illustrates the current practice where each embodiment of each claim must be treated on an individual basis:

Claim No.	Claim dependency	Identification All claims	Approved practice
1	Independent	1	1
2	Depends from 1	2/1	2
3	Depends from 2	3/2/1	3
4	Depends from 2 or 3	4/2/1 4/3/2/1	4/2 4/3
5	Depends from 3	5/3/2/1	5
6	Depends from 2, 3, or 5	6/2/1 6/3/2/1 6/5/3/2/1	6/2 6/3 6/5
7	Depends from 6	7/6/2/1 7/6/3/2/1 7/6/5/3/2/1	7/6/2 7/6/3 7/6/5

When all embodiments in a multiple dependent claim situation (claims 4, 6, and 7 above) are subject to a common rejection, objection, or requirements, reference may be made to the number of the individual dependent claim only. For example, if 4/2 and 4/3 were subject to a common ground of rejection, reference should be made only to claim 4 in the statement of that rejection.

The provisions of 35 U.S.C. 132 require that each Office action make it explicitly clear what rejection, objection and/or requirement is applied to each claim embodiment.

## **G Fees for Multiple Dependent Claims**

### **1. Use of Form PTO-1360 >or PTO/SB/07<**

To assist in the computation of the fees for multiple dependent claims, a separate "Multiple Dependent Claim Fee Calculation Sheet," form PTO-1360 >or PTO/SB/07< has been designed for use with the current "Patent Application Fee Determination Record," form PTO-875 >or PTO/SB/06<. Form PTO-1360 >or

PTO/SB/07< will be placed in the file wrapper by the Office of Initial Patent Examination (OIPE) where multiple dependent claims are in the application as filed. >For Image File Wrapper (IFW) processing, see IFW Manual.< If multiple dependent claims are not included upon filing, but are later added by amendment, the \*\*>TC< technical support staff will place the form in the file wrapper. If there are multiple dependent claims in the application, the total number of independent and dependent claims for fee purposes will be calculated on form PTO-1360 >or PTO/SB/07< and the total number of claims and number of independent claims is then placed on form PTO-875 >or PTO/SB/06< for final fee calculation purposes.

## **2. Calculation of Fees**

### **(a) Proper Multiple Dependent Claim**

35 U.S.C. 41(a), provides that claims in proper multiple dependent form may not be considered as single dependent claims for the purpose of calculating fees. Thus, a multiple dependent claim is considered to be that number of dependent claims to which it refers. Any proper claim depending directly or indirectly from a multiple dependent claim is also considered as the number of dependent claims as referred to in the multiple dependent claim from which it depends.

### **(b) Improper Multiple Dependent Claim**

If none of the multiple dependent claims is proper, the multiple dependent claim fee set forth in 37 CFR 1.16(d) will not be required. However, the multiple dependent claim fee is required if at least one multiple dependent claim is proper.

If any multiple dependent claim is improper, OIPE may indicate that fact by placing an encircled numeral "1" in the "Dep. Claims" column of form PTO-1360 >or PTO/SB/07<. The fee for any improper multiple dependent claim, whether it is defective for either not being in the alternative form or for being directly or indirectly dependent on a prior multiple dependent claim, will only be one, since only an objection to the form of such a claim will normally be made. This procedure also greatly simplifies the calculation of fees. Any claim depending from an improper multiple dependent claim will also be considered to be improper and be counted as one dependent claim.

**(c) Fee calculation example**

<i>Claim No.</i>	<i>Ind.</i>	<i>Dep.</i>
1. Independent	1	
2. Dependent on claim 1		1
3. Dependent on claim 2		1
4. Dependent on claim 2 or 3		2
5. Dependent on claim 4		2
6. Dependent on claim 5		2
7. Dependent on claim 4, 5 or 6		①
8. Dependent on claim 7		①
9. Independent	1	
10. Dependent on claim 1 or 9		2
11. Dependent on claims 1 and 9		①
<b>Total</b>	<b>2</b>	<b>13</b>

**i) Comments On Fee Calculation Example**

*Claim 1* — This is an independent claim; therefore, a numeral “1” is placed opposite claim number 1 in the “Ind.” column.

*Claim 2* — Since this is a claim dependent on a single independent claim, a numeral “1” is placed opposite claim number 2 of the “Dep.” column.

*Claim 3* — Claim 3 is also a single dependent claim, so a numeral “1” is placed in the “Dep.” column.

*Claim 4* — Claim 4 is a proper multiple dependent claim. It refers directly to two claims in the alternative, namely, claim 2 *or* 3. Therefore, a numeral “2” to indicate direct reference to two claims is placed in the “Dep.” column opposite claim number 4.

*Claim 5* — This claim is a singularly dependent claim depending from a multiple dependent claim. For fee calculation purposes, such a claim is counted as being that number of claims to which direct reference is made in the multiple dependent claim from which it depends. In this case, the multiple dependent claim number 4 it depends from counts as 2 claims; therefore, claim 5 also counts as 2 claims. Accordingly, a numeral “2” is placed opposite claim number 5 in the “Dep.” column.

*Claim 6* — Claim 6 depends indirectly from a multiple dependent claim 4. Since claim 4 counts as 2 claims, claim 6 also counts as 2 dependent claims. Consequently, a numeral “2” is placed in the “Dep.” column after claim 6.

*Claim 7* — This claim is a multiple dependent claim since it refers to claims 4, 5, or 6. However, as

can be seen by looking at the “2” in the “Dep.” column opposite claim 4, claim 7 depends from a multiple dependent claim. This practice is improper under 35 U.S.C.112 and 37 CFR 1.75(c). Following the procedure for calculating fees for improper multiple dependent claims, a numeral “1” is placed in the “Dep.” column with a circle drawn around it to alert the examiner that the claim is improper.

*Claim 8* — Claim 8 is improper since it depends from an improper claim. If the base claim is in error, this error cannot be corrected by adding additional claims depending therefrom. Therefore, a numeral “1” with a circle around it is placed in the “Dep.” column.

*Claim 9* — Here again we have an independent claim which is always indicated with a numeral “1” in the “Ind.” column opposite the claim number.

*Claim 10* — This claim refers to two independent claims in the alternative. A numeral “2” is, therefore, placed in the “Dep.” column opposite claim 10.

*Claim 11* — Claim 11 is a dependent claim which refers to two claims in the conjunctive (“1” *and* “9”) rather than in the alternative (“1” *or* “9”). This form is improper under 35 U.S.C. 112 and 37 CFR 1.75(c). Accordingly, since claim 11 is improper, an encircled number “1” is placed in the “Dep.” column opposite Claim 11.

**ii) Calculation of Fee in Fee Example**

After the number of “Ind.” and “Dep.” claims are noted on form PTO-1360 >or PTO/SB/07<, each column is added. In this example, there are 2 independent claims and 13 dependent claims or a total of 15 claims. The number of independent and total claims can then be placed on form PTO-875 >or PTO/SB/06< and the fee calculated.

**II. TREATMENT OF IMPROPER DEPENDENT CLAIMS**

The initial determination, for fee purposes, as to whether a claim is dependent must be made by persons other than examiners; it is necessary, at that time, to accept as dependent virtually every claim which refers to another claim, without determining whether there is actually a true dependent relationship. The initial acceptance of a claim as a dependent claim does not, however, preclude a subsequent holding by the examiner that a claim is not a proper dependent claim. Any claim which is in dependent form but



which is so worded that it, in fact is not, as, for example, it does not include every limitation of the claim on which it depends, will be required to be *canceled* as not being a proper dependent claim; and cancellation of any further claim depending on such a dependent claim will be similarly required. Where a claim in dependent form is not considered to be a proper dependent claim under 37 CFR 1.75(c), the examiner should object to such claim under 37 CFR 1.75(c) and require cancellation of such improper dependent claim or rewriting of such improper dependent claim in independent form. See *Ex parte Porter*, 25 USPQ2d 1144, 1147 (Bd. of Pat. App. & Inter. 1992) (A claim determined to be an improper dependent claim should be treated as a formal matter, in that the claim should be objected to and applicant should be required to cancel the claim (or replace the improper dependent claim with an independent claim) rather than treated by a rejection of the claim under 35 U.S.C. 112, fourth paragraph.). The applicant may thereupon amend the claims to place them in proper dependent form, or may redraft them as independent claims, upon payment of any *necessary* additional fee.

Note, that although 37 CFR 1.75(c) requires the dependent claim to further limit a preceding claim, this rule does not apply to product-by-process claims.

Claims which are in improper dependent form for failing to further limit the subject matter of a previous claim should be objected to under 37 CFR 1.75(c) by using form paragraph 7.36.

¶ 7.36 *Objection, 37 CFR 1.75(c), Improper Dependent Claim*

Claim [1] objected to under 37 CFR 1.75(c), as being of improper dependent form for failing to further limit the subject matter of a previous claim. Applicant is required to cancel the claim(s), or amend the claim(s) to place the claim(s) in proper dependent form, or rewrite the claim(s) in independent form. [2].

**Examiner Note:**

1. In bracket 2, insert an explanation of what is in the claim and why it does not constitute a further limitation.
2. Note *Ex parte Porter*, 25 USPQ2d 1144 (Bd. Pat. App. & Inter. 1992) for situations where a method claim is considered to be properly dependent upon a parent apparatus claim and should not be objected to or rejected under 35 U.S.C. 112, fourth paragraph. See also MPEP § 608.01(n), "Infringement Test" for dependent claims. The test for a proper dependent claim is whether the dependent claim includes every limitation of the parent claim. The test is not whether the claims differ in scope. A proper dependent claim shall not conceivably be infringed by anything which would not also infringe the basic claim.

### III. INFRINGEMENT TEST

The test as to whether a claim is a proper dependent claim is that it shall include every limitation of the claim from which it depends (35 U.S.C. 112, fourth paragraph) or in other words that it shall not conceivably be infringed by anything which would not also infringe the basic claim.

A dependent claim does not lack compliance with 35 U.S.C. 112, fourth paragraph, simply because there is a question as to (1) the significance of the further limitation added by the dependent claim, or (2) whether the further limitation in fact changes the scope of the dependent claim from that of the claim from which it depends. The test for a proper dependent claim under the fourth paragraph of 35 U.S.C. 112 is whether the dependent claim includes every limitation of the claim from which it depends. The test is not one of whether the claims differ in scope.

Thus, for example, if claim 1 recites the combination of elements A, B, C, and D, a claim reciting the structure of claim 1 in which D was omitted or replaced by E would not be a proper dependent claim, even though it placed further limitations on the remaining elements or added still other elements.

Examiners are reminded that a dependent claim is directed to a combination including everything recited in the base claim and what is recited in the dependent claim. It is this combination that must be compared with the prior art, exactly as if it were presented as one independent claim.

The fact that a dependent claim which is otherwise proper might relate to a separate invention which would require a separate search or be separately classified from the claim on which it depends would not render it an improper dependent claim, although it might result in a requirement for restriction.

The fact that the independent and dependent claims are in different statutory classes does not, in itself, render the latter improper. Thus, if claim 1 recites a specific product, a claim for the method of making the product of claim 1 in a particular manner would be a proper dependent claim since it could not be infringed without infringing claim 1. Similarly, if claim 1 recites a method of making a product, a claim for a product made by the method of claim 1 could be a proper dependent claim. On the other hand, if claim 1 recites a method of making a specified product, a claim to the product set forth in claim 1 would not be

a proper dependent claim \*\*>since it is conceivable that the product claim can be infringed without infringing the base method claim if the product can be made by a method other than that recited in the base method claim<.

#### IV. CLAIM FORM AND ARRANGEMENT

A singular dependent claim 2 could read as follows:

2.The product of claim 1 in which . . . .

A series of singular dependent claims is permissible in which a dependent claim refers to a preceding claim which, in turn, refers to another preceding claim.

A claim which depends from a *dependent* claim should not be separated therefrom by any claim which does not also depend from said “dependent claim.” It should be kept in mind that a dependent claim may refer back to any preceding independent claim. These are the only restrictions with respect to the sequence of claims and, in general, applicant’s sequence should not be changed. See MPEP § 608.01(j). Applicant may be so advised by using form paragraph 6.18.

##### ¶ 6.18 Series of Singular Dependent Claims

A series of singular dependent claims is permissible in which a dependent claim refers to a preceding claim which, in turn, refers to another preceding claim.

A claim which depends from a dependent claim should not be separated by any claim which does not also depend from said dependent claim. It should be kept in mind that a dependent claim may refer to any preceding independent claim. In general, applicant’s sequence will not be changed. See MPEP § 608.01(n).

During prosecution, the order of claims may change and be in conflict with the requirement that dependent claims refer to a preceding claim. Accordingly, the numbering of dependent claims and the numbers of preceding claims referred to in dependent claims should be carefully checked when claims are renumbered upon allowance.

#### V. REJECTION AND OBJECTION

If the base claim has been canceled, a claim which is directly or indirectly dependent thereon should be rejected as incomplete. If the base claim is rejected, the dependent claim should be objected to rather than rejected, if it is otherwise allowable.

Form paragraph 7.43 can be used to state the objection.

##### ¶ 7.43 Objection to Claims, Allowable Subject Matter

Claim [1] objected to as being dependent upon a rejected base claim, but would be allowable if rewritten in independent form including all of the limitations of the base claim and any intervening claims.

#### 608.01(o) Basis for Claim Terminology in Description [R-2]

The meaning of every term used in any of the claims should be apparent from the descriptive portion of the specification with clear disclosure as to its import; and in mechanical cases, it should be identified in the descriptive portion of the specification by reference to the drawing, designating the part or parts therein to which the term applies. A term used in the claims may be given a special meaning in the description. No term may be given a meaning repugnant to the usual meaning of the term.

Usually the terminology of the original claims follows the nomenclature of the specification, but sometimes in amending the claims or in adding new claims, new terms are introduced that do not appear in the specification. The use of a confusing variety of terms for the same thing should not be permitted.

New claims and amendments to the claims already in the application should be scrutinized not only for new matter but also for new terminology. While an applicant is not limited to the nomenclature used in the application as filed, he or she should make appropriate amendment of the specification whenever this nomenclature is departed from by amendment of the claims so as to have clear support or antecedent basis in the specification for the new terms appearing in the claims. This is necessary in order to insure certainty in construing the claims in the light of the specification, *Ex parte Kotler*, 1901 C.D. 62, 95 O.G. 2684 (Comm’r Pat. 1901). See 37 CFR 1.75, MPEP § 608.01(i) and § 1302.01. >Note that examiners should ensure that the terms and phrases used in claims presented late in prosecution of the application (including claims amended via an examiner’s amendment) find clear support or antecedent basis in the description so that the meaning of the terms in the claims may be ascertainable by reference to the description, see 37 CFR 1.75(d)(1). If the examiner determines that the claims presented late in prosecution do not

comply with 37 CFR 1.75(d)(1), applicant will be required to make appropriate amendment to the description to provide clear support or antecedent basis for the terms appearing in the claims provided no new matter is introduced.<

The specification should be objected to if it does not provide proper antecedent basis for the claims by using form paragraph 7.44.

#### ¶ 7.44 Claimed Subject Matter Not in Specification

The specification is objected to as failing to provide proper antecedent basis for the claimed subject matter. See 37 CFR 1.75(d)(1) and MPEP § 608.01(o). Correction of the following is required: [1]

### 608.01(p) Completeness [R-2]

Newly filed applications obviously failing to disclose an invention with the clarity required are discussed in MPEP § 702.01.

A disclosure in an application, to be complete, must contain such description and details as to enable any person skilled in the art or science to which the invention pertains to make and use the invention as of its filing date. *In re Glass*, 492 F.2d 1228, 181 USPQ 31 (CCPA 1974).

While the prior art setting may be mentioned in general terms, the essential novelty, the essence of the invention, must be described in such details, including proportions and techniques, where necessary, as to enable those persons skilled in the art to make and utilize the invention.

Specific operative embodiments or examples of the invention must be set forth. Examples and description should be of sufficient scope as to justify the scope of the claims. *Markush* claims must be provided with support in the disclosure for each member of the *Markush* group. Where the constitution and formula of a chemical compound is stated only as a probability or speculation, the disclosure is not sufficient to support claims identifying the compound by such composition or formula.

A complete disclosure should include a statement of utility. This usually presents no problem in mechanical cases. In chemical cases, varying degrees of specificity are required.

A disclosure involving a new chemical compound or composition must teach persons skilled in the art how to make the compound or composition. Incom-

plete teachings may not be completed by reference to subsequently filed applications.

For “Guidelines For Examination Of Applications For Compliance With The Utility Requirement of 35 U.S.C. 101,” see MPEP § 2107.

For “General Principles Governing Utility Rejections,” see MPEP § 2107.01.

For a discussion of the utility requirement under 35 U.S.C. 112, first paragraph, in drug cases, see MPEP § 2107.03 and § 2164.06(a).

For “Procedural Considerations Related to Rejections for Lack of Utility,” see MPEP § 2107.02.

For “Special Considerations for Asserted Therapeutic or Pharmacological Utilities,” see MPEP § 2107.03.

## I. INCORPORATION BY REFERENCE

The \*>Director< has considerable discretion in determining what may or may not be incorporated by reference in a patent application. *General Electric Co. v. Brenner*, 407 F.2d 1258, 159 USPQ 335 (D.C. Cir. 1968). The incorporation by reference practice with respect to applications which issue as U.S. patents provides the public with a patent disclosure which minimizes the public’s burden to search for and obtain copies of documents incorporated by reference which may not be readily available. Through the Office’s incorporation by reference policy, the Office ensures that reasonably complete disclosures are published as U.S. patents. The following is the manner in which the \*>Director< has elected to exercise that discretion. Section A provides the guidance for incorporation by reference in applications which are to issue as U.S. patents. Section B provides guidance for incorporation by reference in benefit applications; i.e., those domestic (35 U.S.C. 120) or foreign (35 U.S.C. 119(a)) applications relied on to establish an earlier effective filing date. >See MPEP § 2181 for the impact of incorporation by reference on the determination of whether applicant has complied with the requirements of 35 U.S.C. 112, second paragraph when 35 U.S.C. 112, sixth paragraph is invoked.<

### A. Review of Applications Which Are To Issue as Patents.

An application as filed must be complete in itself in order to comply with 35 U.S.C. 112. Material nevertheless may be incorporated by reference, *Ex parte*

\*>Schwarze<, 151 USPQ 426 (Bd. Ape. 1966). An application for a patent when filed may incorporate “essential material” by reference to (1) a U.S. patent, (2) a U.S. patent application publication, or (3) a pending U.S. application, subject to the conditions set forth below.

“Essential material” is defined as that which is necessary to (1) describe the claimed invention, (2) provide an enabling disclosure of the claimed invention, or (3) describe the best mode (35 U.S.C. 112). In any application which is to issue as a U.S. patent, essential material may not be incorporated by reference to (1) patents or applications published by foreign countries or a regional patent office, (2) non-patent publications, (3) a U.S. patent or application which itself incorporates “essential material” by reference, or (4) a foreign application.

Nonessential subject matter may be incorporated by reference to (1) patents or applications published by the United States or foreign countries or regional patent offices, (2) prior filed, commonly owned U.S. applications, or (3) non-patent publications however, aperiens and/or other forms of browser executable code cannot be incorporated by reference. See MPEP § 608.01. Nonessential subject matter is subject matter referred to for purposes of indicating the background of the invention or illustrating the state of the art.

Mere reference to another application, patent, or publication is not an incorporation of anything therein into the application containing such reference for the purpose of the disclosure required by 35 U.S.C. 112, first paragraph. *In re de Seversky*, 474 F.2d 671, 177 USPQ 144 (CCPA 1973). In addition to other requirements for an application, the referencing application should include an identification of the referenced patent, application, or publication. Particular attention should be directed to specific portions of the referenced document where the subject matter being incorporated may be found. Guidelines for situations where applicant is permitted to fill in a number for Application No. \_\_\_\_\_ left blank in the application as filed can be found in *In re Fouche*, 439 F.2d 1237, 169 USPQ 429 (CCPA 1971) (Abandoned applications less than 20 years old can be incorporated by reference to the same extent as copending applications; both types are open to the public upon the referencing application issuing as a patent. See MPEP § 103).

## 1. Complete Disclosure Filed

If an application is filed with a complete disclosure, essential material may be canceled by amendment and may be substituted by reference to a U.S. patent or an earlier filed pending U.S. application. The amendment must be accompanied by an affidavit or declaration signed by the applicant, or a practitioner representing the applicant, stating that the material canceled from the application is the same material that has been incorporated by reference.

If an application as filed incorporates essential material by reference to a U.S. patent or a pending and commonly owned U.S. application, applicant may be required prior to examination to furnish the Office with a copy of the referenced material together with an affidavit or declaration executed by the applicant, or a practitioner representing the applicant, stating that the copy consists of the same material incorporated by reference in the referencing application. However, if a copy of a printed U.S. patent is furnished, no affidavit or declaration is required.

Prior to allowance of an application that incorporates essential material by reference to a pending U.S. application, the examiner shall determine if the referenced application has been published or issued as a patent. If the referenced application has been published or issued as a patent, the examiner shall enter the U.S. Patent Application Publication No. or the U.S. Patent No. of the referenced application in the specification of the referencing application (see MPEP § 1302.04). If the referenced application has not been published or issued as a patent, applicant will be required to amend the disclosure of the referencing application to include the material incorporated by reference. The amendment must be accompanied by an affidavit or declaration executed by the applicant, or a practitioner representing the applicant, stating the amendatory material consists of the same material incorporated by reference in the referencing application.

## 2. Improper Incorporation

The filing date of any application wherein essential material is improperly incorporated by reference to a foreign application or patent or to a publication will not be affected because of the reference. In such a case, the applicant will be required to amend the spec-

ification to include the material incorporated by reference. The following form paragraphs may be used.

¶ 6.19 *Incorporation by Reference, Foreign Patent or Application*

The incorporation of essential material in the specification by reference to a foreign application or patent, or to a publication is improper. Applicant is required to amend the disclosure to include the material incorporated by reference. The amendment must be accompanied by an affidavit or declaration executed by the applicant, or a practitioner representing the applicant, stating that the amendatory material consists of the same material incorporated by reference in the referencing application. *In re Hawkins*, 486 F.2d 569, 179 USPQ 157 (CCPA 1973); *In re Hawkins*, 486 F.2d 579, 179 USPQ 163 (CCPA 1973); *In re Hawkins*, 486 F.2d 577, 179 USPQ 167 (CCPA 1973).

¶ 6.19.01 *Improper Incorporation by Reference, General*

The attempt to incorporate subject matter into this application by reference to [1] is improper because [2].

**Examiner Note:**

1. In bracket 1, identify the document such as an application or patent number or other identification.
2. In bracket 2, give reason why it is improper.

The amendment must be accompanied by an affidavit or declaration executed by the applicant, or a practitioner representing the applicant, stating that the amendatory material consists of the same material incorporated by reference in the referencing application. *In re Hawkins*, 486 F.2d 569, 179 USPQ 157 (CCPA 1973); *In re Hawkins*, 486 F.2d 579, 179 USPQ 163 (CCPA 1973); *In re Hawkins*, 486 F.2d 577, 179 USPQ 167 (CCPA 1973).

Reliance on a commonly assigned copending application by a different inventor may ordinarily be made for the purpose of completing the disclosure. See *In re Fried*, 329 F.2d 323, 141 USPQ 27 (CCPA 1964), and *General Electric Co. v. Brenner*, 407 F.2d 1258, 159 USPQ 335 (D.C. Cir. 1968).

Since a disclosure must be complete as of the filing date, subsequent publications or subsequently filed applications cannot be relied on to establish a constructive reduction to practice or an enabling disclosure as of the filing date. *White Consol. Indus., Inc. v. Vega Servo-Control, Inc.*, 713 F.2d 788, 218 USPQ 961 (Fed. Cir. 1983); *In re Scarbrough*, 500 F.2d 560, 182 USPQ 298 (CCPA 1974); *In re Glass*, 492 F.2d 1228, 181 USPQ 31 (CCPA 1974).

**B. *Review of Applications Which Are Relied on To Establish an Earlier Effective Filing Date.***

The limitations on the material which may be incorporated by reference in U.S. patent applications which are to issue as U.S. patents do not apply to applications relied on only to establish an earlier effective filing date under 35 U.S.C. 119 or 35 U.S.C. 120. Neither 35 U.S.C. 119(a) nor 35 U.S.C. 120 places any restrictions or limitations as to how the claimed invention must be disclosed in the earlier application to comply with 35 U.S.C. 112, first paragraph. Accordingly, an application is entitled to rely upon the filing date of an earlier application, even if the earlier application itself incorporates essential material by reference to another document. See *Ex parte Maziere*, 27 USPQ2d 1705, 1706-07 (Bd. Pat. App. & Inter. 1993).

The reason for incorporation by reference practice with respect to applications which are to issue as U.S. patents is to provide the public with a patent disclosure which minimizes the public's burden to search for and obtain copies of documents incorporated by reference which may not be readily available. Through the Office's incorporation by reference policy, the Office ensures that reasonably complete disclosures are published as U.S. patents. The same policy concern does not apply where the sole purpose for which an applicant relies on an earlier U.S. or foreign application is to establish an earlier filing date. Incorporation by reference in the earlier application of (1) patents or applications published by foreign countries or regional patent offices, (2) nonpatent publications, (3) a U.S. patent or application which itself incorporates "essential material" by reference, or (4) a foreign application, is not critical in the case of a "benefit" application.

When an applicant, or a patent owner in a reexamination or interference, claims the benefit of the filing date of an earlier application which incorporates material by reference, the applicant or patent owner may be required to supply copies of the material incorporated by reference. For example, an applicant may claim the benefit of the filing date of a foreign application which itself incorporates by reference another earlier filed foreign application. If necessary, due to an intervening reference, applicant should be required to supply a copy of the earlier filed foreign application, along with an English language transla-

tion. A review can then be made of the foreign application and all material incorporated by reference to determine whether the foreign application discloses the invention sought to be patented in the manner required by the first paragraph of 35 U.S.C. 112 so that benefit may be accorded. *In re Gosteli*, 872 F.2d 1008, 10 USPQ2d 1614 (Fed. Cir. 1989).

>As a safeguard against the omission of a portion of a prior application for which priority is claimed under 35 U.S.C. 119(a)-(d) or (f), or for which benefit is claimed under 35 U.S.C. 119(e) or 120, applicant may include a statement at the time of filing of the later application incorporating by reference the prior application. See MPEP § 201.06(c) where domestic benefit is claimed. See MPEP § 201.13 where foreign priority is claimed. The inclusion of such an incorporation by reference statement in the later-filed application will permit applicant to include subject matter from the prior application into the later-filed application without the subject matter being considered as new matter. For the incorporation by reference to be effective as a proper safeguard, the incorporation by reference statement must be filed at the time of filing of the later-filed application. An incorporation by reference statement added after an application's filing date is not effective because no new matter can be added to an application after its filing date (see 35 U.S.C. 132(a)).<

## II. SIMULATED OR PREDICTED TEST RESULTS OR PROPHETIC EXAMPLES

Simulated or predicted test results and prophetic examples (paper examples) are permitted in patent applications. Working examples correspond to work actually performed and may describe tests which have actually been conducted and results that were achieved. Paper examples describe the manner and process of making an embodiment of the invention which has not actually been conducted. Paper examples should not be represented as work actually done. No results should be represented as actual results unless they have actually been achieved. Paper examples should not be described using the past tense. >*Hoffman-La Roche, Inc. v. Promega Corp.*, 323 F.3d 1354, 1367, 66 USPQ2d 1385, 1394 (Fed. Cir. 2003).<

For problems arising from the designation of materials by trademarks and trade names, see MPEP § 608.01(v).

### 608.01(q) Substitute or Rewritten Specification [R-2]

*37 CFR 1.125. Substitute specification.*

(a) If the number or nature of the amendments or the legibility of the application papers renders it difficult to consider the application, or to arrange the papers for printing or copying, the Office may require the entire specification, including the claims, or any part thereof, be rewritten.

\*\*>

(b) Subject to § 1.312, a substitute specification, excluding the claims, may be filed at any point up to payment of the issue fee if it is accompanied by a statement that the substitute specification includes no new matter.

(c) A substitute specification submitted under this section must be submitted with markings showing all the changes relative to the immediate prior version of the specification of record. The text of any added subject matter must be shown by underlining the added text. The text of any deleted matter must be shown by strike-through except that double brackets placed before and after the deleted characters may be used to show deletion of five or fewer consecutive characters. The text of any deleted subject matter must be shown by being placed within double brackets if strike-through cannot be easily perceived. An accompanying clean version (without markings) must also be supplied. Numbering the paragraphs of the specification of record is not considered a change that must be shown pursuant to this paragraph.<

(d) A substitute specification under this section is not permitted in a reissue application or in a reexamination proceeding.

The specification is sometimes in such faulty English that a new specification is necessary; in such instances, a new specification should be required.

Form paragraph 6.28 may be used where the specification is in faulty English.

#### ¶ 6.28 Idiomatic English

A substitute specification in proper idiomatic English and in compliance with 37 CFR 1.52(a) and (b) is required. The substitute specification filed must be accompanied by a statement that it contains no new matter.

37 CFR 1.125(a) applies to a substitute specification required by the Office. If the number or nature of the amendments or the legibility of the application papers renders it difficult to consider the application, or to arrange the papers for printing or copying, the Office may require the entire specification, including the claims, or any part thereof be rewritten.

Form paragraph 6.28.01 may be used where the examiner, for reasons other than faulty English, requires a substitute specification.

\*\*>

*¶ 6.28.01 Substitute Specification Required by Examiner*

A substitute specification [1] the claims is required pursuant to 37 CFR 1.125(a) because [2].

A substitute specification filed under 37 CFR 1.125(a) must only contain subject matter from the original specification and any previously entered amendment under 37 CFR 1.121. If the substitute specification contains additional subject matter not of record, the substitute specification must be filed under 37 CFR 1.125(b) and (c).

**Examiner Note:**

1. In bracket 1, insert either -- excluding-- or -- including--.
2. In bracket 2, insert clear and concise examples of why a new specification is required.
3. A new specification is required if the number or nature of the amendments render it difficult to consider the application or to arrange the papers for printing or copying, 37 CFR 1.125.
4. See also form paragraph 13.01 for partial rewritten specification.

<

37 CFR 1.125(b) applies to a substitute specification voluntarily filed by the applicant. \*>Subject to the provisions of 37 CFR 1.312, a< substitute specification, excluding claims, may be voluntarily filed by the applicant at any point up to the payment of the issue fee provided it is accompanied by \* a statement that the substitute specification includes no new matter\*\*. The Office will accept a substitute specification voluntarily filed by the applicant if the requirements of 37 CFR 1.125(b) are satisfied.

37 CFR 1.125(c) requires a substitute specification filed under 37 CFR 1.125(a) or (b) be submitted in clean form without markings \*\*>. A marked-up copy of the substitute specification showing all the changes relative to the immediate prior version of the specification of record must also be submitted. The text of any added subject matter must be shown by underlining the added text. The text of any deleted matter must be shown by strike-through except that double brackets placed before and after the deleted characters may be used to show deletion of five or fewer consecutive characters. The text of any deleted subject matter must be shown by being placed within double brackets if strike-through cannot be easily perceived. Numbering the paragraphs of the specification of record is not considered a change that must be shown under 37

CFR 1.125(c)< The paragraphs of any substitute specification, other than the claims, should be individually numbered in Arabic numerals >(for example [0001])< so that any amendment to the specification may be made by replacement paragraph in accordance with 37 CFR 1.121(b)(1).

A substitute specification filed under 37 CFR 1.125(b) must be accompanied by a statement indicating that no new matter was included. There is no obligation on the examiner to make a detailed comparison between the old and the new specifications for determining whether or not new matter has been added. If, however, an examiner becomes aware that new matter is present, objection thereto should be made.

The filing of a substitute specification rather than amending the original application has the advantage for applicants of eliminating the need to prepare an amendment of the specification. If word processing equipment is used by applicants, substitute specifications can be easily prepared. The Office receives the advantage of saving the time needed to enter amendments in the specification and a reduction in the number of printing errors. A substitute specification is not permitted in a reissue application or in a reexamination proceeding. 37 CFR 1.125(d).

A substitute specification which complies with 37 CFR 1.125 should normally be entered. The examiner should write "Enter" or "OK to Enter" and his or her initials in ink in the left margin of the first page of the substitute specification. A substitute specification which is denied entry should be so marked.

Form paragraph 6.28.02 may be used to notify applicant that a substitute specification submitted under 37 CFR 1.125(b) has not been entered. >For Image File Wrapper (IFW) processing, see IFW Manual.<

\*\*>

*¶ 6.28.02 Substitute Specification Filed Under 37 CFR 1.125(b) and (c) Not Entered.*

The substitute specification filed [1] has not been entered because it does not conform to 37 CFR 1.125(b) and (c) because: [2]

**Examiner Note:**

1. In bracket 2, insert statement of why the substitute specification is improper, for example:
  - the statement as to a lack of new matter under 37 CFR 1.125(b) is missing--,
  - a marked-up copy of the substitute specification has not been supplied (in addition to the clean copy)--;

- a clean copy of the substitute specification has not been supplied (in addition to the marked-up copy)--; or,
- the substitute specification has been filed:
  - in a reissue application or in a reexamination proceeding, 37 CFR 1.125(d)-, or
  - after payment of the issue fee-, or
  - containing claims (to be amended)- --.

2. A substitute specification filed after final action or appeal is governed by 37 CFR 1.116. A substitute specification filed after the mailing of a notice of allowance is governed by 37 CFR 1.312.

<

See MPEP § 714.20 regarding entry of amendments which include an unacceptable substitute specification.

For new matter in amendment, see MPEP § 608.04.

For application prepared for issue, see MPEP § 1302.02.

### 608.01(r) Derogatory Remarks About Prior Art in Specification

The applicant may refer to the general state of the art and the advance thereover made by his or her invention, but he or she is not permitted to make derogatory remarks concerning the inventions of others. Derogatory remarks are statements disparaging the products or processes of any particular person other than the applicant, or statements as to the merits or validity of applications or patents of another person. Mere comparisons with the prior art are not considered to be disparaging, *per se*.

### 608.01(s) Restoration of Canceled Matter [R-2]

Canceled text in the specification can be reinstated only by a subsequent amendment presenting the previously canceled matter as a new insertion. 37 CFR 1.121(b)(4). A claim canceled by amendment (deleted in its entirety) may be reinstated only by a subsequent amendment presenting the claim as a new claim with a new claim number. 37 CFR 1.121(c)(\*>5<). See MPEP § 714.24.

### 608.01(t) Use in Subsequent Application

A reservation for a future application of subject matter disclosed but not claimed in a pending application will not be permitted in the pending application. 37 CFR 1.79; MPEP § 608.01(e).

No part of a specification can normally be transferred to another application. Drawings may be transferred to another application only upon the granting of a petition filed under the provisions of 37 CFR 1.182. See MPEP § 608.02(i).

### 608.01(u) Use of Formerly Filed Incomplete Application

Parts of an incomplete application which have been retained by the Office may be used as part of a complete application if the missing parts are later supplied. See MPEP § 506 and § 506.01.

### 608.01(v) Trademarks and Names Used in Trade [R-2]

The expressions “trademarks” and “names used in trade” as used below have the following meanings:

*Trademark:* a word, letter, symbol, or device adopted by one manufacturer or merchant and used to identify and distinguish his or her product from those of others. It is a proprietary word, letter, symbol, or device pointing distinctly to the product of one producer.

*Names Used in Trade:* a nonproprietary name by which an article or product is known and called among traders or workers in the art, although it may not be so known by the public, generally. Names used in trade do not point to the product of one producer, but they identify a single article or product irrespective of producer.

Names used in trade are permissible in patent applications if:

(A) Their meanings are established by an accompanying definition which is sufficiently precise and definite to be made a part of a claim, or

(B) In this country, their meanings are well-known and satisfactorily defined in the literature.

Condition (A) or (B) must be met at the time of filing of the complete application.

>

## I. < TRADEMARKS

The relationship between a trademark and the product it identifies is sometimes indefinite, uncertain, and arbitrary. The formula or characteristics of the product may change from time to time and yet it may continue



to be sold under the same trademark. In patent specifications, every element or ingredient of the product should be set forth in positive, exact, intelligible language, so that there will be no uncertainty as to what is meant. Arbitrary trademarks which are liable to mean different things at the pleasure of manufacturers do not constitute such language. *Ex Parte Kattwinkle*, 12 USPQ 11 (Bd. App. 1931).

However, if the product to which the trademark refers is set forth in such language that its identity is clear, the examiners are authorized to permit the use of the trademark if it is distinguished from common descriptive nouns by capitalization. If the trademark has a fixed and definite meaning, it constitutes sufficient identification unless some physical or chemical characteristic of the article or material is involved in the invention. In that event, as also in those cases where the trademark has no fixed and definite meaning, identification by scientific or other explanatory language is necessary. *In re Gebauer-Fuelnegg*, 121 F.2d 505, 50 USPQ 125 (CCPA 1941).

The matter of sufficiency of disclosure must be decided on an individual case-by-case basis. *In re Metcalfe*, 410 F.2d 1378, 161 USPQ 789 (CCPA 1969).

Where the identification of a trademark is introduced by amendment, it must be restricted to the characteristics of the product known at the time the application was filed to avoid any question of new matter.

If proper identification of the product sold under a trademark, or a product referred to only by a name used in trade, is omitted from the specification and such identification is deemed necessary under the principles set forth above, the examiner should hold the disclosure insufficient and reject on the ground of insufficient disclosure any claims based on the identification of the product merely by trademark or by the name used in trade. If the product cannot be otherwise defined, an amendment defining the process of its manufacture may be permitted. Such amendments must be supported by satisfactory showings establishing that the specific nature or process of manufacture of the product as set forth in the amendment was known at the time of filing of the application.

Although the use of trademarks having definite meanings is permissible in patent applications, the

proprietary nature of the marks should be respected. Trademarks should be identified by capitalizing each letter of the mark (in the case of word or letter marks) or otherwise indicating the description of the mark (in the case of marks in the form of a symbol or device or other nontextual form). Every effort should be made to prevent their use in any manner which might adversely affect their validity as trademarks.

Form paragraph 6.20 may be used.

#### ¶ 6.20 Trademarks and Their Use

The use of the trademark [1] has been noted in this application. It should be capitalized wherever it appears and be accompanied by the generic terminology.

Although the use of trademarks is permissible in patent applications, the proprietary nature of the marks should be respected and every effort made to prevent their use in any manner which might adversely affect their validity as trademarks.

#### Examiner Note:

Capitalize each letter of the word in the bracket or include a proper trademark symbol, such as <sup>TM</sup> or ® following the word.

The examiner should not permit the use of language such as “the product X (a descriptive name) commonly known as Y (trademark)” since such language does not bring out the fact that the latter is a trademark. Language such as “the product X (a descriptive name) sold under the trademark Y” is permissible.

The use of a trademark in the title of an application should be avoided as well as the use of a trademark coupled with the word “type”, e.g., “Band-Aid type bandage.”

In the event that the proprietary trademark is a “symbol or device” depicted in a drawing, either the brief description of the drawing or the detailed description of the drawing should specify that the “symbol or device” is a registered trademark of Company X.

The owner of a trademark may be identified in the specification.

Technology Center Directors should reply to all trademark misuse complaint letters and forward a copy to the editor of this manual. >Where a letter demonstrates a trademark misuse in a patent application publication, the Office should, where the application is still pending, ensure that the trademark is replaced by appropriate generic terminology.<

See Appendix I for a partial listing of trademarks and the particular goods to which they apply.

&gt;

## II. < INCLUSION OF COPYRIGHT OR MASK WORK NOTICE IN PATENTS

*37 CFR 1.71. Detailed description and specification of the invention*

\*\*\*\*\*

(d) A copyright or mask work notice may be placed in a design or utility patent application adjacent to copyright and mask work material contained therein. The notice may appear at any appropriate portion of the patent application disclosure. For notices in drawings, see § 1.84(s). The content of the notice must be limited to only those elements provided for by law. For example, “©1983 John Doe” (17 U.S.C. 401) and “\*M\* John Doe” (17 U.S.C. 909) would be properly limited and, under current statutes, legally sufficient notices of copyright and mask work, respectively. Inclusion of a copyright or mask work notice will be permitted only if the authorization language set forth in paragraph (e) of this section is included at the beginning (preferably as the first paragraph) of the specification.

(e) The authorization shall read as follows:

A portion of the disclosure of this patent document contains material which is subject to (copyright or mask work) protection. The (copyright or mask work) owner has no objection to the facsimile reproduction by anyone of the patent document or the patent disclosure, as it appears in the Patent and Trademark Office patent file or records, but otherwise reserves all (copyright or mask work) rights whatsoever.

*37 CFR 1.84. Standards for drawings*

\*\*\*\*\*

(s) *Copyright or Mask Work Notice.* A copyright or mask work notice may appear in the drawing, but must be placed within the sight of the drawing immediately below the figure representing the copyright or mask work material and be limited to letters having a print size of .32 cm. to .64 cm. (1/8 to 1/4 inches) high. The content of the notice must be limited to only those elements provided for by law. For example, “©1983 John Doe” (17 U.S.C. 401) and “\*M\* John Doe” (17 U.S.C. 909) would be properly limited and, under current statutes, legally sufficient notices of copyright and mask work, respectively. Inclusion of a copyright or mask work notice will be permitted only if the authorization language set forth in § 1.71(e) is included at the beginning (preferably as the first paragraph) of the specification.

\*\*\*\*\*

The U.S. Patent and Trademark Office will permit the inclusion of a copyright or mask work notice in a design or utility patent application, and thereby any patent issuing therefrom, which discloses material on which copyright or mask work protection has previ-

ously been established, under the following conditions:

(A) The copyright or mask work notice must be placed adjacent to the copyright or mask work material. Therefore, the notice may appear at any appropriate portion of the patent application disclosure, including the drawing. However, if appearing in the drawing, the notice must comply with 37 CFR 1.84(s). If placed on a drawing in conformance with these provisions, the notice will not be objected to as extraneous matter under 37 CFR 1.84.

(B) The content of the notice must be limited to only those elements required by law. For example, “©1983 John Doe”(17 U.S.C. 401) and “\*M\* John Doe” (17 U.S.C. 909) would be properly limited, and under current statutes, legally sufficient notices of copyright and mask work respectively.

(C) Inclusion of a copyright or mask work notice will be permitted only if the following authorization in 37 CFR 1.71(e) is included at the beginning (preferably as the first paragraph) of the specification to be printed for the patent:

A portion of the disclosure of this patent document contains material which is subject to (copyright or mask work) protection. The (copyright or mask work) owner has no objection to the facsimile reproduction by anyone of the patent disclosure, as it appears in the Patent and Trademark Office patent files or records, but otherwise reserves all (copyright or mask work) rights whatsoever.

(D) Inclusion of a copyright or mask work notice after a Notice of Allowance has been mailed will be permitted only if the criteria of 37 CFR 1.312 have been satisfied.

The inclusion of a copyright or mask work notice in a design or utility patent application, and thereby any patent issuing therefrom, under the conditions set forth above will serve to protect the rights of the author/inventor, as well as the public, and will serve to promote the mission and goals of the U.S. Patent and Trademark Office. Therefore, the inclusion of a copyright or mask work notice which complies with these conditions will be permitted. However, any departure from these conditions may result in a refusal to permit the desired inclusion. If the authorization required under condition (C) above does not include the specific language “(t)he (copyright or mask work) owner has no objection to the facsimile

reproduction by anyone of the patent document or the patent disclosure, as it appears in the Patent and Trademark Office patent files or records,..." the notice will be objected to as improper by the examiner of the application. If the examiner maintains the objection upon reconsideration, a petition may be filed in accordance with 37 CFR 1.181.

## 608.02 Drawing [R-2]

### 35 U.S.C. 113. Drawings.

The applicant shall furnish a drawing where necessary for the understanding of the subject matter to be patented. When the nature of such subject matter admits of illustration by a drawing and the applicant has not furnished such a drawing, the Commissioner may require its submission within a time period of not less than two months from the sending of a notice thereof. Drawings submitted after the filing date of the application may not be used (i) to overcome any insufficiency of the specification due to lack of an enabling disclosure or otherwise inadequate disclosure therein, or (ii) to supplement the original disclosure thereof for the purpose of interpretation of the scope of any claim.

### 37 CFR 1.81. Drawings required in patent application.

(a) The applicant for a patent is required to furnish a drawing of his or her invention where necessary for the understanding of the subject matter sought to be patented; this drawing, or a high quality copy thereof, must be filed with the application. Since corrections are the responsibility of the applicant, the original drawing(s) should be retained by the applicant for any necessary future correction.

(b) Drawings may include illustrations which facilitate an understanding of the invention (for example, flow sheets in cases of processes, and diagrammatic views).

(c) Whenever the nature of the subject matter sought to be patented admits of illustration by a drawing without its being necessary for the understanding of the subject matter and the applicant has not furnished such a drawing, the examiner will require its submission within a time period of not less than two months from the date of the sending of a notice thereof.

(d) Drawings submitted after the filing date of the application may not be used to overcome any insufficiency of the specification due to lack of an enabling disclosure or otherwise inadequate disclosure therein, or to supplement the original disclosure thereof for the purpose of interpretation of the scope of any claim.

>

## I. < DRAWING REQUIREMENTS

The first sentence of 35 U.S.C. 113 requires a drawing to be submitted upon filing where such drawing is necessary for the understanding of the invention. In this situation, the lack of a drawing renders the application incomplete and, as such, the applica-

tion cannot be given a filing date until the drawing is received. The second sentence of 35 U.S.C. 113 addresses the situation wherein a drawing is not necessary for the understanding of the invention, but the subject matter sought to be patented admits of illustration and no drawing was submitted on filing. The lack of a drawing in this situation does not render the application incomplete but rather is treated as an informality. The examiner should require such drawings in almost all such instances. Such drawings could be required during the initial processing of the application but do not have to be furnished at the time the application is filed. The applicant is given at least 2 months from the date of the letter requiring drawings to submit the drawing(s).

>

## II. < RECEIPT OF DRAWING AFTER THE FILING DATE

If the examiner discovers new matter in a substitute or additional drawing, the drawing should not be entered. The drawing should be objected to as containing new matter. A new drawing without such new matter may be required if the examiner determines that a drawing is needed under 37 CFR 1.81 or 37 CFR 1.83. The examiner's decision would be reviewable by filing a petition under 37 CFR 1.181. The Technology Center (TC) Director would decide such a petition.

>

## III. < HANDLING OF DRAWING REQUIREMENTS UNDER THE FIRST SENTENCE OF 35 U.S.C 113

The Office of Initial Patent Examination (OIPE) will make the initial decision in all new applications as to whether a drawing is "necessary" under the first sentence of 35 U.S.C. 113. A drawing will be considered necessary under the first sentence of 35 U.S.C. 113 in all applications where the drawing is referred to in the specification and one or more figures have been omitted.

The determination under 35 U.S.C. 113 (first sentence) as to when a drawing is necessary will be handled in OIPE in accordance with the following procedure. OIPE will make the initial determination as to whether drawings are required for the understanding of the subject matter of the invention. When

no drawings are included in the application as filed and drawings are required, the application is treated as incomplete and the applicant is so informed by OIPE. A filing date will not be granted and applicant will be notified to complete the application (37 CFR 1.53(e)). If a drawing is later furnished, a filing date may be granted as of the date of receipt of such drawing.

An OIPE formality examiner should not treat an application without drawings as incomplete if drawings are not required. A drawing is not required for a filing date under 35 U.S.C. 111 and 113 if the application contains:

(A) at least one process claim including the term “process” or “method” in its introductory phrase;

(B) at least one composition claim including the term “composition,” “compound,” “mixture” or “pharmaceutical” in its introductory phrase;

(C) at least one claim directed to a coated article or product or to an article or product made from a particular material or composition (i.e., an article of known and conventional character (e.g., a table), coated with or made of a particular composition (e.g., a specified polymer such as polyvinyl-chloride));

(D) at least one claim directed to a laminated article or product (i.e., a laminated article of known and conventional character (e.g., a table)); or

(E) at least one claim directed to an article, apparatus, or system where the sole distinguishing feature is the presence of a particular material (e.g., a hydraulic system using a particular hydraulic fluid, or a conventional packaged suture using a particular material).

For a more complete explanation about when a drawing is required, see MPEP § 601.01(f). For applications submitted without all of the drawings described in the specification, see MPEP § 601.01(g).

If an examiner determines that a filing date should not have been granted in an application because it does not contain drawings, the matter should be brought to the attention of the supervisory patent examiner (SPE) for review. If the SPE decides that drawings are required to understand the subject matter of the invention, the SPE should return the application to OIPE with a typed, signed, and dated memorandum requesting cancellation of the filing date and identifying the subject matter required to be illustrated.

>

#### IV < HANDLING OF DRAWING REQUIREMENTS UNDER THE SECOND SENTENCE OF 35 U.S.C 113 - ILLUSTRATION SUBSEQUENTLY REQUIRED

35 U.S.C.113 addresses the situation wherein a drawing is not necessary for the understanding of the invention, but the subject matter sought to be patented admits of illustration by a drawing and the applicant has not furnished a drawing. The lack of a drawing in this situation does not render the application incomplete but rather is treated as an informality. A filing date will be accorded with the original presentation of the papers, despite the absence of drawings. The acceptance of an application without a drawing does not preclude the examiner from requiring an illustration in the form of a drawing under 37 CFR 1.81(c) or 37 CFR 1.83(c). In requiring such a drawing, the examiner should clearly indicate that the requirement is made under 37 CFR 1.81(c) or 37 CFR 1.83(\*>a<) and be careful not to state that he or she is doing so “because it is necessary for the understanding of the invention,” as that might give rise to an erroneous impression as to the completeness of the application as filed. Examiners making such requirements are to specifically require, as a part of the applicant’s next reply, at least an ink sketch or permanent print of any drawing \* in reply to the requirement, even though no allowable subject matter is yet indicated. This will afford the examiner an early opportunity to determine the sufficiency of the illustration and the absence of new matter. See 37 CFR 1.121 and 37 CFR 1.81(d). One of the following form paragraphs may be used to require a drawing:

##### ¶ 6.23 Subject Matter Admits of Illustration

The subject matter of this application admits of illustration by a drawing to facilitate understanding of the invention. Applicant is required to furnish a drawing under 37 CFR 1.81. No new matter may be introduced in the required drawing.

##### Examiner Note:

When requiring drawings before examination use form paragraph 6.23.01 with a PTOL-90 or PTO-90C form as a cover sheet.

##### ¶ 6.23.01 Subject Matter Admits of Illustration (No Examination of Claims)

The subject matter of this application admits of illustration by a drawing to facilitate understanding of the invention. Applicant is

required to furnish a drawing under 37 CFR 1.81. No new matter may be introduced in the required drawing.

Applicant is given a TWO MONTH time period to submit a drawing in compliance with 37 CFR 1.81. Extensions of time may be obtained under the provisions of 37 CFR 1.136(a). Failure to timely submit a drawing will result in **ABANDONMENT** of the application.

#### Examiner Note:

1. Use of this form paragraph should be extremely rare and limited to those instances where no examination can be performed due to lack of an illustration of the invention resulting in a lack of understanding of the claimed subject matter.
2. Use a PTOL-90 or PTO-90C form as a cover sheet for this communication.

Applicant should also amend the specification accordingly to reference to the new illustration at the time of submission of the \* drawing(s). This may obviate further correspondence where an amendment places the application in condition for allowance.

>

## V. < DRAWING STANDARDS

### 37 CFR 1.84. Standards for drawings.

(a) *Drawings.* There are two acceptable categories for presenting drawings in utility and design patent applications.

(1) *Black ink.* Black and white drawings are normally required. India ink, or its equivalent that secures solid black lines, must be used for drawings; or

(2) *Color.* On rare occasions, color drawings may be necessary as the only practical medium by which to disclose the subject matter sought to be patented in a utility or design patent application or the subject matter of a statutory invention registration. The color drawings must be of sufficient quality such that all details in the drawings are reproducible in black and white in the printed patent. Color drawings are not permitted in international applications (see PCT Rule 11.13), or in an application, or copy thereof, submitted under the Office electronic filing system. The Office will accept color drawings in utility or design patent applications and statutory invention registrations only after granting a petition filed under this paragraph explaining why the color drawings are necessary. Any such petition must include the following:

- (i) The fee set forth in § 1.17(h);
- (ii) Three (3) sets of color drawings;
- (iii) A black and white photocopy that accurately depicts, to the extent possible, the subject matter shown in the color drawing; and

(iv) An amendment to the specification to insert (unless the specification contains or has been previously amended to contain) the following language as the first paragraph of the brief description of the drawings:

The patent or application file contains at least one drawing executed in color. Copies of this patent or patent appli-

cation publication with color drawing(s) will be provided by the Office upon request and payment of the necessary fee.

(b) *Photographs.*—

(1) *Black and white.* Photographs, including photocopies of photographs, are not ordinarily permitted in utility and design patent applications. The Office will accept photographs in utility and design patent applications, however, if photographs are the only practicable medium for illustrating the claimed invention. For example, photographs or photomicrographs of: electrophoresis gels, blots (*e.g.*, immunological, western, Southern, and northern), auto- radiographs, cell cultures (stained and unstained), histological tissue cross sections (stained and unstained), animals, plants, in vivo imaging, thin layer chromatography plates, crystalline structures, and, in a design patent application, ornamental effects, are acceptable. If the subject matter of the application admits of illustration by a drawing, the examiner may require a drawing in place of the photograph. The photographs must be of sufficient quality so that all details in the photographs are reproducible in the printed patent.

(2) *Color photographs.* Color photographs will be accepted in utility and design patent applications if the conditions for accepting color drawings and black and white photographs have been satisfied. See paragraphs (a)(2) and (b)(1) of this section.

(c) *Identification of drawings.* Identifying indicia, if provided, should include the title of the invention, inventor's name, and application number, or docket number (if any) if an application number has not been assigned to the application. If this information is provided, it must be placed on the front of each sheet and centered within the top margin.

(d) *Graphic forms in drawings.* Chemical or mathematical formulae, tables, and waveforms may be submitted as drawings and are subject to the same requirements as drawings. Each chemical or mathematical formula must be labeled as a separate figure, using brackets when necessary, to show that information is properly integrated. Each group of waveforms must be presented as a single figure, using a common vertical axis with time extending along the horizontal axis. Each individual waveform discussed in the specification must be identified with a separate letter designation adjacent to the vertical axis.

(e) *Type of paper.* Drawings submitted to the Office must be made on paper which is flexible, strong, white, smooth, non-shiny, and durable. All sheets must be reasonably free from cracks, creases, and folds. Only one side of the sheet may be used for the drawing. Each sheet must be reasonably free from erasures and must be free from alterations, overwritings, and interlineations. Photographs must be developed on paper meeting the sheet-size requirements of paragraph (f) of this section and the margin requirements of paragraph (g) of this section. See paragraph (b) of this section for other requirements for photographs.

(f) *Size of paper.* All drawing sheets in an application must be the same size. One of the shorter sides of the sheet is regarded as its top. The size of the sheets on which drawings are made must be:

- (1) 21.0 cm. by 29.7 cm. (DIN size A4), or
- (2) 21.6 cm. by 27.9 cm. (8 1/2 by 11 inches).

(g) *Margins.* The sheets must not contain frames around the sight (*i.e.*, the usable surface), but should have scan target points (*i.e.*, cross-hairs) printed on two cater-corner margin corners. Each sheet must include a top margin of at least 2.5 cm. (1 inch), a left side margin of at least 2.5 cm. (1 inch), a right side margin of at least 1.5 cm. (5/8 inch), and a bottom margin of at least 1.0 cm. (3/8 inch), thereby leaving a sight no greater than 17.0 cm. by 26.2 cm. on 21.0 cm. by 29.7 cm. (DIN size A4) drawing sheets, and a sight no greater than 17.6 cm. by 24.4 cm. (6 15/16 by 9 5/8 inches) on 21.6 cm. by 27.9 cm. (8 1/2 by 11 inch) drawing sheets.

(h) *Views.* The drawing must contain as many views as necessary to show the invention. The views may be plan, elevation, section, or perspective views. Detail views of portions of elements, on a larger scale if necessary, may also be used. All views of the drawing must be grouped together and arranged on the sheet(s) without wasting space, preferably in an upright position, clearly separated from one another, and must not be included in the sheets containing the specifications, claims, or abstract. Views must not be connected by projection lines and must not contain center lines. Waveforms of electrical signals may be connected by dashed lines to show the relative timing of the waveforms.

(1) *Exploded views.* Exploded views, with the separated parts embraced by a bracket, to show the relationship or order of assembly of various parts are permissible. When an exploded view is shown in a figure which is on the same sheet as another figure, the exploded view should be placed in brackets.

(2) *Partial views.* When necessary, a view of a large machine or device in its entirety may be broken into partial views on a single sheet, or extended over several sheets if there is no loss in facility of understanding the view. Partial views drawn on separate sheets must always be capable of being linked edge to edge so that no partial view contains parts of another partial view. A smaller scale view should be included showing the whole formed by the partial views and indicating the positions of the parts shown. When a portion of a view is enlarged for magnification purposes, the view and the enlarged view must each be labeled as separate views.

(i) Where views on two or more sheets form, in effect, a single complete view, the views on the several sheets must be so arranged that the complete figure can be assembled without concealing any part of any of the views appearing on the various sheets.

(ii) A very long view may be divided into several parts placed one above the other on a single sheet. However, the relationship between the different parts must be clear and unambiguous.

(3) *Sectional views.* The plane upon which a sectional view is taken should be indicated on the view from which the section is cut by a broken line. The ends of the broken line should be designated by Arabic or Roman numerals corresponding to the view number of the sectional view, and should have arrows to indicate the direction of sight. Hatching must be used to indicate section portions of an object, and must be made by regularly spaced oblique parallel lines spaced sufficiently apart to enable the lines to be distinguished without difficulty. Hatching should not impede the clear reading of the reference characters and lead

lines. If it is not possible to place reference characters outside the hatched area, the hatching may be broken off wherever reference characters are inserted. Hatching must be at a substantial angle to the surrounding axes or principal lines, preferably 45°. A cross section must be set out and drawn to show all of the materials as they are shown in the view from which the cross section was taken. The parts in cross section must show proper material(s) by hatching with regularly spaced parallel oblique strokes, the space between strokes being chosen on the basis of the total area to be hatched. The various parts of a cross section of the same item should be hatched in the same manner and should accurately and graphically indicate the nature of the material(s) that is illustrated in cross section. The hatching of juxtaposed different elements must be angled in a different way. In the case of large areas, hatching may be confined to an edging drawn around the entire inside of the outline of the area to be hatched. Different types of hatching should have different conventional meanings as regards the nature of a material seen in cross section.

(4) *Alternate position.* A moved position may be shown by a broken line superimposed upon a suitable view if this can be done without crowding; otherwise, a separate view must be used for this purpose.

(5) *Modified forms.* Modified forms of construction must be shown in separate views.

(i) *Arrangement of views.* One view must not be placed upon another or within the outline of another. All views on the same sheet should stand in the same direction and, if possible, stand so that they can be read with the sheet held in an upright position. If views wider than the width of the sheet are necessary for the clearest illustration of the invention, the sheet may be turned on its side so that the top of the sheet, with the appropriate top margin to be used as the heading space, is on the right-hand side. Words must appear in a horizontal, left-to-right fashion when the page is either upright or turned so that the top becomes the right side, except for graphs utilizing standard scientific convention to denote the axis of abscissas (of X) and the axis of ordinates (of Y).

(j) *Front page view.* The drawing must contain as many views as necessary to show the invention. One of the views should be suitable for inclusion on the front page of the patent application publication and patent as the illustration of the invention. Views must not be connected by projection lines and must not contain center lines. Applicant may suggest a single view (by figure number) for inclusion on the front page of the patent application publication and patent.

(k) *Scale.* The scale to which a drawing is made must be large enough to show the mechanism without crowding when the drawing is reduced in size to two-thirds in reproduction. Indications such as "actual size" or "scale 1/2" on the drawings are not permitted since these lose their meaning with reproduction in a different format.

(l) *Character of lines, numbers, and letters.* All drawings must be made by a process which will give them satisfactory reproduction characteristics. Every line, number, and letter must be durable, clean, black (except for color drawings), sufficiently dense and dark, and uniformly thick and well-defined. The weight of all lines and letters must be heavy enough to permit adequate

reproduction. This requirement applies to all lines however fine, to shading, and to lines representing cut surfaces in sectional views. Lines and strokes of different thicknesses may be used in the same drawing where different thicknesses have a different meaning.

(m) *Shading*. The use of shading in views is encouraged if it aids in understanding the invention and if it does not reduce legibility. Shading is used to indicate the surface or shape of spherical, cylindrical, and conical elements of an object. Flat parts may also be lightly shaded. Such shading is preferred in the case of parts shown in perspective, but not for cross sections. See paragraph (h)(3) of this section. Spaced lines for shading are preferred. These lines must be thin, as few in number as practicable, and they must contrast with the rest of the drawings. As a substitute for shading, heavy lines on the shade side of objects can be used except where they superimpose on each other or obscure reference characters. Light should come from the upper left corner at an angle of 45°. Surface delineations should preferably be shown by proper shading. Solid black shading areas are not permitted, except when used to represent bar graphs or color.

(n) *Symbols*. Graphical drawing symbols may be used for conventional elements when appropriate. The elements for which such symbols and labeled representations are used must be adequately identified in the specification. Known devices should be illustrated by symbols which have a universally recognized conventional meaning and are generally accepted in the art. Other symbols which are not universally recognized may be used, subject to approval by the Office, if they are not likely to be confused with existing conventional symbols, and if they are readily identifiable.

(o) *Legends*. Suitable descriptive legends may be used subject to approval by the Office, or may be required by the examiner where necessary for understanding of the drawing. They should contain as few words as possible.

(p) *Numbers, letters, and reference characters*.

(1) Reference characters (numerals are preferred), sheet numbers, and view numbers must be plain and legible, and must not be used in association with brackets or inverted commas, or enclosed within outlines, *e.g.*, encircled. They must be oriented in the same direction as the view so as to avoid having to rotate the sheet. Reference characters should be arranged to follow the profile of the object depicted.

(2) The English alphabet must be used for letters, except where another alphabet is customarily used, such as the Greek alphabet to indicate angles, wavelengths, and mathematical formulas.

(3) Numbers, letters, and reference characters must measure at least .32 cm. (1/8 inch) in height. They should not be placed in the drawing so as to interfere with its comprehension. Therefore, they should not cross or mingle with the lines. They should not be placed upon hatched or shaded surfaces. When necessary, such as indicating a surface or cross section, a reference character may be underlined and a blank space may be left in the hatching or shading where the character occurs so that it appears distinct.

(4) The same part of an invention appearing in more than one view of the drawing must always be designated by the same

reference character, and the same reference character must never be used to designate different parts.

(5) Reference characters not mentioned in the description shall not appear in the drawings. Reference characters mentioned in the description must appear in the drawings.

(q) *Lead lines*. Lead lines are those lines between the reference characters and the details referred to. Such lines may be straight or curved and should be as short as possible. They must originate in the immediate proximity of the reference character and extend to the feature indicated. Lead lines must not cross each other. Lead lines are required for each reference character except for those which indicate the surface or cross section on which they are placed. Such a reference character must be underlined to make it clear that a lead line has not been left out by mistake. Lead lines must be executed in the same way as lines in the drawing. See paragraph (l) of this section.

(r) *Arrows*. Arrows may be used at the ends of lines, provided that their meaning is clear, as follows:

(1) On a lead line, a freestanding arrow to indicate the entire section towards which it points;

(2) On a lead line, an arrow touching a line to indicate the surface shown by the line looking along the direction of the arrow; or

(3) To show the direction of movement.

(s) *Copyright or Mask Work Notice*. A copyright or mask work notice may appear in the drawing, but must be placed within the sight of the drawing immediately below the figure representing the copyright or mask work material and be limited to letters having a print size of 32 cm. to 64 cm. (1/8 to 1/4 inches) high. The content of the notice must be limited to only those elements provided for by law. For example, “©1983 John Doe” (17 U.S.C. 401) and “\*M\* John Doe” (17 U.S.C. 909) would be properly limited and, under current statutes, legally sufficient notices of copyright and mask work, respectively. Inclusion of a copyright or mask work notice will be permitted only if the authorization language set forth in § 1.71(e) is included at the beginning (preferably as the first paragraph) of the specification.

(t) *Numbering of sheets of drawings*. The sheets of drawings should be numbered in consecutive Arabic numerals, starting with 1, within the sight as defined in paragraph (g) of this section. These numbers, if present, must be placed in the middle of the top of the sheet, but not in the margin. The numbers can be placed on the right-hand side if the drawing extends too close to the middle of the top edge of the usable surface. The drawing sheet numbering must be clear and larger than the numbers used as reference characters to avoid confusion. The number of each sheet should be shown by two Arabic numerals placed on either side of an oblique line, with the first being the sheet number and the second being the total number of sheets of drawings, with no other marking.

(u) *Numbering of views*.

(1) The different views must be numbered in consecutive Arabic numerals, starting with 1, independent of the numbering of the sheets and, if possible, in the order in which they appear on the drawing sheet(s). Partial views intended to form one complete view, on one or several sheets, must be identified by the same number followed by a capital letter. View numbers must be pre-

ceded by the abbreviation “FIG.” Where only a single view is used in an application to illustrate the claimed invention, it must not be numbered and the abbreviation “FIG.” must not appear.

(2) Numbers and letters identifying the views must be simple and clear and must not be used in association with brackets, circles, or inverted commas. The view numbers must be larger than the numbers used for reference characters.

(v) *Security markings.* Authorized security markings may be placed on the drawings provided they are outside the sight, preferably centered in the top margin.

(w) *Corrections.* Any corrections on drawings submitted to the Office must be durable and permanent.

(x) *Holes.* No holes should be made by applicant in the drawing sheets.

(y) *Types of drawings.* See § 1.152 for design drawings, § 1.165 for plant drawings, and § 1.174 for reissue drawings.

Drawings on paper are acceptable as long as they are in compliance with 37 CFR 1.84. Corrections thereto must be made in the form of replacement sheets >labeled, in the header, “Replacement Sheet”< since the Office does not release drawings for correction. See 37 CFR 1.85.

Good quality copies made on office copiers are acceptable if the lines are uniformly thick, black, and solid. Facsimile copies of drawings \*\*>are acceptable if included with application papers mailed or hand-carried to the Office or if submitted at the time of payment of the issue fee (see “Payment of the Issue Fee and Filing Related Correspondence by Facsimile,” 1254 O.G. 91 (January 15, 2002)). Applicants should ensure that the facsimile transmission process does not unreasonably degrade the quality of the drawings<.

Drawings are currently accepted in two different size formats. It is, however, required that all \*>drawing sheets< in a particular application be the same size for ease of handling and reproduction.

For examples of proper drawings, in addition to selected rules of practice related to patent drawings and interpretations of those rules, see the “Guide for the Preparation of Patent Drawings” which is available from the \*\*>USPTO web site at [www.uspto.gov](http://www.uspto.gov)<.

For information regarding certified copies of an application-as-filed which does not meet the sheet size/margin and quality requirements of 37 CFR 1.52, 1.84(f), and 1.84(g), see MPEP § 608.01.

For design patent drawings, 37 CFR 1.152, see MPEP § 1503.02.

For plant patent drawings, 37 CFR 1.165, see MPEP § 1606.

For reissue application drawings, see MPEP § 1413.

For correction of drawings, see MPEP § 608.02(p). For prints, preparation and distribution, see MPEP § 508 and § 608.02(m). For prints, return of drawings, see MPEP § 608.02(y).

>For amendment of drawings, see MPEP § 714.<

For pencil notations of classification and name or initials of assistant examiner to be placed on drawings, see MPEP § 719.03.

The filing of a divisional or continuation application under the provisions of 37 CFR 1.53(b) (unexecuted application) does not obviate the need for acceptable drawings. See MPEP § 608.02(b).

See MPEP § 601.01(f) for treatment of applications filed without drawings and MPEP § 601.01(g) for treatment of applications filed without all figures of drawings.

>

## VI. < DEFINITIONS

A number of different terms are used when referring to drawings in patent applications. The following definitions are used in this Manual.

*Original drawings:* The drawing submitted with the application when filed.

*Substitute drawing:* A drawing filed later than the filing date of an application. Usually submitted to replace an original informal drawing.

*Acceptable drawing:* A drawing that is acceptable for publication of the application or issuance of the patent.

*Corrected drawing:* A drawing that includes corrections of informalities and \* changes approved by the examiner.

*Informal drawing:* A drawing which does not comply with the form requirements of 37 CFR 1.84. Drawings may be informal because they are not on the proper size sheets, the quality of the lines is poor, or for other reasons such as the size of reference elements. Informal drawings could be acceptable for the purposes of publication and examination. An objection will generally only be made to an informal drawing if the Office is unable to reproduce the drawing or the contents of the drawing are unacceptable to the examiner.



*Drawing print:* This term is used for the white paper print prepared by the Scanning Division of the Office of Initial Patent Examination (OIPE) of \* original drawings >in paper application files<. The drawing prints contain the application number near the left-hand margin. Drawing prints should be placed on the top on the right-hand flap of the application file wrapper. >A drawing print is not made for image file wrapper (IFW) applications. For IFW processing, see IFW Manual.<

*Interference print:* This term is used to designate the copy prepared of the original drawings filed in file cabinets separate from the >paper< file wrappers and \* used to make interference searches. >For IFW processing, see IFW Manual.<

*Plan:* This term is used to illustrate the top view.

*Elevation* This term is used to illustrate views showing the height of objects.

>

## VII. < BLACK AND WHITE PHOTOGRAPHS

37 CFR 1.84. Standards for drawings.

\*\*\*\*\*

### (b) Photographs.—

(1) *Black and white.* Photographs, including photocopies of photographs, are not ordinarily permitted in utility and design patent applications. The Office will accept photographs in utility and design patent applications, however, if photographs are the only practicable medium for illustrating the claimed invention. For example, photographs or photomicrographs of: electrophoresis gels, blots (e.g., immunological, western, Southern, and northern), auto- radiographs, cell cultures (stained and unstained), histological tissue cross sections (stained and unstained), animals, plants, in vivo imaging, thin layer chromatography plates, crystalline structures, and, in a design patent application, ornamental effects, are acceptable. If the subject matter of the application admits of illustration by a drawing, the examiner may require a drawing in place of the photograph. The photographs must be of sufficient quality so that all details in the photographs are reproducible in the printed patent.

\*\*\*\*\*

Photographs or photomicrographs (not photolithographs or other reproductions of photographs made by using screens) printed on sensitized paper are acceptable as final drawings, in lieu of India ink drawings, to illustrate inventions which are incapable of being accurately or adequately depicted by India ink drawings, e.g., electrophoresis gels, blots, (e.g., immunological, western, Southern, and northern),

autoradiographs, cell cultures (stained and unstained), histological tissue cross sections (stained and unstained), animals, plants, in vivo imaging, thin layer chromatography plates, crystalline structures, metallurgical microstructures, textile fabrics, grain structures and ornamental effects. The photographs or photomicrographs must show the invention more clearly than they can be done by India ink drawings and otherwise comply with the rules concerning such drawings.

\*>Black and white photographs< submitted in lieu of ink drawings must comply with 37 CFR 1.84(b). There is no requirement for a petition or petition fee, and only one set of photographs is required. See 1213 O.G. 108 (Aug. 4, 1998) and 1211 O.G. 34 (June 9, 1998) and 37 CFR 1.84(b)(1).

Such photographs to be acceptable must be made on photographic paper having the following characteristics which are generally recognized in the photographic trade: double weight paper with a surface described as smooth with a white tint. Note that photographs filed on or after October 1, 2001 may no longer be mounted on Bristol Board. See 37 CFR 1.84(e) and 1246 O.G. 106 (May 22, 2001). If several photographs are used to make one sheet of drawings, the photographs must be contained (i.e., developed) on a single sheet.

See MPEP § 1503.02 for discussion of photographs used in design patent applications.

>Photographs may be treated as artifacts when the patent application is an IFW application since the photographs may not be able to be accurately reproduced by scanning.

## VIII. < COLOR DRAWINGS OR COLOR PHOTOGRAPHS

37 CFR 1.84. Standards for drawings.

(a) Drawings. There are two acceptable categories for presenting drawings in utility and design patent applications:

\*\*\*\*\*

(2) *Color.* On rare occasions, color drawings may be necessary as the only practical medium by which to disclose the subject matter sought to be patented in a utility or design patent application or the subject matter of a statutory invention registration. The color drawings must be of sufficient quality such that all details in the drawings are reproducible in black and white in the printed patent. Color drawings are not permitted in international applications (see PCT Rule 11.13), or in an application, or copy thereof, submitted under the Office electronic filing system. The

Office will accept color drawings in utility or design patent applications and statutory invention registrations only after granting a petition filed under this paragraph explaining why the color drawings are necessary. Any such petition must include the following:

- (i) The fee set forth in § 1.17(h);
- (ii) Three (3) sets of color drawings;
- (iii) A black and white photocopy that accurately depicts, to the extent possible, the subject matter shown in the color drawing; and
- (iv) An amendment to the specification to insert (unless the specification contains or has been previously amended to contain) the following language as the first paragraph of the brief description of the drawings:

The patent or application file contains at least one drawing executed in color. Copies of this patent or patent application publication with color drawing(s) will be provided by the Office upon request and payment of the necessary fee.

(b) Photographs.

\*\*\*\*\*

(2) *Color photographs.* Color photographs will be accepted in utility and design patent applications if the conditions for accepting color drawings and black and white photographs have been satisfied. See paragraphs (a)(2) and (b)(1) of this section.

\*\*\*\*\*

Limited use of color drawings in utility patent applications is provided for in 37 CFR 1.84(a)(2) and (b)(2). Unless a petition is filed and granted, color drawings or color photographs will not be accepted in a utility or design patent application. The examiner must object to the color drawings or color photographs as being improper and require applicant either to cancel the drawings or to provide substitute black and white drawings.

Under 37 CFR 1.84(a)(2) and (b)(2), the applicant must file a petition with fee requesting acceptance of the color drawings or color photographs. Three sets of color drawings or color photographs must also be submitted (37 CFR 1.84(a)(2)(ii)). However, the requirement of 37 CFR 1.84(a)(2)(iii) for a black and white photocopy of the color drawings or color photographs has been waived. See 1246 O.G. 106 (May 22, 2001). The petition is decided by a Supervisory Patent Examiner. See MPEP § 1002.02(d).

>If the application is an IFW application, the color photographs are maintained in an artifact folder.<

Where color drawings or color photographs are filed in a continuing application, applicant must renew the petition under 37 CFR 1.84(a)(2) and (b)(2)

even though a similar petition was filed in the prior application. Until the renewed petition is granted, the examiner must object to the color drawings or color photographs as being improper.

In light of the substantial administrative and economic burden associated with printing a utility patent with color drawings or color photographs, the patent copies which are printed at issuance of the patent will depict the drawings in black and white only. However, a set of color drawings or color photographs will be attached to the Letters Patent. Moreover, copies of the patent with color drawings or color photographs attached thereto will be provided by the U.S. Patent and Trademark Office upon special request and payment of the fee necessary to recover the actual costs associated therewith.

Accordingly, the petition must also be accompanied by a proposed amendment to insert the following language as the first paragraph in the portion of the specification containing a brief description of the drawings:

The patent or application file contains at least one drawing executed in color. Copies of this patent or patent application publication with color drawing(s) will be provided by the U.S. Patent and Trademark Office upon request and payment of the necessary fee.

If color drawings or color photographs have been filed, but the required petition has not, form paragraph 6.24.01 may be used to notify applicant that a petition is needed.

\*\*>

*¶ 6.24.01 Color Photographs and Color Drawings, Petition Required*

Color photographs and color drawings are acceptable only for examination purposes unless a petition filed under 37 CFR 1.84(a)(2) is granted permitting their use as acceptable drawings. In the event that applicant wishes to use the drawings currently on file as acceptable drawings, a petition must be filed for acceptance of the color photographs or color drawings as acceptable drawings. Any such petition must be accompanied by the appropriate fee set forth in 37 CFR 1.17(h), three sets of color drawings or color photographs, as appropriate, and, unless already present, an amendment to include the following language as the first paragraph of the brief description of the drawings section of the specification:

The patent or application file contains at least one drawing executed in color. Copies of this patent or patent application publication with color drawing(s) will be provided by the Office upon request and payment of the necessary fee.

Color photographs will be accepted if the conditions for accepting color drawings have been satisfied.

**Examiner Note:**

1. This form paragraph should be used only if the application contains color photographs or color drawings as the drawings required by 37 CFR 1.81.
2. The requirement of 37 CFR 1.84(a)(2)(iii) for a black and white photocopy of the color drawings or color photographs has been waived. See 1246 O.G. 34 (May 22, 2001).
3. Do not use this form paragraph for black and white photographs. The requirement for a petition, petition fee, and three sets of black and white photographs has been eliminated. See 1213 O.G. 108 (August 4, 1998), 1211 O.G. 34 (June 9, 1999) and 37 CFR 1.84(b).

<

It is anticipated that such a petition will be granted only when the U.S. Patent and Trademark Office has determined that a color drawing or color photograph is the only practical medium by which to disclose in a printed utility patent the subject matter to be patented.

It is emphasized that a decision to grant the petition should not be regarded as an indication that color drawings or color photographs are necessary to comply with a statutory requirement. In this latter respect, clearly it is desirable to file any desired color drawings or color photographs as part of the original application papers in order to avoid issues concerning statutory defects (e.g., lack of enablement under 35 U.S.C. 112 or new matter under 35 U.S.C. 132). \*\*

>

**IX. < DRAWING SYMBOLS**

37 CFR 1.84(n) indicates that graphic drawing symbols and other labeled representations may be

used for conventional elements where appropriate, subject to approval by the Office. Also, suitable legends may be used, or may be required, in proper cases. For examples of suitable symbols and legends, see the “Guide for the Preparation of Patent Drawings” available from the \*\*>USPTO web site at [www.uspto.gov](http://www.uspto.gov)<.

\*\*>The American National Standards Institute (ANSI) is a private non-profit organization whose numerous publications include some that pertain to graphical symbols. Such publications, for examples, Graphic Symbols for Fluid Power Diagrams, IEEE Standard Graphic Symbols for Logic Functions, Graphic Symbols for Electrical and Electronics Diagrams, are considered to be generally acceptable in patent drawings. ANSI headquarters are at 1819 L Street, NW, Suite 600, Washington, DC 20036, with offices at 25 West 43<sup>rd</sup> Street, New York, NY 10036. The organization’s Internet address is [www.ansi.org](http://www.ansi.org). Although ANSI documents and other published sources may be used as guides during the selection of graphic symbols for patent drawings,< the Office will not “approve” \*\*>any published collection of< symbols as a group because their use and clarity must be decided on a case-by-case basis\*\*. Overly specific symbols should be avoided. Symbols with unclear meanings should be labeled for clarification.

\*\*

The following symbols should be used to indicate various materials where the material is an important feature of the invention. The use of conventional features is very helpful in making prior art searches.

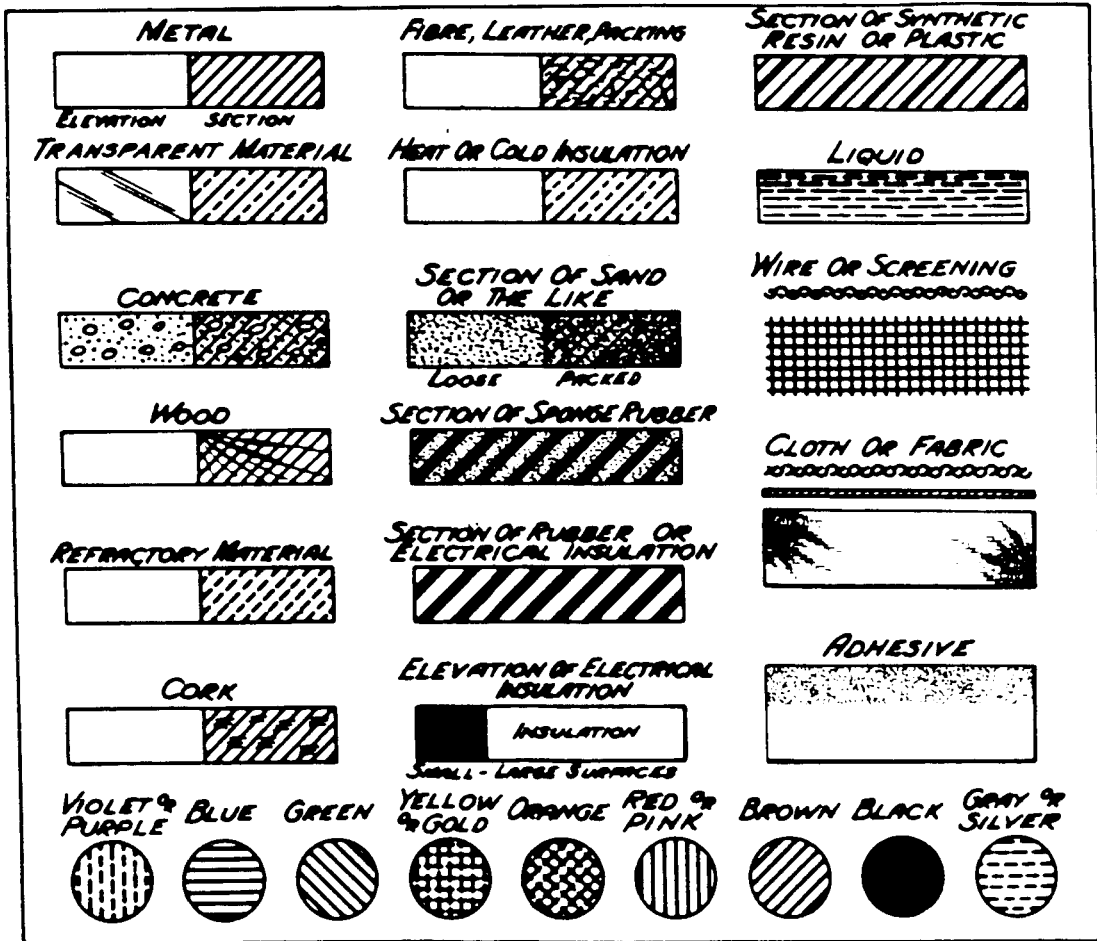

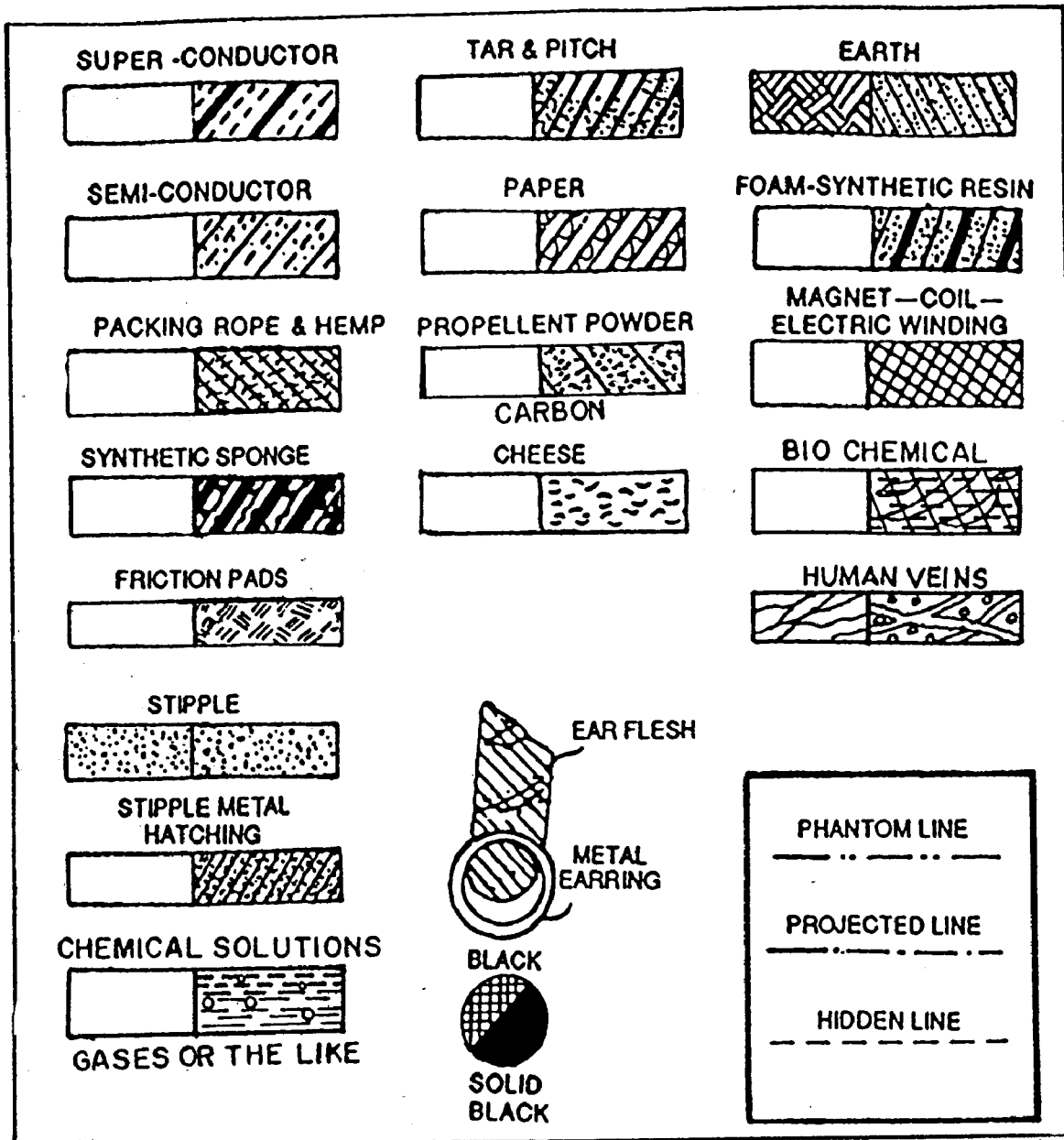

### 608.02(a) New Drawing — When Replacement is Required Before Examination [R-2]

See MPEP § 608.02 for the procedure to follow when drawings have not been filed, but a drawing will aid in the understanding of the invention. See MPEP § 601.01(f) for the procedure to follow when applications appear to be missing sheets of drawings. Drawings in utility and plant applications \*\* will be reviewed by the Office of Initial Patent Examination (OIPE) for compliance with certain requirements of 37 CFR 1.84. OIPE will send a Notice to File Corrected Application Papers if the drawings are not acceptable for purposes of publication. The notice will give applicant a time period of 2 months from the mailing date of the notice to file acceptable drawings. This time period for reply is extendable under 37 CFR 1.136(a). OIPE will not release applications to the Technology Centers until acceptable drawings are \* >filed< in the applications.

\*\*If at the time of the initial assignment of an application to an examiner's docket, or if at the time the application is taken up for action, the supervisory patent examiner believes the \* drawings to be of such a condition as to not permit reasonable examination of the application, applicant should be required to immediately submit corrected drawings. However, if the \* drawings do permit reasonable examination and the supervisory patent examiner believes the drawings are of such a character as to render the application defective under 35 U.S.C. 112, examination should begin immediately with a requirement for corrected drawings and a rejection of the claims as not being in compliance with 35 U.S.C. 112, first paragraph, being made.

If the drawings have been indicated by the applicant as informal, but no objection has been made to the drawings >by OIPE (drawings considered acceptable by OIPE)<, the examiner should not require replacement of the "informal" drawings with new drawings. If the examiner does make objections to the drawings, the examiner should require correction in reply to the Office action and not permit the objection to be held in abeyance. See MPEP § 608.02(b), § 608.02(d) - § 608.02(h) and § 608.02(p) for further information on specific grounds for finding drawings informalities.

### UNTIMELY FILED DRAWINGS

If a drawing is not timely received in reply to a notice from the Office or a letter from the examiner who requires a drawing, the application becomes abandoned for failure to reply.

For the handling of additional, duplicate, or substitute drawings, see MPEP § 608.02(h).

### 608.02(b) Informal Drawings [R-2]

37 CFR 1.85. *Corrections to drawings.*

(a) A utility or plant application will not be placed on the files for examination until objections to the drawings have been corrected. Except as provided in § 1.215(c), any patent application publication will not include drawings filed after the application has been placed on the files for examination. Unless applicant is otherwise notified in an Office action, objections to the drawings in a utility or plant application will not be held in abeyance, and a request to hold objections to the drawings in abeyance will not be considered a *bona fide* attempt to advance the application to final action (§ 1.135(c)). If a drawing in a design application meets the requirements of § 1.84(e), (f), and (g) and is suitable for reproduction, but is not otherwise in compliance with § 1.84, the drawing may be admitted for examination.

(b) The Office will not release drawings for purposes of correction. If corrections are necessary, new corrected drawings must be submitted within the time set by the Office.

(c) If a corrected drawing is required or if a drawing does not comply with § 1.84 at the time an application is allowed, the Office may notify the applicant and set a three month period of time from the mail date of the notice of allowability within which the applicant must file a corrected or formal drawing in compliance with § 1.84 to avoid abandonment. This time period is not extendable under § 1.136(a) or § 1.136(b).

In instances where the drawing is such that the prosecution can be carried on without the corrections, applicant is informed of the reasons why the drawing is objected to on Form PTO-948 or in an examiner's action, and that the drawing is admitted for examination purposes only (see MPEP § 707.07(a)). To be fully responsive, an amendment must include \* corrected drawings \*\*. See 37 CFR 1.85(c) and 37 CFR 1.121(d). The objection to the drawings will not be held in abeyance.

>

### I. < INFORMAL DRAWINGS

\*\* >The Office no longer considers drawings as formal or informal. Drawings are either acceptable or not acceptable. Drawings< will be accepted by the Office of Initial Patent Examination (OIPE) if the

drawings are readable and reproducible for publication purposes. See MPEP § 507.

Examiners should review the drawings for disclosure of the claimed invention and for proper use of reference numerals. Unless applicant is otherwise notified in an Office action, objections to the drawings in a utility or plant application will not be held in abeyance. A request to hold objections to the drawings in abeyance will not be considered a *bona fide* attempt to advance the application to final action (37 CFR 1.135(c)). Drawing corrections should be made promptly before allowance of the application in order to avoid delays in issuance of the application as a patent or a reduction to any term adjustment. See 37 CFR 1.704(c)(10).

>

## II. < NOTIFYING APPLICANT

If the original drawings are *\*not acceptable*, a 2-part form, PTO-948, may be used to indicate what the *\*objections* are and that new corrected drawings are required. In either case, the *\* drawings* will be accepted as satisfying the requirements of 37 CFR 1.51. The examiners are directed to advise the applicants by way of form PTO-948 (see MPEP § 707.07(a)) in the first Office action of the reasons why the drawings are *\*\*not acceptable*. If the examiner discovers a defect in the content of the drawing, one or more of the form paragraphs reproduced below may be used to notify applicant.

*\*\*>*

### ¶ 6.21 *New Drawings, Competent Draftsperson*

New corrected drawings are required in this application because [I]. Applicant is advised to employ the services of a competent patent draftsperson outside the Office, as the U.S. Patent and Trademark Office no longer prepares new drawings. The corrected drawings are required in reply to the Office action to avoid abandonment of the application. The requirement for corrected drawings will not be held in abeyance.

### ¶ 6.22 *Drawings Objected To*

The drawings are objected to because [1]. Corrected drawings sheets are required in reply to the Office action to avoid abandonment of the application. Any amended replacement drawing sheet should include all of the figures appearing on the immediate prior version of the sheet, even if only one figure is being amended. The figure or figure number of an amended drawing should not be labeled as “amended.” If a drawing figure is to be canceled, the appropriate figure must be removed from the replacement sheet, and where necessary, the remaining figures must be renumbered and appropriate changes made to the brief description of the sev-

eral views of the drawings for consistency. Additional replacement sheets may be necessary to show the renumbering of the remaining figures. The replacement sheet(s) should be labeled Replacement Sheet in the page header (as per 37 CFR 1.84(c)) so as not to obstruct any portion of the drawing figures. If the changes are not accepted by the examiner, the applicant will be notified and informed of any required corrective action in the next Office action. The objection to the drawings will not be held in abeyance.

### Examiner Note:

1. In bracket 1, insert the reason for the objection, for example, --the drawings do not show every feature of the invention specified in the claims-- or --the unlabeled rectangular box(es) shown in the drawings should be provided with descriptive text labels--.
2. Unless applicant is otherwise notified in an Office action, objections to the drawings in a utility or plant application will not be held in abeyance, and a request to hold objections to the drawings in abeyance will not be considered a *bona fide* attempt to advance the application to final action. See 37 CFR 1.85(a).
3. This form paragraph may be followed by form paragraph 6.27 to require a marked up copy of the amended drawing figure(s) including annotations indicating the changes made in the corrected drawings.

### ¶ 6.26 *Informal Drawings Do Not Permit Examination*

The informal drawings are not of sufficient quality to permit examination. Accordingly, replacement drawing sheets are required in reply to this Office action. The replacement sheet(s) should be labeled Replacement Sheet in the page header (as per 37 CFR 1.84(c)) so as not to obstruct any portion of the drawing figures. If the changes are not accepted by the examiner, the applicant will be notified and informed of any required corrective action in the next Office action.

Applicant is given a TWO MONTH time period to submit new drawings in compliance with 37 CFR 1.81. Extensions of time may be obtained under the provisions of 37 CFR 1.136(a). Failure to timely submit replacement drawing sheets will result in ABANDONMENT of the application.

### Examiner Note:

1. Use of this form paragraph should be extremely rare and limited to those instances where no examination can be performed due to the poor quality of the drawings resulting in a lack of understanding of the claimed subject matter.
2. Use a PTOL-90 or PTO-90C form as a cover sheet for this communication.

## III. < HANDLING OF REPLACEMENT *\*\* DRAWINGS*

In those situations where an application is filed with *\*unacceptable* drawings, applicants *\*\*will* be notified by OIPE to file new acceptable drawings complying with 37 CFR 1.84 and 1.121(d). < If the *\*\*requirement* for corrected drawings appears on the notice of allowability (PTOL-37), the drawings

must be filed within three months of the date of mailing of the notice of allowability. Also, each sheet of the drawing should include the application number and the art unit in the upper center margin (37 CFR 1.84(c)) and labeled, in the header, "Replacement Sheet." In the past, some drawings have been misdirected because the art unit indicated on the filing receipt was used rather than that indicated on the notice forms.

In utility applications, the examination will normally be conducted using the originally presented drawings\*. The sufficiency of disclosure, as concerns the subject matter claimed, will be made by the examiner utilizing the original drawings. IT IS APPLICANT'S RESPONSIBILITY TO SEE THAT NO NEW MATTER IS ADDED when submitting replacement drawings after allowance since they will not normally be reviewed by an examiner. Of course, if the examiner notices new matter in the replacement drawings, appropriate action to have the new matter deleted should be undertaken.

### 608.02(c) Drawing Print Kept in File Wrapper [R-2]

The drawing prints must always be kept on top of the papers on the right side of the file wrapper under any bibliographic data sheet >, if the application is maintained in paper. If the application is maintained in an image file wrapper (IFW) and the drawings are photographs or in color, the original photographs or color drawings may be maintained in an artifact folder. For IFW processing, see IFW Manual<.

Applications may be sent to issue or to the Files Repository without the original drawing, if any, if the drawing cannot be located. For an application sent to issue with missing drawings, see MPEP § 608.02(z). For abandoned applications sent to the Files Repository, a notation should be made on the Contents portion of the file wrapper that the drawings were missing.

Upon initial processing, the original drawings are placed in the center portion of the application file wrapper under the specification >, if the application is maintained in paper,< and the executed oath or declaration by the Scanning Division.

### 608.02(d) Complete Illustration in Drawings [R-2]

37 CFR 1.83. *Content of drawing.*

(a) The drawing in a nonprovisional application must show every feature of the invention specified in the claims. However, conventional features disclosed in the description and claims, where their detailed illustration is not essential for a proper understanding of the invention, should be illustrated in the drawing in the form of a graphical drawing symbol or a labeled representation (e.g., a labeled rectangular box).

(b) When the invention consists of an improvement on an old machine the drawing must when possible exhibit, in one or more views, the improved portion itself, disconnected from the old structure, and also in another view, so much only of the old structure as will suffice to show the connection of the invention therewith.

(c) Where the drawings in a nonprovisional application do not comply with the requirements of paragraphs (a) and (b) of this section, the examiner shall require such additional illustration within a time period of not less than two months from the date of the sending of a notice thereof. Such corrections are subject to the requirements of § 1.81(d).

Any structural detail that is of sufficient importance to be described should be shown in the drawing. (*Ex parte Good*, 1911 C.D. 43, 164 O.G. 739 (Comm'r Pat. 1911).)

Form paragraph 6.22.01, 6.22.04, or 6.36, where appropriate, may be used to require illustration.

\*\*>

#### ¶ 6.22.01 Drawings Objected To, Details Not Shown

The drawings are objected to under 37 CFR 1.83(a) because they fail to show [1] as described in the specification. Any structural detail that is essential for a proper understanding of the disclosed invention should be shown in the drawing. MPEP § 608.02(d). Corrected drawing sheets are required in reply to the Office action to avoid abandonment of the application. Any amended replacement drawing sheet should include all of the figures appearing on the immediate prior version of the sheet, even if only one figure is being amended. The figure or figure number of an amended drawing should not be labeled as "amended." If a drawing figure is to be canceled, the appropriate figure must be removed from the replacement sheet, and where necessary, the remaining figures must be renumbered and appropriate changes made to the brief description of the several views of the drawings for consistency. Additional replacement sheets may be necessary to show the renumbering of the remaining figures. The replacement sheet(s) should be labeled Replacement Sheet in the page header (as per 37 CFR 1.84(c)) so as not to obstruct any portion of the drawing figures. If the changes are not accepted by the examiner, the applicant will be notified and informed of any required corrective action in the next Office action. The objection to the drawings will not be held in abeyance.



**Examiner Note:**

1. In bracket 1, identify the structural details not shown in the drawings.
2. Unless applicant is otherwise notified in an Office action, objections to the drawings in a utility or plant application will not be held in abeyance, and a request to hold objections to the drawings in abeyance will not be considered a bona fide attempt to advance the application to final action. See 37 CFR 1.85(a).
3. This form paragraph may be followed by form paragraph 6.27 to require a marked up copy of the amended drawing figure(s) including annotations indicating the changes made in the corrected drawings.

*¶ 6.22.04 Drawings Objected to, Incomplete*

The drawings are objected to under 37 CFR 1.83(b) because they are incomplete. 37 CFR 1.83(b) reads as follows:

When the invention consists of an improvement on an old machine the drawing must when possible exhibit, in one or more views, the improved portion itself, disconnected from the old structure, and also in another view, so much only of the old structure as will suffice to show the connection of the invention therewith.

Corrected drawing sheets are required in reply to the Office action to avoid abandonment of the application. Any amended replacement drawing sheet should include all of the figures appearing on the immediate prior version of the sheet, even if only one figure is being amended. The figure or figure number of an amended drawing should not be labeled as “amended.” If a drawing figure is to be canceled, the appropriate figure must be removed from the replacement sheet, and where necessary, the remaining figures must be renumbered and appropriate changes made to the brief description of the several views of the drawings for consistency. Additional replacement sheets may be necessary to show the renumbering of the remaining figures. The replacement sheet(s) should be labeled Replacement Sheet in the page header (as per 37 CFR 1.84(c)) so as not to obstruct any portion of the drawing figures. If the changes are not accepted by the examiner, the applicant will be notified and informed of any required corrective action in the next Office action. The objection to the drawings will not be held in abeyance.

**Examiner Note:**

1. Supply a full explanation, if it is not readily apparent how the drawings are incomplete.
2. Unless applicant is otherwise notified in an Office action, objections to the drawings in a utility or plant application will not be held in abeyance, and a request to hold objections to the drawings in abeyance will not be considered a bona fide attempt to advance the application to final action. See 37 CFR 1.85(a).
3. This form paragraph may be followed by form paragraph 6.27 to require a marked up copy of the amended drawing figure(s) including annotations indicating the changes made in the corrected drawings..

*¶ 6.36 Drawings Do Not Show Claimed Subject Matter*

The drawings are objected to under 37 CFR 1.83(a). The drawings must show every feature of the invention specified in the

claims. Therefore, the [1] must be shown or the feature(s) canceled from the claim(s). No new matter should be entered.

Corrected drawing sheets are required in reply to the Office action to avoid abandonment of the application. Any amended replacement drawing sheet should include all of the figures appearing on the immediate prior version of the sheet, even if only one figure is being amended. The figure or figure number of an amended drawing should not be labeled as “amended.” If a drawing figure is to be canceled, the appropriate figure must be removed from the replacement sheet, and where necessary, the remaining figures must be renumbered and appropriate changes made to the brief description of the several views of the drawings for consistency. Additional replacement sheets may be necessary to show the renumbering of the remaining figures. The replacement sheet(s) should be labeled Replacement Sheet in the page header (as per 37 CFR 1.84(c)) so as not to obstruct any portion of the drawing figures. If the changes are not accepted by the examiner, the applicant will be notified and informed of any required corrective action in the next Office action. The objection to the drawings will not be held in abeyance.

**Examiner Note:**

In bracket 1, insert the features that must be shown.

<

See also MPEP § 608.02.

## 608.02(e) Examiner Determines Completeness and Consistency of Drawings [R-2]

The examiner should see to it that the figures are correctly described in the brief description of the several views of the drawing section of the specification, that the reference characters are properly applied, that no single reference character is used for two different parts or for a given part and a modification of such part, and that there are no superfluous illustrations.

One or more of the following form paragraphs may be used to require correction.

\*\*>

*¶ 6.22.02 Drawings Objected to, Different Numbers Refer to Same Part*

The drawings are objected to as failing to comply with 37 CFR 1.84(p)(4) because reference characters “[1]” and “[2]” have both been used to designate [3]. Corrected drawing sheets are required in reply to the Office action to avoid abandonment of the application. Any amended replacement drawing sheet should include all of the figures appearing on the immediate prior version of the sheet, even if only one figure is being amended. The replacement sheet(s) should be labeled Replacement Sheet in the page header (as per 37 CFR 1.84(c)) so as not to obstruct any portion of the drawing figures. If the changes are not accepted by the examiner, the applicant will be notified and informed of any required correc-

tive action in the next Office action. The objection to the drawings will not be held in abeyance.

**Examiner Note:**

1. In brackets 1 and 2, identify the numbers which refer to the same part.
2. In bracket 3, identify the part which is referred to by different numbers.
3. Unless applicant is otherwise notified in an Office action, objections to the drawings in a utility or plant application will not be held in abeyance, and a request to hold objections to the drawings in abeyance will not be considered a bona fide attempt to advance the application to final action. See 37 CFR 1.85(a).
4. This form paragraph may be followed by form paragraph 6.27 to require a marked up copy of the amended drawing figure(s) including annotations indicating the changes made in the corrected drawings.

*¶ 6.22.03 Drawings Objected to, Different Parts Referred to by Same Number*

The drawings are objected to as failing to comply with 37 CFR 1.84(p)(4) because reference character “[1]” has been used to designate both [2] and [3]. Corrected drawing sheets are required in reply to the Office action to avoid abandonment of the application. Any amended replacement drawing sheet should include all of the figures appearing on the immediate prior version of the sheet, even if only one figure is being amended. The replacement sheet(s) should be labeled Replacement Sheet in the page header (as per 37 CFR 1.84(c)) so as not to obstruct any portion of the drawing figures. If the changes are not accepted by the examiner, the applicant will be notified and informed of any required corrective action in the next Office action. The objection to the drawings will not be held in abeyance.

**Examiner Note:**

1. In bracket 1, identify the number which refers to the different parts.
2. In brackets 2 and 3, identify the parts which are referred to by the same number.
3. Unless applicant is otherwise notified in an Office action, objections to the drawings in a utility or plant application will not be held in abeyance, and a request to hold objections to the drawings in abeyance will not be considered a bona fide attempt to advance the application to final action. See 37 CFR 1.85(a).
4. This form paragraph may be followed by form paragraph 6.27 to require a marked up copy of the amended drawing figure(s) including annotations indicating the changes made in the corrected drawings.

*¶ 6.22.06 Drawings Objected to, Reference Numbers Not in Drawings*

The drawings are objected to as failing to comply with 37 CFR 1.84(p)(5) because they do not include the following reference sign(s) mentioned in the description: [1]. Corrected drawing sheets are required in reply to the Office action to avoid abandonment of the application. Any amended replacement drawing sheet should include all of the figures appearing on the immediate prior version of the sheet, even if only one figure is being amended. The

replacement sheet(s) should be labeled Replacement Sheet in the page header (as per 37 CFR 1.84(c)) so as not to obstruct any portion of the drawing figures. If the changes are not accepted by the examiner, the applicant will be notified and informed of any required corrective action in the next Office action. The objection to the drawings will not be held in abeyance.

**Examiner Note:**

1. In bracket 1, specify the reference characters which are not found in the drawings, including the page and line number where they first occur in the specification.
2. This form paragraph may be modified to require or allow the applicant to delete the reference character(s) from the description instead of adding them to the drawing(s).
3. Unless applicant is otherwise notified in an Office action, objections to the drawings in a utility or plant application will not be held in abeyance, and a request to hold objections to the drawings in abeyance will not be considered a bona fide attempt to advance the application to final action. See 37 CFR 1.85(a).
4. This form paragraph may be followed by form paragraph 6.27 to require a marked up copy of the amended drawing figure(s) including annotations indicating the changes made in the corrected drawings.

*¶ 6.22.07 Drawings Objected to, Reference Numbers Not in Specification*

The drawings are objected to as failing to comply with 37 CFR 1.84(p)(5) because they include the following reference character(s) not mentioned in the description: [1]. Corrected drawing sheets, or amendment to the specification to add the reference character(s) in the description are required in reply to the Office action to avoid abandonment of the application. Any amended replacement drawing sheet should include all of the figures appearing on the immediate prior version of the sheet, even if only one figure is being amended. The replacement sheet(s) should be labeled Replacement Sheet in the page header (as per 37 CFR 1.84(c)) so as not to obstruct any portion of the drawing figures. If the changes are not accepted by the examiner, the applicant will be notified and informed of any required corrective action in the next Office action. The objection to the drawings will not be held in abeyance.

**Examiner Note:**

1. In bracket 1, specify the reference characters which are not found in the specification, including the figure in which they occur.
2. Unless applicant is otherwise notified in an Office action, objections to the drawings in a utility or plant application will not be held in abeyance, and a request to hold objections to the drawings in abeyance will not be considered a bona fide attempt to advance the application to final action. See 37 CFR 1.85(a).
3. This form paragraph may be followed by form paragraph 6.27 to require a marked up copy of the amended drawing figure(s) including annotations indicating the changes made in the corrected drawings.

<

### 608.02(f) Modifications in Drawings [R-2]

Modifications may not be shown in broken lines on figures which show in solid lines another form of the invention. *Ex parte Badger*, 1901 C.D. 195, 97 O.G. 1596 (Comm'r Pat. 1901).

All modifications described must be illustrated, or the text canceled. (*Ex parte Peck*, 1901 C.D. 136, 96 O.G. 2409 (Comm'r Pat. 1901).) This requirement does not apply to a mere reference to minor variations nor to well-known and conventional parts.

Form paragraph 6.22.05 may be used to require correction.

\*\*>

#### ¶ 6.22.05 Drawings Objected to, Modifications in Same Figure

The drawings are objected to under 37 CFR 1.84(h)(5) because Figure [1] show(s) modified forms of construction in the same view. Corrected drawing sheets are required in reply to the Office action to avoid abandonment of the application. Any amended replacement drawing sheet should include all of the figures appearing on the immediate prior version of the sheet, even if only one figure is being amended. The figure or figure number of an amended drawing should not be labeled as "amended." If a drawing figure is to be canceled, the appropriate figure must be removed from the replacement sheet, and where necessary, the remaining figures must be renumbered and appropriate changes made to the brief description of the several views of the drawings for consistency. Additional replacement sheets may be necessary to show the renumbering of the remaining figures. The replacement sheet(s) should be labeled Replacement Sheet in the page header (as per 37 CFR 1.121(d)) so as not to obstruct any portion of the drawing figures. If the changes are not accepted by the examiner, the applicant will be notified and informed of any required corrective action in the next Office action. The objection to the drawings will not be held in abeyance.

#### Examiner Note:

1. In bracket 1, insert the appropriate Figure number(s).
2. Unless applicant is otherwise notified in an Office action, objections to the drawings in a utility or plant application will not be held in abeyance, and a request to hold objections to the drawings in abeyance will not be considered a bona fide attempt to advance the application to final action. See 37 CFR 1.85(a).
3. This form paragraph may be followed by form paragraph 6.27 to require a marked up copy of the amended drawing figure(s) including annotations indicating the changes made in the corrected drawings.

<

### 608.02(g) Illustration of Prior Art [R-2]

Figures showing the prior art are usually unnecessary and should be canceled. *Ex parte Elliott*, 1904 C.D. 103, 109 O.G. 1337 (Comm'r Pat. 1904). However, where needed to understand applicant's invention, they may be retained if designated by a legend such as "Prior Art."

If the prior art figure is not labeled, form paragraph 6.36.01 may be used.

\*\*>

#### ¶ 6.36.01 Illustration of "Prior Art"

Figure [1] should be designated by a legend such as --Prior Art-- because only that which is old is illustrated. See MPEP § 608.02(g). Corrected drawings are required in reply to the Office action to avoid abandonment of the application. The replacement sheet(s) should be labeled Replacement Sheet in the page header (as per 37 CFR 1.121(d)) so as not to obstruct any portion of the drawing figures. If the changes are not accepted by the examiner, the applicant will be notified and informed of any required corrective action in the next Office action. The objection to the drawings will not be held in abeyance.

<

### 608.02(h) \*\*>Replacement< Drawings [R-2]

When an amendment is filed stating that \*\*>replacement< sheets of drawings are filed with the amendment and such drawings have not been transmitted to the Technology Center (TC), the technical support staff in the TC should attempt to locate the missing drawings. In the next communication of the examiner, the applicant is notified if the drawings have been received and whether or not the \*\*>replacement< drawings have been entered in the application. If the \*\*>replacement< drawings are not entered, the examiner should give the applicant a concise and complete explanation as to why the drawings were not entered.

\*\*>Replacement< drawings, together with the file wrapper, may be routed through the TC Draftsperson if the examiner would like the draftsperson's assistance in identifying errors in the drawings. >For Image File Wrapper (IFW) processing, see IFW Manual.< The draftsperson will note any defects of the drawings on a PTO-948.

The examiner should not overlook such factors as new matter, the necessity for the \*>replacement< sheets and consistency with other sheets. The techni-

cal support staff will routinely enter all \*\*>replacement sheets in the contents of the application. For IFW processing, see IFW Manual.< If the examiner decides that the sheets should not be entered, the examiner should provide the applicant with the complete, explicit reasoning for the denial of entry. The entries made by the technical support staff will be marked “(N.E).”

Form paragraph 6.37 may be used to acknowledge \*\*>replacement drawing sheets.

¶ 6.37 *Acknowledgment of Replacement Drawing Sheets*

The drawings were received on [1]. These drawings are [2].

**Examiner Note:**

1. In bracket 2, insert either --acceptable-- or --not acceptable--.
2. If not acceptable because of noncompliance with 37 CFR 1.121(d), an explanation must be provided.
3. If not acceptable because of informalities noted on PTO-948, use form paragraph 6.43.

<

Alternatively, PTOL-326 Office Action Summary includes a block for acknowledgment of \*\*>replacement< drawings.

\*\*

For return of drawing, see MPEP § 608.02(y).

### 608.02(i) Transfer of Drawings From Prior Applications

Transfer of drawings from a first pending application to another will be made only upon the granting of a petition filed under 37 CFR 1.182 which must set forth a hardship situation requiring such transfer of drawings.

### 608.02(m) Drawing Prints [R-2]

Preparation and distribution of drawing prints is discussed in MPEP § 508.

Prints are made of \*>acceptable< drawings of an \* application >maintained in paper<. These prints are kept on top of the papers on the right side of the file wrapper under any bibliographic data sheet. See MPEP § 719.01(b). >No drawing prints are made for an image file wrapper (IFW) application.<

\*\* The original drawing, of course, should not be marked up by the examiner. Where, as in an electrical wiring application, it is desirable to identify the various circuits by different colors, or in any more or less complex application, it is advantageous to apply leg-

ends, arrows, or other indicia, \*\*>the drawing prints may be used and retained unofficially in the file since the drawing prints are no longer needed for a record of the drawings as originally filed. If the application is maintained in paper, the drawing prints, as colored by the examiner, may be retained in the paper application file. If the application is an IFW application, the drawing prints may be retained by the examiner.<

Prints remain in the >paper application< file at all times except as provided in MPEP § 608.02(c).

### INTERFERENCE PRINTS

\*>An interference< print is prepared of each drawing in all applications having a filing date. \*\* The classification of the application should be placed on the interference print. All interference prints are then placed in the interference cabinets.

If an application has several sheets of drawings, the interference prints should be stapled together at their top edges before being filed. If the number of sheets of prints is too large to be stapled, a fastener should be placed through the holes at the top.

The time when the interference prints are removed from the \*>interference< cabinets is determined by the Technology Center Director.

The drawings filed by applicant remain in the >paper< file wrapper.

### 608.02(n) Duplicate Prints in Patentability Report Applications

In patentability report cases having drawings, the examiner to whom the application is assigned should normally obtain a duplicate set of the interference prints of the drawing for filing in the Technology Center (TC) to which the application is referred.

When an application that has had patentability report prosecution is passed for issue or becomes abandoned, notification of this fact is given by the TC having jurisdiction of the case to each TC that submitted a patentability report. The examiner of each such reporting TC notes the date of allowance or abandonment on his or her duplicate set of prints. At such time as these prints become of no value to the reporting TC, they may be destroyed.

For patentability reports, see MPEP § 705 to § 705.01(f).

## 608.02(o) Notations Entered on Drawing [R-2]

\*\*

>Drawings are no longer endorsed with an application number or receipt date.< A drafts person's "stamp" to indicate approval is no longer required on patent drawings, and these stamps are no longer used by drafts persons. If the drawings in an allowed application are not indicated as having been disapproved or canceled, the most-recently filed drawings will be used for printing the patent.

## 608.02(p) Correction of Drawings [R-2]

37 CFR 1.121. *Manner of making amendments in application.*

\*\*\*\*\*

\*\*>

(d) *Drawings.* One or more application drawings shall be amended in the following manner: Any changes to an application drawing must be in compliance with § 1.84 and must be submitted on a replacement sheet of drawings which shall be an attachment to the amendment document and, in the header, labeled "Replacement Sheet." Any replacement sheet of drawings shall include all of the figures appearing on the immediate prior version of the sheet, even if only one figure is amended. All changes to the drawing(s) shall be explained, in detail, in either the drawing amendment or remarks section of the amendment paper.

(1) A marked-up copy of any amended drawing figure, including annotations indicating the changes made, may be included. The marked-up copy must be clearly labeled as "Annotated Marked-up Drawings" and must be presented in the amendment or remarks section that explains the change to the drawings.

(2) A marked-up copy of any amended drawing figure, including annotations indicating the changes made, must be provided when required by the examiner.

<

\*\*\*\*\*

37 CFR 1.85. *Corrections to drawings*

(a) A utility or plant application will not be placed on the files for examination until objections to the drawings have been corrected. Except as provided in § 1.215(c), any patent application publication will not include drawings filed after the application has been placed on the files for examination. Unless applicant is otherwise notified in an Office action, objections to the drawings in a utility or plant application will not be held in abeyance, and a request to hold objections to the drawings in abeyance will not be considered a *bona fide* attempt to advance the application to final action (§ 1.135(c)). If a drawing in a design application meets the requirements of § 1.84(e), (f), and (g) and is suitable for reproduction, but is not otherwise in compliance with § 1.84, the drawing may be admitted for examination.

(b) The Office will not release drawings for purposes of correction. If corrections are necessary, new corrected drawings must be submitted within the time set by the Office.

(c) If a corrected drawing is required or if a drawing does not comply with § 1.84 at the time an application is allowed, the Office may notify the applicant and set a three month period of time from the mail date of the notice of allowability within which the applicant must file a corrected or formal drawing in compliance with § 1.84 to avoid abandonment. This time period is not extendable under § 1.136(a) or § 1.136(b).

For corrections which are deferrable, see MPEP § 608.02(b). For correction at allowance and issue, see MPEP § 608.02(w) and MPEP § 1302.05.

A canceled figure may be reinstated. An amendment should be made to the specification adding the brief description of the view if a canceled figure is reinstated.

The following form paragraphs may be used to notify applicants of drawing corrections.

\*\*

### ¶ 6.39 USPTO No Longer Makes Drawing Changes

The United States Patent and Trademark Office no longer makes drawing changes. See 1017 O.G. 4. It is applicant's responsibility to ensure that the drawings are corrected. Corrections must be made in accordance with the instructions below.

#### Examiner Note:

This form paragraph is to be used whenever the applicant has filed a request for the Office to make drawing changes. Form paragraph 6.40 must follow.

\*\*>

### ¶ 6.40 Information on How To Effect Drawing Changes

#### INFORMATION ON HOW TO EFFECT DRAWING CHANGES

##### Replacement Drawing Sheets

Drawing changes must be made by presenting replacement figures which incorporate the desired changes and which comply with 37 CFR 1.84. An explanation of the changes made must be presented either in the drawing amendments, or remarks, section of the amendment. Any replacement drawing sheet must be identified in the top margin as "Replacement Sheet" (37 CFR 1.121 (d)) and include all of the figures appearing on the immediate prior version of the sheet, even though only one figure may be amended. The figure or figure number of the amended drawing(s) must not be labeled as "amended." If the changes to the drawing figure(s) are not accepted by the examiner, applicant will be notified of any required corrective action in the next Office action. No further drawing submission will be required, unless applicant is notified.

Identifying indicia, if provided, should include the title of the invention, inventor's name, and application number, or docket number (if any) if an application number has not been assigned to

the application. If this information is provided, it must be placed on the front of each sheet and centered within the top margin.

#### **Annotated Drawing Sheets**

A marked-up copy of any amended drawing figure, including annotations indicating the changes made, may be submitted or required by the examiner. The annotated drawing sheets must be clearly labeled as “Annotated Marked-up Drawings” and accompany the replacement sheets.

#### **Timing of Corrections**

Applicant is required to submit acceptable corrected drawings within the time period set in the Office action. See 37 CFR 1.85(a). Failure to take corrective action within the set period will result in **ABANDONMENT** of the application.

If corrected drawings are required in a Notice of Allowability (PTOL-37), the new drawings **MUST** be filed within the **THREE MONTH** shortened statutory period set for reply in the “Notice of Allowability.” Extensions of time may **NOT** be obtained under the provisions of 37 CFR 1.136 for filing the corrected drawings after the mailing of a Notice of Allowability.

#### *¶ 6.41 Reminder That USPTO No Longer Makes Drawing Changes*

Applicant is reminded that the U.S. Patent and Trademark Office no longer makes drawing changes and that it is applicant’s responsibility to ensure that the drawings are corrected in accordance with the instructions set forth in the paper mailed on [1].

#### **Examiner Note:**

This form paragraph is to be used when the applicant has been previously provided with information on how to effect drawing changes (i.e., either by way of form paragraph 6.40 or a PTO-948 has been previously sent).

#### *¶ 6.42 Reminder That Applicant Must Make Drawing Changes*

Applicant is reminded that in order to avoid an abandonment of this application, the drawings must be corrected in accordance with the instructions set forth in the paper mailed on [1].

#### **Examiner Note:**

This form paragraph is to be used when allowing the application and when applicant has previously been provided with information on how to effect drawing changes (i.e., by way of form paragraph 6.40 or a PTO-948 has been previously sent).

<

#### *¶ 6.43 Drawings Contain Informalities, Application Allowed*

The drawings filed on[1] are acceptable subject to correction of the informalities indicated on the attached “Notice of Draftsperson’s Patent Drawing Review,” PTO-948. In order to avoid abandonment of this application, correction is required in reply to the Office action. The correction will not be held in abeyance.

#### **Examiner Note:**

Use this form paragraph when allowing the application, particularly at time of first action issue. Form paragraph 6.40 or 6.41 must follow.

\*\*

#### *¶ 6.47 Examiner’s Amendment Involving Drawing Changes*

The following changes to the drawings have been approved by the examiner and agreed upon by applicant: [1]. In order to avoid abandonment of the application, applicant must make these agreed upon drawing changes.

#### **Examiner Note:**

1. In bracket 1, insert the agreed upon drawing changes.
2. Form paragraphs 6.39 and 6.40 should follow, as appropriate.

### **608.02(q) Conditions Precedent to Amendment of Drawing**

See MPEP § 507 for changes to the patent drawings for purposes of a patent application publication.

If applicant wishes to amend the original drawings, at his or her own initiative, applicant is encouraged to submit new drawings as soon as possible, and preferably before allowance of the application.

\*\*

### **608.02(t) Cancellation of Figures [R-2]**

\*\*>If a drawing figure is canceled, a replacement sheet of drawings must be submitted without the figure (see 37 CFR 1.121(d)). If the canceled drawing figure was the only drawing on the sheet, then only a marked-up copy of the drawing sheet including an annotation showing that the drawing has been cancelled is required. The marked-up (annotated) copy must be clearly labeled as 'Annotated Sheet' and must be presented in the amendment or remarks section of the amendment document which explains the changes to the drawings (see 37 CFR 1.121(d)(1)). The brief description of the drawings should also be amended to reflect this change.<

### **608.02(v) Drawing Changes Which Require \*>Annotated Sheets< [R-2]**

When changes are to be made in the drawing itself, other than mere changes in reference characters, designations of figures, or inking over lines pale and rough, \*\*>an annotated sheet or marked-up copy of the drawing should be filed with a replacement drawing<. Ordinarily, broken lines may be changed to full without a sketch.

\*>Annotated sheets< filed by an applicant and used for correction of the drawing will not be returned. All such \*>annotated sheets< must be in ink or permanent prints.

### **608.02(w) Drawing Changes Which May Be Made Without Applicant's \*>Annotated Sheets< [R-2]**

Where an application is ready for issue except for a slight defect in the drawing not involving change in structure, the examiner will prepare a letter to the applicant indicating the change to be made and \*>include a marked-up copy of< the drawing >showing< the addition or alteration to be made. The marked-up copy of the drawing should be attached to the letter to the applicant >and a copy placed in the application file<.

The correction must be made at applicant's expense.

As a guide to the examiner, the following corrections are illustrative of those that may be made by \*>an annotated sheet<:

(A) Adding two or three reference characters or exponents.

(B) Changing one or two numerals or figure ordinals. *Garrett v. Cox*, 233 F.2d 343, 346, 110 USPQ 52, 54 (CCPA 1956).

(C) Removing superfluous matter.

(D) Adding or reversing directional arrows.

(E) Changing Roman Numerals to Arabic Numerals to agree with specification.

(F) Adding section lines or brackets, where easily executed.

(G) Changing lead lines.

(H) Correcting misspelled legends.

### **608.02(x) \*\* Drawing Corrections >or Changes Accepted Unless Notified Otherwise< [R-2]**

\*\*>Drawing corrections or changes will be entered at the time they are presented, unless applicant is notified to the contrary by the examiner in the action following the amended drawing submission.<

### **CORRECTION \*\*>OR CHANGE NOT ACCEPTED<**

Where the \*\*>corrected or changed drawing is not accepted<, for example, because the \*>submitted corrections or< changes are erroneous, or involve new matter or \*\* do not include all necessary corrections, the >applicant will be notified and informed of any required corrective action in the next Office action. The <examiner should explicitly and clearly set forth all the reasons for not approving the corrections to the drawings in the next communication to the applicant. See MPEP § 608.02(p) for suggested form paragraphs that may be used by examiners to notify applicants of drawing corrections.

### **608.02(y) Return of Drawing [R-2]**

\*\*>Drawings< will not be returned to the applicant.

### **608.02(z) Allowable Applications Needing Drawing Corrections or Corrected Drawings [R-2]**

If an application is being allowed, and corrected drawings have not been filed, form PTOL-37 provides an appropriate check box for requiring corrected drawings.

Allowable applications with \* drawings >that were indicated by the applicant to be informal< should be turned in for counting and forwarding to the Publishing Division without the drawings having been corrected. Examiners should not require new drawings merely because the applicant indicated that the drawings submitted on filing were informal. \*>If at allowance, the examiner determines that correction is required, the< drawings requiring correction should be placed as the top papers in the center fold of the file wrapper >, if the application is maintained in paper. For Image File Wrapper (IFW) processing, see IFW Manual<. A proposed drawing correction, for example a drawing sheet with corrections marked in pencil, should be stapled to the right outside flap of the file wrapper over the area having the search information. Care should be taken to make certain that the corrections have been approved by the examiner. Such approval should be made by the examiner prior to counting the allowance of the application by writing "Approved," the examiner's initials or full name,

and the date, on the front page of the proposed drawing corrections.

Extensions of time to provide acceptable drawings after the mailing of a notice of allowability are no longer permitted. \*\* If the Office of Publications receives drawings that cannot be scanned or are otherwise unacceptable for publication, the Office of Publication will mail a requirement for corrected drawings, giving applicant a shortened statutory period of two months (with no extensions of time permitted) to reply. The drawings will ordinarily not be returned to the examiner for corrections.

>

### **I. < APPLICATIONS HAVING LOST DRAWINGS**

A replacement drawing should be obtained from the Office of Initial Patent Examination's records of the application as originally filed. If the reproduced drawings are not acceptable for publishing, applicant should be required to submit corrected drawings.

The Notice of Allowability is verified and printed using PALM, and the Notice is mailed to the applicant.

The application is then forwarded to Licensing and Review or the Publishing Division, as appropriate, using the PALM transaction code after the application has been revised for issue.

>

### **II. < UTILITY PATENT APPLICATIONS RECEIVING FORMAL DRAWINGS AFTER THE NOTICE OF ALLOWABILITY**

Where \*>replacement< drawings are received in utility patent applications examined with informal drawings and the Notice of Allowability was mailed prior to the receipt of the \*>replacement< drawings, the technical support staff should forward the \*>replacement< drawings to the Publishing Division. Submission to the examiner is not necessary unless an amendment accompanies the drawings which changes the specification, such as where the description of figures is added or canceled.

>

### **III. < BORROWING FILES FROM PUBLISHING DIVISION**

Allowed files requiring drawing corrections are sent to the Publishing Division. At times, examiners have a need to borrow these applications. When borrowing applications, examining corps personnel must submit a request to the Office of Patent Publications Customer Service Center.

>

### **IV. < 37 CFR 1.312 AMENDMENTS**

\*\*>For information on handling amendments to drawings filed under 37 CFR 1.312, see MPEP § 714.16.<

\*\*

## **608.03 Models, Exhibits, Specimens [R-2]**

*35 U.S.C. 114. Models, specimens.*

The Director may require the applicant to furnish a model of convenient size to exhibit advantageously the several parts of his invention.

When the invention relates to a composition of matter, the Director may require the applicant to furnish specimens or ingredients for the purpose of inspection or experiment.

*37 CFR 1.91. Models or exhibits not generally admitted as part of application or patent.*

(a) A model or exhibit will not be admitted as part of the record of an application unless it:

(1) Substantially conforms to the requirements of § 1.52 or § 1.84;

(2) Is specifically required by the Office; or

(3) Is filed with a petition under this section including:

(i) The fee set forth in § 1.17(h); and

(ii) An explanation of why entry of the model or exhibit in the file record is necessary to demonstrate patentability.

(b) Notwithstanding the provisions of paragraph (a) of this section, a model, working model, or other physical exhibit may be required by the Office if deemed necessary for any purpose in examination of the application.

Models or exhibits are generally not admitted as part of an application or patent unless the requirements of 37 CFR 1.91 are satisfied.

With the exception of cases involving perpetual motion, a model is not ordinarily required by the Office to demonstrate the \*>operability< of a device. If \*>operability< of a device is questioned, the appli-



cant must establish it to the satisfaction of the examiner, but he or she may choose his or her own way of so doing.

A physical exhibit, not to be part of the application, is generally not refused except when bulky or dangerous. Such exhibit, if left with the examiner, may be disposed of at the discretion of the Office.

*37 CFR 1.93. Specimens.*

When the invention relates to a composition of matter, the applicant may be required to furnish specimens of the composition, or of its ingredients or intermediates, for the purpose of inspection or experiment.

See MPEP Chapter 2400 regarding treatment of biotechnology deposits.

### **608.03(a) Handling of Models, Exhibits, and Specimens [R-2]**

All models and exhibits received in the U.S. Patent and Trademark Office should be taken to the Technology Center (TC) assigned the related application for examination. The receipt of all models and exhibits which are to be entered into the application file record must be properly recorded on the "Contents" portion of the application file wrapper >or, if the application is an Image File Wrapper (IFW) application, on an artifact sheet. For IFW processing, see IFW Manual section 3.6<.

A label indicating the application number, filing date, and attorney's name and address should be attached to the model or exhibit so that it is clearly identified and easily returned after prosecution of the application is closed, if return is requested and the model or exhibit is deemed not necessary for the examination of the application. See 37 CFR 1.94.

If the model or exhibit cannot be conveniently stored within the application file wrapper >or in an artifact folder<, it should not be accepted.

Models and exhibits may be presented for demonstration purposes during an interview. The models and exhibits should be taken away by applicant or his/her attorney or agent at the conclusion of the interview since models or exhibits are generally not permitted to be admitted as part of the application or patent unless the requirements of 37 CFR 1.91 are satisfied. See MPEP § 713.08. A full description of what was demonstrated or exhibited during the interview must be made of record. See 37 CFR 1.133. Any model or

exhibit that is left with the examiner at the conclusion of the interview, which is not made part of the application or patent, may be disposed of at the discretion of the Office.

*37 CFR 1.94. Return of models, exhibits or specimens.*

\*\*>Models, exhibits, or specimens in applications which have become abandoned, and also in other applications on conclusion of the prosecution, may be returned to the applicant upon demand and at his expense, unless it is deemed necessary that they be preserved in the Office. Such physical exhibits in contested cases may be returned to the parties at their expense. If not claimed within a reasonable time, they may be disposed of at the discretion of the Director.<

Upon request by applicant for the return of a model or exhibit, the model or exhibit will be returned to applicant at applicant's expense if (\*>A<) the examiner determines that it is not necessary to preserve the model or exhibit in the Office, and (\*>B<) the model or exhibit has not been earlier disposed of by the Office. A letter should be written to applicant by the TC stating that the model or exhibit is being returned under separate cover, and the model or exhibit should be forwarded with a copy of the letter and an address label to the Mail Center for wrapping and return.

For disposition of exhibits which are part of the record, see MPEP § 715.07(d).

For plant specimens, see MPEP § 1607 and 37 CFR 1.166.

*37 CFR 1.95. Copies of exhibits.*

\*\*>Copies of models or other physical exhibits will not ordinarily be furnished by the Office, and any model or exhibit in an application or patent shall not be taken from the Office except in the custody of an employee of the Office specially authorized by the Director.<

### **608.04 New Matter**

*37 CFR 1.121. Manner of making amendments in applications.*

\*\*\*\*\*

(f) *No new matter.* No amendment may introduce new matter into the disclosure of an application.

\*\*\*\*\*

In establishing a disclosure, applicant may rely not only on the specification and drawing as filed but also on the original claims if their content justifies it. See MPEP § 608.01(1).

While amendments to the specification and claims involving new matter are ordinarily entered, such

matter is required to be canceled from the descriptive portion of the specification, and the claims affected are rejected under 35 U.S.C. 112, first paragraph.

When new matter is introduced into the specification, the amendment should be objected to under 35 U.S.C. 132 (35 U.S.C. 251 if a reissue application) and a requirement made to cancel the new matter. The subject matter which is considered to be new matter must be clearly identified by the examiner. If the new matter has been entered into the claims or affects the scope of the claims, the claims affected should be rejected under 35 U.S.C. 112, first paragraph, because the new matter is not described in the application as originally filed.

A “new matter” amendment of the drawing is ordinarily not entered; neither is an additional or substitute sheet containing “new matter” even though provisionally entered by the TC technical support staff. See MPEP § 608.02(h).

The examiner’s holding of new matter may be petitionable or appealable. See MPEP § 608.04(c).

For new matter in reissue application, see MPEP § 1411.02. For new matter in substitute specification, see MPEP § 608.01(q).

**Note:** No amendment is permitted in a provisional application after it receives a filing date.

### **608.04(a) Matter Not in Original Specification, Claims, or Drawings**

Matter not in the original specification, claims, or drawings is usually new matter. Depending on circumstances such as the adequacy of the original disclosure, the addition of inherent characteristics such as chemical or physical properties, a new structural formula or a new use may be new matter. See *Ex parte Vander Wal*, 109 USPQ 119, 1956 C.D. 11, 705 O.G. 5 (Bd. App. 1955) (physical properties), *Ex parte Fox*, 128 USPQ 157, 1960 C.D. 28, 761 O.G. 906 (Bd. App. 1957) (new formula) and *Ex parte Ayers*, 108 USPQ 444 (Bd. App. 1955) (new use). For rejection of claim involving new matter, see MPEP § 706.03(o).

For completeness of disclosure, see MPEP § 608.01(p). For trademarks and tradenames, see MPEP § 608.01(v).

### **608.04(b) New Matter by Preliminary Amendment [R-2]**

An amendment is sometimes filed along with the filing of the application. Where a 37 CFR 1.53(b) application is filed without a signed oath or declaration and such application is accompanied by an amendment, that amendment is considered a part of the original disclosure. The subsequently filed oath or declaration must refer to both the application and the amendment. See MPEP § 714.01(e).

An amendment which adds additional disclosure filed with a request for a continuation-in-part application filed prior to December 1, 1997 under former 37 CFR 1.62 is automatically considered a part of the original disclosure of the application by virtue of the rule. Therefore, the oath or declaration filed in such an application must identify the amendment adding additional disclosure as one of the papers which the inventor(s) has “reviewed and understands” in order to comply with 37 CFR 1.63. If the original oath or declaration submitted in a continuation-in-part application filed prior to December 1, 1997 under former 37 CFR 1.62 does not contain a reference to the amendment filed with the request for an application under former 37 CFR 1.62, the examiner must require a supplemental oath or declaration referring to the amendment.

### **608.04(c) Review of Examiner’s Holding of New Matter**

Where the new matter is confined to amendments to the specification, review of the examiner’s requirement for cancellation is by way of petition. But where the alleged new matter is introduced into or affects the claims, thus necessitating their rejection on this ground, the question becomes an appealable one, and should not be considered on petition even though that new matter has been introduced into the specification also. 37 CFR 1.181 and 37 CFR 1.191 afford the explanation of this seemingly inconsistent practice as affecting new matter in the specification.

## 608.05 Sequence Listing Table, or Computer Program Listing Appendix Submitted on a Compact Disc [R-2]

37 CFR 1.52. *Language, paper, writing, margins, compact disc specifications.*

\*\*\*\*\*

(e) *Electronic documents that are to become part of the permanent United States Patent and Trademark Office records in the file of a patent application or reexamination proceeding.*

(1) The following documents may be submitted to the Office on a compact disc in compliance with this paragraph:

- (i) A computer program listing (see § 1.96);
- (ii) A “Sequence Listing” (submitted under § 1.821(c)); or
- (iii) A table (see § 1.58) that has more than 50 pages of text.

(2) A compact disc as used in this part means a Compact Disc-Read Only Memory (CD-ROM) or a Compact Disc-Recordable (CD-R) in compliance with this paragraph. A CD-ROM is a “read-only” medium on which the data is pressed into the disc so that it cannot be changed or erased. A CD-R is a “write once” medium on which once the data is recorded, it is permanent and cannot be changed or erased.

(3)(i) Each compact disc must conform to the International Standards Organization (ISO) 9660 standard, and the contents of each compact disc must be in compliance with the American Standard Code for Information Interchange (ASCII).

(ii) Each compact disc must be enclosed in a hard compact disc case within an unsealed padded and protective mailing envelope and accompanied by a transmittal letter on paper in accordance with paragraph (a) of this section. The transmittal letter must list for each compact disc the machine format (*e.g.*, IBM-PC, Macintosh), the operating system compatibility (*e.g.*, MS-DOS, MS-Windows, Macintosh, Unix), a list of files contained on the compact disc including their names, sizes in bytes, and dates of creation, plus any other special information that is necessary to identify, maintain, and interpret the information on the compact disc. Compact discs submitted to the Office will not be returned to the applicant.

(4) Any compact disc must be submitted in duplicate unless it contains only the “Sequence Listing” in computer readable form required by § 1.821(e). The compact disc and duplicate copy must be labeled “Copy 1” and “Copy 2,” respectively. The transmittal letter which accompanies the compact disc must include a statement that the two compact discs are identical. In the event that the two compact discs are not identical, the Office will use the compact disc labeled “Copy 1” for further processing. Any amendment to the information on a compact disc must be by way of a replacement compact disc in compliance with this paragraph containing the substitute information, and must be accompanied by a statement that the replacement compact disc contains no new matter. The compact disc and copy must be labeled “COPY 1 REPLACEMENT MM/DD/YYYY” (with the month, day and

year of creation indicated), and “COPY 2 REPLACEMENT MM/DD/YYYY,” respectively.

(5) The specification must contain an incorporation-by-reference of the material on the compact disc in a separate paragraph (§ 1.77(b)(4)), identifying each compact disc by the names of the files contained on each of the compact discs, their date of creation and their sizes in bytes. The Office may require applicant to amend the specification to include in the paper portion any part of the specification previously submitted on compact disc.

(6) A compact disc must also be labeled with the following information:

- (i) The name of each inventor (if known);
  - (ii) Title of the invention;
  - (iii) The docket number, or application number if known, used by the person filing the application to identify the application; and
  - (iv) A creation date of the compact disc.
- (v) If multiple compact discs are submitted, the label shall indicate their order (*e.g.* “1 of X”).
- (vi) An indication that the disk is “Copy 1” or “Copy 2” of the submission. See paragraph (b)(4) of this section.

(7) If a file is unreadable on both copies of the disc, the unreadable file will be treated as not having been submitted. A file is unreadable if, for example, it is of a format that does not comply with the requirements of paragraph (e)(3) of this section, it is corrupted by a computer virus, or it is written onto a defective compact disc.

### 37 CFR 1.77. *Arrangement of application elements.*

(a) The elements of the application, if applicable, should appear in the following order:

- (1) Utility application transmittal form.
- (2) Fee transmittal form.
- (3) Application data sheet (see § 1.76).
- (4) Specification.
- (5) Drawings.
- (6) Executed oath or declaration.

(b) The specification should include the following sections in order:

- (1) Title of the invention, which may be accompanied by an introductory portion stating the name, citizenship, and residence of the applicant (unless included in the application data sheet).
- (2) Cross-reference to related applications (unless included in the application data sheet).
- (3) Statement regarding federally sponsored research or development.
- (4) Reference to a “Sequence Listing,” a table, or a computer program listing appendix submitted on a compact disc and an incorporation-by-reference of the material on the compact disc (see § 1.52(e)(5)). The total number of compact discs including duplicates and the files on each compact disc shall be specified.
- (5) Background of the invention.
- (6) Brief summary of the invention.
- (7) Brief description of the several views of the drawing.
- (8) Detailed description of the invention.
- (9) A claim or claims.
- (10) Abstract of the disclosure.

(11)“Sequence Listing,” if on paper (see §§ 1.821 through 1.825).

(c) The text of the specification sections defined in paragraphs (b)(1) through (b)(11) of this section, if applicable, should be preceded by a section heading in uppercase and without underlining or bold type.

Special procedures for the presentation of large tables, computer program listings and certain biosequences on compact discs are set forth in 37 CFR 1.52(e). Use of compact discs is desirable in view of the lengthy data listings being submitted as part of the disclosure in some patent applications. Such listings are often several hundred pages or more in length. By filing and publishing such data listings on compact disc rather than on paper, substantial cost savings can result to the applicants, the public, and the U.S. Patent and Trademark Office.

## BACKGROUND

A compact disc submitted under 37 CFR 1.52(e) must either be a CD-ROM or a CD-R. A CD-ROM is made by a process of pressing the disc from a master template; the data cannot be erased or rewritten. A CD-R is a compact disc that has a recording medium only capable of writing once. CD-RW type media which are erasable and rewriteable are not acceptable. Limiting the media types to CD-ROM and CD-R media will ensure the longevity and integrity of the data submitted. The files stored on the compact disc must contain only ASCII characters. No non-ASCII characters or proprietary file formats are permitted. A text viewer is recommended for viewing ASCII files. While virtually any word processor may be used to view an ASCII file, care must be taken since a word processor will often not distinguish ASCII and non-ASCII files when displayed. For example, a word processor normally does not display hidden proprietary non-ASCII characters used for formatting when viewing a non-ASCII word processor file.

Compact disc(s) filed on the date that the application was accorded a filing date are to be treated as part of the originally filed disclosure even if the requisite “incorporation by reference” statement (see 37 CFR 1.77(b)(4)) is omitted. Similarly, if a preliminary amendment that accompanies the application when it is filed in the Office is identified in the oath or declaration, and the preliminary amendment includes compact disc(s), the compact disc(s) will be treated as part of the original disclosure. The compact disc(s) is con-

sidered part of the original disclosure by virtue of its inclusion with the application on the date the application is accorded a filing date. The incorporation by reference statement of the material on the compact disc is required to be part of the specification to allow the Office the option of separately printing the material on compact disc. The examiner should require applicant(s) to insert this statement if it is omitted or the examiner may insert the statement by examiner’s amendment at the time of allowance.

All compact discs submitted under 37 CFR 1.52(e) must be submitted in duplicate labeled as “copy 1” and “copy 2” respectively. If more than one compact disc is required to hold all of the information, each compact disc must be submitted in duplicate to form two sets of discs: one set labeled “copy 1” and a second set labeled “copy 2.” Both disc copies should initially be routed to the Office of Initial Patent Examination (OIPE). The compact discs will be checked by OIPE for viruses, readability, the presence of non-ASCII files, and compliance with the file and disc labeling requirements. OIPE will retain one copy of the discs and place the other copy in a holder fastened into the application file jacket. >For Image File Wrapper (IFW) processing, see IFW Manual sections 2.2 and 3.6.< In the event that there is not a complete set of files on both copies of the originally filed discs, OIPE will retain the originally filed discs and send a notice to the applicant to submit an additional complete copy. For provisional applications, OIPE will provide applicant notification and, where appropriate, require correction for virus infected compact discs, unreadable compact discs (or unreadable files thereon), and missing duplicate discs. An amendment to the material on a compact disc must be done by submitting a replacement compact disc with the amended file(s). The amendment should include a corresponding amendment to the description of the compact disc and the files contained on the compact disc in the paper portion of the specification. A replacement compact disc containing the amended files must contain all of the files of the original compact disc that were not amended. This will insure that the Office, printer, and public can quickly access all of the current files in an application or patent by referencing only the latest set of compact discs.

Compact discs should be stored in the compact disc holder provided in each application file. The compact

discs, especially the non-label side, should not be scratched, marked or otherwise altered or deformed. Compact discs and application files containing compact discs should not be stored in areas exposed to heat and humidity that might damage the discs.

If a compact disc becomes damaged or lost from the file wrapper, OIPE will make a duplicate replacement copy of the disc from the copy retained in OIPE. At time of allowance, if a replacement disc is required, the application file and replacement request should be forwarded to OIPE to provide the replacement disc.

Examiners may view the files on the application compact disc using virtually any text reader or the MS Word word processor software installed on their workstation. Special text viewing software will be provided on examiner workstations in Technology Centers that receive ASCII files that are not readily readable using the MS Word word processor software.

The following form paragraphs may be used to notify applicant of corrections needed with respect to compact disc submissions.

*¶ 6.60.01 CD-ROM/CD-R Requirements (No Statement that CDs are Identical)*

This application is objected to under 37 CFR 1.52(e)(4) because it does not contain a statement in the transmittal letter that the two compact discs are identical. Correction is required.

*¶ 6.60.02 CD-ROM/CD-R Requirements (No Listing in Transmittal Letter)*

This application is objected to because it contains a data file on CD-ROM/CD-R, however, the transmittal letter does not list for each compact disc, the machine format, the operating system compatibility, a list of files contained on the compact disc including their names, sizes in bytes, and dates of creation, plus any other special information that is necessary to identify, maintain, and interpret the information on the compact disc as required by 37 CFR 1.52(e)(3). A statement listing the required information is required.

*¶ 6.61.01 Specification Lacking List of Compact Disc(s) and /or Associated Files*

Portions of this application are contained on compact disc(s). When portions of an application are contained on a compact disc, the paper portion of the specification must identify the compact disc(s) and list the files including name, file size, and creation date on each of the compact discs. See 37 CFR 1.52(e). Compact disc labeled [1] is not identified in the paper portion of the specification with a listing of all of the files contained on the disc. Applicant is required to amend the specification to identify each disc and the files contained on each disc including the file name, file size, and file creation date.

**Examiner Note:**

In bracket 1, insert the name on the label of the compact disc.

*¶ 6.61.02 Specification Lacking An Incorporation By Reference Statement for the Compact Disc*

This application contains compact disc(s) as part of the originally filed subject matter, but does not contain an incorporation by reference statement for the compact discs. See 37 CFR 1.77(b)(4). Applicant(s) are required to insert in the specification an incorporation-by-reference of the material on the compact disc(s).

*¶ 6.62 Data File on CD-ROM/CD-R Not in ASCII File Format*

This application contains a data file on CD-ROM/CD-R that is not in an ASCII file format. See 37 CFR 1.52(e). File [1] is not in an ASCII format. Applicant is required to resubmit file(s) in ASCII format. No new matter may be introduced in presenting the file(s) in ASCII format.

**Examiner Note:**

1. This form paragraph must be used to indicate whenever a data file (table, computer program listing or Sequence Listing) is submitted in a non-ASCII file format. The file may be in a file format that is proprietary, e.g., a Microsoft Word, Excel or Word Perfect file format; and/or the file may contain non-ASCII characters.
2. In bracket 1, insert the name of the file and whether the file is a non-text proprietary file format and/or contains non-ASCII characters.

The following form paragraphs should be used to respond to amendments which include amended or substituted compact discs.

*¶ 6.70.01 CD-ROM/CD-R Requirements (Amendment Does Not Include Statement that CDs are Identical)*

The amendment filed [1] is objected to under 37 CFR 1.52(e)(4) because it does not contain a statement in the transmittal letter that the two compact discs are identical. Correction is required.

*¶ 6.70.02 CD-ROM/CD-R Requirements (No Listing in Transmittal Letter Submitted With Amendment)*

The amendment filed [1] contains data on compact disc(s). Compact disc labeled [2] is not identified in the transmittal letter and/or the transmittal letter does not list for each compact disc, the machine format, the operating system compatibility, a list of files contained on the compact disc including their names, sizes in bytes, and dates of creation, plus any other special information that is necessary to identify, maintain, and interpret the information on the compact disc as required by 37 CFR 1.52(e)(3). A statement listing the required information is required.

**Examiner Note:**

1. Use this form paragraph when the transmittal letter does not include a listing of the files and required information.
2. In bracket 1, insert the date of the amendment.
3. In bracket 2, insert the name on the label of the compact disc.

¶ 6.71.01 *Specification Lacking List of Compact Disc(s) and/or Associated Files (Amendment Filed With Compact Disc(s))*

The amendment filed [1] contains data on compact disc(s). Compact disc labeled [2] is not identified in the paper portion of the specification with a listing of all of the files contained on the disc. Applicant is required to amend the specification to identify each disc and the files contained on each disc including the file name, file size, and file creation date. See 37 CFR 1.52(e).

**Examiner Note:**

1. In bracket 1, insert the date of the amendment.
2. In bracket 2, insert the name on the label of the compact disc.

¶ 6.71.02 *Specification Lacking An Incorporation By Reference Statement for the Compact Disc (Amendment Filed With Compact Disc)*

The amendment filed [1] amends or adds a compact disc(s). See 37 CFR 1.77(b)(4) and 1.52(e)(5). Applicant is required to update or insert an incorporation-by-reference of the material on the compact disc(s) in the specification.

**Examiner Note:**

1. Use this form paragraph when the CD-ROM/CD-R is filed with an amendment, but the required incorporation-by-reference statement is neither amended nor added to the specification.
2. In bracket 1, insert the date of the amendment.

¶ 6.72.01 *CD-ROM/CD-R Requirements (CDs Not Identical)*

The amendment filed [1] is objected to under 37 CFR 1.52(e)(4) because the two compact discs are not identical. Correction is required.

**Examiner Note:**

1. Use this form paragraph when the two compact discs are not identical.
2. See also form paragraph 6.70.01 where the transmittal letter does not include a statement that the two compact discs are identical.

¶ 6.72.02 *Data File, Submitted With Amendment, on CD-ROM/CD-R Not in ASCII File Format*

The amendment filed [1] contains a data file on CD-ROM/CD-R that is not in an ASCII file format. File [2] is not in an ASCII format. Applicant is required to resubmit file(s) in ASCII format as required by 37 CFR 1.52(e)(3). No new matter may be introduced in presenting the file(s) in ASCII format.

**Examiner Note:**

1. This form paragraph must be used whenever a data file (table, computer program listing or Sequence Listing) is submitted in a non-ASCII file format. The file may be in a file format that is proprietary, e.g., a Microsoft Word, Excel or Word Perfect file format; and/or the file contains non-ASCII characters.
2. In bracket 1, insert the date of the amendment.
3. In bracket 2, insert the name of the file and whether the file is a non-text proprietary file format and/or contains non-ASCII characters.

¶ 6.72.03 *CD-ROM/CD-R Are Not Readable*

The amendment filed [1] contains a data file on CD-ROM/CD-R that is unreadable. Applicant is required to resubmit the file(s) in International Standards Organization (ISO) 9660 standard and American Standard Code for Information Interchange (ASCII) format as required by 37 CFR 1.52(e)(3). No new matter may be introduced in presenting the file in ISO 9660 and ASCII format.

¶ 6.72.04 *CD-ROM/CD-R Contains Viruses*

The amendment filed [1] is objected to because the compact disc contains at least one virus. Correction is required.

¶ 6.72.05 *CD-ROM/CD-R Requirements (Missing Files On Amended Compact Disc)*

The amendment to the application filed [1] is objected to because the newly submitted compact disc(s) do not contain all of the unamended data file(s) together with the amended data file(s) that were on the CD-ROM/CD-R. Since amendments to a compact disc can only be made by providing a replacement compact disc, the replacement disc must include all of the files, both amended and unamended, to be a complete replacement.

**Examiner Note:**

Use this form paragraph when a replacement compact disc is submitted that fails to include all of the files on the original compact disc(s) that have not been cancelled by amendment.

## 608.05(a) Deposit of Computer Program Listings [R-2]

### 37 CFR 1.96. *Submission of computer program listings.*

(a) *General.* Descriptions of the operation and general content of computer program listings should appear in the description portion of the specification. A computer program listing for the purpose of this section is defined as a printout that lists in appropriate sequence the instructions, routines, and other contents of a program for a computer. The program listing may be either in machine or machine-independent (object or source) language which will cause a computer to perform a desired procedure or task such as solve a problem, regulate the flow of work in a computer, or control or monitor events. Computer program listings may be submitted in patent applications as set forth in paragraphs (b) and (c) of this section.

(b) *Material which will be printed in the patent* If the computer program listing is contained in 300 lines or fewer, with each line of 72 characters or fewer, it may be submitted either as drawings or as part of the specification.

(1) *Drawings.* If the listing is submitted as drawings, it must be submitted in the manner and complying with the requirements for drawings as provided in § 1.84. At least one figure numeral is required on each sheet of drawing.

(2) *Specification.*

(i) If the listing is submitted as part of the specification, it must be submitted in accordance with the provisions of § 1.52.

(ii) Any listing having more than 60 lines of code that is submitted as part of the specification must be positioned at the

end of the description but before the claims. Any amendment must be made by way of submission of a substitute sheet.

(c) *As an appendix which will not be printed:* Any computer program listing may, and any computer program listing having over 300 lines (up to 72 characters per line) must, be submitted on a compact disc in compliance with § 1.52(e). A compact disc containing such a computer program listing is to be referred to as a “computer program listing appendix.” The “computer program listing appendix” will not be part of the printed patent. The specification must include a reference to the “computer program listing appendix” at the location indicated in § 1.77(b)(4).

(1) Multiple computer program listings for a single application may be placed on a single compact disc. Multiple compact discs may be submitted for a single application if necessary. A separate compact disc is required for each application containing a computer program listing that must be submitted on a “computer program listing appendix.”

(2) The “computer program listing appendix” must be submitted on a compact disc that complies with § 1.52(e) and the following specifications (no other format shall be allowed):

(i) Computer Compatibility: IBM PC/XT/AT, or compatibles, or Apple Macintosh;

(ii) Operating System Compatibility: MS-DOS, MS-Windows, Unix, or Macintosh;

(iii) Line Terminator: ASCII Carriage Return plus ASCII Line Feed;

(iv) Control Codes: the data must not be dependent on control characters or codes which are not defined in the ASCII character set; and

(v) Compression: uncompressed data.

Special procedures for presentation of computer program listings in the form of compact disc files in U.S. national patent applications are set forth in 37 CFR 1.96. Use of compact disc files is desirable in view of the number of computer program listings being submitted as part of the disclosure in patent applications. Such listings are often several hundred pages in length. By filing and publishing such computer program listings on compact discs rather than on paper, substantial cost savings can result to the applicants, the public, and the U.S. Patent and Trademark Office.

>

## I. < BACKGROUND

A computer program listing, as used in these rules, means the printout that lists, in proper sequence, the instructions, routines, and other contents of a program for a computer. The listing may be either in machine or machine-independent (object or source) programming language which will cause a computer to perform a desired task, such as solving a problem,

regulating the flow of work in computer, or controlling or monitoring events. The general description of the computer program listing will appear in the specification while the computer program listing may appear either directly or as a computer program listing on compact disc appendix to the specification and be incorporated into the specification by reference.

Copies of publicly available computer program listings are available from the U.S. Patent and Trademark Office on paper and on compact disc at the cost set forth in 37 CFR 1.19(a).

>

## II. < DISCUSSION OF THE BACKGROUND AND MAJOR ISSUES INVOLVED

The provisions of 37 CFR 1.52 and 37 CFR 1.84 for submitting specifications and drawings on paper have been found suitable for most patent applications. However, when lengthy computer program listings must be disclosed in a patent application in order to provide a complete disclosure, use of paper copies can become burdensome. The cost of printing long computer programs in patent documents is also very expensive to the U.S. Patent and Trademark Office. Under 37 CFR 1.96, several different methods for submitting computer program listings, including the use of compact discs, are set forth. A computer program listing contained on three hundred printout lines or less may be submitted either as drawings (in compliance with 37 CFR 1.84), as part of the written specification (in compliance with 37 CFR 1.52), or on compact disc (in compliance with 37 CFR 1.52(e)). A computer program listing contained on three hundred and one (301) printout lines or more must be submitted as ASCII files on compact discs (in compliance with 37 CFR 1.96(c)).

Form paragraphs 6.64.01 through 6.64.03 may be used to notify the applicant of this requirement.

\*\*>

### ¶ 6.64.01 *Computer Program Listing Appendix on Compact Disc Requirement*

The description portion of this application contains a computer program listing consisting of more than three hundred (300) lines. In accordance with 37 CFR 1.96(c), a computer program listing of more than three hundred lines must be submitted as a computer program listing appendix on compact disc conforming to the standards set forth in 37 CFR 1.96(c)(2) and must be appropriately referenced in the specification (see 37 CFR 1.77(b)(4)). Accordingly, applicant is required to cancel the computer program listing

appearing in the specification on pages [1], file a computer program listing appendix on compact disc in compliance with 37 CFR 1.96(c), and insert an appropriate reference to the newly added computer program listing appendix on compact disc at the beginning of the specification.

**Examiner Note:**

1. This form paragraph must be used whenever a computer program listing consisting of more than three hundred lines is included as part of the descriptive portion of the specification if the computer program listing was filed on or after September 8, 2000. See MPEP § 608.05(a).
2. In bracket 1, insert the range of page numbers of the specification which include the computer program listing.

*¶ 6.64.02 Computer Program Listing as Printout Within the Specification (More Than 60 Lines And Not More Than Three Hundred Lines)*

This application contains a computer program listing of over sixty (60) lines and less than three hundred and one (301) lines within the written specification. In accordance with 37 CFR 1.96(b), a computer program listing contained on over sixty (60) lines and less than three hundred-one (301) lines must, if submitted as part of the specification, be positioned at the end of the specification and before the claims. Accordingly, applicant is required to cancel the computer program listing and either incorporate such listing in a compact disc in compliance with 37 CFR 1.96, or insert the computer program listing after the detailed description of the invention but before the claims, in the form of direct printouts from a computer's printer with dark solid black letters not less than 0.21 cm. high, on white, unshaded and unlined paper.

**Examiner Note:**

This form paragraph must be used whenever a computer program listing consisting of a paper printout of more than 60 lines and no more than three hundred lines is included as part of the descriptive portion of the specification and the computer program listing was filed on or after September 8, 2000. See MPEP § 608.05(a).

*¶ 6.64.03 Computer Program Listing of More Than Three Hundred Lines*

This application contains a computer program listing of more than three hundred (300) lines. In accordance with 37 CFR 1.96(c), a computer program listing contained on more than three hundred (300) lines must be submitted as a computer program listing appendix on compact disc conforming to the standards set forth in 37 CFR 1.96(c)(2) and must be appropriately referenced in the specification (see 37 CFR 1.77(b)(4)). Accordingly, applicant is required to cancel the current computer program listing, file a computer program listing appendix on compact disc in compliance with 37 CFR 1.96(c), and insert an appropriate reference to the newly added computer program listing appendix on compact disc at the beginning of the specification.

**Examiner Note:**

This form paragraph must be used whenever a computer program listing consisting of a paper printout of more than three hundred lines is filed on or after September 8, 2000.

A computer program listing of more than three hundred lines will not be printed in any patent application publication, patent, or Statutory Invention Registration. See 37 CFR 1.96(c).<

**III. < OTHER INFORMATION**

A computer program listing on compact disc filed with a patent application will be referred to as a Computer Program Listing Appendix on compact disc and will be identified as such on the front page of the patent but will not be part of the printed patent. "Computer Program Listing Appendix on compact disc" denotes the total computer program listing files contained on all compact discs. The face of the file wrapper will bear a label to denote that an appendix on compact disc is included in the application. A statement must be included in the specification to the effect that a computer program listing appendix on compact disc is included in the application. The specification entry must appear at the beginning of the specification immediately following any cross-reference to related applications. 37 CFR 1.77 (b)(4). \*\* When an application containing compact discs is received in the Office of Initial Patent Examination (OIPE), a special envelope will be affixed to the right side of the file wrapper underneath all papers, and the compact discs inserted therein. >For Image File Wrapper (IFW) processing, see IFW Manual section 3.6.< The application file will then proceed on its normal course.

>

**IV. < TEMPORARY CONTINUATION OF MICROFICHE PRACTICE \*\*>UNTIL MARCH 1, 2001<**

The Office \*>provided< for the continuation of prior microfiche appendix practice for computer listings until \*\*>March 1<, 2001. \*\*>All< computer listings as part of the application disclosure >filed prior to March 2, 2001< that are in conformance with the microfiche appendix rules below may rely on the microfiche and need not submit a computer program listing appendix on compact disc; all computer listings as part of the application disclosure not in con-



formance with the microfiche appendix rules below must conform to the requirements of 37 CFR 1.52 and 37 CFR 1.96 as set forth above.

The prior microfiche practice \* continued through \*\*>March 1<, 2001 to accommodate applicants who incurred the time and expense of preparing microfiche. Those applicants with computer program listings in the disclosure who have not prepared microfiche will generally incur significantly less time and expense creating compact disc files than creating microfiche.

All computer listings submitted on microfiche through \*\*>March 1<, 2001, must conform to the requirements of former 37 CFR 1.96(c), as reproduced below:

*Former 37 CFR 1.96. Submission of computer program listings.*

\*\*\*\*\*

(c) *As an appendix which will not be printed.* If a computer program listing printout is eleven or more pages long, applicants must submit such listing in the form of microfiche, referred to in the specification (see § 1.77(a)(6)). Such microfiche filed with a patent application is to be referred to as a “microfiche appendix.” The “microfiche appendix” will not be part of the printed patent. Reference in the application to the “microfiche appendix” must be made at the beginning of the specification at the location indicated in § 1.77(a)(6). Any amendments thereto must be made by way of revised microfiche.

(1) *Availability of appendix.* Such computer program listings on microfiche will be available to the public for inspection, and microfiche copies thereof will be available for purchase with the file wrapper and contents, after a patent based on such application is granted or the application is otherwise made publicly available.

(2) *Submission requirements.* Except as modified or clarified in this paragraph (c)(2), computer-generated information submitted as a “microfiche appendix” to an application shall be in accordance with the standards set forth in 36 CFR Part 1230 (Micrographics).

(i) Film submitted shall be a first generation (camera film) negative appearing microfiche (with emulsion on the back side of the film when viewed with the images right-reading).

(iii) At least the left-most third (50 mm. x 12 mm.) of the header or title area of each microfiche submitted shall be clear or positive appearing so that the Patent and Trademark Office can apply an application number and filing date thereto in an eye-readable form. The middle portion of the header shall be used by applicant to apply an eye-readable application identification such as the title and/or the first inventor's name. The attorney's docket number may be included. The final right-hand portion of the microfiche shall contain sequence information for the microfiche, such as 1 of 4, 2 of 4, etc.

(ii) Reduction ratio of microfiche submitted should be 24:1 or a similar ratio where variation from said ratio is required in order to fit the documents into the image area of the microfiche format used.

(iv) Additional requirements which apply specifically to microfiche of filmed paper copy:

(A) The first frame of each microfiche submitted shall contain a test target.

(B) The second frame of each microfiche submitted must contain a fully descriptive title and the inventor's name as filed.

(C) The pages or lines appearing on the microfiche frames should be consecutively numbered.

(D) Pagination of the microfiche frames shall be from left to right and from top to bottom.

(E) At a reduction of 24:1, resolution of the original microfilm shall be at least 120 lines per mm. (5.0 target).

(F) An index, when included, should appear in the last frame (lower-right hand corner when data is right-reading) of each microfiche.

(v) Microfiche generated by Computer Output Microfilm.

(A) The first frame of each microfiche submitted should contain a resolution test frame.

(B) The second frame of each microfiche submitted must contain a fully descriptive title and the inventor's name as filed.

(C) The pages or lines appearing on the microfiche frames should be consecutively numbered.

(D) It is preferred that pagination of the microfiche frames be from left to right and top to bottom but the alternative, i.e., from top to bottom and from left to right, is also acceptable.

(E) An index, when included, should appear on the last frame (lower-right hand corner when data is right reading) of each microfiche.

\*\*\*\*\*

A microfiche filed with a patent application will be referred to as a “Microfiche Appendix,” and will be identified as such on the front page of the patent but will not be part of the printed patent. “Microfiche Appendix” denotes the total microfiche, whether only one or two or more. One microfiche is equivalent to a maximum of either 63 (9x7) or 98 (14x7) frames (pages), or less. The face of the file wrapper will bear a label to denote that a Microfiche Appendix is included in the application. >For IFW processing, see IFW Manual section 3.6.< A statement must be included in the specification to the effect that a microfiche appendix is included in the application. The specification entry must appear at the beginning of the specification immediately following any cross-reference to related applications. \*\* When an application containing microfiche is received in the Office of Ini-

tial Patent Examination (OIPE), a special envelope will be affixed to the right side of the file wrapper underneath all papers, and the microfiche inserted therein. >For IFW processing, see IFW Manual section 2.2.< The application file will then proceed on its normal course.

>Form paragraph 6.64.04 may be used to notify applicant of an unacceptable microfiche appendix.<

¶ 6.64.04 “Microfiche Appendix” Unacceptable

The computer program listing filed on [1] as a “microfiche appendix” is unacceptable. A computer program listing conforming to the requirements of 37 CFR 1.96 is required.

**Examiner Note:**

1. This form paragraph should be used if a “microfiche appendix” was filed after March 1, 2001 or if a “microfiche appendix” filed on or before March 1, 2001 was not in compliance with former rule 37 CFR 1.96(c). See MPEP § 608.05(a).

2. In bracket 1, insert the date the “microfiche appendix” was filed.

<

\*>

**608.05(b) < Compact Disc Submissions of Large Tables [R-2]**

37 CFR 1.58. *Chemical and mathematical formulae and tables.*

\*\*\*\*\*

(b) Tables that are submitted in electronic form (§§ 1.96(c) and 1.821(c)) must maintain the spatial relationships (*e.g.*, columns and rows) of the table elements and preserve the information they convey. Chemical and mathematical formulae must be encoded to maintain the proper positioning of their characters when displayed in order to preserve their intended meaning.

\*\*\*\*\*

The provisions of 37 CFR 1.52 and 37 CFR 1.58 for submitting specifications and tables on paper have been found suitable for most patent applications. However, when lengthy tables must be disclosed in a patent application in order to provide a complete disclosure, use of paper copies can become burdensome. The cost of printing long tables in patent documents is also very expensive to the U.S. Patent and Trademark Office. In the past, all disclosures forming part of a patent application were presented on paper with the exception of microorganisms and computer program listings. Under 37 CFR 1.58, several different methods for submitting large tables, including the use of CD-ROM and CD-R, are set forth.

The files stored on the compact disc containing the table must contain only ASCII characters. No special formatting characters or proprietary file formats are permitted. Accordingly, great care must be taken so that the spatial arrangement of the data in rows and columns is maintained. This will allow the table to be viewed with virtually any text viewer. A single table contained on fifty pages or less must be submitted either as drawings (in compliance with 37 CFR 1.84) or as part of the specification in paper (in compliance with 37 CFR 1.52).

A single table contained on 51 pages or more may be submitted on a CD-ROM or CD-R (in compliance with 37 CFR 1.52(e) and 37 CFR 1.58). The presentation of a subheading to divide a large table into smaller sections of less than 51 pages should not be used to prevent an applicant from submitting the table on a compact disc unless the subdivided tables are presented as numerous files on the compact disc so as to lose their relationship to the overall large table.

>If tables on more than two hundred consecutive pages, or large numbers of tables (lengthy tables) are submitted on a CD as provided in 37 CFR 1.52(e), or in an electronic format in response to a specific request from the Office of Patent Publication, these lengthy tables will not be published as part of a patent document (*e.g.*, patent, patent application publication or Statutory Invention Registration (SIR)). The lengthy tables will be published separately on the sequence homepage of the USPTO Internet web site (<http://seqdata.uspto.gov>) as an XML file. See, for example, patent application publication nos. US 2003/0235811 A1 and US 2003/0237110 A9.

When the lengthy tables are separately published on the USPTO Internet web site, there will be a standardized ‘Lengthy Table’ statement, in the patent document following of the detailed description (see 37 CFR 1.77(b)(8)).

For a patent application publication, the following page-wide text would appear:

LENGTHY TABLE

The patent application contains a lengthy table section. A copy of the table is available in electronic form from the USPTO web site (<http://seqdata.uspto.gov/?pageRequest=docDetail&docID=20047654321>). An electronic copy of the table will also be available from the USPTO upon

request and payment of the fee set forth in 37 CFR 1.19(b)(3).

For a patent, the following page-wide text would appear:

LENGTHY TABLE

The patent contains a lengthy table section. A copy of the table is available in electronic form from the USPTO web site (<http://seqdata.uspto.gov/?pageRequest=docDetail&docID=7654321B1>). An electronic copy of the table will also be available from the USPTO upon request and payment of the fee set forth in 37 CFR 1.19(b)(3).

For a SIR, the following page-wide text would appear:

LENGTHY TABLE

The statutory invention registration contains a lengthy table section. A copy of the table is available in electronic form from the USPTO web site (<http://seqdata.uspto.gov/?pageRequest=docDetail&docID=H0009999H1>). An electronic copy of the table will also be available from the USPTO upon request and payment of the fee set forth in 37 CFR 1.19(b)(3).

The Office discourages the embedding of a lengthy table in the specification of a patent application. If a lengthy table is embedded in the specification of a patent application, and if the lengthy table is available in an electronic form (either XML or a format convertible to XML), when the patent, patent application publication or SIR is published, the following single-column statement will be inserted in place of each replaced table in the document.

LENGTHY TABLE

Lengthy table referenced here. Please refer to the end of the specification for access instructions.<

Form paragraphs 6.63.01 and 6.63.02 may be used to notify applicant of corrections needed to comply with the requirements of 37 CFR 1.52(e) and 37 CFR 1.58(b) with respect to tables.

\*\*>

*¶ 6.63.01 CD-ROM/CD-R Requirements (Table Listing in Specification)*

The description portion of this application contains a table consisting of less than fifty one (51) pages only on a CD-ROM or CD-R. In accordance with 37 CFR 1.52(e), only a table of at least fifty one (51) pages may be submitted on a CD-ROM or CD-R. Accordingly, applicant is required to cancel the references to the CD-ROM/CD-R table appearing in the specification on pages[1], file a paper version of the table in compliance with 37 CFR 1.52 and change all appropriate references to the former CD-ROM/CD-R table to the newly added paper version of the table in the remainder of the specification

**Examiner Note:**

1. This form paragraph must be used whenever a table on a CD-ROM or CD-R consisting of less than fifty one (51) pages as part of the descriptive portion of the specification is filed on or after September 8, 2000. See MPEP § 608.05(b).
2. In bracket 1, insert the range of page numbers of the specification which reference the table.

<

*¶ 6.63.02 Table on CD-ROM/CD-R Column/Row Relationship Not Maintained*

This application contains a table on CD-ROM/CD-R. Tables presented on CD-ROM/CD-R in compliance with 37 CFR 1.58 must maintain the spacial orientation of the cell entries. The table submitted does not maintain the data within each table cell in its proper row/column alignment. The data is misaligned in the table as follows: [1]. Applicant is required to submit a replacement compact disc with the table data properly aligned.

**Examiner Note:**

1. This form paragraph must be used whenever the data in a table cannot be accurately read because the data in the table cells do not maintain their row and column alignments.
2. In bracket 1, insert the area of the table that does not maintain the row and column alignments.

## 608.05(c) Compact Disc Submissions of Biosequences

Filing of biosequence information on compact disc is now permitted in lieu of filing on paper. See MPEP § 2420 and § 2422.03.

## 609 Information Disclosure Statement [R-2]

*37 CFR 1.97. Filing of information disclosure statement.*

- (a) In order for an applicant for a patent or for a reissue of a patent to have an information disclosure statement in compliance with § 1.98 considered by the Office during the pendency of the

application, the information disclosure statement must satisfy one of paragraphs (b), (c), or (d) of this section.

(b) An information disclosure statement shall be considered by the Office if filed by the applicant within any one of the following time periods:

(1) Within three months of the filing date of a national application other than a continued prosecution application under § 1.53(d);

(2) Within three months of the date of entry of the national stage as set forth in § 1.491 in an international application;

(3) Before the mailing of a first Office action on the merits; or

(4) Before the mailing of a first Office action after the filing of a request for continued examination under § 1.114.

(c) An information disclosure statement shall be considered by the Office if filed after the period specified in paragraph (b) of this section, provided that the information disclosure statement is filed before the mailing date of any of a final action under § 1.113, a notice of allowance under § 1.311, or an action that otherwise closes prosecution in the application, and it is accompanied by one of:

(1) The statement specified in paragraph (e) of this section; or

(2) The fee set forth in § 1.17(p).

(d) An information disclosure statement shall be considered by the Office if filed by the applicant after the period specified in paragraph (c) of this section, provided that the information disclosure statement is filed on or before payment of the issue fee and is accompanied by:

(1) The statement specified in paragraph (e) of this section; and

(2) The fee set forth in § 1.17(p).

(e) A statement under this section must state either:

(1) That each item of information contained in the information disclosure statement was first cited in any communication from a foreign patent office in a counterpart foreign application not more than three months prior to the filing of the information disclosure statement; or

(2) That no item of information contained in the information disclosure statement was cited in a communication from a foreign patent office in a counterpart foreign application, and, to the knowledge of the person signing the certification after making reasonable inquiry, no item of information contained in the information disclosure statement was known to any individual designated in § 1.56(c) more than three months prior to the filing of the information disclosure statement.

(f) No extensions of time for filing an information disclosure statement are permitted under § 1.136. If a *bona fide* attempt is made to comply with § 1.98, but part of the required content is inadvertently omitted, additional time may be given to enable full compliance.

(g) An information disclosure statement filed in accordance with section shall not be construed as a representation that a search has been made.

(h) The filing of an information disclosure statement shall not be construed to be an admission that the information cited in the statement is, or is considered to be, material to patentability as defined in § 1.56(b).

(i) If an information disclosure statement does not comply with either this section or § 1.98, it will be placed in the file but will not be considered by the Office.

*37 CFR 1.98. Content of information disclosure statement.*

(a) Any information disclosure statement filed under § 1.97 shall include:

(1) A list of all patents, publications, applications, or other information submitted for consideration by the Office;

(2) A legible copy of:

(i) Each U.S. patent application publication and U.S. and foreign patent;

(ii) Each publication or that portion which caused it to be listed;

(iii) For each cited pending U.S. application, the application specification including the claims, and any drawing of the application, or that portion of the application which caused it to be listed including any claims directed to that portion; and

(iv) All other information or that portion which caused it to be listed; and

(3)(i) A concise explanation of the relevance, as it is presently understood by the individual designated in § 1.56(c) most knowledgeable about the content of the information, of each patent, publication, or other information listed that is not in the English language. The concise explanation may be either separate from applicant's specification or incorporated therein.

(ii) A copy of the translation if a written English-language translation of a non-English-language document, or portion thereof, is within the possession, custody, or control of, or is readily available to any individual designated in § 1.56(c).

(b)(1) Each U.S. patent listed in an information disclosure statement must be identified by inventor, patent number, and issue date.

(2) Each U.S. patent application publication listed in an information disclosure statement shall be identified by applicant, patent application publication number, and publication date.

(3) Each U.S. application listed in an information disclosure statement must be identified by the inventor, application number, and filing date.

(4) Each foreign patent or published foreign patent application listed in an information disclosure statement must be identified by the country or patent office which issued the patent or published the application, an appropriate document number, and the publication date indicated on the patent or published application.

(5) Each publication listed in an information disclosure statement must be identified by publisher, author (if any), title, relevant pages of the publication, date, and place of publication.

(c) When the disclosures of two or more patents or publications listed in an information disclosure statement are substantively cumulative, a copy of one of the patents or publications may be submitted without copies of the other patents or publications, provided that it is stated that these other patents or publications are cumulative.

(d) A copy of any patent, publication, pending U.S. application or other information, as specified in paragraph (a) of this section, listed in an information disclosure statement is required to be provided, even if the patent, publication, pending U.S. application or other information was previously submitted to, or cited by, the Office in an earlier application, unless:

(1) The earlier application is properly identified in the information disclosure statement and is relied on for an earlier effective filing date under 35 U.S.C. 120; and

(2) The information disclosure statement submitted in the earlier application complies with paragraphs (a) through (c) of this section.

>

(e) The requirement in paragraph (a)(2)(i) of this section for a copy of all listed U.S. patents and U.S. patent application publications does not apply to any information disclosure statement submitted in compliance with the Office's electronic filing system.<

Information Disclosure Statements (IDSs) are not permitted in provisional applications filed under 35 U.S.C. 111(b). See 37 CFR 1.51(d). Since no substantive examination is given in provisional applications, a disclosure of information is unnecessary. Any such statement filed in a provisional application will be returned or destroyed at the option of the Office.

In >nonprovisional< applications filed under 35 U.S.C. 111(a), applicants and other individuals substantively involved with the preparation and/or prosecution of the application have a duty to submit to the Office information which is material to patentability as defined in 37 CFR 1.56. The provisions of 37 CFR 1.97 and 37 CFR 1.98 provide a mechanism by which patent applicants may comply with the duty of disclosure provided in 37 CFR 1.56. Applicants and other individuals substantively involved with the preparation and/or prosecution of the patent application also may want the Office to consider information for a variety of other reasons; e.g., to make sure that the examiner has an opportunity to consider the same information that was considered by these individuals, or by another patent office in a counterpart or related patent application filed in another country.

>Third parties (individuals not covered by 37 CFR 1.56(c)) cannot file information disclosure statements under 37 CFR 1.97 and 37 CFR 1.98. Third parties may only submit patents and publications in compliance with 37 CFR 1.99 in applications published under 35 U.S.C. 122(b). See MPEP § 1134.01. Alternatively, third parties may provide information to the applicant who may submit the information to the Office in an IDS. See 37 CFR 1.56(d). The Office will review any improper IDS filed by a third party to determine whether the submission is in compliance with 37 CFR 1.99. The Office will discard any submission that is not in compliance with 37 CFR 1.99, before the application is forwarded to the examiner for examination.<

An information disclosure statement filed in accordance with the provisions of 37 CFR 1.97 and 37 CFR 1.98 will be considered by the examiner assigned to the application. The requirements for the content of a statement have been simplified in the rules, to encourage individuals associated in a substantive way with the filing and prosecution of a patent application to submit information to the Office so the examiner can \*>evaluate< its relevance to the claimed invention. The procedures for submitting an information disclosure statement under the rules are designed to encourage individuals to submit information to the Office promptly and in a uniform manner. These rules provide certainty for the public by defining the requirements for submitting information disclosure statements to the Office so that the Office will consider information contained therein before a patent is granted.

The filing of an information disclosure statement shall not be construed as a representation that a search has been made. 37 CFR 1.97(g). There is no requirement that an applicant for a patent make a patentability search. Further, the filing of an information disclosure statement shall not be construed to be an admission that the information cited in the statement is, or is considered to be, material to patentability as defined in 37 CFR 1.56(b). 37 CFR 1.97(h). See MPEP § 2129 regarding admissions by applicant.

In order to have information considered by the Office during the pendency of a patent application, an information disclosure statement must be (1) in compliance with the content requirements of 37 CFR 1.98, and (2) filed in accordance with the procedural

requirements of 37 CFR 1.97. The requirements as to content are discussed in subsection III.A below. The requirements based on the time of filing the statement are discussed in subsection III.B below. Examiner handling of information disclosure statements is discussed in subsection III.C below. >For discussion of IDS filed electronically (e-IDS) via the Office's Electronic Filing System (EFS), see subsection IV. below.<

Once the minimum requirements of 37 CFR 1.97 and 37 CFR 1.98 are met, the examiner has an obligation to consider the information. Consideration by the examiner of the information submitted in an IDS means nothing more than considering the documents in the same manner as other documents in Office search files are considered by the examiner while conducting a search of the prior art in a proper field of search. The initials of the examiner placed adjacent to the citations on the PTO-1449 or PTO/SB/08A and 08B or its equivalent mean that the information has been considered by the examiner to the extent noted above. \*\* Information submitted to the Office that does not comply with the requirements of 37 CFR 1.97 and 37 CFR 1.98 will not be considered by the Office but will be placed in the application file.

Multiple information disclosure statements may be filed in a single application, and they will be considered, provided each is in compliance with the appropriate requirements of 37 CFR 1.97 and 37 CFR 1.98. Use of form PTO-1449, "Information Disclosure Citation," or PTO/SB/08A and 08B, "Information Disclosure Statement," is encouraged as a means to provide the required list of information as set forth in 37 CFR 1.98(a)(1). Applicants are encouraged to use the USPTO forms when preparing an information disclosure statement. A copy of forms PTO-1449, "Information Disclosure Citation" and PTO/SB/08A and 08B are reproduced at the end of this section to indicate how the forms should be completed. The forms will enable applicants to comply with the requirement to list each item of information being submitted and to provide the Office with a uniform listing of citations and with a ready way to indicate that the information has been considered.

## **I. IDS IN CONTINUED EXAMINATIONS OR CONTINUING APPLICATIONS**

### **A. *IDS That Has Been Considered (1) in the Parent Application, or (2) Prior to the Filing of a Request for Continued Examination (RCE)***

#### **1. Continued Prosecution Applications (CPAs) Filed Under 37 CFR 1.53(d) or File Wrapper Continuing (FWC) Applications Filed Under Former 37 CFR 1.62**

Information which has been considered by the Office in the parent application of a continued prosecution application (CPA) filed under 37 CFR 1.53(d), or a file wrapper continuing application (FWC) filed prior to December 1, 1997 under former 37 CFR 1.62, will be part of the file before the examiner and need not be resubmitted in the continuing application to have the information considered and listed on the patent.

#### **2. Continuation Applications or Divisional Applications, Filed Under 37 CFR 1.53(b) or Filed Under Former 37 CFR 1.60, or Continuation-In-Part Applications Filed Under 37 CFR 1.53(b)**

The examiner will consider information which has been considered by the Office in a parent application when examining (A) a continuation application filed under 37 CFR 1.53(b) or filed under former 37 CFR 1.60, (B) a divisional application filed under 37 CFR 1.53(b) or filed under former 37 CFR 1.60, or (C) a continuation-in-part application filed under 37 CFR 1.53(b). \*>A listing of the< information need not be resubmitted in the continuing application unless the applicant desires the information to be printed on the patent.

#### **3. Requests for Continued Examination (RCE) Under 37 CFR 1.114**

Information which has been considered by the Office in the application before the filing of a RCE will be part of the file before the examiner and need not be resubmitted to have the information considered by the examiner and listed on the patent.

**B. IDS That Has Not Been Considered (1) in the Parent Application, or (2) Prior to the Filing of a Request for Continued Examination**

**1. Continued Prosecution Applications Filed Under 37 CFR 1.53(d)**

Information filed in the parent application that complies with the content requirements of 37 CFR 1.98 will be considered by the examiner in the CPA. No specific request from the applicant that the previously submitted information be considered by the examiner is required.

**2. File Wrapper Continuing Application Filed Under Former 37 CFR 1.62**

For FWC applications filed prior to December 1, 1997 under former 37 CFR 1.62, in order to ensure consideration of information complying with the content requirements of 37 CFR 1.98 previously submitted, but not considered, in a parent application, applicant must either specifically request that the previously submitted information be considered in the FWC or resubmit the information in the FWC in compliance with 37 CFR 1.97 and 37 CFR 1.98.

**3. Continuation Applications or Divisional Applications, Filed Under 37 CFR 1.53(b) or Filed Under Former 37 CFR 1.60, or Continuation-In-Part Applications Filed Under 37 CFR 1.53(b)**

For these types of applications, in order to ensure consideration of information previously submitted, but not considered, in a parent application, applicant must resubmit the information in the continuing application in compliance with 37 CFR 1.97 and 37 CFR 1.98. >Pursuant to 37 CFR 1.98(d), if the IDS submitted in the parent application complies with 37 CFR 1.98(a) to (c), copies of the patents, publications, pending U.S. applications, or other information submitted in the parent application need not be resubmitted in the continuing application.<

**4. Requests for Continued Examination Under 37 CFR 1.114**

Information filed in the application in compliance with the content requirements of 37 CFR 1.98 before the filing of a RCE will be considered by the exam-

iner after the filing of the RCE. For example, an applicant filed an IDS in compliance with 37 CFR 1.98 after the mailing of a final Office action, but the IDS did not comply with the requirements of 37 CFR 1.97(d)(1) and (d)(2) and therefore, the IDS was not considered by the examiner. After applicant files a RCE, the examiner will consider the IDS filed prior to the filing of the RCE. For more details on RCE, see MPEP § 706.07(h).

**II. NATIONAL STAGE APPLICATIONS**

The examiner will consider the documents cited in the international search report in a PCT national stage application when the Form PCT/DO/EO/903 indicates that both the international search report and the copies of the documents are present in the national stage file. In such a case, the examiner should consider the documents from the international search report and indicate by a statement in the first Office action that the information has been considered. There is no requirement that the examiner list the documents on a PTO-892 form.

In a national stage application, the following form paragraphs may be used where appropriate to notify applicant regarding references listed in the search report of the international application:

\*\*>

*¶ 6.53 References Considered in 37 U.S.C. 371 Application Based Upon Search Report - Prior to Allowance*

The references cited in the Search Report [1] have been considered, but will not be listed on any patent resulting from this application because they were not provided on a separate list in compliance with 37 CFR 1.98(a)(1). In order to have the references printed on such resulting patent, a separate listing, preferably on a PTO-1449 or PTO/SB/08A and 08B form, must be filed within the set period for reply to this Office action.

**Examiner Note:**

1. In bracket [1], identify the office (e.g., PCT, EPO, etc.) that issued the search report and the date it issued.
2. This form paragraph may be used for PCT National Stage applications submitted under 35 U.S.C. 371 where the examiner has obtained copies of the cited references. For applications filed from US, JPO or EPO search authorities, the copies of the references should be supplied by those offices under the trilateral agreement. However, if receipt of such copies is not indicated on the PCT/DO/EO/903 form in the file, burden is on the applicant to supply copies for consideration. See MPEP § 1893.03(g).
3. Instead of using this form paragraph, the examiner may list the references on a PTO-892, thereby notifying the applicant that

the references have been considered and will be printed on any patent resulting from this application.

4. This form paragraph should only be used prior to allowance when a statutory period for reply is being set in the Office action.

5. If the application is being allowed, form paragraph 6.54 should be used with the Notice of Allowability instead of this form paragraph.

*¶ 6.54 References Considered in 37 U.S.C. 371 Application Based Upon Search Report - Ready for Allowance*

The references cited in the Search Report [1] have been considered, but will not be listed on any patent resulting from this application because they were not provided on a separate list in compliance with 37 CFR 1.98(a)(1). In order to have the references printed on such resulting patent, a separate listing, preferably on a PTO-1449 or PTO/SB/08A and 08B form, must be filed within ONE MONTH of the mailing date of this communication. NO EXTENSION OF TIME WILL BE GRANTED UNDER EITHER 37 CFR 1.136(a) OR (b) to comply with this requirement.

**Examiner Note:**

1. In bracket [1], identify the office (e.g., PCT, EPO, etc.) that issued the search report and the date it issued.

2. This form paragraph may be used for PCT National Stage applications submitted under 35 U.S.C. 371 where the examiner has obtained copies of the cited references. For applications filed from US, JPO or EPO search authorities, the copies of the references should be supplied by those offices under the trilateral agreement. However, if receipt of such copies is not indicated on the PCT/DO/EO/903 form in the file, burden is on the applicant to supply copies for consideration. See MPEP § 1893.03(g).

3. Instead of using this form paragraph, the examiner may list the references on a PTO-892, thereby notifying the applicant that the references have been considered and will be printed on any patent resulting from this application.

*¶ 6.55 References Not Considered in 35 U.S.C. 371 Application Based Upon Search Report*

The listing of references in the Search Report is not considered to be an information disclosure statement (IDS) complying with 37 CFR 1.98. 37 CFR 1.98(a)(2) requires a legible copy of: (1) each U.S. and foreign patent; (2) each publication or that portion which caused it to be listed; (3) for each cited pending U.S. application, the application specification including claims, and any drawing of the application, or that portion of the application which caused it to be listed including any claims directed to that portion; and (4) all other information, or that portion which caused it to be listed. In addition, each IDS must include a list of all patents, publications, applications, or other information submitted for consideration by the Office (see 37 CFR 1.98(a)(1) and (b)), and MPEP § 609 subsection III. A(1) states, “the list ... must be submitted on a separate paper.” Therefore, the references cited in the Search Report have not been considered. Applicant is advised that the date of submission of any item of information or any missing element(s) will be the date of submission for purposes of determining compliance with the requirements based on

the time of filing the IDS, including all “statement” requirements of 37 CFR 1.97(e). See MPEP § 609 subsection III. C(1).

**Examiner Note:**

1. This form paragraph may be used in National Stage applications submitted under 35 U.S.C. 371 where the international searching authority was not the US, EPO or JPO.

<

**III. MINIMUM REQUIREMENTS FOR AN INFORMATION DISCLOSURE STATEMENT**

**A. Content**

An information disclosure statement must comply with the provisions of 37 CFR 1.98 as to content for the information listed in the IDS to be considered by the Office. Each information disclosure statement must comply with the applicable provisions of subsection III.A(1), A(2), and A(3) below.

**A (1) List of All Patents, Publications, U.S. Applications, or Other Information**

Each information disclosure statement must include a list of all patents, publications, U.S. applications, or other information submitted for consideration by the Office.

37 CFR 1.98(b) requires that each item of information in an IDS be identified properly. U.S. patents must be identified by the inventor, patent number, and issue date. U.S. patent application publications must be identified by the applicant, patent application publication number, and publication date. U.S. applications must be identified by the inventor, the eight digit application number (the two digit series code and the six digit serial number), and the filing date. If a U.S. application being listed in an IDS has been issued as a patent, the applicant should list the patent in the IDS instead of the application. Each foreign patent or published foreign patent application must be identified by the country or patent office which issued the patent or published the application, an appropriate document number, and the publication date indicated on the patent or published application. Each publication must be identified by publisher, author (if any), title, relevant pages of the publication, and date and place of publication. The date of publication supplied must include at least the month and year of publication, except that the year of publication (without the



month) will be accepted if the applicant points out in the information disclosure statement that the year of publication is sufficiently earlier than the effective U.S. filing date and any foreign priority date so that the particular month of publication is not in issue. The place of publication refers to the name of the journal, magazine, or other publication in which the information being submitted was published.

The list of information complying with the identification requirements of 37 CFR 1.98(b) may not be incorporated into the specification of the application in which it is being supplied, but must be submitted in a separate paper. A separate list is required so that it is easy to confirm that applicant intends to submit an information disclosure statement and because it provides a readily available checklist for the examiner to indicate which identified documents have been considered. A copy of a separate list (generated by the Office) will also provide a simple means of communication to applicant to indicate the listed documents that have been considered and those listed documents that have not been considered. Use of either form PTO-1449, Information Disclosure Citation, or PTO/SB/08A and 08B, Information Disclosure Statement, to list the documents is encouraged. See subsection C(2) below.

### **A (2) Legible Copies**

In addition to the list of information, each information disclosure statement must also include a legible copy of:

(A) Each U.S. patent application publication, and U.S. \*\* patent >, with the exception that copies of such U.S. patent documents are not required if the IDS is electronically submitted via EFS or the IDS is filed in an application filed after June 30, 2003 or entered the national stage under 35 U.S.C. 371 after June 30, 2003. See subsection IV. below for a discussion of e-IDS<;

(B) >Each foreign patent document;

(C) <Each publication or that portion which caused it to be listed;

\*>

(D) < For each cited pending >unpublished< U.S. application, the application specification including the claims, and any drawings of the application, or that

portion of the application which caused it to be listed including any claims directed to that portion; and

\*>

(E) < All other information or that portion which caused it to be listed.

37 CFR 1.98(a)(2)(iii) requires a copy of a pending U.S. application that is being cited in an IDS. If the pending U.S. application is only identified in the specification's background information rather than being part of an IDS submission, a copy need not be supplied. Pursuant to 37 CFR 1.98(a)(2)(iii), applicant may choose to cite only a portion of a pending application including any claims directed to that portion rather than the entire application.

There are exceptions to this requirement that a copy of the information must be provided. First, 37 CFR 1.98(d) states that a copy of any patent, publication, pending U.S. application, or other information listed in an information disclosure statement is not required to be provided if: (1) the information was previously cited by or submitted to, the Office in a prior application, provided that the prior application is properly identified in the IDS and is relied on for an earlier filing date under 35 U.S.C. 120; and (2) the IDS submitted in the earlier application complies with 37 CFR 1.98(a)-(c). If both of these conditions are met, the examiner will consider the information previously cited or submitted to the Office and considered by the Office in a prior application relied on under 35 U.S.C. 120. This exception to the requirement for copies of information does not apply to information which was cited in an international application under the Patent Cooperation Treaty. If the information cited or submitted in the prior application was not in English, a concise explanation of the relevance of the information to the new application is not required unless the relevance of the information differs from its relevance as explained in the prior application. See subsection III.A(3) below.

Second, 37 CFR 1.98(c) states that when the disclosures of two or more patents or publications listed in an information disclosure statement are substantively cumulative, a copy of one of the patents or publications may be submitted without copies of the other patents or publications provided that a statement is made that these other patents or publications are cumulative. The examiner will then consider only the patent or publication of which a copy is submitted and will so indicate on the list, form PTO-1449, or PTO/

listing of the cumulative information. But see *Semiconductor Energy Laboratory Co. v. Samsung Electronics Co.*, 204 F.3d 1368, 1374, 54 USPQ2d 1001, 1005 (Fed. Cir. 2000) (Reference was not cumulative since it contained a more complete combination of the claimed elements than any other reference before the examiner. “A withheld reference may be highly material when it discloses a more complete combination of relevant features, even if those features are before the patent examiner in other references.” (citations omitted).).

37 CFR 1.98(a)(3)(ii) states that if a written English language translation of a non-English language document, or portion thereof, is within the possession, custody or control of, or is readily available to any individual designated in 37 CFR 1.56(c), a copy of the translation shall accompany the statement. Translations are not required to be filed unless they have been reduced to writing and are actually translations of what is contained in the non-English language information. If no translation is submitted, the examiner will consider the information in view of the concise explanation and insofar as it is understood on its face, e.g., drawings, chemical formulas, English language abstracts, in the same manner that non-English language information in Office search files is considered by examiners in conducting searches.

### **A (3) Concise Explanation of Relevance for Non-English Language Information**

Each information disclosure statement must further include a concise explanation of the relevance, as it is presently understood by the individual designated in 37 CFR 1.56(c) most knowledgeable about the content of the information listed that is not in the English language. The concise explanation may be either separate from the specification or incorporated therein with the page(s) and lines of the specification where it is incorporated being noted in the IDS.

The requirement for a concise explanation of relevance is limited to information that is not in the English language. The explanation required is limited to the relevance as understood by the individual designated in 37 CFR 1.56(c) most knowledgeable about the content of the information at the time the information is submitted to the Office. If a complete translation of the information into English is submitted with the non-English language information, no concise

explanation is required. An English-language equivalent application may be submitted to fulfill this requirement if it is, in fact, a translation of a foreign language application being listed in an information disclosure statement. There is no requirement for the translation to be verified. Submission of an English language abstract of a reference may fulfill the requirement for a concise explanation. Where the information listed is not in the English language, but was cited in a search report or other action by a foreign patent office in a counterpart foreign application, the requirement for a concise explanation of relevance can be satisfied by submitting an English-language version of the search report or action which indicates the degree of relevance found by the foreign office. This may be an explanation of which portion of the reference is particularly relevant, to which claims it applies, or merely an “X”, “Y”, or “A” indication on a search report. The requirement for a concise explanation of non-English language information would not be satisfied by a statement that a reference was cited in the prosecution of a United States application which is not relied on under 35 U.S.C. 120.

If information cited or submitted in a prior application relied on under 35 U.S.C. 120 was not in English, a concise explanation of the relevance of the information to the new application is not required unless the relevance of the information differs from its relevance as explained in the prior application.

The concise explanation may indicate that a particular figure or paragraph of the patent or publication is relevant to the claimed invention. It might be a simple statement pointing to similarities between the item of information and the claimed invention. It is permissible but not necessary to discuss differences between the cited information and the claims. However, see *Semiconductor Energy Laboratory Co. v. Samsung Electronics Co.*, 204 F.3d 1368, 1376, 54 USPQ2d 1001, 1007 (Fed. Cir. 2000) (“[A]lthough MPEP Section 609A(3) allows the applicant some discretion in the manner in which it phrases its concise explanation, it nowhere authorizes the applicant to intentionally omit altogether key teachings of the reference.”).

In *Semiconductor Energy Laboratory*, patentee during prosecution submitted an untranslated 29-page Japanese reference as well as a concise explanation of its relevance and an existing one-page partial English translation, both of which were directed to less mate-

rial portions of the reference. The untranslated portions of the Japanese reference “contained a more complete combination of the elements claimed [in the patent] than anything else before the PTO.” 204 F.3d at 1376, 54 USPQ2d at 1005. The patentee, whose native language was Japanese, was held to have understood the materiality of the reference. “The duty of candor does not require that the applicant translate every foreign reference, but only that the applicant refrain from submitting partial translations and concise explanations that it knows will misdirect the examiner’s attention from the reference’s relevant teaching.” 204 F.3d at 1378, 54 USPQ2d at 1008.

Although a concise explanation of the relevance of the information is not required for English language information, applicants are encouraged to provide a concise explanation of why the English-language information is being submitted and how it is understood to be relevant. Concise explanations (especially those which point out the relevant pages and lines) are helpful to the Office, particularly where documents are lengthy and complex and applicant is aware of a section that is highly relevant to patentability or where a large number of documents are submitted and applicant is aware that one or more are highly relevant to patentability.

### **B. Time for Filing**

The procedures and requirements under 37 CFR 1.97 for submitting an information disclosure statement are linked to four stages in the processing of a patent application:

(1)(a) for national applications (not including CPAs), within 3 months of filing, or before the mailing of a first Office action on the merits, whichever is later;

(b) for international applications, within 3 months of the date of entry of the national stage as set forth in 37 CFR 1.491 or before the mailing of a first Office action on the merits in the national stage application, whichever is later;

(c) for continued examinations (i.e., RCEs filed under 37 CFR 1.114) and CPAs filed under 37 CFR 1.53(d), before the mailing of a first Office action on the merits;

(2) after the period in (1), but prior to the prosecution of the application closes, i.e., before the mail-

ing of a final Office action, a Notice of Allowance, or an *Ex parte Quayle* action, whichever is earlier;

(3) after the period in (2) but on or before the date the issue fee is paid; and

(4) after the period in (3) and up to the time the patent application can be effectively withdrawn from issue under 37 CFR 1.313(c).

These procedures and requirements apply to applications filed under 35 U.S.C. 111(a) (utility), 161 (plants), 171 (designs), and 251 (reissue), as well as international applications entering the national stage under 35 U.S.C. 371.

The requirements based on the time when the information disclosure statement is filed are summarized as follows.

<u>Time when IDS is filed</u>	<u>37 CFR 1.97 Requirements</u>
(1)(a) for national applications (not including CPAs), within 3 months of filing or before first Office action on the merits, whichever is later; (b) for national stage applications, within 3 months of entry into national stage or before first Office action on the merits, whichever is later; (c) for RCEs and CPAs before the first Office action on the merits.	None (IDS will be considered).
(2) After (1) but before final action, notice of allowance, or <i>Quayle</i> action.	1.97(e) statement or 1.17(p) fee.
(3) After (2) and before (or with) payment of issue fee.	1.97(e) statement, and 1.17(p) fee.

<u>Time when IDS is filed</u>	<u>37 CFR 1.97 Requirements</u>
(4) After payment of issue fee.	IDS will not be considered. (See petition under 37 CFR 1.313(c) to withdraw from issue.)

**B (1) Information Disclosure Statement Filed BEFORE First Action on the Merits or Within Three (3) Months of Actual Filing Date (37 CFR 1.97(b))**

An information disclosure statement will be considered by the examiner if filed within any one of the following time periods:

(A) for national applications (not including CPAs), within 3 months of the filing date of the national application or before the mailing date of a first Office action on the merits;

(B) for international applications, within 3 months of the date of entry of the national stage as set forth in 37 CFR 1.491 or before the mailing date of a first Office action on the merits; or

(C) for RCEs and CPAs, before the mailing date of a first Office action on the merits.

An information disclosure statement filed within one of these periods requires neither a fee nor a statement under 37 CFR 1.97(e). An information disclosure statement will be considered to have been filed on the day it was received in the Office, or on an earlier date of mailing if accompanied by a properly executed certificate of mailing or facsimile transmission under 37 CFR 1.8, or if it is in compliance with the provisions of “Express Mail” delivery under 37 CFR 1.10.>If the last day of the three months period set forth in 37 CFR 1.97(b)(1) and (b)(2) falls on a Saturday, Sunday, or a Federal holiday within the District of Columbia, the IDS will be considered timely if filed on the next succeeding business day which is not a Saturday, Sunday, or a Federal holiday. See 37 CFR 1.7(a).< An Office action is mailed on the date indicated in the Office action.

It would not be proper to make final a first Office action in a continuing application or in an application after the filing of a RCE if the information submitted in the IDS during the time period set forth in 37 CFR 1.97(b) is used in a new ground of rejection.

**(a) National or International Applications**

The term “national application” includes continuing applications (continuations, divisions, and continuations-in-part but not CPAs), so 3 months will be measured from the actual filing date of an application as opposed to the effective filing date of a continuing application. For international applications, the 3 months will be measured from the date of entry of the national stage.

All information disclosure statements that comply with the content requirements of 37 CFR 1.98 and are filed within 3 months of the filing date, will be considered by the examiner, regardless of whatever else has occurred in the examination process up to that point in time. Thus, in the rare instance that a final Office action, a notice of allowance, or an *Ex parte Quayle* action is mailed prior to a date which is 3 months from the filing date, any information contained in a complete information disclosure statement filed within that 3-month window will be considered by the examiner.

Likewise, an information disclosure statement will be considered if it is filed later than 3 months after the application filing date but before the mailing date of a first Office action on the merits. An action on the merits means an action which treats the patentability of the claims in an application, as opposed to only formal or procedural requirements. An action on the merits would, for example, contain a rejection or indication of allowability of a claim or claims rather than just a restriction requirement (37 CFR 1.142) or just a requirement for additional fees to have a claim considered (37 CFR 1.16(d)). Thus, if an application was filed on January 2 and the first Office action on the merits was not mailed until 6 months later on July 2, the examiner would be required to consider any proper information disclosure statement filed prior to July 2.

**(b) RCE and CPA**

The 3-month window as discussed above does not apply to a RCE filed under 37 CFR 1.114 or a CPA

filed under 37 CFR 1.53(d) >(effective July 14, 2003, CPAs are only available for design applications)<. An IDS filed after the filing of a RCE will be considered if the IDS is filed before the mailing date of a first Office action on the merits. A RCE is not the filing of an application, but merely the continuation of prosecution in the current application. After the mailing of a RCE, such application is treated as an amended application by the examiner and is subject to a short turnover time. Therefore, applicants are encouraged to file any IDS with the filing of a RCE. See MPEP § 706.07(h) for details on RCEs.

Similarly, an IDS filed in a CPA will be considered if the IDS is filed before the mailing date of a first Office action on the merits. Applicants are encouraged to file any IDS in a CPA as early as possible, preferably at the time of filing of the CPA request.

If an IDS cannot be filed before the mailing of a first Office action on the merits (generally within 2 months from the filing of the RCE or CPA), applicants may request a 3-month suspension of action under 37 CFR 1.103(c) in an application at the time of filing of the RCE, or under 37 CFR 1.103(b) in a CPA, at the time of filing of the CPA. Where an IDS is mailed to the Office shortly before the expiration of a 3-month suspension under 37 CFR 1.103(b) or (c), applicant is requested to make a courtesy call to notify the examiner as to the IDS submission.

**B (2) Information Disclosure Filed After B(1) but BEFORE Mailing of Final Action, Notice of Allowance, or an Ex parte Quayle Action (37 CFR 1.97(c))**

An information disclosure statement will be considered by the examiner if filed after the period specified in subsection III.B(1) above, but prior to the date the prosecution of the application closes, i.e., before (not on the same day as the mailing date of any of the following:

a final action under 37 CFR 1.113, e.g., final rejection;

a notice of allowance under 37 CFR 1.311; or

an action that closes prosecution in the application, e.g., an *Ex parte Quayle* action, whichever occurs first, provided the information disclosure statement is accompanied by either (1) a statement as specified in 37 CFR 1.97(e) (see the discussion in subsection III.B(5) below); or (2) the fee

set forth in 37 CFR 1.17(p). If a final action, notice of allowance, or an *Ex parte Quayle* action is mailed in an application and later withdrawn, the application will be considered as not having had a final action, notice of allowance, or an *Ex parte Quayle* action mailed for purposes of considering an information disclosure statement.

An *Ex parte Quayle* action is an action that closes the prosecution in the application as referred to in 37 CFR 1.97(c). Therefore, an information disclosure statement filed after an *Ex parte Quayle* action, must comply with the provisions of 37 CFR 1.97(d).

**(a) Information is Used in a New Ground of Rejection**

**i) Final Rejection is Not Appropriate**

If information submitted during the period set forth in 37 CFR 1.97(c) with a statement under 37 CFR 1.97(e) is used in a new ground of rejection on unamended claims, the next Office action will not be made final since in this situation it is clear that applicant has submitted the information to the Office promptly after it has become known and the information is being submitted prior to a final determination on patentability by the Office.

**ii) Final Rejection Is Appropriate**

The information submitted with a statement under 37 CFR 1.97(e) can be used in a new ground of rejection and the next Office action can be made final, if the new ground of rejection was necessitated by amendment of the application by applicant. Where the information is submitted during this period with a fee as set forth in 37 CFR 1.17(p), the examiner may use the information submitted, and make the next Office action final whether or not the claims have been amended, provided that no other new ground of rejection which was not necessitated by amendment to the claims is introduced by the examiner. See MPEP § 706.07(a).

**B(3) Information Disclosure Statement Filed After B(2), but Prior to Payment of Issue Fee 37 CFR 1.97(d)**

An information disclosure statement will be considered by the examiner if filed on or after the mailing date of any of the following: a final action under 37

CFR 1.113; a notice of allowance under 37 CFR 1.311; or an action that closes prosecution in the application, e.g., an *Ex parte Quayle* action, but before or simultaneous with payment of the issue fee, provided the statement is accompanied by:

- (A) a statement as specified in 37 CFR 1.97(e) (see the discussion in subsection B(5); and
- (B) the fee set forth in 37 CFR 1.17(p).

These requirements are appropriate in view of the late stage of prosecution when the information is being submitted, i.e., after the examiner has reached a final determination on the patentability of the claims presented for examination. Payment of the fee (37 CFR 1.17(p)) and submission of the appropriate statement (37 CFR 1.97(e)) are the essential elements for having information considered at this advanced stage of prosecution, assuming the content requirements of 37 CFR 1.98 are satisfied.

Form paragraph 6.52 may be used to inform the applicant that the information disclosure statement is being considered.

¶ 6.52 *Information Disclosure Statement Filed After Prosecution Has Been Closed*

The information disclosure statement (IDS) submitted on [1] was filed after the mailing date of the [2] on [3]. The submission is in compliance with the provisions of 37 CFR 1.97. Accordingly, the information disclosure statement is being considered by the examiner.

**Examiner Note:**

1. In bracket 1, insert the date the IDS was filed.
2. In bracket 2, insert --final Office action--, --Notice of Allowance--, or an --*Ex parte Quayle* action-- as appropriate.

The requirements of 37 CFR 1.97 provide for consideration by the Office of information which is submitted within a reasonable time, i.e., within 3 months after an individual designated in 37 CFR 1.56(c) becomes aware of the information or within 3 months of the information being cited in a communication from a foreign patent office in a counterpart foreign application. This undertaking by the Office to consider information would be available throughout the pendency of the application until the point where the patent issue fee was paid.

If an applicant chose not to comply, or could not comply, with the requirements of 37 CFR 1.97(d), the applicant may file a RCE under 37 CFR 1.114, or a continuing application under 37 CFR 1.53(b) \*\*>(or

37 CFR 1.53(d) if the application is a design application)< to have the information considered by the examiner. If the applicant files a continuing application under 37 CFR 1.53(b), the parent application could be permitted to become abandoned by not paying the issue fee required in the Notice of Allowance. If the prior application is a design application, \*\* the filing of a continued prosecution application under 37 CFR 1.53(d) automatically abandons the prior application. See the discussion in subsection I. above under the heading “IDS IN CONTINUED EXAMINATIONS AND CONTINUING APPLICATION.”

**B (4) Information Disclosure Statement Filed After Payment of Issue Fee**

After the issue fee has been paid on an application, it is impractical for the Office to attempt to consider newly submitted information. Information disclosure statements filed after payment of the issue fee in an application will not be considered but will merely be placed in the application file. See subsection C below. The application may be withdrawn from issue at this point, pursuant to 37 CFR 1.313(c)(2) or 1.313(c)(3) so that the information can be considered in the application upon the filing of a RCE under 37 CFR 1.114 or in a continuing application filed under 37 CFR 1.53(b) \*\*>(or 37 CFR 1.53(d) if the application is a design application)<. In this situation, a RCE, or a CPA (if the prior application is a design application\*\*), or a continuing application filed under 37 CFR 1.53(b) could be filed even though the issue fee had already been paid. See MPEP § 1308. Applicants are encouraged to file the petition under 37 CFR 1.313(c)(2) with a RCE, or the petition under 37 CFR 1.313(c)(3) with a CPA or continuing application under 37 CFR 1.53(b), by facsimile transmission to the Office of Petitions (see MPEP § 1730 for the facsimile number). The Office cannot ensure that any petition under 37 CFR 1.313(c) will be acted upon prior to the date of patent grant. Applicants considering filing a petition under 37 CFR 1.313(c) are encouraged to call the Office of Petitions to determine whether sufficient time remains before the patent issue date to consider and grant a petition under 37 CFR 1.313(c). The petition need not be accompanied by the information disclosure statement if the size of the statement makes its submission by facsimile impracticable, but the petition should indicate that an

IDS will be filed in the application or in the continuing application if it does not accompany the petition under 37 CFR 1.313(c). The IDS should be filed before the mailing of a first Office action on the merits. If the IDS cannot be filed within this time period, applicants may request a three-month suspension of action under 37 CFR 1.103 at the time of filing of the RCE or CPA. See the discussion above in paragraph III.B(1)(b) above.

Alternatively, for example, a petition pursuant to 37 CFR 1.313(c)(1) could be filed if applicant states that one or more claims are unpatentable. This statement that one or more claims are unpatentable over the information must be unequivocal. A statement that a serious question as to patentability of a claim has been raised, for example, would not be acceptable to withdraw an application from issue under 37 CFR 1.313(c)(1). Form paragraph 13.09 may be used.

\*\*>

¶ 13.09 *Information Disclosure Statement, Issue Fee Paid*

Applicant's information disclosure statement of [1] was filed after the issue fee was paid. Information disclosure statements filed after payment of the issue fee will not be considered, but will be placed in the file. However, the application may be withdrawn from issue in order to file a request for continued examination (RCE) under 37 CFR 1.114 upon the grant of a petition under 37 CFR 1.313(c)(2), or a continuing application under 37 CFR 1.53(b) (or a continued prosecution application (CPA) under 37 CFR 1.53(d) if the CPA is for a design patent and the prior application of the CPA is a design application) upon the grant of a petition filed under the provisions of 37 CFR 1.313(c)(3). Alternatively, the other provisions of 37 CFR 1.313 may apply, e.g., a petition to withdraw the application from issue under the provisions of 37 CFR 1.313(c)(1) may be filed together with an unequivocal statement by the applicant that one or more claims are unpatentable over the information contained in the statement. The information disclosure statement would then be considered upon withdrawal of the application from issue under 37 CFR 1.313(c)(1).

**Examiner Note:**

1. For information disclosure statements submitted after the issue fee has been paid, use this form paragraph with form PTOL-90 or PTO-90C.
2. In bracket 1, insert the filing date of the IDS.

<

If an application has been withdrawn from issue under one of the provisions of 37 CFR 1.313(c)(1)-(3), it will be treated as though no notice of allowance had been mailed and the issue fee had not yet been paid with regard to the time for filing information dis-

closure statements. Petitions under 37 CFR 1.313(c) should be directed to the Office of Petitions in the Office of the Deputy Commissioner for Patent Examination Policy. See MPEP § 1308.

**B(5) Statement Under 37 CFR 1.97(e)**

A statement under 37 CFR 1.97(e) must state either

(1) that each item of information contained in the information disclosure statement was first cited in any communication from a foreign patent office in a counterpart foreign application not more than three months prior to the filing of the statement, or

(2) that no item of information contained in the information disclosure statement was cited in a communication from a foreign patent office in a counterpart foreign application, and, to the knowledge of the person signing the statement after making reasonable inquiry, no item of information contained in the information disclosure statement was known to any individual designated in 37 CFR 1.56(c) more than three months prior to the filing of the statement.

A statement under 37 CFR 1.97(e) can contain either of two statements. One statement is that each item of information in an information disclosure statement was first cited in any communication, such as a search report, from a patent office outside the U.S. in a counterpart foreign application not more than 3 months prior to the filing date of the statement. Applicant would not be able to make a statement under 37 CFR 1.97(e) where an item of information was first cited by a foreign patent office, for example, a year before the filing of the IDS, in a communication from that foreign patent office, and the same item of information is once again cited by another foreign patent office within three months prior to the filing of the IDS in the Office. Similarly, applicant would not be able to make a statement under 37 CFR 1.97(e) where an item of information was cited in an examination report and the same item of information was previously cited more than three months prior to the filing of the IDS in the Office, in a search report from the same foreign patent office. Under this statement, it does not matter whether any individual with a duty of disclosure actually knew about any of the information cited before receiving the search report.

The date on the communication by the foreign patent office begins the 3-month period in the same

manner as the mailing of an Office action starts a 3-month shortened statutory period for reply. If the communication contains two dates, the mailing date of the communication is the one which begins the 3-month period. The date which begins the 3-month period is not the date the communication was received by a foreign associate or the date it was received by a U.S. registered practitioner. Likewise, the statement will be considered to have been filed on the date the statement was received in the Office, or on an earlier date of mailing or transmission if accompanied by a properly executed certificate of mailing or facsimile transmission under 37 CFR 1.8, or if it is in compliance with the provisions for "Express Mail" delivery under 37 CFR 1.10.

The term counterpart foreign patent application means that a claim for priority has been made in either the U.S. application or a foreign application based on the other, or that the disclosures of the U.S. and foreign patent applications are substantively identical (e.g., an application filed in the European Patent Office claiming the same U.K. priority as claimed in the U.S. application).

Communications from foreign patent offices in foreign applications sometimes include a list of the family of patents corresponding to a particular patent being cited in the communication. The family of patents may include a United States patent or other patent in the English language. Some applicants submit information disclosure statements to the PTO which list and include copies of both the particular patent cited in the foreign patent office communication and the related United States or other English language patent from the family list. Since this is to be encouraged, the United States or other English language patent will be construed as being cited by the foreign patent office for purposes of a statement under 37 CFR 1.97(e)(1). The examiner should consider the United States or other English language patent if 37 CFR 1.97 and 37 CFR 1.98 are complied with.

If an information disclosure statement includes a copy of a dated communication from a foreign patent office which clearly shows that the statement is being submitted within 3 months of the date on the communication, the copy will be accepted as the required \*>statement under 37 CFR 1.97(e)(1)<. It will be assumed, in the absence of evidence to the contrary,

that the communication was for a counterpart foreign application.

In the alternative, a statement can be made if no item of information contained in the information disclosure statement was cited in a communication from a foreign patent office in a counterpart foreign application and, to the knowledge of the person signing the statement after making reasonable inquiry, neither was it known to any individual having a duty to disclose more than 3 months prior to the filing of the statement. >If an inventor of the U.S. application is also a named inventor of one of the items of information contained in the IDS, the 37 CFR 1.97(e)(2) statement cannot be made for that particular item of information, and if made, will not be accepted.<

The phrase "after making reasonable inquiry" makes it clear that the individual making the statement has a duty to make reasonable inquiry regarding the facts that are being stated. The statement can be made by a registered practitioner who represents a foreign client and who relies on statements made by the foreign client as to the date the information first became known. A registered practitioner who receives information from a client without being informed whether the information was known for more than 3 months, however, cannot make the statement under 37 CFR 1.97(e)(2) without making reasonable inquiry. For example, if an inventor gave a publication to the attorney prosecuting an application with the intent that it be cited to the Office, the attorney should inquire as to when that inventor became aware of the publication and should not submit a statement under 37 CFR 1.97(e)(2) to the Office until a satisfactory response is received. The statement can be based on present, good faith knowledge about when information became known without a search of files being made.

A statement under 37 CFR 1.97(e) need not be in the form of an oath or a declaration under 37 CFR 1.68. A statement under 37 CFR 1.97(e) by a registered practitioner or any other individual that the statement was filed within the 3-month period of either first citation by a foreign patent office or first discovery of the information will be accepted as dispersive of compliance with this provision in the absence of evidence to the contrary. For example, a statement under 37 CFR 1.97(e) could read as follows:



I hereby state that each item of information contained in this Information Disclosure Statement was first cited in any communication from a foreign patent office in a counterpart foreign application not more than 3 months prior to the filing of this statement.,

or

I hereby state that no item of information in the Information Disclosure Statement filed herewith was cited in a communication from a foreign patent office in a counterpart foreign application, and, to my knowledge after making reasonable inquiry, no item of information contained in this Information Disclosure Statement was known to any individual designated in 37 CFR 1.56(c) more than 3 months prior to the filing of this Information Disclosure Statement.

An information disclosure statement may include two lists and two statements, similar to the above examples, in situations where some of the information listed was cited in a communication from a foreign patent office not more than 3 months prior to filing the statement and some was not, but was not known more than 3 months prior to filing the statement.

A copy of the foreign search report need not be submitted with the statement under 37 CFR 1.97(e), but an individual may wish to submit an English-language version of the search report to satisfy the requirement for a concise explanation where non-English language information is cited. The time at which information was known to any individual designated in 37 CFR 1.56(c) is the time when the information was discovered in association with the application even if awareness of the materiality came later. The Office wishes to encourage prompt evaluation of the relevance of information and to have a date certain for determining if a statement under 37 CFR 1.97(e) can properly be made. A statement on information and belief would not be sufficient. Examiners should not remind or otherwise make any comment about an individual's duty of candor and good faith. Questions about the adequacy of any statement received in writing by the Office should be directed to the Office of Patent Legal Administration.

#### **B(6) Extensions of Time (37 CFR 1.97(f))**

No extensions of time for filing an information disclosure statement are permitted under 37 CFR 1.136(a) or (b). If a *bona fide* attempt is made to comply with the content requirements of 37 CFR 1.98, but part of the required content is inadvertently omitted,

additional time may be given to enable full compliance.

#### ***C. Examiner Handling of Information Disclosure Statements***

Information disclosure statements will be reviewed for compliance with the requirements of 37 CFR 1.97 and 37 CFR 1.98 as discussed in subsection III.A and B above. Applicant will be notified of compliance and noncompliance with the rules as discussed below.

#### **C(1) Noncomplying Information Disclosure Statements**

Pursuant to 37 CFR 1.97(i), submitted information, filed before the grant of a patent, which does not comply with 37 CFR 1.97 and 37 CFR 1.98 will be placed in the file, but will not be considered by the Office. Information submitted after the grant of a patent must comply with 37 CFR 1.501.

If an information disclosure statement does not comply with the requirements based on the time of filing of the IDS as discussed in subsection III.B above, including the requirements for fees and/or statement under 37 CFR 1.97(e), the IDS will be placed in the application file, but none of the information will be considered by the examiner. The examiner may use form paragraph 6.49 which is reproduced below to inform applicant that the information has not been considered. Applicant may then file a new information disclosure statement or correct the deficiency in the previously filed IDS, but the date that the new IDS or correction is filed will be the date of the IDS for purposes of determining compliance with the requirements based on the time of filing of the IDS (37 CFR 1.97).

The examiner should write "not considered" on an information disclosure statement where none of the information listed complies with the requirements, e.g., no copies of listed items submitted. >For Image File Wrapper (IFW) processing, see IFW Manual.< If none of the information listed on a PTO-1449 or PTO/SB/08A and 08B form is considered, a diagonal line should also be drawn in pencil across the form and the form placed on the right side of the application file to instruct the printer not to list the information on the face of the patent if the application goes to issue. The paper containing the disclosure statement or list will be placed in the record in the application file. The

examiner will inform applicant that the information has not been considered and the reasons why by using form paragraphs 6.49 through 6.49.09. If the improper citation appears as part of another paper, e.g., an amendment, which may be properly entered and considered, the portion of the paper which is proper for consideration will be considered.

If an item of information in an IDS fails to comply with all the requirements of 37 CFR 1.97 and 37 CFR 1.98, that item of information in the IDS will not be considered and a line should be drawn through the citation to show that it has not been considered. However, other items of information that do comply with all the requirements of 37 CFR 1.97 and 37 CFR 1.98 will be considered by the examiner.

If information listed in the specification rather than in a separate paper, or if the other content requirements as discussed in subsection III.A above are not complied with, the information need not be considered by the examiner, in which case, the examiner should notify applicant in the next Office action that the information has not been considered.

#### (a) Form Paragraphs

##### ¶ 6.49 Information Disclosure Statement Not Considered

The information disclosure statement filed [1] fails to comply with the provisions of 37 CFR 1.97, 1.98 and MPEP § 609 because [2]. It has been placed in the application file, but the information referred to therein has not been considered as to the merits. Applicant is advised that the date of any resubmission of any item of information contained in this information disclosure statement or the submission of any missing element(s) will be the date of submission for purposes of determining compliance with the requirements based on the time of filing the statement, including all requirements for statements under 37 CFR 1.97(e). See MPEP § 609 subsection III, C(1).

#### Examiner Note:

See MPEP § 609 for situations where the use of this form paragraph would be appropriate.

##### ¶ 6.49.01 Information Disclosure Statement Not Considered, After First Action, But Before the Prosecution of the Application Closes, No Statement

The information disclosure statement filed [1] fails to comply with 37 CFR 1.97(c) because it lacks a statement as specified in 37 CFR 1.97(e). It has been placed in the application file, but the information referred to therein has not been considered.

##### ¶ 6.49.02 Information Disclosure Statement Not Considered, After First Action, But Before the Prosecution of the Application Closes, No Fee

The information disclosure statement filed [1] fails to comply with 37 CFR 1.97(c) because it lacks the fee set forth in 37 CFR 1.17(p). It has been placed in the application file, but the information referred to therein has not been considered.

##### ¶ 6.49.03 Information Disclosure Statement Not Considered, After the Prosecution of the Application Closes, Issue Fee Not Paid, No Statement

The information disclosure statement filed [1] fails to comply with 37 CFR 1.97(d) because it lacks a statement as specified in 37 CFR 1.97(e). It has been placed in the application file, but the information referred to therein has not been considered.

##### ¶ 6.49.05 Information Disclosure Statement Not Considered, After the Prosecution of the Application Closes, Issue Fee Not Paid, No Fee

The information disclosure statement filed [1] fails to comply with 37 CFR 1.97(d) because it lacks the fee set forth in 37 CFR 1.17(p). It has been placed in the application file, but the information referred to therein has not been considered.

##### ¶ 6.49.06 Information Disclosure Statement Not Considered, References Listed in Specification

The listing of references in the specification is not a proper information disclosure statement. 37 CFR 1.98(b) requires a list of all patents, publications, applications, or other information submitted for consideration by the Office, and MPEP § 609 subsection III A(1) states, "the list may not be incorporated into the specification but must be submitted in a separate paper." Therefore, unless the references have been cited by the examiner on form PTO-892, they have not been considered.

\*\*>

##### ¶ 6.49.07 Information Disclosure Statement Not Considered, No Copy of References

The information disclosure statement filed [1] fails to comply with 37 CFR 1.98(a)(2), which requires a legible copy of each U.S. and foreign patent; each publication or that portion which caused it to be listed; for each cited pending U.S. application, the application specification including the claims, and any drawing of the application, or that portion of the application which caused it to be listed including any claims directed to that portion and all other information or that portion which caused it to be listed. It has been placed in the application file, but the information referred to therein has not been considered.

#### Examiner Note:

Do not use this form paragraph when the missing reference(s) are U.S. patents or U.S. patent application publications and the IDS was submitted electronically. See 37 CFR 1.98(e).

<

¶ 6.49.08 *Information Disclosure Statement Not Considered, No List of References*

The information disclosure statement filed [1] fails to comply with 37 CFR 1.98(a)(1), which requires a list of all patents, publications, applications, or other information submitted for consideration by the Office. It has been placed in the application file, but the information referred to therein has not been considered.

¶ 6.49.09 *Information Disclosure Statement Not Considered, No Explanation of Relevance of Non-English Language Information*

The information disclosure statement filed [1] fails to comply with 37 CFR 1.98(a)(3)(i) because it does not include a concise explanation of the relevance, as it is presently understood by the individual designated in 37 CFR 1.56(c) most knowledgeable about the content of the information, of each reference listed that is not in the English language. It has been placed in the application file, but the information referred to therein has not been considered.

¶ 6.51 *Time for Completing Information Disclosure Statement*

The information disclosure statement filed on [1] does not fully comply with the requirements of 37 CFR 1.98 because: [2]. Since the submission appears to be *bona fide*, applicant is given **ONE (1) MONTH** from the date of this notice to supply the above-mentioned omissions or corrections in the information disclosure statement. **NO EXTENSION OF THIS TIME LIMIT MAY BE GRANTED UNDER EITHER 37 CFR 1.136(a) OR (b).** Failure to timely comply with this notice will result in the above-mentioned information disclosure statement being placed in the application file with the non-complying information **not** being considered. See 37 CFR 1.97(i).

**Examiner Note:**

Use this form paragraph if an IDS complies with the timing requirements of 37 CFR 1.97 but part of the content requirements of 37 CFR 1.98 has been inadvertently omitted.

This practice does not apply where there has been a deliberate omission of some necessary part of an Information Disclosure Statement or where the requirements based on the time of filing the statement, as set forth in 37 CFR 1.97, have not been complied with.

**C(2) Complying Information Disclosure Statements**

The information contained in information disclosure statements which comply with both the content requirements of 37 CFR 1.98 and the requirements, based on the time of filing the statement, of 37 CFR 1.97 will be considered by the examiner. Consideration by the examiner of the information submitted in an IDS means that the examiner will consider the documents in the same manner as other documents in Office search files are considered by the examiner

while conducting a search of the prior art in a proper field of search. The initials of the examiner placed adjacent to the citations on the PTO-1449 or PTO/SB/08A and 08B or its equivalent mean that the information has been considered by the examiner to the extent noted above. \*\*

Examiners must consider all citations submitted in conformance with the rules and this section, and their initials when placed adjacent to the considered citations on the list or in the boxes provided on a form PTO-1449 or PTO/SB/08A and 08B provides a clear record of which citations have been considered by the Office. The examiner must also fill in his or her name and the date the information was considered in blocks at the bottom of the PTO-1449 or PTO/SB/08A and 08B form. If the citations are submitted on a list other than on a form PTO-1449 or PTO/SB/08A and 08B, the examiner may write “all considered” and his or her initials to indicate that all citations have been considered. >For IFW processing, see IFW Manual section 3.< If any of the citations are considered, a copy of the submitted list, form PTO-1449, or PTO/SB/08A and 08B, as reviewed by the examiner, will be returned to the applicant with the next communication. Those citations not considered by the examiner will have a line drawn through the citation and any citations considered will have the examiner's initials adjacent thereto. The original copy of the list, form PTO-1449, or PTO/SB/08A and 08B will be entered into the application file. The copy returned to applicant will serve both as acknowledgement of receipt of the information disclosure statement and as an indication as to which references were considered by the examiner. Forms PTO-326 and PTOL-37 include a box to indicate the attachment of form PTO-1449 or PTO/SB/08A and 08B.

Information which complies with requirements as discussed in this section but which is in a non-English language will be considered in view of the concise explanation submitted (subsection III.A(3) above) and insofar as it is understood on its face, e.g., drawings, chemical formulas, in the same manner that non-English language information in Office search files is considered by examiners in conducting searches. The examiner need not have the information translated unless it appears to be necessary to do so. The examiner will indicate that the non-English language information has been considered in the same manner as

consideration is indicated for information submitted in English. The examiner should not require that a translation be filed by applicant. The examiner should not make any comment such as that the non-English language information has only been considered to the extent understood, since this fact is inherent. See *Semiconductor Energy Laboratory Co. V. Samsung Electronics Co.*, 204 F.3d 1368, 1377-78, 54 USPQ2d 1001, 1008 (Fed. Cir. 2000) (“[A]s MPEP Section 609C(2) reveals, the examiner’s understanding of a foreign reference is generally limited to that which he or she can glean from the applicant’s concise statement...Consequently, while the examiner’s initials require that we presume that he or she considered the [foreign] reference, this presumption extends only to the examiner’s consideration of the brief translated portion and the concise statement.”).

Since information is required to be submitted in a separate paper listing the citations rather than in the specification, there is no need to mark “All checked” or “Checked” in the margin of a specification containing citations.

If an item of information in an IDS fails to comply with requirements of 37 CFR 1.97 and 37 CFR 1.98, a line should be drawn through the citation to show that it has not been considered. The other items of information listed that do comply with the requirements of 37 CFR 1.97 and 37 CFR 1.98 will be considered by the examiner and will be appropriately initialed.

### **C (3) Documents Submitted As Part of Applicant’s Reply to Office Action**

Occasionally, documents are submitted and relied on by an applicant when replying to an Office action. These documents may be relied on by an applicant, for example, to show that an element recited in the claim is operative or that a term used in the claim has a recognized meaning in the art. Documents may be in any form but are typically in the form of an affidavit, declaration, patent, or printed publication.

To the extent that a document is submitted as evidence directed to an issue of patentability raised in an Office action, and the evidence is timely presented, applicant need not satisfy the requirements of 37 CFR 1.97 and 37 CFR 1.98 in order to have the examiner consider the information contained in the document relied on by applicant. In other words, compliance with the information disclosure rules is not a thresh-

old requirement to have information considered when submitted by applicant to support an argument being made in a reply to an Office action. >However, consideration by the examiner of the document submitted as evidence directed to an issue of patentability raised in the Office action is limited to the portion of the document relied upon as rebuttal evidence; the entirety of the document may not necessarily be considered by the examiner.<

At the same time, the document supplied and relied on by applicant as evidence need not be processed as an item of information that was cited in an information disclosure statement. The record should reflect whether the evidence was considered, but listing on a form (e.g., PTO-892, PTO-1449, or PTO/SB/08A and 08B) and appropriate marking of the form by the examiner is not required.

For example, if applicant submits and relies on three patents as evidence in reply to the first Office action and also lists those patents on a PTO-1449 or PTO/SB/08A and 08B along with two journal articles, but does not file a statement under 37 CFR 1.97(e) or the fee set forth in 37 CFR 1.17(p), it would be appropriate for the examiner to indicate that the teachings relied on by applicant in the three patents have been considered, but to line through the citation of all five documents on the PTO-1449 or PTO/SB/08A and 08B and to inform applicant that the information disclosure statement did not comply with 37 CFR 1.97(c).

### ***D. Information Printed on Patent***

A citation listed on form PTO-1449 or PTO/SB/08A and 08B and considered by the examiner in accordance with this section will be printed on the patent. A citation listed in a separate paper, equivalent to but not on form PTO-1449 or PTO/SB/08A and 08B, and considered by the examiner in accordance with this section will be printed on the patent if the list is on a separate sheet which is clearly identified as an information disclosure statement and the list lends itself to easy capture of the necessary information by the Office printing contractor, i.e., each item of information is listed on a single line, the lines are at least double-spaced from each other, the information is uniform in format for each listed item, and the list includes a column for the examiner’s initials to indicate that the information was considered. For patents printed after January 1, 2001, citations from

information disclosure statements that are printed on the face of the patent will be distinguished from citations cited by the examiner on a form PTO-892. The citations cited by the examiner on a form PTO-892 will be marked with an asterisk. If an item of information is cited more than once in an IDS and on a form PTO-892, the citation of the item will be listed only once on the patent as a citation cited by the examiner.

If the applicant does not provide classification information for a citation, or if the examiner lines through incorrect classification data, the citation will be printed on the face of the patent without the classification information. If a U.S. patent application num-

ber is listed on a PTO-1449 or PTO/SB/08A and 08B form or its equivalent and the examiner considers the information and initials the form, the application number will be printed on the patent. Applicants may wish to list U.S. patent application numbers on other than a form PTO-1449 or PTO/SB/08A and 08B format to avoid the application numbers of pending applications being published on the patent. If a citation is not printed on the patent but has been considered by the examiner in accordance with this section, the patented file will reflect that fact as noted in subsection III.C(2) above.





&gt;

#### IV. IDSs ELECTRONICALLY SUBMITTED (e-IDSs) USING THE EFS

As of May of 2002 IDSs may be submitted to the Office via the EFS. Applicants can file an e-IDS using the EFS by (A) entering the references' citation information in an electronic data entry form, equivalent to the paper PTO-1449 form, and (B) transmitting the electronic data entry form data to the Office. This electronic form allows only citations of U.S. patents and U.S. patent application publications. No paper copies of U.S. patents and U.S. patent application publications cited in the IDS are required to be submitted by the applicants with the e-IDS. If any references to foreign patent documents or non-patent literature documents (NPLs) or unpublished U.S. patent applications are to be cited, applicants must submit those citations on a separate, conventional paper PTO-1449 (or revised forms PTO/SB/08A and/or PTO/SB/08B). A legible copy of each cited foreign patent document, NPL, and unpublished U.S. patent application must accompany the conventional IDS form and the requirements of 37 CFR 1.97 and 1.98 must be complied with for the IDS to be considered by the Office.

The electronic IDS form may be included with a new EFS electronic application filing, or it may be submitted for previously filed patent applications. An e-IDS contains an electronic list of U.S. patent numbers and U.S. patent application publication numbers. An individual e-IDS may contain a listing of up to 50 U.S. patents and 50 U.S. patent application publications. To file a complete IDS containing more than 50 U.S. patents and/or 50 U.S. patent application publications, applicants are permitted to file more than one e-IDS. Similarly, applicants may file a portion of an IDS using e-IDS and another portion using conventional paper procedures for references that cannot be submitted using e-IDS (e.g., NPLs).

If more than one e-IDS is necessary and/or it is necessary to file the e-IDS with a conventional paper IDS to file a complete IDS for which a fee is required under 37 CFR 1.17(p), only a single fee under 37 CFR 1.17(p) will be required under the following conditions:

(A) the fee required by 37 CFR 1.17(p) is included with the first e-IDS submission (since it will normally be processed first);

(B) all subsequent submissions making up the IDS should explicitly state that the fee was included in the earlier submission and request that the one fee be accepted for the second and any subsequent submission; and

(C) all subsequent submissions (electronic or paper) must be received by the Office on the same date as the first e-IDS submission with which the fee was included.

A subsequent non-electronic submission is considered received by the Office on the same date as the first e-IDS submission with which the fee was included for purposes of the fee due under 37 CFR 1.17(p) if it is deposited in Express Mail under 37 CFR 1.10, deposited in the first class U.S. mail with a certificate of mailing in accordance with 37 CFR 1.8, or transmitted by facsimile with a certificate of transmission in accordance with 37 CFR 1.8, on the same date as the first e-IDS submission with which the fee was included. If a subsequent e-IDS submission is received by the Office on a date later than the date the fee was paid, the later submission will require an additional fee.

A paper copy of the e-IDS form will be placed in paper application files, similar to the PTO/SB/08A, PTO/SB/08B and PTO-1449 forms. The e-IDS form has the title "Electronic Information Disclosure Statement" at the top. A copy of the e-IDS form will be scanned to become part of the IFW for IFW applications. In all applications, the e-IDS will be added to the application file contents listing, and to the EXPO database record for the application.

If the e-IDS complies with the requirements of 37 CFR 1.97, examiners must consider the e-IDS and complete the e-IDS form by initialing, signing, and dating the e-IDS form entries. Examiners may notice numbering gaps in the "Citation No." column on the printed e-IDS form due to an applicant data entry error. This data entry error will not affect the e-IDS and is not a sufficient reason not to consider the e-IDS. A copy of the initialed, signed, and dated e-IDS form must be sent to the applicant. The original completed e-IDS form will be retained in the application file if the application file is maintained in paper. The completed copy of the e-IDS form sent to an applicant



in an IFW application should be made of record in the IFW when the copy is sent to the applicant.

An electronic list of all U.S. patents and U.S. patent application publications on an e-IDS form is available and accessible from the examiner's workstation by clicking on the e-IDS icon, on the workstation desktop. Consideration of the e-IDS may not be deferred and an examiner should not require an applicant to submit paper copies of e-IDS references. It is most important that the U.S. patent and U.S. patent application publication numbers listed on the e-IDS be accurate and devoid of transcription error since no copies of the documents listed on the e-IDS are provided in the file wrapper for the examiner to review. Instead the examiner will electronically retrieve the U.S. patents and U.S. patent application publications identified by the cited document numbers. The only mechanism for having the correct document reviewed and considered when an erroneous U.S. patent or U.S. patent application publication is cited in an e-IDS will be by citing the correct citation number in a subsequent IDS that conforms to the requirements of 37 CFR 1.97 and 1.98.

Examiners can copy and paste U.S. patent and U.S. patent application publication numbers from the e-IDS to EAST and/or WEST for searching. For applications maintained in paper, the e-IDS reference listing form has a bar code that corresponds to the U.S. patent numbers and U.S. patent application publica-

tion numbers which may be wanded using the Examiner's bar code reader. Examiners should copy and paste U.S. patent and U.S. patent application publication numbers from the e-IDS to EAST and/or WEST to review the references that are listed in the e-IDS.

The Office's EFS system starting with version 5.1 released on April 14, 2003, permits applicants and registered practitioners to sign portions of an EFS submission with an electronic signature. The electronic signature is any typed combination of alphanumeric characters. The electronic signature does not have to be between forward slashes. The electronic signature may be on EFS transmittal letters, declarations, powers of attorney, fee sheets, and later filed biosequence listings. The pen and ink, and copy requirements for signatures in 37 CFR 1.4 are waived. See the notice published in the *Official Gazette* on October 8, 2002 at 1263 O.G. 60. Accordingly, an e-IDS should not be denied consideration solely because it has an alpha numeric electronic signature if filed on or after April 14, 2003.

If the e-IDS transmittal letter and list of references is missing from an application file, an examiner may request that the technical support staff obtain an additional printed copy of the letter and reference list from the Office of Initial Patent Examination (OIPE).<

\*\*



# Chapter 700 Examination of Applications

<b>701</b>	<b>Statutory Authority for Examination</b>	706.02(i)	Form Paragraphs for Use in Rejections Under 35 U.S.C. 102
<b>702</b>	<b>Requisites of the Application</b>	706.02(j)	Contents of a 35 U.S.C. 103 Rejection
702.01	Obviously Informal Cases	706.02(k)	Provisional Rejection (Obviousness) Under 35 U.S.C. 102(e)/103
<b>703</b>	<b>“General Information Concerning Patents”</b>	706.02(l)	Rejections Under 35 U.S.C. 102(f)/103 and 35 U.S.C. 102(g)/103; 35 U.S.C. 103(c)
<b>704</b>	<b>Search and Requirements for Information</b>	706.02(l)(1)	Rejections Under 35 U.S.C. 102(e)/103; 35 U.S.C. 103(c)
704.01	Search	706.02(l)(2)	Establishing Common Ownership
704.10	Requirements for Information	706.02(l)(3)	Examination Procedure With Respect to 35 U.S.C. 103(c)
704.11	What Information May Be Required	706.02(m)	Form Paragraphs for Use in Rejections Under 35 U.S.C. 103
704.11(a)	Examples of Information Reasonably required	706.02(n)	Biotechnology Process Applications; 35 U.S.C. 103(b)
704.11(b)	When May a Requirement for Information Be Made	706.03	Rejections Not Based on Prior Art
704.12	Replies to a Requirement for Information	706.03(a)	Rejections under 35 U.S.C. 101
704.12(a)	Relationship of Requirement for Information to Duty of Disclosure	706.03(b)	Barred by Atomic Energy Act
704.12(b)	What Constitutes A Complete Reply	706.03(c)	Rejections Under 35 U.S.C. 112, First Paragraph
704.12(c)	Treatment of Incomplete Reply	706.03(d)	Rejections Under 35 U.S.C. 112, Second Paragraph
704.13	Time Periods for Reply	706.03(k)	Duplicate Claims
704.14	Making a Requirement for Information	706.03(m)	Nonelected Inventions
704.14(a)	Format of the Requirement	706.03(o)	New Matter
704.14(b)	Examiner’s Obligation Following Applicant’s Reply	706.03(s)	Foreign Filing Without License
704.14(c)	Petitions to Requirements Under 37 CFR 1.105	706.03(u)	Disclaimer
704.14(d)	Relationship to Information Disclosure Statements	706.03(v)	After Interference or Public Use Proceeding
<b>705</b>	<b>Patentability Reports</b>	706.03(w)	<i>Res Judicata</i>
705.01	Instructions re Patentability Reports	706.03(x)	Reissue
705.01(a)	Nature of P.R., Its Use and Disposal	706.04	Rejection of Previously Allowed Claims
705.01(b)	Sequence of Examination	706.05	Rejection After Allowance of Application
705.01(c)	Counting and Recording P.R.s	706.06	Rejection of Claims Copied From Patent
705.01(d)	Duplicate Prints of Drawings	706.07	Final Rejection
705.01(e)	Limitation as to Use	706.07(a)	Final Rejection, When Proper on Second Action
705.01(f)	Interviews With Applicants	706.07(b)	Final Rejection, When Proper on First Action
<b>706</b>	<b>Rejection of Claims</b>	706.07(c)	Final Rejection, Premature
706.01	Contrasted With Objections	706.07(d)	Final Rejection, Withdrawal of, Premature
706.02	Rejection on Prior Art	706.07(e)	Withdrawal of Final Rejection, General
706.02(a)	Rejections Under 35 U.S.C. 102(a), (b), or (e); Printed Publication or Patent	706.07(f)	Time for Reply to Final Rejection
706.02(b)	Overcoming a 35 U.S.C. 102 Rejection Based on a Printed Publication or Patent	706.07(g)	Transitional After-Final Practice
706.02(c)	Rejections Under 35 U.S.C. 102(a) or (b); Knowledge by Others or Public Use or Sale	706.07(h)	Request for Continued Examination (RCE) Practice
706.02(d)	Rejections Under 35 U.S.C. 102(c)	<b>707</b>	<b>Examiner’s Letter or Action</b>
706.02(e)	Rejections Under 35 U.S.C. 102(d)	707.01	Primary Examiner Indicates Action for New Assistant
706.02(f)	Rejections Under 35 U.S.C. 102(e)	707.02	Applications Up for Third Action and 5-Year Applications
706.02(f)(1)	Examination Guidelines for Applying References Under 35 U.S.C. 102(e)	707.05	Citation of References
706.02(f)(2)	Provisional Rejections Under 35 U.S.C. 102(e); Reference Is a Copending U.S. Patent Application	707.05(a)	Copies of Cited References
706.02(g)	Rejections Under 35 U.S.C. 102(f)		
706.02(h)	Rejections Under 35 U.S.C. 102(g)		

## MANUAL OF PATENT EXAMINING PROCEDURE

- |   |  |
|---|--|
| <p>707.05(b) Citation of Related Art and Information by Applicants</p> <p>707.05(c) Order of Listing</p> <p>707.05(d) Reference Cited in Subsequent Actions</p> <p>707.05(e) Data Used in Citing References</p> <p>707.05(f) Effective Dates of Declassified Printed Matter</p> <p>707.05(g) Incorrect Citation of References</p> <p>707.06 Citation of Decisions, Orders Memorandums, and Notices</p> <p>707.07 Completeness and Clarity of Examiner's Action</p> <p>707.07(a) Complete Action on Formal Matters</p> <p>707.07(b) Requiring New Oath</p> <p>707.07(c) Draftsperson's Requirement</p> <p>707.07(d) Language To Be Used in Rejecting Claims</p> <p>707.07(e) Note All Outstanding Requirements</p> <p>707.07(f) Answer All Material Traversed</p> <p>707.07(g) Piecemeal Examination</p> <p>707.07(h) Notify of Inaccuracies in Amendment</p> <p>707.07(i) Each Claim To Be Mentioned in Each Office Action</p> <p>707.07(j) State When Claims Are Allowable</p> <p>707.07(k) Numbering Paragraphs</p> <p>707.07(l) Comment on Examples</p> <p>707.08 Reviewing and Initialing by Assistant Examiner</p> <p>707.09 Signing by Primary or Other Authorized Examiner</p> <p>707.10 Entry</p> <p>707.11 Date</p> <p>707.12 Mailing</p> <p>707.13 Returned Office Action</p> <p><b>708 Order of Examination</b></p> <p>708.01 List of Special Cases</p> <p>708.02 Petition To Make Special</p> <p>708.03 Examiner Tenders Resignation</p> <p><b>709 Suspension of Action</b></p> <p>709.01 Overlapping Applications by Same Applicant or Owned by Same Assignee</p> <p><b>710 Period for Reply</b></p> <p>710.01 Statutory Period</p> <p>710.01(a) Statutory Period, How Computed</p> <p>710.02 Shortened Statutory Period and Time Limit Actions Computed</p> <p>710.02(b) Shortened Statutory Period: Situations In Which Used</p> <p>710.02(c) Specified Time Limits: Situations in Which Used</p> <p>710.02(d) Difference Between Shortened Statutory Periods for Reply and Specified Time Limits</p> <p>710.02(e) Extension of Time</p> <p>710.04 Two Periods Running</p> | <p>710.04(a) Copying Patent Claims</p> <p>710.05 Period Ending on Saturday, Sunday, or a Federal Holiday</p> <p>710.06 Situations When Reply Period Is Reset or Restarted</p> <p><b>711 Abandonment of Patent Application</b></p> <p>711.01 Express or Formal Abandonment</p> <p>711.02 Failure To Take Required Action During Statutory Period</p> <p>711.02(a) Insufficiency of Reply</p> <p>711.02(b) Special Situations Involving Abandonment</p> <p>711.02(c) Termination of Proceedings</p> <p>711.03 Reconsideration of Holding of Abandonment; Revival</p> <p>711.03(a) Holding Based on Insufficiency of Reply</p> <p>711.03(b) Holding Based on Failure To Reply Within Period</p> <p>711.03(c) Petitions Relating to Abandonment</p> <p>711.03(d) Examiner's Statement on Petition To Set Aside Examiner's Holding</p> <p>711.04 Public Access to Abandoned Applications</p> <p>711.04(a) Pulling and Forwarding Abandoned Applications</p> <p>711.04(b) Ordering of Patented and Abandoned Files</p> <p>711.04(c) Notifying Applicants of Abandonment</p> <p>711.05 Letter of Abandonment Received After Application Is Allowed</p> <p>711.06 Abstracts, Abbreviations, and Defensive Publications</p> <p>711.06(a) Citation and Use of Abstracts, Abbreviations, and Defensive Publications as References</p> <p><b>713 Interviews</b></p> <p>713.01 General Policy, How Conducted</p> <p>713.02 Interviews Prior to First Official Action</p> <p>713.03 Interview for "Sounding Out" Examiner Not Permitted</p> <p>713.04 Substance of Interview Must Be Made of Record</p> <p>713.05 Interviews Prohibited or Granted, Special Situations</p> <p>713.06 No <i>Inter Partes</i> Questions Discussed <i>Ex Parte</i></p> <p>713.07 Exposure of Other Cases</p> <p>713.08 Demonstration, Exhibits, Models</p> <p>713.09 Finally Rejected Application</p> <p>713.10 Interview Preceding Filing Amendment Under 37 CFR 1.312</p> <p><b>714 Amendments, Applicant's Action</b></p> <p>714.01 Signatures to Amendments</p> <p>714.01(a) Unsigned or Improperly Signed Amendment</p> <p>714.01(c) Signed by Attorney or Agent Not of Record</p> |
|---|--|

## EXAMINATION OF APPLICATIONS

714.01(d)	Amendment Signed by Applicant But Not by Attorney or Agent of Record	715.01(a)	Reference Is a Joint Patent or Published Application to Applicant and Another
714.01(e)	Amendments Before First Office Action	715.01(b)	Reference and Application Have Common Assignee
714.02	Must Be Fully Responsive	715.01(c)	Reference Is Publication of Applicant's Own Invention
714.03	Amendments Not Fully Responsive, Action To Be Taken	715.01(d)	Activities Applied Against the Claims
714.03(a)	Amendment Unduly Interferes With the Preparation of an Office Action	715.02	How Much of the Claimed Invention Must Be Shown, Including the General Rule as to Generic Claims
714.04	Claims Presented in Amendment With No Attempt To Point Out Patentable Novelty	715.03	Genus-Species, Practice Relative to Cases Where Predictability Is in Question
714.05	Examiner Should Immediately Inspect	715.04	Who May Make Affidavit or Declaration; Formal Requirements of Affidavits and Declarations
714.06	Amendments Sent to Wrong Technology Center	715.05	U.S. Patent or Application Publication Claiming Same Invention
714.07	Amendments Not in Permanent Ink	715.07	Facts and Documentary Evidence
714.08	Telegraphic Amendment	715.07(a)	Diligence
714.10	Claims Added in Excess of Filing Fee	715.07(b)	Interference Testimony Sometimes Used
714.11	Amendment Filed During Interference Proceedings	715.07(c)	Acts Relied Upon Must Have Been Carried Out in This Country or a NAFTA or WTO Member Country
714.12	Amendments After Final Rejection or Action	715.07(d)	Disposition of Exhibits
714.13	Amendments After Final Rejection or Action, Procedure Followed	715.08	Passed Upon by Primary Examiner
714.14	Amendments After Allowance of All Claims	715.09	Seasonable Presentation
714.15	Amendment Received in Technology Center After Mailing of Notice of Allowance	715.10	Review of Affidavit or Declaration for Evidence of Prior Public Use or Sale or Failure to Disclose Best Mode
714.16	Amendment After Notice of Allowance, 37 CFR 1.312		
714.16(a)	Amendments Under 37 CFR 1.312, Copied Patent Claims	<b>716</b>	<b>Affidavits or Declarations Traversing Rejections, 37 CFR 1.132</b>
714.16(b)	Amendments Under 37 CFR 1.312 Filed With a Motion Under 37 CFR 1.633	716.01	Generally Applicable Criteria
714.16(c)	Amendments Under 37 CFR 1.312, Additional Claims	716.01(a)	Objective Evidence of Nonobviousness
714.16(d)	Amendments Under 37 CFR 1.312, Handling	716.01(b)	Nexus Requirement and Evidence of Nonobviousness
714.16(e)	Amendments Under 37 CFR 1.312, Entry in Part	716.01(c)	Probative Value of Objective Evidence
714.17	Amendment Filed After the Period for Reply Has Expired	716.01(d)	Weighing Objective Evidence
714.18	Entry of Amendments	716.02	Allegations of Unexpected Results
714.19	List of Amendments, Entry Denied	716.02(a)	Evidence Must Show Unexpected Results
714.20	List of Amendments Entered in Part	716.02(b)	Burden on Applicant
714.21	Amendments Inadvertently Entered, No Legal Effect	716.02(c)	Weighing Evidence of Expected and Unexpected Results
714.22	Entry of Amendments, Directions for **	716.02(d)	Unexpected Results Commensurate in Scope With Claimed Invention
714.23	Entry of Amendments, Directions for, Defective	716.02(e)	Comparison With Closest Prior Art
714.24	Amendment of Amendments	716.02(f)	Advantages Disclosed or Inherent
714.25	Discourtesy of Applicant or Attorney	716.02(g)	Declaration or Affidavit Form
<b>715</b>	<b>Swearing Back of Reference — Affidavit or Declaration Under 37 CFR 1.131</b>	716.03	Commercial Success
715.01	37 CFR 1.131 Affidavits Versus 37 CFR 1.132 Affidavits	716.03(a)	Commercial Success Commensurate in Scope With Claimed Invention
		716.03(b)	Commercial Success Derived From Claimed Invention

- 716.04 Long-Felt Need and Failure of Others
- 716.05 Skepticism of Experts
- 716.06 Copying
- 716.07 Inoperability of References
- 716.08 Utility and Operability of Applicant's Disclosure
- 716.09 Sufficiency of Disclosure
- 716.10 Attribution
- 718 Affidavit or Declaration to Disqualify Commonly Owned Patent or Published Application as Prior Art, 37 CFR 1.130**
- 719 File Wrapper**
  - 719.01 Papers in File Wrapper
    - 719.01(a) Arrangement of Papers in File Wrapper
    - 719.01(b) Prints
  - 719.02 Data Entered on File Wrapper
    - 719.02(b) Name or Residence of Inventor or Title Changed
  - 719.03 Classification During Examination
  - 719.04 Index of Claims
  - 719.05 Field of Search
  - 719.06 Foreign Filing Dates
  - 719.07 Related Applications
- 720 Public Use Proceedings**
  - 720.01 Preliminary Handling
  - 720.02 Examiner Determination of *Prima Facie* Showing
  - 720.03 Preliminary Hearing
  - 720.04 Public Use Proceeding Testimony
  - 720.05 Final Decision
- 724 Trade Secret, Proprietary, and Protective Order Materials**
  - 724.01 Completeness of the Patent File Wrapper
  - 724.02 Method of Submitting Trade Secret, Proprietary, and/or Protective Order Materials
  - 724.03 Types of Trade Secret, Proprietary, and/or Protective Order Materials Submitted Under MPEP § 724.02
  - 724.04 Office Treatment and Handling of Materials Submitted Under MPEP § 724.02
    - 724.04(a) Materials Submitted in an Application Covered by 35 U.S.C. 122
    - 724.04(b) Materials Submitted in Reissue Applications Open to the Public Under 37 CFR 1.11(b)
    - 724.04(c) Materials Submitted in Reexamination File Open to the Public Under 37 CFR 1.11(d)
  - 724.05 Petition To Expunge Information or Copy of Papers in Application File
  - >724.06 Handling of Petitions to Expunge Information or Copy of Papers in Application File<

## 701 Statutory Authority for Examination

### 35 U.S.C. 131. Examination of application.

The Director shall cause an examination to be made of the application and the alleged new invention; and if on such examination it appears that the applicant is entitled to a patent under the law, the Director shall issue a patent therefor.

The main conditions precedent to the grant of a patent to an applicant are set forth in 35 U.S.C. 101, 102 and 103.

### 35 U.S.C. 101. Inventions patentable.

Whoever invents or discovers any new and useful process, machine, manufacture, or composition of matter, or any new and useful improvement thereof, may obtain a patent therefor, subject to the conditions and requirements of this title.

Form paragraph 7.04 copies 35 U.S.C. 101. See MPEP § 706.03(a).

### 35 U.S.C. 100. Definitions.

When used in this title unless the context otherwise indicates -

- (a) The term "invention" means invention or discovery.
- (b) The term "process" means process, art, or method, and includes a new use of a known process, machine, manufacture, composition of matter, or material.
- (c) The terms "United States" and "this country" mean the United States of America, its territories and possessions.
- (d) The word "patentee" includes not only the patentee to whom the patent was issued but also the successors in title to the patentee.
- (e) The term "third-party requester" means a person requesting *ex parte* reexamination under section 302 or *inter partes* reexamination under section 311 who is not the patent owner.

## 702 Requisites of the Application [R-2]

When a new application is assigned in the Technology Center, the examiner should review the contents of the application to determine if the application meets the requirements of 35 U.S.C. 111(a). Any matters affecting the filing date or abandonment of the application, such as lack of an oath or declaration, filing fee, or claims should be checked before the application is placed in the storage racks to await the first action. >For Image File Wrapper (IFW) processing, see IFW Manual sections 3.1 and 3.3.<

The examiner should be careful to see that the application meets all the requisites set forth in MPEP Chapter 600 both as to formal matters and as to the completeness and clarity of the disclosure. If all of the requisites are not met, applicant may be called upon

for necessary amendments. Such amendments, however, must not include new matter.

## 702.01 Obviously Informal Cases [R-2]

When an application is reached for its first Office action and it is then discovered to be impractical to give a complete action on the merits because of an informal or insufficient disclosure, the following procedure may be followed:

(A) A reasonable search should be made of the invention so far as it can be understood from the disclosure, objects of invention and claims and any apparently pertinent art cited. In the rare case in which the disclosure is so incomprehensible as to preclude a reasonable search, the Office action should clearly inform applicant that no search was made;

(B) Informalities noted by the Office of Initial Patent Examination (OIPE) and deficiencies in the drawing should be pointed out by means of attachments to the Office action (see MPEP § 707.07(a));

(C) A requirement should be made that the specification be revised to conform to idiomatic English and United States >patent< practice;

(D) The claims should be rejected as failing to define the invention in the manner required by 35 U.S.C. 112 if they are informal. A blanket rejection is usually sufficient.

The examiner should attempt to point out the points of informality in the specification and claims. The burden is on the applicant to revise the application to render it in proper form for a complete examination.

If a number of obviously informal claims are filed in an application, such claims should be treated as being a single claim for fee and examination purposes.

It is obviously to applicant's advantage to *file* the application with an adequate disclosure and with claims which conform to the U.S. Patent and Trademark Office usages and requirements. This should be done whenever possible. If, however, due to the pressure of a Convention deadline or other reasons, this is not possible, applicants are urged to submit *promptly, preferably within 3 months after filing*, a preliminary amendment which corrects the obvious informalities. The informalities should be corrected to the extent that the disclosure is readily understood and the claims to be initially examined are in proper form,

particularly as to dependency, and otherwise clearly define the invention. "New matter" must be excluded from these amendments since preliminary amendments >filed after the filing date of the application< do not enjoy original disclosure status. See MPEP § 608.04(b).

Whenever, upon examination, it is found that the terms or phrases or modes of characterization used to describe the invention are not sufficiently consonant with the art to which the invention pertains, or with which it is most nearly connected, to enable the examiner to make the examination specified in 37 CFR 1.104, the examiner should make a reasonable search of the invention so far as it can be understood from the disclosure. The action of the examiner may be limited to a citation of what appears to be the most pertinent prior art found and a request that applicant correlate the terminology of the specification with art-accepted terminology before further action is made.

Use form paragraph 7.01 where the terminology is such that a proper search cannot be made.

>

### *¶ 7.01 Use of Unconventional Terminology, Cannot Be Examined*

A preliminary examination of this application reveals that it includes terminology which is so different from that which is generally accepted in the art to which this invention pertains that a proper search of the prior art cannot be made. For example: [1]

Applicant is required to provide a clarification of these matters or correlation with art-accepted terminology so that a proper comparison with the prior art can be made. Applicant should be careful not to introduce any new matter into the disclosure (i.e., matter which is not supported by the disclosure as originally filed).

A shortened statutory period for reply to this action is set to expire ONE MONTH or THIRTY DAYS, whichever is longer, from the mailing date of this letter.

### **Examiner Note:**

1. Use this or form paragraph 7.02 when a proper search cannot be made. However, see MPEP § 702.01 which requires a reasonable search.
2. In bracket 1, fill in an appropriate indication of the terminology, properties, units of data, etc. that are the problem as well as the pages of the specification involved.
3. For the procedure to be followed when only the drawing is informal, see MPEP §§ 608.02(a) and 608.02(b).

<

Use form paragraph 7.02 where the application is so incomprehensible that a reasonable search cannot be made.

### ¶ 7.02 Disclosure Is Incomprehensible

The disclosure is objected to under 37 CFR 1.71, as being so incomprehensible as to preclude a reasonable search of the prior art by the examiner. For example, the following items are not understood: [1]

Applicant is required to submit an amendment which clarifies the disclosure so that the examiner may make a proper comparison of the invention with the prior art.

Applicant should be careful not to introduce any new matter into the disclosure (*i.e.*, matter which is not supported by the disclosure as originally filed).

A shortened statutory period for reply to this action is set to expire ONE MONTH or THIRTY DAYS, whichever is longer, from the mailing date of this letter.

#### Examiner Note:

1. Use this form paragraph when a search cannot be made.
2. In bracket 1, indicate the page numbers and features which are not understood.
3. See form paragraphs 6.28 and 6.30 for improper idiomatic English.
4. Use form paragraphs 7.31.01 – 7.31.04, as appropriate, for a rejection of claims (when necessary) based on the deficiencies set forth in this form paragraph.

For the procedure to be followed when only the drawing is informal, see MPEP § 608.02(a) and § 608.02(b).

## 703 “General Information Concerning Patents”

The booklet “General Information Concerning Patents” for use by applicants contemplating the filing or prosecution of their own applications, may be purchased from the Superintendent of Documents, U.S. Government Printing Office, Washington, D.C. 20402. The booklet is also available from the USPTO Web page at: <http://www.uspto.gov>.

## 704 Search and Requirements for Information

### 704.01 Search

After reading the specification and claims, the examiner searches the prior art. The subject of searching is more fully treated in MPEP Chapter 900. See especially MPEP § 904 through § 904.03. The invention should be thoroughly understood before a search is undertaken. However, informal cases, or those which can only be imperfectly understood when they come up for action in their regular turn are also given a search, in order to avoid piecemeal prosecution.

## PREVIOUS EXAMINER’S SEARCH

When an examiner is assigned to act on an application which has received one or more actions by some other examiner, full faith and credit should be given to the search and action of the previous examiner unless there is a clear error in the previous action or knowledge of other prior art. In general the second examiner should not take an entirely new approach to the application or attempt to reorient the point of view of the previous examiner, or make a new search in the mere hope of finding something. See MPEP § 719.05.

### 704.10 Requirements for Information [R-2]

37 CFR 1.105. *Requirements for information.*

(a)(1) In the course of examining or treating a matter in a pending or abandoned application filed under 35 U.S.C. 111 or 371 (including a reissue application), in a patent, or in a reexamination proceeding, the examiner or other Office employee may require the submission, from individuals identified under § 1.56(c), or any assignee, of such information as may be reasonably necessary to properly examine or treat the matter, for example:

(i) *Commercial databases:* The existence of any particularly relevant commercial database known to any of the inventors that could be searched for a particular aspect of the invention.

(ii) *Search:* Whether a search of the prior art was made, and if so, what was searched.

(iii) *Related information:* A copy of any non-patent literature, published application, or patent (U.S. or foreign), by any of the inventors, that relates to the claimed invention.

(iv) *Information used to draft application:* A copy of any non-patent literature, published application, or patent (U.S. or foreign) that was used to draft the application.

(v) *Information used in invention process:* A copy of any non-patent literature, published application, or patent (U.S. or foreign) that was used in the invention process, such as by designing around or providing a solution to accomplish an invention result.

(vi) *Improvements:* Where the claimed invention is an improvement, identification of what is being improved.

(vii) *In Use:* Identification of any use of the claimed invention known to any of the inventors at the time the application was filed notwithstanding the date of the use.

(2) Where an assignee has asserted its right to prosecute pursuant to § 3.71(a) of this chapter, matters such as paragraphs (a)(1)(i), (iii), and (vii) of this section may also be applied to such assignee.

(3) Any reply that states that the information required to be submitted is unknown and/or is not readily available to the party or parties from which it was requested will be accepted as a complete reply.

(b) The requirement for information of paragraph (a)(1) of this section may be included in an Office action, or sent separately.

(c) A reply, or a failure to reply, to a requirement for information under this section will be governed by §§ 1.135 and 1.136.

An examiner or other Office employee may require from individuals identified under 37 CFR 1.56(c), or any assignee, the submission of such information as may be reasonably necessary to properly examine or treat a matter in a pending or abandoned application filed under 35 U.S.C. 111, in a pending or abandoned application that has entered the national stage under 35 U.S.C. 371, in a patent, or in a reexamination proceeding. The scope of 37 CFR 1.105 is extended to any assignee because the information required may be known to some members of the assignee even if not known by the inventors.

The authority for the Office to make such requirements arises from the statutory requirements of examination pursuant to 35 U.S.C. 131 and 132. An examiner or other Office employee may make a requirement for information reasonably necessary to the examination or treatment of a matter in accordance with the policies and practices set forth by the Director(s) of the Technology Center or other administrative unit to which that examiner or other Office employee reports. >See *Star Fruits S.N.C. v. United States*, 280 F.Supp.2d 512, 515-16 (E.D. Va 2003)(“Beyond that which a patent applicant is duty-bound to disclose pursuant to 37 CFR 1.56, an examiner may require the production of ‘such information as may be reasonably necessary to properly examine or treat the matter.’”)<

## **704.11 What Information May Be Required**

Information which may be required under 37 CFR 1.105 is that information reasonably necessary to properly examine or treat a matter in a pending or abandoned application filed under 35 U.S.C. 111 (including a reissue application), in a pending or abandoned application that has entered the national stage under 35 U.S.C. 371, in a patent, or in a reexamination proceeding.

There must be a reasonable basis for the information required that would aid in the examination of an application or treatment of some matter. A requirement for information under 37 CFR 1.105 places a substantial burden on the applicant that is to be mini-

mized by clearly focusing the reason for the requirement and the scope of the expected response. Thus, the scope of the requirement should be narrowly defined, and a requirement under 37 CFR 1.105 may only be made when the examiner has a reasonable basis for requiring information.

### **INFORMATION REASONABLY NECESSARY FOR FINDING PRIOR ART**

The criteria stated in 37 CFR 1.105 for making a requirement for information is that the information be reasonably necessary to the examination or treatment of a matter in an application. The information required would typically be that necessary for finding prior art or for resolving an issue arising from the results of the search for art or from analysis of the application file. A requirement for information necessary for finding prior art is not a substitute for the examiner performing a search of the relevant prior art; the examiner must make a search of the art according to MPEP § 704.01 and §§ 904 – 904.03.

The criteria of reasonable necessity is generally met, e.g., where:

(A) the examiner’s search and preliminary analysis demonstrates that the claimed subject matter cannot be adequately searched by class or keyword among patents and typical sources of non-patent literature, or

(B) either the application file or the lack of relevant prior art found in the examiner’s search justifies asking the applicant if he or she has information that would be relevant to the patentability determination.

The first instance generally occurs where the invention as a whole is in a new area of technology which has no patent classification or has a class with few pieces of art that diverge substantially from the nature of the claimed subject matter. In this situation, the applicant is likely to be among the most knowledgeable in the art, as evidenced by the scarcity of art, and requiring the applicant’s information of areas of search is justified by the need for the applicant’s expertise.

The second instance generally occurs where the application file, or other related applications or publications authored by the applicant, suggests the applicant likely has access to information necessary to a more complete understanding of the invention and



its context. In this situation, the record suggests that the details of such information may be relevant to the issue of patentability, and thus shows the need for information in addition to that already submitted by the applicant.

### **704.11(a) Examples of Information Reasonably Required**

37 CFR 1.105(a)(1)(i)-(vii) lists specific examples of information that may be reasonably required. Other examples, not meant to be exhaustive, of information that may be reasonably required for examination of an application include:

(A) The name and citation of any particularly relevant indexed journal, or treatise.

(B) The trade name of any goods or services the claimed subject matter is embodied in.

(C) The citation for, the dates initially published and copies of any advertising and promotional literature prepared for any goods or services the claimed subject matter has been embodied in.

(D) The citation for and copies of any journal articles describing any goods or services the claimed subject matter has been embodied in.

(E) The trade names and providers of any goods or services in competition with the goods or services the claimed subject matter has been embodied in.

(F) Any written descriptions or analyses, prepared by any of the inventors or assignees, of goods or services in competition with the goods or services the claimed subject matter has been embodied in.

(G) Identification of pending or abandoned applications filed by at least one of the inventors or assigned to the same assignee as the current application that disclose similar subject matter that are not otherwise identified in the current application.

(H) A reply to a matter raised in a protest under 37 CFR 1.291.

(I) An explanation of technical material in a publication, such as one of the inventor's publications.

(J) The identification of changes made in a reformatted continuing application filed under 37 CFR 1.53(b).

(K) A mark-up for a continuation-in-part application showing the subject matter added where there is an intervening reference.

(L) Comments on a new decision by the Federal Circuit that appears on point.

(M) The publication date of an undated document mentioned by applicant that may qualify as printed publication prior art (35 U.S.C. 102(a) or (b)).

(N) Comments on information of record which raises a question of whether applicant derived the invention from another under 35 U.S.C. 102(f).

### **704.11(b) When May a Requirement for Information Be Made [R-2]**

A requirement for information under 37 CFR 1.105 is discretionary. A requirement may be made at any time once the necessity for it is recognized and should be made at the earliest opportunity after the necessity is recognized. The optimum time for making a requirement is prior to or with a first action on the merits because the examiner has the maximum opportunity to consider and apply the response. Ordinarily, a request for information should not be made with or after a final rejection.

>

#### **I. < PRIOR TO THE FIRST ACTION ON THE MERITS**

It may be appropriate to make a requirement for information prior to the first action on the merits, such as with a restriction requirement, when the examiner's search and preliminary analysis demonstrates that the claimed subject matter cannot be adequately searched by class or keyword among patents or in areas of emerging technology where the Office has minimal prior art.

Factors to be considered for the appropriateness of a separate requirement for information prior to the first action on the merits include:

(A) Whether the claimed subject matter is in a newly established art area without a well-developed prior art resource pool;

(B) Whether the applicant submitted an Information Disclosure Statement;

(C) Whether the specification's background description adequately describes the background of the disclosed subject matter;

(D) Whether related documents, written by an inventor or an employee of the assignee, which were

not submitted, are found during the search or described in the application file;

(E) Whether non-patent literature is referred to in the disclosure, but a copy has not been supplied; and

(F) Whether the specification's background of the invention describes information as being known or conventional, which may be considered as an admission of prior art, but such information is unfamiliar to examiner and cannot be found within the application file or from the examiner's search, and further details of the information would be relevant to the question of patentability.

>

## II. <WITH THE FIRST ACTION ON THE MERITS

A requirement for information may be combined with a first action on the merits that includes at least one rejection, if, for example, either the application file or the lack of relevant prior art found in the examiner's search justifies asking the applicant if he or she has information that would be relevant to the patentability determination.

It is not appropriate to make a requirement for information based on a lack of relevant prior art with a first action on the merits allowance or *Ex parte Quayle* action.

>

## III. < AFTER THE FIRST ACTION ON THE MERITS

A requirement for information made after the first action on the merits may be appropriate when the application file justifies asking the applicant if he or she has information that would be relevant to the patentability determination. It is rarely appropriate to require information because of a lack of relevant prior art after the first action on the merits.

A requirement for information is not proper when no further action would be taken by the examiner. The reasonable necessity criteria for a requirement for information implies further action by the examiner. This means that actions in which requirements for information necessary for examination are made should generally be a non-final action because the applicant's reply must be considered and applied as appropriate.

Under limited circumstances, requirements under 37 CFR 1.105 may be made in an application that is issued or abandoned. Such a requirement would normally be made only during part of some ongoing proceeding involving the issued patent or abandoned application. Examples of proceedings when an examiner or other Office employee would issue such a request in an abandoned application include proceedings to revive the abandoned application. Examples of proceedings when an examiner or other Office employee would issue such a request in a patent include proceedings to change inventorship and reexamination proceedings.

## 704.12 Replies to a Requirement for Information

Replies to requirements for information must be complete and filed within the time period set including any extensions. Failure to reply within the time period set will result in the abandonment of the application. All replies for a request for information should be checked for completeness. Any incomplete reply can be completed within the original time period set including any extensions. Supplemental replies filed after the expiration of the original period for reply including any extensions of time must comply with all other rules for submissions of information.

### 704.12(a) Relationship of Requirement for Information to Duty of Disclosure [R-2]

The duty of candor and good faith under 37 CFR 1.56 applies to the applicant's reply to a requirement for information under 37 CFR 1.105, and requires that the applicant reply to a requirement under 37 CFR 1.105 with information reasonably and readily available.

37 CFR 1.56 requires parties identified in 37 CFR 1.56(c) to disclose to the Office information material to the patentability of the claimed subject matter. This threshold is substantially higher than that for requiring information under 37 CFR 1.105, which is reasonable necessity to the examination of the application. >See, e.g., *Star Fruits S.N.C. v. United States*, 280 F.Supp.2d 512, 515-16 (E.D. Va 2003) ("Beyond that which a patent applicant is duty-bound to disclose pursuant to 37 CFR 1.56, an examiner may require the

production of ‘such information as may be reasonably necessary to properly examine or treat the matter.’”<

In contrast with the applicant’s duty to disclose on his or her own initiative information material to patentability under 37 CFR 1.56, the Office has the authority to require information reasonably necessary to the examination or treatment of a matter in an application. Such information may not be considered material to patentability by applicant, hence applicant would not be required to provide the information under 37 CFR 1.56. The information is instead reasonably necessary to determine the state of the art, the context in which the invention is practiced, the directions in which the relevant art are advancing, the similarity between the claimed subject matter and other art worked on by the applicants and their assignees or to otherwise proceed in the examination and treatment of matters in an application.

Similar to 37 CFR 1.56, applicant is required by 37 CFR 1.105 to submit information already known, but there is no requirement to search for information that is unknown. Unlike 37 CFR 1.56, applicant is required by 37 CFR 1.105 to submit information that may not be material to patentability in itself, but that is necessary to obtain a complete record from which a determination of patentability may be determined.

### **704.12(b) What Constitutes a Complete Reply**

A complete reply to a 37 CFR 1.105 requirement is a reply to each enumerated requirement for information giving either the information required or a statement that the information required to be submitted is unknown and/or is not readily available to the party or parties from which it was requested. There is no requirement for the applicant to show that the required information was not, in fact, readily attainable, but applicant is required to make a good faith attempt to obtain the information and to make a reasonable inquiry once the information is requested.

A reply stating that the information required to be submitted is unknown and/or is not readily available to the party or parties from which it was requested will generally be sufficient unless, for example, it is clear the applicant did not understand the requirement, or the reply was ambiguous and a more specific answer is possible.

### **704.12(c) Treatment of an Incomplete Reply [R-2]**

An incomplete reply to a 37 CFR 1.105 requirement in a pending application or reexamination proceeding is handled in the same manner as an amendment not fully responsive to a non-final \*>Office< action. See 37 CFR 1.135(c) and MPEP § 714.03. Where the reply is a *bona fide* reply, form paragraph 7.95 may be used. Note that a 37 CFR 1.105 requirement, even absent an action on the merits, is an Office action.

#### *¶ 7.95 Bona Fide, Non-Responsive Amendments*

The reply filed on [1] is not fully responsive to the prior Office action because of the following omission(s) or matter(s): [2]. See 37 CFR 1.111. Since the above-mentioned reply appears to be *bona fide*, applicant is given a TIME PERIOD of **ONE (1) MONTH** or **THIRTY (30) DAYS** from the mailing date of this notice, whichever is longer, within which to supply the omission or correction in order to avoid abandonment. **EXTENSIONS OF THIS TIME PERIOD MAY BE GRANTED UNDER 37 CFR 1.136(a).**

#### **Examiner Note:**

This practice does not apply where there has been a deliberate omission of some necessary part of a complete reply, or where the application is subject to a final Office action. Under such cases, the examiner has no authority to grant an extension if the period for reply has expired. See form paragraph 7.91.

### **704.13 Time Periods for Reply [R-2]**

A reply, or a failure to reply, to a requirement for information under 37 CFR 1.105 will be governed by 37 CFR 1.135 and 1.136. See MPEP § 710 *et seq.*

Requirements for information under 37 CFR 1.105 made without an action on the merits should set a shortened statutory period of two months for reply. Applicant may extend the time period for reply up to six months in accordance with 37 CFR 1.136(a).

Requirements sent with an \*>Office< action on the merits, and not as a separate Office action, will be given the same period for reply as the action on the merits.

A requirement for information under 37 CFR 1.105 is an Office action under 35 U.S.C. 132 for patent term adjustment purposes. See MPEP § 2730 for information pertaining to patent term adjustment.

## 704.14 Making a Requirement for Information

A requirement for information under 37 CFR 1.105 should be narrowly specified and limited in scope. It is a significant burden on both the applicant and the Office since the applicant must collect and submit the required information and the examiner must consider all the information that is submitted. A requirement for information is only warranted where the benefit from the information exceeds the burden in obtaining information.

### 704.14(a) Format of the Requirement [R-1]

The requirement must clearly indicate that a requirement under 37 CFR 1.105 is being made, the basis for the requirement, and what information is being required. Requirements should specify the particular art area involved, and the particular claimed subject matter within such art area, in which the information is required in order to avoid overly burdening the applicant and to avoid inviting large volumes of information that are not relevant to the need for the information. The requirement should also clearly indicate the form the required information is expected to take. That is, whether the requirement is for citations and copies of individual art references, for the identification of whole collections of art, for answers to questions, or for another specified form.

A requirement for information under 37 CFR 1.105 is generally prepared as a separate document that may be attached to an Office action on the merits or mailed as a stand alone action. The rule permits a requirement to be included within an Office action, but creating a separate document is preferable because the existence of the requirement is immediately brought to the attention of the recipient and it is more readily routed by the applicant to the parties best able to respond.

The requirement should state why the requirement has been made and how the information is necessary to the examination.

### FORM PARAGRAPHS

The following form paragraphs should be used when preparing a requirement for information:

#### ¶ 7.105 Requirement for Information, Heading

Applicant and the assignee of this application are required under 37 CFR 1.105 to provide the following information that the examiner has determined is reasonably necessary to the examination of this application.

#### Examiner Note:

1. This form paragraph should appear at the beginning of any requirement for information under 37 CFR 1.105, and should be followed by an explanation of why the required information is necessary for examination. Form paragraphs 7.106 – 7.121 may be used as appropriate.
2. The requirement for information should conclude with form paragraphs 7.122 – 7.126 as appropriate.

The following form paragraphs should be used as appropriate where the information required pertains to a search for prior art, or to citations and/or copies of publications:

#### ¶ 7.106 Domain of Search

The information is required to extend the domain of search for prior art. Limited amounts of art related to the claimed subject matter are available within the Office, and are generally found in class [1] and subclasses [2], which describe [3]. A broader range of art to search is necessary to establish the level of knowledge of those of ordinary skill in the claimed subject matter art of [4].

#### Examiner Note:

1. This form paragraph must be preceded by form paragraph 7.105, and should be followed by form paragraphs 7.122 – 7.126 as appropriate.
2. In bracket 4, insert a description of the art claimed but not found in the classification system.

#### ¶ 7.107 Level of Skill and Knowledge in the Art

The information is required to document the level of skill and knowledge in the art of [1].

#### Examiner Note:

This form paragraph must be preceded by form paragraph 7.105, and should be followed by form paragraphs 7.122 – 7.126 as appropriate.

#### ¶ 7.108 Background Description

The information is required to complete the background description in the disclosure by documenting [1].

#### Examiner Note:

This form paragraph must be preceded by form paragraph 7.105, and should be followed by form paragraphs 7.122 – 7.126 as appropriate.

#### ¶ 7.109 Products and Services Embodying Invention

The information is required to identify products and services embodying the disclosed subject matter of [1] and identify the properties of similar products and services found in the prior art.

#### Examiner Note:

This form paragraph must be preceded by form paragraph 7.105, and should be followed by form paragraphs 7.122 – 7.126 as appropriate.

\*\*>

¶ 7.110 *Art Suggested as Relevant*

The information is required to enter in the record the art suggested by the applicant as relevant to this examination in [1].

**Examiner Note:**

1. This form paragraph must be preceded by form paragraph 7.105, and should be followed by form paragraphs 7.122 – 7.126 as appropriate.
2. In bracket 1, describe where in the application file applicant suggests that the art is relevant, e.g., the specification and the relevant page thereof, or a paper received in the Office on a specified date and the relevant page thereof.

<

¶ 7.111 *List of Keywords*

In response to this requirement, please provide a list of keywords that are particularly helpful in locating publications related to the disclosed art of [1].

**Examiner Note:**

This form paragraph must be preceded by form paragraph 7.105, and should be followed by form paragraphs 7.122 – 7.126 as appropriate.

¶ 7.112 *Citations for Electronically Searchable Databases or Other Indexed Collections*

In response to this requirement, please provide a list of citations to electronically searchable databases or other indexed collections containing publications that document the knowledge within the disclosed art of [1].

**Examiner Note:**

This form paragraph must be preceded by form paragraph 7.105, and should be followed by form paragraphs 7.122 – 7.126 as appropriate.

\*\*>

¶ 7.113 *Copy of Art Referred to in the Disclosure, But Not Submitted*

In response to this requirement, please provide a copy of each of the following items of art referred to in the [1].

**Examiner Note:**

1. This form paragraph must be preceded by form paragraph 7.105, and should be followed by form paragraphs 7.122 – 7.126 as appropriate.
2. In bracket 1, describe where in the application file applicant refers to art that has not been previously submitted, e.g., the specification and the relevant page thereof, or a paper received in the Office on a specified date and the relevant page thereof.

<

¶ 7.114 *Copies of Publications Authored by Inventor(s)*

In response to this requirement, please provide copies of each publication which any of the applicants authored or co-authored and which describe the disclosed subject matter of [1].

**Examiner Note:**

This form paragraph must be preceded by form paragraph 7.105, and should be followed by form paragraphs 7.122 – 7.126 as appropriate.

¶ 7.115 *Art Relied Upon for Description of Prior Art*

In response to this requirement, please provide the title, citation and copy of each publication that is a source used for the description of the prior art in the disclosure. For each publication, please provide a concise explanation of that publication's contribution to the description of the prior art.

**Examiner Note:**

1. This form paragraph must be preceded by form paragraph 7.105, and should be followed by form paragraphs 7.122 – 7.126 as appropriate.
2. This requirement is limited in that only those documents actually relied on, rather than documents believed to be relevant, are required.

¶ 7.116 *Art Relied Upon for Development of Invention*

In response to this requirement, please provide the title, citation and copy of each publication that any of the applicants relied upon to develop the disclosed subject matter that describes the applicant's invention, particularly as to developing [1]. For each publication, please provide a concise explanation of the reliance placed on that publication in the development of the disclosed subject matter.

**Examiner Note:**

1. This form paragraph must be preceded by form paragraph 7.105, and should be followed by form paragraphs 7.122 – 7.126 as appropriate.
2. This requirement is limited in that only those documents actually relied on, rather than documents believed to be relevant, are required.
3. In bracket 1, insert a description of the most important inventive elements.

\*\*>

¶ 7.117 *Art Relied Upon for Drafting Claimed Subject Matter*

In response to this requirement, please provide the title, citation and copy of each publication that was relied upon to draft the claimed subject matter. For each publication, please provide a concise explanation of the reliance placed on that publication in distinguishing the claimed subject matter from the prior art.

**Examiner Note:**

1. This form paragraph must be preceded by form paragraph 7.105, and should be followed by form paragraphs 7.122 – 7.126 as appropriate.

2. This requirement is limited in that only those documents actually relied on, rather than documents believed to be relevant, are required.

<

*¶ 7.118 Results of Applicant's Prior Art Search*

In response to this requirement, please state whether any search of prior art was performed. If a search was performed, please state the citation for each prior art collection searched. If any art retrieved from the search was considered material to demonstrating the knowledge of a person having ordinary skill in the art to the disclosed [1], please provide the citation for each piece of art considered and a copy of the art.

**Examiner Note:**

1. This form paragraph must be preceded by form paragraph 7.105, and should be followed by form paragraphs 7.122 – 7.126 as appropriate.
2. In bracket 1, describe the subject matter for which art is required.

*¶ 7.119 Names of Products or Services Incorporating Claimed Invention*

In response to this requirement, please provide the names of any products or services that have incorporated the claimed subject matter.

**Examiner Note:**

This form paragraph must be preceded by form paragraph 7.105, and should be followed by form paragraphs 7.122 – 7.126 as appropriate.

*¶ 7.120 Names of Products or Services Incorporating Disclosed Prior Art*

In response to this requirement, please provide the names of any products or services that have incorporated the disclosed prior art [1].

**Examiner Note:**

1. This form paragraph must be preceded by form paragraph 7.105, and should be followed by form paragraphs 7.122 – 7.126 as appropriate.
2. In bracket 1, specify the attributes of the prior art that most closely approximate the claimed subject matter to narrow the focus of the reply.

*¶ 7.121 Details of Improvement Over the Prior Art*

In response to this requirement, please state the specific improvements of the subject matter in claims [1] over the disclosed prior art and indicate the specific elements in the claimed subject matter that provide those improvements. For those claims expressed as means or steps plus function, please provide the specific page and line numbers within the disclosure which describe the claimed structure and acts.

**Examiner Note:**

This form paragraph must be preceded by form paragraph 7.105, and should be followed by form paragraphs 7.122 – 7.126 as appropriate.

The following form paragraphs should appear at the end of the requirement for information, as appropriate:

*¶ 7.122 Submission of Only Pertinent Pages Where Document is Large*

In responding to those requirements that require copies of documents, where the document is a bound text or a single article over 50 pages, the requirement may be met by providing copies of those pages that provide the particular subject matter indicated in the requirement, or where such subject matter is not indicated, the subject matter found in applicant's disclosure.

**Examiner Note:**

1. This form paragraph must be preceded by form paragraph 7.105, and should be followed by form paragraphs 7.122 – 7.126 as appropriate.
2. Use this form paragraph where the scope of the requirement for information specifically includes copies of publications.

*¶ 7.123 Waiver of Fee and Statement Requirements for Certain Information Disclosures*

The fee and certification requirements of 37 CFR 1.97 are waived for those documents submitted in reply to this requirement. This waiver extends only to those documents within the scope of the requirement under 37 CFR 1.105 that are included in the applicant's first complete communication responding to this requirement. Any supplemental replies subsequent to the first communication responding to this requirement and any information disclosures beyond the scope of this requirement under 37 CFR 1.105 are subject to the fee and certification requirements of 37 CFR 1.97 where appropriate.

**Examiner Note:**

1. This form paragraph must be preceded by form paragraph 7.105, and should be followed by form paragraph 7.124 and either form paragraph 7.125 or 7.126 as appropriate.
2. Use this form paragraph where the scope of the requirement for information specifically includes citations to and/or copies of publications.

*¶ 7.124 Contents of Good Faith Reply*

The applicant is reminded that the reply to this requirement must be made with candor and good faith under 37 CFR 1.56. Where the applicant does not have or cannot readily obtain an item of required information, a statement that the item is unknown or cannot be readily obtained will be accepted as a complete reply to the requirement for that item.

**Examiner Note:**

1. This form paragraph must be preceded by form paragraph 7.105, and should be followed by form paragraphs 7.125 or 7.126 as appropriate.
2. This form paragraph should appear in the conclusion of any requirement for information.

*¶ 7.125 Conclusion of Requirement That Accompanies Office Action*

This requirement is an attachment of the enclosed Office action. A complete reply to the enclosed Office action must include a complete reply to this requirement. The time period for reply to this requirement coincides with the time period for reply to the enclosed Office action.

**Examiner Note:**

1. This form paragraph must be preceded by form paragraph 7.105, and should appear at the conclusion of any requirement for information that accompanies an Office action. If the requirement for information is mailed without any other Office action, use form paragraph 7.126 instead.
2. Form paragraph 7.127 should appear at the end of any Office action that includes an attached requirement for information.

*¶ 7.126 Conclusion Of Requirement Mailed Without Any Other Office Action*

This requirement is subject to the provisions of 37 CFR 1.134, 1.135 and 1.136 and has a shortened statutory period of [1] months. EXTENSIONS OF THIS TIME PERIOD MAY BE GRANTED UNDER 37 CFR 1.136(a).

**Examiner Note:**

1. This form paragraph must be preceded by form paragraph 7.105, and should appear at the conclusion of any requirement for information mailed without any other Office action. If the requirement for information is mailed an Office action, use form paragraph 7.125 instead .
2. The period for reply is ordinarily set for 2 months.

*¶ 7.127 Conclusion of Office Action That Includes Requirement*

This Office action has an attached requirement for information under 37 CFR 1.105. A complete reply to this Office action must include a complete reply to the attached requirement for information. The time period for reply to the attached requirement coincides with the time period for reply to this Office action.

**Examiner Note:**

This form paragraph should appear at the end of any Office action that includes an attached requirement for information.

**704.14(b) Examiner's Obligation Following Applicant's Reply [R-2]**

The examiner must consider the information submitted with the applicant's reply and apply the information as the examiner deems appropriate. This obligation arises from the examiner's assertion that the information is necessary to the examination in making the requirement.

Information constituting identification of areas of search must be considered and the examiner must indicate which areas were used and which areas were

not used in performing a search. This indication may be placed in the file wrapper search notes, or may be made by notations on the applicant's reply, with the examiner's initials and date, and with a notation in the file wrapper search notes that searching based on the 37 CFR 1.105 requirement was made according to the notes on the applicant's reply. >For Image File Wrapper (IFW) processing, see IFW Manual section 3.7.<

Information constituting answers to queries posed by the examiner or another Office employee must be considered, and the record must indicate that the answers were considered. This indication may be made minimally by indicating "Considered" with the initials and date of the person making such consideration on the reply. >For Image File Wrapper (IFW) processing, see IFW Manual section 3.7.<

Art that is submitted in response to a 37 CFR 1.105 requirement must be considered, at least to the extent that art submitted with an Information Disclosure Statement under 37 CFR 1.97 and 1.98 is considered. See MPEP § 609. If the applicant provides a written list of citations for the art submitted with a reply to a 37 CFR 1.105 requirement, an examiner must indicate on that list which art has been considered and which art has not been considered, in the same manner as with an Information Disclosure Statement under 37 CFR 1.97 and 1.98. >For Image File Wrapper (IFW) processing, see IFW Manual section 3.7.< If the applicant provides no such list, there is no requirement for the examiner to prepare such a list or otherwise make the submitted art of record unless the examiner relies on such art in a rejection.

It is never appropriate to deny considering information that is submitted in reply to, and is within the scope of, a requirement under 37 CFR 1.105. However, information that is beyond the scope of a 37 CFR 1.105 requirement, submitted along with information responding to a requirement under 37 CFR 1.105, need not be considered unless the submission of such art conforms to the provisions of 37 CFR 1.97 and 1.98, and MPEP § 609. The criteria for measuring the scope of a 37 CFR 1.105 requirement is the plain meaning of the text of the requirement. For this reason, it is essential that the scope of information required be carefully specified. If art which is beyond the scope of a 37 CFR 1.105 requirement is submitted in accordance with the provisions of 37 CFR 1.97 and 1.98, and MPEP § 609, such art

must be considered according to the provisions of 37 CFR 1.97 and 37 CFR 1.98.

#### **704.14(c) Petitions to Requirements Under 37 CFR 1.105**

Applicants who seek to have a requirement under 37 CFR 1.105 withdrawn or modified, or who seek to have information submitted under 37 CFR 1.105 considered, may submit a petition under 37 CFR 1.181 to the Director of the Technology Center in which the requirement was issued. However, a petition is not a reply to a 37 CFR 1.105 requirement. The time period for the applicant to reply to the 37 CFR 1.105 requirement continues to run, even where a petition has been submitted.

#### **704.14(d) Relationship to Information Disclosure Statements**

The initial reply, if responsive to the requirement for information under 37 CFR 1.105 and submitted within the original time period for reply including any extensions of time, does not have to satisfy the fee and/or certification requirements of 37 CFR 1.97 and 1.98. Applicant should list the references on a copy of Form PTO-1449 or PTO/SB/08 to have the citations entered in the record. Any replies made subsequent to the initial reply must meet the provisions of 37 CFR 1.97 and 1.98 as appropriate.

Any submission of art beyond the scope of a requirement for information under 37 CFR 1.105 is a submission of art under 37 CFR 1.97 and 1.98 and MPEP § 609, and must meet the provisions of 37 CFR 1.97 and 1.98 for the art to be considered.

Where information is submitted in a reply to a requirement under 37 CFR 1.105, the examiner may NOT make the next Office action relying on that art final unless all instances of the application of such art are necessitated by amendment. This section explicitly distinguishes the practice following a reply under 37 CFR 1.105 from the practice in MPEP § 609 (paragraph B(2)) and MPEP § 706.07(a) following a submission of an Information Disclosure Statement under 37 CFR 1.97 and 1.98.

### **705 Patentability Reports**

Where an application, properly assigned to one Technology Center (TC), is found to contain one or

more claims, *per se*, classifiable in one or more other TCs, which claims are not divisible *inter se* or from the claims which govern classification of the application in the first TC, the application may be referred to the other TC(s) concerned for a report as to the patentability of certain designated claims. This report is known as a Patentability Report (P.R.) and is signed by the primary examiner in the reporting TC.

The report, if legibly written, need not be typed.

Note that the Patentability Report practice is only to be used in extraordinary circumstances. See MPEP § 705.01(e).

#### **705.01 Instructions re Patentability Reports [R-2]**

When an application comes up for any action and the primary examiners involved (i.e., from both the requesting and the requested Technology Center (TC)) agree that a Patentability Report is necessary, and if the TC Director of the requesting TC approves, the application is forwarded to the proper TC with a memorandum attached, for instance, "For Patentability Report from TC -- as to claims --." >For Image File Wrapper (IFW) processing, see IFW Manual.<

#### **705.01(a) Nature of P.R., Its Use and Disposal [R-2]**

The primary examiner in the Technology Center (TC) from which the Patentability Report is requested, if he or she approves the request, will direct the preparation of the Patentability Report. This Patentability Report is written or typed on a memorandum form and will include the citation of all pertinent references and a complete action on all claims involved. The field of search covered should be endorsed on the file wrapper by the examiner making the report. >For Image File Wrapper (IFW) processing, see IFW Manual.< When an examiner to whom an application has been forwarded for a Patentability Report is of the opinion that final action is in order as to the referred claims, he or she should so state. The Patentability Report when signed by the primary examiner in the reporting TC will be returned to the TC to which the application is regularly assigned and placed in the file wrapper.



The examiner preparing the Patentability Report will be entitled to receive an explanation of the disclosure from the examiner to whom the case is assigned to avoid duplication of work.

If the primary examiner in a reporting TC is of the opinion that a Patentability Report is not in order, he or she should so advise the primary examiner in the forwarding TC.

>

### **I. < DISAGREEMENT AS TO CLASSIFICATION**

Conflict of opinion as to classification may be referred to a patent classifier for decision.

If the primary examiner in the TC having jurisdiction of the application agrees with the Patentability Report, he or she should incorporate the substance thereof in his or her action, which action will be complete as to *all* claims. The Patentability Report in such a case is *not* given a paper number but is allowed to remain in the file until the application is finally disposed of by allowance or abandonment, at which time it should be removed. >For Image File Wrapper (IFW) processing, see IFW Manual.<

>

### **II. < DISAGREEMENT ON PATENTABILITY REPORT**

If the primary examiner does not agree with the Patentability Report or any portion thereof, he or she may consult with the primary examiner responsible for the report. If agreement as to the resulting action cannot be reached, the primary examiner having jurisdiction of the application need not rely on the Patentability Report but may make his or her own action on the referred claims, in which case the Patentability Report should be removed from the file.

>

### **III. < APPEAL TAKEN**

When an appeal is taken from the rejection of claims, all of which are examinable in the TC preparing a Patentability Report, and the application is otherwise allowable, formal transfer of the application to said TC should be made for the purpose of appeal only. >For Image File Wrapper (IFW) processing, see IFW Manual section 3.1.< The receiving TC will take jurisdiction of the application and prepare the exam-

iner's answer. At the time of allowance, the application may be sent to issue by said TC with its classification determined by the controlling claims remaining in the application.

### **705.01(b) Sequence of Examination**

In the event that the supervisory patent examiners concerned in a P.R. case cannot agree as to the order of examination by their Technology Centers (TCs), the supervisory patent examiner having jurisdiction of the application will direct that a complete search be made of the art relevant to his or her claims prior to referring the application to another TC for report. The TC to which the application is referred will be advised of the results of this search.

If the supervisory patent examiners are of the opinion that a different sequence of search is expedient, the order of search should be correspondingly modified.

### **705.01(c) Counting and Recording P.R.s**

The forwarding of the application for a Patentability Report is not to be treated as a transfer by the forwarding Technology Center (TC). When the P.R. is completed and the application is ready for return to the forwarding TC, it is not counted either as a receipt or action by transfer. Credit, however, is given for the time spent.

The date status of the application in the reporting TC will be determined on the basis of the dates in the TC of original jurisdiction. To ensure orderly progress in the reported dates, a timely reminder should be furnished to the TC making the P.R.

### **705.01(d) Duplicate Prints of Drawings [R-2]**

In Patentability Report applications having drawings, the examiner to whom the case is assigned will furnish to the Technology Center (TC) to which the application is referred, prints of such sheets of the drawings as are applicable, for interference search purposes. >For Image File Wrapper (IFW) processing, see IFW Manual section 3.1.< That this has been done may be indicated by a pencil notation on the file wrapper. >For Image File Wrapper (IFW) processing, see IFW Manual.<

When an application that has had Patentability Report prosecution is passed for issue or becomes abandoned, NOTIFICATION of this fact will AT ONCE be given by the TC having jurisdiction of the application to each TC that submitted a Patentability Report. The examiner of each such reporting TC will note the date of allowance or abandonment on the duplicate set of prints. At such time as these prints become of no value to the reporting TC, they may be destroyed.

### **705.01(e) Limitation as to Use [R-2]**

The above outlined Patentability Report practice is not obligatory and should be resorted to only where it will save total examiner time or result in improved quality of action due to specialized knowledge. A saving of total examiner time that is required to give a complete examination of an application is of primary importance. Patentability Report practice is based on the proposition that when plural, indivisible inventions are claimed, in some instances either less time is required for examination, or the results are of better quality, when specialists on each character of the claimed invention treat the claims directed to their specialty. However, in many instances a single examiner can give a complete examination of as good quality on all claims, and in less total examiner time than would be consumed by the use of the Patentability Report practice.

Where claims are directed to the same character of invention but differ in scope only, prosecution by Patentability Report is never proper.

Exemplary situation where Patentability Reports are ordinarily not proper are as follows:

(A) Where the claims are related as a manufacturing process and a product defined by the process of manufacture. The examiner having jurisdiction of the process can usually give a complete, adequate examination in less total examiner time than would be consumed by the use of a Patentability Report.

(B) Where the claims are related as product and a process which involves merely the fact that a product having certain characteristics is made. The examiner having jurisdiction of the product can usually make a complete and adequate examination.

(C) Where the claims are related as a combination distinguished solely by the characteristics of a subcombination and such subcombination, *per se*. The

examiner having jurisdiction of the subcombination can usually make a complete and adequate examination.

Where it can be shown that a Patentability Report will save total examiner time, one is permitted with the approval of the Director of the Technology Center to which the application is assigned. The "Approved" stamp should be impressed on the memorandum requesting the Patentability Report. >For Image File Wrapper (IFW) processing, see IFW Manual.<

### **705.01(f) Interviews With Applicants**

In situations where an interview is held on an application in which a Patentability Report has been adopted, the reporting Technology Center may be called on for assistance at the interview when it concerns claims treated by them. See MPEP § 713 to § 713.10 regarding interviews in general.

## **706 Rejection of Claims [R-2]**

After the application has been read and the claimed invention understood, a prior art search for the claimed invention is made. With the results of the prior art search, including any references provided by the applicant, the patent application should be reviewed and analyzed in conjunction with the state of the prior art to determine whether the claims define a useful, novel, nonobvious, and enabled invention that has been clearly described in the specification. The goal of examination is to clearly articulate any rejection early in the prosecution process so that the applicant has the opportunity to provide evidence of patentability and otherwise reply completely at the earliest opportunity. The examiner then reviews all the evidence, including arguments and evidence responsive to any rejection, before issuing the next Office action. Where the examiner determines that information reasonably necessary for the examination should be required from the applicant under 37 CFR 1.105, such a requirement should generally be made either prior to or with the first Office action on the merits and should follow the procedures in MPEP § 704.10 *et seq.*

Although this part of the Manual explains the procedure in rejecting claims, the examiner should never overlook the importance of his or her role in allowing claims which properly define the invention.

37 CFR 1.104. *Nature of examination.*

\*\*\*\*\*

(c) *Rejection of claims.*

(1) If the invention is not considered patentable, or not considered patentable as claimed, the claims, or those considered unpatentable will be rejected.

(2) In rejecting claims for want of novelty or for obviousness, the examiner must cite the best references at his or her command. When a reference is complex or shows or describes inventions other than that claimed by the applicant, the particular part relied on must be designated as nearly as practicable. The pertinence of each reference, if not apparent, must be clearly explained and each rejected claim specified.

(3) In rejecting claims the examiner may rely upon admissions by the applicant, or the patent owner in a reexamination proceeding, as to any matter affecting patentability and, insofar as rejections in applications are concerned, may also rely upon facts within his or her knowledge pursuant to paragraph (d)(2) of this section.

(4) Subject matter which is developed by another person which qualifies as prior art only under 35 U.S.C. 102(f) or (g) may be used as prior art under 35 U.S.C. 103 against a claimed invention unless the entire rights to the subject matter and the claimed invention were commonly owned by the same person or organization or subject to an obligation of assignment to the same person or organization at the time the claimed invention was made.

(5) The claims in any original application naming an inventor will be rejected as being precluded by a waiver in a published statutory invention registration naming that inventor if the same subject matter is claimed in the application and the statutory invention registration. The claims in any reissue application naming an inventor will be rejected as being precluded by a waiver in a published statutory invention registration naming that inventor if the reissue application seeks to claim subject matter:

(i) Which was not covered by claims issued in the patent prior to the date of publication of the statutory invention registration; and

(ii) Which was the same subject matter waived in the statutory invention registration.

\*\*\*\*\*

&gt;

**I. < UNIFORM APPLICATION OF THE PATENTABILITY STANDARD**

The standards of patentability applied in the examination of claims must be the same throughout the Office. In every art, whether it be considered “complex,” “newly developed,” “crowded,” or “competitive,” all of the requirements for patentability (e.g., novelty, usefulness and unobviousness, as provided in

35 U.S.C. 101, 102, and 103) must be met before a claim is allowed. The mere fact that a claim recites in detail all of the features of an invention (i.e., is a “picture” claim) is never, in itself, justification for the allowance of such a claim.

An application should not be allowed, unless and until issues pertinent to patentability have been raised and resolved in the course of examination and prosecution, since otherwise the resultant patent would not justify the statutory presumption of validity (35 U.S.C. 282), nor would it “strictly adhere” to the requirements laid down by Congress in the 1952 Act as interpreted by the Supreme Court. The standard to be applied in all cases is the “preponderance of the evidence” test. In other words, an examiner should reject a claim if, in view of the prior art and evidence of record, it is more likely than not that the claim is unpatentable.

&gt;

**II. < DEFECTS IN FORM OR OMISSION OF A LIMITATION; CLAIMS OTHERWISE ALLOWABLE**

When an application discloses patentable subject matter and it is apparent from the claims and the applicant's arguments that the claims are intended to be directed to such patentable subject matter, but the claims in their present form cannot be allowed because of defects in form or omission of a limitation, the examiner should not stop with a bare objection or rejection of the claims. The examiner's action should be constructive in nature and when possible should offer a definite suggestion for correction.

&gt;

**III. < PATENTABLE SUBJECT MATTER DISCLOSED BUT NOT CLAIMED**

If the examiner is satisfied after the search has been completed that patentable subject matter has been disclosed and the record indicates that the applicant intends to claim such subject matter, he or she may note in the Office action that certain aspects or features of the patentable invention have not been claimed and that if properly claimed such claims may be given favorable consideration.

&gt;

#### IV. < RECONSIDERATION OF CLAIMS AFTER REPLY BY APPLICANT

37 CFR 1.112. *Reconsideration before final action.*

After reply by applicant or patent owner (§ 1.111 or § 1.945) to a non-final action and any comments by an *inter partes* reexamination requester (§ 1.947), the application or the patent under reexamination will be reconsidered and again examined. The applicant, or in the case of a reexamination proceeding the patent owner and any third party requester, will be notified if claims are rejected, objections or requirements made, or decisions favorable to patentability are made, in the same manner as after the first examination (§ 1.104). Applicant or patent owner may reply to such Office action in the same manner provided in § 1.111 or § 1.945, with or without amendment, unless such Office action indicates that it is made final (§ 1.113) or an appeal (§ 1.191) has been taken (§ 1.116), or in an *inter partes* reexamination, that it is an action closing prosecution (§ 1.949) or a right of appeal notice (§ 1.953).

37 CFR 1.112 provides for the reconsideration and continued examination of an application or a patent under reexamination after reply by the applicant or the patent owner. If claims are rejected, or objections or requirements made, applicant or patent owner will be notified in the same manner as after the first examination. Applicant or patent owner may reply to such Office action in the same manner provided in 37 CFR 1.111 or 37 CFR 1.945, with or without amendment, unless such Office action indicates that it is made final (37 CFR 1.113), or an appeal under 37 CFR 1.191 has been taken (37 CFR 1.116), or in an *inter partes* reexamination, that it is an action closing prosecution (37 CFR 1.949) or a right of appeal notice (37 CFR 1.953). Once an appeal has been taken in an application, any amendment is subject to the provisions of 37 CFR 1.116(b) and (c), even if the appeal is in reply to a non-final Office action.

&gt;

#### V. < REJECTIONS IN STATUTORY INVENTION REGISTRATIONS

See MPEP Chapter 1100 for rejection of claims in an application for a Statutory Invention Registration.

#### 706.01 Contrasted With Objections [R-2]

The refusal to grant claims because the subject matter as claimed is considered unpatentable is called a

“rejection.” The term “rejected” must be applied to such claims in the examiner’s action. If the form of the claim (as distinguished from its substance) is improper, an “objection” is made. An example of a matter of form as to which objection is made is dependency of a claim on a rejected claim, if the dependent claim is otherwise allowable. See MPEP § 608.01(n). The practical difference between a rejection and an objection is that a rejection, involving the merits of the claim, is subject to review by the Board of Patent Appeals and Interferences, while an objection, if persisted, may be reviewed only by way of petition to the \*>Director of the USPTO<.

Similarly, the Board will not hear or decide issues pertaining to objections and formal matters which are not properly before the Board. These formal matters should not be combined in appeals to the Board.

#### 706.02 Rejection on Prior Art [R-2]

35 U.S.C. 102. *Conditions for patentability; novelty and loss of right to patent.*

A person shall be entitled to a patent unless —

(a) the invention was known or used by others in this country, or patented or described in a printed publication in this or a foreign country, before the invention thereof by the applicant for patent, or

(b) the invention was patented or described in a printed publication in this or a foreign country or in public use or on sale in this country, more than one year prior to the date of the application for patent in the United States, or

(c) he has abandoned the invention, or

(d) the invention was first patented or caused to be patented, or was the subject of an inventor’s certificate, by the applicant or his legal representatives or assigns in a foreign country prior to the date of the application for patent in this country on an application for patent or inventor’s certificate filed more than twelve months before the filing of the application in the United States, or

(e) the invention was described in — (1) an application for patent, published under section 122(b), by another filed in the United States before the invention by the applicant for patent or (2) a patent granted on an application for patent by another filed in the United States before the invention by the applicant for patent, except that an international application filed under the treaty defined in section 351(a) shall have the effects for the purposes of this subsection of an application filed in the United States only if the international application designated the United States and was published under Article 21(2) of such treaty in the English language; or

(f) he did not himself invent the subject matter sought to be patented, or

(g)(1)during the course of an interference conducted under section 135 or section 291, another inventor involved therein establishes, to the extent permitted in section 104, that before such

person's invention thereof the invention was made by such other inventor and not abandoned, suppressed, or concealed, or (2) before such person's invention thereof, the invention was made in this country by another inventor who had not abandoned, suppressed, or concealed it. In determining priority of invention under this subsection, there shall be considered not only the respective dates of conception and reduction to practice of the invention, but also the reasonable diligence of one who was first to conceive and last to reduce to practice, from a time prior to conception by the other.

*35 U.S.C. 103. Conditions for patentability; non-obvious subject matter.*

(a) A patent may not be obtained though the invention is not identically disclosed or described as set forth in section 102 of this title, if the differences between the subject matter sought to be patented and the prior art are such that the subject matter as a whole would have been obvious at the time the invention was made to a person having ordinary skill in the art to which said subject matter pertains. Patentability shall not be negated by the manner in which the invention was made.

(b)(1) Notwithstanding subsection (a), and upon timely election by the applicant for patent to proceed under this subsection, a biotechnological process using or resulting in a composition of matter that is novel under section 102 and nonobvious under subsection (a) of this section shall be considered nonobvious if-

(A) claims to the process and the composition of matter are contained in either the same application for patent or in separate applications having the same effective filing date; and

(B) the composition of matter, and the process at the time it was invented, were owned by the same person or subject to an obligation of assignment to the same person.

(2) A patent issued on a process under paragraph (1)-

(A) shall also contain the claims to the composition of matter used in or made by that process, or

(B) shall, if such composition of matter is claimed in another patent, be set to expire on the same date as such other patent, notwithstanding section 154.

(3) For purposes of paragraph (1), the term "biotechnological process" means-

(A) a process of genetically altering or otherwise inducing a single- or multi-celled organism to-

(i) express an exogenous nucleotide sequence,

(ii) inhibit, eliminate, augment, or alter expression of an endogenous nucleotide sequence, or

(iii) express a specific physiological characteristic not naturally associated with said organism;

(B) cell fusion procedures yielding a cell line that expresses a specific protein, such as a monoclonal antibody; and

(C) a method of using a product produced by a process defined by subparagraph (A) or (B), or a combination of subparagraphs (A) and (B).

(c) Subject matter developed by another person, which qualifies as prior art only under one or more of subsections (e), (f), and (g) of section 102 of this title, shall not preclude patentability under this section where the subject matter and the claimed invention were, at the time the invention was made, owned by the same

person or subject to an obligation of assignment to the same person.

By far the most frequent ground of rejection is on the ground of unpatentability in view of the prior art, that is, that the claimed subject matter is either not novel under 35 U.S.C. 102, or else it is obvious under 35 U.S.C. 103. The language to be used in rejecting claims should be unequivocal. See MPEP § 707.07(d).

>

## **I. < CHOICE OF PRIOR ART; BEST AVAILABLE**

Prior art rejections should ordinarily be confined strictly to the best available art. Exceptions may properly be made, for example, where:

(A) the propriety of a 35 U.S.C. 102 or 103 rejection depends on a particular interpretation of a claim;

(B) a claim is met only in terms by a reference which does not disclose the inventive concept involved; or

(C) the most pertinent reference seems likely to be antedated by a 37 CFR 1.131 affidavit or declaration.

Such rejections should be backed up by the best other art rejections available. Merely cumulative rejections, i.e., those which would clearly fall if the primary rejection were not sustained, should be avoided.

See also MPEP § 707.05.

>

## **II. < RELIANCE UPON ABSTRACTS AND FOREIGN LANGUAGE DOCUMENTS IN SUPPORT OF A REJECTION**

Prior art uncovered in searching the claimed subject matter of a patent application often includes English language abstracts of underlying documents, such as technical literature or foreign patent documents which may not be in the English language. When an abstract is used to support a rejection, the evidence relied upon is the facts contained in the abstract, not additional facts that may be contained in the underlying full text document. Citation of and reliance upon an abstract without citation of and reliance upon the underlying scientific document is generally inappropriate where

both the abstract and the underlying document are prior art. See *Ex parte Jones*, 62 USPQ2d 1206, 1208 (Bd. Pat. App. & Inter. 2001) (unpublished).

To determine whether both the abstract and the underlying document are prior art, a copy of the underlying document must be obtained and analyzed. If the document is in a language other than English and the examiner seeks to rely on that document, a translation must be obtained so that the record is clear as to the precise facts the examiner is relying upon in support of the rejection. The record must also be clear as to whether the examiner is relying upon the abstract or the full text document to support a rejection. The rationale for this is several-fold. It is not uncommon for a full text document to reveal that the document fully anticipates an invention that the abstract renders obvious at best. The converse may also be true, that the full text document will include teachings away from the invention that will preclude an obviousness rejection under 35 U.S.C. 103, when the abstract alone appears to support the rejection. An abstract can have a different effective publication date than the full text document. Because all patentability determinations are fact dependent, obtaining and considering full text documents at the earliest practicable time in the examination process will yield the fullest available set of facts upon which to determine patentability, thereby improving quality and reducing pendency.

When both the abstract and the underlying document qualify as prior art, the underlying document should normally be used to support a rejection. In limited circumstances, it may be appropriate for the examiner to make a rejection in a non-final Office action based in whole or in part on the abstract only without relying on the full text document. In such circumstances, the full text document and a translation (if not in English) may be supplied in the next Office action. Whether the next Office action may be made final is governed by MPEP § 706.07(a).

>

### III. < REEXAMINATION

For scope of rejections in *>ex parte<* reexamination proceedings, see MPEP § 2258 and in *inter partes* reexamination, see MPEP § 2658.

>

### IV. < DISTINCTION BETWEEN 35 U.S.C. 102 AND 103

The distinction between rejections based on 35 U.S.C. 102 and those based on 35 U.S.C. 103 should be kept in mind. Under the former, the claim is anticipated by the reference. No question of obviousness is present. In other words, for anticipation under 35 U.S.C. 102, the reference must teach every aspect of the claimed invention either explicitly or impliedly. Any feature not directly taught must be inherently present. Whereas, in a rejection based on 35 U.S.C. 103, the reference teachings must somehow be modified in order to meet the claims. The modification must be one which would have been obvious to one of ordinary skill in the art at the time the invention was made. See MPEP § 2131 - § 2146 for guidance on patentability determinations under 35 U.S.C. 102 and 103.

>

### V. < DETERMINING THE EFFECTIVE FILING DATE OF THE APPLICATION

The effective filing date of a U.S. application may be determined as follows:

(A) If the application is a continuation or divisional of one or more earlier U.S. applications or international applications and if the requirements of 35 U.S.C. 120 and 365(c), respectively, have been satisfied, the effective filing date is the same as the earliest filing date in the line of continuation or divisional applications.

(B) If the application is a continuation-in-part of an earlier U.S. application or international application, any claims in the new application not supported by the specification and claims of the parent application have an effective filing date equal to the filing date of the new application. Any claims which are fully supported under 35 U.S.C. 112 by the earlier parent application have the effective filing date of that earlier parent application.

(C) If the application claims foreign priority under 35 U.S.C. 119(a)-(d) or 365(a), the effective filing date is the filing date of the U.S. application, unless situation (A) or (B) as set forth above applies. The filing date of the foreign priority document is not

the effective filing date, although the filing date of the foreign priority document may be used to overcome certain references. See MPEP § 706.02(b) and § 2136.05.

(D) If the application properly claims benefit under 35 U.S.C. 119(e) to a provisional application, the effective filing date is the filing date of the provisional application for any claims which are fully supported under the first paragraph of 35 U.S.C. 112 by the provisional application.

See MPEP § 1893.03(b) for determining the effective filing date of an application under 35 U.S.C. 371. See MPEP § 201.11(a) and § 1895 for additional information on determining the effective filing date of a continuation, divisional, or continuation-in-part of a PCT application designating the U.S. See also MPEP § 1895.01 and § 1896 which discuss differences between applications filed under 35 U.S.C. 111(a) and international applications that enter national stage under 35 U.S.C. 371.

### **706.02(a) Rejections Under 35 U.S.C. 102(a), (b), or (e); Printed Publication or Patent [R-2]**

Once the examiner conducts a search and finds a printed publication or patent which discloses the claimed invention, the examiner should determine whether the rejection should be made under 35 U.S.C. 102(a), (b), or (e).

In order to determine which section of 35 U.S.C. 102 applies, the effective filing date of the application must be determined and compared with the date of the reference. See MPEP § 706.02 regarding determination of effective filing date of the application.

>

#### **I. < DETERMINING THE REFERENCE ISSUE OR PUBLICATION DATE**

The examiner must determine the issue or publication date of the reference so that a proper comparison between the application and reference dates can be made. A magazine is effective as a printed publication under 35 U.S.C. 102(b) as of the date it reached the addressee and not the date it was placed in the mail. *Protein Foundation Inc. v. Brenner*, 260 F. Supp. 519, 151 USPQ 561 (D.D.C. 1966). See MPEP § 707.05(f). For foreign patents see MPEP § 901.05.

See MPEP § 2124, § 2126, and § 2128 - § 2128.02 for case law relevant to reference date determination.

>

#### **II. < DETERMINING WHETHER TO APPLY 35 U.S.C. 102(a), (b), or (e)**

\*>

##### **A. < 35 U.S.C. 102(b)**

First, the examiner should consider whether the reference qualifies as prior art under 35 U.S.C. 102(b) because this section results in a statutory bar to obtaining a patent. If the publication or issue date of the reference is more than 1 year prior to the effective filing date of the application (MPEP § 706.02), the reference qualifies as prior art under 35 U.S.C. 102(b).

Where the last day of the year dated from the date of publication falls on a Saturday, Sunday or Federal holiday, the publication is not a statutory bar under 35 U.S.C. 102(b) if the application was filed on the next succeeding business day. *Ex parte Olah*, 131 USPQ 41 (Bd. App. 1960) (The Board in *Olah* held that 35 U.S.C. 21(b) is applicable to the filing of an original application for patent and that applicant's own activity will not bar a patent if the 1-year grace period expires on a Saturday, Sunday, or Federal holiday and the application's U.S. filing date is the next succeeding business day.) Despite changes to 37 CFR 1.6(a)(2) and 1.10 which permit the USPTO to accord a filing date to an application as of the date of deposit as "Express Mail" with the U.S. Postal Service in accordance with 37 CFR 1.10 (e.g., a Saturday filing date), the rule changes do not affect applicant's concurrent right to defer the filing of an application until the next business day when the last day for "taking any action" falls on a Saturday, Sunday, or Federal holiday (e.g., the last day of the 1-year grace period falls on a Saturday).

\*>

##### **B. < 35 U.S.C. 102(e)**

If the publication or issue date of the reference is too recent for 35 U.S.C. 102(b) to apply, then the examiner should consider 35 U.S.C. 102(e).

In order to apply a reference under 35 U.S.C. 102(e), the inventive entity of the application must be different than that of the reference. Note that, where

there are joint inventors, only one inventor need be different for the inventive entities to be different and a rejection under 35 U.S.C. 102(e) is applicable even if there are some inventors in common between the application and the reference.

Revised 35 U.S.C. 102(e), as amended by the American Inventors Protection Act of 1999 (AIPA) (Pub. L. 106-113, 113 Stat. 1501 (1999)), and as further amended by the Intellectual Property and High Technology Technical Amendments Act of 2002 (Pub. L. 107-273, 116 Stat. 1758 (2002)), applies in the examination of all applications, whenever filed, and the reexamination of, or other proceedings to contest, all patents. The filing date of the application being examined is no longer relevant in determining what version of 35 U.S.C. 102(e) to apply in determining the patentability of that application, or the patent resulting from that application. The revised statutory provisions supersede all previous versions of 35 U.S.C. 102(e) and 374, with only one exception, which is when the potential reference is based on an international application filed prior to November 29, 2000 (discussed further below). Furthermore, the provisions amending 35 U.S.C. 102(e) and 374 in Pub. L. 107-273 are completely retroactive to the effective date of the relevant provisions in the AIPA (November 29, 2000). See MPEP § 706.02(f)(1) for examination guidelines on the application of 35 U.S.C. 102(e).

*35 U.S.C. 102. Conditions for patentability; novelty and loss of right to patent.*

\*\*\*\*\*

(e) the invention was described in — (1) an application for patent, published under section 122(b), by another filed in the United States before the invention by the applicant for patent or (2) a patent granted on an application for patent by another filed in the United States before the invention by the applicant for patent, except that an international application filed under the treaty defined in section 351(a) shall have the effects for the purposes of this subsection of an application filed in the United States only if the international application designated the United States and was published under Article 21(2) of such treaty in the English language; or

\*\*\*\*\*

As mentioned above, references based on international applications that were filed prior to November 29, 2000 are subject to the former (pre-AIPA) version of 35 U.S.C. 102(e) as set forth below.

*Former 35 U.S.C. 102. Conditions for patentability; novelty and loss of right to patent.*

A person shall be entitled to a patent unless-

\*\*\*\*\*

(e) the invention was described in a patent granted on an application for patent by another filed in the United States before the invention thereof by the applicant for patent, or on an international application by another who has fulfilled the requirements of paragraphs (1), (2), and (4) of section 371(c) of this title before the invention thereof by the applicant for patent.

\*\*\*\*\*

Revised 35 U.S.C. 102(e) has two separate clauses, namely, 35 U.S.C. 102(e)(1) for **publications** of patent applications and 35 U.S.C. 102(e)(2) for U.S. patents. 35 U.S.C. 102(e)(1), in combination with amended 35 U.S.C. 374, created a new category of prior art by providing prior art effect for certain **publications** of patent applications, including certain international applications, as of their effective United States filing dates (which will include certain international filing dates). Under revised 35 U.S.C. 102(e), an international filing date which is on or after November 29, 2000 is a United States filing date if the international application designated the United States and was published by the World Intellectual Property Organization (WIPO) under the Patent Cooperation Treaty (PCT) Article 21(2) in the English language. Therefore, the prior art date of a reference under 35 U.S.C. 102(e) may be the international filing date (if all three conditions noted above are met) or an earlier U.S. filing date for which priority or benefit is properly claimed. Publication under PCT Article 21(2) may result from a request for early publication by an applicant of an international application or after the expiration of 18-months after the earliest claimed filing date in an international application. An applicant of an international application that has designated only the U.S. would continue to be required to request publication from WIPO as the reservation under PCT Article 64(4) continues to be in effect for such applicants. International applications, which: (1) were filed prior to November 29, 2000, or (2) did not designate the U.S., or (3) were not published in English under PCT Article 21(2) by WIPO, may not be used to reach back (bridge) to an earlier filing date through a priority or benefit claim for prior art purposes under 35 U.S.C. 102(e).



Revised 35 U.S.C. 102(e) eliminated the reference to fulfillment of the 35 U.S.C. 371(c)(1), (2) and (4) requirements. As a result, United States **patents** issued directly from international applications filed on or after November 29, 2000 will no longer be available as prior art under 35 U.S.C. 102(e) as of the date the requirements of 35 U.S.C. 371(c)(1), (2) and (4) have been satisfied. Under 35 U.S.C. 102(e)(2), as amended by the AIPA and Pub. L. 107-273, an international filing date which is on or after November 29, 2000 is a United States filing date for purposes of determining the earliest effective prior art date of a patent if the international application designated the United States and was published in the English language under PCT Article 21(2) by WIPO.

No international filing dates prior to November 29, 2000 may be relied upon as a prior art date under 35 U.S.C. 102(e) in accordance with the last sentence of the effective date provisions of Pub. L. 107-273. **Patents** issued directly, or indirectly, from international applications filed before November 29, 2000 may only be used as prior art based on the provisions of 35 U.S.C. 102(e) in effect before November 29, 2000. Thus, the 35 U.S.C. 102(e) date of such a prior art patent is the earliest of the date of compliance with 35 U.S.C. 371(c)(1), (2) and (4), or the filing date of the later-filed U.S. continuing application that claimed the benefit of the international application. **Publications** of international applications filed before November 29, 2000 (which would include WIPO publications and U.S. publications of the national stage (35 U.S.C. 371)) do not have a 35 U.S.C. 102(e) date at all (however, such publications are available as prior art under 35 U.S.C. 102(a) or (b) as of the publication date). Specifically, under revised 35 U.S.C. 374, the international application must be filed on or after November 29, 2000 for its WIPO publication to be “deemed a publication under section 122(b)” and thus available as a possible prior art reference under 35 U.S.C. 102(e) as amended by the AIPA.

\*>

### C. < 35 U.S.C. 102(a)

Even if the reference is prior art under 35 U.S.C. 102(e), the examiner should still consider 35 U.S.C. 102(a) for two reasons. First, if the reference is a U.S. patent or patent application publication of, or claims benefit of, an international application, the publication

of the international application under PCT Article 21(2) may be the earliest prior art date under 35 U.S.C. 102(a) for the disclosure. Second, references that are only prior art under 35 U.S.C. 102(e), (f), or (g) and applied in a rejection under 35 U.S.C. 103(a) are subject to being disqualified under 35 U.S.C. 103(c) if the reference and the application were commonly owned, or subject to an obligation of common assignment, at the time the invention was made. For 35 U.S.C. 102(a) to apply, the reference must have a publication date earlier in time than the effective filing date of the application, and must not be applicant’s own work.

### 706.02(b) Overcoming a 35 U.S.C. 102 Rejection Based on a Printed Publication or Patent [R-2]

A rejection based on 35 U.S.C. 102(b) can be overcome by:

(A) Persuasively arguing that the claims are patentably distinguishable from the prior art;

(B) Amending the claims to patentably distinguish over the prior art; \*

(C) Perfecting priority under 35 U.S.C. \*\* 120, within the time \*>period< set in 37 CFR 1.78(a) or filing a grantable petition under 37 CFR 1.78(a), by amending the specification of the application to contain a specific reference to a prior application or by filing an application data sheet under 37 CFR 1.76 which contains a specific reference to a prior application in accordance with 37 CFR 1.78(a), and by establishing that the prior application satisfies the enablement and written description requirements of 35 U.S.C. 112, first paragraph. See MPEP § 201.11 and § 706.02>; or

(D) Perfecting priority claim under 35 U.S.C. 119(e) by complying with the requirements of 37 CFR 1.78(a) (see item (C) above). Since a provisional application could not have been filed more than one year prior to the filing of a nonprovisional application that claims benefit to the provisional application, in order to overcome a rejection under 35 U.S.C. 102(b), there must be at least one intermediate application between the provisional application and the nonprovisional application under examination, e.g., chain of prior applications. In order to overcome the rejection under 35 U.S.C. 102(b), priority must be perfected for

the chain of prior applications (35 U.S.C. 119(e) and 120 must be perfected). See MPEP § 201.11.<

A rejection based on 35 U.S.C. 102(e) can be overcome by:

(A) Persuasively arguing that the claims are patentably distinguishable from the prior art;

(B) Amending the claims to patentably distinguish over the prior art;

(C) Filing an affidavit or declaration under 37 CFR 1.132 showing that the reference invention is not by “another.” See MPEP § 715.01(a), § 715.01(c), and § 716.10;

(D) Filing an affidavit or declaration under 37 CFR 1.131 showing prior invention, if the reference is not a U.S. patent or a U.S. patent application publication claiming the same patentable invention as defined in 37 CFR 1.601(n). See MPEP § 715 for more information on 37 CFR 1.131 affidavits. When the claims of the reference U.S. patent or U.S. patent application publication and the application are directed to the same invention or are obvious variants, an affidavit or declaration under 37 CFR 1.131 is not an acceptable method of overcoming the rejection. Under these circumstances, the examiner must determine whether a double patenting rejection or interference is appropriate. If there is a common assignee or inventor between the application and patent, a double patenting rejection must be made. See MPEP § 804. If there is no common assignee or inventor and the rejection under 35 U.S.C. 102(e) is the only possible rejection, the examiner must determine whether an interference should be declared. See MPEP Chapter 2300 for more information regarding interferences;

(E) Perfecting a claim to priority under 35 U.S.C. 119(a)-(d) within the time period set in 37 CFR 1.55(a)(1) or filing a grantable petition under 37 CFR 1.55(c). See MPEP § 201.13. The foreign priority filing date must antedate the reference and be perfected. The filing date of the priority document is not perfected unless applicant has filed a certified priority document in the application (and an English language translation, if the document is not in English) (see 37 CFR 1.55(a)(3)) and the examiner has established that the priority document satisfies the enablement and description requirements of 35 U.S.C. 112, first paragraph; or

(F) Perfecting priority under 35 U.S.C. 119(e) or 120, within the time periods set in 37 CFR 1.78(a) or filing a grantable petition under 37 CFR 1.78(a), by amending the specification of the application to contain a specific reference to a prior application or by filing an application data sheet under 37 CFR 1.76 which contains a specific reference to a prior application in accordance with 37 CFR 1.78(a), and by establishing that the prior application satisfies the enablement and written description requirements of 35 U.S.C. 112, first paragraph. See MPEP § 201.11 and § 706.02.

A rejection based on 35 U.S.C. 102(a) can be overcome by:

(A) Persuasively arguing that the claims are patentably distinguishable from the prior art;

(B) Amending the claims to patentably distinguish over the prior art;

(C) Filing an affidavit or declaration under 37 CFR 1.131 showing prior invention, if the reference is not a U.S. patent or a U.S. patent application publication claiming the same patentable invention as defined in 37 CFR 1.601(n). See MPEP § 715 for information on the requirements of 37 CFR 1.131 affidavits. When the claims of the reference U.S. patent or U.S. patent application publication and the application are directed to the same invention or are obvious variants, an affidavit or declaration under 37 CFR 1.131 is not appropriate to overcome the rejection.

(D) Filing an affidavit or declaration under 37 CFR 1.132 showing that the reference invention is not by “another.” See MPEP § 715.01(a), § 715.01(c), and § 716.10;

(E) Perfecting a claim to priority under 35 U.S.C. 119(a)-(d) as explained in reference to 35 U.S.C. 102(e) above;

(F) Perfecting priority under 35 U.S.C. 119(e) or 120 as explained in reference to 35 U.S.C. 102(e) above.

### **706.02(c) Rejections Under 35 U.S.C. 102(a) or (b); Knowledge by Others or Public Use or Sale**

An applicant may make an admission, or submit evidence of sale of the invention or knowledge of the invention by others, or the examiner may have per-

sonal knowledge that the invention was sold by applicant or known by others in this country. The language “in this country” means in the United States only and does not include other WTO or NAFTA member countries. In these cases the examiner must determine if 35 U.S.C. 102(a) or 102(b) applies. See MPEP § 2133.03 for a discussion of case law treating the “public use” and “on sale” statutory bars.

If the activity is by an entity other than the inventors or assignee, such as sale by another, manufacture by another or disclosure of the invention by applicant to another then both 35 U.S.C. 102(a) and (b) may be applicable. If the evidence only points to knowledge within the year prior to the effective filing date then 35 U.S.C. 102(a) applies. However, no rejection under 35 U.S.C. 102(a) should be made if there is evidence that applicant made the invention and only disclosed it to others within the year prior to the effective filing date.

35 U.S.C. 102(b) is applicable if the activity occurred more than 1 year prior to the effective filing date of the application. See MPEP § 2133.03 for a discussion of “on sale” and “public use” bars under 35 U.S.C. 102(b).

Note that as an aid to resolving public use or on sale issues, as well as to other related matters of 35 U.S.C. 102(b) activity, an applicant may be required to answer specific questions posed by the examiner and to explain or supplement any evidence of record. See 35 U.S.C. 132, 37 CFR 1.104(a)(2). Information sought should be restricted to that which is reasonably necessary for the examiner to render a decision on patentability. The examiner may consider making a requirement for information under 37 CFR 1.105 where the evidence of record indicates reasonable necessity. See MPEP § 704.10 *et seq.*

A 1- or 2-month time period should be set by the examiner for any reply to the requirement, unless the requirement is part of an Office action having a shortened statutory period, in which case the period for reply to the Office action will also apply to the requirement. If applicant fails to reply in a timely fashion to a requirement for information, the application will be regarded as abandoned. 35 U.S.C. 133. See MPEP § 2133.03.

If there is not enough information on which to base a public use or on sale rejection, the examiner should

make a requirement for more information. Form paragraph 7.104 can be used.

#### ¶ 7.104 Requirement for Information, Public Use or Sale

An issue of public use or on sale activity has been raised in this application. In order for the examiner to properly consider patentability of the claimed invention under 35 U.S.C. 102(b), additional information regarding this issue is required as follows: [1]

Applicant is reminded that failure to fully reply to this requirement for information will result in a holding of abandonment.

#### Examiner Note:

1. Information sought should be restricted to that which is reasonably necessary for the examiner to render a decision on patentability. See MPEP § 2133.03.
2. A one or two month time period should be set by the examiner for reply to the requirement unless it is part of an Office action having an SSP, in which case the period for reply will apply also to the requirement.
3. If sufficient evidence already exists to establish a *prima facie* case of public use or on sale, use form paragraph 7.16 to make a rejection under 35 U.S.C. 102(b). See MPEP § 2133.03.

### 706.02(d) Rejections Under 35 U.S.C. 102(c)

Under 35 U.S.C. 102(c), abandonment of the “invention” (as distinguished from abandonment of an application) results in loss of right to a patent. See MPEP § 2134 for case law which sets forth the criteria for abandonment under 35 U.S.C. 102(c).

### 706.02(e) Rejections Under 35 U.S.C. 102(d) [R-2]

35 U.S.C. 102(d) establishes four conditions which, if all are present, establish a statutory bar against the granting of a patent in this country:

(A) The foreign application must be filed more than 12 months before the effective filing date of the United States application. See MPEP § 706.02 regarding determination of the effective filing date of the application.

(B) The foreign and United States applications must be filed by the same applicant, his or her legal representatives or assigns.

(C) The foreign application must have actually issued as a patent or inventor’s certificate (e.g., granted by sealing of the papers in Great Britain) before the filing in the United States. It need not be

published but the patent rights granted must be enforceable.

(D) The same invention must be involved.

If such a foreign patent or inventor's certificate is discovered by the examiner, the rejection is made under 35 U.S.C. 102(d) on the ground of statutory bar.

See MPEP § 2135.01 for case law which further clarifies each of the four requirements of 35 U.S.C. 102(d).

### SEARCHING FOR 35 U.S.C. 102(d) PRIOR ART

The examiner should only undertake a search for an issued foreign patent for use as 35 U.S.C. 102(d) prior art if there is a reasonable possibility that a foreign patent covering the same subject matter as the U.S. application has been granted to the same inventive entity before the U.S. effective filing date, i.e., the time period between foreign and U.S. filings is greater than the usual time it takes for a patent to issue in the foreign country. Normally, the probability of the inventor's foreign patent issuing before the U.S. filing date is so slight as to make such a search unproductive. However, it should be kept in mind that the average pendency varies greatly between foreign countries. In Belgium, for instance, a patent may be granted in just a month after its filing, while in Japan the patent may not issue for \*\*>several years<.

The search for a granted patent can be accomplished on an electronic database either by the examiner or by the staff of the Scientific and Technical Information Center. See MPEP § 901.06(a), paragraph IV.B., for more information on online searching. The document must be a patent or inventor's certificate and not merely a published or laid open application.

### 706.02(f) >Rejection Under 35 U.S.C. 102(e) [R-1]

35 U.S.C. 102(e), in part, allows for certain prior art (i.e., U.S. patents, U.S. patent application publications and WIPO publications of international applications) to be applied against the claims as of its effective U.S. filing date. This provision of 35 U.S.C. 102 is mostly utilized when the publication or issue date is too recent for the reference to be applied under 35 U.S.C. 102(a) or (b). In order to apply a reference under 35 U.S.C. 102(e), the inventive entity of the

application must be different than that of the reference. Note that, where there are joint inventors, only one inventor need be different for the inventive entities to be different and a rejection under 35 U.S.C. 102(e) is applicable even if there are some inventors in common between the application and the reference.<

### 706.02(f)(1) Examination Guidelines for Applying References Under 35 U.S.C. 102(e) [R-2]

#### I. DETERMINE THE APPROPRIATE 35 U.S.C. 102(e) >DATE< FOR EACH POTENTIAL REFERENCE BY FOLLOWING THE GUIDELINES, EXAMPLES, AND FLOW CHARTS SET FORTH BELOW:

(A) The potential reference must be a U.S. patent, a U.S. application publication (35 U.S.C. 122(b)) or a WIPO publication of an international application under PCT Article 21(2) in order to apply the reference under 35 U.S.C. 102(e).

(B) Determine if the potential reference resulted from, or claimed the benefit of, an international application. If the reference does, go to step (C) below. The 35 U.S.C. 102(e) date of a reference that did not result from, nor claimed the benefit of, an international application is its earliest effective U.S. filing date, taking into consideration any proper benefit claims to prior U.S. applications under 35 U.S.C. 119(e) or 120 if the prior application(s) properly supports the subject matter used to make the rejection \*\*>in compliance with 35 U.S.C. 112, first paragraph. See MPEP § 2136.02<.

(C) If the potential reference resulted from, or claimed the benefit of, an international application, the following must be determined:

(1) If the international application meets the following three conditions:

- (a) an international filing date on or after November 29, 2000;
- (b) designated the United States; and
- (c) published under PCT Article 21(2) in English,

then the international filing date is a U.S. filing date for prior art purposes under 35 U.S.C. 102(e). If such an international application properly claims benefit to an earlier-filed U.S. or international applica-

tion, or to an earlier-filed U.S. provisional application, apply the reference under 35 U.S.C. 102(e) as of the earlier filing date, assuming all the conditions of 35 U.S.C. 102(e), 119(e), 120, or 365(c) are met. >The subject matter used in the rejection must be disclosed in the earlier-filed application in compliance with 35 U.S.C. 112, first paragraph, in order for that subject matter to be entitled to the earlier filing date under 35 U.S.C. 102(e).< Note, where the earlier application is an international application, the earlier international application must satisfy the same three conditions (i.e., filed on or after November 29, 2000, designated the U.S., and had been published in English under PCT Article 21(2)) for the earlier international filing date to be a U.S. filing date for prior art purposes under 35 U.S.C. 102(e).

(2) If the international application was filed on or after November 29, 2000, but did **not** designate the United States or was **not** published in English under PCT Article 21(2), do **not** treat the international filing date as a U.S. filing date >for prior art purposes<. In this situation, do **not** apply the reference as of its international filing date, its date of completion of the 35 U.S.C. 371(c)(1), (2) and (4) requirements, or any earlier filing date to which such an international application claims benefit or priority. The reference may be applied under 35 U.S.C. 102(a) or (b) as of its publication date, or 35 U.S.C. 102(e) as of any later U.S. filing date of an application that properly claimed the benefit of the international application (if applicable).

(3) If the international application has an international filing date prior to November 29, 2000, apply the reference under the provisions of 35 U.S.C. 102 and 374, prior to the AIPA amendments:

(a) For U.S. patents, apply the reference under 35 U.S.C. 102(e) as of the earlier of the date of completion of the requirements of 35 U.S.C. 371(c)(1), (2) and (4) or the filing date of the later-filed U.S. application that claimed the benefit of the international application;

(b) For U.S. application publications and WIPO publications directly resulting from international applications under PCT Article 21(2), never apply these references under 35 U.S.C. 102(e). These references may be applied as of their publication dates under 35 U.S.C. 102(a) or (b);

(c) For U.S. application publications of applications that claim the benefit under 35 U.S.C. 120 or 365(c) of an international application filed prior to November 29, 2000, apply the reference under 35 U.S.C. 102(e) as of the actual filing date of the later-filed U.S. application that claimed the benefit of the international application.

(4) Examiners should be aware that although a publication of, or a U.S. Patent issued from, an international application may not have a 35 U.S.C. 102(e) date at all, or may have a 35 U.S.C. 102(e) date that is after the effective filing date of the application being examined (so it is not “prior art”), the corresponding WIPO publication of an international application may have an earlier 35 U.S.C. 102(a) or (b) date.

(D) Foreign applications’ filing dates that are claimed (via 35 U.S.C. 119(a)-(d), (f), or 365(a)) in applications, which have been published as U.S. or WIPO application publications or patented in the U.S., may **not** be used as 35 U.S.C. 102(e) dates for prior art purposes. This includes international filing dates claimed as foreign priority dates under 35 U.S.C. 365(a).

## II. EXAMPLES

In order to illustrate the prior art dates of U.S. and WIPO **publications** of patent applications and U.S. **patents** under 35 U.S.C. 102(e), nine examples are presented below. The examples only cover the most common factual situations that might be encountered when determining the 35 U.S.C. 102(e) date of a reference. Examples 1 and 2 involve only U.S. application publications and U.S. patents. Example 3 involves a priority claim to a foreign patent application. Examples 4-9 involve international applications. The **time lines** in the examples below show the history of the prior art **references** that could be applied against the claims of the application under examination, or the patent under reexamination.

The examples only show the information necessary to determine a prior art date under 35 U.S.C. 102(e). Also, the dates in the examples below are arbitrarily used and are presented for illustrative purposes only. Therefore, correlation of patent grant dates with Tuesdays or application publication dates with Thursdays may not be portrayed in the examples.

**Example 1:** Reference Publication and Patent of 35 U.S.C. 111(a) Application with no Priority/Benefit Claims.

For reference publications and patents of patent applications filed under 35 U.S.C. 111(a) with no claim for the benefit of, or priority to, a prior application, the prior art dates under 35 U.S.C. 102(e) accorded to these references are the earliest effective U.S. filing dates. Thus, a publication and patent of a 35 U.S.C. 111(a) application, which does not claim any benefit under either 35 U.S.C. 119(e), 120 or 365(c), would be accorded the application's actual filing date as its prior art date under 35 U.S.C. 102(e).

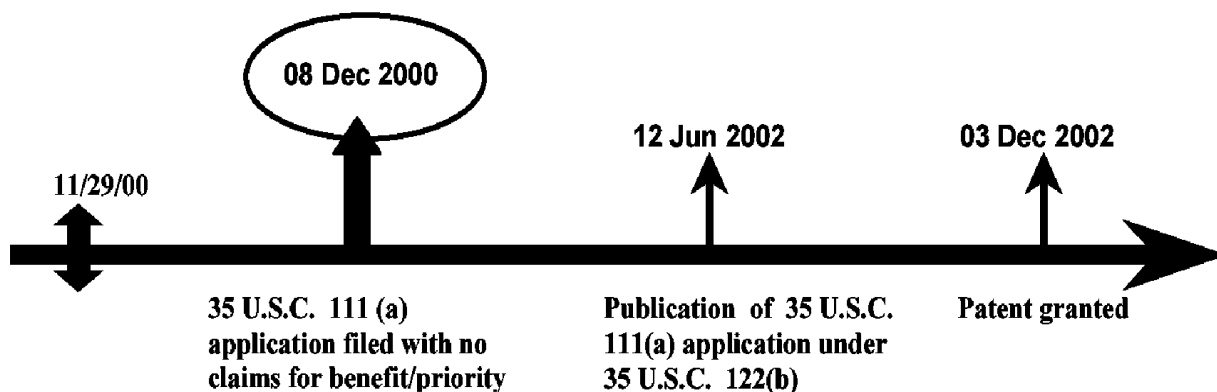

The 35 U.S.C. 102(e)(1) date for the Publication is 08 Dec. 2000.

The 35 U.S.C. 102(e)(2) date for the Patent is: 08 Dec. 2000.

**Example 2:** Reference Publication and Patent of 35 U.S.C. 111(a) Application with Priority/Benefit Claim to a Prior U.S. Provisional or Nonprovisional Application.

For reference publications and patents of patent applications filed under 35 U.S.C. 111(a), the prior art dates under 35 U.S.C. 102(e) accorded to these references are the earliest effective U.S. filing dates. Thus, a publication and patent of a 35 U.S.C. 111(a) application, which claims priority under 35 U.S.C. 119(e) to a prior U.S. provisional application or claims the benefit under 35 U.S.C. 120 of a prior nonprovisional application, would be accorded the earlier filing date as its prior art date under 35 U.S.C. 102(e), assuming the earlier-filed application has proper support for the subject matter as required by 35 U.S.C. 119(e) or 120.

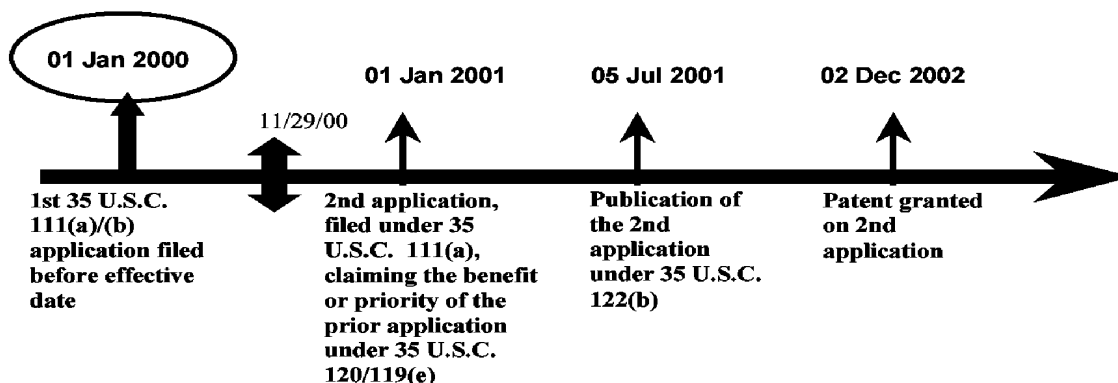

The 35 U.S.C. 102(e)(1) date for the Publication is: 01 Jan. 2000.

The 35 U.S.C. 102(e)(2) date for the Patent is: 01 Jan. 2000.

**Example 3:** Reference Publication and Patent of 35 U.S.C. 111(a) Application with 35 U.S.C. 119(a)-(d) Benefit Claim to a Prior Foreign Application.

For reference publications and patents of patent applications filed under 35 U.S.C. 111(a), the prior art dates under 35 U.S.C. 102(e) accorded to these references are the earliest effective U.S. filing dates. No benefit of the filing date of the foreign application is given under 35 U.S.C. 102(e) for prior art purposes (*In re Hilmer*, 149 USPQ 480 (CCPA 1966)). Thus, a publication and patent of a 35 U.S.C. 111(a) application, which claims benefit under 35 U.S.C. 119(a)-(d) to a prior foreign-filed application (or under 35 U.S.C. 365(a) to an international application), would be accorded its U.S. filing date as its prior art date under 35 U.S.C. 102(e). >In the example below, it is assumed that the earlier-filed U.S. application has proper support for the subject matter of the later-filed U.S. application as required by 35 U.S.C. 120.<

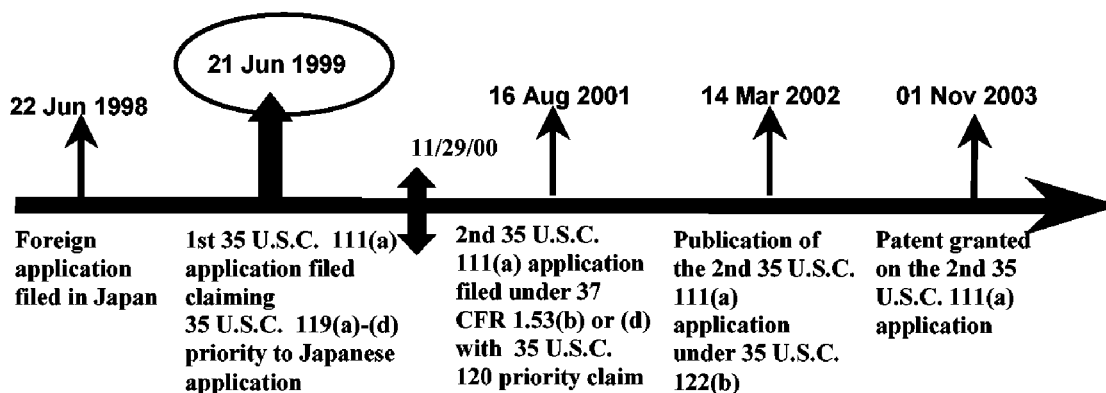

The 35 U.S.C. 102(e)(1) date for the Publication is: 21 June 1999.

The 35 U.S.C. 102(e)(2) date for the Patent is: 21 June 1999.

**Example 4:** References based on the **national stage (35 U.S.C. 371)** of an **International Application filed on or after November 29, 2000** and which was published in **English** under PCT Article 21(2).

All references, whether the WIPO publication, the U.S. patent application publication or the U.S. patent, of an international application (IA) that was filed on or after November 29, 2000, designated the U.S., and was published in English under PCT Article 21(2) by WIPO have the 35 U.S.C. 102(e) prior art date of the international filing date or earlier effective U.S. filing date. No benefit of the international filing date (nor any U.S. filing dates prior to the IA), however, is given for 35 U.S.C. 102(e) prior art purposes if the IA was published under PCT Article 21(2) in a language other than English.

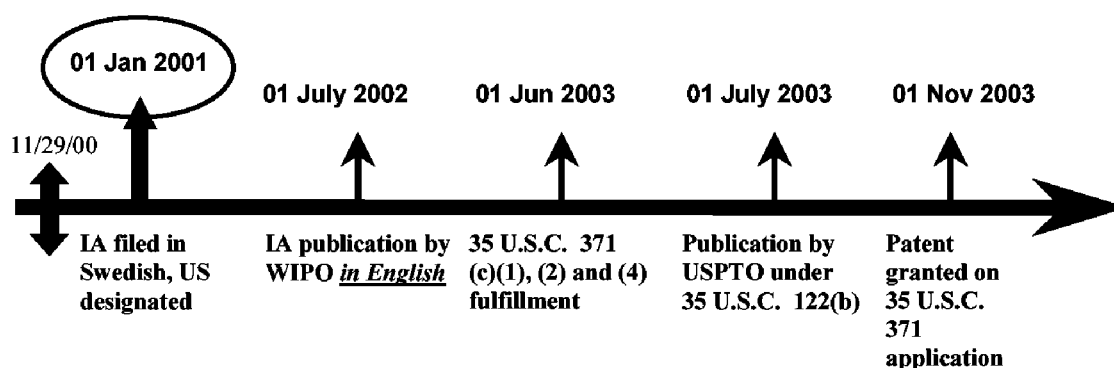

The 35 U.S.C. 102(e)(1) date for the IA Publication by WIPO is: 01 Jan. 2001.

The 35 U.S.C. 102(e)(1) date for the Publication by USPTO is: 01 Jan. 2001.

The 35 U.S.C. 102(e)(2) date for the Patent is: 01 Jan. 2001.

#### Additional Priority/Benefit Claims:

If a later-filed U.S. nonprovisional (35 U.S.C. 111(a)) application claimed the benefit of the IA in the example above, the 35 U.S.C. 102(e) date of the patent or publication of the later-filed U.S. application would be the international filing date, assuming the earlier-filed IA has proper support for the subject matter relied upon as required by 35 U.S.C. 120.

If the IA properly claimed priority to an earlier-filed U.S. provisional (35 U.S.C. 111(b)) application or the benefit of an earlier-filed U.S. nonprovisional (35 U.S.C. 111(a)) application, the 35 U.S.C. 102(e) date for all the references would be the filing date of the earlier-filed U.S. application, assuming the earlier-filed application has proper support for the subject matter relied upon as required by 35 U.S.C. 119(e) or 120.



**Example 5:** References based on the **national stage (35 U.S.C. 371)** of an **International Application filed on or after November 29, 2000** and which was **not** published in **English** under PCT Article 21(2).

All references, whether the WIPO publication, the U.S. patent application publication or the U.S. patent, of an international application (IA) that was filed on or after November 29, 2000 but was **not** published in **English** under PCT Article 21(2) have no 35 U.S.C. 102(e) prior art date at all. According to 35 U.S.C. 102(e), no benefit of the international filing date (nor any U.S. filing dates prior to the IA) is given for 35 U.S.C. 102(e) prior art purposes if the IA was published under PCT Article 21(2) in a language other than English, regardless of whether the international application entered the national stage. Such references may be applied under 35 U.S.C. 102(a) or (b) as of their publication dates, but never under 35 U.S.C. 102(e).

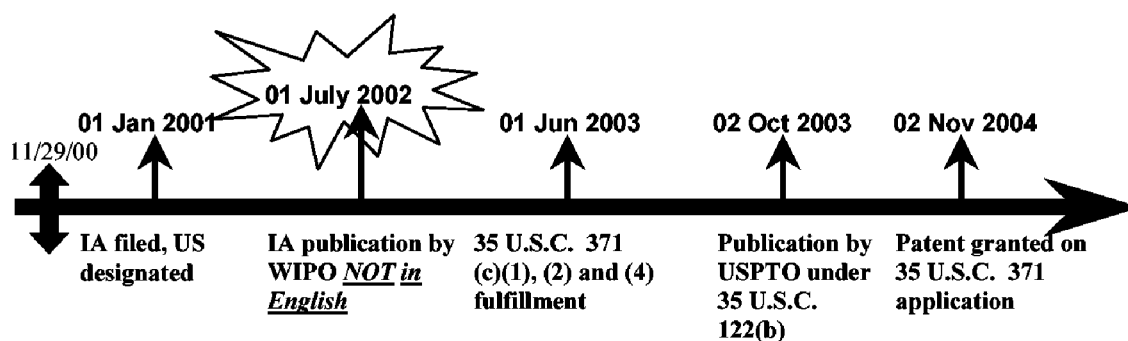

The 35 U.S.C. 102(e)(1) date for the IA Publication by WIPO is: None.

The 35 U.S.C. 102(e)(1) date for the Publication by USPTO is: None.

The 35 U.S.C. 102(e)(2) date for the Patent is: None.

The IA publication by WIPO can be applied under 35 U.S.C. 102(a) or (b) as of its publication date (01 July 2002).

#### Additional Priority/Benefit Claims:

If the IA properly claimed priority/benefit to any earlier-filed U.S. application (whether provisional or nonprovisional), there would still be no 35 U.S.C. 102(e) date for all the references.

If a later-filed U.S. nonprovisional (35 U.S.C. 111(a)) application claimed the benefit of the IA in the example above, the 35 U.S.C. 102(e) date of the patent or publication of the later-filed U.S. application would be the actual filing date of the later-filed U.S. application.

**Example 6:** References based on the national stage (**35 U.S.C. 371**) of an **International Application filed prior to November 29, 2000** (language of the publication under PCT Article 21(2) is not relevant).

The reference U.S. patent issued from an international application (IA) that was filed prior to November 29, 2000 has a 35 U.S.C. 102(e) prior art date of the date of fulfillment of the requirements of 35 U.S.C. 371(c)(1), (2) and (4). This is the pre-AIPA 35 U.S.C. 102(e). The application publications, both the WIPO publication and the U.S. publication, published from an international application that was filed prior to November 29, 2000, do not have any 35 U.S.C. 102(e) prior art date. According to the effective date provisions as amended by Pub. L. 107-273, the amendments to 35 U.S.C. 102(e) and 374 are not applicable to international applications having international filing dates prior to November 29, 2000. The application publications can be applied under 35 U.S.C. 102(a) or (b) as of their publication dates.

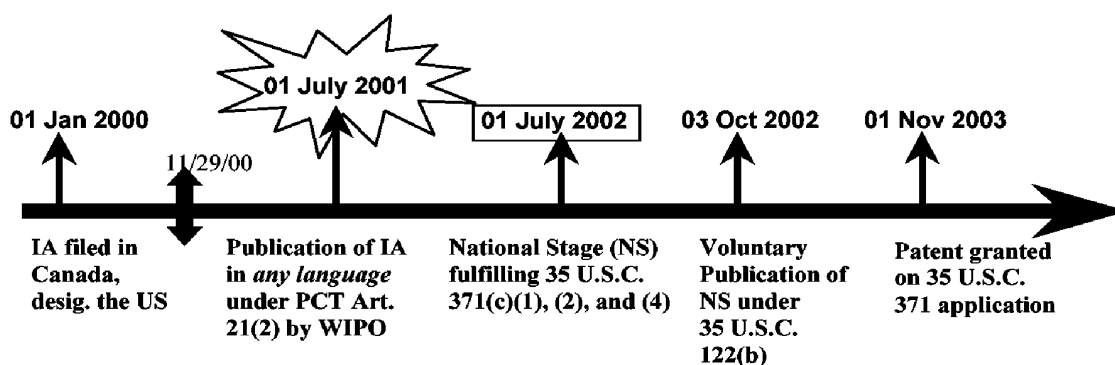

The 35 U.S.C. 102(e)(1) date for the IA Publication by WIPO is: None.

The 35 U.S.C. 102(e)(1) date for the Publication by USPTO is: None.

The 35 U.S.C. 102(e)(2) date for the Patent is: 01 July 2002.

The IA publication by WIPO can be applied under 35 U.S.C. 102(a) or (b) as of its publication date (01 July 2001).

#### Additional Priority/Benefit Claims:

If the IA properly claimed priority/benefit to any earlier-filed U.S. application (whether provisional or nonprovisional), there would still be no 35 U.S.C. 102(e)(1) date for the U.S. and WIPO application publications, and the 35 U.S.C. 102(e) date for the patent will still be 01 July 2002 (the date of fulfillment of the requirements under 35 U.S.C. 371(c)(1), (2) and (4)).

If a later-filed U.S. nonprovisional (35 U.S.C. 111(a)) application claimed the benefit of the IA in the example above, the 35 U.S.C. 102(e)(1) date of the application publication of the later-filed U.S. application would be the actual filing date of the later-filed U.S. application, and the 35 U.S.C. 102(e) date of the patent of the later-filed U.S. application would be 01 July 2002 (the date that the earlier-filed IA fulfilled the requirements of 35 U.S.C. 371(c)(1), (2) and (4)).

If the patent was based on a later-filed U.S. application that claimed the benefit of the international application and the later filed U.S. application's filing date is before the date the requirements of 35 U.S.C. 371(c)(1),(2) and (4) were fulfilled (if fulfilled at all), the 35 U.S.C. 102(e) date of the patent would be the filing date of the later-filed U.S. application that claimed the benefit of the international application.

**Example 7:** References based on a 35 U.S.C. 111(a) Application which is a **Continuation of an International Application**, which was filed on or after **November 29, 2000, designated the U.S.** and was **published in English** under PCT Article 21(2).

All references, whether the WIPO publication, the U.S. patent application publication or the U.S. patent of, or claiming the benefit of, an international application (IA) that was filed on or after November 29, 2000, designated the U.S., and was published in English under PCT Article 21(2) have the 35 U.S.C. 102(e) prior art date of the international filing date or earlier effective U.S. filing date. No benefit of the international filing date (nor any U.S. filing dates prior to the IA), however, is given for 35 U.S.C. 102(e) purposes if the IA was published under PCT Article 21(2) by WIPO in a language other than English. >In the example below, it is assumed that the earlier-filed IA has proper support for the subject matter of the later-filed U.S. application as required by 35 U.S.C. 120 and 365(c).<

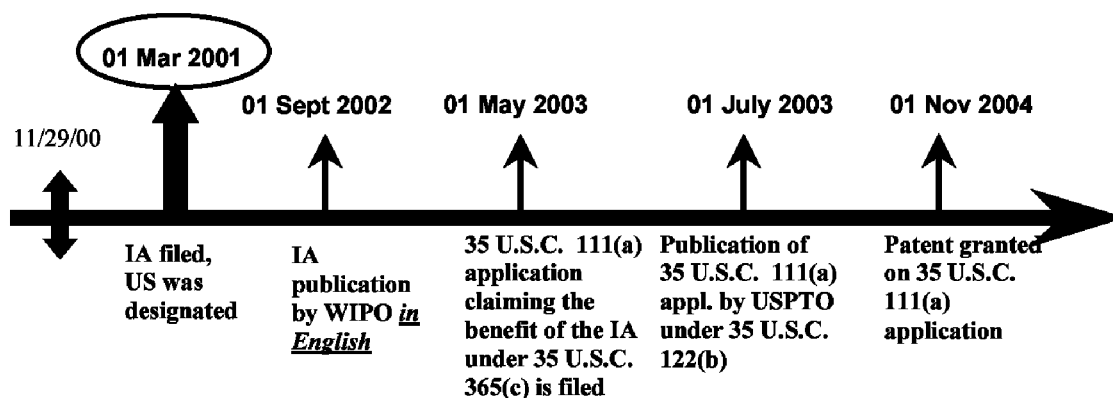

The 35 U.S.C. 102(e)(1) date for the IA Publication by WIPO is: 01 Mar. 2001.

The 35 U.S.C. 102(e)(1) date for the Publication by USPTO is: 01 Mar. 2001.

The 35 U.S.C. 102(e)(2) date for the Patent is: 01 Mar. 2001.

Additional Priority/Benefit Claims:

If the IA properly claimed priority to an earlier-filed U.S. provisional (35 U.S.C. 111(b)) application or the benefit of an earlier-filed U.S. nonprovisional (35 U.S.C. 111(a)) application, the 35 U.S.C. 102(e) date for all the references would be the filing date of the earlier-filed U.S. application, assuming the earlier-filed application has proper support for the subject matter relied upon as required by 35 U.S.C. 119(e) or 120.

If a second, later-filed U.S. nonprovisional (35 U.S.C. 111(a)) application claimed the benefit of the 35 U.S.C. 111(a) application in the example above, the 35 U.S.C. 102(e) date of the patent or publication of the second, later-filed U.S. application would still be the international filing date of the IA, assuming the earlier-filed IA has proper support for the subject matter relied upon as required by 35 U.S.C. 120 and 365(c).

**Example 8:** References based on a 35 U.S.C. 111(a) Application which is a **Continuation of an International Application**, which was **filed on or after November 29, 2000** and was **not published in English** under PCT Article 21(2).

Both the U.S. publication and the U.S. patent of the 35 U.S.C. 111(a) continuation of an international application (IA) that was filed on or after November 29, 2000 but **not** published in English under PCT Article 21(2) have the 35 U.S.C. 102(e) prior art date of the actual U.S. filing date of the 35 U.S.C. 111(a) application. No benefit of the international filing date (nor any U.S. filing dates prior to the IA) is given for 35 U.S.C. 102(e) purposes since the IA was published under PCT Article 21(2) in a language other than English. The IA publication under PCT Article 21(2) does not have a prior art date under 35 U.S.C. 102(e)(1) because the IA was not published in English under PCT Article 21(2). The IA publication under PCT Article 21(2) can be applied under 35 U.S.C. 102(a) or (b) as of its publication date.

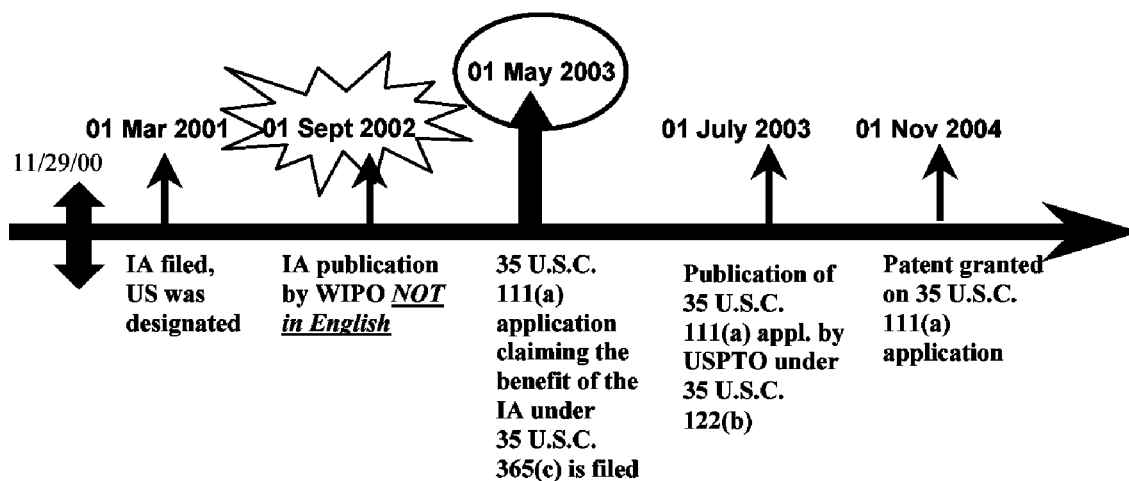

The 35 U.S.C. 102(e)(1) date for the IA Publication by WIPO is: None.  
 The 35 U.S.C. 102(e)(1) date for the Publication by USPTO is: 01 May 2003.  
 The 35 U.S.C. 102(e)(2) date for the Patent is: 01 May 2003

The IA publication by WIPO can be applied under 35 U.S.C. 102(a) or (b) as of its publication date (01 Sept 2002).

Additional Priority/Benefit Claims:

If the IA properly claimed priority/benefit to any earlier-filed U.S. application (whether provisional or nonprovisional), there would still be no 35 U.S.C. 102(e)(1) date for the IA publication by WIPO, and the U.S. patent application publication and patent would still have a 35 U.S.C. 102(e) date of the actual filing date of the later-filed 35 U.S.C. 111(a) application in the example above (01 May 2003).

If a second, later-filed U.S. nonprovisional (35 U.S.C. 111(a)) application claimed the benefit of the 35 U.S.C. 111(a) application in the example above, the 35 U.S.C. 102(e) date of the patent or publication of the second, later-filed U.S. application would still be the actual filing date of the 35 U.S.C. 111(a) application in the example above (01 May 2003).

**Example 9:** References based on a 35 U.S.C. 111(a) Application which is a **Continuation** (filed prior to any entry of the national stage) **of an International Application**, which was **filed prior to November 29, 2000** (language of the publication under PCT Article 21(2) is not relevant).

Both the U.S. publication and the U.S. patent of the 35 U.S.C. 111(a) continuation (filed prior to any entry of the national stage) of an international application (IA) that was filed prior to November 29, 2000 have the 35 U.S.C. 102(e) prior art date of their actual U.S. filing date under 35 U.S.C. 111(a). No benefit of the international filing date (nor any U.S. filing dates prior to the IA) is given for 35 U.S.C. 102(e) prior art purposes since the IA was filed prior to November 29, 2000. The IA publication under PCT Article 21(2) does not have a prior art date under 35 U.S.C. 102(e)(1) because the IA was filed prior to November 29, 2000. The IA publication under PCT Article 21(2) can be applied under 35 U.S.C. 102(a) or (b) as of its publication date.

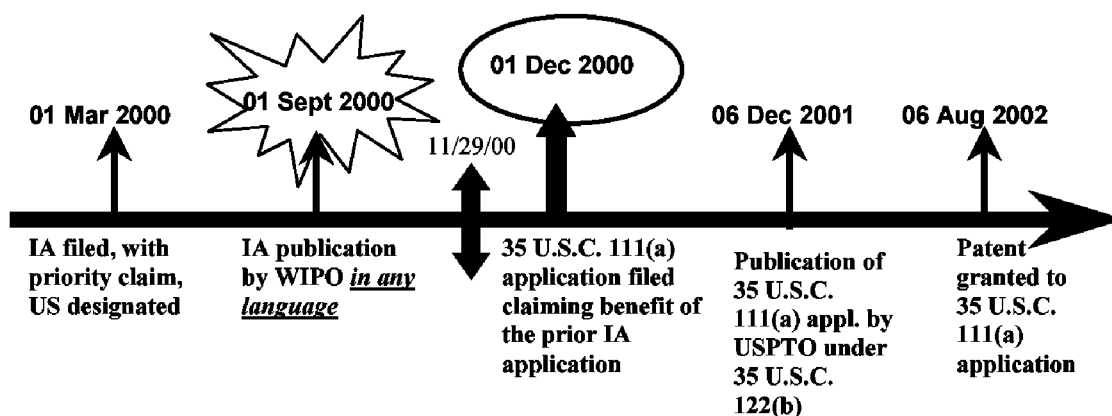

The 35 U.S.C. 102(e)(1) date for the IA Publication by WIPO is: None.  
 The 35 U.S.C. 102(e)(1) date for the Publication by USPTO is: 01 Dec. 2000.  
 The 35 U.S.C. 102(e)(2) date for the Patent is: 01 Dec. 2000.

The IA publication by WIPO can be applied under 35 U.S.C. 102(a) or (b) as of its publication date (01 Sept 2000).

Additional Priority/Benefit Claims:

If the IA properly claimed priority/benefit to any earlier-filed U.S. application (whether provisional or nonprovisional), there would still be no 35 U.S.C. 102(e)(1) date for the IA publication by WIPO, and the U.S. application publication and patent would still have a 35 U.S.C. 102(e) date of the actual filing date of later-filed 35 U.S.C. 111(a) application in the example above (01 Dec 2000).

If a second, later-filed U.S. nonprovisional (35 U.S.C. 111(a)) application claimed the benefit of 35 U.S.C. 111(a) application in the example above, the 35 U.S.C. 102(e) date of the patent or publication of the second, later-filed U.S. application would still be the actual filing date of the 35 U.S.C. 111(a) application in the example above (01 Dec 2000).

### **III. FLOWCHARTS**

**FLOWCHARTS FOR 35 U.S.C. § 102(e) DATES:**  
**Apply to all applications and patents, whenever filed**  
**Chart I: For U.S. patent or U.S. patent application publication under**  
**35 U.S.C. § 122(b) (includes publications of § 371 applications)**

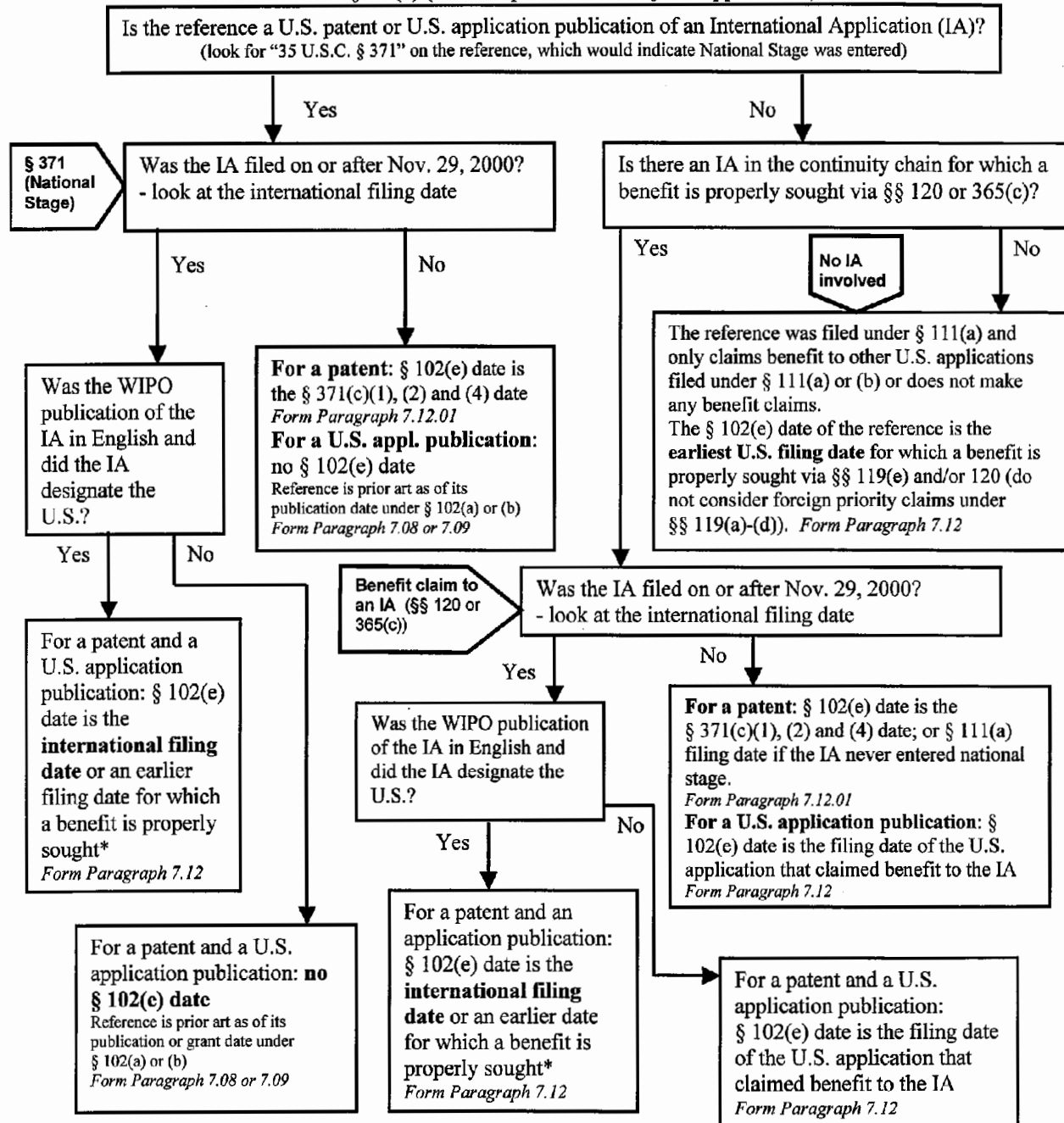

\* Consider benefit claims properly made under § 119(e) to U.S. provisional applications, § 120 to U.S. nonprovisional applications, and § 365(c) involving IAs. Do NOT consider foreign priority claims.

**FLOWCHARTS FOR 35 U.S.C. § 102(e) DATES:**  
**Apply to all applications and patents, whenever filed**  
**Chart II: For WIPO publication of International Applications (IAs)**

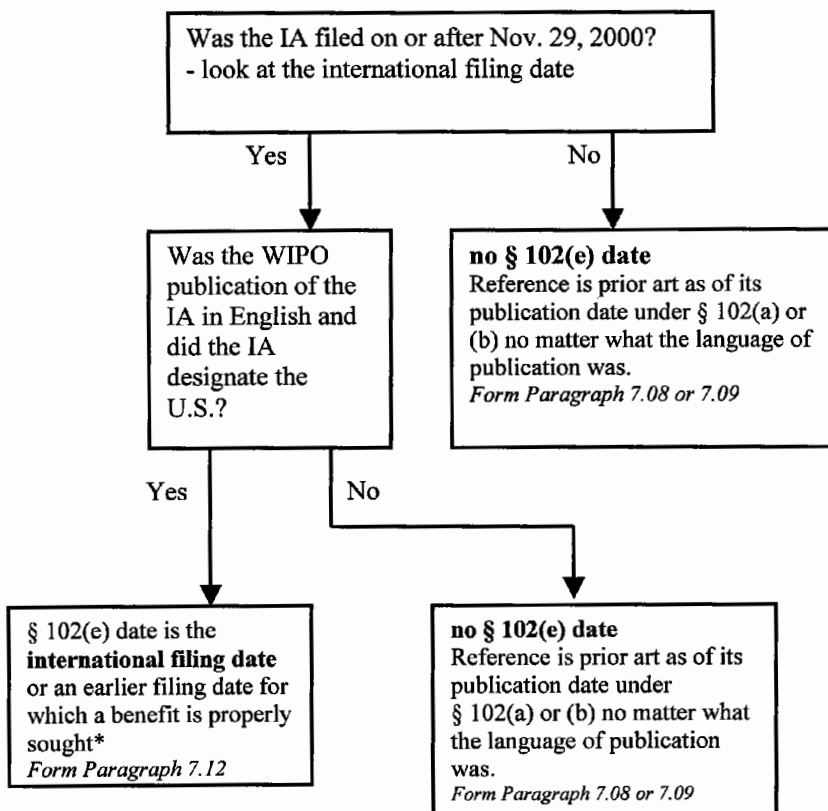

\* Consider benefit claims properly made under § 119(e) to U.S. provisional applications, § 120 to U.S. nonprovisional applications, and § 365(c) involving IAs. Do NOT consider foreign priority claims.

**Glossary of Terms:**

**U.S. patent application publication** = pre-grant publication by the USPTO under 35 U.S.C. § 122(b)

**International application (IA)** = an application filed under the Patent Cooperation Treaty (PCT)

**§ 371 application** = an IA that has entered the national stage in the U.S. (35 U.S.C. § 371(c)(1), (2) and (4))

**November 29, 2000** = the effective date for the amendments to §§ 102(e) and 374

**WIPO** = World Intellectual Property Organization

**WIPO Publication** = a publication of an IA under PCT Article 21(2) (e.g., Publication No. WO 99/12345)

**§ 111(a)** = provision of the patent code that states the **filing** requirements for **nonprovisional applications**

**§ 111(b)** = provision of the patent code that states the **filing** requirements for **provisional applications**

**§ 119(e)** = provision of the patent code that allows for **priority claims to provisional applications**

**§ 119(a)-(d)** = provision of the patent code that allows for **priority claims to foreign applications**

**§ 120** = provision of the patent code that allows for **benefit claims to nonprovisional applications**

**§ 365(c)** = provision of the patent code that allows for **benefit claims to international applications**



&gt;

### 706.02(f)(2) < \* Provisional Rejections Under 35 U.S.C. 102(e); Reference Is a Copending U.S. Patent Application [R-1]

If \*\* >an earlier filed, copending, and unpublished< U.S. patent application discloses subject matter which would anticipate the claims in \*>a later filed< pending U.S. application which has a different inventive entity, the examiner should determine whether a provisional 35 U.S.C. 102(e) rejection >of the later filed application< can be made.>In addition, a provisional 35 U.S.C. 102(e) rejection may be made, in the circumstances described below, if the earlier filed, pending application has been published as redacted (37 CFR 1.217) and the subject matter relied upon in the rejection is not supported in the redacted publication of the patent application.<

#### I. COPENDING U.S. APPLICATIONS HAVING AT LEAST ONE COMMON INVENTOR OR ARE COMMONLY ASSIGNED

If (1) at least one common inventor exists between the applications or the applications are commonly assigned and (2) the effective filing dates are different, then a provisional rejection of the later filed application should be made. The provisional rejection is appropriate in circumstances where if the earlier filed application is published or becomes a patent it would constitute actual prior art under 35 U.S.C. 102. Since \*>the earlier-filed< application is >not< published at the time of the \* rejection, the rejection must be >provisionally< made under 35 U.S.C. 102(e).

A provisional rejection under 35 U.S.C. 102(e) can be overcome in the same manner that a 35 U.S.C. 102(e) rejection can be overcome. See MPEP § 706.02(b). The provisional rejection can also be overcome by abandoning the applications and filing a new application containing the subject matter of both.

Form paragraph 7.15.01 \*\* should be used \*\* when making a provisional rejection under 35 U.S.C. 102(e).

#### ¶ 7.15.01 Provisional Rejection, 35 U.S.C. 102(e) - Common Assignee or At Least One Common Inventor

Claim [1] provisionally rejected under 35 U.S.C. 102(e) as being anticipated by copending Application No. [2] which has a common [3] with the instant application.

Based upon the earlier effective U.S. filing date of the copending application, it would constitute prior art under 35 U.S.C. 102(e), if published under 35 U.S.C. 122(b) or patented. This provisional rejection under 35 U.S.C. 102(e) is based upon a presumption of future publication or patenting of the copending application. [4].

This provisional rejection under 35 U.S.C. 102(e) might be overcome either by a showing under 37 CFR 1.132 that any invention disclosed but not claimed in the copending application was derived from the inventor of this application and is thus not the invention “by another,” or by an appropriate showing under 37 CFR 1.131.

This rejection may not be overcome by the filing of a terminal disclaimer. See *In re Bartfeld*, 925 F.2d 1450, 17 USPQ2d 1885 (Fed. Cir. 1991).

#### Examiner Note:

1. This form paragraph is used to provisionally reject over a copending application with an earlier filing date that discloses the claimed invention which has not been published under 35 U.S.C. 122. The copending application must have either a common assignee or at least one common inventor.
2. Use 35 U.S.C. 102(e) as amended by the American Inventors Protection Act and the Intellectual Property and High Technology Technical Amendments Act of 2002 (form paragraph 7.12) to determine the copending application reference’s prior art date, unless the copending application reference is based directly, or indirectly, from an international application which has an international filing date prior to November 29, 2000. If the copending application reference is either a national stage of an international application (application under 35 U.S.C. 371) which has an international filing date prior to November 29, 2000, or a continuing application claiming benefit under 35 U.S.C. 120, 121, or 365(c) to an international application having an international filing date prior to November 29, 2000, use pre-AIPA 35 U.S.C. 102(e) (form paragraph 7.12.01). See the Examiner Notes for form paragraphs 7.12 and 7.12.01 to assist in the determination of the 35 U.S.C. 102(e) date.
3. If the application being examined was filed before November 29, 1999, and the claims would have been obvious over the invention disclosed in the other copending application, use form paragraph 7.21.01.
4. If the application being examined was filed on or after November 29, 1999, and there is no evidence of common ownership of record, and the claims would have been obvious over the invention disclosed in the other copending application, use form paragraph 7.21.01.
5. In bracket 3, insert either --assignee-- or --inventor--.
6. In bracket 4, an appropriate explanation may be provided in support of the examiner’s position on anticipation, if necessary.
7. If the claims of the copending application conflict with the claims of the instant application, a provisional double patenting

rejection should also be given using form paragraphs 8.30 and 8.32.

8. If evidence is additionally of record to show that either invention is prior art unto the other under 35 U.S.C. 102(f) or (g), a rejection using form paragraphs 7.13 and/or 7.14 should also be made.

## II. COENDING APPLICATIONS HAVING NO COMMON INVENTOR OR ASSIGNEE

If there is no common assignee or common inventor and the application was not published pursuant to 35 U.S.C. 122(b), the confidential status of applications under 35 U.S.C. 122(a) must be maintained and no rejection can be made relying on the earlier filed >, unpublished< application >, or subject matter not supported in a redacted application publication,< as prior art under 35 U.S.C. 102(e). If the filing dates of the applications are within 6 months of each other (3 months for simple subject matter) then interference may be proper. See MPEP Chapter 2300. If the application with the earliest effective U.S. filing date will not be published pursuant to 35 U.S.C. 122(b), it must be allowed to issue once all the statutory requirements are met. After the patent is published, it may be used as a reference in a rejection under 35 U.S.C. 102(e) in the still pending application as appropriate. See MPEP § 706.02(a) and § 2136 *et seq.*

### 706.02(g) Rejections Under 35 U.S.C. 102(f)

35 U.S.C. 102(f) bars the issuance of a patent where an applicant did not invent the subject matter being claimed and sought to be patented. See also 35 U.S.C. 101, which requires that whoever invents or discovers is the party who may obtain a patent for the particular invention or discovery. The examiner must presume the applicants are the proper inventors unless there is proof that another made the invention and that applicant derived the invention from the true inventor.

See MPEP § 2137 - § 2137.02 for more information on the substantive requirements of rejections under 35 U.S.C. 102(f).

### 706.02(h) Rejections Under 35 U.S.C. 102(g)

35 U.S.C. 102(g) bars the issuance of a patent where another made the invention in the United States before applicant and had not abandoned, suppressed, or concealed it. This section of 35 U.S.C. 102 forms a basis for interference practice. See MPEP Chapter 2300 for more information on interference procedure. See MPEP § 2138 - § 2138.06 for more information on the requirements of 35 U.S.C. 102(g).

### 706.02(i) Form Paragraphs for Use in Rejections Under 35 U.S.C. 102 [R-1]

The following form paragraphs should be used in making the appropriate rejections.

Note that the particular part of the reference relied upon to support the rejection should be identified.

#### ¶ 7.07 *Statement of Statutory Basis, 35 U.S.C. 102*

The following is a quotation of the appropriate paragraphs of 35 U.S.C. 102 that form the basis for the rejections under this section made in this Office action:

A person shall be entitled to a patent unless --

#### **Examiner Note:**

1. The statute is no longer being re-cited in all Office actions. It is only required in first actions on the merits and final rejections. Where the statute is not being cited in an action on the merits, use form paragraph 7.103.
2. Form paragraphs 7.07 to 7.14 are to be used ONLY ONCE in a given Office action.

#### ¶ 7.08 *102(a), Activity by Another Before Invention by Applicant*

(a) the invention was known or used by others in this country, or patented or described in a printed publication in this or a foreign country, before the invention thereof by the applicant for a patent.

#### **Examiner Note:**

This form paragraph must be preceded by form paragraph 7.07.

#### ¶ 7.09 *102(b), Activity More Than One Year Prior to Filing*

(b) the invention was patented or described in a printed publication in this or a foreign country or in public use or on sale in this country, more than one year prior to the date of application for patent in the United States.

#### **Examiner Note:**

This form paragraph must be preceded by paragraph form 7.07, and may be preceded by form paragraph 7.08.

¶ 7.10 102(c), *Invention Abandoned*

(c) he has abandoned the invention.

**Examiner Note:**

This form paragraph must be preceded by form paragraph 7.07, and may be preceded by one or more of form paragraphs 7.08 and 7.09.

¶ 7.11 102(d), *Foreign Patenting*

(d) the invention was first patented or caused to be patented, or was the subject of an inventor's certificate, by the applicant or his legal representatives or assigns in a foreign country prior to the date of the application for patent in this country on an application for patent or inventor's certificate filed more than twelve months before the filing of the application in the United States.

**Examiner Note:**

This form paragraph must be preceded by form paragraph 7.07, and may be preceded by one or more of form paragraphs 7.08 to 7.10.

\*\*>

¶ 7.12 *Rejection under 35 U.S.C. 102(e), Patent Application Publication or Patent to Another with Earlier Filing Date, in view of the American Inventors Protection Act of 1999 (AIPA) and the Intellectual Property and High Technology Technical Amendments Act of 2002*

(e) the invention was described in (1) an application for patent, published under section 122(b), by another filed in the United States before the invention by the applicant for patent or (2) a patent granted on an application for patent by another filed in the United States before the invention by the applicant for patent, except that an international application filed under the treaty defined in section 351(a) shall have the effects for purposes of this subsection of an application filed in the United States only if the international application designated the United States and was published under Article 21(2) of such treaty in the English language.

**Examiner Note:**

1. This form paragraph should only be used if the reference is one of the following:

- (a) a U.S. patent or a publication of a U.S. application for patent filed under 35 U.S.C. 111(a);
- (b) a U.S. patent issued directly or indirectly from, or a U.S. or WIPO publication of, an international application if the international application has an **international filing date on or after November 29, 2000**.

2. In determining the 35 U.S.C. 102(e) date, consider priority/benefit claims to earlier-filed U.S. provisional applications under 35 U.S.C. 119(e), U.S. nonprovisional applications under 35 U.S.C. 120 or 121, and international applications under 35 U.S.C. 120, 121 or 365(c) if the subject matter used to make the rejection is appropriately supported in the relied upon earlier-filed application's disclosure (and any intermediate application(s)). Do NOT consider foreign priority claims under 35 U.S.C. 119(a)-(d) and 365(a).

3. In order to rely on an international filing date for prior art purposes under 35 U.S.C. 102(e), the international application must have been filed on or after November 29, 2000, it must have designated the U.S., and the international publication under PCT Article 21(2) by WIPO must have been in English. If any one of the conditions is not met, the international filing date is not a U.S. filing date for prior art purposes under 35 U.S.C. 102(e).

4. If an international application was published by WIPO in a language other than English, or did not designate the U.S., the International Application's publication by WIPO, the U.S. publication of the national stage application (35 U.S.C. 371) of the international application and a U.S. patent issued from the national stage of the international application may not be applied as a reference under 35 U.S.C. 102(e). The reference may be applied under 35 U.S.C. 102(a) or (b) as of its publication date. See form paragraphs 7.08 and 7.09.

5. If an international application was published by WIPO in a language other than English, or did not designate the U.S., the U.S. publication of, or a U.S. patent issued from, a continuing application claiming benefit under 35 U.S.C. 120, 121, or 365(c) to such an international application, has a 35 U.S.C. 102(e) date as of the earliest U.S. filing date after the international filing date.

6. If the reference is a U.S. patent issued directly, or indirectly, from an international application that has an international filing date prior to November 29, 2000, use form paragraph 7.12.01. In that situation, pre-AIPA 35 U.S.C. 102(e) is applicable in the determination of the prior art date of the patent issued from such an international application.

7. If the reference is a publication of an international application (including the U.S. publication of a national stage (35 U.S.C. 371)) that has an international filing date prior to November 29, 2000, do not use this form paragraph. Such a reference may not be applied as a prior art reference under 35 U.S.C. 102(e). The reference may be applied under 35 U.S.C. 102(a) or (b) as of its publication date. See form paragraphs 7.08 and 7.09.

8. This form paragraph must be preceded by form paragraph 7.07, and may be preceded by one or more of form paragraphs 7.08 to 7.11.

¶ 7.12.01 *Rejection under 35 U.S.C. 102(e), Patent to Another with Earlier Filing Date, Reference is a U.S. Patent Issued Directly or Indirectly From a National Stage of, or a Continuing Application Claiming Benefit under 35 U.S.C. 365(c) to, an International Application Having an International Filing Date Prior to November 29, 2000*

(e) the invention was described in a patent granted on an application for patent by another filed in the United States before the invention thereof by the applicant for patent, or on an international application by another who has fulfilled the requirements of paragraphs (1), (2), and (4) of section 371(c) of this title before the invention thereof by the applicant for patent.

The changes made to 35 U.S.C. 102(e) by the American Inventors Protection Act of 1999 (AIPA) and the Intellectual Property and High Technology Technical Amendments Act of 2002 do not apply when the reference is a U.S. patent resulting directly or indirectly from an international application filed before November 29, 2000. Therefore, the prior art date of the reference is determined

under 35 U.S.C. 102(e) prior to the amendment by the AIPA (pre-AIPA 35 U.S.C. 102(e)).

**Examiner Note:**

1. This form paragraph should only be used if the reference is a U.S. patent issued directly or indirectly from either a national stage of an international application (application under 35 U.S.C. 371) which has an international filing date prior to November 29, 2000 or a continuing application claiming benefit under 35 U.S.C. 365(c) to an international application having an international filing date prior to November 29, 2000.

2. If the reference is a U.S. patent issued directly from a national stage of such an international application, the reference's 35 U.S.C. 102(e) date is the date that the requirements of 35 U.S.C. 371(c)(1), (2) and (4) were fulfilled. The language of WIPO publication (PCT) is not relevant in this situation. Caution: the international publication of the international application (PCT) by WIPO may have an earlier prior art date under 35 U.S.C. 102(a) or 102(b).

3. If the reference is a U.S. patent issued directly from a continuing application claiming benefit under 35 U.S.C. 120, 121 or 365(c) to such an international application (which had not entered the national stage prior to the continuing application's filing date, otherwise see note 4), the prior art reference's 35 U.S.C. 102(e) date is the actual U.S. filing date of the continuing application. Caution: the international publication of the international application (PCT) by WIPO may have an earlier prior art date under 35 U.S.C. 102(a) or 102(b).

4. In determining the 35 U.S.C. 102(e) date, consider priority/benefit claims to earlier-filed U.S. provisional applications under 35 U.S.C. 119(e), U.S. nonprovisional applications under 35 U.S.C. 120 or 121, and international applications under 35 U.S.C. 120, 121 or 365(c) only if the subject matter used to make the rejection is appropriately supported in the relied upon earlier-filed application's disclosure (and any intermediate application(s)). A benefit claim to a U.S. patent of an earlier-filed international application may only result in an effective U.S. filing date as of the date the requirements of 35 U.S.C. 371(c)(1), (2) and (4) were fulfilled. Do NOT consider any priority/benefit claims to U.S. applications which are filed before an international application. Do NOT consider foreign priority claims under 35 U.S.C. 119(a)-(d) and 365(a).

5. This form paragraph must be preceded by form paragraph 7.07, and may be preceded by one or more of form paragraphs 7.08 to 7.11.

<

¶ 7.13 102(f), *Applicant Not the Inventor*

(f) he did not himself invent the subject matter sought to be patented.

**Examiner Note:**

This form paragraph must be preceded by form paragraph 7.07, and may be preceded by one or more of form paragraphs 7.08 to 7.12.

¶ 7.14 102(g), *Priority of Invention*

(g)(1) during the course of an interference conducted under section 135 or section 291, another inventor involved therein establishes, to the extent permitted in section 104, that before such person's invention thereof the invention was made by such other inventor and not abandoned, suppressed, or concealed, or (2) before such person's invention thereof, the invention was made in this country by another inventor who had not abandoned, suppressed, or concealed it. In determining priority of invention under this subsection, there shall be considered not only the respective dates of conception and reduction to practice of the invention, but also the reasonable diligence of one who was first to conceive and last to reduce to practice, from a time prior to conception by the other.

**Examiner Note:**

This form paragraph must be preceded by form paragraph 7.07, and may be preceded by one or more of form paragraphs 7.08 to 7.13.

¶ 7.15 *Rejection, 35 U.S.C. 102(a), (b) Patent or Publication, and (g)*

Claim [1] rejected under 35 U.S.C. 102[2] as being [3] by [4].

**Examiner Note:**

1. In bracket 2, insert the appropriate paragraph letter or letters of 35 U.S.C. 102 in parentheses. If paragraph (e) of 35 U.S.C. 102 is applicable, use form paragraph 7.15.02 or 7.15.03.

2. In bracket 3, insert either --clearly anticipated-- or --anticipated-- with an explanation at the end of the paragraph.

3. In bracket 4, insert the prior art relied upon.

4. This rejection must be preceded either by form paragraph 7.07 and form paragraphs 7.08, 7.09, and 7.14 as appropriate, or by form paragraph 7.103.

5. If 35 U.S.C. 102(e) is also being applied, this form paragraph must be followed by either form paragraph 7.15.02 or 7.15.03.

\*\*>

¶ 7.15.01 *Provisional Rejection, 35 U.S.C. 102(e) - Common Assignee or At Least One Common Inventor*

Claim [1] provisionally rejected under 35 U.S.C. 102(e) as being anticipated by copending Application No. [2] which has a common [3] with the instant application.

Based upon the earlier effective U.S. filing date of the copending application, it would constitute prior art under 35 U.S.C. 102(e), if published under 35 U.S.C. 122(b) or patented. This provisional rejection under 35 U.S.C. 102(e) is based upon a presumption of future publication or patenting of the copending application. [4].

This provisional rejection under 35 U.S.C. 102(e) might be overcome either by a showing under 37 CFR 1.132 that any invention disclosed but not claimed in the copending application was derived from the inventor of this application and is thus not the invention "by another," or by an appropriate showing under 37 CFR 1.131.

This rejection may not be overcome by the filing of a terminal disclaimer. See *In re Bartfeld*, 925 F.2d 1450, 17 USPQ2d 1885 (Fed. Cir. 1991).

#### Examiner Note:

1. This form paragraph is used to provisionally reject over a copending application with an earlier filing date that discloses the claimed invention which has not been published under 35 U.S.C. 122. The copending application must have either a common assignee or at least one common inventor.
2. Use 35 U.S.C. 102(e) as amended by the American Inventors Protection Act and the Intellectual Property and High Technology Technical Amendments Act of 2002 (form paragraph 7.12) to determine the copending application reference's prior art date, unless the copending application reference is based directly, or indirectly, from an international application which has an international filing date prior to November 29, 2000. If the copending application reference is either a national stage of an international application (application under 35 U.S.C. 371) which has an international filing date prior to November 29, 2000, or a continuing application claiming benefit under 35 U.S.C. 120, 121, or 365(c) to an international application having an international filing date prior to November 29, 2000, use pre-AIPA 35 U.S.C. 102(e) (form paragraph 7.12.01). See the Examiner Notes for form paragraphs 7.12 and 7.12.01 to assist in the determination of the 35 U.S.C. 102(e) date.
3. If the application being examined was filed before November 29, 1999, and the claims would have been obvious over the invention disclosed in the other copending application, use form paragraph 7.21.01.
4. If the application being examined was filed on or after November 29, 1999, and there is no evidence of common ownership of record, and the claims would have been obvious over the invention disclosed in the other copending application, use form paragraph 7.21.01.
5. In bracket 3, insert either --assignee-- or --inventor--.
6. In bracket 4, an appropriate explanation may be provided in support of the examiner's position on anticipation, if necessary.
7. If the claims of the copending application conflict with the claims of the instant application, a provisional double patenting rejection should also be given using form paragraphs 8.30 and 8.32.
8. If evidence is additionally of record to show that either invention is prior art unto the other under 35 U.S.C. 102(f) or (g), a rejection using form paragraphs 7.13 and/or 7.14 should also be made.

#### ¶ 7.15.02 Rejection, 35 U.S.C. 102(e), Common Assignee or Inventor(s)

Claim [1] rejected under 35 U.S.C. 102(e) as being anticipated by [2].

The applied reference has a common [3] with the instant application. Based upon the earlier effective U.S. filing date of the reference, it constitutes prior art under 35 U.S.C. 102(e). This rejection under 35 U.S.C. 102(e) might be overcome either by a showing under 37 CFR 1.132 that any invention disclosed but not

claimed in the reference was derived from the inventor of this application and is thus not the invention "by another," or by an appropriate showing under 37 CFR 1.131.

#### Examiner Note:

1. This form paragraph is used to reject over a patent or patent application publication with an earlier filing date that discloses but does not claim the same invention. The patent or patent application publication must have either a common assignee or a common inventor.
2. 35 U.S.C. 102(e) as amended by the American Inventors Protection Act of 1999 (AIPA) and the Intellectual Property and High Technology Technical Amendments Act of 2002 (form paragraph 7.12) must be applied if the reference is one of the following:
  - a. a U.S. patent or a publication of a U.S. application for patent filed under 35 U.S.C. 111(a);
  - b. a U.S. patent issued directly or indirectly from, or a U.S. or WIPO publication of, an international application if the international application has **an international filing date on or after November 29, 2000**.

See the Examiner Notes for form paragraph 7.12 to assist in the determination of the 35 U.S.C. 102(e) date of the reference.
3. Pre-AIPA 35 U.S.C. 102(e) (form paragraph 7.12.01) must be applied if the reference is a U.S. patent issued directly, or indirectly, from an international application filed prior to November 29, 2000. See the Examiner Notes for form paragraph 7.12.01 to assist in the determination of the 35 U.S.C. 102(e) date of the reference.
4. In determining the 35 U.S.C. 102(e) date, consider priority/benefit claims to earlier-filed U.S. provisional applications under 35 U.S.C. 119(e), U.S. nonprovisional applications under 35 U.S.C. 120 or 121, and international applications under 35 U.S.C. 120, 121 or 365(c) if the subject matter used to make the rejection is appropriately supported in the relied upon earlier-filed application's disclosure (and any intermediate application(s)). A benefit claim to a U.S. patent of an earlier-filed international application, which has an international filing date prior to November 29, 2000, may only result in an effective U.S. filing date as of the date the requirements of 35 U.S.C. 371(c)(1), (2) and (4) were fulfilled. Do NOT consider any priority/benefit claims to U.S. applications which are filed before an international application that has an international filing date prior to November 29, 2000. Do NOT consider foreign priority claims under 35 U.S.C. 119(a)-(d) and 365(a).
5. If the reference is a publication of an international application (including voluntary U.S. publication under 35 U.S.C. 122 of the national stage or a WIPO publication) that has an international filing date prior to November 29, 2000, did not designate the United States or was not published in English by WIPO, do not use this form paragraph. Such a reference is not a prior art reference under 35 U.S.C. 102(e). The reference may be applied under 35 U.S.C. 102(a) or (b) as of its publication date. See form paragraphs 7.08 and 7.09.
6. In bracket 3, insert either --assignee-- or --inventor--.
7. This form paragraph must be preceded by either of form paragraphs 7.12 or 7.12.01.

8. Patent application publications may only be used if this form paragraph was preceded by form paragraph 7.12.

*¶ 7.15.03 Rejection, 35 U.S.C. 102(e), No Common Assignee or Inventor(s)*

Claim [1] rejected under 35 U.S.C. 102(e) as being [2] by [3].

**Examiner Note:**

1. This form paragraph is used to reject over a patent or patent application publication with an earlier filing date that discloses but does not claim the same invention. The patent or patent application publication is not required to have a common assignee nor a common inventor.

2. 35 U.S.C. 102(e) as amended by the American Inventors Protection Act of 1999 (AIPA) and the Intellectual Property and High Technology Technical Amendments Act of 2002 (form paragraph 7.12) must be applied if the reference is one of the following:

a. a U.S. patent or a publication of a U.S. application for patent filed under 35 U.S.C. 111(a);

b. a U.S. patent issued directly or indirectly from, or a U.S. or WIPO publication of, an international application if the international application has **an international filing date on or after November 29, 2000**.

See the Examiner Notes for form paragraph 7.12 to assist in the determination of the 35 U.S.C. 102(e) date of the reference.

3. Pre-AIPA 35 U.S.C. 102(e) (form paragraph 7.12.01) must be applied if the reference is a U.S. patent issued directly, or indirectly, from an international application filed prior to November 29, 2000. See the Examiner Notes for form paragraph 7.12.01 to assist in the determination of the 35 U.S.C. 102(e) date of the reference.

4. In determining the 35 U.S.C. 102(e) date, consider priority/benefit claims to earlier-filed U.S. provisional applications under 35 U.S.C. 119(e), U.S. nonprovisional applications under 35 U.S.C. 120 or 121, and international applications under 35 U.S.C. 120, 121 or 365(c) if the subject matter used to make the rejection is appropriately supported in the relied upon earlier-filed application's disclosure (and any intermediate application(s)). A benefit claim to a U.S. patent of an earlier-filed international application, which has an international filing date prior to November 29, 2000, may only result in an effective U.S. filing date as of the date the requirements of 35 U.S.C. 371(c)(1), (2) and (4) were fulfilled. Do NOT consider any priority/benefit claims to U.S. applications which are filed before an international application that has an international filing date prior to November 29, 2000. Do NOT consider foreign priority claims under 35 U.S.C. 119(a)-(d) and 365(a).

5. If the reference is a publication of an international application (including voluntary U.S. publication under 35 U.S.C. 122 of the national stage or a WIPO publication) that has an international filing date prior to November 29, 2000, did not designate the United States or was not published in English by WIPO, do not use this form paragraph. Such a reference is not a prior art reference under 35 U.S.C. 102(e). The reference may be applied under

35 U.S.C. 102(a) or (b) as of its publication date. See form paragraphs 7.08 and 7.09.

6. In bracket 2, insert either --clearly anticipated-- or --anticipated-- with an explanation at the end of the paragraph.

7. In bracket 3, insert the prior art relied upon.

8. This form paragraph must be preceded by either of form paragraphs 7.12 or 7.12.01.

9. Patent application publications may only be used if this form paragraph was preceded by form paragraph 7.12.

<

*¶ 7.16 Rejection, 35 U.S.C. 102(b), Public Use or on Sale*

Claim [1] rejected under 35 U.S.C. 102(b) based upon a public use or sale of the invention. [2]

**Examiner Note:**

1. This form paragraph must be preceded either by form paragraphs 7.07 and 7.09 or by form paragraph 7.103.

2. A full explanation of the evidence establishing a public use or sale must be provided in bracket 2.

*¶ 7.17 Rejection, 35 U.S.C. 102(c), Abandonment of Invention*

Claim [1] rejected under 35 U.S.C. 102(c) because the invention has been abandoned. [2]

**Examiner Note:**

1. This form paragraph must be preceded either by form paragraph 7.07 and 7.10 or by form paragraph 7.103.

2. In bracket 2, insert a full explanation of the evidence establishing abandonment of the invention. See MPEP § 2134.

*¶ 7.18 Rejection, 35 U.S.C. 102(d), Foreign Patenting*

Claim [1] rejected under 35 U.S.C. 102(d) as being barred by applicants [2].

[3]

**Examiner Note:**

1. This form paragraph must be preceded either by form paragraphs 7.07 and 7.11 or by form paragraph 7.103.

2. In bracket 3, insert an explanation of this rejection which must include appropriate dates and how they make the foreign patent available under 35 U.S.C. 102(d).

3. Refer to MPEP § 2135 for applicable 35 U.S.C. 102(d) prior art.

*¶ 7.19 Rejection, 35 U.S.C. 102(f), Applicant Not the Inventor*

Claim [1] rejected under 35 U.S.C. 102(f) because the applicant did not invent the claimed subject matter. [2]

**Examiner Note:**

1. This paragraph must be preceded either by paragraphs 7.07 and 7.13 or by paragraph 7.103.

2. In bracket 2, insert an explanation of the supporting evidence establishing that applicant was not the inventor. See MPEP § 2137.

### 706.02(j) Contents of a 35 U.S.C. 103 Rejection

35 U.S.C. 103 authorizes a rejection where, to meet the claim, it is necessary to modify a single reference or to combine it with one or more other references. After indicating that the rejection is under 35 U.S.C. 103, the examiner should set forth in the Office action:

(A) the relevant teachings of the prior art relied upon, preferably with reference to the relevant column or page number(s) and line number(s) where appropriate,

(B) the difference or differences in the claim over the applied reference(s),

(C) the proposed modification of the applied reference(s) necessary to arrive at the claimed subject matter, and

(D) an explanation why one of ordinary skill in the art at the time the invention was made would have been motivated to make the proposed modification.

To establish a *prima facie* case of obviousness, three basic criteria must be met. First, there must be some suggestion or motivation, either in the references themselves or in the knowledge generally available to one of ordinary skill in the art, to modify the reference or to combine reference teachings. Second, there must be a reasonable expectation of success. Finally, the prior art reference (or references when combined) must teach or suggest all the claim limitations. The teaching or suggestion to make the claimed combination and the reasonable expectation of success must both be found in the prior art and not based on applicant's disclosure. *In re Vaeck*, 947 F.2d 488, 20 USPQ2d 1438 (Fed. Cir. 1991). See MPEP § 2143 - § 2143.03 for decisions pertinent to each of these criteria.

The initial burden is on the examiner to provide some suggestion of the desirability of doing what the inventor has done. "To support the conclusion that the claimed invention is directed to obvious subject matter, either the references must expressly or impliedly suggest the claimed invention or the examiner must present a convincing line of reasoning as to why the artisan would have found the claimed invention to have been obvious in light of the teachings of the references." *Ex parte Clapp*, 227 USPQ 972, 973 (Bd.

Pat. App. & Inter. 1985). See MPEP § 2144 - § 2144.09 for examples of reasoning supporting obviousness rejections.

Where a reference is relied on to support a rejection, whether or not in a minor capacity, that reference should be positively included in the statement of the rejection. See *In re Hoch*, 428 F.2d 1341, 1342 n.3 166 USPQ 406, 407 n. 3 (CCPA 1970).

It is important for an examiner to properly communicate the basis for a rejection so that the issues can be identified early and the applicant can be given fair opportunity to reply. Furthermore, if an initially rejected application issues as a patent, the rationale behind an earlier rejection may be important in interpreting the scope of the patent claims. Since issued patents are presumed valid (35 U.S.C. 282) and constitute a property right (35 U.S.C. 261), the written record must be clear as to the basis for the grant. Since patent examiners cannot normally be compelled to testify in legal proceedings regarding their mental processes (see MPEP § 1701.01), it is important that the written record clearly explain the rationale for decisions made during prosecution of the application.

See MPEP § 2141 - § 2144.09 generally for guidance on patentability determinations under 35 U.S.C. 103, including a discussion of the requirements of *Graham v. John Deere*, 383 U.S. 1, 148 USPQ 459 (1966). See MPEP § 2145 for consideration of applicant's rebuttal arguments. See MPEP § 706.02(l) - § 706.02(l)(3) for a discussion of prior art disqualified under 35 U.S.C. 103(c).

### 706.02(k) Provisional Rejection (Obviousness) Under 35 U.S.C. 102(e)/103 [R-2]

Effective November 29, 1999, subject matter which was prior art under former 35 U.S.C. 103 via 35 U.S.C. 102(e) is now disqualified as prior art against the claimed invention if that subject matter and the claimed invention "were, at the time the invention was made, owned by the same person or subject to an obligation of assignment to the same person." This change to 35 U.S.C. 103(c) applies to all utility, design and plant patent applications filed on or after November 29, 1999, including continuing applications filed under 37 CFR 1.53(b), continued prosecution applications filed under 37 CFR 1.53(d),

and reissues. The amendment to 35 U.S.C. 103(c) does not affect any application filed before November 29, 1999, a request for examination under 37 CFR 1.129 of such an application, nor a request for continued examination under 37 CFR 1.114 of such an application. The changes to 35 U.S.C. 102(e) in the Intellectual Property and High Technology Technical Amendments Act of 2002 (Pub. L. 107-273, 116 Stat. 1758 (2002)) did not affect the exclusion under 35 U.S.C. 103(c) as amended on November 29, 1999. See MPEP § 706.02(1)(1) for additional information regarding disqualified prior art under 35 U.S.C. 102(e)/ 103.

Where two applications of different inventive entities are copending, not published under 35 U.S.C. 122(b), and the filing dates differ, a provisional rejection under 35 U.S.C. 102(e)/103 should be made in the later filed application if the applications have a common assignee or a common inventor, unless the later application was filed on or after November 29, 1999 and the applications were commonly owned or subject to an obligation of assignment to the same person at the time the later invention was made. See MPEP § 706.02(1)(3) for examination procedure with respect to 35 U.S.C. 103(c). See also MPEP § 706.02(f) for examination procedure in determining when provisional rejections are appropriate. Otherwise the confidential status of unpublished application, or any part thereof, under 35 U.S.C. 122 must be maintained. Such a rejection alerts the applicant that he or she can expect an actual rejection on the same ground if one of the applications issues and also lets applicant know that action must be taken to avoid the rejection.

This gives applicant the opportunity to analyze the propriety of the rejection and possibly avoid the loss of rights to desired subject matter. Provisional rejections of the obviousness type under 35 U.S.C. 102(e)/ 103 are rejections applied to copending applications having different effective filing dates wherein each application has a common assignee or a common inventor. The earlier filed application, if patented >or published<, would constitute prior art under 35 U.S.C. 102(e). The rejection can be overcome by:

(A) Arguing patentability over the earlier filed application;

(B) Combining the subject matter of the copending applications into a single application claiming benefit under 35 U.S.C. 120 of the prior applications and abandoning the copending applications (Note that a claim in a subsequently filed application that relies on a combination of prior applications may not be entitled to the benefit of an earlier filing date under 35 U.S.C. 120 since 35 U.S.C. 120 requires that the earlier filed application contain a disclosure which complies with 35 U.S.C. 112, first paragraph for each claim in the subsequently filed application. *Studiengesellschaft Kohle m.b.H. v. Shell Oil Co.*, 112 F.3d 1561, 42 USPQ2d 1674 (Fed. Cir. 1997).);

(C) Filing an affidavit or declaration under 37 CFR 1.132 showing that any unclaimed invention disclosed in the copending application was derived from the inventor of the other application and is thus not invention “by another” (see MPEP § 715.01(a), § 715.01(c), and § 716.10);

(D) Filing an affidavit or declaration under 37 CFR 1.131 showing a date of invention prior to the effective U.S. filing date of the copending application. See MPEP § 715; or

(E) For an application filed on or after November 29, 1999, showing that the prior art and the claimed invention were, at the time the invention was made, owned by the same person or subject to an obligation of assignment to the same person.

Where the applications are claiming the same patentable invention, a terminal disclaimer and an affidavit or declaration under 37 CFR 1.130 may be used to overcome a rejection under 35 U.S.C. 103 in a common ownership situation if the earlier filed application has been published or matured into a patent. See MPEP § 718.

If a provisional rejection is made and the copending applications are combined into a single application and the resulting single application is subject to a restriction requirement, the divisional application would not be subject to a provisional or actual rejection under 35 U.S.C. 102(e)/103 since the provisions of 35 U.S.C. 121 preclude the use of a patent issuing therefrom as a reference against the other application. Additionally, the resulting continuation-in-part is entitled to 35 U.S.C. 120 benefit of each of the prior applications. This is illustrated in Example 2, below.



The following examples are instructive as to the application of 35 U.S.C. 102(e)/103 in applications filed prior to November 29, 1999:

**Example 1.** Assumption: Employees A and B work for C, each with knowledge of the other's work, and with obligation to assign inventions to C while employed.

SITUATIONS	RESULTS
1. A invents X and later files application.	This is permissible.
2. B modifies X to XY. B files application before A's filing.	No 35 U.S.C. 102(f)/103 or 102(g)/103 rejection; provisional 35 U.S.C. 102(e)/103 rejection applies. Provisional double patenting rejection made.
3. B's patent issues.	A's claims rejected under 35 U.S.C. 102(e)/103 and double patenting.
4. A files 37 CFR 1.130 affidavit to disqualify B's patent as prior art where the same patentable invention is being claimed. Terminal disclaimer filed under 37 CFR 1.321(c).	Rejection under 35 U.S.C. 102(e)/103 may be overcome and double patenting rejection may be overcome if inventions X and XY are commonly owned and all requirements of 37 CFR 1.130 and 1.321 are met.

In situation (2.) above, the result is a provisional rejection by the examiner under 35 U.S.C. 102(e)/103. The rejection is provisional since the subject matter and the prior art are pending applications.

**Example 2.** Assumption: Employees A and B work for C, each with knowledge of the other's work, and with obligation to assign inventions to C while employed.

SITUATIONS	RESULTS
1. A invents X and files application.	This is permissible.
2. B modifies X to XY after A's application is filed. B files application establishing that A and B were both under obligation to assign inventions to C at the time the inventions were made.	Provisional 35 U.S.C. 102(e)/103 rejection made; provisional double patenting rejection made; no 35 U.S.C. 102(f)/103 or 102(g)/103 rejection made.
3. A and B file continuing application claiming priority to their earlier applications and abandon the earlier applications.	Assume it is proper that restriction be required between X and XY.
4. X is elected and patent issues on X with divisional application being timely filed on XY.	No rejection of divisional application under 35 U.S.C. 102(e)/103 in view of 35 U.S.C. 121.

The following examples are instructive as to rejections under 35 U.S.C. 102(e)/103 in applications filed on or after November 29, 1999:

**Example 3.** Assumption: Employees A and B work for C, each with knowledge of the other's work, and with obligation to assign inventions to C while employed. Employee A's application, filed on or after November 29, 1999, is being examined.

SITUATIONS	RESULTS
1. A invents X and later files application.	This is permissible.
2. B modifies X to XY. B files application before A's filing. A files an application on invention X.	Provisional 35 U.S.C. 102(e)/103 rejection and a provisional double patenting rejection made.
3. B's patent issues.	A's claims rejected under 35 U.S.C. 102(e)/103 and double patenting.
4. A files evidence of common ownership of inventions X and XY at the time invention XY was made to disqualify B's patent as prior art. In addition, A files a terminal disclaimer under 37 CFR 1.321(c).	Rejection under 35 U.S.C. 102(e)/103 will be withdrawn and double patenting rejection will be obviated if inventions X and XY are commonly owned at the time invention XY was made and all requirements of 37 CFR 1.321 are met.

In situation (2.) above, the result is a provisional rejection by the examiner under 35 U.S.C. 102(e)/103. The rejection is provisional since the subject matter and the prior art are pending applications.

**Example 4.** Assumption: Employees A and B work for C, each with knowledge of the other's work, and with obligation to assign inventions to C while employed. Employee B's application, filed on or after November 29, 1999, is being examined.

SITUATIONS	RESULTS
1. A invents X and files application.	This is permissible.
2. B modifies X to XY after A's application is filed. B files evidence establishing that A and B were both under obligation to assign inventions to C at the time the invention XY was made.	Provisional 35 U.S.C. 102(e)/103 rejection cannot be made; provisional double patenting rejection made; no 35 U.S.C. 102(e)/103 or 102(g)/103 rejection made.
3. B files a terminal disclaimer under 37 CFR 1.321(c).	The provisional double patenting rejection made in B's application would be obviated if all requirements of 37 CFR 1.321 are met.

### EXAMINATION OF CONTINUING APPLICATION COMMONLY OWNED WITH ABANDONED PARENT APPLICATION TO WHICH BENEFIT IS CLAIMED UNDER 35 U.S.C. 120

An application claiming the benefit of a prior filed copending national or international application under 35 U.S.C. 120 must name as an inventor at least one inventor named in the prior filed application. The prior filed application must also disclose the named inventor's invention claimed in at least one claim of the later filed application in the manner provided by the first paragraph of 35 U.S.C. 112. This practice contrasts with the practice in effect prior to November 8, 1984 (the date of enactment of Public Law 98-622) where the inventorship entity in each of the applications was required to be the same for benefit under 35 U.S.C. 120.

So long as the applications have at least one inventor in common and the other requirements are met, the Office will permit a claim for 35 U.S.C. 120 benefit without any additional submissions or notifications from applicants regarding inventorship differences.

In addition to the normal examination conducted by the examiner, he or she must examine the earlier filed application to determine if the earlier and later applications have at least one inventor in common and that the other 35 U.S.C. 120 requirements are met. The claim for 35 U.S.C. 120 benefit will be permitted without examination of the earlier application for disclosure and support of at least one claim of the later filed application under 35 U.S.C. 112, first paragraph unless it becomes necessary to do so, for example, because of an intervening reference.

### 706.02(I) Rejections Under 35 U.S.C. 102(f)/103 and 35 U.S.C. 102(g)/103; 35 U.S.C. 103(c) [R-2]

35 U.S.C. 103. *Conditions for patentability; non-obvious subject matter.*

\*\*\*\*\*

(c) Subject matter developed by another person, which qualifies as prior art only under one or more of subsections (e), (f), and (g) of section 102 of this title, shall not preclude patentability under this section where the subject matter and the claimed invention were, at the time the invention was made, owned by the same

person or subject to an obligation of assignment to the same person.

Prior to November 29, 1999, 35 U.S.C. 103(c) provided that subject matter developed by another which qualifies as "prior art" only under subsections 35 U.S.C. 102(f) or 35 U.S.C. 102(g) is not to be considered when determining whether an invention sought to be patented is obvious under 35 U.S.C. 103, provided the subject matter and the claimed invention were commonly owned at the time the invention was made. See MPEP § 706.02(1)(1) for information regarding when prior art under 35 U.S.C. 102(e)/103 is disqualified under 35 U.S.C. 103(c).

For applications filed prior to November 29, 1999, the subject matter that is disqualified as prior art under 35 U.S.C. 103(c) is strictly limited to subject matter that A) qualifies as prior art only under 35 U.S.C. 102(f) or 35 U.S.C. 102(g), and B) was commonly owned with the claimed invention at the time the invention was made. If the subject matter that qualifies as prior art only under 35 U.S.C. 102(f) or 35 U.S.C. 102(g) was not commonly owned at the time of the invention, the subject matter is not disqualified as prior art under 35 U.S.C. 103(c). See *OddzOn Products, Inc. v. Just Toys, Inc.*, 122 F.3d 1396, 1403-04, 43 USPQ2d 1641, 1646 (Fed. Cir. 1997) ("We therefore hold that subject matter derived from another not only is itself unpatentable to the party who derived it under § 102(f), but, when combined with other prior art, may make a resulting obvious invention unpatentable to that party under a combination of §§ 102(f) and 103.") If the subject matter qualifies as prior art under any other subsection (e.g., subsection 35 U.S.C. 102(a), 35 U.S.C. 102(b), or 35 U.S.C. 102(e)) it will not be disqualified as prior art under 35 U.S.C. 103(c).

It is important to recognize that 35 U.S.C. 103(c) applies only to consideration of prior art for purposes of obviousness under 35 U.S.C. 103. It does not apply to or affect subject matter which **\*\*>**is applied in a rejection< under 35 U.S.C. 102. A patent applicant urging that subject matter is disqualified has the burden of establishing that it was commonly owned at the time the claimed invention was made. Absent proper evidence of common ownership at the time the later invention was made, the appropriate rejection under 35 U.S.C. 102(f) or 35 U.S.C. 102(g) as it applies through 35 U.S.C. 103 should be made. See MPEP

§ 706.02(1)(2) for information pertaining to establishing common ownership.

Information learned from or transmitted to persons outside the organization is not disqualified as prior art. The term “subject matter” will be construed broadly, in the same manner the term is construed in the remainder of 35 U.S.C. 103. The term “another” as used in 35 U.S.C. 103 means any inventive entity other than the inventor and would include the inventor and any other persons. The term “developed” is to be read broadly and is not limited by the manner in which the development occurred. The term “commonly owned” means wholly owned by the same person(s), or organization(s) at the time the invention was made. See MPEP § 706.02(1)(2).

Inventors of subject matter not commonly owned at the time of the invention, but currently commonly owned, may file as joint inventors in a single application. However, the claims in such an application are not protected from a 35 U.S.C. 102(f)/103 or 35 U.S.C. 102(g)/103 rejection. Applicants in such cases have an obligation pursuant to 37 CFR 1.56 to point out the inventor and invention dates of each claim and the lack of common ownership at the time the later invention was made to enable the examiner to consider the applicability of a 35 U.S.C. 102(f)/103 or 35 U.S.C. 102(g)/103 rejection. The examiner will assume, unless there is evidence to the contrary, that applicants are complying with their duty of disclosure.

Foreign applicants will sometimes combine the subject matter of two or more related applications with different inventors into a single U.S. application naming joint inventors. The examiner will make the assumption, absent contrary evidence, that the applicants are complying with their duty of disclosure if no information is provided relative to invention dates and common ownership at the time the later invention was made. Such a claim for 35 U.S.C. 119(a)-(d) benefit based upon the foreign filed applications is appropriate and 35 U.S.C. 119(a)-(d) benefit can be accorded based upon each of the foreign filed applications.

## **706.02(I)(1) Rejections Under 35 U.S.C. 102(e)/103; 35 U.S.C. 103(c) [R-2]**

*35 U.S.C. 103. Conditions for patentability; non-obvious subject matter.*

\*\*\*\*\*

(c) Subject matter developed by another person, which qualifies as prior art only under one or more of subsections (e), (f), and (g) of section 102 of this title, shall not preclude patentability under this section where the subject matter and the claimed invention were, at the time the invention was made, owned by the same person or subject to an obligation of assignment to the same person.

Effective November 29, 1999, subject matter which was prior art under former 35 U.S.C. 103 via 35 U.S.C. 102(e) is now disqualified as prior art against the claimed invention if that subject matter and the claimed invention “were, at the time the invention was made, owned by the same person or subject to an obligation of assignment to the same person.” This change to 35 U.S.C. 103(c) applies to all utility, design and plant patent applications filed on or after November 29, 1999, including continuing applications filed under 37 CFR 1.53(b), continued prosecution application filed under 37 CFR 1.53(d), and reissues. The amendment to 35 U.S.C. 103(c) does not affect any application filed before November 29, 1999, a request for examination under 37 CFR 1.129 of such an application, nor a request for continued examination under 37 CFR 1.114 of such an application. The Intellectual Property and High Technology Technical Amendments Act of 2002 (Pub. L. 107-273, 116 Stat. 1758 (2002) did not further amend the exclusion under 35 U.S.C.103(c) as amended on November 29, 1999.

The mere filing of a continuing application on or after November 29, 1999, with the required evidence of common ownership, will serve to exclude commonly owned 35 U.S.C. 102(e) prior art that was applied, or could have been applied, in a rejection under 35 U.S.C. 103 in the parent application. For reissue applications, the doctrine of recapture may prevent \*\* the presentation of claims in >the< reissue applications that were amended or cancelled from the application which matured into the patent for which reissue is being sought, if the claims were amended or cancelled to distinguish the claimed invention from 35 U.S.C. 102(e)/103 prior art which was commonly

owned or assigned at the time the invention was made. >If an examiner determines that this situation applies in the reissue application under examination, a consultation with the Office of Patent Legal Administration should be initiated via the Technology Center Special Program Examiner.<

35 U.S.C. 103(c) applies only to prior art usable in an obviousness rejection under 35 U.S.C. 103. Subject matter that qualifies as anticipatory prior art under 35 U.S.C. 102, including 35 U.S.C. 102(e), is not affected, and may still be used to reject claims as being anticipated.

The burden of establishing that subject matter is disqualified as prior art is placed on applicant once the examiner has established a *prima facie* case of obviousness based on the subject matter. >The fact that the reference and the application have the same assignee is not, by itself, sufficient evidence to disqualify the prior art under 35 U.S.C. 103(c). There must be a statement that the common ownership was “at the time the invention was made.”<

See MPEP § 706.02(1)(2) for information regarding establishing common ownership. See MPEP § 706.02(1)(3) for examination procedure with respect to 35 U.S.C. 103(c). Non-statutory and statutory double patenting rejections, based on subject matter now disqualified as prior art in amended 35 U.S.C. 103(c), should still be made as appropriate. See MPEP § 804.

### **706.02(1)(2) Establishing Common Ownership [R-2]**

In order to be disqualified as prior art under 35 U.S.C. 103(c), the subject matter which would otherwise be prior art to the claimed invention and the claimed invention must be commonly owned at the time the claimed invention was made >or subject to an obligation of assignment that would establish common ownership<. See MPEP § 706.02(1) for 35 U.S.C. 102(f)/103 or 35 U.S.C. 102(g)/103 prior art disqualified under 35 U.S.C. 103(c). See MPEP § 706.02(1)(1) for 35 U.S.C. 102(e)/103 prior art disqualified under 35 U.S.C. 103(c).

#### **I. DEFINITION OF COMMON OWNERSHIP**

The term “commonly owned” is intended to mean that the subject matter which would otherwise be prior art to the claimed invention and the claimed

invention are entirely or wholly owned by the same person(s) or organization(s)>/business entity(ies)< at the time the claimed invention was made. If the person(s) or organization(s) owned less than 100 percent of the subject matter which would otherwise be prior art to the claimed invention, or less than 100 percent of the claimed invention, then common ownership would not exist. Common ownership requires that the person(s) or organization(s)>/business entity(ies)< own 100 percent of the subject matter and 100 percent of the claimed invention.

Specifically, if an invention claimed in an application is owned by more than one entity and those entities seek to exclude the use of a reference under 35 U.S.C. 103, then the reference must be owned by, or subject to an obligation of assignment to, the same entities that owned the application, at the time the later invention was made. For example, assume Company A owns twenty percent of patent Application X and Company B owns eighty percent of patent Application X at the time the invention of Application X was made. In addition, assume that Companies A and B seek to exclude the use of Reference Z under 35 U.S.C. 103. Reference Z must have been co-owned, or have been under an obligation of assignment to both companies, on the date the invention was made in order for the exclusion to be properly requested. A statement such as “Application X and Patent Z were, at the time the invention of Application X was made, jointly owned by Companies A and B” would be sufficient evidence of common ownership.

For applications owned by a joint venture of two or more entities, both the application and the reference must have been owned by, or subject to an obligation of assignment to, the joint venture at the time the invention was made. For example, if Company A and Company B formed a joint venture, Company C, both Application X and Reference Z must have been owned by, or subject to an obligation of assignment to, Company C at the time the invention was made in order for Reference Z to be properly excluded as prior art under 35 U.S.C. 103(c). If Company A by itself owned Reference Z at the time the invention of Application X was made >and Application X was owned by Company C on the date the invention was made<, >then< a request for the exclusion of Reference Z as prior art under 35 U.S.C. 103(c) would not be proper.

As long as principal ownership rights to either the subject matter or the claimed invention reside in different persons or organizations common ownership does not exist. A license of the claimed invention to another by the owner where basic ownership rights are retained would not defeat ownership.

The requirement for common ownership at the time the claimed invention was made is intended to preclude obtaining ownership of subject matter after the claimed invention was made in order to disqualify that subject matter as prior art against the claimed invention.

The question of whether common ownership exists at the time the claimed invention was made is to be determined on the facts of the particular case in question. Actual ownership of the subject matter and the claimed invention by the same individual(s) or organization(s) or a legal obligation to assign both the subject matter and the claimed invention to the same individual(s) or organization(s)/business entity(ies) must be in existence at the time the claimed invention was made in order for the subject matter to be disqualified as prior art. A moral or unenforceable obligation would not evidence common ownership.

Under 35 U.S.C. 103(c), an applicant's admission that subject matter was developed prior to applicant's invention would not make the subject matter prior art to applicant if the subject matter qualifies as prior art only under sections 35 U.S.C. 102(f) or 35 U.S.C. 102(g), or, for applications filed on or after November 29, 1999, 35 U.S.C. 102(e), and if the subject matter and the claimed invention were commonly owned at the time the invention was made. See *In re Fout*, 675 F.2d 297, 213 USPQ 532 (CCPA 1982), for a decision involving an applicant's admission which was used as prior art against their application. If the subject matter and invention were not commonly owned, an admission that the subject matter is prior art would be usable under 35 U.S.C. 103.

The burden of establishing that subject matter is disqualified as prior art under 35 U.S.C. 103(c) is intended to be placed and reside upon the person or persons urging that the subject matter is disqualified. For example, a patent applicant urging that subject matter is disqualified as prior art under 35 U.S.C. 103(c), would have the burden of establishing that it was commonly owned at the time the claimed invention was made. The patentee in litigation would like-

wise properly bear the same burden placed upon the applicant before the U.S. Patent and Trademark Office. To place the burden upon the patent examiner or the defendant in litigation would not be appropriate since evidence as to common ownership at the time the claimed invention was made might not be available to the patent examiner or the defendant in litigation, but such evidence, if it exists, should be readily available to the patent applicant or the patentee.

In view of 35 U.S.C. 103(c), the \*>Director< has reinstated in appropriate circumstances the practice of rejecting claims in commonly owned applications of different inventive entities on the grounds of double patenting. Such rejections can be overcome in appropriate circumstances by the filing of terminal disclaimers. This practice has been judicially authorized. See *In re Bowers*, 359 F.2d 886, 149 USPQ 57 (CCPA 1966). The use of double patenting rejections which then could be overcome by terminal disclaimers preclude patent protection from being improperly extended while still permitting inventors and their assignees to obtain the legitimate benefits from their contributions. See also MPEP § 804.

The following examples are provided for illustration only:

**Example 1**

Parent Company owns 100% of Subsidiaries A and B

- inventions of A and B are commonly owned by the Parent Company.

**Example 2**

Parent Company owns 100% of Subsidiary A and 90% of Subsidiary B

- inventions of A and B are not commonly owned by the Parent Company.

**Example 3**

If same person owns subject matter and invention at time invention was made, license to another may be made without the subject matter becoming prior art.

**Example 4**

Different Government inventors retaining certain rights (e.g. foreign filing rights) in separate inventions owned by Government precludes common ownership of inventions.

**Example 5**

Company A and Company B form joint venture Company C. Employees of A, while working for C with an obligation to assign inventions to C, invent invention #1; employees of B while working for C with an obligation to assign inventions to C, invent invention #2, with knowledge of #1.

Question: Are #1 and #2 commonly owned at the time the later invention was made so as to preclude a rejection under 35 U.S.C. 102(e), (f) or (g) in view of 35 U.S.C. 103?

Answer: Yes- If the required evidence of common ownership is made of record in the patent application file. If invention #1 was invented by employees of Company A **not** working for Company C and Company A maintained sole ownership of invention #1 at the time invention #2 was made, inventions #1 and #2 would not be commonly owned as required by 35 U.S.C. 103(c).

**Example 6**

Company A owns 40% of invention #1 and 60% of invention #2, and Company B owns 60% of invention #1 and 40% of invention #2 at the time invention #2 was made.

-inventions #1 and #2 are commonly owned.

>

**Example 7**

Company B has a joint research project with University A. Under the terms of the joint research project, University A has agreed that all of its patents will be jointly owned by Company B and University A. Professor X, who works for University A, has an employee agreement with University A assigning all his patents only to University A. After the joint research project agreement is executed, University A files patent application #1 for the invention of Professor X, before Company B files patent application #2 on a similar invention.

- inventions #1 and #2 are commonly owned because Professor X's obligation to assign patents to University A who has an obligation to assign patents to the A-B joint venture legally establishes Professor X's obligation to assign patents to the A-B joint venture.

**Example 8**

Inventor X working at Company A invents and files patent application #1 on technology T, owned by Company A. After application #1 is filed, Company A spins off a 100% owned Subsidiary B for technology T including the transfer of the ownership of patent application #1 to Subsidiary B. After Subsidiary B is formed, inventor Y (formerly a Company A employee, but now an employee of Subsidiary B obligated to assign to Subsidiary B) jointly files application #2 with inventor X (now also an employee of Subsidiary B with an obligation to assign to Subsidiary B), which is directed to a possibly unobvious improvement to technology T.

- the inventions of applications #1 and #2 are commonly owned since Subsidiary B is a wholly owned subsidiary of Company A.<

The examiner must examine the application as to all grounds except 35 U.S.C. 102(e), (f) and (g) as they apply through 35 U.S.C. 103 only if the application file(s) establishes common ownership at the time the later invention was made. Thus, it is necessary to look to the time at which common ownership exists. If common ownership does not exist at the time the later invention was made, the earlier invention is not disqualified as potential prior art under 35 U.S.C. 102(e), (f) and (g) as they apply through 35 U.S.C. 103. An invention is "made" when conception is complete as defined in *Mergenthaler v. Scudder*, 11 App. D.C. 264, 81 O.G. 1417, 1897 C.D. 724 (D.C. Cir. 1897); *In re Tansel*, 253 F.2d 241, 117 USPQ 188 (CCPA 1958). See *Pfaff v. Wells Elecs.*, 525 U.S. 55, 119 S. Ct. 304, 312, 48 USPQ2d 1641, 1647 (1998) ("the invention must be ready for patenting . . . by proof that prior to the critical date the inventor had prepared drawing or other descriptions of the invention that were sufficiently specific to enable a person skilled in the art to practice the invention.") Common ownership at the time the invention was made for purposes of obviating a 35 U.S.C. 102(e)/35 U.S.C. 103, 35 U.S.C. 102(f)/35 U.S.C. 103 or 35 U.S.C. 102(g)/35 U.S.C. 103 rejection may be established irrespective of whether the invention was made in the United States or abroad. The provisions of 35 U.S.C. 104, however, will continue to apply to other proceedings in the U.S. Patent and Trademark Office, e.g. in an interference proceeding, with regard to establishing a

date of invention by knowledge or use thereof, or other activity with respect thereto, in a foreign country. The foreign filing date will continue to be used for interference purposes under 35 U.S.C. 119(a)-(d) and 35 U.S.C. 365.

## II. EVIDENCE REQUIRED TO ESTABLISH COMMON OWNERSHIP

It is important to recognize just what constitutes sufficient evidence to establish common ownership at the time the invention was made. The common ownership must be shown to exist at the time the later invention was made. A statement of present common ownership is not sufficient. *In re Onda*, 229 USPQ 235 (Comm'r Pat. 1985).

The following statement is sufficient evidence to establish common ownership of, or an obligation for assignment to, the same person(s) or organizations(s):

Applications and references (whether patents, patent applications, patent application publications, etc.) will be considered by the examiner to be owned by, or subject to an obligation of assignment to the same person, at the time the invention was made, if the applicant(s) or an attorney or agent of record makes a statement to the effect that the application and the reference were, at the time the invention was made, owned by, or subject to an obligation of assignment to, the same person.

See "Guidelines Setting Forth a Modified Policy Concerning the Evidence of Common Ownership, or an Obligation of Assignment to the Same Person, as Required by 35 U.S.C. 103(c)," 1241 O.G. 96 (December 26, 2000). The applicant(s) or the representative(s) of record have the best knowledge of the ownership of their application(s) and reference(s), and their statement of such is sufficient evidence because of their paramount obligation of candor and good faith to the USPTO.

The statement concerning common ownership should be clear and conspicuous (e.g., on a separate piece of paper or in a separately labeled section) in order to ensure that the examiner quickly notices the statement. Applicants may, but are not required to, submit further evidence, such as assignment records, affidavits or declarations by the common owner, or court decisions, *in addition to* the above-mentioned statement concerning common ownership.

For example, an attorney or agent of record receives an Office action for Application X in which

all the claims are rejected under 35 U.S.C. 103(a) using Patent A in view of Patent B wherein Patent A is only available as prior art under 35 U.S.C. 102(e), (f), and/or (g). In her response to the Office action, the attorney or agent of record for Application X states, in a clear and conspicuous manner, that:

"Application X and Patent A were, at the time the invention of Application X was made, owned by Company Z."

This statement alone is sufficient evidence to disqualify Patent A from being used in a rejection under 35 U.S.C. 103(a) against the claims of Application X.

In rare instances, the examiner may have independent evidence that raises a material doubt as to the accuracy of applicant's representation of either (1) the common ownership of, or (2) the existence of an obligation to commonly assign, the application being examined and the applied U.S. patent or U.S. patent application publication reference. In such cases, the examiner may explain why the accuracy of the representation is doubted, and require objective evidence of common ownership of, or the existence of an obligation to assign, the application being examined and the applied reference as of the date of invention of the application being examined. As mentioned above, applicant(s) may submit, *in addition to* the above-mentioned statement regarding common ownership, the following objective evidence:

(A) Reference to assignments recorded in the U.S. Patent and Trademark Office in accordance with 37 CFR Part 3 which convey the entire rights in the applications to the same person(s) or organization(s);

(B) Copies of unrecorded assignments which convey the entire rights in the applications to the same person(s) or organization(s) are filed in each of the applications;

(C) An affidavit or declaration by the common owner is filed which states that there is common ownership and states facts which explain why the affiant or declarant believes there is common ownership, which affidavit or declaration may be signed by an official of the corporation or organization empowered to act on behalf of the corporation or organization when the common owner is a corporation or other organization; and

(D) Other evidence is submitted which establishes common ownership of the applications.



### **706.02(1)(3) Examination Procedure With Respect to 35 U.S.C. 103(c) [R-2]**

Examiners are reminded that a reference used in an anticipatory rejection under 35 U.S.C. 102(e), (f), or (g) is not disqualified as prior art if evidence is provided to show common ownership by, or an obligation of assignment to, the same person at the time the invention was made. Such a commonly owned reference is only disqualified when

(A) proper evidence is filed,

(B) the reference *only* qualifies as prior art under 35 U.S.C. 102(f) or (g), or 35 U.S.C. 102(e) for applications filed on or after November 29, 1999, (e.g. not 35 U.S.C. 102(a) or (b)) and

(C) the reference was used in an obviousness rejection under 35 U.S.C. 103(a).

Applications and patents will be considered to be owned by, or subject to an obligation of assignment to, the same person, at the time the invention was made, if the applicant(s) or an attorney or agent of record makes a statement to the effect that the application and the reference were, at the time the invention was made, owned by, or subject to an obligation of assignment to, the same person(s) or organization(s).

See MPEP § 706.02(1)(2) for additional information pertaining to establishing common ownership.

>

#### **I. <EXAMINATION OF APPLICATIONS OF DIFFERENT INVENTIVE ENTITIES WHERE COMMON OWNERSHIP HAS NOT BEEN ESTABLISHED**

If the application file being examined does not establish that it and the reference patent(s) or application(s) are owned by, or subject to an obligation of assignment to, the same person, at the time the invention was made, the examiner will:

(A) assume the application(s) and patent(s) are not commonly owned;

(B) examine the application on all grounds other than any conflict between the reference patent(s) or application(s) arising from a possible 35 U.S.C. 103 rejection based on 35 U.S.C. 102(e), (f) and/or (g);

(C) consider the applicability of any references under 35 U.S.C. 103 based on 35 U.S.C. 102(e), (f) and/or (g), including provisional rejections under 35 U.S.C. 102(e)/103; and

(D) apply the best references against the claimed invention by rejections under 35 U.S.C. 102 and 103, including any rejections under 35 U.S.C. 103 based on 35 U.S.C. 102(e), (f) and/or (g), until such time that a statement is made that the application(s) and patent(s) were commonly owned, at the time the invention was made. When applying any 35 U.S.C. 102(e)/103 references against the claims in applications filed on or after November 29, 1999, the examiner should anticipate that a statement of common ownership may disqualify any patent or application applied in a rejection under 35 U.S.C. 103 based on 35 U.S.C. 102(e). See MPEP § 706.02(1)(1). If such a statement is filed in reply to the 35 U.S.C. 102(e)/103 rejection and the claims are not amended, the examiner may not make the next Office action final if a new rejection is made. See MPEP § 706.07(a).

>

#### **II. < EXAMINATION OF APPLICATIONS OF DIFFERENT INVENTIVE ENTITIES FILED ON OR AFTER NOVEMBER 29, 1999 WHERE COMMON OWNERSHIP HAS BEEN ESTABLISHED**

If the application being examined establishes that it and any reference patent or application were owned by, or subject to an obligation or assignment to, the same person, at the time the invention was made, the examiner will:

(A) examine the applications as to all grounds except 35 U.S.C. 102(e), (f) and (g) as they apply through 35 U.S.C. 103, including provisional rejections under 35 U.S.C. 102(e)/103;

(B) examine the applications for double patenting, including statutory and nonstatutory double patenting, and make a provisional rejection, if appropriate; and

(C) invite the applicant to file a terminal disclaimer to overcome any provisional or actual nonstatutory double patenting rejection, if appropriate.

>

### III. <EXAMINATION OF APPLICATIONS OF DIFFERENT INVENTIVE ENTITIES FILED PRIOR TO NOVEMBER 29, 1999 WHERE COMMON OWNERSHIP HAS BEEN ESTABLISHED

In applications filed prior to November 29, 1999, the disclosure of an earlier filed patent application which issues as a patent continues to be prior art under 35 U.S.C. 102(e) against a later invented and filed application of another inventor even though the patent and the later invention were owned by, or subject to, an obligation of assignment to the same person at the time the later invention was made. See MPEP § 706.02(1)(1).

If the application being examined establishes that it and any reference patent or application were owned by, or subject to an obligation or assignment to, the same person, at the time the invention was made, the examiner will:

(A) examine the applications as to all grounds except 35 U.S.C. 102(f) and (g) as they apply through 35 U.S.C. 103;

(B) examine the applications for double patenting, including statutory and nonstatutory double patenting, and make a provisional rejection, if appropriate; and

(C) examine the later filed application under 35 U.S.C. 102(e) as it applies through 35 U.S.C. 103 and make a provisional rejection under 35 U.S.C. 102(e)/35 U.S.C. 103 in the later filed application, if appropriate; and

(D) invite the applicant to file a terminal disclaimer to overcome any provisional or actual non-statutory double patenting rejection, if appropriate, and permit the applicant of the later filed application to file an affidavit or declaration under 37 CFR 1.131, or a terminal disclaimer and an affidavit or declaration under 37 CFR 1.130 if the same patentable invention is being claimed and the commonly owned application has issued as a patent (see MPEP § 715.05 and § 718), or an affidavit or declaration under 37 CFR 1.132 showing the invention is not “by another,” to overcome the provisional or actual 35 U.S.C. 102(e)/35 U.S.C. 103 rejection, if appropriate. An affidavit or declaration under 37 CFR 1.130 cannot be used to overcome a provisional 35 U.S.C. 102(e)/103 rejection. See MPEP § 718.

&gt;

### IV. < DOUBLE PATENTING REJECTIONS

Commonly owned applications of different inventive entities may be rejected on the ground of double patenting, even if the later filed application claims 35 U.S.C. 120 benefit to the earlier application. A rejection based on a pending application would be a provisional rejection. The practice of rejecting claims on the ground of double patenting in commonly owned applications of different inventive entities is in accordance with existing case law and prevents an organization from obtaining two or more patents with different expiration dates covering nearly identical subject matter. See MPEP § 804 for guidance on double patenting issues. In accordance with established patent law doctrines, double patenting rejections can be overcome in certain circumstances by disclaiming, pursuant to the existing provisions of 37 CFR 1.321, the terminal portion of the term of the later patent and including in the disclaimer a provision that the patent shall be enforceable only for and during the period the patent is commonly owned with the application or patent which formed the basis for the rejection, thereby eliminating the problem of extending patent life. See MPEP § 804 and § 804.02.

### 706.02(m) Form Paragraphs for Use in Rejections Under 35 U.S.C. 103 [R-2]

The following form paragraphs should be used in making the appropriate rejections under 35 U.S.C. 103.

#### ¶ 7.20 Statement of Statutory Basis, 35 U.S.C. 103(a)

The following is a quotation of 35 U.S.C. 103(a) which forms the basis for all obviousness rejections set forth in this Office action:

(a) A patent may not be obtained though the invention is not identically disclosed or described as set forth in section 102 of this title, if the differences between the subject matter sought to be patented and the prior art are such that the subject matter as a whole would have been obvious at the time the invention was made to a person having ordinary skill in the art to which said subject matter pertains. Patentability shall not be negated by the manner in which the invention was made.

#### Examiner Note:

1. The statute is not to be cited in all Office actions. It is only required in first actions on the merits employing 35 U.S.C. 103(a) and final rejections. Where the statute is being applied, but is not cited in an action on the merits, use paragraph 7.103.
2. This form paragraph should only be used ONCE in a given Office action.
3. This form paragraph must precede form paragraphs 7.20.01 - 7.22 when this form paragraph is used to cite the statute in first actions and final rejections.

*¶ 7.20.01 For Applications filed Prior to November 29, 1999, 103(a) Rejection Using Art Disqualified Under 102 (f) or (g)*

Applicant has provided evidence in this file showing that the invention was owned by, or subject to an obligation of assignment to, the same entity as [1] at the time this invention was made. Accordingly, [2] is disqualified as prior art through 35 U.S.C. 102(f) or (g) in any rejection under 35 U.S.C. 103(a) in this application. However, this applied art additionally qualifies as prior art under another subsection of 35 U.S.C. 102 and accordingly is not disqualified as prior art under 35 U.S.C. 103(a).

Applicant may overcome the applied art either by a showing under 37 CFR 1.132 that the invention disclosed therein was derived from the inventor of this application, and is therefore, not the invention “by another,” or by antedating the applied art under 37 CFR 1.131.

**Examiner Note:**

1. This form paragraph must be included following form paragraph 7.20 in all actions containing rejections under 35 U.S.C. 103(a) using art that is disqualified under 103(c) using 102(f) or (g), but which qualifies under another section of 35 U.S.C. 102.
2. In brackets 1 and 2, identify the commonly owned applied art (patent or co-pending application).
3. Use this form paragraph only in applications filed prior to November 29, 1999. For applications filed on or after November 29, 1999, use form paragraph 7.20.03.

*¶ 7.20.03 For Applications Filed On Or After November 29, 1999, 103(a) Rejection Using Art Disqualified Under 102(e), (f) or (g)*

Applicant has provided evidence in this file showing that the invention was owned by, or subject to an obligation of assignment to, the same entity as [1] at the time this invention was made. Accordingly, [2] is disqualified as prior art through 35 U.S.C. 102(e), (f) or (g) in any rejection under 35 U.S.C. 103(a) in this application. However, this applied art additionally qualifies as prior art under another subsection of 35 U.S.C. 102 and accordingly is not disqualified as prior art under 35 U.S.C. 103(a).

Applicant may overcome the applied art either by a showing under 37 CFR 1.132 that the invention disclosed therein was derived from the inventor of this application, and is therefore, not the invention “by another,” or by antedating the applied art under 37 CFR 1.131.

**Examiner Note:**

1. This form paragraph must be included following form paragraph 7.20 in all actions containing rejection under 35 U.S.C.

103(a) using art that is disqualified under 103(c) using 102(e), (f) or (g), but which qualifies under another section of 35 U.S.C. 102.

2. In brackets 1 and 2, identify the commonly owned applied art (patent or co-pending application).
3. Use this form paragraph only in applications filed on or after November 29, 1999. For applications filed prior to November 29, 1999, use form paragraph 7.20.01.

*¶ 7.20.02 Joint Inventors, Common Ownership Presumed*

This application currently names joint inventors. In considering patentability of the claims under 35 U.S.C. 103(a), the examiner presumes that the subject matter of the various claims was commonly owned at the time any inventions covered therein were made absent any evidence to the contrary. Applicant is advised of the obligation under 37 CFR 1.56 to point out the inventor and invention dates of each claim that was not commonly owned at the time a later invention was made in order for the examiner to consider the applicability of 35 U.S.C. 103(c) and potential 35 U.S.C. 102(e), (f) or (g) prior art under 35 U.S.C. 103(a).

**Examiner Note:**

This paragraph must be used in all applications with joint inventors (unless the claims are clearly restricted to only one claimed invention, e.g., only a single claim is presented in the application).

\*\*>

*¶ 7.21 Rejection, 35 U.S.C. 103(a)*

Claim [1] rejected under 35 U.S.C. 103(a) as being unpatentable over [2].

**Examiner Note:**

1. This paragraph must be preceded by either form paragraph 7.20 or form paragraph 7.103.
2. An explanation of the rejection applying the Graham v. Deere test must follow this form paragraph.
3. If the rejection relies upon prior art under 35 U.S.C. 102(e), use 35 U.S.C. 102(e) as amended by the American Inventors Protection Act to determine the reference’s prior art date, unless the reference is a U.S. patent issued directly, or indirectly, from an international application which has an international filing date prior to November 29, 2000. In other words, use pre-AIPA 35 U.S.C. 102(e) only if the reference is a U.S. patent issued directly or indirectly from either a national stage of an international application (application under 35 U.S.C. 371) which has an international filing date prior to November 29, 2000 or a continuing application claiming benefit under 35 U.S.C. 120, 121 or 365(c) to an international application having an international filing date prior to November 29, 2000. See the Examiner Notes for form paragraphs 7.12 and 7.12.01 to assist in the determination of the reference’s 35 U.S.C. 102(e) date.
4. For applications being examined that were filed on or after November 29, 1999, if this rejection relies upon art that is disqualified under 35 U.S.C. 102(e), (f) or (g) based upon the common ownership of the invention, paragraph 7.20.03 must follow this paragraph
5. For applications being examined that were filed prior to November 29, 1999, if this rejection relies upon art that is disqual-

ified under 35 U.S.C. 102(f) or (g) based upon the common ownership of the invention, paragraph 7.20.01 must follow this paragraph.

6. If this rejection is a provisional 35 U.S.C. 103(a) rejection based upon a copending application that would comprise prior art under 35 U.S.C. 102(e) if patented, use paragraph 7.21.01 instead of this paragraph.

*¶ 7.21.01 Provisional Rejection, 35 U.S.C. 103(a), Common Assignee or at Least One Common Inventor*

Claim [1] provisionally rejected under 35 U.S.C. 103(a) as being obvious over copending Application No. [2] which has a common [3] with the instant application. Based upon the earlier effective U.S. filing date of the copending application, it would constitute prior art under 35 U.S.C. 102(e) if published or patented. This provisional rejection under 35 U.S.C. 103(a) is based upon a presumption of future publication or patenting of the conflicting application. [4]

This provisional rejection might be overcome either by a showing under 37 CFR 1.132 that any invention disclosed but not claimed in the copending application was derived from the inventor of this application and is thus not the invention “by another,” or by a showing of a date of invention for the instant application prior to the effective U.S. filing date of the copending application under 37 CFR 1.131. For applications filed on or after November 29, 1999, this rejection might also be overcome by showing that the subject matter of the reference and the claimed invention were, at the time the invention was made, owned by the same person or subject to an obligation of assignment to the same person. See MPEP § 706.02(1)(1) and § 706.02(1)(2)

**Examiner Note:**

1. This paragraph is used to provisionally reject claims not patentably distinct from the disclosure in a copending application having an earlier U.S. filing date and also having either a common assignee or at least one common inventor. This form paragraph should **not** be used in applications filed on or after November 29, 1999 when the application being examined establishes that it and any reference patent or application were owned by, or subject to an obligation or assignment to, the same person, at the time the invention was made. See MPEP § 706.02(1)(3).

2. Use 35 U.S.C. 102(e) as amended by the American Inventors Protection Act (AIPA) to determine the copending application reference’s prior art date, unless the copending application reference is based directly, or indirectly, from an international application which has an international filing date prior to November 29, 2000. If the copending application reference is either a national stage of an international application (application under 35 U.S.C. 371) which has an international filing date prior to November 29, 2000, or a continuing application claiming benefit under 35 U.S.C. 120, 121, or 365(c) to an international application having an international filing date prior to November 29, 2000, use pre-AIPA 35 U.S.C. 102(e) to determine the copending application reference’s prior art date. See the Examiner Notes for form paragraphs 7.12 and 7.12.01 to assist in the determination of the 35 U.S.C. 102(e) date.

3. If the claimed invention is fully disclosed in the copending application, use paragraph 7.15.01.

4. In bracket 3, insert either --assignee-- or --inventor--.

5. In bracket 4, insert explanation of obviousness.

6. If the claimed invention is also claimed in the copending application, a provisional obviousness double patenting rejection should additionally be made using paragraph 8.33 and 8.37.

7. If evidence indicates that the copending application is also prior art under 35 U.S.C. 102(f) or (g) and the copending application has not been disqualified as prior art in a 35 U.S.C. 103(a) rejection based upon common ownership, a rejection should additionally be made under 35 U.S.C. 103(a) using paragraph 7.21 (e.g., applicant has named the prior inventor in response to a requirement made using paragraph 8.28).

<

*¶ 7.21.02 Rejection, 35 U.S.C. 103(a), Common Assignee or at Least One Common Inventor*

Claim [1] rejected under 35 U.S.C. 103(a) as being obvious over [2].

The applied reference has a common [3] with the instant application. Based upon the earlier effective U.S. filing date of the reference, it constitutes prior art under 35 U.S.C. 102(e). This rejection under 35 U.S.C. 103(a) might be overcome by: (1) a showing under 37 CFR 1.132 that any invention disclosed but not claimed in the reference was derived from the inventor of this application and is thus not an invention “by another”; (2) a showing of a date of invention for the claimed subject matter of the application which corresponds to subject matter disclosed but not claimed in the reference, prior to the effective U.S. filing date of the reference under 37 CFR 1.131; or (3) an oath or declaration under 37 CFR 1.130 stating that the application and reference are currently owned by the same party and that the inventor named in the application is the prior inventor under 35 U.S.C. 104, together with a terminal disclaimer in accordance with 37 CFR 1.321(c). For applications filed on or after November 29, 1999, this rejection might also be overcome by showing that the subject matter of the reference and the claimed invention were, at the time the invention was made, owned by the same person or subject to an obligation of assignment to the same person. See MPEP § 706.02(1)(1) and § 706.02(1)(2). [4]

**Examiner Note:**

1. This paragraph is used to reject over a reference (patent or published application) with an earlier filing date that discloses the claimed invention, and that only qualifies as prior art under 35 U.S.C. 102(e). If the reference qualifies as prior art under 35 U.S.C. 102(a) or (b), then this form paragraph should not be used (form paragraph 7.21 should be used instead). The reference must have either a common assignee or at least one common inventor. This form paragraph should **not** be used in applications filed on or after November 29, 1999 when the application being examined establishes that it and any reference were owned by, or subject to an obligation or assignment to, the same person, at the time the invention was made. See MPEP § 706.02(1)(3).

2. 35 U.S.C. 102(e) as amended by the American Inventors Protection Act of 1999 (AIPA) must be applied if the reference is one of the following:

a. a U.S. patent or a publication of a U.S. application for patent filed under 35 U.S.C. 111(a);

b. a U.S. patent issued directly or indirectly from, or a U.S. or WIPO publication of, an international application if the international application has an **international filing date on or after November 29, 2000**.

See the Examiner Notes for form paragraph 7.12 to assist in the determination of the 35 U.S.C. 102(e) date of the reference.

3. Pre-AIPA 35 U.S.C. 102(e) must be applied if the reference is a U.S. patent issued directly, or indirectly, from an international application filed prior to November 29, 2000. See the Examiner Notes for form paragraph 7.12.01 to assist in the determination of the 35 U.S.C. 102(e) date of the reference.

4. In bracket 3, insert either --assignee-- or --inventor--.

5. In bracket 4, insert explanation of obviousness.

\*\*>

¶ 7.22 *Rejection, 35 U.S.C. 103(a), Further in View Of*

Claim [1] rejected under 35 U.S.C. 103(a) as being unpatentable over [2] as applied to claim [3] above, and further in view of [4].

**Examiner Note:**

1. This form paragraph must be preceded by form paragraph 7.21.

2. An explanation of the rejection applying the Graham v. Deere test must follow this form paragraph.

3. If the rejection relies upon prior art under 35 U.S.C. 102(e), use 35 U.S.C. 102(e) as amended by the American Inventors Protection Act to determine the reference's prior art date, unless the reference is a U.S. patent issued directly, or indirectly, from an international application which has an international filing date prior to November 29, 2000. In other words, use pre-AIPA 35 U.S.C. 102(e) only if the reference is a U.S. patent issued directly or indirectly from either a national stage of an international application (application under 35 U.S.C. 371) which has an international filing date prior to November 29, 2000 or a continuing application claiming benefit under 35 U.S.C. 120, 121 or 365(c) to an international application having an international filing date prior to November 29, 2000. See the Examiner Notes for form paragraphs 7.12 and 7.12.01 to assist in the determination of the reference's 35 U.S.C. 102(e) date.

<

¶ 7.23 *Graham v. Deere, Test for Obviousness*

The factual inquiries set forth in *Graham v. John Deere Co.*, 383 U.S. 1, 148 USPQ 459 (1966), that are applied for establishing a background for determining obviousness under 35 U.S.C. 103(a) are summarized as follows:

1. Determining the scope and contents of the prior art.
2. Ascertaining the differences between the prior art and the claims at issue.
3. Resolving the level of ordinary skill in the pertinent art.
4. Considering objective evidence present in the application indicating obviousness or nonobviousness.

**Examiner Note:**

This form paragraph may be used, if appropriate, in response to an argument of the use of *Graham v. Deere*.

\*\*>

¶ 7.27 *Rejection, 35 U.S.C. 102 or 103(a)*

Claim [1] rejected under 35 U.S.C. 102([2]) as anticipated by or, in the alternative, under 35 U.S.C. 103(a) as obvious over [3].

**Examiner Note:**

1. This form paragraph is NOT intended to be commonly used as a substitute for a rejection under 35 U.S.C. 102. In other words, a single rejection under either 35 U.S.C. 102 or 35 U.S.C. 103(a) should be made whenever possible using appropriate form paragraphs 7.15 to 7.19, 7.21 and 7.22. Examples of circumstances where this paragraph may be used are as follows:

a. When the interpretation of the claim(s) is or may be in dispute, i.e., given one interpretation, a rejection under 35 U.S.C. 102 is appropriate and given another interpretation, a rejection under 35 U.S.C. 103(a) is appropriate. See MPEP §§ 2111- 2116.01 for guidelines on claim interpretation.

b. When the reference discloses all the limitations of a claim except a property or function, and the examiner cannot determine whether or not the reference inherently possesses properties which anticipate or render obvious the claimed invention but has basis for shifting the burden of proof to applicant as in *In re Fitzgerald*, 619 F.2d 67, 205 USPQ 594 (CCPA 1980). See MPEP §§ 2112-2112.02.

c. When the reference teaches a small genus which places a claimed species in the possession of the public as in *In re Schumann*, 572 F.2d 312, 197 USPQ 5 (CCPA 1978), and the species would have been obvious even if the genus were not sufficiently small to justify a rejection under 35 U.S.C. 102. See MPEP §§ 2131.02 and 2144.08 for more information on anticipation and obviousness of species by a disclosure of a genus.

d. When the reference teaches a product that appears to be the same as, or an obvious variant of, the product set forth in a product-by-process claim although produced by a different process. See *In re Marosi*, 710 F.2d 799, 218 USPQ 289 (Fed. Cir. 1983) and *In re Thorpe*, 777 F.2d 695, 227 USPQ 964 (Fed. Cir. 1985). See also MPEP § 2113.

e. When the reference teaches all claim limitations except a means plus function limitation and the examiner is not certain whether the element disclosed in the reference is an equivalent to the claimed element and therefore anticipatory, or whether the prior art element is an obvious variant of the claimed element. See MPEP §§ 2183- 2184.

f. When the ranges disclosed in the reference and claimed by applicant overlap in scope but the reference does not contain a specific example within the claimed range. See the concurring opinion in *Ex parte Lee*, 31 USPQ2d 1105 (Bd. Pat. App. & Inter. 1993). See MPEP § 2131.03.

2. If the interpretation of the claim(s) renders the claim(s) indefinite, a rejection under 35 U.S.C. 112, 2nd paragraph, may be appropriate.

3. In bracket 2, insert the appropriate paragraph letter(s) in parenthesis.

4. A full explanation should follow this form paragraph.

5. If the rejection relies upon prior art under 35 U.S.C. 102(e), use 35 U.S.C. 102(e) as amended by the American Inventors Protection Act to determine the reference's prior art date, unless the reference is a U.S. patent issued directly, or indirectly, from an international application which has an international filing date prior to November 29, 2000. In other words, use pre-AIPA 35 U.S.C. 102(e) only if the reference is a U.S. patent issued directly or indirectly from either a national stage of an international application (application under 35 U.S.C. 371) which has an international filing date prior to November 29, 2000 or a continuing application claiming benefit under 35 U.S.C. 120, 121 or 365(c) to an international application having an international filing date prior to November 29, 2000. See the Examiner Notes for form paragraphs 7.12 and 7.12.01 to assist in the determination of the reference's 35 U.S.C. 102(e) date.

6. This form paragraph must be preceded by 7.07, one or more of form paragraphs 7.08 to 7.14 as appropriate, and form paragraph 7.20 or form paragraph 7.103.

<

## **706.02(n) Biotechnology Process Applications; 35 U.S.C. 103(b) [R-1]**

*35 U.S.C. 103. Conditions for patentability; non-obvious subject matter.*

\*\*\*\*\*

(b)(1) Notwithstanding subsection (a), and upon timely election by the applicant for patent to proceed under this subsection, a biotechnological process using or resulting in a composition of matter that is novel under section 102 and nonobvious under subsection (a) of this section shall be considered nonobvious if-

(A) claims to the process and the composition of matter are contained in either the same application for patent or in separate applications having the same effective filing date; and

(B) the composition of matter, and the process at the time it was invented, were owned by the same person or subject to an obligation of assignment to the same person.

(2) A patent issued on a process under paragraph (1)-

(A) shall also contain the claims to the composition of matter used in or made by that process, or

(B) shall, if such composition of matter is claimed in another patent, be set to expire on the same date as such other patent, notwithstanding section 154.

(3) For purposes of paragraph (1), the term "biotechnological process" means-

(A) a process of genetically altering or otherwise inducing a single- or multi-celled organism to-

- (i) express an exogenous nucleotide sequence,
  - (ii) inhibit, eliminate, augment, or alter expression of an endogenous nucleotide sequence, or
  - (iii) express a specific physiological characteristic not naturally associated with said organism;
- (B) cell fusion procedures yielding a cell line that expresses a specific protein, such as a monoclonal antibody; and
- (C) a method of using a product produced by a process defined by subparagraph (A) or (B), or a combination of subparagraphs (A) and (B).

\*\*\*\*\*

35 U.S.C. 103(b) is applicable to biotechnological processes only. 35 U.S.C. 103(b) precludes a rejection of process claims which involve the use or making of certain nonobvious biotechnological compositions of matter under 35 U.S.C. 103(a).

35 U.S.C. 103(b) requires that:

(A) the biotechnological process and composition of matter be contained in either the same application or in separate applications having the same effective filing date;

(B) both the biotechnological process and composition of matter be owned or subject to an assignment to the same person at the time the process was invented;

(C) a patent issued on the process also contain the claims to the composition of matter used in or made by the process, or, if the process and composition of matter are in different patents, the patents expire on the same date;

(D) the biotechnological process falls within the definition set forth in 35 U.S.C. 103(b); and

(E) a timely election be made to proceed under the provisions of 35 U.S.C. 103(b).

An election to proceed under 35 U.S.C. 103(b) shall be made by way of petition under 37 CFR 1.182. The petition must establish that all the requirements set forth in 35 U.S.C. 103(b) have been satisfied.

An election will normally be considered timely if it is made no later than the earlier of either the payment of the issue fee or the filing of an appeal brief in an application which contains a composition of matter claim which has not been rejected under 35 U.S.C. 102 or 103.

In an application where at least one composition of matter claim has not been rejected under 35 U.S.C. 102 or 103, a 35 U.S.C. 103(b) election may be made by submitting the petition and an amendment

requesting entry of process claims which correspond to the composition of matter claim.

For applications pending on or after November 1, 1995, in which the issue fee has been paid prior to March 26, 1996, the timeliness requirement for an election under 35 U.S.C. 103(b) will be considered satisfied if the conditions of 37 CFR 1.312(b) are met. However, if a patent is granted on an application entitled to the benefit of 35 U.S.C. 103(b) without an election having been made as a result of error without deceptive intent, patentees may file a reissue application to permit consideration of process claims which qualify for 35 U.S.C. 103(b) treatment.

See MPEP § 2116.01 for a discussion of the Federal Circuit's decisions in *In re Ochiai*, 71 F.3d 1565, 37 USPQ 1127 (Fed. Cir. 1995) and *In re Brouwer*, 77 F.3d 422, 37 USPQ2d 1663 (Fed. Cir. 1996) which address the general issue of whether an otherwise conventional process could be patented if it were limited to making or using a nonobvious product. In view of the Federal Circuit's decisions in *Ochiai* and *Brouwer*, an applicant's need to rely upon 35 U.S.C. 103(b) should be rare. See also 1184 O.G. 86 (Comm'r Pat. 1996). See 35 U.S.C. 282 for the effect of a determination of nonobviousness under 35 U.S.C. 103(b)(1) on the presumption of validity.

### 706.03 Rejections Not Based on Prior Art

The primary object of the examination of an application is to determine whether or not the claims are patentable over the prior art. This consideration should not be relegated to a secondary position while undue emphasis is given to nonprior art or "technical" rejections. Effort in examining should be concentrated on truly essential matters, minimizing or eliminating effort on technical rejections which are not really critical. Where a major technical rejection is proper (e.g., lack of proper disclosure, undue breadth, utility, etc.) such rejection should be stated with a full development of the reasons rather than by a mere conclusion coupled with some stereotyped expression.

Rejections based on nonstatutory subject matter are explained in MPEP § 706.03(a), § 2105, § 2106 - § 2106.02, and § 2107 - § 2107.02. Rejections based on subject matter barred by the Atomic Energy Act are explained in MPEP § 706.03(b). Rejections based on duplicate claims are addressed in MPEP

§ 706.03(k), and double patenting rejections are addressed in MPEP § 804. See MPEP § 706.03(o) for rejections based on new matter. Foreign filing without a license is discussed in MPEP § 706.03(s). Disclaimer, after interference or public use proceeding, *res judicata*, and reissue are explained in MPEP § 706.03(u) to § 706.03(x). Rejections based on 35 U.S.C. 112 are discussed in MPEP § 2161 - § 2174. IF THE LANGUAGE IN THE FORM PARAGRAPHS IS INCORPORATED IN THE OFFICE ACTION TO STATE THE REJECTION, THERE WILL BE LESS CHANCE OF A MISUNDERSTANDING AS TO THE GROUNDS OF REJECTION.

### 706.03(a) Rejections Under 35 U.S.C. 101 [R-2]

>

#### I. <SUBJECT MATTER ELIGIBILITY

Patents are not granted for all new and useful inventions and discoveries. The subject matter of the invention or discovery must come within the boundaries set forth by 35 U.S.C. 101, which permits patents to be granted only for "any new and useful process, machine, manufacture, or composition of matter, or any new and useful improvement thereof."

The term "process" as defined in 35 U.S.C. 100, means process, art or method, and includes a new use of a known process, machine, manufacture, composition of matter, or material.

See MPEP § 2105 for patentability of microorganisms and MPEP § 2106 - § 2106.02 for patentability of mathematical algorithms or computer programs.

Decisions have determined the limits of the statutory classes. Examples of subject matter not patentable under the statute follow:

>

#### A. <Printed Matter

For example, a mere arrangement of printed matter, though seemingly a "manufacture," is rejected as not being within the statutory classes. See *In re Miller*, 418 F.2d 1392, 164 USPQ 46 (CCPA 1969); *Ex parte Gwinn*, 112 USPQ 439 (Bd. App. 1955); and *In re Jones*, 373 F.2d 1007, 153 USPQ 77 (CCPA 1967).

&gt;

**B. < Naturally Occurring Article**

Similarly, a thing occurring in nature, which is substantially unaltered, is not a “manufacture.” A shrimp with the head and digestive tract removed is an example. *Ex parte Grayson*, 51 USPQ 413 (Bd. App. 1941).

&gt;

**C. < Scientific Principle**

A scientific principle, divorced from any tangible structure, can be rejected as not within the statutory classes. *O’Reilly v. Morse*, 56 U.S. (15 How.) 62 (1854).

This subject matter is further limited by the Atomic Energy Act explained in MPEP § 706.03(b).

&gt;

**II. < UTILITY**

A rejection on the ground of lack of utility includes the more specific grounds of inoperativeness, involving perpetual motion, frivolous, fraudulent, and against public policy. The statutory basis for this rejection is 35 U.S.C. 101. See MPEP § 2107 for guidelines governing rejections for lack of utility. See MPEP § 2107.01 - § 2107.03 for legal precedent governing the utility requirement.

Use Form Paragraphs 7.04 through 7.05.03 to reject under 35 U.S.C. 101.

¶ 7.04 *Statement of Statutory Basis, 35 U.S.C. 101*  
35 U.S.C. 101 reads as follows:

Whoever invents or discovers any new and useful process, machine, manufacture, or composition of matter, or any new and useful improvement thereof, may obtain a patent therefor, subject to the conditions and requirements of this title.

**Examiner Note:**

This paragraph must precede the first use of 35 U.S.C. 101 in all first actions on the merits and final rejections.

¶ 7.05 *Rejection, 35 U.S.C. 101, -Heading Only- (Utility, Non-Statutory, Inoperative)*

Claim [1] rejected under 35 U.S.C. 101 because

**Examiner Note:**

1. This form paragraph must be followed by any one of form paragraphs 7.05.01- 7.05.03 or another appropriate reason.

2. Explain the rejection following the recitation of the statute and the use of form paragraphs 7.05.01-7.05.03 or other reason.

3. See MPEP §§ 706.03(a) and 2105- 2107.03 for other situations.

4. This form paragraph must be preceded by form paragraph 7.04 in first actions and final rejections.

¶ 7.05.01 *Rejection, 35 U.S.C. 101, Non-Statutory*

the claimed invention is directed to non-statutory subject matter. [1]

**Examiner Note:**

In bracket 1, insert identification of non-statutory subject matter.

¶ 7.05.02 *Rejection, 35 U.S.C. 101, Utility Lacking*

the claimed invention lacks patentable utility. [1]

**Examiner Note:**

In bracket 1, provide explanation of lack of utility, such as, for example, that which is frivolous, fraudulent, against public policy. See MPEP §§ 706.03 (a) and 2105- 2107.03.

¶ 7.05.03 *Rejection, 35 U.S.C. 101, Inoperative*

the disclosed invention is inoperative and therefore lacks utility. [1]

**Examiner Note:**

In bracket 1, explain why invention is inoperative.

¶ 7.05.04 *Utility Rejections Under 35 U.S.C. 101 and 35 U.S.C. 112, First Paragraph*

Claim [1] rejected under 35 U.S.C. 101 because the claimed invention is not supported by either a [2] asserted utility or a well established utility.

[3]

Claim [4] also rejected under 35 U.S.C. 112, first paragraph. Specifically, since the claimed invention is not supported by either a [5] asserted utility or a well established utility for the reasons set forth above, one skilled in the art clearly would not know how to use the claimed invention.

**Examiner Note:**

1. Where the specification would not enable one skilled in the art to make the claimed invention, or where alternative reasons support the enablement rejection, a separate rejection under 35 U.S.C. 112, first paragraph, enablement should be made using the factors set forth in *In re Wands*, 858 F.2d 731, 8 USPQ2d 1400 (Fed. Cir. 1988) and an undue experimentation analysis. See MPEP §§ 2164- 2164.08(c).

2. Use Format A, B, or C below as appropriate.

**Format A:**

(a) Insert the same claim numbers in brackets 1 and 4.

(b) Insert --specific and substantial-- in inserts 2 and 5.

(c) In bracket 3, insert the explanation as to why the claimed invention is not supported by either a specific and substantial asserted utility or a well established utility.



(d) Format A is to be used when there is no asserted utility and when there is an asserted utility but that utility is not specific and substantial.

Format B:

- (a) Insert the same claim numbers in brackets 1 and 4.
- (b) Insert --credible-- in inserts 2 and 5.
- (c) In bracket 3, insert the explanation as to why the claimed invention is not supported by either a credible asserted utility or a well established utility.

Format C:

For claims that have multiple utilities, some of which are not specific and substantial, some of which are not credible, but none of which are specific, substantial and credible:

- (a) Insert the same claim numbers in brackets 1 and 4.
- (b) Insert --specific and substantial asserted utility, a credible-- in inserts 2 and 5.
- (c) In bracket 3, insert the explanation as to why the claimed invention is not supported by either a specific and substantial asserted utility, a credible asserted utility or a well established utility. Each utility should be addressed.

### **706.03(b) Barred by Atomic Energy Act [R-2]**

A limitation on what can be patented is imposed by the Atomic Energy Act of 1954. Section 151(a) (42 U.S.C. 2181(a))>< thereof reads in part as follows:

No patent shall hereafter be granted for any invention or discovery which is useful solely in the utilization of special nuclear material or atomic energy in an atomic weapon.

The terms “atomic energy” and “special nuclear material” are defined in Section 11 of the Act (42 U.S.C. 2014).

Sections 151(c) and 151(d) (42 U.S.C. 2181(c) and (d)) set up categories of pending applications relating to atomic energy that must be brought to the attention of the Department of Energy. Under 37 CFR >\*1.14(d)<, applications for patents which disclose or which appear to disclose, or which purport to disclose, inventions or discoveries relating to atomic energy are reported to the Department of Energy and the Department will be given access to such applications, but such reporting does not constitute a determination that the subject matter of each application so reported is in fact useful or an invention or discovery or that such application in fact discloses subject matter in categories specified by the Atomic Energy Act.

All applications received in the U.S. Patent and Trademark Office are screened by Technology Center (TC) work group 3640 personnel, under 37 CFR

>1.14(d)<, in order for the \*>Director< to fulfill his or her responsibilities under section 151(d) (42 U.S.C. 2181(d))>< of the Atomic Energy Act. Papers subsequently added must be inspected promptly by the examiner when received to determine whether the application has been amended to relate to atomic energy and those so related must be promptly forwarded to Licensing and Review in TC work group 3640.

All rejections based upon sections 151(a)(42 U.S.C. 2181(a))><, 152 (42 U.S.C. 2182), and 155 (42 U.S.C. 2185) of the Atomic Energy Act must be made only by TC work group 3640 personnel.

### **706.03(c) Rejections Under 35 U.S.C. 112, First Paragraph [R-2]**

Rejections based on the first paragraph of 35 U.S.C. 112 are discussed in MPEP § 2161 - § 2165.04. For a discussion of the utility requirements of 35 U.S.C. 112, first paragraph, and 35 U.S.C. 101, see MPEP § 2107 - § 2107.03. The appropriate form paragraphs 7.30.01 and 7.31.01 through 7.33.01 should be used in making rejections under 35 U.S.C. 112, first paragraph.

*¶ 7.30.01 Statement of Statutory Basis, 35 U.S.C. 112, First Paragraph*

The following is a quotation of the first paragraph of 35 U.S.C. 112:

The specification shall contain a written description of the invention, and of the manner and process of making and using it, in such full, clear, concise, and exact terms as to enable any person skilled in the art to which it pertains, or with which it is most nearly connected, to make and use the same and shall set forth the best mode contemplated by the inventor of carrying out his invention.

**Examiner Note:**

1. The statute is no longer being re-cited in all Office actions. It is only required in first actions on the merits and final rejections. Where the statute is not being cited in an action on the merits, use paragraph 7.103.
2. Form paragraphs 7.30.01 and 7.30.02 are to be used ONLY ONCE in a given Office action.

\*\*>

*¶ 7.31.01 Rejection, 35 U.S.C. 112, 1st Paragraph, Description Requirement, Including New Matter Situations*

Claim [1] rejected under 35 U.S.C. 112, first paragraph, as failing to comply with the written description requirement. The claim(s) contains subject matter which was not described in the

specification in such a way as to reasonably convey to one skilled in the relevant art that the inventor(s), at the time the application was filed, had possession of the claimed invention. [2]

**Examiner Note:**

1. This rejection must be preceded by form paragraph 7.30.01 or 7.103.
2. In bracket 2, identify (by suitable reference to page and line numbers and/or drawing figures) the subject matter not properly described in the application as filed, and provide an explanation of your position. The explanation should include any questions the examiner asked which were not satisfactorily resolved and consequently raise doubt as to possession of the claimed invention at the time of filing.

<

Form paragraph 7.31.02 should be used when it is the examiner's position that nothing within the scope of the claims is enabled. In such a rejection, the examiner should explain all the reasons why nothing within the scope of the claim is enabled. To make sure all relevant issues are raised, this should include any issues regarding the breadth of the claims relative to the guidance in the disclosure.

\*\*>

*¶ 7.31.02 Rejection, 35 U.S.C. 112, 1st Paragraph, Enablement*

Claim [1] rejected under 35 U.S.C. 112, first paragraph, as failing to comply with the enablement requirement. The claim(s) contains subject matter which was not described in the specification in such a way as to enable one skilled in the art to which it pertains, or with which it is most nearly connected, to make and/or use the invention. [2]

**Examiner Note:**

1. This rejection must be preceded by form paragraph 7.30.01 or 7.103.
2. If the problem is one of scope, form paragraph 7.31.03 should be used.
3. In bracket 2, identify the claimed subject matter for which the specification is not enabling. Also explain why the specification is not enabling, applying the factors set forth in *In re Wands*, 858 F.2d 731, 737, 8 USPQ2d 1400, 1404 (Fed. Cir. 1998) as appropriate. See also MPEP § 2164.01(a) and § 2164.04. The explanation should include any questions the examiner may have asked which were not satisfactorily resolved and consequently raise doubt as to enablement.
4. Where an essential component or step of the invention is not recited in the claims, use form paragraph 7.33.01.

<

Form paragraph 7.31.03 should be used when it is the examiner's position that something within the scope of the claims is enabled but the claims are not limited to that scope.

*¶ 7.31.03 Rejection, 35 U.S.C. 112, 1st Paragraph: Scope of Enablement*

Claim [1] rejected under 35 U.S.C. 112, first paragraph, because the specification, while being enabling for [2], does not reasonably provide enablement for [3]. The specification does not enable any person skilled in the art to which it pertains, or with which it is most nearly connected, to [4] the invention commensurate in scope with these claims. [5]

**Examiner Note:**

1. This rejection must be preceded by form paragraph 7.30.01 or 7.103.
2. This form paragraph is to be used when the scope of the claims is not commensurate with the scope of the enabling disclosure.
3. In bracket 2, identify the claimed subject matter for which the specification is enabling. This may be by reference to specific portions of the specification.
4. In bracket 3, identify aspect(s) of the claim(s) for which the specification is not enabling.
5. In bracket 4, fill in only the appropriate portion of the statute, i.e., one of the following: --make--, --use--, or --make and use--.
6. In bracket 5, identify the claimed subject matter for which the specification is not enabling. Also explain why the specification is not enabling, applying the factors set forth in *In re Wands*, 858 F.2d 731, 737, 8 USPQ2d 1400, 1404 (Fed. Cir. 1998) as appropriate. See also MPEP § 2164.01(a) and § 2164.04. The explanation should include any questions posed by the examiner which were not satisfactorily resolved and consequently raise doubt as to enablement.

*¶ 7.31.04 Rejection, 35 U.S.C. 112, 1st Paragraph: Best Mode Requirement*

Claim [1] rejected under 35 U.S.C. 112, first paragraph, because the best mode contemplated by the inventor has not been disclosed. Evidence of concealment of the best mode is based upon [2].

**Examiner Note:**

1. This rejection must be preceded by form paragraph 7.30.01 or 7.103.
2. In bracket 2, insert the basis for holding that the best mode has been concealed, e.g., the quality of applicant's disclosure is so poor as to effectively result in concealment.
3. Use of this form paragraph should be rare. See MPEP §§ 2165-2165.04.

Form paragraph 7.33.01 should be used when it is the examiner's position that a feature considered critical or essential by applicant to the practice of the claimed invention is missing from the claim.

*¶ 7.33.01 Rejection, 35 U.S.C. 112, 1st Paragraph, Essential Subject Matter Missing From Claims (Enablement)*

Claim [1] rejected under 35 U.S.C. 112, first paragraph, as based on a disclosure which is not enabling. [2] critical or essential to the practice of the invention, but not included in the

claim(s) is not enabled by the disclosure. See *In re Mayhew*, 527 F.2d 1229, 188 USPQ 356 (CCPA 1976). [3]

**Examiner Note:**

1. This rejection must be preceded by form paragraph 7.30.01 or 7.103.
2. In bracket 2, recite the subject matter omitted from the claims.
3. In bracket 3, give the rationale for considering the omitted subject matter critical or essential.
4. The examiner shall cite the statement, argument, date, drawing, or other evidence which demonstrates that a particular feature was considered essential by the applicant, is not reflected in the claims which are rejected.

**706.03(d) Rejections Under 35 U.S.C. 112, Second Paragraph [R-2]**

Rejections under 35 U.S.C. 112, second paragraph, are discussed in MPEP § 2171 - § 2174. Form paragraphs 7.30.02 and 7.34 through 7.35.01 should be used to reject under 35 U.S.C. 112, second paragraph.

¶ 7.30.02 *Statement of Statutory Basis, 35 U.S.C. 112, Second Paragraph*

The following is a quotation of the second paragraph of 35 U.S.C. 112:

The specification shall conclude with one or more claims particularly pointing out and distinctly claiming the subject matter which the applicant regards as his invention.

**Examiner Note:**

1. The statute is no longer being re-cited in all Office actions. It is only required in first actions on the merits and final rejections. Where the statute is not being cited in an action on the merits, use paragraph 7.103.
2. Paragraphs 7.30.01 and 7.30.02 are to be used ONLY ONCE in a given Office action.

\*\*>

¶ 7.34 *Rejection, 35 U.S.C. 112, 2nd Paragraph, Failure To Claim Applicant's Invention*

Claim [1] rejected under 35 U.S.C. 112, second paragraph, as failing to set forth the subject matter which applicant(s) regard as their invention. Evidence that claim [2] fail(s) to correspond in scope with that which applicant(s) regard as the invention can be found in the reply filed [3]. In that paper, applicant has stated [4], and this statement indicates that the invention is different from what is defined in the claim(s) because [5].

**Examiner Note:**

1. This rejection must be preceded by form paragraph 7.30.02 or 7.103.
2. This paragraph is to be used only where applicant has stated, somewhere other than in the application, as filed, that the invention is something different from what is defined in the claim(s).

3. In bracket 3, identify the submission by applicant (which is not the application, as filed, but may be in the remarks by applicant, in the brief, in an affidavit, etc.) by the date the paper was filed in the USPTO.

4. In bracket 4, set forth what applicant has stated in the submission to indicate a different invention.

5. In bracket 5, explain how the statement indicates an invention other than what is being claimed.

<

¶ 7.34.01 *Rejection, 35 U.S.C. 112, 2nd Paragraph, Failure To Particularly Point out and Distinctly Claim (Indefinite)*

Claim [1] rejected under 35 U.S.C. 112, second paragraph, as being indefinite for failing to particularly point out and distinctly claim the subject matter which applicant regards as the invention.

**Examiner Note:**

1. This rejection must be preceded by form paragraph 7.30.02 or 7.103.2. This form paragraph should be followed by one or more of the following form paragraphs 7.34.02 - 7.34.11, as applicable. If none of these form paragraphs are appropriate, a full explanation of the deficiency of the claims should be supplied. Whenever possible, identify the particular term(s) or limitation(s) which render the claim(s) indefinite and state why such term or limitation renders the claim indefinite. If the scope of the claimed subject matter can be determined by one having ordinary skill in the art, a rejection using this form paragraph would not be appropriate. See MPEP §§ 2171 - 2174 for guidance. See also form paragraph 7.34.15 for *pro se* applicants.

¶ 7.34.02 *Terminology Used Inconsistent with Accepted Meaning*

Where applicant acts as his or her own lexicographer to specifically define a term of a claim contrary to its ordinary meaning, the written description must clearly redefine the claim term and set forth the uncommon definition so as to put one reasonably skilled in the art on notice that the applicant intended to so redefine that claim term. *Process Control Corp. v. HydReclaim Corp.*, 190 F.3d 1350, 1357, 52 USPQ2d 1029, 1033 (Fed. Cir. 1999). The term “[1]” in claim [2] is used by the claim to mean “[3]”, while the accepted meaning is “[4].” The term is indefinite because the specification does not clearly redefine the term.

**Examiner Note:**

1. In bracket 3, point out the meaning that is assigned to the term by applicant's claims, taking into account the entire disclosure.
2. In bracket 4, point out the accepted meaning of the term. Support for the examiner's stated accepted meaning should be provided through the citation of an appropriate reference source, e.g., textbook or dictionary. See MPEP § 2173.05(a).
3. This paragraph must be preceded by form paragraph 7.34.01.
4. This paragraph should only be used where the specification does not clearly redefine the claim term at issue.

¶ 7.34.03 *Relative Term - Term of Degree Rendering Claim Indefinite*

The term “[1]” in claim [2] is a relative term which renders the claim indefinite. The term “[1]” is not defined by the claim, the specification does not provide a standard for ascertaining the requisite degree, and one of ordinary skill in the art would not be reasonably apprised of the scope of the invention. [3]

**Examiner Note:**

1. In bracket 3, explain which parameter, quantity, or other limitation in the claim has been rendered indefinite by the use of the term appearing in bracket 1.
2. This form paragraph must be preceded by form paragraph 7.34.01.

¶ 7.34.04 *Broader Range/Limitation And Narrow Range/Limitation in Same Claim*

A broad range or limitation together with a narrow range or limitation that falls within the broad range or limitation (in the same claim) is considered indefinite, since the resulting claim does not clearly set forth the metes and bounds of the patent protection desired. Note the explanation given by the Board of Patent Appeals and Interferences in *Ex parte Wu*, 10 USPQ2d 2031, 2033 (Bd. Pat. App. & Inter. 1989), as to where broad language is followed by “such as” and then narrow language. The Board stated that this can render a claim indefinite by raising a question or doubt as to whether the feature introduced by such language is (a) merely exemplary of the remainder of the claim, and therefore not required, or (b) a required feature of the claims. Note also, for example, the decisions of *Ex parte Steigewald*, 131 USPQ 74 (Bd. App. 1961); *Ex parte Hall*, 83 USPQ 38 (Bd.App. 1948); and *Ex parte Hasche*, 86 USPQ 481 (Bd. App. 1949). In the present instance, claim [1] recites the broad recitation [2], and the claim also recites [3] which is the narrower statement of the range/limitation.

**Examiner Note:**

1. In bracket 2, insert the broader range/limitation and where it appears in the claim; in bracket 3, insert the narrow range/limitation and where it appears. This form paragraph may be modified to fit other instances of indefiniteness in the claims.
2. This form paragraph must be preceded by form paragraph 7.34.01.

¶ 7.34.05 *Lack of Antecedent Basis in the Claims*

Claim [1] recites the limitation [2] in [3]. There is insufficient antecedent basis for this limitation in the claim.

**Examiner Note:**

1. In bracket 2, insert the limitation which lacks antecedent basis, for example --said lever-- or --the lever--.
2. In bracket 3, identify where in the claim(s) the limitation appears, for example, --line 3--, --the 3<sup>rd</sup> paragraph of the claim--, --the last 2 lines of the claim--, etc.
3. This form paragraph should ONLY be used in aggravated situations where the lack of antecedent basis makes the scope of the claim indeterminate. It must be preceded by form paragraph 7.34.01.

¶ 7.34.06 *Use Claims*

Claim [1] provides for the use of [2], but, since the claim does not set forth any steps involved in the method/process, it is unclear what method/process applicant is intending to encompass. A claim is indefinite where it merely recites a use without any active, positive steps delimiting how this use is actually practiced. Claim [3] is rejected under 35 U.S.C. 101 because the claimed recitation of a use, without setting forth any steps involved in the process, results in an improper definition of a process, i.e., results in a claim which is not a proper process claim under 35 U.S.C. 101. See for example *Ex parte Dunki*, 153 USPQ 678 (Bd. App. 1967) and *Clinical Products, Ltd. v. Brenner*, 255 F. Supp. 131, 149 USPQ 475 (D.D.C. 1966).

**Examiner Note:**

1. In bracket 2, insert what is being used. For example, insert --the monoclonal antibodies of claim 4--, where the claim recites “a method for using monoclonal antibodies of claim 4 to purify interferon.”
2. See MPEP § 2173.05(q).
3. This form paragraph must be preceded by form paragraph 7.34.01.

¶ 7.34.07 *Claims Are a Literal Translation*

The claims are generally narrative and indefinite, failing to conform with current U.S. practice. They appear to be a literal translation into English from a foreign document and are replete with grammatical and idiomatic errors.

**Examiner Note:**

This form paragraph must be preceded by form paragraph 7.34.01.

¶ 7.34.08 *Indefinite Claim Language: “For Example”*

Regarding claim [1], the phrase “for example” renders the claim indefinite because it is unclear whether the limitation(s) following the phrase are part of the claimed invention. See MPEP § 2173.05(d).

**Examiner Note:**

This form paragraph must be preceded by form paragraph 7.34.01.

¶ 7.34.09 *Indefinite Claim Language: “Or The Like”*

Regarding claim [1], the phrase “or the like” renders the claim(s) indefinite because the claim(s) include(s) elements not actually disclosed (those encompassed by “or the like”), thereby rendering the scope of the claim(s) unascertainable. See MPEP § 2173.05(d).

**Examiner Note:**

This form paragraph must be preceded by form paragraph 7.34.01.

¶ 7.34.10 *Indefinite Claim Language: “Such As”*

Regarding claim [1], the phrase “such as” renders the claim indefinite because it is unclear whether the limitations following the phrase are part of the claimed invention. See MPEP § 2173.05(d).

**Examiner Note:**

This form paragraph must be preceded by form paragraph 7.34.01.

*¶ 7.34.11 Modifier of “Means” Lacks Function*

Regarding claim [1], the word “means” is preceded by the word(s) “[2]” in an attempt to use a “means” clause to recite a claim element as a means for performing a specified function. However, since no function is specified by the word(s) preceding “means,” it is impossible to determine the equivalents of the element, as required by 35 U.S.C. 112, sixth paragraph. See *Ex parte Klumb*, 159 USPQ 694 (Bd. App. 1967).

**Examiner Note:**

1. It is necessary for the words which precede “means” to convey a function to be performed. For example, the phrase “latch means” is definite because the word “latch” conveys the function “latching.” In general, if the phrase can be restated as “means for \_\_\_\_\_,” and it still makes sense, it is definite. In the above example, “latch means” can be restated as “means for latching.” This is clearly definite. However, if “conduit means” is restated as “means for conduiting,” the phrase makes no sense because the word “conduit” has no functional connotation, and the phrase is indefinite.
2. This form paragraph must be preceded by form paragraph 7.34.01.

*¶ 7.34.12 Essential Steps Omitted*

Claim [1] rejected under 35 U.S.C. 112, second paragraph, as being incomplete for omitting essential steps, such omission amounting to a gap between the steps. See MPEP § 2172.01. The omitted steps are: [2]

**Examiner Note:**

1. This rejection must be preceded by form paragraph 7.30.02 or 7.103.
2. In bracket 2, recite the steps omitted from the claims.
3. Give the rationale for considering the omitted steps critical or essential.

*¶ 7.34.13 Essential Elements Omitted*

Claim [1] rejected under 35 U.S.C. 112, second paragraph, as being incomplete for omitting essential elements, such omission amounting to a gap between the elements. See MPEP § 2172.01. The omitted elements are: [2]

**Examiner Note:**

1. This rejection must be preceded by form paragraph 7.30.02 or 7.103.
2. In bracket 2, recite the elements omitted from the claims.
3. Give the rationale for considering the omitted elements critical or essential.

*¶ 7.34.14 Essential Cooperative Relationships Omitted*

Claim [1] rejected under 35 U.S.C. 112, second paragraph, as being incomplete for omitting essential structural cooperative relationships of elements, such omission amounting to a gap between the necessary structural connections. See MPEP § 2172.01. The omitted structural cooperative relationships are: [2]

**Examiner Note:**

1. This rejection must be preceded by form paragraph 7.30.02 or 7.103.
2. In bracket 2, recite the structural cooperative relationships of elements omitted from the claims.
3. Give the rationale for considering the omitted structural cooperative relationships of elements being critical or essential.

*¶ 7.34.15 Rejection Under 35 U.S.C. 112, Pro Se*

Claim [1] rejected as failing to define the invention in the manner required by 35 U.S.C. 112, second paragraph.

The claim(s) are narrative in form and replete with indefinite and functional or operational language. The structure which goes to make up the device must be clearly and positively specified. The structure must be organized and correlated in such a manner as to present a complete operative device. The claim(s) must be in one sentence form only. Note the format of the claims in the patent(s) cited.

*¶ 7.35 Rejection, 35 U.S.C. 112, 2nd Paragraph, Failure To Particularly Point Out And Distinctly Claim - Omnibus Claim*

Claim [1] rejected under 35 U.S.C. 112, second paragraph, as being indefinite in that it fails to point out what is included or excluded by the claim language. This claim is an omnibus type claim.

**Examiner Note:**

1. This rejection must be preceded by form paragraph 7.30.02 or 7.103.
2. Use this paragraph to reject an “omnibus” type claim. No further explanation is necessary.
3. See MPEP § 1302.04(b) for cancellation of such a claim by examiner's amendment upon allowance.
4. An example of an omnibus claim is: “A device substantially as shown and described.”

*¶ 7.35.01 Trademark or Trade Name as a Limitation in the Claim*

Claim [1] contains the trademark/trade name [2]. Where a trademark or trade name is used in a claim as a limitation to identify or describe a particular material or product, the claim does not comply with the requirements of 35 U.S.C. 112, second paragraph. See *Ex parte Simpson*, 218 USPQ 1020 (Bd. App. 1982). The claim scope is uncertain since the trademark or trade name cannot be used properly to identify any particular material or product. A trademark or trade name is used to identify a source of goods, and not the goods themselves. Thus, a trademark or trade name does not identify or describe the goods associated with the trademark or trade name. In the present case, the trademark/trade name is used to identify/describe [3] and, accordingly, the identification/description is indefinite.

**Examiner Note:**

1. In bracket 2, insert the trademark/trade name and where it is used in the claim.
2. In bracket 3, specify the material or product which is identified or described in the claim by the trademark/trade name.

**706.03(k) Duplicate Claims**

Inasmuch as a patent is supposed to be limited to only one invention or, at most, several closely related indivisible inventions, limiting an application to a single claim, or a single claim to each of the related inventions might appear to be logical as well as convenient. However, court decisions have confirmed applicant's right to restate (i.e., by plural claiming) the invention in a reasonable number of ways. Indeed, a mere difference in scope between claims has been held to be enough.

Nevertheless, when two claims in an application are duplicates, or else are so close in content that they both cover the same thing, despite a slight difference in wording, it is proper after allowing one claim to object to the other claim under 37 CFR 1.75 as being a substantial duplicate of the allowed claim.

Form paragraphs 7.05.05 and 7.05.06 may be used where duplicate claims are present in an application.

*¶ 7.05.05 Duplicate Claims, Warning*

Applicant is advised that should claim [1] be found allowable, claim [2] will be objected to under 37 CFR 1.75 as being a substantial duplicate thereof. When two claims in an application are duplicates or else are so close in content that they both cover the same thing, despite a slight difference in wording, it is proper after allowing one claim to object to the other as being a substantial duplicate of the allowed claim. See MPEP § 706.03(k).

**Examiner Note:**

1. Use this form paragraph whenever two claims are found to be substantial duplicates, but they are not allowable. This will give the applicant an opportunity to correct the problem and avoid a later objection.
2. If the claims are allowable, use form paragraph 7.05.06.

*¶ 7.05.06 Duplicate Claims, Objection*

Claim [1] objected under 37 CFR 1.75 as being a substantial duplicate of claim [2]. When two claims in an application are duplicates or else are so close in content that they both cover the same thing, despite a slight difference in wording, it is proper after allowing one claim to object to the other as being a substantial duplicate of the allowed claim. See MPEP § 706.03(k).

**Examiner Note:**

If the duplicate claims are not allowable, use form paragraph 7.05.05.

See MPEP § 804 for double patenting rejections of inventions not patentable over each other.

**706.03(m) Nonelected Inventions**

See MPEP § 821 to § 821.03 for treatment of claims held to be drawn to nonelected inventions.

**706.03(o) New Matter**

*35 U.S.C. 132. Notice of rejection; reexamination.*

(a) Whenever, on examination, any claim for a patent is rejected, or any objection or requirement made, the Director shall notify the applicant thereof, stating the reasons for such rejection, or objection or requirement, together with such information and references as may be useful in judging of the propriety of continuing the prosecution of his application; and if after receiving such notice, the applicant persists in his claim for a patent, with or without amendment, the application shall be reexamined. No amendment shall introduce new matter into the disclosure of the invention.

\*\*\*\*\*

In amended cases, subject matter not disclosed in the original application is sometimes added and a claim directed thereto. Such a claim is rejected on the ground that it recites elements without support in the original disclosure under 35 U.S.C. 112, first paragraph, *Waldemar Link, GmbH & Co. v. Osteonics Corp.* 32 F.3d 556, 559, 31 USPQ2d 1855, 1857 (Fed. Cir. 1994); *In re Rasmussen*, 650 F.2d 1212, 211 USPQ 323 (CCPA 1981). See MPEP § 2163.06 - § 2163.07(b) for a discussion of the relationship of new matter to 35 U.S.C. 112, first paragraph. New matter includes not only the addition of wholly unsupported subject matter, but may also include adding specific percentages or compounds after a broader original disclosure, or even the omission of a step from a method. See MPEP § 608.04 to § 608.04(c). See *In re Wertheim*, 541 F.2d 257, 191 USPQ 90 (CCPA 1976) and MPEP § 2163.05 for guidance in determining whether the addition of specific percentages or compounds after a broader original disclosure constitutes new matter.

In the examination of an application following amendment thereof, the examiner must be on the alert to detect new matter. 35 U.S.C. 132 should be employed as a basis for objection to amendments to the abstract, specification, or drawings attempting to add new disclosure to that originally disclosed on filing.

If subject matter capable of illustration is originally claimed and it is not shown in the drawing, the claim

is not rejected but applicant is required to add it to the drawing. See MPEP § 608.01(1).

If new matter is added to the specification, it should be objected to by using Form Paragraph 7.28.

#### ¶ 7.28 *Objection to New Matter Added to Specification*

The amendment filed [1] is objected to under 35 U.S.C. 132 because it introduces new matter into the disclosure. 35 U.S.C. 132 states that no amendment shall introduce new matter into the disclosure of the invention. The added material which is not supported by the original disclosure is as follows: [2].

Applicant is required to cancel the new matter in the reply to this Office action.

#### **Examiner Note:**

1. This form paragraph is not to be used in reissue applications; use form paragraph 14.22.01 instead.
2. In bracket 2, identify the new matter by page and the line numbers and/or drawing figures and provide an appropriate explanation of your position. This explanation should address any statement by applicant to support the position that the subject matter is described in the specification as filed. It should further include any unresolved questions which raise a doubt as to the possession of the claimed invention at the time of filing.
3. If new matter is added to the claims, or affects the claims, a rejection under 35 U.S.C. 112, first paragraph, using form paragraph 7.31.01 should also be made. If new matter is added only to a claim, an objection using this paragraph should not be made, but the claim should be rejected using form paragraph 7.31.01. As to any other appropriate prior art or 35 U.S.C. 112 rejection, the new matter must be considered as part of the claimed subject matter and cannot be ignored.

### **706.03(s) Foreign Filing Without License**

#### *35 U.S.C. 182. Abandonment of invention for unauthorized disclosure.*

The invention disclosed in an application for patent subject to an order made pursuant to section 181 of this title may be held abandoned upon its being established by the Commissioner of Patents that in violation of said order the invention has been published or disclosed or that an application for a patent therefor has been filed in a foreign country by the inventor, his successors, assigns, or legal representatives, or anyone in privity with him or them, without the consent of the Commissioner of Patents. The abandonment shall be held to have occurred as of the time of violation. The consent of the Commissioner of Patents shall not be given without the concurrence of the heads of the departments and the chief officers of the agencies who caused the order to be issued. A holding of abandonment shall constitute forfeiture by the applicant, his successors, assigns, or legal representatives, or anyone in privity with him or them, of all claims against the United States based upon such invention.

#### *35 U.S.C. 184. Filing of application in foreign country.*

Except when authorized by a license obtained from the Commissioner of Patents a person shall not file or cause or authorize to be filed in any foreign country prior to six months after filing in the United States an application for patent or for the registration of a utility model, industrial design, or model in respect of an invention made in this country. A license shall not be granted with respect to an invention subject to an order issued by the Commissioner of Patents pursuant to section 181 of this title without the concurrence of the head of the departments and the chief officers of the agencies who caused the order to be issued. The license may be granted retroactively where an application has been filed abroad through error and without deceptive intent and the application does not disclose an invention within the scope of section 181 of this title.

The term “application” when used in this chapter includes applications and any modifications, amendments, or supplements thereto, or divisions thereof.

The scope of a license shall permit subsequent modifications, amendments, and supplements containing additional subject matter if the application upon which the request for the license is based is not, or was not, required to be made available for inspection under section 181 of this title and if such modifications, amendments, and supplements do not change the general nature of the invention in a manner which would require such application to be made available for inspection under such section 181. In any case in which a license is not, or was not, required in order to file an application in any foreign country, such subsequent modifications, amendments, and supplements may be made, without a license, to the application filed in the foreign country if the United States application was not required to be made available for inspection under section 181 and if such modifications, amendments, and supplements do not, or did not, change the general nature of the invention in a manner which would require the United States application to have been made available for inspection under such section 181.

#### *35 U.S.C. 185. Patent barred for filing without license.*

Notwithstanding any other provisions of law any person, and his successors, assigns, or legal representatives, shall not receive a United States patent for an invention if that person, or his successors, assigns, or legal representatives shall, without procuring the license prescribed in section 184 of this title, have made, or consented to or assisted another’s making, application in a foreign country for a patent or for the registration of a utility model, industrial design, or model in respect of the invention. A United States patent issued to such person, his successors, assigns, or legal representatives shall be invalid, unless the failure to procure such license was through error and without deceptive intent, and the patent does not disclose subject matter within the scope of section 181 of this title.

If, upon examining an application, the examiner learns of the existence of a corresponding foreign application which appears to have been filed before the United States application had been on file for 6 months, and if the invention apparently was made in

this country, he or she shall refer the application to Licensing and Review Section of Technology Center (TC) working group 3640, calling attention to the foreign application. Pending investigation of the possible violation, the application may be returned to the TC for prosecution on the merits. When it is otherwise in condition for allowance, the application will be again submitted to Licensing and Review Section of TC work group 3640 unless the latter has already reported that the foreign filing involves no bar to the United States application.

If it should be necessary to take action under 35 U.S.C. 185, Licensing and Review Section of TC work group 3640 will request transfer of the application to it.

### 706.03(u) Disclaimer

Claims may be rejected on the ground that applicant has disclaimed the subject matter involved. Such disclaimer may arise, for example, from the applicant's failure to:

(A) make claims suggested for interference with another application under 37 CFR 1.605 (See MPEP § 2305.02),

(B) copy a claim from a patent when suggested by the examiner (MPEP § 2305.02), or

(C) respond or appeal, within the time limit fixed, to the examiner's rejection of claims copied from a patent (see MPEP § 2307.02).

The rejection on disclaimer applies to all claims not patentably distinct from the disclaimed subject matter as well as to the claims directly involved.

Rejections based on disclaimer should be made by using one of Form Paragraphs 7.48 and 7.49.

#### ¶ 7.48 Failure To Present Claims for Interference

Claim [1] rejected under 35 U.S.C. [2] based upon claim [3] of Patent No. [4].

Failure to present claims and/or take necessary steps for interference purposes after notification that interfering subject matter is claimed constitutes a disclaimer of the subject matter. This amounts to a concession that, as a matter of law, the patentee is the first inventor in this country. See *In re Oguie*, 517 F.2d 1382, 186 USPQ 227 (CCPA 1975).

#### Examiner Note:

1. This form paragraph should be used only after applicant has been notified that interference proceedings must be instituted before the claims can be allowed and applicant has refused to copy the claims.

2. In bracket 2, insert --102(g)-- or --102(g)/103(a)--.

3. In bracket 4, insert the patent number, and --in view of \_\_\_\_\_-- if another reference is also relied upon. When the rejection is under 35 U.S.C. 103(a), the examiner's basis for a finding of obviousness should be included. Note that interferences may include obvious variants, see MPEP § 2306.

#### ¶ 7.49 Rejection, Disclaimer, Failure To Appeal

Claim [1] stand finally disposed of for failure to reply to or appeal from the examiner's rejection of such claim(s) presented for interference within the specified time. See 37 CFR 1.661 and 1.663.

### 706.03(v) After Interference or Public Use Proceeding

For rejections following an interference, see MPEP § 2363.03.

The outcome of public use proceedings may also be the basis of a rejection. See 37 CFR 1.292 and *In re Kaslow*, 707 F.2d 1366, 217 USPQ 1089 (Fed. Cir. 1983).

Upon termination of a public use proceeding including a case also involved in an interference, in order for a prompt resumption of the interference proceedings, a notice should be sent to the Board of Patent Appeals and Interferences notifying them of the disposition of the public use proceeding.

### 706.03(w) Res Judicata

*Res judicata* may constitute a proper ground for rejection. However, as noted below, the Court of Customs and Patent Appeals has materially restricted the use of *res judicata* rejections. It should be applied only when the earlier decision was a decision of the Board of Appeals or any one of the reviewing courts and when there is no opportunity for further court review of the earlier decision.

The timely filing of a second application copending with an earlier application does not preclude the use of *res judicata* as a ground of rejection for the second application claims.

When making a rejection on *res judicata*, action should ordinarily be made also on the basis of prior art, especially in continuing applications. In most situations the same prior art which was relied upon in the earlier decision would again be applicable.

In the following cases a rejection of a claim on the ground of *res judicata* was sustained where it was based on a prior adjudication, against the inventor on



the same claim, a patentably nondistinct claim, or a claim involving the same issue.

*In re Freeman*, 30 F.3d 1459, 31 USPQ 2d 1444 (Fed. Cir. 1994).

*Edgerton v. Kingland*, 168 F. 2d 121, 75 USPQ 307 (D.C. Cir. 1947).

*In re Szwarc*, 319 F.2d 277, 138 USPQ 208 (CCPA 1963).

*In re Katz*, 467 F.2d 939, 167 USPQ 487 (CCPA 1970) (prior decision by District Court).

In the following cases for various reasons, *res judicata* rejections were reversed.

*In re Fried*, 312 F.2d 930, 136 USPQ 429 (CCPA 1963) (differences in claims).

*In re Szwarc*, 319 F.2d 277, 138 USPQ 208 (CCPA 1963) (differences in claim).

*In re Hellbaum*, 371 F.2d 1022, 152 USPQ 571 (CCPA 1967) (differences in claims).

*In re Herr*, 377 F.2d 610, 153 USPQ 548 (CCPA 1967) (same claims, new evidence, prior decision by CCPA).

*In re Kaghan*, 387 F.2d 398, 156 USPQ 130 (CCPA 1967) (prior decision by Board of Appeals, final rejection on prior art withdrawn by examiner “to simplify the issue,” differences in claims; holding of waiver based on language in MPEP at the time).

*In re Craig*, 411 F.2d 1333, 162 USPQ 157 (CCPA 1969) (Board of Appeals held second set of claims patentable over prior art).

*In re Fisher*, 427 F.2d 833, 166 USPQ 18 (CCPA 1970) (difference in claims).

*In re Russell*, 439 F.2d 1228, 169 USPQ 426 (CCPA 1971) (new evidence, rejection on prior art reversed by court).

*In re Ackermann*, 444 F.2d 1172, 170 USPQ 340 (CCPA 1971) (prior decision by Board of Appeals, new evidence, rejection on prior art reversed by court).

*Plastic Contact Lens Co. v. Gottschalk*, 484 F.2d 837, 179 USPQ 262 (D.C. Cir. 1973) (follows *In re Kaghan*).

### 706.03(x) Reissue

The examination of reissue applications is covered in MPEP Chapter 1400.

35 U.S.C. 251 forbids the granting of a reissue “enlarging the scope of the claims of the original patent” unless the reissue is applied for within 2 years

from the grant of the original patent. This is an absolute bar and cannot be excused. This prohibition has been interpreted to apply to any claim which is broader in any respect than the claims of the original patent. Such claims may be rejected as being barred by 35 U.S.C. 251. However, when the reissue is applied for within 2 years, the examiner does not go into the question of undue delay.

The same section permits the filing of a reissue application by the assignee of the entire interest only in cases where it does not “enlarge the scope of the claims of the original patent.” Such claims which do enlarge the scope may also be rejected as barred by the statute. In *In re Bennett*, 766 F.2d 524, 226 USPQ 413 (Fed. Cir. 1985), however, the court permitted the erroneous filing by the assignee in such a case to be corrected.

A defective reissue oath affords a ground for rejecting all the claims in the reissue application. See MPEP § 1444.

Note that a reissue application is “special” and remains so even if applicant does not make a prompt reply.

### 706.04 Rejection of Previously Allowed Claims [R-1]

A claim noted as allowable shall thereafter be rejected only after the proposed rejection has been submitted to the primary examiner for consideration of all the facts and approval of the proposed action.

Great care should be exercised in authorizing such a rejection. See *Ex parte Grier*, 1923 C.D. 27, 309 O.G. 223 (Comm’r Pat. 1923); *Ex parte Hay*, 1909 C.D. 18, 139 O.G. 197 (Comm’r Pat. 1909).

### PREVIOUS ACTION BY DIFFERENT EXAMINER

Full faith and credit should be given to the search and action of a previous examiner unless there is a clear error in the previous action or knowledge of other prior art. In general, an examiner should not take an entirely new approach or attempt to reorient the point of view of a previous examiner, or make a new search in the mere hope of finding something. >*Amgen, Inc. v. Hoechst Marion Roussel, Inc.*, 126 F. Supp. 2d 69, 139, 57 USPQ2d 1449, 1499-50 (D. Mass. 2001).<

Because it is unusual to reject a previously allowed claim, the examiner should point out in his or her office action that the claim now being rejected was previously allowed by using Form Paragraph 7.50.

¶ 7.50 *Claims Previously Allowed, Now Rejected, New Art*

The indicated allowability of claim [1] is withdrawn in view of the newly discovered reference(s) to [2]. Rejection(s) based on the newly cited reference(s) follow.

**Examiner Note:**

1. In bracket 2, insert the name(s) of the newly discovered reference.
2. Any action including this form paragraph requires the signature of a Primary Examiner. MPEP § 1004.

## 706.05 Rejection After Allowance of Application

See MPEP § 1308.01 for a rejection based on a reference after allowance.

## 706.06 Rejection of Claims Copied From Patent

See MPEP § 2307.02.

## 706.07 Final Rejection [R-2]

37 CFR 1.113. *Final rejection or action.*

\*\*>

(a) On the second or any subsequent examination or consideration by the examiner the rejection or other action may be made final, whereupon applicants, or for *ex parte* reexaminations filed under § 1.510, patent owner's reply is limited to appeal in the case of rejection of any claim (§ 1.191), or to amendment as specified in § 1.114 or § 1.116. Petition may be taken to the Director in the case of objections or requirements not involved in the rejection of any claim (§ 1.181). Reply to a final rejection or action must comply with § 1.114 or paragraph (c) of this section. For final actions in an *inter partes* reexamination filed under § 1.913, see § 1.953.<

(b) In making such final rejection, the examiner shall repeat or state all grounds of rejection then considered applicable to the claims in the application, clearly stating the reasons in support thereof.

(c) Reply to a final rejection or action must include cancellation of, or appeal from the rejection of, each rejected claim. If any claim stands allowed, the reply to a final rejection or action must comply with any requirements or objections as to form.

Before final rejection is in order a clear issue should be developed between the examiner and applicant. To bring the prosecution to as speedy conclusion as possible and at the same time to deal justly by both

the applicant and the public, the invention as disclosed and claimed should be thoroughly searched in the first action and the references fully applied; and in reply to this action the applicant should amend with a view to avoiding all the grounds of rejection and objection. Switching from one subject matter to another in the claims presented by applicant in successive amendments, or from one set of references to another by the examiner in rejecting in successive actions claims of substantially the same subject matter, will alike tend to defeat attaining the goal of reaching a clearly defined issue for an early termination, i.e., either an allowance of the application or a final rejection.

While the rules no longer give to an applicant the right to "amend as often as the examiner presents new references or reasons for rejection," present practice does not sanction hasty and ill-considered final rejections. The applicant who is seeking to define his or her invention in claims that will give him or her the patent protection to which he or she is justly entitled should receive the cooperation of the examiner to that end, and not be prematurely cut off in the prosecution of his or her application. But the applicant who dallies in the prosecution of his or her application, resorting to technical or other obvious subterfuges in order to keep the application pending before the primary examiner, can no longer find a refuge in the rules to ward off a final rejection.

The examiner should never lose sight of the fact that in every case the applicant is entitled to a full and fair hearing, and that a clear issue between applicant and examiner should be developed, if possible, before appeal. However, it is to the interest of the applicants as a class as well as to that of the public that prosecution of an application be confined to as few actions as is consistent with a thorough consideration of its merits.

Neither the statutes nor the Rules of Practice confer any right on an applicant to an extended prosecution; *Ex parte Hoogendam*, 1939 C.D. 3, 499 O.G.3, 40 USPQ 389 (Comm'r Pat. 1939).

## STATEMENT OF GROUNDS

In making the final rejection, all outstanding grounds of rejection of record should be carefully reviewed, and any such grounds relied on in the final rejection should be reiterated. They must also be

clearly developed to such an extent that applicant may readily judge the advisability of an appeal unless a single previous Office action contains a complete statement supporting the rejection.

However, where a single previous Office action contains a complete statement of a ground of rejection, the final rejection may refer to such a statement and also should include a rebuttal of any arguments raised in the applicant's reply. If appeal is taken in such a case, the examiner's answer should contain a complete statement of the examiner's position. The final rejection letter should conclude with Form Paragraph 7.39.

#### ¶ 7.39 Action Is Final

THIS ACTION IS MADE FINAL. Applicant is reminded of the extension of time policy as set forth in 37 CFR 1.136(a).

A shortened statutory period for reply to this final action is set to expire THREE MONTHS from the mailing date of this action. In the event a first reply is filed within TWO MONTHS of the mailing date of this final action and the advisory action is not mailed until after the end of the THREE-MONTH shortened statutory period, then the shortened statutory period will expire on the date the advisory action is mailed, and any extension fee pursuant to 37 CFR 1.136(a) will be calculated from the mailing date of the advisory action. In no event, however, will the statutory period for reply expire later than SIX MONTHS from the mailing date of this final action.

#### Examiner Note:

1. This form paragraph should **not** be used in reissue litigation cases (SSP- 1 month) or in reexamination proceedings (SSP- 1 or 2 months).
2. 37 CFR 1.136(a) should not be available in a reissue litigation case and is not available in reexamination proceedings.

Form paragraph 7.39.01 may be used to notify applicant of options available after final rejection.

#### ¶ 7.39.01 Final Rejection, Options for Applicant, Pro Se

This action is a **final rejection** and is intended to close the prosecution of this application. Applicant's reply under 37 CFR 1.113 to this action is limited either to an appeal to the Board of Patent Appeals and Interferences or to an amendment complying with the requirements set forth below.

If applicant should desire to appeal any rejection made by the examiner, a Notice of Appeal must be filed within the period for reply identifying the rejected claim or claims appealed. The Notice of Appeal must be accompanied by the required appeal fee of \$[1].

If applicant should desire to file an amendment, entry of a proposed amendment after final rejection cannot be made as a matter of right unless it merely cancels claims or complies with a formal requirement made earlier. Amendments touching the merits of the application which otherwise might not be proper may be admitted

upon a showing a good and sufficient reasons why they are necessary and why they were not presented earlier.

A reply under 37 CFR 1.113 to a final rejection must include the appeal from, or cancellation of, each rejected claim. The filing of an amendment after final rejection, whether or not it is entered, does not stop the running of the statutory period for reply to the final rejection unless the examiner holds the claims to be in condition for allowance. Accordingly, if a Notice of Appeal has not been filed properly within the period for reply, or any extension of this period obtained under either 37 CFR 1.136(a) or (b), the application will become abandoned.

#### Examiner Note:

The form paragraph must be preceded by any one of form paragraphs 7.39, 7.40, 7.40.01, 7.41, 7.42.03, or 7.42.09.

The Office Action Summary Form PTOL-326 should be used in all Office actions up to and including final rejections.

For amendments filed after final rejection, see MPEP § 714.12 and § 714.13.

For final rejection practice in reexamination proceedings see MPEP § 2271.

### 706.07(a) Final Rejection, When Proper on Second Action [R-1]

Due to the change in practice as affecting final rejections, older decisions on questions of prematureness of final rejection or admission of subsequent amendments do not necessarily reflect present practice.

Under present practice, second or any subsequent actions on the merits shall be final, except where the examiner introduces a new ground of rejection that is neither necessitated by applicant's amendment of the claims nor based on information submitted in an information disclosure statement filed during the period set forth in 37 CFR 1.97(c) with the fee set forth in 37 CFR 1.17(p). Where information is submitted in an information disclosure statement during the period set forth in 37 CFR 1.97(c) with a fee, the examiner may use the information submitted, e.g., a printed publication or evidence of public use, and make the next Office action final whether or not the claims have been amended, provided that no other new ground of rejection which was not necessitated by amendment to the claims is introduced by the examiner. See MPEP § 609 paragraph (B)(2). Furthermore, a second or any subsequent action on the merits in any application or patent undergoing reexamination proceedings will not be made final if it includes a

rejection, on newly cited art, other than information submitted in an information disclosure statement filed under 37 CFR 1.97(c) with the fee set forth in 37 CFR 1.17 (p), of any claim not amended by applicant or patent owner in spite of the fact that other claims may have been amended to require newly cited art. Where information is submitted in a reply to a requirement under 37 CFR 1.105, the examiner may NOT make the next Office action relying on that art final unless all instances of the application of such art are necessitated by amendment.

A second or any subsequent action on the merits in any application or patent involved in reexamination proceedings should not be made final if it includes a rejection, on prior art not of record, of any claim amended to include limitations which should reasonably have been expected to be claimed. See MPEP § 904 *et seq.* For example, one would reasonably expect that a rejection under 35 U.S.C. 112 for the reason of incompleteness would be replied to by an amendment supplying the omitted element.

>A second or any subsequent action on the merits in any application or patent involved in reexamination proceedings may not be made final if it contains a new ground of rejection necessitated by the amendments to 35 U.S.C. 102(e) by the Intellectual Property and High Technology Technical Amendments Act of 2002 (Pub. L. 107-273, 116 Stat. 1758 (2002)), unless the new ground of rejection was necessitated by an amendment to the claims or as a result of information submitted in an information disclosure statement under 37 CFR 1.97(c) with the fee set forth in 37 CFR 1.17(p).<

When applying any 35 U.S.C. 102(e)/103 references against the claims of an application filed on or after November 29, 1999, the examiner should anticipate that a statement averring common ownership at the time the invention was made may disqualify any patent or application applied in a rejection under 35 U.S.C. 103 based on 35 U.S.C. 102(e). If such a statement is filed in reply to the 35 U.S.C. 102(e)/103 rejection and the claims are not amended, the examiner may not make the next Office action final if a new rejection is made. See MPEP § 706.02(1)(3).

See MPEP § 809.02(a) for actions which indicate generic claims as not allowable.

In the consideration of claims in an amended case where no attempt is made to point out the patentable

novelty, the examiner should be on guard not to allow such claims. See MPEP § 714.04. The claims may be finally rejected if, in the opinion of the examiner, they are clearly open to rejection on grounds of record.

Form paragraph 7.40 should be used where an action is made final including new grounds of rejection necessitated by applicant's amendment.

*¶ 7.40 Action Is Final, Necessitated by Amendment*

Applicant's amendment necessitated the new ground(s) of rejection presented in this Office action. Accordingly, **THIS ACTION IS MADE FINAL**. See MPEP § 706.07(a). Applicant is reminded of the extension of time policy as set forth in 37 CFR 1.136(a).

A shortened statutory period for reply to this final action is set to expire THREE MONTHS from the mailing date of this action. In the event a first reply is filed within TWO MONTHS of the mailing date of this final action and the advisory action is not mailed until after the end of the THREE-MONTH shortened statutory period, then the shortened statutory period will expire on the date the advisory action is mailed, and any extension fee pursuant to 37 CFR 1.136(a) will be calculated from the mailing date of the advisory action. In no event, however, will the statutory period for reply expire later than SIX MONTHS from the mailing date of this final action.

**Examiner Note:**

1. This form paragraph should **not** be used in reissue litigation cases (SSP- 1 month) or in reexamination proceedings (SSP- 1 or 2 months).
2. 37 CFR 1.136(a) should not be available in a reissue litigation case and is not available in reexamination proceedings.

*¶ 7.40.01 Action Is Final, Necessitated by IDS With Fee*

Applicant's submission of an information disclosure statement under 37 CFR 1.97(c) with the fee set forth in 37 CFR 1.17(p) on [1] prompted the new ground(s) of rejection presented in this Office action. Accordingly, **THIS ACTION IS MADE FINAL**. See MPEP § 609(B)(2)(i). Applicant is reminded of the extension of time policy as set forth in 37 CFR 1.136(a).

A shortened statutory period for reply to this final action is set to expire THREE MONTHS from the mailing date of this action. In the event a first reply is filed within TWO MONTHS of the mailing date of this final action and the advisory action is not mailed until after the end of the THREE-MONTH shortened statutory period, then the shortened statutory period will expire on the date the advisory action is mailed, and any extension fee pursuant to 37 CFR 1.136(a) will be calculated from the mailing date of the advisory action. In no event, however, will the statutory period for reply expire later than SIX MONTHS from the mailing date of this final action.

**Examiner Note:**

1. This form paragraph should **not** be used and a final rejection is improper where there is another new ground of rejection introduced by the examiner which was not necessitated by amendment to the claims.

2. In bracket 1, insert the filing date of the information disclosure statement containing the identification of the item of information used in the new ground of rejection.

### 706.07(b) Final Rejection, When Proper on First Action [R-1]

The claims of a new application may be finally rejected in the first Office action in those situations where (A) the new application is a continuing application of, or a substitute for, an earlier application, and (B) all claims of the new application (1) are drawn to the same invention claimed in the earlier application, and (2) would have been properly finally rejected on the grounds and art of record in the next Office action if they had been entered in the earlier application.

>A first Office action in a continuing or substitute application may not be made final if it contains a new ground of rejection necessitated by the amendments to 35 U.S.C. 102(e) by the Intellectual Property and High Technology Technical Amendments of 2002 (Pub. L. 107-273, 116 Stat. 1758 (2002)).<

However, it would not be proper to make final a first Office action in a continuing or substitute application where that application contains material which was presented in the earlier application after final rejection or closing of prosecution but was denied entry because (A) new issues were raised that required further consideration and/or search, or (B) the issue of new matter was raised.

Further, it would not be proper to make final a first Office action in a continuation-in-part application where any claim includes subject matter not present in the earlier application.

A request for an interview prior to first action on a continuing or substitute application should ordinarily be granted.

A first action final rejection should be made by using Form Paragraphs 7.41 or 7.41.03, as appropriate.

#### ¶ 7.41 Action Is Final, First Action

This is a [1] of applicant's earlier Application No. [2]. All claims are drawn to the same invention claimed in the earlier application and could have been finally rejected on the grounds and art of record in the next Office action if they had been entered in the earlier application. Accordingly, **THIS ACTION IS MADE FINAL** even though it is a first action in this case. See MPEP § 706.07(b). Applicant is reminded of the extension of time policy as set forth in 37 CFR 1.136(a).

A shortened statutory period for reply to this final action is set to expire **THREE MONTHS** from the mailing date of this action. In the event a first reply is filed within **TWO MONTHS** of the mailing date of this final action and the advisory action is not mailed until after the end of the **THREE-MONTH** shortened statutory period, then the shortened statutory period will expire on the date the advisory action is mailed, and any extension fee pursuant to 37 CFR 1.136(a) will be calculated from the mailing date of the advisory action. In no event, however, will the statutory period for reply expire later than **SIX MONTHS** from the mailing date of this final action.

#### Examiner Note:

1. In bracket 1, insert either --continuation-- or --substitute--, as appropriate.
2. If an amendment was refused entry in the parent case on the grounds that it raised new issues or new matter, this form paragraph cannot be used. See MPEP § 706.07(b).
3. This form paragraph should **not** be used in reissue litigation cases (SSP- 1 month) or in reexamination proceedings (SSP-1 or 2 months).
4. 37 CFR 1.136(a) should not be available in a reissue litigation case and is not available in reexamination proceedings.

#### ¶ 7.41.03 Action Is Final, First Action Following Submission Under 37 CFR 1.53(d), Continued Prosecution Application (CPA)

All claims are drawn to the same invention claimed in the parent application prior to the filing of this Continued Prosecution Application under 37 CFR 1.53(d) and could have been finally rejected on the grounds and art of record in the next Office action. Accordingly, **THIS ACTION IS MADE FINAL** even though it is a first action after the filing under 37 CFR 1.53(d). Applicant is reminded of the extension of time policy as set forth in 37 CFR 1.136(a).

A shortened statutory period for reply to this final action is set to expire **THREE MONTHS** from the mailing date of this action. In the event a first reply is filed within **TWO MONTHS** of the mailing date of this final action and the advisory action is not mailed until after the end of the **THREE-MONTH** shortened statutory period, then the shortened statutory period will expire on the date the advisory action is mailed, and any extension fee pursuant to 37 CFR 1.136(a) will be calculated from the mailing date of the advisory action. In no event, however, will the statutory period for reply expire later than **SIX MONTHS** from the mailing date of this final action.

#### Examiner Note:

1. This form paragraph is for a first action final rejection in a Continued Prosecution Application filed under 37 CFR 1.53(d).
2. This form paragraph must be preceded by one of form paragraphs 2.30 or 2.35, as appropriate.

#### ¶ 7.42.09 Action Is Final, First Action Following Request for Continued Examination under 37 CFR 1.114

All claims are drawn to the same invention claimed in the application prior to the entry of the submission under 37 CFR 1.114 and could have been finally rejected on the grounds and art

of record in the next Office action if they had been entered in the application prior to entry under 37 CFR 1.114. Accordingly, **THIS ACTION IS MADE FINAL** even though it is a first action after the filing of a request for continued examination and the submission under 37 CFR 1.114. See MPEP § 706.07(b). Applicant is reminded of the extension of time policy as set forth in 37 CFR 1.136(a).

A shortened statutory period for reply to this final action is set to expire **THREE MONTHS** from the mailing date of this action. In the event a first reply is filed within **TWO MONTHS** of the mailing date of this final action and the advisory action is not mailed until after the end of the **THREE-MONTH** shortened statutory period, then the shortened statutory period will expire on the date the advisory action is mailed, and any extension fee pursuant to 37 CFR 1.136(a) will be calculated from the mailing date of the advisory action. In no event, however, will the statutory period for reply expire later than **SIX MONTHS** from the mailing date of this final action.

#### **Examiner Note:**

This form paragraph is for a first action final rejection following a Request for Continued Examination filed under 37 CFR 1.114.

### **706.07(c) Final Rejection, Premature**

Any question as to prematureness of a final rejection should be raised, if at all, while the application is still pending before the primary examiner. This is purely a question of practice, wholly distinct from the tenability of the rejection. It may therefore not be advanced as a ground for appeal, or made the basis of complaint before the Board of Patent Appeals and Interferences. It is reviewable by petition under 37 CFR 1.181. See MPEP § 1002.02(c).

### **706.07(d) Final Rejection, Withdrawal of, Premature**

If, on request by applicant for reconsideration, the primary examiner finds the final rejection to have been premature, he or she should withdraw the finality of the rejection. The finality of the Office action must be withdrawn while the application is still pending. The examiner cannot vacate the final rejection once the application is abandoned.

Form paragraph 7.42 should be used when withdrawing the finality of the rejection of the last Office action.

#### *¶ 7.42 Withdrawal of Finality of Last Office Action*

Applicant's request for reconsideration of the finality of the rejection of the last Office action is persuasive and, therefore, the finality of that action is withdrawn.

### **706.07(e) Withdrawal of Final Rejection, General**

See MPEP § 714.12 and § 714.13 for amendments after final rejection.

Once a final rejection that is not premature has been entered in an application/reexamination proceeding, it should not be withdrawn at the applicant's or patent owner's request except on a showing under 37 CFR 1.116(b). Further amendment or argument will be considered in certain instances. An amendment that will place the application either in condition for allowance or in better form for appeal may be admitted. Also, amendments complying with objections or requirements as to form are to be permitted after final action in accordance with 37 CFR 1.116(a).

The examiner may withdraw the rejection of finally rejected claims. If new facts or reasons are presented such as to convince the examiner that the previously rejected claims are in fact allowable or patentable in the case of reexamination, then the final rejection should be withdrawn. Occasionally, the finality of a rejection may be withdrawn in order to apply a new ground of rejection.

Although it is permissible to withdraw a final rejection for the purpose of entering a new ground of rejection, this practice is to be limited to situations where a new reference either fully meets at least one claim or meets it except for differences which are shown to be completely obvious. Normally, the previous rejection should be withdrawn with respect to the claim or claims involved.

The practice should not be used for application of subsidiary references, or of cumulative references, or of references which are merely considered to be better than those of record.

When a final rejection is withdrawn, all amendments filed after the final rejection are ordinarily entered.

New grounds of rejection made in an Office action reopening prosecution after the filing of an appeal brief require the approval of the supervisory patent examiner. See MPEP § 1002.02(d).

### **706.07(f) Time for Reply to Final Rejection [R-2]**

The time for reply to a final rejection is as follows:

(A) All final rejections setting a 3-month shortened statutory period (SSP) for reply should contain one of form paragraphs 7.39, 7.40, 7.40.01, 7.41, 7.41.03, or 7.42.09 advising applicant that if the reply is filed within 2 months of the date of the final Office action, the shortened statutory period will expire at 3 months from the date of the final rejection or on the date the advisory action is mailed, whichever is later. Thus, a variable reply period will be established. If the last day of “2 months of the date of the final Office action” falls on Saturday, Sunday, or a Federal holiday within the District of Columbia, and a reply is filed on the next succeeding day which is not a Saturday, Sunday, or a Federal holiday, pursuant to 37 CFR 1.7(a), the reply is deemed to have been filed within the 2 months period and the shortened statutory period will expire at 3 months from the date of the final rejection or on the mailing date of the advisory action, whichever is later (see MPEP § 710.05). In no event can the statutory period for reply expire later than 6 months from the >mailing< date of the final rejection.

(B) If the form paragraph setting a variable reply period is inadvertently not included in the final Office action, the SSP for reply will end 3 months from the date of the final Office action and cannot be extended other than by making a petition and paying a fee pursuant to 37 CFR 1.136(a). However, if an advisory action is mailed in such a case where the reply to the final action has been filed within 2 months, the examiner should vacate the original SSP and reset the period for reply to correspond with the Office policy set forth in the Notice entitled “Procedure for Handling Amendments Under 37 CFR 1.116,” 1027 O.G. 71 (Feb. 8, 1983). See paragraph (F) below.

(C) This procedure of setting a variable reply period in the final rejection dependent on when applicant files a first reply to a final Office action does not apply to situations where a SSP less than 3 months is set, e.g., reissue litigation applications (1-month SSP) or any reexamination proceeding.

>

## I. < ADVISORY ACTIONS

(D) Where the final Office action sets a variable reply period as set forth in paragraph (A) above AND applicant files a complete first reply to the final Office

action within 2 months of the date of the final Office action, the examiner must determine if the reply:

(1) places the application in condition for allowance — then the application should be processed as an allowance and no extension fees are due;

(2) places the application in condition for allowance except for matters of form which the examiner can change without authorization from applicant, MPEP § 1302.04 — then the application should be amended as required and processed as an allowance and no extension fees are due; or

(3) does not place the application in condition for allowance — then the advisory action should inform applicant that the SSP for reply expires 3 months from the date of the final rejection or as of the mailing date of the advisory action, whichever is later, by checking the appropriate box at the top portion of the Advisory Action form, PTOL-303.

If PTOL-303 is not used, then use Form Paragraph 7.67.01 on all advisory actions where a first complete reply has been filed within 2 months of the date of the final Office action.

### ¶ 7.67.01 *Advisory After Final, Heading, 1st Reply Filed Within 2 Months*

The shortened statutory period for reply expires THREE MONTHS from the mailing date of the final rejection or as of the mailing date of this advisory action, whichever is later. In no event, however, will the statutory period for reply expire later than SIX MONTHS from the mailing date of the final rejection.

Any extension fee required pursuant to 37 CFR 1.17 will be calculated from the date that the shortened statutory period for reply expires as set forth above.

#### **Examiner Note:**

1. This form paragraph should be used in all advisory actions if:
  - a. it was the FIRST reply to the to the final rejection, and
  - b. it was filed within two months of the date of the final rejection.
2. If a notice of appeal has been filed, also use form paragraph 7.68.
3. DO NOT USE THIS FORM PARAGRAPH FOR REEXAMINATION PROCEEDINGS.
4. Follow with form paragraph 7.41.01 if transitional provisions of 37 CFR 1.129(a) are applicable.

(E) Where the final Office action sets a variable reply period as set forth in paragraph (A) above, and applicant does NOT file a complete first reply to the final Office action within 2 months, examiners should use form paragraph 7.67.

(F) Where the final Office action does not set a variable reply period as set forth in paragraph (A)

above AND applicant does file a complete first reply to the final Office action within 2 months, and if an advisory action is necessary and cannot be mailed within 3 months of the final Office action, the examiner should vacate the original SSP and reset the reply period to expire on the mailing date of the advisory action by using form paragraph 7.67.02. In no case can the statutory period for reply expire later than 6 months from the date of the final Office action. Note that form paragraph 7.67.02 can be used with the advisory action (preferable) or after the advisory action is mailed to correct the error of not setting a variable reply period.

*¶ 7.67.02 Advisory After Final, Heading, No Variable SSP Set in Final*

Since the first reply to the final Office action was filed within TWO MONTHS of the mailing date of that action and the advisory action was not mailed within THREE MONTHS of that date, the THREE-MONTH shortened statutory period for reply set in the final Office action is hereby vacated and reset to expire as of the mailing date of this advisory action. See Notice entitled "Procedure for Handling Amendments Under 37 CFR 1.116," published in the *Official Gazette* at 1027 O.G. 71, February 8, 1983. In no event, however, will the statutory period for reply expire later than SIX MONTHS from the mailing date of the final Office action.

Any extension fee required pursuant to 37 CFR 1.17 will be calculated from the mailing date of the advisory action.

**Examiner Note:**

1. This form paragraph should be used in all advisory actions where:
  - a. the reply is a first reply to the final action;
  - b. the reply was filed within two months of the mailing date of the final; and
  - c. the final action failed to inform applicant of a variable SSP beyond the normal three month period, as is set forth in form paragraphs 7.39 to 7.41.
2. If the final action set a variable SSP, do not use this form paragraph, use form paragraph 7.67.01 instead.
3. If a notice of appeal has been filed, also use form paragraph 7.68.
4. Follow with form paragraph 7.41.01 if transitional provisions of 37 CFR 1.129(a) are applicable.

(G) When an advisory action properly contains either form paragraph 7.67.01 or 7.67.02, the time for applicant to take further action (including the calculation of extension fees under 37 CFR 1.136(a)) begins to run 3 months from the date of the final rejection, or from the date of the advisory action, whichever is later. Extension fees cannot be prorated for portions of a month. In no event can the statutory period for

reply expire later than 6 months from the date of the final rejection. For example, if applicant initially replies within 2 months from the date of mailing of a final rejection and the examiner mails an advisory action before the end of 3 months from the date of mailing of the final rejection, the shortened statutory period will expire at the end of 3 months from the date of mailing of the final rejection. In such case, if a petition for extension of time is granted, the due date for a reply is computed from the date stamped or printed on the Office action with the final rejection. See MPEP § 710.01(a). If the examiner, however, does not mail an advisory action until after the end of the 3-month period, the shortened statutory period will expire on the date the examiner mails the advisory action and any extension of time fee would be calculated from the mailing date of the advisory action.

>

**II. < EXAMINER'S AMENDMENTS**

(H) Where a complete first reply to a final Office action has been filed within 2 months of the final Office action, an examiner's amendment to place the application in condition for allowance may be made without the payment of extension fees even if the examiner's amendment is made more than 3 months from the date of the final Office action. Note that an examiner's amendment may not be made more than 6 months from the date of the final Office action, as the application would be abandoned at that point by operation of law.

(I) Where a complete first reply to a final Office action has not been filed within 2 months of the final Office action, applicant's authorization to make an amendment to place the application in condition for allowance must be made either within the 3 month shortened statutory period or within an extended period for reply that has been petitioned and paid for by applicant pursuant to 37 CFR 1.136(a). However, an examiner's amendment correcting only formal matters which are identified for the first time after a reply is made to a final Office action would not require any extension fee, since the reply to the final Office action put the application in condition for allowance except for the correction of formal matters, the correction of which had not yet been required by the examiner.



(J) An extension of time under 37 CFR 1.136(a) requires a petition for an extension and the appropriate fee provided for in 37 CFR 1.17. Where an extension of time is necessary to place an application in condition for allowance (e.g., when an examiner's amendment is necessary after the shortened statutory period for reply has expired), applicant may file the required petition and fee or give authorization to the examiner to make the petition of record and charge a specified fee to a deposit account. Office employees may not accept oral (telephonic) instructions to complete the Credit Card Payment Form or otherwise charge a patent process or trademark process fee (as opposed to information product or service fees) to a credit card. When authorization to make a petition for an extension of time of record is given to the examiner, the authorization must be given before the extended period expires. The authorization must be made of record in an examiner's amendment by indicating the name of the person making the authorization, when the authorization was given, the deposit account number to be charged, the length of the extension requested and the amount of the fee to be charged to the deposit account. Form Paragraph 13.02.02 should be used.

\*\*>

¶ 13.02.02 *Extension of Time and Examiner's Amendment Authorized by Telephone*

An extension of time under 37 CFR 1.136(a) is required in order to make an examiner's amendment which places this application in condition for allowance. During a telephone conversation conducted on [1], [2] requested an extension of time for [3] MONTH(S) and authorized the Director to charge Deposit Account No. [4] the required fee of \$ [5] for this extension and authorized the following examiner's amendment. Should the changes and/or additions be unacceptable to applicant, an amendment may be filed as provided by 37 CFR 1.312. To ensure consideration of such an amendment, it MUST be submitted no later than the payment of the issue fee.

**Examiner Note:**

See MPEP § 706.07(f), item (J) which explains when an extension of time is needed in order to make amendments to place the application in condition for allowance.

### III. < PRACTICE AFTER FINAL

(K) Replies after final should be processed and considered promptly by all Office personnel.

(L) Replies after final should not be considered by the examiner unless they are filed within the SSP or are accompanied by a petition for an extension of time and the appropriate fee (37 CFR 1.17 and 37 CFR 1.136(a)). See also MPEP § 710.02(e). This requirement also applies to supplemental replies filed after the first reply.

(M) Interviews may be conducted after the expiration of the shortened statutory period for reply to a final Office action but within the 6-month statutory period for reply *without* the payment of an extension fee.

(N) Formal matters which are identified for the first time after a reply is made to a final Office action and which require action by applicant to correct may be required in an *Ex parte Quayle* action if the application is otherwise in condition for allowance. No extension fees would be required since the reply puts the application in condition for allowance except for the correction of formal matters — the correction of which had not yet been required by the examiner.

(O) If prosecution is to be reopened after a final Office action has been replied to, the finality of the previous Office action should be withdrawn to avoid the issue of abandonment and the payment of extension fees. For example, if a new reference comes to the attention of the examiner which renders unpatentable a claim indicated to be allowable, the Office action should begin with a statement to the effect: "The finality of the Office action mailed is hereby withdrawn in view of the new ground of rejection set forth below." Form paragraph 7.42 could be used in addition to this statement. See MPEP § 706.07(d).

### 706.07(g) Transitional After-Final Practice

37 CFR 1.129. *Transitional procedures for limited examination after final rejection and restriction practice.*

(a) An applicant in an application, other than for reissue or a design patent, that has been pending for at least two years as of June 8, 1995, taking into account any reference made in such application to any earlier filed application under 35 U.S.C. 120, 121 and 365(c), is entitled to have a first submission entered and considered on the merits after final rejection under the following circumstances: The Office will consider such a submission, if the first submission and the fee set forth in § 1.17(r) are filed prior to the filing of an appeal brief and prior to abandonment of the application. The finality of the final rejection is automatically withdrawn upon the timely filing of the submission and payment of the fee set forth in § 1.17(r). If a subsequent final rejection is made in

the application, applicant is entitled to have a second submission entered and considered on the merits after the subsequent final rejection under the following circumstances: The Office will consider such a submission, if the second submission and a second fee set forth in § 1.17(r) are filed prior to the filing of an appeal brief and prior to abandonment of the application. The finality of the subsequent final rejection is automatically withdrawn upon the timely filing of the submission and payment of the second fee set forth in § 1.17(r). Any submission filed after a final rejection made in an application subsequent to the fee set forth in § 1.17(r) having been twice paid will be treated as set forth in § 1.116. A submission as used in this paragraph includes, but is not limited to, an information disclosure statement, an amendment to the written description, claims or drawings and a new substantive argument or new evidence in support of patentability.

\*\*\*\*\*

(c) The provisions of this section shall not be applicable to any application filed after June 8, 1995.

In order to facilitate the completion of prosecution of applications pending in the USPTO as of June 8, 1995 and to ease the transition between a 17-year patent term and a 20-year patent term, Public Law 103-465 provided for the further limited reexamination of an application pending for 2 years or longer as of June 8, 1995, taking into account any reference

made in the application to any earlier filed application under 35 U.S.C. 120, 121, or 365(c). The further limited reexamination permits applicants to present for consideration, as a matter of right upon payment of a fee, a submission after a final rejection has been issued on an application. An applicant will be able to take advantage of this provision on two separate occasions provided the submission and fee are presented prior to the filing of the Appeal Brief and prior to abandonment of the application. This will have the effect of enabling an applicant to essentially reopen prosecution of the pending application on two separate occasions by paying a fee for each occasion, and avoid the impact of refiling the application to obtain consideration of additional claims and/or information relative to the claimed subject matter. The transitional after-final practice is only available to applications filed on or before June 8, 1995 and it is not available for reissue or design applications or reexamination proceedings.

The following flowchart illustrates the transitional after-final procedures set forth in 37 CFR 1.129(a).

**Transitional After-Final Provision - 37 CFR 1.129(a)**

Starting June 8, 1995

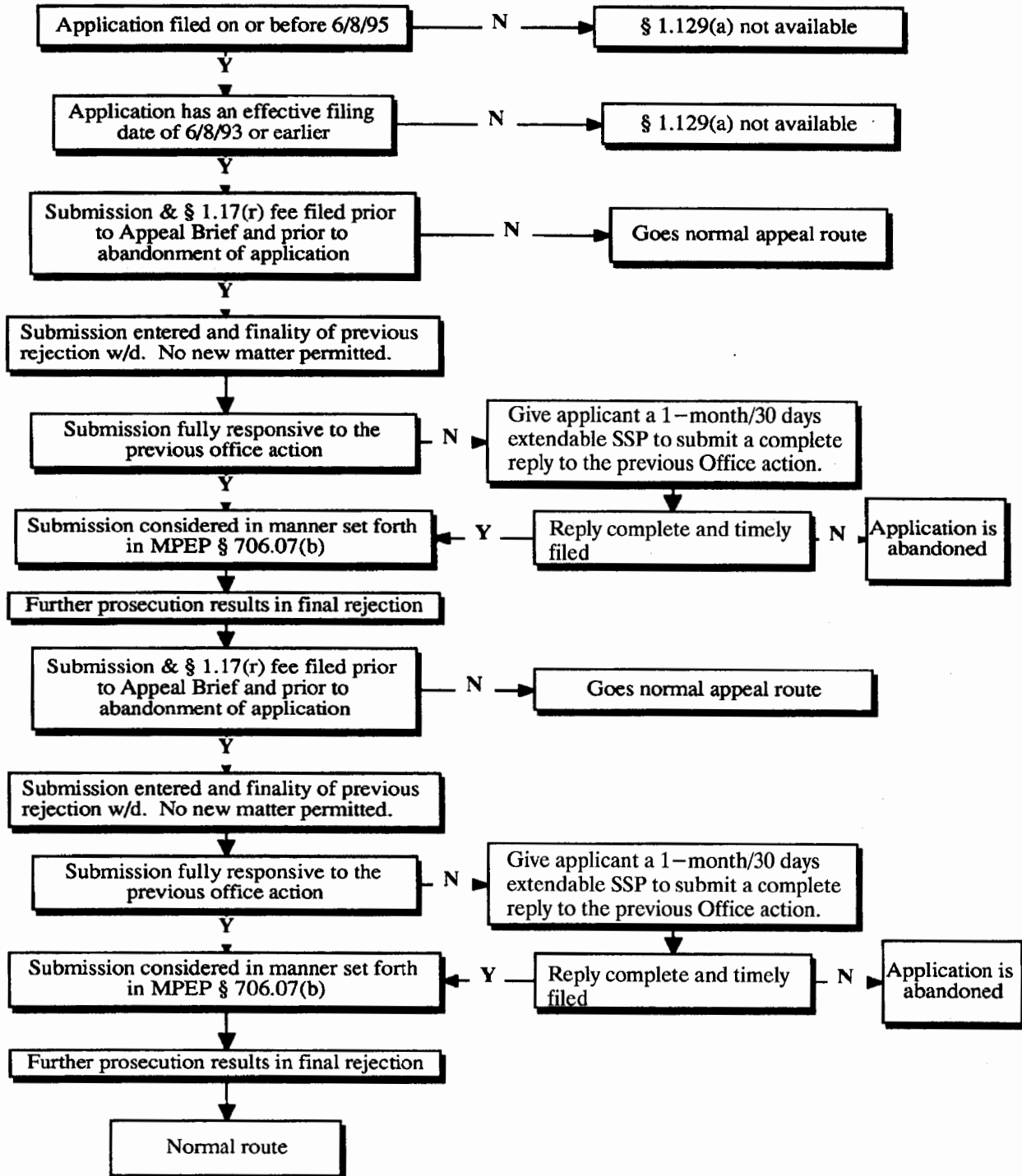

Effective June 8, 1995, in any pending application having an actual or effective filing date of June 8, 1993 or earlier, applicant is entitled, under 37 CFR 1.129(a), to have a first submission after final rejection entered and considered on the merits, if the submission and the fee set forth in 37 CFR 1.17(r) are filed prior to the filing of an Appeal Brief under 37 CFR 1.192 and prior to abandonment. For an application entering national stage under 35 U.S.C. 371 or an application filed under 35 U.S.C. 111(a) claiming benefit under 35 U.S.C. 120 of a PCT application designating the U.S., the PCT international filing date will be used to determine whether the application has been pending for at least 2 years as of June 8, 1995.

Form paragraph 7.41.01 may be used to notify applicant that the application qualifies under 37 CFR 1.129(a).

*¶ 7.41.01 Transitional After Final Practice, First Submission (37 CFR 1.129(a))*

This application is subject to the provisions of Public Law 103-465, effective June 8, 1995. Accordingly, since this application has been pending for at least two years as of June 8, 1995, taking into account any reference to an earlier filed application under 35 U.S.C. 120, 121 or 365(c), applicant, under 37 CFR 1.129(a), is entitled to have a first submission entered and considered on the merits if, prior to abandonment, the submission and the fee set forth in 37 CFR 1.17(r) are filed prior to the filing of an appeal brief under 37 CFR 1.192. Upon the timely filing of a first submission and the appropriate fee of \$ [1] for a [2] entity under 37 CFR 1.17(r), the finality of the previous Office action will be withdrawn. If a notice of appeal and the appeal fee set forth in 37 CFR 1.17(e) were filed prior to or with the payment of the fee set forth in 37 CFR 1.17(r), the payment of the fee set forth in 37 CFR 1.17(r) by applicant will be construed as a request to dismiss the appeal and to continue prosecution under 37 CFR 1.129(a). In view of 35 U.S.C. 132, no amendment considered as a result of payment of the fee set forth in 37 CFR 1.17(r) may introduce new matter into the disclosure of the application.

If applicant has filed multiple proposed amendments which, when entered, would conflict with one another, specific instructions for entry or non-entry of each such amendment should be provided upon payment of any fee under 37 CFR 1.17(r).

**Examiner Note:**

1. This form paragraph may follow any of form paragraphs 7.39-7.41, 7.67-7.67.02, 7.72-7.78 or 7.80 in any application filed prior to June 9, 1995, which has been pending for at least two years as of June 8, 1995, taking into account any reference under 35 U.S.C. 120, 121 or 365(c) to a previously filed application and no previous fee has been paid under 37 CFR 1.17(r).
2. This form paragraph should NOT be used in a design or reissue application, or in a reexamination proceeding.

3. In bracket 1, insert the current fee for a large or small entity, as appropriate.
4. In bracket 2, insert --small-- or --large--, depending on the current status of the application.

The submission under 37 CFR 1.129(a) may comprise, but is not limited to, an information disclosure statement, an amendment to the written description, claims or drawings, a new substantive argument and/or new evidence. No amendment considered as a result of payment of the fee set forth in 37 CFR 1.17(r) may introduce new matter into the disclosure of the application 35 U.S.C. 132. In view of the fee set forth in 37 CFR 1.17(r), any information disclosure statement previously refused consideration in the application because of applicant's failure to comply with 37 CFR 1.97(c) or (d) will be treated as though it has been filed within one of the time periods set forth in 37 CFR 1.97(b) and will be considered without the petition and petition fee required in 37 CFR 1.97(d), if it complies with the requirements of 37 CFR 1.98.

If the application qualifies under 37 CFR 1.129(a), that is, it was filed on or before June 8, 1995 and the application has an effective U.S. filing date of June 8, 1993 or earlier, the examiner must check to see if the submission and 37 CFR 1.17(r) fee were filed prior to the filing of the Appeal Brief and prior to abandonment of the application. If an amendment was timely filed in reply to the final rejection but the fee set forth in 37 CFR 1.17(r) did not accompany the amendment, examiners will continue to consider these amendments in an expedited manner as set forth in MPEP § 714.13 and issue an advisory action notifying applicant whether the amendment has been entered. If the examiner indicated in an advisory action that the amendment has not been entered, applicant may then pay the fee set forth in 37 CFR 1.17(r) and any necessary fee to avoid abandonment of the application and obtain entry and consideration of the amendment as a submission under 37 CFR 1.129(a). If the submission and the fee set forth in 37 CFR 1.17(r) were timely filed in reply to the final rejection and no advisory action has been issued prior to the payment of the fee set forth in 37 CFR 1.17(r), no advisory action will be necessary. The examiner will notify applicant that the finality of the previous office action has been withdrawn pursuant to 37 CFR 1.129(a). It is noted that if the submission is accompanied by a "conditional" payment of the fee set forth in 37 CFR 1.17(r), i.e., an

authorization to charge the fee set forth in 37 CFR 1.17(r) to a deposit account or to a credit card in the event that the submission would not otherwise be entered, the PTO will treat the conditional payment as an unconditional payment of the 37 CFR 1.17(r) fee.

The finality of the final rejection is automatically withdrawn upon the timely filing of the submission and payment of the fee set forth in 37 CFR 1.17(r). Upon the timely payment of the fee set forth in 37 CFR 1.17(r), all previously unentered submissions, submissions filed with the 37 CFR 1.17(r) fee, and any submissions filed prior to the mailing of the next Office action will be entered. Any conflicting amendments should be clarified for entry by the applicant upon payment of the 37 CFR 1.17(r) fee. Absent specific instructions for entry, all submissions filed as of the date of the withdrawal of the finality of the previous final action will be entered in the order in which they were filed. Form paragraph 7.42.01 should be used to notify applicant that the finality of the previous Office action has been withdrawn.

*¶ 7.42.01 Withdrawal of Finality of Last Office Action - Transitional Application Under 37 CFR 1.129(a)*

Since this application is eligible for the transitional procedure of 37 CFR 1.129(a), and the fee set forth in 37 CFR 1.17(r) has been timely paid, the finality of the previous Office action has been withdrawn pursuant to 37 CFR 1.129(a). Applicant's [1] submission after final filed on [2] has been entered.

**Examiner Note:**

Insert --first-- or --second-- in bracket 1.

If a Notice of Appeal and the appeal fee set forth in 37 CFR 1.17(b) were filed prior to or with the payment of the fee set forth 37 CFR 1.17(r), the payment of the fee set forth in 37 CFR 1.17(r) by applicant is construed as a request to dismiss the appeal and to continue prosecution under 37 CFR 1.129(a).

Upon the timely payment of the fee set forth in 37 CFR 1.17(r), if the examiner determines that the submission is not fully responsive to the previous Office action, e.g., if the submission only includes an information disclosure statement, applicant will be given a new shortened statutory period of 1 month or 30 days, whichever is longer, to submit a complete reply. Form paragraph 7.42.02 should be used.

*¶ 7.42.02 Nonresponsive Submission Filed Under 37 CFR 1.129(a)*

The timely submission under 37 CFR 1.129(a) filed on [1] is not fully responsive to the prior Office action because [2]. Since

the submission appears to be a *bona fide* attempt to provide a complete reply to the prior Office action, applicant is given a shortened statutory period of ONE MONTH or THIRTY DAYS from the mailing date of this letter, whichever is longer, to submit a complete reply. This shortened statutory period supersedes the time period set in the prior Office action. This time period may be extended pursuant to 37 CFR 1.136(a). If a notice of appeal and the appeal fee set forth in 37 CFR 1.17(e) were filed prior to or with the payment of the fee set forth in 37 CFR 1.17(r), the payment of the fee set forth in 37 CFR 1.17(r) by applicant is construed as a request to dismiss the appeal and to continue prosecution under 37 CFR 1.129(a). The appeal stands dismissed.

**Examiner Note:**

The reasons why the examiner considers the submission not to be fully responsive must be set forth in bracket 2.

After submission and payment of the fee set forth in 37 CFR 1.17(r), the next Office action on the merits may be made final only under the conditions for making a first action in a continuing application final set forth in MPEP § 706.07(b).

Form paragraph 7.42.03 may be used if it is appropriate to make the first action final following a submission under 37 CFR 1.129(a).

*¶ 7.42.03 Action Is Final, First Action Following Submission Under 37 CFR 1.129(a)*

All claims are drawn to the same invention claimed in the application prior to the entry of the submission under 37 CFR 1.129(a) and could have been finally rejected on the grounds and art of record in the next Office action if they had been entered in the application prior to entry under 37 CFR 1.129(a). Accordingly, **THIS ACTION IS MADE FINAL** even though it is a first action after the submission under 37 CFR 1.129(a). See MPEP § 706.07(b). Applicant is reminded of the extension of time policy as set forth in 37 CFR 1.136(a).

A shortened statutory period for reply to this final action is set to expire THREE MONTHS from the mailing date of this action. In the event a first reply is filed within TWO MONTHS of the mailing date of this final action and the advisory action is not mailed until after the end of the THREE-MONTH shortened statutory period, then the shortened statutory period will expire on the date the advisory action is mailed, and any extension fee pursuant to 37 CFR 1.136(a) will be calculated from the mailing date of the advisory action. In no event, however, will the statutory period for reply expire later than SIX MONTHS from the mailing date of this final action.

**Examiner Note:**

Also use form paragraph 7.41.02 if this is a final rejection following a first submission under 37 CFR 1.129(a).

If a subsequent final rejection is made in the application, applicant would be entitled to have a second submission entered and considered on the merits under the same conditions set forth for consideration

of the first submission. Form paragraph 7.41.02 should be used.

¶ 7.41.02 *Transitional After Final Practice, Second Submission (37 CFR 1.129(a))*

Since the fee set forth in 37 CFR 1.17(r) for a first submission subsequent to a final rejection has been previously paid, applicant, under 37 CFR 1.129(a), is entitled to have a second submission entered and considered on the merits if, prior to abandonment, the second submission and the fee set forth in 37 CFR 1.17(r) are filed prior to the filing of an appeal brief under 37 CFR 1.192. Upon the timely filing of a second submission and the appropriate fee of \$ [1] for a [2] entity under 37CFR 1.17(r), the finality of the previous Office action will be withdrawn. If a notice of appeal and the appeal fee set forth in 37 CFR 1.17(e) were filed prior to or with the payment of the fee set forth in 37 CFR 1.17(r), the payment of the fee set forth in 37 CFR 1.17(r) by applicant will be construed as a request to dismiss the appeal and to continue prosecution under 37 CFR 1.129(a). In view of 35 U.S.C. 132, no amendment considered as a result of payment of the fee set forth in 37 CFR 1.17(r) may introduce new matter into the disclosure of the application.

**Examiner Note:**

1. This form paragraph is to follow any of form paragraphs 7.39- 7.41 in any application filed prior to June 9, 1995, which has been pending for at least two years as of June 8, 1995, taking into account any reference under 35 U.S.C. 120, 121 or 365(c) to a previously filed application and a first submission fee has been previously paid under 37 CFR 1.17(r).
2. This form paragraph should NOT be used in a design or reissue application or in a reexamination proceeding.
3. In bracket 1, insert the current fee for a large or small entity, as appropriate.
4. In bracket 2, insert --small-- or --large--, depending on the current status of the application.
5. If the fee set forth in 37 CFR 1.17(r) has been twice paid, the provisions of 37 CFR 1.129(a) are no longer available.

Any submission filed after a final rejection made in the application subsequent to the fee set forth in 37 CFR 1.17(r) having been twice paid will be treated in accordance with the current after-final practice set forth in 37 CFR 1.116.

**706.07(h) Request for Continued Examination (RCE) Practice [R-2]**

35 U.S.C. 132. *Notice of rejection; reexamination.*

\*\*\*\*\*

(b) The Director shall prescribe regulations to provide for the continued examination of applications for patent at the request of the applicant. The Director may establish appropriate fees for such continued examination and shall provide a 50 percent reduc-

tion in such fees for small entities that qualify for reduced fees under section 41(h)(1) of this title.

*37 CFR 1.114. Request for continued examination.*

(a) If prosecution in an application is closed, an applicant may request continued examination of the application by filing a submission and the fee set forth in § 1.17(e) prior to the earliest of:

- (1) Payment of the issue fee, unless a petition under § 1.313 is granted;
- (2) Abandonment of the application; or
- (3) The filing of a notice of appeal to the U.S. Court of Appeals for the Federal Circuit under 35 U.S.C. 141, or the commencement of a civil action under 35 U.S.C. 145 or 146, unless the appeal or civil action is terminated.

(b) Prosecution in an application is closed as used in this section means that the application is under appeal, or that the last Office action is a final action (§ 1.113), a notice of allowance (§ 1.311), or an action that otherwise closes prosecution in the application.

(c) A submission as used in this section includes, but is not limited to, an information disclosure statement, an amendment to the written description, claims, or drawings, new arguments, or new evidence in support of patentability. If reply to an Office action under 35 U.S.C. 132 is outstanding, the submission must meet the reply requirements of § 1.111.

(d) If an applicant timely files a submission and fee set forth in § 1.17(e), the Office will withdraw the finality of any Office action and the submission will be entered and considered. If an applicant files a request for continued examination under this section after appeal, but prior to a decision on the appeal, it will be treated as a request to withdraw the appeal and to reopen prosecution of the application before the examiner. An appeal brief under § 1.192 or a reply brief under § 1.193(b), or related papers, will not be considered a submission under this section.

(e) The provisions of this section do not apply to:

- (1) A provisional application;
- (2) An application for a utility or plant patent filed under 35 U.S.C. 111(a) before June 8, 1995;
- (3) An international application filed under 35 U.S.C. 363 before June 8, 1995;
- (4) An application for a design patent; or
- (5) A patent under reexamination.

35 U.S.C. 132(b) provides for continued examination of an application at the request of the applicant (request for continued examination or RCE) upon payment of a fee, without requiring the applicant to file a continuing application under 37 CFR 1.53(b) \*\*. To implement the RCE practice, 37 CFR 1.114 provides a procedure under which an applicant may obtain continued examination of an application in which prosecution is closed (e.g., the application is under final rejection or a notice of allowance) by filing a submission and paying a specified fee. >Applicants cannot file an RCE to obtain continued

examination on the basis of claims that are independent and distinct from the claims previously claimed and examined as a matter of right (i.e., applicant cannot switch inventions). See 37 CFR 1.145. Any newly submitted claims that are directed to an invention that is independent and distinct from the invention previously claimed will be withdrawn from consideration and not entered. See subsection VI. below. An RCE is not the filing of a new application. Thus, the Office will not convert an RCE to a new application such as an application filed under 37 CFR 1.53(b) or a continued prosecution application (CPA) under 37 CFR 1.53(d).

## I. CONDITIONS FOR FILING AN RCE

The provisions of 37 CFR 1.114 apply to utility or plant applications filed under 35 U.S.C. 111(a) on or after June 8, 1995, or international applications filed under 35 U.S.C. 363 on or after June 8, 1995. The RCE provisions of 37 CFR 1.114 do not apply to:

- (A) a provisional application;
- (B) an application for a utility or plant patent filed under 35 U.S.C. 111(a) before June 8, 1995;
- (C) an international application filed under 35 U.S.C. 363 before June 8, 1995;
- (D) an application for a design patent; or
- (E) a patent under reexamination.

See 37 CFR 1.114(e).

An applicant may obtain continued examination of an application by filing a request for continued examination (see form PTO/SB/30), a submission and the fee set forth in 37 CFR 1.17(e) prior to the earliest of:

- (A) payment of the issue fee (unless a petition under 37 CFR 1.313 is granted);
- (B) abandonment of the application; or
- (C) the filing of a notice of appeal to the U.S. Court of Appeals for the Federal Circuit or the commencement of a civil action (unless the appeal or civil action is terminated).

See 37 CFR 1.114(a). An applicant cannot request continued examination of an application until after prosecution in the application is closed. See 37 CFR 1.114(a). Prosecution in an application is closed if the application is under appeal, or the last Office action is

a final action (37 CFR 1.113), a notice of allowance (37 CFR 1.311), or an action that otherwise closes prosecution in the application (e.g., an Office action under *Ex parte Quayle*, 25 USPQ 74, 453 O.G. 213 (Comm'r Pat. 1935)).

## II. SUBMISSION REQUIREMENT

A "submission" as used in 37 CFR 1.114 includes, but is not limited to, an information disclosure statement, an amendment to the written description, claims, or drawings, new arguments, or new evidence in support of patentability. See 37 CFR 1.114(c). If a reply to an Office action under 35 U.S.C. 132 is outstanding, the submission must meet the reply requirements of 37 CFR 1.111. See 37 CFR 1.114(c). Thus, an applicant may file a submission under 37 CFR 1.114 containing only an information disclosure statement (37 CFR 1.97 and 1.98) in an application subject to a notice of allowance under 35 U.S.C. 151, but not in an application where the last Office action is a final rejection or an Office action under *Ex parte Quayle*, 25 USPQ 74, 453 O.G. 213 (Comm'r Pat. 1935), or in an application that is under appeal. A request for a suspension of action, an appeal brief or a reply brief (or related papers) will not be considered a submission under 37 CFR 1.114. See 37 CFR 1.103 and 1.114(d). The submission, however, may consist of the arguments in a previously filed appeal brief or reply brief, or may simply consist of a statement that incorporates by reference the arguments in a previously filed appeal brief or reply brief. In addition, a previously filed amendment after final (whether or not entered) may satisfy this submission requirement.

Arguments submitted after final rejection, which were entered by the examiner but not found persuasive, may satisfy the submission requirement if such arguments are responsive within the meaning of 37 CFR 1.111 to the Office action. Consideration of whether any submission is responsive within the meaning of 37 CFR 1.111 to the last outstanding Office action is done without factoring in the "final" status of such outstanding Office action. Thus, a reply which might not be acceptable as a reply under 37 CFR 1.113 when the application is under a final rejection may be acceptable as a reply under 37 CFR 1.111.

&gt;

Status of the Application	The Submission:	For More Information
After Final	Must include a reply under 37 CFR 1.111 to the final rejection (e.g., an amendment filed with the RCE or a previously-filed after final amendment).	See subsections V. and VI.
After <i>Ex Parte Quayle</i> action	Must include a reply to the <i>Ex Parte Quayle</i> action.	See subsection IX.
After allowance	Includes, but not limited to, an IDS, amendment, new arguments, <b>or</b> new evidence.	See subsection IX.
After appeal	Must include a reply under 37 CFR 1.111 to the final rejection (e.g., a statement that incorporates by reference the arguments in a previously filed appeal brief or reply brief).	See subsections X., XI., and XII.

&lt;



### III. INITIAL PROCESSING

An RCE will be initially processed by the Technology Center (TC) assigned the application. Technical support personnel in the TC will verify that:

- (A) the RCE was filed on or after May 29, 2000;
- (B) the application was filed on or after June 8, 1995;
- (C) the application is a utility or plant application (*e.g.*, not a design application);
- (D) the application was pending (*i.e.*, not patented or abandoned) when the RCE was filed;
- (E) prosecution in the application is closed (*e.g.*, the last Office action is a final rejection, notice of allowance, or an Office action under *Ex parte Quayle*, 25 USPQ 74, 453 O.G. 213 (Comm'r Pat. 1935), or the application is under appeal);
- (F) the RCE was filed before the payment of the issue fee or, if not, a petition under 37 CFR 1.313 to withdraw the application from issue was filed and granted;
- (G) the RCE was accompanied by the proper fee(s) including the RCE fee under 37 CFR 1.17(e); and
- (H) the RCE included a submission as required by 37 CFR 1.114.

#### A. *Treatment of Improper RCE*

If one or more conditions for filing an RCE have **not** been satisfied, applicant will be so notified. Generally, a "Notice of Improper Request for Continued Examination (RCE)," Form PTO-2051, will be mailed to applicant. An improper RCE will **not** operate to toll the running of any time period set in the previous Office action for reply to avoid abandonment of the application.

If an examiner discovers that an improper RCE has been forwarded to the examiner in error, the application should be immediately returned to a head supervisory legal instruments examiner (HSLIE) within the TC.

#### 1. **Prosecution Is Not Closed**

If prosecution in the application is not closed, applicant will be notified of the improper RCE and any amendment/reply will be entered. Thereafter, the application will be forwarded to the examiner for con-

sideration of the amendment/reply under 37 CFR 1.111.

#### 2. **Application Is Under Appeal**

If the application is under appeal and the RCE was not accompanied by the fee set forth in 37 CFR 1.17(e) and/or a submission as required by 37 CFR 1.114, the application will be forwarded to the examiner for appropriate treatment and applicant will be notified of the improper RCE (See subsection X below).

#### B. *Ambiguous Transmittal Paper*

If an applicant files a transmittal paper that is ambiguous as to whether it is a continued prosecution application (CPA) under 37 CFR 1.53(d) or a request for continued examination (RCE) under 37 CFR 1.114 (*e.g.*, contains references to both an RCE and a CPA), and the application is a plant or utility application filed on or after June 8, 1995, the Office will treat the transmittal paper as an RCE under 37 CFR 1.114 since effective July 14, 2003, CPA practice has been eliminated as to plant and utility applications. If an applicant files a transmittal paper that is ambiguous as to whether it is a CPA or an RCE, and the application is a design application, the Office will treat the transmittal paper as a request for a CPA under 37 CFR 1.53(d) since RCE practice does not apply to design applications. Other papers filed with the transmittal paper (*e.g.*, a preliminary amendment or information disclosure statement) will not be taken into account in determining whether a transmittal paper is a CPA, or an RCE, or ambiguous as to whether it is a CPA or an RCE. If, however, applicant files an unambiguous transmittal paper that is an RCE in a design application, it will be treated as an improper RCE and a "Notice of Improper Request for Continued Examination (RCE)," Form PTO-2051, will be mailed to the applicant. An RCE is not a type of new application filing. Therefore, the Office cannot convert an RCE (whether proper or improper) to a new application such as a CPA under 37 CFR 1.53(d).

#### C. *Treatment of Conditional RCE*

If a submission is accompanied by a "conditional" RCE and payment of the RCE fee under 37 CFR 1.17(e) (*i.e.*, an authorization to charge the 37 CFR

1.17(e) fee to a deposit account in the event that the submission would not otherwise be entered), the Office will treat the “conditional” RCE and payment as if an RCE and payment of the fee set forth in 37 CFR 1.17(e) had been filed.

#### **D. Treatment of Proper RCE**

If the conditions for filing an RCE have been satisfied, the technical support personnel will process the >proper< RCE. Any previously filed unentered amendments, amendments filed with the RCE, and any amendments filed prior to the mailing of the next Office action (after the RCE) will normally be entered. >All< amendments filed as of the date the RCE is filed are entered in the order in which they were filed >in the absence of any specific instructions for entry. For example, if applicant files an amendment after final rejection which is denied entry by the examiner and applicant subsequently files an RCE with an amendment but the RCE is silent as to whether or not the previously filed after-final amendment should be entered, then the Office will enter both amendments in the order in which they were filed. If, however, applicant files an amendment after final rejection which is denied entry by the examiner and applicant subsequently files an RCE with an amendment including specific instructions that the previously filed after-final amendment is not to be entered, then the Office will enter the amendment filed with the RCE but will not enter the after-final amendment<. If conflicting amendments have been previously filed, applicant should clarify which amendments should be entered upon filing the RCE (and fee). Applicants are encouraged to file all amendments no later than the filing of the RCE to avoid disapproval of entry under 37 CFR 1.111(b). See MPEP § 714.03(a). If additional time is needed to prepare and file a supplement (e.g., affidavit or declaration containing test data) to the previously filed submission, applicant should consider filing a suspension of action by the Office under 37 CFR 1.103(c) with the RCE. For more details on suspension of action, see MPEP § 709.

After entry of any amendments and processing of the fee(s), the application will be forwarded to the examiner. >Applicant< does not need to pay a fee

for excess claims previously paid for prior to the filing of the RCE. Of course, new claims in excess of the number previously paid for, which are filed with the RCE or thereafter, will require payment of the appropriate fees(s) under 37 CFR 1.16.

#### **IV. IMPROPER CPA TREATED AS RCE**

37 CFR 1.53(d)(1)\* has been amended to provide that CPA practice under 37 CFR 1.53(d) does **not** apply to >utility and plant applications. Effective July 14, 2003, a CPA may only be filed if the prior nonprovisional application is a design application that is complete as defined by 37 CFR 1.51(b).<

In the event that an applicant files a request for a CPA >(on or after July 14, 2003)< of a utility or plant application that was filed on or after >June 8, 1995<, the Office will automatically treat the improper CPA as an RCE of the prior application (identified in the request for CPA) under 37 CFR 1.114. If the CPA does not satisfy the requirements of 37 CFR 1.114 to be a proper RCE (e.g., lacks a submission under 37 CFR 1.114(b), or is not accompanied by the fee set forth in 37 CFR 1.17(e)), the improper CPA will \* be treated as an >improper< RCE \*\*, and the time period set in the last Office action (or notice of allowance) will continue to run. If the time period (considering any available extension under 37 CFR 1.136(a)) has expired, the applicant will need to file a petition under 37 CFR 1.137 (with the lacking submission under 37 CFR 1.114(b) or fee set forth in 37 CFR 1.17(e)) to revive the abandoned application.

>Effective July 14, 2003, the Office will not convert an improper CPA into an application under 37 CFR 1.53(b) simply because it is requested by the applicant. The Office will convert an improper CPA into an application under 37 CFR 1.53(b) only if the applicant shows that there are extenuating circumstances that warrant the burdensome process of converting a CPA into an application under 37 CFR 1.53(b) (e.g., restoring the application to pending status and correcting the improper RCE is not possible because the application has issued as a patent).<

Form paragraph 7.42.15 should be used by the examiner to inform applicant that a CPA is being treated as a RCE.

\*\*>

¶ 7.42.15 *Continued Prosecution Application Treated as Continued Examination under 37 CFR 1.114*

The request for a continued prosecution application (CPA) under 37 CFR 1.53(d) filed on [1] is acknowledged. 37 CFR 1.53(d)(1) was amended to provide that a CPA must be for a design patent and the prior application of the CPA must be a design application that is complete as defined by 37 CFR 1.51(b). See *Elimination of Continued Prosecution Application Practice as to Utility and Plant Patent Applications*, final rule, 68 *Fed. Reg.* 32376 (May 30, 2003), 1271 *Off. Gaz. Pat. Office* 143 (June 24, 2003). Since a CPA of this application is not permitted under 37 CFR 1.53(d)(1), the improper request for a CPA is being treated as a request for continued examination of this application under 37 CFR 1.114.

**Examiner Note:**

1. Use this form paragraph to advise the applicant that a CPA is being treated as an RCE.
2. Also use form paragraph 7.42.04, 7.42.05, 7.42.06, or 7.42.07 as applicable, to acknowledge entry of applicant's submission if the fee set forth in 37 CFR 1.17(e) has been timely paid.
3. If the fee set forth in 37 CFR 1.17(e) and/or a submission as required by 37 CFR 1.114 is/are missing and the application is not under appeal, a Notice of Improper Request for Continued Examination should be mailed. If the application is under appeal and the fee set forth in 37 CFR 1.17(e) and/or submission is/are missing, this form paragraph should be followed with one of form paragraphs 7.42.10 - 7.42.14, as applicable.

<

## V. AFTER FINAL REJECTION

If an applicant timely files an RCE with the fee set forth in 37 CFR 1.17(e) and a submission >that meets the reply requirements of 37 CFR 1.111<, the Office will withdraw the finality of any Office action to which a reply is outstanding and the submission will be entered and considered. See 37 CFR 1.114(d). \*\*>The< submission meeting the reply requirements of 37 CFR 1.111 must be timely received to continue prosecution of an application. In other words, the mere request for, and payment of the fee for, continued examination will **not** operate to toll the running of any time period set in the previous Office action for reply to avoid abandonment of the application.

\*>Any submission that is an amendment must comply with the manner of making amendments as set forth in 37 CFR 1.121. See MPEP § 714.03. The amendment must include markings showing the changes relative to the last entered amendment. Even though previously filed unentered amendments after

final may satisfy the submission requirement under 37 CFR 1.114(c), applicants are encouraged to file an amendment at the time of filing the RCE that incorporates all of the desired changes, including changes presented in any previously filed unentered after final amendments, accompanied by instructions not to enter the unentered after final amendments. See subsection VI for treatment of not fully responsive submissions including noncompliant amendments.

If the RCE is proper, form< paragraph 7.42.04 should be used to notify applicant that the finality of the previous Office action has been withdrawn.

¶ 7.42.04 *Continued Examination under 37 CFR 1.114 after Final Rejection*

A request for continued examination under 37 CFR 1.114, including the fee set forth in 37 CFR 1.17(e), was filed in this application after final rejection. Since this application is eligible for continued examination under 37 CFR 1.114, and the fee set forth in 37 CFR 1.17(e) has been timely paid, the finality of the previous Office action has been withdrawn pursuant to 37 CFR 1.114. Applicant's submission filed on [1] has been entered.

**Examiner Note:**

1. Use this form paragraph if a request for continued examination (RCE), including the fee set forth in 37 CFR 1.17(e) and a submission, was filed after a final rejection.
2. In bracket 1, insert the date(s) of receipt of the submission. The submission may be a previously filed amendment(s) after final rejection and/or an amendment accompanying the RCE. As set forth in 37 CFR 1.114, a submission may include an information disclosure statement, an amendment to the written description, claims, or drawings, new arguments, or new evidence in support of patentability. If a reply to the Office action is outstanding the submission must meet the reply requirements of 37 CFR 1.111. Use instead form paragraph 7.42.08 if the submission does not comply with 37 CFR 1.111. Arguments which were previously submitted in a reply after final rejection, which were entered but not found persuasive, may be considered a submission under 37 CFR 1.114 if the arguments are responsive within the meaning of 37 CFR 1.111 to the outstanding Office action. If the last sentence of this form paragraph does not apply (e.g., the submission consists of previously entered arguments), it may be deleted or modified as necessary.
3. To be eligible for continued examination under 37 CFR 1.114, the application must be a utility or plant application filed under 35 U.S.C. 111(a) on or after June 8, 1995, or an international application filed under 35 U.S.C. 363 on or after June 8, 1995. The RCE must be filed on or after May 29, 2000.

## VI. NOT FULLY RESPONSIVE SUBMISSION

If reply to a final Office action is outstanding and the submission is not fully responsive to the final Office action, then it must be a *bona fide* attempt to

provide a complete reply to the final Office action in order for the RCE to toll the period for reply.

>If the submission is not a *bona fide* attempt to provide a complete reply, the RCE should be treated as an improper RCE. Thus, a “Notice of Improper Request for Continued Examination (RCE),” Form PTO-2051, should be prepared by the technical support personnel and mailed to the applicant indicating that the request was not accompanied by a submission complying with the requirements of 37 CFR 1.111 (see 37 CFR 1.114(c)). The RCE will not toll the period for reply and the application will be abandoned after the expiration of the statutory period for reply if no submission complying with 37 CFR 1.111 is filed. For example, if a reply to a final Office action is outstanding and the submission only includes an information disclosure statement (IDS), the submission will not be considered a *bona fide* attempt to provide a complete reply to the final Office action and the period for reply will not be tolled. Similarly, an amendment that would cancel all of the claims in an application and does not present any new or substitute claims is not a *bona fide* attempt to advance the application to final action. The Office will not enter such an amendment. See *Exxon Corp. v. Phillips Petroleum Co.*, 265 F.3d 1249, 60 USPQ2d 1368 (Fed. Cir. 2001).<

If the submission is a *bona fide* attempt to provide a complete reply, applicant should be informed that the submission is not fully responsive to the final Office action, along with the reasons why, and given a new shortened statutory period of one month or thirty days (whichever is longer) to complete the reply. See 37 CFR 1.135(c). Form paragraph 7.42.08 set forth below should be used.

\*\*>Situations where a submission is not a fully responsive submission, but is a *bona fide* attempt to provide a complete reply are:

(A) Non-compliant amendment - An RCE filed with a submission which is an amendment that is not in compliance with 37 CFR 1.121, but which is a *bona fide* attempt to provide a complete reply to the last Office action, should be treated as a proper RCE and a Notice of Noncompliant Amendment should be mailed to the applicant. Applicant is given a time period of one month or thirty days from the mailing date of the notice, whichever is longer, to provide an amendment complying with 37 CFR 1.121. See

MPEP § 714.03 for information on the amendment practice under 37 CFR 1.121.

(B) Presentation of claims for different invention - Applicants cannot file an RCE to obtain continued examination on the basis of claims that are independent and distinct from the claims previously claimed and examined as a matter of right (i.e., applicant cannot switch inventions). See 37 CFR 1.145. If an RCE is filed with an amendment canceling all claims drawn to the elected invention and presenting only claims drawn to a nonelected invention, the RCE should be treated as a proper RCE but the amendment should not be entered. The amendment is not fully responsive and applicant should be given a time period of one month or thirty days (whichever is longer) to submit a complete reply. See MPEP § 821.03. Form paragraphs 8.04 or 8.26 should be used as appropriate.<

*¶ 7.42.08 Request For Continued Examination With Submission Filed Under 37 CFR 1.114 Which is Not Fully Responsive*

Receipt is acknowledged of a request for continued examination under 37 CFR 1.114, including the fee set forth in 37 CFR 1.17(e) and a submission, filed on [1]. The submission, however, is not fully responsive to the prior Office action because [2]. Since the submission appears to be a *bona fide* attempt to provide a complete reply to the prior Office action, applicant is given a shortened statutory period of ONE MONTH or THIRTY DAYS from the mailing date of this letter, whichever is longer, to submit a complete reply. This shortened statutory period for reply supercedes the time period set in the prior Office action. This time period may be extended pursuant to 37 CFR 1.136(a).

**Examiner Note:**

1. Use this form paragraph to acknowledge an RCE filed with the fee and a submission where the submission is not fully responsive to the prior Office action. This form paragraph may be used for any RCE filed with a submission which is not fully responsive, i.e., an RCE filed after final rejection, after allowance, after an Office action under *Ex parte Quayle*, 25 USPQ 74, 453 O.G. 213 (Comm’r Pat. 1935), or after appeal.
2. In bracket 2, identify the reasons why the examiner considers the submission not to be fully responsive.
3. To be eligible for continued examination under 37 CFR 1.114, the application must be a utility or plant application filed under 35 U.S.C. 111(a) on or after June 8, 1995, or an international application filed under 35 U.S.C. 363 on or after June 8, 1995. The RCE must be filed on or after May 29, 2000.

**VII. NEW MATTER**

35 U.S.C. 132(a) provides that “[n]o amendment shall introduce new matter into the disclosure of the

invention.” Any amendment entered pursuant to 37 CFR 1.114 that is determined to contain new matter should be treated in the same manner that a reply under 37 CFR 1.111 determined to contain new matter is currently treated. See MPEP § 706.03(o). In those instances in which an applicant seeks to add new matter to the disclosure of an application, the procedure in 37 CFR 1.114 is not available, and the applicant must file a continuation-in-part application under 37 CFR 1.53(b) containing such new matter. \*\*

### VIII. FIRST ACTION FINAL AFTER FILING AN RCE

The action immediately subsequent to the filing of an RCE with a submission and fee under 37 CFR 1.114 may be made final only if the conditions set forth in MPEP § 706.07(b) for making a first action final in a continuing application are met.

Form paragraph 7.42.09 should be used if it is appropriate to make the first action after the filing of the RCE final.

#### ¶ 7.42.09 *Action Is Final, First Action Following Request for Continued Examination under 37 CFR 1.114*

All claims are drawn to the same invention claimed in the application prior to the entry of the submission under 37 CFR 1.114 and could have been finally rejected on the grounds and art of record in the next Office action if they had been entered in the application prior to entry under 37 CFR 1.114. Accordingly, **THIS ACTION IS MADE FINAL** even though it is a first action after the filing of a request for continued examination and the submission under 37 CFR 1.114. See MPEP § 706.07(b). Applicant is reminded of the extension of time policy as set forth in 37 CFR 1.136(a).

A shortened statutory period for reply to this final action is set to expire THREE MONTHS from the mailing date of this action. In the event a first reply is filed within TWO MONTHS of the mailing date of this final action and the advisory action is not mailed until after the end of the THREE-MONTH shortened statutory period, then the shortened statutory period will expire on the date the advisory action is mailed, and any extension fee pursuant to 37 CFR 1.136(a) will be calculated from the mailing date of the advisory action. In no event, however, will the statutory period for reply expire later than SIX MONTHS from the mailing date of this final action.

#### **Examiner Note:**

This form paragraph is for a first action final rejection following a Request for Continued Examination filed under 37 CFR 1.114.

### IX. AFTER ALLOWANCE OR QUAYLE ACTION

The phrase “withdraw the finality of any Office action” in 37 CFR 1.114(d) includes the withdrawal of the finality of a final rejection, as well as the closing of prosecution by an Office action under *Ex parte Quayle*, \*\*>25 USPQ 74, 453 O.G. 213 (Comm’r Pat. 1935)<, or notice of allowance under 35 U.S.C. 151 (or notice of allowability). Therefore, if an applicant files an RCE with the fee set forth in 37 CFR 1.17(e) and a submission in an application which has been allowed, prosecution will be reopened. If the issue fee has been paid, however, payment of the fee for an RCE and a submission without a petition under 37 CFR 1.313 to withdraw the application from issue will not avoid issuance of the application as a patent. If an RCE (with the fee and a submission) is filed in an allowed application prior to payment of the issue fee, a petition under 37 CFR 1.313 to withdraw the application from issue is not required.

If an RCE >complying with the requirements of 37 CFR 1.114< is filed in an allowed application after the issue fee has been paid and a petition under 37 CFR 1.313 is also filed and granted, \*\* prosecution \*>will be< reopened\*\*>. Applicant< may **not** obtain a refund of the issue fee. If, however, the application is subsequently allowed, \*\*>the Notice of Allowance will reflect an issue fee amount that is due that is the difference between the current issue fee amount and the issue fee that was previously paid<.

Form paragraph 7.42.05 should be used to notify applicant that prosecution has been reopened.

#### ¶ 7.42.05 *Continued Examination Under 37 CFR 1.114 After Allowance or Quayle Action*

A request for continued examination under 37 CFR 1.114, including the fee set forth in 37 CFR 1.17(e), was filed in this application after allowance or after an Office action under *Ex Parte Quayle*, 25 USPQ 74, 453 O.G. 213 (Comm’r Pat. 1935). Since this application is eligible for continued examination under 37 CFR 1.114, and the fee set forth in 37 CFR 1.17(e) has been timely paid, prosecution in this application has been reopened pursuant to 37 CFR 1.114. Applicant’s submission filed on [1] has been entered.

#### **Examiner Note:**

1. Use this form paragraph if a request for continued examination (RCE), including the fee set forth in 37 CFR 1.17(e) and a submission, was filed after a notice of allowance (or notice of allowability) or Office action under *Ex parte Quayle*, 25 USPQ 74, 453 O.G. 213 (Comm’r Pat. 1935).

2. In bracket 1 insert the date(s) of receipt of the submission. As set forth in 37 CFR 1.114, a submission may include an information disclosure statement, an amendment to the written description, claims, or drawings, new arguments, or new evidence in support of patentability.

3. To be eligible for continued examination under 37 CFR 1.114, the application must be a utility or plant application filed under 35 U.S.C. 111(a) on or after June 8, 1995, or an international application filed under 35 U.S.C. 363 on or after June 8, 1995. The RCE must be filed on or after May 29, 2000.

4. If the RCE was filed after the issue fee was paid, a petition under 37 CFR 1.313 to withdraw the application from issue must have been filed and *granted*.

## X. AFTER APPEAL BUT BEFORE DECISION BY THE BOARD

If an applicant files an RCE under 37 CFR 1.114 after the filing of a Notice of Appeal to the Board of Patent Appeals and Interferences (Board), but prior to a decision on the appeal, it will be treated as a request to withdraw the appeal and to reopen prosecution of the application before the examiner, regardless of whether the RCE is proper or improper. See 37 CFR 1.114(d). The Office will withdraw the appeal upon the filing of an RCE. Applicants should advise the Board when an RCE under 37 CFR 1.114 is filed in an application containing an appeal awaiting decision. Otherwise, the Board of Patent Appeals and Interferences may refuse to vacate a decision rendered after the filing (but before the recognition by the Office) of an RCE under 37 CFR 1.114.

\*>

### A. Proper RCE

If the RCE is accompanied by a fee (37 CFR 1.17(e)) and a submission that includes a reply which is responsive within the meaning of 37 CFR 1.111 to the last outstanding Office action, the Office will withdraw the finality of the last Office action and the submission will be entered and considered. If the submission is not fully responsive to the last outstanding Office action but is considered to be a *bona fide* attempt to provide a complete reply, applicant will be notified that the submission is not fully responsive, along with the reasons why, and will be given a new time period to complete the reply (using form paragraph 7.42.08). See 37 CFR 1.135(c) and subsection VI.

If the RCE is proper, form paragraph 7.42.06 should be used to notify applicant that the appeal has been withdrawn and prosecution has been reopened.

\*\*>

### ¶ 7.42.06 Continued Examination Under 37 CFR 1.114 After Appeal But Before A Board Decision

A request for continued examination under 37 CFR 1.114 was filed in this application after appeal to the Board of Patent Appeals and Interferences, but prior to a decision on the appeal. Since this application is eligible for continued examination under 37 CFR 1.114 and the fee set forth in 37 CFR 1.17(e) has been timely paid, the appeal has been withdrawn pursuant to 37 CFR 1.114 and prosecution in this application has been reopened pursuant to 37 CFR 1.114. Applicant's submission filed on [1] has been entered.

#### Examiner Note:

1. Use this form paragraph if a request for continued examination (RCE), including the fee set forth in 37 CFR 1.17(e) and a submission, was filed after a Notice of Appeal or an appeal brief, but there has not been a decision on the appeal. Note that it is not necessary for an appeal brief to have been filed.

2. As set forth in 37 CFR 1.114, a submission may include an information disclosure statement, an amendment to the written description, claims, or drawings, new arguments, or new evidence in support of patentability. The submission may consist of arguments in a previously filed appeal brief or reply brief, or an incorporation of such arguments in the transmittal letter or other paper accompanying the RCE.

3. To be eligible for continued examination under 37 CFR 1.114, the application must be a utility or plant application filed under 35 U.S.C. 111(a) on or after June 8, 1995, or an international application filed under 35 U.S.C. 363 on or after June 8, 1995. The RCE must be filed on or after May 29, 2000.

### B. Improper RCE

The appeal will be withdrawn even if the RCE is improper. If an RCE is filed in an application after appeal to the Board but the request does not include the fee required by 37 CFR 1.17(e) or the submission required by 37 CFR 1.114, or both, the examiner should treat the request as an improper RCE and withdraw the appeal pursuant to 37 CFR 1.114(d). If the submission is not considered to be a *bona fide* attempt to provide a complete reply to the last outstanding Office action (e.g., an IDS only), the submission will be treated as an improper submission or no submission at all under 37 CFR 1.114(c) (thus the request is an improper RCE). See subsection VI.

Upon withdrawal of the appeal, the application will be treated in accordance with MPEP § 1215.01 based on whether there are any allowed claims or not. The proceedings as to the rejected claims are

considered terminated. Therefore, if no claim is allowed, the application is abandoned. >Claims which are allowable except for their dependency from rejected claims will be treated as if they were rejected.< See MPEP § 1215.01. If there is at least one allowed claim, the application should be passed to issue on the allowed claim(s). If there is at least one allowed claim but formal matters are outstanding, applicant should be given a shortened statutory period of one month or thirty days (whichever is longer) in which to correct the formal matters. Form paragraphs 7.42.10-7.42.14 should be used as appropriate.

*¶ 7.42.10 Application On Appeal, Request For Continued Examination Under 37 CFR 1.114 Without Submission/Fee; No Claims Allowed*

A request for continued examination under 37 CFR 1.114 was filed in this application on [1] after appeal to the Board of Patent Appeals and Interferences. Therefore, the appeal has been withdrawn pursuant to 37 CFR 1.114. The request, however, lacks the fee required by 37 CFR 1.17(e) and/or the submission required by 37 CFR 1.114. Since the proceedings as to the rejected claims are considered terminated, and no claim is allowed, the application is abandoned. See MPEP 1215.01.

**Examiner Note:**

1. If a request for continued examination was filed after a Notice of Appeal or after an appeal brief, but before a decision on the appeal, and the request lacks the fee set forth in 37 CFR 1.17(e) or a submission or both, use this form paragraph to withdraw the appeal and hold the application abandoned if there are no allowed claims.

2. To be eligible for continued examination under 37 CFR 1.114, the application must be a utility or plant application filed under 35 U.S.C. 111(a) on or after June 8, 1995, or an international application filed under 35 U.S.C. 363 on or after June 8, 1995. The RCE must be filed on or after May 29, 2000.

*¶ 7.42.11 Application On Appeal, Request For Continued Examination Under 37 CFR 1.114 Without Submission; Claim Allowed*

A request for continued examination under 37 CFR 1.114, including the fee set forth in 37 CFR 1.17(e), was filed in this application on [1] after appeal to the Board of Patent Appeals and Interferences. Therefore, the appeal has been withdrawn pursuant to 37 CFR 1.114. The request, however, lacks the submission required by 37 CFR 1.114. Since the proceedings as to the rejected claims are considered terminated, the application will be passed to issue on allowed claim[2]. Claim[3] been canceled. See MPEP § 1215.01.

**Examiner Note:**

1. If a request for continued examination, including the fee, was filed after a Notice of Appeal or after an appeal brief but before a decision on the appeal, and the request lacks the required submission,

use this form paragraph to withdraw the appeal and pass the application to issue on the allowed claims.

2. In bracket 3, insert the claim number(s) of the claim(s) which has/have been canceled followed by either --has-- or --have--. Claims which have been indicated as containing allowable subject matter but are objected to as being dependent upon a rejected claim are to be considered as if they were rejected and therefore are to be canceled along with the rejected claims. See MPEP § 1215.01.

3. This form paragraph should be used with the mailing of a Notice of Allowability.

4. To be eligible for continued examination under 37 CFR 1.114, the application must be a utility or plant application filed under 35 U.S.C. 111(a) on or after June 8, 1995, or an international application filed under 35 U.S.C. 363 on or after June 8, 1995. The RCE must be filed on or after May 29, 2000.

*¶ 7.42.12 Application on Appeal, Request for Continued Examination under 37 CFR 1.114 Without Submission; Claim Allowed with Formal Matters Outstanding*

A request for continued examination under 37 CFR 1.114, including the fee set forth in 37 CFR 1.17(e), was filed in this application on [1] after appeal to the Board of Patent Appeals and Interferences. Therefore, the appeal has been withdrawn pursuant to 37 CFR 1.114. The request, however, lacks the submission required by 37 CFR 1.114. The proceedings as to the rejected claims are considered terminated, and the application will be passed to issue on allowed claim [2] provided the following formal matters are promptly corrected: [3]. Prosecution is otherwise closed. See MPEP § 1215.01. Applicant is required to make the necessary corrections addressing the outstanding formal matters within a shortened statutory period set to expire ONE MONTH or THIRTY DAYS, whichever is longer, from the mailing date of this letter. Extensions of time may be granted under 37 CFR 1.136.

**Examiner Note:**

1. If a request for continued examination, including the fee, was filed after a Notice of Appeal or an appeal brief but before a decision on the appeal, and the request lacks the required submission, use this form paragraph to withdraw the appeal if there are allowed claims but outstanding formal matters need to be corrected.

2. In bracket 3, explain the formal matters which must be corrected.

3. To be eligible for continued examination under 37 CFR 1.114, the application must be a utility or plant application filed under 35 U.S.C. 111(a) on or after June 8, 1995, or an international application filed under 35 U.S.C. 363 on or after June 8, 1995. The RCE must be filed on or after May 29, 2000.

*¶ 7.42.13 Application on Appeal, Request for Continued Examination under 37 CFR 1.114 Without Fee; Claim Allowed*

A request for continued examination under 37 CFR 1.114, including a submission, was filed in this application on [1] after appeal to the Board of Patent Appeals and Interferences. Therefore, the appeal has been withdrawn pursuant to 37 CFR 1.114.

The request, however, lacks the fee required by 37 CFR 1.17(e). Therefore, the submission has not been entered. See 37 CFR 1.116(c). Since the proceedings as to the rejected claims are considered terminated, the application will be passed to issue on allowed claim[2]. Claim[3] been canceled. See MPEP § 1215.01.

#### Examiner Note:

1. If a request for continued examination, including the submission, was filed after a Notice of Appeal or an appeal brief but before a decision on the appeal, and the request lacks the required fee, use this form paragraph to withdraw the appeal and pass the application to issue on the allowed claims.
2. In bracket 3, insert the claim number(s) of the claim(s) which has/have been canceled followed by either --has-- or --have--. Claims which have been indicated as containing allowable subject matter but are objected to as being dependent upon a rejected claim are to be considered as if they were rejected and therefore are to be canceled along with the rejected claims. See MPEP § 1215.01.
3. This form paragraph should be used with the mailing of a Notice of Allowability.
4. To be eligible for continued examination under 37 CFR 1.114, the application must be a utility or plant application filed under 35 U.S.C. 111(a) on or after June 8, 1995, or an international application filed under 35 U.S.C. 363 on or after June 8, 1995. The RCE must be filed on or after May 29, 2000.

#### ¶ 7.42.14 *Application on Appeal, Request for Continued Examination under 37 CFR 1.114 Without Fee; Claim Allowed With Formal Matters Outstanding*

A request for continued examination under 37 CFR 1.114, including a submission, was filed in this application on [1] after appeal to the Board of Patent Appeals and Interferences. Therefore, the appeal has been withdrawn pursuant to 37 CFR 1.114. The request, however, lacks the fee required by 37 CFR 1.17(e). Therefore, the submission has not been entered. See 37 CFR 1.116(c). The proceedings as to the rejected claims are considered terminated, and the application will be passed to issue on allowed claim[2] provided the following formal matters are promptly corrected: [3]. Prosecution is otherwise closed. See MPEP § 1215.01. Applicant is required to make the necessary corrections addressing the outstanding formal matters within a shortened statutory period set to expire ONE MONTH or THIRTY DAYS, whichever is longer, from the mailing date of this letter. Extensions of time may be granted under 37 CFR 1.136.

#### Examiner Note:

1. If a request for continued examination, including a submission, was filed after a Notice of Appeal or an appeal brief but before a decision on the appeal, and the request lacks the fee required by 37 CFR 1.17(e), use this form paragraph to withdraw the appeal if there are allowed claims but outstanding formal matters need to be corrected.
2. In bracket 3, explain the formal matters that must be corrected.
3. To be eligible for continued examination under 37 CFR 1.114, the application must be a utility or plant application filed under 35 U.S.C. 111(a) on or after June 8, 1995, or an interna-

tional application filed under 35 U.S.C. 363 on or after June 8, 1995. The RCE must be filed on or after May 29, 2000.

## XI. AFTER DECISION BY THE BOARD

### A. *Proper RCE After Board Decision*

The filing of an RCE (accompanied by the fee and a submission) after a decision by the Board of Patent Appeals and Interferences, but before the filing of a Notice of Appeal to the Court of Appeals for the Federal Circuit (Federal Circuit) or the commencement of a civil action in federal district court, will also result in the finality of the rejection or action being withdrawn and the submission being considered. >Generally, the time period for filing a notice of appeal to the Federal Circuit or for commencing a civil action is within two months of the Board's decision. See 37 CFR 1.304 and MPEP § 1216. Thus, an RCE filed within this two month time period and before the filing of a notice of appeal to the Federal Circuit or the commencement of a civil action would be timely filed.< In addition to the *res judicata* effect of a Board of Patent Appeals and Interferences decision in an application (see MPEP § 706.03(w)), a Board decision in an application is the "law of the case," and is thus controlling in that application and any subsequent, related application. See MPEP § 1214.01 (where a new ground of rejection is entered by the Board of Patent Appeals and Interferences pursuant to 37 CFR 1.196(b), argument without either amendment of the claims so rejected or the submission of a showing of facts can only result in a final rejection of the claims, since the examiner is without authority to allow the claims unless amended or unless the rejection is overcome by a showing of facts not before the Board of Patent Appeals and Interferences). As such, a submission containing arguments without either amendment of the rejected claims or the submission of a showing of facts will not be effective to remove such rejection.

Form paragraph 7.42.07 should be used to notify applicant that the appeal has been withdrawn and prosecution has been reopened.

#### ¶ 7.42.07 *Continued Examination under 37 CFR 1.114 after Board Decision but Before Further Appeal or Civil Action*

A request for continued examination under 37 CFR 1.114 was filed in this application after a decision by the Board of Patent Appeals and Interferences, but before the filing of a Notice of



Appeal to the Court of Appeals for the Federal Circuit or the commencement of a civil action. Since this application is eligible for continued examination under 37 CFR 1.114 and the fee set forth in 37 CFR 1.17(e) has been timely paid, the appeal has been withdrawn pursuant to 37 CFR 1.114 and prosecution in this application has been reopened pursuant to 37 CFR 1.114. Applicant's submission filed on [1] has been entered.

#### Examiner Note:

1. Use this form paragraph if a request for continued examination (RCE), including the fee set forth in 37 CFR 1.17(e) and a submission, was timely filed after a decision by the Board of Patent Appeals and Interferences but before further appeal or civil action. Generally, the time for filing a notice of appeal to the Federal Circuit or for commencing a civil action is within two months of the Board's decision. See MPEP § 1216 and 37 CFR 1.304.
2. A Board of Patent Appeals and Interferences decision in an application has *res judicata* effect and is the "law of the case" and is thus controlling in that application and any subsequent, related application. Therefore, a submission containing arguments without either an amendment of the rejected claims or the submission of a showing of facts will not be effective to remove such rejection. See MPEP § 706.03(w) and 1214.01.
3. To be eligible for continued examination under 37 CFR 1.114, the application must be a utility or plant application filed under 35 U.S.C. 111(a) on or after June 8, 1995, or an international application filed under 35 U.S.C. 363 on or after June 8, 1995. The RCE must be filed on or after May 29, 2000.

#### B. Improper RCE After Board Decision

If an RCE is filed after a decision by the Board of Patent Appeals and Interferences, but before the filing of a Notice of Appeal to the Federal Circuit or the commencement of a civil action in federal district court, and the RCE was **not** accompanied by the fee and/or the submission, the examiner should notify the applicant that the RCE is improper by using form paragraph 7.42.16 set forth below. If the time for seeking court review has passed without such review being sought, the examiner should include the form paragraph with the mailing of a Notice of Allowability or a Notice of Abandonment depending on the status of the claims. See MPEP § 1214.06. If the time for seeking court review remains, the examiner should include the form paragraph on a PTOL-90. No time period should be set. If a submission is filed with the RCE, but the fee is missing, the examiner should also include a statement as to whether or not the submission has been entered. In general, such a submission should not be entered. If, however, the submission is an amendment that obviously places the application in

condition for allowance, it should be entered with the approval of the supervisory patent examiner. See MPEP § 1214.07. Form paragraph 7.42.16 should not be used if the application is not a utility or plant application filed under 35 U.S.C. 111(a) on or after June 8, 1995, or an international application filed under 35 U.S.C. 363 on or after June 8, 1995. In that situation, a "Notice of Improper Request for Continued Examination (RCE)," Form PTO-2051, should be prepared and mailed by the technical support personnel to notify applicant that continued examination does not apply to the application. When the time for seeking court review has passed without such review being sought, the examiner must take up the application for consideration. See MPEP § 1214.06 for guidance on the action to be taken.

#### ¶ 7.42.16 After Board Decision But Before Further Appeal Or Civil Action, Request for Continued Examination Under 37 CFR 1.114 Without Submission and/or Fee

A request for continued examination (RCE) under 37 CFR 1.114 was filed in this application on [1] after a decision by the Board of Patent Appeals and Interferences, but before the filing of a Notice of Appeal to the Court of Appeals for the Federal Circuit or the commencement of a civil action. The request, however, lacks the fee required by 37 CFR 1.17(e) and/or the submission required by 37 CFR 1.114. Accordingly, the RCE is improper and any time period running was not tolled by the filing of the improper request.

#### Examiner Note:

1. This form paragraph should be used with the mailing of a Notice of Allowability or a Notice of Abandonment, as appropriate, if the time for seeking court review has passed without such review being sought, or it should be used on a PTOL-90 if time still remains.
2. This form paragraph should not be used if the application is not a utility application or a plant application filed under 35 U.S.C. 111(a) on or after June 8, 1995, or an international application filed under 35 U.S.C. 363 on or after June 8, 1995. In that situation, a "Notice of Improper Request for Continued Examination (RCE)," Form PTO-2051, should be prepared and mailed by the technical support personnel to notify applicant that continued examination does not apply to the application.
3. In general, if a submission was filed with the improper RCE in this situation, it should not be entered. An exception exists for an amendment which obviously places the application in condition for allowance. See MPEP § 1214.07. The examiner should also include a statement as to whether or not any such submission has been entered (e.g., "The submission filed with the improper RCE has not been entered.").

## **XII. AFTER APPEAL TO THE FEDERAL CIRCUIT OR CIVIL ACTION**

The procedure set forth in 37 CFR 1.114 is **not** available in an application after the filing of a Notice of Appeal to the Federal Circuit or the commencement of a civil action in federal district court, unless the appeal or civil action is terminated and the application is still pending. If an RCE is filed in an application that has undergone court review, the examiner should bring the application to the attention of the supervisory patent examiner or special program examiner in the TC to determine whether the RCE is proper. Unless an application contains allowed claims (or the court's mandate clearly indicates that further action is to be taken by the Office), the termination of an unsuccessful appeal or civil action results in abandonment of the application. See MPEP § 1216.01.

## **XIII. COMPARISON CHART AND FORMS**

### **A. *Comparison With the Transitional Procedure Set Forth in 37 CFR 1.129(a) and the CPA Procedure Set Forth in 37 CFR 1.53(d)***

The RCE procedure in 37 CFR 1.114 should not be confused with the transitional procedure for the further limited examination of patent applications set forth in 37 CFR 1.129(a) or the CPA procedure set forth in 37 CFR 1.53(d) >(effective July 14, 2003, available only for design applications)<. The following chart provides a comparison of the three different procedures.

### **B. *Forms***

Form PTO/SB/30, "Request for Continued Examination (RCE) Transmittal," may be used by applicant for filing a RCE under 37 CFR 1.114. The form used by the Technology Centers to notify applicant of an improper RCE, "Notice of Improper Request for Continued Examination (RCE)," Form PTO-2051, is shown below.

	<b>Continued prosecution application (CPA) under 37 CFR 1.53(d)</b>	<b>URAA transitional practice under 37 CFR 1.129(a)</b>	<b>Request for continued examination (RCE) under 37 CFR 1.114</b>
1	CPA practice is not applicable to provisional applications or during reexamination Note: >Effective July 14, 2003,< CPA practice has been made inapplicable to any utility or original plant applications ** (including reissue)	37 CFR 1.129(a) practice is applicable only to original utility or original plant applications filed before or on June 8, 1995, and which have been pending for at least two years as of June 8, 1995 (date-wise virtual mutual exclusivity with RCE practice)	RCE practice is not applicable to provisional applications, design applications, applications filed before June 8, 1995, or during reexamination
2	A CPA may be filed before the prosecution in an application is closed	A submission under 37 CFR 1.129(a) must be filed after final rejection and before an appeal brief is filed	A RCE must be filed after the prosecution in an application is closed
3	Statutory authority: 35 U.S.C. 111(a), 120, and 121	Statutory authority: Section 532(a)(2)(A) of Pub. L. 103-465 (uncodified)	Statutory authority: 35 U.S.C. 132(b)
4	The Office treats a CPA as continued examination of the same application, but it is technically/legally a new application	Further examination under 37 CFR 1.129(a) is in fact continued examination of the same application	A RCE is in fact continued examination of the same application
5	The applicant may defer paying the filing fee for a CPA under 37 CFR 1.53(g)	The applicant may not defer paying the fee for a submission under 37 CFR 1.129(a)	The applicant may not defer paying the fee for a RCE
6	The fee for a CPA must be the statutory filing fee: basic filing fee plus any applicable excess claims fees (even if previously paid in the prior application)	The Office sets the fee (fee need not include excess claims fee for claims previously paid for): the fee is set at an amount equal to the basic filing fee of a utility application (small entity reduction is available)	The Office sets the fee for a RCE (RCE fee need not include excess claims fee for claims previously paid for): the RCE fee is set at an amount equal to the basic filing fee of a utility application (small entity reduction is available)

	<b>Continued prosecution application (CPA) under 37 CFR 1.53(d)</b>	<b>URAA transitional practice under 37 CFR 1.129(a)</b>	<b>Request for continued examination (RCE) under 37 CFR 1.114</b>
7	A patent issuing on a CPA filed on or after May 29, 2000, is entitled to the patent term adjustment provisions of the AIPA, regardless of the filing date of any prior application of the CPA. A patent issuing on a CPA is <b>not</b> entitled to any patent term adjustment accumulated during prosecution of any prior application of the CPA.	An application that is eligible for the transitional practice of 37 CFR 1.129(a) is <b>not</b> entitled to the patent term adjustment provisions of the AIPA.	Filing a RCE on or after May 29, 2000, will <b>not</b> cause an application to be entitled to the patent term adjustment provisions of the AIPA. If an application is entitled to the patent term adjustment provisions of the AIPA ( <i>i.e.</i> , was itself filed on or after May 29, 2000), filing a RCE cuts-off the applicant's ability to accumulate any additional patent term adjustment against the three-year pendency provision, but does not otherwise affect patent term adjustment.
8	No limit on the number of times an applicant may file a CPA to obtain continued examination.	An applicant may have only two (2) submissions entered as a matter of right under 37 CFR 1.129(a).	No limit on the number of times an applicant may file a RCE to obtain continued examination.
9	A CPA is not entitled to the benefit of a Certificate of Mailing under 37 CFR 1.8.	A submission under 37 CFR 1.129(a) is entitled to the benefit of a Certificate of Mailing under 37 CFR 1.8.	A RCE is entitled to the benefit of a Certificate of Mailing under 37 CFR 1.8.
10	Applicants may file a continuation or divisional CPA, but not a CIP CPA.	Applicants may not switch inventions (divisional equivalent) as a matter of right or add new matter (CIP equivalent).	Applicants may not switch inventions (divisional equivalent) as a matter of right or add new matter (CIP equivalent).
11	A CPA abandons the (previously) pending application: appeals to the BPAI or courts in the prior application become moot automatically.	A submission under 37 CFR 1.129(a) does not abandon the (previously and currently) pending application: no appeal issues because Office requires such submission to be filed before an appeal (to BPAI) brief is filed.	A RCE does not abandon the (previously and currently) pending application: appeals to the BPAI are dismissed by operation of 37 CFR 1.114 but any pending court action must be dismissed to restore jurisdiction over the application to the Office.
12	Inventorship carries over unless the applicant provides a statement deleting inventors.	Inventorship carries/continues: any change must be via 37 CFR 1.48.	Inventorship carries/continues: any change must be via 37 CFR 1.48.

	<b>Continued prosecution application (CPA) under 37 CFR 1.53(d)</b>	<b>URAA transitional practice under 37 CFR 1.129(a)</b>	<b>Request for continued examination (RCE) under 37 CFR 1.114</b>
13	Small entity status does not carry (but can be claimed by reference to status in prior application or payment of small entity filing fee)	Small entity status carries/continues	Small entity status carries/continues**
*>14<	Submission need not include a reply that is a <i>bona fide</i> attempt to advance the application	Submission must include a reply that is a <i>bona fide</i> attempt to advance the application (37 CFR 1.111)	Submission must include a reply that is a <i>bona fide</i> attempt to advance the application (37 CFR 1.111) if a reply to an Office action is outstanding
*>15<	A CPA filed on or after November 29, 2000, will be subject to the eighteen-month publication provisions of the AIPA	Submission on or after November 29, 2000, does not subject application to the eighteen-month publication provisions of the AIPA; voluntary publication may be requested	Submission on or after November 29, 2000, does not subject application to the eighteen-month publication provisions of the AIPA; voluntary publication may be requested
*>16<	A CPA based on the national stage of an international application is an application filed under 35 U.S.C. 111(a) and thus it is subject to restriction practice in accordance with 37 CFR 1.141-1.146	If a submission is filed in a national stage application under 35 U.S.C. 371, the application is still subject to unity of invention practice in accordance with 37 CFR 1.475 and 1.499	If a submission is filed in a national stage application under 35 U.S.C. 371, the application is still subject to unity of invention practice in accordance with 37 CFR 1.475 and 1.499

EXAMINATION OF APPLICATIONS

706.07(h)

\*\*>

PTO/SB/30 (09-03)

Approved for use through 07/31/2008. OMB 0651-0031  
U.S. Patent and Trademark Office, U.S. DEPARTMENT OF COMMERCE

Under the Paperwork Reduction Act of 1995, no persons are required to respond to a collection of information unless it contains a valid OMB control number.

<p style="text-align: center;"><b>Request for Continued Examination (RCE) Transmittal</b></p> <p>Address to: Mail Stop RCE Commissioner for Patents P.O. Box 1450 Alexandria, VA 22313-1450</p>	<i>Application Number</i>	
	<i>Filing Date</i>	
	<i>First Named Inventor</i>	
	<i>Art Unit</i>	
	<i>Examiner Name</i>	
	<i>Attorney Docket Number</i>	

**This is a Request for Continued Examination (RCE) under 37 CFR 1.114 of the above-identified application.**  
Request for Continued Examination (RCE) practice under 37 CFR 1.114 does not apply to any utility or plant application filed prior to June 8, 1995, or to any design application. See Instruction Sheet for RCEs (not to be submitted to the USPTO) on page 2.

1. **Submission required under 37 CFR 1.114** Note: If the RCE is proper, any previously filed unentered amendments and amendments enclosed with the RCE will be entered in the order in which they were filed unless applicant instructs otherwise. If applicant does not wish to have any previously filed unentered amendment(s) entered, applicant must request non-entry of such amendment(s).

a.  Previously submitted. If a final Office action is outstanding, any amendments filed after the final Office action may be considered as a submission even if this box is not checked.

i.  Consider the arguments in the Appeal Brief or Rely Brief previously filed on \_\_\_\_\_

ii.  Other \_\_\_\_\_

b.  Enclosed

i.  Amendment/Reply

ii.  Affidavit(s)/ Declaration(s)

iii.  Information Disclosure Statement (IDS)

iv.  Other \_\_\_\_\_

2. **Miscellaneous**

a.  Suspension of action on the above-identified application is requested under 37 CFR 1.103(c) for a period of \_\_\_\_\_ months. (Period of suspension shall not exceed 3 months; Fee under 37 CFR 1.17(i) required)

b.  Other \_\_\_\_\_

3. **Fees** The RCE fee under 37 CFR 1.17(e) is required by 37 CFR 1.114 when the RCE is filed. The Director is hereby authorized to charge the following fees, or credit any overpayments, to

a.  Deposit Account No. \_\_\_\_\_

i.  RCE fee required under 37 CFR 1.17(e)

ii.  Extension of time fee (37 CFR 1.136 and 1.17)

iii.  Other \_\_\_\_\_

b.  Check in the amount of \$ \_\_\_\_\_ enclosed

c.  Payment by credit card (Form PTO-2038 enclosed)

**WARNING: Information on this form may become public. Credit card information should not be included on this form. Provide credit card information and authorization on PTO-2038.**

SIGNATURE OF APPLICANT, ATTORNEY, OR AGENT REQUIRED	
Name (Print/Type)	Registration No. (Attorney/Agent)
Signature	Date

CERTIFICATE OF MAILING OR TRANSMISSION	
I hereby certify that this correspondence is being deposited with the United States Postal Service with sufficient postage as first class mail in an envelope addressed to: Mail Stop RCE, Commissioner for Patents, P. O. Box 1450, Alexandria, VA 22313-1450 or facsimile transmitted to the U.S. Patent and Trademark Office on the date shown below.	
Name (Print/Type)	
Signature	Date

This collection of information is required by 37 CFR 1.114. The information is required to obtain or retain a benefit by the public which is to file (and by the USPTO to process) an application. Confidentiality is governed by 35 U.S.C. 122 and 37 CFR 1.14. This collection is estimated to take 12 minutes to complete, including gathering, preparing, and submitting the completed application form to the USPTO. Time will vary depending upon the individual case. Any comments on the amount of time you require to complete this form and/or suggestions for reducing this burden, should be sent to the Chief Information Officer, U.S. Patent and Trademark Office, U.S. Department of Commerce, P.O. Box 1450, Alexandria, VA 22313-1450. DO NOT SEND FEES OR COMPLETED FORMS TO THIS ADDRESS. SEND TO: Mail Stop RCE, Commissioner for Patents, P.O. Box 1450, Alexandria, VA 22313-1450.  
If you need assistance in completing the form, call 1-800-PTO-9199 and select option 2.

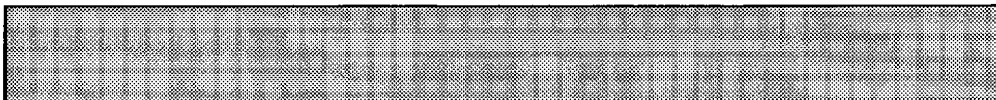
**NOTES:**

An RCE is not a new application, and filing an RCE will not result in an application being accorded a new filing date.

**Filing Qualifications:**

The application must be a utility or plant application filed on or after June 8, 1995. The application cannot be a provisional application, a utility or plant application filed before June 8, 1995, a design application, or a patent under reexamination. See 37 CFR 1.114(e).

**Filing Requirements:**

***Prosecution in the application must be closed.*** Prosecution is closed if the application is under appeal, or the last Office action is a final action, a notice of allowance, or an action that otherwise closes prosecution in the application (e.g., an Office action under *Ex parte Quayle*). See 37 CFR 1.114(b).

***A submission and a fee are required at the time the RCE is filed.*** If reply to an Office action under 35 U.S.C. 132 is outstanding (e.g., the application is under final rejection), the submission must meet the reply requirements of 37 CFR 1.111. If there is no outstanding Office action, the submission can be an information disclosure statement, an amendment, new arguments, or new evidence. See 37 CFR 1.114(c). The submission may be a previously filed amendment (e.g., an amendment after final rejection).

**WARNINGS:****Request for Suspension of Action:**

All RCE filing requirements must be met before suspension of action is granted. A request for a suspension of action under 37 CFR 1.103(c) does not satisfy the submission requirement and does not permit the filing of the required submission to be suspended.

**Improper RCE will NOT toll Any Time Period:**

***Before Appeal*** - If the RCE is improper (e.g., prosecution in the application is not closed or the submission or fee has not been filed) and the application is not under appeal, the time period set forth in the last Office action will continue to run and the application will be abandoned after the statutory time period has expired if a reply to the Office action is not timely filed. No additional time will be given to correct the improper RCE.

***Under Appeal*** - If the RCE is improper (e.g., the submission or the fee has not been filed) and the application is under appeal, the improper RCE is effective to withdraw the appeal. Withdrawal of the appeal results in the allowance or abandonment of the application depending on the status of the claims. If there are no allowed claims, the application is abandoned. If there is at least one allowed claim, the application will be passed to issue on the allowed claim(s). See MPEP 1215.01.

**See MPEP 706.07(h) for further information on the RCE practice.**

## Notice of Improper Request for Continued Examination



**Commissioner for Patents**  
**United States Patent and Trademark Office**  
 P.O. Box 1450  
 Alexandria, VA 22313-1450  
 www.uspto.gov

APPLICATION NUMBER	FILING DATE	FIRST NAMED APPLICANT	ATTY. DOCKET NO./TITLE
--------------------	-------------	-----------------------	------------------------

DATE MAILED:

**NOTICE OF IMPROPER REQUEST FOR CONTINUED EXAMINATION (RCE)**

The request for continued examination (RCE) under 37 CFR 1.114 filed on \_\_\_\_\_ is improper for reason(s) indicated below:

- 1. Continued examination under 37 CFR 1.114 does not apply to an application for a design patent. Applicant may wish to consider filing a continuing application under 37 CFR 1.53(b) or a CPA under 37 CFR 1.53(d). An RCE cannot be treated as a CPA.
- 2. Continued examination under 37 CFR 1.114 does not apply to an application that was filed before June 8, 1995. Applicant may wish to consider filing a continuing application under 37 CFR 1.53(b).
- 3. Continued examination under 37 CFR 1.114 does not apply to an application unless prosecution in the application is closed. If the RCE was accompanied by a reply to a non-final Office action, the reply will be entered and considered under 37 CFR 1.111. If the RCE was not accompanied by a reply, the time period set forth in the last Office action continues to run from the mailing date of that action.
- 4. The request was not filed before payment of the issue fee, and no petition under 37 CFR 1.313 was granted. If this application has not yet issued as a patent, applicant may wish to consider filing either a petition under 37 CFR 1.313 to withdraw this application from issue, or a continuing application under 37 CFR 1.53(b).
- 5. The request was not filed before abandonment of the application. The application was abandoned, or proceedings terminated on \_\_\_\_\_. Applicant may wish to consider filing a petition under 37 CFR 1.137 to revive this abandoned application.
- 6. The request was not accompanied by the fee set forth in 37 CFR 1.17(e) as required by 37 CFR 1.114. Since the application is not under appeal, the time period set forth in the final Office action or notice of allowance continues to run from the mailing date of that action or notice.
- 7. The request was not accompanied by a submission as required by 37 CFR 1.114. Since the application is not under appeal, the time period set forth in the final Office action or notice of allowance continues to run from the mailing date of that action or notice.

**Note:** A continued prosecution application (CPA) under 37 CFR 1.53(d) cannot be filed in a utility or plant application. A CPA filed in a utility or plant application that has a filing date **on or after June 8, 1995** will be treated as an RCE under 37 CFR 1.114. The request for a CPA in the instant application, however, has been treated as an improper RCE for the reason(s) indicated above.

***A copy of this notice MUST be returned with any reply.***

Direct the reply and any questions concerning this notice to:

\_\_\_\_\_, Technology Center \_\_\_\_\_

(703) 30 \_\_\_\_\_

FORM PTO-2051 (Rev. 7/2003)



## 707 Examiner's Letter or Action [R-2]

### 37 CFR 1.104. Nature of examination.

#### (a) Examiner's action.

(1) On taking up an application for examination or a patent in a reexamination proceeding, the examiner shall make a thorough study thereof and shall make a thorough investigation of the available prior art relating to the subject matter of the claimed invention. The examination shall be complete with respect both to compliance of the application or patent under reexamination with the applicable statutes and rules and to the patentability of the invention as claimed, as well as with respect to matters of form, unless otherwise indicated.

(2) The applicant, or in the case of a reexamination proceeding, both the patent owner and the requester, will be notified of the examiner's action. The reasons for any adverse action or any objection or requirement will be stated in an Office action and such information or references will be given as may be useful in aiding the applicant, or in the case of a reexamination proceeding the patent owner, to judge the propriety of continuing the prosecution.

(3) An international-type search will be made in all national applications filed on and after June 1, 1978.

(4) Any national application may also have an international-type search report prepared thereon at the time of the national examination on the merits, upon specific written request therefor and payment of the international-type search report fee set forth in § 1.21(e). The Patent and Trademark Office does not require that a formal report of an international-type search be prepared in order to obtain a search fee refund in a later filed international application.

(b) *Completeness of examiner's action.* The examiner's action will be complete as to all matters, except that in appropriate circumstances, such as misjoinder of invention, fundamental defects in the application, and the like, the action of the examiner may be limited to such matters before further action is made. However, matters of form need not be raised by the examiner until a claim is found allowable.

#### (c) Rejection of claims.

(1) If the invention is not considered patentable, or not considered patentable as claimed, the claims, or those considered unpatentable will be rejected.

(2) In rejecting claims for want of novelty or for obviousness, the examiner must cite the best references at his or her command. When a reference is complex or shows or describes inventions other than that claimed by the applicant, the particular part relied on must be designated as nearly as practicable. The pertinence of each reference, if not apparent, must be clearly explained and each rejected claim specified.

(3) In rejecting claims the examiner may rely upon admissions by the applicant, or the patent owner in a reexamination proceeding, as to any matter affecting patentability and, insofar as rejections in applications are concerned, may also rely upon facts within his or her knowledge pursuant to paragraph (d)(2) of this section.

(4) Subject matter which is developed by another person which qualifies as prior art only under 35 U.S.C. 102(e), (f) or (g)

may be used as prior art under 35 U.S.C. 103 against a claimed invention unless the entire rights to the subject matter and the claimed invention were commonly owned by the same person or organization or subject to an obligation of assignment to the same person or organization at the time the claimed invention was made.

(5) The claims in any original application naming an inventor will be rejected as being precluded by a waiver in a published statutory invention registration naming that inventor if the same subject matter is claimed in the application and the statutory invention registration. The claims in any reissue application naming an inventor will be rejected as being precluded by a waiver in a published statutory invention registration naming that inventor if the reissue application seeks to claim subject matter:

(i) Which was not covered by claims issued in the patent prior to the date of publication of the statutory invention registration; and

(ii) Which was the same subject matter waived in the statutory invention registration.

#### (d) Citation of references.

(1) If domestic patents are cited by the examiner, their numbers and dates, and the names of the patentees will be stated. If domestic patent application publications are cited by the examiner, their publication number, publication date, and the names of the applicants will be stated. If foreign published applications or patents are cited, their nationality or country, numbers and dates, and the names of the patentees will be stated, and such other data will be furnished as may be necessary to enable the applicant, or in the case of a reexamination proceeding, the patent owner, to identify the published applications or patents cited. In citing foreign published applications or patents, in case only a part of the document is involved, the particular pages and sheets containing the parts relied upon will be identified. If printed publications are cited, the author (if any), title, date, pages or plates, and place of publication, or place where a copy can be found, will be given.

(2) When a rejection in an application is based on facts within the personal knowledge of an employee of the Office, the data shall be as specific as possible, and the reference must be supported, when called for by the applicant, by the affidavit of such employee, and such affidavit shall be subject to contradiction or explanation by the affidavits of the applicant and other persons.

(e) *Reasons for allowance.* If the examiner believes that the record of the prosecution as a whole does not make clear his or her reasons for allowing a claim or claims, the examiner may set forth such reasoning. The reasons shall be incorporated into an Office action rejecting other claims of the application or patent under reexamination or be the subject of a separate communication to the applicant or patent owner. The applicant or patent owner may file a statement commenting on the reasons for allowance within such time as may be specified by the examiner. Failure by the examiner to respond to any statement commenting on reasons for allowance does not give rise to any implication.

For Office actions in reexamination proceedings, see MPEP § 2260.

Under the current first action procedure, the examiner signifies on the Office Action Summary Form

PTOL-326 certain information including the period set for reply, any attachments, and a “Summary of Action,” which is the position taken on all the claims.

Current procedure also allows the examiner, in the exercise of his or her professional judgment to indicate that a discussion with applicant’s or patent owner’s representative may result in agreements whereby the application or patent under reexamination may be placed in condition for allowance and that the examiner will telephone the representative within about 2 weeks. Under this practice the applicant’s or patent owner’s representative can be adequately prepared to conduct such a discussion. Any resulting amendment may be made either by the applicant’s or patent owner’s attorney or agent or by the examiner in an examiner’s amendment. It should be recognized that when extensive amendments are necessary it would be preferable if they were filed by the attorney or agent of record, thereby reducing the professional and clerical workload in the Office and also providing the file wrapper with a better record, including applicant’s arguments for allowability as required by 37 CFR 1.111.

The list of references cited appears on a separate form, Notice of References Cited, PTO-892 (copy in MPEP § 707.05) attached to applicant’s copies of the action. Where applicable, Notice of Draftsperson’s Patent Drawing Revision, PTO-948 and Notice of Informal Patent Application, PTO-152 are attached to the first action.

The attachments have the same paper number and are to be considered as part of the Office action.

Replies to Office actions should include the application number as well as the 4-digit art unit number and the examiner’s name to expedite handling within the Office. Further, applicants are encouraged to include the 4-digit confirmation number on every paper filed in the Office. See MPEP § 503 for an explanation of the confirmation number.

In accordance with the patent statute, “Whenever, on examination, any claim for a patent is rejected, or any objection . . . made,” notification of the reasons for rejection and/or objection together with such information and references as may be useful in judging the propriety of continuing the prosecution (35 U.S.C. 132) should be given.

When considered necessary for adequate information, the particular figure(s) of the drawing(s), and/or

page(s) or paragraph(s) of the reference(s), and/or any relevant comments briefly stated should be included. For rejections under 35 U.S.C. 103, the way in which a reference is modified or plural references are combined should be set out.

In exceptional cases, as to satisfy the requirements under 37 CFR 1.104(c)(2), and in *pro se* cases where the inventor is unfamiliar with patent law and practice, a more complete explanation may be needed.

Objections to the disclosure, explanation of references cited but not applied, indication of allowable subject matter, requirements (including requirements for restriction if applicable) and any other pertinent comments may be included. Office Action Summary form PTOL-326, which serves as the first page of the Office action (although a Form PTOL-90 may be used as a coversheet for the correspondence address and the mail date of the Office action), is to be used with all first actions and will identify any allowed claims.

One of form paragraphs 7.100, 7.101, or 7.102 should conclude all actions.

\*\*>

#### *¶ 7.100 Name And Number of Examiner To Be Contacted*

Any inquiry concerning this communication should be directed to [1] at telephone number [2].

#### **Examiner Note:**

1. This form paragraph, form paragraph 7.101, or form paragraph 7.102 should be used at the conclusion of all actions.
2. In bracket 1, insert the name of the examiner designated to be contacted first regarding inquiries about the Office action. This could be either the non-signatory examiner preparing the action or the signatory examiner.
3. In bracket 2, insert the individual area code and phone number of the examiner to be contacted.

#### *¶ 7.101 Telephone Inquiry Contacts- Non 5/4/9 Schedule*

Any inquiry concerning this communication or earlier communications from the examiner should be directed to [1] whose telephone number is [2]. The examiner can normally be reached on [3] from [4] to [5].

If attempts to reach the examiner by telephone are unsuccessful, the examiner’s supervisor, [6], can be reached on [7]. The fax phone number for the organization where this application or proceeding is assigned is (703) 872-9306.

Information regarding the status of an application may be obtained from the Patent Application Information Retrieval (PAIR) system. Status information for published applications may be obtained from either Private PAIR or Public PAIR. Status information for unpublished applications is available through Private PAIR only. For more information about the PAIR system, see <http://pair-direct.uspto.gov>. Should you have questions on access

to the Private PAIR system, contact the Electronic Business Center (EBC) at 866-217-9197 (toll-free).

**Examiner Note:**

1. In bracket 1, insert your name.
2. In bracket 2, insert your individual area code and phone number.
3. In bracket 3, insert the days that you work every week, e.g. "Monday-Thursday" for an examiner off every Friday.
4. In brackets 4 and 5, insert your normal duty hours, e.g. "6:30 AM - 5:00 PM."
5. In bracket 6, insert your SPE's name.
6. In bracket 7, insert your SPE's area code and phone number.

*¶ 7.102 Telephone Inquiry Contacts- 5/4/9 Schedule*

Any inquiry concerning this communication or earlier communications from the examiner should be directed to [1] whose telephone number is [2]. The examiner can normally be reached on [3] from [4] to [5]. The examiner can also be reached on alternate [6].

If attempts to reach the examiner by telephone are unsuccessful, the examiner's supervisor, [7], can be reached on [8]. The fax phone number for the organization where this application or proceeding is assigned is (703) 872-9306.

Information regarding the status of an application may be obtained from the Patent Application Information Retrieval (PAIR) system. Status information for published applications may be obtained from either Private PAIR or Public PAIR. Status information for unpublished applications is available through Pri-

vate PAIR only. For more information about the PAIR system, see <http://pair-direct.uspto.gov>. Should you have questions on access to the Private PAIR system, contact the Electronic Business Center (EBC) at 866-217-9197 (toll-free).

**Examiner Note:**

1. In bracket 1, insert your name.
2. In bracket 2, insert your individual area code and phone number.
3. In bracket 3, insert the days that you work every week, e.g. "Monday-Thursday" for an examiner off on alternate Fridays.
4. In brackets 4 and 5, insert your normal duty hours, e.g. "6:30 AM - 4:00 PM."
5. In bracket 6, insert the day in each pay-period that is your compressed day off, e.g. "Fridays" for an examiner on a 5/4/9 work schedule with the first Friday off.
6. In bracket 7, insert your SPE's name.
7. In bracket 8, insert your SPE's area code and phone number.

<

Where the text of sections of Title 35, U.S. Code was previously reproduced in an Office action, form paragraph 7.103 may be used.

*¶ 7.103 Statute Cited in Prior Action*

The text of those sections of Title 35, U.S. Code not included in this action can be found in a prior Office action.

\*\*>

<b>Office Action Summary</b>	<b>Application No.</b>	<b>Applicant(s)</b>	
	<b>Examiner</b>	<b>Art Unit</b>	

-- The MAILING DATE of this communication appears on the cover sheet with the correspondence address --

**Period for Reply**

A SHORTENED STATUTORY PERIOD FOR REPLY IS SET TO EXPIRE \_\_\_\_ MONTH(S) FROM THE MAILING DATE OF THIS COMMUNICATION.

- Extensions of time may be available under the provisions of 37 CFR 1.136(a). In no event, however, may a reply be timely filed after SIX (6) MONTHS from the mailing date of this communication.
- If the period for reply specified above is less than thirty (30) days, a reply within the statutory minimum of thirty (30) days will be considered timely.
- If NO period for reply is specified above, the maximum statutory period will apply and will expire SIX (6) MONTHS from the mailing date of this communication.
- Failure to reply within the set or extended period for reply will, by statute, cause the application to become ABANDONED (35 U.S.C. § 133). Any reply received by the Office later than three months after the mailing date of this communication, even if timely filed, may reduce any earned patent term adjustment. See 37 CFR 1.704(b).

**Status**

1)  Responsive to communication(s) filed on \_\_\_\_.

2a)  This action is **FINAL**.                      2b)  This action is non-final.

3)  Since this application is in condition for allowance except for formal matters, prosecution as to the merits is closed in accordance with the practice under *Ex parte Quayle*, 1935 C.D. 11, 453 O.G. 213.

**Disposition of Claims**

4)  Claim(s) \_\_\_\_ is/are pending in the application.

4a) Of the above claim(s) \_\_\_\_ is/are withdrawn from consideration.

5)  Claim(s) \_\_\_\_ is/are allowed.

6)  Claim(s) \_\_\_\_ is/are rejected.

7)  Claim(s) \_\_\_\_ is/are objected to.

8)  Claim(s) \_\_\_\_ are subject to restriction and/or election requirement.

**Application Papers**

9)  The specification is objected to by the Examiner.

10)  The drawing(s) filed on \_\_\_\_ is/are: a)  accepted or b)  objected to by the Examiner.  
 Applicant may not request that any objection to the drawing(s) be held in abeyance. See 37 CFR 1.85(a).  
 Replacement drawing sheet(s) including the correction is required if the drawing(s) is objected to. See 37 CFR 1.121(d).

11)  The oath or declaration is objected to by the Examiner. Note the attached Office Action or form PTO-152.

**Priority under 35 U.S.C. § 119**

12)  Acknowledgment is made of a claim for foreign priority under 35 U.S.C. § 119(a)-(d) or (f).

a)  All    b)  Some \*    c)  None of:

1.  Certified copies of the priority documents have been received.

2.  Certified copies of the priority documents have been received in Application No. \_\_\_\_.

3.  Copies of the certified copies of the priority documents have been received in this National Stage application from the International Bureau (PCT Rule 17.2(a)).

\* See the attached detailed Office action for a list of the certified copies not received.

**Attachment(s)**

1) <input type="checkbox"/> Notice of References Cited (PTO-892)	4) <input type="checkbox"/> Interview Summary (PTO-413) Paper No(s)/Mail Date. ____.
2) <input type="checkbox"/> Notice of Draftsperson's Patent Drawing Review (PTO-948)	5) <input type="checkbox"/> Notice of Informal Patent Application (PTO-152)
3) <input type="checkbox"/> Information Disclosure Statement(s) (PTO-1449 or PTO/SB/08) Paper No(s)/Mail Date ____.	6) <input type="checkbox"/> Other: ____.

<

### 707.01 Primary Examiner Indicates Action for New Assistant [R-2]

After the search has been completed, action is taken in the light of the references found. Where the assistant examiner has been in the Office but a short time, it is the duty of the primary examiner to review the application thoroughly. The usual procedure is for the assistant examiner to explain the invention and discuss the references which he or she regards as most pertinent. The primary examiner may indicate the action to be taken, whether restriction or election of species is to be required, or whether the claims are to be considered on their merits. If action on the merits is to be given, the >primary< examiner may indicate how the references are to be applied in cases where the claim is to be rejected, or authorize allowance if it is not met in the references and no further field of search is known.

### 707.02 Applications Up for Third Action and 5-Year Applications [R-2]

The supervisory patent examiners should impress their assistants with the fact that the shortest path to the final disposition of an application is by finding the best references on the first search and carefully applying them.

The supervisory patent examiners are expected to personally check on the pendency of every application which is up for the third or subsequent \*>Office< action with a view to finally concluding its prosecution.

Any application that has been pending five years should be carefully studied by the supervisory patent examiner and every effort >should be< made to terminate its prosecution. In order to accomplish this result, the application is to be considered “special” by the examiner.

### 707.05 Citation of References [R-2]

37 CFR 1.104. *Nature of examination.*

\*\*\*\*\*

(d) *Citation of references.*

(1) If domestic patents are cited by the examiner, their numbers and dates, and the names of the patentees will be stated. If domestic patent application publications are cited by the exam-

iner, their publication number, publication date, and the names of the applicants will be stated. If foreign published applications or patents are cited, their nationality or country, numbers and dates, and the names of the patentees will be stated, and such other data will be furnished as may be necessary to enable the applicant, or in the case of a reexamination proceeding, the patent owner, to identify the published applications or patents cited. In citing foreign published applications or patents, in case only a part of the document is involved, the particular pages and sheets containing the parts relied upon will be identified. If printed publications are cited, the author (if any), title, date, pages or plates, and place of publication, or place where a copy can be found, will be given.

(2) When a rejection in an application is based on facts within the personal knowledge of an employee of the Office, the data shall be as specific as possible, and the reference must be supported, when called for by the applicant, by the affidavit of such employee, and such affidavit shall be subject to contradiction or explanation by the affidavits of the applicant and other persons.

\*\*\*\*\*

During the examination of an application or reexamination of a patent, the examiner should cite appropriate prior art which is nearest to the subject matter defined in the claims. When such prior art is cited, its pertinence should be explained.

The examiner must consider all the prior art references (alone and in combination) cited in the application or reexamination, including those cited by the applicant in a properly submitted Information Disclosure Statement. See MPEP § 609.

Form paragraph 7.96 may be used as an introductory sentence.

#### ¶ 7.96 *Citation of Relevant Prior Art*

The prior art made of record and not relied upon is considered pertinent to applicant's disclosure. [1]

#### **Examiner Note:**

When such prior art is cited, its relevance should be explained in bracket 1 in accordance with MPEP § 707.05.

Effective June 8, 1995, Public Law 103-465 amended 35 U.S.C. 154 to change the term of a patent to 20 years measured from the filing date of the earliest U.S. application for which benefit under 35 U.S.C. 120, 121 or 365(c) is claimed. The 20-year patent term applies to all utility and plant patents issued on applications filed on or after June 8, 1995. As a result of the 20-year patent term, it is expected, in certain circumstances, that applicants may cancel their claim to priority by amending the specification to delete any references to prior applications. Therefore, examiners should search all applications based on the actual U.S. filing date of the application rather

than on the filing date of any parent U.S. application for which priority is claimed. Examiners should cite of interest all material prior art having an effective filing date after the filing date of the U.S. parent application but before the actual filing date of the application being examined.

Allowed applications should generally contain a citation of pertinent prior art for printing in the patent, even if no claim presented during the prosecution was considered unpatentable over such prior art. Only in those instances where a proper search has not revealed any prior art relevant to the claimed invention is it appropriate to send an application to issue with no art cited. In the case where no prior art is cited, the examiner must write "None" on a form PTO-892 and insert it in the file wrapper. >For Image File Wrapper (IFW) processing, see IFW Manual section 3.7.< Where references have been cited during the prosecution of parent applications and a continuing application, having no newly cited references, is ready for allowance, the cited references of the parent applications should be listed on a form PTO-892. The form should then be placed in the file of the continuing application. >For Image File Wrapper (IFW) processing, see IFW Manual section 3.7.< See MPEP § 1302.12. In a continued prosecution application filed under 37 CFR 1.53(d) \*\*, it is not necessary to prepare a new form PTO-892 since the form from the parent application is in the same file wrapper and will be used by the printer.

In all continuation and continuation-in-part applications, the parent applications should be reviewed for pertinent prior art.

Applicants and/or applicants' attorney in PCT related national applications may wish to cite the material citations from the PCT International Search Report by an information disclosure statement under 37 CFR 1.97 and 1.98 in order to ensure consideration by the examiner.

In those instances where no information disclosure statement has been filed by the applicant and where documents are cited in the International Search Report but neither a copy of the documents nor an English translation (or English family member) is provided, the examiner may exercise discretion in deciding whether to take necessary steps to obtain the copy and/or translation.

Copies of documents cited will be provided as set forth in MPEP § 707.05(a). That is, copies of docu-

ments cited by the examiner will be provided to applicant *except* where the documents:

(A) are cited by applicant in accordance with MPEP § 609, § 707.05(b), and § 708.02;

(B) have been referred to in applicant's disclosure statement;

(C) are cited and have been provided in a parent application;

(D) are cited by a third party in a submission under 37 CFR 1.99 >(MPEP § 1134.01)<; or

(E) are U.S. Patents >or U.S. application publications< which are cited at allowance (MPEP § 1302.04).

See MPEP § 707.05(e) regarding data used in citing references.

### **707.05(a) Copies of Cited References [R-2]**

Copies of cited references (except as noted below) are automatically furnished without charge to applicant together with the Office action in which they are cited. Copies of the cited references are also placed in the application file for use by the examiner during the prosecution.

Copies of references cited by applicant in accordance with MPEP § 609, § 707.05(b) and § 708.02 are *not* furnished to applicant with the Office action. Additionally, copies of references cited in continuation applications if they had been previously cited in the parent application are not furnished. The examiner should check the left hand column of form PTO-892 if a copy of the reference is not to be furnished to the applicant.

Copies of foreign patent documents and nonpatent literature (NPL) which are cited by the examiner at the time of allowance will be furnished to applicant with the Office action, and copies of the same will also be retained in the file. >For Image File Wrapper (IFW) processing, see IFW Manual section 3.7.< This will apply to all allowance actions, including first action allowances and *Ex Parte Quayle* actions.

In the rare instance where no art is cited in a \*>continuing< application, all the references cited during the prosecution of the parent application will be listed at allowance for printing in the patent.

To assist in providing copies of references, the examiner should:

(A) Write the citation of the references on form PTO-892, "Notice of References Cited";

(B) Place the form PTO-892 in the front of the file wrapper;

(C) Include in the application file wrapper all of the references cited by the examiner which are to be furnished to the applicant and which have been obtained from the classified search file;

(D) Make two copies of each reference which is to be supplied and which has been located in a place other than the classified search file (e.g., textbooks, bound magazines, personal search material, etc.). Using red ink identify one copy as "File Copy" and the other copy as "Applicant's Copy". Both copies should be placed in the application file wrapper >(for Image File Wrapper (IFW) processing, see IFW Manual)<;

(E) Turn the application in to the technical support staff for counting. Any application which is

handed in without all of the required references will be returned to the examiner. The missing reference(s) should be obtained and the file returned to the technical support staff as quickly as possible. >For Image File Wrapper (IFW) processing, see IFW Manual section 3.7.<

In the case of design applications, procedures are the same as set forth in MPEP § 707.05 (a)-(g) except that less than the entire disclosure of a cited U.S. utility patent may be supplied with the action by the Design Group. Copies of all sheets of drawings relied on and of the first page of the specification are furnished without charge. Any other subject matter, including additional pages of specification relied on by the examiner will be provided without charge. Where an applicant desires a complete copy of a cited U.S. patent, it may be obtained through Patent and Trademark Copy Sales at the usual charge.

<b>Notice of References Cited</b>	Application/Control No.	Applicant(s)/Patent Under Reexamination	
	Examiner	Art Unit	Page of

**U.S. PATENT DOCUMENTS**

*	A	B	C	D	E	F	G	H	I	J	K	L	M

**FOREIGN PATENT DOCUMENTS**

*	N	O	P	Q	R	S	T

**NON-PATENT DOCUMENTS**

*	U	V	W	X
	Include as applicable: Author, Title Date, Publisher, Edition or Volume, Pertinent Pages)			

\*A copy of this reference is not being furnished with this Office action. (See MPEP § 707.05(a) )  
 Dates in MM-YYYY format are publication dates. Classifications may be US or foreign.



## **707.05(b) Citation of Related Art and Information by Applicants [R-2]**

>

### **I. < CITATION OF RELATED ART BY APPLICANTS**

MPEP § 609 sets forth guidelines for applicants, their attorneys and agents who desire to submit prior art for consideration by the U.S. Patent and Trademark Office.

Submitted citations will not in any way diminish the obligation of examiners to conduct independent prior art searches, or relieve examiners of citing >other< pertinent prior art of which they may be aware\*\*.

Prior art submitted by applicant in the manner provided in MPEP § 609 will not be supplied with an Office action.

>

### **II. < CITATION OF RELATED INFORMATION BY APPLICANTS**

37 CFR 1.105 and MPEP § 704.10 *et seq.* set forth procedures for examiners to require applicants, their attorneys and agents to submit information reasonably necessary for the Office to examine an application or treat a matter being addressed in an application.

Any such requirement, and any information submitted in reply thereto, will not in any way diminish the obligation of examiners to conduct independent prior art searches, or relieve examiners of citing >other< pertinent prior art of which they may be aware\*\*.

Information submitted by applicant in the manner provided in MPEP § 704.10 *et seq.* will not be supplied with an Office action.

### **707.05(c) Order of Listing**

In citing references for the first time, the identifying data of the citation should be placed on form PTO-892 “Notice of References Cited,” a copy of which will be attached to the Office action. No distinction is to be made between references on which a claim is rejected and those formerly referred to as “pertinent.” With the exception of applicant submitted

citations, MPEP § 609 and § 708.02, it is recommended that the pertinent features of references which are not used as a basis for rejection be pointed out briefly.

See MPEP § 1302.12.

### **707.05(d) Reference Cited in Subsequent Actions [R-2]**

Where an applicant in an amendatory paper refers to a reference that is subsequently relied upon by the examiner, such reference shall be cited by the examiner in the usual manner using a form PTO-892, “Notice of References Cited,” unless applicant has listed the reference on a >form< PTO-1449 or >PTO/SB/08< that has been initialed by the examiner.

### **707.05(e) Data Used in Citing References [R-2]**

37 CFR 1.104(d) (see also MPEP § 707.05 and § 901.05(a)) requires the examiner to provide certain data when citing references. The examiner should provide the citations on the “Notice of References Cited” form PTO-892 (copy at MPEP § 707.05).

>

#### **I. < U.S. PATENT DOCUMENTS**

If a U.S. patent application publication is cited by the examiner, the publication number, publication date, name of the applicant, class, and subclass should be cited under the section “U.S. Patent Documents” on the form PTO-892. For U.S. patents, the patent number, patent date, name of the patentee, class and subclass should also be cited under the same section. In addition, examiners are encouraged to cite the kind codes printed on U.S. patent application publications and patents. See MPEP § 901.04(a) for an explanation of the kind codes. See MPEP § 901.04 for details concerning the various series of U.S. patents and how to cite them. Note that patents of the X-Series (dated prior to July 4, 1836) are *not* to be cited by number. Some U.S. patents issued in 1861 have two numbers thereon. The larger number should be cited.

Defensive Publications and Statutory Invention Registrations (SIRs) should be cited under the section “U.S. Patent Documents” on the form PTO-892 (see MPEP § 711.06(a) and § 901.06(a)).

&gt;

## II. < FOREIGN PATENTS AND FOREIGN PUBLISHED APPLICATIONS

In citing foreign patents, the patent number, kind code, citation date, name of the country, name of the patentee, and U.S. class and subclass, if appropriate, must be given. Foreign patents searched in those Technology Centers (TCs) filing by International Patent Classification (IPC) will be cited using the appropriate IPC subclass/group/subgroup. On the file wrapper “Searched” box and PTO-892, the IPC subclass/group/subgroup shall be cited in the spaces provided for “Classification.” >For Image File Wrapper (IFW) processing, see IFW Manual section 3.7.<

Where less than the entire disclosure of the reference is relied upon, the sheet and page numbers specifically relied upon and the total number of sheets of drawing and pages of specification must be included (except applicant submitted citations). If the entire disclosure is relied on, the total number of sheets and pages are not required to be included on the PTO-892.

Publications such as German allowed applications and Belgian and Netherlands printed specifications should be similarly handled.

See MPEP § 901.05(a) for a chart in which foreign language terms indicative of foreign patent and publication dates to be cited are listed.

&gt;

## III. < PUBLICATIONS

Abstracts, abbreviations, Alien Property Custodian publications, withdrawn U.S. patents, withdrawn U.S. patent application publications, and other non-patent documents should be cited under the section “Non-Patent Documents” on the form PTO-892). See MPEP § 711.06(a) for citation of abstracts, and abbreviations. See MPEP § 901.06(c) for citation of Alien Property Custodian publications. In citing a publication, sufficient information should be given to determine the identity and facilitate the location of the publication. For books, the data required by 37 CFR 1.104(d) (MPEP § 707.05) with the specific pages relied on identified together with the Scientific and Technical Information Center (STIC) call number will suffice. The call number appears on the “spine” of the book if the book is thick enough and, in any event, on the back of the title page. Books on interlibrary loan

will be marked with the call numbers of the other library, of course. THIS NUMBER SHOULD NOT BE CITED. The same convention should be followed in citing articles from periodicals. The call number should be cited for periodicals owned by the STIC, but not for periodicals borrowed from other libraries. In citing periodicals, information sufficient to identify the article includes the author(s) and title of the article and the title, volume number issue number, date, and pages of the periodical. If the copy relied on is located only in the Technology Center making the action (there may be no call number), the additional information, “Copy in Technology Center — —” should be given.

The following are examples of nonpatent bibliographical citations:

(A) *For books:*

Winslow, C. E. A. *Fresh Air and Ventilation*. N.Y., E. P. Dutton, 1926. p. 97-112. T117653.W5.

(B) *For parts of books:*

Smith, J. F. “Patent Searching.” in: Singer, T.E.R., *Information and Communication Practice in Industry* (New York, Reinhold, 1958), pp. 157-165. T 175.S5.

(C) *For encyclopedia articles:*

Calvert, R. “Patents (Patent Law).” in: *Encyclopedia of Chemical Technology* (1952 ed.), vol. 9, pp. 868-890. Ref. TP9.E68.

(D) *For sections of handbooks:*

*Machinery’s Handbook*, 16th ed. New York, International Press, 1959. pp. 1526-1527. TJ151.M3 1959.

(E) *For periodical articles:*

Noyes, W. A. A *Climate for Basic Chemical Research*  
*Chemical & Engineering News*, Vol. 38, no. 42 (Oct. 17, 1960), pp. 91-95. TP1.I418.

The following are examples of how withdrawn U.S. patents and withdrawn U.S. patent application publications should be cited:

(A) *Withdrawn U.S. patents:*

US 6,999,999, 10/2002, Brown et al., 403/155 (withdrawn).

(B) *Withdrawn U.S. patents application publications:*

US 2002/0009999 A1, 7/2002, Jones et al., 403/155 (withdrawn).

Titles of books and periodicals SHOULD NOT be abbreviated because an abbreviation such as P.S.E.B.M. will not be sufficient to identify the publication. References are to be cited so that anyone reading a patent may identify and retrieve the publications cited. Bibliographic information provided must be at least enough to identify the publication, author, title and date. For books, minimal information includes the author, title, and date. For periodicals, at least the title of the periodical, the volume number, date, and pages should be given. These minimal citations may be made ONLY IF the complete bibliographic details are unknown or unavailable.

Where a nonpatent literature reference with a document identification number is cited, the identification number and the class and subclass should be included on form PTO-892. For example, the citation should be as follows: (S00840001) Winslow, C.E.A. Fresh Air and Ventilation N.Y., E.P. Dutton, 1926, p. 97-112, TH 7653, W5, 315/22.

If the original publication is located outside the Office, the examiner should immediately make or order a photocopy of at least the portion relied upon and indicate the class and subclass in which it will be filed, if any.

>

#### IV. < ELECTRONIC DOCUMENTS

An electronic document is one that can be retrieved from an online source (e.g., the Internet, online database, etc.) or sources found on electronic storage media (e.g., CD-ROM, magnetic disk or tape, etc.). Many references in paper format may also be retrieved as electronic documents. Other references are retrievable only from electronic sources.

The U.S. Patent and Trademark Office follows the format recommended by World Intellectual Property Organization (WIPO) Standard ST.14, "Recommendation for the Inclusion of References Cited in Patent Documents." The format for the citation of an electronic document is as similar as possible to the format used for paper documents of the same type, but with the addition of the following information in the locations indicated, where appropriate:

(A) the type of electronic medium provided in square brackets [ ] after the title of the publication or

the designation of the host document, e.g., [online], [CD-ROM], [disk], [magnetic tape];

(B) the date when the document was retrieved from the electronic media in square brackets following after the date of publication, e.g., [retrieved on March 4, 1998], [retrieved on 1998-03-04]. The four-digit year must always be given.

(C) identification of the source of the document using the words "Retrieved from" and its address where applicable. This item will precede the citation of the relevant passages.

(D) specific passages of the text could be indicated if the format of the document includes pagination or an equivalent internal referencing system, or by the first and last words of the passage cited.

Office copies of an electronic document must be retained if the same document may not be available for retrieval in the future. This is especially important for sources such as the Internet and online databases.

If an electronic document is also available in paper form it does not need to be identified as an electronic document, unless it is considered desirable or useful to do so.

#### Examples 1-4: Documents retrieved from online databases outside the Internet

##### Example 1:

SU 1511467 A (BRYAN MECH) 1989-09-30 (abstract) World Patents Index [online]. London, U.K.: Derwent Publications, Ltd. [retrieved on 1998-02-24]. Retrieved from: Questel/Orbit, Paris, France. DW9016, Accession No. 90-121923.

##### Example 2:

DONG, X. R. 'Analysis of patients of multiple injuries with AIS-ISS and its clinical significance in the evaluation of the emergency managements', Chung Hua Wai Ko Tsa Chih, May 1993, Vol. 31, No. 5, pages 301-302. (abstract) Medline [online]. Bethesda, MD, USA: United States National Library of Medicine [retrieved on 24 February 1998]. Retrieved from: Dialog Information Services, Palo Alto, CA, USA. Medline Accession no. 94155687, Dialog Accession No. 07736604.

##### Example 3:

JENSEN, B. P. 'Multilayer printed circuits: production and application II'. Electronik, June-July

1976, No. 6-7, pages 8, 10,12,14,16. (abstract) INSPEC [online]. London, U.K.: Institute of Electrical Engineers [retrieved on 1998-02-24]. Retrieved from: STN International, Columbus, Ohio, USA. Accession No. 76:956632.

**Example 4:**

JP 3002404 (TAMURA TORU) 1991-03-13 (abstract). [online] [retrieved on 1998-09-02]. Retrieved from: EPO PAJ Database.

**Examples 5-11: Documents retrieved from the Internet****Example 5:****(Entire Work – Book or Report)**

WALLACE, S., and BAGHERZADEH, N. Multiple Branch and Block Prediction. Third International Symposium on High-Performance Computer Architecture [online], February 1997 [retrieved on 1998-05-20]. Retrieved from the Internet:< URL: <http://www.eng.uci.edu/comp.arch/papers-wallace/hpca3-block.ps>>.

**Example 6:****(Part of Work – chapter or equivalent designation)**

National Research Council, Board on Agriculture, Committee on Animal Nutrition, Subcommittee on Beef Cattle Nutrition. Nutrient Requirements of Beef Cattle [online]. 7th revised edition. Washington, DC: National Academy Press, 1996 [retrieved on 1998-06-10]. Retrieved from the Internet:< URL: <http://www2.nap.edu/htbin/docpage?title=Nutrient+Requirements+of+Beef+Cattle%3A+Seventh+Revised+Edition%2C+1996&dload=0&path=/ext5/extra&name=054265%2Erdo&docid=00805F50FE7b%3A840052612&colid=4%7C6%7C41&start=38>> Chapter 3, page 24, table 3-1.

**Example 7:****(Electronic Serial – articles or other contributions)**

Ajtai. Generating Hard Instances of Lattice Problems. Electronic Colloquium on Computational Complexity, Report TR96-007 [online], [retrieved on 1996-01-30]. Retrieved from the Internet

<URL: <ftp://ftp.eccc.uni-trier.de/pub/eccc/reports/1996/TR96-007/index.html>>

**Example 8:****(Electronic bulletin boards, message systems, and discussion lists – Entire System)**

BIOMET-L (A forum for the Bureau of Biometrics of New York) [online]. Albany (NY): Bureau of Biometrics, New York State Health Department, July, 1990 [retrieved 1998-02-24]. Retrieved from the Internet: <listserv@health.state.ny.us>, message: subscribe BIOMET-L your real name.

**Example 9:****(Electronic bulletin boards, message systems, and discussion lists – Contributions)**

PARKER, Elliott. 'Re: citing electronic journals'. In PACS-L (Public Access Computer Systems Forum) [online]. Houston (TX): University of Houston Libraries, November 24, 1989; 13:29:35 CST [retrieved on 1998-02-24]. Retrieved from the Internet: <URL:telnet://bruser@a.cni.org>.

**Example 10:****(Electronic mail)**

'Plumb design of a visual thesaurus'. The Scout Report [online]. 1998, vol. 5 no. 3 [retrieved on 1998-05-18]. Retrieved from Internet electronic mail: <listserv@cs.wisc.edu>, subscribe message: info scout-report. ISSN: 1092-3861\cf15.

**Example 11:**

Corebuilder 3500 Layer 3 High-function Switch. Datasheet [online]. 3Com Corporation, 1997 [retrieved on 1998-02-24]. Retrieved from the Internet: <URL: [www.3com.com/products/dsheets/400347.html](http://www.3com.com/products/dsheets/400347.html)>.

**(Product Manual/Catalogue or other information obtained from a Web-site)****Example 12:**

HU D9900111 Industrial Design Application, (HADJDUTEJ TEJIPARI RT, DEBRECEN) 1999-09-28, [online], [retrieved on 1999-10-26] Retrieved from the Industrial Design Database of the Hungarian Patent Office using Internet <URL: <http://www.hpo.hu/English/db/indigo/>>.

### Examples 13 and 14: Documents retrieved from CD-ROM products

#### Examples 13 and 14:

JP 0800085 A (TORAY IND INC), (abstract), 1996-05-31. In: Patent Abstracts of Japan [CD-ROM].

#### Examples 14:

HAYASHIDA, O. et. al.: Specific molecular recognition by chiral cage-type cyclophanes having leucine, valine, and alanine residues. In: Tetrahedron 1955, Vol. 51 (31), p. 8423-36. In: CA on CD [CD-ROM]. Columbus, OH: CAS.\f5Abstract 124:9350.

### 707.05(f) Effective Dates of Declassified Printed Matter

In using declassified material as references there are usually two pertinent dates to be considered, namely, the printing date and the publication date. The printing date in some instances will appear on the material and may be considered as that date when the material was prepared for limited distribution. The publication date is the date of release when the material was made available to the public. See *Ex parte Harris*, 79 USPQ 439 (Comm'r Pat. 1948). If the date of release does not appear on the material, this date may be determined by reference to the Office of Technical Services, Department of Commerce.

In the use of any of the above noted material as an anticipatory publication, the date of release following declassification is the effective date of publication within the meaning of the statute.

For the purpose of anticipation predicated upon prior knowledge under 35 U.S.C. 102(a) the above noted declassified material may be taken as *prima facie* evidence of such prior knowledge as of its printing date even though such material was classified at that time. When so used the material does not constitute an absolute statutory bar and its printing date may be antedated by an affidavit or declaration under 37 CFR 1.131.

### 707.05(g) Incorrect Citation of References [R-2]

Where an error in citation of a reference is brought to the attention of the Office by applicant, a letter cor-

recting the error, together with a correct copy of the reference, is sent to applicant. See MPEP § 710.06. Where the error is discovered by the examiner, applicant is also notified and the period for reply restarted. In either case, the examiner is directed to correct the error, in ink, in the paper in which the error appears, and place his or her initials on the margin of such paper, together with a notation of the paper number of the action in which the citation has been correctly given. See MPEP § 710.06. >For Image File Wrapper (IFW) processing, see IFW Manual.<

Form paragraphs 7.81-7.83 may be used to correct citations or copies of references cited.

#### ¶ 7.81 Correction Letter Re Last Office Action

In response to applicant's [1] regarding the last Office action, the following corrective action is taken.

The period for reply of [2] MONTHS set in said Office action is restarted to begin with the mailing date of this letter.

#### Examiner Note:

1. In bracket 1, insert --telephone inquiry of \_\_\_\_\_-- or --communication dated \_\_\_\_\_--.
2. In bracket 2, insert new period for reply.
3. This form paragraph must be followed by one or more of form paragraphs 7.82, 7.82.01 or 7.83.
4. Before restarting the period, the SPE should be consulted.

#### ¶ 7.82 Correction of Reference Citation

The reference [1] was not correctly cited in the last Office action. The correct citation is shown on the attached PTO-892.

#### Examiner Note:

1. Every correction MUST be reflected on a corrected or new PTO-892.
2. This form paragraph must follow form paragraph 7.81.
3. If a copy of the PTO-892 is being provided without correction, use form paragraph 7.83 instead of this form paragraph.
4. Also use form paragraph 7.82.01 if reference copies are being supplied.

#### ¶ 7.82.01 Copy of Reference(s) Furnished

Copies of the following references not previously supplied are enclosed:

#### Examiner Note:

1. The reference copies being supplied must be listed following this form paragraph.
2. This form paragraph must be preceded by form paragraph 7.82.01 and may also be used with form paragraphs 7.82 or 7.83.

>

#### ¶ 7.82.02 Copy of Provisional Application(s) Relied Upon for Prior Art Effect May Not Be Supplied

If a copy of a provisional application listed on the bottom portion of the accompanying Notice of References Cited (PTO-892)

form is not included with this Office action and the PTO-892 has been annotated to indicate that the copy was not readily available, it is because the copy could not be readily obtained when the Office action was mailed. Should applicant desire a copy of such a provisional application, applicant should promptly request the copy from the Office of Public Records (OPR) in accordance with 37 CFR 1.14(a)(1)(iv), paying the required fee under 37 CFR 1.19(b)(1). If a copy is ordered from OPR, the shortened statutory period for reply to this Office action will not be reset under MPEP § 710.06 unless applicant can demonstrate a substantial delay by the Office in fulfilling the order for the copy of the provisional application. Where the applicant has been notified on the PTO-892 that a copy of the provisional application is not readily available, the provision of MPEP § 707.05(a) that a copy of the cited reference will be automatically furnished without charge does not apply.

<

¶ 7.83 *Copy of Office Action Supplied*

[1] of the last Office action is enclosed.

**Examiner Note:**

1. In bracket 1, explain what is enclosed. For example:
  - a. "A corrected copy"
  - b. "A complete copy"
  - c. A specific page or pages, e.g., "Pages 3-5"
  - d. "A Notice of References Cited, Form PTO-892"
2. This form paragraph should follow form paragraph 7.81 and may follow form paragraphs 7.82 and 7.82.01.

In any application otherwise ready for issue, in which the erroneous citation has not been formally corrected in an official paper, the examiner is directed to correct the citation by examiner's amendment accompanying the Notice of Allowability form PTOL-37.

If a FOREIGN patent is incorrectly cited: for example, the wrong country is indicated or the country omitted from the citation, the General Reference Branch of the Scientific and Technical Library may be helpful. The date and number of the patent are often sufficient to determine the correct country which granted the patent.

## 707.06 Citation of Decisions, Orders Memorandums, and Notices [R-2]

In citing court decisions, the USPQ citation should be given and, when it is convenient to do so, the U.S., CCPA or Federal Reporter citation should also be provided.

The citation of manuscript decisions which are not available to the public should be avoided.

It is important to recognize that a federal district court decision that has been reversed on appeal cannot be cited as authority.

In citing a manuscript decision which is available to the public but which has not been published, the tribunal rendering the decision and complete data identifying the paper should be given. Thus, a decision of the Board of Patent Appeals and Interferences which has not been published but which is available to the public in the patented file should be cited, as " *Ex parte* — — — — —, decision of the Board of Patent Appeals and Interferences, Patent No. — — — — —, paper No. — — — — —, — — — — — pages."

Decisions found only in patented files should be cited only when there is no published decision on the same point.

When a \*>Director's< order, notice or memorandum not yet incorporated into this manual is cited in any official action, the title and date of the order, notice or memorandum should be given. When appropriate other data, such as a specific issue of the *Journal of the Patent and Trademark Office Society* or of the *Official Gazette* in which the same may be found, should also be given.

## 707.07 Completeness and Clarity of Examiner's Action

37 CFR 1.104. *Nature of examination.*

\*\*\*\*\*

(b) *Completeness of examiner's action.* The examiner's action will be complete as to all matters, except that in appropriate circumstances, such as misjoinder of invention, fundamental defects in the application, and the like, the action of the examiner may be limited to such matters before further action is made. However, matters of form need not be raised by the examiner until a claim is found allowable.

\*\*\*\*\*

## 707.07(a) Complete Action on Formal Matters [R-2]

Forms are placed in informal applications listing informalities noted by the Draftsperson (form PTO-948) and the Office of Initial Patent Examination (form PTO-152). Each of these forms comprises an original for the file record and a copy to be mailed to

applicant as a part of the examiner's first action. >For Image File Wrapper (IFW) processing, see IFW Manual.< They are specifically referred to as attachments to the action and are marked with its paper number. In every instance where these forms are to be used, they should be mailed with the examiner's *first* action, and any additional formal requirements which the examiner desires to make should be included in the *first* action.

When any formal requirement is made in an examiner's action, that action should, in all cases where it indicates allowable subject matter, call attention to 37 CFR 1.111(b) and state that a complete reply must either comply with all formal requirements or specifically traverse each requirement not complied with.

\*\*>

¶ 7.43.03 Allowable Subject Matter, Formal Requirements Outstanding

As allowable subject matter has been indicated, applicant's reply must either comply with all formal requirements or specifically traverse each requirement not complied with. See 37 CFR 1.111(b) and MPEP § 707.07(a).

**Examiner Note:**

This form paragraph would be appropriate when changes must be made prior to allowance. For example, when drawing corrections have been held in abeyance or when corrections to the specification have to be made prior to allowance.

<

**707.07(b) Requiring New Oath**

See MPEP § 602.02.

**707.07(c) Draftsperson's Requirement**

See MPEP § 707.07(a); also MPEP § 608.02(a), (e), and (s).

**707.07(d) Language To Be Used in Rejecting Claims**

Where a claim is refused for any reason relating to the merits thereof it should be "rejected" and the ground of rejection fully and clearly stated, and the word "reject" must be used. The examiner should designate the *statutory basis* for any ground of rejection by express reference to a section of 35 U.S.C. in the opening sentence of each ground of rejection. If the claim is rejected as broader than the enabling disclo-

sure, the reason for so holding should be given; if rejected as indefinite the examiner should point out wherein the indefiniteness resides; or if rejected as incomplete, the element or elements lacking should be specified, or the applicant be otherwise advised as to what the claim requires to render it complete.

See MPEP § 706.02 (i), (j), and (m) for language to be used.

Everything of a personal nature must be avoided. Whatever may be the examiner's view as to the utter lack of patentable merit in the disclosure of the application examined, he or she should not express in the record the opinion that the application is, or appears to be, devoid of patentable subject matter. Nor should he or she express doubts as to the allowability of allowed claims or state that every doubt has been resolved in favor of the applicant in granting him or her the claims allowed.

The examiner should, as a part of the first Office action on the merits, identify any claims which he or she judges, as presently recited, to be allowable and/or should suggest any way in which he or she considers that rejected claims may be amended to make them allowable. If the examiner does not do this, then by implication it will be understood by the applicant or his or her attorney or agent that in the examiner's opinion, as presently advised, there appears to be no allowable claim nor anything patentable in the subject matter to which the claims are directed.

**IMPROPERLY EXPRESSED REJECTIONS**

An omnibus rejection of the claim "on the references and for the reasons of record" is stereotyped and usually not informative and should therefore be avoided. This is especially true where certain claims have been rejected on one ground and other claims on another ground.

A plurality of claims should never be grouped together in a common rejection, unless that rejection is equally applicable to all claims in the group.

**707.07(e) Note All Outstanding Requirements**

In taking up an amended application for action the examiner should note in every letter all the requirements outstanding against the application. Every point in the prior action of an examiner which is still applicable must be repeated or referred to, to prevent the

implied waiver of the *requirement*. Such requirements include requirements for information under 37 CFR 1.105 and MPEP § 704.10; however the examiner should determine whether any such requirement has been satisfied by a negative reply under 37 CFR 1.105(a)(3).

As soon as allowable subject matter is found, correction of all informalities then present should be *required*.

### **707.07(f) Answer All Material Traversed [R-1]**

>In order to provide a complete application file history and to enhance the clarity of the prosecution history record, an examiner must provide clear explanations of all actions taken by the examiner during prosecution of an application.<

Where the requirements are traversed, or suspension thereof requested, the examiner should make proper reference thereto in his or her action on the amendment.

Where the applicant traverses any rejection, the examiner should, if he or she repeats the rejection, take note of the applicant's argument and answer the substance of it.

>If applicant's arguments are persuasive and upon reconsideration of the rejection, the examiner determines that the previous rejection should be withdrawn, the examiner must provide in the next Office communication the reasons why the previous rejection is withdrawn by referring specifically to the page(s) and line(s) of applicant's remarks which form the basis for withdrawing the rejection. It is not acceptable for the examiner to merely indicate that all of applicant's remarks form the basis for withdrawing the previous rejection. Form paragraph 7.38.01 may be used. If the withdrawal of the previous rejection results in the allowance of the claims, the reasons, which form the basis for the withdrawal of the previous rejection, may be included in a reasons for allowance. See MPEP § 1302.14.

If applicant's arguments are persuasive and the examiner determines that the previous rejection should be withdrawn but that, upon further consideration, a new ground of rejection should be made, form paragraph 7.38.02 may be used. See MPEP § 706.07(a) to determine whether the Office action may be made final.<

If a rejection of record is to be applied to a new or amended claim, specific identification of that ground of rejection, as by citation of the paragraph in the former Office letter in which the rejection was originally stated, should be given.

### **ANSWERING ASSERTED ADVANTAGES**

After an Office action, the reply (in addition to making amendments, etc.) may frequently include arguments and affidavits to the effect that the prior art cited by the examiner does not teach how to obtain or does not inherently yield one or more advantages (new or improved results, functions or effects), which advantages are urged to warrant issue of a patent on the allegedly novel subject matter claimed.

If it is the examiner's considered opinion that the asserted advantages are not sufficient to overcome the rejection(s) of record, he or she should state the reasons for his or her position in the record, preferably in the action following the assertion or argument relative to such advantages. By so doing the applicant will know that the asserted advantages have actually been considered by the examiner and, if appeal is taken, the Board of Patent Appeals and Interferences will also be advised. See MPEP § 716 *et seq.* for the treatment of affidavits and declarations under 37 CFR 1.132.

The importance of answering applicant's arguments is illustrated by *In re Herrmann*, 261 F.2d 598, 120 USPQ 182 (CCPA 1958) where the applicant urged that the subject matter claimed produced new and useful results. The court noted that since applicant's statement of advantages was not questioned by the examiner or the Board of Appeals, it was constrained to accept the statement at face value and therefore found certain claims to be allowable. See also *In re Soni*, 54 F.3d 746, 751, 34 USPQ2d 1684, 1688 (Fed. Cir. 1995) (Office failed to rebut applicant's argument).

Form paragraphs 7.37 through \*>7.37.13< may be used where applicant's arguments are not persuasive\*\*.

>Form paragraphs 7.38 through 7.38.02 may be used where applicant's arguments are moot or persuasive.<

#### *¶ 7.37 Arguments Are Not Persuasive*

Applicant's arguments filed [1] have been fully considered but they are not persuasive. [2]



**Examiner Note:**

1. The examiner must address all arguments which have not already been responded to in the statement of the rejection.
2. In bracket 2, provide explanation as to non-persuasiveness.

*¶ 7.38 Arguments Are Moot Because of New Ground(s) of Rejection*

Applicant's arguments with respect to claim [1] have been considered but are moot in view of the new ground(s) of rejection.

**Examiner Note:**

The examiner must, however, address any arguments presented by the applicant which are still relevant to any references being applied.

>

*¶ 7.38.01 Arguments Persuasive, Previous Rejection/Objection Withdrawn*

Applicant's arguments, see [1], filed [2], with respect to [3] have been fully considered and are persuasive. The [4] of [5] has been withdrawn.

**Examiner Note:**

1. In bracket 1, identify the page(s) and line number(s) from applicant's remarks which form the basis for withdrawing the previous rejection/objection.
2. In bracket 3, insert claim number, figure number, the specification, the abstract, etc.
3. In bracket 4, insert rejection or objection.
4. In bracket 5, insert claim number, figure number, the specification, the abstract, etc.

*¶ 7.38.02 Arguments Persuasive, New Ground(s) of Rejection*

Applicant's arguments, see [1], filed [2], with respect to the rejection(s) of claim(s) [3] under [4] have been fully considered and are persuasive. Therefore, the rejection has been withdrawn. However, upon further consideration, a new ground(s) of rejection is made in view of [5].

**Examiner Note:**

1. In bracket 1, identify the page(s) and line number(s) from applicant's remarks which form the basis for withdrawing the previous rejection.
2. In bracket 3, insert the claim number(s).
3. In bracket 4, insert the statutory basis for the previous rejection.
4. In bracket 5, insert the new ground(s) of rejection, e.g., different interpretation of the previously applied reference, newly found prior art reference(s), and provide an explanation of the rejection.

<

*¶ 7.37.01 Unpersuasive Argument: Age of Reference(s)*

In response to applicant's argument based upon the age of the references, contentions that the reference patents are old are not

impressive absent a showing that the art tried and failed to solve the same problem notwithstanding its presumed knowledge of the references. See *In re Wright*, 569 F.2d 1124, 193 USPQ 332 (CCPA 1977).

**Examiner Note:**

This form paragraph must be preceded by form paragraph 7.37.

*¶ 7.37.02 Unpersuasive Argument: Bodily Incorporation*

In response to applicant's argument that [1], the test for obviousness is not whether the features of a secondary reference may be bodily incorporated into the structure of the primary reference; nor is it that the claimed invention must be expressly suggested in any one or all of the references. Rather, the test is what the combined teachings of the references would have suggested to those of ordinary skill in the art. See *In re Keller*, 642 F.2d 413, 208 USPQ 871 (CCPA 1981).

**Examiner Note:**

1. In bracket 1, briefly restate applicant's arguments with respect to the issue of bodily incorporation.
2. This form paragraph must be preceded by form paragraph 7.37.

*¶ 7.37.03 Unpersuasive Argument: Hindsight Reasoning*

In response to applicant's argument that the examiner's conclusion of obviousness is based upon improper hindsight reasoning, it must be recognized that any judgment on obviousness is in a sense necessarily a reconstruction based upon hindsight reasoning. But so long as it takes into account only knowledge which was within the level of ordinary skill at the time the claimed invention was made, and does not include knowledge gleaned only from the applicant's disclosure, such a reconstruction is proper. See *In re McLaughlin*, 443 F.2d 1392, 170 USPQ 209 (CCPA 1971).

**Examiner Note:**

This form paragraph must be preceded by form paragraph 7.37.

*¶ 7.37.04 Unpersuasive Argument: No Suggestion To Combine*

In response to applicant's argument that there is no suggestion to combine the references, the examiner recognizes that obviousness can only be established by combining or modifying the teachings of the prior art to produce the claimed invention where there is some teaching, suggestion, or motivation to do so found either in the references themselves or in the knowledge generally available to one of ordinary skill in the art. See *In re Fine*, 837 F.2d 1071, 5 USPQ2d 1596 (Fed. Cir. 1988) and *In re Jones*, 958 F.2d 347, 21 USPQ2d 1941 (Fed. Cir. 1992). In this case, [1].

**Examiner Note:**

1. In bracket 1, explain where the motivation for the rejection is found, either in the references, or in the knowledge generally available to one of ordinary skill in the art.
2. This form paragraph must be preceded by form paragraph 7.37.

¶ 7.37.05 *Unpersuasive Argument: Nonanalogous Art*

In response to applicant's argument that [1] is nonanalogous art, it has been held that a prior art reference must either be in the field of applicant's endeavor or, if not, then be reasonably pertinent to the particular problem with which the applicant was concerned, in order to be relied upon as a basis for rejection of the claimed invention. See *In re Oetiker*, 977 F.2d 1443, 24 USPQ2d 1443 (Fed. Cir. 1992). In this case, [2].

**Examiner Note:**

1. In bracket 1, enter the name of the reference which applicant alleges is nonanalogous.
2. In bracket 2, explain why the reference is analogous art.
3. This form paragraph must be preceded by form paragraph 7.37.

¶ 7.37.06 *Unpersuasive Argument: Number of References*

In response to applicant's argument that the examiner has combined an excessive number of references, reliance on a large number of references in a rejection does not, without more, weigh against the obviousness of the claimed invention. See *In re Gorman*, 933 F.2d 982, 18 USPQ2d 1885 (Fed. Cir. 1991).

**Examiner Note:**

This form paragraph must be preceded by form paragraph 7.37.

¶ 7.37.07 *Unpersuasive Argument: Applicant Obtains Result Not Contemplated by Prior Art*

In response to applicant's argument that [1], the fact that applicant has recognized another advantage which would flow naturally from following the suggestion of the prior art cannot be the basis for patentability when the differences would otherwise be obvious. See *Ex parte Obiaya*, 227 USPQ 58, 60 (Bd. Pat. App. & Inter. 1985).

**Examiner Note:**

1. In bracket 1, briefly restate applicant's arguments with respect to the issue of results not contemplated by the prior art.
2. This form paragraph must be preceded by form paragraph 7.37.

¶ 7.37.08 *Unpersuasive Argument: Arguing Limitations Which Are Not Claimed*

In response to applicant's argument that the references fail to show certain features of applicant's invention, it is noted that the features upon which applicant relies (i.e., [1]) are not recited in the rejected claim(s). Although the claims are interpreted in light of the specification, limitations from the specification are not read into the claims. See *In re Van Geuns*, 988 F.2d 1181, 26 USPQ2d 1057 (Fed. Cir. 1993).

**Examiner Note:**

1. In bracket 1, recite the features upon which applicant relies, but which are not recited in the claim(s).
2. This form paragraph must be preceded by form paragraph 7.37.

¶ 7.37.09 *Unpersuasive Argument: Intended Use*

In response to applicant's argument that [1], a recitation of the intended use of the claimed invention must result in a structural difference between the claimed invention and the prior art in order to patentably distinguish the claimed invention from the prior art. If the prior art structure is capable of performing the intended use, then it meets the claim. In a claim drawn to a process of making, the intended use must result in a manipulative difference as compared to the prior art. See *In re Casey*, 152 USPQ 235 (CCPA 1967) and *In re Otto*, 136 USPQ 458, 459 (CCPA 1963).

**Examiner Note:**

1. In bracket 1, briefly restate applicant's arguments with respect to the issue of intended use.
2. This form paragraph must be preceded by form paragraph 7.37.

¶ 7.37.10 *Unpersuasive Argument: Limitation(s) in Preamble*

In response to applicant's arguments, the recitation [1] has not been given patentable weight because the recitation occurs in the preamble. A preamble is generally not accorded any patentable weight where it merely recites the purpose of a process or the intended use of a structure, and where the body of the claim does not depend on the preamble for completeness but, instead, the process steps or structural limitations are able to stand alone. See *In re Hirao*, 535 F.2d 67, 190 USPQ 15 (CCPA 1976) and *Kropa v. Robie*, 187 F.2d 150, 152, 88 USPQ 478, 481 (CCPA 1951).

**Examiner Note:**

1. In bracket 1, briefly restate the recitation about which applicant is arguing.
2. This form paragraph must be preceded by form paragraph 7.37.

¶ 7.37.11 *Unpersuasive Argument: General Allegation of Patentability*

Applicant's arguments fail to comply with 37 CFR 1.111(b) because they amount to a general allegation that the claims define a patentable invention without specifically pointing out how the language of the claims patentably distinguishes them from the references.

**Examiner Note:**

This form paragraph must be preceded by form paragraph 7.37.

¶ 7.37.12 *Unpersuasive Argument: Novelty Not Clearly Pointed Out*

Applicant's arguments do not comply with 37 CFR 1.111(c) because they do not clearly point out the patentable novelty which he or she thinks the claims present in view of the state of the art disclosed by the references cited or the objections made. Further, they do not show how the amendments avoid such references or objections.

**Examiner Note:**

This form paragraph must be preceded by form paragraph 7.37.

¶ 7.37.13 *Unpersuasive Argument: Arguing Against References Individually*

In response to applicant's arguments against the references individually, one cannot show nonobviousness by attacking references individually where the rejections are based on combinations of references. See *In re Keller*, 642 F.2d 413, 208 USPQ 871 (CCPA 1981); *In re Merck & Co.*, 800 F.2d 1091, 231 USPQ 375 (Fed. Cir. 1986).

**Examiner Note:**

This form paragraph must be preceded by form paragraph 7.37.

**707.07(g) Piecemeal Examination**

Piecemeal examination should be avoided as much as possible. The examiner ordinarily should reject each claim on all valid grounds available, avoiding, however, undue multiplication of references. (See MPEP § 904.03.) Major technical rejections on grounds such as lack of proper disclosure, lack of enablement, serious indefiniteness and *res judicata* should be applied where appropriate even though there may be a seemingly sufficient rejection on the basis of prior art. Where a major technical rejection is proper, it should be stated with a full development of reasons rather than by a mere conclusion coupled with some stereotyped expression.

In cases where there exists a sound rejection on the basis of prior art which discloses the "heart" of the invention (as distinguished from prior art which merely meets the terms of the claims), secondary rejections on minor technical grounds should ordinarily not be made. Certain technical rejections (e.g. negative limitations, indefiniteness) should not be made where the examiner, recognizing the limitations of the English language, is not aware of an improved mode of definition.

Some situations exist where examination of an application appears best accomplished by limiting action on the claim thereof to a particular issue. These situations include the following:

(A) Where an application is too informal for a complete action on the merits. See MPEP § 702.01;

(B) Where there is an undue multiplicity of claims, and there has been no successful telephone request for election of a limited number of claims for full examination. See MPEP § 2173.05(n);

(C) Where there is a misjoinder of inventions and there has been no successful telephone request for election. See MPEP § 803, § 806.02, § 812.01;

(D) Where disclosure is directed to perpetual motion. See *Ex parte Payne*, 1904 C.D. 42, 108 O.G. 1049 (Comm'r Pat. 1903). However, in such cases, the best prior art readily available should be cited and its pertinency pointed out without specifically applying it to the claims.

On the other hand, a rejection on the grounds of *res judicata*, no *prima facie* showing for reissue, new matter, or inoperativeness (not involving perpetual motion) should be accompanied by rejection on all other available grounds.

**707.07(h) Notify of Inaccuracies in Amendment**

See MPEP § 714.23.

**707.07(i) Each Claim To Be Mentioned in Each Office Action [R-2]**

In every Office action, each pending claim should be mentioned by number, and its treatment or status given. Since a claim retains its original numeral throughout the prosecution of the application, its history through successive actions is thus easily traceable. Each action should include a summary of the status of all claims presented for examination. Form PTO-326 "Office Action Summary" should be used.

Claims retained under 37 CFR 1.142 and claims retained under 37 CFR 1.146 should be treated as set out in MPEP § 821 to § 821.03 and § 809.02(c).

See MPEP § 2363.03 for treatment of claims in the application of losing party in interference.

The Index of Claims should be kept up to date as set forth in MPEP § 719.04. For Image File Wrapper (IFW) processing, see IFW Manual.

**707.07(j) State When Claims Are Allowable [R-2]**

>

**I. < INVENTOR FILED APPLICATIONS**

When, during the examination of a *pro se* application it becomes apparent to the examiner that there is patentable subject matter disclosed in the application, the examiner should draft one or more claims for the applicant and indicate in his or her action that such

claims would be allowed if incorporated in the application by amendment.

This practice will expedite prosecution and offer a service to individual inventors not represented by a registered patent attorney or agent. Although this practice may be desirable and is permissible in any case deemed appropriate by the examiner, it will be expected to be applied in all cases where it is apparent that the applicant is unfamiliar with the proper preparation and prosecution of patent applications.

>

## II. < ALLOWABLE EXCEPT AS TO FORM

When an application discloses patentable subject matter and it is apparent from the claims and applicant's arguments that the claims are intended to be directed to such patentable subject matter, but the claims in their present form cannot be allowed because of defects in form or omission of a limitation, the examiner should not stop with a bare objection or rejection of the claims. The examiner's action should be constructive in nature and, when possible, should offer a definite suggestion for correction. Further, an examiner's suggestion of allowable subject matter may justify indicating the possible desirability of an interview to accelerate early agreement on allowable claims.

If the examiner is satisfied after the search has been completed that patentable subject matter has been disclosed and the record indicates that the applicant intends to claim such subject matter, the examiner may note in the Office action that certain aspects or features of the patentable invention have not been claimed and that if properly claimed such claims may be given favorable consideration.

If a claim is otherwise allowable but is dependent on a canceled claim or on a rejected claim, the Office action should state that the claim would be allowable if rewritten in independent form.

>

## III. < EARLY ALLOWANCE OF CLAIMS

Where the examiner is satisfied that the prior art has been fully developed and some of the claims are clearly allowable, the allowance of such claims should not be delayed.

Form paragraphs 7.43, 7.43.01, and 7.43.02 may be used to indicate allowable subject matter.

### ¶ 7.43 *Objection to Claims, Allowable Subject Matter*

Claim [1] objected to as being dependent upon a rejected base claim, but would be allowable if rewritten in independent form including all of the limitations of the base claim and any intervening claims.

\*\*>

#### ¶ 7.43.01 *Allowable Subject Matter, Claims Rejected Under 35 U.S.C. 112, Second Paragraph, Independent Claim/Dependent Claim*

Claim [1] would be allowable if rewritten or amended to overcome the rejection(s) under 35 U.S.C. 112, 2nd paragraph, set forth in this Office action.

#### **Examiner Note:**

This form paragraph is to be used when (1) the noted independent claim(s) or (2) the noted dependent claim(s), which depend from an allowable claim, have been rejected solely on the basis of 35 U.S.C. 112, second paragraph, and would be allowable if amended to overcome the rejection.

#### ¶ 7.43.02 *Allowable Subject Matter, Claims Rejected Under 35 U.S.C. 112, Second Paragraph, Dependent Claim*

Claim [1] would be allowable if rewritten to overcome the rejection(s) under 35 U.S.C. 112, 2nd paragraph, set forth in this Office action and to include all of the limitations of the base claim and any intervening claims.

#### **Examiner Note:**

This form paragraph is to be used only when the noted dependent claim(s), which depend from a claim that is rejected based on prior art, have been rejected solely on the basis of 35 U.S.C. 112, second paragraph, and would be allowable if amended as indicated.

<

#### ¶ 7.43.04 *Suggestion of Allowable Drafted Claim(s), Pro Se*

The following claim [1] drafted by the examiner and considered to distinguish patentably over the art of record in this application, [2] presented to applicant for consideration:

[3].

#### **Examiner Note:**

1. If the suggested claim is not considered to be embraced by the original oath or declaration, a supplemental oath or declaration should be required under 37 CFR 1.67.
2. In bracket 2, insert --is-- or --are--.
3. In bracket 3, insert complete text of suggested claim(s).

Form paragraph 7.97 may be used to indicate allowance of claims.

### ¶ 7.97 *Claims Allowed*

Claim [1] allowed.

### 707.07(k) Numbering Paragraphs

It is good practice to number the paragraphs of the Office action consecutively. This facilitates their identification in the future prosecution of the application.

### 707.07(l) Comment on Examples

The results of the tests and examples should not normally be questioned by the examiner unless there is reasonable basis for questioning the results. If the examiner questions the results, the appropriate claims should be rejected as being based on an insufficient disclosure under 35 U.S.C. 112, first paragraph. *In re Borkowski*, 422 F.2d 904, 164 USPQ 642 (CCPA 1970). See MPEP § 2161 through § 2164.08(c) for a discussion of the written description and enablement requirements of 35 U.S.C. 112, first paragraph. The applicant must reply to the rejection, for example, by providing the results of an actual test or example which has been conducted, or by providing relevant arguments that there is strong reason to believe that the result would be as predicted. Care should be taken that new matter is not entered into the application.

If questions are present as to operability or utility, consideration should be given to the applicability of a rejection under 35 U.S.C. 101. See MPEP § 706.03(a) and § 2107 *et seq.*

### 707.08 Reviewing and Initialing by Assistant Examiner [R-2]

The full surname of the examiner who prepares the Office action will, in all cases, be typed at the end of the action. The telephone number below this should be called if the application is to be discussed or an interview arranged. Form paragraph 7.100, 7.101 or 7.102 should be used.

#### ¶ 7.100 Name And Number of Examiner To Be Contacted

Any inquiry concerning this communication should be directed to [1] at telephone number [2].

#### Examiner Note:

1. This form paragraph, form paragraph 7.101, or form paragraph 7.102 should be used at the conclusion of all actions.
2. In bracket 1, insert the name of the examiner designated to be contacted first regarding inquiries about the Office action. This could be either the non-signatory examiner preparing the action or the signatory examiner.

3. In bracket 2, insert the individual area code and phone number of the examiner to be contacted.

\*\*>

#### ¶ 7.101 Telephone Inquiry Contacts- Non 5/4/9 Schedule

Any inquiry concerning this communication or earlier communications from the examiner should be directed to [1] whose telephone number is [2]. The examiner can normally be reached on [3] from [4] to [5].

If attempts to reach the examiner by telephone are unsuccessful, the examiner's supervisor, [6], can be reached on [7]. The fax phone number for the organization where this application or proceeding is assigned is (703) 872-9306.

Information regarding the status of an application may be obtained from the Patent Application Information Retrieval (PAIR) system. Status information for published applications may be obtained from either Private PAIR or Public PAIR. Status information for unpublished applications is available through Private PAIR only. For more information about the PAIR system, see <http://pair-direct.uspto.gov>. Should you have questions on access to the Private PAIR system, contact the Electronic Business Center (EBC) at 866-217-9197 (toll-free).

#### Examiner Note:

1. In bracket 1, insert your name.
2. In bracket 2, insert your individual area code and phone number.
3. In bracket 3, insert the days that you work every week, e.g. "Monday-Thursday" for an examiner off every Friday.
4. In brackets 4 and 5, insert your normal duty hours, e.g. "6:30 AM - 5:00 PM."
5. In bracket 6, insert your SPE's name.
6. In bracket 7, insert your SPE's area code and phone number.

#### ¶ 7.102 Telephone Inquiry Contacts- 5/4/9 Schedule

Any inquiry concerning this communication or earlier communications from the examiner should be directed to [1] whose telephone number is [2]. The examiner can normally be reached on [3] from [4] to [5]. The examiner can also be reached on alternate [6].

If attempts to reach the examiner by telephone are unsuccessful, the examiner's supervisor, [7], can be reached on [8]. The fax phone number for the organization where this application or proceeding is assigned is (703) 872-9306.

Information regarding the status of an application may be obtained from the Patent Application Information Retrieval (PAIR) system. Status information for published applications may be obtained from either Private PAIR or Public PAIR. Status information for unpublished applications is available through Private PAIR only. For more information about the PAIR system, see <http://pair-direct.uspto.gov>. Should you have questions on access to the Private PAIR system, contact the Electronic Business Center (EBC) at 866-217-9197 (toll-free).

#### Examiner Note:

1. In bracket 1, insert your name.
2. In bracket 2, insert your individual area code and phone number.

3. In bracket 3, insert the days that you work every week, e.g. "Monday-Thursday" for an examiner off on alternate Fridays.
4. In brackets 4 and 5, insert your normal duty hours, e.g. "6:30 AM - 4:00 PM."
5. In bracket 6, insert the day in each pay-period that is your compressed day off, e.g. "Fridays" for an examiner on a 5/4/9 work schedule with the first Friday off.
6. In bracket 7, insert your SPE's name.
7. In bracket 8, insert your SPE's area code and phone number.

<

After the action is typed, the examiner who prepared the action reviews it for correctness. The surname or initials of the examiner who prepared the action and the date on which the action was typed should appear below the action. If this examiner does not have the authority to sign the action, he or she should initial above the typed name or initials, and forward the action to the authorized signatory examiner for signing.

### **707.09 Signing by Primary or Other Authorized Examiner**

Although only the original is signed, the word "Examiner" and the name of the signer should appear on the original and copies.

All Office actions and other correspondence should be signed promptly.

### **707.10 Entry [R-2]**

The original, signed by the authorized examiner, is the copy which is placed in the file wrapper. The character of the action, its paper number and the date of mailing are entered in black ink on the outside of the file wrapper under "Contents." >For Image File Wrapper (IFW) processing, see IFW Manual section 3.7.<

### **707.11 Date**

The mailing date should not be typed when the Office action is written, but should be stamped or printed on all copies of the action after it has been signed by the authorized signatory examiner and the copies are about to be mailed.

### **707.12 Mailing [R-2]**

Copies of the examiner's action are mailed by the Technology Center after the original, initialed by the assistant examiner and signed by the authorized sig-

natory examiner, has been placed in the file. After the copies are mailed the original is returned for placement in the file. >For Image File Wrapper (IFW) processing, see IFW Manual section 3.7.<

### **707.13 Returned Office Action [R-2]**

Office actions are sometimes returned to the Office because the United States Postal Service has not been able to deliver them. The examiner should use every reasonable means to ascertain the correct address and forward the action again, after stamping it "remailed" with the date thereof and redirecting it if there is any reason to believe that the action would reach applicant at such new address. If the Office action was addressed to an attorney, a letter may be written to the inventor or assignee informing him or her of the returned action. The period running against the application begins with the date of remailing. *Ex parte Gourtoff*, 1924 C.D. 153, 329 O.G. 536 (Comm'r Pat. 1924).

If the Office is not finally successful in delivering the letter, it is placed, with the envelope, in the file wrapper. >For an Image File Wrapper (IFW), a copy of the letter, and a copy of the envelope should be added to the IFW (see IFW Manual).< If the period dating from the remailing elapses with no communication from applicant, the application is abandoned.

### **708 Order of Examination [R-2]**

Nonprovisional applications filed in the U.S. Patent and Trademark Office and accepted as complete applications are assigned for examination to the respective examining Technology Centers (TCs) having the classes of inventions to which the applications relate. Nonprovisional applications shall be taken up for examination by the examiner to whom they have been assigned in the order in which they have been filed except for those applications in which examination has been advanced pursuant to 37 CFR 1.102. See 37 CFR 1.496 and MPEP § 1893.03 for the order of examination of international applications in the national stage, including taking up out of order certain national stage applications which have been indicated as satisfying the criteria of PCT Article 33(1)-(4) as to novelty, inventive step and industrial applicability.

Applications which have been acted upon by the examiner, and which have been placed by the applicant in condition for further action by the examiner

(amended applications) shall be taken up for action in such order as shall be determined by the \*>Director of the USPTO<.

Each examiner will give priority to that application in his or her docket, whether amended or new, which has the *oldest effective U.S. filing date*. Except as rare circumstances may justify Technology Center Directors in granting individual exceptions, this basic policy applies to all applications.

The actual filing date of a continuation-in-part application is used for docketing purposes. However, the examiner may act on a continuation-in-part application by using the effective filing date, if desired.

If at any time an examiner determines that the “effective filing date” status of any application differs from what the records show, the technical support staff should be informed, who should promptly amend the records to show the correct status, with the date of correction.

The order of examination for each examiner is to give priority to reissue applications and to reexamination proceedings, with top priority to reissue applications in which litigation has been stayed (MPEP § 1442.03)\*>,< to >*ex parte*< reexamination proceedings involved in litigation (MPEP § 2261), >and to *inter partes* reexamination proceedings involved in litigation (MPEP § 2661),< then to those special cases having a fixed 30-day due date, such as examiner’s answers and decisions on motions. Most other cases in the “special” category (for example, interference cases, cases made special by petition, cases ready for final conclusion, etc.) will continue in this category, with the first effective U.S. filing date among them normally controlling priority.

All amendments before final rejection should be responded to within two months of receipt.

## 708.01 List of Special Cases [R-2]

37 CFR 1.102. *Advancement of examination.*

\*\*>

(a) Applications will not be advanced out of turn for examination or for further action except as provided by this part, or upon order of the Director to expedite the business of the Office, or upon filing of a request under paragraph (b) of this section or upon filing a petition under paragraphs (c) or (d) of this section with a showing which, in the opinion of the Director, will justify so advancing it.<

(b) Applications wherein the inventions are deemed of peculiar importance to some branch of the public service and the head

of some department of the Government requests immediate action for that reason, may be advanced for examination.

(c) A petition to make an application special may be filed without a fee if the basis for the petition is the applicant’s age or health or that the invention will materially enhance the quality of the environment or materially contribute to the development or conservation of energy resources.

(d) A petition to make an application special on grounds other than those referred to in paragraph (c) of this section must be accompanied by the fee set forth in § 1.17(h).

Certain procedures by the examiners take precedence over actions even on special cases.

For example, all papers typed and ready for signature should be completed and mailed.

All issue cases returned with a “Printer Waiting” slip must be processed and returned within the period indicated.

Reissue applications, particularly those involved in stayed litigation, should be given priority.

Applications in which practice requires that the examiner act within a set period, such as 2 months after appellants brief to furnish the examiner’s answers (MPEP § 1208), necessarily take priority over special cases without specific time limits.

If an examiner has an application in which he or she is satisfied that it is in condition for allowance, or in which he or she is satisfied will have to be finally rejected, he or she should give such action forthwith instead of making the application await its turn.

The following is a list of special cases (those which are advanced out of turn for examination):

(A) Applications wherein the inventions are deemed of peculiar importance to some branch of the public service and when for that reason the head of some department of the Government requests immediate action and the \*>Director of the USPTO< so orders (37 CFR 1.102).

(B) Applications made special as a result of a petition. (See MPEP § 708.02.)

Subject alone to diligent prosecution by the applicant, an application for patent that has once been made special and advanced out of turn for examination by reason of a ruling made in that particular case (by the \*>Director of the USPTO< or \*\*>a< Commissioner) will continue to be special throughout its entire course of prosecution in the U.S. Patent and Trademark Office, including appeal, if any, to the Board of Patent Appeals and Interferences.

(C) Applications for reissues, particularly those involved in stayed litigation (37 CFR 1.176).

(D) Applications remanded by an appellate tribunal for further action.

(E) An application, once taken up for action by an examiner according to its effective filing date, should be treated as special by an examiner, art unit or Technology Center to which it may subsequently be transferred; exemplary situations include new cases transferred as the result of a telephone election and cases transferred as the result of a timely reply to any official action.

(F) Applications which appear to interfere with other applications previously considered and found to be allowable, or which will be placed in interference with an unexpired patent or patents.

(G) Applications ready for allowance, or ready for allowance except as to formal matters.

(H) Applications which are in condition for final rejection.

(I) Applications pending more than 5 years, including those which, by relation to a prior United States application, have an effective pendency of more than 5 years. See MPEP § 707.02.

(J) Reexamination proceedings, MPEP § 2261 >and § 2661<.

See also MPEP § 714.13, § 1207 and § 1309.

## 708.02 Petition To Make Special [R-2]

37 CFR 1.102. *Advancement of examination.*

\*\*>

(a) Applications will not be advanced out of turn for examination or for further action except as provided by this part, or upon order of the Director to expedite the business of the Office, or upon filing of a request under paragraph (b) of this section or upon filing a petition under paragraphs (c) or (d) of this section with a showing which, in the opinion of the Director, will justify so advancing it.<

(b) Applications wherein the inventions are deemed of peculiar importance to some branch of the public service and the head of some department of the Government requests immediate action for that reason, may be advanced for examination.

(c) A petition to make an application special may be filed without a fee if the basis for the petition is the applicant's age or health or that the invention will materially enhance the quality of the environment or materially contribute to the development or conservation of energy resources.

(d) A petition to make an application special on grounds other than those referred to in paragraph (c) of this section must be accompanied by the fee set forth in § 1.17(h).

New applications ordinarily are taken up for examination in the order of their effective United States filing dates. Certain exceptions are made by way of petitions to make special, which may be granted under the conditions set forth below.

### I. MANUFACTURE

An application may be made special on the ground of prospective manufacture upon the filing of a petition accompanied by the fee under 37 CFR 1.17(h) and a statement by the applicant, assignee or an attorney/agent registered to practice before the Office alleging:

(A) The possession by the prospective manufacturer of sufficient presently available capital (stating approximately the amount) and facilities (stating briefly the nature thereof) to manufacture the invention in quantity or that sufficient capital and facilities will be made available if a patent is granted;

If the prospective manufacturer is an individual, there must be a corroborating statement from some responsible party, as for example, an officer of a bank, showing that said individual has the required available capital to manufacture;

(B) That the prospective manufacturer will not manufacture, or will not increase present manufacture, unless certain that the patent will be granted;

(C) That the prospective manufacturer obligates himself, herself or itself, to manufacture the invention, in the United States or its possessions, in quantity immediately upon the allowance of claims or issuance of a patent which will protect the investment of capital and facilities; and

(D) That the applicant or assignee has made or caused to be made a careful and thorough search of the prior art, or has a good knowledge of the pertinent prior art.

Applicant must provide one copy of each of the references deemed most closely related to the subject matter encompassed by the claims if said references are not already of record.

### II. INFRINGEMENT

Subject to a requirement for a further showing as may be necessitated by the facts of a particular case, an application may be made special because of actual infringement (but not for prospective infringement)



upon payment of the fee under 37 CFR 1.17(h) and the filing of a petition accompanied by a statement by the applicant, assignee, or an attorney/agent registered to practice before the Office alleging:

(A) That there is an infringing device or product actually on the market or method in use;

(B) That a rigid comparison of the alleged infringing device, product, or method with the claims of the application has been made, and that, in his or her opinion, some of the claims are unquestionably infringed; and

(C) That he or she has made or caused to be made a careful and thorough search of the prior art or has a good knowledge of the pertinent prior art.

Applicant must provide one copy of each of the references deemed most closely related to the subject matter encompassed by the claims if said references are not already of record.

Models or specimens of the infringing product or that of the application should not be submitted unless requested.

### III. APPLICANT'S HEALTH

An application may be made special upon a petition by applicant accompanied by any evidence showing that the state of health of the applicant is such that he or she might not be available to assist in the prosecution of the application if it were to run its normal course, such as a doctor's certificate or other medical certificate. No fee is required for such a petition. See 37 CFR 1.102(c).

### IV. APPLICANT'S AGE

An application may be made special upon filing a petition including any evidence showing that the applicant is 65 years of age, or more, such as a birth certificate or applicant's statement. No fee is required with such a petition. See 37 CFR 1.102(c).

### V. ENVIRONMENTAL QUALITY

The U.S. Patent and Trademark Office will accord "special" status to all patent applications for inventions which materially enhance the quality of the environment of mankind by contributing to the restoration or maintenance of the basic life-sustaining natural elements, i.e., air, water, and soil.

All applicants desiring to participate in this program should petition that their applications be accorded "special" status. Such petitions should be accompanied by statements under 37 CFR 1.102 by the applicant, assignee, or an attorney/agent registered to practice before the Office explaining how the inventions contribute to the restoration or maintenance of one of these life-sustaining elements. No fee is required for such a petition. See 37 CFR 1.102(c).

### VI. ENERGY

The U.S. Patent and Trademark Office will, on petition, accord "special" status to all patent applications for inventions which materially contribute to (A) the discovery or development of energy resources, or (B) the more efficient utilization and conservation of energy resources. Examples of inventions in category (A) would be developments in fossil fuels (natural gas, coal, and petroleum), hydrogen fuel technologies, nuclear energy, solar energy, etc. Category (B) would include inventions relating to the reduction of energy consumption in combustion systems, industrial equipment, household appliances, etc.

All applicants desiring to participate in this program should petition that their applications be accorded "special" status. Such petitions should be accompanied by statements under 37 CFR 1.102 by the applicant, assignee, or an attorney/agent registered to practice before the Office explaining how the invention materially contributes to category (A) or (B) set forth above. No fee is required for such a petition, 37 CFR 1.102(c).

### VII. INVENTIONS RELATING TO RECOMBINANT DNA

In recent years revolutionary genetic research has been conducted involving recombinant deoxyribonucleic acid ("recombinant DNA"). Recombinant DNA research appears to have extraordinary potential benefit for mankind. It has been suggested, for example, that research in this field might lead to ways of controlling or treating cancer and hereditary defects. The technology also has possible applications in agriculture and industry. It has been likened in importance to the discovery of nuclear fission and fusion. At the same time, concern has been expressed over the safety of this type of research. The National Institutes of Health (NIH) has released guidelines for the

conduct of research concerning recombinant DNA. These "Guidelines for Research Involving Recombination DNA Molecules," were published in the *Federal Register* of July 7, 1976, 41 FR 27902-27943. NIH is sponsoring experimental work to identify possible hazards and safety practices and procedures.

In view of the exceptional importance of recombinant DNA and the desirability of prompt disclosure of developments in the field, the U.S. Patent and Trademark Office will accord "special" status to patent applications relating to safety of research in the field of recombinant DNA. Upon appropriate petition and payment of the fee under 37 CFR 1.17(h), the Office will make special patent applications for inventions relating to safety of research in the field of recombinant DNA. Petitions for special status should be accompanied by statements under 37 CFR 1.102 by the applicant, assignee, or statements by an attorney/agent registered to practice before the Office explaining the relationship of the invention to safety of research in the field of recombinant DNA research. The fee set forth under 37 CFR 1.17(h) must also be paid.

### VIII. SPECIAL EXAMINING PROCEDURE FOR CERTAIN NEW APPLICATIONS — ACCELERATED EXAMINATION

A new application (one which has not received any examination by the examiner) may be granted special status provided that applicant (and this term includes applicant's attorney or agent) complies with each of the following items:

(A) Submits a petition to make special accompanied by the fee set forth in 37 CFR 1.17(h);

(B) Presents all claims directed to a single invention, or if the Office determines that all the claims presented are not obviously directed to a single invention, will make an election without traverse as a prerequisite to the grant of special status.

The election may be made by applicant at the time of filing the petition for special status. Should applicant fail to include an election with the original papers or petition and the Office determines that a requirement should be made, the established telephone restriction practice will be followed.

If otherwise proper, examination on the merits will proceed on claims drawn to the elected invention.

If applicant refuses to make an election without traverse, the application will not be further examined at that time. The petition will be denied on the ground that the claims are not directed to a single invention, and the application will await action in its regular turn.

Divisional applications directed to the nonelected inventions will not automatically be given special status based on papers filed with the petition in the parent application. Each such application must meet on its own all requirements for the new special status;

(C) Submits a statement(s) that a pre-examination search was made, listing the field of search by class and subclass, publication, Chemical Abstracts, foreign patents, etc. >The pre-examination search must be directed to the invention as claimed in the application for which special status is requested.< A search made by a foreign patent office satisfies this requirement >if the claims in the corresponding foreign application are of the same or similar scope to the claims in the U.S. application for which special status is requested<;

(D) Submits one copy each of the references deemed most closely related to the subject matter encompassed by the claims if said references are not already of record; and

(E) Submits a detailed discussion of the references, which discussion points out, with the particularity required by 37 CFR 1.111 (b) and (c), how the claimed subject matter is patentable over the references.

In those instances where the request for this special status does not meet all the prerequisites set forth above, applicant will be notified and the defects in the request will be stated. The application will remain in the status of a new application awaiting action in its regular turn. In those instances where a request is defective in one or more respects, applicant will be given *one* opportunity to perfect the request in a renewed petition to make special. If perfected, the request will then be granted. If not perfected in the first renewed petition, any additional renewed petitions to make special may or may not be considered at the discretion of the Technology Center (TC) Special Program Examiner.

Once a request has been granted, prosecution will proceed according to the procedure set forth below;

there is no provision for “withdrawal” from this special status.

The special examining procedure of VIII (accelerated examination) involves the following procedures:

(A) The new application, having been granted special status as a result of compliance with the requirements set out above will be taken up by the examiner before all other categories of applications except those clearly in condition for allowance and those with set time limits, such as examiner's answers, etc., and will be given a complete first action which will include *all* essential matters of merit as to all claims. The examiner's search will be restricted to the *subject matter encompassed by the claims*. A first action rejection will set a 3-month shortened period for reply.

(B) During the 3-month period for reply, applicant is encouraged to arrange for an interview with the examiner in order to resolve, with finality, as many issues as possible. In order to afford the examiner time for reflective consideration before the interview, applicant or his or her representative should cause to be placed in the hands of the examiner at least one working day prior to the interview, a copy (clearly denoted as such) of the amendment that he or she proposes to file in response to the examiner's action. Such a paper will not become a part of the file, but will form a basis for discussion at the interview.

(C) Subsequent to the interview, or responsive to the examiner's first action if no interview was had, applicant will file the “record” reply. The reply at this stage, to be proper, must be restricted to the rejections, objections, and requirements made. Any amendment which would require broadening the search field will be treated as an improper reply.

(D) The examiner will, within 1 month from the date of receipt of applicant's formal reply, take up the application for final disposition. This disposition will constitute either a final action which terminates with the setting of a 3-month period for reply, or a notice of allowance. The examiner's reply to any amendment submitted after final rejection should be prompt and by way of form PTOL-303, by passing the application to issue, or by an examiner's answer should applicant choose to file an appeal brief at this time. The use of these forms is not intended to open the door to further prosecution. Of course, where relatively minor issues

or deficiencies might be easily resolved, the examiner may use the telephone to inform the applicant of such.

(E) A personal interview after a final Office action will not be permitted unless requested by the examiner. However, telephonic interviews will be permitted where appropriate for the purpose of correcting any minor outstanding matters.

After allowance, these applications are given top priority for printing. See MPEP § 1309.

## **IX. SPECIAL STATUS FOR PATENT APPLICATIONS RELATING TO SUPERCONDUCTIVITY**

In accordance with the President's mandate directing the U.S. Patent and Trademark Office to accelerate the processing of patent applications and adjudication of disputes involving superconductivity technologies when requested by the applicant to do so, the U.S. Patent and Trademark Office will, on request, accord “special” status to all patent applications for inventions involving superconductivity materials. Examples of such inventions would include those directed to superconductive materials themselves as well as to their manufacture and application. In order that the U.S. Patent and Trademark Office may implement this procedure, we invite all applicants desiring to participate in this program to request that their applications be accorded “special” status. Such requests should be accompanied by a statement under 37 CFR 1.102 that the invention involves superconductive materials. No fee is required.

## **X. INVENTIONS RELATING TO HIV/AIDS AND CANCER**

In view of the importance of developing treatments and cures for HIV/AIDS and cancer and the desirability of prompt disclosure of advances made in these fields, the U.S. Patent and Trademark Office will accord “special” status to patent applications relating to HIV/AIDS and cancer.

Applicants who desire that an application relating to HIV/AIDS or cancer be made special should file a petition and the fee under 37 CFR 1.17(h) requesting the U.S. Patent and Trademark Office to make the application special. The petition for special status should be accompanied by a statement explaining

how the invention contributes to the diagnosis, treatment or prevention of HIV/AIDS or cancer.

## **XI. INVENTIONS FOR COUNTERING TERRORISM**

In view of the importance of developing technologies for countering terrorism and the desirability of prompt disclosure of advances made in these fields, the U.S. Patent and Trademark Office will accord “special” status to patent applications relating to counter-terrorism inventions.

International terrorism as defined in 18 U.S.C. 2331 includes “activities that - (A) involve violent acts or acts dangerous to human life that are a violation of the criminal laws of the United States or of any State, or that would be a criminal violation if committed within the jurisdiction of the United States or of any State; [and] (B) appear to be intended - (i) to intimidate or coerce a civilian population; (ii) to influence the policy of a government by intimidation or coercion; or (iii) to affect the conduct of a government by assassination or kidnapping...” The types of technology for countering terrorism could include, but are not limited to, systems for detecting/identifying explosives, aircraft sensors/security systems, and vehicular barricades/disabling systems.

Applicants who desire that an application relating to inventions for countering terrorism be made special should file a petition with the petition fee under 37 CFR 1.17(h) requesting the U.S. Patent and Trademark Office to make the application special. The petition for special status should be accompanied by a statement explaining how the invention contributes to countering terrorism.

## **XII. SPECIAL STATUS FOR APPLICATIONS RELATING TO BIOTECHNOLOGY FILED BY APPLICANTS WHO ARE SMALL ENTITIES**

Applicants who are small entities may request that their biotechnology applications be granted “special” status. Applicant must file a petition with the petition fee under 37 CFR 1.17(h) requesting the special status and must:

(A) state that small entity status has been established or include a statement establishing small entity status;

(B) state that the subject of the patent application is a major asset of the small entity; and

(C) state that the development of the technology will be significantly impaired if examination of the patent application is delayed, including an explanation of the basis for making the statement.

## **FORMAL REQUIREMENTS OF PETITION TO MAKE SPECIAL**

Any petition to make special should:

(A) be in writing; and

(B) identify the application by application number and filing date.

## **HANDLING OF PETITIONS TO MAKE SPECIAL**

Applications which have been made special will be advanced out of turn for examination and will continue to be treated as special throughout the entire prosecution in the Office.

Each petition to make special, regardless of the ground upon which the petition is based and the nature of the decision, is made of record in the application file, together with the decision thereon. The part of the Office that rules on a petition is responsible for properly entering that petition and the resulting decision in the file record. The petition, with any attached papers and supporting affidavits, will be given a single paper number and so entered in the “Contents” of the file. The decision will be accorded a separate paper number and similarly entered. To ensure entries in the “Contents” in proper order, the technical support staff in the TC will make certain that all papers prior to a petition have been entered and/or listed in the application file before forwarding it for consideration of the petition. Note MPEP § 1002.02 (s). >For Image File Wrapper (IFW) processing, see IFW Manual.<

Petitions to make special are decided by the Special Program Examiner of the TC to which the application is assigned.

## **708.03 Examiner Tenders Resignation [R-2]**

Whenever an examiner tenders his or her resignation, the supervisory patent examiner should see that the remaining time as far as possible is used in

winding up the old complicated cases or those with involved records and getting as many of his or her amended cases as possible ready for final disposition.

If the examiner has considerable experience in his or her particular art, it is also advantageous to the Office if he or she indicates (in pencil) in the file wrappers of application in his or her docket, the field of search or other pertinent data that he or she considers appropriate. >For Image File Wrapper (IFW) processing, see IFW Manual.<

## 709 Suspension of Action [R-2]

### 37 CFR 1.103. Suspension of action by the Office.

(a) *Suspension for cause.* On request of the applicant, the Office may grant a suspension of action by the Office under this paragraph for good and sufficient cause. The Office will not suspend action if a reply by applicant to an Office action is outstanding. Any petition for suspension of action under this paragraph must specify a period of suspension not exceeding six months. Any petition for suspension of action under this paragraph must also include:

(1) A showing of good and sufficient cause for suspension of action; and

(2) The fee set forth in § 1.17(h), unless such cause is the fault of the Office.

(b) *Limited suspension of action in a continued prosecution application (CPA) filed under § 1.53(d).* On request of the applicant, the Office may grant a suspension of action by the Office under this paragraph in a continued prosecution application filed under § 1.53(d) for a period not exceeding three months. Any request for suspension of action under this paragraph must be filed with the request for an application filed under § 1.53(d), specify the period of suspension, and include the processing fee set forth in § 1.17(i).

(c) *Limited suspension of action after a request for continued application (RCE) under § 1.114.* On request of the applicant, the Office may grant a suspension of action by the Office under this paragraph after the filing of a request for continued examination in compliance with § 1.114 for a period not exceeding three months. Any request for suspension of action under this paragraph must be filed with the request for continued examination under § 1.114, specify the period of suspension, and include the processing fee set forth in § 1.17(i).

(d) *Deferral of examination.* On request of the applicant, the Office may grant a deferral of examination under the conditions specified in this paragraph for a period not extending beyond three years from the earliest filing date for which a benefit is claimed under title 35, United States Code. A request for deferral of examination under this paragraph must include the publication fee set forth in § 1.18(d) and the processing fee set forth in § 1.17(i). A

request for deferral of examination under this paragraph will not be granted unless:

(1) The application is an original utility or plant application filed under § 1.53(b) or resulting from entry of an international application into the national stage after compliance with § 1.495;

(2) The applicant has not filed a nonpublication request under § 1.213(a), or has filed a request under § 1.213(b) to rescind a previously filed nonpublication request;

(3) The application is in condition for publication as provided in § 1.211(c); and

(4) The Office has not issued either an Office action under 35 U.S.C. 132 or a notice of allowance under 35 U.S.C. 151.

(e) *Notice of suspension on initiative of the Office.* The Office will notify applicant if the Office suspends action by the Office on an application on its own initiative.

\*\*>

(f) *Suspension of action for public safety or defense.* The Office may suspend action by the Office by order of the Director if the following conditions are met:<

(1) The application is owned by the United States;

(2) Publication of the invention may be detrimental to the public safety or defense; and

(3) The appropriate department or agency requests such suspension.

(g) *Statutory invention registration.* The Office will suspend action by the Office for the entire pendency of an application if the Office has accepted a request to publish a statutory invention registration in the application, except for purposes relating to patent interference proceedings under Subpart E of this part.

Suspension of action (37 CFR 1.103) should not be confused with extension of time for reply (37 CFR 1.136). It is to be noted that a suspension of action applies to an impending Office action by the examiner whereas an extension of time for reply applies to action by the applicant. In other words, the action cannot be suspended in an application which contains an outstanding Office action or requirement awaiting reply by the applicant. It is only the action by the examiner which can be suspended under 37 CFR 1.103.

Suspension of action under 37 CFR 1.103(a)-(d) at the applicant's request will cause a reduction in patent term adjustment accumulated (if any) under 37 CFR 1.703. The reduction is equal to the number of days beginning on the date a request for suspension of action was filed and ending on the date of the termination of the suspension. See 37 CFR 1.704(c)(1).

&gt;

**I. <REQUEST BY THE APPLICANT**

Request, 37 CFR Section	Requirement	Fee(s), 37 CFR Section	Maximum length of Suspension
1.103(a)	Petition with a showing of good and sufficient cause.	1.17(h)	6 months
1.103(b)	Request at the time of filing a CPA	1.17(i)	3 months
1.103(c)	Request at the time of filing an RCE	1.17(i)	3 months
1.103(d)	See below in “Deferral of Examination”	1.17(i)&1.18(d)	3 yrs. from earliest filing date for which a benefit is claimed under Title 35.

**A. *Petition Under 37 CFR 1.103(a) With a Showing of Good and Sufficient Cause***

A request that action in an application be delayed will be granted only under the provisions of 37 CFR 1.103, which provides for “Suspension of Action.” A petition for suspension of action under 37 CFR 1.103(a) must:

(A) be presented as a separate paper\*><

(B) be accompanied by the petition fee set forth in 37 CFR 1.17(h)\*><

(C) request a specific and reasonable period of suspension not greater than 6 months\*>< and

(D) present good and sufficient reasons why the suspension is necessary.

If the requirements of 37 CFR 1.103(a) are not met, applicants should expect that their applications, whether new or amended, will be taken up for action by the examiner in the order provided in MPEP § 708, Order of Examination.

A petition for suspension of action to allow applicant time to submit an information disclosure statement will be denied as failing to present good and sufficient reasons, since 37 CFR 1.97 provides adequate recourse for the timely submission of prior art for consideration by the examiner.

In new applications, the mere inclusion in the transmittal form letter of a request that action be delayed cannot be relied upon to avoid immediate action in the application. However, applicant may consider filing a request for deferral of examination under 37 CFR 1.103(d) (see below for the requirements). Applicants should be aware of the possibility of requesting suspension of action by the Office under 37 CFR 1.103(b) or (c) for a period not exceeding three months at the time of filing a continued prosecution application (CPA) under 37 CFR 1.53(d) >if the application is a design application,< or a request for continued examination (RCE) under 37 CFR 1.114. >Note that effective July 14, 2003, CPA practice does not apply to utility and plant applications.< Many Technology Center (TC) art units and examiners have short pendency to first action, and new applications may be taken up for action before preliminary amendments are filed in those applications. Where a preliminary amendment and petition to suspend action have been filed, it would be helpful to telephone the examiner in that regard to avoid having the amendment and the first Office action cross in the mail. The following form paragraphs should be used to notify the grant or denial of the petition under 37 CFR 1.103(a):

*¶ 7.54 Suspension of Action, Applicant’s Request*

Pursuant to applicant’s request filed on [1], action by the Office is suspended on this application under 37 CFR 1.103(a) for a period of [2] months. At the end of this period, applicant is

required to notify the examiner and request continuance of prosecution or a further suspension. See MPEP § 709.

**Examiner Note:**

1. Maximum period for suspension is 6 months.
2. Only the Technology Center Director can grant second or subsequent suspensions. See MPEP § 1003. Such approval must appear on the Office letter.

*¶ 7.56 Request for Suspension, Denied, Outstanding Office Action*

Applicant's request filed [1], for suspension of action in this application under 37 CFR 1.103(a), is denied as being improper. Action cannot be suspended in an application awaiting a reply by the applicant. See MPEP § 709.

**B. Request for Suspension Under 37 CFR 1.103(b) or (c)**

Applicants may request a suspension of action by the Office under 37 CFR 1.103(b) or (c) for a period not exceeding three months in a continued prosecution application (CPA) filed under 37 CFR 1.53(d) >if the application is a design application<, or in a continued examination (RCE) filed under 37 CFR 1.114. The request for suspension must be filed at the time of filing of the CPA or RCE.

>

**1. < Requirements**

The Office will not grant the requested suspension of action unless the following requirements are met:

(A) the request must be filed with the filing of a >design< CPA or an RCE (applicants may use the check box provided on the transmittal form PTO/SB/29 or PTO/SB/30, or submit the request on a separate paper);

(1) if the request is filed with an RCE, the RCE must be in compliance with 37 CFR 1.114, i.e., the RCE must be accompanied by a submission and the fee set forth in 37 CFR 1.17(e). Note that the payment of the RCE filing fee may not be deferred and the request for suspension cannot substitute for the submission;

(2) if the request is filed with a CPA, a filing date must be assigned to the CPA;

(B) the request should specify the period of suspension in a whole number of months (maximum of 3 months. If the request specifies no period of suspen-

sion or a period of suspension that exceeds 3 months, the Office will assume that a 3-month suspension is requested; and

(C) the request must include the processing fee set forth in 37 CFR 1.17(i).

>

**2. < Missing Parts for the CPA (Filing Date Granted)**

If the Office assigns a filing date to the >design< CPA, the request for suspension will be processed, even if the CPA was not accompanied by the CPA filing fee. The suspension request acts to suspend a first Office action by the examiner but will not affect the processing of the CPA for a missing part. The applicant will be given a notice that provides a time period of 2 months from the date of the notification to pay the CPA filing fee and the surcharge set forth in 37 CFR 1.16(e). Applicant must pay the CPA filing fee and the surcharge within 2 months to avoid the abandonment of the CPA. Pursuant to applicant's request for suspension, the action by the Office will be suspended on the CPA for the period requested by the applicant, starting on the filing date of the CPA.

>

**3. < Improper RCE or CPA (No Filing Date Granted)**

If the CPA or the RCE is improper (e.g., a filing date was not accorded in the CPA or the RCE was filed without a submission or the RCE fee), the Office will not recognize the request for suspension, and action by the Office will not be suspended. A notice of improper CPA \*\* or \*\*>RCE< will be sent to applicant as appropriate. The time period set in the previous Office communication (e.g., a final Office action or a notice of allowance) continues to run from the mailing date of that communication. If applicant subsequently files another RCE, the request for suspension should be resubmitted to ensure that the Office processes the request for suspension properly. The request for suspension of action will not be processed until the Office accords a filing date to the CPA or receives a proper RCE in compliance with 37 CFR 1.114.

&gt;

#### 4. < Improper Request for Suspension

If the CPA or the RCE is properly filed, but the request for suspension is improper (e.g., the request for suspension was filed untimely or without the processing fee set forth in 37 CFR 1.17(i)), action by the Office will not be suspended on the application. The Office will process the CPA or RCE and place the application on the examiner's docket. The examiner will notify the applicant of the denial of the request in the next Office communication using the following form paragraph:

¶ 7.56.01 Request for Suspension of Action under 37 CFR 1.103, Denied

Applicant's request filed [1], for suspension of action in this application under 37 CFR 1.103(b) or (c) is denied as being improper. The request was (1) not filed at the time of filing a CPA or RCE, and/or (2) not accompanied by the requisite fee as set forth in 37 CFR 1.17(i). See MPEP § 709.

##### Examiner Note:

In bracket 1, insert the filing date of the request for suspension of action.

&gt;

#### 5. < Proper Request for Suspension

If the CPA or the RCE and the request for suspension of action are proper, the Office's technical support staff will process the CPA or RCE, and the request for suspension of action. A notification of the approval of the request for suspension will be sent to the applicant. The application will be placed in suspension status until the end of the suspension period. The suspension request acts to suspend a first Office action by the examiner. Once the suspension period has expired, the application will be placed on the examiner's docket for further prosecution.

##### C. Request for Deferral of Examination Under 37 CFR 1.103(d)

In new applications, applicants may request a deferral of examination under 37 CFR 1.103(d) for a period not extending beyond three years from the earliest filing date for which a benefit is claimed under 35 U.S.C. 119(a)-(d), (e), (f), 120, 121, or 365. The request must be filed before the Office issues an Office action under 35 U.S.C. 132 or a notice of

allowance in the application. The suspension will start on the day that the Office grants the request for deferral of examination. Once the deferral of examination has been granted, the application will not be taken up for action by the examiner until the suspension period expires. For example, if an applicant files a request for deferral of examination under 37 CFR 1.103(d) for the maximum period permitted under the rule in an application that claims priority of a foreign application filed 1/3/00, the action by the Office on the application will be suspended and the application will automatically be placed in a regular new case status on the examiner's docket on 1/4/03 (36 months from the effective filing date of the application, i.e., 1/3/00).

&gt;

#### 1. < Requirements

Form PTO/SB/37 (reproduced at the end of this section) may be used to submit a request for deferral of examination under 37 CFR 1.103(d).

A request for deferral of examination under 37 CFR 1.103(d) must include:

(A) a period of suspension, in a whole number of months, not extending beyond three years from the earliest effective filing date (if the request includes no period of suspension or a period that exceeds the maximum period permitted under the rule, i.e., beyond 3 years from the earliest effective filing date, the Office will assume that the maximum period is requested);

(B) the publication fee set forth in 37 CFR 1.18(d); and

(C) the processing fee set forth in 37 CFR 1.17(i).

The Office will not grant a deferral of examination unless the following conditions are met:

(A) the application must be

(1) an original utility or plant application filed under 37 CFR 1.53(b) **or**

(2) an application resulting from entry of an international application into the national stage after compliance with 37 CFR 1.495 (the application cannot be a design application, a reissue application, or a CPA under 37 CFR 1.53(d));

(B) the application must be filed on or after November 29, 2000 (the effective date of the eighteen month publication provisions of the AIPA); **or** if the



application is filed before November 29, 2000, the applicant must submit:

(1) a request for voluntary publication under 37 CFR 1.221 (see the first check box on the form PTO/SB/37),

(2) the fee for the voluntary publication set forth in 37 CFR 1.17(i),

(3) a copy of the application in compliance with the Office's electronic filing system (EFS) requirements, and

(4) the confirmation number;

(C) the applicant has not filed a nonpublication request under 37 CFR 1.213(a), **or** if a nonpublication request has been filed in the application, the applicant must file a request under 37 CFR 1.213(b) to rescind a previously filed nonpublication request (see the second check box on the form PTO/SB/37);

(D) the application must be in condition for publication as provided in 37 CFR 1.211(c) (if the application has been forwarded to the Technology Center by the Office of Initial Patent Examination (OIPE), the application can be assumed to be in condition for publication); and

(E) the Office has not issued either an Office action under 35 U.S.C. 132 (e.g., a restriction, a first Office action on the merits, or a requirement under 37 CFR 1.105) or a notice of allowance under 35 U.S.C. 151.

>

## 2. < Improper Request

If the request is improper, the following form paragraphs may be used to notify the applicant of the denial of the request:

¶ 7.56.02 *Request for Deferral of Examination under 37 CFR 1.103(d), Denied*

Applicant's request filed on [1], for deferral of examination under 37 CFR 1.103(d) in the application is denied as being improper. [2]

See MPEP § 709.

### Examiner Note:

1. In bracket 1, insert the filing date of the request for deferral of examination.
2. In bracket 2, insert the reason(s) for denying the request. For example, if appropriate insert --The applicant has not filed a request under 37 CFR 1.213(b) to rescind the previously filed nonpublication request--; --A first Office action has been issued in

the application--; or --Applicant has not submitted a request for voluntary publication under 37 CFR 1.221--.

>

## 3. < Proper Request

A supervisory patent examiner's approval is required for the grant of a deferral of examination in an application. If the request is proper, the following form paragraph may be used to notify applicant that the request for deferral has been granted:

¶ 7.54.01 *Request for Deferral of Examination under 37 CFR 1.103(d), Granted*

Applicant's request filed on [1], for deferral of examination under 37 CFR 1.103(d) in the application has been approved. The examination of the application will be deferred for a period of [2] months.

### Examiner Note:

1. In bracket 1, insert the filing date of the request for deferral of examination.
2. In bracket 2, insert the number of months for the deferral.

## D. Termination of Suspension of Action

Once the request for suspension of action under 37 CFR 1.103 has been approved, action on the application will be suspended until the suspension period has expired, unless the applicant submits a request for termination of the suspension of action prior to the end of the suspension period. The request for termination of a suspension of action will be effective when an appropriate official of the Office takes action thereon. If the request for termination properly identifies the application and the period of suspension has not expired when the Office acts on the request, the Office will terminate the suspension and place the application on the examiner's docket. An acknowledgment should be sent to the applicant using the following form paragraph:

¶ 7.54.02 *Request for Termination of a Suspension of Action, Granted*

Applicant's request filed on [1], for termination of a suspension of action under 37 CFR 1.103, has been approved. The suspension of action has been terminated on the date of mailing this notice.

### Examiner Note:

In bracket 1, insert the filing date of the request for termination of the suspension of action.

&gt;

**II. < AT THE INITIATIVE OF THE OFFICE**

Suspension of action at the initiative of the Office should be avoided, if possible, because such suspension will cause delays in examination, will increase pendency of the application, and may lead to a shortening of the effective patent term or, conversely, patent term extension, or adjustment, due to the suspension. Once a suspension of action has been initiated, it should be terminated immediately once the reason for initiating the suspension no longer exists, even if the suspension period has not expired.

37 CFR 1.103(e) provides that the Office will notify applicant if the Office suspends action in an application on its own initiative. Every suspension of action initiated by the Office will be limited to a time period of a maximum of 6 months. An examiner may grant an initial suspension of Office action on his or her own initiative, as in MPEP § 709.01 and § 2315.01, for a maximum period of 6 months. A notification of suspension must be mailed to the applicant for each Office-initiated suspension of action, even for second or subsequent suspensions, and must include a suspension period (a maximum of 6 months). When the suspension period has expired, the examiner should take up action on the application or evaluate all possibilities for giving an action on the merits. For example, if a reference is still not available after waiting for six months, the examiner should try to find another source for the information or update the search to find another reference that can be used to make a rejection. If, in an extraordinary circumstance, a second or subsequent suspension is nec-

essary, the examiner must obtain the TC director's approval (see MPEP § 1003) and prepare another suspension notification with a suspension period (a maximum of 6 months). The notification for a second or subsequent suspension must be signed by the TC Director.

Suspension of action under 37 CFR 1.103(f) is decided by the TC Director of work group 3640.

The following form paragraphs should be used in actions relating to suspension of action at the initiative of the Office.

*¶ 7.52 Suspension of Action, Awaiting New Reference*

A reference relevant to the examination of this application may soon become available. *Ex parte* prosecution is SUSPENDED FOR A PERIOD OF [1] MONTHS from the mailing date of this letter. Upon expiration of the period of suspension, applicant should make an inquiry as to the status of the application.

**Examiner Note:**

1. Maximum period for suspension is six months.
2. The TC Director must approve all second or subsequent suspensions, see MPEP § 1003.
3. The TC Director's signature must appear on the letter granting any second or subsequent suspension.

*¶ 7.53 Suspension of Action, Possible Interference*

All claims are allowable. However, due to a potential interference, *ex parte* prosecution is SUSPENDED FOR A PERIOD OF [1] MONTHS from the mailing date of this letter. Upon expiration of the period of suspension, applicant should make an inquiry as to the status of the application.

**Examiner Note:**

1. Maximum period for suspension is six months.
2. The TC Director must approve all second or subsequent suspensions, see MPEP § 1003.
3. The TC Director's signature must appear on the letter granting any second or subsequent suspension.

\*\*>

PTO/SB/97 (08-93)

Approved for use through 07/31/2006. OMB 0651-0031

U.S. Patent and Trademark Office; U. S. DEPARTMENT OF COMMERCE

Under the Paperwork Reduction Act of 1995, no persons are required to respond to a collection of information unless it displays a valid OMB control number.

<b>Request for Deferral of Examination 37 CFR 1.103(d)</b>			
Application Number		Art Unit	
Filing Date		Examiner Name	
First Named Inventor		Attorney Docket Number	
<p>Address to: Commissioner for Patents P.O. Box 1450 Alexandria, VA 22313-1450</p> <p>I hereby request deferral of examination under 37 CFR 1.103(d) for the above-identified (non-reissue) utility or plant application filed under 37 CFR 1.53(b) for a period of _____ months (maximum 3 years), from the earliest filing date for which a benefit is claimed. Deferral of examination under 37 CFR 1.103(d) is suspension of action. As a result, any patent term adjustment may be reduced. See 37 CFR 1.704(c)(1).</p> <p><b>Note:</b> The request will not be granted unless the application is in condition for publication as provided in 37 CFR 1.211(c) and the Office has not issued either an Office action under 35 U.S.C. 132 or a notice of allowance under 35 U.S.C. 151.</p> <p><input type="checkbox"/> If the application is filed prior to November 29, 2000:</p> <p>I hereby request voluntary publication of the above-identified application under 37 CFR 1.221. A copy of the application in compliance with the Office's electronic filing system requirements has been submitted and the confirmation number is _____</p> <p><b>Note:</b> A request for voluntary publication under 37 CFR 1.221 requires a copy of the application in compliance with the Office's electronic filing system (EFS) requirements as set forth in the USPTO Electronic Business Center Web Page at <a href="http://www.uspto.gov/ebc">www.uspto.gov/ebc</a>, the publication fee set forth in 37 CFR 1.18(d), and the processing fee for the voluntary publication set forth in 37 CFR 1.17(i).</p> <p><input type="checkbox"/> If applicant previously filed a nonpublication request under 37 CFR 1.213(a):</p> <p>I hereby rescind under 37 CFR 1.213(b) the previous filed request that the above-identified application not be published under 35 U.S.C. 122(b).</p> <p><b>Note:</b> Application will be scheduled for publication at 18 months from the earliest claimed filing date for which a benefit is claimed.</p> <p><b>Fees</b></p> <p>a. <input type="checkbox"/> The Director is hereby authorized to charge the following fees, or credit any overpayment, to Deposit Account No. _____</p> <p>i. <input type="checkbox"/> Processing fee set forth in 37 CFR 1.17(i) for request for deferral of examination.</p> <p>ii. <input type="checkbox"/> Publication fee set forth in 37 CFR 1.18(d).</p> <p>iii. <input type="checkbox"/> Processing fee set forth in 37 CFR 1.17(i) for voluntary publication.</p> <p>iv. <input type="checkbox"/> Other _____</p> <p>b. <input type="checkbox"/> Check in the amount of \$ _____ is enclosed.</p> <p>c. <input type="checkbox"/> Payment by credit card (Form PTO-2038 enclosed).</p> <p><b>WARNING: Information in this form may become public. Credit card information should not be included on this form. Provide credit card information and authorization on PTO-2038.</b></p> <p><b>Note:</b> The publication fee set forth in 37 CFR 1.18(d) and the processing fee in 37 CFR 1.17(i) for deferral of examination are required when the request of deferral of examination is filed.</p>			
Name (Print/Type)		Registration Number (Attorney/Agent)	
Signature		Date	
<p><b>Note:</b> Signature of all the inventors or assignees of record of the entire interest or their representative(s) are required. Submit multiple forms for more than one signature, see below*.</p> <p><input type="checkbox"/> *Total of _____ forms are submitted.</p>			

This collection of information is required by 37 CFR 1.103(d). The information is required to obtain or retain a benefit by the public which is to file (and by the USPTO to process) an application. Confidentiality is governed by 35 U.S.C. 122 and 37 CFR 1.14. This collection is estimated to take 12 minutes to complete, including gathering, preparing, and submitting the completed application form to the USPTO. Time will vary depending upon the individual case. Any comments on the amount of time you require to complete this form and/or suggestions for reducing this burden, should be sent to the Chief Information Officer, U.S. Patent and Trademark Office, U.S. Department of Commerce, P.O. Box 1450, Alexandria, VA 22313-1450. DO NOT SEND FEES OR COMPLETED FORMS TO THIS ADDRESS. SEND TO: Commissioner for Patents, P.O. Box 1450, Alexandria, VA 22313-1450.

If you need assistance in completing the form, call 1-800-PTO-9199 and select option 2.

<

### 709.01 Overlapping Applications by Same Applicant or Owned by Same Assignee [R-1]

Examiners should not consider *ex parte*, when raised by an applicant, questions which are pending before the Office in *inter partes* proceedings involving the same applicant. See *Ex parte Jones*, 1924 C.D. 59, 327 O.G. 681 (Comm'r Pat. 1924).

Because of this, where one of several applications of the same inventor which contain overlapping claims gets into an interference, it was formerly the practice to suspend action by the Office on the applications not in the interference in accordance with *Ex parte McCormick*, 1904 C.D. 575, 113 O.G. 2508 (Comm'r Pat 1924).

However, the better practice would appear to be to reject claims in an application related to another application in interference over the counts of the interference and in the event said claims are not canceled in the outside application, prosecution of said application should be suspended pending the final determination of priority in the interference. >See MPEP § 2315.01.<

If, on the other hand, applicant wishes to prosecute the outside application, and presents good reasons in support, prosecution should be continued. *Ex parte Bullier*, 1899 C.D. 155, 88 O.G. 1161 (Comm'r Pat 1899); *In re Seebach*, 88 F.2d 722, 33 USPQ 149 (CCPA 1937); *In re Hammell*, 332 F.2d 796, 141 USPQ 832 (CCPA 1964). See MPEP § 804.03.

## 710 Period for Reply

35 U.S.C. 133. *Time for prosecuting application.*

Upon failure of the applicant to prosecute the application within six months after any action therein, of which notice has been given or mailed to the applicant, or within such shorter time, not less than thirty days, as fixed by the Director in such action, the application shall be regarded as abandoned by the parties thereto, unless it be shown to the satisfaction of the Director that such delay was unavoidable.

35 U.S.C. 267. *Time for taking action in Government applications.*

Notwithstanding the provisions of sections 133 and 151 of this title, the Director may extend the time for taking any action to three years, when an application has become the property of the United States and the head of the appropriate department or agency of the Government has certified to the Director that the invention disclosed therein is important to the armament or defense of the United States.

See MPEP Chapter 1200 for period for reply when appeal is taken or court review sought.

Extension of time under 35 U.S.C. 267 is decided by the Technology Center Director of work group 3640.

### 710.01 Statutory Period

37 CFR 1.135. *Abandonment for failure to reply within time period.*

(a) If an applicant of a patent application fails to reply within the time period provided under § 1.134 and § 1.136, the application will become abandoned unless an Office action indicates otherwise.

(b) Prosecution of an application to save it from abandonment pursuant to paragraph (a) of this section must include such complete and proper reply as the condition of the application may require. The admission of, or refusal to admit, any amendment after final rejection or any amendment not responsive to the last action, or any related proceedings, will not operate to save the application from abandonment.

(c) When reply by the applicant is a *bona fide* attempt to advance the application to final action, and is substantially a complete reply to the non-final Office action, but consideration of some matter or compliance with some requirement has been inadvertently omitted, applicant may be given a new time period for reply under § 1.134 to supply the omission.

The maximum statutory period for reply to an Office action is 6 months. 35 U.S.C. 133. Shortened periods are currently used in practically all cases. See MPEP § 710.02(b).

37 CFR 1.135 provides that if no reply is filed within the time set in the Office action under 37 CFR 1.134 or as it may be extended under 37 CFR 1.136, the application will be abandoned unless an Office action indicates that another consequence, such as disclaimer, will take place.

37 CFR 1.135(b) specifies that: (A) the admission of, or refusal to admit, any amendment after final rejection, or any related proceedings, will not operate to save the application from abandonment; and (B) the admission of, or refusal to admit, any amendment not responsive to the last action, or any related proceedings, will not operate to save the application from abandonment.

37 CFR 1.135(c) was amended to change the practice of providing a non-statutory time limit (generally 1 month) during which an applicant may supply an omission to a previous reply. Under the current practice, the examiner may set a shortened statutory time period (generally 1 month) during which an

applicant must supply the omission to the previous reply to avoid abandonment.

The prior practice under 37 CFR 1.135(c) was to set a time limit during which the applicant could supply the omission to the previous reply. Failure to supply the omission resulted in the abandonment of the application as of the due date for the previous reply. Filing a new application during the time limit, but beyond the due date for the previous reply, could have caused a loss of patent rights due to the lack of copendency between the applications.

37 CFR 1.135(c) now authorizes the examiner to accept a reply to a non-final Office action that is *bona fide* and is substantially complete but for an inadvertent omission as an adequate reply to avoid abandonment under 35 U.S.C. 133 and 37 CFR 1.135. When a *bona fide* attempt to reply includes an inadvertent omission that precludes action on the merits of the application (e.g., an amendment is unsigned or improperly signed, or presents an amendment with additional claims so as to require additional fees pursuant to 37 CFR 1.16(b), (c), or (d)), the examiner may consider that reply adequate to avoid abandonment under 35 U.S.C. 133 and 37 CFR 1.135, and give the applicant a shortened statutory time period of 1 month to correct the omission (e.g., provide a duplicate paper or ratification, or submit the additional claims fees or cancel the claims so that no fee is due). The failure to timely supply the omission will result in abandonment under 35 U.S.C. 133 and 37 CFR 1.135. Extensions of time under 37 CFR 1.136(a) or (b) will be available, unless the action setting the shortened statutory period indicates otherwise.

When a *bona fide* attempt to reply includes an omission that does not preclude action on the merits of the application (e.g., a reply fails to address a rejection or objection), the examiner may waive the deficiency in the reply and act on the application. The examiner may repeat and make final the rejection, objection, or requirement that was the subject of the omission. Thus, a reply to a non-final Office action that is *bona fide* but includes an omission may be treated by: (A) issuing an Office action that does not treat the reply on its merits but requires the applicant to supply the omission to avoid abandonment; or (B) issuing an Office action that does treat the reply on its merits (and which can also require the applicant to supply the omission to avoid abandonment).

Finally, whether a 1-month shortened statutory time period is provided to the applicant to supply the omission to the previous reply is within the discretion of the examiner. Where the examiner determines that the omission was not inadvertent (e.g., the applicant is abusing the provisions of 37 CFR 1.135(c) to gain additional time to file a proper reply or to delay examination of the application), the examiner should notify the applicant of the omission in the reply and advise the applicant that the omission to the previous reply must be supplied within the period for reply to the prior action, including extensions of time under 37 CFR 1.136(a), if permitted. See also MPEP § 714.03.

### 710.01(a) Statutory Period, How Computed

The actual time taken for reply is computed from the date stamped or printed on the Office action to the date of receipt by the Office of applicant's reply. No cognizance is taken of fractions of a day and applicant's reply is due on the corresponding day of the month 6 months or any lesser number of months specified after the Office action.

For example, reply to an Office action with a 3-month shortened statutory period dated November 30 is due on the following February 28 (or 29 if it is a leap year), while a reply to an Office action dated February 28 is due on May 28 and not on the last day of May. *Ex parte Messick*, 7 USPQ 57 (Comm'r Pat. 1930).

A 1-month extension of time extends the time for reply to the date corresponding to the Office action date in the following month. For example, a reply to an Office action mailed on January 31 with a 3-month shortened statutory period would be due on April 30. If a 1-month extension of time were given, the reply would be due by May 31. The fact that April 30 may have been a Saturday, Sunday, or Federal holiday has no effect on the extension of time. Where the period for reply is extended by some time period other than "1-month" or an even multiple thereof, the person granting the extension should indicate the *date* upon which the extended period for reply will expire.

When a timely reply is ultimately not filed, the application is regarded as abandoned after midnight of the date the period for reply expired. In the above example where May 31 is not a Saturday, Sunday, or

Federal holiday and no further extensions of time are obtained prior to the end of the 6-month statutory period, the application would be abandoned as of June 1. The fact that June 1 may be a Saturday, Sunday, or Federal holiday does not change the abandonment date since the reply was due on May 31, a business day. See MPEP § 711.04(a) regarding the pulling and forwarding of abandoned applications.

A 30-day period for reply in the Office means 30 calendar days including Saturdays, Sundays, and federal holidays. However, if the period ends on a Saturday, Sunday, or Federal holiday, the reply is timely if it is filed on the next succeeding business day. If the period for reply is extended, the time extended is added to the last calendar day of the original period, as opposed to being added to the day it would have been due when said last day is a Saturday, Sunday, or Federal holiday.

The date of receipt of a reply to an Office action is given by the “Office date” stamp which appears on the reply paper.

In some cases the examiner’s Office action does not determine the beginning of a statutory reply period. In all cases where the statutory reply period runs from the date of a previous action, a statement to that effect should be included.

Since extensions of time are available pursuant to 37 CFR 1.136(a), it is incumbent upon applicants to recognize the date for reply so that the proper fee for any extension will be submitted. Thus, the date upon which any reply is due will normally be indicated only in those instances where the provisions of 37 CFR 1.136(a) are not available. See MPEP Chapter 2200 for reexamination proceedings.

## **710.02 Shortened Statutory Period and Time Limit Actions Computed [R-2]**

### *37 CFR 1.136. Extensions of time.*

(a)(1) If an applicant is required to reply within a nonstatutory or shortened statutory time period, applicant may extend the time period for reply up to the earlier of the expiration of any maximum period set by statute or five months after the time period set for reply, if a petition for an extension of time and the fee set in § 1.17(a) are filed, unless:

- (i) Applicant is notified otherwise in an Office action;
- (ii) The reply is a reply brief submitted pursuant to § 1.193(b);

(iii) The reply is a request for an oral hearing submitted pursuant to § 1.194(b);

(iv) The reply is to a decision by the Board of Patent Appeals and Interferences pursuant to § 1.196, § 1.197 or § 1.304; or

(v) The application is involved in an interference declared pursuant to § 1.611.

(2) The date on which the petition and the fee have been filed is the date for purposes of determining the period of extension and the corresponding amount of the fee. The expiration of the time period is determined by the amount of the fee paid. A reply must be filed prior to the expiration of the period of extension to avoid abandonment of the application (§ 1.135), but in no situation may an applicant reply later than the maximum time period set by statute, or be granted an extension of time under paragraph (b) of this section when the provisions of this paragraph are available. See § 1.136(b) for extensions of time relating to proceedings pursuant to §§ 1.193(b), 1.194, 1.196 or 1.197; § 1.304 for extensions of time to appeal to the U.S. Court of Appeals for the Federal Circuit or to commence a civil action; § 1.550(c) for extensions of time in *ex parte* reexamination proceedings, § 1.956 for extensions of time in *inter partes* reexamination proceedings; and § 1.645 for extensions of time in interference proceedings.

(3) A written request may be submitted in an application that is an authorization to treat any concurrent or future reply, requiring a petition for an extension of time under this paragraph for its timely submission, as incorporating a petition for extension of time for the appropriate length of time. An authorization to charge all required fees, fees under § 1.17, or all required extension of time fees will be treated as a constructive petition for an extension of time in any concurrent or future reply requiring a petition for an extension of time under this paragraph for its timely submission. Submission of the fee set forth in § 1.17(a) will also be treated as a constructive petition for an extension of time in any concurrent reply requiring a petition for an extension of time under this paragraph for its timely submission.

(b) When a reply cannot be filed within the time period set for such reply and the provisions of paragraph (a) of this section are not available, the period for reply will be extended only for sufficient cause and for a reasonable time specified. Any request for an extension of time under this paragraph must be filed on or before the day on which such reply is due, but the mere filing of such a request will not affect any extension under this paragraph. In no situation can any extension carry the date on which reply is due beyond the maximum time period set by statute. See § 1.304 for extensions of time to appeal to the U.S. Court of Appeals for the Federal Circuit or to commence a civil action; § 1.645 for extensions of time in interference proceedings; § 1.550(c) for extensions of time in *ex parte* reexamination proceedings; and § 1.956 for extensions of time in *inter partes* reexamination proceedings.

(c) If an applicant is notified in a “Notice of Allowability” that an application is otherwise in condition for allowance, the following time periods are not extendable if set in the “Notice of Allowability” or in an Office action having a mail date on or after the mail date of the “Notice of Allowability”:

(1) The period for submitting an oath or declaration in compliance with § 1.63;

(2) The period for submitting formal drawings set under § 1.85(c); and

(3) The period for making a deposit set under § 1.809(c).

37 CFR 1.136 implements 35 U.S.C. 41(a)(8) which directs the \*>Director of the USPTO< to charge fees for extensions of time to take action in patent applications.

Under 37 CFR 1.136 (35 U.S.C. 133) an applicant may be required to reply in a shorter period than 6 months, not less than 30 days. Some situations in which shortened periods for reply are used are listed in MPEP § 710.02(b).

In other situations, for example, the rejection of a copied patent claim, the examiner may require applicant to reply on or before a specified date. These are known as time limit actions and are established under authority of 35 U.S.C. 2 and 3. Some situations in which time limits are set are noted in MPEP § 710.02(c). The time limit requirement should be typed in capital letters where required.

An indication of a shortened time for reply should appear prominently on the first page of all copies of actions in which a shortened time for reply has been set so that a person merely scanning the action can easily see it.

Shortened statutory periods are subject to the provisions of 37 CFR 1.136(a) unless applicant is notified otherwise in an Office action. See MPEP § 710.02(e) for a discussion of extensions of time. See Chapter 2200 for >ex parte< reexamination proceedings >and Chapter 2600 for *inter partes* reexamination proceedings<.

### **710.02(b) Shortened Statutory Period: Situations in Which Used [R-2]**

Under the authority given him or her by 35 U.S.C. 133, the \*>Director of the USPTO< has directed the examiner to set a shortened period for reply to every action. The length of the shortened statutory period to be used depends on the type of reply required. Some specific cases of shortened statutory periods for reply are given below. These periods may be changed under special, rarely occurring circumstances.

A shortened statutory period may not be less than 30 days (35 U.S.C. 133).

### **1 MONTH (NOT LESS THAN 30 DAYS)**

(A) Requirement for restriction or election of species only (no action on the merits) ..... MPEP § 809.02(a) and § 817.

(B) When a reply by an applicant for a nonfinal Office action is *bona fide* but includes an inadvertent omission, the examiner may set a 1 month (not less than 30 days) shortened statutory time period to correct the omission .... MPEP § 710.01 and § 714.03.

### **2 MONTHS**

(A) Winning party in a terminated interference to reply to an unanswered Office action ..... MPEP § 2363.02.

Where, after the termination of an interference proceeding, the application of the winning party contains an unanswered Office action, final rejection or any other action, the primary examiner notifies the applicant of this fact. In this case reply to the Office action is required within a shortened statutory period running from the date of such notice. See *Ex parte Peterson*, 49 USPQ 119, 1941 C.D. 8, 525 O.G. 3 (Comm'r Pat. 1941).

(B) To reply to an *Ex parte Quayle* Office action ..... MPEP § 714.14.

When an application is in condition for allowance, except as to matters of form, such as correction of the specification, a new oath, etc., the application will be considered special and prompt action taken to require correction of formal matters. Such action should include an indication on the Office Action Summary form PTOL-326 that prosecution on the merits is closed in accordance with the decision in *Ex parte Quayle*, 25 USPQ 74, 453 O.G. 213 (Comm'r Pat. 1935). A 2-month shortened statutory period for reply should be set.

(C) Multiplicity rejection — no other rejection ..... MPEP § 2173.05(n).

### **3 MONTHS**

To reply to any Office action on the merits.

### **PERIOD FOR REPLY RESTARTED**

\*\*>Where the citation of a reference is incorrect or an Office action contains some other defect and this error is called to the attention of the Office within 1 month of the mail date of the action, the Office will

restart the previously set period for reply to run from the date the error is corrected, if requested to do so by applicant. See MPEP § 710.06.

### **710.02(c) Specified Time Limits: Situations in Which Used [R-2]**

There are certain situations in which the examiner specifies a time for the applicant to take some action, and the applicant's failure to timely take the specified action results in a consequence other than abandonment. Situations in which a specified time limit for taking an action is set are as follows:

(A) Where a member of the public files a petition under 37 CFR 1.14(a) for access to an application, the Office may give the applicant a specified time (usually 3 weeks) within which to state any objections to the granting of the petition for access and the reasons why it should be denied. The failure to timely reply will not affect the prosecution of the application (assuming that it is still pending), but will result in the Office rendering a decision on the petition for access without considering any objections by the applicant. See MPEP § 103.

(B) Where an information disclosure statement complies with the requirements set forth in 37 CFR 1.97 (including the requirement for fees or statement under 37 CFR 1.97(e) based upon the time of filing), but part of the content requirement of 37 CFR 1.98 has been inadvertently omitted, the examiner may set a 1-month time limit for completion of the information disclosure statement. The failure to timely comply will not result in abandonment of the application, but will result in the information disclosure statement being placed in the application file with the noncomplying information not being considered. See MPEP § 609.

(C) Where an application is otherwise allowable but contains a traverse of a restriction requirement, the applicant may be given a specified time (e.g., a 1-month time limit) to cancel claims to the nonelected invention or species or take other appropriate action (i.e., petition the restriction requirement under 37 CFR 1.144). The failure to timely file a petition under 37 CFR 1.144 (or cancel the claims to the nonelected invention or species) will not result in abandonment of the application, but will be treated as authorization to cancel the claims to the non-elected

invention or species, and the application will be passed to issue. See 37 CFR 1.141 and 1.144, and MPEP § 809.02(c) and § 821.01.

(D) A portion of 37 CFR 1.605(a) provides that in suggesting claims for interference:

The applicant to whom the claim is suggested shall amend the application by presenting the suggested claim within a time specified by the examiner, not less than one month. Failure or refusal of an applicant to timely present the suggested claim shall be taken without further action as a disclaimer by the applicant of the invention defined by the suggested claim.

The failure to timely present the suggested claim will not result in abandonment of the application, but will be treated as a disclaimer by the applicant of the invention defined by the suggested claim. See MPEP § 2305.02.

Where the failure to take the specified action may result in abandonment (e.g., filing a new complete appeal brief correcting the deficiencies in a prior appeal brief), a time period should be set for taking the specified action. Where the condition of the application requires that such action not be subject to extensions under 37 CFR 1.136, the action should specify that the provisions of 37 CFR 1.136 (or 1.136(a)) do not apply to the time period for taking action (i.e., a specified time limit should not be set simply to exclude the possibility of extending the period for reply under 37 CFR 1.136).

### **710.02(d) Difference Between Shortened Statutory Periods for Reply and Specified Time Limits [R-2]**

Examiners and applicants should not lose sight of the distinction between a specified time for a particular action and a shortened statutory period for reply under 35 U.S.C. 133:

(A) The penalty attaching to failure to take a particular action within a specified time is a loss of rights in regard to the particular matter (e.g., the failure to timely copy suggested claims results in a disclaimer of the involved subject matter). On the other hand, a failure to reply within the set statutory period under 35 U.S.C. 133 results in abandonment of the entire application. Abandonment of an application is not



appealable, but a petition to revive may be granted if the delay was unavoidable (37 CFR 1.137(a)) or unintentional (37 CFR 1.137(b)).

(B) As a specified time or time limit is not a shortened statutory period under 35 U.S.C. 133, the Office may specify a time for taking action (or a time limit) of less than the 30 day minimum specified in 35 U.S.C. 133. See MPEP § 103.

(C) Where an applicant replies a day or two after the specified time, the delay may be excused by the examiner if satisfactorily explained. The examiner may use his or her discretion to request an explanation for the delay if the reason for the delay is not apparent from the reply. A reply 1 day late in an application carrying a shortened statutory period under 35 U.S.C. 133, no matter what the excuse, results in abandonment. Extensions of the statutory period under 35 U.S.C. 133 may be obtained under 37 CFR 1.136, provided the extension does not go beyond the 6-month statutory period from the date of the Office action (35 U.S.C. 133).

The 2-month time period for filing an appeal brief on appeal to the Board of Patent Appeals and Interferences (37 CFR 1.192(a)) and the 1-month time period for filing a new appeal brief to correct the deficiencies in a defective appeal brief (37 CFR 1.192(d)) are time periods, but are not (shortened) statutory periods for reply set pursuant to 35 U.S.C. 133. Thus, these periods are, unless otherwise provided, extendable by up to 5 months under 37 CFR 1.136(a), and, in an exceptional situation, further extendable under 37 CFR 1.136(b) (i.e., these periods are not statutory periods subject to the 6-month maximum set in 35 U.S.C. 133). In addition, the failure to file an appeal brief (or a new appeal brief) within the time period set in 37 CFR 1.192(a) (or (d)) results in dismissal of the appeal. The dismissal of an appeal results in abandonment, unless there is any allowed claim(s) (see MPEP § 1215.04), in which case the examiner should cancel the nonallowed claims and *\*>allow<* the application.

The 2-month time period for reply to A Notice to File Missing Parts of an Application is not identified on the Notice as a statutory period subject to 35 U.S.C. 133. Thus, extensions of time of up to 5 months under 37 CFR 1.136(a), followed by additional time under 37 CFR 1.136(b), when appropriate, are permitted.

## 710.02(e) Extension of Time [R-2]

37 CFR 1.136. *Extensions of time.*

(a)(1) If an applicant is required to reply within a nonstatutory or shortened statutory time period, applicant may extend the time period for reply up to the earlier of the expiration of any maximum period set by statute or five months after the time period set for reply, if a petition for an extension of time and the fee set in § 1.17(a) are filed, unless:

- (i) Applicant is notified otherwise in an Office action;
- (ii) The reply is a reply brief submitted pursuant to § 1.193(b);
- (iii) The reply is a request for an oral hearing submitted pursuant to § 1.194(b);
- (iv) The reply is to a decision by the Board of Patent Appeals and Interferences pursuant to § 1.196, § 1.197 or § 1.304; or
- (v) The application is involved in an interference declared pursuant to § 1.611.

(2) The date on which the petition and the fee have been filed is the date for purposes of determining the period of extension and the corresponding amount of the fee. The expiration of the time period is determined by the amount of the fee paid. A reply must be filed prior to the expiration of the period of extension to avoid abandonment of the application (§ 1.135), but in no situation may an applicant reply later than the maximum time period set by statute, or be granted an extension of time under paragraph (b) of this section when the provisions of this paragraph are available. See § 1.136(b) for extensions of time relating to proceedings pursuant to §§ 1.193(b), 1.194, 1.196 or 1.197; § 1.304 for extensions of time to appeal to the U.S. Court of Appeals for the Federal Circuit or to commence a civil action; § 1.550(c) for extensions of time in *ex parte* reexamination proceedings, § 1.956 for extensions of time in *inter partes* reexamination proceedings; and § 1.645 for extensions of time in interference proceedings.

(3) A written request may be submitted in an application that is an authorization to treat any concurrent or future reply, requiring a petition for an extension of time under this paragraph for its timely submission, as incorporating a petition for extension of time for the appropriate length of time. An authorization to charge all required fees, fees under § 1.17, or all required extension of time fees will be treated as a constructive petition for an extension of time in any concurrent or future reply requiring a petition for an extension of time under this paragraph for its timely submission. Submission of the fee set forth in § 1.17(a) will also be treated as a constructive petition for an extension of time in any concurrent reply requiring a petition for an extension of time under this paragraph for its timely submission.

(b) When a reply cannot be filed within the time period set for such reply and the provisions of paragraph (a) of this section are not available, the period for reply will be extended only for sufficient cause and for a reasonable time specified. Any request for an extension of time under this paragraph must be filed on or before the day on which such reply is due, but the mere filing of such a request will not affect any extension under this paragraph. In no situation can any extension carry the date on which reply is due beyond the maximum time period set by statute. See § 1.304

for extensions of time to appeal to the U.S. Court of Appeals for the Federal Circuit or to commence a civil action; § 1.645 for extensions of time in interference proceedings; § 1.550(c) for extensions of time in *ex parte* reexamination proceedings; and § 1.956 for extensions of time in *inter partes* reexamination proceedings.

(c) If an applicant is notified in a “Notice of Allowability” that an application is otherwise in condition for allowance, the following time periods are not extendable if set in the “Notice of Allowability” or in an Office action having a mail date on or after the mail date of the “Notice of Allowability”:

(1) The period for submitting an oath or declaration in compliance with § 1.63;

(2) The period for submitting formal drawings set under § 1.85(c); and

(3) The period for making a deposit set under § 1.809(c).

37 CFR 1.136 provides for two distinct procedures to extend the period for action or reply in particular situations. The procedure which is available for use in a particular situation will depend upon the circumstances. 37 CFR 1.136(a) permits an applicant to file a petition for extension of time and a fee as set forth in 37 CFR 1.17(a) up to 5 months after the end of the time period set to take action except:

(A) where prohibited by statute,

(B) where prohibited by one of the items listed in the rule, or

(C) where applicant has been notified otherwise in an Office action.

The petition and fee must be filed within the extended time period for reply requested in the petition and can be filed prior to, with, or without the reply. The filing of the petition and fee will extend the time period to take action up to 5 months dependent on the amount of the fee paid except in those circumstances noted above. 37 CFR 1.136(a) will effectively reduce the amount of paperwork required by applicants and the Office since the extension will be effective upon filing of the petition and payment of the appropriate fee and without acknowledgment or action by the Office and since the petition and fee can be filed with or without the reply. 37 CFR 1.136(b) provides for requests for extensions of time upon a showing of sufficient cause when the procedure of 37 CFR 1.136(a) is not available. Although the petition and fee procedure of 37 CFR 1.136(a) will normally be available within 5 months after a set period for reply has expired, an extension request for cause under 37 CFR 1.136(b) must be filed during the set

period for reply. Extensions of time in interference proceedings are governed by 37 CFR 1.645.

It should be very carefully noted that neither the primary examiner nor the \*>Director of the USPTO< has authority to extend the shortened statutory period unless a petition for the extension is filed. While the shortened period may be extended within the limits of the statutory 6 months period, no extension can operate to extend the time beyond the 6 months.

Any request under 37 CFR 1.136(b) for extension of time for reply must state a reason in support thereof. Such extensions will only be granted for sufficient cause and must be filed prior to the end of the set period for reply.

Extensions of time with the payment of a fee pursuant to 37 CFR 1.136 are possible in reply to most Office actions of the examiner. Exceptions include:

(A) all extensions in a reexamination proceeding (see 37 CFR 1.550(c) and MPEP § 2265);

(B) all extensions during an interference proceeding (but not preparatory to an interference where a claim is suggested for interference);

(C) those specific situations where an Office action states that the provisions of 37 CFR 1.136(a) are not applicable (e.g., reply to a notice of allowability, in reissue applications associated with litigation, or where an application in allowable condition has nonelected claims and time is set to cancel such claims); and

(D) those limited instances where applicant is given a specified time limit to take certain actions.

The fees for extensions of time are set forth in 37 CFR 1.17(a) and are subject to a 50% reduction for persons or concerns qualifying as small entities. The fees itemized at 37 CFR 1.17(a) are cumulative. Thus, if an applicant has paid an extension fee in the amount set forth in 37 CFR 1.17(a)(1) for a 1-month extension of time and thereafter decides that an additional 1 month is needed, the proper fee would be the amount set forth in 37 CFR 1.17(a)(2) less the amount set forth in 37 CFR 1.17(a)(1) which was previously paid.

37 CFR 1.136(a)(3) provides that:

(A) a written request may be submitted in an application that is an authorization to treat any concurrent or future reply that requires a petition for an extension of time under 37 CFR 1.136(a) to be timely,

as incorporating a petition for extension of time for the appropriate length of time;

(B) an authorization to charge all required fees, fees under 37 CFR 1.17, or all required extension of time fees will be treated as a constructive petition for an extension of time in any concurrent or future reply requiring a petition for an extension of time under 37 CFR 1.136(a) to be timely; and

(C) submission of the fee set forth in 37 CFR 1.17(a) will be treated as a constructive petition for an extension of time in any concurrent reply requiring a petition for an extension of time under 37 CFR 1.136(a) to be timely.

This is a change in practice, in that applicants were previously required to file a petition (some writing that manifested an intent to obtain an extension of time) in reply to the Office action for which the extension was requested.

37 CFR 1.136(a)(3) is a “safety net” to avoid a potential loss of patent rights for applicants who inadvertently omitted a petition, but who had:

(A) previously filed a written request to treat a reply requiring an extension of time as incorporating a petition for such extension of time;

(B) previously filed an authorization to charge all required fees, fees under 37 CFR 1.17, or all required extension of time fees; or

(C) submitted the fee set forth in 37 CFR 1.17(a) with the reply.

The Office strongly recommends including a written petition for any desired extension of time in reply to the Office action for which the extension was requested to avoid processing delays.

A proper petition may be **>only a few sentences<** such as

The applicant herewith petitions the **>Director of the United States Patent and Trademark Office<** to extend the time for reply to the Office action dated \_\_\_\_ for \_\_\_\_ month(s) from \_\_\_\_ to \_\_\_\_ . Submitted herewith is a check for \$\_\_\_\_ to cover the cost of the extension [Please Charge my deposit account number \_\_\_\_ , in the amount of \$ \_\_\_\_ to cover the cost of the extension. Any deficiency or overpayment should be charged or credited to the above numbered deposit account.]

37 CFR 1.136(a)(2) provides, in part, that “[t]he date on which the petition and the fee have been filed is the date for purposes of determining the period of

extension and the corresponding amount of the fee.” Thus, a petition under 37 CFR 1.136(a) need not be accompanied by a reply (e.g., in situations in which the extension is necessary for copendency with a continuing application). 37 CFR 1.136(a)(2), however, clarifies that “[a] reply must be filed prior to the expiration of the period of extension to avoid abandonment of the application” under 35 U.S.C. 133 and 37 CFR 1.135 (e.g., where the extension is obtained solely for the purpose of copendency with a continuing application, and no reply is filed, the application will become abandoned upon expiration of the so-extended period for reply).

While a petition for an extension of time under 37 CFR 1.136(a) must be filed within the extended period for reply, the petition need not be filed within the original shortened statutory period for reply. If a petition for an extension of time under 37 CFR 1.136(a) (with or without a reply) requests an insufficient period of extension such that the petition would be filed outside the so-extended period for reply, but the period for reply could be further extended under 37 CFR 1.136(a) such that the petition would be filed within the further extended period for reply, it is Office practice to simply treat the petition for extension of time as requesting the period of extension necessary to make the petition filed within the further extended period for reply if the petition or application contains an authorization to charge extension fees or fees under 37 CFR 1.17 to a deposit account. That is, in such situations a petition for an extension of time under 37 CFR 1.136(a) is simply construed as requesting the appropriate period of extension. For example, if a petition (and requisite fee) for a two-month extension of time containing an authorization to charge fee deficiencies to a deposit account are filed in an application four and one-half months after the date a notice of appeal was filed in that application, it is Office practice to treat the petition as requesting the period of extension (three months) necessary to make the petition filed within the extended period for reply. This practice applies even if no further reply (appeal brief or continued prosecution application (CPA) under 37 CFR 1.53(d)) is filed in the application to be treated as a constructive petition for an extension of time under 37 CFR 1.136(a)(3).

To facilitate processing, any petition for an extension of time (or petition to revive under 37 CFR

1.137) in which a continuing application is filed in lieu of a reply should specifically refer to the filing of the continuing application and also should include an express abandonment of the prior application conditioned upon the granting of the petition and the granting of a filing date to the continuing application.

Applicants are cautioned that an extension of time will not be effected in the prior application by filing a petition for an extension of time, extension fee, or fee authorization, in the continuing application. This is because the petition for an extension of time (or constructive petition under 37 CFR 1.136(a)(3)) must be directed toward and filed in the application to which it pertains in accordance with 37 CFR 1.4 and 1.5.

Where a reply is filed after the set period for reply has expired and no petition or fee accompanies it, the reply will not be accepted as timely until the petition (which may be a constructive petition under 37 CFR 1.136(a)(3)) and the appropriate fee are submitted. For example, if an Office action sets a 3-month period for reply and applicant replies in the 4th month and includes only the petition for a 1-month extension of time, the reply is not acceptable until the fee is filed. If the fee is not filed until the 5th month, an additional fee for the 2nd month extension would also be required in order to render the reply timely.

An extension of time under 37 CFR 1.136 is not necessary when submitting a supplemental reply to an Office action if a complete first reply was timely filed in reply to the Office action.

When the provisions of 37 CFR 1.136(a) are not applicable, extensions of time for cause pursuant to 37 CFR 1.136(b) may be possible. Any such extension must be filed on or before the day on which the reply is due. The mere filing of such a request will not effect any extension. All such requests are to be decided by the Technology Center (TC) Director. No extension can operate to extend the time beyond the 6-month statutory period. Extensions of time under 37 CFR 1.136(b) (or 37 CFR 1.136(a)) are not available to extend the time period set in a Notice of Allowability, or in an Office action having a mail date after the mail date of the Notice of Allowability, to submit an oath or declaration in compliance with 37 CFR 1.63, to submit formal drawings, or to make a deposit of biological material.

If a request for extension of time under 37 CFR 1.136(b) is filed in duplicate and accompanied by a stamped return-addressed envelope, the Office will indicate the action taken on the duplicate and return it promptly in the envelope. >For Image File Wrapper (IFW) processing, see IFW Manual.< Utilization of this procedure is optional on the part of applicant. In this procedure, the action taken on the request should be noted on the original and on the copy which is to be returned. The notation on the original, which becomes a part of the file record, should be signed by the person granting or denying the extension, and the name and title of that person should also appear in the notation on the copy which is returned to the person requesting the extension.

When the request is granted, no further action by the Office is necessary. When the request is granted in part, the extent of the extension granted will be clearly indicated on both the original and on the copy which is to be returned. When the request is denied, the reason for the denial will be indicated on both the original and on the copy which is to be returned or a formal decision letter giving the reason for the denial will be forwarded promptly after the mailing of the duplicate.

If the request for extension of time is granted, the due date is computed from the date stamped or printed on the action, as opposed to the original due date. See MPEP § 710.01(a). For example, a reply to an action with a 3-month shortened statutory period, dated November 30, is due on the following February 28 (or 29, if it is a leap year). If the period for reply is extended an additional month, the reply becomes due on March 30, not on March 28.

\*\*>Hand-carried requests for extensions of time will no longer be accepted in the TCs. Hand-carried requests for extensions of time may only be delivered to the Customer Window, which is located at:

U.S. Patent and Trademark Office  
2011 South Clark Place  
Customer Window  
Crystal Plaza Two, Lobby, Room 1B03  
Arlington, VA 22202

Applicant< should be advised promptly regarding action taken on the request >for extension of time under 37 CFR 1.136(b)< so that the file record will be complete.

Form paragraphs 7.98 or 7.98.01 may be used where a reply is filed late but an extension of time is possible.

*¶ 7.98 Reply Is Late, Extension of Time Suggested*

Applicant's reply was received in the Office on [1], which is after the expiration of the period for reply set in the last Office action mailed on [2]. This application will become abandoned unless applicant obtains an extension of time to reply to the last Office action under 37 CFR 1.136(a).

**Examiner Note:**

Since the provisions of 37 CFR 1.136(a) do not apply to reexamination proceedings or to litigation related reissue applications, do not use this form paragraph in these cases.

*¶ 7.98.01 Reply Is Late, Extension of Time Suggested, Pro Se*

Applicant's reply to the Office Action of [1] was received in the Patent and Trademark Office on [2], which is after the expiration of the period for reply set in the above noted Office action. The application will become abandoned unless applicant obtains an extension of the period for reply set in the above noted Office action. An extension of the reply period may be obtained by filing a petition under 37 CFR 1.136(a). The petition must be accompanied by the appropriate fee as set forth in 37 CFR 1.17 (copy of current fee schedule attached). The date on which the reply, the petition, and the fee have been filed is the date of the reply and also the date for purposes of determining the period of extension and the corresponding amount of the fee due. The expiration of the time period is determined by the amount of the fee paid. Applicant is advised that in no case can any extension carry the date for reply to an Office action beyond the maximum period of SIX MONTHS set by statute. Additionally, extensions may not be granted under 37 CFR 1.136(a) for more than FIVE MONTHS beyond the time period set in an Office action.

**Examiner Note:**

Enclose a photocopy of current fee schedule with action so that applicant can determine the required fee.

>

**I. < FINAL REJECTION — TIME FOR REPLY**

If an applicant initially replies within 2 months from the date of mailing of any final rejection setting a 3-month shortened statutory period for reply and the Office does not mail an advisory action until after the end of the 3-month shortened statutory period, the period for reply for purposes of determining the amount of any extension fee will be the date on which the Office mails the advisory action advising applicant of the status of the application, but in no event can the period extend beyond 6 months from the date

of the final rejection. This procedure applies only to a first reply to a final rejection. The following language must be included by the examiner in each final rejection.

A SHORTENED STATUTORY PERIOD FOR REPLY TO THIS FINAL ACTION IS SET TO EXPIRE THREE MONTHS FROM THE DATE OF THIS ACTION. IN THE EVENT A FIRST REPLY IS FILED WITHIN TWO MONTHS OF THE MAILING DATE OF THIS FINAL ACTION AND THE ADVISORY ACTION IS NOT MAILED UNTIL AFTER THE END OF THE THREE-MONTH SHORTENED STATUTORY PERIOD, THEN THE SHORTENED STATUTORY PERIOD WILL EXPIRE ON THE DATE THE ADVISORY ACTION IS MAILED, AND ANY EXTENSION FEE PURSUANT TO 37 CFR 1.136(a) WILL BE CALCULATED FROM THE MAILING DATE OF THE ADVISORY ACTION. IN NO EVENT WILL THE STATUTORY PERIOD FOR REPLY EXPIRE LATER THAN SIX MONTHS FROM THE DATE OF THIS FINAL ACTION.

For example, if applicant initially replies within 2 months from the date of mailing of a final rejection and the examiner mails an advisory action before the end of 3 months from the date of mailing of the final rejection, the shortened statutory period will expire at the end of 3 months from the date of mailing of the final rejection. In such a case, if a petition for extension of time is granted, the due date for a reply is computed from the date stamped or printed on the Office action with the final rejection. See MPEP § 710.01(a). If the examiner, however, does not mail an advisory action until after the end of 3 months, the shortened statutory period will expire on the date the examiner mails the advisory action and any extension of time fee may be calculated from the mailing date of the advisory action. >In no event will the statutory period for reply expire later than 6 months from the mailing date of the final Office action.<

See also MPEP § 706.07(f).

>

**II. < EXTENSIONS OF TIME TO SUBMIT AFFIDAVITS AFTER FINAL REJECTION**

Frequently, applicants request an extension of time, stating as a reason therefor that more time is needed in which to submit an affidavit. When such a request is filed after final rejection, the granting of the request for extension of time is without prejudice to the right of the examiner to question why the affidavit is now

necessary and why it was not earlier presented. If applicant's showing is insufficient, the examiner may deny entry of the affidavit, notwithstanding the previous grant of an extension of time to submit it. The grant of an extension of time in these circumstances serves merely to keep the application from becoming abandoned while allowing the applicant the opportunity to present the affidavit or to take other appropriate action. Moreover, prosecution of the application to save it from abandonment must include such timely, complete and proper action as required by 37 CFR 1.113. The admission of the affidavit for purposes other than allowance of the application, or the refusal to admit the affidavit, and any proceedings relative thereto, shall not operate to save the application from abandonment.

Implicit in the above practice is the fact that affidavits submitted after final rejection are subject to the same treatment as amendments submitted after final rejection. *In re Affidavit Filed After Final Rejection*, 152 USPQ 292 (Comm'r Pat. 1966).

Failure to file a reply during the shortened statutory period results in abandonment of the application.

Extensions of time to appeal to the courts under 37 CFR 1.304 is covered in MPEP § 1216.

>

### III. < NO EXTENSIONS OF TIME AFTER PAYMENT OF ISSUE FEE

The statutory (nonextendable) time period for payment of the issue fee is 3 months from the date of the Notice of Allowance (35 U.S.C. 151). In situations where informalities such as drawing corrections or submission of supplemental or corrected declarations are outstanding at the time of allowance, applicants will be notified on the PTOL-37 (Notice of Allowability) of such informalities. Extensions of time under 37 CFR 1.136(a) or (b) are NOT available to correct such informalities. Any such informalities must be corrected and the issue fee >and the publication fee, if required,< must be paid within the 3-month period.

#### 710.04 Two Periods Running

There sometimes arises a situation where two different periods for reply are running against an application, the one limited by the regular statutory period, the other by the limited period set in a subsequent

Office action. The running of the first period is not suspended nor affected by an *ex parte* limited time action or even by an appeal therefrom. For an exception involving suggested claims, see MPEP § 2305.03.

#### 710.04(a) Copying Patent Claims

Where, in an application in which there is an unanswered rejection of record, claims are copied from a patent and all of these claims are rejected there results a situation where two different periods for reply are running against the application. One period, the first, is the regular statutory period of the unanswered rejection of record, the other period is the limited period set for reply to the rejection (either first or final). The date of the last unanswered Office action on the claims other than the copied patent claims is the controlling date of the statutory period. See *Ex parte Milton*, 63 USPQ 132 (P.O. Super Exam. 1938). See also MPEP § 2305.02.

#### 710.05 Period Ending on Saturday, Sunday, or a Federal Holiday

35 U.S.C. 21. Filing date and day for taking action.

\*\*\*\*\*

(b) When the day, or the last day, for taking any action or paying any fee in the United States Patent and Trademark Office falls on Saturday, Sunday, or a Federal holiday within the District of Columbia the action may be taken, or the fee paid, on the next succeeding secular or business day.

37 CFR 1.7. Times for taking action; Expiration on Saturday, Sunday, or Federal holiday.

(a) Whenever periods of time are specified in this part in days, calendar days are intended. When the day, or the last day fixed by statute or by or under this part for taking any action or paying any fee in the United States Patent and Trademark Office falls on Saturday, Sunday, or on a Federal holiday within the District of Columbia, the action may be taken, or the fee paid, on the next succeeding business day which is not a Saturday, Sunday, or a Federal holiday. See § 1.304 for time for appeal or for commencing civil action.

(b) If the day that is twelve months after the filing date of a provisional application under 35 U.S.C. 111(b) and § 1.53(c) falls on Saturday, Sunday, or on a Federal holiday within the District of Columbia, the period of pendency shall be extended to the next succeeding secular or business day which is not a Saturday, Sunday, or a Federal holiday.

The Federal holidays under 5 U.S.C. 6103(a) are New Year's Day, January 1; Martin Luther King's

birthday, the third Monday in January; Washington's Birthday, the third Monday in February; Memorial Day, the last Monday in May; Independence Day, July 4; Labor Day, the first Monday in September; Columbus Day, the second Monday in October; Veteran's Day, November 11; Thanksgiving Day, the fourth Thursday in November; and Christmas Day, December 25. Whenever a Federal holiday falls on a Sunday, the following day (Monday) is also a Federal holiday. Exec. Order No. 10,358, 17 Fed. Reg., 5269; 5 U.S.C. 6103.

When a Federal holiday falls on a Saturday, the preceding day, Friday, is considered to be a Federal holiday and the U.S. Patent and Trademark Office will be closed for business on that day (5 U.S.C. 6103). Accordingly, any action or fee due on such a Federal holiday Friday or Saturday is to be considered timely if the action is taken, or the fee paid, on the next succeeding day which is not a Saturday, Sunday, or a Federal holiday.

Pursuant to 5 U.S.C. 6103(c), Inauguration Day (January 20, every 4 years) "is a legal public holiday for the purpose of statutes relating to pay and leave of employees . . ." employed in the District of Columbia and surrounding areas. It further provides that when Inauguration Day falls on a Sunday, the next day selected for the observance of the Inauguration is considered a legal public holiday for purposes of this subsection. No provision is made for an Inauguration Day falling on a Saturday.

When an amendment is filed a day or two later than the expiration of the period fixed by statute, care should be taken to ascertain whether the last day of that period was Saturday, Sunday, or a Federal holiday and if so, whether the amendment was filed or the fee paid on the next succeeding day which is not a Saturday, Sunday, or a Federal holiday.

An amendment received on such succeeding day which was due on Saturday, Sunday, or Federal holiday is endorsed on the file wrapper with the date of receipt. The Saturday, Sunday, or Federal holiday is also indicated.

The period of pendency of a provisional application will be extended to the next succeeding secular or business day which is not a Saturday, Sunday, or a Federal holiday, if the day that is twelve months after the filing date of the provisional application under 35 U.S.C. 111(b) and 37 CFR 1.53(c) falls on Satur-

day, Sunday, or a Federal holiday within the District of Columbia. See 35 U.S.C. 119(e)(3) and MPEP § 201.04(b).

### **710.06 Situations When Reply Period Is Reset or Restarted [R-2]**

Where the citation of a reference is incorrect or an Office action contains some other defect and this error is called to the attention of the Office within 1 month of the mail date of the action, the Office will restart the previously set period for reply to run from the date the error is corrected, if requested to do so by applicant. If the error is brought to the attention of the Office within the period for reply set in the Office action but more than 1 month after the date of the Office action, the Office will set a new period for reply, if requested to do so by the applicant, to substantially equal the time remaining in the reply period. For example, if the error is brought to the attention of the Office 5 weeks after mailing the action, then the Office would set a new 2-month period for reply. The new period for reply must be at least 1 month and would run from the date the error is corrected. See MPEP § 707.05(g) for the manner of correcting the record where there has been an erroneous citation.

Where for any reason it becomes necessary to refile any action (MPEP § 707.13), the action should be correspondingly redated, as it is the remailing date that establishes the beginning of the period for reply. *Ex parte Gourtoff*, 1924 C.D. 153, 329 O.G. 536 (Comm'r Pat. 1924). >For Image File Wrapper (IFW) processing, see IFW Manual.<

A supplementary action after a rejection explaining the references more explicitly or giving the reasons more fully, even though no further references are cited, establishes a new date from which the statutory period runs.

If the error in citation or other defective Office action is called to the attention of the Office after the expiration of the period for reply, the period will not be restarted and any appropriate extension fee will be required to render a reply timely. The Office letter correcting the error will note that the time period for reply remains as set forth in the previous Office action.

See MPEP § 505, § 512, and § 513 for U.S. Patent and Trademark Office practice on date stamping documents.

In the event that correspondence from the Office is received late (A) due to delays in the U.S. Postal Service, or (B) because the mail was delayed in leaving the USPTO (the postmark date is later than the mail date printed on the correspondence), applicants may petition to reset the period for reply, which petition shall be evaluated according to the guidelines which follow. Where the Office action involved in the petition was mailed by a Technology Center (TC), the authority to decide such petitions has been delegated to the TC Director. See Notice entitled "Petition to reset a period for response due to late receipt of a PTO action," 1160 O.G. 14 (March 1, 1994).

&gt;

#### **I. < PETITIONS TO RESET A PERIOD FOR REPLY DUE TO LATE RECEIPT OF AN OFFICE ACTION**

The Office will grant a petition to restart the previously set period for reply to an Office action to run from the date of receipt of the Office action at the correspondence address when the following criteria are met:

(A) the petition is filed within 2 weeks of the date of receipt of the Office action at the correspondence address;

(B) a substantial portion of the set reply period had elapsed on the date of receipt (e.g., at least 1 month of a 2- or 3-month reply period had elapsed); and

(C) the petition includes (1) evidence showing the date of receipt of the Office action at the correspondence address (e.g., a copy of the Office action having the date of receipt of the Office action at the correspondence address stamped thereon, a copy of the envelope (which contained the Office action) having the date of receipt of the Office action at the correspondence address stamped thereon, etc.), and (2) a statement setting forth the date of receipt of the Office action at the correspondence address and explaining how the evidence being presented establishes the date of receipt of the Office action at the correspondence address.

There is no statutory requirement that a shortened statutory period of longer than 30 days to reply to an Office action be reset due to delay in the mail or in the Office. However, when a substantial portion of the set

reply period had elapsed on the date of receipt at the correspondence address (e.g., at least 1 month of a 2- or 3-month period had elapsed), the procedures set forth above for late receipt of action are available. Where an Office action was received with less than 2 months remaining in a shortened statutory period of 3 months the period may be restarted from the date of receipt. Where the period remaining is between 2 and 3 months, the period will be reset only in extraordinary situations, e.g., complex Office action suggesting submission of comparative data.

&gt;

#### **II. < PETITIONS TO RESET A PERIOD FOR REPLY DUE TO A POSTMARK DATE LATER THAN THE MAIL DATE PRINTED ON AN OFFICE ACTION**

The Office will grant a petition to restart the previously set period for reply to an Office action to run from the postmark date shown on the Office mailing envelope which contained the Office action when the following criteria are met:

(A) the petition is filed within 2 weeks of the date of receipt of the Office action at the correspondence address;

(B) the reply period was for payment of the issue fee, or the reply period set was 1 month or 30 days; and

(C) the petition includes (1) evidence showing the date of receipt of the Office action at the correspondence address (e.g., copy of the Office action having the date of receipt of the Office action at the correspondence address stamped thereon, etc.), (2) a copy of the envelope which contained the Office action showing the postmark date, and (3) a statement setting forth the date of receipt of the Office action at the correspondence address and stating that the Office action was received in the postmarked envelope.

The provisions of 37 CFR 1.8 and 1.10 apply to the filing of the above-noted petitions with regard to the requirement that the petition be filed within 2 weeks of the date of receipt of the Office action.

The showings outlined above may not be sufficient if there are circumstances that point to a conclusion that the Office action may have been delayed after receipt rather than a conclusion that the Office action was delayed in the mail or in the Office.



## 711 Abandonment of Patent Application [R-2]

*37 CFR 1.135. Abandonment for failure to reply within time period.*

(a) If an applicant of a patent application fails to reply within the time period provided under § 1.134 and § 1.136, the application will become abandoned unless an Office action indicates otherwise.

(b) Prosecution of an application to save it from abandonment pursuant to paragraph (a) of this section must include such complete and proper reply as the condition of the application may require. The admission of, or refusal to admit, any amendment after final rejection or any amendment not responsive to the last action, or any related proceedings, will not operate to save the application from abandonment.

(c) When reply by the applicant is a *bona fide* attempt to advance the application to final action, and is substantially a complete reply to the non-final Office action, but consideration of some matter or compliance with some requirement has been inadvertently omitted, applicant may be given a new time period for reply under § 1.134 to supply the omission.

*37 CFR 1.138. Express abandonment.*

(a) An application may be expressly abandoned by filing a written declaration of abandonment identifying the application in the United States Patent and Trademark Office. Express abandonment of the application may not be recognized by the Office before the date of issue or publication unless it is actually received by appropriate officials in time to act.

(b) A written declaration of abandonment must be signed by a party authorized under § 1.33(b)(1), (b)(3), or (b)(4) to sign a paper in the application, except as otherwise provided in this paragraph. A registered attorney or agent, not of record, who acts in a representative capacity under the provisions of § 1.34(a) when filing a continuing application, may expressly abandon the prior application as of the filing date granted to the continuing application.

(c) An applicant seeking to abandon an application to avoid publication of the application (see § 1.211(a)(1)) must submit a declaration of express abandonment by way of a petition under this section including the fee set forth in § 1.17(h) in sufficient time to permit the appropriate officials to recognize the abandonment and remove the application from the publication process. Applicant should expect that the petition will not be granted and the application will be published in regular course unless such declaration of express abandonment and petition are received by the appropriate officials more than four weeks prior to the projected date of publication.

Abandonment may be either of the invention or of an application. This discussion is concerned with abandonment of the application for patent.

An abandoned application, in accordance with 37 CFR 1.135 and 1.138, is one which is removed

from the Office docket of pending applications through:

(A) formal abandonment

(1) by the applicant (acquiesced in by the assignee if there is one),

(2) by the attorney or agent of record including an associate attorney or agent appointed by the principal attorney or agent and whose power is of record, or

(3) by a registered attorney or agent acting in a representative capacity under 37 CFR 1.34(a) when filing a continuing application; or

(B) failure of applicant to take appropriate action within a specified time at some stage in the prosecution of the application.

Where an applicant, himself or herself, formally abandons an application and there is a corporate assignee, the acquiescence must be made through an officer whose official position is indicated and is authorized to sign on behalf of the corporate assignee.

### 711.01 Express or Formal Abandonment [R-2]

The applicant (acquiesced in by an assignee of record), or the attorney/agent of record, if any, can sign an express abandonment. It is imperative that the attorney or agent of record exercise every precaution in ascertaining that the abandonment of the application is in accordance with the desires and best interests of the applicant prior to signing a letter of express abandonment of a patent application. Moreover, special care should be taken to ensure that the appropriate application is correctly identified in the letter of abandonment.

A letter of abandonment properly signed becomes effective when an appropriate official of the Office takes action thereon. When so recognized, the date of abandonment may be the date of recognition or a different date if so specified in the letter itself. For example, where a continuing application is filed with a request to abandon the prior application as of the filing date accorded the continuing application, the date of the abandonment of the prior application will be in accordance with the request once it is recognized.

Action in recognition of an express abandonment may take the form of an acknowledgment by the examiner or by the Publishing Division of the receipt of the express abandonment, indicating that it is in compliance with 37 CFR 1.138.

It is suggested that divisional applications be reviewed before filing to ascertain whether the prior application should be abandoned. Care should be exercised in situations such as these as the Office looks on express abandonments as acts of deliberation, intentionally performed.

Applications may be expressly abandoned as provided for in 37 CFR 1.138. When a letter expressly abandoning an application (not in issue) is received, the examiner should acknowledge receipt thereof, and indicate whether it does or does not comply with the requirements of 37 CFR 1.138.

The filing of a request for a continued prosecution application (CPA) under 37 CFR 1.53(d) \*\* is considered to be a request to expressly abandon the prior application as of the filing date granted the continuing application.

Form paragraph 7.88 may be used to acknowledge proper express abandonments.

\*\*>

#### ¶ 7.88 Acknowledge Express Abandonment

This application is abandoned in view of the letter of express abandonment complying with 37 CFR 1.138 filed on [1].

#### Examiner Note:

1. With the exception of express abandonments resulting from the filing of a continued prosecution application under 37 CFR 1.53(d) or when filed with a continuing application, all express abandonments must be signed by all of the inventors, the owners of the entire interest, or an attorney or agent of record.
2. The provisions of 37 CFR 1.34 do **not** apply to express abandonments unless filed with a continuing application.

<

If the letter expressly abandoning the application does comply with 37 CFR 1.138, the examiner should respond by using a “Notice of Abandonment” form PTO-1432, and by checking the appropriate box(es). The examiner’s signature should appear at the bottom of the form. If such a letter does not comply with the requirements of 37 CFR 1.138, a fully explanatory letter should be sent.

Form paragraph 7.89 may be used to acknowledge improper express abandonments.

#### ¶ 7.89 Letter of Express Abandonment, Improper

The letter filed on [1] does not comply with the requirements of 37 CFR 1.138, and therefore is not a proper letter of express abandonment.

#### Examiner Note:

The reasons why the letter fails to comply with 37 CFR 1.138 must be fully explained, e.g., the individual signing the express abandonment is not of record. See the “Examiner Note” of form paragraph 7.88.

A letter of express abandonment which is not timely filed (because it was not filed within the period for reply), is not acceptable to expressly abandon the application. The letter of express abandonment should be endorsed on the file wrapper and placed in the application file but not formally entered. >For Image File Wrapper (IFW) processing, see IFW Manual.<

The application should be pulled for abandonment after expiration of the \*>maximum< permitted period for reply (see MPEP § 711.04(a)) and applicant notified of the abandonment for failure to reply within the statutory period. See MPEP § 711.02 and § 711.04(c).

In view of the doctrine set forth in *Ex parte Lass-cell*, 1884 C.D. 66, 29 O.G. 861 (Comm’r Pat. 1884), an amendment \*\* canceling all of the claims, even though said amendment is signed by the applicant himself/herself and the assignee, is not an express abandonment. >The Office, however, will not enter any amendment that would cancel all of the claims in an application without presenting any new or substitute claims. See *Exxon Corp. v. Phillips Petroleum Co.*, 265 F.3d 1249, 60 USPQ2d 1368 (Fed. Cir. 2001).< Such an amendment is regarded as nonresponsive and \*\*>is not a *bona fide* attempt to advance the application to final action. The practice set forth in 37 CFR 1.135(c) does not apply to such amendment. Applicant< should be notified as explained in MPEP § 714.03 to § 714.05.

An attorney or agent not of record in an application may file a withdrawal of an appeal under 37 CFR 1.34(a) except in those instances where such withdrawal would result in abandonment of the application. In such instances the withdrawal of appeal is in fact an express abandonment.

&gt;

**I. < AFTER NOTICE OF ALLOWANCE**

If a letter of express abandonment is being submitted in an allowed application, the express abandonment should be accompanied by a petition to withdraw from issue under 37 CFR 1.313 and the fee set forth in 37 CFR 1.17(h). Also see MPEP § 1308. The express abandonment may not be recognized by the Office unless it is actually received by appropriate officials in time to \*\*>withdraw the application from< issue. 37 CFR 1.313 provides that an allowed application will not be withdrawn from issue except by approval of the \*>Director of the USPTO<, and that after the issue fee has been paid, it will not be withdrawn upon petition by the applicant for any reason except those reasons listed in 37 CFR 1.313(c), which include express abandonment of the application. An application may be withdrawn from issue for express abandonment of the application in favor of a continuing application. The petition under 37 CFR 1.313 accompanied by the petition fee should be addressed to the Office of Petitions. If the petition and the letter of abandonment are received by appropriate officials in sufficient time to act on the petition and remove the application from the issue process, the letter of abandonment will be acknowledged by the Office of Patent Publication after the petition is granted. >Petitions to withdraw an application from issue under 37 CFR 1.313(c) may be:

(A) mailed to Mail Stop Petition, Commissioner for Patents, P.O. Box 1450, Alexandria, VA 22313-1450;

(B) transmitted by facsimile transmission to (703) 872-9306; or

(C) hand-carried to the Office of Petitions, Crystal Plaza 4, 2201 South Clark Place, Room 3C23, Arlington, VA 22202.

Applicants are strongly encouraged to hand-carry the petition to the Office of Petitions to allow sufficient time to process the petition and if the petition can be granted, withdraw the application from issue.<

See MPEP § 711.05 and § 1308. In cases where 37 CFR 1.313 precludes giving effect to an express abandonment, the appropriate remedy is a petition,

with fee, under 37 CFR 1.183, showing an extraordinary situation where justice requires suspension of 37 CFR 1.313.

&gt;

**II. < TO AVOID PUBLICATION OF APPLICATION**

A petition under 37 CFR 1.138(c) for express abandonment to avoid publication of the application (see 37 CFR 1.211(a)(1)) accompanied by the petition fee set forth in 37 CFR 1.17(h) \*\*>may be:

(A) mailed to Mail Stop Express Abandonment, Commissioner for Patents, P.O. Box 1450, Alexandria, VA 22313-1450;

(B) transmitted by facsimile transmission to the Pre-Grant Publication Division at (703) 305-8568; or

(C) hand-carried to the Pre-Grant Publication Division, 2231 Crystal Drive, Room 905, Arlington, VA 22202.

Because a petition under 37 CFR 1.138(c) will not stop publication of the application unless it is recognized and acted on by the Pre-Grant Publication Division in sufficient time to avoid publication, applicants should use either method (B) or (C) in all instances where the projected publication date is less than 3 months from the date of the petition.< This will increase the chance of such petition being received by the appropriate officials in sufficient time to recognize the abandonment and remove the application from the publication process. The petition will be granted when it is recognized in sufficient time to avoid publication of the application. The petition will be denied when it is not recognized in time to avoid publication. Generally, a petition under 37 CFR 1.138(c) will not be granted and the application will be published in regular course unless such declaration of express abandonment and petition are received by the appropriate officials more than four weeks prior to the projected date of publication. It is unlikely that a petition filed within four weeks of the projected date of publication will be effective to avoid publication. Also note that withdrawal of an application from issue after payment of the issue fee may not be effective to avoid publication of an application under 35 U.S.C. 122(b). See 37 CFR 1.313(d).

**APPLICATION IN INTERFERENCE**

A written declaration of abandonment of the application signed only by an attorney or agent of record, when the application sought to be expressly or formally abandoned is the subject of an interference proceeding under 35 U.S.C. 135, is not effective to terminate the interference, and will not be considered until after *ex parte* prosecution is resumed. In order to be effective to terminate an interference proceeding, an abandonment of the application must be signed by

the inventor with the written consent of the assignee where there has been an assignment.

>

**IV. < FORM FOR FILING EXPRESS ABANDONMENT**

\*\* >Copies of the appropriate forms< for use in filing an express abandonment under 37 CFR 1.138 in favor of a continuing application >(form PTO/SB/24)< or to avoid publication of the application



EXAMINATION OF APPLICATIONS

711.01

PTO/SB/24A (04-04)  
 Approved for use through 07/31/2006. OMB 0651-0031  
 U.S. Patent and Trademark Office; U.S. DEPARTMENT OF COMMERCE

Under the Paperwork Reduction Act of 1995, no persons are required to respond to a collection of information unless it displays a valid OMB control number.

<p align="center"><b>PETITION FOR EXPRESS ABANDONMENT TO AVOID PUBLICATION UNDER 37 CFR 1.138(c)</b></p> <hr/> <p>Fax the petition directly to the Pre-Grant Publication Division at (703) 305-8568                  Or Mail the petition to:  <b>Mail Stop Express Abandonment</b>                  Commissioner for Patents                  P.O. Box 1450, Alexandria, VA 22313-1450</p>	<b>Application Number</b>	
	<b>Filing Date</b>	
	<b>First Named Inventor</b>	
	<b>Art Unit</b>	
	<b>Examiner Name</b>	
	<b>Attorney Docket Number</b>	

**Petition for Express Abandonment to Avoid Publication under 37 CFR 1.138(c)**

I hereby petition to expressly abandon the above-identified application to avoid publication.

**Petition Fee** – must be filed with petition to avoid delays in recognizing the petition.

a.  The Director is hereby authorized to charge the petition fee under 37 CFR 1.17(h) to Deposit Account No. \_\_\_\_\_.

b.  Check in the amount of \$ \_\_\_\_\_ is enclosed.

c.  Payment by credit card (Form PTO-2038 is enclosed).

**NOTE:** A paper requesting express abandonment of an application is not effective unless and until an appropriate USPTO official recognizes and acts on the paper. See the Manual of Patent Examining Procedure (MPEP), section 711.01. In addition, the paper will not stop publication of the application unless a petition under 37 CFR 1.138(c) is recognized and acted on by the Pre-Grant Publication Division in sufficient time to avoid publication (e.g., more than four (4) weeks prior to the projected publication date).

I am the:  applicant.  
 assignee of record of the entire interest. See 37 CFR 3.71.  
 Statement under 37 CFR 3.73(b) is enclosed. (Form PTO/SB/96)  
 attorney or agent of record. Registration Number \_\_\_\_\_

\_\_\_\_\_  
 Signature

\_\_\_\_\_  
 Date

\_\_\_\_\_  
 Typed or printed name

\_\_\_\_\_  
 Telephone Number

Note: Signatures of all the inventors or assignees of record of the entire interest or their representative(s) are required. Submit multiple forms if more than one signature is required, see below.

Total of \_\_\_\_\_ forms are submitted.

This collection of information is required by 37 CFR 1.138(c). The information is required to obtain or retain a benefit by the public which is to file (and by the USPTO to process) an application. Confidentiality is governed by 35 U.S.C. 122 and 37 CFR 1.14. This collection is estimated to take 12 minutes to complete, including gathering, preparing, and submitting the completed application form to the USPTO. Time will vary depending upon the individual case. Any comments on the amount of time you require to complete this form and/or suggestions for reducing this burden, should be sent to the Chief Information Officer, U.S. Patent and Trademark Office, U.S. Department of Commerce, P.O. Box 1450, Alexandria, VA 22313-1450. DO NOT SEND FEES OR COMPLETED FORMS TO THIS ADDRESS. SEND TO: Mail Stop Express Abandonment, Commissioner for Patents, P.O. Box 1450, Alexandria, VA 22313-1450.

If you need assistance in completing the form, call 1-800-PTO-9199 and select option 2.

<

## 711.02 Failure To Take Required Action During Statutory Period [R-2]

37 CFR 1.135(a) specifies that an application becomes abandoned if applicant “fails to reply” to an office action within the fixed statutory period. This failure may result either from (A) failure to reply within the statutory period, or (B) insufficiency of reply, i.e., failure to file a “complete and proper reply, as the condition of the case may require” within the statutory period (37 CFR 1.135(b)).

When an amendment is filed after the expiration of the statutory period, the application is abandoned and the remedy is to petition to revive it. The examiner should notify the applicant or attorney at once that the application has been abandoned by using Notice of Abandonment form PTOL-1432. The proper boxes on the form should be checked and the blanks for the dates of the proposed amendment and the Office action completed. The late amendment is endorsed on the file wrapper but not formally entered. See MPEP § 714.17.

Form paragraph 7.90 or 7.98.02 may also be used.

### ¶ 7.90 Abandonment, Failure to Reply

This application is abandoned in view of applicant’s failure to submit a proper reply to the Office action mailed on [1] within the required period for reply.

#### Examiner Note:

1. A letter of abandonment should not be mailed until after the period for requesting an extension of time under 37 CFR 1.136(a) has expired.
2. In *pro se* cases see form paragraph 7.98.02.

\*\*>

### ¶ 7.98.02 Reply Is Late, Petition To Revive Suggested, Pro Se

Applicant’s reply to the Office Action of [1] was received in the Patent and Trademark Office on [2], which is after the expiration of the period for reply set in the last Office Action. Since no time remains for applicant to obtain an extension of the period for reply by filing a petition under 37 CFR 1.136(a), this application is *abandoned*. Applicant is advised that the abandonment of this application may only be overcome by filing a petition to revive under 37 CFR 1.137. A petition to revive may be appropriate if applicant’s failure to reply was either unavoidable or unintentional, as set forth below.

#### A. Failure to reply was unavoidable.

A petition to revive an abandoned application on the grounds that the failure to reply was unavoidable (37 CFR 1.137(a)) must be accompanied by: (1) the required reply (which has been filed); (2) a showing to the satisfaction of the Director that the entire delay in filing the required reply from the due date for the reply until the filing of a grantable petition pursuant to 37 CFR 1.137(a) was unavoidable; (3) any terminal disclaimer required pursuant to 37 CFR 1.137(c); and (4) the \$[3] petition fee as set forth in 37 CFR 1.17(l). No consideration to the substance of a petition will be given until this fee is received.

The showing requirement can be met by submission of statements of fact establishing that the delay in filing the reply was unavoidable, as well as inadvertent. This must include: (1) a satisfactory showing that the cause of the delay resulting in failure to reply in timely fashion to the Office action was unavoidable; and (2) a satisfactory showing that the cause of any delay during the time period between abandonment and filing of the petition to revive was also unavoidable.

A terminal disclaimer and the \$[4] terminal disclaimer fee is required under 37 CFR 1.137(c) if the application is: (1) a design application, (2) a utility application filed before June 8, 1995, or (3) a plant application filed before June 8, 1995. The terminal disclaimer must dedicate to the public a terminal part of the term of any patent granted the application equivalent to the period of abandonment of the application, and must also apply to any patent granted on any application containing a specific reference under 35 U.S.C. 120, 121 or 365(c) to the application for which revival is sought.

#### B. Failure to reply was unintentional.

A petition to revive an abandoned application on the grounds that the failure to reply was unintentional (37 CFR 1.137(b)) must be accompanied by: (1) the required reply (which has been filed); (2) a statement that the entire delay in filing the required reply from the due date for the reply until the filing of a grantable petition pursuant to 37 CFR 1.137(b) was unintentional; (3) any terminal disclaimer required pursuant to 37 CFR 1.137(c) (see above discussion); and (4) the \$[5] petition fee as set forth in 37 CFR 1.17(m). No consideration to the substance of a petition will be given until this fee is received. The Director may require additional information where there is a question whether the delay was unintentional.

The required items and fees must be submitted promptly under a cover letter entitled “Petition to Revive.”

Further correspondence with respect to this matter should be addressed as follows:

By mail:

Mail Stop Petition  
Commissioner for Patents  
P.O. Box 1450  
Alexandria, VA 22313-1450

By FAX:

(703) 872-9306

Attn: Office of Petitions

Telephone inquiries with respect to this matter should be directed to the Office of Petitions Staff at (703) 305-9282. For more detailed information, see MPEP § 711.03(c).

<

To pass on questions of abandonment, it is essential that the examiner know the dates that mark the beginning and end of the statutory period under varying situations. Applicant's reply must reach the Office within the set shortened statutory period for reply dating from the date stamped or printed on the Office letter or within the extended time period obtained under 37 CFR 1.136. (See MPEP § 710 to § 710.06.)

For a petition to withdraw a holding of abandonment based upon failure to receive an Office action, see MPEP § 711.03(c).

### 711.02(a) Insufficiency of Reply

Abandonment may result from a situation where applicant's reply is within the period for reply but is not fully responsive to the Office action. But see MPEP § 710.02(c). See also MPEP § 714.02 to § 714.04.

#### ¶ 7.91 Reply Is Not Fully Responsive, Extension of Time Suggested

The reply filed on [1] is not fully responsive to the prior Office action because: [2]. Since the period for reply set forth in the prior Office action has expired, this application will become abandoned unless applicant corrects the deficiency and obtains an extension of time under 37 CFR 1.136(a).

The date on which the petition under 37 CFR 1.136(a) and the appropriate extension fee have been filed is the date for purposes of determining the period of extension and the corresponding amount of the fee. In no case may an applicant reply outside the SIX (6) MONTH statutory period or obtain an extension for more than FIVE (5) MONTHS beyond the date for reply set forth in an Office action. A fully responsive reply must be timely filed to avoid abandonment of this application.

#### Examiner Note:

1. In bracket 2, set forth why the examiner considers there to be a failure to take "complete and proper action" within the statutory period.
2. If the reply appears to be a *bona fide* attempt to respond with an inadvertent omission, do not use this form paragraph; instead use form paragraph 7.95.

### 711.02(b) Special Situations Involving Abandonment [R-2]

The following situations involving questions of abandonment often arise, and should be specially noted:

(A) Copying claims from a patent when not suggested by the U.S. Patent and Trademark Office does not constitute a reply to the last Office action and will not save the application from abandonment, unless the last Office action relied solely on the patent for the rejection of all the claims rejected in that action.

(B) An application may become abandoned through withdrawal of, or failure to prosecute, an appeal to the Board of Patent Appeals and Interferences. See MPEP § 1215.01 to § 1215.04.

(C) An application may become abandoned through dismissal of appeal to the Court of Appeals for the Federal Circuit or civil action, where there was not filed prior to such dismissal an amendment putting the application in condition for issue or fully responsive to the Board's decision. Abandonment results from failure to perfect an appeal as required by the Court of Appeals for the Federal Circuit. See MPEP § 1215.04 and § 1216.01.

(D) Where claims are suggested for interference near the end of the period for reply running against the application\*\*. See MPEP § 2305.

\*\*>

(E) < Where a continued prosecution application (CPA) under 37 CFR 1.53(d) is filed. See MPEP § 201.06(d) and § 711.01.

\*>

(F) < Prior to a decision by the Board, an application on appeal that has no allowed claims may become abandoned when a \*\*>Request for Continued Examination (RCE)< is improperly filed without the appropriate fee or a submission (37 CFR 1.114(d)) in the application. The filing of an RCE will be treated as a withdrawal of the appeal by the applicant. See MPEP § 706.07(h), paragraph X.

\*>

(G) < When a reply to a final Office action is outstanding, an application may become abandoned if an RCE is filed without a timely submission that meets the reply requirements of 37 CFR 1.111. The filing of an improper RCE will not operate to toll the running of any time period set in the previous Office action for



reply to avoid abandonment of the application. See MPEP § 706.07(h), paragraph VI.

\*>

(H) < Prior to payment of the issue fee, an allowed application may become abandoned if an RCE is improperly filed without the appropriate fee or a submission in the application. The improper RCE will not operate to toll the running of the time period for payment of the issue fee. See MPEP § 706.07(h), paragraph IX.

### **711.02(c) Termination of Proceedings**

“Termination of proceedings” is an expression found in 35 U.S.C. 120. As there stated, a second application is considered to be copending with an earlier application if it is filed before

(A) the patenting,

(B) the abandonment of, or

(C) termination of proceedings on the earlier application.

“Before” has consistently been interpreted, in this context, to mean “not later than.”

In each of the following situations, proceedings are terminated:

(A) When the issue fee is not paid and the application is abandoned for failure to pay the issue fee, proceedings are terminated as of the date the issue fee was due and the application is the same as if it were abandoned after midnight on that date (but if the issue fee is later accepted, on petition, the application is revived). See MPEP § 711.03(c).

(B) If an application is in interference wherein all the claims present in the application correspond to the counts and the application loses the interference as to all the claims, then proceedings on that application are terminated as of the date appeal or review by civil action was due if no appeal or civil action was filed.

(C) Proceedings are terminated in an application after decision by the Board of Patent Appeals and Interferences as explained in MPEP § 1214.06.

(D) Proceedings are terminated after a decision by the court as explained in MPEP § 1216.01.

### **711.03 Reconsideration of Holding of Abandonment; Revival**

When advised of the abandonment of his or her application, applicant may either ask for reconsideration of such holding, if he or she disagrees with it on the basis that there is no abandonment in fact; or petition for revival under 37 CFR 1.137.

#### **711.03(a) Holding Based on Insufficiency of Reply**

Applicant may deny that the reply was incomplete.

While the primary examiner has no authority to act upon an application in which no action by applicant was taken during the period for reply, he or she may reverse his or her holding as to whether or not an amendment received during such period was responsive and act on an application of such character which he or she has previously held abandoned. This is not a revival of an abandoned application but merely a holding that the application was never abandoned. See also MPEP § 714.03.

#### **711.03(b) Holding Based on Failure To Reply Within Period**

When an amendment reaches the U.S. Patent and Trademark Office after the expiration of the period for reply and there is no dispute as to the dates involved, no question of reconsideration of a holding of abandonment can be presented.

However, the examiner and the applicant may disagree as to the date on which the period for reply commenced to run or ends. In this situation, as in the situation involving sufficiency of reply, the applicant may take issue with the examiner and point out to him or her that his or her holding was erroneous.

#### **711.03(c) Petitions Relating to Abandonment [R-2]**

*37 CFR 1.135. Abandonment for failure to reply within time period.*

(a) If an applicant of a patent application fails to reply within the time period provided under § 1.134 and § 1.136, the application will become abandoned unless an Office action indicates otherwise.

(b) Prosecution of an application to save it from abandonment pursuant to paragraph (a) of this section must include such complete and proper reply as the condition of the application may

require. The admission of, or refusal to admit, any amendment after final rejection or any amendment not responsive to the last action, or any related proceedings, will not operate to save the application from abandonment.

(c) When reply by the applicant is a *bona fide* attempt to advance the application to final action, and is substantially a complete reply to the non-final Office action, but consideration of some matter or compliance with some requirement has been inadvertently omitted, applicant may be given a new time period for reply under § 1.134 to supply the omission.

**37 CFR 1.137. Revival of abandoned application, terminated reexamination proceeding, or lapsed patent.**

(a) *Unavoidable.* If the delay in reply by applicant or patent owner was unavoidable, a petition may be filed pursuant to this paragraph to revive an abandoned application, a reexamination proceeding terminated under §§ 1.550(d) or 1.957(b) or (c), or a lapsed patent. A grantable petition pursuant to this paragraph must be accompanied by:

(1) The reply required to the outstanding Office action or notice, unless previously filed;

(2) The petition fee as set forth in § 1.17(l);

\*\*>

(3) A showing to the satisfaction of the Director that the entire delay in filing the required reply from the due date for the reply until the filing of a grantable petition pursuant to this paragraph was unavoidable; and<

(4) Any terminal disclaimer (and fee as set forth in § 1.20(d)) required pursuant to paragraph (d) of this section.

(b) *Unintentional.* If the delay in reply by applicant or patent owner was unintentional, a petition may be filed pursuant to this paragraph to revive an abandoned application, a reexamination proceeding terminated under §§ 1.550(d) or 1.957(b) or (c), or a lapsed patent. A grantable petition pursuant to this paragraph must be accompanied by:

(1) The reply required to the outstanding Office action or notice, unless previously filed;

(2) The petition fee as set forth in § 1.17(m);

\*\*>

(3) A statement that the entire delay in filing the required reply from the due date for the reply until the filing of a grantable petition pursuant to this paragraph was unintentional. The Director may require additional information where there is a question whether the delay was unintentional; and<

(4) Any terminal disclaimer (and fee as set forth in § 1.20(d)) required pursuant to paragraph (d) of this section.

(c) *Reply.* In a nonprovisional application abandoned for failure to prosecute, the required reply may be met by the filing of a continuing application. In a nonprovisional utility or plant application filed on or after June 8, 1995, and abandoned for failure to prosecute, the required reply may also be met by the filing of a request for continued examination in compliance with § 1.114. In an application or patent, abandoned or lapsed for failure to pay the issue fee or any portion thereof, the required reply must include payment of the issue fee or any outstanding balance. In an application, abandoned for failure to pay the publication fee, the required reply must include payment of the publication fee.

(d) *Terminal disclaimer.*

(1) Any petition to revive pursuant to this section in a design application must be accompanied by a terminal disclaimer and fee as set forth in § 1.321 dedicating to the public a terminal part of the term of any patent granted thereon equivalent to the period of abandonment of the application. Any petition to revive pursuant to this section in either a utility or plant application filed before June 8, 1995, must be accompanied by a terminal disclaimer and fee as set forth in § 1.321 dedicating to the public a terminal part of the term of any patent granted thereon equivalent to the lesser of:

(i) The period of abandonment of the application; or

(ii) The period extending beyond twenty years from the date on which the application for the patent was filed in the United States or, if the application contains a specific reference to an earlier filed application(s) under 35 U.S.C. 120, 121, or 365(c), from the date on which the earliest such application was filed.

(2) Any terminal disclaimer pursuant to paragraph (d)(1) of this section must also apply to any patent granted on a continuing utility or plant application filed before June 8, 1995, or a continuing design application, that contains a specific reference under 35 U.S.C. 120, 121, or 365(c) to the application for which revival is sought.

(3) The provisions of paragraph (d)(1) of this section do not apply to applications for which revival is sought solely for purposes of copendency with a utility or plant application filed on or after June 8, 1995, to lapsed patents, or to reexamination proceedings.

(e) *Request for reconsideration.* Any request for reconsideration or review of a decision refusing to revive an abandoned application, a terminated reexamination proceeding, or lapsed patent upon petition filed pursuant to this section, to be considered timely, must be filed within two months of the decision refusing to revive or within such time as set in the decision. Unless a decision indicates otherwise, this time period may be extended under:

(1) The provisions of § 1.136 for an abandoned application or lapsed patent;

(2) The provisions of § 1.550(c) for a terminated *ex parte* reexamination proceeding filed under § 1.510; or

(3) The provisions of § 1.956 for a terminated *inter partes* reexamination proceeding filed under § 1.913.

(f) *Abandonment for failure to notify the Office of a foreign filing:* A nonprovisional application abandoned pursuant to 35 U.S.C. 122(b)(2)(B)(iii) for failure to timely notify the Office of the filing of an application in a foreign country or under a multinational treaty that requires publication of applications eighteen months after filing, may be revived only pursuant to paragraph (b) of this section. The reply requirement of paragraph (c) of this section is met by the notification of such filing in a foreign country or under a multinational treaty, but the filing of a petition under this section will not operate to stay any period for reply that may be running against the application.

(g) *Provisional applications:* A provisional application, abandoned for failure to timely respond to an Office requirement, may be revived pursuant to this section. Subject to the provisions of 35 U.S.C. 119(e)(3) and § 1.7(b), a provisional application will

not be regarded as pending after twelve months from its filing date under any circumstances.

\*\*>

*37 CFR 1.181. Petition to the Director.*

(a) Petition may be taken to the Director:<

(1) From any action or requirement of any examiner in the *ex parte* prosecution of an application, or in *ex parte* or *inter partes* prosecution of a reexamination proceeding which is not subject to appeal to the Board of Patent Appeals and Interferences or to the court;

\*\*>

(2) In cases in which a statute or the rules specify that the matter is to be determined directly by or reviewed by the Director; and

(3) To invoke the supervisory authority of the Director in appropriate circumstances. For petitions in interferences, see § 1.644.<

\*\*\*\*\*

(f) The mere filing of a petition will not stay any period for reply that may be running against the application, nor act as a stay of other proceedings. Any petition under this part not filed within two months of the mailing date of the action or notice from which relief is requested may be dismissed as untimely, except as otherwise provided. This two-month period is not extendable.

\*\*\*\*\*

## I. PETITION TO WITHDRAW HOLDING OF ABANDONMENT

A petition to revive an abandoned application (discussed below) should not be confused with a petition from an examiner's holding of abandonment. Where an applicant contends that the application is not in fact abandoned (e.g., there is disagreement as to the sufficiency of the reply, or as to controlling dates), a petition under 37 CFR 1.181(a) requesting withdrawal of the holding of abandonment is the appropriate course of action, and such petition does not require a fee. Where there is no dispute as to whether an application is abandoned (e.g., the applicant's contentions merely involve the cause of abandonment), a petition under 37 CFR 1.137 (accompanied by the appropriate petition fee) is necessary to revive the abandoned application.

\*\*>Two additional procedures are available for reviving an application that has become abandoned due to a failure to reply to an Office Action: (1) a petition under 37 CFR 1.137(a) based on unavoidable delay; and (2) a petition under 37 CFR 1.137(b) based on unintentional delay.

### A. *Petition To Withdraw Holding of Abandonment Based on Failure To Receive Office Action*<

In *Delgar v. Schulyer*, 172 USPQ 513 (D.D.C. 1971), the court decided that the Office should mail a new Notice of Allowance in view of the evidence presented in support of the contention that the applicant's representative did not receive the original Notice of Allowance. Under the reasoning of *Delgar*, an allegation that an Office action was never received may be considered in a petition to withdraw the holding of abandonment. If adequately supported, the Office may grant the petition to withdraw the holding of abandonment and remail the Office action. That is, the reasoning of *Delgar* is applicable regardless of whether an application is held abandoned for failure to timely pay the issue fee (35 U.S.C. 151) or for failure to prosecute (35 U.S.C. 133).

To minimize costs and burdens to practitioners and the Office, the Office has modified the showing required to establish nonreceipt of an Office action. The showing required to establish nonreceipt of an Office communication must include a statement from the practitioner stating that the Office communication was not received by the practitioner and attesting to the fact that a search of the file jacket and docket records indicates that the Office communication was not received. A copy of the docket record where the nonreceived Office communication would have been entered had it been received and docketed must be attached to and referenced in practitioner's statement. For example, if a three month period for reply was set in the nonreceived Office action, a copy of the docket report showing all replies docketed for a date three months from the mail date of the nonreceived Office action must be submitted as documentary proof of nonreceipt of the Office action. \*\*

The showing outlined above may not be sufficient if there are circumstances that point to a conclusion that the Office action may have been lost after receipt rather than a conclusion that the Office action was lost in the mail (e.g., if the practitioner has a history of not receiving Office actions).

Evidence of nonreceipt of an Office communication or action (e.g., Notice of Abandonment or an advisory action) other than that action to which reply was required to avoid abandonment would not warrant withdrawal of the holding of abandonment.

Abandonment takes place by operation of law for failure to reply to an Office action or timely pay the issue fee, not by operation of the mailing of a Notice of Abandonment. See *Lorenz v. Finkl*, 333 F.2d 885, 889-90, 142 USPQ 26, 29-30 (CCPA 1964); *Krahn v. Commissioner*, 15 USPQ2d 1823, 1824 (E.D. Va 1990); *In re Application of Fischer*, 6 USPQ2d 1573, 1574 (Comm'r Pat. 1988).

\*\*>

**B. *Petition To Withdraw Holding of Abandonment Based on Evidence That a Reply Was Timely Mailed or Filed***

37 CFR 1.10(c) through 1.10(e) set forth procedures for petitioning the Director of the USPTO to accord a filing date to correspondence as of the date of deposit of the correspondence as "Express Mail." A petition to withdraw the holding of abandonment relying upon a timely reply placed in "Express Mail" must include an appropriate petition under 37 CFR 1.10(c), (d), or (e) (see MPEP § 513). When a paper is shown to have been mailed to the Office using the "Express Mail" procedures, the paper must be entered in PALM with the "Express Mail" date.

Similarly, applicants may establish that a reply was filed with a postcard receipt that properly identifies the reply and provides *prima facie* evidence that the reply was timely filed. See MPEP § 503. For example, if the application has been held abandoned for failure to file a reply to a first Office action, and applicant has a postcard receipt showing that an amendment was timely filed in response to the Office action, then the holding of abandonment should be withdrawn upon the filing of a petition to withdraw the holding of abandonment. When the reply is shown to have been timely filed based on a postcard receipt, the reply must be entered into PALM using the date of receipt of the reply as shown on the post card receipt.

Where a certificate of mailing under 37 CFR 1.8, but not a postcard receipt, is relied upon in a petition to withdraw the holding of abandonment, see 37 CFR 1.8(b) and MPEP § 512. As stated in 37 CFR 1.8(b)(3) the statement that attests to the previous timely mailing or transmission of the correspondence must be on a personal knowledge basis, or to the satisfaction of the Director of the USPTO. If the statement attesting to the previous timely mailing is not made by

the person who signed the Certificate of Mailing (i.e., there is no personal knowledge basis), then the statement attesting to the previous timely mailing should include evidence that supports the conclusion that the correspondence was actually mailed (e.g., copies of a mailing log establishing that correspondence was mailed for that application). When the correspondence is shown to have been timely filed based on a certificate of mailing, the correspondence is entered into PALM with the actual date of receipt (i.e., the date that the duplicate copy of the papers was filed with the statement under 37 CFR 1.8).

**C. *Treatment of Untimely Petition To Withdraw Holding of Abandonment***

37 CFR 1.181(f) provides that, *inter alia*, except as otherwise provided, any petition not filed within 2 months from the action complained of may be dismissed as untimely. Therefore, any petition (under 37 CFR 1.181) to withdraw the holding of abandonment not filed within 2 months of the mail date of a notice of abandonment (the action complained of) may be dismissed as untimely. 37 CFR 1.181(f).

Rather than dismiss an untimely petition to withdraw the holding of abandonment under 37 CFR 1.181(f), the Office may require a terminal disclaimer as a condition of granting an untimely petition to withdraw the holding of abandonment.

**1. *Design Applications, Utility Applications Filed Before June 8, 1995, and Plant Applications Filed Before June 8, 1995***

**(a) *Applicant Receives Notice of Abandonment***

In any design application, any utility application filed before June 8, 1995, or any plant application filed before June 8, 1995, if applicant receives a notice of abandonment, any petition to withdraw the holding of abandonment that is not filed within two months of the mail date of the notice of abandonment will **not** (absent extraordinary circumstances) be treated on its merits **unless** accompanied by a terminal disclaimer under 37 CFR 1.321(a), and the required fee set forth in 37 CFR 1.20(d). The period to be disclaimed is the terminal part of the term of any patent granted on the application, or of any patent granted on any utility or plant application that claims the benefit of the filing date of the application under

35 U.S.C. 120, 121, or 365(c), equivalent to the period between:

(A) the date that is two months after the mail date of the notice of abandonment; and

(B) the filing date of a grantable petition to withdraw the holding of abandonment.

Form PTO/SB/62 is the appropriate terminal disclaimer to be used.

### **(b) Applicant Does Not Receive Notice of Abandonment**

In any design application, any utility application filed before June 8, 1995, or any plant application filed before June 8, 1995, if applicant never receives the notice of abandonment, any petition to withdraw the holding of abandonment that is not filed within twelve months from the date of applicant's filing (or date of submission, if the correspondence was never received by the Office) of correspondence with the Office for which further action by the Office can reasonably be expected, will **not** (absent extraordinary circumstances) be treated on its merit **unless** accompanied by a terminal disclaimer under 37 CFR 1.321(a), and the required fee set forth in 37 CFR 1.20(d). The period to be disclaimed is the terminal part of the term of any patent granted thereon, or of any patent granted on any utility or plant application that claims the benefit of the filing date of the application under 35 U.S.C. 120, 121, or 365(c), equivalent to the period between:

(A) the date that is twelve months from the date of applicant's filing or submission of correspondence with the Office, for which further action by the Office can reasonably be expected; and

(B) the filing date of a grantable petition to withdraw the holding of abandonment.

Form PTO/SB/62 is the appropriate terminal disclaimer to be used.

## **2. Utility and Plant Applications Filed on or After June 8, 1995 but Before May 29, 2000**

In utility and plant applications filed on or after June 8, 1995, but before May 29, 2000, a terminal dis-

claimer should **not** be required as a condition of granting an untimely petition to withdraw the holding of abandonment. However, the Office of Patent Legal Administration (OPLA) must be consulted in such situations if the holding of abandonment involves a period during: (A) appellate review by the Board of Patent Appeals and Interferences; (B) an interference proceeding under 35 U.S.C. 135(a), including any suspension due to an interference proceeding; or (C) which the application was in a sealed condition or prosecution was suspended due to a secrecy order under 35 U.S.C. 181. This is because it is necessary to effect (if appropriate) a reduction of patent term extension under the "due diligence" provisions of 37 CFR 1.701(d)(2).

## **3. Utility and Plant Applications Filed on or After May 29, 2000**

In utility and plant applications filed on or after May 29, 2000, a terminal disclaimer should **not** be required as a condition of granting an untimely petition to withdraw the holding of abandonment. This is because any patent term adjustment is automatically reduced under the provisions of 37 CFR 1.704(c)(4) in applications subject to the patent term adjustment provisions of the American Inventors Protection Act of 1999 (AIPA) if a petition to withdraw a holding of abandonment is not filed within two months from the mailing date of the notice of abandonment, and if applicant does not receive the notice of abandonment, any patent term adjustment is reduced under the provisions of 37 CFR 1.704(a) by a period equal to the period of time during which the applicant "failed to engage in reasonable efforts to conclude prosecution" (processing or examination) of the application.

Where the record indicates that the applicant intentionally delayed the filing of a petition to withdraw the holding of abandonment, the Office may simply dismiss the petition as untimely (37 CFR 1.181(f)) solely on the basis of such intentional delay in taking action in the application without further addressing the merits of the petition. Obviously, intentional delay in seeking the revival of an abandoned application precludes relief under 37 CFR 1.137(a) or (b) (discussed below).

## II. < PETITIONS TO REVIVE AN ABANDONED APPLICATION, OR ACCEPT LATE PAYMENT OF ISSUE FEE

37 CFR 1.137 provides for the revival of abandoned applications and lapsed patents for the failure:

(A) to timely reply to an Office requirement in a provisional application;

(B) to timely prosecute in a nonprovisional application;

(C) to timely pay the issue fee for a design application;

(D) to timely pay the issue fee for a utility or plant application; and

(E) to timely pay any outstanding balance of the issue fee (lapsed patents).

A petition under 37 CFR 1.137(a) requires:

(A) the required reply, unless previously filed;

(B) the petition fee as set forth in 37 CFR 1.17(l);

(C) a showing to the satisfaction of the \*>Director of the USPTO< that the entire delay in filing the required reply from the due date for the reply until the filing of a grantable petition pursuant to 37 CFR 1.137(a) was unavoidable; and

(D) any terminal disclaimer required pursuant to 37 CFR 1.137(d).

A petition under 37 CFR 1.137(b) requires:

(A) the required reply, unless previously filed;

(B) the petition fee as set forth in 37 CFR 1.17(m);

(C) a statement that the entire delay in filing the required reply from the due date for the reply until the filing of a grantable petition pursuant to 37 CFR 1.137(b) was unintentional; and

(D) any terminal disclaimer required pursuant to 37 CFR 1.137(d).

The \*>Director of the USPTO< may require additional information where there is a question whether the delay was unintentional.

### A. Reply Requirement

Unlike a petition to withdraw the holding of abandonment, a petition to revive under 37 CFR 1.137 must be accompanied by, *inter alia*, the required reply. See *Ex parte Richardson*, 1906 Dec. Comm'r Pat. 83 (1905) ("This Office has no authority to revive

a case upon which no action has been taken within [the period for reply], but merely has authority to determine after an action is taken whether the delay in presenting it was unavoidable."). Generally, the required reply is the reply sufficient to have avoided abandonment, had such reply been timely filed. >A petition for an extension of time under 37 CFR 1.136 and a fee for such an extension of time are not required to be included with the reply.<

37 CFR 1.137(c) applies to the reply requirement for petitions under 37 CFR 1.137(a) and (b). In a nonprovisional application abandoned for failure to prosecute, the required reply may be met by the filing of a continuing application. In a nonprovisional utility or plant application filed on or after June 8, 1995, and abandoned for failure to prosecute, the required reply may also be met by the filing of a request for continued examination (RCE) in compliance with 37 CFR 1.114. In an application or patent, abandoned or lapsed for failure to pay the issue fee or any portion thereof, the required reply must include payment of the issue fee or any outstanding balance. In an application, abandoned for failure to pay the publication fee, the required reply must include payment of the publication fee. See below for more details on the reply requirement in specific situations of abandonment.

### 1. Abandonment for Failure To Pay the Issue Fee or Publication Fee

While the revival of applications abandoned for failure to timely prosecute and for failure to timely pay the issue fee are incorporated together in 37 CFR 1.137, the statutory provisions for the revival of an application abandoned for failure to timely prosecute and for failure to timely submit the issue fee are mutually exclusive. See *Brenner v. Ebbert*, 398 F.2d 762, 157 USPQ 609 (D.C. Cir. 1968). 35 U.S.C. 151 authorizes the acceptance of a delayed payment of the issue fee, if the issue fee "is submitted ... and the delay in payment is shown to have been unavoidable." 35 U.S.C. 41(a)(7) likewise authorizes the acceptance of an "unintentionally delayed payment of the fee for issuing each patent." Thus, 35 U.S.C. 41(a)(7) and 151 each require payment of the issue fee as a condition of reviving an application abandoned or patent lapsed for failure to pay the issue fee. Therefore, the filing of a continuing application without payment of

the issue fee or any outstanding balance thereof is not an acceptable reply in an application abandoned or patent lapsed for failure to pay the issue fee or any portion thereof.

The Notice of Allowance requires the timely payment of the issue fee in effect on the date of its mailing to avoid abandonment of the application. In instances in which there is an increase in the issue fee by the time of payment of the issue fee required in the Notice of Allowance, the Office will mail a notice requiring payment of the balance of the issue fee then in effect. See *In re Mills*, 12 USPQ2d 1847, 1848 (Comm'r Pat. 1989). The phrase "for failure to pay the issue fee or any portion thereof" applies to those instances in which the applicant fails to pay either the issue fee required in the Notice of Allowance or the balance of the issue fee required in a subsequent notice. In such instances, the reply must be the issue fee then in effect, if no portion of the issue fee was previously submitted, or any outstanding balance of the issue fee then in effect, if a portion of the issue fee was previously submitted.

In an application abandoned for failure to pay the publication fee, the required reply must include payment of the publication fee. Even if an application abandoned for failure to pay the publication fee is being revived solely for purposes of continuity with a continuing application, the petition to revive under 37 CFR 1.137 must include payment of the publication fee.

## 2. Abandonment for Failure To Reply in a Nonprovisional Application

### (a) Abandonment for Failure To Reply to a Non-Final Action

The required reply to a non-final action in a non-provisional application abandoned for failure to prosecute may be either:

- (A) an argument or an amendment under 37 CFR 1.111;
- (B) the filing of a continuing application under 37 CFR 1.53(b) (or a continued prosecution application (CPA) under 37 CFR 1.53(d) if the application is \*\* a design application).

The grant of a petition under 37 CFR 1.137 is not a determination that any reply under 37 CFR 1.111 is complete. Where the proposed reply is to a non-final

Office action, the petition may be granted if the reply appears to be *bona fide*. After revival of the application, the patent examiner may, upon more detailed review, determine that the reply is lacking in some respect. In this limited situation, the patent examiner should send out a letter giving a 1-month shortened statutory period under 37 CFR 1.135(c) for correction of the error or omission. Extensions of time under 37 CFR 1.136(a) are permitted. If applicant does not correct the omission within the time period set in the letter (including any extension), the application is again abandoned.

### (b) Abandonment for Failure To Reply to a Final Action

A reply under 37 CFR 1.113 to a final action \*\*>must include a request for continued examination (RCE) under 37 CFR 1.114 or cancellation of, or appeal from the rejection of, each claim so rejected.< Accordingly, in a nonprovisional application abandoned for failure to reply to a final action, the reply required for consideration of a petition to revive must be:

- (A) a Notice of Appeal and appeal fee;
- (B) an amendment under 37 CFR 1.116 that cancels all the rejected claims or otherwise *prima facie* places the application in condition for allowance;
- (C) the filing of \*\*>an RCE< (accompanied by a submission >that meets the reply requirements of 37 CFR 1.111< and the requisite fee) under 37 CFR 1.114 for utility or plant applications filed on or after June 8, 1995 (see paragraph (d) below); or
- (D) the filing of a continuing application under 37 CFR 1.53(b) (or a CPA under 37 CFR 1.53(d) if the application is \*\* a design application).

When a notice of appeal is the reply filed pursuant to 37 CFR 1.137(a)(1) or 1.137(b)(1), the time period under 37 CFR 1.192 for filing the appeal brief will be set by the \*>Director of the USPTO< in the decision granting the petition.

An application subject to a final action in which a proposed amendment under 37 CFR 1.116 is filed as the required reply will normally be routed by the Office of Petitions to the Technology Center (TC) to determine whether a proposed amendment places the application in condition for allowance prior to granting any petition to revive such application. The exam-

iner is instructed that if the reply places the application in condition for allowance, the examiner should write in the margin of the reply “OK to enter upon revival.” >For Image File Wrapper (IFW) processing, see IFW Manual.< If the petition is otherwise grantable and the examiner indicates that the reply places the application in condition for allowance, the petition will be granted. If, on the other hand, the reply would not place the application in condition for allowance, the examiner is instructed to complete form PTOL-303 and return the form to the Office of Petitions with the application. From PTOL-303 should not be mailed to the applicant by the examiner. In this situation, the Office of Petitions will not grant the petition. A copy of the form PTOL-303 is marked with the notation “Courtesy Copy” by the Office of Petitions. The courtesy copy is sent as an attachment with the decision on the petition. The advisory form PTOL-303 merely serves as an advisory notice to the Office of Petitions regarding the decision of the examiner on the amendment after final rejection. >For Image File Wrapper (IFW) processing, see IFW Manual.<

**(c) Abandonment for Failure To File an Appeal Brief**

In those situations where abandonment occurred because of the failure to file an appeal brief, the reply required pursuant to 37 CFR 1.137(a)(1) or 1.137(b)(1) must be either:

(A) an appeal brief in compliance with 37 CFR 1.192(c) and appeal brief fee;

(B) the filing of an RCE accompanied by a submission and the requisite fee in compliance with 37 CFR 1.114 for utility or plant applications filed on or after June 8, 1995 (see paragraph **(d)** below); or

(C) the filing of a continuing application under 37 CFR 1.53(b) (or a CPA under 37 CFR 1.53(d) if the application is \*\* a design application).

**(d) Filing an RCE as the Required Reply**

For utility or plant applications abandoned for failure to reply to a final Office action or for failure to file an appeal brief, the required reply may be the filing of an RCE accompanied by a submission and the requisite fee. When an RCE is the reply filed pursuant to

37 CFR 1.137(a)(1) or 1.137(b)(1) to revive such an application, the submission accompanying the RCE must be a reply responsive within the meaning of 37 CFR 1.111 to the last Office action. Consideration of whether the submission is responsive within the meaning of 37 CFR 1.111 to the last Office action is done without factoring in the “final” status of such action. The submission may be a previously filed amendment after final or a statement that incorporates by reference the arguments in a previously filed appeal or reply brief. See MPEP § 706.07(h), paragraph II.

The petition may be granted if the submission appears to be a *bona fide* attempt to provide a complete reply to the last Office action. After revival of the application, the examiner may, upon a more detailed review, determine that the reply is lacking in some respect. In this limited situation, the examiner should send out a letter giving a 1-month shortened statutory period under 37 CFR 1.135(c) for correction of the error or omission. Extensions of time under 37 CFR 1.136(a) are permitted. If the applicant does not correct the omission within the time period set in the letter (including any extension), the application is again abandoned.

**(e) A Continuing Application or RCE May Be Required by the Office**

The Office may require the filing of a continuing application or an RCE (if the prosecution prior to abandonment was closed) (or request for further examination pursuant to 37 CFR 1.129(a)) to meet the reply requirement of 37 CFR 1.137(a)(1) (or 37 CFR 1.137(b)(1)) where, under the circumstances of the application, treating a reply under 37 CFR 1.111 or 1.113 would place an inordinate burden on the Office. Exemplary circumstances of when treating a reply under 37 CFR 1.111 or 1.113 may place an inordinate burden on the Office are where:

(A) an application has been abandoned for an inordinate period of time;

(B) an application file contains multiple or conflicting replies to the last Office action; \*>or<

(C) the reply or replies submitted under 37 CFR 1.137(a)(1) (or 37 CFR 1.137(b)(1)) are questionable as to compliance with 37 CFR 1.111 or 1.113.



### 3. Abandonment for Failure To Notify the Office of a Foreign Filing After the Submission of a Non-Publication Request

If an applicant makes a nonpublication request upon filing with the appropriate certifications, the utility or plant application filed on or after November 29, 2000 will not be published under 35 U.S.C. 122(b)(1). See 35 U.S.C. 122(b)(2)(B)(i). >If an applicant makes a nonpublication request and then rescinds, pursuant to 35 U.S.C. 122(b)(2)(B)(ii), the nonpublication request before or on the date a counterpart application is filed in a foreign country, or under a multilateral international agreement, that requires eighteen-month publication, the nonpublication request will be treated as annulled and the application will be treated as if the nonpublication request were never made. See MPEP § 1123 and § 1124.< An applicant who has made a nonpublication request>,< but who subsequently files an application directed to the invention disclosed in the >U.S.< application \*\* in a foreign country, or under a multilateral international agreement, that requires eighteen-month publication >before the nonpublication request is rescinded<, must>, in addition to the rescission,< notify the Office of such filing within forty-five days after the date of such filing. \*\*>The requirement in 35 U.S.C. 122(b)(2)(B)(iii) for notice of the foreign filing is in addition to any rescission of the nonpublication request under 35 U.S.C. 122(b)(2)(B)(ii). If an applicant files a counterpart application in a foreign country after having filed an application in the USPTO with a nonpublication request, filing a rescission of the nonpublication request under 35 U.S.C. 122(b)(2)(B)(ii) without also providing a notice of the foreign filing in a timely manner will result in the abandonment of the U.S. application under 35 U.S.C. 122(b)(2)(B)(iii).< 35 U.S.C. 122(b)(2)(B)(iii), however, also provides that an application abandoned as a result of the failure to timely provide such a notice to the Office is subject to revival if the “delay in submitting the notice was unintentional.”

35 U.S.C. 122(b)(2)(B)(iii) provides for revival only on the basis of unintentional delay, and not on the basis of unavoidable delay. Therefore, a nonprovisional application abandoned pursuant to 35 U.S.C. 122(b)(2)(B)(iii) for failure to timely notify the Office of the filing of an application in a foreign country or under a multinational treaty that requires eighteen-

month publication may be revived only on the basis of unintentional delay pursuant to 37 CFR 1.137(b). The reply requirement of 37 CFR 1.137(c) is met by the notification of such filing in a foreign country or under a multinational treaty, but the filing of a petition under 37 CFR 1.137(b) will not operate to stay any period for reply that may be running against the application. Since the Office cannot ascertain whether an application is abandoned under 35 U.S.C. 122(b)(2)(B)(iii), the Office may continue to process and examine the application until the Office is notified of applicant’s failure to meet the forty-five days notice requirement of 35 U.S.C. 122(b)(2)(B)(iii). Therefore, the filing of a petition under 37 CFR 1.137(b) to revive such an application will not operate to stay any period for reply that may be running against the application. >Applicants may use form PTO/SB/64a to file a petition for revival under 37 CFR 1.137(b).<

#### B. Petition Fee Requirement

35 U.S.C. 41(a)(7) provides that a petition for the revival of an unintentionally abandoned application or for the unintentionally delayed payment of the issue fee must be accompanied by the petition fee set forth in 37 CFR 1.17(m), unless the petition is filed under 35 U.S.C. 133 or 151 (on the basis of unavoidable delay), in which case the fee is set forth in 37 CFR 1.17(l). Thus, unless the circumstances warrant the withdrawal of the holding of abandonment (i.e., it is determined that the application is not properly held abandoned), the payment of a petition fee to obtain the revival of an abandoned application is a statutory prerequisite to revival of the abandoned application, and cannot be waived.

In addition, the phrase “[o]n filing” in 35 U.S.C. 41(a)(7) means that the petition fee is required for the filing (and not merely the grant) of a petition under 37 CFR 1.137. See H.R. Rep. No. 542, 97th Cong., 2d Sess. 6 (1982), *reprinted in* 1982 U.S.C.C.A.N. 770 (“[t]he fees set forth in this section are due on filing the petition”). Therefore, the Office: (A) will not refund the petition fee required by 37 CFR 1.17(l) or 1.17(m), regardless of whether the petition under 37 CFR 1.137 is dismissed or denied; and (B) will not reach the merits of any petition under 37 CFR 1.137 lacking the requisite petition fee.

The phrase “unless the petition is filed under [35 U.S.C.] 133 or 151” signifies that petitions to revive filed on the basis of “unavoidable” delay (under 35 U.S.C. 133 or 151) are a subset of petitions to revive filed on the basis of unintentional delay. That is, “unavoidable” delay and “unintentional” delay are not alternatives; “unavoidable” delay is the epitome of “unintentional” delay. Any petition to revive an abandoned application or lapsed patent must meet the minimal “unintentional” delay threshold, and an applicant need only pay the fee specified in 37 CFR 1.17(l) (rather than the fee specified in 37 CFR 1.17(m)) if the petition is also accompanied by an adequate showing that the entire delay in filing the required reply, from the due date for the reply until the filing of a grantable petition pursuant to 37 CFR 1.137(a), was unavoidable.

### C. *Unintentional and Unavoidable Delay*

Petitions under 37 CFR 1.137(b) are less burdensome (statement(s) rather than a showing accompanied by documentary evidence) to file and are evaluated under the less stringent “unintentional delay” standard. Applicants determining whether to file a petition to revive an application under 37 CFR 1.137(b) or 1.137(a) should take the following into account:

While the Office reserves the authority to require further information concerning the cause of abandonment and delay in filing a petition to revive, the Office relies upon the applicant’s duty of candor and good faith and accepts the statement that “the entire delay in filing the required reply from the due date for the reply until the filing of a grantable petition pursuant to 37 CFR 1.137(b) was unintentional” without requiring further information in the vast majority of petitions under 37 CFR 1.137(b). This is because the applicant is obligated under 37 CFR 10.18 to inquire into the underlying facts and circumstances when a practitioner provides this statement to the Office. In addition, providing an inappropriate statement in a petition under 37 CFR 1.137(b) to revive an abandoned application may have an adverse effect when attempting to enforce any patent resulting from the application. See *Lumenyte Int’l Corp. v. Cable Lite Corp.*, Nos. 96-1011, 96-1077, 1996 U.S. App. LEXIS 16400, 1996 WL 383927 (Fed. Cir. July 9, 1996)(unpublished)(patents held unenforceable due to

a finding of inequitable conduct in submitting an inappropriate statement that the abandonment was unintentional).

Even if the Office requires further information in a petition under 37 CFR 1.137(b), such petition is still significantly less burdensome to prepare and prosecute than a petition under 37 CFR 1.137(a). The Office is almost always satisfied as to whether “the entire delay...was unintentional” on the basis of statement(s) by the applicant or representative explaining the cause of the delay (accompanied at most by copies of correspondence relevant to the period of delay). A showing of unavoidable delay will (in addition to the above) require: (1) evidence concerning the procedures in place that should have avoided the error resulting in the delay; (2) evidence concerning the training and experience of the persons responsible for the error; and (3) copies of any applicable docketing records to show that the error was in fact the cause of the delay. See MPEP § 711.03(c)(III)(C)(2). In addition, a petition under 37 CFR 1.137(a) must establish that the delay was unavoidable, and not just that it was unintentional. Thus, many petitions originally filed under 37 CFR 1.137(a) end up being granted under 37 CFR 1.137(b) when the applicant realizes that sufficient evidence concerning the delay is too difficult to obtain or the cause of delay simply does not amount to “unavoidable delay” within the meaning of 37 CFR 1.137(a).

Since the requirements of 37 CFR 1.137(a) are more exacting than the corresponding requirements of 37 CFR 1.137(b), a petition under 37 CFR 1.137(a) is significantly less likely to be grantable as filed than is a petition under 37 CFR 1.137(b). The Office usually must render a number of interlocutory decisions dismissing a petition under 37 CFR 1.137(a) and requesting additional evidence until either the applicant provides a satisfactory showing of unavoidable delay (in which case the petition can be granted) or the Office concludes that the applicant cannot provide a satisfactory showing of unavoidable delay (in which case the petition must be denied). Thus, the period between when an applicant first files a petition to revive and the Office renders a decision granting (or denying) that petition will, more often than not, be much longer if the petition is under 37 CFR 1.137(a) than it would have been if the petition were under 37 CFR 1.137(b).

## 1. Unintentional Delay

The legislative history of Public Law 97-247, § 3, 96 Stat. 317 (1982), reveals that the purpose of 35 U.S.C. 41(a)(7) is to permit the Office to have more discretion than in 35 U.S.C. 133 or 151 to revive abandoned applications in appropriate circumstances, but places a limit on this discretion stating that “[u]nder this section a petition accompanied by [the requisite fee] would not be granted where the abandonment or the failure to pay the fee for issuing the patent was intentional as opposed to being unintentional or unavoidable.” H.R. Rep. No. 542, 97th Cong., 2d Sess. 6-7 (1982), *reprinted in* 1982 U.S.C.C.A.N. 770-71. A delay resulting from a deliberately chosen course of action on the part of the applicant is not an “unintentional” delay within the meaning of 37 CFR 1.137(b).

Where the applicant deliberately permits an application to become abandoned (e.g., due to a conclusion that the claims are unpatentable, that a rejection in an Office action cannot be overcome, or that the invention lacks sufficient commercial value to justify continued prosecution), the abandonment of such application is considered to be a deliberately chosen course of action, and the resulting delay cannot be considered as “unintentional” within the meaning of 37 CFR 1.137(b). See *In re Application of G*, 11 USPQ2d 1378, 1380 (Comm’r Pat. 1989). An intentional course of action is not rendered unintentional when, upon reconsideration, the applicant changes his or her mind as to the course of action that should have been taken. See *In re Maldaque*, 10 USPQ2d 1477, 1478 (Comm’r Pat. 1988).

A delay resulting from a deliberately chosen course of action on the part of the applicant does not become

an “unintentional” delay within the meaning of 37 CFR 1.137(b) because:

(A) the applicant does not consider the claims to be patentable over the references relied upon in an outstanding Office action;

(B) the applicant does not consider the allowed or patentable claims to be of sufficient breadth or scope to justify the financial expense of obtaining a patent;

(C) the applicant does not consider any patent to be of sufficient value to justify the financial expense of obtaining the patent;

(D) the applicant does not consider any patent to be of sufficient value to maintain an interest in obtaining the patent; or

(E) the applicant remains interested in eventually obtaining a patent, but simply seeks to defer patent fees and patent prosecution expenses.

Likewise, a change in circumstances that occurred subsequent to the abandonment of an application does not render “unintentional” the delay resulting from a previous deliberate decision to permit an application to be abandoned. These matters simply confuse the question of whether there was a deliberate decision not to continue the prosecution of an application with why there was a deliberate decision not to continue the prosecution of an application.

In order to expedite treatment, applicants filing a petition under 37 CFR 1.137(b) to revive an abandoned application are advised to include the statement “the entire delay in filing the required reply from the due date for the reply until the filing of a grantable petition pursuant to 37 CFR 1.137(b) was unintentional,” even if applicant chooses to include a statement of the facts concerning the delay. Applicants may use the forms provided by the Office (PTO/SB/64>, PTO/SB/64a,< or PTO/SB/64PCT).

EXAMINATION OF APPLICATIONS

711.03(c)

\*\*>

PTO/SB/64 (11-03)

Approved for use through 07/31/2008. OMB 0651-0031

U.S. Patent and Trademark Office; U.S. DEPARTMENT OF COMMERCE

Under the Paperwork Reduction Act of 1995, no persons are required to respond to a collection of information unless it displays a valid OMB control number.

<b>PETITION FOR REVIVAL OF AN APPLICATION FOR PATENT ABANDONED UNINTENTIONALLY UNDER 37 CFR 1.137(b)</b>	Docket Number (Optional)
<p>First named inventor:</p> <p>Application No.: _____ Art Unit: _____</p> <p>Filed: _____ Examiner: _____</p> <p>Title: _____</p> <p>Attention: Office of Petitions  <b>Mail Stop Petition</b>                  Commissioner for Patents                  P.O. Box 1450                  Alexandria, VA 22313-1450                  FAX: (703) 872-9306</p> <p style="text-align: center;">NOTE: If information or assistance is needed in completing this form, please contact Petitions Information at (703) 305-9282.</p> <p>The above-identified application became abandoned for failure to file a timely and proper reply to a notice or action by the United States Patent and Trademark Office. The date of abandonment is the day after the expiration date of the period set for reply in the Office notice or action plus an extensions of time actually obtained.</p> <p style="text-align: center;">APPLICANT HEREBY PETITIONS FOR REVIVAL OF THIS APPLICATION</p> <p>NOTE: A grantable petition requires the following items:</p> <ul style="list-style-type: none"> <li>(1) Petition fee;</li> <li>(2) Reply and/or issue fee;</li> <li>(3) Terminal disclaimer with disclaimer fee --required for all utility and plant applications filed before June 8, 1995; and for all design applications; and</li> <li>(4) Statement that the entire delay was unintentional.</li> </ul> <p>1. Petition fee</p> <p><input type="checkbox"/> Small entity-fee \$ _____ (37 CFR 1.17(m)). Applicant claims small entity status. See 37 CFR 1.27.</p> <p><input type="checkbox"/> Other than small entity - fee \$ _____ (37 CFR 1.17(m))</p> <p>2. Reply and/or fee</p> <p>A. The reply and/or fee to the above-noted Office action in the form of _____ (identify type of reply):</p> <p><input type="checkbox"/> has been filed previously on _____.</p> <p><input type="checkbox"/> is enclosed herewith.</p> <p>B. The issue fee of \$ _____.</p> <p><input type="checkbox"/> has been paid previously on _____.</p> <p><input type="checkbox"/> is enclosed herewith.</p>	

[Page 1 of 2]

This collection of information is required by 37 CFR 1.137. The information is required to obtain or retain a benefit by the public which is to file (and by the USPTO to process) an application. Confidentiality is governed by 35 U.S.C. 122 and 37 CFR 1.14. This collection is estimated to take 1.0 hour to complete, including gathering, preparing, and submitting the completed application form to the USPTO. Time will vary depending upon the individual case. Any comments on the amount of time you require to complete this form and/or suggestions for reducing this burden, should be sent to the Chief Information Officer, U.S. Patent and Trademark Office, U.S. Department of Commerce, P.O. 1450, Alexandria, VA 22313-1450. DO NOT SEND FEES OR COMPLETED FORMS TO THIS ADDRESS. **SEND TO: Mail Stop Petition, Commissioner for Patents, P.O. Box 1450, Alexandria, VA 22313-1450.**

If you need assistance in completing the form, call 1-800-PTO-9199 and select option 2.

Under the Paperwork Reduction Act of 1995, no persons are required to respond to a collection of information unless it displays a valid OMB control number.

3. Terminal disclaimer with disclaimer fee

- Since this utility/plant application was filed on or after June 8, 1995, no terminal disclaimer is required.
- A terminal disclaimer (and disclaimer fee (37 CFR 1.20(d)) of \$ \_\_\_\_\_ for a small entity or \$ \_\_\_\_\_ for other than a small entity) disclaiming the required period of time is enclosed herewith (see PTO/SB/63).

4. STATEMENT: The entire delay in filing the required reply from the due date for the required reply until the filing of a grantable petition under 37 CFR 1.137(b) was unintentional. [NOTE. The United States Patent and Trademark Office may require additional information if there is a question as to whether either the abandonment or the delay in filing a petition under 37 CFR 1.137(b) was unintentional (MPEP 711.03(c), subsections (III)(C) and (D))].

**WARNING: Information on this form may become public. Credit card information should not be included on this form. Provide credit card information and authorization on PTO-2038.**

_____	_____
Date	Signature
Telephone Number: _____	_____
	Typed or printed name
	_____
	Address
	_____
	Address

- Enclosures:  Fee Payment
- Reply
- Terminal Disclaimer Form
- Additional sheets containing statements establishing unintentional delay
- Other: \_\_\_\_\_

CERTIFICATE OF MAILING OR TRANSMISSION [37 CFR 1.8(a)]

I hereby certify that this correspondence is being:

- deposited with the United States Postal Service on the date shown below with sufficient postage as first class mail in an envelope addressed to: **Mail Stop Petition**, Commissioner for Patents, P.O. Box 1450, Alexandria, VA 22313-1450.
- transmitted by facsimile on the date shown below to the United States Patent and Trademark Office at (703) 872-9306.

_____	_____
Date	Signature
	_____
	Type or printed name of person signing certificate

PTO/SB/64a (11-03)  
 Approved for use through 07/31/2006. OMB 0651-0031  
 U.S. Patent and Trademark Office; U.S. DEPARTMENT OF COMMERCE

Under the Paperwork Reduction Act of 1995, no persons are required to respond to a collection of information unless it displays a valid OMB control number.

<b>PETITION FOR REVIVAL OF AN APPLICATION FOR PATENT ABANDONED FOR FAILURE TO NOTIFY THE OFFICE OF A FOREIGN OR INTERNATIONAL FILING (37 CFR 1.137(f))</b>		Docket Number (Optional)
First named inventor:		
Application No.:	Art Unit:	
Filed:	Examiner:	
Title:		
Attention: Office of Petitions <b>Mail Stop Petition</b> Commissioner for Patents P.O. Box 1450 Alexandria, VA 22313-1450 FAX: (703) 872-9306		
NOTE: If information or assistance is needed in completing this form, please contact Petitions Information at (703) 305-9282.		
The above-identified application became abandoned pursuant to 35 U.S.C. 122(b)(2)(B)(iii) for failure to timely notify the Office of the filing of an application in a foreign country or under a multinational international treaty that requires publication of applications eighteen months after filing. The date of abandonment is the day after the expiration date of the forty-five (45) day period set in 35 U.S.C. 122(b)(2)(B)(iii).		
PURSUANT TO 37 CFR 1.137(f), APPLICANT HEREBY PETITIONS FOR REVIVAL OF THIS APPLICATION UNDER 37 CFR 1.137(b)		
1. Petition fee		
<input type="checkbox"/> Small entity-fee \$ _____ (37 CFR 1.17(m)). Applicant claims small entity status. See 37 CFR 1.27.		
<input type="checkbox"/> Other than small entity - fee \$ _____ (37 CFR 1.17(m))		
2. Notice of Foreign or International Filing (35 U.S.C. 122(b)(2)(B)(iii) and 37 CFR 1.213(c))		
Subsequent to the filing of the above-identified application, an application was filed in another country, or under a multinational international treaty (e.g., filed under the Patent Cooperation Treaty), that requires publication of applications eighteen months after filing. The filing date of the subsequently-filed foreign or international application is _____.		

[Page 1 of 2]

This collection of information is required by 37 CFR 1.137. The information is required to obtain or retain a benefit by the public which is to file (and by the USPTO to process) an application. Confidentiality is governed by 35 U.S.C. 122 and 37 CFR 1.14. This collection is estimated to take 1.0 hour to complete, including gathering, preparing, and submitting the completed application form to the USPTO. Time will vary depending upon the individual case. Any comments on the amount of time you require to complete this form and/or suggestions for reducing this burden, should be sent to the Chief Information Officer, U.S. Patent and Trademark Office, U.S. Department of Commerce, P.O. 1450, Alexandria, VA 22313-1450. DO NOT SEND FEES OR COMPLETED FORMS TO THIS ADDRESS. SEND TO: Commissioner for Patents, P.O. Box 1450, Alexandria, VA 22313-1450.

If you need assistance in completing the form, call 1-800-PTO-9199 and select option 2.

Under the Paperwork Reduction Act of 1995, no persons are required to respond to a collection of information unless it displays a valid OMB control number.

STATEMENT: The entire delay in filing the required notice of a foreign or international filing from the due date for the required notice until the filing of a grantable petition under 37 CFR 1.137(b) was unintentional.

[NOTE. The United States Patent and Trademark Office may require additional information if there is a question as to whether either the abandonment or the delay in filing a petition under 37 CFR 1.137(b) was unintentional (MPEP 711.03(c), subsections (III)(C) and (D))].

WARNING: Information on this form may become public. Credit card information should not be included on this form. Provide credit card information and authorization on PTO-2038.

\_\_\_\_\_ Date \_\_\_\_\_ Signature \_\_\_\_\_

Telephone Number: \_\_\_\_\_

\_\_\_\_\_ Typed or printed name \_\_\_\_\_

\_\_\_\_\_ Address \_\_\_\_\_

\_\_\_\_\_

- Enclosures:  Fee Payment
- Additional sheets containing statements establishing unintentional delay
- Other: \_\_\_\_\_

CERTIFICATE OF MAILING OR TRANSMISSION [37 CFR 1.8(a)]

I hereby certify that this correspondence is being:

deposited with the United States Postal Service on the date shown below with sufficient postage as first class mail in an envelope addressed to: Mail Stop Petition, Commissioner for Patents, P.O. Box 1450, Alexandria, VA 22313-1450.

transmitted by facsimile on the date shown below to the United States Patent and Trademark Office at (703) 872-9306.

\_\_\_\_\_ Date \_\_\_\_\_ Signature \_\_\_\_\_

\_\_\_\_\_ Type or printed name of person signing certificate \_\_\_\_\_

EXAMINATION OF APPLICATIONS

711.03(c)

PTO/SB/64/PCT (04-04)

Approved for use 03/31/2007, OMB 0651-0021

U.S. Patent and Trademark Office, U.S. DEPARTMENT OF COMMERCE

Under the Paperwork Reduction Act of 1995, no persons are required to respond to a collection of information unless it displays a valid OMB control number.

<p><b>PETITION FOR REVIVAL OF AN INTERNATIONAL APPLICATION FOR PATENT DESIGNATING THE U.S. ABANDONED UNINTENTIONALLY UNDER 37 CFR 1.137(b)</b></p>	<p>Docket Number (Optional)</p>
<p>First Named Inventor:</p> <p>International (PCT) Application No.: _____ U.S. Application No.: _____ (if known)</p> <p>Filed:</p> <p>Title:</p> <p>Attention: PCT Legal Staff Mail Stop PCT Commissioner for Patents P.O. Box 1450 Alexandria, VA 22313-1450</p> <p>The above-identified application became abandoned as to the United States because the fees and documents required by 35 U.S.C. 371(c) were not filed prior to the expiration of the time set in 37 CFR 1.494(b) or (c) or 1.495(b) or (c) as applicable. The date of abandonment is the day after the date on which the 35 U.S.C. 371(c) requirements were due. See 37 CFR 1.494(g) or 1.495(h).</p> <p style="text-align: center;"><b>APPLICANT HEREBY PETITIONS FOR REVIVAL OF THIS APPLICATION</b></p> <p>NOTE: A grantable petition requires the following items:</p> <ol style="list-style-type: none"> <li>(1) Petition fee</li> <li>(2) Proper reply</li> <li>(3) Terminal disclaimer with disclaimer fee which is required for all international applications having an international filing date before June 8, 1995; and</li> <li>(4) Statement that the entire delay was unintentional.</li> </ol> <p>1. Petition fee</p> <p><input type="checkbox"/> Small entity- fee \$ _____ (37 CFR 1.17(m)). Applicant claims small entity status. See 37 CFR 1.27.</p> <p><input type="checkbox"/> Other than small entity - fee \$ _____ (37 CFR 1.17(m))</p> <p>2. Proper reply</p> <p>A. The proper reply (the missing 35 U.S.C. 371(c) requirement(s)) in the form of _____ (identify type of reply):</p> <p><input type="checkbox"/> has been filed previously on _____.</p> <p><input type="checkbox"/> is enclosed herewith.</p>	

[Page 1 of 2]

This collection of information is required by 37 CFR 1.137(b). The information is required to obtain or retain a benefit by the public which is to file (and by the USPTO to process) an application. Confidentiality is governed by 35 U.S.C. 122 and 37 CFR 1.14. This collection is estimated to take 1.0 hour to complete, including gathering, preparing, and submitting the completed application form to the USPTO. Time will vary depending upon the individual case. Any comments on the amount of time you require to complete this form and/or suggestions for reducing this burden, should be sent to the Chief Information Officer, U.S. Patent and Trademark Office, U.S. Department of Commerce, P.O. Box 1450, Alexandria, VA 22313-1450. DO NOT SEND FEES OR COMPLETED FORMS TO THIS ADDRESS. SEND TO: Mail Stop PCT, Commissioner for Patents, P.O. Box 1450, Alexandria, VA 22313-1450.

If you need assistance in completing the form, call 1-800-PTO-9199 and select option 2.



3. Terminal disclaimer with disclaimer fee

- Since this international application has an international filing date on or after June 8, 1995, no terminal disclaimer is required.
- A terminal disclaimer (and disclaimer fee (37 CFR 1.20(d)) of \$ \_\_\_\_\_ for a small entity or \$ \_\_\_\_\_ for other than a small entity) disclaiming the required period of time is enclosed herewith (see PTO/SB/63).

4. Statement. The entire delay in filing the required reply from the due date for the required reply until the filing of a grantable petition under 37 CFR 1.137(b) was unintentional.

**WARNING: Information on this form may become public. Credit card information should not be included on this form. Provide credit card information and authorization on PTO-2038.**

\_\_\_\_\_ Date

\_\_\_\_\_ Signature

\_\_\_\_\_ Telephone Number

\_\_\_\_\_ Typed or Printed Name

\_\_\_\_\_ Registration Number, if applicable

\_\_\_\_\_ Address

\_\_\_\_\_ Address

- Enclosures:  Response
- Fee Payment
- Terminal Disclaimer
- \_\_\_\_\_

## 2. Unavoidable Delay

As discussed above, “unavoidable” delay is the epitome of “unintentional” delay. Thus, an intentional delay precludes revival under 37 CFR 1.137(a) (“unavoidable” delay) or 37 CFR 1.137(b) (“unintentional” delay). See *Maldague*, 10 USPQ2d at 1478.

Decisions on reviving abandoned applications on the basis of “unavoidable” delay have adopted the reasonably prudent person standard in determining if the delay was unavoidable:

The word ‘unavoidable’ . . . is applicable to ordinary human affairs, and requires no more or greater care or diligence than is generally used and observed by prudent and careful men in relation to their most important business. It permits them in the exercise of this care to rely upon the ordinary and trustworthy agencies of mail and telegraph, worthy and reliable employees, and such other means and instrumentalities as are usually employed in such important business. If unexpectedly, or through the unforeseen fault or imperfection of these agencies and instrumentalities, there occurs a failure, it may properly be said to be unavoidable, all other conditions of promptness in its rectification being present.

*In re Mattullath*, 38 App. D.C. 497, 514-15 (1912)(quoting *Pratt*, 1887 Dec. Comm’r Pat. 31, 32-33 (1887)); see also *Winkler v. Ladd*, 221 F. Supp. 550, 552, 138 USPQ 666, 667-68 (D.D.C. 1963), *aff’d*, 143 USPQ 172 (D.C. Cir. 1963); *Ex parte Henrich*, 1913 Dec. Comm’r Pat. 139, 141 (1913). In addition, decisions on revival are made on a “case-by-case basis, taking all the facts and circumstances into account.” *Smith v. Mossinghoff*, 671 F.2d 533, 538, 213 USPQ 977, 982 (D.C. Cir. 1982). Finally, a petition cannot be granted where a petitioner has failed to meet his or her burden of establishing that the delay was “unavoidable.” *Haines v. Quigg*, 673 F. Supp. 314, 316-17, 5 USPQ2d 1130, 1131-32 (N.D. Ind. 1987).

A delay resulting from an error (e.g., a docketing error) on the part of an employee in the performance of a clerical function may provide the basis for a showing of “unavoidable” delay, provided it is shown that:

(A) the error was the cause of the delay at issue;

(B) there was in place a business routine for performing the clerical function that could reasonably be relied upon to avoid errors in its performance; and

(C) the employee was sufficiently trained and experienced with regard to the function and routine for its performance that reliance upon such employee represented the exercise of due care.

See *In re Egbers*, 6 USPQ2d 1869, 1872 (Comm’r Pat. 1988), *rev’d on other grounds sub nom., Theodor Groz & Sohne & Ernst Bechert Nadelfabrik KG v. Quigg*, 10 USPQ2d 1787 (D.D.C. 1988); *In re Katrapat*, 6 USPQ2d 1863, 1867-68 (Comm’r Pat. 1988). For example, where an application becomes abandoned as a consequence of a change of correspondence address (the Office action being mailed to the old, uncorrected address and failing to reach the applicant in sufficient time to permit a timely reply) an adequate showing of “unavoidable” delay will require a showing that due care was taken to adhere to the requirement for prompt notification in each concerned application of the change of address (see MPEP § 601.03), and must include an adequate showing that a timely notification of the change of address was filed in the application concerned, and in a manner reasonably calculated to call attention to the fact that it was a notification of a change of address. The following do not constitute proper notification of a change in correspondence address:

(A) the mere inclusion, in a paper filed in an application for another purpose, of an address differing from the previously provided correspondence address, without mention of the fact that an address change was being made;

(B) the notification on a paper listing plural applications as being affected (except as provided for under the Customer Number practice - see MPEP § 403); or

(C) the lack of notification, or belated notification, to the U.S. Patent and Trademark Office of the change in correspondence address.

Delay resulting from the lack of knowledge or improper application of the patent statute, rules of practice or the MPEP, however, does not constitute “unavoidable” delay. See *Haines*, 673 F. Supp. at 317, 5 USPQ2d at 1132; *Vincent v. Mossinghoff*, 230 USPQ 621, 624 (D.D.C. 1985); *Smith v. Diamond*, 209 USPQ 1091 (D.D.C. 1981); *Potter v. Dann*, 201 USPQ 574 (D.D.C. 1978); *Ex parte Murray*, 1891 Dec. Comm’r Pat. 130, 131 (1891). For example, as 37 CFR 1.116 and 1.135(b) are manifest

that proceedings concerning an amendment after final rejection will not operate to avoid abandonment of the application in the absence of a timely and proper appeal, a delay is not “unavoidable” when the applicant simply permits the maximum extendable statutory period for reply to a final Office action to expire while awaiting a notice of allowance or other action. Likewise, as a “reasonably prudent person” would file papers or fees in compliance with 37 CFR 1.8 or 1.10 to ensure their timely filing in the USPTO, as well as preserve adequate evidence of such filing, a delay caused by an applicant’s failure to file papers or fees in compliance with 37 CFR 1.8 and 1.10 does not constitute “unavoidable” delay. See *Krahn*, 15 USPQ2d at 1825. Finally, a delay caused by an applicant’s lack of knowledge or improper application of the patent statute, rules of practice or the MPEP is not rendered “unavoidable” due to: (A) the applicant’s reliance upon oral advice from USPTO employees; or (B) the USPTO’s failure to advise the applicant of any deficiency in sufficient time to permit the applicant to take corrective action. See *In re Sivertz*, 227 USPQ 255, 256 (Comm’r Pat. 1985).

35 U.S.C. 133 and 151 each require a showing that the “delay” was “unavoidable,” which requires not only a showing that the delay which resulted in the abandonment of the application was unavoidable, but also a showing of unavoidable delay until the filing of a petition to revive. See *In re Application of Takao*, 17 USPQ2d 1155 (Comm’r Pat. 1990). The burden of continuing the process of presenting a grantable petition in a timely manner likewise remains with the applicant until the applicant is informed that the petition is granted. *Id.* at 1158. Thus, an applicant seeking to revive an “unavoidably” abandoned application must cause a petition under 37 CFR 1.137(a) to be filed without delay (i.e., promptly upon becoming notified, or otherwise becoming aware, of the abandonment of the application).

An applicant who fails to file a petition under 37 CFR 1.137(a) “promptly” upon becoming notified, or otherwise becoming aware, of the abandonment of

the application will not be able to show that the entire delay in filing the required reply from the due date for the reply until the filing of a grantable petition pursuant to 37 CFR 1.137(a) was unavoidable. The removal of the language in 37 CFR 1.137(a) requiring that any petition thereunder be “promptly filed after the applicant is notified of, or otherwise becomes aware of, the abandonment” should **not** be viewed as: (A) permitting an applicant, upon becoming notified, or otherwise becoming aware, of the abandonment of the application, to delay the filing of a petition under 37 CFR 1.137(a); or (B) changing (or modifying) the result in *In re Application of S*, 8 USPQ2d 1630 (Comm’r Pat. 1988), in which a petition under 37 CFR 1.137(a) was denied due to the applicant’s deliberate deferral in filing a petition under 37 CFR 1.137. An applicant who deliberately chooses to delay the filing of a petition under 37 CFR 1.137 (as in *Application of S*, 8 USPQ2d at 1632) will not be able to show that “the entire delay in filing the required reply from the due date for the reply until the filing of a grantable petition pursuant to [37 CFR 1.137(a)] was unavoidable” or even make an appropriate statement that “the entire delay in filing the required reply from the due date for the reply until the filing of a grantable petition pursuant to [37 CFR 1.137(b)] was unintentional.”

The dismissal or denial of a petition under 37 CFR 1.137(a) does not preclude an applicant from obtaining relief pursuant to 37 CFR 1.137(b) on the basis of unintentional delay (unless the decision dismissing or denying the petition under 37 CFR 1.137(a) indicates otherwise). In such an instance, a petition under 37 CFR 1.137(b) may be filed accompanied by the fee set forth in 37 CFR 1.17(m), the required reply, a statement that the entire delay in filing the required reply from the due date for the reply until the filing of a grantable petition pursuant to 37 CFR 1.137(b) was unintentional, and any terminal disclaimer required by 37 CFR 1.137(c).

Form PTO/SB/61 >or PTO/SB/61PCT< may be used to file a petition for revival of an unavoidably abandoned application.

EXAMINATION OF APPLICATIONS

711.03(c)

\*\*>

PTO/SB/61 (11-03)

Approved for use through 07/31/2006. OMB 0651-0031

U.S. Patent and Trademark Office; U.S. DEPARTMENT OF COMMERCE

Under the Paperwork Reduction Act of 1995, no persons are required to respond to a collection of information unless it displays a valid OMB control number.

<p><b>PETITION FOR REVIVAL OF AN APPLICATION FOR PATENT ABANDONED UNAVOIDABLY UNDER 37 CFR 1.137(a)</b></p>		<p>Docket Number (Optional)</p>
<p>First Named Inventor:</p>	<p>Art Unit:</p>	
<p>Application Number:</p>	<p>Examiner:</p>	
<p>Filed:</p>		
<p>Title:</p>		
<p>Attention: Office of Petitions <b>Mail Stop Petition</b> Commissioner for Patents P.O. Box 1450 Alexandria, VA 22313-1450</p>		
<p>NOTE: If information or assistance is needed in completing this form, please contact Petitions Information at (703) 305-9382.</p>		
<p>The above-identified application became abandoned for failure to file a timely and proper reply to a notice or action by the United States Patent and Trademark Office. The date of abandonment is the day after the expiration date of the period set for reply in the Office notice or action plus any extensions of time actually obtained.</p>		
<p>APPLICANT HEREBY PETITIONS FOR REVIVAL OF THIS APPLICATION. NOTE: A grantable petition requires the following items:</p>		
<p>(1) Petition fee. (2) Reply and/or issue fee. (3) Terminal disclaimer with disclaimer fee-required for all utility and plant applications filed before June 8, 1995, and for all design applications; and (4) Adequate showing of the cause of unavoidable delay.</p>		
<p>1. Petition fee</p>		
<p><input type="checkbox"/> Small entity – fee \$ _____ (37 CFR 1.17(l)). Applicant claims small entity status. See 37 CFR 1.27.</p>		
<p><input type="checkbox"/> Other than small entity – fee \$ _____ (37 CFR 1.17(l)).</p>		
<p>2. Reply and/or fee</p>		
<p>A. The reply and/or fee to the above-noted Office action in the form of _____ (identify the type of reply):</p>		
<p><input type="checkbox"/> has been filed previously on _____.</p>		
<p><input type="checkbox"/> is enclosed herewith.</p>		
<p>B. The issue fee of \$ _____</p>		
<p><input type="checkbox"/> has been filed previously on _____.</p>		
<p><input type="checkbox"/> is enclosed herewith.</p>		

[Page 1 of 3]

This collection of information is required by 37 CFR 1.137(a). The information is required to obtain or retain a benefit by the public which is to file (and by the USPTO to process) an application. Confidentiality is governed by 35 U.S.C. 122 and 37 CFR 1.14. This collection is estimated to take 8 hours to complete, including gathering, preparing, and submitting the completed application form to the USPTO. Time will vary depending upon the individual case. Any comments on the amount of time you require to complete this form and/or suggestions for reducing this burden, should be sent to the Chief Information Officer, U.S. Patent and Trademark Office, U.S. Department of Commerce, P.O. Box 1450, Alexandria, VA 22313-1450. DO NOT SEND FEES OR COMPLETED FORMS TO THIS ADDRESS. SEND TO: Mail Stop Petition, Commissioner for Patents, P.O. Box 1450, Alexandria, VA 22313-1450.  
If you need assistance in completing the form, call 1-800-PTO-9199 and select option 2.

Under the Paperwork Reduction Act of 1995, no persons are required to respond to a collection of information unless it displays a valid OMB control number.

**PETITION FOR REVIVAL OF AN APPLICATION FOR PATENT ABANDONED  
UNAVOIDABLY UNDER 37 CFR 1.137(a)**

3. Terminal disclaimer with disclaimer fee

- Since this utility/plant application was filed on or after June 8, 1995, no terminal disclaimer is required.
- A terminal disclaimer (and disclaimer fee (37 CFR 1.20(d)) of \$ \_\_\_\_\_ for a small entity or \$ \_\_\_\_\_ for other than a small entity) disclaiming the required period of time is enclosed herewith (see PTO/SB/63).

4. An adequate showing of the cause of the delay, and that the entire delay in filing the required reply from the due date for the reply until the filing of a grantable petition under 37 CFR 1.137(a) was unavoidable, is enclosed.

**WARNING: Information on this form may become public. Credit card information should not be included on this form. Provide credit card information and authorization on PTO-2038.**

\_\_\_\_\_  
Date Signature

\_\_\_\_\_  
Telephone Number Typed or printed name

\_\_\_\_\_  
Registration Number, if applicable Address

\_\_\_\_\_  
Address

- Enclosure
- Fee Payment
  - Reply
  - Terminal Disclaimer Form
  - Additional sheets containing statements establishing unavoidable delay
  - \_\_\_\_\_

**CERTIFICATE OF MAILING OR TRANSMISSION (37 CFR 1.8(a))**

I hereby certify that this correspondence is being:

- deposited with the United States Postal Service on the date shown below with sufficient postage as first class mail in an envelope addressed to **Mail Stop Petition**, Commissioner for Patents, P.O. Box 1450, Alexandria, VA 22313-1450.
- transmitted by facsimile on the date shown below to the United States Patent and Trademark Office at (703) 872-9306.

\_\_\_\_\_  
Date Signature

\_\_\_\_\_  
Typed or printed name of person signing certificate

PTO/SB/61 (11-03)

Approved for use through 07/31/2006. OMB 0651-0031  
U.S. Patent and Trademark Office; U.S. DEPARTMENT OF COMMERCE

Under the Paperwork Reduction Act of 1995, no persons are required to respond to a collection of information unless it displays a valid OMB control number.

**PETITION FOR REVIVAL OF AN APPLICATION FOR PATENT ABANDONED  
UNAVOIDABLY UNDER 37 CFR 1.137(a)**

NOTE: The following showing of the cause of unavoidable delay must be signed by all applicants or by any other party who is presenting statements concerning the cause of delay.

\_\_\_\_\_  
Date

\_\_\_\_\_  
Signature

\_\_\_\_\_  
Registration Number, if applicable

\_\_\_\_\_  
Typed or printed name

(In the space provided below, please explain in detail the reasons for the delay in filing a proper reply.)

*(Please attach additional sheets if additional space is needed.)*

[Page 3 of 3]

PTO/SB/61/PCT (04-04)

Approved for use through 03/31/2007. OMB 0651-0021

U.S. Patent and Trademark Office; U.S. DEPARTMENT OF COMMERCE

Under the Paperwork Reduction Act of 1995, no persons are required to respond to a collection of information unless it displays a valid OMB control number.

<b>PETITION FOR REVIVAL OF AN INTERNATIONAL APPLICATION FOR PATENT DESIGNATING THE U.S. ABANDONED UNAVOIDABLY UNDER 37 CFR 1.137(a)</b>		Docket Number (Optional)
First named inventor:	U.S. Application No.:	
International (PCT) Application Number:	(if known)	
Filed:		
Title:		
<p>Attention: PCT Legal Staff          Mail Stop PCT          Commissioner for Patents          P.O. Box 1450          Alexandria, VA 22313-1450</p>		
<p>The above-identified application became abandoned as to the United States because the fees and documents required by 35 U.S.C. 371(c) were not filed prior to the expiration of the time set in 37 CFR 1.494(b) or (c) or 1.495(b) or (c) (as applicable). The date of abandonment is the day after the date on which the 35 U.S.C. 371(c) requirements were due. See 37 CFR 1.494(g) or 1.495(h).</p>		
<b>APPLICANT HEREBY PETITIONS FOR REVIVAL OF THIS APPLICATION</b>		
NOTE: A grantable petition requires the following items:		
(1) Petition fee;		
(2) Proper reply;		
(3) Terminal disclaimer with disclaimer fee—required for all international applications having an international filing date before June 8, 1995; and		
(4) Adequate showing of the cause of unavoidable delay.		
1. Petition fee		
<input type="checkbox"/> small entity – fee \$ _____ (37 CFR 1.17(l)). Applicant claims small entity status. See 37 CFR 1.27.		
<input type="checkbox"/> Other than small entity - fee \$ _____ (37 CFR 1.17(l))		
2. Proper reply		
A. The proper reply (the missing 35 U.S.C. 371(c) requirements) in the form of _____ (identify the type of reply):		
<input type="checkbox"/> was previously filed on _____		
<input type="checkbox"/> is enclosed herewith.		

[Page 1 of 3]

This collection of information is required by 37 CFR 1.137(a). The information is required to obtain or retain a benefit by the public which is to file (and by the USPTO to process) an application. Confidentiality is governed by 35 U.S.C. 122 and 37 CFR 1.14. This collection is estimated to take 8.0 hours to complete, including gathering, preparing, and submitting the completed application form to the USPTO. Time will vary depending upon the individual case. Any comments on the amount of time you require to complete this form and/or suggestions for reducing this burden, should be sent to the Chief Information Officer, U.S. Patent and Trademark Office, U.S. Department of Commerce, P.O. Box 1450, Alexandria, VA 22313-1450. DO NOT SEND FEES OR COMPLETED FORMS TO THIS ADDRESS. SEND TO: Mail Stop PCT, Commissioner for Patents, P.O. Box 1450, Alexandria, VA 22313-1450.

If you need assistance in completing the form, call 1-800-PTO-9199 and select option 2.

PTO/SB/61/PCT (04-04)  
Approved for use through 03/31/2007. OMB 0651-0021  
U.S. Patent and Trademark Office; U.S. DEPARTMENT OF COMMERCE

Under the Paperwork Reduction Act of 1995, no persons are required to respond to a collection of information unless it displays a valid OMB control number.

**PETITION FOR REVIVAL OF AN INTERNATIONAL APPLICATION FOR PATENT  
DESIGNATING THE U.S. ABANDONED UNAVOIDABLY UNDER 37 CFR 1.137(a)**

3. Terminal disclaimer with disclaimer fee

- Since this international application has an international filing date on or after June 8, 1995, no terminal disclaimer is required.
- A terminal disclaimer (and disclaimer fee (37 CFR 1.20(d)) of \$ \_\_\_\_\_ for a small entity or \$ \_\_\_\_\_ for other than a small entity) disclaiming the required period of time is enclosed herewith (see PTO/SB/63).

4. An adequate showing of the cause of the delay, and that the entire delay in filing the 35 U.S.C. 371(c) requirements (or a continuing U.S. application) from their due date until the filing of a grantable petition 37 CFR 1.137(a) was unavoidable, is enclosed.

**WARNING: Information on this form may become public. Credit card information should not be included on this form. Provide credit card information and authorization on PTO-2038.**

\_\_\_\_\_  
Date

\_\_\_\_\_  
Signature

\_\_\_\_\_  
Telephone Number

\_\_\_\_\_  
Typed or Printed Name

\_\_\_\_\_  
Registration Number, if applicable

\_\_\_\_\_  
Address

\_\_\_\_\_  
Address

- Enclosures:
- Additional sheets containing statements establishing unavoidable delay
  - Fee Payment
  - Reply
  - Terminal Disclaimer Form
  - \_\_\_\_\_





#### ***D. Delay Until the Filing of a Grantable Petition***

There are three periods to be considered during the evaluation of a petition under 37 CFR 1.137:

(A) the delay in reply that originally resulted in the abandonment;

(B) the delay in filing an initial petition pursuant to 37 CFR 1.137 to revive the application; and

(C) the delay in filing a **grantable** petition pursuant to 37 CFR 1.137 to revive the application.

As discussed above, the abandonment of an application is considered to be a deliberately chosen course of action, and the resulting delay cannot be considered as “unintentional” within the meaning of 37 CFR 1.137(b), where the applicant deliberately permits the application to become abandoned. See *Application of G*, 11 USPQ2d at 1380. Likewise, where the applicant deliberately chooses not to seek or persist in seeking the revival of an abandoned application, or where the applicant deliberately chooses to delay seeking the revival of an abandoned application, the resulting delay in seeking revival of the abandoned application cannot be considered as “unintentional” within the meaning of 37 CFR 1.137(b). An intentional delay resulting from a deliberate course of action chosen by the applicant is not affected by:

(A) the correctness of the applicant’s (or applicant’s representative’s) decision to abandon the application or not to seek or persist in seeking revival of the application;

(B) the correctness or propriety of a rejection, or other objection, requirement, or decision by the Office; or

(C) the discovery of new information or evidence, or other change in circumstances subsequent to the abandonment or decision not to seek or persist in seeking revival.

Obviously, delaying the revival of an abandoned application, by a deliberately chosen course of action, until the industry or a competitor shows an interest in the invention is the antithesis of an “unavoidable” or “unintentional” delay. An intentional abandonment of an application, or an intentional delay in seeking the revival of an abandoned application, precludes a finding of unavoidable or unintentional delay pursuant to 37 CFR 1.137. See *Maldague*, 10 USPQ2d at 1478.

The Office does not generally question whether there has been an intentional or otherwise impermissible delay in filing an initial petition pursuant to 37 CFR 1.137(a) or (b), when such petition is filed: (A) within 3 months of the date the applicant is first notified that the application is abandoned; **and** (2) within 1 year of the date of abandonment of the application. Thus, an applicant seeking revival of an abandoned application is advised to file a petition pursuant to 37 CFR 1.137 within 3 months of the first notification that the application is abandoned to avoid the question of intentional delay being raised by the Office (or by third parties seeking to challenge any patent issuing from the application).

Where a petition pursuant to 37 CFR 1.137(a) or (b) is not filed within 3 months of the date the applicant is first notified that the application is abandoned, the Office will consider there to be a question as to whether the delay was unavoidable or unintentional. In such instances,

(A) the Office will require a showing as to how the delay between the date the applicant was first notified that the application was abandoned and the date a 37 CFR 1.137(a) petition was filed was “unavoidable”; or

(B) the Office may require further information as to the cause of the delay between the date the applicant was first notified that the application was abandoned and the date a 37 CFR 1.137(b) petition was filed, and how such delay was “unintentional.”

To avoid delay in the consideration of the merits of a petition under 37 CFR 1.137(a) or (b) in instances in which such petition was not filed within 3 months of the date the applicant was first notified that the application was abandoned, applicants should include a showing as to how the delay between the date the applicant was first notified by the Office that the application was abandoned and the filing of a petition under 37 CFR 1.137 was (A) “unavoidable” in a petition under 37 CFR 1.137(a); or (B) “unintentional” in a petition under 37 CFR 1.137(b).

Where a petition pursuant to 37 CFR 1.137(a) or (b) is not filed within 1 year of the date of abandonment of the application (note that abandonment takes place by operation of law, rather than by the mailing of a Notice of Abandonment) the Office will require:

(A) further information as to when the applicant (or the applicant's representative) first became aware of the abandonment of the application; and

(B) a showing as to how the delay in discovering the abandoned status of the application occurred despite the exercise of due care or diligence on the part of the applicant (or applicant's representative) (see *Pratt*, 1887 Dec. Comm'r Pat. at 32-33).

To avoid delay in the consideration of the merits of a petition under 37 CFR 1.137(a) or (b) in instances in which such petition was not filed within 1 year of the date of abandonment of the application, applicants should include:

(A) the date that the applicant first became aware of the abandonment of the application; and

(B) a showing as to how the delay in discovering the abandoned status of the application occurred despite the exercise of due care or diligence on the part of the applicant.

In either instance, applicant's failure to carry the burden of proof to establish that the "entire" delay was "unavoidable" or "unintentional" may lead to the denial of a petition under 37 CFR 1.137(a) or 37 CFR 1.137(b), regardless of the circumstances that originally resulted in the abandonment of the application.

#### **E. Party Whose Delay Is Relevant**

The question under 37 CFR 1.137 is whether the delay on the part of the party having the right or authority to reply to avoid abandonment (or not reply) was unavoidable or unintentional. When the applicant assigns the entire right, title, and interest in an invention to a third party (and thus does not retain any legal or equitable interest in the invention), the applicant's delay is irrelevant in evaluating whether the delay was unavoidable or even unintentional. See *Kim v. Quigg*, 718 F. Supp. 1280, 1284, 12 USPQ2d 1604, 1607-08 (E.D. Va. 1989). When an applicant assigns the application to a third party (e.g., the inventor/applicant's employer), and the third party decides not to file a reply to avoid abandonment, the applicant's actions, inactions or intentions are irrelevant under 37 CFR 1.137, unless the third party has reassigned the application to the applicant prior to the due date for the reply. *Id.*

Likewise, where the applicant permits a third party (whether a partial assignee, licensee, or other party) to

control the prosecution of an application, the third party's decision whether or not to file a reply to avoid abandonment is binding on the applicant. See *Winkler*, 221 F. Supp. at 552, 138 USPQ at 667. Where an applicant enters an agreement with a third party for the third party to take control of the prosecution of an application, the applicant will be considered to have given the third party the right and authority to prosecute the application to avoid abandonment (or not prosecute), unless, by the express terms of the contract between applicant and the third party, the third party is conducting the prosecution of the application for the applicant solely in a fiduciary capacity. See *Futures Technology Ltd. v. Quigg*, 684 F. Supp. 430, 431, 7 USPQ2d 1588, 1589 (E.D. Va. 1988). Otherwise, the applicant will be considered to have given the third party unbridled discretion to prosecute (or not prosecute) the application to avoid abandonment, and will be bound by the actions or inactions of such third party.

#### **F. Burden of Proof To Establish Unavoidable or Unintentional Delay**

37 CFR 1.137(a)(3) requires a showing to the satisfaction of the \*>Director of the USPTO< that the entire delay in filing the required reply from the due date for the reply until the filing of a grantable petition pursuant to 37 CFR 1.137(a) was unavoidable. Therefore, the Office will require the applicant in every petition under 37 CFR 1.137(a) to carry the burden of proof to establish that the delay from the due date for the reply until the filing of a grantable petition was unavoidable. See *Haines*, 673 F. Supp. at 316-17, 5 USPQ2d at 1131-32.

37 CFR 1.137(b)(3) requires that a petition under 37 CFR 1.137(b) must be accompanied by a statement that the entire delay in providing the required reply from the due date for the reply until the filing of a grantable petition pursuant to 37 CFR 1.137(b) was unintentional, but also provides that \*\*>“[t]he Director may require additional information where there is a question whether the delay was unintentional.”< While the Office will generally require only the statement that the entire delay in providing the required reply from the due date for the reply until the filing of a grantable petition pursuant to 37 CFR 1.137(b) was unintentional, the Office may require an applicant to carry the burden of proof to establish that the delay

from the due date for the reply until the filing of a grantable petition was unintentional within the meaning of 35 U.S.C. 41(a)(7) and 37 CFR 1.137(b) where there is a question whether the entire delay was unintentional. See *Application of G*, 11 USPQ2d at 1380.

### **G Terminal Disclaimer Requirement**

37 CFR 1.137(d) requires that a petition under either 37 CFR 1.137(a) or 1.137(b) be accompanied by a terminal disclaimer (and fee), regardless of the period of abandonment, in:

(A) a design application;

(B) a nonprovisional utility application filed before June 8, 1995; or

(C) a nonprovisional plant application filed before June 8, 1995.

In addition, a terminal disclaimer (and fee) is also required for a utility or plant application filed on or after June 8, 1995, but before May 29, 2000, where the application became abandoned (1) during appeal, (2) during interference, or (3) while under a secrecy order. The reason being that utility and plant patents issuing on applications filed on or after June 8, 1995, but before May 29, 2000, are eligible for the patent term extension under former 35 U.S.C. 154(b) (as a result of the Uruguay Round Agreements Act (URAA)). See 35 U.S.C. 154(b) (1999); see also 37 CFR 1.701. If such an application is abandoned (1) during appeal, (2) during interference, or (3) while under a secrecy order, the patentee of a patent issuing from such an application is eligible for patent term extension for the entire period of abandonment. The requirement for a terminal disclaimer for these situations will make certain that any patent term extension obtained for the period of abandonment while the application is under appeal, interference, or a secrecy order will be dedicated to the public. For utility and plant applications filed on or after May 29, 2000, a terminal disclaimer (and fee) is not required since the period of abandonment is reduced from the patent term adjustment pursuant to 37 CFR 1.704.

The terminal disclaimer submitted in a design application must dedicate to the public a terminal part of the term of any patent granted thereon equivalent to the period of abandonment of the application. The terminal disclaimer submitted in either a utility or plant application filed before June 8, 1995 must dedicate to

the public a terminal part of the term of any patent granted thereon equivalent to the lesser of: (1) the period of abandonment of the application; or (2) the period extending beyond twenty years from the date on which the application for the patent was filed in the United States or, if the application contains a specific reference to an earlier filed application(s) under 35 U.S.C. 120, 121, or 365(c), from the date on which the earliest such application was filed. The terminal disclaimer must also apply to any patent granted on any continuing utility or plant application filed before June 8, 1995, or any continuing design application, entitled under 35 U.S.C. 120, 121, or 365(c) to the benefit of the filing date of the application for which revival is sought. The terminal disclaimer requirement of 37 CFR 1.137(d) does not apply to applications for which revival is sought solely for purposes of copendency with a utility or plant application filed on or after June 8, 1995, or to lapsed patents.

The Office cannot determine (at the time a petition to revive is granted) the period disclaimed (i.e., which period is lesser: the period of abandonment of the application, or the period extending beyond twenty years from the date on which the application for the patent was filed in the United States or, if the application contains a specific reference to an earlier filed application(s) under 35 U.S.C. 120, 121, or 365(c), from the date on which the earliest such application was filed). Therefore, the Office will not indicate the period disclaimed under 37 CFR 1.137(d) in its decision granting a petition to revive an abandoned application.

The filing of a terminal disclaimer is not a substitute for unavoidable or unintentional delay. See *Application of Takao*, 17 USPQ2d at 1159. The requirement that the entire delay have been unavoidable (37 CFR 1.137(a)) or at least unintentional (37 CFR 1.137(b)) is distinct from the requirement for a terminal disclaimer. Therefore, the filing of a terminal disclaimer cannot excuse an intentional delay in filing a petition or renewed petition to revive an abandoned application. Likewise, an unavoidable or unintentional delay in filing a petition or renewed petition to revive an abandoned application will not warrant waiver of the terminal disclaimer requirement of 37 CFR 1.137(d).

In the event that an applicant considers the requirement for a terminal disclaimer to be inappropriate

under the circumstances of the application at issue, the applicant should file a petition under 37 CFR 1.183 (and petition fee) to request a waiver of this requirement of 37 CFR 1.183. Such a petition may request waiver of this requirement *in toto*, or to the extent that such requirement exceeds the period considered by applicant as the appropriate period of disclaimer. The grant of such a petition, however, is strictly limited to situations wherein applicant has made a showing of an “extraordinary situation” in

which “justice requires” the requested relief. An example of such a situation is when the abandonment of the application caused no actual delay in prosecution (e.g., an application awaiting decision by the Board of Appeals and Interferences during period of abandonment).

Forms PTO/SB/62 and PTO/SB/63 may be used when filing a terminal disclaimer in accordance with 37 CFR 1.137(d).

\*\*>

PTO/SB/62 (08-03)  
 Approved for use through 07/31/2006. OMB 0651-0031  
 Patent and Trademark Office; U.S. DEPARTMENT OF COMMERCE

Under the Paperwork Reduction Act of 1995, no persons are required to respond to a collection of information unless it displays a valid OMB control number.

<p><b>TERMINAL DISCLAIMER TO ACCOMPANY PETITION</b>                  (Period Specified)</p>	<p>Docket Number (Optional)</p>
<p>In re Application of:</p> <p>Name:</p> <p>Application Number:</p> <p>Filed:</p> <p>For:</p> <p>The owner*, _____ of _____ percent interest in the above-identified application hereby disclaims the terminal _____ months of any patent granted on the above-identified application or on any application that contains a specific reference under 35 U.S.C. 120, 121, or 365(c) to this application. This disclaimer is binding upon the grantee, its successors or assigns.</p> <p>Check either box 1 or 2 below, if appropriate.</p> <p>1. <input type="checkbox"/> For submissions on behalf of an organization (e.g., corporation, partnership, university, government agency, etc.), the person signing is empowered to act on behalf of the organization.</p> <p>I hereby declare that all statements made herein of my own knowledge are true and that all statements made on information and belief are believed to be true; and further, that these statements are made with knowledge that willful false statements and the like so made are punishable by fine or imprisonment, or both, under Section 1001, Title 18 of the United States Code, and that such willful false statements may jeopardize the validity of the application or any patent issuing thereon.</p> <p>2. <input type="checkbox"/> The undersigned is an attorney of record.</p>	
<p>_____ Telephone Number</p>	<p>_____ Signature</p>
<p>_____ Date</p>	<p>_____ Typed or printed name</p>
<p>Registration Number, if applicable</p> <p><input type="checkbox"/> Terminal disclaimer fee under 37 CFR 1.20(d) included.</p> <p><b>WARNING: Information on this form may become public. Credit card information should not be included on this form. Provide credit card information and authorization on PTO-2038.</b></p> <p>* Certification under 37 CFR 3.73(b) is required if terminal disclaimer is signed by the assignee (owner). Form PTO/SB/96 may be used for making this certification. See MPEP § 324.</p>	

This collection of information is required by 37 CFR 1.137. The information is required to obtain or retain a benefit by the public which is to file (and by the USPTO to process) an application. Confidentiality is governed by 35 U.S.C. 122 and 37 CFR 1.14. This collection is estimated to take 12 minutes to complete, including gathering, preparing, and submitting the completed application form to the USPTO. Time will vary depending upon the individual case. Any comments on the amount of time you require to complete this form and/or suggestions for reducing this burden, should be sent to the Chief Information Officer, U.S. Patent and Trademark Office, U.S. Department of Commerce, P.O. Box 1450, Alexandria, VA 22313-1450. DO NOT SEND FEES OR COMPLETED FORMS TO THIS ADDRESS. SEND TO: Commissioner for Patents, P.O. Box 1450, Alexandria, VA 22313-1450.

If you need assistance in completing the form, call 1-800-PTO-9199 and select option 2.

PTO/SB/63 (08-03)  
 Approved for use through 07/31/2006. OMB 0651-0031  
 U.S. Patent and Trademark Office; U.S. DEPARTMENT OF COMMERCE

Under the Paperwork Reduction Act of 1995, no persons are required to a collection of information unless it displays a valid OMB control number.

<b>TERMINAL DISCLAIMER TO ACCOMPANY PETITION</b>	Docket Number (Optional)
<p>In re Application of:</p> <p>Name: _____</p> <p>Application Number: _____</p> <p>Filed: _____</p> <p>For: _____</p> <p>The owner*, _____ of _____ percent interest in the above-identified application hereby disclaims a terminal part of the term of any patent granted the above-identified application equivalent to: (1) if the above-identified application is a design application, the period of abandonment of the above-identified application, and (2) if the above-identified application is a utility or plant application, the lesser of: (a) the period of abandonment of the application; or (b) the period extending beyond twenty years from the date on which the above-identified application was filed in the United States or, if the application contains a specific reference to an earlier filed application(s) under 35 U.S.C. 120, 121, or 365(c), from the date on which the earliest such application was filed. This disclaimer also applies to any patent granted on a utility or plant application filed before June 8, 1995, or a design application, that contains a specific reference under 35 U.S.C. 120, 121, or 365(c) to the above-identified application. This disclaimer is binding upon the grantee, and its successors or assigns.</p> <p>Check either box 1 or 2 below, if appropriate.</p> <p>1. <input type="checkbox"/> For submissions on behalf of an organization (e.g., corporation, partnership, university, government agency, etc.), the undersigned is empowered to act on behalf of the organization.</p> <p>2. <input type="checkbox"/> The undersigned is an attorney or agent of record.</p> <div style="display: flex; justify-content: space-between; margin-top: 20px;"> <div style="width: 45%; text-align: center;"> <p>_____</p> <p>Signature</p> </div> <div style="width: 45%; text-align: center;"> <p>_____</p> <p>Date</p> </div> </div> <div style="display: flex; justify-content: space-between; margin-top: 20px;"> <div style="width: 45%; text-align: center;"> <p>_____</p> <p>Telephone Number</p> </div> <div style="width: 45%; text-align: center;"> <p>_____</p> <p>Typed or Printed Name</p> </div> </div> <p><input type="checkbox"/> Terminal disclaimer fee under 37 CFR 1.20(d) included.</p> <p><b>WARNING: Information on this form may become public. Credit card information should not be included on this form. Provide credit card information and authorization on PTO-2036.</b></p> <p>* Statement under 37 CFR 3.73(b) is required if terminal disclaimer is signed by the assignee (owner). Form PTO/SB/96 may be used for making this certification. See MPEP § 324.</p>	

This collection of information is required by 37 CFR 1.137. The information is required to obtain or retain a benefit by the public which is to file (and by the USPTO to process) an application. Confidentiality is governed by 35 U.S.C. 122 and 37 CFR 1.14. This collection is estimated to take 12 minutes to complete, including gathering, preparing, and submitting the completed application form to the USPTO. Time will vary depending upon the individual case. Any comments on the amount of time you require to complete this form and/or suggestions for reducing this burden, should be sent to the Chief Information Officer, U.S. Patent and Trademark Office, U.S. Department of Commerce, P.O. Box 1450, Alexandria, VA 22313-1450. DO NOT SEND FEES OR COMPLETED FORMS TO THIS ADDRESS. SEND TO: Commissioner for Patents, P.O. Box 1450, Alexandria, VA 22313-1450.

*If you need assistance in completing the form, call 1-800-PTO-9199 and select option 2.*

### **H. Request for Reconsideration**

37 CFR 1.137(e) requires that any request for reconsideration or review of a decision refusing to revive an abandoned application or lapsed patent must be filed within 2 months of the decision refusing to revive or within such time as set in the decision. 37 CFR 1.137(e) further provides that, unless a decision indicates otherwise, this time period for requesting reconsideration or review may be extended under the provisions of 37 CFR 1.136.

37 CFR 1.137(e) specifies a time period within which a renewed petition pursuant to 37 CFR 1.137 must be filed to be considered timely. Where an applicant files a renewed petition, request for reconsideration, or other petition seeking review of a prior decision on a petition pursuant to 37 CFR 1.137 outside the time period specified in 37 CFR 1.137(e), the Office may require, *inter alia*, a specific showing as to how the entire delay was “unavoidable” (37 CFR 1.137(a)) or “unintentional” (37 CFR 1.137(b)). As discussed above, a delay resulting from the applicant deliberately choosing not to persist in seeking the revival of an abandoned application cannot be considered “unavoidable” or “unintentional” within the meaning of 37 CFR 1.137, and the correctness or propriety of the decision on the prior petition pursuant to 37 CFR 1.137, the correctness of the applicant’s (or the applicant’s representative’s) decision not to persist in seeking revival, the discovery of new information or evidence, or other change in circumstances subsequent to the abandonment or decision to not persist in seeking revival are immaterial to such intentional delay caused by the deliberate course of action chosen by the applicant.

### **I. Provisional Applications**

37 CFR 1.137 is applicable to a provisional application abandoned for failure to reply to an Office requirement. A petition under 37 CFR 1.137(a) or (b) must be accompanied by any outstanding reply to an Office requirement, since 37 CFR 1.137(a)(1) and 1.137(b)(1) permit the filing of a continuing application in lieu of the required reply only in a nonprovisional application.

35 U.S.C. 111(b)(5) provides that a provisional application shall be regarded as abandoned 12 months after its filing date and shall not be subject to revival after such 12-month period. 37 CFR 1.137(g) pro-

vides that a provisional application, abandoned for failure to timely respond to an Office requirement, may be revived pursuant to 37 CFR 1.137, however a provisional application will not be regarded as pending after twelve months from its filing date under any circumstances. Note that the pendency of a provisional application is extended to the next succeeding secular or business day if the day that is twelve months after the filing date of the provisional application falls on a Saturday, Sunday, or Federal holiday within the District of Columbia. See 35 U.S.C. 119(e)(3).

A provisional application may be abandoned prior to 12 months from its filing date for failure to reply to an Office requirement (e.g., failure to submit the filing fee and/or cover sheet). Applicant may petition to have an abandoned provisional application revived as a pending provisional application for a period of no longer than 12 months from the filing date of the provisional application where the delay was unavoidable or unintentional. It would be permissible to file a petition for revival later than 12 months from the filing date of the provisional application but only to revive the application for the 12-month period following the filing of the provisional application. Thus, even if the petition were granted to establish the pendency up to the end of the 12-month period, the provisional application would not be considered pending after 12 months from its filing date.

### **711.03(d) Examiner’s Statement on Petition To Set Aside Examiner’s Holding [R-2]**

37 CFR 1.181 states that the examiner \*\*>“may be directed by the Director to furnish a written statement within a specific time setting forth the reasons for his or her decision upon the matters averred in the petition, supplying a copy thereof to the petitioner.”< Unless requested, however, such a statement should not be prepared. See MPEP § 1002.01.

### **711.04 Public Access to Abandoned Applications [R-2]**

\*\*>Access will be provided to the application file itself for any non-Image File Wrapper (IFW) abandoned published application. When access to the IFW system is available in the File Information Unit (FIU)



and/or Internet access to abandoned published IFW applications, such files will be provided to the public via the FIU and/or Internet. Since there is no paper file wrapper for IFW applications, if electronic access is not available to the public, then access to IFW files is only available by ordering a copy of the application-as-filed, the file contents of the published application or a specific document in the file of the published application from the Office of Public Records and payment of the appropriate fee set forth in 37 CFR 1.19(b). See 37 CFR 1.14(a)(1)(ii).

Access to an abandoned unpublished application may be provided to any person if a written request for access is submitted, and the abandoned application is identified or relied upon:

(A) in a U.S. patent application publication or patent;

(B) in statutory invention registration; or

(C) in an international application that is published in accordance with PCT Article 21(2).

An application is considered identified in a document such as a patent when the application number or serial number and filing date, first named inventor, title and filing date or other application specific information are provided in the text of the patent, but not when the identification is made in a paper in the file contents of the patent and is not included in the printed patent. See 37 CFR 1.14(a)(1)(iv). A copy of the application-as-filed, the file contents of the abandoned application, or a specific document in the file of the abandoned application may also be provided to any person upon written request, and payment of the fee set forth in 37 CFR 1.19(b). See 37 CFR 1.14(a)(1)(iv). See also MPEP § 103. Form PTO/SB/68 may be used to request access of an abandoned application under 37 CFR 1.14(a)(1)(iv).<

#### **711.04(a) Pulling and Forwarding Abandoned Applications [R-1]**

The files of abandoned applications are pulled and forwarded to the Files Repository on a biweekly basis 1 month after the full 6-month statutory period has expired. However, the date of abandonment is after midnight of the date on which the set shortened statutory period, including any extensions under 37 CFR 1.136, expired.

The applications should be carefully scrutinized by the appropriate examiner to verify that they are actually abandoned. A check should be made of files containing a decision of the Board of Patent Appeals and \*>Interferences< for the presence of allowed claims to avoid their being erroneously sent to the Files Repository.

Although the abandoned files are not pulled until the maximum permissible period for which an extension of time under 37 CFR 1.136(a) plus 1 month has expired, the date of the abandonment is after midnight of the date the period for reply actually expired. This is normally the end of the 3-month shortened statutory period.

#### **711.04(b) Ordering of Patented and Abandoned Files [R-2]**

In examination of an application it is sometimes necessary to inspect the application papers of a previously patented or abandoned application. It is always necessary to do so in the examination of a reissue application.

Recently patented and abandoned files are stored at the Files Repository located near the other USPTO buildings in Crystal City (Arlington, VA). Older files are housed in warehouses located off site (outside of Crystal City). >Image File Wrapper (IFW) applications are stored electronically and do not have a paper file wrapper to be stored. The electronic file is the official record of the application. See the IFW Manual section 3.7.<

Patented and abandoned files are ordered by means of a PALM video display transaction. To place such an order, the examiner is required to input his/her PALM location code, employee number, and patent number(s) and/or application number(s) of the file(s) that are needed. After transmission of the request transaction by the examiner, a “response” screen appears on the video display terminal which informs him/her of the status of the request for each file. The examiner is informed that the request is:

(A) accepted;

(B) accepted, but for which the file is stored at a warehouse off site (in which case delivery time is increased);

(C) not accepted since the file is not located at the repository or warehouse;

(D) not accepted since a previous request for the file has not yet been filled; or

(E) not accepted since the patent or application number inputted is not valid.

Periodically each day, personnel at the Files Repository perform a PALM print transaction which produces a list of all accepted requests in patent number order and, for requests for abandoned files, in application number order. The printed record of each request is detached from the list when its associated file is found. It is then stapled to it. Throughout the day, periodic deliveries of files are made directly to the offices of their requestors by Files Repository personnel. Upon delivery of files at the various locations, files that are ready to be returned to the repository are picked up. >For applications stored in IFW, this process is no longer necessary.<

With the exception of certain older files, the drawings of patented and abandoned files, if any, are now stored within their respective application file wrappers. Since it is desired not to separate one from the other, both the file and its drawings are delivered when a file is ordered. >For applications stored in IFW, it is no longer necessary to order or deliver the files.<

#### **711.04(c) Notifying Applicants of Abandonment**

The Patent Examining Corps currently mails to the correspondence address of record, a Notice of Abandonment form PTOL-1432 in all applications which become abandoned in the Corps for failure to prosecute. However, in no case will mere failure to receive a notice of abandonment affect the status of an abandoned application.

This procedure should enable applicants to take appropriate and diligent action to reinstate an application inadvertently abandoned for failure to timely reply to an official communication. In most cases, a petition to revive under 37 CFR 1.137 will be the appropriate remedy. It may be that a reply to the Office action was mailed to the Office with a certificate of mailing declaration as a part thereof (MPEP § 512) but was not received in the Office. In this instance, adequate relief may be available by means of a petition to withdraw the holding of abandonment.

In any instance, if action is not taken promptly after receiving the notice of abandonment, appropriate relief may not be granted. If a lack of diligent action is predicated on the contention that neither the Office action nor the notice of abandonment was received, one may presume that there is a problem with the correspondence address of record. Accordingly, attention is directed to MPEP § 402 and § 601.03 dealing with changes of address. In essence, it is imperative that a paper notifying the Office of a change of address be filed promptly in each application in which the correspondence address is to be changed (except as provided for under Customer Number practice — see MPEP § 403).

#### **711.05 Letter of Abandonment Received After Application Is Allowed**

Receipt of a letter of abandonment while an application is allowed is acknowledged by the Publishing Division.

An express abandonment arriving after the issue fee has been paid will not be accepted without a showing of one of the reasons indicated in 37 CFR 1.313(c), or else a showing under 37 CFR 1.183 justifying suspension of 37 CFR 1.313. See also MPEP § 711.01.

#### **711.06 Abstracts, Abbreviations, and Defensive Publications [R-2]**

>

##### **I. < ABSTRACTS**

Abstracts were prepared and published in accordance with the Notice of January 25, 1949, 619 O.G. 258. Each abstract includes a summary of the disclosure of the abandoned application, and in applications having drawings, a figure of the drawing. The publication of such abstracts was discontinued in 1953.

>

##### **II. < ABBREVIATURES**

Abbreviations were prepared and published in accordance with the procedure indicated in the Notice of October 13, 1964, 808 O.G. 1. Each abbreviation contains a specific portion of the disclosure of the abandoned application, preferably a detailed representative claim, and, in applications having drawings, a

figure of the drawing. The publication of such abbreviations was discontinued in 1965.

>

### III. < DEFENSIVE PUBLICATIONS

The Defensive Publication Program, which provided for the publication of the abstract of the technical disclosure of a pending application if the applicant waived his or her rights to an enforceable patent, was available between April 1968 and May 8, 1985. The program was ended in view of the applicant's ability to obtain a Statutory Invention Registration.

An application was laid open for public inspection under the Defensive Publication Program and the applicant provisionally abandoned the application, retaining rights to an interference for a limited period of 5 years from the earliest effective U.S. filing date.

The defensive publication of an application precluded a continuing application (divisional, continuation-in-part, or continuation) filed under 35 U.S.C. 120 from being entitled to the benefit of the filing date of the defensively published application unless a continuing application was filed within 30 months after the earliest effective U.S. filing date. Where a similar application was not filed until after expiration of the 30 month period, the application was examined, but it was not entitled to claim the benefit of the earlier filing date of the defensive publication application.

If a first continuing application was filed within 30 months from the earliest U.S. effective filing date of the application published under the Defensive Publication Program, later copending continuing applications (such as divisions if restriction is required during the prosecution of the first continuing application) were not barred and could be filed during the pendency of the first continuing application, even though beyond the 30 month period, without loss of the right to claim the benefit of the filing date of the Defensive Publication application.

The Defensive Publication Abstract and a selected figure of the drawing, if any, were published in the *Official Gazette*. Defensive Publication Search Copies, containing the defensive publication abstract and suitable drawings, if any, were provided for the application file, the Patent Search Room and the examiner's search files. A defensive publication is not a patent or an application publication under 35 U.S.C.

122(b); it is a publication. Therefore, it is prior art only as of its publication date. See MPEP § 2136.

The defensive publication application files are maintained in the File Information Unit (Record Room).

#### *Defensive Publication Number*

Distinct numbers are assigned to all Defensive Publications published December 16, 1969 through October 1980, for example.

T 869 001

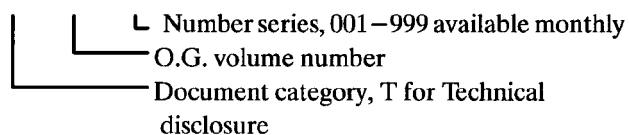

For Defensive Publications published on and after November 4, 1980, a different numbering system is used.

The revised numbering system is as follows:

T XXX XX

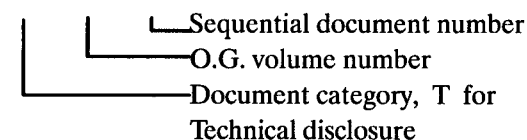

Defensive Publications are included in subclass lists and subscription orders. The distinct numbers are used for all official reference and document copy requirements.

A conversion table from the application serial number to the distinct number for all Defensive Publications published before December 16, 1969 appears at 869 O.G. 687.

### 711.06(a) Citation and Use of Abstracts, Abbreviations, and Defensive Publications as References [R-2]

It is important that abstracts, abbreviations, and defensive publications (O.G. Defensive Publication and Defensive Publication Search Copy) be referred to as publications.

These printed publications are cited as prior art under 35 U.S.C. 102(a) or 102(b) effective from the date of publication in the *Official Gazette*. See *Ex*

*parte Osmond*, 191 USPQ 334 (Bd. App. 1973) and *Ex Parte Osmond*, 191 USPQ 340 (Bd. App. 1976). See also MPEP § 2136.

An application or portion thereof from which an abstract, abbreviation or defensive publication has been prepared \*\* may be used as a reference under 35 U.S.C.102(a), effective from the actual date of filing in the United States, only for evidence of prior knowledge of another.

These publications may be used alone or in combination with other prior art in rejecting claims under 35 U.S.C. 102 and 103.

Defensive Publications are listed with “U.S. Patent Documents.” Abstracts and Abbreviations are listed under “Other References” in the citation thereof as follows:

(A) Abstracts and Abbreviations

Brown, (abstract or abbreviation) of Serial No. ...., filed ....., published in O.G. ...., on ....., (list classification).

(B) Applications or designated portions thereof, abstracts, abbreviations, and defensive publications

Jones, Application Serial No. ...., filed ....., laid open to public inspection on ..... as noted at ..... O.G. (portion of application relied on), (list classification, if any).

## 713 Interviews

The personal appearance of an applicant, attorney, or agent before the examiner or a telephone conversation or video conference or electronic mail between such parties presenting matters for the examiner’s consideration is considered an interview.

### 713.01 General Policy, How Conducted [R-2]

37 CFR 1.133. *Interviews.*

\*\*>

(a)(1) Interviews with examiners concerning applications and other matters pending before the Office must be conducted on Office premises and within Office hours, as the respective examiners may designate. Interviews will not be permitted at any other time or place without the authority of the Director.<

(2) An interview for the discussion of the patentability of a pending application will not occur before the first Office action, unless the application is a continuing or substitute application.

(3) The examiner may require that an interview be scheduled in advance.

(b) In every instance where reconsideration is requested in view of an interview with an examiner, a complete written statement of the reasons presented at the interview as warranting favorable action must be filed by the applicant. An interview does not remove the necessity for reply to Office actions as specified in §§ 1.111 and 1.135.

Interviews must be conducted on the Office premises, such as in examiner’s offices, conference rooms or the video conference center.

Interviews are permissible \*\*> during normal business hours on Monday through Friday except the hours in which the examiner is working overtime.<

>

#### I. <SPECIAL PROCEDURES FOR USING INTERNET ELECTRONIC MAIL

Internet e-mail shall NOT be used to conduct an exchange or communications similar to those exchanged during telephone or personal interviews unless a written authorization > from the applicants or an attorney/agent of record< has been given to use Internet e-mail. See MPEP § 502.03. In such cases, a paper copy of the Internet e-mail contents MUST be made and placed in the patent application file as required by the Federal Records Act in the same manner as an Examiner Interview Summary Form is entered.

>

#### II. <VIDEO CONFERENCE CENTER

In the interest of providing better service to its customers, the U.S. Patent and Trademark Office (USPTO) has established a Video Conference Center (VCC) to expedite patent and trademark prosecution. The VCC is presently administered by the Patent Academy and is available for authorized official business during normal business hours (8:30 AM - 5:00 PM, EST). The VCC equipment includes a high resolution document camera, direct computer input, VCR display capability, and a high speed, high resolution G-4 facsimile machine. The Patent and Trademark Depository Library Program office maintains a current list of all the off-site locations where a video conference may be held. At this time, use of the VCC will be limited to our partnership Patent and Trademark Depository Libraries (PTDLs) located at Sunnyvale, Calif. and the Great Lakes Patent and Trademark Center at the Detroit Public Library, which have duplicate

video equipment. Customers wishing to utilize the facilities at the above noted PTDLs, rather than coming to the USPTO for a face-to-face interview, should contact the patent examiner \*\* and identify two alternative dates and times for a video conference. The patent examiner \*\* will then contact Patent Academy personnel who will, in turn, make all the arrangements. The customer will be notified as to the date and time of the video conference >by Office personnel<.

>

### III. <SCHEDULING AND CONDUCTING AN INTERVIEW

An interview should normally be arranged for in advance, as by letter, facsimile, electronic mail, telegram or telephone call, in order to insure that the primary examiner and/or the examiner in charge of the application will be present and available in the Office. When applicant is initiating a request for an interview, an "Applicant Initiated Interview Request" form (PTOL-413A) should be submitted to the examiner prior to the interview in order to permit the examiner to prepare in advance for the interview and to focus on the issues to be discussed. This form should identify the participants of the interview, the proposed date of the interview, whether the interview will be personal, telephonic, or video conference, and should include a brief description of the issues to be discussed. A copy of the completed "Applicant Initiated Interview Request" form should be attached to the Interview Summary form, PTOL-413 at the completion of the interview and a copy should be given to applicant or applicant's representative. >Applicants are encouraged to use form PTO-413A, however, the fact that applicant does not submit an "Applicant Initiated Interview Request" form is not, by itself, grounds for the examiner to deny a request for an interview.< An interview in the Video Conference Center must be arranged at least 3 days in advance. When a second art unit is involved (Patentability Report), the availability of the second examiner should also be checked. \*See MPEP § 705.01(f).\* An appointment for interview once arranged should be kept. Many applicants and attorneys plan trips to Washington or off-site video conferencing locations in reliance upon such appointments. When, after an appointment has been made, circumstances compel

the absence of the examiner or examiners necessary to an effective interview, the other party should be notified immediately so that substitute arrangements may be made.

When a telephone call is made to an examiner and it becomes evident that a lengthy discussion will ensue or that the examiner needs time to restudy the situation, the call should be terminated with an agreement that the examiner will call back at a specified time. Such a call and all other calls originated by the examiner should be made through the \*\*>Office's telephone system< even though a collect call had been authorized. It is helpful if amendments and other papers, such as the letter of transmittal, include the complete telephone number with area code and extension, preferably near the signature of the writer.

The unexpected appearance of an attorney or applicant requesting an interview without any previous notice to the examiner may well justify his or her refusal of the interview at that time, particularly in an involved case.

An examiner's suggestion of allowable subject matter may justify indicating the possibility of an interview to accelerate early agreement on allowable claims.

An interview should be had only when the nature of the case is such that the interview could serve to develop and clarify specific issues and lead to a mutual understanding between the examiner and the applicant, and thereby advance the prosecution of the application. Thus, the attorney when presenting himself or herself for an interview should be fully prepared to discuss the issues raised in the Office action. When it is obvious that the attorney is not so prepared, an interview should not be permitted. It is desirable that the attorney or applicant indicate in advance what issues he or she desires to discuss at the interview by submitting, in writing, a proposed amendment. This would permit the examiner to prepare in advance for the interview and to focus on the matters set forth in the proposed amendment.

Examiners should avoid unnecessary interruptions during interviews with attorneys or inventors. In this regard, examiners should \*\* not \*>take< incoming telephone calls unless such are of an emergency nature. As appropriate, examiners should familiarize themselves with the status and existing issues in an

application or reexamination proceeding before an interview.

The examiner should not hesitate to state, if such be the case, that claims presented for consideration at the interview require further search and study. Nor should the examiner hesitate to conclude an interview when it appears that no common ground can be reached nor when it becomes apparent that the application requires further amendment or an additional action by the examiner. However, the examiner should attempt to identify issues and resolve differences during the interview as much as possible.

It is the responsibility of both parties to the interview to see that it is not extended beyond a reasonable period, usually not longer than 30 minutes. It is the duty of the primary examiner to see that an interview is not extended beyond a reasonable period even when he or she does not personally participate in the interview.

During an interview with an applicant who is prosecuting his or her own case and is not familiar with Office procedure the examiner may make suggestions that will advance the prosecution of this case; this lies wholly within his or her discretion. Too much time, however, should not be allowed for such interviews.

Examiners may grant one interview after final rejection. See MPEP § 713.09.

Where the reply to a first complete action includes a request for an interview, a telephone consultation to be initiated by the examiner or a video conference, or where an out-of-town attorney under similar circumstances requests that the examiner defer taking any further action on the case until the attorney's next visit to Washington (provided such visit is not beyond the date when the Office action would normally be given), the examiner, as soon as he or she has considered the effect of the reply, should grant such request if it appears that the interview or consultation would result in expediting the case to a final action.

Where agreement is reached as a result of an interview, applicant's representative should be advised that an amendment pursuant to the agreement should be promptly submitted. If the amendment prepares the case for final action, the examiner should take the case up as special. If not, the case should await its turn.

Consideration of a filed amendment may be had by hand delivery of a duplicate copy of \*>the< amendment.

Early communication of the results of the consideration should be made to applicant; if requested, indicate on attorney's copy any agreement; initial and date both copies.

Although entry of amendatory matter usually requires actual presence of the original paper, examiner and technical support staff processing should proceed as far as practicable based on the duplicate copy. The extent of processing will depend on each amendment. >For Image File Wrapper (IFW) processing, see IFW Manual section 3.5.<

The substance of any interview, whether in person, by video conference, by electronic mail or by telephone must be made of record in the application. See MPEP § 502.03 and § 713.04.

>

#### **IV. <VIEWING OF VIDEO TAPES DURING INTERVIEWS**

The U.S. Patent and Trademark Office has video tape equipment available in the facilities of the Patent Academy for viewing video tapes from applicants during interviews with patent examiners.

The video tape equipment may use VHS and UHS (3/4-inch tape) cassettes.

Attorneys or applicants wishing to show a video tape during an examiner interview must be able to demonstrate that the content of the video tape has a bearing on an outstanding issue in the application and its viewing will advance the prosecution of the application. Prior approval of viewing of a video tape during an interview must be granted by the supervisory patent examiner. Also, use of the room and equipment must be granted by the Training Manager to avoid any conflict with the Patent Academy.

Requests to use video tape viewing equipment for an interview should be made at least 1 week in advance to allow the Patent Academy staff sufficient time to ensure the availability and proper scheduling of both a room and equipment.

Interviews using Office video tape equipment will be held only in the Patent Academy facilities located in Crystal Square Four, Suite 700, 1745 Jefferson Davis Highway, Arlington, VA 22202. Attorneys or applicants should not contact the Patent Academy

directly regarding availability and scheduling of video equipment. All scheduling of rooms and equipment should be done through and by the examiner conducting the interview. The substance of the interview, including a summary of the content of the video tape must be made of record in the application. See MPEP § 713.04.

>

**V. <EXAMINATION BY EXAMINER  
OTHER THAN THE ONE WHO  
CONDUCTED THE INTERVIEW**

Sometimes the examiner who conducted the interview is transferred to another Technology Center or

resigns, and the examination is continued by another examiner. If there is an indication that an interview had been held, the second examiner should ascertain if any agreements were reached at the interview. Where conditions permit, as in the absence of a clear error or knowledge of other prior art, the second examiner should take a position consistent with the agreements previously reached. See MPEP § 812.01 for a statement of telephone practice in restriction and election of species situations.

PTOL-413A (12-02)  
Approved for use through xx/xx/xxxx. OMB 0851-0031  
U.S. Patent and Trademark Office: U.S. DEPARTMENT OF COMMERCE

### Applicant Initiated Interview Request Form

Application No.: \_\_\_ / \_\_\_ / \_\_\_ First Named Applicant: \_\_\_\_\_  
 Examiner: \_\_\_\_\_ Art Unit: \_\_\_\_\_ Status of Application: \_\_\_\_\_

**Tentative Participants:**

(1) \_\_\_\_\_ (2) \_\_\_\_\_  
 (3) \_\_\_\_\_ (4) \_\_\_\_\_

Proposed Date of Interview: \_\_\_\_\_ Proposed Time: \_\_\_\_\_ (AM/PM)

**Type of Interview Requested:**

(1)  Telephonic (2)  Personal (3)  Video Conference

Exhibit To Be Shown or Demonstrated:  YES  NO

If yes, provide brief description: \_\_\_\_\_

### Issues To Be Discussed

Issues (Rej., Obj., etc)	Claims/ Fig. #s	Prior Art	Discussed	Agreed	Not Agreed
(1) _____	_____	_____	<input type="checkbox"/>	<input type="checkbox"/>	<input type="checkbox"/>
(2) _____	_____	_____	<input type="checkbox"/>	<input type="checkbox"/>	<input type="checkbox"/>
(3) _____	_____	_____	<input type="checkbox"/>	<input type="checkbox"/>	<input type="checkbox"/>
(4) _____	_____	_____	<input type="checkbox"/>	<input type="checkbox"/>	<input type="checkbox"/>

Continuation Sheet Attached

**Brief Description of Arguments to be Presented:**

\_\_\_\_\_  
 \_\_\_\_\_  
 \_\_\_\_\_

An interview was conducted on the above-identified application on \_\_\_\_\_.

**NOTE:**

This form should be completed by applicant and submitted to the examiner in advance of the interview (see MPEP § 713.01).

This application will not be delayed from issue because of applicant's failure to submit a written record of this interview. Therefore, applicant is advised to file a statement of the substance of this interview (37 CFR 1.133(b)) as soon as possible.

\_\_\_\_\_  
 (Applicant/Applicant's Representative Signature)

\_\_\_\_\_  
 (Examiner/SPE Signature)

This collection of information is required by 37 CFR 1.133. The information is required to obtain or retain a benefit by the public which is to file (and by the USPTO to process) an application. Confidentiality is governed by 35 U.S.C. 122 and 37 CFR 1.14. This collection is estimated to take 21 minutes to complete, including gathering, preparing, and submitting the completed application form to the USPTO. Time will vary depending upon the individual case. Any comments on the amount of time you require to complete this form and/or suggestions for reducing this burden, should be sent to the Chief Information Officer, U.S. Patent and Trademark Office, U.S. Department of Commerce, Washington, DC 20231. DO NOT SEND FEES OR COMPLETED FORMS TO THIS ADDRESS. SEND TO: Commissioner for Patents, Washington, DC 20231.

*If you need assistance in completing the form, call 1-800-PTO-9199 and select option 2.*



## 713.02 Interviews Prior to First Official Action [R-1]

Prior to filing, no interview is permitted. However, in the examiner's discretion, a limited amount of time may be spent in indicating the field of search to an attorney, searcher or inventor.

A request for an interview prior to the first Office action is ordinarily granted in continuing or substitute applications. A request for an interview in all other applications before the first action is untimely and will not be acknowledged if written, or granted if oral. 37 CFR 1.133(a).

### SEARCHING IN GROUP

Search in the Technology Center art unit should be permitted only with the consent of a primary examiner.

### EXPOUNDING PATENT LAW

The U.S. Patent and Trademark Office cannot act as an expounder of the patent law, nor as a \*>counselor< for individuals.

## 713.03 Interview for "Sounding Out" Examiner Not Permitted

Interviews that are solely for the purpose of "sounding out" the examiner, as by a local attorney acting for an out-of-town attorney, should not be permitted when it is apparent that any agreement that would be reached is conditional upon being satisfactory to the principal attorney.

## 713.04 Substance of Interview Must Be Made of Record [R-2]

A complete written statement as to the substance of any face-to-face, video conference, electronic mail or telephone interview with regard to the merits of an application must be made of record in the application, whether or not an agreement with the examiner was reached at the interview. See 37 CFR 1.133(b), MPEP § 502.03 and § 713.01.

37 CFR 1.133. Interviews.

\*\*\*\*\*

(b) In every instance where reconsideration is requested in view of an interview with an examiner, a complete written state-

ment of the reasons presented at the interview as warranting favorable action must be filed by the applicant. An interview does not remove the necessity for reply to Office actions as specified in §§ 1.111 and 1.135.

37 CFR 1.2. *Business to be transacted in writing.*

All business with the Patent and Trademark Office should be transacted in writing. The personal attendance of applicants or their attorneys or agents at the Patent and Trademark Office is unnecessary. The action of the Patent and Trademark Office will be based exclusively on the written record in the Office. No attention will be paid to any alleged oral promise, stipulation, or understanding in relation to which there is disagreement or doubt.

The action of the U.S. Patent and Trademark Office cannot be based exclusively on the written record in the Office if that record is itself incomplete through the failure to record the substance of interviews.

It is the responsibility of the applicant or the attorney or agent to make the substance of an interview of record in the application file, except where the interview was initiated by the examiner and the examiner indicated on the "Examiner Initiated Interview Summary" form (PTOL-413B) that the examiner will provide a written summary. It is the examiner's responsibility to see that such a record is made and to correct material inaccuracies which bear directly on the question of patentability.

Examiners must complete an Interview Summary form PTOL-413 for each interview where a matter of substance has been discussed during the interview by checking the appropriate boxes and filling in the blanks. If applicant initiated the interview, a copy of the completed "Applicant Initiated Interview Request" form, PTOL-413A (if available), should be attached to the Interview Summary form, PTOL-413 and a copy be given to the applicant (or applicant's attorney or agent), upon completion of the interview. If the examiner initiates an interview, the examiner should complete part I of the "Examiner Initiated Interview Summary" form, PTOL-413B, in advance of the interview identifying the rejections, claims and prior art documents to be discussed with applicant. The examiner should complete parts II and III of the "Examiner Initiated Interview Summary" form at the conclusion of the interview. The completed PTOL-413B form will be considered a proper interview summary record and it will not be necessary for the examiner to complete a PTOL-413 form. Discussions regarding only procedural matters, directed solely to restriction requirements for which interview

recordation is otherwise provided for in MPEP § 812.01, or pointing out typographical errors in Office actions or the like, are excluded from the interview recordation procedures below. Where a complete record of the interview has been incorporated in an examiner's amendment, it will not be necessary for the examiner to complete an Interview Summary form.

The Interview Summary form PTOL 413 shall be given an appropriate paper number, placed in the right hand portion of the file, and listed on the "Contents" list on the file wrapper. >For Image File Wrapper (IFW) processing, see IFW Manual.< In a personal interview, the duplicate copy of the Interview Summary form along with any attachment(s) is given to the applicant (or attorney or agent) at the conclusion of the interview. In the case of a telephonic, electronic mail or video conference interview, the copy is mailed to the applicant's correspondence address either with or prior to the next official communication. In addition, a copy of the form may be faxed to applicant (or applicant's attorney or agent) at the conclusion of the interview. If additional correspondence from the examiner is not likely before an allowance or if other circumstances dictate, the Interview Summary form should be mailed promptly after the telephonic, electronic mail or video conference interview rather than with the next official communication.

The PTOL-413 form provides for recordation of the following information:

- (A) application number;
- (B) name of applicant;
- (C) name of examiner;
- (D) date of interview;
- (E) type of interview (personal, telephonic, electronic mail or video conference);
- (F) name of participant(s) (applicant, attorney, or agent, etc.);
- (G) an indication whether or not an exhibit was shown or a demonstration conducted;
- (H) an identification of the claims discussed;
- (I) an identification of the specific prior art discussed;
- (J) an indication whether an agreement was reached and if so, a description of the general nature of the agreement (may be by attachment of a copy of amendments or claims agreed as being allowable). (Agreements as to allowability are tentative and do

not restrict further action by the examiner to the contrary.);

(K) the signature of the examiner who conducted the interview;

(L) names of other U.S. Patent and Trademark Office personnel present.

The PTOL-413 form also contains a statement reminding the applicant of his or her responsibility to record the substance of the interview.

It is desirable that the examiner orally remind the applicant of his or her obligation to record the substance of the interview in each case unless the interview was initiated by the examiner and the examiner indicated on the "Examiner Initiated Interview Summary" form, PTOL-413B, that the examiner will provide a written summary.

Where an interview initiated by the applicant results in the allowance of the application, the applicant is advised to file a written record of the substance of the interview as soon as possible to prevent any possible delays in the issuance of a patent. Where an examiner initiated interview directly results in the allowance of the application, the examiner may check the appropriate box on the "Examiner Initiated Interview Summary" form, PTOL-413B, to indicate that the examiner will provide a written record of the substance of the interview with the Notice of Allowability.

It should be noted, however, that the Interview Summary form will not be considered a complete and proper recordation of the interview unless it includes, or is supplemented by the applicant, or the examiner to include, all of the applicable items required below concerning the substance of the interview.

The complete and proper recordation of the substance of any interview should include at least the following applicable items:

- (A) a brief description of the nature of any exhibit shown or any demonstration conducted;
- (B) identification of the claims discussed;
- (C) identification of specific prior art discussed;
- (D) identification of the principal proposed amendments of a substantive nature discussed, unless these are already described on the Interview Summary form completed by the examiner;
- (E) the general thrust of the principal arguments of the applicant and the examiner should

also be identified, even where the interview is initiated by the examiner. The identification of arguments need not be lengthy or elaborate. A verbatim or highly detailed description of the arguments is not required. The identification of the arguments is sufficient if the general nature or thrust of the principal arguments can be understood in the context of the application file. Of course, the applicant may desire to emphasize and fully describe those arguments which he or she feels were or might be persuasive to the examiner;

(F) a general indication of any other pertinent matters discussed;

(G) if appropriate, the general results or outcome of the interview; and

(H) in the case of an interview via electronic mail, a paper copy of the Internet e-mail contents **MUST** be made and placed in the patent application file as required by the Federal Records Act in the same manner as an Examiner Interview Summary Form, PTOL 413, is entered.

Examiners are expected to carefully review the applicant's record of the substance of an interview. If the record is not complete or accurate, the examiner may give the applicant a 1-month time period to complete the reply under 37 CFR 1.135(c) where the record of the substance of the interview is in a reply to a nonfinal Office action.

#### *¶ 7.84 Amendment Is Non-Responsive to Interview*

The reply filed on [1] is not fully responsive to the prior Office action because it fails to include a complete or accurate record of the substance of the [2] interview. [3] Since the above-mentioned reply appears to be *bona fide*, applicant is given a TIME PERIOD of **ONE (1) MONTH or THIRTY (30) DAYS** from the mailing date of this notice, whichever is longer, within which to supply the omission or correction in order to avoid abandonment. **EXTENSIONS OF THIS TIME PERIOD MAY BE GRANTED UNDER 37 CFR 1.136(a).**

#### **Examiner Note:**

1. In bracket 2, insert the date of the interview.
2. In bracket 3, explain the deficiencies.

#### **EXAMINER TO CHECK FOR ACCURACY**

Applicant's summary of what took place at the interview should be carefully checked to determine the accuracy of any argument or statement attributed to the examiner during the interview. If there is an inaccuracy and it bears directly on the question of patentability, it should be pointed out in the next Office letter. If the claims are allowable for other reasons of record, the examiner should send a letter setting forth his or her version of the statement attributed to him or her.

If the record is complete and accurate, the examiner should place the indication "Interview record OK" on the paper recording the substance of the interview along with the date and the examiner's initials. >For Image File Wrapper (IFW) processing, see IFW Manual.<

### Examiner Initiated Interview Summary

Application No.: \_\_\_\_\_ / \_\_\_\_\_      First Named Applicant: \_\_\_\_\_  
 Examiner: \_\_\_\_\_      Art Unit: \_\_\_\_\_      Status of Application: \_\_\_\_\_

**All Participants:**

(1) \_\_\_\_\_ (2) \_\_\_\_\_

(3) \_\_\_\_\_ (4) \_\_\_\_\_

Date of Interview: \_\_\_\_\_ Time: \_\_\_\_\_ (AM/PM)

**Type of Interview:**

(1)  Telephonic      (2)  Video Conference  
 (3)  Personal (Copy given to:  Applicant or  Applicant's representative)

Exhibit Shown or Demonstrated:  YES       NO

If yes, provide brief description: \_\_\_\_\_

**Part I.**

**Rejection(s) to be discussed:**

- (1)  
(2)  
(3)  
(4)

**Claims to be discussed:**

**Prior art documents to be discussed:**

- (1)  
(2)  
(3)  
(4)

**Part II.**

**SUBSTANCE OF INTERVIEW DESCRIBING THE GENERAL NATURE OF WHAT WAS DISCUSSED:**

Continuation Sheet attached

**Part III.**

It is not necessary for applicant to provide a separate record of the substance of the interview, since the interview directly resulted in the allowance of the application. The examiner will provide a written summary of the substance of the interview in the Notice of Allowability.

It is not necessary for applicant to provide a separate record of the substance of the interview, since the interview did not result in resolution of all issues. A brief summary by the examiner appears in Part II. above.

\_\_\_\_\_  
 (Examiner/SPE Signature)

\_\_\_\_\_  
 (Applicant/Applicant's Representative Signature -- if appropriate)

## 713.05 Interviews Prohibited or Granted, Special Situations [R-2]

>For< Saturday interviews, see MPEP § 713.01.

Except in unusual situations, no interview is permitted after the brief on appeal is filed or after an application has been passed to issue.

An interview may be appropriate before applicant's first reply when the examiner has suggested that allowable subject matter is present or where it will assist applicant in judging the propriety of continuing the prosecution.

Office employees are forbidden to hold either oral or written communication with an unregistered or a suspended or excluded attorney or agent regarding an application unless it is one in which said attorney or agent is the applicant. See MPEP § 105.

Interviews (MPEP § 713) are frequently requested by persons whose credentials are of such informal character that there is serious question as to whether such persons are entitled to any information under the provisions of 37 CFR 1.14. In general, interviews are not granted to persons who lack proper authority from the applicant or attorney or agent of record in the form of a paper on file in the application \*\*. A MERE POWER TO INSPECT IS NOT SUFFICIENT AUTHORITY FOR GRANTING AN INTERVIEW INVOLVING THE MERITS OF THE APPLICATION.

\*\*>Interviews are generally not< granted to registered individuals who are known to be the local representatives of the attorney in the application \*\*>unless< a power of attorney to them is \* of record in the particular application. \*\*>Note that pursuant to 37 CFR 10.57(c), a practitioner cannot authorize other registered practitioners to conduct interviews without consent of the client after full disclosure. Furthermore, a practitioner can not authorize a nonpractitioner to conduct interviews since this would be contrary to 37 CFR 10.47.<

While a registered practitioner not of record may request a telephone interview (if the practitioner is authorized to do so by the applicant or the attorney of record), it is recommended that a facsimile transmission of a power of attorney be filed prior to the interview. Otherwise, the examiner will conduct the

telephone interview with the Office's file closed and work solely from the practitioner's file, which may be difficult to do over the phone.

Interviews normally should not be granted unless the requesting party has authority to bind the principal concerned.

The availability of personal interviews in the "Conference Period," which is the time between the filing of applicant's thorough first reply and a concluding action by the examiner, for attorneys resident or frequently in the Washington, D.C. area is obvious. For others, more remote, telephone, electronic mail, or video conference interviews may prove valuable. However, present Office policy places great emphasis on telephone interviews initiated by the examiner to attorneys and agents of record. See MPEP § 408.

The examiner, by making a telephone call, may be able to suggest minor, probably quickly acceptable changes which would result in allowance. If there are *major* questions or suggestions, the call might state them concisely, and suggest a further telephone, electronic mail, or personal interview, at a prearranged later time, giving applicant more time for consideration before discussing the points raised.

For an interview with an examiner who does not have negotiation authority, arrangements should always include an examiner who does have such authority, and who is familiar with the application, so that authoritative agreement may be reached at the time of the interview.

### GROUPED INTERVIEWS

For attorneys remote from the Washington, D.C. area who prefer personal or video conference interviews, the grouped interview practice is effective. If in any case there is a prearranged interview, *with agreement to file a prompt supplemental amendment putting the case as nearly as may be in condition for concluding action*, prompt filing of the supplemental amendment gives the application special status, and brings it up for immediate special action.

### 713.06 No *Inter Partes* Questions Discussed *Ex Parte*

The examiner may not discuss *inter partes* questions *ex parte* with any of the interested parties.

### 713.07 Exposure of Other Cases

Prior to an interview in the examiner's room, the examiner should arrange his or her desk so that all files, drawings and other papers, except those necessary in the interview, are placed out of view. See MPEP § 101.

### 713.08 Demonstration, Exhibits, Models [R-2]

The invention in question may be exhibited or demonstrated during the interview by a model thereof. A model received by the examiner from the applicant or his or her attorney which complies with 37 CFR 1.91 and which is made part of the application record must be properly recorded on the "Contents" portion of the application file wrapper. See MPEP § 608.03 and § 608.03(a). >For Image File Wrapper (IFW) processing, see IFW Manual section 3.6.<

Oftentimes a model or exhibit is not given into the custody of the Office but is brought directly into the \*>Technology Center< by the attorney solely for inspection or demonstration during the course of the interview. This is permissible. If the model or exhibit is merely used for demonstration purpose and is not made part of the record (does not comply with 37 CFR 1.91), a full description as to what was demonstrated/exhibited must be made of record in the application. See 37 CFR 1.133(b). Demonstrations of apparatus or exhibits too large to be brought into the Office may be viewed by the examiner outside of the Office (in the Washington, D.C. area) with the approval of the supervisory patent examiner. It is presumed that the witnessing of the demonstration or the reviewing of the exhibit is actually essential in the developing and clarifying of the issues involved in the application.

### 713.09 Finally Rejected Application

Normally, one interview after final rejection is permitted. However, prior to the interview, the intended purpose and content of the interview should be presented briefly, preferably in writing. Such an interview may be granted if the examiner is convinced that disposal or clarification for appeal may be accomplished with only nominal further consideration. Interviews merely to restate arguments of record or to discuss new limitations which would require more

than nominal reconsideration or new search should be denied. See MPEP § 714.13.

Interviews may be held after the expiration of the shortened statutory period and prior to the maximum permitted statutory period of 6 months without an extension of time. See MPEP § 706.07(f).

A second or further interview after a final rejection may be held if the examiner is convinced that it will expedite the issues for appeal or disposal of the application.

### 713.10 Interview Preceding Filing Amendment Under 37 CFR 1.312

After an application is sent to issue, it is technically no longer under the jurisdiction of the primary examiner. 37 CFR 1.312. An interview with an examiner that would involve a detailed consideration of claims sought to be entered and perhaps entailing a discussion of the prior art for determining whether or not the claims are allowable should not be given. Obviously an applicant is not entitled to a greater degree of consideration in an amendment presented informally than is given an applicant in the consideration of an amendment when formally presented, particularly since consideration of an amendment filed under 37 CFR 1.312 cannot be demanded as a matter of right.

Requests for interviews on cases where a notice of allowance has been mailed should be granted only with specific approval of the Technology Center Director upon a showing in writing of extraordinary circumstances.

## 714 Amendments, Applicant's Action [R-2]

\*\*>

*37 CFR 1.121. Manner of making amendments in application.*

(a) *Amendments in applications, other than reissue applications.* Amendments in applications, other than reissue applications, are made by filing a paper, in compliance with § 1.52, directing that specified amendments be made.

(b) *Specification.* Amendments to the specification, other than the claims, computer listings (§ 1.96) and sequence listings (§ 1.825), must be made by adding, deleting or replacing a paragraph, by replacing a section, or by a substitute specification, in the manner specified in this section.

(1) *Amendment to delete, replace, or add a paragraph.* Amendments to the specification, including amendment to a section heading or the title of the invention which are considered for amendment purposes to be an amendment of a paragraph, must be made by submitting:

(i) An instruction, which unambiguously identifies the location, to delete one or more paragraphs of the specification, replace a paragraph with one or more replacement paragraphs, or add one or more paragraphs;

(ii) The full text of any replacement paragraph with markings to show all the changes relative to the previous version of the paragraph. The text of any added subject matter must be shown by underlining the added text. The text of any deleted matter must be shown by strike-through except that double brackets placed before and after the deleted characters may be used to show deletion of five or fewer consecutive characters. The text of any deleted subject matter must be shown by being placed within double brackets if strikethrough cannot be easily perceived;

(iii) The full text of any added paragraphs without any underlining; and

(iv) The text of a paragraph to be deleted must not be presented with strike-through or placed within double brackets. The instruction to delete may identify a paragraph by its paragraph number or include a few words from the beginning, and end, of the paragraph, if needed for paragraph identification purposes.

(2) *Amendment by replacement section.* If the sections of the specification contain section headings as provided in § 1.77(b), § 1.154(b), or § 1.163(c), amendments to the specification, other than the claims, may be made by submitting:

(i) A reference to the section heading along with an instruction, which unambiguously identifies the location, to delete that section of the specification and to replace such deleted section with a replacement section; and

(ii) A replacement section with markings to show all changes relative to the previous version of the section. The text of any added subject matter must be shown by underlining the added text. The text of any deleted matter must be shown by strike-through except that double brackets placed before and after the deleted characters may be used to show deletion of five or fewer consecutive characters. The text of any deleted subject matter must be shown by being placed within double brackets if strike-through cannot be easily perceived.

(3) *Amendment by substitute specification.* The specification, other than the claims, may also be amended by submitting:

(i) An instruction to replace the specification; and

(ii) A substitute specification in compliance with §§ 1.125(b) and (c).

(4) *Reinstatement of previously deleted paragraph or section.* A previously deleted paragraph or section may be reinstated only by a subsequent amendment adding the previously deleted paragraph or section.

(5) *Presentation in subsequent amendment document.* Once a paragraph or section is amended in a first amendment document, the paragraph or section shall not be represented in a subsequent amendment document unless it is amended again or a substitute specification is provided.

(c) *Claims.* Amendments to a claim must be made by rewriting the entire claim with all changes (*e.g.*, additions and deletions) as indicated in this subsection, except when the claim is being canceled. Each amendment document that includes a change to an existing claim, cancellation of an existing claim or addition of a new claim, must include a complete listing of all claims ever presented, including the text of all pending and withdrawn claims, in the application. The claim listing, including the text of the claims, in the amendment document will serve to replace all prior versions of the claims, in the application. In the claim listing, the status of every claim must be indicated after its claim number by using one of the following identifiers in a parenthetical expression: (Original), (Currently amended), (Canceled), (Withdrawn), (Previously presented), (New), and (Not entered).

(1) *Claim listing.* All of the claims presented in a claim listing shall be presented in ascending numerical order. Consecutive claims having the same status of “canceled” or “not entered” may be aggregated into one statement (*e.g.*, Claims 1–5 (canceled)). The claim listing shall commence on a separate sheet of the amendment document and the sheet(s) that contain the text of any part of the claims shall not contain any other part of the amendment.

(2) *When claim text with markings is required.* All claims being currently amended in an amendment paper shall be presented in the claim listing, indicate a status of “currently amended,” and be submitted with markings to indicate the changes that have been made relative to the immediate prior version of the claims. The text of any added subject matter must be shown by underlining the added text. The text of any deleted matter must be shown by strike-through except that double brackets placed before and after the deleted characters may be used to show deletion of five or fewer consecutive characters. The text of any deleted subject matter must be shown by being placed within double brackets if strike-through cannot be easily perceived. Only claims having the status of “currently amended,” or “withdrawn” if also being amended, shall include markings. If a withdrawn claim is currently amended, its status in the claim listing may be identified as “withdrawn— currently amended.”

(3) *When claim text in clean version is required.* The text of all pending claims not being currently amended shall be presented in the claim listing in clean version, *i.e.*, without any markings in the presentation of text. The presentation of a clean version of any claim having the status of “original,” “withdrawn” or “previously presented” will constitute an assertion that it has not been changed relative to the immediate prior version, except to omit markings that may have been present in the immediate prior version of the claims of the status of “withdrawn” or “previously presented.” Any claim added by amendment must be indicated with the status of “new” and presented in clean version, *i.e.*, without any underlining.

(4) *When claim text shall not be presented; canceling a claim.*

(i) No claim text shall be presented for any claim in the claim listing with the status of “canceled” or “not entered.”

(ii) Cancellation of a claim shall be effected by an instruction to cancel a particular claim number. Identifying the

status of a claim in the claim listing as “canceled” will constitute an instruction to cancel the claim.

(5) *Reinstatement of previously canceled claim.* A claim which was previously canceled may be reinstated only by adding the claim as a “new” claim with a new claim number.

(d) *Drawings.* One or more application drawings shall be amended in the following manner: Any changes to an application drawing must be in compliance with § 1.84 and must be submitted on a replacement sheet of drawings which shall be an attachment to the amendment document and, in the header, labeled “Replacement Sheet.” Any replacement sheet of drawings shall include all of the figures appearing on the immediate prior version of the sheet, even if only one figure is amended. All changes to the drawing(s) shall be explained, in detail, in either the drawing amendment or remarks section of the amendment paper.

(1) A marked-up copy of any amended drawing figure, including annotations indicating the changes made, may be included. The marked-up copy must be clearly labeled as “Annotated Marked-up Drawings” and must be presented in the amendment or remarks section that explains the change to the drawings.

(2) A marked-up copy of any amended drawing figure, including annotations indicating the changes made, must be provided when required by the examiner.

(e) *Disclosure consistency.* The disclosure must be amended, when required by the Office, to correct inaccuracies of description and definition, and to secure substantial correspondence between the claims, the remainder of the specification, and the drawings.

(f) *No new matter.* No amendment may introduce new matter into the disclosure of an application.

(g) *Exception for examiner’s amendments.* Changes to the specification, including the claims, of an application made by the Office in an examiner’s amendment may be made by specific instructions to insert or delete subject matter set forth in the examiner’s amendment by identifying the precise point in the specification or the claim(s) where the insertion or deletion is to be made. Compliance with paragraphs (b)(1), (b)(2), or (c) of this section is not required.

(h) *Amendment sections.* Each section of an amendment document (e.g., amendment to the claims, amendment to the specification, replacement drawings, and remarks) must begin on a separate sheet.

(i) *Amendments in reissue applications.* Any amendment to the description and claims in reissue applications must be made in accordance with § 1.173.

(j) *Amendments in reexamination proceedings.* Any proposed amendment to the description and claims in patents involved in reexamination proceedings must be made in accordance with § 1.530.

(k) *Amendments in provisional applications.* Amendments in provisional applications are not usually made. If an amendment is made to a provisional application, however, it must comply with the provisions of this section. Any amendments to a provi-

sional application shall be placed in the provisional application file but may not be entered.<

## I. WHEN APPLICANT MAY AMEND

The applicant may amend:

(A) before or after the first examination and action and also after the second or subsequent examination or reconsideration as specified in 37 CFR 1.112;

(B) after final rejection, if the amendment meets the criteria of 37 CFR 1.116; and

(C) when and as specifically required by the examiner.

Amendments in provisional applications are not normally made. If an amendment is made to a provisional application, however, it must comply with the provisions of 37 CFR 1.121. Any amendments to a provisional application will be placed in the provisional application file, but may not be entered.

## II. MANNER OF MAKING AMENDMENTS

\*\*>

All amendments filed on or after July 30, 2003 must comply with 37 CFR 1.121 as revised in the notice of final rule making published in the *Federal Register* on June 30, 2003 at 65 *Fed. Reg.* 38611. The manner of making amendments has been revised to assist in the implementation of beginning-to-end electronic image processing of patent applications. Specifically, changes have been made to facilitate electronic image data capture and processing and streamline the patent application process. If an amendment filed on or after July 30, 2003 does not comply with revised 37 CFR 1.121, the Office will notify applicants via a Notice of Non-Compliant Amendment that the amendment is not accepted. See MPEP § 714.03.

The revised amendment practice is summarized as follows.

### A. Amendment Sections

Each section of an amendment document (e.g., Specification Amendments, Claim Amendments, Drawing Amendments, and Remarks) must begin on a separate sheet to facilitate separate indexing and electronic scanning of each section of an amendment document for placement in an image file wrapper.



It is recommended that applicants use the following format when submitting amendment papers. The amendment papers should include, in the following order:

(A) a cover sheet, or introductory comments, providing the appropriate application information (e.g., application number, applicant, filing date) and which serves as a table of contents to the amendment document by indicating on what page of the amendment document each of the following sections begin;

(B) a section (must begin on a separate sheet) entitled “Amendments to the Specification” (if there are any amendments to the specification). This section should include all amendments to the specification including amendments to the abstract of the disclosure;

(C) a section (must begin on a separate sheet) entitled “Amendments to the Claims” which includes a complete listing of all claims ever presented in the application (if there are any amendments to the claims);

(D) a section (must begin on a separate sheet) entitled “Amendments to the Drawings” in which all changes to the drawings are discussed (if there are any amendments to the drawings);

(E) a remarks section (must begin on a separate sheet); and

(F) any drawings being submitted including any “Replacement Sheet,” “New Sheet,” or “Annotated Marked-Up Drawings.”

### ***B. < Amendments to the Specification***

>Amendments to the specification, other than the claims, computer listings (37 CFR 1.96) and sequence listings (37 CFR 1.825), must be made by adding, deleting or replacing a paragraph, by replacing a section, or by a substitute specification.< In order to delete, replace or add a paragraph to the specification of an application, the amendment must unambiguously identify the paragraph to be modified either by paragraph number (see MPEP § 608.01), page and line, or any other unambiguous method and be accompanied by **>any replacement or new paragraph(s).** Replacement paragraphs must include markings to show the changes. A separate clean version of any replacement paragraphs is not required. Any new paragraphs must be presented in clean form without any markings (i.e., underlining)<.

Where paragraph numbering has been included in an application as provided in 37 CFR 1.52(b)(6), applicants can easily refer to a specific paragraph by number when presenting an amendment. If a numbered paragraph is to be replaced by a single paragraph, the added replacement paragraph should be numbered with the same number of the paragraph being replaced. Where more than one paragraph is to replace a single original paragraph, the added paragraphs should be numbered using the number of the original paragraph for the first replacement paragraph, followed by increasing decimal numbers for the second and subsequent added paragraphs, e.g., original paragraph [0071] has been replaced with paragraphs [0071], [0071.1], and [0071.2]. If a numbered paragraph is deleted, the numbering of the subsequent paragraphs should remain unchanged.

37 CFR 1.121(b)(1)(ii) requires that the **>full** text of any replacement paragraph be provided with markings to show all the changes relative to the previous version of the paragraph. The text of any added subject matter must be shown by underlining the added text. The text of any deleted subject matter must be shown by strike-through except that double brackets placed before and after the deleted characters may be used to show the deletion of five or fewer consecutive characters (e.g., **[[error]]**). The text of any deleted subject matter must be shown by being placed within double brackets if strike-through cannot be easily perceived (e.g., deletion of the number “4” must be shown as **[[4]]**). As an alternative to using double brackets, however, extra portions of text may be included before and after text being deleted, all in strike-through, followed by including and underlining the extra text with the desired change (e.g., **~~number 4~~ as number 14 as**). For added paragraphs, 37 CFR 1.121(b)(2)(iii) requires that the full text of any added paragraph(s) be presented in clean form without any underlining. Similarly, under 37 CFR 1.121(b)(2)(iv), a marked up version does not have to be supplied for any deleted paragraph(s). It is sufficient to merely indicate or identify any paragraph that has been deleted. The instruction to delete may identify a paragraph by its paragraph number, page and line number, or include a few words from the beginning, and end, or the paragraph, if needed for paragraph identification<.

Applicants are also permitted to amend the specification by replacement sections (e.g., as provided in 37 CFR 1.77(b), 1.154(b), or 1.163(c)). As with replacement paragraphs, the amended version of a replacement section is required to be provided with markings to show all the changes relative to the previous version of the section. The text of any added subject matter must be shown by underlining the added text. The text of any deleted subject matter must be shown by strike-through except that double brackets placed before and after the deleted characters may be used to show the deletion of five or fewer consecutive characters. The text of any deleted subject matter must be shown by being placed within double brackets if strike-through cannot be easily perceived.

Applicants are also permitted to amend the specification by submitting a substitute specification, provided the requirements of 37 CFR 1.125(b) and (c) are met. An accompanying separate marked up version showing the changes in the specification relative to the previous version is also required.

Any previously deleted paragraph or section can only be reinstated by a subsequent amendment presenting the previously deleted subject matter. A direction by applicant to remove a previously entered amendment will not be permitted.

>

### C. *Amendments to the Claims*

Each amendment document that includes a change to an existing claim, including the deletion of an existing claim, or submission of a new claim, must include a complete listing of all claims in the application. After each claim number, the status of the claim must be indicated in a parenthetical expression, and the text of each claim under examination as well as all withdrawn claims (each with markings if any, to show current changes) must be presented. The listing will serve to replace all prior versions of the claims in the application.

(A) The current status of all of the claims in the application, including any previously canceled or withdrawn claims, must be given. Status is indicated in a parenthetical expression following the claim number by one of the following: (original), (currently amended), (previously presented), (canceled), (withdrawn), (new), or (not entered). The text of all pending

claims under examination and withdrawn claims must be submitted each time any claim is amended. Canceled and not entered claims must be listed by only the claim number and status, without presenting the text of the claims.

(B) All claims being currently amended must be presented with markings to indicate the changes that have been made relative to the immediate prior version. The changes in any amended claim must be shown by strike-through (for deleted matter) or underlining (for added matter) with 2 exceptions: (1) for deletion of five or fewer consecutive characters, double brackets may be used (e.g., [[eroor]]); (2) if strike-through cannot be easily perceived (e.g., deletion of number “4” or certain punctuation marks), double brackets must be used (e.g., [[4]]). As an alternative to using double brackets, however, extra portions of text may be included before and after text being deleted, all in strike-through, followed by including and underlining the extra text with the desired change (e.g., ~~number 4~~ as number 14 as). An accompanying clean version is not required and should not be presented. Only claims of the status “currently amended” or “withdrawn” will include markings.

(C) The text of pending claims not being currently amended, including withdrawn claims, must be presented in clean version, i.e., without any markings. Any claim presented in clean version will constitute an assertion that it has not been changed relative to the immediate prior version except to omit markings that may have been present in the immediate prior version of the claims.

(D) A claim being canceled must be indicated as “canceled;” the text of the claim must not be presented. Providing an instruction to cancel is optional.

(E) Any claims added by amendment must be indicated as “new” and the text of the claim must not be underlined.

(F) All of the claims in each amendment paper must be presented in ascending numerical order. Consecutive canceled or not entered claims may be aggregated into one statement (e.g., Claims 1 – 5 (canceled)).

A canceled claim can be reinstated only by a subsequent amendment presenting the claim as a new claim with a new claim number.

Example of listing of claims:

Claims 1-5 (canceled)

Claim 6 (withdrawn): A process for molding a bucket.

Claim 7 (previously presented): A bucket with a handle.

Claim 8 (currently amended): A bucket with a ~~green~~ blue handle.

Claim 9 (withdrawn): The process for molding a bucket of claim 6 using molten plastic material.

Claim 10 (original): The bucket of claim 8 with a wooden handle.

Claim 11 (canceled)

Claim 12 (previously presented): A bucket having a circumferential upper lip.

Claim 13 (not entered)

Claim 14 (new): A bucket with plastic sides and bottom.<

37 CFR 1.121(g) permits the Office to make amendments to the specification, including the claims, by examiner's amendments without paragraph/section/claim replacement in the interest of expediting prosecution and reducing cycle time. Additions or deletions of subject matter in the specification, including the claims, may be made by instructions to make the change at a precise location in the specification or the claims. >Examiner's amendments do not need to comply with paragraphs (b)(1), (b)(2), or (c) of 37 CFR 1.121.< See MPEP § 1302.04.

\*\*

\*>

#### D. < Amendments to the Drawing

\*\*>Any changes to an application drawing must comply with 37 CFR 1.84 and must be submitted on a replacement sheet of drawings. The replacement sheet of drawings must be an attachment to the amendment document and must be identified in the top margin as

"Replacement Sheet." The replacement drawing sheet must include all of the figures appearing on the immediate prior version of the sheet, even if only one figure is amended. The figure or figure number of the amended drawing(s) must not be labeled as "amended." A marked-up copy of any amended drawing figure, including annotations indicating the changes made, may be included. The marked-up copy must be clearly labeled as "Annotated Marked-up Drawings" and must be presented in the amendment or remarks section that explains the change to the drawings. A marked-up copy of any amended drawing figure, including annotations indicating the changes made, must be provided when required by the examiner.<

An explanation of the changes made must be presented in >the "Amendments to the Drawings" or< the remarks section of the amendment >document<. If the changes to the drawing figure(s) are not approved by the examiner, applicant will be notified in the next Office action. \*\*

>

### III. <AMENDMENT IN REEXAMINATION PROCEEDINGS >AND REISSUE APPLICATIONS<

>Amendments in reissue applications must be made in accordance with 37 CFR 1.173. Amendments in *ex parte* and *inter partes* reexamination proceedings must be made in accordance with 37 CFR 1.530.< In patent-owner-filed >*ex parte*< reexaminations, the patent owner may amend at the time of the request for >*ex parte*< reexamination in accordance with 37 CFR 1.510(e). In any >*ex parte*< reexamination proceeding, no amendment or response can be filed between the date of the request for >*ex parte*< reexamination and the order for >*ex parte*< reexamination. See 37 CFR 1.530(a). Following the order for >*ex parte*< reexamination under 37 CFR 1.525 and prior to the examination phase of \*>*ex parte*< reexamination proceeding, an amendment may be filed only with the patent owner's statement under 37 CFR 1.530(b). During the examination phase of the >*ex parte*< reexamination proceeding, an amendment may be filed:

(A) after the first examination as specified in 37 CFR 1.112;

(B) after final rejection or an appeal has been taken, if the amendment meets the criteria of 37 CFR 1.116; and

(C) when and as specifically required by the examiner.

See also MPEP § 714.12.

For amendments in *>ex parte<* reexamination proceedings see MPEP § 2250 and § 2266. >For amendments by patent owner in an *inter partes* reexamination proceeding, see MPEP § 2666.01 and § 2672. For amendments in reissue applications, see MPEP § 1453.<

## 714.01 Signatures to Amendments

An amendment must be signed by a person having authority to prosecute the application. An unsigned or improperly signed amendment will not be entered. See MPEP § 714.01(a).

To facilitate any telephone call that may become necessary, it is recommended that the complete telephone number with area code and extension be given, preferably near the signature.

### 714.01(a) Unsigned or Improperly Signed Amendment [R-2]

37 CFR 1.33. *Correspondence respecting patent applications, reexamination proceedings, and other proceedings.*

\*\*\*\*\*

(b) *Amendments and other papers.* Amendments and other papers, except for written assertions pursuant to § 1.27(c)(2)(ii) of this part, filed in the application must be signed by:

(1) A registered attorney or agent of record appointed in compliance with § 1.34(b);

(2) A registered attorney or agent not of record who acts in a representative capacity under the provisions of § 1.34(a);

(3) An assignee as provided for under § 3.71(b) of this chapter; or

(4) All of the applicants (§ 1.41(b)) for patent, unless there is an assignee of the entire interest and such assignee has taken action in the application in accordance with § 3.71 of this chapter.

\*\*\*\*\*

An unsigned amendment or one not properly signed by a person having authority to prosecute the application is not entered. This applies, for instance, where

the amendment is signed by only one of two applicants and the one signing has not been given a power of attorney by the other applicant.

If copies of papers which require an original signature as set forth in 37 CFR 1.4(e) are filed, the signature must be applied after the copies are made. MPEP § 714.07.

When an unsigned or improperly signed amendment is received the amendment will be listed *\*\*>*in the contents of the application file<, but not entered. The examiner will notify applicant of the status of the application, advising him or her to furnish a duplicate amendment properly signed or to ratify the amendment already filed. In an application not under final rejection, applicant should be given a 1-month time period in which to ratify the previously filed amendment (37 CFR 1.135(c)).

Applicants may be advised of unsigned amendments by use of form paragraph 7.84.01.

#### ¶ 7.84.01 Paper Is Unsigned

The proposed reply filed on [1] has not been entered because it is unsigned. Since the above-mentioned reply appears to be *bona fide*, applicant is given a TIME PERIOD of **ONE (1) MONTH** or **THIRTY (30) DAYS** from the mailing date of this notice, whichever is longer, within which to supply the omission or correction in order to avoid abandonment. EXTENSIONS OF THIS TIME PERIOD MAY BE GRANTED UNDER 37 CFR 1.136(a).

Sometimes problems arising from unsigned or improperly signed amendments may be disposed of by calling in the local representative of the attorney or agent of record, since he or she may have the authority to sign the amendment.

An amendment signed by a person whose name is known to have been removed from the registers of attorneys and agents under the provisions of 37 CFR 10.11 is not entered. The file and unentered amendment are submitted to the Office of Enrollment and Discipline for appropriate action.

### 714.01(c) Signed by Attorney or Agent Not of Record

See MPEP § 405. A registered attorney or agent acting in a representative capacity under 37 CFR 1.34, may sign amendments even though he or she does not have a power of attorney in the application. See MPEP § 402.

### **714.01(d) Amendment Signed by Applicant but Not by Attorney or Agent of Record**

If an amendment signed by the applicant is received in an application in which there is a duly appointed attorney or agent, the amendment should be entered and acted upon. Attention should be called to 37 CFR 1.33(a) in patent applications and to 37 CFR 1.33(c) in reexamination proceedings. Two copies of the action should be prepared, one being sent to the attorney and the other directly to the applicant. The notation: "Copy to applicant" should appear on the original and on both copies.

### **714.01(e) Amendments Before First Office Action [R-2]**

A preliminary amendment is an amendment that is received in the Office on or before the mail date of the first Office action under 37 CFR 1.104. See 37 CFR 1.115(a). \*\*>Since a request for continued examination (RCE) is not a new application, an amendment filed before the first Office action after the filing of the RCE is not a preliminary amendment. See MPEP § 706.07(h).

#### **I. PRELIMINARY AMENDMENTS MUST COMPLY WITH 37 CFR 1.121**

Any preliminary amendment, regardless of when it is filed, must comply with 37 CFR 1.121, e.g., the preliminary amendment must include a complete listing of all of the claims and each section of the amendment must begin on a separate sheet of paper. See MPEP § 714. Preliminary amendments made in a transmittal letter of the application will not comply with 37 CFR 1.121. For example, applicants should include the reference to a prior filed application in the first sentence of the specification following the title or in an application data sheet in compliance with 37 CFR 1.78 instead of submitting the reference in a preliminary amendment in a transmittal letter. See MPEP § 201.11. If a preliminary amendment fails to comply with 37 CFR 1.121, applicant will be notified by way of a Notice of Non-Compliant Amendment and given a non-extendable period of one month to bring the amendment into compliance with 37 CFR 1.121. If the applicant takes no corrective action, examination

of the application will commence without consideration of the proposed changes in the non-compliant preliminary amendment. See MPEP § 714.03.

Filing a preliminary amendment is not recommended because the changes made by the preliminary amendment may not be reflected in the patent application publication even if the preliminary amendment is referred to in an oath or declaration. If there is insufficient time to have the preliminary amendment be entered into the Office file wrapper of the application before technical preparations for publication of the application have begun, the preliminary amendment will not be reflected in the patent application publication. Technical preparations for publication of an application generally begin four months prior to the projected date of publication. For more information on publication of applications, see MPEP § 1121. Applicants may avoid preliminary amendments by incorporating any desired amendments into the text of the specification including a new set of claims, even where the application is a continuation or divisional application of a previously filed patent application. In such a continuation or divisional application, a clean copy of a specification (i.e., reflecting amendments made in the parent application) may be submitted together with a copy of the oath or declaration from the previously filed application so long as no new matter is included in the specification. See 37 CFR 1.63(d)(1)(iii) and MPEP § 201.06(c).

#### **II. PRELIMINARY AMENDMENTS FILED WITH THE APPLICATION<**

A preliminary amendment not filed along with the original application does not enjoy the status of part of the original disclosure. See MPEP § 608.04(b). Where an application filed under 37 CFR 1.53(b) is filed without a signed oath or declaration and such application is accompanied by an amendment, that amendment is considered a part of the original disclosure. The subsequently filed oath or declaration must refer to both the application and the amendment. >If the subsequently filed oath or declaration refers to the application but does not refer to the amendment, applicants will be required to submit a supplemental oath or declaration referring to both the application and the amendment filed with the original application.< Any copy of the application as filed must include a copy of the amendment as well, particularly

where certified copies for priority purposes are requested.

\*\*

Any amendment canceling claims in order to reduce the filing fee should be filed with the application. \*\* See MPEP § 506. >If a preliminary amendment accompanying a nonprovisional application cancels claims, it will be effective to diminish the number of claims to be considered in calculating the filing fee. See MPEP § 607. If the preliminary amendment accompanying the nonprovisional application cancels all claims without presenting any new claims, the Office will not enter such an amendment. See *Exxon Corp. v. Phillips Petroleum Co.*, 265 F.3d 1249, 60 USPQ2d 1369 (Fed. Cir. 2001) and MPEP § 601.01(e). Thus, the application will not be denied a filing date merely because such a preliminary amendment was submitted on filing. For fee calculation purposes, the Office will treat such an application as containing only a single claim.

### III. PRELIMINARY AMENDMENTS MUST BE TIMELY

Any preliminary amendments should either accompany the application or be filed after the application has received its application number and filing date so that the preliminary amendments would include the appropriate identifications (e.g., the application number and filing date). See MPEP § 502. Any amendments filed after the mail date of the first Office action is not a preliminary amendment. If the date of receipt (37 CFR 1.6) of the amendment is later than the mail date of the first Office action and is not responsive to the first Office action, the Office will not mail a new Office action, but simply advise the applicant that the amendment is nonresponsive to the first Office action and that a responsive reply must be timely filed to avoid abandonment. See MPEP § 714.03.<

A preliminary amendment will be entered unless it is disapproved by the >Director<. A preliminary amendment may be disapproved by the >Director< if the preliminary amendment unduly interferes with the preparation of an Office action. 37 CFR 1.115(b). See MPEP § 714.03(a).

## 714.02 Must Be Fully Responsive [R-2]

37 CFR 1.111. Reply by applicant or patent owner to a non-final Office action.

(a)(1) If the Office action after the first examination (§ 1.104) is adverse in any respect, the applicant or patent owner, if he or she persists in his or her application for a patent or reexamination proceeding, must reply and request reconsideration or further examination, with or without amendment. See §§ 1.135 and 1.136 for time for reply to avoid abandonment.

\*\*>

(2) A second (or subsequent) supplemental reply will be entered unless disapproved by the Director. A second (or subsequent) supplemental reply may be disapproved if the second (or subsequent) supplemental reply unduly interferes with an Office action being prepared in response to the previous reply. Factors that will be considered in disapproving a second (or subsequent) supplemental reply include:<

(i) The state of preparation of an Office action responsive to the previous reply as of the date of receipt (§ 1.6) of the second (or subsequent) supplemental reply by the Office; and

(ii) The nature of any changes to the specification or claims that would result from entry of the second (or subsequent) supplemental reply.

(b) In order to be entitled to reconsideration or further examination, the applicant or patent owner must reply to the Office action. The reply by the applicant or patent owner must be reduced to a writing which distinctly and specifically points out the supposed errors in the examiner's action and must reply to every ground of objection and rejection in the prior Office action. The reply must present arguments pointing out the specific distinctions believed to render the claims, including any newly presented claims, patentable over any applied references. If the reply is with respect to an application, a request may be made that objections or requirements as to form not necessary to further consideration of the claims be held in abeyance until allowable subject matter is indicated. The applicant's or patent owner's reply must appear throughout to be a *bona fide* attempt to advance the application or the reexamination proceeding to final action. A general allegation that the claims define a patentable invention without specifically pointing out how the language of the claims patentably distinguishes them from the references does not comply with the requirements of this section.

(c) In amending in reply to a rejection of claims in an application or patent under reexamination, the applicant or patent owner must clearly point out the patentable novelty which he or she thinks the claims present in view of the state of the art disclosed by the references cited or the objections made. The applicant or patent owner must also show how the amendments avoid such references or objections.

In all cases where reply to a requirement is indicated as necessary >for< further consideration of the claims, or where allowable subject matter has been indicated in an application, a complete reply must

either comply with the formal requirements or specifically traverse each one not complied with.

Drawing and specification corrections, presentation of a new oath and the like are generally considered as formal matters, although the filing of drawing corrections in reply to an objection to the drawings cannot normally be held in abeyance. However, the line between formal matter and those touching the merits is not sharp, and the determination of the merits of an application may require that such corrections, new oath, etc., be insisted upon prior to any indication of allowable subject matter.

The claims may be amended by canceling particular claims, by presenting new claims, or by rewriting particular claims as indicated in 37 CFR 1.121(c). The requirements of 37 CFR 1.111(b) must be complied with by pointing out the specific distinctions believed to render the claims patentable over the references in presenting arguments in support of new claims and amendments.

An amendment submitted after a second or subsequent non-final action on the merits which is otherwise responsive but which increases the number of claims drawn to the invention previously acted upon is not to be held not fully responsive for that reason alone. (See 37 CFR 1.112, MPEP § 706.)

The prompt development of a clear issue requires that the replies of the applicant meet the objections to and rejections of the claims. Applicant should also specifically point out the support for any amendments made to the disclosure. See MPEP § 2163.06.

An amendment which does not comply with the provisions of 37 CFR 1.121(b), (c), (d), and (h) may be held not fully responsive. See MPEP § 714.22.

Replies to requirements to restrict are treated under MPEP § 818.

### **714.03 Amendments Not Fully Responsive, Action To Be Taken [R-2]**

*37 CFR 1.135. Abandonment for failure to reply within time period.*

\*\*\*\*\*

(c) When reply by the applicant is a *bona fide* attempt to advance the application to final action, and is substantially a complete reply to the non-final Office action, but consideration of some matter or compliance with some requirement has been inad-

vertently omitted, applicant may be given a new time period for reply under § 1.134 to supply the omission.

An examiner may treat an amendment not fully responsive to a non-final Office action by:

(A) accepting the amendment as an adequate reply to the non-final Office action to avoid abandonment under 35 U.S.C. 133 and 37 CFR 1.135;

(B) notifying the applicant that the reply must be completed within the remaining period for reply to the non-final Office action (or within any extension pursuant to 37 CFR 1.136(a)) to avoid abandonment; or

(C) setting a new time period for applicant to complete the reply pursuant to 37 CFR 1.135(c).

The treatment to be given to the amendment depends upon:

(A) whether the amendment is *bona fide*;

(B) whether there is sufficient time for applicant's reply to be filed within the time period for reply to the non-final Office action; and

(C) the nature of the deficiency.

If an amendment submitted on or after July 30, 2003, fails to comply with 37 CFR 1.121 (as revised on June 30, 2003), the Office will notify applicant by a Notice of Non-Compliant Amendment, that the amendment fails to comply with the requirements of 37 CFR 1.121 and applicant will be given a period of time in which to comply with the rule. Applicant's reply to a Notice of Non-Compliant Amendment should consist of a corrected version of only that portion of the amendment which previously failed to comply with 37 CFR 1.121. It is not necessary for applicant to resubmit the entire amendment document. If the amendment that fails to comply with the requirements of the rule is a preliminary amendment, the Legal Instruments Examiner (LIE) will send the Notice which sets a time limit of 30 days or one month, whichever is later, for reply. No extensions of time are permitted. Failure to submit a timely reply will result in the application being examined without entry of the preliminary amendment. If the amendment which fails to comply with the requirements of the rule is an amendment after a non-final Office action, the LIE will send the Notice which sets a time limit of 30 days or one month, whichever is later, for reply (37 CFR 1.135). Extensions of time are permitted (37 CFR 1.136(a)). Failure to reply to this Notice

will result in abandonment of the application. See MPEP § 714.22 for treatment of non-compliant amendments after final rejection.

Where an amendment substantially responds to the rejections, objections, or requirements in a non-final Office action (and is a *bona fide* attempt to advance the application to final action) but contains a minor deficiency (e.g., fails to treat every rejection, objection, or requirement), the examiner may simply act on the amendment and issue a new (non-final or final) Office action. The new Office action may simply reiterate the rejection, objection, or requirement not addressed by the amendment (or otherwise indicate that such rejection, objection, or requirement is no longer applicable). This course of action would not be appropriate in instances in which an amendment contains a serious deficiency (e.g., the amendment is unsigned or does not appear to have been filed in reply to the non-final Office action). Where the amendment is *bona fide* but contains a serious omission, the examiner should: A) if there is sufficient time remaining for applicant's reply to be filed within the time period for reply to the non-final Office action (or within any extension pursuant to 37 CFR 1.136(a)), notify applicant that the omission must be supplied within the time period for reply; or B) if there is insufficient time remaining, issue an Office action setting a 1-month time period to complete the reply pursuant to 37 CFR 1.135(c). In either event, the examiner should not further examine the application on its merits unless and until the omission is timely supplied.

If a new time period for reply is set pursuant to 37 CFR 1.135(c), applicant must supply the omission within this new time period for reply (or any extensions under 37 CFR 1.136(a) thereof) in order to avoid abandonment of the application. The applicant, however, may file a continuing application during this period (in addition or as an alternative to supplying the omission), and may also file any further reply as permitted under 37 CFR 1.111.

Where there is sufficient time remaining in the period for reply (including extensions under 37 CFR 1.136(a)), the applicant may simply be notified that the omission must be supplied within the remaining time period for reply. This notification should be made, if possible, by telephone, and, when such notification is made by telephone, an interview summary

record (see MPEP § 713.04) must be completed and entered into the file of the application to provide a record of such notification. When notification by telephone is not possible, the applicant must be notified in an Office communication that the omission must be supplied within the remaining time period for reply. For example, when an amendment is filed shortly after an Office action has been mailed, and it is apparent that the amendment was not filed in reply to such Office action, the examiner need only notify the applicant (preferably by telephone) that a reply responsive to the Office action must be supplied within the remaining time period for reply to such Office action.

The practice set forth in 37 CFR 1.135(c) does not apply where there has been a deliberate omission of some necessary part of a complete reply; rather, 37 CFR 1.135(c) is applicable only when the missing matter or lack of compliance is considered by the examiner as being "inadvertently omitted." For example, if an election of species has been required and applicant does not make an election because he or she believes the requirement to be improper, the amendment on its face is not a "*bona fide* attempt to advance the application to final action" (37 CFR 1.135(c)), and the examiner is without authority to postpone decision as to abandonment. >Similarly, an amendment that would cancel all of the claims in an application and does not present any new or substitute claims is not a *bona fide* attempt to advance the application to final action. The Office will not enter such an amendment. See *Exxon Corp. v. Phillips Petroleum Co.*, 265 F.3d 1249, 60 USPQ2d 1368 (Fed. Cir. 2001). If there is time remaining to reply to the non-final Office action (or within any extension of time pursuant to 37 CFR 1.136(a)), applicant will be notified to complete the reply within the remaining time period to avoid abandonment.< Likewise, once an inadvertent omission is brought to the attention of the applicant, the question of inadvertence no longer exists. Therefore, a second Office action giving another new (1 month) time period to supply the omission would not be appropriate under 37 CFR 1.135(c).

37 CFR 1.135(c) authorizes, but does not require, an examiner to give the applicant a new time period to supply an omission. Thus, where the examiner concludes that the applicant is attempting to abuse the practice under 37 CFR 1.135(c) to obtain additional time for filing a reply (or where there is sufficient



time for applicant's reply to be filed within the time period for reply to the non-final Office action), the examiner need only indicate by telephone or in an Office communication (as discussed above) that the reply must be completed within the period for reply to the non-final Office action or within any extension pursuant to 37 CFR 1.136(a) to avoid abandonment.

The practice under 37 CFR 1.135(c) of giving applicant a time period to supply an omission in a *bona fide* reply does **not** apply after a final Office action. Amendments after final are approved for entry only if they place the application in condition for allowance or in better form for appeal. Otherwise, they are not approved for entry. See MPEP § 714.12 and § 714.13. Thus, an amendment should be denied entry if some point necessary for a complete reply under 37 CFR 1.113 (after final) was omitted, even if the omission was through an apparent oversight or inadvertence. Where a submission after a final Office action or appeal (e.g., an amendment under 37 CFR 1.116) does not place the application in condition for allowance, the period for reply under 37 CFR 1.113 continues to run until a reply under 37 CFR 1.113 (i.e., a notice of appeal or an amendment that places the application in condition for allowance) is filed. The nature of the omission (e.g., whether the amendment raises new issues, or would place the application in condition for allowance but for it being unsigned or not in compliance with 37 CFR 1.121) is immaterial. The examiner cannot give the applicant a time period under 37 CFR 1.135(c) to supply the omission; however, applicant may obtain additional time under 37 CFR 1.136(a) to file another or supplemental amendment in order to supply the omission.

When a reply to a final Office action substantially places the application in condition for allowance, an examiner may request that the applicant (or representative) authorize an examiner's amendment to correct the omission and place the application in condition for allowance, in which case the date of the reply is the date of such authorization (and not the date the incomplete reply was filed). An examiner also has the authority to enter the reply, withdraw the finality of the last Office action, and issue a new Office action,

which may be a non-final Office action, a final Office action (if appropriate), or an action closing prosecution on the merits in an otherwise allowable application under *Ex parte Quayle*, 25 USPQ 74, 1935 C.D. 11, 435 O.G. 213 (Comm'r Pat. 1935) (if appropriate). These courses of action, however, are solely within the discretion of the examiner. It is the applicant's responsibility to take the necessary action in an application under a final Office action to provide a complete reply under 37 CFR 1.113.

Where there is an informality as to the fee in connection with an amendment to a **non-final** Office action presenting additional claims, the applicant is notified by the technical support staff \*\*. See MPEP § 607 and § 714.10.

Form paragraph 7.95, and optionally form paragraph 7.95.01, should be used where a *bona fide* reply is not fully responsive.

#### ¶ 7.95 *Bona Fide, Non-Responsive Amendments*

The reply filed on [1] is not fully responsive to the prior Office action because of the following omission(s) or matter(s): [2]. See 37 CFR 1.111. Since the above-mentioned reply appears to be *bona fide*, applicant is given a TIME PERIOD of **ONE (1) MONTH** or **THIRTY (30) DAYS** from the mailing date of this notice, whichever is longer, within which to supply the omission or correction in order to avoid abandonment. **EXTENSIONS OF THIS TIME PERIOD MAY BE GRANTED UNDER 37 CFR 1.136(a).**

#### **Examiner Note:**

This practice does not apply where there has been a deliberate omission of some necessary part of a complete reply, or where the application is subject to a final Office action. Under such cases, the examiner has no authority to grant an extension if the period for reply has expired. See form paragraph 7.91.

#### ¶ 7.95.01 *Lack of Arguments in Response*

Applicant should submit an argument under the heading "Remarks" pointing out disagreements with the examiner's contentions. Applicant must also discuss the references applied against the claims, explaining how the claims avoid the references or distinguish from them.

#### **Examiner Note:**

1. This form paragraph must be preceded by form paragraph 7.95.
2. This form paragraph is intended primarily for use in *pro se* applications.

## 714.03(a) Amendment Unduly Interferes With the Preparation of an Office Action [R-2]

### I. PRELIMINARY AMENDMENT

37 CFR 1.115. *Preliminary amendments.*

(a) A preliminary amendment is an amendment that is received in the Office (§ 1.6) on or before the mail date of the first Office action under § 1.104.

\*\*>

(b)(1) A preliminary amendment will be entered unless disapproved by the Director. A preliminary amendment may be disapproved if the preliminary amendment unduly interferes with the preparation of a first Office action in an application. Factors that will be considered in disapproving a preliminary amendment include:<

(i) The state of preparation of a first Office action as of the date of receipt (§ 1.6) of the preliminary amendment by the Office; and

(ii) The nature of any changes to the specification or claims that would result from entry of the preliminary amendment.

(2) A preliminary amendment will not be disapproved if it is filed no later than:

(i) Three months from the filing date of an application under § 1.53(b);

(ii) The filing date of a continued prosecution application under § 1.53(d); or

(iii) Three months from the date the national stage is entered as set forth in § 1.491 in an international application.

(c) The time periods specified in paragraph (b)(2) of this section are not extendable.

Once the examiner has started to prepare a first Office action, entry of a preliminary amendment may be disapproved if the preliminary amendment unduly interferes with the preparation of the first Office action. Applicants are encouraged to \*>file< all preliminary amendments with the application or as soon as possible thereafter. Entry of a preliminary amendment will not be disapproved if it is filed no later than:

(A) 3 months from the filing date of the application under 37 CFR 1.53(b);

(B) 3 months from the date the national stage is entered as set forth in 37 CFR 1.491 in an international application;

(C) the filing date of a CPA under 37 CFR 1.53(d); or

(D) the last day of any suspension period requested by applicant under 37 CFR 1.103 (see MPEP § 709).

Even if the examiner has spent a significant amount of time preparing the first Office action, entry of a preliminary amendment filed within these time periods should not be disapproved under 37 CFR 1.115(b). These time periods are not extendable. See 37 CFR 1.115(c).

If a preliminary amendment is filed after these time periods and the conditions set forth in paragraph III (below) are met, entry of the preliminary amendment may be denied subject to the approval of the supervisory patent examiner (MPEP § 1002.02(d)).

See MPEP § 714.01(e) for additional information pertaining to amendments before first Office action.

### II. SECOND (OR) SUBSEQUENT SUPPLEMENTAL AMENDMENT

37 CFR 1.111. *Reply by applicant or patent owner to a non-final Office action.*

(a)(1) If the Office action after the first examination (§ 1.104) is adverse in any respect, the applicant or patent owner, if he or she persists in his or her application for a patent or reexamination proceeding, must reply and request reconsideration or further examination, with or without amendment. See §§ 1.135 and 1.136 for time for reply to avoid abandonment.

\*\*>

(2) A second (or subsequent) supplemental reply will be entered unless disapproved by the Director. A second (or subsequent) supplemental reply may be disapproved if the second (or subsequent) supplemental reply unduly interferes with an Office action being prepared in response to the previous reply. Factors that will be considered in disapproving a second (or subsequent) supplemental reply include:<

(i) The state of preparation of an Office action responsive to the previous reply as of the date of receipt (§ 1.6) of the second (or subsequent) supplemental reply by the Office; and

(ii) The nature of any changes to the specification or claims that would result from entry of the second (or subsequent) supplemental reply.

\*\*\*\*\*

Generally, a second (or subsequent) supplemental reply (i.e., the third (or subsequent) reply) will be entered unless it unduly interferes with an Office action being prepared in response to a previous reply. For example, after the mailing of a first Office action, the applicant filed an amendment (the first reply) on 1/8/01, a supplemental amendment (the second reply) on 2/8/01, and a second supplemental reply (the third reply) on 2/28/01. If the examiner has updated the search and almost completed the Office action before the Office receives the third reply, and the third reply adds numerous claims that would require the

examiner to update the search, then the examiner with the SPE's approval may deny the entry of the third reply.

Applicants are encouraged to include a complete reply to an outstanding Office action in the first reply to prevent the need for supplemental replies. If the conditions set forth in paragraph III (below) are met, the entry of a second (or subsequent) supplemental amendment may be denied subject to the approval of the supervisory patent examiner (MPEP § 1002.02(d)).

### III. WHEN DISAPPROVAL IS APPROPRIATE

The factors that will be considered for denying entry of preliminary amendments under 37 CFR 1.115 and second (or subsequent) supplemental replies under 37 CFR 1.111 are the same. The factors include:

(A) The state of preparation of a first Office action as of the date of receipt (37 CFR 1.6) of the preliminary amendment or the second (or subsequent) supplemental reply by the Office; and

(B) The nature of any changes to the specification or claims that would result from entry of the preliminary amendment or the second (or subsequent) supplemental reply.

The entry of a preliminary amendment or a second (or subsequent) supplemental reply >that< would unduly >interfere< with the preparation of an Office action \* may be denied if the following two conditions are met:

(A) the examiner has devoted a significant amount of time on the preparation of an Office action before the amendment or reply is received in the Office (i.e., the 37 CFR 1.6 receipt date of the amendment or reply); and

(B) the entry of the amendment or reply would require significant additional time in the preparation of the Office action.

For example, if the examiner has spent a significant amount of time to conduct a prior art search or draft an Office action before a preliminary amendment or a second (or subsequent) supplemental reply is received by the Office, the first condition is satisfied. Entry of the amendment or reply may be denied if it:

- (A) amends the claims;
- (B) adds numerous new claims;
- (C) amends the specification to change the scope of the claims;
- (D) amends the specification so that a new matter issue would be raised;
- (E) includes arguments;
- (F) includes an affidavit or declaration under 37 CFR 1.131 or 37 CFR 1.132; or
- (G) includes evidence traversing rejections from a prior Office action,

and would require the examiner to spend significant additional time to conduct another prior art search or revise the Office action (i.e., the second condition is satisfied). This list is not an exhaustive list, and the entry of a preliminary amendment or second (or subsequent) supplemental reply may be denied in other situations that satisfy the two conditions set forth above. Once these conditions are met, the examiner should obtain the approval of the SPE before the entry of the amendment or reply may be denied.

### IV. WHEN DISAPPROVAL IS INAPPROPRIATE

Denying entry of a preliminary amendment under 37 CFR 1.115 or a second (or subsequent) supplemental reply under 37 CFR 1.111(a)(2) is inappropriate if either:

(A) the examiner has NOT devoted a significant amount of time on the preparation of an Office action before the amendment or reply is received in the Office (i.e., the 37 CFR 1.6 receipt date of the amendment or reply); or

(B) the entry of the amendment or reply would NOT require significant additional time in the preparation of the Office action.

Thus, the amendment or reply will be entered unless it is denied entry for other reasons such as those listed in MPEP § 714.19.

For example, if before the preliminary amendment or the second (or subsequent) supplemental reply is received in the Office, the examiner has not started working on the Office action or has started, but has merely inspected the file for formal requirements, then the examiner should enter and consider the preliminary amendment or second (or subsequent) supplemental reply.

Furthermore, even if the examiner has devoted a significant amount of time to prepare an Office action prior to the date the preliminary amendment or the second (or subsequent) supplemental reply is received in the Office, it is not appropriate to disapprove the entry of such an amendment or reply if it:

(A) merely cancels some of the pending claims;

(B) amends the claims to overcome rejections under 35 U.S.C. 112, second paragraph;

(C) amends the claims to place the application in condition for allowance; or

(D) only includes changes that were previously suggested by the examiner, and would not require the examiner to spend significant additional time to revise the Office action.

If a supplemental reply is received in the Office after the mail date of an Office action, and it is not responsive to that Office action, the Office will not mail a new Office action responsive to that supplemental reply. As a courtesy, applicant may be notified that the supplemental reply is nonresponsive to the mailed Office action and that a responsive reply (under 37 CFR 1.111 or 1.113 as the situation may be) to the mailed Office action must be timely filed to avoid abandonment. Also see MPEP § 714.03 for replies not fully responsive and MPEP § 714.05 when the Office action crosses in the mail with a supplemental reply.

### **Form Paragraphs**

Form paragraphs 7.46 and 7.47 should be used to notify applicant that the entry of a preliminary amendment or a second (or subsequent) supplemental reply (i.e., the third (or subsequent) reply) is denied because the amendment or reply unduly interferes with the preparation of an Office action.

#### *¶ 7.46 Preliminary Amendment Unduly Interferes with the Preparation of an Office Action*

The preliminary amendment filed on [1] was not entered because entry of the amendment would unduly interfere with the preparation of the Office action. See 37 CFR 1.115(b). The examiner spent a significant amount of time on the preparation of an Office action before the preliminary amendment was received. On the date of receipt of the amendment, the examiner had completed [2].

Furthermore, entry of the preliminary amendment would require significant additional time on the preparation of the Office

action. Specifically, entry of the preliminary amendment would require the examiner to [3].

A responsive reply (under 37 CFR 1.111 or 37 CFR 1.113 as appropriate) to this Office action must be timely filed to avoid abandonment.

If this is not a final Office action, applicant may wish to resubmit the amendment along with a responsive reply under 37 CFR 1.111 to ensure proper entry of the amendment.

#### **Examiner Note:**

1. In bracket 1, provide the date that the Office received the preliminary amendment (use the date of receipt under 37 CFR 1.6, not the certificate of mailing date under 37 CFR 1.8).

2. In bracket 2, provide an explanation on the state of preparation of the Office action as of the receipt date of the preliminary amendment. For example, where appropriate insert --the claim analysis and the search of prior art of all pending claims-- or --the drafting of the Office action and was waiting for the supervisory patent examiner's approval--.

3. In bracket 3, provide a brief explanation of how entry of the preliminary amendment would require the examiner to spend significant additional time in the preparation of the Office action. For example, where appropriate insert --conduct prior art search in another classification area that was not previously searched and required-- or --revise the Office action extensively to address the new issues raised and the new claims added in the preliminary amendment--.

#### *¶ 7.47 Second (or Subsequent) Supplemental Reply Unduly Interferes with the Preparation of an Office Action*

The second (or subsequent) supplemental reply filed on [1] was not entered because entry of the reply would unduly interfere with the preparation of the Office action. See 37 CFR 1.111(a)(2). The examiner spent a significant amount of time on the preparation of an Office action before the reply was received. On the date of receipt of the reply, the examiner had completed [2].

Furthermore, entry of the reply would require significant additional time in the preparation of the Office action. Specifically, entry of the reply would require the examiner to [3].

A responsive reply (under 37 CFR 1.111 or 37 CFR 1.113 as appropriate) to this Office action must be timely filed to avoid abandonment.

If this is not a final Office action, applicant may wish to resubmit the reply along with a responsive reply under 37 CFR 1.111 to ensure proper entry of the reply.

#### **Examiner Note:**

1. In bracket 1, provide the date that the Office received the second (or subsequent) supplemental reply (use the date of receipt under 37 CFR 1.6, not the certificate of mailing date under 37 CFR 1.8).

2. In bracket 2, provide an explanation on the state of preparation of the Office action as of the receipt date of the reply. For example, where appropriate insert --the prior art search and analysis of all the arguments presented in the prior replies-- or --the drafting of the Office action and was waiting for the supervisory patent examiner's approval--.

3. In bracket 3, provide a brief explanation of how entry of the reply would require the examiner to spend significant additional

time in the preparation of the Office action. For example, where appropriate insert --conduct prior art search in another classification area that was not previously searched and required-- or --revise the Office action extensively to address new issues raised and new claims added in the reply--.

### **714.04 Claims Presented in Amendment With No Attempt To Point Out Patentable Novelty**

In the consideration of claims in an amended case where no attempt is made to point out the patentable novelty, the claims should *not* be allowed. See 37 CFR 1.111 and MPEP § 714.02.

An amendment failing to point out the patentable novelty which the applicant believes the claims present in view of the state of the art disclosed by the references cited or the objections made may be held to be not fully responsive and a time period set to furnish a proper reply if the statutory period has expired or almost expired (MPEP § 714.03). However, if the claims as amended are clearly open to rejection on grounds of record, a final rejection should generally be made.

### **714.05 Examiner Should Immediately Inspect**

Actions by applicant, especially those filed near the end of the period for reply, should be inspected immediately upon filing to determine whether they are completely responsive to the preceding Office action so as to prevent abandonment of the application. If found inadequate, and sufficient time remains, applicant should be notified of the deficiencies and warned to complete the reply within the period. See MPEP § 714.03.

All amended applications forwarded to the examiner should be inspected at once to determine the following:

(A) If the amendment is properly signed (MPEP § 714.01(a)).

(B) If the amendment has been filed within the statutory period, set shortened period, or time limit (MPEP § 710 - § 710.05).

(C) If the amendment is fully responsive (MPEP § 714.03 and § 714.04) and complies with 37 CFR 1.121.

(D) If the changes made by the amendment warrant transfer (MPEP § 903.08(d)).

(E) If the application is special (MPEP § 708.01).

(F) If claims suggested to applicant for interference purposes have been copied. (MPEP § 2305).

(G) If there is a traversal of a requirement for restriction (MPEP § 818.03(a)).

(H) If “easily erasable” paper or other nonpermanent method of preparation or reproduction has been used (MPEP § 714.07).

(I) If applicant has cited references (MPEP § 707.05(b) and § 1302.12).

(J) If a terminal disclaimer has been filed (MPEP § 508.01, § 804.02, § 804.03, and § 1490).

(K) If any matter involving security has been added (MPEP § 115).

### **ACTION CROSSES AMENDMENT**

A supplemental action is usually necessary when an amendment is filed on or before the mailing date of the regular action but reaches the Technology Center later. The supplemental action should be promptly prepared. It need not reiterate all portions of the previous action that are still applicable but it should specify which portions are to be disregarded, pointing out that the period for reply runs from the mailing of the supplemental action. The action should be headed “Responsive to amendment of (date) and supplemental to the action mailed (date).”

### **714.06 Amendments Sent to Wrong Technology Center**

See MPEP § 508.01.

### **714.07 Amendments Not in Permanent Ink**

37 CFR 1.52(a) requires “permanent dark ink or its equivalent” to be used on papers which will become part of the record and *In re Benson*, 122 USPQ 279, 1959 C.D. 5, 744 O.G. 353 (Comm’r Pat. 1959), holds that documents on so-called “easily erasable” paper violate the requirement. The fact that 37 CFR 1.52(a) has not been complied with may be discovered as soon as the amendment reaches the TC or later when the application is reached for action. In the first instance, applicant is promptly notified that the amendment is not entered and is required to file a

permanent copy within 1 month or to order a copy to be made by the U.S. Patent and Trademark Office at his or her expense. Physical entry of the amendment will be made from the permanent copy.

If there is no appropriate reply within the 1-month limit, a copy is made by the Patent and Trademark Office, applicant being notified and required to remit the charges or authorize charging them to his or her deposit account or credit card. See MPEP § 509.

In the second instance, when the nonpermanence of the amendment is discovered only when the application is reached for action, similar steps are taken, but action on the application is not held up, the requirement for a permanent copy of the amendment being included in the Office action.

A good direct or indirect copy, such as photocopy or facsimile transmission, on satisfactory paper is acceptable. But see *In re Application Papers Filed Jan. 20, 1956*, 706 O.G. 4 (Comm'r Pat. 1956). Although a good copy is acceptable, signatures must be applied after the copy is made if the papers require an original signature as set forth in 37 CFR 1.4(e).

See MPEP § 608.01 for more discussion on acceptable copies.

### 714.08 Telegraphic Amendment

When a telegraphic amendment is received, the telegram is placed in the file but not entered. Applicant will be notified that the telegram is not accepted as a reply to the previous Office action and is not entered. The time period for reply to the Office action continues to run and is extendable under 37 CFR 1.136.

### 714.10 Claims Added in Excess of Filing Fee

The patent statute provides for the presentation of claims added in excess of the filing fee. On payment of an additional fee (see MPEP § 607), these excess claims may be presented any time after the application is filed, which of course, includes the time before the first action.

### 714.11 Amendment Filed During Interference Proceedings

See MPEP § 2364.01.

## 714.12 Amendments After Final Rejection or Action

*37 CFR 1.116. Amendments after final action or appeal.*

(a) An amendment after final action or appeal must comply with § 1.114 or this section.

(b) After a final rejection or other final action (§ 1.113) in an application or in an *ex parte* reexamination filed under § 1.510, or an action closing prosecution (§ 1.949) in an *inter partes* reexamination filed under § 1.913, amendments may be made canceling claims or complying with any requirement of form expressly set forth in a previous Office action. Amendments presenting rejected claims in better form for consideration on appeal may be admitted. The admission of, or refusal to admit, any amendment after a final rejection, a final action, an action closing prosecution, or any related proceedings will not operate to relieve the application or patent under reexamination from its condition as subject to appeal or to save the application from abandonment under § 1.135, or the reexamination from termination. No amendment can be made in an *inter partes* reexamination proceeding after the right of appeal notice under § 1.953 except as provided for in paragraph (d) of this section.

(c) If amendments touching the merits of the application or patent under reexamination are presented after final rejection, or after appeal has been taken, or when such amendment might not otherwise be proper, they may be admitted upon a showing of good and sufficient reasons why they are necessary and were not earlier presented.

(d) No amendment can be made as a matter of right in appealed cases. After decision on appeal, amendments can only be made as provided in §§ 1.198 and 1.981, or to carry into effect a recommendation under § 1.196 or § 1.977.

Once a final rejection that is not premature has been entered in an application, applicant or patent owner no longer has any right to unrestricted further prosecution. This does not mean that no further amendment or argument will be considered. Any amendment that will place the application either in condition for allowance or in better form for appeal may be entered. Also, amendments complying with objections or requirements as to form are to be permitted after final action in accordance with 37 CFR 1.116(b). Ordinarily, amendments filed after the final action are not entered unless approved by the examiner. See MPEP § 706.07(f), § 714.13 and § 1207.

*The prosecution of an application before the examiner should ordinarily be concluded with the final action. However, one personal interview by applicant may be entertained after such final action if circumstances warrant.* Thus, only one request by applicant for a personal interview after final should be granted, but in exceptional circumstances, a second

personal interview may be initiated by the *examiner* if in his or her judgment this would materially assist in placing the application in condition for *allowance*.

Many of the difficulties encountered in the prosecution of patent applications after final rejection may be alleviated if each applicant includes, at the time of filing or no later than the first reply, claims varying from the broadest to which he or she believes he or she is entitled to the most detailed that he or she is willing to accept.

### **714.13 Amendments After Final Rejection or Action, Procedure Followed [R-2]**

>

#### **I. < FINAL REJECTION — TIME FOR REPLY**

If an applicant initially replies within 2 months from the date of mailing of any final rejection setting a 3-month shortened statutory period for reply and the Office does not mail an advisory action until after the end of the 3-month shortened statutory period, the period for reply for purposes of determining the amount of any extension fee will be the date on which the Office mails the advisory action advising applicant of the status of the application, but in no event can the period extend beyond 6 months from the date of the final rejection. This procedure applies only to a first reply to a final rejection. The following language must be included by the examiner in each final rejection:

A SHORTENED STATUTORY PERIOD FOR REPLY TO THIS FINAL ACTION IS SET TO EXPIRE THREE MONTHS FROM THE DATE OF THIS ACTION. IN THE EVENT A FIRST REPLY IS FILED WITHIN TWO MONTHS OF THE MAILING DATE OF THIS FINAL ACTION AND THE ADVISORY ACTION IS NOT MAILED UNTIL AFTER THE END OF THE THREE-MONTH SHORTENED STATUTORY PERIOD, THEN THE SHORTENED STATUTORY PERIOD WILL EXPIRE ON THE DATE THE ADVISORY ACTION IS MAILED, AND ANY EXTENSION FEE PURSUANT TO 37 CFR 1.136(a) WILL BE CALCULATED FROM THE MAILING DATE OF THE ADVISORY ACTION. IN NO EVENT WILL THE STATUTORY PERIOD FOR REPLY EXPIRE LATER THAN SIX MONTHS FROM THE DATE OF THIS FINAL ACTION.

This wording is part of form paragraphs 7.39, 7.40, 7.40.01, 7.41, 7.41.03, and 7.42.09. Form paragraph 7.39 appears in MPEP § 706.07. Form paragraphs 7.40 and 7.40.01 appear in MPEP § 706.07(a). Form paragraphs 7.41, 7.41.03, and 7.42.09 appear in MPEP § 706.07(b).

For example, if applicant initially replies within 2 months from the date of mailing of a final rejection and the examiner mails an advisory action before the end of 3 months from the date of mailing of the final rejection, the shortened statutory period will expire at the end of 3 months from the date of mailing of the final rejection. In such a case, any extension fee would then be calculated from the end of the 3-month period. If the examiner, however, does not mail an advisory action until after the end of 3 months, the shortened statutory period will expire on the date the examiner mails the advisory action and any extension fee may be calculated from that date. In the event that a first reply is not filed within 2 months of the mailing date of the final rejection, any extension fee pursuant to 37 CFR 1.136(a) will be calculated from the end of the reply period set in the final rejection.

Failure to file a reply during the shortened statutory period results in abandonment of the application unless the time is extended under the provisions of 37 CFR 1.136.

>

#### **II. < ENTRY NOT A MATTER OF RIGHT**

It should be kept in mind that applicant cannot, as a matter of right, amend any finally rejected claims, add new claims after a final rejection (see 37 CFR 1.116) or reinstate previously canceled claims.

Except where an amendment merely cancels claims, adopts examiner suggestions, removes issues for appeal, or in some other way requires only a cursory review by the examiner, compliance with the requirement of a showing under 37 CFR 1.116(c) is expected in all amendments after final rejection. Failure to properly reply under 37 CFR 1.113 to the final rejection results in abandonment. A reply under 37 CFR 1.113 is limited to:

- (A) an amendment complying with 37 CFR 1.116;
- (B) a Notice of Appeal (and appeal fee); or
- (C) a request for continued examination (RCE) filed under 37 CFR 1.114 with a submission (i.e., an

amendment that meets the reply requirement of 37 CFR 1.111) and the fee set forth in 37 CFR 1.17(e). RCE practice under 37 CFR 1.114 does not apply to utility or plant patent applications filed before June 8, 1995 and design applications.

Further examination of the application may be obtained by filing a continued prosecution application (CPA) under 37 CFR 1.53(d), if the application is a design application. See MPEP § 201.06(d). Effective July 14, 2003, CPA practice does not apply to utility and plant applications \*\*.

An amendment filed at any time after final rejection, but before an appeal brief is filed, may be entered upon or after filing of an appeal brief provided the total effect of the amendment is to (A) remove issues for appeal, and/or (B) adopt examiner suggestions.

See also MPEP § 1207 and § 1211.

The U.S. Patent and Trademark Office does not recognize “conditional” authorizations to charge an appeal fee if an amendment submitted after a final Office action is not entered. Any “conditional” authorization to charge an appeal fee set forth in 37 CFR 1.17(b) will be treated as an unconditional payment of the fee set forth in 37 CFR 1.17(b).

\*\*

>

### III. < ACTION BY EXAMINER

See also MPEP § 706.07(f).

In the event that a proposed amendment does not place the case in better form for appeal, nor in condition for allowance, applicant should be promptly informed of this fact, whenever possible, within the statutory period. The refusal to enter the proposed amendment should not be arbitrary. The proposed amendment should be given sufficient consideration to determine whether the claims are in condition for allowance and/or whether the issues on appeal are simplified. Ordinarily, the specific deficiencies of the amendment need not be discussed. However, if the proposed amendment raises the issue of new matter, the examiner should identify the subject matter that would constitute new matter. If the proposed amendment presents new issues requiring further consideration and/or search, the examiner should provide an explanation as to the reasons why the proposed amendment raises new issues that would require fur-

ther consideration and/or search. The reasons for nonentry should be concisely expressed. For example:

(A) The claims, if amended as proposed, would not avoid any of the rejections set forth in the last Office action, and thus the amendment would not place the case in condition for allowance or in better condition for appeal.

(B) The claims, if amended as proposed, would raise the issue of new matter.

(C) The claims as amended present new issues requiring further consideration or search.

(D) Since the amendment presents additional claims without canceling any finally rejected claims it is not considered as placing the application in better condition for appeal. *Ex parte Wirt*, 1905 C.D. 247, 117 O.G. 599 (Comm’r Pat. 1905).

Examiners should indicate the status of each claim of record or proposed in the amendment, and which proposed claims would be entered on the filing of an appeal if filed in a separate paper. Whenever such an amendment is entered for appeal purposes, the examiner must indicate on the advisory action which individual rejection(s) set forth in the action from which the appeal was taken (e.g., the final rejection) would be used to reject the new or amended claim(s).

Applicant should be notified, if certain portions of the amendment would be acceptable as placing some of the claims in better form for appeal or complying with objections or requirements as to form, if a separate paper were filed containing only such amendments. Similarly, if the proposed amendment to some of the claims would render them allowable, applicant should be so informed. This is helpful in assuring the filing of a brief consistent with the claims as amended. A statement that the final rejection stands and that the statutory period runs from the date of the final rejection is also in order.

Advisory Action form PTOL-303 should be used to acknowledge receipt of a reply from applicant after final rejection where such reply is prior to filing of an appeal brief and does not place the application in condition for allowance. This form has been devised to advise applicant of the disposition of the proposed amendments to the claims and of the effect of any argument or affidavit not placing the application in condition for allowance or which could not be made



allowable by a telephone call to clear up minor matters.

Any amendment timely filed after a final rejection should be immediately considered to determine whether it places the application in condition for allowance or in better form for appeal. An examiner is expected to turn in a response to an amendment after final rejection within 10 calendar days from the time the amendment is received by the examiner. A reply to an amendment after final rejection should be mailed within 30 days of the date the amendment is received by the Office. In *all* instances, both before and after final rejection, in which an application is placed in condition for allowance, applicant should be notified promptly of the allowability of the claims by a Notice of Allowability form PTOL-37. If delays in processing the Notice of Allowability are expected, e.g., because an extensive examiner's amendment must be entered, and the end of a statutory period for reply is near, the examiner should notify applicant by way of an interview that the application has been placed in condition for allowance, and an Examiner Initiated Interview Summary PTOL-413B should be mailed. Prompt notice to applicant is important because it may avoid an unnecessary appeal and act as a safeguard against a holding of abandonment. Every effort should be made to mail the letter before the period for reply expires.

If no appeal has been filed within the period for reply and no amendment has been submitted to make the application allowable or which can be entered in part (see MPEP § 714.20), the application stands abandoned.

It should be noted that under 37 CFR 1.181(f), the filing of a 37 CFR 1.181 petition will not stay the period for reply to an examiner's action which may be running against an application. See MPEP § 1207 for appeal and post-appeal procedure. For after final rejection practice relative to affidavits or declarations filed under 37 CFR 1.131 and 1.132, see MPEP § 715.09 and § 716.

Form paragraphs 7.67-7.80 are to be used when issuing advisory actions after a final rejection.

*¶ 7.67 Advisory After Final, Heading, Before Appeal*

The period for reply [1] to run [2] MONTHS from the mailing date of the final rejection. Any extension of time must be obtained by filing a petition under 37 CFR 1.136(a) accompanied by the appropriate fee. The date on which the petition under 37 CFR 1.136(a) and the appropriate extension fee have been filed is

the date for purposes of determining the period of extension and the corresponding amount of the fee. A reply within the meaning of 37 CFR 1.113 or a request for continued examination (RCE) in compliance with 37 CFR 1.114 must be timely filed to avoid abandonment of this application.

**Examiner Note:**

1. This form paragraph should appear as a heading in all advisory actions prior to appeal. After appeal, use form paragraph 7.68.
2. In bracket 1, insert --continues-- if applicant has not submitted a petition for an extension of time along with the appropriate fee under 37 CFR 1.136. If a proper extension has been requested under 37 CFR 1.136, insert --is extended-- in bracket 1.
3. In bracket 2, insert the full statutory period resulting from any extensions of time which have been granted, e.g., --FOUR-- months.
4. DO NOT USE THIS FORM PARAGRAPH FOR REEXAMINATION PROCEEDINGS.
5. Follow with form paragraph 7.41.01 if transitional provisions of 37 CFR 1.129(a) are applicable.

*¶ 7.67.01 Advisory After Final, Heading, 1st Reply Filed Within 2 Months*

The shortened statutory period for reply expires THREE MONTHS from the mailing date of the final rejection or as of the mailing date of this advisory action, whichever is later. In no event, however, will the statutory period for reply expire later than SIX MONTHS from the mailing date of the final rejection.

Any extension fee required pursuant to 37 CFR 1.17 will be calculated from the date that the shortened statutory period for reply expires as set forth above.

**Examiner Note:**

1. This form paragraph should be used in all advisory actions if:
  - a. it was the FIRST reply to the to the final rejection, and
  - b. it was filed within two months of the date of the final rejection.
2. If a notice of appeal has been filed, also use form paragraph 7.68.
3. DO NOT USE THIS FORM PARAGRAPH FOR REEXAMINATION PROCEEDINGS.
4. Follow with form paragraph 7.41.01 if transitional provisions of 37 CFR 1.129(a) are applicable.

*¶ 7.67.02 Advisory After Final, Heading, No Variable SSP Set in Final*

Since the first reply to the final Office action was filed within TWO MONTHS of the mailing date of that action and the advisory action was not mailed within THREE MONTHS of that date, the THREE-MONTH shortened statutory period for reply set in the final Office action is hereby vacated and reset to expire as of the mailing date of this advisory action. See Notice entitled "Procedure for Handling Amendments Under 37 CFR 1.116," published in the *Official Gazette* at 1027 O.G. 71, February 8, 1983. In no event, however, will the statutory period for reply expire later than SIX MONTHS from the mailing date of the final Office action.

Any extension fee required pursuant to 37 CFR 1.17 will be calculated from the mailing date of the advisory action.

**Examiner Note:**

1. This form paragraph should be used in all advisory actions where:
  - a. the reply is a first reply to the final action;
  - b. the reply was filed within two months of the mailing date of the final; and
  - c. the final action failed to inform applicant of a variable SSP beyond the normal three month period, as is set forth in form paragraphs 7.39 to 7.41.
2. If the final action set a variable SSP, do not use this form paragraph, use form paragraph 7.67.01 instead.
3. If a notice of appeal has been filed, also use form paragraph 7.68.
4. Follow with form paragraph 7.41.01 if transitional provisions of 37 CFR 1.129(a) are applicable.

*¶ 7.68 Advisory After Final, Heading, After Appeal*

An appeal under 37 CFR 1.191 was filed in this application on [1]. Appellant's brief is due on [2] in accordance with 37 CFR 1.192(a).

**Examiner Note:**

1. This paragraph must precede paragraph 7.70 if the amendment is entered.
2. This paragraph must precede paragraph 7.71 if the amendment is not entered.

*¶ 7.69 Advisory After Final, Before Appeal, Amendment To Be Entered*

The amendment filed [1] under 37 CFR 1.116 in reply to the final rejection will be entered upon the filing of an appeal, but is not deemed to place the application in condition for allowance. Upon the filing of an appeal and entry of the amendment, the status of the claims would be as follows:

**Allowed claim(s): [2]**

**Rejected claim(s): [3]**

**Claim(s) objected to: [4]**

**Examiner Note:**

1. This paragraph must be preceded by paragraph 7.67, 7.67.01 or 7.67.02.
2. In brackets 2-4 indicate the status of all claims.
3. Whenever an amendment is entered for appeal purposes, you must follow the last paragraph above with form paragraph 7.69.01 or other language to indicate how the new or amended claim(s) would be rejected (whether the rejections are exactly the same as in the final Office action or there is a shift to one or more different individual grounds of rejection in the final Office action). This may be done by using form paragraph 7.69.01 for each group of claims subject to the same rejection.

*¶ 7.69.01 Advisory Action, Proposed Rejection of Claims, Before Appeal*

See 37 CFR 1.193(a)(2) which provides for the inclusion of the proposed rejection(s) detailed below in the Examiner's Answer if applicant elects to file an appeal to the Board of Patent Appeals

and Interferences in this proceeding. To be complete, such rejection(s) must be addressed in any brief on appeal.

Upon appeal and entry of the amendment:

Claim(s) [1] would be rejected for the reasons set forth in [2] of the final Office action mailed [3].

**Examiner Note:**

1. In bracket 1, identify all the new or amended claim(s) that would be grouped together in a single rejection.
2. In bracket 2, identify the rejection by referring to either the paragraph number or the statement of the rejection (e.g., the rejection under 35 U.S.C. § 103 based upon A in view of B) in the final Office action under which the claims would be rejected on appeal.
3. Repeat this form paragraph for each group of claims subject to the same rejection(s).
4. A statement of reasons for allowance, or other appropriate information may be added if necessitated by entry of the amendment.

*¶ 7.70 Advisory After Final, After Appeal, Amendment Entered*

The amendment filed [1] under 37 CFR 1.116 in reply to the final rejection has been entered, but is not deemed to place the application in condition for allowance. For purposes of appeal, the status of the claims is as follows:

**Allowed claim(s): [2]**

**Rejected claim(s): [3]**

**Claim(s) objected to: [4]**

**Examiner Note:**

1. This paragraph must be preceded by paragraph 7.68.
2. In brackets 2-4 indicate the status of all pending claims.
3. Whenever an amendment is entered for appeal purposes, you must follow the last paragraph above with form paragraph 7.70.01 or other language to indicate how the new or amended claim(s) would be rejected (whether the rejections are exactly the same as in the final Office action or there is a shift to one or more different individual grounds of rejection in the final Office action). This may be done by using form paragraph 7.70.01 for each group of claims subject to the same rejection.
4. A statement of reasons for allowance, or other appropriate information may be added if necessitated by entry of the amendment.

*¶ 7.70.01 Advisory Action, Proposed Rejection of Claims*

See 37 CFR 1.193(a)(2) which provides for the inclusion of the proposed rejection(s) detailed below in the Examiner's Answer if applicant elects to file an appeal to the Board of Patent Appeals and Interferences in this proceeding. To be complete, such rejection(s) must be addressed in any brief on appeal.

Claim(s) [1] would be rejected for the reasons set forth in [2] of the final Office action mailed [3].

**Examiner Note:**

1. In bracket 1, identify all the new or amended claim(s) that would be grouped together in a single rejection.
2. In bracket 2, identify the rejection by referring to either the paragraph number or the statement of the rejection (e.g., the rejection

tion under 35 U.S.C. § 103 based upon A in view of B) in the final Office action under which the claims would be rejected on appeal.

3. Repeat this form paragraph for each group of claims subject to the same rejection(s).

4. A statement of reasons for allowance, or other appropriate information may be added if necessitated by entry of the amendment.

*¶ 7.71 Advisory After Final, Amendment Not Entered*

The amendment filed [1] under 37 CFR 1.116 in reply to the final rejection has been considered but is not deemed to place the application in condition for allowance and will not be entered because:

**Examiner Note:**

1. This paragraph must be preceded by paragraph 7.67, 7.67.01 or 7.67.02 if an appeal has not been taken, or by paragraph 7.68 if an appeal has been taken.
2. If it is not known whether a notice of appeal has been filed and the full six month period has expired, do not use paragraphs 7.67, 7.67.01, 7.67.02 or 7.68; use instead the following: "If an appeal under 37 CFR 1.191 has not been properly filed, this application is abandoned."
3. One or more of the appropriate paragraphs 7.72 to 7.76 must directly follow this paragraph.

\*\*>

*¶ 7.71.01 Advisory After Final, Rewritten Claims Not Entered*

The amendment filed [1] under 37 CFR 1.116 will not be entered. Applicant's amendment would be entered if not presented with claim [2]. The inclusion of claim [3] raises new issues under 37 CFR 1.116. Thus, the entire paper is denied entry.

**Examiner Note:**

1. This paragraph must be preceded by either paragraph 7.67, 7.67.01, 7.67.02 or 7.68.
2. In bracket 1, insert date of receipt of amendment.
3. In brackets 2 and 3, insert number of any claim which raises new issues. An explanation should follow bracket 2.

<

*¶ 7.72 Advisory After Final, Lacks Showing, Why Necessary and Not Earlier Presented*

There is no convincing showing under 37 CFR 1.116(b) why the proposed amendment is necessary and was not earlier presented.

**Examiner Note:**

1. Paragraph 7.71 must precede this paragraph.
2. Do not use this paragraph as the sole reason for refusing entry of the amendment unless the situation is aggravated, in which case a full explanation is necessary.
3. Follow with form paragraph 7.41.01 if transitional provisions of 37 CFR 1.129(a) are applicable and only if not used in previous action.

*¶ 7.73 Advisory After Final, Raises New Issues*

The proposed amendment raises new issues that would require further consideration and/or search.

**Examiner Note:**

1. This paragraph must be preceded by paragraph 7.71.
2. The new issues including questions of new matter must be clearly identified following this form paragraph. (Examples are sufficient if the new issues are extensive.)
3. Follow with form paragraph 7.41.01 if transitional provisions of 37 CFR 1.129(a) are applicable and only if not used in previous action.

*¶ 7.75 Advisory After Final, Form for Appeal Not Improved*

The proposed amendment is not deemed to place the application in better form for appeal by materially simplifying the issues for appeal.

**Examiner Note:**

1. This paragraph must be preceded by paragraph 7.71.
2. Follow with form paragraph 7.41.01 if transitional provisions of 37 CFR 1.129(a) are applicable and only if not used in a previous action.

*¶ 7.76 Advisory After Final, Additional Claims Presented*

The proposed amendment presents additional claims without canceling a corresponding number of finally rejected claims.

**Examiner Note:**

1. This paragraph must be preceded by paragraph 7.71.
2. Follow with form paragraph 7.41.01 if transitional provisions of 37 CFR 1.129(a) are applicable and only if not used in a previous action.

*¶ 7.78 Advisory After Final, Proposed New Claims Would Be Allowable*

Claim [1] as proposed would be allowable if submitted in a separately filed amendment canceling all non-allowed claims.

**Examiner Note:**

1. This paragraph must be preceded by paragraph 7.71.
2. Follow with form paragraph 7.41.01 if transitional provisions of 37 CFR 1.129(a) are applicable and only if not used in a previous action.

*¶ 7.79 Advisory After Final, Affidavit, Exhibit, or Request for Reconsideration Considered*

The [1] has been entered and considered but does not overcome the rejection because [2].

**Examiner Note:**

1. This paragraph must be preceded by either paragraph 7.67, 7.67.01, 7.67.02 or 7.68.
2. In bracket 1, insert --affidavit--, --declaration--, --exhibit--, or --request for reconsideration--.
3. An explanation should be provided in bracket 2.

4. Follow with form paragraph 7.41.01 if transitional provisions of 37 CFR 1.129(a) are applicable and only if not used in a previous action.

*¶ 7.80 Advisory After Final, Affidavit or Exhibit Not Considered*

The [1] will not be considered because good and sufficient reasons why it was not earlier presented have not been shown. [2]

**Examiner Note:**

1. This paragraph must be preceded by either paragraph 7.67, 7.67.01, 7.67.02 or 7.68.
2. In bracket 1, insert --affidavit--, --declaration--, --exhibit--, or --request for reconsideration--.
3. An explanation should follow in bracket 2.
4. Follow with form paragraph 7.41.01 if transitional provisions of 37 CFR 1.129(a) are applicable and only if not used in a previous action.

>

**IV. < HAND DELIVERY OF PAPERS**

\*\*>

Hand carried papers for the Technology Centers (TCs) may only be delivered to the Customer Window which is located at:

U.S. Patent and Trademark Office  
2011 South Clark Place  
Customer Window  
Crystal Plaza Two, Lobby, Room 1B03  
Arlington, VA 22202

Effective December 1, 2003, all official patent application related correspondence for organizations reporting to the Commissioner of Patents (e.g., TCs, the Office of Patent Publication, and the Office of Petitions) that is hand-carried (or delivered by other delivery services, e.g., FedEx, UPS, etc.) must be delivered to the Customer Window, with a few limited exceptions. See MPEP § 502. Hand-carried amendments and other replies after final rejection (37 CFR 1.116) will no longer be accepted in the TCs. Any courier who attempts delivery of such after final correspondence at a TC (or where it is no longer permitted) will be re-directed to the Customer Window. Some time after the initial move to Carlyle, Alexandria, an additional depository in the Carlyle facility for hand-carried correspondence will be established. Patent application related compact disks (CDs) and

other non-paper submissions that are hand-carried must be delivered to the Customer Window.

**V. < EXPEDITED PROCEDURE FOR PROCESSING AMENDMENTS AND OTHER REPLIES AFTER FINAL REJECTION (37 CFR 1.116)**

In an effort to improve the timeliness of the processing of amendments and other replies under 37 CFR 1.116, and thereby provide better service to the public, an expedited processing procedure has been established which the public may utilize in filing amendments and other replies after final rejection under 37 CFR 1.116. In order for an applicant to take advantage of the expedited procedure>< the amendment or other reply under 37 CFR 1.116 will have to be marked as a “Reply under 37 CFR 1.116 — Expedited Procedure - Technology Center (Insert Technology Center Number)” on the upper right portion of the amendment or other reply and the envelope must be marked “\*>Mail Stop< AF” in the lower left hand corner. The markings preferably should be written in a bright color with a felt point marker. If the reply is mailed to the Office, the envelope should contain only replies under 37 CFR 1.116 and should be mailed to “\*\*>Mail Stop AF, Commissioner for Patents, P.O. Box 1450, Alexandria, Virginia, 22313-1450<.” Instead of mailing the envelope to “\*>Mail Stop< AF” as noted above, the reply may be hand-carried to the \*\*>Customer Window located at:

U.S. Patent and Trademark Office  
2011 South Clark Place  
Customer Window  
Crystal Plaza Two, Lobby, Room 1B03  
Arlington, VA 22202

The outside of the envelope should be marked< “Reply Under 37 CFR 1.116 - Expedited Procedure - Technology Center (Insert Technology Center Number).”

Upon receipt by the U.S. Patent and Trademark Office from the U.S. Postal Service of an envelope appropriately marked “\*>Mail Stop< AF,” the envelope will be specially processed by the Mail Center and >for non-Image File Wrapper applications (non-IFW)< forwarded promptly to the examining TC, via the Office of Finance if any fees have to be charged or otherwise processed. >For IFW

application processing, see IFW Manual.< Upon receipt of the reply in the TC it will be promptly processed by a designated technical support staff member and forwarded to the examiner, via the supervisory patent examiner (SPE), for action. The SPE is responsible for ensuring that prompt action on the reply is taken by the examiner. If the examiner to which the application is assigned is not available and will not be available for an extended period, the SPE will ensure that action on the application is promptly taken to assure meeting the USPTO goal described below. Once the examiner has completed his or her consideration of the reply, the examiner's action will be promptly typed >and printed,< and mailed by technical support staff >or other Office< personnel designated to expedite the processing of replies filed under this procedure. The TC supervisory personnel, e.g., the supervisory patent examiner, supervisory applications examiner, and TC Director are responsible for ensuring that actions on replies filed under this procedure are promptly processed and mailed. The U.S. Patent and Trademark Office goal is to mail the examiner's action on the reply within 1 month from the date on which the amendment or reply is received by the U.S. Patent and Trademark Office.

Applicants are encouraged to utilize this expedited procedure in order to facilitate U.S. Patent and Trademark Office processing of replies under 37 CFR 1.116. If applicants do not utilize the procedure by appropriately marking the envelope and enclosed papers, the benefits expected to be achieved therefrom will not be attained. The procedure cannot be expected to result in achievement of the goal in applications in which the delay results from actions by the applicant, e.g., delayed interviews, applicant's desire to file a further reply, or a petition by applicant which requires a decision and delays action on the reply. In any application in which a reply under this procedure has been filed and no action by the examiner has been received within the time referred to herein, plus normal mailing time, a telephone call to the SPE of the relevant TC art unit would be appropriate in order to permit the SPE to determine the cause for any delay. If the SPE is unavailable or if no satisfactory reply is received, the TC Director should be contacted.

## 714.14 Amendments After Allowance of All Claims

Under the decision in *Ex parte Quayle*, 25 USPQ 74, 1935 C.D. 11; 453 O.G. 213 (Comm'r Pat. 1935), after all claims in an application have been allowed the prosecution of the application on the merits is closed even though there may be outstanding formal objections which preclude fully closing the prosecution.

Amendments touching the merits are treated in a manner similar to amendments after final rejection, though the prosecution may be continued as to the formal matters. See MPEP § 714.12 and § 714.13.

See MPEP § 714.20 for amendments entered in part.

See MPEP § 607 for additional fee requirements.

Use form paragraph 7.51 to issue an *Ex parte Quayle* action.

### ¶ 7.51 *Quayle* Action

This application is in condition for allowance except for the following formal matters: [1].

Prosecution on the merits is closed in accordance with the practice under *Ex parte Quayle*, 1935 C.D. 11, 453 O.G. 213.

A shortened statutory period for reply to this action is set to expire **TWO MONTHS** from the mailing date of this letter.

### Examiner Note:

Explain the formal matters which must be corrected in bracket 1.

## 714.15 Amendment Received in Technology Center After Mailing of Notice of Allowance

Where an amendment, even though prepared by applicant prior to allowance, does not reach the Office until after the notice of allowance has been mailed, such amendment has the status of one filed under 37 CFR 1.312. Its entry is a matter of grace. For discussion of amendments filed under 37 CFR 1.312, see MPEP § 714.16 to § 714.16(e).

If, however, the amendment is filed in the Office prior to the mailing out of the notice of allowance, but is received by the examiner after the mailing of the notice of allowance, it has the same standing in the application as though the notice had not been mailed. Where the application has not been closed to further prosecution, as by final rejection of one or more claims, or by an action allowing all of the claims,

applicant may be entitled to have such amendment entered even though it may be necessary to withdraw the application from issue. Such withdrawal, however, is unnecessary if the amendatory matter is such as the examiner would recommend for entry under 37 CFR 1.312.

As above implied, the application will not be withdrawn from issue for the entry of an amendment that would reopen the prosecution if the Office action next preceding the notice of allowance closed the application to further amendment, i.e., by indicating the patentability of all of the claims, or by allowing some and finally rejecting the remainder.

After an applicant has been notified that the claims are all allowable, further prosecution of the merits of the application is a matter of grace and not of right. *Ex parte Quayle*, 25 USPQ 74, 1935 C.D. 11, 453 O.G. 213 (Comm'r Pat. 1935).

## **714.16 Amendment After Notice of Allowance, 37 CFR 1.312 [R-2]**

\*\*>

*37 CFR 1.312. Amendments after allowance.*

No amendment may be made as a matter of right in an application after the mailing of the notice of allowance. Any amendment filed pursuant to this section must be filed before or with the payment of the issue fee, and may be entered on the recommendation of the primary examiner, approved by the Director, without withdrawing the application from issue.<

The amendment of an application by applicant after allowance falls within the guidelines of 37 CFR 1.312. Further, the amendment of an application broadly encompasses any change in the file record of the application. Accordingly, the following are examples of "amendments" by applicant after allowance which must comply with 37 CFR 1.312:

- (A) an amendment to the specification,
- (B) a change in the drawings,
- (C) an amendment to the claims,
- (D) a change in the inventorship,
- (E) the submission of prior art, etc.

Finally, it is pointed out that an amendment under 37 CFR 1.312 must be filed on or before the date the issue fee is paid>, except where the amendment is required by the Office of Patent Publication, see MPEP § 714.16(d), subsection III. An amendment

under 37 CFR 1.312 must comply with the provisions of 37 CFR 1.121<.

The \*>Director< has delegated the approval of recommendations under 37 CFR 1.312 to the supervisory patent examiners.

With the exception of a supplemental oath or declaration submitted in a reissue, a supplemental oath or declaration is not treated as an amendment under 37 CFR 1.312. See MPEP § 603.01. A supplemental reissue oath or declaration is treated as an amendment under 37 CFR 1.312 because the correction of the patent which it provides is an amendment of the patent, even though no amendment is physically entered into the specification or claim(s). Thus, for a reissue oath or declaration submitted after allowance to be entered, the reissue applicant must comply with 37 CFR 1.312 in the manner set forth in this section.

After the Notice of Allowance has been mailed, the application is technically no longer under the jurisdiction of the primary examiner. He or she can, however, make examiner's amendments (see MPEP § 1302.04) and has authority to enter amendments submitted after Notice of Allowance of an application which embody merely the correction of formal matters in the specification or drawing, or formal matters in a claim without changing the scope thereof, or the cancellation of claims from the application, without forwarding to the supervisory patent examiner for approval.

Amendments other than those which merely embody the correction of formal matters without changing the scope of the claims require approval by the supervisory patent examiner. The Technology Center (TC) Director establishes TC policy with respect to the treatment of amendments directed to trivial informalities which seldom affect significantly the vital formal requirements of any patent, namely, (A) that its disclosure be adequately clear, and (B) that any invention present be defined with sufficient clarity to form an adequate basis for an enforceable contract.

Consideration of an amendment under 37 CFR 1.312 cannot be demanded as a matter of right. Prosecution of an application should be conducted before, and thus be complete *including editorial revision of the specification and claims* at the time of the Notice of Allowance. However, where amendments of the type noted are shown (A) to be needed for proper disclosure or protection of the invention, and

(B) to require no substantial amount of additional work on the part of the Office, they may be considered and, if proper, entry may be recommended by the primary examiner.

\*\*

The requirements of 37 CFR 1.111(c) (MPEP § 714.02) with respect to pointing out the patentable novelty of any claim sought to be added or amended, apply in the case of an amendment under 37 CFR 1.312, as in ordinary amendments. See MPEP § 713.04 and § 713.10 regarding interviews. As to amendments affecting the disclosure, the scope of any claim, or that add a claim, the remarks accompanying the amendment must fully and clearly state the reasons on which reliance is placed to show:

(A) why the amendment is needed;

(B) why the proposed amended or new claims require no additional search or examination;

(C) why the claims are patentable; and

(D) why they were not presented earlier.

>

## I. < NOT TO BE USED FOR CONTINUED PROSECUTION

37 CFR 1.312 was never intended to provide a way for the continued prosecution of an application after it has been passed for issue. When the recommendation is against entry, a detailed statement of reasons is not necessary in support of such recommendation. The simple statement that the proposed claim is not obviously allowable and briefly the reason why is usually adequate. Where appropriate, any one of the following reasons is considered sufficient:

(A) an additional search is required;

(B) more than a cursory review of the record is necessary; or

(C) the amendment would involve materially added work on the part of the Office, e.g., checking excessive editorial changes in the specification or claims.

Where claims added by amendment under 37 CFR 1.312 are all of the form of dependent claims, some of the usual reasons for nonentry are less likely to apply although questions of new matter, sufficiency of disclosure, or undue multiplicity of claims could arise.

See MPEP § 607 and § 714.16(c) for additional fee requirements.

>

## II. < AMENDMENTS FILED AFTER PAYMENT OF ISSUE FEE

No amendments should be filed after the date the issue fee has been paid.

### ¶ 13.10 Amendment Filed After the Payment of Issue Fee, Not Entered

Applicant's amendment filed on [1] will not be entered because the amendment was filed after the issue fee was paid. 37 CFR 1.312 no longer permits filing an amendment after the date the issue fee has been paid.

#### Examiner Note:

1. Use this paragraph with form PTOL-90 or PTO-90C.
2. In bracket 1, insert the date of the amendment.

## 714.16(a) Amendments Under 37 CFR 1.312, Copied Patent Claims

See MPEP § 2305.04 for the procedure to be followed when an amendment is received after notice of allowance which includes one or more claims copied or substantially copied from a patent.

The entry of the copied patent claims is not a matter of right. See MPEP § 714.19.

See MPEP § 607 and § 714.16(c) for additional fee requirements.

## 714.16(b) Amendments Under 37 CFR 1.312 Filed With a Motion Under 37 CFR 1.633

Where an amendment filed with a motion under 37 CFR 1.633(c)(2) applies to an application in issue, the amendment is not entered unless and until the motion has been granted.

## 714.16(c) Amendments Under 37 CFR 1.312, Additional Claims

If the amendment under 37 CFR 1.312 adds claims (total and independent) in excess of the number previously paid for, additional fees are required. The amendment is *not* considered by the examiner unless accompanied by the full fee required. See MPEP § 607 and 35 U.S.C. 41.

## 714.16(d) Amendments Under 37 CFR 1.312, Handling [R-2]

>

### I. < AMENDMENTS AFFECTING THE DISCLOSURE OF THE SPECIFICATION, ADDING CLAIMS, OR CHANGING THE SCOPE OF ANY CLAIM

Amendments under 37 CFR 1.312 are sent by the Office of Initial Patent Examination (OIPE) to the Publishing Division which, in turn, forwards>, for non-Image File Wrapper applications (non-IFW),< the proposed amendment, file, and drawing (if any) to the Technology Center (TC) which allowed the application. \*\*>For IFW applications, amendments under 37 CFR 1.312 must be sent to the Office of Initial Patent Examination (OIPE) Central Scanning. OIPE Central Scanning will scan the amendments. Upon upload of the images, OIPE Central Scanning will message the Office of Patent Publication (PUBS). PUBS will review the messages and forward the messages to the Technology Center (TC), which allowed the application. Once the TC completes the action, the TC will message PUBS that issue processing can resume. If an amendment under 37 CFR 1.312 has been filed directly with the TC, the paper will be forwarded to the OIPE Central Scanning.

Hand delivered amendments under 37 CFR 1.312 are no longer accepted in the TC. Hand delivered amendments (unless specifically required by PUBS, see subsection III. below) may only be delivered to the Customer Window located at:

U.S. Patent and Trademark Office  
2011 South Clark Place  
Customer Window  
Crystal Plaza Two, Lobby, Room 1B03  
Arlington, VA 22202<

In the event that the class and subclass in which the application is classified has been transferred to another TC after the application was allowed, the proposed amendment, file and drawing (if any) are transmitted directly to said other TC and the Publishing Division notified. If the examiner who allowed the application is still employed in the U.S. Patent and Trademark Office but not in said other TC, he or she

may be consulted about the propriety of the proposed amendment and given credit for any time spent in giving it consideration.

The amendment is PROMPTLY considered by the examiner who indicates whether or not its entry is recommended by writing “Enter — 312,” “Do Not Enter” or “Enter In Part” thereon in red ink in the upper left corner. >For IFW processing, see IFW Manual.

In addition, the amendment must comply with the provisions of 37 CFR 1.121.<

If the amendment is favorably considered, it is entered and a Response to Rule 312 Communication (PTO-271) is prepared. The primary examiner indicates his or her recommendation by stamping and signing his or her name on the PTO-271. Form paragraph 7.85 may also be used to indicate entry.

#### ¶ 7.85 Amendment Under 37 CFR 1.312 Entered

The amendment filed on [1] under 37 CFR 1.312 has been entered.

#### Examiner Note:

Use this form paragraph both for amendments under 37 CFR 1.312 that do not affect the scope of the claims (may be signed by primary examiner) and for amendments being entered under 37 CFR 1.312 which do affect the scope of the claims (requires signature of supervisory patent examiner). See MPEP § 714.16.

If the examiner’s recommendation is completely adverse, a report giving the reasons for nonentry is typed on the Response to Rule 312 Communication form PTO-271 and signed by the primary examiner.

Form paragraph 7.87 may also be used to indicate nonentry.

#### ¶ 7.87 Amendment Under 37 CFR 1.312 Not Entered

The proposed amendment filed on [1] under 37 CFR 1.312 has not been entered. [2]

#### Examiner Note:

The reasons for non-entry should be specified in bracket 2:  
-- The amendment changes the scope of the claims.--; or  
-- The amendment was filed in a reissue application and was not accompanied by a supplemental reissue oath or declaration, 37 CFR 1.175(b). --

In either case, whether the amendment is entered or not entered, the file, drawing, and unmailed notices are forwarded to the supervisory patent examiner for consideration, approval, and mailing.

For entry-in-part, see MPEP § 714.16(e).



The filling out of the appropriate form by the technical support staff does not signify that the amendment has been admitted; for, though actually entered it is not officially admitted unless and until approved by the supervisory patent examiner.

See MPEP § 607 and § 714.16(c) for additional fee requirements.

\*\*

>

## II. < AMENDMENTS WHICH EMBODY MERELY THE CORRECTION OF FORMAL MATTERS IN THE SPECIFICATION, FORMAL CHANGES IN A CLAIM WITHOUT CHANGING THE SCOPE THEREOF, OR THE CANCELLATION OF CLAIMS

The examiner indicates approval of amendments concerning merely formal matters by writing “Enter Formal Matters Only” thereon. Such amendments do not require submission to the supervisory patent examiner prior to entry. See MPEP § 714.16. The Response to Rule 312 Communication form PTO-271 is date stamped and mailed by the TC. If such amendments are disapproved either in whole or in part, they require the signature of the supervisory patent examiner. \*\*>For IFW processing, see IFW Manual.

## III. AMENDMENTS REQUIRED BY THE OFFICE OF PATENT PUBLICATION

In preparation of a patent for issuance as a patent grant, if the Office of Patent Publication (PUBS) discovers an error in the text, or drawings of a patent application, including any missing text, or an inconsistency between the drawings and the application papers, PUBS may require an appropriate amendment to the specification or drawings. 37 CFR 1.312, however, does not permit an amendment after the payment of the issue fee without withdrawal of the application from issue. In order to be able to accept such an amendment as may be required without having to withdraw an application from issue, effective February 24, 2004, PUBS has been delegated the authority to waive the requirement of 37 CFR 1.312 and accept an amendment filed after the payment of the issue fee.

Furthermore, these amendments required by PUBS may be hand delivered to PUBS located at:

Office of Patent Publication  
2231 Crystal Drive, Room 907  
Arlington, VA 22202

Applicants may also fax these amendments required by PUBS to (703) 746-4000.<

## 714.16(e) Amendments Under 37 CFR 1.312, Entry in Part [R-2]

The general rule that an amendment cannot be entered in part and refused in part should not be relaxed, but when, under 37 CFR 1.312, an amendment, for example, is proposed containing a plurality of claims or amendments to claims, some of which may be entered and some not, the acceptable claims or amendments should be entered in the application. If necessary, the claims should be renumbered to run consecutively with the claims already in the case. The refused claims or amendments should be canceled in lead pencil on the amendment. >For Image File Wrapper (IFW) processing, see IFW Manual.<

The examiner should then submit a Response to Rule 312 Communication form PTO-271 recommending the entry of the acceptable portion of the amendment and the nonentry of the remaining portion together with his or her reasons therefor. The claims entered should be indicated by number in this response. Applicant may also be notified by using form paragraph 7.86.

### ¶ 7.86 Amendment Under 37 CFR 1.312 Entered in Part

The amendment filed on [1] under 37 CFR 1.312 has been entered-in-part. [2]

### Examiner Note:

When an amendment under 37 CFR 1.312 is proposed containing plural changes, some of which may be acceptable and some not, the acceptable changes should be entered. An indication of which changes have and have not been entered with appropriate explanation should follow in bracket 2.

Handling is similar to complete entry of a 37 CFR 1.312 amendment.

Entry in part is not recommended unless the full additional fee required, if any, accompanies the amendment. See MPEP § 607 and § 714.16(c).

### **714.17 Amendment Filed After the Period for Reply Has Expired [R-2]**

When an application is not prosecuted within the period set for reply and thereafter an amendment is filed without a petition for extension of time and fee pursuant to 37 CFR 1.136(a), such amendment shall be endorsed on the file wrapper of the application, but not formally entered. The technical support staff shall immediately notify the applicant, by telephone and letter, that the amendment was not filed within the time period and therefore cannot be entered and that the application is abandoned unless a petition for extension of time and the appropriate fee are timely filed. See MPEP § 711.02. >For Image File Wrapper (IFW) processing, see IFW Manual.<

See MPEP § 710.02(e) for a discussion of the requirements of 37 CFR 1.136(a).

### **714.18 Entry of Amendments [R-2]**

Amendments are stamped with the date of their receipt in the Technology Center (TC). It is important to observe the distinction which exists between the stamp which shows the date of receipt of the amendment in the TC (“Technology Center Date” stamp) and the stamp bearing the date of receipt of the amendment by the Office (“Office Date” stamp). The latter date, placed in the left-hand corner, should always be referred to in writing to the applicant with regard to his or her amendment. >For Image File Wrapper (IFW) processing, see IFW Manual.<

All amendments received in the technical support staff sections are processed and with the applications delivered to the supervisory patent examiner for his or her review and distribution to the examiners.

Every mail delivery should be carefully screened to remove all amendments replying to a final action in which a time period is running against the applicant. Such amendments should be processed within the next 24 hours.

The purpose of this procedure is to ensure uniform and prompt treatment by the examiners of all applications where the applicant is awaiting a reply to a proposed amendment after final action. By having all of these applications pass over the supervisory patent examiner’s desk, he or she will be made aware of the need for any special treatment, if the situation so war-

rants. For example, the supervisory patent examiner will know whether or not the examiner in each application is on extended leave or otherwise incapable of moving the application within the required time periods (see MPEP § 714.13). In cases of this type, the applicant should receive an Office communication in sufficient time to adequately consider his or her next action if the application is not allowed. Consequently, technical support staff handling will continue to be special when these applications are returned by the examiners to the technical support staff.

>Evaluation of the amendment after final rejection for compliance with 37 CFR 1.121 should be left to the examiner, and not treated by the technical support staff before forwarding the amendment to the examiner. If the examiner determines that the proposed amendment is not in compliance with 37 CFR 1.121, the examiner should notify applicant of this fact and attach a Notice of Non-Compliant Amendment to the advisory action.<

The amendment or letter is placed in the file, given its number as a paper in the application, and its character endorsed on the file wrapper in red ink. >For IFW processing, see IFW Manual.<

When several amendments are made in an application on the same day no particular order as to the hour of the receipt or the mailing of the amendments can be assumed, but consideration of the application must be given as far as possible as though all the papers filed were a composite single paper.

After entry of the amendment the application is “up for action.” It is forwarded to the examiner, and he or she is responsible for its proper disposal. The examiner should immediately inspect the amendment as set forth in MPEP § 714.05. After inspection, if no immediate or special action is required, the application awaits examination in regular order.

See MPEP § 714.03 for the treatment of preliminary amendments and non-final amendments that are not in compliance with 37 CFR 1.121. See MPEP § 714.22 for treatment of non-compliant amendments after final rejection.

### **714.19 List of Amendments, Entry Denied [R-2]**

The following types of amendments are ordinarily denied entry:

(A) An amendment presenting an unpatentable claim, or a claim requiring a new search or otherwise raising a new issue in an application whose prosecution before the primary examiner has been closed, as where

(1) All claims have been allowed,

(2) All claims have been finally rejected (for exceptions see MPEP § 714.12, § 714.13, and § 714.20, item (D)),

(3) Some claims have been allowed and the remainder finally rejected. See MPEP § 714.12 to § 714.14.

(B) Substitute specification that does not comply with 37 CFR 1.125. See MPEP § 608.01(q) and § 714.20.

(C) A patent claim suggested by the examiner and not presented within the time limit set or an extension thereof, unless entry is authorized by the \*>Director<. See MPEP § 2305.03.

(D) While copied patent claims are generally admitted even though the application is under final rejection or on appeal, under certain conditions, the claims may be refused entry. See MPEP § 2307.03.

(E) An unsigned or improperly signed amendment or one signed by a suspended or excluded attorney or agent.

(F) An amendment filed in the U.S. Patent and Trademark Office after the expiration of the statutory period or set time period for reply and any extension thereof. See MPEP § 714.17.

(G) An amendment so worded that it cannot be entered with certain accuracy. See MPEP § 714.23.

(H) An amendment \*\* canceling all of the claims and presenting no substitute claim or claims. See MPEP § 711.01.

(I) An amendment in an application no longer within the examiner's jurisdiction with certain exceptions in applications in issue, except on approval of the \*>Director<. See MPEP § 714.16.

(J) Amendments to the drawing held by the examiner to contain new matter are not entered until the question of new matter is settled. This practice of nonentry because of alleged new matter, however, does not apply in the case of amendments to the specification and claims. See MPEP § 608.04 and § 706.03(o).

(K) An amendatory paper containing objectionable remarks that, in the opinion of the examiner,

brings it within the condemnation of 37 CFR 1.3, will be submitted to the Technology Center (TC) Director \*\*. See MPEP § 714.25 and MPEP § 1003. If the TC Director determines that the remarks are in violation of 37 CFR 1.3, he or she will \*>notify the applicant of the non-entry of< the paper.

(L) Amendments not in permanent ink. Amendments on so-called "easily erasable paper." See MPEP § 714.07.

(M) An amendment presenting claims (total and independent) in excess of the number previously paid for and not accompanied by the full fee for the claims or an authorization to charge the fee to a deposit account or credit card. See MPEP § 509.

(N) An amendment canceling all claims drawn to the elected invention and presenting only claims drawn to the nonelected invention should not be entered. Such an amendment is nonresponsive. Applicant should be notified as directed in MPEP § 714.03 and § 714.05. See MPEP § 821.03.

(O) An amendment including changes to the specification/claims which is not in compliance with 37 CFR 1.121, \*>e.g.<, one which does not include replacement paragraphs \*>or claim listings<. See MPEP § 714.22.

(P) A preliminary amendment that unduly interferes with the preparation of a first Office action. Factors to be considered in denying entry of the preliminary amendment are set forth in 37 CFR 1.115(b). See MPEP § 714.03(a).

(Q) A second (or subsequent) supplemental reply that unduly interferes with an Office action being prepared in response to the previous reply. Factors to be considered in denying entry of the reply are set forth in 37 CFR 1.111(a)(2). See MPEP § 714.03(a).

While amendments falling within any of the foregoing categories should not be entered by the examiner at the time of filing, a subsequent showing by applicant may lead to entry of the amendment.

## 714.20 List of Amendments Entered in Part [R-2]

To avoid confusion of the record the general rule prevails that an amendment should not be entered in part. \*\*>At times<, the strict observance of its letter may sometimes work more harm than would result from its infraction, especially if the amendment in

question is received at or near the end of the period for reply. Thus:

(A) An “amendment” presenting an unacceptable substitute specification along with amendatory matter, as amendments to claims or new claims, should be entered in part, rather than refused entry *in toto*. The substitute specification should be denied entry and so marked, while the rest of the paper should be entered. The application as thus amended is acted on when reached in its turn, the applicant being advised that the substitute specification has not been entered.

See 37 CFR 1.125 and MPEP § 608.01(q) for information regarding the submission of a substitute specification.

Under current practice, substitute specifications may be voluntarily filed by the applicant if he or she desires. A proper substitute specification will normally be accepted by the Office even if it has not been required by the examiner. >However, entry of a substitute specification filed after the notice of allowance has been mailed (37 CFR 1.312) is not a matter of right.<

(B) An amendment under 37 CFR 1.312, which in part is approved and in other part disapproved, is entered only as to the approved part. See MPEP § 714.16(e).

(C) In an application in which prosecution on the merits is closed, i.e., after the issuance of an *Ex Parte Quayle* action, where an amendment is presented curing the noted formal defect and adding one or more claims some or all of which are in the opinion of the examiner not patentable, or will require a further search, the amendment in such a case will be entered only as to the formal matter. Applicant has no right to have new claims considered or entered at this point in the prosecution.

(D) In an amendment accompanying a motion granted only in part, the amendment is entered only to the extent that the motion was granted.

\*\*

**NOTE.** The examiner writes “Enter” in red ink and his or her initials in the left margin opposite the enterable portions. >For Image File Wrapper (IFW) processing, see IFW Manual.<

## 714.21 Amendments Inadvertently Entered, No Legal Effect [R-2]

If the technical support staff inadvertently enters an amendment when it should not have been entered, such entry is of no legal effect, and the same action is taken as if the changes had not been actually made, inasmuch as they have not been legally made. Unless such unauthorized entry is deleted, suitable notation should be made on the margin of the amendatory paper, as “Not Officially Entered.” >For Image File Wrapper (IFW) processing, see IFW Manual.<

If an amendatory paper is to be retained in the file, even though not entered, it should be given a paper number and listed on the file wrapper with the notation “Not Entered.” See 37 CFR 1.3 and MPEP § 714.25 for an example of a paper which may be >denied entry<.

## 714.22 Entry of Amendments, Directions for [R-2]

\*\*>

*37 CFR 1.121. Manner of making amendments in applications.*

(a) *Amendments in applications, other than reissue applications.* Amendments in applications, other than reissue applications, are made by filing a paper, in compliance with § 1.52, directing that specified amendments be made.

(b) *Specification.* Amendments to the specification, other than the claims, computer listings (§ 1.96) and sequence listings (§ 1.825), must be made by adding, deleting or replacing a paragraph, by replacing a section, or by a substitute specification, in the manner specified in this section.

(1) *Amendment to delete, replace, or add a paragraph.* Amendments to the specification, including amendment to a section heading or the title of the invention which are considered for amendment purposes to be an amendment of a paragraph, must be made by submitting:

(i) An instruction, which unambiguously identifies the location, to delete one or more paragraphs of the specification, replace a paragraph with one or more replacement paragraphs, or add one or more paragraphs;

(ii) The full text of any replacement paragraph with markings to show all the changes relative to the previous version of the paragraph. The text of any added subject matter must be shown by underlining the added text. The text of any deleted matter must be shown by strike-through except that double brackets placed before and after the deleted characters may be used to show deletion of five or fewer consecutive characters. The text of any deleted subject matter must be shown by being placed within double brackets if strikethrough cannot be easily perceived;

(iii) The full text of any added paragraphs without any underlining; and;

(iv) The text of a paragraph to be deleted must not be presented with strike-through or placed within double brackets. The instruction to delete may identify a paragraph by its paragraph number or include a few words from the beginning, and end, of the paragraph, if needed for paragraph identification purposes.

(2) *Amendment by replacement section.* If the sections of the specification contain section headings as provided in § 1.77(b), § 1.154(b), or § 1.163(c), amendments to the specification, other than the claims, may be made by submitting:

(i) A reference to the section heading along with an instruction, which unambiguously identifies the location, to delete that section of the specification and to replace such deleted section with a replacement section; and;

(ii) A replacement section with markings to show all changes relative to the previous version of the section. The text of any added subject matter must be shown by underlining the added text. The text of any deleted matter must be shown by strike-through except that double brackets placed before and after the deleted characters may be used to show deletion of five or fewer consecutive characters. The text of any deleted subject matter must be shown by being placed within double brackets if strike-through cannot be easily perceived.

(3) *Amendment by substitute specification.* The specification, other than the claims, may also be amended by submitting:

(i) An instruction to replace the specification; and

(ii) A substitute specification in compliance with §§ 1.125(b) and (c).

(4) *Reinstatement of previously deleted paragraph or section.* A previously deleted paragraph or section may be reinstated only by a subsequent amendment adding the previously deleted paragraph or section.

(5) *Presentation in subsequent amendment document.* Once a paragraph or section is amended in a first amendment document, the paragraph or section shall not be represented in a subsequent amendment document unless it is amended again or a substitute specification is provided.

(c) *Claims.* Amendments to a claim must be made by rewriting the entire claim with all changes (e.g., additions and deletions) as indicated in this subsection, except when the claim is being canceled. Each amendment document that includes a change to an existing claim, cancellation of an existing claim or addition of a new claim, must include a complete listing of all claims ever presented, including the text of all pending and withdrawn claims, in the application. The claim listing, including the text of the claims, in the amendment document will serve to replace all prior versions of the claims, in the application. In the claim listing, the status of every claim must be indicated after its claim number by using one of the following identifiers in a parenthetical expression: (Original), (Currently amended), (Canceled), (Withdrawn), (Previously presented), (New), and (Not entered).

(1) *Claim listing.* All of the claims presented in a claim listing shall be presented in ascending numerical order. Consecu-

tive claims having the same status of “canceled” or “not entered” may be aggregated into one statement (e.g., Claims 1–5 (canceled)). The claim listing shall commence on a separate sheet of the amendment document and the sheet(s) that contain the text of any part of the claims shall not contain any other part of the amendment.

(2) *When claim text with markings is required.* All claims being currently amended in an amendment paper shall be presented in the claim listing, indicate a status of “currently amended,” and be submitted with markings to indicate the changes that have been made relative to the immediate prior version of the claims. The text of any added subject matter must be shown by underlining the added text. The text of any deleted matter must be shown by strike-through except that double brackets placed before and after the deleted characters may be used to show deletion of five or fewer consecutive characters. The text of any deleted subject matter must be shown by being placed within double brackets if strike-through cannot be easily perceived. Only claims having the status of “currently amended,” or “withdrawn” if also being amended, shall include markings. If a withdrawn claim is currently amended, its status in the claim listing may be identified as “withdrawn—currently amended.”

(3) *When claim text in clean version is required.* The text of all pending claims not being currently amended shall be presented in the claim listing in clean version, i.e., without any markings in the presentation of text. The presentation of a clean version of any claim having the status of “original,” “withdrawn” or “previously presented” will constitute an assertion that it has not been changed relative to the immediate prior version, except to omit markings that may have been present in the immediate prior version of the claims of the status of “withdrawn” or “previously presented.” Any claim added by amendment must be indicated with the status of “new” and presented in clean version, i.e., without any underlining.

(4) *When claim text shall not be presented; canceling a claim.*

(i) No claim text shall be presented for any claim in the claim listing with the status of “canceled” or “not entered.”

(ii) Cancellation of a claim shall be effected by an instruction to cancel a particular claim number. Identifying the status of a claim in the claim listing as “canceled” will constitute an instruction to cancel the claim.

(5) *Reinstatement of previously canceled claim.* A claim which was previously canceled may be reinstated only by adding the claim as a “new” claim with a new claim number.

(d) *Drawings.* One or more application drawings shall be amended in the following manner: Any changes to an application drawing must be in compliance with § 1.84 and must be submitted on a replacement sheet of drawings which shall be an attachment to the amendment document and, in the header, labeled “Replacement Sheet.” Any replacement sheet of drawings shall include all of the figures appearing on the immediate prior version of the sheet, even if only one figure is amended. All changes to the drawing(s) shall be explained, in detail, in either the drawing amendment or remarks section of the amendment paper.

(1) A marked-up copy of any amended drawing figure, including annotations indicating the changes made, may be included. The marked-up copy must be clearly labeled as “Annotated Marked-up Drawings” and must be presented in the amendment or remarks section that explains the change to the drawings.

(2) A marked-up copy of any amended drawing figure, including annotations indicating the changes made, must be provided when required by the examiner.

(e) *Disclosure consistency.* The disclosure must be amended, when required by the Office, to correct inaccuracies of description and definition, and to secure substantial correspondence between the claims, the remainder of the specification, and the drawings.

(f) *No new matter.* No amendment may introduce new matter into the disclosure of an application.

(g) *Exception for examiner’s amendments.* Changes to the specification, including the claims, of an application made by the Office in an examiner’s amendment may be made by specific instructions to insert or delete subject matter set forth in the examiner’s amendment by identifying the precise point in the specification or the claim(s) where the insertion or deletion is to be made. Compliance with paragraphs (b)(1), (b)(2), or (c) of this section is not required.

(h) *Amendment sections.* Each section of an amendment document (e.g., amendment to the claims, amendment to the specification, replacement drawings, and remarks) must begin on a separate sheet.

(i) *Amendments in reissue applications.* Any amendment to the description and claims in reissue applications must be made in accordance with § 1.173.

(j) *Amendments in reexamination proceedings.* Any proposed amendment to the description and claims in patents involved in reexamination proceedings must be made in accordance with § 1.530.

(k) *Amendments in provisional applications.* Amendments in provisional applications are not usually made. If an amendment is made to a provisional application, however, it must comply with the provisions of this section. Any amendments to a provisional application shall be placed in the provisional application file but may not be entered.

The term “brackets” set forth in 37 CFR 1.121 means square brackets, thus: [ ]. It does not encompass and is to be distinguished from parentheses ( ).

## TREATMENT OF NON-COMPLIANT AMENDMENTS:

Preliminary amendments and non-final amendments which are not in compliance with 37 CFR 1.121 are handled by the technical support staff. The technical support staff notifies applicant of the defects by mailing a Notice of Non-Compliant Amendment. See MPEP § 714.03.

Amendments submitted after a final rejection are to be forwarded in unentered status to the examiners, who should address any non-compliance issues in an advisory action and attach a Notice of Non-Compliant Amendment. If an amendment after final rejection fails to place the application in condition for allowance by removing all rejections and/or objections applied in the final rejection, applicant will be so notified by the examiner in an advisory action. If the amendment fails to comply with the requirements of 37 CFR 1.121, and the amendment is considered to be informal, the examiner should provide reasons for the non-compliance and require applicant to re-submit any sections considered to be non-compliant within any remaining period of time (set in the final rejection). No further extensions of time or new time periods which might serve to extend the six-month statutory period will be set in the advisory action. If time remains in the period set in the final rejection, applicants may re-submit any sections considered to be non-compliant, or request an extension of time (with appropriate fee) in which to do so, but will not be able to obtain an extension beyond the six-month statutory deadline. Submission of any amendment at or near the end of the statutory period should be accompanied by the filing of a Notice of Appeal, in order to eliminate the risk of abandonment prior to the examiner acting on the amendment.

It is suggested that examiners explain in an advisory action the reasons why the amendment after final fails to comply with 37 CFR 1.121, July 30, 2003.

\*\*

## 714.23 Entry of Amendments, Directions for, Defective [R-2]

The directions for the entry of an amendment may be defective. Examples include inaccuracy in the paragraph number and/or page and line designated, or a lack of precision where the paragraph or section to which insertion of the amendment is directed occurs. If the correct place of entry is clear from the context, the amendatory paper will be properly amended in the Technology Center and notation thereof, initialed in ink by the examiner, who will assume full responsibility for the change, will be made on the margin of the amendatory paper. For Image File Wrapper (IFW) processing, see IFW Manual. In the next Office

action the applicant should be informed of this alteration in the amendment and the entry of the amendment as thus amended. The applicant will also be informed of the nonentry of an amendment where defective directions and context leave doubt as to the intent of applicant.

### **714.24 Amendment of Amendments [R-2]**

When a replacement paragraph or section \*of< the specification is to be amended, it should be wholly rewritten and the original insertion canceled\*\*. >A marked-up version of the replacement paragraph or section of the specification should be presented using underlining to indicate added subject matter and strike-through to indicate deleted subject matter.< Matter canceled by amendment can be reinstated only by a subsequent amendment presenting the canceled matter as a new insertion. A claim cancelled by amendment (deleted in its entirety) may be reinstated only by a subsequent amendment presenting the claim as a new claim with a new claim number.

### **714.25 Discourtesy of Applicant or Attorney [R-2]**

\*\*>

*37 CFR 1.3. Business to be conducted with decorum and courtesy.*

Applicants and their attorneys or agents are required to conduct their business with the United States Patent and Trademark Office with decorum and courtesy. Papers presented in violation of this requirement will be submitted to the Director and will not be entered. A notice of the non-entry of the paper will be provided. Complaints against examiners and other employees must be made in correspondence separate from other papers.<

All papers received in the U.S. Patent and Trademark Office should be briefly reviewed by the technical support staff, before entry, sufficiently to determine whether any discourteous remarks appear therein.

If the attorney or agent is discourteous in the remarks or arguments in his or her amendment, either the discourtesy should be entirely ignored or the paper submitted to the Technology Center (TC) Director \*\*>for review<. See MPEP § 1003. If the TC Director determines that the remarks are in violation of

37 CFR 1.3, the TC Director will \*\*>send a notice of non-entry of the paper to the applicant<.

### **715 Swearing Back of Reference — Affidavit or Declaration Under 37 CFR 1.131 [R-2]**

*37 CFR 1.131. Affidavit or declaration of prior invention.*

(a) When any claim of an application or a patent under reexamination is rejected, the inventor of the subject matter of the rejected claim, the owner of the patent under reexamination, or the party qualified under §§ 1.42, 1.43, or 1.47, may submit an appropriate oath or declaration to establish invention of the subject matter of the rejected claim prior to the effective date of the reference or activity on which the rejection is based. The effective date of a U.S. patent, U.S. patent application publication, or international application publication under PCT Article 21(2) is the earlier of its publication date or date that it is effective as a reference under 35 U.S.C. 102(e). Prior invention may not be established under this section in any country other than the United States, a NAFTA country, or a WTO member country. Prior invention may not be established under this section before December 8, 1993, in a NAFTA country other than the United States, or before January 1, 1996, in a WTO member country other than a NAFTA country. Prior invention may not be established under this section if either:

(1) The rejection is based upon a U.S. patent or U.S. patent application publication of a pending or patented application to another or others which claims the same patentable invention as defined in § 1.601(n); or

(2) The rejection is based upon a statutory bar.

(b) The showing of facts shall be such, in character and weight, as to establish reduction to practice prior to the effective date of the reference, or conception of the invention prior to the effective date of the reference coupled with due diligence from prior to said date to a subsequent reduction to practice or to the filing of the application. Original exhibits of drawings or records, or photocopies thereof, must accompany and form part of the affidavit or declaration or their absence satisfactorily explained.

37 CFR 1.131(a) has been amended to implement the relevant provisions of Public Law 103-182, 107 Stat. 2057 (1993) (North American Free Trade Agreement Act), Public Law 103-465, 108 Stat. 4809 (1994) (Uruguay Round Agreements Act), and Public Law 106-113, 113 Stat. 1501 (1999) (American Inventors Protection Act), respectively. Under 37 CFR 1.131(a) as amended, which provides for the establishment of a date of completion of the invention in a NAFTA or WTO member country, as well as in the United States, an applicant can establish a date of completion in a NAFTA member country on or after December 8, 1993, the effective date of section 331 of Public Law 103-182, the North American Free Trade Agreement Act, and can establish a date of comple-

tion in a WTO member country other than a NAFTA member country on or after January 1, 1996, the effective date of section 531 of Public Law 103-465, the Uruguay Round Agreements Act (URAA). Acts occurring prior to the effective dates of NAFTA or URAA may be relied upon to show completion of the invention; however, a date of completion of the invention may not be established under 37 CFR 1.131 before December 8, 1993 in a NAFTA country or before January 1, 1996 in a WTO country other than a NAFTA country.

If a country joined the WTO after January 1, 1996, the effective date for proving inventive activity in that country for the purpose of 35 U.S.C. 104 and 37 CFR 1.131 is the date the country becomes a member of the WTO. See MPEP § 201.13 for a list that includes WTO member countries (the notation “W<sup>0</sup>” indicates the country became a WTO member after January 1, 1996).

Any printed publication or activity dated prior to an applicant’s or patent owner’s effective filing date, or any domestic patent of prior filing date, which is in its disclosure pertinent to the claimed invention, is available for use by the examiner as a reference, either basic or auxiliary, in the rejection of the claims of the application or patent under reexamination. In addition, patent application publications and certain international application publications having an effective prior art date prior to the application being examined may be used in a rejection of the claims. See MPEP § 706.02(a) and § 2136 - § 2136.03.

Such a rejection may be overcome, in certain instances noted below, by filing of an affidavit or declaration under 37 CFR 1.131, known as “swearing back” of the reference.

It should be kept in mind that it is the rejection that is withdrawn and not the reference.

>

#### **I. < SITUATIONS WHERE 37 CFR 1.131 AFFIDAVITS OR DECLARATIONS CAN BE USED**

Affidavits or declarations under 37 CFR 1.131 may be used, for example:

(A) To antedate a reference or activity that qualifies as prior art under 35 U.S.C. 102(a) and not under 35 U.S.C. 102(b), e.g., where the prior art date under

35 U.S.C. 102(a) of the patent, the publication or activity used to reject the claim(s) is less than 1 year prior to applicant’s or patent owner’s effective filing date.

(B) To antedate a reference that qualifies as prior art under 35 U.S.C. 102(e), where the reference has a prior art date under 35 U.S.C. 102(e) prior to applicant’s effective filing date, and shows but does not claim the same patentable invention. See MPEP § 715.05 for a discussion of “same patentable invention.” See MPEP § 706.02(a) and § 2136 through § 2136.03 for an explanation of what references qualify as prior art under 35 U.S.C. 102(e).

>

#### **II. < SITUATIONS WHERE 37 CFR 1.131 AFFIDAVITS OR DECLARATIONS ARE INAPPROPRIATE**

An affidavit or declaration under 37 CFR 1.131 is not appropriate in the following situations:

(A) Where the reference publication date is more than 1 year prior to applicant’s or patent owner’s effective filing date. Such a reference is a “statutory bar” under 35 U.S.C. 102(b) as referenced in 37 CFR 1.131(a)(2). A reference that only qualifies as prior art under 35 U.S.C. 102(a) or (e) is not a “statutory bar.”

(B) Where the reference U.S. patent or U.S. patent application publication claims the same patentable invention. See MPEP § 715.05 for a discussion of “same patentable invention” and MPEP § 2306. Where the reference patent and the application or patent under reexamination are commonly owned, and the inventions defined by the claims in the application or patent under reexamination and by the claims in the patent are not identical but are not patentably distinct, a terminal disclaimer and an affidavit or declaration under 37 CFR 1.130 may be used to overcome a rejection under 35 U.S.C. 103. See MPEP § 718.

(C) Where the reference is a foreign patent for the same invention to applicant or patent owner or his or her legal representatives or assigns issued prior to the filing date of the domestic application or patent on an application filed more than 12 months prior to the filing date of the domestic application. See 35 U.S.C. 102(d).



(D) Where the effective filing date of applicant's or patent owner's parent application or an International Convention proved filing date is prior to the effective date of the reference, an affidavit or declaration under 37 CFR 1.131 is unnecessary because the reference \*should not have been used. See MPEP § 201.11 to § 201.15.

(E) Where the reference is a prior U.S. patent to the same entity, claiming the same invention. The question involved is one of "double patenting."

(F) Where the reference is the disclosure of a prior U.S. patent to the same party, not copending. The question is one of dedication to the public. Note however, *In re Gibbs*, 437 F.2d 486, 168 USPQ 578 (CCPA 1971) which substantially did away with the doctrine of dedication.

(G) Where applicant has clearly admitted on the record that subject matter relied on in the reference is prior art. In this case, that subject matter may be used as a basis for rejecting his or her claims and may not be overcome by an affidavit or declaration under 37 CFR 1.131. *In re Hellsund*, 474 F.2d 1307, 177 USPQ 170 (CCPA 1973); *In re Garfinkel*, 437 F.2d 1000, 168 USPQ 659 (CCPA 1971); *In re Blout*, 333 F.2d 928, 142 USPQ 173 (CCPA 1964); *In re Lopresti*, 333 F.2d 932, 142 USPQ 177 (CCPA 1964).

(H) Where the subject matter relied upon is prior art under 35 U.S.C. 102(f).

(I) Where the subject matter relied on in the reference is prior art under 35 U.S.C. 102(g). 37 CFR 1.131 is designed to permit an applicant to overcome rejections based on references or activities which are not statutory bars, but which have dates prior to the effective filing date of the application but subsequent to the applicant's actual date of invention. However, when the subject matter relied on is also available under 35 U.S.C. 102(g), a 37 CFR 1.131 affidavit or declaration cannot be used to overcome it. *In re Bass*, 474 F.2d 1276, 177 USPQ 178 (CCPA 1973). This is because subject matter which is available under 35 U.S.C. 102(g) by definition must have been made before the applicant made his or her invention. By contrast, references under 35 U.S.C. 102(a) and (e), for example, merely establish a presumption that their subject matter was made before applicant's invention date. It is this presumption which may be rebutted by evidence submitted under 37 CFR 1.131.

(J) Where the subject matter corresponding to a lost count in an interference is either prior art under 35 U.S.C. 102(g) or barred to applicant by the doctrine of interference estoppel. *In re Bandel*, 348 F.2d 563, 146 USPQ 389 (CCPA 1965); *In re Kroekel*, 803 F.2d 705, 231 USPQ 640 (Fed. Cir. 1986). See also *In re Deckler*, 977 F.2d 1449, 24 USPQ2d 1448 (Fed. Cir. 1992) (Under the principles of *res judicata* and *collateral estoppel*, applicant was not entitled to claims that were patentably indistinguishable from the claim lost in interference even though the subject matter of the lost count was not available for use in an obviousness rejection under 35 U.S.C. 103). But see *In re Zletz*, 893 F.2d 319, 13 USPQ2d 1320 (Fed. Cir. 1989) (A losing party to an interference, on showing that the invention now claimed is not "substantially the same" as that of the lost count, may employ the procedures of 37 CFR 1.131 to antedate the filing date of an interfering application). On the matter of when a "lost count" in an interference constitutes prior art under 35 U.S.C. 102(g), see *In re McKellin*, 529 F.2d 1342, 188 USPQ 428 (CCPA 1976) (A count is not prior art under 35 U.S.C. 102(g) as to the loser of an interference where the count was lost based on the winner's foreign priority date). Similarly, where one party in an interference wins a count by establishing a date of invention in a NAFTA or WTO member country (see 35 U.S.C. 104), the subject matter of that count is unpatentable to the other party by the doctrine of interference estoppel, even though it is not available as statutory prior art under 35 U.S.C. 102(g). See MPEP § 2138.01 and § 2138.02.

>

### III. < REFERENCE DATE TO BE OVERCOME

The date to be overcome under 37 CFR 1.131 is the effective date of the reference (i.e., the date on which the reference is available as prior art).

#### A. *U.S. Patents, U.S. Patent Application Publications, and International Application Publications*

See MPEP § 706.02(a)>, § 706.02(f)(1),< and § 2136 through § 2136.03 for a detailed discussion of the effective date of a U.S. patent, U.S. patent applica-

tion publication, or WIPO publication of an international application as a reference.

U.S. patents, U.S. patent application publications, and WIPO publications of international applications are available as prior art under 35 U.S.C. 102(e) against all patent applications and patents under reexamination.

Should it be established that the portion of the patent, or patent application publication, disclosure relied on as the reference was introduced into the patent application by amendment and as such was new matter, the date to be overcome by the affidavit or declaration is the date of amendment. *In re Willien*, 74 F.2d 550, 24 USPQ 210 (CCPA 1935). The effective date of a domestic patent when used as a reference is not the foreign filing date to which the application for patent may have been entitled under 35 U.S.C. 119(a) during examination. *In re Hilmer*, 359 F.2d 859, 149 USPQ 480 (CCPA 1966). Therefore, the date to be overcome under 37 CFR 1.131 is the effective U.S. filing date, not the foreign priority date. When a U.S. patent or U.S. patent application publication reference is entitled to claim the benefit of an earlier filed application, its effective filing date is determined under 35 U.S.C. 102(e). See MPEP § 706.02(a)>, § 706.02(f)(1),< and § 2136 through § 2136.03.

### **B. Foreign Patents**

See MPEP § 2126 through § 2127 regarding date of availability of foreign patents as prior art.

### **C. Printed Publications**

A printed publication, including a published foreign patent application, is effective as of its publication date, not its date of receipt by the publisher. For additional information regarding effective dates of printed publications, see MPEP § 2128 through § 2128.02.

### **D. Activities**

An applicant may make an admission, or submit evidence of use of the invention or knowledge of the invention by others, or the examiner may have personal knowledge that the invention was used or known by others in this country. See MPEP § 706.02(c) and § 2133.03. The effective date of the

activity used to reject the claim(s) is the date the activity was first known to have occurred.

## **FORM PARAGRAPHS**

Form paragraphs 7.57-7.64 may be used to respond to 37 CFR 1.131 affidavits.

### *¶ 7.57 Affidavit or Declaration Under 37 CFR 1.131: Ineffective-Heading*

The [1] filed on [2] under 37 CFR 1.131 has been considered but is ineffective to overcome the [3] reference.

#### **Examiner Note:**

1. In bracket 1, insert either --affidavit-- or --declaration--.
2. This form paragraph must be followed by one or more of form paragraphs 7.58 to 7.63 or a paragraph setting forth proper basis for the insufficiency, such as failure to establish acts performed in this country, or that the scope of the declaration or affidavit is not commensurate with the scope of the claim(s).

\*\*>

### *¶ 7.58 Affidavit or Declaration Under 37 CFR 1.131: Ineffective, Claiming Same Invention*

The [1] reference is a U.S. patent or U.S. patent application publication of a pending or patented application that claims the rejected invention. An affidavit or declaration is inappropriate under 37 CFR 1.131(a) when the reference is claiming the same patentable invention, see MPEP § 2306. If the reference and this application are not commonly owned, the reference can only be overcome by establishing priority of invention through interference proceedings. See MPEP Chapter 2300 for information on initiating interference proceedings. If the reference and this application are commonly owned, the reference may be disqualified as prior art by an affidavit or declaration under 37 CFR 1.130. See MPEP § 718.

#### **Examiner Note:**

1. If used to respond to the submission of an affidavit under 37 CFR 1.131, this paragraph must be preceded by paragraph 7.57.
2. This form paragraph may be used without form paragraph 7.57 when an affidavit has not yet been filed, and the examiner desires to notify applicant that the submission of an affidavit under 37 CFR 1.131 would be inappropriate.

<

### *¶ 7.59 Affidavit or Declaration Under 37 CFR 1.131: Ineffective, Insufficient Evidence of Reduction to Practice Before Reference Date*

The evidence submitted is insufficient to establish a reduction to practice of the invention in this country or a NAFTA or WTO member country prior to the effective date of the [1] reference. [2]

#### **Examiner Note:**

1. This form paragraph must be preceded by form paragraph 7.57.

2. An explanation of the lack of showing of the alleged reduction to practice must be provided in bracket 2.

*¶ 7.60 Affidavit or Declaration Under 37 CFR 1.131: Ineffective, Reference Is a Statutory Bar*

The [1] reference is a statutory bar under 35 U.S.C. 102(b) and thus cannot be overcome by an affidavit or declaration under 37 CFR 1.131.

**Examiner Note:**

This form paragraph must be preceded by form paragraph 7.57.

*¶ 7.61 Affidavit or Declaration Under 37 CFR 1.131: Ineffective, Insufficient Evidence of Conception*

The evidence submitted is insufficient to establish a conception of the invention prior to the effective date of the [1] reference. While conception is the mental part of the inventive act, it must be capable of proof, such as by demonstrative evidence or by a complete disclosure to another. Conception is more than a vague idea of how to solve a problem. The requisite means themselves and their interaction must also be comprehended. See *Mergenthaler v. Scudder*, 1897 C.D. 724, 81 O.G. 1417 (D.C. Cir. 1897). [2]

**Examiner Note:**

1. This form paragraph must be preceded by form paragraph 7.57.
2. An explanation of the deficiency in the showing of conception must be presented in bracket 2.
3. If the affidavit additionally fails to establish either diligence or a subsequent reduction to practice, this form paragraph should be followed by form paragraph 7.62 and/or 7.63. If either diligence or a reduction to practice is established, a statement to that effect should follow this paragraph.

*¶ 7.62 Affidavit or Declaration Under 37 CFR 1.131: Ineffective, Diligence Lacking*

The evidence submitted is insufficient to establish diligence from a date prior to the date of reduction to practice of the [1] reference to either a constructive reduction to practice or an actual reduction to practice. [2]

**Examiner Note:**

1. This form paragraph must be preceded by form paragraph 7.57.
2. If the affidavit additionally fails to establish conception, this paragraph must also be preceded by form paragraph 7.61. If the affidavit establishes conception, a statement to that effect should be added to this paragraph.
3. If the affidavit additionally fails to establish an alleged reduction to practice prior to the application filing date, this paragraph must be followed by form paragraph 7.63. If such an alleged reduction to practice is established, a statement to that effect should be added to this paragraph.
4. An explanation of the reasons for a holding of non-diligence must be provided in bracket 2.
5. See MPEP § 715.07(a), *Ex parte Merz*, 75 USPQ 296 (Bd. App. 1947), which indicates that diligence is not required after reduction to practice.

*¶ 7.63 Affidavit or Declaration Under 37 CFR 1.131: Ineffective, Insufficient Evidence of Actual Reduction to Practice*

The evidence submitted is insufficient to establish applicant's alleged actual reduction to practice of the invention in this country or a NAFTA or WTO member country after the effective date of the [1] reference. [2].

**Examiner Note:**

1. This form paragraph must be preceded by form paragraph 7.57.
2. If the alleged reduction to practice is prior to the effective date of the reference, do not use this paragraph. See form paragraph 7.59.
3. If the affidavit additionally fails to establish either conception or diligence, form paragraphs 7.61 and/or 7.62 should precede this paragraph. If either conception or diligence is established, a statement to that effect should be included after this paragraph.
4. An explanation of the lack of showing of the alleged reduction to practice must be given in bracket 2.

*¶ 7.64 Affidavit or Declaration Under 37 CFR 1.131: Effective To Overcome Reference*

The [1] filed on [2] under 37 CFR 1.131 is sufficient to overcome the [3] reference.

**Examiner Note:**

1. In bracket 1, insert either --affidavit-- or --declaration--.
2. In bracket 2, insert the filing date of the affidavit or declaration.
3. In bracket 3, insert the name of the reference.

## 715.01 37 CFR 1.131 Affidavits Versus 37 CFR 1.132 Affidavits

The purpose of a 37 CFR 1.131 affidavit or declaration is to overcome a prior art rejection by proving invention of the claimed subject matter by applicant prior to the effective date of the reference or activity relied upon in the rejection.

In some situations, an applicant may, alternatively, be able to overcome prior art rejections relying on references or activities which are available as prior art under 35 U.S.C. 102(a) or references which are available as prior art under 35 U.S.C. 102(e) by proving that the subject matter relied upon in the reference or activity was applicant's own invention.

Similarly, where the reference relied upon in a 35 U.S.C. 103 rejection qualifies as prior art only under 35 U.S.C. 102(f) or (g), or, in an application filed on or after November 29, 1999, under 35 U.S.C. 102(e), applicant may be able to

overcome this rejection by proving that the subject matter relied upon and the claimed invention were commonly owned or subject to common assignment at the time the later invention was made. See MPEP § 706.02(l)(1) through § 706.02(l)(3).

### **715.01(a) Reference Is a Joint Patent or Published Application to Applicant and Another [R-2]**

When subject matter, disclosed but not claimed in a patent or application publication filed jointly by S and another, is claimed in a later application filed by S, the joint patent or application publication is a valid reference >under 35 U.S.C. 102(a) or (e)< unless overcome by affidavit or declaration under 37 CFR 1.131 or an unequivocal declaration under 37 CFR 1.132 by S that he/she conceived or invented the subject matter disclosed in the patent or application publication and relied on in the rejection. *In re DeBaun*, 687 F.2d 459, 214 USPQ 933 (CCPA 1982). See MPEP § 716.10 for a discussion of the use of 37 CFR 1.132 affidavits or declarations to overcome rejections by establishing that the subject matter relied on in the patent or application publication was the invention of the applicant. Disclaimer by the other patentee or applicant of the application publication should not be required but, if submitted, may be accepted by the examiner.

Although affidavits or declarations submitted for the purpose of establishing that the reference discloses applicant's invention are properly filed under 37 CFR 1.132, rather than 37 CFR 1.131, such affidavits submitted improperly under 37 CFR 1.131 will be considered as though they were filed under 37 CFR 1.132 to traverse a ground of rejection. *In re Facius*, 408 F.2d 1396, 161 USPQ 294 (CCPA 1969).

### **715.01(b) Reference and Application Have Common Assignee**

The mere fact that the reference patent or application publication which shows but does not claim certain subject matter and the application which claims it are owned by the same assignee does not avoid the necessity of filing an affidavit or declaration under 37 CFR 1.131, in the absence of a showing under 37 CFR 1.132 that the patentee derived the subject matter relied on from the applicant (MPEP § 716.10).

The common assignee does not obtain any rights in this regard by virtue of common ownership which he or she would not have in the absence of common ownership. *In re Frilette*, 412 F.2d 269, 162 USPQ 163 (CCPA 1969); *Pierce v. Watson*, 275 F.2d 890, 124 USPQ 356 (D.C. Cir. 1960); *In re Beck*, 155 F.2d 398, 69 USPQ 520 (CCPA 1946). Where, however, a rejection is applied under 35 U.S.C. 102(f)/103 or 35 U.S.C. 102(g)/103, or, in an application filed on or after November 29, 1999, under 35 U.S.C. 102(e)/103 using the reference, a showing that the invention was commonly owned, or subject to an obligation of assignment to the same person, at the time the later invention was made would preclude such a rejection or be sufficient to overcome such a rejection. See MPEP § 706.02(l) and § 706.02(l)(1).

### **715.01(c) Reference Is Publication of Applicant's Own Invention [R-2]**

Unless it is a statutory bar, a rejection based on a publication may be overcome by a showing that it was published either by applicant himself/herself or on his/her behalf. Since such a showing is not made to show a date of invention by applicant prior to the date of the reference under 37 CFR 1.131, the limitation in 35 U.S.C. 104 and in 37 CFR 1.131(a)(1) that only acts which occurred in this country or in a NAFTA or WTO member country may be relied on to establish a date of invention is not applicable. *Ex parte Lemieux*, 115 USPQ 148, 1957 C.D. 47, 725 O.G. 4 (Bd. App. 1957); *Ex parte Powell*, 1938 C.D. 15, 489 O.G. 231 (Bd. App. 1938). See MPEP § 716.10 regarding 37 CFR 1.132 affidavits submitted to show that the reference is a publication of applicant's own invention.

>

#### **I. < CO-AUTHORSHIP**

Where the applicant is one of the co-authors of a publication cited against his or her application, he or she may overcome the rejection by filing an affidavit or declaration under 37 CFR 1.131. Alternatively, the applicant may overcome the rejection by filing a specific affidavit or declaration under 37 CFR 1.132 establishing that the article is describing applicant's own work. An affidavit or declaration by applicant alone indicating that applicant is the sole inventor and that the others were merely working under his or her direction is sufficient to remove the publication as a

reference under 35 U.S.C. 102(a). *In re Katz*, 687 F.2d 450, 215 USPQ 14 (CCPA 1982).

>

## II. < DERIVATION

When the unclaimed subject matter of a patent, application publication, or other publication is applicant's own invention, a rejection<, which is not a statutory bar,> on that patent or publication may be removed by submission of evidence establishing the fact that the patentee, applicant of the published application, or author derived his or her knowledge of the relevant subject matter from applicant. Moreover applicant must further show that he or she made the invention upon which the relevant disclosure in the patent, application publication, or other publication is based. *In re Mathews*, 408 F.2d 1393, 161 USPQ 276 (CCPA 1969); *In re Facius*, 408 F.2d 1396, 161 USPQ 294 (CCPA 1969).

### 715.01(d) Activities Applied Against the Claims

Unless it is a statutory bar, a rejection based on an activity showing that the claimed invention was used or known prior to the filing date of the application may be overcome by an affidavit or declaration under 37 CFR 1.131 establishing a date of invention prior to the date of the activity. Alternatively, the applicant(s) may overcome the rejection by filing a specific affidavit or declaration under 37 CFR 1.132 showing that the activity was performed by the applicant(s).

### 715.02 How Much of the Claimed Invention Must Be Shown, Including the General Rule as to Generic Claims [R-2]

The 37 CFR 1.131 affidavit or declaration must establish possession of either the whole invention claimed or something falling within the claim (such as a species of a claimed genus), in the sense that the claim as a whole reads on it. *In re Tanczyn*, 347 F.2d 830, 146 USPQ 298 (CCPA 1965) (Where applicant claims an alloy comprising both nitrogen and molybdenum, an affidavit showing applicant made an alloy comprising nitrogen but not molybdenum is not sufficient under 37 CFR 1.131 to overcome a rejection under 35 U.S.C. 103 based on the combined teachings

of one reference disclosing an alloy comprising nitrogen but not molybdenum and a second reference disclosing an alloy comprising molybdenum but not nitrogen). Note, however, where the differences between the claimed invention and the disclosure of the reference(s) are so small as to render the claims obvious over the reference(s), an affidavit or declaration under 37 CFR 1.131 is required to show no more than the reference shows. *In re Stryker*, 435 F.2d 1340, 168 USPQ 372 (CCPA 1971). In other words, where the examiner, in rejecting a claim under 35 U.S.C. 103, has treated a claim limitation as being an obvious feature or modification of the disclosure of the reference(s) relied upon, without citation of a reference which teaches such feature or modification, a 37 CFR 1.131 affidavit or declaration may be sufficient to overcome the rejection even if it does not show such feature or modification.

Further, a 37 CFR 1.131 affidavit is not insufficient merely because it does not show the identical disclosure of the reference(s) or the identical subject matter involved in the activity relied upon. If the affidavit contains facts showing a completion of the invention commensurate with the extent of the invention as claimed is shown in the reference or activity, the affidavit or declaration is sufficient, whether or not it is a showing of the identical disclosure of the reference or the identical subject matter involved in the activity. See *In re Wakefield*, 422 F.2d 897, 164 USPQ 636 (CCPA 1970).

Even if applicant's 37 CFR 1.131 affidavit is not fully commensurate with the rejected claim, the applicant can still overcome the rejection by showing that the differences between the claimed invention and the showing under 37 CFR 1.131 would have been obvious to one of ordinary skill in the art, in view of applicant's 37 CFR 1.131 evidence, prior to the effective date of the reference(s) or the activity. Such evidence is sufficient because applicant's possession of what is shown carries with it possession of variations and adaptations which would have been obvious, at the same time, to one of ordinary skill in the art. However, the affidavit or declaration showing must still establish possession of the invention (i.e., the basic inventive concept) and not just of what one reference (in a combination of applied references) happens to show, if that reference does not itself teach the basic inventive concept. *In re Spiller*, 500 F.2d 1170,

182 USPQ 614 (CCPA 1974) (Claimed invention was use of electrostatic forces to adhere dry starch particles to a wet paper web on the Fourdrinier wire of a paper-making machine. 37 CFR 1.131 affidavit established use of electrostatic forces to adhere starch particles to wet blotting paper moved over a fluidized bed of starch particles prior to the applied reference date. Affidavit was sufficient in view of prior art reference showing that deposition of dry coatings directly on wet webs on the Fourdrinier wire of a paper-making machine was well known in the art prior to the date of the applied reference. The affidavit established possession of the basic invention, i.e., use of electrostatic forces to adhere starch to wet paper.).

>

#### **I. < SWEARING BEHIND ONE OF A PLURALITY OF COMBINED REFERENCES**

Applicant may overcome a 35 U.S.C. 103 rejection based on a combination of references by showing completion of the invention by applicant prior to the effective date of any of the references; applicant need not antedate the reference with the earliest filing date. However, as discussed above, applicant's 37 CFR 1.131 affidavit must show possession of either the whole invention as claimed or something falling within the claim(s) prior to the effective date of the reference being antedated; it is not enough merely to show possession of what the reference happens to show if the reference does not teach the basic inventive concept.

Where a claim has been rejected under 35 U.S.C. 103 based on Reference A in view of Reference B, with the effective date of secondary Reference B being earlier than that of Reference A, the applicant can rely on the teachings of Reference B to show that the differences between what is shown in his or her 37 CFR 1.131 affidavit or declaration and the claimed invention would have been obvious to one of ordinary skill in the art prior to the date of Reference A. However, the 37 CFR 1.131 affidavit or declaration must still establish possession of the claimed invention, not just what Reference A shows, if Reference A does not teach the basic inventive concept.

>

#### **II. < GENERAL RULE AS TO GENERIC CLAIMS**

A reference or activity applied against generic claims may (in most cases) be antedated as to such claims by an affidavit or declaration under 37 CFR 1.131 showing completion of the invention of only a single species, within the genus, prior to the effective date of the reference or activity (assuming, of course, that the reference or activity is not a statutory bar or a patent, or an application publication, claiming the same invention). See *Ex parte Biesecker*, 144 USPQ 129 (Bd. App. 1964). See, also, *In re Fong*, 288 F.2d 932, 129 USPQ 264 (CCPA 1961); *In re Defano*, 392 F.2d 280, 157 USPQ 192 (CCPA 1968) (distinguishing chemical species of genus compounds from embodiments of a single invention). See, however, MPEP § 715.03 for practice relative to cases in unpredictable arts.

#### **715.03 Genus-Species, Practice Relative to Cases Where Predictability Is in Question [R-2]**

Where generic claims have been rejected on a reference or activity which discloses a species not antedated by the affidavit or declaration, the rejection will not ordinarily be withdrawn, subject to the rules set forth below, unless the applicant is able to establish that he or she was in possession of the generic invention prior to the effective date of the reference or activity. In other words, the affidavit or declaration under 37 CFR 1.131 must show as much as the minimum disclosure required by a patent specification to furnish support for a generic claim.

>

#### **I. < REFERENCE OR ACTIVITY DISCLOSES SPECIES**

##### **A. *Species Claim***

Where the claim under rejection recites a species and the reference or activity discloses the claimed species, the rejection can be overcome under 37 CFR 1.131 directly by showing prior completion of the claimed species or indirectly by a showing of prior completion of a different species coupled with a

showing that the claimed species would have been an obvious modification of the species completed by applicant. See *In re Spiller*, 500 F.2d 1170, 182 USPQ 614 (CCPA 1974).

### **B. Genus Claim**

The principle is well established that the disclosure of a species in a cited reference is sufficient to prevent a later applicant from obtaining a “generic claim.” *In re Gosteli*, 872 F.2d 1008, 10 USPQ2d 1614 (Fed. Cir. 1989); *In re Slayter*, 276 F.2d 408, 125 USPQ 345 (CCPA 1960).

Where the only pertinent disclosure in the reference or activity is a single species of the claimed genus, the applicant can overcome the rejection directly under 37 CFR 1.131 by showing prior possession of the species disclosed in the reference or activity. On the other hand, a reference or activity which discloses several species of a claimed genus can be overcome directly under 37 CFR 1.131 only by a showing that the applicant completed, prior to the date of the reference or activity, all of the species shown in the reference. *In re Stempel*, 241 F.2d 755, 113 USPQ 77 (CCPA 1957).

Proof of prior completion of a species different from the species of the reference or activity will be sufficient to overcome a reference indirectly under 37 CFR 1.131 if the species shown in the reference or activity would have been obvious in view of the species shown to have been made by the applicant. *In re Clarke*, 356 F.2d 987, 148 USPQ 665 (CCPA 1966); *In re Plumb*, 470 F.2d 1403, 176 USPQ 323 (CCPA 1973); *In re Hostettler*, 356 F.2d 562, 148 USPQ 514 (CCPA 1966). Alternatively, if the applicant cannot show possession of the species of the reference or activity in this manner, the applicant may be able to antedate the reference or activity indirectly by, for example, showing prior completion of one or more species which put him or her in possession of the claimed genus prior to the reference’s or activity’s date. The test is whether the species completed by applicant prior to the reference date or the activity’s date provided an adequate basis for inferring that the invention has generic applicability. *In re Plumb*, 470 F.2d 1403, 176 USPQ 323 (CCPA 1973); *In re Rainer*, 390 F.2d 771, 156 USPQ 334 (CCPA 1968); *In re Clarke*, 356 F.2d 987, 148 USPQ 665 (CCPA

1966); *In re Shokal*, 242 F.2d 771, 113 USPQ 283 (CCPA 1957).

It is not necessary for the affidavit evidence to show that the applicant viewed his or her invention as encompassing more than the species actually made. The test is whether the facts set out in the affidavit are such as would persuade one skilled in the art that the applicant possessed so much of the invention as is shown in the reference or activity. *In re Schaub*, 537 F.2d 509, 190 USPQ 324 (CCPA 1976).

### **C. Species Versus Embodiments**

References or activities which disclose one or more embodiments of a single claimed invention, as opposed to species of a claimed genus, can be overcome by filing a 37 CFR 1.131 affidavit showing prior completion of a single embodiment of the invention, whether it is the same or a different embodiment from that disclosed in the reference or activity. See *In re Fong*, 288 F.2d 932, 129 USPQ 264 (CCPA 1961) (Where applicant discloses and claims a washing solution comprising a detergent and polyvinylpyrrolidone (PVP), with no criticality alleged as to the particular detergent used, the PVP being used as a soil-suspending agent to prevent the redeposition of the soil removed, the invention was viewed as the use of PVP as a soil-suspending agent in washing with a detergent. The disclosure in the reference of the use of PVP with two detergents, both of which differed from that shown in applicant’s 37 CFR 1.131 affidavit, was considered a disclosure of different embodiments of a single invention, rather than species of a claimed genus); *In re Defano*, 392 F.2d 280, 157 USPQ 192 (CCPA 1968).

>

## **II. < REFERENCE OR ACTIVITY DISCLOSES CLAIMED GENUS**

In general, where the reference or activity discloses the claimed genus, a showing of completion of a single species within the genus is sufficient to antedate the reference or activity under 37 CFR 1.131. *Ex parte Biesecker*, 144 USPQ 129 (Bd. App. 1964).

In cases where predictability is in question, on the other hand, a showing of prior completion of one or a few species within the disclosed genus is generally not sufficient to overcome the reference or activity. *In re Shokal*, 242 F.2d 771, 113 USPQ 283 (CCPA

1957). The test is whether the species completed by applicant prior to the reference date or the date of the activity provided an adequate basis for inferring that the invention has generic applicability. *In re Mantell*, 454 F.2d 1398, 172 USPQ 530 (CCPA 1973); *In re Rainer*, 390 F.2d 771, 156 USPQ 334 (CCPA 1968); *In re DeFano*, 392 F.2d 280, 157 USPQ 192 (CCPA 1968); *In re Clarke*, 356 F.2d 987, 148 USPQ 665 (CCPA 1965). In the case of a small genus such as the halogens, which consists of four species, a reduction to practice of three, or perhaps even two, species might show possession of the generic invention, while in the case of a genus comprising hundreds of species, reduction to practice of a considerably larger number of species would be necessary. *In re Shokal, supra*.

It is not necessary for the affidavit evidence to show that the applicant viewed his or her invention as encompassing more than the species he or she actually made. The test is whether the facts set out in the affidavit are such as would persuade one skilled in the art that the applicant possessed so much of the invention as is shown in the reference. *In re Schaub*, 537 F.509, 190 USPQ 324 (CCPA 1976).

### **715.04 Who May Make Affidavit or Declaration; Formal Requirements of Affidavits and Declarations [R-2]**

>

#### **I. < WHO MAY MAKE AFFIDAVIT OR DECLARATION**

The following parties may make an affidavit or declaration under 37 CFR 1.131:

(A) All the inventors of the subject matter claimed.

(B) An affidavit or declaration by less than all named inventors of an application is accepted where it is shown that less than all named inventors of an application invented the subject matter of the claim or claims under rejection. For example, one of two joint inventors is accepted where it is shown that one of the joint inventors is the sole inventor of the claim or claims under rejection.

(C) \*\*>If a petition under 37 CFR 1.47 was granted or the application was accepted under 37 CFR 1.42 or 1.43, the affidavit or declaration may be

signed by the 37 CFR 1.47 applicant or the legal representative, where appropriate.<

(D) The assignee or other party in interest when it is not possible to produce the affidavit or declaration of the inventor. *Ex parte Foster*, 1903 C.D. 213, 105 O.G. 261 (Comm'r Pat. 1903).

Affidavits or declarations to overcome a rejection of a claim or claims must be made by the inventor or inventors of the subject matter of the rejected claim(s), a party qualified under 37 CFR 1.42, 1.43, or 1.47, or the assignee or other party in interest when it is not possible to produce the affidavit or declaration of the inventor(s). Thus, where all of the named inventors of a pending application are not inventors of every claim of the application, any affidavit under 37 CFR 1.131 could be signed by only the inventor(s) of the subject matter of the rejected claims. Further, where it is shown that a joint inventor is deceased, refuses to sign, or is otherwise unavailable, the signatures of the remaining joint inventors are sufficient. However, the affidavit or declaration, even though signed by fewer than all the joint inventors, must show completion of the invention by all of the joint inventors of the subject matter of the claim(s) under rejection. *In re Carlson*, 79 F.2d 900, 27 USPQ 400 (CCPA 1935).

>

#### **II. < FORMAL REQUIREMENTS OF AFFIDAVITS AND DECLARATIONS**

An affidavit is a statement in writing made under oath before a notary public, magistrate, or officer authorized to administer oaths. See MPEP § 604 through § 604.06 for additional information regarding formal requirements of affidavits.

37 CFR 1.68 permits a declaration to be used instead of an affidavit. The declaration must include an acknowledgment by the declarant that willful false statements and the like are punishable by fine or imprisonment, or both (18 U.S.C. 1001) and may jeopardize the validity of the application or any patent issuing thereon. The declarant must set forth in the body of the declaration that all statements made of the declarant's own knowledge are true and that all statements made on information and belief are believed to be true.



## 715.05 U.S. Patent or Application Publication Claiming Same Invention [R-2]

When the reference in question is a noncommonly owned U.S. patent or patent application publication claiming the same invention as applicant and its publication date is less than 1 year prior to the presentation of claims to that invention in the application being examined, applicant's remedy, if any, must be by way of 37 CFR 1.608 instead of 37 CFR 1.131. If the reference is claiming the same invention as the application and its publication date is less than 1 year prior to the presentation of claims to that invention in the application, this fact should be noted in the Office action. The reference can then be overcome only by way of interference. See MPEP §§ 2306-2308. If the reference is *\*>a U.S. patent which claims< the same invention as the application and its *>issue< date is *\*\* more >than 1 year< prior to the presentation of claims to that invention in the application, a rejection of the claims of the application under 35 U.S.C. 135(b)>(1)< should be made. See *In re McGrew*, 120 F.3d 1236, 1238, 43 USPQ2d 1632, 1635 (Fed. Cir. 1997) (The court holding that application of 35 U.S.C. 135(b) is not limited to *inter partes* interference proceedings, but may be used as a basis for *ex parte* rejections.).***

*>If the reference is a U.S. application publication under 35 U.S.C. 122(b), or a WIPO publication on an international application filed on or after November 29, 2000, which claims the same invention as the application being examined and its publication date is more than 1 year prior to the presentation of claims to that invention in the application being examined, a rejection of the claims of the application (being examined) under 35 U.S.C. 135(b)(2) should be made only if the application being examined was filed after the publication date of the reference.<*

Form paragraph 23.14 or 23.14.01 may be used when making a rejection under 35 U.S.C. 135(b).

### ¶ 23.14 Claims Not Copied Within One Year of Patent Issue Date

Claim [I] rejected under 35 U.S.C. 135(b) as not being made prior to one year from the date on which U.S. Patent No. [2] was granted. See *In re McGrew*, 120 F.3d 1236, 1238, 43 USPQ2d 1632,1635 (Fed. Cir. 1997) where the Court held that the applica-

tion of 35 U.S.C. 135(b) is not limited to *inter partes* interference proceedings, but may be used as a basis for *ex parte* rejections.

### ¶ 23.14.01 Claims Not Copied Within One Year of Application Publication Date

Claim [I] rejected under 35 U.S.C. 135(b) as not being made prior to one year from the date on which [2] was published under 35 U.S.C. 122(b). See *In re McGrew*, 120 F.3d 1236, 1238, 43 USPQ2d 1632,1635 (Fed. Cir. 1997) where the Court held that the application of 35 U.S.C. 135(b) is not limited to *inter partes* interference proceedings, but may be used as a basis for *ex parte* rejections.

#### Examiner Note:

1. In bracket 2, insert the publication number of the published application.
2. This form paragraph should only be used if the application being examined was filed after the publication date of the published application.

Where the reference and the application or patent under reexamination are commonly owned, and the inventions defined by the claims in the application or patent under reexamination and by the claims in the reference are not identical but are not patentably distinct, a terminal disclaimer and an affidavit or declaration under 37 CFR 1.130 may be used to overcome a rejection under 35 U.S.C. 103. See MPEP § 718.

A 37 CFR 1.131 affidavit is ineffective to overcome a United States patent or patent application publication, not only where there is a verbatim correspondence between claims of the application and of the patent, but also where there is no patentable distinction between the respective claims. *In re Clark*, 457 F.2d 1004, 173 USPQ 359 (CCPA 1972); *In re Hidy*, 303 F.2d 954, 133 USPQ 650 (CCPA 1962); *In re Teague*, 254 F.2d 145, 117 USPQ 284 (CCPA 1958); *In re Ward*, 236 F.2d 428, 111 USPQ 101 (CCPA 1956); *In re Wagenhorst*, 62 F.2d 831, 16 USPQ 126 (CCPA 1933).

If the application (or patent under reexamination) and the domestic reference contain claims which are identical, or which are not patentably distinct, then the application and patent are claiming the "same patentable invention," defined by 37 CFR 1.601(n) as follows:

Invention "A" is the *same patentable invention* as an invention "B" when invention "A" is the same as (35 U.S.C. 102) or is obvious (35 U.S.C. 103) in view of invention "B" assuming invention "B" is prior art with respect to invention "A."

As provided in 37 CFR 1.601(i), an interference may be declared whenever an examiner is of the opinion that an application and a reference contain claims for the “same patentable invention.” An applicant who is claiming an invention which is identical to, or obvious in view of, the invention as claimed in a domestic patent or patent application publication cannot employ an affidavit under 37 CFR 1.131 as a means for avoiding an interference with the reference. To allow an applicant to do so would result in the issuance of two patents to the same invention.

Since 37 CFR 1.131 defines “same patentable invention” in the same way as the interference rules (37 CFR 1.601(n)), the USPTO cannot prevent an applicant from overcoming a reference by a 37 CFR 1.131 affidavit or declaration on the grounds that the reference claims applicant’s invention and, at the same time, deny applicant an interference on the grounds that the claims of the application and those of the reference are not for substantially the same invention. See *In re Eickmeyer*, 602 F.2d 974, 202 USPQ 655 (CCPA 1979). Where, in denying an applicant’s motion in interference to substitute a broader count, it is held that the limitation to be deleted was material for the opponent patentee, this constitutes a holding that the proposed count is for an invention which is not the “same patentable invention” claimed by the reference. Therefore, the applicant may file an affidavit or declaration under 37 CFR 1.131 to overcome a prior art rejection based on the reference. *Adler v. Kluver*, 159 USPQ 511 (Bd. Pat. Int. 1968).

Form paragraph 7.58 (reproduced in MPEP § 715) may be used to note such a situation in the Office action.

## 715.07 Facts and Documentary Evidence [R-2]

>

### I. < GENERAL REQUIREMENTS

The essential thing to be shown under 37 CFR 1.131 is priority of invention and this may be done by any satisfactory evidence of the fact. FACTS, not conclusions, must be alleged. Evidence in the form of exhibits may accompany the affidavit or declaration. Each exhibit relied upon should be specifically referred to in the affidavit or declaration, in terms of what it is relied upon to show. For example, the alle-

gations of fact might be supported by submitting as evidence one or more of the following:

- (A) attached sketches;
- (B) attached blueprints;
- (C) attached photographs;
- (D) attached reproductions of notebook entries;
- (E) an accompanying model;
- (F) attached supporting statements by witnesses, where verbal disclosures are the evidence relied upon. *Ex parte Ovshinsky*, 10 USPQ2d 1075 (Bd. Pat. App. & Inter. 1989);
- (G) testimony given in an interference. Where interference testimony is used, the applicant must point out which parts of the testimony are being relied on; examiners cannot be expected to search the entire interference record for the evidence. *Ex parte Homan*, 1905 C.D. 288 (Comm’r Pat. 1905);
- (H) Disclosure documents (MPEP § 1706) may be used as documentary evidence of conception.

Exhibits and models must comply with the requirements of 37 CFR 1.91 to be entered into an application file. See also MPEP § 715.07(d).

A general allegation that the invention was completed prior to the date of the reference is not sufficient. *Ex parte Saunders*, 1883 C.D. 23, 23 O.G. 1224 (Comm’r Pat. 1883). Similarly, a declaration by the inventor to the effect that his or her invention was conceived or reduced to practice prior to the reference date, without a statement of facts demonstrating the correctness of this conclusion, is insufficient to satisfy 37 CFR 1.131.

37 CFR 1.131(b) requires that original exhibits of drawings or records, or photocopies thereof, accompany and form part of the affidavit or declaration or their absence satisfactorily explained. In *Ex parte Donovan*, 1890 C.D. 109, 52 O.G. 309 (Comm’r Pat. 1890) the court stated

If the applicant made sketches he should so state, and produce and describe them; if the sketches were made and lost, and their contents remembered, they should be reproduced and furnished in place of the originals. The same course should be pursued if the disclosure was by means of models. If neither sketches nor models are relied upon, but it is claimed that verbal disclosures, sufficiently clear to indicate definite conception of the invention, were made the witness should state as nearly as possible the language used in imparting knowledge of the invention to others.

However, when reviewing a 37 CFR 1.131 affidavit or declaration, the examiner must consider all of the evidence presented in its entirety, including the affidavits or declarations and all accompanying exhibits, records and “notes.” An accompanying exhibit need not support all claimed limitations, provided that any missing limitation is supported by the declaration itself. *Ex parte Ovshinsky*, 10 USPQ2d 1075 (Bd. Pat. App. & Inter. 1989).

The affidavit or declaration and exhibits must clearly explain which facts or data applicant is relying on to show completion of his or her invention prior to the particular date. Vague and general statements in broad terms about what the exhibits describe along with a general assertion that the exhibits describe a reduction to practice “amounts essentially to mere pleading, unsupported by proof or a showing of facts” and, thus, does not satisfy the requirements of 37 CFR 1.131(b). *In re Borkowski*, 505 F.2d 713, 184 USPQ 29 (CCPA 1974). Applicant must give a clear explanation of the exhibits pointing out exactly what facts are established and relied on by applicant. 505 F.2d at 718-19, 184 USPQ at 33. See also *In re Harry*, 333 F.2d 920, 142 USPQ 164 (CCPA 1964) (Affidavit “asserts that facts exist but does not tell what they are or when they occurred.”).

&gt;

## II. < ESTABLISHMENT OF DATES

If the dates of the exhibits have been removed or blocked off, the matter of dates can be taken care of in the body of the oath or declaration.

When alleging that conception or a reduction to practice occurred prior to the effective date of the reference, the dates in the oath or declaration may be the actual dates or, if the applicant or patent owner does not desire to disclose his or her actual dates, he or she may merely allege that the acts referred to occurred prior to a specified date. However, the actual dates of acts relied on to establish diligence must be provided. See MPEP § 715.07(a) regarding the diligence requirement.

&gt;

## III. < THREE WAYS TO SHOW PRIOR INVENTION

The affidavit or declaration must state FACTS and produce such documentary evidence and exhibits in

support thereof as are available to show conception and completion of invention in this country or in a NAFTA or WTO member country (MPEP § 715.07(c)), at least the conception being at a date prior to the effective date of the reference. Where there has not been reduction to practice prior to the date of the reference, the applicant or patent owner must also show diligence in the completion of his or her invention from a time just prior to the date of the reference continuously up to the date of an actual reduction to practice or up to the date of filing his or her application (filing constitutes a constructive reduction to practice, 37 CFR 1.131).

As discussed above, 37 CFR 1.131(b) provides three ways in which an applicant can establish prior invention of the claimed subject matter. The showing of facts must be sufficient to show:

(A) reduction to practice of the invention prior to the effective date of the reference; or

(B) conception of the invention prior to the effective date of the reference coupled with due diligence from prior to the reference date to a subsequent (actual) reduction to practice; or

(C) conception of the invention prior to the effective date of the reference coupled with due diligence from prior to the reference date to the filing date of the application (constructive reduction to practice).

A conception of an invention, though evidenced by disclosure, drawings, and even a model, is not a complete invention under the patent laws, and confers no rights on an inventor, and has no effect on a subsequently granted patent to another, UNLESS THE INVENTOR FOLLOWS IT WITH REASONABLE DILIGENCE BY SOME OTHER ACT, such as an actual reduction to practice or filing an application for a patent. *Automatic Weighing Mach. Co. v. Pneumatic Scale Corp.*, 166 F.2d 288, 1909 C.D. 498, 139 O.G. 991 (1st Cir. 1909).

Conception is the mental part of the inventive act, but it must be capable of proof, as by drawings, complete disclosure to another person, etc. In *Mergenthaler v. Scudder*, 1897 C.D. 724, 81 O.G. 1417 (D.C. Cir. 1897), it was established that conception is more than a mere vague idea of how to solve a problem; the means themselves and their interaction must be comprehended also.

In general, proof of actual reduction to practice requires a showing that the apparatus actually existed and worked for its intended purpose. However, “there are some devices so simple that a mere construction of them is all that is necessary to constitute reduction to practice.” *In re Asahi/America Inc.*, 68 F.3d 442, 37 USPQ2d 1204, 1206 (Fed. Cir. 1995) (Citing *Newkirk v. Lulejian*, 825 F.2d 1581, 3 USPQ2d 1793 (Fed. Cir. 1987) and *Sachs v. Wadsworth*, 48 F.2d 928, 929, 9 USPQ 252, 253 (CCPA 1931). The claimed restraint coupling held to be so simple a device that mere construction of it was sufficient to constitute reduction to practice. Photographs, coupled with articles and a technical report describing the coupling in detail were sufficient to show reduction to practice.).

The facts to be established under 37 CFR 1.131 are similar to those to be proved in interference. The difference lies in the way in which the evidence is presented. If applicant disagrees with a holding that the facts are insufficient to overcome the rejection, his or her remedy is by appeal from the continued rejection.

See MPEP § 2138.04 through § 2138.06 for a detailed discussion of the concepts of conception, reasonable diligence, and reduction to practice.

For the most part, the terms “conception,” “reasonable diligence,” and “reduction to practice” have the same meanings under 37 CFR 1.131 as they have in interference proceedings. However, in *In re Eickmeyer*, 602 F.2d 974, 202 USPQ 655 (CCPA 1979), the court stated:

The purpose of filing a [37 CFR 1.]131 affidavit is not to demonstrate prior invention, *per se*, but merely to antedate the effective date of a reference. See *In re Moore*, 58 CCPA 1340, 444 F.2d 572, 170 USPQ 260 (1971). Although the test for sufficiency of an affidavit under Rule 131(b) parallels that for determining priority of invention in an interference under 35 U.S.C. 102(g), it does not necessarily follow that Rule 131 practice is controlled by interference law. To the contrary, “[t]he parallel to interference practice found in Rule 131(b) should be recognized as one of convenience rather than necessity.” *Id.* at 1353, 444 F.2d at 580, 170 USPQ at 267. Thus, “the ‘conception’ and ‘reduction to practice’ which must be established under the rule need not be the same as what is required in the ‘interference’ sense of those terms.” *Id.*; accord, *In re Borkowski*, 505 F.2d 713, 718-19, 184 USPQ 29, 33 (CCPA 1974).

One difference is that in interference practice a reduction to practice requires a proof that a utility was

known, whereas under 37 CFR 1.131 practice, proof of a utility must be shown only if the reference discloses a utility. *In re Wilkinson*, 304 F.2d 673, 134 USPQ 171 (CCPA 1962); *In re Moore*, 444 F.2d 572, 170 USPQ 260 (CCPA 1971). Where proof of utility is required, whether or not test results are required to establish the utility of the subject matter in question depends on the facts of each case. The ultimate issue is whether the evidence is such that one of ordinary skill in the art would be satisfied to a reasonable certainty that the subject matter necessary to antedate the reference possessed the alleged utility. *In re Blake*, 358 F.2d 750, 149 USPQ 217 (CCPA 1966). Also, in interference practice, conception, reasonable diligence, and reduction to practice require corroboration, whereas averments made in a 37 CFR 1.131 affidavit or declaration do not require corroboration; an applicant may stand on his or her own affidavit or declaration if he or she so elects. *Ex parte Hook*, 102 USPQ 130 (Bd. App. 1953).

Form paragraph 7.59 or 7.63 (both reproduced in MPEP § 715) may be used where insufficient evidence is included in a 37 CFR 1.131 affidavit.

### 715.07(a) Diligence

Where conception occurs prior to the date of the reference, but reduction to practice is afterward, it is not enough merely to allege that applicant or patent owner had been diligent. *Ex parte Hunter*, 1889 C.D. 218, 49 O.G. 733 (Comm’r Pat. 1889). Rather, applicant must show evidence of facts establishing diligence.

In determining the sufficiency of a 37 CFR 1.131 affidavit or declaration, diligence need not be considered unless conception of the invention prior to the effective date is clearly established, since diligence comes into question only after prior conception is established. *Ex parte Kantor*, 177 USPQ 455 (Bd. App. 1958).

What is meant by diligence is brought out in *Christie v. Seybold*, 1893 C.D. 515, 64 O.G. 1650 (6th Cir. 1893). In patent law, an inventor is either diligent at a given time or he is not diligent; there are no degrees of diligence. An applicant may be diligent within the meaning of the patent law when he or she is doing nothing, if his or her lack of activity is excused. Note, however, that the record must set forth an explanation or excuse for the inactivity; the USPTO

or courts will not speculate on possible explanations for delay or inactivity. See *In re Nelson*, 420 F.2d 1079, 164 USPQ 458 (CCPA 1970). Diligence must be judged on the basis of the particular facts in each case. See MPEP § 2138.06 for a detailed discussion of the diligence requirement for proving prior invention.

Under 37 CFR 1.131, the critical period in which diligence must be shown begins just prior to the effective date of the reference or activity and ends with the date of a reduction to practice, either actual or constructive (i.e., filing a United States patent application). Note, therefore, that only diligence before reduction to practice is a material consideration. The “lapse of time between the completion or reduction to practice of an invention and the filing of an application thereon” is not relevant to an affidavit or declaration under 37 CFR 1.131. See *Ex parte Merz*, 75 USPQ 296 (Bd. App. 1947).

Form paragraph 7.62 (reproduced in MPEP § 715) may be used to respond to a 37 CFR 1.131 affidavit where diligence is lacking.

### **715.07(b) Interference Testimony Sometimes Used**

In place of an affidavit or declaration the testimony of the applicant in an interference may be sometimes used to antedate a reference in lieu of 37 CFR 1.131 affidavit or declaration.

The part of the testimony to form the basis of priority over the reference should be pointed out. *Ex parte Bowyer*, 1939 C.D. 5, 42 USPQ 526 (Comm’r Pat. 1939).

### **715.07(c) Acts Relied Upon Must Have Been Carried Out in This Country or a NAFTA or WTO Member Country**

35 U.S.C. 104. *Invention Made Abroad.*

(a) IN GENERAL.—

(1) PROCEEDINGS.—In proceedings in the Patent and Trademark Office, in the courts, and before any other competent authority, an applicant for a patent, or a patentee, may not establish a date of invention by reference to knowledge or use thereof, or other activity with respect thereto, in a foreign country other than a NAFTA country or a WTO member country, except as provided in sections 119 and 365 of this title.

(2) RIGHTS.—If an invention was made by a person, civil or military—

(A) while domiciled in the United States, and serving in any other country in connection with operations by or on behalf of the United States,

(B) while domiciled in a NAFTA country and serving in another country in connection with operations by or on behalf of that NAFTA country, or

(C) while domiciled in a WTO member country and serving in another country in connection with operations by or on behalf of that WTO member country, that person shall be entitled to the same rights of priority in the United States with respect to such invention as if such invention had been made in the United States, that NAFTA country, or that WTO member country, as the case may be.

(3) USE OF INFORMATION.—To the extent that any information in a NAFTA country or a WTO member country concerning knowledge, use, or other activity relevant to proving or disproving a date of invention has not been made available for use in a proceeding in the Patent and Trademark Office, a court, or any other competent authority to the same extent as such information could be made available in the United States, the Director, court, or such other authority shall draw appropriate inferences, or take other action permitted by statute, rule, or regulation, in favor of the party that requested the information in the proceeding.

(b) DEFINITIONS.—As used in this section—

(1) The term “NAFTA country” has the meaning given that term in section 2(4) of the North American Free Trade Agreement Implementation Act; and

(2) The term “WTO member country” has the meaning given that term in section 2(10) of the Uruguay Round Agreements Act.

The 37 CFR 1.131 affidavit or declaration must contain an allegation that the acts relied upon to establish the date prior to the reference or activity were carried out in this country or in a NAFTA country or WTO member country. See 35 U.S.C. 104.

Under 37 CFR 1.131(a), which provides for the establishment of a date of completion of the invention in a NAFTA or WTO member country, as well as in the United States, an applicant can establish a date of completion in a NAFTA member country on or after December 8, 1993, the effective date of section 331 of Public Law 103-182, the North American Free Trade Agreement Act, and can establish a date of completion in a WTO member country other than a NAFTA member country on or after January 1, 1996, the effective date of section 531 of Public Law 103-465, the Uruguay Round Agreements Act. Acts occurring prior to the effective dates of NAFTA or URAA may be relied upon to show completion of the invention; however, a date of completion of the invention may not be established under 37 CFR 1.131

before December 8, 1993 in a NAFTA country or before January 1, 1996 in a WTO country other than a NAFTA country.

### **715.07(d) Disposition of Exhibits**

Exhibits, such as those filed as part of an affidavit or declaration under 37 CFR 1.131, must comply with the requirements of 37 CFR 1.91 to be entered into an application file. Exhibits that do not comply with the requirements of 37 CFR 1.91 will be disposed of or returned to applicant at the discretion of the Office. See also MPEP § 608.03(a).

### **715.08 Passed Upon by Primary Examiner**

The question of sufficiency of affidavits or declarations under 37 CFR 1.131 should be reviewed and decided by a primary examiner.

Review of questions of formal sufficiency and propriety are by petition. Such petitions are answered by the Technology Center Directors (MPEP § 1002.02(c)).

Review on the merits of a 37 CFR 1.131 affidavit or declaration is by appeal to the Board of Patent Appeals and Interferences.

### **715.09 Seasonable Presentation**

Affidavits or declarations under 37 CFR 1.131 must be timely presented in order to be admitted. Affidavits and declarations submitted under 37 CFR 1.131 and other evidence traversing rejections are considered timely if submitted:

(A) prior to a final rejection;

(B) before appeal in an application not having a final rejection; or

(C) after final rejection and submitted

(1) with a first reply after final rejection for the purpose of overcoming a new ground of rejection or requirement made in the final rejection, or

(2) with a satisfactory showing under 37 CFR 1.116(b) or 37 CFR 1.195, or  
(3) under 37 CFR 1.129(a).

All admitted affidavits and declarations are acknowledged and commented upon by the examiner in his or her next succeeding action.

For affidavits or declarations under 37 CFR 1.131 filed after appeal, see 37 CFR 1.195 and MPEP § 1211.02.

Review of an examiner's refusal to enter an affidavit as untimely is by petition and not by appeal to the Board of Patent Appeals and Interferences. *In re Deters*, 515 F.2d 1152, 185 USPQ 644 (CCPA 1975); *Ex parte Hale*, 49 USPQ 209 (Bd. App. 1941). See MPEP § 715.08 regarding review of questions of propriety of 37 CFR 1.131 affidavits and declarations.

### **715.10 Review of Affidavit or Declaration for Evidence of Prior Public Use or Sale or Failure to Disclose Best Mode**

Any affidavits or declarations submitted under 37 CFR 1.131 and the accompanying evidence must be reviewed carefully by the examiner in order to determine whether they show that the claimed invention was "in public use" or "on sale" in this country more than one year prior to the effective filing date of the application, which acts constitute a statutory bar under 35 U.S.C. 102(b). Although the rejection based on the reference(s) or activity sought to be antedated may actually be overcome by such an affidavit or declaration, the effect of the applicant's prior "public use" or "on sale" activities may not be overcome under 37 CFR 1.131. See MPEP § 2133.03 regarding rejections based on "public use" and "on sale" statutory bars.

Where the 37 CFR 1.131 evidence relies on an embodiment of the invention not disclosed in the application, the question of whether the application includes the "best mode" must be considered. However, a "best mode" rejection should not be made unless the record, taken as a whole, establishes by a preponderance of the evidence that applicant's specification has not set forth the best mode contemplated by the inventor of carrying out the invention. See MPEP § 2165 - § 2165.04 regarding the best mode requirement of the first paragraph of 35 U.S.C. 112.

## 716 Affidavits or Declarations Traversing Rejections, 37 CFR 1.132

*37 CFR 1.132. Affidavits or declarations traversing rejections or objections.*

When any claim of an application or a patent under reexamination is rejected or objected to, any evidence submitted to traverse the rejection or objection on a basis not otherwise provided for must be by way of an oath or declaration under this section.

It is the responsibility of the primary examiner to personally review and decide whether affidavits or declarations submitted under 37 CFR 1.132 for the purpose of traversing grounds of rejection are responsive to the rejection and present sufficient facts to overcome the rejection.

This rule sets forth the general policy of the Office consistently followed for a long period of time of receiving affidavit evidence traversing rejections or objections. All affidavits or declarations presented which do not fall within or under other specific rules are to be treated or considered as falling under this rule.

Form paragraph 7.65 or 7.66 and any of form paragraphs 7.66.01 through 7.66.05, as appropriate, should be used to comment on a 37 CFR 1.132 affidavit or declaration.

*¶ 7.65 Affidavit or Declaration Under 37 CFR 1.132: Effective To Withdraw Rejection*

The [1] under 37 CFR 1.132 filed [2] is sufficient to overcome the rejection of claim [3] based upon [4].

### Examiner Note:

1. In bracket 1, insert either --affidavit-- or --declaration--.
2. In bracket 2, insert the filing date of the affidavit or declaration.
3. In bracket 3, insert the affected claim or claims.
4. In bracket 4, indicate the rejection that has been overcome, including the statutory grounds, e.g.: insufficiency of disclosure under 35 U.S.C. 112, first paragraph; lack of utility under 35 U.S.C. 101; inoperativeness under 35 U.S.C. 101; a specific reference applied under 35 U.S.C. 103; etc. See MPEP § 716.

*¶ 7.66 Affidavit or Declaration Under 37 CFR 1.132: Insufficient*

The [1] under 37 CFR 1.132 filed [2] is insufficient to overcome the rejection of claim [3] based upon [4] as set forth in the last Office action because:

### Examiner Note:

1. In bracket 1, insert either --affidavit-- or --declaration--.

2. In bracket 2, insert the filing date of the affidavit or declaration.
3. In bracket 3, insert the claim or claims affected.
4. In bracket 4, indicate the rejection that has not been overcome, including the statutory grounds, i.e.: insufficiency of disclosure under 35 U.S.C. 112, first paragraph; lack of utility and/or inoperativeness under 35 U.S.C. 101; a specific reference applied under 35 U.S.C. 103; etc. See MPEP § 716.
5. Following this form paragraph, set forth the reasons for the insufficiency; e.g., categories include: --untimely--; --fails to set forth facts--; --facts presented are not germane to the rejection at issue--; --showing is not commensurate in scope with the claims--; etc. See MPEP § 716. Also include a detailed explanation of the reasons why the affidavit or declaration is insufficient. Any of form paragraphs 7.66.01 - 7.66.05 may be used, as appropriate.

*¶ 7.66.01 Reason Why Affidavit or Declaration Under 37 CFR 1.132 Is Insufficient: Affiant Has Never Seen Invention Before*

It includes statements which amount to an affirmation that the affiant has never seen the claimed subject matter before. This is not relevant to the issue of nonobviousness of the claimed subject matter and provides no objective evidence thereof. See MPEP § 716.

### Examiner Note:

1. This form paragraph must be preceded by form paragraph 7.66.
2. A full explanation must be provided, if appropriate.

*¶ 7.66.02 Reason Why Affidavit or Declaration Under 37 CFR 1.132 Is Insufficient: Invention Works as Intended*

It includes statements which amount to an affirmation that the claimed subject matter functions as it was intended to function. This is not relevant to the issue of nonobviousness of the claimed subject matter and provides no objective evidence thereof. See MPEP § 716.

### Examiner Note:

1. This form paragraph must be preceded by form paragraph 7.66.
2. A full explanation must be provided, if appropriate.

*¶ 7.66.03 Reason Why Affidavit or Declaration Under 37 CFR 1.132 Is Insufficient: Refers Only to Invention, Not to Claims*

It refers only to the system described in the above referenced application and not to the individual claims of the application. As such the declaration does not show that the objective evidence of nonobviousness is commensurate in scope with the claims. See MPEP § 716.

### Examiner Note:

1. This form paragraph must be preceded by form paragraph 7.66.
2. A full explanation must be provided, if appropriate.

¶ 7.66.04 Reason Why Affidavit or Declaration Under 37 CFR 1.132 Is Insufficient: No Evidence of Long-Felt Need

It states that the claimed subject matter solved a problem that was long standing in the art. However, there is no showing that others of ordinary skill in the art were working on the problem and if so, for how long. In addition, there is no evidence that if persons skilled in the art who were presumably working on the problem knew of the teachings of the above cited references, they would still be unable to solve the problem. See MPEP § 716.04.

**Examiner Note:**

1. This form paragraph must be preceded by form paragraph 7.66.
2. A full explanation must be provided, if appropriate.

¶ 7.66.05 Reason Why Affidavit or Declaration Under 37 CFR 1.132 Is Insufficient: Conclusion

In view of the foregoing, when all of the evidence is considered, the totality of the rebuttal evidence of nonobviousness fails to outweigh the evidence of obviousness.

**Examiner Note:**

This form paragraph should be presented as a conclusion to your explanation of why the affidavit or declaration under 37 CFR 1.132 is insufficient, and it must be preceded by form paragraph 7.66.

## 716.01 Generally Applicable Criteria [R-2]

The following criteria are applicable to all evidence traversing rejections submitted by applicants, including affidavits or declarations submitted under 37 CFR 1.132:

(A) *Timeliness.*

Evidence traversing rejections must be timely or seasonably filed to be entered and entitled to consideration. *In re Rothermel*, 276 F.2d 393, 125 USPQ 328 (CCPA 1960).

Affidavits and declarations submitted under 37 CFR 1.132 and other evidence traversing rejections are considered timely if submitted:

- (1) prior to a final rejection,
- (2) before appeal in an application not having a final rejection, or
- (3) after final rejection and submitted
  - (i) with a first reply after final rejection for the purpose of overcoming a new ground of rejection or requirement made in the final rejection, or

(ii) with a satisfactory showing under 37 CFR 1.116(b) or 37 CFR 1.195, or

(iii) under 37 CFR 1.129(a).

(B) *Consideration of evidence.*

Evidence traversing rejections, when timely presented, must be considered by the examiner whenever present. All entered affidavits, declarations, and other evidence traversing rejections are acknowledged and commented upon by the examiner in the next succeeding action. The extent of the commentary depends on the action taken by the examiner. Where an examiner holds that the evidence is sufficient to overcome the *prima facie* case, the comments should be consistent with the guidelines for statements of reasons for allowance. See MPEP § 1302.14. Where the evidence is insufficient to overcome the rejection, the examiner must specifically explain why the evidence is insufficient. General statements such as “the declaration lacks technical validity” or “the evidence is not commensurate with the scope of the claims” without an explanation supporting such findings are insufficient.

## 716.01(a) Objective Evidence of Nonobviousness [R-2]

### OBJECTIVE EVIDENCE MUST BE CONSIDERED \*>WHEN TIMELY< PRESENT

Affidavits or declarations, when timely presented, containing evidence of criticality or unexpected results, commercial success, long-felt but unsolved needs, failure of others, skepticism of experts, etc., must be considered by the examiner in determining the issue of obviousness of claims for patentability under 35 U.S.C. 103. The Court of Appeals for the Federal Circuit stated in *Stratoflex, Inc. v. Aeroquip Corp.*, 713 F.2d 1530, 1538, 218 USPQ 871, 879 (Fed. Cir. 1983) that “evidence rising out of the so-called ‘secondary considerations’ must always when present be considered en route to a determination of obviousness.” Such evidence might give light to circumstances surrounding the origin of the subject matter sought to be patented. As indicia of obviousness or unobviousness, such evidence may have relevancy. *Graham v. John Deere Co.*, 383 U.S. 1, 148 USPQ 459 (1966); *In re Palmer*, 451 F.2d 1100, 172 USPQ 126 (CCPA 1971); *In re Fielder*, 471 F.2d 640, 176 USPQ 300 (CCPA 1973). The



*Graham v. John Deere* pronouncements on the relevance of commercial success, etc. to a determination of obviousness were not negated in *Sakraida v. Ag Pro*, 425 U.S. 273, 189 USPQ 449 (1979) or *Anderson's-Black Rock Inc. v. Pavement Salvage Co.*, 396 U.S. 57, 163 USPQ 673 (1969), where reliance was placed upon *A&P Tea Co. v. Supermarket Corp.*, 340 U.S. 147, 87 USPQ 303 (1950). See *Dann v. Johnston*, 425 U.S. 219, 226 n.4, 189 USPQ 257, 261 n. 4 (1976).

Examiners must consider comparative data in the specification which is intended to illustrate the claimed invention in reaching a conclusion with regard to the obviousness of the claims. *In re Margolis*, 785 F.2d 1029, 228 USPQ 940 (Fed. Cir. 1986). The lack of objective evidence of nonobviousness does not weigh in favor of obviousness. *Miles Labs. Inc. v. Shandon Inc.*, 997 F.2d 870, 878, 27 USPQ2d 1123, 1129 (Fed. Cir. 1993), *cert. denied*, 127 L. Ed. 232 (1994). However, where a *prima facie* case of obviousness is established, the failure to provide rebuttal evidence is dispositive.

### **716.01(b) Nexus Requirement and Evidence of Nonobviousness**

#### **TO BE OF PROBATIVE VALUE, ANY SECONDARY EVIDENCE MUST BE RELATED TO THE CLAIMED INVENTION (NEXUS REQUIRED)**

The weight attached to evidence of secondary considerations by the examiner will depend upon its relevance to the issue of obviousness and the amount and nature of the evidence. Note the great reliance apparently placed on this type of evidence by the Supreme Court in upholding the patent in *United States v. Adams*, 383 U.S. 39, 148 USPQ 479 (1966).

To be given substantial weight in the determination of obviousness or nonobviousness, evidence of secondary considerations must be relevant to the subject matter as claimed, and therefore the examiner must determine whether there is a nexus between the merits of the claimed invention and the evidence of secondary considerations. *Ashland Oil, Inc. v. Delta Resins & Refractories, Inc.*, 776 F.2d 281, 305 n.42, 227 USPQ 657, 673-674 n. 42 (Fed. Cir. 1985), *cert. denied*, 475 U.S. 1017 (1986). The term "nexus" designates a factually and legally sufficient connection

between the objective evidence of nonobviousness and the claimed invention so that the evidence is of probative value in the determination of nonobviousness. *Demaco Corp. v. F. Von Langsdorff Licensing Ltd.*, 851 F.2d 1387, 7 USPQ2d 1222 (Fed. Cir.), *cert. denied*, 488 U.S. 956 (1988).

### **716.01(c) Probative Value of Objective Evidence [R-2]**

>

#### **I. < TO BE OF PROBATIVE VALUE, ANY OBJECTIVE EVIDENCE SHOULD BE SUPPORTED BY ACTUAL PROOF**

Objective evidence which must be factually supported by an appropriate affidavit or declaration to be of probative value includes evidence of unexpected results, commercial success, solution of a long-felt need, inoperability of the prior art, invention before the date of the reference, and allegations that the author(s) of the prior art derived the disclosed subject matter from the applicant. See, for example, *In re De Blauwe*, 736 F.2d 699, 705, 222 USPQ 191, 196 (Fed. Cir. 1984) ("It is well settled that unexpected results must be established by factual evidence." "[A]ppellants have not presented any experimental data showing that prior heat-shrinkable articles split. Due to the absence of tests comparing appellant's heat shrinkable articles with those of the closest prior art, we conclude that appellant's assertions of unexpected results constitute mere argument."). See also *In re Lindner*, 457 F.2d 506, 508, 173 USPQ 356, 358 (CCPA 1972); *Ex parte George*, 21 USPQ2d 1058 (Bd. Pat. App. & Inter. 1991).

>

#### **II. < ATTORNEY ARGUMENTS CANNOT TAKE THE PLACE OF EVIDENCE**

The arguments of counsel cannot take the place of evidence in the record. *In re Schulze*, 346 F.2d 600, 602, 145 USPQ 716, 718 (CCPA 1965). Examples of attorney statements which are not evidence and which must be supported by an appropriate affidavit or declaration include statements regarding unexpected results, commercial success, solution of a long-felt need, inoperability of the prior art, invention before the date of the reference, and allegations that the

author(s) of the prior art derived the disclosed subject matter from the applicant.

See MPEP § 2145 generally for case law pertinent to the consideration of applicant's rebuttal arguments.

>

### III. < OPINION EVIDENCE

Although factual evidence is preferable to opinion testimony, such testimony is entitled to consideration and some weight so long as the opinion is not on the ultimate legal conclusion at issue. While an opinion as to a legal conclusion is not entitled to any weight, the underlying basis for the opinion may be persuasive. *In re Chilowsky*, 306 F.2d 908, 134 USPQ 515 (CCPA 1962) (expert opinion that an application meets the requirements of 35 U.S.C. 112 is not entitled to any weight; however, facts supporting a basis for deciding that the specification complies with 35 U.S.C. 112 are entitled to some weight); *In re Lindell*, 385 F.2d 453, 155 USPQ 521 (CCPA 1967) (Although an affiant's or declarant's opinion on the ultimate legal issue is not evidence in the case, "some weight ought to be given to a persuasively supported statement of one skilled in the art on what was not obvious to him." 385 F.2d at 456, 155 USPQ at 524 (emphasis in original)).

In assessing the probative value of an expert opinion, the examiner must consider the nature of the matter sought to be established, the strength of any opposing evidence, the interest of the expert in the outcome of the case, and the presence or absence of factual support for the expert's opinion. *Ashland Oil, Inc. v. Delta Resins & Refractories, Inc.*, 776 F.2d 281, 227 USPQ 657 (Fed. Cir. 1985), *cert. denied*, 475 U.S. 1017 (1986). See also *In re Oelrich*, 579 F.2d 86, 198 USPQ 210 (CCPA 1978) (factually based expert opinions on the level of ordinary skill in the art were sufficient to rebut the *prima facie* case of obviousness); *Ex parte Gray*, 10 USPQ2d 1922 (Bd. Pat. App. & Inter. 1989) (statement in publication dismissing the "preliminary identification of a human b-NGF-like molecule" in the prior art, even if considered to be an expert opinion, was inadequate to overcome the rejection based on that prior art because there was no factual evidence supporting the statement); *In re Carroll*, 601 F.2d 1184, 202 USPQ 571 (CCPA 1979) (expert opinion on what the prior art taught, supported by documentary evidence and for-

mulated prior to the making of the claimed invention, received considerable deference); *In re Beattie*, 974 F.2d 1309, 24 USPQ2d 1040 (Fed. Cir. 1992) (declarations of seven persons skilled in the art offering opinion evidence praising the merits of the claimed invention were found to have little value because of a lack of factual support); *Ex parte George*, 21 USPQ2d 1058 (Bd. Pat. App. & Inter. 1991) (conclusory statements that results were "unexpected," unsupported by objective factual evidence, were considered but were not found to be of substantial evidentiary value).

Although an affidavit or declaration which states only conclusions may have some probative value, such an affidavit or declaration may have little weight when considered in light of all the evidence of record in the application. *In re Brandstadter*, 484 F.2d 1395, 179 USPQ 286 (CCPA 1973).

An affidavit of an applicant as to the advantages of his or her claimed invention, while less persuasive than that of a disinterested person, cannot be disregarded for this reason alone. *Ex parte Keyes*, 214 USPQ 579 (Bd. App. 1982); *In re McKenna*, 203 F.2d 717, 97 USPQ 348 (CCPA 1953).

### 716.01(d) Weighing Objective Evidence [R-2]

#### IN MAKING A FINAL DETERMINATION OF PATENTABILITY, EVIDENCE SUPPORTING PATENTABILITY MUST BE WEIGHED AGAINST EVIDENCE SUPPORTING *PRIMA FACIE* CASE

When an applicant >timely< submits evidence traversing a rejection, the examiner must reconsider the patentability of the claimed invention. The ultimate determination of patentability must be based on consideration of the entire record, by a preponderance of evidence, with due consideration to the persuasiveness of any arguments and any secondary evidence. *In re Oetiker*, 977 F.2d 1443, 24 USPQ2d 1443 (Fed. Cir. 1992). The submission of objective evidence of patentability does not mandate a conclusion of patentability in and of itself. *In re Chupp*, 816 F.2d 643, 2 USPQ2d 1437 (Fed. Cir. 1987). Facts established by rebuttal evidence must be evaluated along with the facts on which the conclusion of a *prima facie* case was reached, not against the conclusion itself. *In re*

*Eli Lilly*, 902 F.2d 943, 14 USPQ2d 1741 (Fed. Cir. 1990). In other words, each piece of rebuttal evidence should not be evaluated for its ability to knockdown the *prima facie* case. All of the competent rebuttal evidence taken as a whole should be weighed against the evidence supporting the *prima facie* case. *In re Piasecki*, 745 F.2d 1468, 1472, 223 USPQ 785, 788 (Fed. Cir. 1984). Although the record may establish evidence of secondary considerations which are indicia of nonobviousness, the record may also establish such a strong case of obviousness that the objective evidence of nonobviousness is not sufficient to outweigh the evidence of obviousness. *Newell Cos. v. Kenney Mfg. Co.*, 864 F.2d 757, 769, 9 USPQ2d 1417, 1427 (Fed. Cir. 1988), *cert. denied*, 493 U.S. 814 (1989); *Richardson-Vicks, Inc., v. The Upjohn Co.*, 122 F.3d 1476, 1484, 44 USPQ2d 1181, 1187 (Fed. Cir. 1997) (showing of unexpected results and commercial success of claimed ibuprofen and pseudoephedrine combination in single tablet form, while supported by substantial evidence, held not to overcome strong *prima facie* case of obviousness). See *In re Piasecki*, 745 F.2d 1468, 223 USPQ 785 (Fed. Cir. 1984) for a detailed discussion of the proper roles of the examiner's *prima facie* case and applicant's rebuttal evidence in the final determination of obviousness.

If, after evaluating the evidence, the examiner is still not convinced that the claimed invention is patentable, the next Office action should include a statement to that effect and identify the reason(s) (e.g., evidence of commercial success not convincing, the commercial success not related to the technology, etc.). See *Demaco Corp. v. F. Von Langsdorff Licensing Ltd.*, 851 F.2d 1387, 7 USPQ2d 1222 (Fed. Cir.), *cert. denied*, 488 U.S. 956 (1988). See also MPEP § 716.01. See MPEP § 2144.08, paragraph II.B., for guidance in determining whether rebuttal evidence is sufficient to overcome a *prima facie* case of obviousness.

## 716.02 Allegations of Unexpected Results

Any differences between the claimed invention and the prior art may be expected to result in some differences in properties. The issue is whether the properties differ to such an extent that the difference is really unexpected. *In re Merck & Co.*, 800 F.2d 1091, 231 USPQ 375 (Fed. Cir. 1986) (differences in seda-

tive and anticholinergic effects between prior art and claimed antidepressants were not unexpected). In *In re Waymouth*, 499 F.2d 1273, 1276, 182 USPQ 290, 293 (CCPA 1974), the court held that unexpected results for a claimed range as compared with the range disclosed in the prior art had been shown by a demonstration of "a marked improvement, over the results achieved under other ratios, as to be classified as a difference in kind, rather than one of degree." Compare *In re Wagner*, 371 F.2d 877, 884, 152 USPQ 552, 560 (CCPA 1967) (differences in properties cannot be disregarded on the ground they are differences in degree rather than in kind); *Ex parte Gelles*, 22 USPQ2d 1318, 1319 (Bd. Pat. App. & Inter. 1992) ("we generally consider a discussion of results in terms of 'differences in degree' as compared to 'differences in kind' . . . to have very little meaning in a relevant legal sense").

### 716.02(a) Evidence Must Show Unexpected Results [R-2]

>

#### I. < GREATER THAN EXPECTED RESULTS ARE EVIDENCE OF NONOBVIOUSNESS

"A greater than expected result is an evidentiary factor pertinent to the legal conclusion of obviousness ... of the claims at issue." *In re Corkill*, 711 F.2d 1496, 226 USPQ 1005 (Fed. Cir. 1985). In *Corkill*, the claimed combination showed an additive result when a diminished result would have been expected. This result was persuasive of nonobviousness even though the result was equal to that of one component alone. Evidence of a greater than expected result may also be shown by demonstrating an effect which is greater than the sum of each of the effects taken separately (i.e., demonstrating "synergism"). *Merck & Co. Inc. v. Biocraft Laboratories Inc.*, 874 F.2d 804, 10 USPQ2d 1843 (Fed. Cir.), *cert. denied*, 493 U.S. 975 (1989). However, a greater than additive effect is not necessarily sufficient to overcome a *prima facie* case of obviousness because such an effect can either be expected or unexpected. Applicants must further show that the results were greater than those which would have been expected from the prior art to an unobvious extent, and that the results are of a signifi-

cant, practical advantage. *Ex parte The NutraSweet Co.*, 19 USPQ2d 1586 (Bd. Pat. App. & Inter. 1991) (Evidence showing greater than additive sweetness resulting from the claimed mixture of saccharin and L-aspartyl-L-phenylalanine was not sufficient to outweigh the evidence of obviousness because the teachings of the prior art lead to a general expectation of greater than additive sweetening effects when using mixtures of synthetic sweeteners.).

&gt;

## II. < SUPERIORITY OF A PROPERTY SHARED WITH THE PRIOR ART IS EVIDENCE OF NONOBVIOUSNESS

Evidence of unobvious or unexpected advantageous properties, such as superiority in a property the claimed compound shares with the prior art, can rebut *prima facie* obviousness. “Evidence that a compound is unexpectedly superior in one of a spectrum of common properties . . . can be enough to rebut a *prima facie* case of obviousness.” No set number of examples of superiority is required. *In re Chupp*, 816 F.2d 643, 646, 2 USPQ2d 1437, 1439 (Fed. Cir. 1987) (Evidence showing that the claimed herbicidal compound was more effective than the closest prior art compound in controlling quackgrass and yellow nutsedge weeds in corn and soybean crops was sufficient to overcome the rejection under 35 U.S.C. 103, even though the specification indicated the claimed compound was an average performer on crops other than corn and soybean.). See also *Ex parte A*, 17 USPQ2d 1716 (Bd. Pat. App. & Inter. 1990) (unexpected superior therapeutic activity of claimed compound against anaerobic bacteria was sufficient to rebut *prima facie* obviousness even though there was no evidence that the compound was effective against all bacteria).

&gt;

## III. < PRESENCE OF AN UNEXPECTED PROPERTY IS EVIDENCE OF NONOBVIOUSNESS

Presence of a property not possessed by the prior art is evidence of nonobviousness. *In re Papesch*, 315 F.2d 381, 137 USPQ 43 (CCPA 1963) (rejection of claims to compound structurally similar to the prior art compound was reversed because claimed compound unexpectedly possessed anti-inflammatory properties not possessed by the prior art compound);

*Ex parte Thumm*, 132 USPQ 66 (Bd. App. 1961) (Appellant showed that the claimed range of ethylene diamine was effective for the purpose of producing “‘regenerated cellulose consisting substantially entirely of skin’ ” whereas the prior art warned “‘this compound has ‘practically no effect.’ ”). The submission of evidence that a new product possesses unexpected properties does not necessarily require a conclusion that the claimed invention is nonobvious. *In re Payne*, 606 F.2d 303, 203 USPQ 245 (CCPA 1979). See the discussion of latent properties and additional advantages in MPEP § 2145.

&gt;

## IV. < ABSENCE OF AN EXPECTED PROPERTY IS EVIDENCE OF NONOBVIOUSNESS

Absence of property which a claimed invention would have been expected to possess based on the teachings of the prior art is evidence of unobviousness. *Ex parte Mead Johnson & Co.* 227 USPQ 78 (Bd. Pat. App. & Inter. 1985) (Based on prior art disclosures, claimed compounds would have been expected to possess beta-andrenergic blocking activity; the fact that claimed compounds did not possess such activity was an unexpected result sufficient to establish unobviousness within the meaning of 35 U.S.C. 103.).

## 716.02(b) Burden on Applicant [R-2]

&gt;

### I. < BURDEN ON APPLICANT TO ESTABLISH RESULTS ARE UNEXPECTED AND SIGNIFICANT

The evidence relied \*>upon< should establish “that the differences in results are in fact unexpected and unobvious and of both statistical and practical significance.” *Ex parte Gelles*, 22 USPQ2d 1318, 1319 (Bd. Pat. App. & Inter. 1992) (Mere conclusions in appellants’ brief that the claimed polymer had an unexpectedly increased impact strength “are not entitled to the weight of conclusions accompanying the evidence, either in the specification or in a declaration.”); *Ex parte C*, 27 USPQ2d 1492 (Bd. Pat. App. & Inter. 1992) (Applicant alleged unexpected results with regard to the claimed soybean plant, however there was no basis for judging the practical significance of

data with regard to maturity date, flowering date, flower color, or height of the plant.). See also *In re Nolan*, 553 F.2d 1261, 1267, 193 USPQ 641, 645 (CCPA 1977) and *In re Eli Lilly*, 902 F.2d 943, 14 USPQ2d 1741 (Fed. Cir. 1990) as discussed in MPEP § 716.02(c).

&gt;

## II. < APPLICANTS HAVE BURDEN OF EXPLAINING PROFFERED DATA

“[A]ppellants have the burden of explaining the data in any declaration they proffer as evidence of non-obviousness.” *Ex parte Ishizaka*, 24 USPQ2d 1621, 1624 (Bd. Pat. App. & Inter. 1992).

&gt;

## III. < DIRECT AND INDIRECT COMPARATIVE TESTS ARE PROBATIVE OF NON-OBVIOUSNESS

Evidence of unexpected properties may be in the form of a direct or indirect comparison of the claimed invention with the closest prior art which is commensurate in scope with the claims. See *In re Boesch*, 617 F.2d 272, 205 USPQ 215 (CCPA 1980) and MPEP § 716.02(d) - § 716.02(e). See *In re Blondel*, 499 F.2d 1311, 1317, 182 USPQ 294, 298 (CCPA 1974) and *In re Fouche*, 439 F.2d 1237, 1241-42, 169 USPQ 429, 433 (CCPA 1971) for examples of cases where indirect comparative testing was found sufficient to rebut a *prima facie* case of obviousness.

The patentability of an intermediate may be established by unexpected properties of an end product “when one of ordinary skill in the art would reasonably ascribe to a claimed intermediate the ‘contributing cause’ for such an unexpectedly superior activity or property.” *In re Magerlein*, 602 F.2d 366, 373, 202 USPQ 473, 479 (CCPA 1979). “In order to establish that the claimed intermediate is a ‘contributing cause’ of the unexpectedly superior activity or property of an end product, an applicant must identify the cause of the unexpectedly superior activity or property (compared to the prior art) in the end product and establish a nexus for that cause between the intermediate and the end product.” *Id.* at 479.

## 716.02(c) Weighing Evidence of Expected and Unexpected Results [R-2]

&gt;

### I. < EVIDENCE OF UNEXPECTED AND EXPECTED PROPERTIES MUST BE WEIGHED

Evidence of unexpected results must be weighed against evidence supporting *prima facie* obviousness in making a final determination of the obviousness of the claimed invention. *In re May*, 574 F.2d 1082, 197 USPQ 601 (CCPA 1978) (Claims directed to a method of effecting analgesia without producing physical dependence by administering the levo isomer of a compound having a certain chemical structure were rejected as obvious over the prior art. Evidence that the compound was unexpectedly nonaddictive was sufficient to overcome the obviousness rejection. Although the compound also had the expected result of potent analgesia, there was evidence of record showing that the goal of research in this area was to produce an analgesic compound which was nonaddictive, enhancing the evidentiary value of the showing of nonaddictiveness as an indicia of nonobviousness.). See MPEP § 716.01(d) for guidance on weighing evidence submitted to traverse a rejection.

Where the unexpected properties of a claimed invention are not shown to have a significance equal to or greater than the expected properties, the evidence of unexpected properties may not be sufficient to rebut the evidence of obviousness. *In re Nolan*, 553 F.2d 1261, 1267, 193 USPQ 641, 645 (CCPA 1977) (Claims were directed to a display/memory device which was *prima facie* obvious over the prior art. The court found that a higher memory margin and lower operating voltage would have been expected properties of the claimed device, and that a higher memory margin appears to be the most significant improvement for a memory device. Although applicant presented evidence of unexpected properties with regard to lower peak discharge current and higher luminous efficiency, these properties were not shown to have a significance equal to or greater than that of the expected higher memory margin and lower operating voltage. The court held the evidence of nonobviousness was not sufficient to rebut the evidence of obviousness.); *In re Eli Lilly*, 902 F.2d 943,

14 USPQ2d 1741 (Fed. Cir. 1990) (Evidence of improved feed efficiency in steers was not sufficient to rebut *prima facie* case of obviousness based on prior art which specifically taught the use of compound X537A to enhance weight gain in animals because the evidence did not show that a significant aspect of the claimed invention would have been unexpected.).

>

## II. < EXPECTED BENEFICIAL RESULTS ARE EVIDENCE OF OBVIOUSNESS

“Expected beneficial results are evidence of obviousness of a claimed invention, just as unexpected results are evidence of unobviousness thereof.” *In re Gershon*, 372 F.2d 535, 538, 152 USPQ 602, 604 (CCPA 1967) (resultant decrease of dental enamel solubility accomplished by adding an acidic buffering agent to a fluoride containing dentifrice was expected based on the teaching of the prior art); *Ex parte Blanc*, 13 USPQ2d 1383 (Bd. Pat. App. & Inter. 1989) (Claims at issue were directed to a process of sterilizing a polyolefinic composition which contains an antioxidant with high-energy radiation. Although evidence was presented in appellant’s specification showing that particular antioxidants are effective, the Board concluded that these beneficial results would have been expected because one of the references taught a claimed antioxidant is very efficient and provides better results compared with other prior art antioxidants.).

### 716.02(d) Unexpected Results Commensurate in Scope With Claimed Invention [R-2]

Whether the unexpected results are the result of unexpectedly improved results or a property not taught by the prior art, the “objective evidence of non-obviousness must be commensurate in scope with the claims which the evidence is offered to support.” In other words, the showing of unexpected results must be reviewed to see if the results occur over the entire claimed range. *In re Clemens*, 622 F.2d 1029, 1036, 206 USPQ 289, 296 (CCPA 1980) (Claims were directed to a process for removing corrosion at “elevated temperatures” using a certain ion exchange resin (with the exception of claim 8 which recited a

temperature in excess of 100C). Appellant demonstrated unexpected results via comparative tests with the prior art ion exchange resin at 110C and 130C. The court affirmed the rejection of claims 1-7 and 9-10 because the term “elevated temperatures” encompassed temperatures as low as 60C where the prior art ion exchange resin was known to perform well. The rejection of claim 8, directed to a temperature in excess of 100C, was reversed.). See also *In re Peterson*, 315 F.3d 1325, 1329-31, 65 USPQ2d 1379, 1382-85 (Fed. Cir. 2003) (data showing improved alloy strength with the addition of 2% rhenium did not evidence unexpected results for the entire claimed range of about 1-3% rhenium); *In re Grasselli*, 713 F.2d 731, 741, 218 USPQ 769, 777 (Fed. Cir. 1983) (Claims were directed to certain catalysts containing an alkali metal. Evidence presented to rebut an obviousness rejection compared catalysts containing sodium with the prior art. The court held this evidence insufficient to rebut the *prima facie* case because experiments limited to sodium were not commensurate in scope with the claims.).

>

## I. < NONOBVIOUSNESS OF A GENUS OR CLAIMED RANGE MAY BE SUPPORTED BY DATA SHOWING UNEXPECTED RESULTS OF A SPECIES OR NARROWER RANGE UNDER CERTAIN CIRCUMSTANCES

The nonobviousness of a broader claimed range can be supported by evidence based on unexpected results from testing a narrower range if one of ordinary skill in the art would be able to determine a trend in the exemplified data which would allow the artisan to reasonably extend the probative value thereof. *In re Kollman*, 595 F.2d 48, 201 USPQ 193 (CCPA 1979) (Claims directed to mixtures of an herbicide known as “FENAC” with a diphenyl ether herbicide in certain relative proportions were rejected as *prima facie* obvious. Applicant presented evidence alleging unexpected results testing three species of diphenyl ether herbicides over limited relative proportion ranges. The court held that the limited number of species exemplified did not provide an adequate basis for concluding that similar results would be obtained for the other diphenyl ether herbicides within the scope of the generic claims. Claims 6-8 recited a

FENAC:diphenyl ether ratio of 1:1 to 4:1 for the three specific ethers tested. For two of the claimed ethers, unexpected results were demonstrated over a ratio of 16:1 to 2:1, and the effectiveness increased as the ratio approached the untested region of the claimed range. The court held these tests were commensurate in scope with the claims and supported the nonobviousness thereof. However, for a third ether, data was only provided over the range of 1:1 to 2:1 where the effectiveness decreased to the “expected level” as it approached the untested region. This evidence was not sufficient to overcome the obviousness rejection.); *In re Lindner*, 457 F.2d 506, 509, 173 USPQ 356, 359 (CCPA 1972) (Evidence of nonobviousness consisted of comparing a single composition within the broad scope of the claims with the prior art. The court did not find the evidence sufficient to rebut the *prima facie* case of obviousness because there was “no adequate basis for reasonably concluding that the great number and variety of compositions included in the claims would behave in the same manner as the tested composition.”).

&gt;

## II. < DEMONSTRATING CRITICALITY OF A CLAIMED RANGE

To establish unexpected results over a claimed range, applicants should compare a sufficient number of tests both inside and outside the claimed range to show the criticality of the claimed range. *In re Hill*, 284 F.2d 955, 128 USPQ 197 (CCPA 1960).

### 716.02(e) Comparison With Closest Prior Art [R-2]

An affidavit or declaration under 37 CFR 1.132 must compare the claimed subject matter with the closest prior art to be effective to rebut a *prima facie* case of obviousness. *In re Burckel*, 592 F.2d 1175, 201 USPQ 67 (CCPA 1979). “A comparison of the *claimed* invention with the disclosure of each cited reference to determine the number of claim limitations in common with each reference, bearing in mind the relative importance of particular limitations, will usually yield the closest single prior art reference.” *In re Merchant*, 575 F.2d 865, 868, 197 USPQ 785, 787 (CCPA 1978) (emphasis in original). Where the comparison is not identical with the reference disclosure, deviations therefrom should be explained, *In re*

*Finley*, 174 F.2d 130, 81 USPQ 383 (CCPA 1949), and if not explained should be noted and evaluated, and if significant, explanation should be required. *In re Armstrong*, 280 F.2d 132, 126 USPQ 281 (CCPA 1960) (deviations from example were inconsequential).

&gt;

## I. < THE CLAIMED INVENTION MAY BE COMPARED WITH PRIOR ART THAT IS CLOSER THAN THAT APPLIED BY THE EXAMINER

Applicants may compare the claimed invention with prior art that is more closely related to the invention than the prior art relied upon by the examiner. *In re Holladay*, 584 F.2d 384, 199 USPQ 516 (CCPA 1978); *Ex parte Humber*, 217 USPQ 265 (Bd. App. 1961) (Claims to a 13-chloro substituted compound were rejected as obvious over nonchlorinated analogs of the claimed compound. Evidence showing unexpected results for the claimed compound as compared with the 9-, 12-, and 14- chloro derivatives of the compound rebutted the *prima facie* case of obviousness because the compounds compared against were closer to the claimed invention than the prior art relied upon.).

&gt;

## II. < COMPARISONS WHEN THERE ARE TWO EQUALLY CLOSE PRIOR ART REFERENCES

Showing unexpected results over one of two equally close prior art references will not rebut *prima facie* obviousness unless the teachings of the prior art references are sufficiently similar to each other that the testing of one showing unexpected results would provide the same information as to the other. *In re Johnson*, 747 F.2d 1456, 1461, 223 USPQ 1260, 1264 (Fed. Cir. 1984) (Claimed compounds differed from the prior art either by the presence of a trifluoromethyl group instead of a chloride radical, or by the presence of an unsaturated ester group instead of a saturated ester group. Although applicant compared the claimed invention with the prior art compound containing a chloride radical, the court found this evidence insufficient to rebut the *prima facie* case of obviousness because the evidence did not show rela-

tive effectiveness over all compounds of the closest prior art. An applicant does not have to test all the compounds taught by each reference, “[h]owever, where an applicant tests less than all cited compounds, *the test must be sufficient to permit a conclusion respecting the relative effectiveness of applicant’s claimed compounds and the compounds of the closest prior art.*” *Id.* (quoting *In re Payne*, 606 F.2d 303, 316, 203 USPQ 245, 256 (CCPA 1979)) (emphasis in original).).

>

### III. < THE CLAIMED INVENTION MAY BE COMPARED WITH THE CLOSEST SUBJECT MATTER THAT EXISTS IN THE PRIOR ART

Although evidence of unexpected results must compare the claimed invention with the closest prior art, applicant is not required to compare the claimed invention with subject matter that does not exist in the prior art. *In re Geiger*, 815 F.2d 686, 689, 2 USPQ2d 1276, 1279 (Fed. Cir. 1987) (Newman, J., concurring) (Evidence rebutted *prima facie* case by comparing claimed invention with the most relevant prior art. Note that the majority held the Office failed to establish a *prima facie* case of obviousness.); *In re Chapman*, 357 F.2d 418, 148 USPQ 711 (CCPA 1966) (Requiring applicant to compare claimed invention with polymer suggested by the combination of references relied upon in the rejection of the claimed invention under 35 U.S.C. 103 “would be requiring comparison of the results of the invention with the results of the invention.” 357 F.2d at 422, 148 USPQ at 714.).

#### 716.02(f) Advantages Disclosed or Inherent

The totality of the record must be considered when determining whether a claimed invention would have been obvious to one of ordinary skill in the art at the time the invention was made. Therefore, evidence and arguments directed to advantages not disclosed in the specification cannot be disregarded. *In re Chu*, 66 F.3d 292, 298-99, 36 USPQ2d 1089, 1094-95

(Fed. Cir. 1995) (Although the purported advantage of placement of a selective catalytic reduction catalyst in the bag retainer of an apparatus for controlling emissions was not disclosed in the specification, evidence and arguments rebutting the conclusion that such placement was a matter of “design choice” should have been considered as part of the totality of the record. “We have found no cases supporting the position that a patent applicant’s evidence or arguments traversing a § 103 rejection must be contained within the specification. There is no logical support for such a proposition as well, given that obviousness is determined by the totality of the record including, in some instances most significantly, the evidence and arguments proffered during the give-and-take of *ex parte* patent prosecution.” 66 F.3d at 299, 36 USPQ2d at 1095.). See also *In re Zenitz*, 333 F.2d 924, 928, 142 USPQ 158, 161 (CCPA 1964) (evidence that claimed compound minimized side effects of hypotensive activity must be considered because this undisclosed property would inherently flow from disclosed use as tranquilizer); *Ex parte Sasajima*, 212 USPQ 103, 104 - 05 (Bd. App. 1981) (evidence relating to initially undisclosed relative toxicity of claimed pharmaceutical compound must be considered).

The specification need not disclose proportions or values as critical for applicants to present evidence showing the proportions or values to be critical. *In re Saunders*, 444 F.2d 599, 607, 170 USPQ 213, 220 (CCPA 1971).

#### 716.02(g) Declaration or Affidavit Form

“The reason for requiring evidence in declaration or affidavit form is to obtain the assurances that any statements or representations made are correct, as provided by 35 U.S.C. 25 and 18 U.S.C. 1001.” Permitting a publication to substitute for expert testimony would circumvent the guarantees built into the statute. *Ex parte Gray*, 10 USPQ2d 1922, 1928 (Bd. Pat. App. & Inter. 1989). Publications may, however, be evidence of the facts in issue and should be considered to the extent that they are probative.



**716.03 Commercial Success [R-2]**

&gt;

**I. < NEXUS BETWEEN CLAIMED INVENTION AND EVIDENCE OF COMMERCIAL SUCCESS REQUIRED**

An applicant who is asserting commercial success to support its contention of nonobviousness bears the burden of proof of establishing a nexus between the claimed invention and evidence of commercial success.

The Federal Circuit has acknowledged that applicant bears the burden of establishing nexus, stating:

In the *ex parte* process of examining a patent application, however, the PTO lacks the means or resources to gather evidence which supports or refutes the applicant's assertion that the sale constitute commercial success. *C.f. Ex parte Remark*, 15 USPQ2d 1498, 1503 (Bd. Pat. App. & Int. 1990)(evidentiary routine of shifting burdens in civil proceedings inappropriate in *ex parte* prosecution proceedings because examiner has no available means for adducing evidence). Consequently, the PTO must rely upon the applicant to provide hard evidence of commercial success.

*In re Huang*, 100 F.3d 135, 139-40, 40 USPQ2d 1685, 1689 (Fed. Cir. 1996). See also *In re GPAC*, 57 F.3d 1573, 1580, 35 USPQ2d 1116, 1121 (Fed. Cir. 1995); *In re Paulsen*, 30 F.3d 1475, 1482, 31 USPQ2d 1671, 1676 (Fed. Cir. 1994) (Evidence of commercial success of articles not covered by the claims subject to the 35 U.S.C. 103 rejection was not probative of nonobviousness).

The term "nexus" designates a factually and legally sufficient connection between the evidence of commercial success and the claimed invention so that the evidence is of probative value in the determination of nonobviousness. *Demaco Corp. v. F. Von Langsdorff Licensing Ltd.*, 851 F.2d 1387, 7 USPQ2d 1222 (Fed. Cir. 1988).

&gt;

**II. < COMMERCIAL SUCCESS ABROAD IS RELEVANT**

Commercial success abroad, as well as in the United States, is relevant in resolving the issue of

nonobviousness. *Lindemann Maschinenfabrik GMBH v. American Hoist & Derrick Co.*, 730 F.2d 1452, 221 USPQ 481 (Fed. Cir. 1984).

**716.03(a) Commercial Success Commensurate in Scope With Claimed Invention [R-2]**

&gt;

**I. < EVIDENCE OF COMMERCIAL SUCCESS MUST BE COMMENSURATE IN SCOPE WITH THE CLAIMS**

Objective evidence of nonobviousness including commercial success must be commensurate in scope with the claims. *In re Tiffin*, 448 F.2d 791, 171 USPQ 294 (CCPA 1971) (evidence showing commercial success of thermoplastic foam "cups" used in vending machines was not commensurate in scope with claims directed to thermoplastic foam "containers" broadly). In order to be commensurate \*in< scope with the claims, the commercial success must be due to claimed features, and not due to unclaimed features. *Joy Technologies Inc. v. Manbeck*, 751 F. Supp. 225, 229, 17 USPQ2d 1257, 1260 (D.D.C. 1990), *aff'd*, 959 F.2d 226, 228, 22 USPQ2d 1153, 1156 (Fed. Cir. 1992) (Features responsible for commercial success were recited only in allowed dependent claims, and therefore the evidence of commercial success was not commensurate in scope with the broad claims at issue.).

An affidavit or declaration attributing commercial success to a product or process "constructed according to the disclosure and claims of [the] patent application" or other equivalent language does not establish a nexus between the claimed invention and the commercial success because there is no evidence that the product or process which has been sold corresponds to the claimed invention, or that whatever commercial success may have occurred is attributable to the product or process defined by the claims. *Ex parte Standish*, 10 USPQ2d 1454, 1458 (Bd. Pat. App. & Inter. 1988).

&gt;

## II. < REQUIREMENTS WHEN CLAIMED INVENTION IS NOT COEXTENSIVE WITH COMMERCIAL PRODUCT OR PROCESS

If a particular range is claimed, applicant does not need to show commercial success at every point in the range. “Where, as here, the claims are directed to a combination of ranges and procedures not shown by the prior art, and where substantial commercial success is achieved at an apparently typical point within those ranges, and the affidavits definitely indicate that operation throughout the claimed ranges approximates that at the particular points involved in the commercial operation, we think the evidence as to commercial success is persuasive.” *In re Hollingsworth*, 253 F.2d 238, 240, 117 USPQ 182, 184 (CCPA 1958). See also *Demaco Corp. v. F. Von Langsdorff Licensing Ltd.*, 851 F.2d 1387, 7 USPQ2d 1222 (Fed. Cir. 1988) (where the commercially successful product or process is not coextensive with the claimed invention, applicant must show a legally sufficient relationship between the claimed feature and the commercial product or process).

### 716.03(b) Commercial Success Derived From Claimed Invention [R-2]

&gt;

## I. < COMMERCIAL SUCCESS MUST BE DERIVED FROM THE CLAIMED INVENTION

In considering evidence of commercial success, care should be taken to determine that the commercial success alleged is directly derived from the invention claimed, in a marketplace where the consumer is free to choose on the basis of objective principles, and that such success is not the result of heavy promotion or advertising, shift in advertising, consumption by purchasers normally tied to applicant or assignee, or other business events extraneous to the merits of the claimed invention, etc. *In re Mageli*, 470 F.2d 1380, 176 USPQ 305 (CCPA 1973) (conclusory statements or opinions that increased sales were due to the merits of the invention are entitled to little weight); *In re Noznick*, 478 F.2d 1260, 178 USPQ 43 (CCPA 1973).

In *ex parte* proceedings before the Patent and Trademark Office, an applicant must show that the claimed features were responsible for the commercial success of an article if the evidence of nonobviousness is to be accorded substantial weight. See *In re Huang*, 100 F.3d 135, 140, 40 USPQ2d 1685, 1690 (Fed. Cir. 1996) (Inventor’s opinion as to the purchaser’s reason for buying the product is insufficient to demonstrate a nexus between the sales and the claimed invention.). Merely showing that there was commercial success of an article which embodied the invention is not sufficient. *Ex parte Remark*, 15 USPQ2d 1498, 1502-02 (Bd. Pat. App. & Inter. 1990). Compare *Demaco Corp. v. F. Von Langsdorff Licensing Ltd.*, 851 F.2d 1387, 7 USPQ2d 1222 (Fed. Cir. 1988) (In civil litigation, a patentee does not have to prove that the commercial success is not due to other factors. “A requirement for proof of the negative of all imaginable contributing factors would be unfairly burdensome, and contrary to the ordinary rules of evidence.”).

See also *Pentec, Inc. v. Graphic Controls Corp.*, 776 F.2d 309, 227 USPQ 766 (Fed. Cir. 1985) (commercial success may have been attributable to extensive advertising and position as a market leader before the introduction of the patented product); *In re Fielder*, 471 F.2d 690, 176 USPQ 300 (CCPA 1973) (success of invention could be due to recent changes in related technology or consumer demand; here success of claimed voting ballot could be due to the contemporary drive toward greater use of automated data processing techniques); *EWP Corp. v. Reliance Universal, Inc.*, 755 F.2d 898, 225 USPQ 20 (Fed. Cir. 1985) (evidence of licensing is a secondary consideration which must be carefully appraised as to its evidentiary value because licensing programs may succeed for reasons unrelated to the unobviousness of the product or process, e.g., license is mutually beneficial or less expensive than defending infringement suits); *Hybritech Inc. v. Monoclonal Antibodies, Inc.*, 802 F.2d 1367, 231 USPQ 81 (Fed. Cir. 1986) (Evidence of commercial success supported a conclusion of nonobviousness of claims to an immunometric “sandwich” assay with monoclonal antibodies. Patentee’s assays became a market leader with 25% of the market within a few years. Evidence of advertising did not show absence of a nexus between commercial success and the merits of the claimed invention

because spending 25-35% of sales on marketing was not inordinate (mature companies spent 17-32% of sales in this market), and advertising served primarily to make industry aware of the product because this is not kind of merchandise that can be sold by advertising hyperbole.).

&gt;

## II. < COMMERCIAL SUCCESS MUST FLOW FROM THE FUNCTIONS AND ADVANTAGES DISCLOSED OR INHERENT IN THE SPECIFICATION DESCRIPTION

To be pertinent to the issue of nonobviousness, the commercial success of devices falling within the claims of the patent must flow from the functions and advantages disclosed or inherent in the description in the specification. Furthermore, the success of an embodiment within the claims may not be attributable to improvements or modifications made by others. *In re Vamco Machine & Tool, Inc.*, 752 F.2d 1564, 224 USPQ 617 (Fed. Cir. 1985).

&gt;

## III. < IN DESIGN CASES, ESTABLISHMENT OF NEXUS IS ESPECIALLY DIFFICULT

Establishing a nexus between commercial success and the claimed invention is especially difficult in design cases. Evidence of commercial success must be clearly attributable to the design to be of probative value, and not to brand name recognition, improved performance, or some other factor. *Litton Systems, Inc. v. Whirlpool Corp.*, 728 F.2d 1423, 221 USPQ 97 (Fed. Cir. 1984) (showing of commercial success was not accompanied by evidence attributing commercial success of Litton microwave oven to the design thereof).

&gt;

## IV. < SALES FIGURES MUST BE ADEQUATELY DEFINED

Gross sales figures do not show commercial success absent evidence as to market share, *Cable Electric Products, Inc. v. Genmark, Inc.*, 770 F.2d 1015, 226 USPQ 881 (Fed. Cir. 1985), or as to the time period during which the product was sold, or as to what sales would normally be expected in the market,

*Ex parte Standish*, 10 USPQ2d 1454 (Bd. Pat. App. & Inter. 1988).

## 716.04 Long-Felt Need and Failure of Others [R-2]

&gt;

### I. < THE CLAIMED INVENTION MUST SATISFY A LONG-FELT NEED WHICH WAS RECOGNIZED, PERSISTENT, AND NOT SOLVED BY OTHERS

Establishing long-felt need requires objective evidence that an art recognized problem existed in the art for a long period of time without solution. The relevance of long-felt need and the failure of others to the issue of obviousness depends on several factors. First, the need must have been a persistent one that was recognized by those of ordinary skill in the art. *In re Gershon*, 372 F.2d 535, 539, 152 USPQ 602, 605 (CCPA 1967) (“Since the alleged problem in this case was first recognized by appellants, and others apparently have not yet become aware of its existence, it goes without saying that there could not possibly be any evidence of either a long felt need in the . . . art for a solution to a problem of dubious existence or failure of others skilled in the art who unsuccessfully attempted to solve a problem of which they were not aware.”); *Orthopedic Equipment Co., Inc. v. All Orthopedic Appliances, Inc.*, 707 F.2d 1376, 217 USPQ 1281 (Fed. Cir. 1983) (Although the claimed invention achieved the desirable result of reducing inventories, there was no evidence of any prior unsuccessful attempts to do so.).

Second, the long-felt need must not have been satisfied by another before the invention by applicant. *Newell Companies v. Kenney Mfg. Co.*, 864 F.2d 757, 768, 9 USPQ2d 1417, 1426 (Fed. Cir. 1988) (Although at one time there was a long-felt need for a “do-it-yourself” window shade material which was adjustable without the use of tools, a prior art product fulfilled the need by using a scored plastic material which could be torn. “[O]nce another supplied the key element, there was no long-felt need or, indeed, a problem to be solved”).

Third, the invention must in fact satisfy the long-felt need. *In re Cavanagh*, 436 F.2d 491, 168 USPQ 466 (CCPA 1971).

&gt;

## II. < LONG-FELT NEED IS MEASURED FROM THE DATE A PROBLEM IS IDENTIFIED AND EFFORTS ARE MADE TO SOLVE IT

Long-felt need is analyzed as of the date the problem is identified and articulated, and there is evidence of efforts to solve that problem, not as of the date of the most pertinent prior art references. *Texas Instruments Inc. v. Int'l Trade Comm'n*, 988 F.2d 1165, 1179, 26 USPQ2d 1018, 1029 (Fed. Cir. 1993).

&gt;

## III. < OTHER FACTORS CONTRIBUTING TO THE PRESENCE OF A LONG-FELT NEED MUST BE CONSIDERED

The failure to solve a long-felt need may be due to factors such as lack of interest or lack of appreciation of an invention's potential or marketability rather than want of technical know-how. *Scully Signal Co. v. Electronics Corp. of America*, 570 F.2d 355, 196 USPQ 657 (1st. Cir. 1977).

See also *Environmental Designs, Ltd. v. Union Oil Co. of Cal.*, 713 F.2d 693, 698, 218 USPQ 865, 869 (Fed. Cir. 1983) (presence of legislative regulations for controlling sulfur dioxide emissions did not militate against existence of long-felt need to reduce the sulfur content in the air); *In re Tiffin*, 443 F.2d 344, 170 USPQ 88 (CCPA 1971) (fact that affidavit supporting contention of fulfillment of a long-felt need was sworn by a licensee adds to the weight to be accorded the affidavit, as long as there is a *bona fide* licensing agreement entered into at arm's length).

### 716.05 Skepticism of Experts

"Expressions of disbelief by experts constitute strong evidence of nonobviousness." *Environmental Designs, Ltd. v. Union Oil Co. of Cal.*, 713 F.2d 693, 698, 218 USPQ 865, 869 (Fed. Cir. 1983) (citing *United States v. Adams*, 383 U.S. 39, 52, 148 USPQ 479, 483-484 (1966)) (The patented process converted all the sulfur compounds in a certain effluent gas stream to hydrogen sulfide, and thereafter treated the resulting effluent for removal of hydrogen sulfide. Before learning of the patented process, chemical experts, aware of earlier failed efforts to reduce the sulfur content of effluent gas streams, were of the

opinion that reducing sulfur compounds to hydrogen sulfide would not adequately solve the problem.).

"The skepticism of an expert, expressed before these inventors proved him wrong, is entitled to fair evidentiary weight, . . . as are the five to six years of research that preceded the claimed invention." *In re Dow Chemical Co.*, 837 F.2d 469, 5 USPQ2d 1529 (Fed. Cir. 1988); *Burlington Industries Inc. v. Quigg*, 822 F.2d 1581, 3 USPQ2d 1436 (Fed. Cir. 1987) (testimony that the invention met with initial incredulity and skepticism of experts was sufficient to rebut the *prima facie* case of obviousness based on the prior art).

### 716.06 Copying

Another form of secondary evidence which may be presented by applicants during prosecution of an application, but which is more often presented during litigation, is evidence that competitors in the marketplace are copying the invention instead of using the prior art. However, more than the mere fact of copying is necessary to make that action significant because copying may be attributable to other factors such as a lack of concern for patent property or contempt for the patentees ability to enforce the patent. *Cable Electric Products, Inc. v. Genmark, Inc.*, 770 F.2d 1015, 226 USPQ 881 (Fed. Cir. 1985). Evidence of copying was persuasive of nonobviousness when an alleged infringer tried for a substantial length of time to design a product or process similar to the claimed invention, but failed and then copied the claimed invention instead. *Dow Chem. Co. v. American Cyanamid Co.*, 837 F.2d 469, 2 USPQ2d 1350 (Fed. Cir. 1987). Alleged copying is not persuasive of nonobviousness when the copy is not identical to the claimed product, and the other manufacturer had not expended great effort to develop its own solution. *Pentec, Inc. v. Graphic Controls Corp.*, 776 F.2d 309, 227 USPQ 766 (Fed. Cir. 1985). See also *Vandenberg v. Dairy Equipment Co.*, 740 F.2d 1560, 1568, 224 USPQ 195, 199 (Fed. Cir. 1984) (evidence of copying not found persuasive of nonobviousness) and *Panduit Corp. v. Dennison Manufacturing Co.*, 774 F.2d 1082, 1098-99, 227 USPQ 337, 348, 349 (Fed. Cir. 1985), *vacated on other grounds*, 475 U.S. 809, 229 USPQ 478 (1986), *on remand*, 810 F.2d 1561, 1 USPQ2d 1593 (Fed. Cir. 1987) (evidence of copying found persuasive of nonobviousness where admit-

ted infringer failed to satisfactorily produce a solution after 10 years of effort and expense).

### **716.07 Inoperability of References**

Since every patent is presumed valid (35 U.S.C. 282), and since that presumption includes the presumption of operability (*Metropolitan Eng. Co. v. Coe*, 78 F.2d 199, 25 USPQ 216 (D.C.Cir. 1935)),examiners should not express any opinion on the operability of a patent. Affidavits or declarations attacking the operability of a patent cited as a reference must rebut the presumption of operability by a preponderance of the evidence. *In re Sasse*, 629 F.2d 675, 207 USPQ 107 (CCPA 1980).

Further, since in a patent it is presumed that a process if used by one skilled in the art will produce the product or result described therein, such presumption is not overcome by a mere showing that it is possible to operate within the disclosure without obtaining the alleged product. *In re Weber*, 405 F.2d 1403, 160 USPQ 549 (CCPA 1969). It is to be presumed also that skilled workers would as a matter of course, if they do not immediately obtain desired results, make certain experiments and adaptations, within the skill of the competent worker. The failures of experimenters who have no interest in succeeding should not be accorded great weight. *In re Michalek*, 162 F.2d 229, 74 USPQ 107 (CCPA 1947); *In re Reid*, 179 F.2d 998, 84 USPQ 478 (CCPA 1950).

Where the affidavit or declaration presented asserts inoperability in features of the reference which are not relied upon, the reference is still effective as to other features which are operative. *In re Shepherd*, 172 F.2d 560, 80 USPQ 495 (CCPA 1949).

Where the affidavit or declaration presented asserts that the reference relied upon is inoperative, the claims represented by applicant must distinguish from the alleged inoperative reference disclosure. *In re Crosby*, 157 F.2d 198, 71 USPQ 73 (CCPA 1946). See also *In re Epstein*, 32 F.3d 1559, 31 USPQ2d 1817 (Fed. Cir. 1994) (lack of diagrams, flow charts, and other details in the prior art references did not render them nonenabling in view of the fact that applicant's own specification failed to provide such detailed information, and that one skilled in the art would have known how to implement the features of the references).

If a patent teaches or suggests the claimed invention, an affidavit or declaration by patentee that he or she did not intend the disclosed invention to be used as claimed by applicant is immaterial. *In re Pio*, 217 F.2d 956, 104 USPQ 177 (CCPA 1954). Compare *In re Yale*, 434 F.2d 66, 168 USPQ 46 (CCPA 1970) (Correspondence from a co-author of a literature article confirming that the article misidentified a compound through a typographical error that would have been obvious to one of ordinary skill in the art was persuasive evidence that the erroneously typed compound was not put in the possession of the public.).

### **716.08 Utility and Operability of Applicant's Disclosure**

See MPEP § 2107.02, for guidance on when it is proper to require evidence of utility or operativeness, and how to evaluate any evidence which is submitted to overcome a rejection under 35 U.S.C. 101 for lack of utility. See MPEP § 2107 - § 2107.03 generally for utility examination guidelines and an overview of legal precedent relevant to the utility requirement of 35 U.S.C. 101.

### **716.09 Sufficiency of Disclosure**

See MPEP § 2164 - § 2164.08(c) for guidance in determining whether the specification provides an enabling disclosure in compliance with 35 U.S.C. 112, first paragraph.

Once the examiner has established a *prima facie* case of lack of enablement, the burden falls on the applicant to present persuasive arguments, supported by suitable proofs where necessary, that one skilled in the art would have been able to make and use the claimed invention using the disclosure as a guide. *In re Brandstadter*, 484 F.2d 1395, 179 USPQ 286 (CCPA 1973). Evidence to supplement a specification which on its face appears deficient under 35 U.S.C. 112 must establish that the information which must be read into the specification to make it complete would have been known to those of ordinary skill in the art. *In re Howarth*, 654 F.2d 103, 210 USPQ 689 (CCPA 1981) (copies of patent specifications which had been opened for inspection in Rhodesia, Panama, and Luxembourg prior to the U.S. filing date of the applicant were not sufficient to overcome a rejection for lack of enablement under 35 U.S.C. 112, first paragraph).

Affidavits or declarations presented to show that the disclosure of an application is sufficient to one skilled in the art are not acceptable to establish facts which the specification itself should recite. *In re Buchner*, 929 F.2d 660, 18 USPQ2d 1331 (Fed. Cir. 1991) (Expert described how he would construct elements necessary to the claimed invention whose construction was not described in the application or the prior art; this was not sufficient to demonstrate that such construction was well-known to those of ordinary skill in the art.); *In re Smyth*, 189 F.2d 982, 90 USPQ 106 (CCPA 1951).

Affidavits or declarations purporting to explain the disclosure or to interpret the disclosure of a pending application are usually not considered. *In re Oppenauer*, 143 F.2d 974, 62 USPQ 297 (CCPA 1944). But see *Glaser v. Strickland*, 220 USPQ 446 (Bd. Pat. Int. 1983) which reexamines the rationale on which *In re Oppenauer* was based in light of the Federal Rules of Evidence. The Board stated as a general proposition “Opinion testimony which merely purports to state that a claim or count, is ‘disclosed’ in an application involved in an interference . . . should not be given any weight. Opinion testimony which purports to state that a particular feature or limitation of a claim or count is disclosed in an application involved in an interference and which explains the underlying factual basis for the opinion may be helpful and can be admitted. The weight to which the latter testimony may be entitled must be evaluated strictly on a case-by-case basis.”

## 716.10 Attribution

Under certain circumstances an affidavit or declaration may be submitted which attempts to attribute an activity, a reference or part of a reference to the applicant. If successful, the activity or the reference is no longer applicable. When subject matter, disclosed but not claimed in a patent application filed jointly by S and another, is claimed in a later application filed by S, the joint patent or joint patent application publication is a valid reference available as prior art under 35 U.S.C. 102(a), (e), or (f) unless overcome by affidavit or declaration under 37 CFR 1.131 showing prior invention (see MPEP § 715) or an unequivocal declaration by S under 37 CFR 1.132 that he or she conceived or invented the subject matter disclosed in the patent or published application. Disclaimer by the

other patentee or other applicant of the published application should not be required but, if submitted, may be accepted by the examiner.

Where there is a published article identifying the authorship (MPEP § 715.01(c)) or a patent or an application publication identifying the inventorship (MPEP § 715.01(a)) that discloses subject matter being claimed in an application undergoing examination, the designation of authorship or inventorship does not raise a presumption of inventorship with respect to the subject matter disclosed in the article or with respect to the subject matter disclosed but not claimed in the patent or published application so as to justify a rejection under 35 U.S.C. 102(f).

However, it is incumbent upon the inventors named in the application, in response to an inquiry regarding the appropriate inventorship under 35 U.S.C. 102(f) or to rebut a rejection under 35 U.S.C. 102(a) or (e), to provide a satisfactory showing by way of affidavit under 37 CFR 1.132 that the inventorship of the application is correct in that the reference discloses subject matter derived from the applicant rather than invented by the author, patentee, or applicant of the published application notwithstanding the authorship of the article or the inventorship of the patent or published application. *In re Katz*, 687 F.2d 450, 455, 215 USPQ 14, 18 (CCPA 1982) (inquiry is appropriate to clarify any ambiguity created by an article regarding inventorship and it is then incumbent upon the applicant to provide “a satisfactory showing that would lead to a reasonable conclusion that [applicant] is the . . . inventor” of the subject matter disclosed in the article and claimed in the application).

An uncontradicted “unequivocal statement” from the applicant regarding the subject matter disclosed in an article, patent, or published application will be accepted as establishing inventorship. *In re DeBaun*, 687 F.2d 459, 463, 214 USPQ 933, 936 (CCPA 1982). However, a statement by the applicants regarding their inventorship in view of an article, patent, or published application may not be sufficient where there is evidence to the contrary. *Ex parte Kroger*, 218 USPQ 370 (Bd. App. 1982) (a rejection under 35 U.S.C. 102(f) was affirmed notwithstanding declarations by the alleged actual inventors as to their inventorship in view of a nonapplicant author submitting a letter declaring the author’s inventorship); *In re Carreira*, 532 F.2d 1356, 189 USPQ 461 (CCPA 1976)

(disclaiming declarations from patentees were directed at the generic invention and not at the claimed species, hence no need to consider derivation of the subject matter).

A successful 37 CFR 1.132 affidavit or declaration establishing derivation by the author, patentee, or applicant of the published application of a first reference does not enable an applicant to step into the shoes of that author, patentee, or applicant of the published application in regard to its date of publication so as to defeat a later second reference. *In re Costello*, 717 F.2d 1346, 1350, 219 USPQ 389, 392 (Fed. Cir. 1983).

## EXAMPLES

The following examples demonstrate the application of an attribution affidavit or declaration.

### Example 1

During the search the examiner finds a reference fully describing the claimed invention. The applicant is the author or patentee and it was published or patented less than one year prior to the filing date of the application. The reference cannot be used against applicant since it does not satisfy the 1-year time requirement of 35 U.S.C. 102(b).

### Example 2

Same facts as above, but the author or patentee is an entity different from applicant. Since the entities are different, the reference is prior art under 35 U.S.C. 102(a) or (e).

In the situation described in Example 2, an affidavit under 37 CFR 1.132 may be submitted to show that the relevant portions of the reference originated with or were obtained from applicant. Thus the affidavit attempts to convert the fact situation from that described in Example 2 to the situation described in Example 1.

## 718 Affidavit or Declaration to Disqualify Commonly Owned Patent as Prior Art, 37 CFR 1.130

*37 CFR 1.130. Affidavit or declaration to disqualify commonly owned patent or published application as prior art.*

(a) When any claim of an application or a patent under reexamination is rejected under 35 U.S.C. 103 on a U.S. patent or U.S.

patent application publication which is not prior art under 35 U.S.C. 102(b), and the inventions defined by the claims in the application or patent under reexamination and by the claims in the patent or published application are not identical but are not patentably distinct, and the inventions are owned by the same party, the applicant or owner of the patent under reexamination may disqualify the patent or patent application publication as prior art. The patent or patent application publication can be disqualified as prior art by submission of:

(1) A terminal disclaimer in accordance with § 1.321(c); and

(2) An oath or declaration stating that the application or patent under reexamination and patent or published application are currently owned by the same party, and that the inventor named in the application or patent under reexamination is the prior inventor under 35 U.S.C. 104.

(b) When an application or a patent under reexamination claims an invention which is not patentably distinct from an invention claimed in a commonly owned patent with the same or a different inventive entity, a double patenting rejection will be made in the application or a patent under reexamination. A judicially created double patenting rejection may be obviated by filing a terminal disclaimer in accordance with § 1.321(c).

See MPEP § 804.03 and § 706.02(1) through § 706.02(1)(3) for subject matter disqualified as prior art under 35 U.S.C. 103(c) where the subject matter and the claimed invention were, at the time the invention was made, owned by the same person or subject to an obligation of assignment to the same person.

37 CFR 1.130(a) addresses those situations in which the rejection in an application or patent under reexamination to be overcome is a rejection under 35 U.S.C. 103 in view of a U.S. patent or U.S. patent application publication due to the requirement in 37 CFR 1.131 that any U.S. patent or U.S. patent application publication to be antedated not claim the same patentable invention (as defined in 37 CFR 1.601(n)) as the application or patent under reexamination. The applicant or patent owner is also prevented from proceeding in an interference due to the provision in 37 CFR 1.602(a) that an interference will not normally be declared or continued between applications owned by a single party, or an application and an unexpired patent owned by a single party.

As 37 CFR 1.130(a) addresses those situations in which the inventions defined by the claims in the application or patent under reexamination and by the claims in the U.S. patent or patent application publication are not patentably distinct, 37 CFR 1.130(a)(1) requires a terminal disclaimer in accordance with 37 CFR 1.321(c), and 37 CFR 1.130(a)(2) requires an oath or declaration stating, *inter alia*, that the inventor

named in the application or patent under reexamination is the prior inventor under 35 U.S.C. 104. The inventor named in the application or patent under reexamination must have invented the claimed subject matter before the actual date of invention of the subject matter of the reference claims. The affidavit or declaration may be signed by the inventor(s), the attorney or agent of record, or assignee(s) of the entire interest.

The phrase “prior inventor under 35 U.S.C. 104” requires that the inventor named in the application or patent be the prior inventor within the meaning of 35 U.S.C. 104, in that an applicant or patent owner may not:

(A) establish a date of invention in a foreign country other than a NAFTA or WTO member country;

(B) establish a date of invention in a WTO member country other than a NAFTA country earlier than January 1, 1996; or

(C) establish a date of invention in a NAFTA country other than the U.S. earlier than December 8, 1993.

37 CFR 1.130(b) provides that when an application or a patent under reexamination claims an invention which is not patentably distinct from an invention claimed in a commonly owned patent with the same or a different inventive entity, a double patenting rejection will be made in the application or a patent under reexamination. A judicially created double patenting rejection may be obviated by filing a terminal disclaimer in accordance with 37 CFR 1.321(c). See MPEP § 804.02.

A U.S. patent or U.S. patent application publication that anticipates the claimed subject matter cannot be disqualified as prior art under 35 U.S.C. 103(c) or 37 CFR 1.130 or 1.131.

## 719 File Wrapper

The folder in which the U.S. Patent and Trademark Office maintains the application papers is referred to as a file wrapper.

### 719.01 Papers in File Wrapper [R-2]

Papers that do not become a permanent part of the record should not be entered on the “Contents” of the file wrapper. All papers legally entered on the “Con-

tents” of the file wrapper are given a paper number. No paper legally entered on the “Contents” should ever be withdrawn or **>expunged** from the application file<, especially a part of the original disclosure of the application, without special authority of the **>Director**<. However, 37 CFR 1.59 provides that certain documents may be **>expunged**< if they were unintentionally submitted or contain proprietary information which has not been made public and is not important to a decision of patentability. See MPEP § 724. Certain oaths executed abroad may be returned but a copy is retained in the file. See MPEP § 604.04(a). >For Image File Wrapper (IFW) processing, see IFW Manual sections 3.3 and 3.4.<

Form paragraph 7.214 may be used to notify applicant that papers in an application that has received a filing date ordinarily will not be returned.

#### ¶ 7.214 Papers Not Returned, Pro Se

Papers in an application that has received a filing date pursuant to 37 CFR 1.53 ordinarily will not be returned. If applicant has not preserved copies of the papers, the Office will furnish copies at applicant’s expense. See 37 CFR 1.19 for a list of the current fees. See MPEP § 724.05 for information pertaining to petitions to expunge information.

### 719.01(a) Arrangement of Papers in File Wrapper [R-2]

Until revision for allowance, the specification, amendments and all other communications from applicant are fastened to the left side (center fold) of the file wrapper. They are in inverse chronological order, that is, the communication with the latest Mail Center “Office Date” is on top. A similar arrangement is followed on the right side, where Office actions and other communications from the Office are fastened, except that the drawing print is always kept on top for the convenience of the examiner.

Where amendments are submitted in duplicate, the copy is destroyed except where the duplicate is received within the time period for reply and the original is late. In this latter situation both copies are placed in the file. The “original” is entered with reference made to the copy.

At allowance, only those papers required by the printer are placed in the left side (center section) of the file wrapper. >For Image File Wrapper (IFW) processing, see IFW Manual sections 3.3 and 3.4.<



**719.01(b) Prints [R-2]**

The prints of the drawing are fastened inside the file wrapper by the Office of Initial Patent Examination.

The white paper prints are always kept on top of the papers on the right of the file wrapper. >For Image File Wrapper (IFW) processing, see IFW Manual sections 3.3.<

All prints and inked sketches subsequently filed to be part of the record should be endorsed with the application number of the corresponding application. Note MPEP § 608.02(m).

**719.02 Data Entered on File Wrapper [R-2]**

It is sometimes necessary to make corrections to the data on the file wrapper label or, for 09/series applications, the PALM bib-data sheet placed in the file wrapper.

If the examiner notices an error in any of the data originally entered on the file wrapper or on the PALM bib-data sheet, he or she should:

- for 08/ or earlier series applications: make the correction in red ink on the file wrapper and forward the application to the TC technical support staff for correction of the PALM database;

- for 09/series applications: make the correction in red ink on the PALM bib-data sheet and forward the application to the TC technical support staff for correction of the PALM database and printing of a new PALM bib-data sheet for placement in the file wrapper;

- for 10/ and above series applications: make the correction in red ink on the file wrapper and forward the application to the TC technical support staff for correction of the PALM database and printing of a new adhesive file wrapper label to be placed on the file wrapper.

Instances where correction is necessary include:

(A) Correction of inventorship such as changes in the order of the names or a change in the name of an inventor, granted by petition, and additions or deletions of inventors under 37 CFR 1.48. See MPEP § 605.04(g).

(B) Correction of the filing date.

(C) Correction concerning prior U.S. applications which have application number errors. See MPEP § 202.02.

(D) Correction of a claim for benefit under 35 U.S.C. 120, 121, or 365(c). See MPEP § 201.11 and § 1302.09.

If an error is noticed in the name or address of the assignee, it should be corrected by the Assignment Division.

See also MPEP § 707.10 and § 719.01.

>For Image File Wrapper (IFW) processing, see IFW Manual sections 3.3 and 3.7.<

**719.02(b) Name or Residence of Inventor or Title Changed [R-2]**

The distinction between “residence” and \*\*>mailing< address should not be lost sight of. See MPEP § 605.02 and § 605.03.

MPEP § 605.04(c) explains the procedure to be followed when applicant changes name.

Unless specifically requested by applicant, the residence will not be changed on the file. For example, if a new oath gives a different residence from the original, the file will not be changed.

>For a patent application publication to be published with a new residence, the information must be entered into the Office electronic records at least nine weeks before the publication date of the application. For a patent to issue with the new residence, applicants are strongly encouraged to file an Application Data Sheet (37 CFR 1.76) showing the new residence information. Patents are printed from the documents in the application file and the data shown in the Office electronic records, other than the images of the papers in the file, are not necessarily relied upon.<

**719.03 Classification During Examination**

When a new application is received in a Technology Center, the classification of the application and the initials or name of the examiner who will examine it or other assigned docket designation are noted in pencil in the designated spaces on the file wrapper. These notations should be kept current.

## CLASSIFICATION HISTORY BOX ENTRIES

Classifiers and examiners who review an application for the purpose of assigning a class for examination should indicate in CLASSIFICATION HISTORY box on the file wrapper that such a review took place. The purpose for providing this information is to reduce needless routing of applications and save examiners' and classifiers' time. The information should include the name and initials of each examiner or classifier consulted, the class(es) an application was considered for, and the date that the review took place. No other information is permitted in this box. These entries will not be printed on any resulting patent publication. See MPEP § 903.07(a) for recording consultations in the SEARCH NOTES box on the file wrapper that involve a question of the propriety of the classification of subject matter and/or the need for a cross-reference.

### 719.04 Index of Claims [R-2]

Constant reference is made to the "Index of Claims" found in the inside of the file wrapper of all applications. It should be kept up to date so as to be a reliable index of all claims standing in an application, and of the amendment in which the claims are to be found.

The preprinted series of claim numbers appearing on the file wrapper refer to the claim numbers as originally filed while the adjacent column should be used for the entry of the final numbering of the allowed claims.

Independent claims should be designated in the Index of Claims by encircling the claim number in red ink.

A line in red ink should be drawn below the number corresponding to the number of claims originally presented.

Thereafter, a line in red ink should be drawn below the number corresponding to the highest numbered claim added by each amendment. Just outside the Index of Claims form opposite the number corresponding to the first claim of each amendment there should be placed the letter designating the amendment.

If the claims are amended in rewritten form under 37 CFR 1.121(c), the original claim number should not be stricken from the Index of Claims but a notation should be made in red ink in the margin to

the left of the original claim number, i.e., "Amend. 1"; if the claim is rewritten a second time, "Amend. 1" should be changed by striking out "1" and inserting "2" above it.

As any claim is canceled, a line in red ink should be drawn through its number.

A space is provided for completion by the examiner to indicate the date and type of each Office action together with the resulting status of each claim. A list of codes for identifying each type of Office action appears below the Index. At the time of allowance, the examiner places the final patent claim numbers in the column marked "Final." >For Image File Wrapper (IFW) processing, see IFW Manual.<

### 719.05 Field of Search [R-2]

In the first action on the merits of an application, the examiner shall make an initial endorsement in black ink, in the space provided on the right outside panel of the file wrapper, of the classes and subclasses of domestic and foreign patents, abstract collections, and publications in which the search for prior art was made. Other information collections and sources in which the search for prior art was made must also be identified by the examiner. The examiner must also indicate the date(s) on which the search was conducted. In subsequent actions, where the search is brought up to date and/or where a further search is made, the examiner must endorse and initial on the file wrapper that the search has been updated and/or identify the additional field of search. Any search updates should include all of the databases and the search queries and classifications employed in the original search. See MPEP § 904. Great care should be taken so as to clearly indicate the places searched and the date(s) on which the search was conducted.

In order to provide a complete, accurate, and uniform record of what has been searched and considered by the examiner for each application, the U.S. Patent and Trademark Office has established procedures for recording search data in the application file. Such a record is of importance to anyone evaluating the strength and validity of a patent, particularly if the patent is involved in litigation. These procedures will also facilitate the printing of certain search data on patents.

Under the procedures, searches are separated into two categories and listed, as appropriate, in either the

“SEARCHED” box or “SEARCH NOTES” box on the file wrapper. >For Image File Wrapper (IFW) processing, see IFW Manual section 3.7.<

### I. “SEARCHED” BOX ENTRIES

Search entries made here, except those for search updates (see item I(C) below), will be printed under “Field of Search” on the patent front page. Therefore, the following searches will be recorded in the “SEARCHED” box by the examiner along with the date and the examiner’s initials, according to the following guidelines:

(A) *A complete search of a subclass*, including all United States and foreign patent documents, whether filed by U.S. or IPC classification, and other publications placed therein.

The complete classification (class and subclass) should be recorded.

#### Examples

424/270, 272, 273

224/42.1 F

414/DIG. 4

D3/32 R

A61K 9/22

A61K 31/56 - A61K 31/585

(B) *A limited search of a subclass*, for example, a search that is restricted to an identifiable portion of the patent documents placed therein. If, however, only the publications in a subclass are searched, such an entry is to be made under “SEARCH NOTES” rather than under “SEARCHED.” (See item II(D) below.)

The class and subclass, followed by the information defining the portion of the subclass searched, in parenthesis, should be recorded.

#### Examples

414/1 (U.S. only)

238/6 (1954 to date)

(C) *An update of a search previously made*. This search entry will be recorded in a manner to indicate clearly which of the previously recorded searches have been updated, followed by the expression “(updated).” Search update entries, although recorded in the “SEARCHED” box, will not be printed.

#### Examples

424/270 (updated)

414/DIG. 4 (updated)

Above (updated)

When a search made in a parent application is updated during the examination of a continuing application, those searches updated, followed by “(updated from parent S.N. ....)” will be recorded. If the parent application has been patented, the patent number “Pat. N. ....” instead of application number in the above phrase will be recorded. The examiner should recopy the entire search updated from the parent on the file wrapper of the continuing application to the extent pertinent to the continuing application.

#### Examples

273/29 BC (updated from

343/114.5 parent S.N. 08/495,123)

116/DIG.47 (updated from

D7/73, 74 parent Pat. N. 4,998,999)

>For IFW processing, see IFW Manual section 3.7.<

### II. “SEARCH NOTES” BOX ENTRIES

Entries made in the “SEARCH NOTES” box are of equal importance to those placed in the “SEARCHED” box; however, these entries are not to be printed on any resulting patent. They are intended to complete the application file record of areas and/or documents considered by the examiner in his or her search. The examiner should record the following searches in this box and in the manner indicated, with each search dated and initialled:

(A) *A cursory search*, or scanning, of a U.S. subclass or IPC subclass/group/subgroup, i.e., a search usually made to determine if the documents classified there are relevant. Record the classification, followed by “(cursory).”

#### Examples

250/13 (cursory)

A61K 9/44 (cursory)

(B) *A consultation* with other examiners to determine if relevant search fields exist in their areas of expertise.

If the subclass is not searched, record the class and subclass discussed, followed by “(consulted).” This entry may also include the name of the examiner consulted and the art unit.

### Examples

24/ fasteners (consulted)

24/ fasteners (consulted J. Doe A.U. 3501)

24/201 R-230 AV (consulted)

(C) A *search of a publication* not located within the classified patent file, e.g., a library search, a text book search, a Chemical Abstracts search, etc. Record according to the following for each type of literature search:

(1) *Abstracting publications*, such as Chemical Abstracts, record name of publications, list terms consulted in index, and indicate period covered.

### Examples

*Chem. Abs.*, Palladium hydride Jan.-June 1975

*Eng. Index*, Data Conversion Analog to Digital 1975

(2) *Periodicals* — list by title\*\*, volume, issue, pages and date<, as appropriate.

### Examples

*Popular Mechanics*, June-Dec. 1974

*Lubrication Engineering*, vols. 20-24

(3) *Books* — list by title>\*,< author, edition or date>, pages<, as appropriate.

### Example

*Introduction to Hydraulic Fluids*, Roger E. Hatton, 1962

(4) *Other types of literature* not specifically mentioned herein (i.e., catalogs, manufacturer’s literature, private collections, etc.).

Record data as necessary to provide unique identification of material searched.

### Example

*Sears Roebuck* catalog, Spring-Summer, 1973.

Where a book or specific issue of a periodical is cited by the examiner, it is not necessary to list the specific book or periodical in the “SEARCH NOTES” box.

A cursory or browsing search through a number of materials that are not found to be of significant relevance may be indicated in a collective manner, e.g., “Browsed STIC shelves under QA 76.5” or “Browsed text books in STIC relating to.....” More detailed reviews or searches through books and periodicals or any search of terms in abstracting publications should be specifically recorded, however.

(5) *Computer Search in Scientific and Technical Information Center (STIC)* — An online computerized literature searching service which uses key terms and index terms to locate relevant publications in many large bibliographic data bases is available in the STIC. Members of the STIC staff are assigned to assist examiners in selecting key terms and to conduct a search. To record a computer search conducted by STIC, see instructions in II(F) below.

(D) A search of only the *publications in a subclass*.

Record class and subclass followed by “(publications only).”

### Examples

43/56 (publications only)

99/DIG. 15 (publications only)

(E) *A review of art cited in a parent application* or an original patent, as required for all continuation and continuation-in-part applications, divisional applications, reissue applications and reexamination proceedings, or a review of art cited in related applications.

Record the application number of a parent application that is still pending or abandoned, followed by “refs. checked” or “refs. ck’ed.” If for any reason not all of the references have been checked because they are not available or clearly not relevant, such exceptions should be noted.

**Examples**

S. N. 495,123 refs. checked

S. N. 490,000 refs. checked

S. N. 480,111 refs. checked except for Greek patent to Kam

S. N.410,113 refs. not checked since the file was not available

Record the patent number of a parent or related application that is now patented or of an original patent now being reissued with “refs. checked” or “refs. ck’ed.”

**Examples**

Pat. 3,900,000 refs. checked

Pat. 3,911,111 refs. ck’ed

(F) *In each action involving a search of a computer accessed text or chemical structure or sequence database*, the examiner shall endorse, in the SEARCH NOTES box on the file wrapper flap, the name of the database service, the date when the search was made or was brought up to date and the examiner’s initials. All entries shall be made in BLACK INK. Computer database searches including text, chemical structure, or sequences shall be documented in the SEARCH NOTES box on the file wrapper by providing the following minimum information:

- (1) The search logic or chemical structure or sequence used as a query;
- (2) The name of the file or files searched and the database service;
- (3) Date of the search; and
- (4) The examiner’s initials.

Three ways in which this minimum documentation can be provided are:

- (1) supplying, and as necessary annotating, the computer search printout resulting from a computer assisted search (see examples 1 and 2 and “Printouts” below), or
- (2) recording the required information on the Search Request Form PTO-1590, or
- (3) recording the required information in the SEARCH NOTES box.

For methods (1) and (2), the name of the database service and the expressions “(see form)” or “(see printout)” should be recorded in the SEARCH NOTES box as appropriate with the date and the examiner’s initials.

>

**A. < Printouts**

Most of the database services accessed in application searches provide a command to display or print the search history which includes most, if not all, of the minimum required information for documenting database searches. Table 1 below lists the history command for each database service and which of the required minimum documentation elements are missing when the history command is entered. The missing elements may be documented by writing them on the printout of the search history or by supplying further portions of the search transcript which do include the missing elements. In some instances, depending on the database service, the log off command will supply the missing data element. A printout of the history command and log out response containing the required data elements is acceptable as full documentation of a search. For example, this is the case with \*>searches in< STN and \*>Questel-Orbit<; the name of the database service is not provided by entering the history command and must be supplied by the inclusion of the log off command. Another example is with WEST. Neither the Freeform Search page nor the Show S Numbers page prints the date of the search, therefore, the date of the WEST search must be documented in writing.>For IFW processing, see IFW Manual section 3.7.<

If there are several search statements in the history, the statement or statements of which the results were reviewed should be indicated by circling them in BLACK INK. The form or printout page(s) with the required data elements should be hole punched and placed in the application file on the right hand flap of the file wrapper. >For IFW processing, see IFW Manual section 3.7.<

TABLE 1					
<i>History Commands and Missing Elements by Database Service</i>					
Database Service	History Command	Name of Database Service	Search Logic	Name of File Searched	Date of Search
Dialog	*>ds; show files <sup>2</sup> <	no	yes	*>yes<	missing <sup>3</sup>
STN <sup>1</sup>	d his full	no <sup>5</sup>	yes	yes	yes
*	*	*	*	*	*
*>Questel-Orbit<	hi <sup>2</sup> >or his <sup>2</sup> <	no <sup>5</sup>	yes	yes	missing <sup>3</sup>
*>Lexis Nexis <sup>TM</sup> <	r <sup>2</sup>	no	yes	yes	yes
**>ABSS System<	none	yes <sup>3</sup>	yes <sup>4</sup>	yes	yes
EAST	Details grid <sup>8</sup>	no <sup>10</sup>	yes	yes	yes
WEST	Free Form Search page <sup>9</sup> Show S Numbers page	yes	yes	yes	missing <sup>11</sup>

<sup>1</sup> In a structure search in STN, in addition to “d his full”, the structure should be printed out while in the Registry File. The command string for this is “d L# que stat,” where L# is the number of the answer set of a full file structure search.

<sup>2</sup> Need to enter history command for each file searched before changing file or logging off.

<sup>3</sup> Information provided as part of search result file for each request.

<sup>4</sup> Search query sequence provided as part of search result file for each request.

<sup>5</sup> Displayed by log off command.

<sup>6</sup> Name and number of file provided at file entry; number only of file given when leaving the file; number only of last file accessed given at log off.

<sup>7</sup> Name of the file given at file entry and when leaving the file; name of last file accessed given at log off.

8	Print details grid for Active folder to document current search; print Details grid for Saved folder to document saved search.
9	Print Freeform Search page to document current search; print Show S Numbers page to document saved search.
10	Shown on printed EAST cover page.
11	Must be written in BLACK INK.

&gt;

**B. < Explanation of Table Terminology**

History Command - Generally, a display of what the user has asked the search software to do. Will display the search logic entered by the user. Some histories are limited to display of the searches done only in the current file while others deliver a complete record of what file or files were accessed and all searches done since sign on. Dialog, \*\*>Questel-Orbit<, and \*>LexisNexis™< are services limited to display of the searches done only in the current file.

Name of Database Service - Most services do not display this information as part of the search transcript. None of the services in the table, except WEST, list that information as part of the history command. However, \*\*>Questel-Orbit<, and STN supply the name of the database service during log off.

Search Logic - Generally, a display of the search commands executed by the search software. For a structure or sequence search, this can be a printout of the structure or sequence used to query the system.

Name of File Searched - This is the name of the collection of data accessed. In some services, the file name is only displayed when the file is selected and not in response to the history display command; Dialog and \*\*>Questel-Orbit< are two such services. For example, Dialog supplies only the file number with the log off command. The file number alone is not adequate documentation of a search. The name of the file is required.

Date of Search - WEST, Dialog, \*\*>and Questel-Orbit< do not display the date of search as part of the history command. Dialog \*\*>and Questel-Orbit< supply the date of search during log off; the date of search for WEST must be written on the search report.

Nucleotide and peptide sequence searches will be fully documented by a printout of the search query \*>SEQ ID NO,< and \* beginning of the search result file. Each query \* should be clearly related to the appropriate search result, if necessary, by appropriate annotation.

&gt;

**C. < Other Databases**

For other types of publicly accessible computer accessed databases (e.g., CD-ROM databases, specialized databases, etc.), record data as necessary to provide unique identification of material searched and sufficient information as to the search query or request so that the search can be updated. The record should also document the location of the database and its form (CD-ROM, etc.).

**Example: Citing a biotech CD-ROM database**

Entrez: Sequences, National Center for Biotechnology Information, Version 7.19.91b (CD-ROM, TC 1600) Searched HIV and vaccine; neighbored Galloway article dated 6/5/91 on April 1, 1990.

**Example: Citing a nonbiotech CD-ROM database**

Computer Select, (November, 1991), Ziff Davis Communications Co., (CD-ROM, STIC), Searched Unix and emulation on December 1, 1991.

**III. INFORMATION NOT RECORDED ON THE FILE WRAPPER**

For an indication of consideration or nonconsideration of prior art citations submitted by applicant in Information Disclosure Statements (37 CFR 1.97 and 1.98), see MPEP § 609.



\*\*>

Access DB# \_\_\_\_\_

### SEARCH REQUEST FORM

Scientific and Technical Information Center

Requester's Full Name: \_\_\_\_\_ Examiner # : \_\_\_\_\_ Date: \_\_\_\_\_  
 Art Unit: \_\_\_\_\_ Phone Number 30 \_\_\_\_\_ Serial Number: \_\_\_\_\_  
 Mail Box and Bldg/Room Location: \_\_\_\_\_ Results Format Preferred (circle): PAPER DISK E-MAIL

**If more than one search is submitted, please prioritize searches in order of need.**

\*\*\*\*\*

Please provide a detailed statement of the search topic, and describe as specifically as possible the subject matter to be searched. Include the elected species or structures, keywords, synonyms, acronyms, and registry numbers, and combine with the concept or utility of the invention. Define any terms that may have a special meaning. Give examples or relevant citations, authors, etc, if known. Please attach a copy of the cover sheet, pertinent claims, and abstract.

Title of Invention: \_\_\_\_\_

Inventors (please provide full names): \_\_\_\_\_

Earliest Priority Filing Date: \_\_\_\_\_

*\*For Sequence Searches Only\* Please include all pertinent information (parent, child, divisional, or issued patent numbers) along with the appropriate serial number.*

\*\*\*\*\*  
**STAFF USE ONLY**

	Type of Search	Vendors and cost where applicable
Searcher: _____	NA Sequence (#) _____	STN _____
Searcher Phone #: _____	AA Sequence (#) _____	Dialog _____
Searcher Location: _____	Structure (#) _____	Questel/Orbit _____
Date Searcher Picked Up: _____	Bibliographic _____	Dr.Link _____
Date Completed: _____	Litigation _____	Lexis/Nexis _____
Searcher Prep & Review Time: _____	Fulltext _____	Sequence Systems _____
Clerical Prep Time: _____	Patent Family _____	WWW/Internet _____
Online Time: _____	Other _____	Other (specify) _____

PTO-1590 (8-01)

<

SEARCHED					
Class	Sub.	Date	Exmr.		
D7	78, 74 (Updated from Present Patent No. 4,000,000)	8-21-91	RKL		
424 D3 414	270 32R 1 (U.S. only)	} 8-21-91	RKL		
424 100	270 (updated) 99			} 11-26-91	AAM
Above	(updated)				
IPC					
A61K A61K A61k	9/22 31/56 31/585	} 4-22-92	F3		

INTERFERENCE SEARCHED			
Class	Sub.	Date	Exmr.

SEARCH NOTES		
	Date	Exmr.
S. N. 495,125 refs. Ck'd 250/13 (cursory) 24/ separable fasteners (consulted Globe, All 351)	} 8-21-91	RKL
<u>Chem. Abs.</u> , Palladium hydride, Jan. - June 1990		11-26-91
<u>Popular Mechanics</u> June - Dec. 1990	↓	↓
<u>Introduction to Hydraulic Fluids</u> Roger E. Hatton, 1962		
45/36 (Publications only)		
A61K 9/44 (cursory)		
APS    USPAT 3    laser and agric? Dialog (See form)	↓	↓
STN    (See printout)		
Entries: Sequences NCBI Y7-19-91 b (CD ROM GB 130) Searched HIV & vaccine, neighbored Galloway article dated 6/5/91		

## 719.06 Foreign Filing Dates

See MPEP § 201.14(c), § 202.03 and § 201.14(d).

## 719.07 Related Applications [R-2]

The file wrapper or the PALM bib-data sheet (for 09/series applications) should identify earlier filed related applications.

See MPEP § 202.02 and § 202.03.

>For Image File Wrapper (IFW) processing, see IFW Manual section 3.7.<

## 720 Public Use Proceedings [R-2]

37 CFR 1.292. *Public use proceedings.*

\*\*>

(a) When a petition for the institution of public use proceedings, supported by affidavits or declarations is found, on reference to the examiner, to make a prima facie showing that the invention claimed in an application believed to be on file had been in public use or on sale more than one year before the filing of the application, a hearing may be had before the Director to determine whether a public use proceeding should be instituted. If instituted, the Director may designate an appropriate official to conduct the public use proceeding, including the setting of times for taking testimony, which shall be taken as provided by §§ 1.671 through 1.685. The petitioner will be heard in the proceedings but after decision therein will not be heard further in the prosecution of the application for patent.<

(b) The petition and accompanying papers, or a notice that such a petition has been filed, shall be entered in the application file if:

(1) The petition is accompanied by the fee set forth in § 1.17(j);

(2) The petition is served on the applicant in accordance with § 1.248, or filed with the Office in duplicate in the event service is not possible; and

(3) The petition is submitted prior to the date the application was published or the mailing of a notice of allowance under § 1.311, whichever occurs first.

(c) A petition for institution of public use proceedings shall not be filed by a party to an interference as to an application involved in the interference. Public use and on sale issues in an interference shall be raised by a preliminary motion under § 1.633(a).

Public use proceedings are provided for in 37 CFR 1.292. The institution of public use proceedings is discretionary with the \*>Director of the USPTO<. This section is intended to provide guidance when a question concerning public use proceedings arises.

Any member of the public other than the applicant, including private persons, corporate entities, and government agencies, may file a petition under 37 CFR

1.292. A petition may be filed by an attorney or other representative on behalf of an unnamed principal since 37 CFR 1.292 does not require that the principal be identified. A petition and fee (37 CFR 1.17(j)) are required to initiate consideration of whether to institute a public use proceeding. The petitioner ordinarily has information concerning a pending application which claims, in whole or in part, subject matter that the petitioner alleges was in “public use” or “on sale” in this country more than one year prior to the effective United States filing date of the pending application (see 35 U.S.C. 119 and 120). He or she thus asserts that a statutory bar (35 U.S.C. 102(b) alone or in combination with 35 U.S.C. 103) exists which prohibits the patenting of the subject matter of the application.

When public use petitions and accompanying papers are submitted they, or a notice in lieu thereof, will be entered in the application file if the petition is:

(A) accompanied by the fee set forth in 37 CFR 1.17(j);

(B) served on the applicant in accordance with 37 CFR 1.248, or filed with the Office in duplicate in the event service is not possible; and

(C) submitted prior to the >date the application was published or the< mailing of a notice of allowance under 37 CFR 1.311>, whichever occurs first<.

Duplicate copies should be submitted only when, after diligent effort, it has not been possible for petitioner to serve a copy of the petition on the applicant, or his or her attorney or agent in accordance with 37 CFR 1.248 in which case the Office of Patent Legal Administration of the Office of the Deputy Commissioner for Patent Examination Policy will attempt to get the duplicate copy to the applicant, or his or her attorney or agent.

Notice of a petition for a public use proceeding will be entered in the file in lieu of the petition itself when the petition and the accompanying papers are too bulky to accompany the file. Any public use papers not physically entered in the file will be publicly available whenever the application file wrapper is available. >For Image File Wrapper (IFW) processing, see IFW Manual section 3.3.<

There are two types of public use proceedings: *ex parte* and *inter partes*. It is important to understand the difference. In the *ex parte* situation, the petitioner is not entitled, as a matter of right, to

inspect the pending application. Thus, he or she stands in no better position than any other member of the public regarding access to the pending application. In the *inter partes* situation, the pending application is a reissue application. In the *inter partes* situation, the petitioner is privy to the contents of the pending application (37 CFR 1.612). Thus, as pointed out below, the petitioner in the *inter partes* situation participates in the public use proceedings to a greater degree than in the *ex parte* situation. A petitioner who was once involved in a terminated interference with a pending application is no longer privy to the application contents and will accordingly be treated as an *ex parte* petitioner. It should be noted that petitions filed on and after February 11, 1985 will not be allowed in accordance with 37 CFR 1.292(c) unless the petition arises out of an interference declared prior to February 11, 1985 or the interference was declared after February 11, 1985 but arose from an interference declared prior to that date.

Since February 11, 1985, a petition for institution of public use proceedings cannot be filed by a party to an interference as to an application involved in the interference. Public use issues can only be raised by a preliminary motion under 37 CFR 1.633(a). However, if the issue of public use arises out of an interference declared prior to February 11, 1985, the petition may be filed by a party to the interference as to an application involved in the interference.

There may be cases where a public use petition has been filed in an application which has been restricted or is subject to a proper restriction requirement. If the petition alleges that subject matter covering both elected claims and nonelected claims is a statutory bar, only that part of the petition drawn to subject matter of the elected claims will be considered. However, if a public use proceeding is ultimately instituted, it will not necessarily be limited to the subject matter of the elected claims but may include the nonelected subject matter. Any evidence adduced on the nonelected subject matter may be used in any subsequently-filed application claiming subject matter without the requirement of a new fee (37 CFR 1.17(j)). The petitioner will not be heard regarding the appropriateness of any restriction requirement.

A petition under 37 CFR 1.292 must be submitted in writing, must specifically identify the application to which the petition is directed by application number

or serial number and filing date, and should include a listing of all affidavits or declarations and exhibits relied on. The petition must contain a sufficient description of the subject matter that the petitioner alleges was in “public use” or “on sale,” including any necessary photographs, drawings, diagrams, \*->exhibits<, or flowcharts, to enable the examiner to compare the claimed subject matter to the subject matter alleged to have been in “public use” or “on sale.” In addition, the petition and any accompanying papers must either (A) reflect that a copy of the same has been served upon the applicant or upon the applicant’s attorney or agent of record; or (B) be filed with the Office in duplicate in the event service is not possible.

It is important that any petition in a pending application specifically identify the application to which the petition is directed with the identification being as complete as possible. The following information, if known, should be placed on the petition:

- (A) Name of Applicant(s).
- (B) Application number.
- (C) Confirmation number.
- (D) Filing date of application.
- (E) Title of invention.
- (F) Technology Center art unit number.
- (G) Name of examiner to whom the application is assigned.
- (H) Current status and location of application.
- (I) The word “ATTENTION:” followed by the area of the Office to which the petition is directed as set forth below.

In addition, to the above information, the petition itself should be clearly identified as a “PETITION UNDER 37 CFR 1.292.” If the petition is accompanied by exhibits or other attachments, these should also contain identifying information thereon in order to prevent them from becoming inadvertently separated and lost.

Any petition under 37 CFR 1.292 can be submitted by mail to the \*->Commissioner for Patents, P.O. Box 1450, Alexandria, VA 22313-1450<, and should be directed to the attention of the director of the particular Technology Center (TC) in which the application is pending. If the petitioner is unable to specifically identify the application to which the petition is directed, but, nevertheless, believes such an

application to be pending, the petition should be directed to the attention of the Office of Patent Legal Administration of the Office of the Deputy Commissioner for Patent Examination Policy or to \*\*>“Mail Stop Petition,”< along with as much identifying data for the application as possible.

Where a petition is directed to a reissue application for a patent which is involved in litigation, the outside envelope and the top right-hand portion of the petition should be marked with the words “REISSUE LITIGATION.” The notations preferably should be written in a bright color with a felt point marker. Any “REISSUE LITIGATION” petition mailed to the Office should be so marked and mailed to \*\*>“Mail Stop Petition.”< However, in view of the urgent nature of most “REISSUE LITIGATION” petitions, petitioners may wish to hand-carry the petition \*\* in order to ensure prompt receipt and to avoid any unnecessary delays. \*\*>These hand-carried petitions and replies may only be delivered to the Customer Window located at:

U.S. Patent and Trademark Office  
2011 South Clark Place  
Customer Window  
Crystal Plaza Two, Lobby, Room 1B03  
Arlington, VA 22202<

Every effort should be made by a petitioner to effect service of the petition upon the attorney or agent of record or upon the applicant if no attorney or agent is of record. Of course, the copy served upon applicant or upon applicant’s attorney or agent should be a complete copy including a copy of each photograph, drawing, diagram, exhibit, flowchart, or other document relied on. The petition filed in the Office should reflect, by an appropriate “Certificate of Service,” that service has been made as provided in 37 CFR 1.248. Only in those instances where service is not possible should the petition be filed in duplicate in order that the Office can attempt service. In addition, all other papers filed by the petitioner relating to the petition or subsequent public use proceeding must be served in accordance with 37 CFR 1.248.

### **720.01 Preliminary Handling [R-2]**

A petition filed under 37 CFR 1.292 should be forwarded to the Office of Patent Legal Administration (OPLA) of the Office of the Deputy Commissioner

for Patent Examination Policy. A member of the OPLA staff will ascertain whether the formal requirements of 37 CFR 1.292 have been fulfilled. In particular, the petition will be reviewed to see whether the petition has been filed prior to the >earliest of the date the application was published or the< mailing of a notice of allowance under 37 CFR 1.311, if the alleged use or sale occurred in this country more than 1 year before the effective filing date of the application, whether the petition contains affidavits or declarations and exhibits to establish the facts alleged, whether the papers have been filed in duplicate, or one copy has been served on applicant and whether the required fee has been tendered. The application file is ordered and its status ascertained so that appropriate action may be taken.

A petition under 37 CFR 1.292 must be “submitted prior to the >date the application was published or the< mailing of a notice of allowance under 37 CFR 1.311>, whichever occurs first<.” As a practical matter, any petition should be submitted as soon as possible after the petitioner becomes aware of the existence of the application to which the petition is to be directed. By submitting a petition early in the examination process, i.e., before the Office acts on the application if possible, the petitioner ensures that the petition will receive maximum consideration and will be of the most benefit to the Office in its examination of the application.

Since a petition under 37 CFR 1.292 cannot be considered subsequent to issuance of the application as a patent or abandonment of the application, the petition will not be considered if the application is not pending when the petition and application are provided to the member of the OPLA staff (i.e., that the application was pending at the time the petition was filed would be immaterial to its ultimate consideration). A petition submitted prior to the >earliest of the date the application was published or the< mailing of a notice of allowance under 37 CFR 1.311, but not provided to the member of the OPLA staff with the application file prior to issuance or abandonment of the application, will be entered in the application file, but will be dismissed as moot. A petition filed after final rejection will be considered if the application >has not been published and< is still pending when the petition and application are provided to the member of the OPLA staff. However, prosecution will not ordinarily

be reopened after final rejection if the subject matter alleged in the petition to have been in “public use” or “on sale” is merely cumulative of the prior art cited in the final rejection. If a petition is filed after the date the application was published or the mailing of a notice of allowance under 37 CFR 1.311, it will be dismissed as untimely.

A petition with regard to a reissue application should be filed within the 2-month period following announcement of the filing of the reissue application in the *Official Gazette*. If, for some reason, the petition cannot be filed within the 2-month period provided by 37 CFR 1.176, the petition can be submitted at a later time, but petitioner must be aware that reissue applications are “special” and a later filed petition may be received after action by the examiner. Any request by a petitioner in a reissue application for an extension of the 2-month period following the announcement in the *Official Gazette* will be considered only if filed in the form of a petition under 37 CFR 1.182 and accompanied by the petition fee set forth in 37 CFR 1.17(h). The petition must explain why the additional time is necessary and the nature of the allegations to be made in the petition. A copy of such petition must be served upon applicant in accordance with 37 CFR 1.248. The petition should be directed to the appropriate Technology Center (TC). Any such petition will be critically reviewed as to demonstrated need before being granted since the delay of examination of a reissue application of another party is being requested. Accordingly, the requests should be made only where necessary, for the minimum period required, and with a justification establishing the necessity for the extension.

If the petition is a “REISSUE LITIGATION” petition, it is particularly important that it be filed early if petitioner wishes it considered prior to the first Office action on the application. Petitioners should be aware that the Office will entertain petitions under 37 CFR 1.183, when accompanied by the petition fee set forth in 37 CFR 1.17(h), to waive the 2-month delay period of 37 CFR 1.176 in appropriate circumstances. Accordingly, petitioners in reissue applications cannot automatically assume that the full 2-month delay period of 37 CFR 1.176 will always be available.

In those *ex parte* situations where a petitioner cannot identify the pending application by application number, the petition papers will be forwarded to the

appropriate TC Director for an identification search. Once the application file(s) is located, it should be forwarded to the OPLA.

If the petition filed in the Office does not indicate service on applicant or applicant’s attorney or agent, and is not filed in duplicate, then the Office will undertake to determine whether or not service has been made by contacting applicant or applicant’s attorney or agent by telephone or in writing to ascertain if service has been made. If service has not been made and no duplicate has been filed, then the Office may request petitioner to file such a duplicate before the petition is referred to the examiner. Alternatively, if the petition involves only a few pages, the Office may, in its sole discretion, elect to reproduce the petition rather than delay referring it to the examiner. If duplicate petition papers are mailed to applicant or applicant’s attorney or agent by the Office, the application file should reflect that fact, either by a letter transmitting the petition or, if no transmittal letter is used, simply by an appropriate notation in the “Contents” section of the application file wrapper. For Image File Wrapper (IFW) processing, see IFW Manual section 3.4.

If the petition is not submitted prior to the earliest of the date the application was published or the mailing of a notice of allowance under 37 CFR 1.311, it should not be entered in the application file. The applicant should be notified that the petition is untimely and that it is not being entered in the application file. The handling of the petition will vary depending on the particular following situation.

(A) *Service Of Copy Included*

Where the petition includes an indication of service of copy on the applicant, the original petition should be discarded.

(B) *Service Of Copy Not Included*

Where the petition does not include an indication of service and a duplicate copy of the petition is or is not present, the duplicate copy (if present) should be discarded and the original petition should be sent to the applicant along with the notification of nonentry.

## **720.02 Examiner Determination of Prima Facie Showing [R-2]**

Once the Office of Patent Legal Administration (OPLA) staff member has determined that the petition

meets the formal requirements of 37 CFR 1.292, and the application's status warrants consideration of the petition, he or she will prepare a letter \*\* forwarding the petition and the application file to the examiner for determination of whether a *prima facie* case of public use or sale in this country of the claimed subject matter is established by the petition. Any other papers that have been filed by the parties involved, such as a reply by the applicant or additional submissions by the petitioner, will also be forwarded to the examiner. Whether additional papers are accepted is within the discretion of the OPLA staff member. However, protracted paper filing is discouraged since the parties should endeavor to present their best case as to the *prima facie* showing at the earliest possible time. No oral hearings or interviews will be granted at this stage, and the examiner is cautioned not to answer any inquiries by the petitioner or applicant.

A *prima facie* case is established by the petition if the examiner finds that the facts asserted in the affidavit(s) or declaration(s), as supported by the exhibits, if later proved true by testimony taken in the public use proceeding, would result in a statutory bar to the claims under 35 U.S.C. 102(b) alone or in combination with 35 U.S.C. 103. See MPEP § 2133.03 *et seq.*

To make this determination, the examiner must identify exactly *what* was in public use or on sale, whether it was in use or on sale in this country more than 1 year before the effective filing date, and whether the pending claims "read" on or are obvious over what has been shown to be in public use or on sale. On this last point, the examiner should compare all pending claims with the matter alleged to have been in use or on sale, not just the claims identified by petitioner.

In situations where the petition alleges only that the claims are obvious over subject matter asserted to be in public use or on sale, the petition should include prior art or other information on which it relies and explain how the prior art or other information in combination with the subject matter asserted to be in public use or on sale renders the claims obvious. The examiner is not expected to make a search of the prior art in evaluating the petition. If, however, the examiner determines that a *prima facie* case of anticipation under 35 U.S.C. 102(b) has not been established but, at the time of evaluating the petition, the examiner is aware of prior art or other information which, in his or

her opinion, renders the claims obvious over the subject matter asserted to be in public use or on sale the examiner may determine that a *prima facie* case is made out, even if the petition alleged only that the claims were anticipated under 35 U.S.C. 102(b).

After having made his/her determination, the examiner will forward a memorandum to the \*\*>OPLA staff member<, stating his or her findings and his or her decision as to whether a *prima facie* case has been established. The findings should include a summary of the alleged facts, a comparison of at least one claim with the device alleged to be in public use or on sale, and any other pertinent facts which will aid the \*\*>OPLA staff member< in conducting the preliminary hearing. The report should be prepared in triplicate and addressed to the \*\*>OPLA staff member<.

### 720.03 Preliminary Hearing [R-2]

Where the examiner concludes that a *prima facie* showing has not been established, both the petitioner and the applicant are so notified by the Office of the Deputy Commissioner for Patent Examination Policy and the application proceedings are resumed without giving the parties an opportunity to be heard on the correctness of the examiner's decision. Where the examiner concludes that a *prima facie* case has been established, the \*>Director of the USPTO< may hold a preliminary hearing. In such case, the parties will be notified by letter of the examiner's conclusion and of the time and date of the hearing. In *ex parte* cases, whether or not the examiner has concluded that a *prima facie* showing has been established, no copy of the examiner's memorandum to the \*\*>Office of Patent Legal Administration (OPLA) staff member< will be forwarded to the petitioner. However, in such cases where the petition covers restrictable subject matter and it is evident that petitioner is not aware of a restriction requirement which has been or may be made, petitioner will be informed that the examiner's conclusion is limited to elected subject matter. While not so specifically captioned, the notification of this hearing amounts to an order to show cause why a public use proceeding should not be held. No new evidence is to be introduced or discussed at this hearing. The format of the hearing is established by the member of the \*\*>OPLA staff<. The examiner may attend as an observer only.

Where the hearing is held in the *ex parte* situation, great care will be taken to avoid discussion of any matters of the application file which are not already of knowledge to petitioner. Of course, applicant may of his or her own action or consent notify the petitioner of the nature of his or her claims or other related matters.

After the hearing is concluded, the **>OPLA staff member<** will decide whether public use proceedings are to be initiated, and he/she will send appropriate notice to the parties.

**720.04 Public Use Proceeding Testimony [R-2]**

When the **>Office of Patent Legal Administration (OPLA) staff member<** decides to institute public use proceedings, the application is referred to the examiner who will conduct all further proceedings. The fact that the affidavits or declarations and exhibits presented with the petition for institution of the public use proceedings have been held to make out a *prima facie* case does not mean that the statutory bar has been conclusively established. The statutory bar can only be established by testimony taken in accordance with normal rules of evidence, including the right of cross-examination. The affidavits or declarations are not to be considered part of the testimony and in no case can they be used as evidence on behalf of the party submitting them unless the affidavits or declarations are submitted as a part of the petitioner's testimony.

The procedure for taking testimony in a public use proceeding is similar to that for taking testimony in an interference. Normally, no representative of the **>Director of the USPTO<** need be present at the taking of the testimony. Note that 37 CFR 1.672(a) limits noncompelled direct testimony to affidavits. See 37 CFR 1.601(b) for the meaning of affidavit.

The examiner will set a schedule of times for taking testimony and for filing the record and briefs on the basis of the following:

>

**I. < SCHEDULE FOR TESTIMONY**

(A) Testimony for petitioner to close . . . . . [specify a date, e.g., January 10, 1997, which is approximately 60 days after the letter]

(B) Time for the applicant to file objections to admissibility of petitioner's evidence to close . . . . . [specify a date which is approximately 20 days after date (A)]

(C) Time for the petitioner to file supplemental evidence to overcome objections to close 20 days from above date, i.e., . . . . . [specify a date which is exactly 20 days after date (B), unless the date is a Saturday, Sunday or federal holiday, in which case use the next business day]

(D) Time for the applicant to request cross-examination of the petitioner's affiants to close . . . . . [specify a date which is approximately 20 days after date (C)]

(E) Time for cross-examination of the petitioner's affiants to close . . . . . [specify a date which is approximately 30 days after date (D)]

(F) Rebuttal testimony by applicant to close . . . . . [specify a date which is approximately 20 days after date (E)]

>

**II. < SCHEDULE FOR FILING AND SERVING COPIES OF RECORD AND BRIEFS**

One copy of each of the petitioner's and the applicant's record and exhibits (see 37 CFR 1.653) is due . . . . [specify a date which is approximately 30 days after date (F)]

Petitioner's brief is due . . . . . [specify a date which is approximately 30 days after previous date]

Applicant's brief is due . . . . . [specify a date which is approximately 20 days after previous date]

Applicant and petitioner may agree on a different schedule for testimony, records, and briefs, provided the last brief is due no later than the date set forth above and provided a copy of the new schedule is filed by either applicant or petitioner. No extension of time will be permitted under 37 CFR 1.136(a). Any petition to extend the time for filing the last brief must be filed under 37 CFR 1.136(b).

A certified transcript of a deposition must be filed in the U.S. Patent and Trademark Office within one month after the date of deposition. 37 CFR 1.678.

All papers in the public use proceeding shall be served in accordance with 37 CFR 1.248.



It is understood from the above scheduling of times that a given time period begins with the close of the previous period, and that the completion of testimony or the filing of the record or a brief before the close of the corresponding period does not change its closing date. To avoid confusion, the examiner should indicate specific dates for the close of each period.

In *ex parte* cases and in *inter partes* cases where the pending application is a reissue, an oral hearing is ordinarily not held.

In all public use proceedings, whether the ultimate issue is anticipation under 35 U.S.C. 102(b) or obviousness over 35 U.S.C. 103, testimony will be limited to the issues of public use or on sale. No testimony will be received on whether the claimed subject matter would have been obvious over subject matter asserted to be in public use or on sale.

### 720.05 Final Decision [R-2]

The final decision of the examiner should be “analogous to that rendered by the [Board of Patent Appeals and Interferences] in an interference proceeding, analyzing the testimony” and stating conclusions. *In re Townsend*, 1913 C.D. 55, 188 O.G. 513 (Comm’r Pat. 1913). In reaching his or her decision, the examiner is not bound by the prior finding that a *prima facie* case has been established.

If the examiner concludes that a public use or sale bar exists, he or she will enter a rejection to that effect in the application file, predicating that rejection on the evidence considered and the findings and decision reached in the public use proceeding. Even if a rejection is not made, the examiner’s written action should reflect that the evidence of 35 U.S.C. 102(b) activity has in fact been considered. Likewise, if the examiner concludes that a *prima facie* case (A) has not been established, or (B) has been established and rebutted (MPEP § 2133.03(e) *et seq.*) then the examiner’s written action should so indicate. Strict adherence to this format should cause the rationale employed by the examiner in the written action to be self-evident. In this regard, the use of reasons for allowance pursuant to 37 CFR 1.104(e) may also be appropriate. See MPEP § 1302.14. In *ex parte* cases where the petitioner does not have access to the file, no copy of the examiner’s action is mailed to the petitioner by the Office.

There is no review from the final decision of the examiner in the public use proceedings. A petition under 37 CFR 1.181, requesting that the \*>Director of the USPTO< exercise his or her supervisory authority and vacate the examiner’s decision, will not be entertained except where there is a showing of clear error. See *Ex parte Hartley*, 1908 C.D. 224, 136 O.G. 1767 (Comm’r Pat. 1908). Once the application returns to its *ex parte* status, appellate review under 35 U.S.C. 134 and 141-145 may be had of any adverse decision rejecting claim(s), as a result of the examiner’s decisions as to public use or sale.

### 724 Trade Secret, Proprietary, and Protective Order Materials

Situations arise in which it becomes necessary, or desirable, for parties to proceedings in the Patent and Trademark Office relating to pending patent applications or reexamination proceedings to submit to the Office trade secret, proprietary, and/or protective order materials. Such materials may include those which are subject to a protective or secrecy order issued by a court or by the International Trade Commission (ITC). While one submitting materials to the Office in relation to a pending patent application or reexamination proceeding must generally assume that such materials will be made of record in the file and be made public, the Office is not unmindful of the difficulties this sometimes imposes. The Office is also cognizant of the sentiment expressed by the court in *In re Sarkar*, 575 F.2d 870, 872, 197 USPQ 788, 791 (CCPA 1978), which stated:

[T]hat wherever possible, trade secret law and patent laws should be administered in such manner that the former will not deter an inventor from seeking the benefit of the latter, because, the public is *most* benefited by the early disclosure of the invention in consideration of the patent grant. If a patent applicant is unwilling to pursue his right to a patent at the risk of certain loss of trade secret protection, the two systems will conflict, the public will be deprived of knowledge of the invention in many cases, and inventors will be reluctant to bring unsettled legal questions of significant current interest . . . for resolution.

Parties bringing information to the attention of the Office for use in the examination of applications and reexaminations are frequently faced with the prospect of having legitimate trade secret, proprietary, or protective order material disclosed to the public.

Inventors and others covered by 37 CFR 1.56(c) and 1.555 have a duty to disclose to the Office information they are aware of which is material to patentability. 37 CFR 1.56(b) states that

information is material to patentability when it is not cumulative to information already of record or being made of record in the application, and

(1) It establishes, by itself or in combination with other information, a *prima facie* case of unpatentability of a claim; or

(2) It refutes, or is inconsistent with, a position the applicant takes in:

(i) Opposing an argument of unpatentability relied on by the Office, or

(ii) Asserting an argument of patentability.

A *prima facie* case of unpatentability is established when the information compels a conclusion that a claim is unpatentable under the preponderance of evidence, burden-of-proof standard, giving each term in the claim its broadest reasonable construction consistent with the specification, and before any consideration is given to evidence which may be submitted in an attempt to establish a contrary conclusion of patentability.

It is incumbent upon patent applicants, therefore, to bring “material” information to the attention of the Office. It matters not whether the “material” information can be classified as a trade secret, or as proprietary material, or whether it is subject to a protective order. The obligation is the same; it must be disclosed if “material to patentability” as defined in 37 CFR 1.56(b). The same duty rests upon a patent owner under 37 CFR 1.555 whose patent is undergoing reexamination.

Somewhat the same problem faces a protestor under 37 CFR 1.291(a) who believes that trade secret, proprietary, or protective order material should be considered by the Office during the examination of an application.

In some circumstances, it may be possible to submit the information in such a manner that legitimate trade secrets, etc., will not be disclosed, e.g., by appropriate deletions of nonmaterial portions of the information. This should be done only where there will be no loss of information material to patentability under 37 CFR 1.56 or 1.555.

The provisions of this section do not relate to material appearing in the description of the patent application.

### **724.01 Completeness of the Patent File Wrapper**

It is the intent of the Office that the patent file wrapper be as complete as possible insofar as “material” information is concerned. The Office attempts to minimize the potential conflict between full disclosure of “material” information as required by 37 CFR 1.56 and protection of trade secret, proprietary, and protective order material to the extent possible.

The procedures set forth in the following sections are designed to enable the Office to ensure as complete a patent file wrapper as possible while preventing unnecessary public disclosure of trade secrets, proprietary material, and protective order material.

### **724.02 Method of Submitting Trade Secret, Proprietary, and/or Protective Order Materials [R-2]**

Information which is considered by the party submitting the same to be either trade secret material or proprietary material, and any material subject to a protective order, must be clearly labeled as such and be filed in a sealed, clearly labeled, envelope or container. Each document or item must be clearly labeled as a “Trade Secret” document or item, a “Proprietary” document or item, or as an item or document “Subject To Protective Order.” It is essential that the terms “Confidential,” “Secret,” and “Restricted” or “Restricted Data” not be used when marking these documents or items in order to avoid confusion with national security information documents which are marked with these terms (note also MPEP § 121). If the item or document is “Subject to Protective Order” the proceeding, including the tribunal, must be set forth on each document or item. Of course, the envelope or container, as well as each of the documents or items, must be labeled with complete identifying information for the file to which it is directed, including the Office or area to which the envelope or container is directed.

Examples of appropriate labels for such an envelope or container addressed to an application are as

follows: (Appropriate changes would be made for papers filed in a reexamination file.)

A. "TRADE SECRET MATERIAL NOT OPEN TO PUBLIC. TO BE OPENED ONLY BY EXAMINER OR OTHER AUTHORIZED U.S. PATENT AND TRADEMARK OFFICE EMPLOYEE.

>DO NOT SCAN<

In re Application of

Application No.

Filed:

For: (Title of Invention)

TC Art Unit:

Examiner:

\*\*

B. "PROPRIETARY MATERIAL NOT OPEN TO PUBLIC. TO BE OPENED ONLY BY EXAMINER OR OTHER AUTHORIZED U.S. PATENT AND TRADEMARK OFFICE EMPLOYEE.

>DO NOT SCAN<

In re Application of

Application No.

Filed:

For: (Title of Invention)

TC Art Unit:

Examiner:

\*\*

C. "MATERIAL SUBJECT TO PROTECTIVE ORDER — NOT OPEN TO PUBLIC. TO BE OPENED ONLY BY EXAMINER OR OTHER AUTHORIZED U.S. PATENT AND TRADEMARK OFFICE EMPLOYEE.

>DO NOT SCAN<

Tribunal Issuing Protective Order:

Civil Action or Other Identification No.:

Date of Order:

Current Status of Proceeding: (Pending, Stayed, etc.)

In re application of:

Application No.

Filed:

For: (Title of Invention)

TC Art Unit:

Examiner:

\*\*

The envelope or container must be accompanied by a transmittal letter which also contains the same identifying information as the envelope or container. The transmittal letter must also state that the materials in the envelope or container are considered trade secrets or proprietary, or are subject to a protective order, and are being submitted for consideration under MPEP § 724. A petition under 37 CFR 1.59 and fee therefor (37 CFR 1.17(h)) to expunge the information, if found *not* to be important to a reasonable examiner in deciding whether to allow the application to issue as a patent, **\*\*>should<** accompany the envelope or container.

In order to ensure that such an envelope or container is not mishandled, either prior to reaching the Office, or in the Office, the envelope or container should **\*\*>be hand-carried to the Customer Window located at:**

U.S. Patent and Trademark Office

2011 South Clark Place

Customer Window

Crystal Plaza Two, Lobby, Room 1B03

Arlington, VA 22202

The envelope or container may also be mailed to the Commissioner for Patents, P.O. Box 1450, Alexandria, VA 22313-1450.

Upon receipt of the envelope or container, the Office will place the envelope or container in an Artifact folder if the application is an Image File Wrapper (IFW) application. If the application is maintained in paper, the confidential or proprietary information will be retained in the envelope or container.<

### **724.03 Types of Trade Secret, Proprietary, and/or Protective Order Materials Submitted Under MPEP § 724.02**

The types of materials or information contemplated for submission under MPEP § 724.02 include information "material to patentability" but does not include information favorable to patentability. Thus, any trade secret, proprietary, and/ or protective order materials which are required to be submitted on behalf of a patent applicant under 37 CFR 1.56 or patent owner under 37 CFR 1.555 can be submitted in accordance with MPEP § 724.02. Neither 37 CFR

1.56 nor 1.555 require the disclosure of information favorable to patentability, e.g., evidence of commercial success of the invention (see 42 Fed. Reg. 5590). Such information should not be submitted in accordance with MPEP § 724.02. If any trade secret, proprietary, and/or protective order materials are submitted in amendments, arguments in favor of patentability, or affidavits under 37 CFR 1.131 or 1.132, they will be made of record in the file and will not be given any special status.

Insofar as protestors under 37 CFR 1.291(a) are concerned, submissions can be made in accordance with MPEP § 724.02 before the patent application is published, if protestor or petitioner has access to the application involved. After the patent application has been published under 35 U.S.C. 122(b)(1), no protest may be filed without the express consent of the applicant. Any submission filed by a protestor must follow the requirements for service. The Office cannot ensure that the party or parties served will maintain the information secret. If the party or parties served find it necessary or desirable to comment on material submitted under MPEP § 724 before it is, or without its being, found “material to patentability,” such comments should either (A) not disclose the details of the material or (B) be submitted in a separate paper under MPEP § 724.02.

#### **724.04 Office Treatment and Handling of Materials Submitted Under MPEP § 724.02 [R-2]**

The exact methods of treating and handling materials submitted under MPEP § 724.02 will differ slightly depending upon whether the materials are submitted in an original application subject to the requirements of 35 U.S.C. 122 or whether the submission is made in a reissue application or reexamination file open to the public under 37 CFR 1.11(b) or (d). Prior to publication, an original application is not open to the public under 35 U.S.C. 122(a). After the application has been published under 35 U.S.C. 122(b)(1), copies of the file wrapper of the pending application are available to any member of the public who has filed a request under **\*\***>37 CFR 1.14(a)(1)(ii) or (a)(1)(iii)<. See MPEP § 103.

**\*\***>If the application file and contents are available to the public pursuant to 37 CFR 1.11 or 1.14, any

materials submitted under MPEP § 724.02 will only be released to the public with any other application papers if no petition to expunge (37 CFR 1.59) was filed prior to the mailing of a notice of allowability or notice of abandonment, or if a petition to expunge was filed and the petition was denied. Prior to the mailing of the notice of allowability or notice of abandonment, the examiner will review the patent application file and determine if a petition to expunge is in the application file but not acted upon. If the application is being allowed, if the materials submitted under MPEP § 724.02 are found not to be important to a reasonable examiner in deciding whether to allow the application to issue as a patent, the petition to expunge will be granted and the materials will be expunged. If the materials are found to be important to a reasonable examiner in deciding whether to allow the application to issue as a patent, the petition to expunge will be denied and the materials will become part of the application record and will be available to the public upon issuance of the application as a patent. With the mailing of the notice of abandonment, if a petition to expunge has been filed, irrespective of whether the materials are found to be important or not to a reasonable examiner in deciding on patentability, the petition to expunge will be granted and the materials expunged.<

Upon receipt of the submission, the transmittal letter and the envelope or container will be date stamped and brought to the attention of the examiner or other Office employee responsible for evaluating the submission. The receipt of the transmittal letter and envelope or container will be noted on the “Contents” of the application or reexamination file. >For Image File Wrapper (IFW) processing, see IFW Manual section 3.6.< In addition, the face of the application or reexamination file will have the notation placed thereon to indicate that trade secret, proprietary, or protective order material has been filed. >For Image File Wrapper (IFW) processing, see IFW Manual section 3.6.< The location of the material will also be specified. The words “TRADE SECRET MATERIALS FILED WHICH ARE NOT OPEN TO PUBLIC” on the face of the file are sufficient to indicate the presence of trade secret material. Similar notations will be made for either proprietary or protective order materials.

### 724.04(a) Materials Submitted in an Application Covered by 35 U.S.C. 122 [R-2]

Any materials submitted under MPEP § 724.02 in an application covered by 35 U.S.C. 122 will be treated in the following manner:

(A) The submitted material will be maintained in the original envelope or container (clearly marked “Not Open To The Public”) and will not be publicly available until a determination has been made as to whether or not the information is important to a reasonable examiner in deciding whether to allow the application to issue as a patent. \*\*>Prior to publication, an original application is not available to the public under 35 U.S.C. 122(a). After publication of the application under 35 U.S.C. 122(b)(1), where the application file and contents are available to the public pursuant to 37 CFR 1.11 or 1.14, any materials submitted under MPEP § 724.02 will only be released to the public with any other application papers if no petition to expunge (37 CFR 1.59) was filed prior to the mailing of a notice of allowability or notice of abandonment, or if a petition to expunge was filed and the petition was denied.<

(B) >If the application is to be abandoned, prior to the mailing of a notice of abandonment, the examiner will review the patent application file and determine if a petition to expunge is in the application file but not acted upon. If a petition to expunge has been filed, irrespective of whether the materials are found to be important or not to a reasonable examiner in deciding on patentability, the petition to expunge will be granted and the materials expunged. If no petition to expunge has been filed, the materials will be available to the public under 37 CFR 1.14(a)(1)(ii) or (a)(1)(iv).

(C) If the application is being allowed, prior to the mailing of a notice of allowability, the examiner will review the patent application file and determine if a petition to expunge is in the application file but not acted upon.< The examiner, or other appropriate Office official who is responsible for considering the information, will make a determination as to whether or not any portion or all of the information submitted is important to a reasonable examiner in deciding whether to allow the application to issue as a patent.

>

(D) < If any portion or all of the submitted information is found important to a reasonable examiner in deciding whether to allow the application to issue as a patent, >the petition to expunge will be denied and the information< will become a part of the file history >(and scanned, if the application is an Image File Wrapper (IFW) application)<, which upon issuance of the application as a patent would become available to the public.

>

(E) < If any portion or all of the submitted information is found *not* to be important to a reasonable examiner in deciding whether to allow the application to issue as a patent, \*\*>the petition to expunge will be granted and the information expunged.<

(F) \*\* >If a petition to expunge is not filed prior to the mailing of the notice of allowability, the materials submitted under MPEP § 724.02 will be released to the public upon the issuance of the application as a patent and upon the filing of a request and the appropriate fee (37 CFR 1.14).<

(G) Any petition to expunge the submitted information or any portion thereof under 37 CFR 1.59(b) will be treated in accordance with MPEP § 724.05.

### 724.04(b) Materials Submitted in Reissue Applications Open to the Public Under 37 CFR 1.11(b) [R-2]

Any materials submitted under MPEP § 724.02 in a reissue application open to the public under 37 CFR 1.11(b) will be treated in the following manner:

(A) >Materials submitted under MPEP § 724.02 will only be released to the public with any other application papers if no petition to expunge (37 CFR 1.59) was filed prior to the mailing of a notice of allowability or notice of abandonment, or if a petition to expunge was filed and the petition was denied.< The submitted information will be maintained separate from the reissue application file and will not be publicly available until a determination has been made as to whether or not the information is important to a reasonable examiner in deciding whether to allow the application to issue as a patent.

(B) >If the reissue application is to be abandoned, prior to the mailing of a notice of abandonment, the

examiner will review the reissue application file and determine if a petition to expunge is in the reissue application file but not acted upon. If a petition to expunge has been filed, irrespective of whether the materials are found to be important or not to a reasonable examiner in deciding on patentability, the petition to expunge will be granted and the materials expunged. If no petition to expunge has been filed, the materials will be available to the public under 37 CFR 1.11(b).

(C) If the reissue application is being allowed, prior to the mailing of a notice of allowability, the examiner will review the reissue application file and determine if a petition to expunge is in the reissue application file but not acted upon. The examiner, or other appropriate Office official who is responsible for considering the information, will make a determination as to whether or not any portion or all of the information submitted is important to a reasonable examiner in deciding whether to allow the application to issue as a patent.

\*>

(D) < If any portion or all of the submitted information is found important to a reasonable examiner in deciding whether to allow the application to issue as a patent, \*\*>the petition to expunge will be denied and the information< will thereafter become a permanent part of the reissue application file and open to the public.

\*>

(E) < If any portion or all of the submitted information is found *not* to be important to a reasonable examiner in deciding whether to allow the application to issue as a patent, \*\*>the petition to expunge will be granted and the information expunged.<

(F) \*\*>If a petition to expunge is not filed prior to the mailing of the notice of allowability, the materials submitted under MPEP § 724.02 will become a permanent part of the reissue application file and open to the public under 37 CFR 1.11(b).<

(G) Any petition to expunge a portion or all of the submitted information will be treated in accordance with MPEP § 724.05.

### **724.04(c) Materials Submitted in Reexamination File Open to the Public Under 37 CFR 1.11(d) [R-2]**

Any materials submitted under MPEP § 724.02 in a reexamination file open to the public under 37 CFR 1.11(d) will be treated in the following manner:

(A) >Materials submitted under MPEP § 724.02 will only be released to the public with any other papers in the reexamination file if no petition to expunge (37 CFR 1.59) was filed prior to the mailing of a Notice of Intent to Issue Reexamination Certificate (NIRC), or if a petition to expunge was filed and the petition was denied.< The submitted information will be maintained separate from the reexamination file and will not be publicly available until a determination has been made as to whether or not the information is important to a reasonable examiner in deciding whether or not a claim is patentable.

(B) >Prior to the mailing of a NIRC, the examiner will review the reexamination file and determine if a petition to expunge is in the reexamination file but not acted upon.< The examiner, or other appropriate Office official who is responsible for considering the information, will make a determination as to whether or not any portion or all of the information submitted is important to a reasonable examiner in deciding whether or not a claim is patentable.

(C) If any portion or all of the submitted information is found important to a reasonable examiner in deciding whether or not a claim is patentable, \*\*>the petition to expunge will be denied and the information< will thereafter become a permanent part of the reexamination file and open to the public.

(D) If any portion or all of the submitted information is found *not* to be important to a reasonable examiner in deciding whether or not a claim is patentable, \*\*>the petition to expunge will be granted and the information expunged.<

(E) >If a petition to expunge is not filed prior to the mailing of the NIRC, the materials submitted under MPEP § 724.02 will become a permanent part of the reexamination file and open to the public under 37 CFR 1.11(d).<

\*>

(F) < Any petition to expunge a portion or all of the submitted information under 37 CFR 1.59(b) will be treated in accordance with MPEP § 724.05.

## **724.05 Petition To Expunge Information or Copy of Papers in Application File [R-2]**

### **I. INFORMATION SUBMITTED UNDER MPEP § 724.02**

A petition under 37 CFR 1.59(b) to expunge information submitted under MPEP § 724.02>, or that should have been submitted under MPEP § 724.02 (as where proprietary information is submitted in an information disclosure statement but inadvertently not submitted in a sealed envelope as discussed in MPEP § 724.02)< will be entertained only if the petition fee (37 CFR 1.17(h)) is filed and the information has been found *not* to be important to a reasonable examiner in deciding on patentability. If the information is found to be important to a reasonable examiner in deciding on patentability, any petition to expunge the information will be denied. Any such petition to expunge information submitted under MPEP § 724.02 should be submitted at the time of filing the information under MPEP § 724.02 and directed to the Technology Center (TC) to which the application is assigned. Such petition must contain:

(A) a clear identification of the information to be expunged without disclosure of the details thereof;

(B) a clear statement that the information to be expunged is trade secret material, proprietary material, and/or subject to a protective order, and that the information has not been otherwise made public;

(C) a commitment on the part of the petitioner to retain such information for the period of any patent with regard to which such information is submitted;

(D) a statement that the petition to expunge is being submitted by, or on behalf of, the party in interest who originally submitted the information;

(E) the fee as set forth in 37 CFR 1.17(i) for a petition under 37 CFR 1.59(b).

Any such petition to expunge should accompany the submission of the information and, in any event, must be submitted in sufficient time that it can be acted on prior to the \*\*>mailing of a notice of

allowability or a notice of abandonment for original and reissue applications, or prior to the mailing of a Notice of Intent to Issue Reexamination Certificate (NIRC) for reexamination proceedings.< Timely submission of the petition is, accordingly, extremely important. If the petition does not accompany the information when it is initially submitted, the petition should be submitted while the application or reexamination is pending in the Technology Center (TC) and before it is transmitted to the Publishing Division. \*\*>If a petition to expunge is not filed prior to the mailing of a notice of allowability or a notice of abandonment for original and reissue applications, or prior to the mailing of a NIRC for reexamination proceedings<, any material then in the file will remain therein and be open to the public in accordance with 37 CFR 1.14. Accordingly, it is important that both the submission of any material under MPEP § 724.02 and the submission of any petition to expunge occur as early as possible during the examination process. The decision will be held in abeyance and be decided upon the close of prosecution on the merits.

### **II. INFORMATION UNINTENTIONALLY SUBMITTED IN APPLICATION**

A petition to expunge information unintentionally submitted in an application (other than information forming part of the original disclosure) may be filed under 37 CFR 1.59(b), provided that:

(A) the Office can effect such return prior to the issuance of any patent on the application in issue;

(B) it is stated that the information submitted was unintentionally submitted and the failure to obtain its return would cause irreparable harm to the party who submitted the information or to the party in interest on whose behalf the information was submitted;

(C) the information has not otherwise been made public;

(D) there is a commitment on the part of the petitioner to retain such information for the period of any patent with regard to which such information is submitted;

(E) it is established to the satisfaction of the \*>Director< that the information to be returned is not material information under 37 CFR 1.56; and

(F) the petition fee as set forth in 37 CFR 1.17(h) is included.

A request to \*>expunge< information that has not been clearly identified as information that may be later subject to such a request by marking and placement in a separate sealed envelope or container shall be treated on a case-by-case basis. Applicants should note that unidentified information that is a trade secret, proprietary, or subject to a protective order that is submitted in an Information Disclosure Statement may inadvertently be placed in an Office prior art search file by the examiner due to the lack of such identification and may not be retrievable.

### III. INFORMATION SUBMITTED IN INCORRECT APPLICATION

37 CFR 1.59(b) also covers the situation where an unintended heading has been placed on papers so that they are present in an incorrect application file. In such a situation, a petition should request \*\*>that< the papers >be expunged< rather than \*\*>transferred< to the correct application file. >For Image File Wrapper (IFW) processing, see IFW Manual.< The grant of such a petition will be governed by the factors enumerated in paragraph II of this section in regard to the unintentional submission of information. Where the Office can determine the correct application file that the papers were actually intended for, based on identifying information in the heading of the papers (e.g., application number, filing date, title of invention and inventor(s) name(s)), the Office will transfer the papers to the correct application file for which they were intended without the need of a petition.

### IV. INFORMATION FORMING PART OF THE ORIGINAL DISCLOSURE

A petition to expunge a part of the original disclosure must be filed under 37 CFR 1.183, since such a request requires a waiver of the requirements of 37 CFR 1.59(a). Petitions under 37 CFR 1.183 should be directed to the Office of Petitions. The petition must explain why justice requires waiver of the rules to permit the requested material to be expunged. It should be noted that petitions to expunge information which is a part of the original disclosure, such as the specification and drawings, will ordinarily not be favorably entertained. The original disclosures of applications are scanned for record keeping purposes. Accordingly, the grant of a petition to expunge infor-

mation which is part of the original disclosure would require that the USPTO record of the originally filed application be changed, which may not be possible.

## 724.06 Handling of Petitions To Expunge Information or Copy of Papers in Application File [R-2]

*37 CFR 1.59. Expungement of information or copy of papers in application file.*

\*\*>

(a)(1) Information in an application will not be expunged, except as provided in paragraph (b) of this section.

(2) Information forming part of the original disclosure (*i.e.*, written specification including the claims, drawings, and any preliminary amendment specifically incorporated into an executed oath or declaration under §§ 1.63 and 1.175) will not be expunged from the application file.

(b) An applicant may request that the Office expunge information, other than what is excluded by paragraph (a)(2) of this section, by filing a petition under this paragraph. Any petition to expunge information from an application must include the fee set forth in § 1.17(h) and establish to the satisfaction of the Director that the expungement of the information is appropriate in which case a notice granting the petition for expungement will be provided.

(c) Upon request by an applicant and payment of the fee specified in § 1.19(b), the Office will furnish copies of an application, unless the application has been disposed of (*see* §§ 1.53(e), (f) and (g)). The Office cannot provide or certify copies of an application that has been disposed of.<

\*\*\*\*\*

37 CFR 1.59 provides that information, other than the original disclosure of the application, may be expunged from the file wrapper provided a petition to expunge under 37 CFR 1.59(b) and the required fee set forth in 37 CFR 1.17(h) are filed, and further that petitioner has established to the satisfaction of the \*>Director< that the return of the information is appropriate. \*>Expungement< of information that was originally submitted to the Office under MPEP § 724.02>, or that should have been submitted in a sealed envelope as discussed in MPEP § 724.02,< is appropriate when the petitioner complies with items (A)-(E) set forth in MPEP § 724.05, paragraph I, and the examiner or other appropriate Office official who is responsible for considering the information has determined that the information is not important to a reasonable examiner in deciding whether to allow the application (*i.e.*, the information is not material to patentability). \*>Expungement< of information that was



inadvertently submitted to the Office is appropriate provided that items (A)-(F) set forth in MPEP § 724.05, paragraph II, are satisfied. See also MPEP § 724.

Where the information to be expunged was not submitted pursuant to MPEP § 724.02 or as part of an Information Disclosure Statement, the petition should be sent to the Office of Petitions for decision.

The decision on the petition to expunge should be held in abeyance until the application is allowed or an *Ex parte Quayle* action, or a Notice of Abandonment is mailed, at which time the petition will be decided. However, where it is clear that the information was submitted in the wrong application, then the decision on the petition should not be held in abeyance. See MPEP § 724.05, paragraph III. In a pending application that has not been allowed or in which an *Ex parte Quayle* action has not been mailed, the examiner may not have finally considered what is material to a decision of patentability of the claims. Petitioner may be notified that the decision on the petition under 37 CFR 1.59(b) to expunge information in an application will be held in abeyance and be decided upon allowance of the application, or the mailing of an *Ex parte Quayle* action or a Notice of Abandonment using form paragraph 7.204.

\*\*>

¶ 7.204 *Petition Under 37 CFR 1.59(b) To Expunge Information: Decision Held in Abeyance*

In re Application of [1] :  
 Appl. No.: [2] : RESPONSE TO PETITION  
 Filed: [3] : UNDER 37 CFR 1.59  
 For: [4] :

This is a response to the petition under 37 CFR 1.59(b), filed [5], to expunge information from the above identified application.

The decision on the petition will be held in abeyance until allowance of the application or mailing of an *Ex parte Quayle* action or a Notice of Abandonment, at which time the petition will be decided.

Petitioner requests that a document entitled [6], filed [7], be expunged from the record. Petitioner states either: (A) that the information contains trade secret material, proprietary material and/or material that is subject to a protective order which has not been made public; or (B) that the information submitted was unintentionally submitted and the failure to obtain its return would cause irreparable harm to the party who submitted the information or to the party in interest on whose behalf the information was submitted, and the information has not otherwise been made public. The petition fee set forth in 37 CFR 1.17(h) has been paid.

The decision on the petition is held in abeyance because prosecution on the merits is not closed. Accordingly, it is not appropri-

ate to make a final determination of whether or not the material requested to be expunged is “material,” with “materiality” being defined as any information which the examiner considers as being important to a determination of patentability of the claims. Thus, the decision on the petition to expunge must be held in abeyance at this time.

During prosecution on the merits, the examiner will determine whether or not the identified document is considered to be “material.” If the information is not considered by the examiner to be material, the information will be removed from the official file.

**Examiner Note:**

1. A Technology Center Director decides this petition only if the information was submitted pursuant to MPEP § 724.02.
2. The petition should be sent to the Office of Petitions for decision if:
  - (a) the information was not submitted pursuant to MPEP § 724.02. Information which is part of the original disclosure (specification including any claims, drawings, and any preliminary amendment referred to in the oath or declaration) cannot be expunged under 37 CFR 1.59. Some papers entered into the application file, e.g., arguments made in an amendment, may be expunged under appropriate circumstance, however, the petition should be sent to the Office of Petitions for decision; or
  - (b) the petition is also accompanied by a petition under 37 CFR 1.183 requesting waiver of one of the requirements explicitly set forth in 37 CFR 1.59 (e.g., requesting expungement of part of the original disclosure).
3. This decision is printed with the USPTO letterhead.
4. In bracket 6, clearly identify the document which petitioner requests to expunge. For example, refer to the author and title of the document.
5. Mail with PTO-90C cover sheet.

<

When an application has been allowed, an *Ex parte Quayle* action has been mailed, or an application is abandoned, a petition to expunge should be decided by a TC Director (see MPEP § 1002.02(c)). At this time a determination must be made as to whether the information in question is material. Form paragraph 7.205 should be used to grant a petition to expunge, whereas form paragraphs 7.206-7.213 should be used to dismiss such a petition.

\*\*>

¶ 7.205 *Petition Under 37 CFR 1.59(b) To Expunge Information Granted*

In re Application of [1] :  
 Appl. No.: [2] : DECISION ON PETITION  
 Filed: [3] : UNDER 37 CFR 1.59  
 For: [4] :

This is a decision on the petition under 37 CFR 1.59(b), filed [5], to expunge information from the above identified application.

The petition is granted.

Petitioner requests that a document entitled [6], filed [7], be expunged from the record. Petitioner states that either (A) that the information contains trade secret material, proprietary material and/or material that is subject to a protective order which has not been made public; or (B) that the information submitted was unintentionally submitted and the failure to obtain its return would cause irreparable harm to the party who submitted the information or to the party in interest on whose behalf the information was submitted, and the information has not otherwise been made public. The petition fee set forth in 37 CFR 1.17(h) has been paid.

The information in question has been determined by the undersigned to not be material to the examination of the instant application.

Applicant is required to retain the expunged material(s) for the life of any patent which issues on the above-identified application.

The expunged material has been removed from the official file.

Enclosure: [8]

#### Examiner Note:

1. A Technology Center Director decides this petition only if the information was submitted pursuant to MPEP § 724.02. Furthermore, a petition to expunge may not be granted unless the application has been allowed or is abandoned, or an *Ex Parte Quayle* action has been mailed.

2. The petition should be sent to the Office of Petitions for decision if:

(a) the information was not submitted pursuant to MPEP § 724.02. Information which is part of the original disclosure (specification including any claims, drawings, and any preliminary amendment referred to in the oath or declaration) cannot be expunged under 37 CFR 1.59. Some papers entered into the application file, e.g., arguments made in an amendment, may be expunged under appropriate circumstance, however, the petition should be sent to the Office of Petitions for decision; or

(b) the petition is also accompanied by a petition under 37 CFR 1.183 requesting waiver of one of the requirements explicitly set forth in 37 CFR 1.59 (e.g., requesting expungement of part of the original disclosure).

3. This decision is printed with the USPTO letterhead.

4. In brackets 6 and 8, clearly identify the expunged document. For example, refer to the author and title of the document.

5. Mail with PTO-90C cover sheet.

#### ¶ 7.206 *Petition Under 37 CFR 1.59(b) To Expunge Information Dismissed*

In re Application of [1] :  
 Appl. No.: [2] : DECISION ON PETITION  
 Filed: [3] : UNDER 37 CFR 1.59  
 For: [4] :

This is a decision on the petition under 37 CFR 1.59(b), filed [5], to expunge information from the above identified application.

The petition is dismissed.

Petitioner requests that a document entitled [6], filed [7], be expunged from the record.

“Materiality” is defined as any information which the examiner considers as being important to a determination of patentability of the claims.

The petition is deficient because:

#### Examiner Note:

1. A Technology Center Director decides this petition only if the information was submitted pursuant to MPEP § 724.02. However, the petition should not be granted until the application has been allowed or abandoned, or an *Ex parte Quayle* action has been mailed.

2. The petition should be sent to the Office of Petitions for decision if:

(a) the information was not submitted pursuant to MPEP § 724.02. Information which is part of the original disclosure (specification including any claims, drawings, and any preliminary amendment referred to in the oath or declaration) cannot be expunged under 37 CFR 1.59. Some papers entered into the application file, e.g., arguments made in an amendment, may be expunged under appropriate circumstance, however, the petition should be sent to the Office of Petitions for decision; or

(b) the petition is also accompanied by a petition under 37 CFR 1.183 requesting waiver of one of the requirements explicitly set forth in 37 CFR 1.59 (e.g., requesting expungement of part of the original disclosure).

3. This decision is printed with the USPTO letterhead.

4. In bracket 6, clearly identify the document which petitioner requests to expunge. For example, refer to the author and title of the document.

5. This form paragraph must be followed with one or more of form paragraphs 7.207 through 7.213.

<

#### ¶ 7.207 *Petition To Expunge, Conclusion, Lacks Fee*

the petition was not accompanied by the required fee under 37 CFR 1.17(h).

#### ¶ 7.208 *Petition to Expunge, Conclusion, Material to Determination of Patentability*

the information that petitioner requests to expunge is considered to be material to the determination of patentability because [1].

#### Examiner Note:

In bracket 1, provide an explanation of basis for conclusion that information is material to the determination of patentability.

#### ¶ 7.209 *Petition To Expunge, Conclusion, Information Made Public*

the information has been made public. [1]

#### Examiner Note:

In bracket 1, provide explanation of basis for conclusion that information has been made public.

*¶ 7.210 Petition to Expunge, Conclusion, No Commitment to Retain Information*

the petition does not contain a commitment on the part of petitioner to retain the information to be expunged for the period of any patent with regard to which such information is submitted.

*¶ 7.211 Petition to Expunge, Conclusion, No Clear Statement That Information is Trade Secret, Proprietary, and/or Subject to Protective Order, or that Submission Was Unintentional*

the petition does not contain a clear statement that the information requested to be expunged is either: (1) a trade secret, proprietary, and/or subject to a protective order; or (2) was unintentionally submitted and failure to obtain its return would cause irreparable harm to the party who submitted the information or to the party in interest on whose behalf the information was submitted. [1]

**Examiner Note:**

In bracket 1, indicate whether any such statement was provided and, if so, explain why such statement is not clear.

*¶ 7.212 Petition to Expunge, Conclusion, No Clear Identification of Information to be Expunged*

the petition does not clearly identify the information requested to be expunged. [1]

**Examiner Note:**

In bracket 1, explain why the identification of the information requested to be expunged is not clear.

*¶ 7.213 Petition to Expunge, Conclusion, No Statement That Petition Is Submitted By, or on Behalf of, Party in Interest Who Originally Submitted the Information*

the petition does not contain a statement that the petition is being submitted by, or on behalf of, the party in interest who originally submitted the information.



# Chapter 800 Restriction in Applications Filed Under 35 U.S.C. 111; Double Patenting

<b>801</b>	<b>Introduction</b>	806.05(g)	Apparatus and Product Made — Distinctness
<b>802</b>	<b>Basis for Practice in Statute and Rules</b>	806.05(h)	Product and Process of Using
802.01	Meaning of “Independent” and “Distinct”	806.05(i)	Product, Process of Making, and Process of Using — Product Claim Not Allowable
802.02	Definition of Restriction	<b>807</b>	<b>Patentability Report Practice Has No Effect on Restriction Practice</b>
<b>803</b>	<b>Restriction - When Proper</b>	<b>808</b>	<b>Reasons for Insisting Upon Restriction</b>
803.01	Review by Examiner With at Least Partial Signatory Authority	808.01	Independent Inventions
803.02	Restriction — Markush Claims	808.01(a)	Species
803.03	Restriction — Transitional Applications	808.02	Related Inventions
803.03(a)	Transitional Application — Linking Claim Allowable	<b>809</b>	<b>Claims Linking Distinct Inventions</b>
803.03(b)	Transitional Application — Generic Claim Allowable	809.02	Generic Claim Linking Species
803.04	Restriction - Nucleotide Sequences	809.02(a)	Election Required
<b>804</b>	<b>Definition of Double Patenting</b>	809.02(b)	Election Required — Generic Claim Allowable
804.01	Prohibition of Double Patenting Rejections Under 35 U.S.C. 121	809.02(c)	Action Following Election
804.02	Avoiding a Double Patenting Rejection	809.02(d)	No Species Claims
804.03	Treatment of Commonly Owned Cases of Different Inventive Entities	809.02(e)	Generic Claim Allowable in Substance
804.04	Submission to Technology Center Director	809.03	Linking Claims
<b>805</b>	<b>Effect of Improper Joinder in Patent</b>	809.04	Retention of Claims to Nonelected Invention
<b>806</b>	<b>Determination of Distinctness or Independence of Claimed Inventions</b>	<b>810</b>	<b>Action on the Merits</b>
806.01	Compare Claimed Subject Matter	810.01	Not Objectionable When Coupled With Requirement
806.02	Patentability Over the Prior Art Not Considered	810.02	Usually Deferred
806.03	Single Embodiment, Claims Defining Same Essential Features	810.03	Given on Elected Invention When Requirement Is Made Final
806.04	Independent Inventions	<b>811</b>	<b>Time for Making Requirement</b>
806.04(a)	Species — Genus	811.02	Even After Compliance With Preceding Requirement
806.04(b)	Species May Be Related Inventions	811.03	Repeating After Withdrawal Proper
806.04(c)	Subcombination Not Generic to Combination	811.04	Proper Even Though Grouped Together in Parent Application
806.04(d)	Definition of a Generic Claim	<b>812</b>	<b>Who Should Make the Requirement</b>
806.04(e)	Claims Restricted to Species	812.01	Telephone Restriction Practice
806.04(f)	Claims Restricted to Species, by Mutually Exclusive Characteristics	<b>814</b>	<b>Indicate Exactly How Application Is To Be Restricted</b>
806.04(h)	Species Must Be Patentably Distinct From Each Other	<b>815</b>	<b>Make Requirement Complete</b>
806.04(i)	Generic Claims Presented for First Time After Issue of Species	<b>816</b>	<b>Give Reasons for Holding of Independence or Distinctness</b>
806.05	Related Inventions	<b>817</b>	<b>Outline of Letter for Restriction Requirement Between Distinct Inventions</b>
806.05(a)	Combination and Subcombination or Element	<b>818</b>	<b>Election and Reply</b>
806.05(b)	Old Combination — Novel Subcombination	818.01	Election Fixed by Action on Claims
806.05(c)	Criteria of Distinctness for Combination, Subcombination, or Element of a Combination	818.02	Election Other Than Express
806.05(d)	Subcombinations Usable Together	818.02(a)	By Originally Presented Claims
806.05(e)	Process and Apparatus for Its Practice — Distinctness	818.02(b)	Generic Claims Only — No Election of Species
806.05(f)	Process of Making and Product Made — Distinctness	818.02(c)	By Optional Cancellation of Claims
		818.03	Express Election and Traverse
		818.03(a)	Reply Must Be Complete
		818.03(b)	Must Elect, Even When Requirement Is Traversed
		818.03(c)	Must Traverse To Preserve Right of Petition

- 818.03(d) Traverse of Nonallowance of Linking Claims  
 818.03(e) Applicant Must Make Own Election

**819 Office Generally Does Not Permit Shift**

- 819.01 Office May Waive Election and Permit Shift

**820 Not an Election; Permissible Shift**

- 820.01 Old Combination Claimed — Not an Election  
 820.02 Interference Issues — Not an Election

**821 Treatment of Claims Held To Be Drawn to Nonelected Inventions**

- 821.01 After Election With Traverse  
 821.02 After Election Without Traverse  
 821.03 Claims for Different Invention Added After an Office Action  
 821.04 Rejoinder

**822 Claims to Inventions That Are Not Distinct in Plural Applications of Same Inventive Entity**

- 822.01 Copending Before the Examiner

**823 Unity of Invention Under the Patent Cooperation Treaty**

## 801 Introduction

This chapter is limited to a discussion of the subject of restriction and double patenting under Title 35 of the United States Code and Title 37 of the Code of Federal Regulations as it relates to national applications filed under 35 U.S.C. 111(a). The discussion of unity of invention under the Patent Cooperation Treaty Articles and Rules as it is applied as an International Searching Authority, International Preliminary Examining Authority, and in applications entering the National Stage under 35 U.S.C. 371 as a Designated or Elected Office in the U.S. Patent and Trademark Office is covered in Chapter 1800.

## 802 Basis for Practice in Statute and Rules

The basis for restriction and double patenting practices is found in the following statute and rules:

*35 U.S.C. 121. Divisional applications.*

If two or more independent and distinct inventions are claimed in one application, the Director may require the application to be restricted to one of the inventions. If the other invention is made the subject of a divisional application which complies with the requirements of section 120 of this title it shall be entitled to the benefit of the filing date of the original application. A patent issuing on an application with respect to which a requirement for restriction under this section has been made, or on an application filed as a result of such a requirement, shall not be used as a refer-

ence either in the Patent and Trademark Office or in the courts against a divisional application or against the original application or any patent issued on either of them, if the divisional application is filed before the issuance of the patent on the other application. If a divisional application is directed solely to subject matter described and claimed in the original application as filed, the Director may dispense with signing and execution by the inventor. The validity of a patent shall not be questioned for failure of the Director to require the application to be restricted to one invention.

*37 CFR 1.141. Different inventions in one national application.*

(a) Two or more independent and distinct inventions may not be claimed in one national application, except that more than one species of an invention, not to exceed a reasonable number, may be specifically claimed in different claims in one national application, provided the application also includes an allowable claim generic to all the claimed species and all the claims to species in excess of one are written in dependent form (§ 1.75) or otherwise include all the limitations of the generic claim.

(b) Where claims to all three categories, product, process of making, and process of use, are included in a national application, a three way requirement for restriction can only be made where the process of making is distinct from the product. If the process of making and the product are not distinct, the process of using may be joined with the claims directed to the product and the process of making the product even though a showing of distinctness between the product and process of using the product can be made.

*37 CFR 1.142. Requirement for restriction.*

(a) If two or more independent and distinct inventions are claimed in a single application, the examiner in an Office action will require the applicant in the reply to that action to elect an invention to which the claims will be restricted, this official action being called a requirement for restriction (also known as a requirement for division). Such requirement will normally be made before any action on the merits; however, it may be made at any time before final action.

(b) Claims to the invention or inventions not elected, if not canceled, are nevertheless withdrawn from further consideration by the examiner by the election, subject however to reinstatement in the event the requirement for restriction is withdrawn or overruled.

The pertinent Patent Cooperation Treaty (PCT) Articles and Rules are cited and discussed in Chapter 1800. Sections 1850, 1875, and 1893.03(d) should be consulted for discussions on unity of invention:

- (A) before the International Searching Authority;
- (B) before the International Preliminary Examining Authority; and
- (C) in the National Stage under 35 U.S.C. 371.

### **802.01 Meaning of “Independent” and “Distinct”**

35 U.S.C. 121 quoted in the preceding section states that the Commissioner may require restriction if two or more “independent and distinct” inventions are claimed in one application. In 37 CFR 1.141, the statement is made that two or more “independent and distinct inventions” may not be claimed in one application.

This raises the question of the subjects as between which the Commissioner may require restriction. This, in turn, depends on the construction of the expression “independent and distinct” inventions.

“Independent”, of course, means not dependent. If “distinct” means the same thing, then its use in the statute and in the rule is redundant. If “distinct” means something different, then the question arises as to what the difference in meaning between these two words may be. The hearings before the committees of Congress considering the codification of the patent laws indicate that 35 U.S.C. 121: “enacts as law existing practice with respect to division, at the same time introducing a number of changes.”

The report on the hearings does not mention as a change that is introduced, the subjects between which the Commissioner may properly require division.

The term “independent” as already pointed out, means not dependent. A large number of subjects between which, prior to the 1952 Act, division had been proper, are dependent subjects, such as, for example, combination and a subcombination thereof; as process and apparatus used in the practice of the process; as composition and the process in which the composition is used; as process and the product made by such process, etc. If section 121 of the 1952 Act were intended to direct the Commissioner never to approve division between dependent inventions, the word “independent” would clearly have been used alone. If the Commissioner has authority or discretion to restrict independent inventions only, then restriction would be improper as between dependent inventions, e.g., the examples used for purpose of illustration above. Such was clearly not the intent of Congress. Nothing in the language of the statute and nothing in the hearings of the committees indicate any intent to change the substantive law on this subject. On the contrary, joinder of the term “distinct” with the

term “independent”, indicates lack of such intent. The law has long been established that dependent inventions (frequently termed related inventions) such as used for illustration above may be properly divided if they are, in fact, “distinct” inventions, even though dependent.

#### **INDEPENDENT**

The term “independent” (i.e., not dependent) means that there is no disclosed relationship between the two or more subjects disclosed, that is, they are unconnected in design, operation, or effect, for example: (1) species under a genus which species are not usable together as disclosed; or (2) process and apparatus incapable of being used in practicing the process.

#### **DISTINCT**

The term “distinct” means that two or more subjects as disclosed are related, for example, as combination and part (subcombination) thereof, process and apparatus for its practice, process and product made, etc., but are capable of separate manufacture, use, or sale as claimed, AND ARE PATENTABLE (novel and unobvious) OVER EACH OTHER (though they may each be unpatentable because of the prior art). It will be noted that in this definition the term related is used as an alternative for dependent in referring to subjects other than independent subjects.

It is further noted that the terms “independent” and “distinct” are used in decisions with varying meanings. All decisions should be read carefully to determine the meaning intended.

### **802.02 Definition of Restriction**

Restriction, a generic term, includes the practice of requiring an election between distinct inventions, for example, election between combination and subcombination inventions, and the practice relating to an election between independent inventions, for example, and election of species.

### **803 Restriction - When Proper**

Under the statute an application may properly be required to be restricted to one of two or more claimed inventions only if they are able to support separate patents and they are either independent

(MPEP § 806.04 - § 806.04(i)) or distinct (MPEP § 806.05 - § 806.05(i)).

If the search and examination of an entire application can be made without serious burden, the examiner must examine it on the merits, even though it includes claims to independent or distinct inventions.

### CRITERIA FOR RESTRICTION BETWEEN PATENTABLY DISTINCT INVENTIONS

There are two criteria for a proper requirement for restriction between patentably distinct inventions:

(A) The inventions must be independent (see MPEP § 802.01, § 806.04, § 808.01) or distinct as claimed (see MPEP § 806.05 - § 806.05(i)); and

(B) There must be a serious burden on the examiner if restriction is required (see MPEP § 803.02, § 806.04(a) - § 806.04(i), § 808.01(a), and § 808.02).

### GUIDELINES

Examiners must provide reasons and/or examples to support conclusions, but need not cite documents to support the restriction requirement in most cases.

Where plural inventions are capable of being viewed as related in two ways, both applicable criteria for distinctness must be demonstrated to support a restriction requirement.

If there is an express admission that the claimed inventions are obvious over each other within the meaning of 35 U.S.C. 103, restriction should not be required. *In re Lee*, 199 USPQ 108 (Comm'r Pat. 1978).

For purposes of the initial requirement, a serious burden on the examiner may be *prima facie* shown if the examiner shows by appropriate explanation of separate classification, or separate status in the art, or a different field of search as defined in MPEP § 808.02. That *prima facie* showing may be rebutted by appropriate showings or evidence by the applicant. Insofar as the criteria for restriction practice relating to Markush-type claims is concerned, the criteria is set forth in MPEP § 803.02. Insofar as the criteria for restriction or election practice relating to claims to genus-species, see MPEP § 806.04(a) - § 806.04(i) and § 808.01(a).

### 803.01 Review by Examiner with at Least Partial Signatory Authority

Since requirements for restriction under 35 U.S.C. 121 are discretionary with the Commissioner, it becomes very important that the practice under this section be carefully administered. Notwithstanding the fact that this section of the statute apparently protects the applicant against the dangers that previously might have resulted from compliance with an improper requirement for restriction, IT STILL REMAINS IMPORTANT FROM THE STANDPOINT OF THE PUBLIC INTEREST THAT NO REQUIREMENTS BE MADE WHICH MIGHT RESULT IN THE ISSUANCE OF TWO PATENTS FOR THE SAME INVENTION. Therefore, to guard against this possibility, only an examiner with permanent or temporary full signatory authority may sign final and non-final Office actions containing a final requirement for restriction, except that an examiner with permanent or temporary partial signatory authority may sign non-final Office actions containing a final requirement for restriction.

### 803.02 Restriction — Markush Claims

#### PRACTICE RE MARKUSH-TYPE CLAIMS

If the members of the Markush group are sufficiently few in number or so closely related that a search and examination of the entire claim can be made without serious burden, the examiner must examine all the members of the Markush group in the claim on the merits, even though they are directed to independent and distinct inventions. In such a case, the examiner will not follow the procedure described below and will not require restriction.

Since the decisions in *In re Weber*, 580 F.2d 455, 198 USPQ 328 (CCPA 1978) and *In re Haas*, 580 F.2d 461, 198 USPQ 334 (CCPA 1978), it is improper for the Office to refuse to examine that which applicants regard as their invention, unless the subject matter in a claim lacks unity of invention. *In re Harnish*, 631 F.2d 716, 206 USPQ 300 (CCPA 1980); and *Ex parte Hozumi*, 3 USPQ2d 1059 (Bd. Pat. App. & Int. 1984). Broadly, unity of invention exists where compounds included within a Markush group (1) share a

common utility, and (2) share a substantial structural feature disclosed as being essential to that utility.

This subsection deals with Markush-type generic claims which include a plurality of alternatively usable substances or members. In most cases, a recitation by enumeration is used because there is no appropriate or true generic language. A Markush-type claim can include independent and distinct inventions. This is true where two or more of the members are so unrelated and diverse that a prior art reference anticipating the claim with respect to one of the members would not render the claim obvious under 35 U.S.C. 103 with respect to the other member(s). In applications containing claims of that nature, the examiner may require a provisional election of a single species prior to examination on the merits. The provisional election will be given effect in the event that the Markush-type claim should be found not allowable. Following election, the Markush-type claim will be examined fully with respect to the elected species and further to the extent necessary to determine patentability. If the Markush-type claim is not allowable over the prior art, examination will be limited to the Markush-type claim and claims to the elected species, with claims drawn to species patentably distinct from the elected species held withdrawn from further consideration.

As an example, in the case of an application with a Markush-type claim drawn to the compound C-R, wherein R is a radical selected from the group consisting of A, B, C, D, and E, the examiner may require a provisional election of a single species, CA, CB, CC, CD, or CE. The Markush-type claim would then be examined fully with respect to the elected species and any species considered to be clearly unpatentable over the elected species. If on examination the elected species is found to be anticipated or rendered obvious by prior art, the Markush-type claim and claims to the elected species shall be rejected, and claims to the nonelected species would be held withdrawn from further consideration. As in the prevailing practice, a second action on the rejected claims would be made final.

On the other hand, should no prior art be found that anticipates or renders obvious the elected species, the search of the Markush-type claim will be extended. If prior art is then found that anticipates or renders obvious the Markush-type claim with respect to a *nonelected species*, the Markush-type claim shall be

rejected and claims to the nonelected species held withdrawn from further consideration. The prior art search, however, will not be extended unnecessarily to cover all nonelected species. Should applicant, in response to this rejection of the Markush-type claim, overcome the rejection, as by amending the Markush-type claim to exclude the species anticipated or rendered obvious by the prior art, the amended Markush-type claim will be reexamined. The prior art search will be extended to the extent necessary to determine patentability of the Markush-type claim. In the event prior art is found during the reexamination that anticipates or renders obvious the amended Markush-type claim, the claim will be rejected and the action made final. Amendments submitted after the final rejection further restricting the scope of the claim may be denied entry.

### 803.03 Restriction — Transitional Applications

#### PRACTICE RE TRANSITIONAL APPLICATION

*37 CFR 1.129. Transitional procedures for limited examination after final rejection and restriction practice.*

\*\*\*\*\*

(b)(1) In an application, other than for reissue or a design patent, that has been pending for at least three years as of June 8, 1995, taking into account any reference made in the application to any earlier filed application under 35 U.S.C. 120, 121 and 365(c), no requirement for restriction or for the filing of divisional applications shall be made or maintained in the application after June 8, 1995, except where:

(i) The requirement was first made in the application or any earlier filed application under 35 U.S.C. 120, 121 and 365(c) prior to April 8, 1995;

(ii) The examiner has not made a requirement for restriction in the present or parent application prior to April 8, 1995, due to actions by the applicant; or

(iii) The required fee for examination of each additional invention was not paid.

(2) If the application contains more than one independent and distinct invention and a requirement for restriction or for the filing of divisional applications cannot be made or maintained pursuant to this paragraph, applicant will be so notified and given a time period to:

(i) Elect the invention or inventions to be searched and examined, if no election has been made prior to the notice, and pay the fee set forth in 1.17(s) for each independent and distinct invention claimed in the application in excess of one which applicant elects;



(ii) Confirm an election made prior to the notice and pay the fee set forth in § 1.17(s) for each independent and distinct invention claimed in the application in addition to the one invention which applicant previously elected; or

(iii) File a petition under this section traversing the requirement. If the required petition is filed in a timely manner, the original time period for electing and paying the fee set forth in § 1.17(s) will be deferred and any decision on the petition affirming or modifying the requirement will set a new time period to elect the invention or inventions to be searched and examined and to pay the fee set forth in § 1.17(s) for each independent and distinct invention claimed in the application in excess of one which applicant elects.

(3) The additional inventions for which the required fee has not been paid will be withdrawn from consideration under § 1.142(b). An applicant who desires examination of an invention so withdrawn from consideration can file a divisional application under 35 U.S.C. 121.

(c) The provisions of this section shall not be applicable to any application filed after June 8, 1995.

“Restriction” under 37 CFR 1.129(b) applies to both restriction requirements under 37 CFR 1.142 and election of species requirements under 37 CFR 1.146.

37 CFR 1.129(b)(1) provides for examination of more than one independent and distinct invention in certain applications pending for 3 years or longer as of June 8, 1995, taking into account any reference to any earlier application under 35 U.S.C. 120, 121, or 365(c). Applicant will not be permitted to have such additional invention(s) examined in an application if:

(A) the requirement was made in the application or in an earlier application relied on under 35 U.S.C. 120, 121, or 365(c) prior to April 8, 1995;

(B) no restriction requirement was made with respect to the invention(s) in the application or earlier application prior to April 8, 1995, due to actions by the applicant; or

(C) the required fee for examination of each additional invention was not paid.

Only if one of these exceptions applies is a normal restriction requirement appropriate and telephone restriction practice may be used.

Examples of what constitute “actions by the applicant” in 37 CFR 1.129(b)(1) are:

(A) applicant abandoned the application and continued to refile the application such that no Office action could be issued in the application,

(B) applicant requested suspension of prosecution under 37 CFR 1.103(a) such that no Office action could be issued in the application,

(C) applicant disclosed a plurality of independent and distinct inventions in the present or parent application, but delayed presenting claims to more than one of the disclosed independent and distinct inventions in the present or parent application such that no restriction requirement could be made prior to April 8, 1995, and

(D) applicant combined several applications, each of which claimed a different independent and distinct invention, into one large “continuing” application, but delayed filing the continuing application first claiming more than one independent and distinct invention such that no restriction requirement could be made prior to April 8, 1995.

In examples (A) and (B), the fact that the present or parent application claiming independent and distinct inventions was on an examiner’s docket for at least 3 months prior to abandonment or suspension, or in examples (C) and (D), the fact that the amendment claiming independent and distinct inventions was first filed, or the continuing application first claiming the additional independent and distinct inventions was on an examiner’s docket, at least 3 months prior to April 8, 1995, is *prima facie* evidence that applicant’s actions did not prevent the Office from making a requirement for restriction with respect to those independent and distinct inventions prior to April 8, 1995. Furthermore, an extension of time under 37 CFR 1.136(a) does not constitute such “actions by the applicant” under 37 CFR 1.129(b)(1).

**NOTE:** If an examiner believes an application falls under the exception that no restriction could be made prior to April 8, 1995, due to applicant’s action, the application must be brought to the attention of the Technology Center (TC) Special Program Examiner for review.

Under 37 CFR 1.129(b)(2), if the application contains claims to more than one independent and distinct invention, and no requirement for restriction or for the filing of divisional applications can be made or maintained, applicant will be notified and given a time period to:

(A) elect the invention or inventions to be searched and examined, if no election has been made prior to the notice, and pay the fee set forth in 37 CFR 1.17(s) for each independent and distinct invention claimed in the application in excess of one which applicant elects,

(B) in situations where an election was made in reply to a requirement for restriction that cannot be maintained, confirm the election made prior to the notice and pay the fee set forth in 37 CFR 1.17(s) for each independent and distinct invention claimed in the application in addition to the one invention which applicant previously elected, or

(C) file a petition under 37 CFR 1.129(b)(2) traversing the requirement without regard to whether the requirement has been made final. No petition fee is required.

37 CFR 1.129(b)(2) also provides that if the petition is filed in a timely manner, the original time period for electing and paying the fee set forth in 37 CFR 1.17(s) will be deferred and any decision on the petition affirming or modifying the requirement will set a new time period to elect the invention or inventions to be searched and examined and to pay the fee set forth in 37 CFR 1.17(s) for each independent and distinct invention claimed in the application in excess of one which applicant elects.

Under 37 CFR 1.129(b)(3), each additional invention for which the required fee set forth in 37 CFR 1.17(s) has not been paid will be withdrawn from consideration under 37 CFR 1.142(b). An applicant who desires examination of an invention so withdrawn from consideration can file a divisional application under 35 U.S.C. 121.

37 CFR 1.129(c) clarifies that the provisions of 37 CFR 1.129(a) and (b) are not applicable to any application filed after June 8, 1995. However, any application filed on June 8, 1995, would be subject to a 20-year patent term.

Form paragraph 8.41 may be used to notify applicant that the application is a transitional application and is entitled to consideration of additional inventions upon payment of the required fee.

*¶ 8.41 Transitional Restriction or Election of Species Requirement To Be Mailed After June 8, 1995*

This application is subject to the transitional restriction provisions of Public Law 103-465, which became effective on June 8, 1995, because:

1. the application was filed on or before June 8, 1995, and has an effective U.S. filing date of June 8, 1992, or earlier;
2. a requirement for restriction was not made in the present or a parent application prior to April 8, 1995; and
3. the examiner was not prevented from making a requirement for restriction in the present or a parent application prior to April 8, 1995, due to actions by the applicant.

The transitional restriction provisions permit applicant to have more than one independent and distinct invention examined in the same application by paying a fee for each invention in excess of one.

Final rules concerning the transition restriction provisions were published in the *Federal Register* at 60 FR 20195 (April 25, 1995) and in the *Official Gazette* at 1174 O.G. 15 (May 2, 1995). The final rules at 37 CFR 1.17(s) include the fee amount required to be paid for each additional invention as set forth in the following requirement for restriction. See the current fee schedule for the proper amount of the fee.

Applicant must either: (1) elect the invention or inventions to be searched and examined and pay the fee set forth in 37 CFR 1.17(s) for each independent and distinct invention in excess of one which applicant elects; or (2) file a petition under 37 CFR 1.129(b) traversing the requirement.

**Examiner Note:**

1. This form paragraph should be used in all restriction or election of species requirements made in applications subject to the transition restriction provisions set forth in 37 CFR 1.129(b) where the requirement is being mailed after June 8, 1995. The procedure is NOT applicable to any design or reissue application.

**803.03(a) Transitional Application — Linking Claim Allowable**

Whenever divided inventions in a transitional application are rejoined because a linking claim is allowed (MPEP § 809) and applicant paid the fee set forth in 37 CFR 1.17(s) for the additional invention, applicant should be notified that he or she may request a refund of the fee paid for that additional invention.

**803.03(b) Transitional Application — Generic Claim Allowable**

Whenever claims drawn to an additional species in a transitional application for which applicant paid the fee set forth in 37 CFR 1.17(s) are no longer withdrawn from consideration because they are fully embraced by an allowed generic claim, applicant should be notified that he or she may request a refund of the fee paid for that additional species.

**803.03(b)**

## MANUAL OF PATENT EXAMINING PROCEDURE

The determination of when claims to a nonelected species would no longer be withdrawn from consideration should be made as indicated in MPEP § 809.02(b), § 809.02(c), or § 809.02(d).

**Transitional Restriction Provision - 37 CFR 1.129(b)**

**Starting June 8, 1995**

**No Telephone restriction**

**Charge time for examination of additional inventions to 112055**

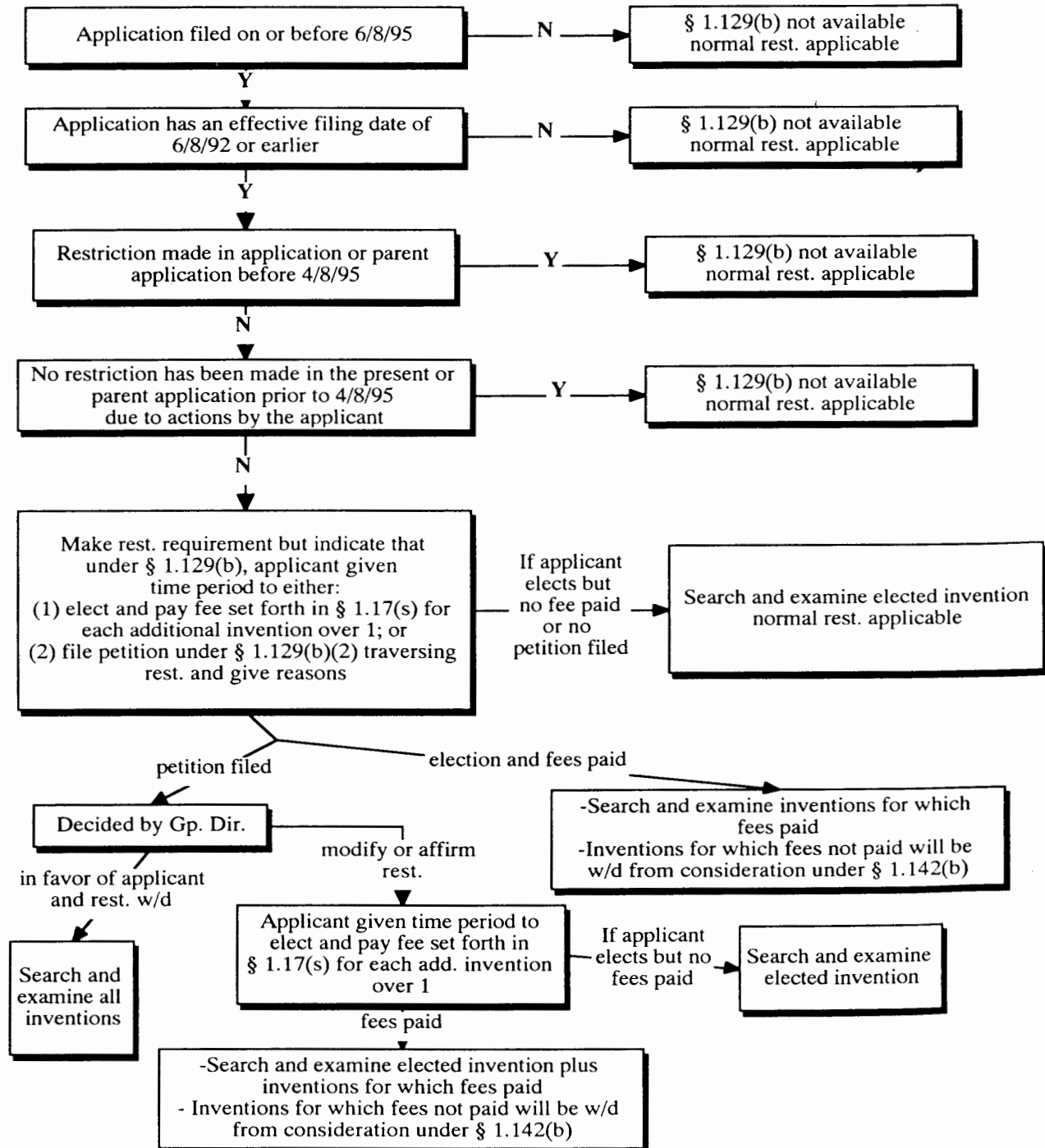

## 803.04 Restriction - Nucleotide Sequences

By statute, “[i]f two or more independent and distinct inventions are claimed in one application, the Commissioner may require the application to be restricted to one of the inventions.” 35 U.S.C. 121. Pursuant to this statute, the rules provide that “[i]f two or more independent and distinct inventions are claimed in a single application, the examiner in his action shall require the applicant . . . to elect that invention to which his claim shall be restricted.” 37 CFR 1.142(a). See also 37 CFR 1.141(a).

Nucleotide sequences encoding different proteins are structurally distinct chemical compounds and are unrelated to one another. These sequences are thus deemed to normally constitute independent and distinct inventions within the meaning of 35 U.S.C. 121. Absent evidence to the contrary, each such nucleotide sequence is presumed to represent an independent and distinct invention, subject to a restriction requirement pursuant to 35 U.S.C. 121 and 37 CFR 1.141 *et seq.* Nevertheless, to further aid the biotechnology industry in protecting its intellectual property without creating an undue burden on the Office, the Commissioner has decided *sua sponte* to partially waive the requirements of 37 CFR 1.141 *et seq.* and permit a reasonable number of such nucleotide sequences to be claimed in a single application. See *Examination of Patent Applications Containing Nucleotide Sequences*, 1192 O.G. 68 (November 19, 1996).

It has been determined that normally ten sequences constitute a reasonable number for examination purposes. Accordingly, in most cases, up to ten independent and distinct nucleotide sequences will be examined in a single application without restriction. In addition to the specifically selected sequences, those sequences which are patentably indistinct from the selected sequences will also be examined. Furthermore, nucleotide sequences encoding the same protein are not considered to be independent and distinct inventions and will continue to be examined together.

In some exceptional cases, the complex nature of the claimed material, for example a protein amino acid sequence reciting three dimensional folds, may necessitate that the reasonable number of sequences to be selected be less than ten. In other cases, applicants

may petition pursuant to 37 CFR 1.181 for examination of additional nucleotide sequences by providing evidence that the different nucleotide sequences do not cover independent and distinct inventions.

See MPEP § 1850 for treatment of claims containing independent and distinct nucleotide sequences in international applications filed under the Patent Cooperation Treaty (PCT) and national stage applications filed under 35 U.S.C. 371.

### EXAMPLES OF NUCLEOTIDE SEQUENCE CLAIMS

Examples of typical nucleotide sequence claims impacted by the partial waiver of 37 CFR 1.141 *et seq.* (and the partial waiver of 37 CFR 1.475 and 1.499 *et seq.*, see MPEP § 1850) include:

(A) an isolated and purified DNA fragment comprising DNA having at least 95% identity to a DNA sequence selected from SEQ ID Nos. 1-1,000;

(B) a combination of DNA fragments comprising SEQ ID Nos. 1-1,000; and

(C) a combination of DNA fragments, said combination containing at least thirty different DNA fragments selected from SEQ ID Nos. 1-1,000.

Applications claiming more than ten individual independent and distinct nucleotide sequences in alternative form, such as set forth in example (A), will be subject to a restriction requirement. Only the ten nucleotide sequences selected in response to the restriction requirement and any other claimed sequences which are patentably indistinct therefrom will be examined.

Applications claiming only a combination of nucleotide sequences, such as set forth in example (B), will generally not be subject to a restriction requirement. The presence of one novel and nonobvious sequence within the combination will render the entire combination allowable. The combination will be searched until one nucleotide sequence is found to be allowable. The order of searching will be chosen by the examiner to maximize the identification of an allowable sequence. If no individual nucleotide sequence is found to be allowable, the examiner will consider whether the combination of sequences taken as a whole renders the claim allowable.

Applications containing only composition claims reciting different combinations of individual

nucleotide sequences, such as set forth in example (C), will be subject to a restriction requirement. Applicants will be required to select one combination for examination. If the selected combination contains ten or fewer sequences, all of the sequences of the combination will be searched. If the selected combination contains more than ten sequences, the combination will be examined following the procedures set forth above for example (B). More specifically, the combination will be searched until one nucleotide sequence is found to be allowable with the examiner choosing the order of search to maximize the identification of an allowable sequence. The identification of any allowable sequence(s) will cause all combinations containing the allowed sequence(s) to be allowed.

In applications containing all three claims set forth in examples (A)-(C), the Office will require restriction of the application to ten sequences for initial examination purposes. Based upon the finding of allowable sequences, claims limited to the allowable sequences as in example (A), all combinations, such as in examples (B) and (C), containing the allowable sequences and any patentably indistinct sequences will be rejoined and allowed.

Rejoinder will be permitted for claims requiring any allowable sequence(s). Any claims which have been restricted and nonselected and which are limited to the allowable sequence(s) will be rejoined and examined.

## 804 Definition of Double Patenting

### *35 U.S.C. 101. Inventions Patentable.*

Whoever invents or discovers any new and useful process, machine, manufacture, or composition of matter or any new and useful improvement thereof, may obtain a patent therefor, subject to the conditions and requirements of this title.

### *35 U.S.C. 121. Divisional Applications.*

If two or more independent and distinct inventions are claimed in one application, the Director may require the application to be restricted to one of the inventions. If the other invention is made the subject of a divisional application which complies with the requirements of section 120 of this title it shall be entitled to the benefit of the filing date of the original application. A patent issuing on an application with respect to which a requirement for restriction under this section has been made, or on an application filed as a result of such a requirement, shall not be used as a reference either in the Patent and Trademark Office or in the courts against a divisional application or against the original application or any patent issued on either of them, if the divisional application is filed before the issuance of the patent on the other application.

If a divisional application is directed solely to subject matter described and claimed in the original application as filed, the Director may dispense with signing and execution by the inventor. The validity of a patent shall not be questioned for failure of the Director to require the application to be restricted to one invention.

The doctrine of double patenting seeks to prevent the unjustified extension of patent exclusivity beyond the term of a patent. The public policy behind this doctrine is that:

The public should . . . be able to act on the assumption that upon the expiration of the patent it will be free to use not only the invention claimed in the patent but also modifications or variants which would have been obvious to those of ordinary skill in the art at the time the invention was made, taking into account the skill in the art and prior art other than the invention claimed in the issued patent.

*In re Zickendraht*, 319 F.2d 225, 232, 138 USPQ 22, 27 (CCPA 1963) (Rich, J., concurring). Double patenting results when the right to exclude granted by a first patent is unjustly extended by the grant of a later issued patent or patents. *In re Van Ornum*, 686 F.2d 937, 214 USPQ 761 (CCPA 1982).

Before consideration can be given to the issue of double patenting, there must be some common relationship of inventorship and/or ownership of two or more patents or applications. Since the doctrine of double patenting seeks to avoid unjustly extending patent rights at the expense of the public, the focus of any double patenting analysis necessarily is on the claims in the multiple patents or patent applications involved in the analysis.

There are generally two types of double patenting rejections. One is the “same invention” type double patenting rejection based on 35 U.S.C. 101 which states in the singular that an inventor “may obtain a patent”. The second is the “nonstatutory-type” double patenting rejection based on a judicially created doctrine grounded in public policy and which is primarily intended to prevent prolongation of the patent term by prohibiting claims in a second patent not patentably distinguishing from claims in a first patent. Nonstatutory double patenting includes rejections based on one-way determination of obviousness and on two-way determination of obviousness. Nonstatutory double patenting could include a rejection which is not the usual “obviousness-type” double patenting rejection. This type of double patenting rejection is rare and is limited to the particular facts of the case. *In re*

*Schneller*, 397 F.2d 350, 158 USPQ 210 (CCPA 1968).

Refer to Charts I-A, I-B, II-A, II-B, III-A, and III-B for an overview of the treatment of applications

having conflicting claims (e.g., where a claim in an application is not patentably distinct from a claim in a patent or another application).

**CONFLICTING CLAIMS BETWEEN:  
TWO APPLICATIONS \***

CHART I-A

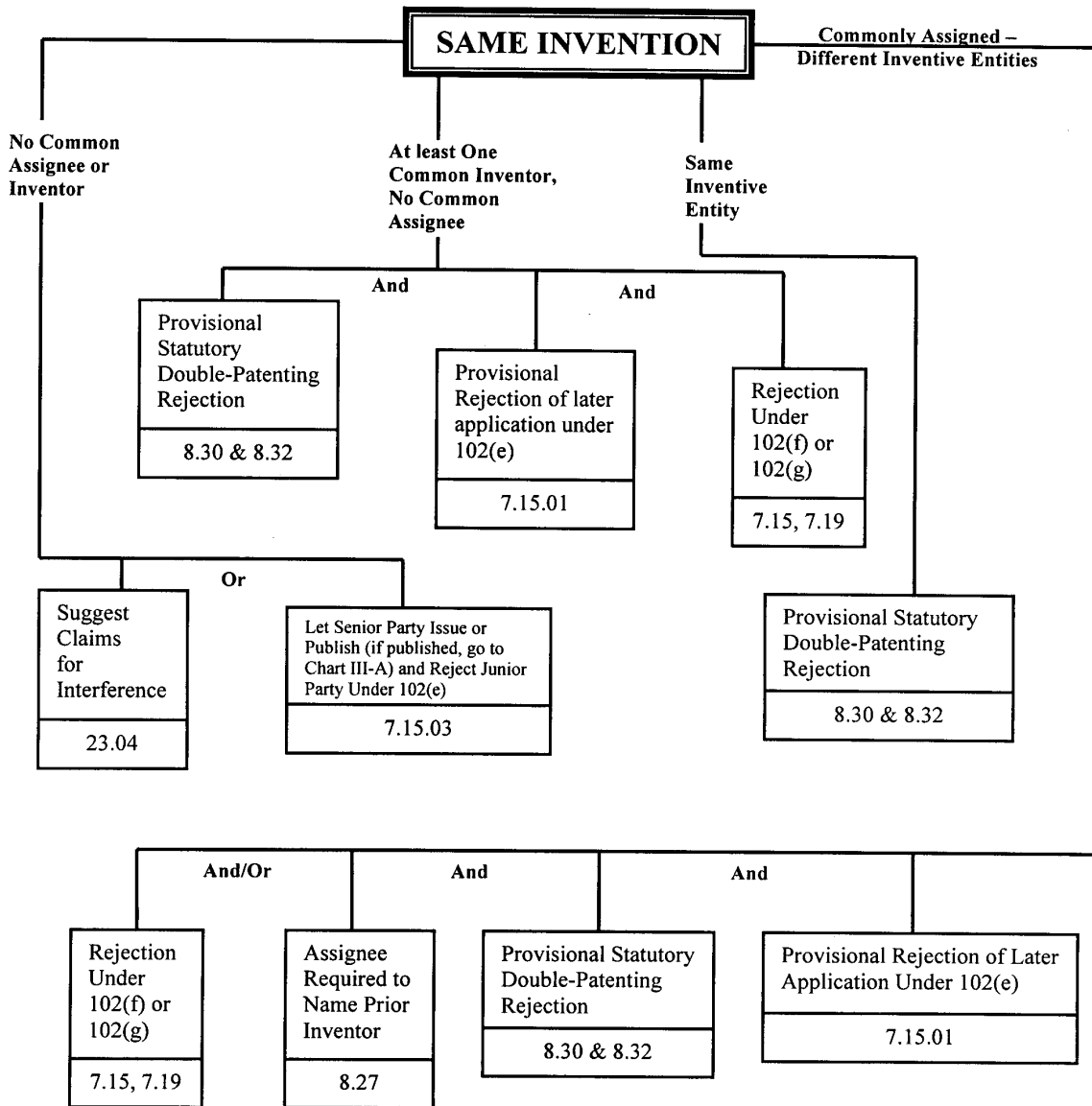

\* This chart applies where the application being applied as a reference has NOT been published.



**CONFLICTING CLAIMS BETWEEN:  
TWO APPLICATIONS \***

**CHART I-B**

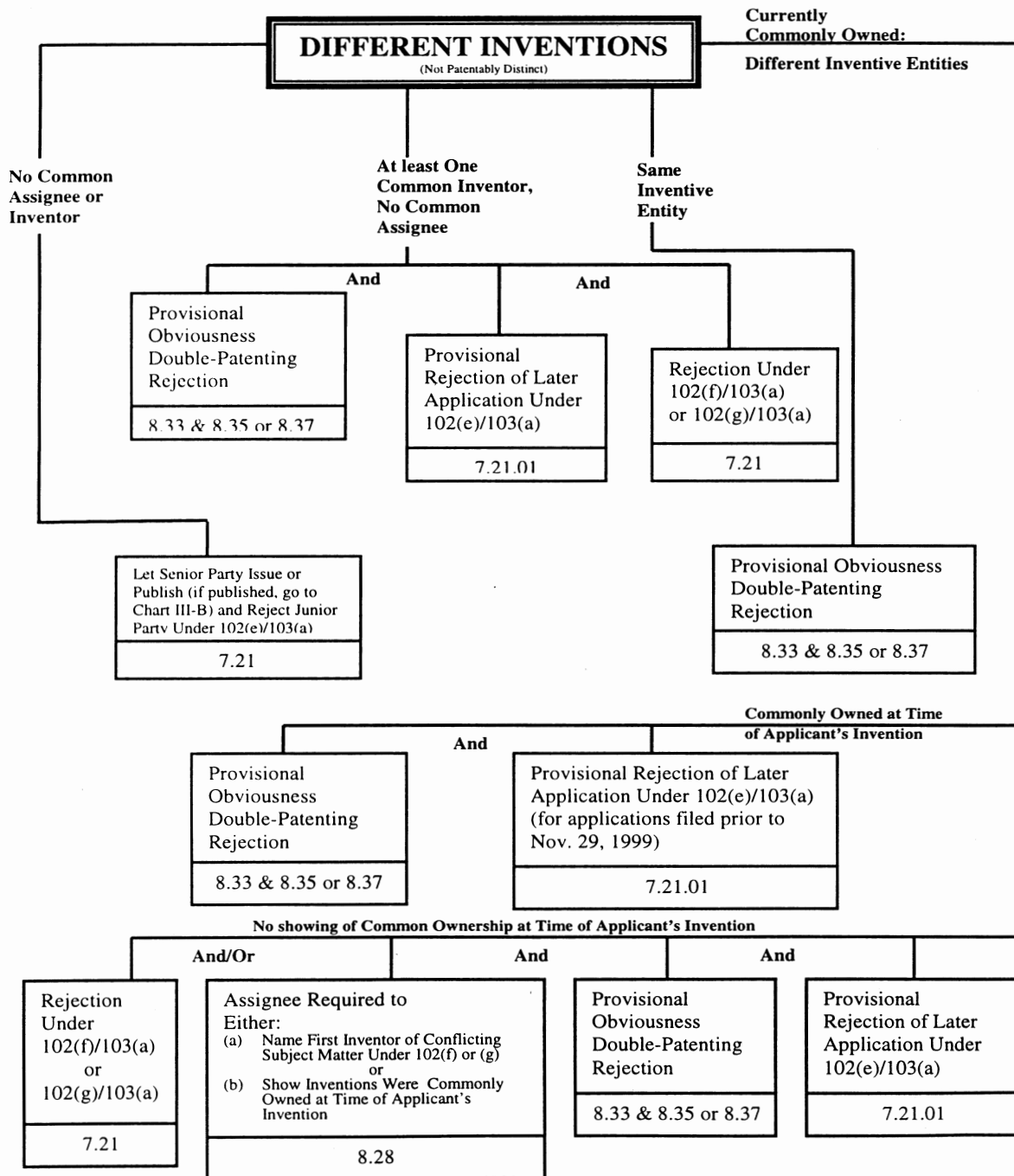

\* This chart applies where the application being applied as a reference has NOT been published.

**CONFLICTING CLAIMS BETWEEN:  
APPLICATION AND A PATENT**

CHART II-A

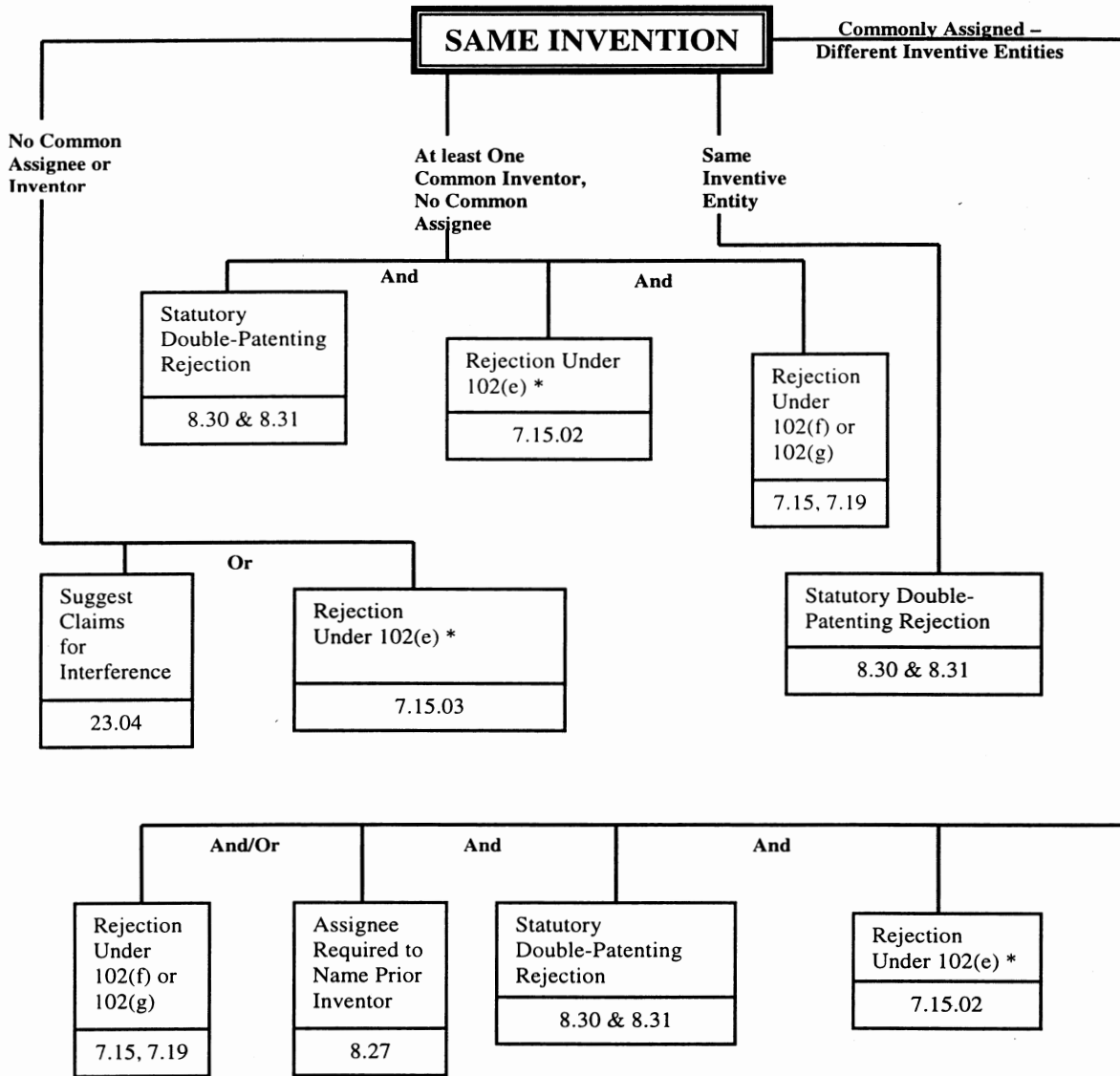

\* A rejection under 35 U.S.C. 102(e) would NOT be appropriate where the application being examined was filed on or after Nov. 29, 2000 or filed prior to Nov. 29, 2000 and voluntarily published, and the reference patent issued from an international application (reference patent has no 102(e) prior art effect).

**CONFLICTING CLAIMS BETWEEN:  
APPLICATION AND A PATENT**

**CHART II-B**

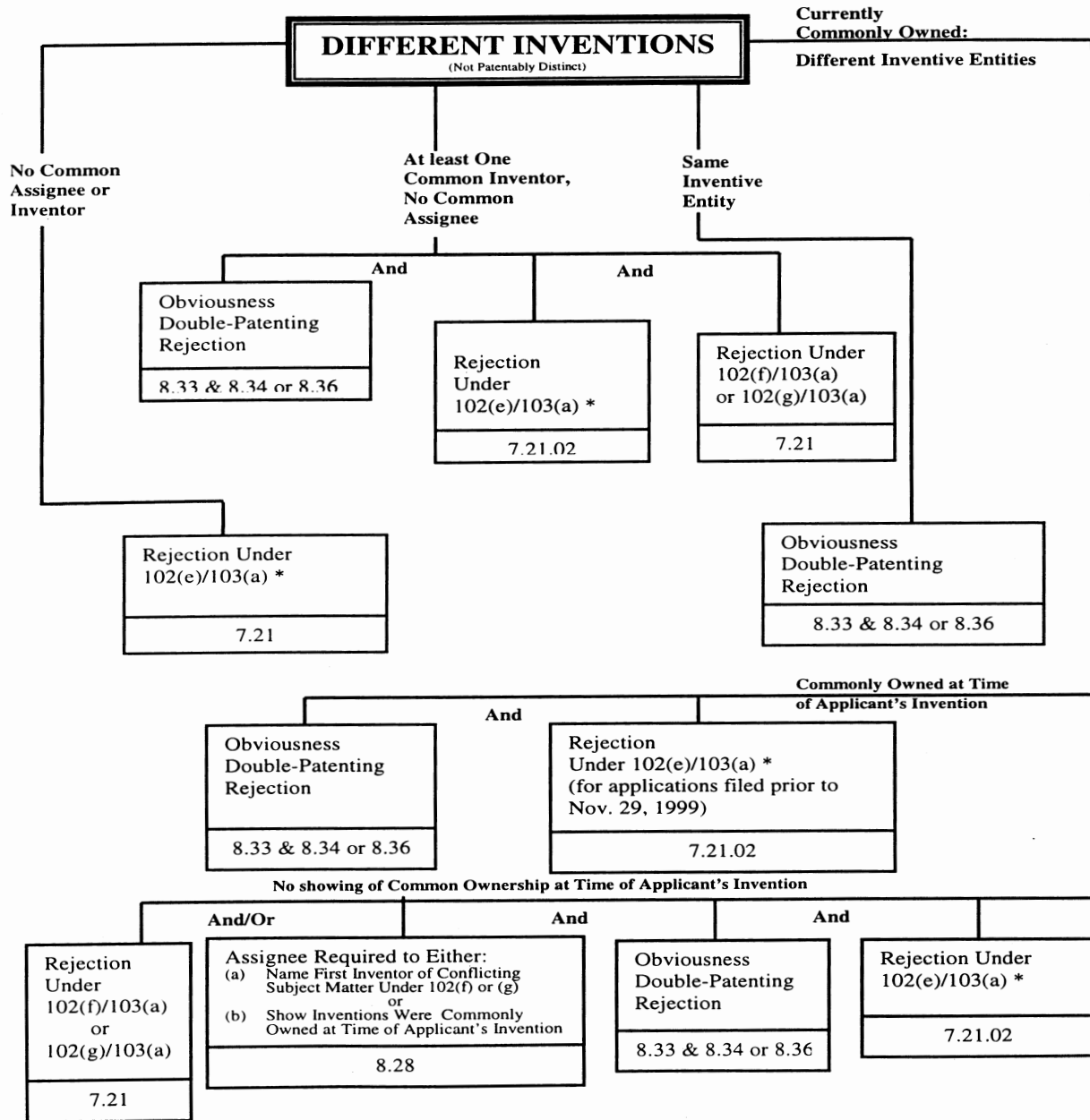

\*The reference patent would NOT be prior art under 35 U.S.C. 102(e) where the patent issued from an international application and the application being examined was filed on or after Nov. 29, 2000 or filed prior to Nov. 29, 2000 and voluntarily published.

**CONFLICTING CLAIMS BETWEEN:  
APPLICATION AND A PUBLISHED  
APPLICATION**

CHART III-A

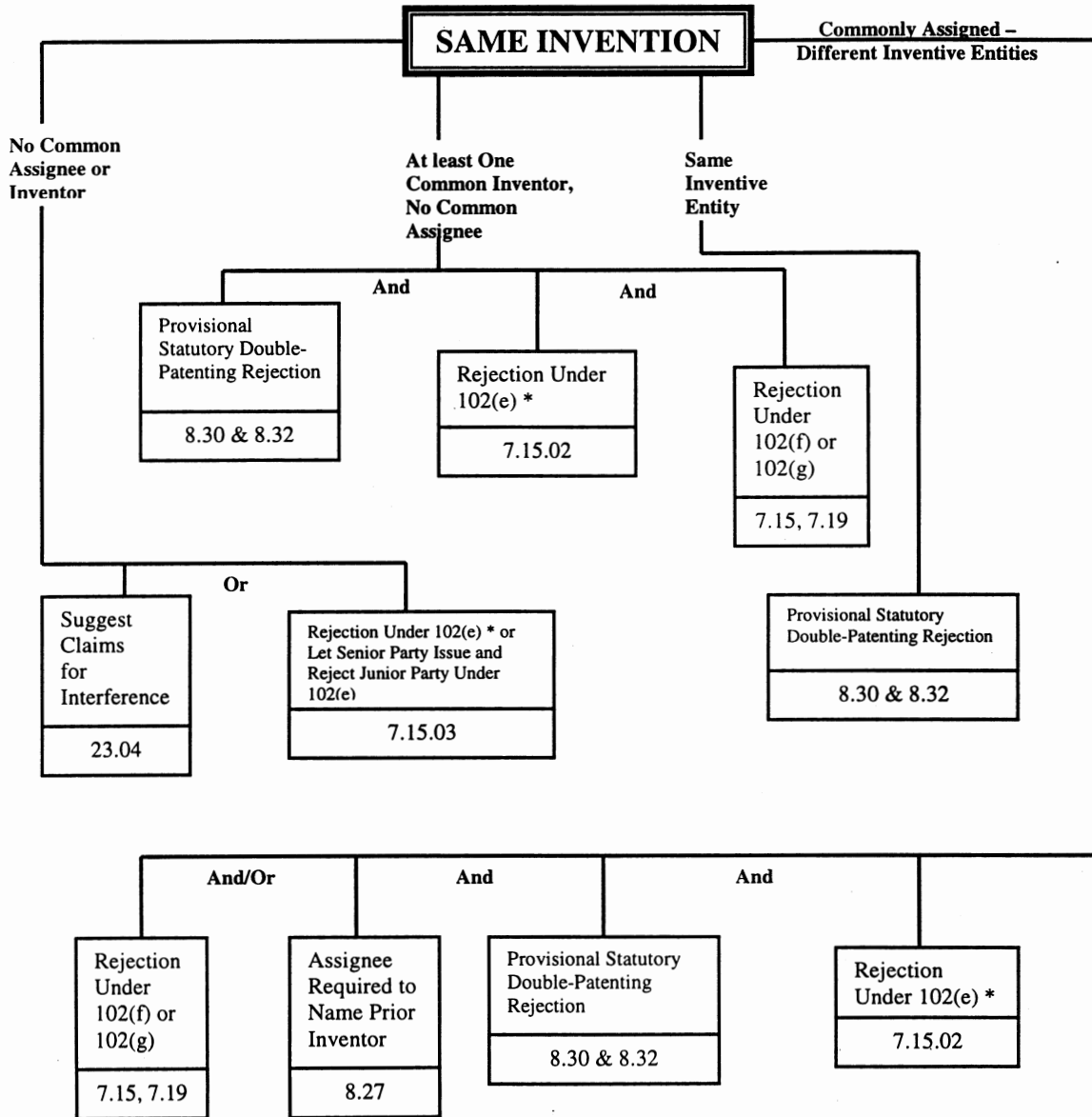

\* Apply 35 U.S.C. 102(e) rejection if the application being examined was filed on or after Nov. 29, 2000 or filed prior to Nov. 29, 2000 and voluntarily published, otherwise, apply rejection under 35 U.S.C. 102(a) or (b), where appropriate and make a "provisional" rejection of the later application under 35 U.S.C. 102(e) using form paragraph 7.15.01.

**CONFLICTING CLAIMS BETWEEN:  
APPLICATION AND A PUBLISHED  
APPLICATION**

CHART III-B

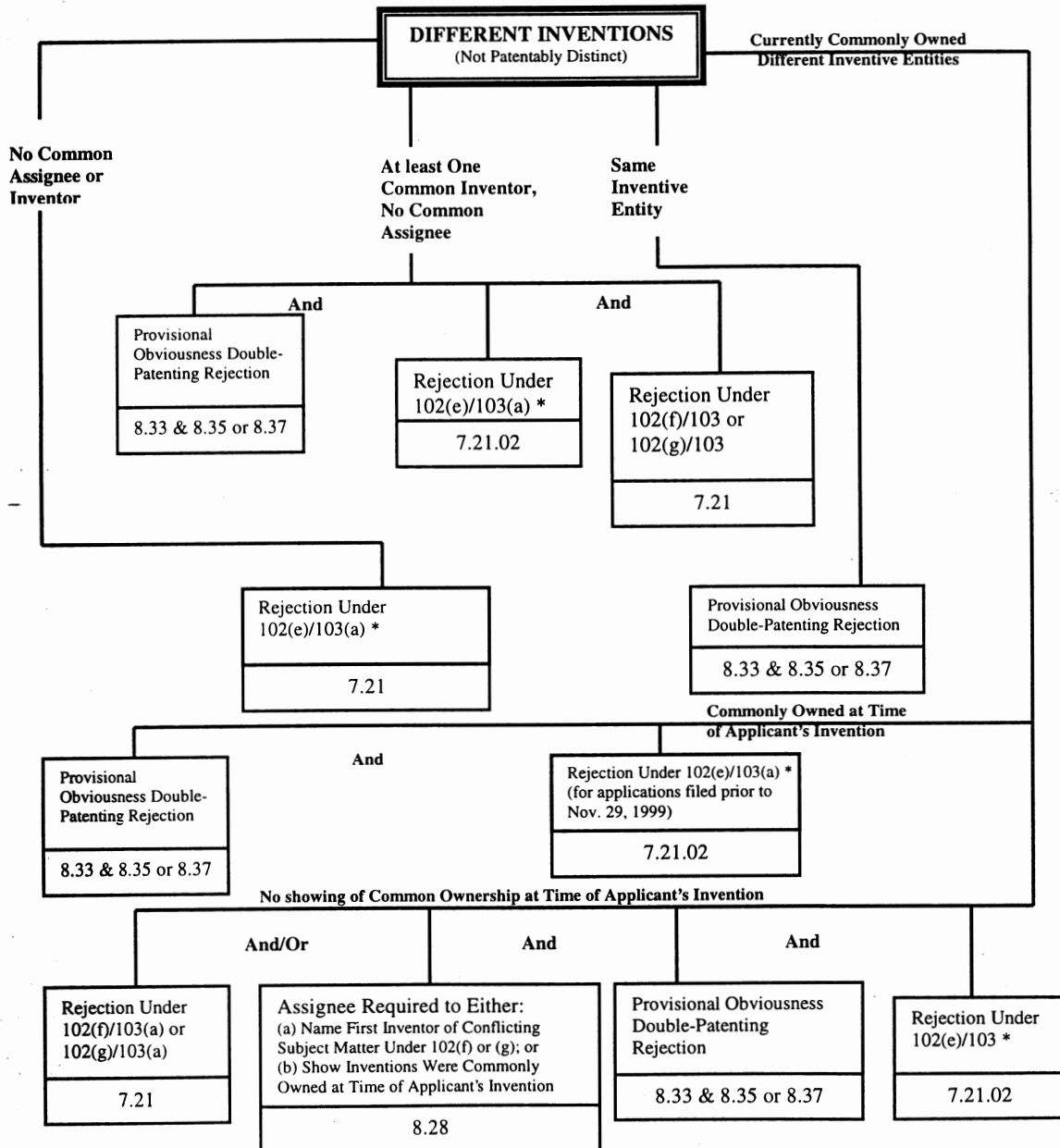

\* Apply 35 U.S.C. 102(e)/103(a) rejection if the application being examined was filed on or after Nov. 29, 2000 or filed prior to Nov. 29, 2000 and voluntarily published, otherwise, apply rejection under 35 U.S.C. 102(a)/103(a) or 102(b)/103(a), where appropriate and make a "provisional" rejection of the later application under 35 U.S.C. 102(e)/103(a) using form paragraph 7.21.01.

## **I. INSTANCES WHERE DOUBLE PATENTING ISSUE CAN BE RAISED**

A double patenting issue may arise between two or more pending applications, between one or more pending applications and a patent, or between one or more pending applications and a published application. A double patenting issue may likewise arise in a reexamination proceeding between the patent claims being reexamined and the claims of one or more applications and/or patents. Double patenting does not relate to international applications which have not yet entered the national stage in the United States.

### **A. *Between Issued Patent and One or More Applications***

Double patenting may exist between an issued patent and an application filed by the same inventive entity, or by an inventive entity having a common inventor with the patent, and/or by the owner of the patent. Since the inventor/patent owner has already secured the issuance of a first patent, the examiner must determine whether the grant of a second patent would give rise to an unjustified extension of the rights granted in the first patent.

### **B. *Between Copending Applications—Provisional Rejections***

Occasionally, the examiner becomes aware of two copending applications filed by the same inventive entity, or by different inventive entities having a common inventor, and/or by a common assignee that would raise an issue of double patenting if one of the applications became a patent. Where this issue can be addressed without violating the confidential status of applications (35 U.S.C. 122), the courts have sanctioned the practice of making applicant aware of the potential double patenting problem if one of the applications became a patent by permitting the examiner to make a “provisional” rejection on the ground of double patenting. *In re Mott*, 539 F.2d 1291, 190 USPQ 536 (CCPA 1976); *In re Wetterau*, 356 F.2d 556, 148 USPQ 499 (CCPA 1966). The merits of such a provisional rejection can be addressed by both the applicant and the examiner without waiting for the first patent to issue.

The “provisional” double patenting rejection should continue to be made by the examiner in each

application as long as there are conflicting claims in more than one application unless that “provisional” double patenting rejection is the only rejection remaining in one of the applications. If the “provisional” double patenting rejection in one application is the only rejection remaining in that application, the examiner should then withdraw that rejection and permit the application to issue as a patent, thereby converting the “provisional” double patenting rejection in the other application(s) into a double patenting rejection at the time the one application issues as a patent.

If the “provisional” double patenting rejections in both applications are the only rejections remaining in those applications, the examiner should then withdraw that rejection in one of the applications (e.g., the application with the earlier filing date) and permit the application to issue as a patent. The examiner should maintain the double patenting rejection in the other application as a “provisional” double patenting rejection which will be converted into a double patenting rejection when the one application issues as a patent.

### **C. *Between One or More Applications and a Published Application - Provisional Rejections***

Double patenting may exist between a published patent application and an application filed by the same inventive entity, or by different inventive entities having a common inventor, and/or by a common assignee. Since the published application has not yet issued as a patent, the examiner is permitted to make a “provisional” rejection on the ground of double patenting. See the discussion regarding “provisional” double patenting rejection in subsection B. above.

### **D. *Reexamination Proceedings***

A double patenting issue may raise a substantial new question of patentability of a claim of a patent, and thus be addressed in a reexamination proceeding. *In re Lonardo*, 119 F.3d 960, 966, 43 USPQ2d 1262, 1266 (Fed. Cir. 1997) (In giving the Commissioner authority under 35 U.S.C. 303(a) in determining the presence of a substantial new question of patentability, “Congress intended that the phrases ‘patents and publications’ and ‘other patents or publications’ in section 303(a) not be limited to *prior art* patents or printed publications.” (emphasis added)). Accordingly, if the issue of double patenting was not

addressed during original prosecution, it may be considered during reexamination.

## II. REQUIREMENTS OF A DOUBLE PATENTING REJECTION (INCLUDING PROVISIONAL REJECTIONS)

When a double patenting rejection is appropriate, it must be based either on statutory grounds or nonstatutory grounds. The ground of rejection employed depends upon the relationship of the inventions being claimed. Generally, a double patenting rejection is not permitted where the claimed subject matter is presented in a divisional application as a result of a restriction requirement made in a parent application under 35 U.S.C. 121.

Where the claims of an application are substantively the same as those of a first patent, they are barred under 35 U.S.C. 101 - the statutory basis for a double patenting rejection. A rejection based on double patenting of the “same invention” type finds its support in the language of 35 U.S.C. 101 which states that “whoever invents or discovers any new and useful process ... may obtain a patent therefor ....” Thus, the term “same invention,” in this context, means an invention drawn to identical subject matter. *Miller v. Eagle Mfg. Co.*, 151 U.S. 186 (1894); *In re Vogel*, 422 F.2d 438, 164 USPQ 619 (CCPA 1970); and *In re Ockert*, 245 F.2d 467, 114 USPQ 330 (CCPA 1957). Where the claims of an application are not the “same” as those of a first patent, but the grant of a patent with the claims in the application would unjustly extend the rights granted by the first patent, a double patenting rejection under nonstatutory grounds is proper.

In determining whether a proper basis exists to enter a double patenting rejection, the examiner must determine the following:

(A) Whether a double patenting rejection is prohibited by the third sentence of 35 U.S.C. 121 (see MPEP § 804.01; if such a prohibition applies, a double patenting rejection cannot be made);

(B) Whether a statutory basis exists; and

(C) Whether a nonstatutory basis exists.

Each determination must be made on the basis of all the facts in the application before the examiner. Charts I-A, I-B, II-A, II-B, III-A, and III-B illustrate the methodology of making such a determination.

Domination and double patenting should not be confused. They are two separate issues. One patent or application “dominates” a second patent or application when the first patent or application has a broad or generic claim which fully encompasses or reads on an invention defined in a narrower or more specific claim in another patent or application. Domination by itself, i.e., in the absence of statutory or nonstatutory double patenting grounds, cannot support a double patenting rejection. *In re Kaplan*, 789 F.2d 1574, 1577-78, 229 USPQ 678, 681 (Fed. Cir. 1986); and *In re Sarrett*, 327 F.2d 1005, 1014-15, 140 USPQ 474, 482 (CCPA 1964). However, the presence of domination does not preclude double patenting. See, e.g., *In re Schneller*, 397 F.2d 350, 158 USPQ 210 (CCPA 1968).

### A. Statutory Double Patenting — 35 U.S.C. 101

In determining whether a statutory basis for a double patenting rejection exists, the question to be asked is: Is the same invention being claimed twice? 35 U.S.C. 101 prevents two patents from issuing on the same invention. “Same invention” means identical subject matter. *Miller v. Eagle Mfg. Co.*, 151 U.S. 186 (1894); *In re Vogel*, 422 F.2d 438, 164 USPQ 619 (CCPA 1970); and *In re Ockert*, 245 F.2d 467, 114 USPQ 330 (CCPA 1957).

A reliable test for double patenting under 35 U.S.C. 101 is whether a claim in the application could be literally infringed without literally infringing a corresponding claim in the patent. *In re Vogel*, 422 F.2d 438, 164 USPQ 619 (CCPA 1970). Is there an embodiment of the invention that falls within the scope of one claim, but not the other? If there is such an embodiment, then identical subject matter is not defined by both claims and statutory double patenting would not exist. For example, the invention defined by a claim reciting a compound having a “halogen” substituent is not identical to or substantively the same as a claim reciting the same compound except having a “chlorine” substituent in place of the halogen because “halogen” is broader than “chlorine.” On the other hand, claims may be differently worded and still define the same invention. Thus, a claim reciting a widget having a length of “36 inches” defines the same invention as a claim reciting the same widget having a length of “3 feet.”

If it is determined that the same invention is being claimed twice, 35 U.S.C. 101 precludes the grant of the second patent regardless of the presence or absence of a terminal disclaimer. *Id.*

Form paragraphs 8.30 and 8.31 (between an issued patent and one or more applications) or 8.32 (provisional rejections) may be used to make statutory double patenting rejections.

¶ *8.30 35 U.S.C. 101, Statutory Basis for Double Patenting “Heading” Only*

A rejection based on double patenting of the “same invention” type finds its support in the language of 35 U.S.C. 101 which states that “whoever invents or discovers any new and useful process... may obtain a patent therefor...” (Emphasis added). Thus, the term “same invention,” in this context, means an invention drawn to identical subject matter. See *Miller v. Eagle Mfg. Co.*, 151 U.S. 186 (1894); *In re Vogel*, 422 F.2d 438, 164 USPQ 619 (CCPA 1970); and *In re Ockert*, 245 F.2d 467, 114 USPQ 330 (CCPA 1957).

A statutory type (35 U.S.C. 101) double patenting rejection can be overcome by canceling or amending the conflicting claims so they are no longer coextensive in scope. The filing of a terminal disclaimer cannot overcome a double patenting rejection based upon 35 U.S.C. 101.

**Examiner Note:**

The above form paragraph must be used as a heading for all subsequent double patenting rejections of the statutory (same invention) type using either of form paragraphs 8.31 or 8.32.

¶ *8.31 Rejection, 35 U.S.C. 101, Double Patenting*

Claim [1] rejected under 35 U.S.C. 101 as claiming the same invention as that of claim [2] of prior U.S. Patent No. [3]. This is a double patenting rejection.

**Examiner Note:**

1. This paragraph must be preceded by form paragraph 8.30 and is used only for double patenting rejections of the same invention claimed in an earlier patent; that is, the “scope” of the inventions claimed is identical.
2. If the conflicting claims are in another copending application, do not use this paragraph. A provisional double patenting rejection should be made using paragraph 8.32.
3. Do not use this paragraph for non-statutory-type double patenting rejections. If non-statutory type, use appropriate form paragraphs 8.33 to 8.39.
4. This paragraph may be used where the conflicting patent and the pending application are:
  - (a) by the same inventive entity, or
  - (b) by a different inventive entity and are commonly assigned even though there is no common inventor, or
  - (c) not commonly assigned but have at least one common inventor.
5. In bracket 3, insert the number of the conflicting patent.

6. If the patent is to a different inventive entity and is commonly assigned with the application, paragraph 8.27 should additionally be used to require the assignee to name the first inventor.

7. If evidence is of record to indicate that the patent is prior art under either 35 U.S.C. 102(f) or (g), a rejection should also be made using paragraphs 7.15 and/or 7.19 in addition to this double patenting rejection.

8. If the patent is to a different inventive entity from the application and the effective U.S. filing date of the patent antedates the effective filing date of the application, a rejection under 35 U.S.C. 102(e) should additionally be made using form paragraph 7.15.02.

¶ *8.32 Provisional Rejection, 35 U.S.C. 101, Double Patenting*

Claim [1] provisionally rejected under 35 U.S.C. 101 as claiming the same invention as that of claim [2] of copending Application No. [3]. This is a provisional double patenting rejection since the conflicting claims have not in fact been patented.

**Examiner Note:**

1. This paragraph must be preceded by form paragraph 8.30 and is used only for double patenting rejections of the same invention claimed in another copending application; that is, the scope of the claimed inventions is identical.
2. If the conflicting claims are from an issued patent, do not use this paragraph. See paragraph 8.31.
3. Do not use this paragraph for non-statutory-type double patenting rejections. See paragraphs 8.33 to 8.39.
4. This paragraph may be used where the conflicting claims are in a copending application that is:
  - (a) by the same inventive entity, or
  - (b) by a different inventive entity and is commonly assigned even though there is no common inventor, or
  - (c) not commonly assigned but has at least one common inventor.
5. Paragraph 8.28 may be used in place of or along with this paragraph to resolve any remaining issues relating to priority under 35 U.S.C. 102(f) or (g).
6. In bracket 3, insert the number of the conflicting application.
7. A provisional double patenting rejection should also be made in the conflicting application.
8. If the copending application is by a different inventive entity and is commonly assigned, paragraph 8.27 should additionally be used to require the assignee to name the first inventor.
9. If evidence is also of record to show that either application is prior art unto the other under 35 U.S.C. 102(f) or (g), a rejection should also be made in the other application using paragraphs 7.15 and/or 7.19 in addition to this provisional double patenting rejection.
10. If the applications do not have the same inventive entity and effective U.S. filing date, a provisional 102(e) rejection should additionally be made in the later-filed application using paragraph 7.15.01.

If the “same invention” is not being claimed twice, an analysis must be made to determine whether a non-statutory basis for double patenting exists.



## B. Nonstatutory Double Patenting

A rejection based on nonstatutory double patenting is based on a judicially created doctrine grounded in public policy so as to prevent the unjustified or improper timewise extension of the right to exclude granted by a patent. *In re Goodman*, 11 F.3d 1046, 29 USPQ2d 2010 (Fed. Cir. 1993); *In re Longi*, 759 F.2d 887, 225 USPQ 645 (Fed. Cir. 1985); *In re Van Ornum*, 686 F.2d 937, 214 USPQ 761 (CCPA 1982); *In re Vogel*, 422 F.2d 438, 164 USPQ 619 (CCPA 1970); *In re Thorington*, 418 F.2d 528, 163 USPQ 644 (CCPA 1969); *In re White*, 405 F.2d 904, 160 USPQ 417 (CCPA 1969); *In re Schneller*, 397 F.2d 350, 158 USPQ 210 (CCPA 1968); *In re Sarett*, 327 F.2d 1005, 140 USPQ 474 (CCPA 1964).

### 1. Obviousness-Type

In determining whether a nonstatutory basis exists for a double patenting rejection, the first question to be asked is — does any claim in the application define an invention that is merely an obvious variation of an invention claimed in the patent? If the answer is yes, then an “obviousness-type” nonstatutory double patenting rejection may be appropriate. Obviousness-type double patenting requires rejection of an application claim when the claimed subject matter is **not patentably distinct** from the subject matter claimed in a commonly owned patent when the issuance of a second patent would provide unjustified extension of the term of the right to exclude granted by a patent. See *Eli Lilly & Co. v. Barr Labs., Inc.*, 251 F.3d 955, 58 USPQ2d 1865 (Fed. Cir. 2001); *Ex parte Davis*, 56 USPQ2d 1434, 1435-36 (Bd. Pat. App. & Inter. 2000).

A double patenting rejection of the obviousness-type is “analogous to [a failure to meet] the nonobviousness requirement of 35 U.S.C. 103” except that the patent principally underlying the double patenting rejection is not considered prior art. *In re Braithwaite*, 379 F.2d 594, 154 USPQ 29 (CCPA 1967). Therefore, any analysis employed in an obviousness-type double patenting rejection parallels the guidelines for analysis of a 35 U.S.C. 103 obviousness determination. *In re Braat*, 937 F.2d 589, 19 USPQ2d 1289 (Fed. Cir. 1991); *In re Longi*, 759 F.2d 887, 225 USPQ 645 (Fed. Cir. 1985).

Since the analysis employed in an obviousness-type double patenting determination parallels the guide-

lines for a 35 U.S.C. 103(a) rejection, the factual inquiries set forth in *Graham v. John Deere Co.*, 383 U.S. 1, 148 USPQ 459 (1966), that are applied for establishing a background for determining obviousness under 35 U.S.C. 103 are employed when making an obvious-type double patenting analysis. These factual inquiries are summarized as follows:

(A) Determine the scope and content of a patent claim and the prior art relative to a claim in the application at issue;

(B) Determine the differences between the scope and content of the patent claim and the prior art as determined in (A) and the claim in the application at issue;

(C) Determine the level of ordinary skill in the pertinent art; and

(D) Evaluate any objective indicia of nonobviousness.

The conclusion of obviousness-type double patenting is made in light of these factual determinations.

Any obviousness-type double patenting rejection should make clear:

(A) The differences between the inventions defined by the conflicting claims — a claim in the patent compared to a claim in the application; and

(B) The reasons why a person of ordinary skill in the art would conclude that the invention defined in the claim in issue is an obvious variation of the invention defined in a claim in the patent.

When considering whether the invention defined in a claim of an application is an obvious variation of the invention defined in the claim of a patent, the disclosure of the patent may not be used as prior art. This does not mean that one is precluded from all use of the patent disclosure.

The specification can always be used as a dictionary to learn the meaning of a term in the patent claim. *In re Boylan*, 392 F.2d 1017, 157 USPQ 370 (CCPA 1968). Further, those portions of the specification which provide support for the patent claims may also be examined and considered when addressing the issue of whether a claim in the application defines an obvious variation of an invention claimed in the patent. *In re Vogel*, 422 F.2d 438, 441-42, 164 USPQ 619, 622 (CCPA 1970). The court in *Vogel* recognized “that it is most difficult, if not meaning-

less, to try to say what is or is not an obvious variation of a claim,” but that one can judge whether or not the invention claimed in an application is an obvious variation of an embodiment disclosed in the patent which provides support for the patent claim. According to the court, one must first “determine how much of the patent disclosure pertains to the invention claimed in the patent” because only “[t]his portion of the specification supports the patent claims and may be considered.” The court pointed out that “this use of the disclosure is not in contravention of the cases forbidding its use as prior art, nor is it applying the patent as a reference under 35 U.S.C. 103, since only the disclosure of the invention claimed in the patent may be examined.”

#### (a) One-Way Obviousness

If the application at issue is the later filed application or both are filed on the same day, only a one-way determination of obviousness is needed in resolving the issue of double patenting, i.e., whether the invention defined in a claim in the application is an obvious variation of the invention defined in a claim in the patent. See, e.g., *In re Berg*, 46 USPQ2d 1226 (Fed. Cir. 1998) (the court applied a one-way test where both applications were filed the same day). If a claimed invention in the application is obvious over a claimed invention in the patent, there would be an unjustified timewise extension of the patent and an obvious-type double patenting rejection is proper. Unless a claimed invention in the application is obvious over a claimed invention in the patent, no double patenting rejection of the obvious-type should be made, but this does not necessarily preclude a rejection based on another type of nonstatutory double patenting (see MPEP § 804, paragraph II.B.2. below).

Similarly, even if the application at issue is the earlier filed application, only a one-way determination of obviousness is needed to support a double patenting rejection in the absence of a finding of: (A) administrative delay on the part of the Office causing delay in prosecution of the earlier filed application; and (B) applicant could not have filed the conflicting claims in a single (i.e., the earlier filed) application. See MPEP § 804, paragraph II.B.1.(b) below.

Form paragraph 8.33 and the appropriate one of form paragraphs 8.34 - 8.37 may be used to make nonstatutory rejections of the obvious-type.

#### (b) Two-Way Obviousness

If the patent is the later filed application, the question of whether the timewise extension of the right to exclude granted by a patent is justified or unjustified must be addressed. A two-way test is to be applied only when the applicant could not have filed the claims in a single application *and* there is administrative delay. *In re Berg*, 46 USPQ2d 1226 (Fed. Cir. 1998) (“The two-way exception can only apply when the applicant could not avoid separate filings, and even then, only if the PTO controlled the rates of prosecution to cause the later filed species claims to issue before the claims for a genus in an earlier application . . . In *Berg's* case, the two applications could have been filed as one, so it is irrelevant to our disposition who actually controlled the respective rates of prosecution.”). In the absence of administrative delay, a one-way test is appropriate. *In re Goodman*, 11 F.3d 1046, 29 USPQ2d 2010 (Fed. Cir. 1993) (applicant's voluntary decision to obtain early issuance of claims directed to a species and to pursue prosecution of previously rejected genus claims in a continuation is a considered election to postpone by the applicant and not administrative delay). Unless the record clearly shows administrative delay by the Office and that applicant could not have avoided filing separate applications, the examiner may use the one-way obviousness determination and shift the burden to applicant to show why a two-way obviousness determination is required.

When making a two-way obviousness determination where appropriate, it is necessary to apply the *Graham* obviousness analysis twice, once with the application claims as the claims in issue, and once with the patent claims as the claims in issue. Where a two-way obviousness determination is required, an obvious-type double patenting rejection is appropriate only where each analysis compels a conclusion that the invention defined in the claims in issue is an obvious variation of the invention defined in a claim in the other application/patent. If either analysis does not compel a conclusion of obviousness, no double patenting rejection of the obvious-type is made, but this does not necessarily preclude a nonstatutory double patenting rejection based on the fundamental reason to prevent unjustified timewise extension of the right to exclude granted by a patent. *In re Schneller*, 397 F.2d 350, 158 USPQ 210 (CCPA 1968).

Although a delay in the processing of applications before the Office that would cause patents to issue in an order different from the order in which the applications were filed is a factor to be considered in determining whether a one-way or two-way obviousness determination is necessary to support a double patenting rejection, it may be very difficult to assess whether an applicant or the administrative process is primarily responsible for a delay in the issuance of a patent. On the one hand, it is applicant who presents claims for examination and pays the issue fee. On the other hand, the resolution of legitimate differences of opinion that must be resolved in an appeal process or the time spent in an interference proceeding can significantly delay the issuance of a patent. Nevertheless, the reasons for the delay in issuing a patent have been considered in assessing the propriety of a double patenting rejection. Thus, in *Pierce v. Allen B. DuMont Laboratories, Inc.*, 297 F.2d 323, 131 USPQ 340 (3d Cir. 1961), the court found that administrative delay may justify the extension of patent rights beyond 17 years but “a considered election to postpone acquisition of the broader [patent after the issuance of the later filed application] should not be tolerated.” In *Pierce*, the patentee elected to participate in an interference proceeding [after all claims in the application had been determined to be patentable] whereby the issuance of the broader patent was delayed by more than 7 years after the issuance of the narrower patent. The court determined that the second issued patent was invalid on the ground of double patenting. Similarly, in *In re Emert*, 124 F.3d 1458, 44 USPQ2d 1149 (Fed. Cir. 1997), the court found that the one-way test is appropriate where applicants, rather than the Office, had significant control over the rate of prosecution of the application at issue. In support of its finding that the applicants were responsible for delaying prosecution of the application during the critical period, the court noted that the applicants had requested and received numerous time extensions in various filings. More importantly, the court noted, after initially receiving an obviousness rejection of all claims, applicants had waited the maximum period to reply (6 months), then abandoned the application in favor of a substantially identical continuation application, then received another obviousness rejection of all claims, again waited the maximum period to reply, and then again abandoned the application in favor of a second

continuation application substantially identical to the original filing. On the other hand, in *General Foods Corp. v. Studiengesellschaft Kohle mbH*, 972 F.2d 1272, 23 USPQ2d 1839 (Fed. Cir. 1992), the court elected not to hold the patentee accountable for a delay in issuing the first filed application until after the second filed application issued as a patent, even where the patentee had intentionally refiled the first filed application as a continuation-in-part after receiving a Notice of Allowance indicating that all claims presented were patentable. Similarly, where, through no fault of the applicant, the claims in a later filed application issue first, an obvious-type double patenting rejection is improper, in the absence of a two-way obviousness determination, because the applicant does not have complete control over the rate of progress of a patent application through the Office. In *re Braat*, 937 F.2d 589, 19 USPQ2d 1289 (Fed. Cir. 1991). While acknowledging that allowance of the claims in the earlier filed application would result in the timewise extension of an invention claimed in the patent, the court was of the view that the extension was justified under the circumstances in this case, indicating that a double patenting rejection would be proper only if the claimed inventions were obvious over each other — a two-way obviousness determination.

Form paragraph 8.33 and the appropriate one of form paragraphs 8.34-8.37 may be used to make non-statutory rejections of the obvious type.

¶ 8.33 *Basis for Nonstatutory Double Patenting, “Heading” Only*

The nonstatutory double patenting rejection is based on a judicially created doctrine grounded in public policy (a policy reflected in the statute) so as to prevent the unjustified or improper timewise extension of the “right to exclude” granted by a patent and to prevent possible harassment by multiple assignees. See *In re Goodman*, 11 F.3d 1046, 29 USPQ2d 2010 (Fed. Cir. 1993); *In re Longi*, 759 F.2d 887, 225 USPQ 645 (Fed. Cir. 1985); *In re Van Ornum*, 686 F.2d 937, 214 USPQ 761 (CCPA 1982); *In re Vogel*, 422 F.2d 438, 164 USPQ 619 (CCPA 1970); and *In re Thorington*, 418 F.2d 528, 163 USPQ 644 (CCPA 1969).

A timely filed terminal disclaimer in compliance with 37 CFR 1.321(c) may be used to overcome an actual or provisional rejection based on a nonstatutory double patenting ground provided the conflicting application or patent is shown to be commonly owned with this application. See 37 CFR 1.130(b).

Effective January 1, 1994, a registered attorney or agent of record may sign a terminal disclaimer. A terminal disclaimer signed by the assignee must fully comply with 37 CFR 3.73(b).

**Examiner Note:**

This form paragraph is to be used as a heading before a non-statutory double patenting rejection using any of form paragraphs 8.34 - 8.39.

¶ 8.34 *Rejection, Obviousness Type Double Patenting - No Secondary Reference(s)*

Claim [1] rejected under the judicially created doctrine of obviousness-type double patenting as being unpatentable over claim [2] of U.S. Patent No. [3]. Although the conflicting claims are not identical, they are not patentable distinct from each other because [4].

**Examiner Note:**

1. This paragraph is used for obviousness-type double patenting rejections based upon a patent.
2. If the obviousness-type double patenting rejection is based upon another application, do not use this paragraph. A provisional double patenting rejection should be made using form paragraphs 8.33 and 8.35 or 8.37.
3. This paragraph may be used where the conflicting invention is claimed in a patent which is:
  - (a) by the same inventive entity, or
  - (b) by a different inventive entity and is commonly assigned even though there is no common inventor, or
  - (c) not commonly assigned but has at least one inventor in common.
4. Form paragraph 8.33 must precede any one of paragraphs 8.34 to 8.39 and must be used only ONCE in an Office action.
5. In bracket 3, insert the number of the patent.
6. If evidence indicates that the conflicting patent is prior art under 35 U.S.C. 102(f) or (g), a rejection should additionally be made under 102(f)/103(a) or 102(g)/103(a) using paragraph 7.21.
7. If the patent is to another inventive entity and has an earlier U.S. filing date, a rejection under 35 U.S.C. 102(e)/103(a) may be made using form paragraph 7.21.02. For applications filed on or after November 29, 1999, rejections under 35 U.S.C. 102(e)/103(a) should not be made or maintained if the applicant provides evidence that the subject matter of the reference and the claimed invention were, at the time the invention was made, owned by the same person or subject to an obligation of assignment to the same person.
8. In bracket 4, provide appropriate rationale of obviousness for any claims being rejected over the claims of the cited patent.

¶ 8.35 *Provisional Rejection, Obviousness Type Double Patenting - No Secondary Reference(s)*

Claim [1] provisionally rejected under the judicially created doctrine of obviousness-type double patenting as being unpatentable over claim [2] of copending Application No. [3]. Although the conflicting claims are not identical, they are not patentably distinct from each other because [4].

This is a provisional obviousness-type double patenting rejection because the conflicting claims have not in fact been patented.

**Examiner Note:**

1. This paragraph should be used when the conflicting claims are in another copending application.

2. If the conflicting claims are in a patent, do not use this paragraph. Use form paragraphs 8.33 and 8.34.

3. This paragraph may be used where the conflicting claims are in a copending application that is:

- (a) by the same inventive entity, or
- (b) is commonly assigned even though there is no common inventor, or
- (c) not commonly assigned but has at least one common inventor.

4. Form paragraph 8.33 must precede any one of paragraphs 8.34 to 8.39 and must be used only ONCE in an office action.

5. If the conflicting application is currently commonly assigned but the file does not establish that the conflicting inventions were commonly owned at the time the later invention was made, form paragraph 8.28 may be used in place of or in addition to this form paragraph to also resolve any issues relating to priority under 102(f) and/or (g).

6. In bracket 3, insert the number of the conflicting application.

7. A provisional double patenting rejection should also be made in the conflicting application.

8. If evidence shows that either application is prior art unto the other under 35 U.S.C. 102(f) or (g) and the copending application has not been disqualified as prior art in a 103 rejection based on common ownership), a rejection should additionally be made in the other application under 35 U.S.C. 102(f)/103(a) or 102(g)/103(a) using paragraph 7.21.

9. If the disclosure of one application may be used to support a rejection of the other and the applications have different inventive entities and different U.S. filing dates, use paragraph 7.21.01 to additionally make a rejection under 35 U.S.C. 102(e)/103(a) rejection in the other application. For applications filed on or after November 29, 1999, rejections under 35 U.S.C. 102(e)/103(a) should not be made or maintained if the applicant provides evidence that the subject matter of the reference and the claimed invention were, at the time the invention was made, owned by the same person or subject to an obligation of assignment to the same person.

10. In bracket 4, provide appropriate rationale for obviousness of claims being rejected over the claims of the cited patent.

¶ 8.36 *Rejection, Obviousness Type Double Patenting - With Secondary Reference(s)*

Claim [1] rejected under the judicially created doctrine of obviousness-type double patenting as being unpatentable over claim [2] of U.S. Patent No. [3] in view of [4]. [5]

**Examiner Note:**

1. This paragraph is used for obviousness-type double patenting rejections where the primary reference is a conflicting patent.
2. If the obviousness double patenting rejection is based on another application, do not use this paragraph. A provisional obviousness-type double patenting rejection should be made using form paragraphs 8.33 and 8.35 or 8.37.
3. This paragraph may be used where the prior invention is claimed in a patent which is:
  - (a) by the same inventive entity, or
  - (b) by a different inventive entity and is commonly assigned even though there is no common inventor, or

- (c) not commonly assigned but has at least one common inventor.
4. Form paragraph 8.33 must precede any one of paragraphs 8.34 to 8.39 and must be used only ONCE in an office action.
  5. In bracket 3, insert the number of the conflicting patent.
  6. In bracket 4, insert the secondary reference.
  7. In bracket 5, insert an explanation of the obviousness-type rejection.
  8. If evidence shows that the conflicting patent is prior art under 35 U.S.C. 102(f) or (g), a rejection should additionally be made under 35 U.S.C. 102(f)/103(a) or 102(g)/103(a) using paragraph 7.21.
  9. If the patent issued to a different inventive entity and has an earlier U.S. filing date, a rejection under 35 U.S.C. 102(e)/103(a) may be made using paragraphs 7.15.02 or 7.21.02. For applications filed on or after November 29, 1999, rejections under 35 U.S.C. 102(e)/103(a) should not be made or maintained if the applicant provides evidence that the subject matter of the reference and the claimed invention were, at the time the invention was made, owned by the same person or subject to an obligation of assignment to the same person.

¶ 8.37 *Provisional Rejection, Obviousness Type Double Patenting - With Secondary Reference(s)*

Claim [1] provisionally rejected under the judicially created doctrine of obviousness-type double patenting as being unpatentable over claim [2] of copending Application No. [3] in view of [4]. [5]

This is a provisional obviousness-type double patenting rejection.

**Examiner Note:**

1. This paragraph is used for obviousness-type double patenting rejections where the primary reference is a conflicting application.
2. If the conflicting claims are in a patent, do not use this paragraph, use form paragraph 8.34.
3. This paragraph may be used where the conflicting claims are in a copending application that is:
  - (a) by the same inventive entity, or
  - (b) is commonly assigned even though there is no common inventor, or
  - (c) not commonly assigned but has at least one common inventor.
4. Form paragraph 8.33 must precede any one of paragraphs 8.34 to 8.39 and must be used only ONCE in an office action.
5. If the conflicting cases are currently commonly assigned but the file does not establish that the conflicting inventions were commonly owned at the time the later invention was made, form paragraph 8.28 may be used in place of or in addition to this form paragraph to also resolve any issues relating to priority under 102(f) and/or (g).
6. In bracket 3, insert the number of the conflicting application.
7. In bracket 4, insert the secondary reference.
8. In bracket 5, insert an explanation of the obviousness-type rejection.
9. A provisional double patenting rejection should also be made in the conflicting application.

10. If evidence shows that either application is prior art unto the other under 35 U.S.C. 102(f) or (g) and the copending application has not been disqualified as prior art in a 35 U.S.C. 103(a) rejection based on common ownership, a rejection should additionally be made under 35 U.S.C. 102(f)/103(a) or 102(g)/103(a) using paragraph 7.21.

11. If the disclosure of one application may be used to support a rejection of the other and the applications have different inventive entities and different U.S. filing dates, use paragraph 7.21.01 to additionally make a rejection under 35 U.S.C. 102(e)/103(a). For applications filed on or after November 29, 1999, rejections under 35 U.S.C. 102(e)/103(a) should not be made or maintained if the applicant provides evidence that the subject matter of the reference and the claimed invention were, at the time the invention was made, owned by the same person or subject to an obligation of assignment to the same person.

**2. Another Type of Nonstatutory Double Patenting Rejection**

There are some unique circumstances where it has been recognized that another type of nonstatutory double patenting rejection is applicable even where the inventions claimed in two or more applications/patents are considered nonobvious over each other. These circumstances are illustrated by the facts before the court in *In re Schneller*, 397 F.2d 350, 158 USPQ 210 (CCPA 1968). In affirming the double patenting rejection, the court summed up the situation:

in appellant's own terms: The combination ABC was old. He made two improvements on it, (1) adding X and (2) adding Y, the result still being a unitary clip of enhanced utility. While his invention can be practiced in the forms ABCX or ABCY, the greatest advantage and best mode of practicing the invention as disclosed is obtained by using both inventions in the combination ABCXY. His first application disclosed ABCXY and other matters. He obtained a patent claiming [a clip comprising] BCX and ABCX, . . . so claiming these combinations as to cover them *no matter what other feature is incorporated in them*, thus *covering effectively ABCXY*. He now, many years later, seeks more claims directed to ABCY *and ABCXY*. Thus, protection he already had would be extended, albeit in somewhat different form, for several years beyond the expiration of his patent, were we to reverse.

397 F.2d at 355-56, 158 USPQ at 216 (emphasis in original).

The court recognized that "there is no double patenting in the sense of claiming the same invention because ABCX and ABCY are, in the technical patent law sense, different inventions. The rule against 'double patenting,' however, is not so circumscribed. The

fundamental reason for the rule is *prevent unjustified timewise extension of the right to exclude* granted by a patent no matter how the extension is brought about. To . . . prevail here, appellant has the burden of establishing that the invention claimed in his patent is ‘independent and distinct’ from the invention of the appealed claims...appellant has clearly not established the independent and distinct character of the inventions of the appealed claims.” 397 F.2d at 354-55, 158 USPQ at 214-15 (emphasis in original). The court observed:

The controlling fact is that patent protection for the clips, fully disclosed in and covered by the claims of the patent, would be extended by allowance of the appealed claims. Under the circumstance of the instant case, wherein we find no valid excuse or mitigating circumstances making it either reasonable or equitable to make an exception, and wherein there is no terminal disclaimer, the rule against “double patenting” must be applied.

397 F.2d at 355, 158 USPQ at 215.

The decision in *In re Schneller* did not establish a rule of general application and thus is limited to the particular set of facts set forth in that decision. The court in *Schneller* cautioned “against the tendency to freeze into rules of general application what, at best, are statements applicable to particular fact situations.” *Schneller*, 397 F.2d at 355, 158 USPQ at 215. Non-statutory double patenting rejections based on *Schneller* **will be rare**. The Technology Center (TC) Director must approve any nonstatutory double patenting rejections based on *Schneller*. If an examiner determines that a double patenting rejection based on *Schneller* is appropriate in his or her application, the examiner should first consult with his or her supervisory patent examiner (SPE). If the SPE agrees with the examiner then approval of the TC Director must be obtained before such a nonstatutory double patenting rejection can be made.

A fact situation similar to that in *Schneller* was presented to a Federal Circuit panel in *In re Kaplan*, 789 F.2d 1574, 229 USPQ 678 (Fed. Cir. 1986). Kaplan had been issued a patent on a process of making chemicals in the presence of an organic solvent. Among the organic solvents disclosed and claimed as being useful were tetraglyme and sulfolane. One unclaimed example in the patent was specifically directed to a mixture of these two solvents. The claims in the application to Kaplan and Walker, the

application before the Office, were directed to essentially the same chemical process, but requiring the use of the solvent mixture of tetraglyme and sulfolane. In reversing the double patenting rejection, the court stated that the mere fact that the broad process claim of the patent requiring an organic solvent reads on or “dominates” the narrower claim directed to basically the same process using a specific solvent mixture does not, *per se*, justify a double patenting rejection. The court also pointed out that the double patenting rejection improperly used the disclosure of the joint invention (solvent mixture) in the Kaplan patent specification as though it were prior art.

A significant factor in the *Kaplan* case was that the broad invention was invented by Kaplan, and the narrow invention (i.e., using a specific combination of solvents) was invented by Kaplan and Walker. Since these applications (as the applications in *Braat*) were filed before the Patent Law Amendments Act of 1984 (Pub. Law 98-622, November 8, 1984) amending 35 U.S.C. 116 to expressly authorize filing a patent application in the names of joint inventors who did not necessarily make a contribution to the invention defined in each claim in the patent, it was necessary to file multiple applications to claim both the broad and narrow inventions. Accordingly, there was a valid reason, driven by statute, why the claims to the specific solvent mixture were not presented for examination in the Kaplan patent application.

Each double patenting situation must be decided on its own facts.

Form paragraph 8.33 and the appropriate one of form paragraphs 8.38 (between an issued patent and one or more applications) and 8.39 (provisional rejections) may be used to make this type of nonstatutory double patenting rejection.

#### ¶ 8.38 Double Patenting - Non-Statutory (Based Solely on Improper Timewise Extension of Patent Rights) With a Patent

Claim [1] rejected under the judicially created doctrine of double patenting over claim [2] of U. S. Patent No. [3] since the claims, if allowed, would improperly extend the “right to exclude” already granted in the patent.

The subject matter claimed in the instant application is fully disclosed in the patent and is covered by the patent since the patent and the application are claiming common subject matter, as follows: [4]

Furthermore, there is no apparent reason why applicant was prevented from presenting claims corresponding to those of the instant application during prosecution of the application which

matured into a patent. See *In re Schneller*, 397 F.2d 350, 158 USPQ 210 (CCPA 1968). See also MPEP § 804.

#### Examiner Note:

1. This form paragraph should only be used where approval from the TC Director to make a nonstatutory double patenting rejection based on *In re Schneller* has been obtained.
2. Use this form paragraph only when the subject matter of the claim(s) is fully disclosed in, and covered by at least one claim of, an issued U.S. Patent which is commonly owned or where there is common inventorship (one or more inventors in common).
3. In bracket 3, insert the number of the patent.
4. In bracket 4, insert a description of the subject matter being claimed which is covered in the patent.
5. Form paragraph 8.33 must precede any one of form paragraphs 8.34 to 8.39 and must be used only ONCE in an Office action.
6. If evidence indicates that the conflicting patent is prior art under 35 U.S.C. 102(f) or (g), a rejection should additionally be made under 35 U.S.C. 102(f)/103(a) or 102(g)/103(a) using form paragraph 7.21.
7. If the patent is to another inventive entity and has an earlier U.S. filing date, a rejection under 35 U.S.C. 102(e)/103(a) may be made using paragraph 7.21.02. For applications filed on or after November 29, 1999, rejections under 35 U.S.C. 102(e)/103(a) should not be made or maintained if the applicant provides evidence that the subject matter of the reference and the claimed invention were, at the time the invention was made, owned by the same person or subject to an obligation of assignment to the same person.

#### ¶ 8.39 Double Patenting - Non-Statutory (Based Solely on Improper Timewise Extension of Patent Rights) With Another Application

Claim [1] provisionally rejected under the judicially created doctrine of double patenting over claim [2] of copending Application No. [3]. This is a provisional double patenting rejection because the conflicting claims have not in fact been patented.

The subject matter claimed in the instant application is fully disclosed in the referenced copending application and would be covered by any patent granted on that copending application since the referenced copending application and the instant application are claiming common subject matter, as follows: [4]

Furthermore, there is no apparent reason why applicant would be prevented from presenting claims corresponding to those of the instant application in the other copending application. See *In re Schneller*, 397 F.2d 350, 158 USPQ 210 (CCPA 1968). See also MPEP § 804.

#### Examiner Note:

1. This form paragraph should only be used where approval from the TC Director to make a nonstatutory double patenting rejection based on *In re Schneller* has been obtained.
2. Use this form paragraph only when the subject matter of the claim(s) is fully disclosed in, and covered by at least one claim of, another copending application which is commonly owned or where there is common inventorship (one or more inventors in common).

3. In bracket 3, insert the number of the conflicting application.
4. In bracket 4, insert a description of the subject matter being claimed which is covered in the copending application.
5. Form paragraph 8.33 must precede any one of form paragraphs 8.34 to 8.39 and must be used only ONCE in an office action.
6. If the conflicting application is currently commonly assigned but the file does not establish that the conflicting inventions were commonly owned at the time the later invention was made, form paragraph 8.28 may be used in place of or in addition to this form paragraph to also resolve any issues relating to priority under 35 U.S.C. 102(f) and/or (g).
7. A provisional double patenting rejection should also be made in the conflicting application.
8. If evidence shows that either application is prior art unto the other under 35 U.S.C. 102(f) or (g) and the copending application has not been disqualified (as prior art in a 103 rejection based on common ownership), a rejection should additionally be made in the other application under 35 U.S.C. 102(f)/103(a) or 102(g)/103(a) using form paragraph 7.21.
9. If the disclosure of one application may be used to support a rejection of the other and the applications have different inventive entities and different U.S. filing dates, use paragraph 7.21.01 to additionally make a rejection under 35 U.S.C. 102(e)/103(a). For applications filed on or after November 29, 1999, rejections under 35 U.S.C. 102(e)/103(a) should not be made or maintained if the applicant provides evidence that the subject matter of the reference and the claimed invention were, at the time the invention was made, owned by the same person or subject to an obligation of assignment to the same person.

### 3. Design/Plant — Utility Situations

Double patenting issues may be raised where an applicant has filed both a utility patent application (35 U.S.C. 111) and either an application for a plant patent (35 U.S.C. 161) or an application for a design patent (35 U.S.C. 171). In general, the same double patenting principles and criteria that are applied in utility-utility situations are applied to utility-plant or utility-design situations. Double patenting rejections in utility-plant situations may be made in appropriate circumstances.

Although double patenting is rare in the context of utility versus design patents, a double patenting rejection of a pending design or utility application can be made on the basis of a previously issued utility or design patent, respectively. *Carman Indus. Inc. v. Wahl*, 724 F.2d 932, 220 USPQ 481 (Fed. Cir. 1983). The rejection is based on the public policy preventing the extension of the term of a patent. Double patenting may be found in a design-utility situation irrespective of whether the claims in the patent relied on in the rejection and the claims in issue involve the same

invention, or whether they involve inventions which are obvious variations of one another. *In re Thorington*, 418 F.2d 528, 163 USPQ 644 (CCPA 1969).

In *Carman Indus.*, the court held that no double patenting existed between a design and utility patent since the claims in the utility patent, drawn to the interior construction of a flow promoter, were not directed to the same invention or an obvious variation of the invention claimed in a design patent directed to the visible external surface configuration of a storage bin flow promoter. The majority opinion in this decision appears to indicate that a two-way obviousness determination is necessary in design-utility cases. 724 F.2d at 940-41, 220 USPQ at 487-88. But see *Carman Indus.* (J. Nies, concurring).

In *Thorington*, the court affirmed a double patenting rejection of claims for a fluorescent light bulb in a utility patent application in view of a previously issued design patent for the same bulb. In another case, a double patenting rejection of utility claims for a finger ring was affirmed in view of an earlier issued design patent, where the drawing in both the design patent and the utility application illustrated the same article. *In re Phelan*, 205 F.2d 183, 98 USPQ 156 (CCPA 1953). A double patenting rejection of a design claim for a flashlight cap and hanger ring was affirmed over an earlier issued utility patent. *In re Barber*, 81 F.2d 231, 28 USPQ 187 (CCPA 1936). A double patenting rejection of claims in a utility patent application directed to a balloon tire construction was affirmed over an earlier issued design patent. *In re Hargraves*, 53 F.2d 900, 11 USPQ 240 (CCPA 1931).

### III. CONTRAST BETWEEN DOUBLE PATENTING REJECTION AND REJECTIONS BASED ON PRIOR ART

Rejections over a patent or another copending application based on double patenting or 35 U.S.C. 103(a) are similar in the sense that both require comparison of the claimed subject matter with at least part of the content of another patent or application, and both may require that an obviousness analysis be made. However, there are significant differences between a rejection based on double patenting and one based on 35 U.S.C. 102(e) prior art under

35 U.S.C. 103(a). *In re Bartfeld*, 925 F.2d 1450, 17 USPQ2d 1885 (Fed. Cir. 1991).

One significant difference is that a double patenting rejection must rely on a comparison with the claims in an issued or to be issued patent, whereas an obviousness rejection based on the same patent under 35 U.S.C. 102(e)/103(a) relies on a comparison with what is disclosed (whether or not claimed) in the same issued or to be issued patent. In a 35 U.S.C. 102(e)/103(a) rejection over a prior art patent, the reference patent is available for all that it fairly discloses to one of ordinary skill in the art, regardless of what is claimed. *In re Bowers*, 359 F.2d 886, 149 USPQ 570 (CCPA 1966).

A second significant difference is that a terminal disclaimer cannot be used to obviate a rejection based on 35 U.S.C. 102(e)/103(a) prior art. *In re Fong*, 378 F.2d 977, 154 USPQ 25 (CCPA 1967). The purpose of a terminal disclaimer is to obviate a double patenting rejection by removing the potential harm to the public by issuing a second patent, and not to remove a patent as prior art.

Where the inventions are made by inventors that have assigned their rights to a common assignee, the assignee can take some preemptive measures to avoid having a copending application become prior art under 35 U.S.C. 102(e). The applications can be filed on the same day, or copending applications can be merged into a single continuation-in-part application and the parent applications abandoned. If these steps are undesirable or the first patent has issued, the prior art effect of the first patent may be avoided by a showing under 37 CFR 1.132 that any unclaimed invention disclosed in the first patent was derived from the inventor of the application before the examiner in which the 35 U.S.C. 102(e)/103(a) rejection was made. *In re Katz*, 687 F.2d 450, 215 USPQ 14 (CCPA 1982). See also MPEP § 716.10. It may also be possible for applicant to respond to a 35 U.S.C. 102(e)/103(a) rejection by showing, under 37 CFR 1.131, that the date of invention of the claimed subject matter was prior to the effective filing date of the reference patent which has been relied upon for its unclaimed disclosure. See MPEP § 715. See also 37 CFR 1.130 and MPEP § 718 for affidavits or declarations to disqualify a commonly owned patent as prior art under 35 U.S.C. 103.



Because there are significant differences between a rejection based on double patenting and one based on prior art under 35 U.S.C. 102(e)/103 over the same issued patent, it is both appropriate and necessary that an examiner make both rejections when the facts support both rejections. A prior art reference that renders claimed subject matter obvious under 35 U.S.C. 102(e)/103(a) does not create a double patenting situation where that subject matter is not claimed in the reference patent. Where the subject matter that renders a claim obvious is both claimed and disclosed in a U.S. patent which satisfies the criteria of 35 U.S.C. 102(e), the examiner should make rejections based both on double patenting and 35 U.S.C. 103(a). For applications filed on or after November 29, 1999, rejections under 35 U.S.C. 102(e)/103(a) should not be made or maintained if the applicant provides evidence that the subject matter of the reference and the claimed invention were, at the time the invention was made, owned by the same person or subject to an obligation of assignment to the same person.

### **804.01 Prohibition of Double Patenting Rejections Under 35 U.S.C. 121**

35 U.S.C. 121 authorizes the Commissioner to restrict the claims in a patent application to a single invention when independent and distinct inventions are presented for examination. The third sentence of 35 U.S.C. 121 prohibits the use of a patent issuing on an application with respect to which a requirement for restriction has been made, or on an application filed as a result of such a requirement, as a reference against any divisional application, if the divisional application is filed before the issuance of the patent. The 35 U.S.C. 121 prohibition applies only where the Office has made a requirement for restriction. The prohibition does not apply where the divisional application was voluntarily filed by the applicant and not in response to an Office requirement for restriction. This apparent nullification of double patenting as a ground of rejection or invalidity in such cases imposes a heavy burden on the Office to guard against erroneous requirements for restrictions where the claims define essentially the same invention in differ-

ent language and which, if acquiesced in, might result in the issuance of several patents for the same invention.

The prohibition against holdings of double patenting applies to requirements for restriction between the related subjects treated in MPEP § 806.04 through § 806.05(i), namely, between combination and subcombination thereof, between subcombinations disclosed as usable together, between process and apparatus for its practice, between process and product made by such process and between apparatus and product made by such apparatus, etc., so long as the claims in each application are filed as a result of such requirement.

The following are situations where the prohibition of double patenting rejections under 35 U.S.C. 121 does not apply:

(A) The applicant voluntarily files two or more applications without a restriction requirement by the examiner. *In re Schneller*, 397 F.2d 350, 158 USPQ 210 (CCPA 1968).

(B) The claims of the different applications or patents are not consonant with the restriction requirement made by the examiner, since the claims have been changed in material respects from the claims at the time the requirement was made. For example, the divisional application filed includes additional claims not consonant in scope to the original claims subject to restriction in the parent. *Symbol Technologies, Inc. v. Opticon, Inc.*, 935 F.2d 1569, 19 USPQ2d 1241 (Fed. Cir. 1991) and *Gerber Garment Technology, Inc. v. Lectra Systems, Inc.*, 916 F.2d 683, 16 USPQ2d 1436 (Fed. Cir. 1990). In order for consonance to exist, the line of demarcation between the independent and distinct inventions identified by the examiner in the requirement for restriction must be maintained. 916 F.2d at 688, 16 USPQ2d at 1440.

(C) The restriction requirement was written in a manner which made it clear to applicant that the requirement was made subject to the nonallowance of generic or other linking claims and such generic or linking claims are subsequently allowed. Therefore, if a generic or linking claim is subsequently allowed, the restriction requirement must be withdrawn.

(D) The requirement for restriction (holding of lack of unity of invention) was only made in an international application by the International Searching Authority or the International Preliminary Examining Authority.

(E) The requirement for restriction was withdrawn by the examiner before the patent issues. *In re Ziegler*, 443 F.2d 1211, 170 USPQ 129 (CCPA 1971).

(F) The claims of the second application are drawn to the “same invention” as the first application or patent. *Studiengesellschaft Kohle mbH v. Northern Petrochemical Co.*, 784 F.2d 351, 228 USPQ 837 (Fed. Cir. 1986).

While the situation should not arise where appropriate care is exercised in defining the independent and distinct inventions in a restriction requirement, the issue might arise as to whether 35 U.S.C. 121 prevents the use of a double patenting rejection when the identical invention is claimed in both the patent and the pending application. Under these circumstances, the Office will make the double patenting rejection because the patentee is entitled only to a single patent for an invention. As expressed in *Studiengesellschaft Kohle*, 784 F.2d at 361, 228 USPQ at 844, (J. Newman, concurring), “35 U.S.C. 121 of course does not provide that multiple patents may be granted on the identical invention.”

## 804.02 Avoiding a Double Patenting Rejection

### I. STATUTORY

A rejection based on the statutory type of double patenting can be avoided by amending the conflicting claims so that they are not coextensive in scope. Where the conflicting claims are in one or more pending applications and a patent, a rejection based on statutory type double patenting can also be avoided by canceling the conflicting claims in all the pending applications. Where the conflicting claims are in two or more pending applications, a provisional rejection based on statutory type double patenting can also be avoided by canceling the conflicting claims in all but one of the pending applications. A terminal disclaimer is not effective in overcoming a statutory double patenting rejection.

The use of a 37 CFR 1.131 affidavit in overcoming a statutory double patenting rejection is inappropriate.

*In re Dunn*, 349 F.2d 433, 146 USPQ 479 (CCPA 1965). *Knell v. Muller*, 174 USPQ 460 (Comm’r. Pat. 1971), citing the CCPA decisions in *In re Ward*, 236 F.2d 428, 111 USPQ 101 (CCPA 1956); *In re Teague*, 254 F.2d 145, 117 USPQ 284 (CCPA 1958); and *In re Hidy*, 303 F.2d 954, 133 USPQ 650 (CCPA 1962).

### II. NONSTATUTORY

37 CFR 1.130. Affidavit or declaration to disqualify commonly owned patent or published application as prior art.

\*\*\*\*\*

(b) When an application or a patent under reexamination claims an invention which is not patentably distinct from an invention claimed in a commonly owned patent with the same or a different inventive entity, a double patenting rejection will be made in the application or a patent under reexamination. A judicially created double patenting rejection may be obviated by filing a terminal disclaimer in accordance with § 1.321(c).

A rejection based on a nonstatutory type of double patenting can be avoided by filing a terminal disclaimer in the application or proceeding in which the rejection is made. *In re Vogel*, 422 F.2d 438, 164 USPQ 619 (CCPA 1970); *In re Knohl*, 386 F.2d 476, 155 USPQ 586 (CCPA 1967); and *In re Griswold*, 365 F.2d 834, 150 USPQ 804 (CCPA 1966). The use of a terminal disclaimer in overcoming a nonstatutory double patenting rejection is in the public interest because it encourages the disclosure of additional developments, the earlier filing of applications, and the earlier expiration of patents whereby the inventions covered become freely available to the public. *In re Jentoft*, 392 F.2d 633, 157 USPQ 363 (CCPA 1968); *In re Eckel*, 393 F.2d 848, 157 USPQ 415 (CCPA 1968); and *In re Braithwaite*, 379 F.2d 594, 154 USPQ 29 (CCPA 1967).

The use of a 37 CFR 1.131 affidavit in overcoming a double patenting rejection is inappropriate because the claim or claims in the application are being rejected over a patent which claims the rejected invention. *In re Dunn*, 349 F.2d 433, 146 USPQ 479 (CCPA 1965). 37 CFR 1.131 is inapplicable if the claims of the application and the patent are “directed to substantially the same invention”. It is also inapplicable if there is a lack of “patentable distinctness” between the claimed subject matter. *Knell v. Muller*, 174 USPQ 460 (Comm’r. Pat. 1971), citing the court decisions in *In re Ward*, 236 F.2d 428, 111 USPQ 101

(CCPA 1956); *In re Teague*, 254 F.2d 145, 117 USPQ 284 (CCPA 1958); and *In re Hidy*, 303 F.2d 954, 133 USPQ 65 (CCPA 1962).

A patentee or applicant may disclaim or dedicate to the public the entire term, or any terminal part of the term of a patent. 35 U.S.C. 253. The statute does not provide for a terminal disclaimer of only a specified claim or claims. The terminal disclaimer must operate with respect to all claims in the patent.

The filing of a terminal disclaimer to obviate a rejection based on nonstatutory double patenting is not an admission of the propriety of the rejection. *Quad Environmental Technologies Corp. v. Union Sanitary District*, 946 F.2d 870, 20 USPQ2d 1392 (Fed. Cir. 1991). The court indicated that the “filing of a terminal disclaimer simply serves the statutory function of removing the rejection of double patenting, and raises neither a presumption nor estoppel on the merits of the rejection.”

A terminal disclaimer filed to obviate a double patenting rejection is effective only with respect to the application identified in the disclaimer, unless by its terms it extends to continuing applications. If an appropriate double patenting rejection of the nonstatutory type is made in two or more pending applications, an appropriate terminal disclaimer must be filed in each application.

Claims that differ from each other (aside from minor differences in language, punctuation, etc.), whether or not the difference is obvious, are not considered to be drawn to the same invention for double patenting purposes under 35 U.S.C. 101. In cases where the difference in claims is obvious, terminal disclaimers are effective to overcome double patenting rejections. However, such terminal disclaimers must include a provision that the patent shall be unenforceable if it ceases to be commonly owned with the other application or patent. Note 37 CFR 1.321(c). It should be emphasized that a terminal disclaimer cannot be used to overcome a rejection under 35 U.S.C. 102(e)/103(a).

### **III. TERMINAL DISCLAIMER REQUIRED DESPITE REQUEST TO ISSUE ON COMMON ISSUE DATE**

Applicants are cautioned that reliance upon a common issue date cannot effectively substitute for the filing of one or more terminal disclaimers in order to

overcome a proper double patenting rejection, particularly since a common issue date alone does not avoid the potential problem of dual ownership of patents to patentably indistinct inventions. In any event, the Office cannot ensure that two or more applications will have a common issue date.

### **IV. DISCLAIMING MULTIPLE DOUBLE PATENTING REFERENCES**

If multiple conflicting patents and/or pending applications are applied in double patenting rejections made in a single application, then prior to issuance of that application, it is necessary to disclaim each one of the conflicting double patenting references applied, rather than disclaiming only the conflicting double patenting reference with the earliest issue date (assuming at least one of the references is a patent). A terminal disclaimer fee is required for each terminal disclaimer filed. To avoid paying multiple terminal disclaimer fees, a single terminal disclaimer may be filed, wherein all the conflicting double patenting references are disclaimed therein.

Disclaiming each one of the conflicting double patenting references is necessary to avoid the problem of dual ownership of patents to patentably indistinct inventions in the event that the patent issuing from the application being examined ceases to be commonly owned with any one of the double patenting references that have issued or may issue as a patent. Note that 37 CFR 1.321(c)(3) requires that a terminal disclaimer “[i]nclude a provision that any patent granted on that application or any patent subject to the reexamination proceeding shall be enforceable only for and during such period that said patent is commonly owned with the application or patent which formed the basis for the rejection.”

### **V. REQUIREMENTS OF A TERMINAL DISCLAIMER**

A terminal disclaimer is a statement filed by an owner (in whole or in part) of a patent or a patent to be granted that is used to disclaim or dedicate a portion of the entire term of all the claims of a patent. The requirements for a terminal disclaimer are set forth in 37 CFR 1.321. Sample forms of a terminal disclaimer, and guidance as to the filing and treatment of a terminal disclaimer, are provided in MPEP § 1490.

## VI. TERMINAL DISCLAIMERS REQUIRED TO OVERCOME JUDICIALLY CREATED DOUBLE PATENTING REJECTIONS IN APPLICATIONS FILED ON OR AFTER JUNE 8, 1995

Public Law 103-465 (1994) amended 35 U.S.C. 154(a)(2) to provide that any patent issuing on a utility or plant application filed on or after June 8, 1995 will expire 20 years from its filing date, or, if the application claims the benefit of an earlier filed application under 35 U.S.C. 120, 121, or 365(c), 20 years from the earliest filing date for which a benefit under 35 U.S.C. 120, 121, or 365(c) is claimed. Therefore, any patent issuing on a continuing utility or plant application filed on or after June 8, 1995 will expire 20 years from the earliest filing date for which a benefit is claimed under 35 U.S.C. 120, 121, or 365(c), subject to the provisions of 35 U.S.C. 154(b).

There are at least two reasons for insisting upon a terminal disclaimer to overcome a judicially created double patenting rejection in a continuing application subject to a 20-year term under 35 U.S.C. 154(a)(2). First, 35 U.S.C. 154(b) includes provisions for patent term extension based upon prosecution delays during the application process. Thus, 35 U.S.C. 154 does not ensure that any patent issuing on a continuing utility or plant application filed on or after June 8, 1995 will necessarily expire 20 years from the earliest filing date for which a benefit is claimed under 35 U.S.C. 120, 121, or 365(c). Second, 37 CFR 1.321(c)(3) requires that a terminal disclaimer filed to obviate a judicially created double patenting rejection include a provision that any patent granted on that application be enforceable only for and during the period that the patent is commonly owned with the application or patent which formed the basis for the rejection. This requirement serves to avoid the potential for harassment of an accused infringer by multiple parties with patents covering the same patentable invention (37 CFR 1.601(n)). See, e.g., *In re Van Ornum*, 686 F.2d 937, 944-48, 214 USPQ 761, 767-70 (CCPA 1982). Not insisting upon a terminal disclaimer to overcome a judicially created double patenting rejection in an application subject to a 20-year term under 35 U.S.C. 154(a)(2) would result in the potential for the problem that 37 CFR 1.321(c)(3) was promulgated to avoid.

Accordingly, a terminal disclaimer under 37 CFR 1.321 is required in an application to overcome a judicially created double patenting rejection, even if the application was filed on or after June 8, 1995 and claims the benefit under 35 U.S.C. 120, 121, or 365(c) of the filing date of the patent or application which forms the basis for the rejection. Examiners should respond to arguments that a terminal disclaimer under 37 CFR 1.321 should not be required in a continuing application filed on or after June 8, 1995 to overcome a judicially created double patenting rejection due to the change to 35 U.S.C. 154 by citing to this section of the MPEP or to the *Official Gazette* notice at 1202 O.G. 112 (Sept. 30, 1997).

### 804.03 Treatment of Commonly Owned Cases of Different Inventive Entities

*35 U.S.C. 103. Conditions for patentability; non-obvious subject matter.*

\*\*\*\*\*

(c) Subject matter developed by another person, which qualifies as prior art only under one or more of subsections (e), (f), and (g) of section 102 of this title, shall not preclude patentability under this section where the subject matter and the claimed invention were, at the time the invention was made, owned by the same person or subject to an obligation of assignment to the same person.

*37 CFR 1.78. Claiming benefit of earlier filing date and cross references to other applications.*

\*\*\*\*\*

(c) If an application or a patent under reexamination and at least one other application naming different inventors are owned by the same party and contain conflicting claims, and there is no statement of record indicating that the claimed inventions were commonly owned or subject to an obligation of assignment to the same person at the time the later invention was made, the Office may require the assignee to state whether the claimed inventions were commonly owned or subject to an obligation of assignment to the same person at the time the later invention was made, and, if not, indicate which named inventor is the prior inventor.

*37 CFR 1.130. Affidavit or declaration to disqualify commonly owned patent or published application as prior art.*

(a) When any claim of an application or a patent under reexamination is rejected under 35 U.S.C. 103 on a U.S. patent or U.S. patent application publication which is not prior art under 35 U.S.C. 102(b), and the inventions defined by the claims in the application or patent under reexamination and by the claims in the

patent or published application are not identical but are not patentably distinct, and the inventions are owned by the same party, the applicant or owner of the patent under reexamination may disqualify the patent or patent application publication as prior art. The patent or patent application publication can be disqualified as prior art by submission of:

(1) A terminal disclaimer in accordance with § 1.321(c); and

(2) An oath or declaration stating that the application or patent under reexamination and patent or published application are currently owned by the same party, and that the inventor named in the application or patent under reexamination is the prior inventor under 35 U.S.C. 104.

(b) When an application or a patent under reexamination claims an invention which is not patentably distinct from an invention claimed in a commonly owned patent with the same or a different inventive entity, a double patenting rejection will be made in the application or a patent under reexamination. A judicially created double patenting rejection may be obviated by filing a terminal disclaimer in accordance with § 1.321(c).

## I. DOUBLE PATENTING

The Office has withdrawn the Commissioner's Notice of January 9, 1967, Double Patenting, 834 O.G. 1615 (Jan. 31, 1967), to the extent that it does not authorize a double patenting rejection where different inventive entities are present. The examiner may reject claims in commonly owned applications of different inventive entities on the ground of double patenting. This is in accordance with existing case law and prevents an organization from obtaining two or more patents with different expiration dates covering nearly identical subject matter. See *In re Zickendraht*, 319 F.2d 225, 138 USPQ 22 (CCPA 1963) (the doctrine is well established that claims in different applications need be more than merely different in form or content and that patentable distinction must exist to entitle applicants to a second patent) and *In re Christensen*, 330 F.2d 652, 141 USPQ 295 (CCPA 1964).

Double patenting rejections can be overcome in certain circumstances by disclaiming, pursuant to the provisions of 37 CFR 1.321, the terminal portion of the term of the later patent and including in the disclaimer a provision that the patent shall be enforceable only for and during the period the patent is commonly owned with the application or patent which formed the basis for the rejection, thereby eliminating the problem of extending patent life. 37 CFR 1.130(b).

## II. IDENTIFYING COMMONLY OWNED CASES OR DETERMINING INVENTION PRIORITY

A determination of priority is not required when two inventions come within the provisions of 35 U.S.C. 103(c). Two inventions of different inventive entities come within the provisions of 35 U.S.C. 103(c) when:

(A) the later invention is not anticipated by the earlier invention under 35 U.S.C. 102;

(B) the earlier invention qualifies as prior art for purposes of obviousness under 35 U.S.C. 103 against the later invention only under subsection (f) or (g) of 35 U.S.C. 102, or 35 U.S.C. 102(e) for applications filed on or after November 29, 1999; and

(C) the inventions were, at the time the later invention was made, owned by the same person or subject to an obligation of assignment to the same person.

Pursuant to 37 CFR 1.78(c), where an application or a patent under reexamination and at least one other application of different inventive entities are owned by the same party and contain conflicting claims, the examiner may require the assignee to state whether the claimed inventions come within the provisions of 35 U.S.C. 103(c) (i.e., indicate whether common ownership or an obligation of assignment to the same person existed at the time the later invention was made). If the assignee states that the provisions of 35 U.S.C. 103(c) do not apply to the conflicting claimed inventions, the assignee is required to indicate which named inventor is the prior inventor. Form paragraphs 8.27, 8.28 and 8.28.01 may be used to require the applicant to identify the prior inventor under 37 CFR 1.78(c). In order to avoid abandonment, the assignee must comply with the requirement under 37 CFR 1.78(c) by naming the prior inventor unless the conflicting claims are eliminated in all but one application. If, however, the two inventions come within the provisions of 35 U.S.C. 103(c), it is not necessary to determine priority of invention since the earlier invention is disqualified as prior art against the later invention and since double patenting rejections can be used to ensure that the patent terms expire together. Accordingly, a response to a requirement under 37 CFR 1.78(c) which states that the inventions of different inventive entities come within the provi-

sions of 35 U.S.C. 103(c), is complete without any further inquiry under 37 CFR 1.78(c) as to the prior inventor.

Before making the requirement to identify the prior inventor under 37 CFR 1.78(c), with its threat to hold the application abandoned if the statement is not made by the assignee, the examiner must make sure that claims are present in each application which are conflicting as defined in MPEP § 804. See *In re Rekors*, 203 USPQ 1034 (Comm'r Pat. 1979).

In some situations the application file wrappers may reflect which invention is the prior invention, e.g., by reciting that one invention is an improvement of the other invention. See *Margolis v. Banner*, 599 F.2d 435, 202 USPQ 365 (CCPA 1979) (Court refused to uphold a holding of abandonment for failure to name the prior inventor since the record showed what was invented by the different inventive entities and who was the prior inventor.).

An application in which a requirement to name the prior inventor has been made will not be held abandoned where a timely response indicates that the other application is abandoned or will be permitted to become abandoned and will not be filed as a continuing application. Such a response will be considered sufficient since it renders the requirement to identify the prior inventor moot because the existence of conflicting claims is eliminated. Also note that the conflict between two or more pending applications can be avoided by abandoning the applications and filing a continuation-in-part application merging the conflicting inventions into a single application.

#### **A. Excluding A Prior Art Reference Where Common Ownership Or Assignment Obligation Exists**

In order to be disqualified as prior art under 35 U.S.C. 103(c), the subject matter that would otherwise be prior art to the claimed invention and the claimed invention must be commonly owned at the time the claimed invention was made. For applications filed prior to November 29, 1999, the subject matter that is disqualified as prior art under 35 U.S.C. 103 is strictly limited to subject matter that qualifies as prior art only under 35 U.S.C. 102(f) or 35 U.S.C. 102(g) and was commonly owned with the claimed invention at the time the claimed invention was made. For applications filed on or after November 29, 1999,

the subject matter which was prior art under 35 U.S.C. 103 via 35 U.S.C. 102(e) is also disqualified as prior art against the claimed invention if that subject matter and the claimed invention were commonly owned at the time the claimed invention was made. 35 U.S.C. 103(c) applies only to prior art usable in an obviousness rejection under 35 U.S.C. 103.

To rely upon 35 U.S.C. 103(c), a statement of common ownership must be provided in the record of the application being examined. See MPEP § 706.02(1)(2) regarding evidence required to establish common ownership.

For applications filed prior to November 29, 1999, the subject matter which was prior art under 35 U.S.C. 103 via 35 U.S.C. 102(e) will not be disqualified as prior art under 35 U.S.C. 103(c). However, the prior art under 35 U.S.C. 102(e)/103(a) may be disqualified under 37 CFR 1.130 if: (A) the prior art and the application being examined are commonly owned; (B) the prior art does not anticipate the claimed invention of the application; (C) a terminal disclaimer pursuant to 37 CFR 1.321 is filed; and (D) an oath or declaration is filed stating that the application being examined and the prior art are currently owned by the same party, and that the inventor named in the application is the prior inventor under 35 U.S.C. 104. See MPEP § 718.

### **III. REJECTIONS UNDER 35 U.S.C. 102 AND 103 AND DOUBLE PATENTING**

Form paragraphs 8.27, 8.28 and 8.28.01 may be used to require the applicant to name the prior inventor under 37 CFR 1.78(c).

#### **¶ 8.27 Different Inventors, Common Assignee, Same Invention**

Claim [1] directed to the same invention as that of claim [2] of commonly assigned [3]. The issue of priority under 35 U.S.C. 102(g) and possibly 35 U.S.C. 102(f) of this single invention must be resolved.

Since the U.S. Patent and Trademark Office normally will not institute an interference between applications or a patent and an application of common ownership (see MPEP § 2302), the assignee is required to state which entity is the prior inventor of the conflicting subject matter. A terminal disclaimer has no effect in this situation since the basis for refusing more than one patent is priority of invention under 35 U.S.C. 102(f) or (g) and not an extension of monopoly.

Failure to comply with this requirement will result in a holding of abandonment of this application.

**Examiner Note:**

1. In bracket 3, insert the U.S. patent number or the copending application number.
2. The claims listed in brackets 1 and 2 must be for the same invention. If one invention is obvious in view of the other, do not use this form paragraph; see form paragraph 8.28.
3. A provisional or actual statutory double patenting rejection may also be made using form paragraphs 8.31 or 8.32.
4. If the commonly assigned application or patent has an earlier U.S. filing date, a rejection under 35 U.S.C. 102(e) may also be made using form paragraph 7.15.01 or 7.15.02.

¶ *8.28 Different Inventors, Common Assignee, Obvious Inventions, No Evidence of Common Ownership at Time of Invention*

Claim [1] directed to an invention not patentably distinct from claim [2] of commonly assigned [3]. Specifically, [4].

**Examiner Note:**

1. This form paragraph should be used when the application being examined is commonly assigned with a conflicting application or patent, but there is no indication that they were commonly assigned at the time the invention was actually made.
2. If the conflicting claims are in a patent or a published application with an earlier U.S. filing date, make a rejection under 35 U.S.C. 102(e)/103(a) using form paragraph 7.21.02 in addition to this paragraph.
3. If the conflicting claims are in a commonly assigned, copending application with an earlier filing date, make a provisional 102(e)/103(a) rejection using form paragraph 7.21.01 in addition to this paragraph.
4. In bracket 3, insert the number of the conflicting patent or application.
5. An obviousness double patenting rejection may also be included in the action using form paragraphs 8.34 to 8.36.
6. In bracket 4, explain why the claims in the conflicting cases are not considered to be distinct.
7. Form paragraph 8.28.01 MUST follow this paragraph.

A showing that the inventions were commonly owned at the time the invention in this application was made will preclude a rejection under 35 U.S.C. 103(a) based upon the commonly assigned case as a reference under 35 U.S.C. 102(f) or (g), or 35 U.S.C. 102(e) for applications filed on or after November 29, 1999.

¶ *8.28.01 Advisory Information Relating to Paragraph 8.28*

The U.S. Patent and Trademark Office normally will not institute an interference between applications or a patent and an application of common ownership (see MPEP § 2302). Commonly assigned [1], discussed above, would form the basis for a rejection of the noted claims under 35 U.S.C. 103(a) if the commonly assigned case qualifies as prior art under 35 U.S.C. 102(f) or (g) and the conflicting inventions were not commonly owned at the time the invention in this application was made. In order for the examiner to resolve this issue, the assignee is required under 35 U.S.C. 103(c) and 37 CFR 1.78(c) to either show that the conflicting inventions were commonly owned at the time the invention in this application was made or to name the prior inventor of the con-

flicting subject matter. Failure to comply with this requirement will result in a holding of abandonment of the application.

A showing that the inventions were commonly owned at the time the invention in this application was made will preclude a rejection under 35 U.S.C. 103(a) based upon the commonly assigned case as a reference under 35 U.S.C. 102(f) or (g), or 35 U.S.C. 102(e) for applications filed on or after November 29, 1999.

**Examiner Note:**

This form paragraph should follow paragraph 8.28 and should only be used ONCE in an Office action.

If it is determined that the provisions of 35 U.S.C. 103(c) apply to the commonly owned conflicting inventions of different inventive entities and thereby overcoming the obviousness rejection(s), double patenting rejection(s) should be made as appropriate. If, however, it is determined that the provisions of 35 U.S.C. 103(c) do NOT apply because the inventions were not commonly owned or subject to an obligation of assignment to the same person at the time the later invention was made, and there is evidence of record to indicate that a patent or application is prior art against the application being examined, the examiner should make (A) the appropriate double patenting rejection(s), and (B) the appropriate prior art rejection(s) under 35 U.S.C. 102 and/or 35 U.S.C. 103 in the application being examined. See Charts I-A, I-B, II-A, II-B, III-A and III-B in MPEP § 804. Rejections under 35 U.S.C. 102 or 35 U.S.C. 103 cannot be obviated solely by filing a terminal disclaimer.

¶ *7.15 Rejection, 35 U.S.C. 102(a), (b) Patent or Publication, and (g)*

Claim [1] rejected under 35 U.S.C. 102[2] as being [3] by [4].

**Examiner Note:**

1. In bracket 2, insert the appropriate paragraph letter or letters of 35 U.S.C. 102 in parentheses. If paragraph (e) of 35 U.S.C. 102 is applicable, use form paragraph 7.15.02.
2. In bracket 3, insert either --clearly anticipated-- or --anticipated-- with an explanation at the end of the paragraph.
3. In bracket 4, insert the prior art relied upon.
4. This rejection must be preceded either by form paragraph 7.07 and form paragraphs 7.08, 7.09, and 7.14 as appropriate, or by form paragraph 7.103.
5. If 35 U.S.C. 102(e) is also being applied, this paragraph must be followed by either form paragraph 7.15.02 or 7.15.03.

¶ *7.19 Rejection, 35 U.S.C. 102(f), Applicant Not the Inventor*

Claim [1] rejected under 35 U.S.C. 102(f) because the applicant did not invent the claimed subject matter. [2]

**Examiner Note:**

1. This form paragraph must be preceded either by form paragraphs 7.07 and 7.13 or by form paragraph 7.103.
2. In bracket 2, insert an explanation of the supporting evidence establishing that applicant was not the inventor. See MPEP § 2137.

**¶ 7.21 Rejection, 35 U.S.C. 103(a)**

Claim [1] rejected under 35 U.S.C. 103(a) as being unpatentable over [2].

**Examiner Note:**

1. This form paragraph must be preceded by either form paragraph 7.20 or form paragraph 7.103.
2. An explanation of the rejection applying the *Graham v. Deere* test must follow this form paragraph.
3. If this rejection relies upon art that is disqualified under 35 U.S.C. 102(f) or (g) based upon the common ownership of the invention, form paragraph 7.20.01 must follow this form paragraph.
4. If this rejection is a provisional 35 U.S.C. 103(a) rejection based upon a copending application that would comprise prior art under 35 U.S.C. 102(e) if patented, use paragraph 7.21.01 instead of this paragraph.

**¶ 7.21.01 Provisional Rejection, 35 U.S.C. 103(a), Common Assignee or at Least One Common Inventor**

Claim [1] provisionally rejected under 35 U.S.C. 103(a) as being obvious over copending Application No. [2] which has a common [3] with the instant application. Based upon the earlier effective U.S. filing date of the copending application, it would constitute prior art under 35 U.S.C. 102(e) if patented. This provisional rejection under 35 U.S.C. 103(a) is based upon a presumption of future patenting of the conflicting application. [4]

This provisional rejection might be overcome either by a showing under 37 CFR 1.132 that any invention disclosed but not claimed in the copending application was derived from the inventor of this application and is thus not the invention “by another,” or by a showing of a date of invention for the instant application prior to the effective U.S. filing date of the copending application under 37 CFR 1.131. For applications filed on or after November 29, 1999, this rejection might also be overcome by showing that the subject matter of the reference and the claimed invention were, at the time the invention was made, owned by the same person or subject to an obligation of assignment to the same person. See MPEP § 706.02(1)(1) and § 706.02(1)(2).

**Examiner Note:**

1. This form paragraph is used to provisionally reject claims not patentably distinct from the disclosure in a copending application having an earlier U.S. filing date and also having either a common assignee or at least one common inventor. This form paragraph should **not** be used in applications filed on or after November 29, 1999 when the application being examined establishes that it and any reference application were owned by, or subject to an obligation of assignment to, the same person, at the time the invention was made. See MPEP § 706.02(1)(3).

2. If the claimed invention is fully disclosed in the copending application, use form paragraph 7.15.01.
3. In bracket 3, insert either --assignee-- or --inventor--.
4. In bracket 4, insert explanation of obviousness.
5. If the claimed invention is also claimed in the copending application, a provisional obviousness double patenting rejection should additionally be made using form paragraphs 8.33 and 8.37.
6. If evidence indicates that the copending application is also prior art under 35 U.S.C. 102(f) or (g) and the copending application has not been disqualified as prior art in a 35 U.S.C. 103(a) rejection based upon common ownership, a rejection should additionally be made under 35 U.S.C. 103(a) using form paragraph 7.21 (e.g., applicant has named the prior inventor in response to a requirement made using form paragraph 8.28).

Further, if the conflicting applications have different effective U.S. filing dates, the examiner should consider making a provisional rejection in the later filed application, based on the earlier filed application, under 35 U.S.C. 102(e) or 102(e)/103(a), using form paragraph 7.15.01 or 7.21.01. Similarly, if an application has a later effective U.S. filing date than a conflicting issued patent, the examiner should consider making a rejection in the application, based on the patent, under 35 U.S.C. 102(e) or 102(e)/103(a), using form paragraph 7.15.02 or 7.21.02. Rejections under 35 U.S.C. 102 or 103 cannot be obviated solely by the filing of a terminal disclaimer. However, for applications filed on or after November 29, 1999, a rejection under 35 U.S.C. 102(e) can be overcome by submitting evidence of common ownership, or an obligation to assign to the same person, at the time the invention was made.

**¶ 7.15.01 Provisional Rejection, 35 U.S.C. 102(e) - Common Assignee or At Least One Common Inventor**

Claim [1] provisionally rejected under 35 U.S.C. 102(e) as being anticipated by copending Application No. [2] which has a common [3] with the instant application.

Based upon the earlier effective U.S. filing date of the copending application, it would constitute prior art under 35 U.S.C. 102(e), if patented. This provisional rejection under 35 U.S.C. 102(e) is based upon a presumption of future patenting of the copending application. [4].

This provisional rejection under 35 U.S.C. 102(e) might be overcome either by a showing under 37 CFR 1.132 that any invention disclosed but not claimed in the copending application was derived from the inventor of this application and is thus not the invention “by another,” or by an appropriate showing under 37 CFR 1.131.

This rejection may not be overcome by the filing of a terminal disclaimer. See *In re Bartfeld*, 925 F.2d 1450, 17 USPQ2d 1885 (Fed. Cir. 1991).

**Examiner Note:**



1. This form paragraph is used to provisionally reject over a copending application with an earlier filing date that discloses the claimed invention. The copending application must have either a common assignee or at least one common inventor.
2. If the claims are obvious over the invention disclosed in the other copending application, use form paragraph 7.21.01.
3. In bracket 3, insert either --assignee-- or --inventor--.
4. In bracket 4, an appropriate explanation may be provided in support of the examiner's position on anticipation, if necessary.
5. If the claims of the copending application conflict with the claims of the instant application, a provisional double patenting rejection should also be given using form paragraphs 8.30 and 8.32.
6. If evidence is additionally of record to show that either invention is prior art unto the other under 35 U.S.C. 102(f) or (g), a rejection using form paragraphs 7.13 and/or 7.14 should also be made.

¶ *7.15.02 Rejection, 35 U.S.C. 102(e), Common Assignee or Inventor(s)*

Claim [1] rejected under 35 U.S.C. 102(e) as being anticipated by [2].

The applied reference has a common [3] with the instant application. Based upon the earlier effective U.S. filing date of the reference, it constitutes prior art under 35 U.S.C. 102(e). This rejection under 35 U.S.C. 102(e) might be overcome either by a showing under 37 CFR 1.132 that any invention disclosed but not claimed in the reference was derived from the inventor of this application and is thus not the invention "by another," or by an appropriate showing under 37 CFR 1.131.

**Examiner Note:**

1. This form paragraph is used to reject over a patent with an earlier filing date that discloses but does not claim the same invention. The patent must have either a common assignee or a common inventor.
2. In bracket 3, insert either --assignee-- or --inventor--.

¶ *7.21.02 Rejection, 35 U.S.C. 103(a), Common Assignee or At Least One Common Inventor*

Claim [1] rejected under 35 U.S.C. 103(a) as being obvious over [2].

The applied reference has a common [3] with the instant application. Based upon the earlier effective U.S. filing date of the reference, it constitutes prior art only under 35 U.S.C. 102(e). This rejection under 35 U.S.C. 103(a) might be overcome by: (1) a showing under 37 CFR 1.132 that any invention disclosed but not claimed in the reference was derived from the inventor of this application and is thus not an invention "by another"; (2) a showing of a date of invention for the claimed subject matter of the application which corresponds to subject matter disclosed but not claimed in the reference, prior to the effective U.S. filing date of the reference under 37 CFR 1.131; or (3) an oath or declaration under 37 CFR 1.130 stating that the application and reference are currently owned by the same party and that the inventor named in

the application is the prior inventor under 35 U.S.C. 104, together with a terminal disclaimer in accordance with 37 CFR 1.321(c). For applications filed on or after November 29, 1999, this rejection might also be overcome by showing that the subject matter of the reference and the claimed invention were, at the time the invention was made, owned by the same person or subject to an obligation of assignment to the same person. See MPEP § 706.02(1)(1) and § 706.02(1)(2). [4]

**Examiner Note:**

1. This form paragraph is used to reject over a patent with an earlier filing date that discloses the claimed invention, and that only qualifies as prior art under 35 U.S.C. 102(e). If the patent qualifies as prior art under 35 U.S.C. 102(a) or (b), then this form paragraph should not be used (form paragraphs 7.07 and either 7.08 or 7.09 should be used instead). The patent must have either a common assignee or at least one common inventor. This form paragraph should not be used in applications filed on or after November 29, 1999 when the application being examined establishes that it and any reference patent were owned by, or subject to an obligation of assignment to, the same person, at the time the invention was made. See MPEP § 706.03(1)(3).
2. In bracket 3, insert either --assignee-- or --inventor--.
3. In bracket 4, insert explanation of obviousness.

## 804.04 Submission to Technology Center Director

In order to promote uniform practice, every Office action containing a rejection on the ground of double patenting which relies on the parent application rejecting the claims in a divisional or continuing application where the divisional or continuing application was filed because of a requirement to restrict made by the examiner under 35 U.S.C. 121, including a requirement to elect species, must be submitted to the Technology Center Director for approval prior to mailing. If the rejection on the ground of double patenting is disapproved, it shall not be mailed but other appropriate action shall be taken. Note MPEP § 1003.

## 805 Effect of Improper Joinder in Patent

35 U.S.C. 121, last sentence, provides "the validity of a patent shall not be questioned for failure of the Commissioner to require the application to be restricted to one invention." In other words, under this statute, no patent can be held void for improper joinder of inventions claimed therein.

## **806 Determination of Distinctness or Independence of Claimed Inventions**

The general principles relating to distinctness or independence may be summarized as follows:

(A) Where inventions are independent (i.e., no disclosed relation therebetween), restriction to one thereof is ordinarily proper, MPEP § 806.04 - § 806.04(i), though a reasonable number of species may be claimed when there is an allowed (novel and unobvious) claim generic thereto. 37 CFR 1.141, MPEP § 809.02 - § 809.02(e).

(B) Where inventions are related as disclosed but are distinct as claimed, restriction may be proper.

(C) Where inventions are related as disclosed but are not distinct as claimed, restriction is never proper.

Where restriction is required by the Office double patenting cannot be held, and thus, it is imperative the requirement should never be made where related inventions as claimed are not distinct. For (B) and (C) see MPEP § 806.05 - § 806.05(i) and § 809.03. See MPEP § 802.01 for criteria for patentably distinct inventions.

### **806.01 Compare Claimed Subject Matter**

In passing upon questions of double patenting and restriction, it is the claimed subject matter that is considered and such claimed subject matter must be compared in order to determine the question of distinctness or independence.

### **806.02 Patentability Over the Prior Art Not Considered**

For the purpose of a decision on the question of restriction, and for this purpose only, the claims are ordinarily assumed to be in proper form and patentable (novel and unobvious) over the prior art.

This assumption, of course, is not continued after the question of restriction is settled and the question of patentability of the several claims in view of prior art is taken up.

## **806.03 Single Embodiment, Claims Defining Same Essential Features**

Where the claims of an application define the same essential characteristics of a *single* disclosed embodiment of an invention, restriction therebetween should never be required. This is because the claims are but different definitions of the same disclosed subject matter, varying in breadth or scope of definition.

Where such claims appear in different applications optionally filed by the same inventor, disclosing the same embodiments, see MPEP § 804 - § 804.02.

### **806.04 Independent Inventions**

If it can be shown that the two or more inventions are in fact independent, applicant should be required to restrict the claims presented to but one of such independent inventions. For example:

(A) Two different combinations, not disclosed as capable of use together, having different modes of operation, different functions or different effects are independent. An article of apparel such as a shoe, and a locomotive bearing would be an example. A process of painting a house and a process of boring a well would be a second example.

(B) Where the two inventions are process and apparatus, and the apparatus cannot be used to practice the process or any part thereof, they are independent. A specific process of molding is independent from a molding apparatus which cannot be used to practice the specific process.

(C) Where species under a genus are independent, for example, a genus of paper clips having species differing in the manner in which a section of the wire is formed in order to achieve a greater increase in its holding power.

SPECIES ARE TREATED EXTENSIVELY IN THE FOLLOWING SECTIONS.

### **806.04(a) Species — Genus**

35 U.S.C. 121 provides that restriction may be required to one of two or more independent and distinct inventions. However, 37 CFR 1.141 provides that a reasonable number of species may still be

claimed in one application if the other conditions of the rule are met.

### 806.04(b) Species May Be Related Inventions

Species, while usually independent, may be related under the particular disclosure. Where inventions as disclosed and claimed are both (A) species under a claimed genus and (B) related, then the question of restriction must be determined by both the practice applicable to election of species and the practice applicable to other types of restrictions such as those covered in MPEP § 806.05 - § 806.05(i). If restriction is improper under either practice, it should not be required.

For example, two different subcombinations usable with each other may each be a species of some common generic invention. In *Ex parte Healy*, 1898 C.D. 157, 84 O.G. 1281 (Comm'r Pat. 1898), a clamp for a handle bar stem and a specifically different clamp for a seat post both usable together on a bicycle were claimed. In his decision, the Commissioner considered both the restriction practice under election of species and the practice applicable to restriction between combination and subcombinations.

As a further example, species of carbon compounds may be related to each other as intermediate and final product. Thus, these species are not independent and in order to sustain a restriction requirement, distinctness must be shown. Distinctness is proven if it can be shown that the intermediate product is useful other than to make the final product. Otherwise, the disclosed relationship would preclude their being issued in separate patents.

Form Paragraph 8.14 may be used in intermediate — final product restriction requirements.

#### ¶ 8.14 Intermediate-Final Product

Inventions [1] and [2] are related as mutually exclusive species in an intermediate-final product relationship. Distinctness is proven for claims in this relationship if the intermediate product is

useful to make other than the final product (MPEP § 806.04(b), 3rd paragraph), and the species are patentably distinct (MPEP § 806.04(h)). In the instant case, the intermediate product is deemed to be useful as [3] and the inventions are deemed patentably distinct since there is nothing on this record to show them to be obvious variants. Should applicant traverse on the ground that the species are not patentably distinct, applicant should submit evidence or identify such evidence now of record showing the species to be obvious variants or clearly admit on the record that this is the case. In either instance, if the examiner finds one of the inventions anticipated by the prior art, the evidence or admission may be used in a rejection under 35 U.S.C. 103(a) of the other invention.

#### Examiner Note:

1. This form paragraph is to be used when claims are presented to both an **intermediate** and **final product** (MPEP § 806.04(b)).
2. Conclude restriction requirement with one of form paragraphs 8.21.01 through 8.21.03.

The intermediate and final product must have a mutually exclusive species relationship and as with all species restrictions, must be patentably distinct.

Typically, the intermediate loses its identity in the final product.

Additionally, the intermediate must be shown to be useful to make other than the final product. The examiner must give an example of an alternative use but need not provide documentation. Applicant then has the burden to prove or provide a convincing argument that the intermediate does not have the suggested use.

### 806.04(c) Subcombination Not Generic to Combination

The situation is frequently presented where two different combinations are disclosed, having a subcombination *common to each*. It is frequently puzzling to determine whether a claim readable on two different combinations is generic thereto.

This was recognized in *Ex parte Smith*, 1888 C.D. 131, 44 O.G.1183 (Comm'r Pat. 1888), where it was held that a subcombination was not generic to the different combinations in which it was used.

To exemplify, a claim that defines only the subcombination, e.g., the mechanical structure of a joint, is not a generic or genus claim to two different combinations, e.g., a doughnut cooker and an automobile transmission, each of which utilizes the same form of joint.

#### **806.04(d) Definition of a Generic Claim**

In an application presenting three species illustrated, for example, in Figures 1, 2, and 3, respectively, a generic claim should read on each of these views; but the fact that a claim does so read is not conclusive that it is generic. It may define only an element or subcombination common to the several species.

It is not possible to define a generic claim with that precision existing in the case of a geometrical term. In general, a generic claim should include no material element additional to those recited in the species claims, and must comprehend within its confines the organization covered in each of the species.

For the purpose of obtaining claims to more than one species in the same case, the generic claim cannot include limitations not present in each of the added species claims. Otherwise stated, the claims to the species which can be included in a case in addition to a single species must contain all the limitations of the generic claim.

Once a claim that is determined to be generic is allowed, all of the claims drawn to species in addition to the elected species which include all the limitations of the generic claim will ordinarily be obviously allowable in view of the allowance of the generic claim, since the additional species will depend thereon or otherwise include all of the limitations thereof. When all or some of the claims directed to one of the species in addition to the elected species do not include all the limitations of the generic claim, then that species cannot be claimed in the same case with the other species. See MPEP § 809.02(c).

#### **806.04(e) Claims Restricted to Species**

Claims are definitions of inventions. *Claims are never species.* Claims may be restricted to a single disclosed embodiment (i.e., a single species, and thus be designated a *specific species claim*), or a claim may include two or more of the disclosed embodi-

ments within the breadth and scope of definition (and thus be designated a *generic or genus claim*).

*Species are always the specifically different embodiments.*

Species are *usually* but not always independent as disclosed (see MPEP § 806.04(b)) since there is usually no disclosure of relationship therebetween. The fact that a genus for two different embodiments is capable of being conceived and defined, does not affect the independence of the embodiments, where the case under consideration contains no disclosure of any commonality of operation, function or effect.

#### **806.04(f) Claims Restricted to Species, by Mutually Exclusive Characteristics**

Claims to be restricted to different species must be mutually exclusive. The general test as to when claims are restricted, respectively, to different species is the fact that one claim recites limitations which under the disclosure are found in a first species but not in a second, while a second claim recites limitations disclosed only for the second species and not the first. This is frequently expressed by saying that claims to be restricted to different species must recite the mutually exclusive characteristics of such species.

#### **806.04(h) Species Must Be Patentably Distinct From Each Other**

Where an applicant files a divisional application claiming a species previously claimed but nonelected in the parent case, pursuant to and consonant with a requirement to restrict, there should be no determination of whether or not the species claimed in the divisional application is patentable over the species retained in the parent case since such a determination was made before the requirement to restrict was made.

In a national application containing claims directed to more than a reasonable number of species, the examiner should not require restriction to a reasonable number of species unless he or she is satisfied that he or she would be prepared to allow claims to each of the claimed species over the parent case, if presented in a divisional application filed according to the requirement. Restriction should not be required if the

species claimed are considered clearly unpatentable over each other.

In making a requirement for restriction in an application claiming plural species, the examiner should group together species considered clearly unpatentable over each other, with the statement that restriction as between those species is not required.

Where generic claims are allowed in a national application, applicant may claim in the *same application* additional species as provided by 37 CFR 1.141.

Where, however, an applicant optionally files another national application with claims to a different species, or for a species disclosed but not claimed in a parent case as filed and first acted upon by the examiner, there should be close investigation to determine the presence or absence of patentable difference. See MPEP § 804.01 and § 804.02.

### **806.04(i) Generic Claims Presented for First Time After Issue of Species**

The Office no longer follows the practice of prohibiting the allowance of generic claims that are presented for the first time after the issuance of a copending application claiming plural species. Instead, the Office may reject the generic claims on the grounds of obviousness-type double patenting. Applicant may overcome such a rejection by filing a terminal disclaimer. See *In re Braithwaite*, 379 F.2d 594, 154 USPQ 29 (CCPA 1967).

## **806.05 Related Inventions**

Where two or more related inventions are being claimed, the principal question to be determined in connection with a requirement to restrict or a rejection on the ground of double patenting is whether or not the inventions as claimed are distinct. If they are distinct, restriction may be proper. If they are not distinct, restriction is never proper. If nondistinct inventions are claimed in separate applications or patents, double patenting must be held, except where the

additional applications were filed consonant with a requirement to restrict in a national application.

The various pairs of related inventions are noted in the following sections.

### **806.05(a) Combination and Subcombination or Element**

A combination is an organization of which a subcombination or element is a part.

Relative to questions of restriction where a combination is alleged, the claim thereto must be assumed to be allowable (novel and unobvious) as pointed out in MPEP § 806.02, in the absence of a holding by the examiner to the contrary. When a claim is found in a patent, it has already been found by the Office to be allowable and must be treated on that basis.

### **806.05(b) Old Combination — Novel Subcombination**

Restriction is ordinarily not proper between a combination (AB) that the examiner holds to be old and unpatentable and the subcombination (B) in which the examiner holds the novelty, if any, to reside. *Ex parte Donnell*, 1923 C.D. 54, 315 O.G. 398 (Comm'r Pat.1923). See MPEP § 820.01.

### **806.05(c) Criteria of Distinctness for Combination, Subcombination, or Element of a Combination**

In order to establish that combination and subcombination inventions are distinct, two-way distinctness must be demonstrated.

To support a requirement for restriction, both two-way distinctness and reasons for insisting on restriction are necessary, i.e., separate classification, status, or field of search. See MPEP § 808.02.

The inventions are distinct if it can be shown that a combination as claimed:

(A) does not require the particulars of the subcombination as claimed for patentability (to show novelty and unobviousness), and

(B) the subcombination can be shown to have utility either by itself or in other and different relations.

When these factors cannot be shown, such inventions are not distinct.

The following examples are included for general guidance.

## I. SUBCOMBINATION NOT ESSENTIAL TO COMBINATION

### *AB<sub>br</sub>/B<sub>sp</sub> Restriction Proper*

Where a combination as claimed does not set forth the details of the subcombination as separately claimed and the subcombination has separate utility, the inventions are distinct and restriction is proper if reasons exist for insisting upon the restriction; i.e., separate classification, status, or field of search.

This situation can be diagrammed as combination AB<sub>br</sub> (“br” is an abbreviation for “broad”), and subcombination B<sub>sp</sub> (“sp” is an abbreviation for “specific”). B<sub>br</sub> indicates that in the combination the subcombination is broadly recited and that the specific characteristics set forth in the subcombination claim B<sub>sp</sub> are not set forth in the combination claim.

Since claims to both the subcombination and combination are presented and assumed to be patentable, the omission of details of the claimed subcombination B<sub>sp</sub> in the combination claim AB<sub>br</sub> is evidence that the patentability of the combination does not rely on the details of the specific subcombination.

## II. SUBCOMBINATION ESSENTIAL TO COMBINATION

### *AB<sub>sp</sub>/B<sub>sp</sub> No Restriction*

If there is no evidence that combination AB<sub>sp</sub> is patentable without the details of B<sub>sp</sub>, restriction should not be required. Where the relationship between the claims is such that the separately claimed subcombination B<sub>sp</sub> constitutes the essential distinguishing feature of the combination AB<sub>sp</sub> as claimed, the inventions are not distinct and a requirement for restriction must not be made, even though the subcombination has separate utility.

## III. SOME COMBINATION CLAIMS RECITE SPECIFIC FEATURES OF THE SUBCOMBINATION BUT OTHER COMBINATION CLAIMS GIVE EVIDENCE THAT THE SUBCOMBINATION IS NOT ESSENTIAL TO THE COMBINATION.

### *AB<sub>sp</sub>/AB<sub>br</sub> (Evidence Claim)/B<sub>sp</sub> Restriction Proper*

Claim AB<sub>br</sub> is an evidence claim which indicates that the combination does not rely upon the specific details of the subcombination for its patentability. If claim AB<sub>br</sub> is subsequently found to be unallowable, the question of rejoinder of the inventions restricted must be considered and the letter to the applicant should so state. Therefore, where the combination evidence claim AB<sub>br</sub> does not set forth the details of the subcombination B<sub>sp</sub> and the subcombination B<sub>sp</sub> has separate utility, the inventions are distinct and restriction is proper if reasons exist for insisting upon the restriction.

In applications claiming plural inventions capable of being viewed as related in two ways, for example, as both combination-subcombination and also as different statutory categories, both applicable criteria for distinctness must be demonstrated to support a restriction requirement. See also MPEP § 806.04(b).

Form paragraph 8.15 may be used in combination-subcombination restriction requirements.

#### *¶ 8.15 Combination-Subcombination*

Inventions [1] and [2] are related as combination and subcombination. Inventions in this relationship are distinct if it can be shown that (1) the combination as claimed does not require the particulars of the subcombination as claimed for patentability, and (2) that the subcombination has utility by itself or in other combinations (MPEP § 806.05(c)). In the instant case, the combination as claimed does not require the particulars of the subcombination as claimed because [3]. The subcombination has separate utility such as [4].

#### **Examiner Note:**

1. This form paragraph is to be used when claims are presented to both **combination(s)** and **subcombination(s)** (MPEP § 806.05(c)).
2. In situations involving evidence claims, see MPEP § 806.05(c), example 3, and explain in bracket 3.
3. In bracket 4, suggest utility other than used in the combination.
4. Conclude restriction requirement with one of form paragraphs 8.21.01 through 8.21.03.

The burden is on the examiner to suggest an example of separate utility.

If applicant proves or provides an argument supported by facts, that the other utility, suggested by the examiner, cannot be accomplished, the burden shifts to the examiner to document a viable separate utility or withdraw the requirement.

### 806.05(d) Subcombinations Usable Together

Two or more claimed subcombinations, disclosed as usable together in a single combination, and which can be shown to be separately usable, are usually distinct from each other.

Care should always be exercised in this situation to determine if the several subcombinations are generically claimed. See MPEP § 806.04(b).

Form paragraph 8.16 may be used in restriction requirements between subcombinations.

#### ¶ 8.16 Subcombinations, Usable Together

Inventions [1] and [2] are related as subcombinations disclosed as usable together in a single combination. The subcombinations are distinct from each other if they are shown to be separately usable. In the instant case invention [3] has separate utility such as [4]. See MPEP § 806.05(d).

#### Examiner Note:

1. This form paragraph is to be used when claims are presented to subcombinations usable together (MPEP § 806.05(d)).
2. In bracket 3, insert the appropriate group number or identify the invention.
3. In bracket 4, suggest utility other than with the other invention.
4. Conclude restriction requirement with one of form paragraphs 8.21.01 through 8.21.03.

Only one-way distinctness is required.

The examiner must show, by way of example, that one of the subcombinations has utility other than in the disclosed combination.

Care must be taken to determine if the subcombinations are generically claimed.

Where subcombinations as disclosed and claimed are both (a) species under a claimed genus and (b) related, then the question of restriction must be determined by both the practice applicable to election of species and the practice applicable to related inventions. If restriction is improper under either practice, it should not be required (MPEP § 806.04(b)).

The burden is on the examiner to provide an example.

If applicant proves or provides an argument, supported by facts, that the other use, suggested by the examiner, cannot be accomplished or is not reasonable, the burden is on the examiner to document a viable alternative use or withdraw the requirement.

### 806.05(e) Process and Apparatus for Its Practice — Distinctness

In applications claiming inventions in different statutory categories, only one-way distinctness is generally needed to support a restriction requirement. See MPEP § 806.05(c).

Process and apparatus for its practice can be shown to be distinct inventions, if either or both of the following can be shown: (A) that the process *as claimed* can be practiced by another materially different apparatus or by hand; or (B) that the apparatus *as claimed* can be used to practice another and materially different process.

If the apparatus claims include a claim to “means” for practicing the process, the claim is a linking claim and must be examined with the elected invention. If it is ultimately allowed, rejoinder is required. See MPEP § 809.04.

Form paragraph 8.17 may be used to make restriction requirements between process and apparatus.

#### ¶ 8.17 Process and Apparatus

Inventions [1] and [2] are related as process and apparatus for its practice. The inventions are distinct if it can be shown that either: (1) the process as claimed can be practiced by another materially different apparatus or by hand, or (2) the apparatus as claimed can be used to practice another and materially different process. (MPEP § 806.05(e)). In this case [3].

#### Examiner Note:

1. This form paragraph is to be used when claims are presented to both a **process** and **apparatus for its practice** (MPEP § 806.05(e)).
2. In bracket 3, use one or more of the following reasons:
  - (a) --the process as claimed can be practiced by another and materially different apparatus such as .....--,
  - (b) --the process as claimed can be practiced by hand--,
  - (c) --the apparatus as claimed can be used to practice another and materially different process such as .....--.
3. Conclude restriction requirement with one of form paragraphs 8.21.01 through 8.21.03.

The burden is on the examiner to provide reasonable examples that recite material differences.

If the apparatus claims include a claim to “means” for practicing the process, this claim is a linking claim (except for the presence of this claim restriction between apparatus and process claims would be proper). The linking claim must be examined with the elected invention, but only to the extent necessary to determine if the linking claim is unpatentable. If the linking claim is unpatentable, restriction is proper.

It should be noted that a claim such as, “An apparatus for the practice of the process of claim 1, comprising ...” and then the claim continues with purely apparatus limitations, is not a linking claim. This is merely a preamble similar to a statement of intended use and should be treated as any preamble.

If applicant proves or provides convincing argument that there is no material difference or in the case of a process that cannot be performed by hand (if examiner so argued), the burden is on the examiner to document another materially different process or apparatus or withdraw the requirement.

### **806.05(f) Process of Making and Product Made — Distinctness**

A process of making and a product made by the process can be shown to be distinct inventions if either or both of the following can be shown: (A) that the process *as claimed* is not an obvious process of making the product and the process *as claimed* can be used to make other and different products; or (B) that the product *as claimed* can be made by another and materially different process.

Allegations of different processes or products need not be documented.

A product defined by the process by which it can be made is still a product claim (*In re Bridgeford*, 357 F.2d 679, 149 USPQ 55 (CCPA 1966)) and can be restricted from the process if the examiner can demonstrate that the product as claimed can be made by another materially different process; defining the product in terms of a process by which it is made is nothing more than a permissible technique that applicant may use to define the invention.

If applicant convincingly traverses the requirement, the burden shifts to the examiner to document a viable alternative process or product, or withdraw the requirement.

Form paragraph 8.18 may be used in restriction requirements between product and process of making.

#### **¶ 8.18 Product and Process of Making**

Inventions [1] and [2] are related as process of making and product made. The inventions are distinct if either or both of the following can be shown: (1) that the process as claimed can be used to make other and materially different product or (2) that the product as claimed can be made by another and materially different process (MPEP § 806.05(f)). In the instant case [3].

#### **Examiner Note:**

1. This form paragraph is to be used when claims are presented to both a **product** and the **process of making** the product (MPEP § 806.05(f)).
2. In bracket 3, use one or more of the following reasons:
  - (a) --the process as claimed can be used to make a materially different product such as .....--,
  - (b) --the product as claimed can be made by a materially different process such as .....--.
3. Conclude restriction requirement with one of form paragraphs 8.21.01 through 8.21.03.

### **806.05(g) Apparatus and Product Made — Distinctness**

An apparatus and a product made by the apparatus can be shown to be distinct inventions if either or both of the following can be shown: (A) that the apparatus as claimed is not an obvious apparatus for making the product and the apparatus as claimed can be used to make other and different products; or (B) that the product as claimed can be made by another and materially different apparatus.

Form paragraph 8.19 may be used for restriction requirements between apparatus and product made.

#### **¶ 8.19 Apparatus and Product Made**

Inventions [1] and [2] are related as apparatus and product made. The inventions in this relationship are distinct if either or both of the following can be shown: (1) that the apparatus as claimed is not an obvious apparatus for making the product and the apparatus can be used for making a different product or (2) that the product as claimed can be made by another and materially different apparatus (MPEP § 806.05(g)). In this case [3].

#### **Examiner Note:**

1. This form paragraph is to be used when claims are presented to both the **apparatus** and **product made** (MPEP § 806.05(g)).
2. In bracket 3, use one or more of the following reasons:
  - (a) --the apparatus as claimed is not an obvious apparatus for making the product and the apparatus as claimed can be used to make a different product such as .....--,
  - (b) --the product can be made by a materially different apparatus such as .....--.



3. Conclude restriction requirement with one of form paragraphs 8.21.01 through 8.21.03.

### ONLY ONE-WAY DISTINCTNESS IS REQUIRED

The examiner must show by way of example either (A) that the apparatus as *claimed* is not an obvious apparatus for making the product and the apparatus *as claimed* can be used to make other and different products or (B) that the product *as claimed* can be made by another and materially different apparatus.

The burden is on the examiner to provide an example, but the example need not be documented.

If applicant either proves or provides convincing argument that the alternative example suggested by the examiner is not workable, the burden is on the examiner to suggest another viable example or withdraw the restriction requirement.

### 806.05(h) Product and Process of Using

A product and a process of using the product can be shown to be distinct inventions if either or both of the following can be shown: (A) the process of using as claimed can be practiced with another materially different product; or (B) the product as claimed can be used in a materially different process.

The burden is on the examiner to provide an example, but the example need not be documented.

If the applicant either proves or provides a convincing argument that the alternative use suggested by the examiner cannot be accomplished, the burden is on the examiner to support a viable alternative use or withdraw the requirement.

Form paragraph 8.20 may be used in restriction requirements between the product and method of using.

#### ¶ 8.20 *Product and Process of Using*

Inventions [1] and [2] are related as product and process of use. The inventions can be shown to be distinct if either or both of the following can be shown: (1) the process for using the product as claimed can be practiced with another materially different product or (2) the product as claimed can be used in a materially different process of using that product (MPEP § 806.05(h)). In the instant case [3].

#### Examiner Note:

1. This form paragraph is to be used when claims are presented to both the **product** and **process of using the product** (MPEP § 806.05(h)).
2. In bracket 3, use one or more of the following reasons:

(a) --the process as claimed can be practiced with another materially different product such as .....--,

(b) --the product as claimed can be used in a materially different process such as .....--.

3. Conclude restriction requirement with one of form paragraphs 8.21.01 through 8.21.03.

### 806.05(i) Product, Process of Making, and Process of Using — Product Claim Not Allowable

37 CFR 1.141. *Different inventions in one national application.*

\*\*\*\*\*

(b) Where claims to all three categories, product, process of making, and process of use, are included in a national application, a three way requirement for restriction can only be made where the process of making is distinct from the product. If the process of making and the product are not distinct, the process of using may be joined with the claims directed to the product and the process of making the product even though a showing of distinctness between the product and process of using the product can be made.

Where an application contains claims to a product, claims to a process specially adapted for (i.e., not patentably distinct from, as defined in MPEP § 806.05(f)) making the product, and claims to a process of using the product, and the product claims are not allowable (i.e., not novel and nonobvious), restriction is proper between the process of making and the process of using. In this instance, applicant may be required to elect either (A) the product and process of making it; or (B) the process of using. Unless the examiner can make a showing of distinctness between the process of using and the product (MPEP § 806.05(h)), the product must also be joined with the process of using in grouping (B).

Where the product claims are allowable (i.e., novel and nonobvious), restriction may be required only where the process of making and the product made are distinct (MPEP § 806.05(f)); otherwise, the process of using must be joined with the process of making and product made, even if a showing of distinctness can be made between the product and process of using (MPEP § 806.05(h)).

Determination of patentability of the product need not be made prior to making a requirement for restriction unless the requirement is based on a determination that the product claims are not allowable.

Form paragraph 8.20.01 may be used in product, process of making and process of using situations where the product is not allowable.

¶ 8.20.01 *Product, Process of Making and Process of Using-Product Not Allowable*

Inventions [1] and [2] are related as process of making and process of using the product. The use as claimed cannot be practiced with a materially different product. Since the product is not allowable, restriction is proper between said method of making and method of using. The product claim will be examined along with the elected invention (MPEP § 806.05(i)).

**Examiner Note:**

This form paragraph is to be used when claims are presented to the **product, process of making** and **process of using** where the product claim(s) are not allowable (MPEP § 806.05(i)).

## **807 Patentability Report Practice Has No Effect on Restriction Practice**

Patentability report practice (MPEP § 705), has no effect upon, and does not modify in any way, the practice of restriction, being designed merely to facilitate the handling of cases in which restriction cannot properly be required.

## **808 Reasons for Insisting Upon Restriction**

Every requirement to restrict has two aspects: (A) the reasons (as distinguished from the mere statement of conclusion) why the inventions *as claimed* are either independent or distinct; and (B) the reasons for insisting upon restriction therebetween as set forth in the following sections.

### **808.01 Independent Inventions**

Where the inventions claimed are independent, i.e., where they are not connected in design, operation, or effect under the disclosure of the particular application under consideration (MPEP § 806.04), *the facts relied on for this conclusion are in essence the reasons for insisting upon restriction*. This situation, except for species, is but rarely presented, since persons will seldom file an application containing disclosures of independent things.

Form paragraph 8.20.02 may be used when claims are directed to independent, unrelated inventions.

¶ 8.20.02 *Unrelated Inventions*

Inventions [1] and [2] are unrelated. Inventions are unrelated if it can be shown that they are not disclosed as capable of use together and they have different modes of operation, different functions, or different effects. (MPEP § 806.04, MPEP § 808.01). In the instant case the different inventions [3].

**Examiner Note:**

1. This form paragraph is to be used only when claims are presented to unrelated inventions, e. g., a necktie and a locomotive bearing.
2. In bracket 3, insert reasons for concluding that the inventions are unrelated.

## **808.01(a) Species**

Where there is no disclosure of relationship between species (see MPEP § 806.04(b)), they are independent inventions and election of one invention following a requirement for restriction is mandatory even though applicant disagrees with the examiner. There must be a patentable difference between the species as claimed. See MPEP § 806.04(h). Since the claims are directed to independent inventions, restriction is proper pursuant to 35 U.S.C. 121, and it is not necessary to show a separate status in the art or separate classification.

A single disclosed species must be elected as a prerequisite to applying the provisions of 37 CFR 1.141 to additional species if a generic claim is allowed.

Even if the examiner rejects the generic claims, and even if the applicant cancels the same and admits that the genus is unpatentable, where there is a relationship disclosed between species, such disclosed relationship must be discussed and reasons advanced leading to the conclusion that the disclosed relation does not prevent restriction, in order to establish the propriety of restriction.

**Election of species should not be required if the species claimed are considered clearly unpatentable (obvious) over each other.** In making a requirement for restriction in an application claiming plural species, the examiner should group together species considered clearly unpatentable over each other, with the statement that restriction as between those species is not required.

Election of species should be required prior to a search on the merits (A) in all applications containing claims to a plurality of species with no generic claims,

and (B) in all applications containing both species claims and generic or Markush claims.

In all applications in which no species claims are present and a generic claim recites such a multiplicity of species that an unduly extensive and burdensome search is required, a requirement for an election of species should be made prior to a search of the generic claim.

In all applications where a generic claim is found allowable, the application should be treated as indicated in MPEP § 809.02 (b), § 809.02 (c), or § 809.02 (e). If an election is made pursuant to a telephone requirement, the next action should include a full and complete action on the elected species as well as on any generic claim that may be present.

## 808.02 Related Inventions

Where, as disclosed in the application, the several inventions claimed are related, and such related inventions are not patentably distinct as claimed, restriction under 35 U.S.C. 121 is never proper (MPEP § 806.05). If applicant optionally restricts, double patenting may be held.

Where the related inventions as claimed are shown to be distinct under the criteria of MPEP § 806.05(c) - § 806.05(i), the examiner, in order to establish reasons for insisting upon restriction, must show by appropriate explanation one of the following:

(A) **Separate classification thereof:** This shows that each distinct subject has attained recognition in the art as a separate subject for inventive effort, and also a separate field of search. Patents need not be cited to show separate classification.

(B) **A separate status in the art when they are classifiable together:** Even though they are classified together, each subject can be shown to have formed a separate subject for inventive effort when an explanation indicates a recognition of separate inventive effort by inventors. Separate status in the art may be shown by citing patents which are evidence of such separate status, and also of a separate field of search.

(C) **A different field of search:** Where it is necessary to search for one of the distinct subjects in places where no pertinent art to the other subject exists, a different field of search is shown, even though the two are classified together. The indicated

different field of search must in fact be pertinent to the type of subject matter covered by the claims. Patents need not be cited to show different fields of search.

Where, however, the classification is the same and the field of search is the same and there is no clear indication of separate future classification and field of search, no reasons exist for dividing among related inventions.

## 809 Claims Linking Distinct Inventions

Where, upon examination of an application containing claims to distinct inventions, linking claims are found, restriction can nevertheless be required. See MPEP § 809.03 for definition of linking claims.

A letter including only a restriction requirement or a telephoned requirement to restrict (the latter being encouraged) will be effected, specifying which claims are considered linking. See MPEP § 812.01 for telephone practice in restriction requirements.

No art will be indicated for this type of linking claim and no rejection of these claims made.

A 1-month (not less than 30 days) shortened statutory period will be set for reply to a written requirement. Such action will not be an "action on the merits" for the purpose of the second action final program.

To be complete, a reply to a requirement made according to this section need only include a proper election.

The linking claims must be examined with the invention elected, and should any linking claim be allowed, the restriction requirement must be withdrawn. Any claim(s) directed to the nonelected invention(s), previously withdrawn from consideration, which depends from or includes all the limitations of the allowable linking claim must be rejoined and will be fully examined for patentability. Where such withdrawn claims have been canceled by applicant pursuant to the restriction requirement, upon the allowance of the linking claim(s), the examiner must notify applicant that any canceled, nonelected claim(s) which depends from or includes all the limitations of the allowable linking claim may be reinstated by submitting the claim(s) in an amendment. Upon entry of the amendment, the amended claim(s) will be fully examined for patentability.

**809.02 Generic Claim Linking Species**

Under 37 CFR 1.141, an allowed generic claim may link a reasonable number of species embraced thereby.

The practice is stated in 37 CFR 1.146 as follows:

*37 CFR 1.146. Election of species.*

In the first action on an application containing a generic claim to a generic invention (genus) and claims to more than one patentably distinct species embraced thereby, the examiner may require the applicant in the reply to that action to elect a species of his or her invention to which his or her claim will be restricted if no claim to the genus is found to be allowable. However, if such application contains claims directed to more than a reasonable number of species, the examiner may require restriction of the claims to not more than a reasonable number of species before taking further action in the application.

**809.02(a) Election Required**

Where generic claims are present, the examiner should send a letter including only a restriction requirement or place a telephone requirement to restrict (the latter being encouraged). See MPEP § 812.01 for telephone practice in restriction requirements.

Action as follows should be taken:

(A) Identify generic claims or indicate that no generic claims are present. See MPEP § 806.04(d) for definition of a generic claim.

(B) Clearly identify each (or in aggravated cases at least exemplary ones) of the disclosed species, *to which claims are restricted*. The species are preferably identified as the species of figures 1, 2, and 3 or the species of examples I, II, and III, respectively. In the absence of distinct figures or examples to identify the several species, the mechanical means, the particular material, or other distinguishing characteristic of the species should be stated for each species identified. If the species *cannot be conveniently identified*, the claims may be grouped in accordance with the species to which they are restricted.

(C) Applicant should then be required to elect a single disclosed species under 35 U.S.C. 121, and advised as to the requisites of a complete reply and his or her rights under 37 CFR 1.141.

For generic claims, a search should not be made and art should not be cited.

A 1-month (not less than 30 days) shortened statutory period will be set for reply when a written requirement is made without an action on the merits. This period may be extended under the provisions of 37 CFR 1.136(a). Such action will not be an “action on the merits” for purposes of the second action final program.

To be complete, a reply to a requirement made according to this section should include a proper election along with a listing of all claims readable thereon, including any claims subsequently added.

In those applications wherein a requirement for restriction is accompanied by an action on all claims, such action will be considered to be an action on the merits and the next action should be made final.

*¶ 8.01 Election of Species*

This application contains claims directed to the following patentably distinct species of the claimed invention: [1].

Applicant is required under 35 U.S.C. 121 to elect a single disclosed species for prosecution on the merits to which the claims shall be restricted if no generic claim is finally held to be allowable. Currently, [2] generic.

Applicant is advised that a reply to this requirement must include an identification of the species that is elected consonant with this requirement, and a listing of all claims readable thereon, including any claims subsequently added. An argument that a claim is allowable or that all claims are generic is considered non-responsive unless accompanied by an election.

Upon the allowance of a generic claim, applicant will be entitled to consideration of claims to additional species which are written in dependent form or otherwise include all the limitations of an allowed generic claim as provided by 37 CFR 1.141. If claims are added after the election, applicant must indicate which are readable upon the elected species. MPEP § 809.02(a).

Should applicant traverse on the ground that the species are not patentably distinct, applicant should submit evidence or identify such evidence now of record showing the species to be obvious variants or clearly admit on the record that this is the case. In either instance, if the examiner finds one of the inventions unpatentable over the prior art, the evidence or admission may be used in a rejection under 35 U.S.C. 103(a) of the other invention.

**Examiner Note:**

In bracket 2, insert the appropriate generic claim information.

*¶ 8.02 Election When Claims Are Not Restricted to Species*

Claim [1] generic to a plurality of disclosed patentably distinct species comprising [2]. Applicant is required under 35 U.S.C. 121 to elect a single disclosed species, even though this requirement is traversed.

Should applicant traverse on the ground that the species are not patentably distinct, applicant should submit evidence or identify such evidence now of record showing the species to be obvious variants or clearly admit on the record that this is the case. In

either instance, if the examiner finds one of the inventions unpatentable over the prior art, the evidence or admission may be used in a rejection under 35 U.S.C. 103(a) of the other invention.

**Examiner Note:**

1. This paragraph should be used for the election of requirement described in MPEP § 803.02 (Markush group) and § 809.02(d) (burdensome search necessary).
2. In bracket 2, clearly identify the species from which an election is to be made.

If claims are added after the election, applicant must indicate which are readable on the elected species.

It is necessary to (A) identify generic claims or state that none are present, and (B) clearly identify each species involved.

### 809.02(b) Election Required — Generic Claim Allowable

When a claim generic to two or more claimed species is found to be allowable on the first or any subsequent action on the merits *and election of a single species has not been made*, applicant should be informed that the claim is allowable and generic, and a requirement should be made that applicant elect a single species embraced by the allowed genus unless the species claims are all in the form required by 37 CFR 1.141 and no more than a reasonable number of species are claimed. Form paragraph 8.48 may be used.

¶ 8.48 *Generic Claim(s) Allowable, No Election of Single Species*

Allowed claim [1] generic to a plurality of disclosed patentably distinct species comprising [2]. Applicant is required under 35 U.S.C. 121 to elect a single disclosed species embraced by the allowed genus.

Applicant is advised that a complete reply to this requirement must include an identification of the species that is elected and a listing of all claims readable thereon. Applicant is entitled to consideration of claims to a reasonable number of disclosed species in addition to the elected species provided all the claims to each additional species are written in dependent form or otherwise include all the limitations of an allowed generic claim as provided by 37 CFR 1.141. Applicant's reply must include an identification of such additional species along with a listing of the claims readable on each additional species.

**Examiner Note:**

1. This form paragraph is to be used whenever a claim generic to two or more species is found to be allowable and election of a

single disclosed species embraced thereby has not been made of record.

2. In bracket 1, identify the claim(s) found to be generic and allowable.
3. In bracket 2, identify the plurality of species embraced by the allowed generic claim(s).

### 809.02(c) Action Following Election

An examiner's action subsequent to an election of species should include a complete action on the merits of all claims readable on the elected species.

(A) When the generic claims are rejected, or there is no generic claim, all claims not readable on the elected species should be treated using Form Paragraphs 8.05 and 8.06, as appropriate.

¶ 8.05 *Claims Stand Withdrawn With Traverse*

Claim [1] withdrawn from further consideration pursuant to 37 CFR 1.142(b), as being drawn to a nonelected [2], there being no (allowable) generic or linking claim. Applicant timely traversed the restriction (election) requirement in Paper No. [3].

**Examiner Note:**

In bracket 2, insert --invention-- or --species--.

¶ 8.06 *Claims Stand Withdrawn Without Traverse*

Claim [1] withdrawn from further consideration pursuant to 37 CFR 1.142(b) as being drawn to a nonelected [2], there being no allowable generic or linking claim. Election was made **without** traverse in Paper No. [3].

**Examiner Note:**

In bracket 2, insert --invention--, or --species--.

(B) When a generic claim is subsequently found to be allowable, and not more than a reasonable number of additional species are claimed, treatment shall be as follows:

(1) When *all* claims to each of the additional species are embraced by an allowable generic claim as provided by 37 CFR 1.141, applicant must be advised of the allowable generic claim and that claims drawn to the nonelected species are no longer withdrawn since they are fully embraced by the allowed generic claim.

(2) When *any* claim directed to one of said additional species embraced by an allowed generic claim is not in the required form, all claims to that species should be held to be withdrawn from further consideration by the examiner. The holding should be worded as set forth in form paragraph 8.49.

**¶ 8.49 Allowance of Generic Claim(s), Claims Stand Withdrawn as Not In Required Form**

Claim [1], directed to the species of [2] withdrawn from further consideration since [3] depend upon or otherwise include each of the limitations of an allowed generic claim as required by 37 CFR 1.141.

**Examiner Note:**

1. In bracket 2, insert identification of species followed by --, is-- or --, are--.
2. In bracket 3, insert --it does not-- or --they do not all--.

Note that each additional species is handled separately. When all of the claims to one nonelected species are embraced by an allowable generic claim but each of the claims to another nonelected species is not embraced by an allowable generic claim, applicant must be advised that the claims to the one nonelected species are no longer withdrawn from further consideration but that the claims to the other nonelected species remain withdrawn from further consideration since all of the claims to this other species do not depend upon or fully include all of the limitations of an allowed generic claim as required by 37 CFR 1.141. This holding should be worded as set forth in form paragraph 8.50.

**¶ 8.50 Allowance of Generic Claim(s), Some Claims No Longer Considered Withdrawn**

Claim [1] generic and allowable. Accordingly, the restriction requirement as to the encompassed species is hereby withdrawn and claim [2], directed to the species of [3] no longer withdrawn from consideration since all of the claims to this species depend from or otherwise include each of the limitations of an allowed generic claim. However, claim [4], directed to the species of [5] remain withdrawn from consideration since [6] depend upon or otherwise include all the limitations of an allowed generic claim as required by 37 CFR 1.141.

In view of the above noted withdrawal of the restriction requirement as to the linked species, applicant(s) are advised that if any claim(s) depending from or including all the limitations of the allowable generic linking claim(s) be presented in a continuation or divisional application, such claims may be subject to provisional statutory and/or nonstatutory double patenting rejections over the claims of the instant application. Once a restriction requirement is withdrawn, the provisions of 35 U.S.C. 121 are no longer applicable. See *In re Ziegler*, 44 F.2d 1211, 1215, 170 USPQ 129, 131-32 (CCPA 1971). See also MPEP § 804.01.

**Examiner Note:**

1. In bracket 3, insert an identification of species followed by --, is-- or --, are--.
2. In bracket 5, insert an identification of species.
3. In bracket 6, insert --it does not-- or --they do not all--.

4. If all of the pending claims are in proper form, i.e., they include all the limitations of an allowed generic or linking claim, one of form paragraphs 8.45, 8.46 or 8.47 must be used.

When the application is otherwise ready for issue and there is an allowed generic claim, and applicant has not been previously notified as to the allowance of a generic claim, applicant must be advised of the allowance of a generic claim and given a time limit of 1 month (not less than 30 days) to conform all of the claims to the nonelected species to fully embrace an allowed generic claim or the examiner will cancel the claims to each nonconforming species by examiner's amendment and pass the application to issue. If the election is traversed, an additional paragraph worded as form paragraph 8.03 should be added to the holding.

**¶ 8.03 In Condition for Allowance, Non-elected Claims**

This application is in condition for allowance except for the presence of claim [1] to an invention non-elected with traverse in Paper no. [2]. Applicant is given ONE MONTH or THIRTY DAYS from the date of this letter, whichever is longer, to cancel the noted claims or take other appropriate action (37 CFR 1.144). Failure to take action during this period will be treated as authorization to cancel the noted claims by Examiner's Amendment and pass the case to issue. Extensions of time under 37 CFR 1.136(a) will not be permitted since this application will be passed to issue.

The prosecution of this case is closed except for consideration of the above matter.

**809.02(d) No Species Claims**

Where only generic claims are presented, no restriction can be required except in those applications where the generic claims recite such a multiplicity of species that an unduly extensive and burdensome search is necessary. See MPEP § 808.01(a). If after an action on only generic claims with no restriction requirement, applicant presents species claims to more than one species of the invention, he or she must at that time indicate an election of a single species.

**809.02(e) Generic Claim Allowable in Substance**

Whenever a generic claim is found to be allowable in substance, even though it is objected to or rejected on merely formal grounds, action on the species claims shall thereupon be given as if the generic claim were allowed.

The treatment of the application should be as indicated in MPEP § 809.02(b), § 809.02(c), or § 809.02(d).

### 809.03 Linking Claims

There are a number of situations which arise in which an application has claims to two or more properly divisible inventions, so that a requirement to restrict the application to one would be proper, but presented in the same case are one or more claims (generally called “linking” claims) inseparable therefrom and thus linking together the inventions otherwise divisible.

The most common types of linking claims which, if allowed, act to prevent restriction between inventions that can otherwise be shown to be divisible, are

(A) genus claims linking species claims;

(B) a claim to the necessary process of making a product linking proper process and product claims;

(C) a claim to “means” for practicing a process linking proper apparatus and process claims; and

(D) a claim to the product linking a process of making and a use (process of using).

Where linking claims exist, a letter including a restriction requirement only or a telephoned requirement to restrict (the latter being encouraged) will be effected, specifying which claims are considered to be linking. Examiners should use Form Paragraph 8.12 to make restrictions involving linking claims.

#### ¶ 8.12 Restriction, Linking Claims

Claim [1] link(s) inventions [2] and [3]. The restriction requirement [4] the linked inventions is **subject to** the nonallowance of the linking claim(s), claim [5]. Upon the allowance of the linking claim(s), the restriction requirement as to the linked inventions **shall** be withdrawn and any claim(s) depending from or otherwise including all the limitations of the allowable linking claim(s) will be entitled to examination in the instant application. Applicant(s) are advised that if any such claim(s) depending from or including all the limitations of the allowable linking claim(s) is/are presented in a continuation or divisional application, the claims of the continuation or divisional application may be subject to provisional statutory and/or nonstatutory double patenting rejections over the claims of the instant application. Where a restriction requirement is withdrawn, the provisions of 35 U.S.C. 121 are no longer applicable. *In re Ziegler*, 44 F.2d 1211, 1215, 170 USPQ 129, 131-32 (CCPA 1971). See also MPEP § 804.01.

#### Examiner Note:

1. This form paragraph must be included in any restriction requirement with at least one linking claim present.

2. In bracket 4, insert either --between-- or --among--.
3. In bracket 5, insert the claim number(s) of the linking claims.
4. See related form paragraphs 8.45, 8.46 and 8.47.

For traverse of rejection of linking claim in applications, see MPEP § 818.03(d).

### 809.04 Retention of Claims to Non-elected Invention

Where the requirement for restriction in an application is predicated upon the nonallowability of generic or other type of linking claims, applicant is entitled to retain in the case claims to the nonelected invention or inventions.

If a linking claim is allowed, the examiner must thereafter examine species if the linking claim is generic thereto, or he or she must examine the claims to the nonelected inventions that are linked to the elected invention by such allowed linking claim.

Form paragraph 8.45 should be used to notify applicant of the allowance of a linking claim and that the nonelected claim(s) depending from or including all the limitations of the allowable linking claim, previously withdrawn from consideration, is/are rejoined and fully examined for patentability under 37 CFR 1.104.

#### ¶ 8.45 Allowance of Linking Claim(s), Nonelected Claims Not Canceled

Linking claim [1] allowed. Since the restriction requirement [2] inventions [3], as set forth in Paper No. [4] mailed on [5], was conditioned on the nonallowance of the linking claim(s), **the restriction requirement as to the linked inventions is hereby withdrawn**. Claim [6], previously withdrawn from consideration as a result of the restriction requirement, [7] hereby rejoined and fully examined for patentability under 37 CFR 1.104. In view of the withdrawal of the restriction requirement as to the linked inventions, applicant(s) are advised that if any claim(s) depending from or including all the limitations of the allowable linking claim(s) be presented in a continuation or divisional application, such claims may be subject to provisional statutory and/or nonstatutory double patenting rejections over the claims of the instant application. Once the restriction requirement is withdrawn, the provisions of 35 U.S.C. 121 are no longer applicable. See *In re Ziegler*, 44 F.2d 1211, 1215, 170 USPQ 129, 131-32 (CCPA 1971). See also MPEP § 804.01.

#### Examiner Note:

1. This form paragraph **must** be used upon the allowance of a linking claim following a restriction requirement with at least one linking claim present and wherein the nonelected claims have NOT been canceled. Use form paragraph 8.46 where the nonelected claims HAVE BEEN canceled.

2. In bracket 2, insert either --between-- or --among--.
3. In bracket 7, insert either --is-- or --are--.

Form paragraph 8.46 (or form paragraph 8.47 if appropriate) must be used to notify applicant of the allowance of a linking claim and that the nonelected claim(s) which depended from or included all the limitations of the allowable linking claim canceled by applicant may be reinstated by submitting the claim(s) in an amendment.

*¶ 8.46 Allowance of Linking Claim(s), Nonelected Claims Canceled, Other Issues Remain Outstanding*

Linking claim [1] allowed. Since the restriction requirement [2] inventions [3], as set forth in Paper No. [4] mailed on [5], was conditioned on the nonallowance of the linking claim(s), **the restriction requirement as to the linked inventions is hereby withdrawn.** Claim [6], which depended from or included all the limitations of the allowable linking claim(s), previously withdrawn from consideration as a result of the restriction requirement, [7] canceled by applicant in Paper No. [8]. The canceled, nonelected claim(s) may be reinstated by applicant if submitted in a timely filed amendment in reply to this action. Upon entry of the amendment, such amended claim(s) will be examined for patentability under 37 CFR 1.104.

In view of the withdrawal of the restriction requirement as to the linked inventions, applicant(s) are advised that if any claim(s) depending from or including all the limitations of the allowable linking claim(s) be presented in a continuation or divisional application, such claims may be subject to provisional statutory and/or nonstatutory double patenting rejections over the claims of the instant application. Once the restriction requirement is withdrawn, the provisions of 35 U.S.C. 121 are no longer applicable. See *In re Ziegler*, 44 F.2d 1211, 1215, 170 USPQ 129, 131-32 (CCPA 1971). See also MPEP § 804.01.

**Examiner Note:**

1. This form paragraph (or form paragraph 8.47) **must** be used upon the allowance of a linking claim following a restriction requirement with at least one linking claim present and wherein the nonelected claims HAVE BEEN canceled. Use form paragraph 8.45 where the nonelected claims have NOT been canceled.
2. If no issues remain outstanding and application is otherwise ready for allowance, use form paragraph 8.47 instead of this form paragraph.
3. In bracket 2, insert either --between-- or --among--.
4. In bracket 7, insert either --was-- or --were--.

*¶ 8.47 Allowance of Linking Claim(s), Nonelected Claims Canceled, No Outstanding Issues Remaining*

Linking claim [1] allowed. Since the restriction requirement [2] inventions [3], as set forth in Paper No. [4] mailed on [5], was conditioned on the nonallowance of the linking claim(s), **the restriction requirement as to the linked inventions is hereby withdrawn.** Claim [6], which depended from or included all the limitations of the allowable linking claim(s), previously withdrawn from consideration as a result of the restriction require-

ment, [7] canceled by applicant in Paper No. [8]. The canceled, nonelected claim(s) may be reinstated by applicant if submitted in an amendment, limited to the addition of such claim(s), filed within a time period of ONE MONTH, or THIRTY DAYS, whichever is longer, from the mailing date of this letter. Upon entry of the amendment, such amended claim(s) will be examined for patentability under 37 CFR 1.104. If NO such amendment is submitted within the set time period, the application will be passed to issue. PROSECUTION ON THE MERITS IS OTHERWISE CLOSED.

In view of the withdrawal of the restriction requirement as to the linked inventions, applicant(s) are advised that if any claim(s) depending from or including all the limitations of the allowable linking claim(s) be presented in a continuation or divisional application, such claims may be subject to provisional statutory and/or nonstatutory double patenting rejections over the claims of the instant application. Once the restriction requirement is withdrawn, the provisions of 35 U.S.C. 121 are no longer applicable. See *In re Ziegler*, 44 F.2d 1211, 1215, 170 USPQ 129, 131-32 (CCPA 1971). See also MPEP § 804.01.

**Examiner Note:**

1. This form paragraph (or form paragraph 8.46) **must** be used upon the allowance of a linking claim following a restriction requirement with at least one linking claim present and wherein the nonelected claims HAVE BEEN canceled. Use form paragraph 8.45 where the nonelected claims have NOT been canceled.
2. This form paragraph should be used only when there are no outstanding issues remaining and is to be used with only a PTO-90C cover sheet.
3. In bracket 2, insert either --between-- or --among--.
4. In bracket 7, insert either --was-- or --were--.

When a final requirement is contingent on the nonallowability of the linking claims, applicant may petition from the requirement under 37 CFR 1.144 without waiting for a final action on the merits of the linking claims or applicant may defer his or her petition until the linking claims have been finally rejected, but not later than appeal. See 37 CFR 1.144 and MPEP § 818.03(c).

## 810 Action on the Merits

In general, in an application when only a written requirement to restrict is made, no action on the merits is given.

### 810.01 Not Objectionable When Coupled With Requirement

A basic policy of the present examining program is that the second action on the merits should be made final whenever proper. See MPEP § 706.07(a). In those applications wherein a requirement for



restriction or election is accompanied by a complete action on the merits of all the claims, such action will be considered to be an action on the merits and the next action by the examiner should be made final. When preparing a final action in an application where applicant has traversed the restriction requirement, see MPEP § 821.01.

Although an action on the merits is not necessary to a requirement, it is not objectionable. *Ex parte Lantzke*, 1910 C.D. 100, 156 O.G. 257 (Comm'r Pat. 1910). However, note that a question may arise as to whether there is a serious burden on the examiner.

However, except as noted in MPEP § 809 and § 812.01, if an action is given on the merits, *it must be given on all claims*.

### **810.02 Usually Deferred**

The Office policy is to usually defer action on the merits until after the requirement for restriction is complied with, or withdrawn. *Ex parte Pickles*, 1904 C.D. 126, 109 O.G. 1888 (Comm'r Pat. 1904); *Ex parte Snyder*, 1904 C.D. 242, 110 O.G. 2636 (Comm'r Pat. 1904); and *Ex parte Weston*, 1911 C.D. 218, 173 O.G. 285 (Comm'r Pat. 1911).

### **810.03 Given on Elected Invention When Requirement Is Made Final**

37 CFR 1.143 last sentence states: “[i]f the requirement is repeated and made final, the examiner will at the same time act on the claims to the invention elected.” Thus, action is ordinarily given on the elected invention in the action making the requirement final.

### **811 Time for Making Requirement**

37 CFR 1.142(a), second sentence states: “[i]f the distinctness and independence of the invention be clear, such requirement will be made before any action upon the merits; however, it may be made at any time before final action in the case at the discretion of the examiner.” This means the examiner should make a proper requirement as early as possible in the prosecution, in the first action if possible, otherwise, as soon as the need for a proper requirement develops.

Before making a restriction requirement after the first action on the merits, the examiner will consider whether there will be a serious burden if restriction is not required.

### **811.02 Even After Compliance With Preceding Requirement**

Since 37 CFR 1.142(a) provides that restriction is proper at any stage of prosecution up to final action, a second requirement may be made when it becomes proper, even though there was a prior requirement with which applicant complied. *Ex parte Benke*, 1904 C.D. 63, 108 O.G. 1588 (Comm'r Pat. 1904).

### **811.03 Repeating After Withdrawal Proper**

Where a requirement to restrict is made and withdrawn, because it was improper, when it becomes proper at a later stage in the prosecution, restriction may again be required.

### **811.04 Proper Even Though Grouped Together in Parent Application**

Even though inventions are grouped together in a requirement in a parent application, restriction or election among the inventions may be required in the divisional applications, if proper.

### **812 Who Should Make the Requirement**

The requirement should be made by an examiner who would examine at least one of the inventions.

An examiner should not require restriction in an application if none of the claimed subject matter is classifiable in his or her Technology Center. Such an application should be transferred to a Technology Center to which at least some of the subject matter belongs.

### **812.01 Telephone Restriction Practice**

If an examiner determines that a requirement for restriction should be made in an application, the examiner should formulate a draft of such restriction requirement including an indication of those claims considered to be linking or generic. No search or rejection of the linking claims should be made.

Thereupon, the examiner should telephone the attorney or agent of record and request an oral election, with or without traverse if desired, after the attorney or agent has had time to consider the restriction requirement. However, no telephone communication need be made where the requirement for restriction is complex, the application is being prosecuted by the applicant *pro se*, or the examiner knows from past experience that an election will not be made by telephone. The examiner should arrange for a second telephone call within a reasonable time, generally within 3 working days. If the attorney or agent objects to making an oral election, or fails to respond, the usual restriction letter will be mailed, and this letter should contain reference to the unsuccessful telephone call. (See MPEP § 809 and § 809.02(a)). When an oral election is made, the examiner will then proceed to incorporate into the Office action a formal restriction requirement including the date of the election, the attorney's or agent's name, and a complete record of the telephone interview, followed by a complete action on the elected claims including linking or generic claims if present.

Form paragraphs 8.23 or 8.23.01 should be used to make a telephone election of record.

¶ 8.23 Requirement, When Elected by Telephone

During a telephone conversation with [1] on [2] a provisional election was made [3] traverse to prosecute the invention of [4], claim [5]. Affirmation of this election must be made by applicant in replying to this Office action. Claim [6] withdrawn from further consideration by the examiner, 37 CFR 1.142(b), as being drawn to a non-elected invention.

**Examiner Note:**

1. In bracket 3, insert --with-- or --without--, whichever is applicable.
2. In bracket 4, insert either the elected group or species.
3. An action on the merits of the claims should follow.

¶ 8.23.01 Requirement, No Election by Telephone

A telephone call was made to [1] on [2] to request an oral election to the above restriction requirement, but did not result in an election being made.

**Examiner Note:**

1. In bracket 1, insert the name of the applicant or attorney or agent contacted.
2. In bracket 2, insert the date(s) of the telephone contact(s).
3. This form paragraph should be used in all instances where a telephone election was attempted and the applicant's representative did not or would not make an election.

4. This form paragraph should **not** be used if no contact was made with applicant or applicant's representative.

If, on examination, the examiner finds the elected claims to be allowable and no traverse was made, the letter should be attached to the Notice of Allowability form PTOL-37 and should include cancellation of the nonelected claims, a statement that the prosecution is closed, and that a notice of allowance will be sent in due course. Correction of formal matters in the above-noted situation which cannot be handled by a telephone call and thus requires action by the applicant should be handled under the *Ex parte Quayle* practice, using Office Action Summary form PTOL-326.

Should the elected claims be found allowable in the first action, and an oral traverse was noted, the examiner should include in his or her action a statement under MPEP § 821.01, making the restriction final and giving applicant 1 month to either cancel the nonelected claims or take other appropriate action. (37 CFR 1.144). Failure to take action will be treated as an authorization to cancel the nonelected claims by an examiner's amendment and pass the application to issue. Prosecution of the application is otherwise closed.

In either situation (traverse or no traverse), caution should be exercised to determine if any of the allowed claims are linking or generic claims before canceling the nonelected claims.

Where the respective inventions are located in different Technology Centers (TCs), the requirement for restriction should be made only after consultation with and approval by all TCs involved. If an oral election would cause the application to be examined in another TC, the initiating TC should transfer the application with a signed memorandum of the restriction requirement and a record of the interview. The receiving TC will incorporate the substance of this memorandum in its official letter as indicated above. Differences as to restriction should be settled by the existing chain of command, e.g., supervisory patent examiner or TC director.

This practice is limited to use by examiners who have at least negotiation authority. Other examiners must have the prior approval of their supervisory patent examiner.

## 814 Indicate Exactly How Application Is To Be Restricted

### SPECIES

The mode of indicating how to require restriction between species is set forth in MPEP § 809.02(a).

As pointed out in *Ex parte Ljungstrom*, 1905 C.D. 541, 119 O.G. 2335 (Comm'r Pat. 1905), the particular limitations in the claims and the reasons why such limitations are considered to restrict the claims to a particular disclosed species should be mentioned if necessary to make the requirement clear.

### INVENTIONS OTHER THAN SPECIES

It is necessary to read all of the claims in order to determine what the claims cover. When doing this, the claims directed to each separate subject should be noted along with a statement of the subject matter to which they are drawn.

This is the best way to most clearly and precisely indicate to applicant how the application should be restricted. It consists in identifying each separate subject amongst which restriction is required, and grouping each claim with its subject.

The separate inventions should be identified by a grouping of the claims with a short description of the total extent of the invention claimed in each group, specifying the type or relationship of each group as by stating the group is drawn to a process, or to a subcombination, or to a product, etc., and should indicate the classification or separate status of each group, as for example, by class and subclass.

While every claim should be accounted for, the omission to group a claim, or placing a claim in the wrong group will not affect the propriety of a final requirement where the requirement is otherwise proper and the correct disposition of the omitted or erroneously grouped claim is clear.

### LINKING CLAIMS

The generic or other linking claims should not be associated with any one of the linked inventions since such claims must be examined with any one of the

linked inventions that may be elected. This fact should be clearly stated.

## 815 Make Requirement Complete

When making a requirement every effort should be made to have the requirement complete. If some of the claimed inventions are classifiable in another art unit and the examiner has any doubt as to the proper line among the same, the application should be referred to the examiner of the other art unit for information on that point and such examiner should render the necessary assistance.

## 816 Give Reasons for Holding of Independence or Distinctness

The particular reasons relied on by the examiner for holding that the inventions as claimed are either independent or distinct should be concisely stated. A mere statement of conclusion is inadequate. The reasons upon which the conclusion is based should be given.

For example, relative to combination and a subcombination thereof, the examiner should point out the reasons why he or she considers the subcombination to have utility by itself or in other combinations, and why he or she considers that the combination as claimed does not rely on the subcombination as its essential distinguishing part.

Each other relationship of claimed invention should be similarly treated and the reasons for the conclusions of distinctness of invention as claimed set forth.

The separate inventions should be identified by a grouping of the claims with a short description of the total extent of the invention claimed in each group, specifying the type or relationship of each group as by stating the group is drawn to a process, or to subcombination, or to product, etc., and should indicate the classification or separate status of each group, as for example, by class and subclass. See MPEP § 809.

Note form paragraph 8.13.

### ¶ 8.13 Distinctness (Heading)

The inventions are distinct, each from the other because:

#### Examiner Note:

This form paragraph should be followed by one of form paragraphs 8.14-8.20.02 to show distinctness.

## 817 Outline of Letter for Restriction Requirement Between Distinct Inventions

The statement in MPEP § 809.02 through § 809.02(d) is adequate indication of the form of letter when election of species is required.

No outline of a letter is given for other types of independent inventions since they rarely occur.

The following outline of a letter for a requirement to restrict is intended to cover every type of original restriction requirement between related inventions including those having linking claims.

### OUTLINE OF LETTER

(A) Statement of the requirement to restrict and that it is being made under 35 U.S.C. 121

(1) Identify each group by Roman numeral.

(2) List claims in each group. Check accuracy of numbering of the claims; look for same claims in two groups; and look for omitted claims.

(3) Give short description of total extent of the subject matter claimed in each group, pointing out critical claims of different scope and identifying whether the claims are directed to a combination, subcombination, process, apparatus, or product.

(4) Classify each group.

Form paragraphs 8.08-8.11 should be used to group inventions.

#### ¶ 8.08 Restriction, Two Groupings

Restriction to one of the following inventions is required under 35 U.S.C. 121:

I.Claim [1], drawn to [2], classified in class [3], subclass [4].

II.Claim [5], drawn to [6], classified in class [7], subclass [8].

#### ¶ 8.09 Restriction, 3rd Grouping

III.Claim [1], drawn to [2], classified in class [3], subclass [4].

#### ¶ 8.10 Restriction, 4th Grouping

IV.Claim [1], drawn to [2], classified in class [3], subclass [4].

#### ¶ 8.11 Restriction, Additional Groupings

[1].Claim[2], drawn to [3], classified in class [4], subclass [5].

#### Examiner Note:

In bracket 1, insert the appropriate roman numeral, e.g., --V--, -VI--, etc.

(B) Take into account claims not grouped, indicating their disposition.

(1) Linking claims

(i) Indicate (make no action)

(ii) Statement of groups to which linking claims may be assigned for examination

(2) Other ungrouped claims

(3) Indicate disposition, e.g., previously non-elected, nonstatutory, canceled, etc.

(C) Allegation of distinctness

(1) Point out facts which show distinctness

(2) Treat the inventions as claimed, don't merely state the conclusion that inventions in fact are distinct

(i) Subcombination - Subcombination disclosed as usable together

Each usable alone or in other identified combination

Demonstrate by examiner's suggestion

(ii) Combination - Subcombination

Combination as claimed does not require subcombination

AND

Subcombination usable alone or in other combination

Demonstrate by examiner's suggestion

(iii) Process - Apparatus

Process can be carried out by hand or by other apparatus

Demonstrate by examiner's suggestion

OR

Demonstrate apparatus can be used in other process (rare).

(iv) Process of making and/or Apparatus for making — Product made

Claimed product can be made by other process (or apparatus)

Demonstrate by examiner's suggestion

OR

Demonstrate process of making (or apparatus for making) can produce other product (rare)

(D) Provide reasons for insisting upon restriction

(1) Separate status in the art

(2) Different classification

(3) Same classification but recognition of divergent subject matter

- (4) Divergent fields of search, or
  - (5) Search required for one group not required for the other
- (E) Summary statement
- (1) Summarize (i) distinctness and (ii) reasons for insisting upon restriction, if applicable
  - (2) Include paragraph advising as to reply required.
  - (3) Indicate effect of allowances of linking claims, if any present
  - (4) Indicate effect of cancellation or nonallowance of evidence claims (see MPEP § 806.05(c))

One of form paragraphs 8.21.01 through 8.21.03 must be used at the conclusion of each restriction requirement.

¶ *8.21.01 Conclusion to All Restriction Requirements: Different Classification*

Because these inventions are distinct for the reasons given above and have acquired a separate status in the art as shown by their different classification, restriction for examination purposes as indicated is proper.

**Examiner Note:**

THIS FORM PARAGRAPH (OR ONE OF FORM PARAGRAPHS 8.21.02 OR 8.21.03) MUST BE ADDED AS A CONCLUSION TO ALL RESTRICTION REQUIREMENTS employing any of form paragraphs 8.14 to 8.20.02.

¶ *8.21.02 Conclusion to All Restriction Requirements: Recognized Divergent Subject Matter*

Because these inventions are distinct for the reasons given above and have acquired a separate status in the art because of their recognized divergent subject matter, restriction for examination purposes as indicated is proper.

**Examiner Note:**

THIS FORM PARAGRAPH (OR ONE OF FORM PARAGRAPHS 8.21.01 OR 8.21.03) MUST BE ADDED AS A CONCLUSION TO ALL RESTRICTION REQUIREMENTS employing any of form paragraphs 8.14 to 8.20.02.

¶ *8.21.03 Conclusion to All Restriction Requirements: Different Search*

Because these inventions are distinct for the reasons given above and the search required for Group [1] is not required for Group [2], restriction for examination purposes as indicated is proper.

**Examiner Note:**

THIS FORM PARAGRAPH (OR ONE OF FORM PARAGRAPHS 8.21.01 OR 8.21.02) MUST BE ADDED AS A CON-

CLUSION TO ALL RESTRICTION REQUIREMENTS employing any of form paragraphs 8.14 to 8.20.02.

Form paragraph 8.23.02 must be included in all restriction requirements for applications having joint inventors.

¶ *8.23.02 Joint Inventors, Correction of Inventorship*

Applicant is reminded that upon the cancellation of claims to a non-elected invention, the inventorship must be amended in compliance with 37 CFR 1.48(b) if one or more of the currently named inventors is no longer an inventor of at least one claim remaining in the application. Any amendment of inventorship must be accompanied by a request under 37 CFR 1.48(b) and by the fee required under 37 CFR 1.17(i).

**Examiner Note:**

This form paragraph must be included in all restriction requirements for applications having joint inventors.

## 818 Election and Reply

Election is the designation of the particular one of two or more disclosed inventions that will be prosecuted in the application.

A reply should be made to each point raised by the examiner's action, and may include a traverse or compliance.

A traverse of a requirement to restrict is a statement of the reasons upon which the applicant relies for his or her conclusion that the requirement is in error.

To be complete, a reply to a requirement which merely specifies the linking claims need only include a proper election.

Where a rejection or objection is included with a restriction requirement, applicant, besides making a proper election must also distinctly and specifically point out the supposed errors in the examiner's rejection or objection. See 37 CFR 1.111.

### 818.01 Election Fixed by Action on Claims

Election becomes fixed when the claims in an application have received an action on their merits by the Office.

### 818.02 Election Other Than Express

Election may be made in other ways than expressly in reply to a requirement as set forth in MPEP § 818.02(a) and § 818.02(c).

**818.02(a) By Originally Presented Claims**

Where claims to another invention are properly added and entered in the application before an action is given, they are treated as original claims for purposes of restriction only.

The claims originally presented and acted upon by the Office on their merits determine the invention elected by an applicant in the application, and in any request for continued examination (RCE) which has been filed for the application. Subsequently presented claims to an invention other than that acted upon should be treated as provided in MPEP § 821.03.

**818.02(b) Generic Claims Only —  
No Election of Species**

Where only generic claims are first presented and prosecuted in an application in which no election of a single invention has been made, and applicant later presents species claims to more than one species of the invention, he or she must at that time indicate an election of a single species. The practice of requiring election of species in cases with only generic claims of the unduly extensive and burdensome search type is set forth in MPEP § 808.01(a).

**818.02(c) By Optional Cancellation  
of Claims**

Where applicant is claiming two or more inventions (which may be species or various types of related inventions) and as a result of action on the claims, he or she cancels the claims to one or more of such inventions, leaving claims to one invention, and such claims are acted upon by the examiner, the claimed invention thus acted upon is elected.

**818.03 Express Election and Traverse**

*37 CFR 1.143. Reconsideration of requirement.*

If the applicant disagrees with the requirement for restriction, he may request reconsideration and withdrawal or modification of the requirement, giving the reasons therefor. (See § 1.111). In requesting reconsideration the applicant must indicate a provisional election of one invention for prosecution, which invention shall be the one elected in the event the requirement becomes final. The requirement for restriction will be reconsidered on such a request. If the requirement is repeated and made final, the exam-

iner will at the same time act on the claims to the invention elected.

Election in reply to a requirement may be made either with or without an accompanying traverse of the requirement.

**818.03(a) Reply Must Be Complete**

As shown by the first sentence of 37 CFR 1.143, the traverse to a requirement must be complete as required by 37 CFR 1.111(b) which reads in part: "In order to be entitled to reconsideration or further examination, the applicant or patent owner must reply to the Office action. The reply by the applicant or patent owner must be reduced to a writing which distinctly and specifically points out the supposed errors in the examiner's action and must reply to every ground of objection and rejection in the prior Office action. . . . The applicant's or patent owner's reply must appear throughout to be a *bona fide* attempt to advance the application or the reexamination proceeding to final action. . . ."

Under this rule, the applicant is required to specifically point out the reasons on which he or she bases his or her conclusions that a requirement to restrict is in error. A mere broad allegation that the requirement is in error does not comply with the requirement of 37 CFR § 1.111. Thus the required provisional election (see MPEP § 818.03(b)) becomes an election without traverse.

**818.03(b) Must Elect, Even When  
Requirement Is Traversed**

As noted in the second sentence of 37 CFR 1.143, a provisional election must be made even though the requirement is traversed.

All requirements for restriction should include form paragraph 8.22.

**¶ 8.22 Requirement, Election, Mailed**

Applicant is advised that the reply to this requirement to be complete must include an election of the invention to be examined even though the requirement be traversed (37 CFR 1.143).

**Examiner Note:**

This paragraph can be used in Office actions with or without an action on the merits.

### 818.03(c) Must Traverse To Preserve Right of Petition

37 CFR 1.144. *Petition from requirement for restriction.*

After a final requirement for restriction, the applicant, in addition to making any reply due on the remainder of the action, may petition the Commissioner to review the requirement. Petition may be deferred until after final action on or allowance of claims to the invention elected, but must be filed not later than appeal. A petition will not be considered if reconsideration of the requirement was not requested (see § 1.181).

If applicant does not distinctly and specifically point out supposed errors in the restriction requirement, the election should be treated as an election without traverse and be so indicated to the applicant by use of form paragraph 8.25.02.

¶ 8.25.02 *Election Without Traverse Based on Incomplete Reply*

Applicant's election of [1] in Paper No. [2] is acknowledged. Because applicant did not distinctly and specifically point out the supposed errors in the restriction requirement, the election has been treated as an election without traverse (MPEP § 818.03(a)).

### 818.03(d) Traverse of Nonallowance of Linking Claims

A traverse of the nonallowance of the linking claims is not a traverse of the requirement to restrict; it is a traverse of a holding of nonallowance.

Election combined with a traverse of the nonallowance of the linking claims only is an agreement with the position taken by the Office that restriction is proper if the linking-type claim is not allowable and improper if they are allowable. If the Office allows such a claim, it is bound to withdraw the requirement and to act on all linked inventions. But once all linking claims are canceled 37 CFR 1.144 would not apply, since the record would be one of agreement as to the propriety of restriction.

Where, however, there is a traverse on the ground that there is some relationship (other than and in addition to the linking-type claim) that also prevents restriction, the merits of the requirement are contested and not admitted. Assume a particular situation of process of making and product made where the claim held linking is a claim to product limited by the process of making it. The traverse may set forth particular reasons justifying the conclusion that restriction is improper where the process necessarily makes the product and there is no other present known process

by which the product can be made. If restriction is made final in spite of such traverse, the right to petition is preserved even though all linking claims are canceled.

### 818.03(e) Applicant Must Make Own Election

Applicant must make his or her own election. The examiner will not make the election for the applicant. 37 CFR 1.142, 37 CFR 1.143, second sentence.

### 819 Office Generally Does Not Permit Shift

The general policy of the Office is not to permit the applicant to shift to claiming another invention after an election is once made and action given on the elected subject matter. Note that the applicant cannot, as a matter of right, file a request for continued examination (RCE) to obtain continued examination on the basis of claims that are independent and distinct from the claims previously claimed and examined (i.e., applicant cannot switch inventions by way of an RCE as a matter of right). When claims are presented which the examiner holds are drawn to an invention other than the one elected, he or she should treat the claims as outlined in MPEP § 821.03.

Where the inventions are distinct and of such a nature that the Office compels restriction, an election is not waived even though the examiner gives action upon the patentability of the claims to the nonelected invention. *Ex parte Loewenbach*, 1904 C.D. 170, 110 O.G. 857 (Comm'r Pat. 1904) and *In re Waugh*, 135 F.2d 627, 57 USPQ 371 (CCPA 1943).

Where a continued prosecution application (CPA) filed under 37 CFR 1.53(d), is a continuation of its parent application and not a divisional, or where a File Wrapper Continuation (FWC) filed under former 37 CFR 1.62, is a continuation of its parent application and not a divisional or C-I-P, an express election made in the prior (parent) application in reply to a restriction requirement carries over to the CPA or FWC application unless otherwise indicated by applicant. In no other type of continuing application may an election carry over from the prior application.

Where there is no indication in the CPA or FWC application that a change in election is desired, the examiner's first action should include a repetition of

the restriction requirement made in the prior application to the extent it is still applicable in the CPA or FWC application and a statement that prosecution is being continued on the invention elected and prosecuted by applicant in the prior application. Examples of what is meant by the phrase “otherwise indicated by applicant” would be where the CPA or FWC is filed as (A) a divisional or (B) a continuation and includes an amendment filed prior to first action in the CPA or FWC adding claims to an invention not previously elected. In each of these examples the examiner should make a new restriction requirement in the first action.

### **819.01 Office May Waive Election and Permit Shift**

While applicant, as a matter of right, may not shift from claiming one invention to claiming another, the Office is not precluded from permitting a shift. It may do so where the shift results in no additional work or expense, and particularly where the shift reduces work as by simplifying the issues. *Ex parte Heritage*, Pat. No. 2,375,414 decided January 26, 1944. If the examiner has accepted a shift from claiming one invention to claiming another, the case is not abandoned. *Meden v. Curtis*, 1905 C.D.272, 117 O.G. 1795 (Comm’r Pat. 1905).

### **820 Not an Election; Permissible Shift**

Where the Office rejects on the ground that the process is obvious, the only invention being in the product made, presenting claims to the product is not a shift: *Ex parte Trevette*, 1901 C.D. 170, 97 O.G. 1173 (Comm’r Pat. 1901).

Where a product is elected, there is no shift where examiner holds invention to be in the process. *Ex parte Grier*, 1923 C.D. 27, 309 O.G. 223 (Comm’r Pat. 1923).

Where a genus is allowed, applicant may prosecute a reasonable number of additional species thereunder, in accordance with 37 CFR 1.141. This does not constitute a shift. *Ex parte Sharp*, Patent No. 2,232,739.

### **820.01 Old Combination Claimed — Not an Election**

Where an application originally presents claims to a combination (AB) and the examiner holds the novelty, if any, to reside only in the subcombination (B) *per se* (see MPEP § 806.05(b)), and the claims directed to the combination are rejected, subsequently presented claims to subcombination (B) of the originally claimed combination should not be held constructively nonelected on the ground of previous election of the combination. See MPEP § 821.03. *Ex parte Donnell*, 1923 C.D. 54, 315 O.G. 398 (Comm’r Pat. 1923). The combination and subcombination as defined by the claims under this special situation are not for distinct inventions. See MPEP § 806.05(c).

### **820.02 Interference Issues — Not an Election**

Where an interference is instituted prior to an applicant’s election, the subject matter of the interference issues is not elected. An applicant may, after the termination of the interference, elect any one of the inventions claimed.

### **821 Treatment of Claims Held To Be Drawn to Nonelected Inventions**

Claims held to be drawn to nonelected inventions, including claims to nonelected species, are treated as indicated in MPEP § 821.01 through § 821.03.

The propriety of a requirement to restrict, if traversed, is reviewable by petition under 37 CFR 1.144. *In re Hengehold*, 440 F.2d 1395, 169 USPQ 473 (CCPA 1971).

All claims that the examiner holds as not being directed to the elected subject matter are withdrawn from further consideration by the examiner in accordance with 37 CFR 1.142(b). See MPEP § 809.02(c) and § 821.01 through § 821.03. The examiner should clearly set forth in the Office action the reasons why the claims withdrawn from consideration are not readable on the elected invention. Applicant may traverse the requirement pursuant to 37 CFR 1.143. If a final requirement for restriction is made by the examiner, applicant may file a petition under 37 CFR 1.144 for review of the restriction requirement.



## 821.01 After Election With Traverse

Where the initial requirement is traversed, it should be reconsidered. If, upon reconsideration, the examiner is still of the opinion that restriction is proper, it should be repeated and made final in the next Office action. (See MPEP § 803.01.) In doing so, the examiner should reply to the reasons or arguments advanced by applicant in the traverse. Form paragraph 8.25 should be used to make a restriction requirement final.

### ¶ 8.25 Answer to Arguments With Traverse

Applicant's election with traverse of [1] in Paper No. [2] is acknowledged. The traversal is on the ground(s) that [3]. This is not found persuasive because [4].

The requirement is still deemed proper and is therefore made FINAL.

#### Examiner Note:

1. In bracket 1, insert the invention elected.
2. In bracket 3, insert in summary form, the ground(s) on which traversal is based.
3. In bracket 4, insert the reasons why the traversal was not found to be persuasive.

If the examiner, upon reconsideration, is of the opinion that the requirement for restriction is improper, he or she should state in the next Office action that the requirement for restriction is withdrawn and give an action on all the claims.

If the requirement is repeated and made final, in that and in each subsequent action, the claims to the nonelected invention should be treated by using form paragraph 8.05.

### ¶ 8.05 Claims Stand Withdrawn With Traverse

Claim [1] withdrawn from further consideration pursuant to 37 CFR 1.142(b), as being drawn to a nonelected [2], there being no (allowable) generic or linking claim. Applicant timely traversed the restriction (election) requirement in Paper No. [3].

#### Examiner Note:

In bracket 2, insert --invention-- or --species--.

This will show that applicant has retained the right to petition from the requirement under 37 CFR 1.144. (See MPEP § 818.03(c).)

When the case is otherwise ready for issue, and has not received a final action, the examiner should treat the case by using form paragraph 8.03. (See MPEP § 809.02(c)).

When preparing a final action in an application where there has been a traversal of a requirement for

restriction, the examiner should indicate in the Office action that a complete reply must include cancellation of the claims drawn to the nonelected invention, or other appropriate action (37 CFR 1.144). See form paragraph 8.24.

### ¶ 8.24 Reply to Final Must Include Cancellation

This application contains claim [1] drawn to an invention nonelected with traverse in Paper No. [2]. A complete reply to the final rejection must include cancellation of nonelected claims or other appropriate action (37 CFR 1.144). See MPEP § 821.01.

#### Examiner Note:

For use in FINAL rejections of applications containing claims nonelected with traverse.

Where a reply to a final action has otherwise placed the application in condition for allowance, the failure to cancel claims drawn to the nonelected invention or to take appropriate action will be construed as authorization to cancel these claims by examiner's amendment and pass the application to issue after the expiration of the period for reply.

Note that the petition under 37 CFR 1.144 must be filed not later than appeal. This is construed to mean appeal to the Board of Patent Appeals and Interferences. If the application is ready for allowance after appeal and no petition has been filed, the examiner should simply cancel the nonelected claims by examiner's amendment, calling attention to the provisions of 37 CFR 1.144.

## 821.02 After Election Without Traverse

Where the initial requirement is not traversed, if adhered to, appropriate action should be given on the elected claims. Form paragraphs 8.25.01 or 8.25.02 should be used by the examiner to acknowledge the election without traverse.

### ¶ 8.25.01 Election Without Traverse

Applicant's election without traverse of [1] in Paper No. [2] is acknowledged.

### ¶ 8.25.02 Election Without Traverse Based on Incomplete Reply

Applicant's election of [1] in Paper No. [2] is acknowledged. Because applicant did not distinctly and specifically point out the supposed errors in the restriction requirement, the election has been treated as an election without traverse (MPEP § 818.03(a)).

Claims to the nonelected invention should be treated by using form paragraph 8.06.

¶ 8.06 *Claims Stand Withdrawn Without Traverse*

Claim [1] withdrawn from further consideration pursuant to 37 CFR 1.142(b) as being drawn to a nonelected [2], there being no allowable generic or linking claim. Election was made **without** traverse in Paper No. [3].

**Examiner Note:**

In bracket 2, insert --invention--, or --species--.

This will show that applicant has not retained the right to petition from the requirement under 37 CFR 1.144.

Under these circumstances, when the application is otherwise ready for issue, the claims to the nonelected invention, including nonelected species, may be canceled by an examiner's amendment, and the application passed to issue. However, where the application contains an allowed generic claim, and applicant has not been previously notified as to the allowance of a generic claim, the examiner must, prior to canceling the nonelected claims, notify applicant of the allowance of a generic claim and give applicant a time limit of 1-month (not less than 30 days) to conform all of the claims to the nonelected species to fully embrace an allowed generic claim. See MPEP § 809.02(c). The examiner's amendment should include form paragraph 8.07.

¶ 8.07 *Ready for Allowance Without Traverse*

This application is in condition for allowance except for the presence of claim [1] to [2] nonelected without traverse. Accordingly, claim [3] been canceled.

**Examiner Note:**

In bracket 2, insert --an invention--, --inventions--, --a species--, or --species--.

### 821.03 Claims for Different Invention Added After an Office Action

Claims added by amendment following action by the examiner, MPEP § 818.01, § 818.02(a), to an invention other than previously claimed, should be treated as indicated by 37 CFR 1.145.

*37 CFR 1.145. Subsequent presentation of claims for different invention.*

If, after an office action on an application, the applicant presents claims directed to an invention distinct from and independent of the invention previously claimed, the applicant will be required to restrict the claims to the invention previously claimed

if the amendment is entered, subject to reconsideration and review as provided in §§ 1.143 and 1.144

The action should include form paragraph 8.04.

¶ 8.04 *Election by Original Presentation*

Newly submitted claim [1] directed to an invention that is independent or distinct from the invention originally claimed for the following reasons: [2]

Since applicant has received an action on the merits for the originally presented invention, this invention has been constructively elected by original presentation for prosecution on the merits. Accordingly, claim [3] withdrawn from consideration as being directed to a non-elected invention. See 37 CFR 1.142(b) and MPEP § 821.03.

Of course, a complete action on all claims to the elected invention should be given.

Note that the above practice is intended to have no effect on the practice stated in MPEP § 2303.

An amendment canceling all claims drawn to the elected invention and presenting only claims drawn to the nonelected invention should not be entered. Such an amendment is nonresponsive. Applicant should be notified by using form paragraph 8.26.

¶ 8.26 *Canceled Elected Claims, Non-Responsive*

The amendment filed on [1] canceling all claims drawn to the elected invention and presenting only claims drawn to a non-elected invention is non-responsive (MPEP § 821.03). The remaining claims are not readable on the elected invention because [2].

Since the above-mentioned amendment appears to be a *bona fide* attempt to reply, applicant is given a TIME PERIOD of ONE (1) MONTH or THIRTY (30) DAYS, whichever is longer, from the mailing date of this notice within which to supply the omission or correction in order to avoid abandonment. EXTENSIONS OF THIS TIME PERIOD UNDER 37 CFR 1.136(a) ARE AVAILABLE.

### 821.04 Rejoinder

Where product and process claims drawn to independent and distinct inventions are presented in the same application, applicant may be called upon under 35 U.S.C. 121 to elect claims to either the product or process. See MPEP § 806.05(f) and § 806.05(h). The claims to the nonelected invention will be withdrawn from further consideration under 37 CFR 1.142. See MPEP § 809.02(c) and § 821 through § 821.03. However, if applicant elects claims directed to the product, and a product claim is subsequently found allowable, withdrawn process claims which depend from or otherwise include all the limitations of the allowable product claim will be rejoined.

Where the application as originally filed discloses the product and the process for making and/or using the product, and only claims directed to the product are presented for examination, when a product claim is found allowable, applicant may present claims directed to the process of making and/or using the patentable product by way of amendment pursuant to 37 CFR 1.121. In view of the rejoinder procedure, and in order to expedite prosecution, applicants are encouraged to present such process claims, preferably as dependent claims, in the application at an early stage of prosecution. Process claims which depend from or otherwise include all the limitations of the patentable product will be entered as a matter of right if the amendment is presented prior to final rejection or allowance. Amendments submitted after final rejection are governed by 37 CFR 1.116. Process claims which do not depend from or otherwise include the limitations of the patentable product will be withdrawn from consideration, via an election by original presentation (see MPEP § 821.03). Amendments submitted after allowance are governed by 37 CFR 1.312. Process claims which depend from or otherwise include all the limitations of an allowed product claim and which meet the requirements of 35 U.S.C. 101, 102, 103, and 112 may be entered.

Where applicant voluntarily presents claims to the product and process in separate applications (i.e., no restriction requirement was made by the Office), and one of the applications issues as a patent, the remaining application may be rejected under the doctrine of obviousness-type double patenting, where appropriate (see MPEP § 804 - § 804.03), and applicant may overcome the rejection by the filing of a terminal disclaimer under 37 CFR 1.321(c) where appropriate. Similarly, if copending applications separately present product and process claims, provisional obviousness-type double patenting rejections should be made where appropriate. However, once a determination as to the patentability of the product has been reached any process claim which contains limitations identical to the allowed/allowable product should not be rejected over prior art without consultation with a Technology Center Director.

Where product and process claims are presented in a single application and that application qualifies under the transitional restriction practice pursuant to 37 CFR 1.129(b), applicant may either: (A) elect the

invention to be searched and examined and pay the fee set forth in 37 CFR 1.17(s) and have the additional inventions searched and examined under 37 CFR 1.129(b)(2); or (B) elect the invention to be searched and examined and not pay the additional fee (37 CFR 1.129(b)(3)). Where no additional fee is paid, if the elected invention is directed to the product and the claims directed to the product are subsequently found patentable, process claims which either depend from or include all the limitations of the allowable product will be rejoined. If applicant chooses to pay the fees to have the additional inventions searched and examined pursuant to 37 CFR 1.129(b)(2) even if the product is found allowable, applicant would not be entitled to a refund of the fees paid under 37 CFR 1.129(b) by arguing that the process claims could have been rejoined. 37 CFR 1.26(a) states that “[T]he Commissioner may refund any fee paid by mistake or in excess of that required. A change of purpose after the payment of a fee...will not entitle a party to a refund of such fee...” In this case, the fees paid under 37 CFR 1.129(b) were not paid by mistake nor paid in excess, therefore, applicant would not be entitled to a refund.

In the event of rejoinder, the rejoined process claims will be fully examined for patentability in accordance with 37 CFR 1.104. Thus, to be allowable, the rejoined claims must meet all criteria for patentability including the requirements of 35 U.S.C. 101, 102, 103, and 112. If the application containing the rejoined claims is not in condition for allowance, the subsequent Office action may be made final, or, if the application was already under final rejection, the next Office action may be an advisory action.

Form paragraphs 8.42 through 8.44 should be used to notify applicant of the rejoinder of process claims which depend from or otherwise include all the limitations of an allowable product claim.

#### ¶ 8.42 Rejoinder of Less Than All Process Claims

Claim [1] directed to an allowable product. Pursuant to the procedures set forth in the *Official Gazette* notice dated March 26, 1996 (1184 O.G. 86), claim [2], directed to the process of making or using the patentable product, previously withdrawn from consideration as a result of a restriction requirement, [3] now subject to being rejoined. Process claim [4] hereby rejoined and fully examined for patentability under 37 CFR 1.104. In accordance with the *Official Gazette* notice, *supra*, process claim [5], which [6] not depend from or otherwise include all the limitations of the allowable product, [7] NOT been rejoined.

**Examiner Note:**

1. If ALL previously withdrawn claims are being rejoined, then form paragraph 8.43 should be used instead of this form paragraph.
2. If other non-process claims are present and are NOT being rejoined, use form paragraph 8.44 instead of this form paragraph.
3. In bracket 1, insert the claim number(s) of the allowable product claims followed by either -- is-- or -- are--.
4. In bracket 2, insert the claim number(s) of ALL process claims previously withdrawn from consideration.
5. In bracket 3, insert either --is-- or --are--.
6. In bracket 4, insert the number(s) of the rejoined process claims.
7. In bracket 5, insert the number(s) of the process claims NOT being rejoined followed by either -- is-- or -- are--.
8. In bracket 6, insert --do-- or --does--.
9. In bracket 7, insert --has-- or --have--.
10. If rejoinder occurs after the first Office action on the merits and if any of the rejoined claims are unpatentable, e.g., if a rejection under 35 U.S.C. 112, first paragraph is made, then the next Office action may be made final since the new ground of rejection was necessitated by applicant's reply.

**¶ 8.43 Rejoinder of All Previously Withdrawn Claims**

Claim [1] directed to an allowable product. Pursuant to the procedures set forth in the *Official Gazette* notice dated March 26, 1996 (1184 O.G. 86), claim [2], directed to the process of making or using the patentable product, previously withdrawn from consideration as a result of a restriction requirement, [3] now subject to being rejoined. Claim [4] hereby rejoined and fully examined for patentability under 37 CFR 1.104.

Since all claims previously withdrawn from consideration under 37 CFR 1.142 have been rejoined, the restriction requirement made in the Paper No. [5] is hereby withdrawn.

**Examiner Note:**

1. If LESS THAN ALL previously withdrawn process claims are being rejoined, then form paragraph 8.42 should be used instead of this form paragraph. If LESS THAN ALL previously withdrawn claims are being rejoined, then form paragraph 8.44 should be used instead of this form paragraph.
2. In bracket 1, insert the claim number(s) of the allowable product claim(s) followed by either -- is-- or -- are--.
3. In bracket 2, insert the claim number(s) of the process claim(s) previously withdrawn from consideration.
4. In bracket 3, insert either --is-- or --are--.
5. In bracket 4, insert the number(s) of the process claims being rejoined (should correspond to bracket 2 insert).
6. If rejoinder occurs after the first Office action on the merits and if any of the rejoined claims are unpatentable, e.g., if a rejection under 35 U.S.C. 112, first paragraph is made, then the next Office action may be made final since the new ground of rejection was necessitated by applicant's reply.

**¶ 8.44 Rejoinder of Process Claims, Other Claims Present and Not Rejoined**

Claim [1] directed to an allowable product. Pursuant to the procedures set forth in the *Official Gazette* notice dated March 26,

1996 (1184 O.G. 86), claim [2], directed to the process of making or using the patentable product, previously withdrawn from consideration as a result of a restriction requirement, [3] now subject to being rejoined. Process claim [4] hereby rejoined and fully examined for patentability under 37 CFR 1.104. Claim [5], not directed to the process of making or using the patentable product, will not be rejoined.

**Examiner Note:**

1. If LESS THAN ALL previously withdrawn process claims are being rejoined, then form paragraph 8.42 should be used instead of this form paragraph. If ALL previously withdrawn claims are being rejoined then form paragraph 8.43 should be used instead of this form paragraph.
2. In bracket 1, insert the claim number(s) of the allowable product claim(s) followed by either -- is-- or -- are--.
3. In bracket 2, insert the claim number(s) of the process claim(s) previously withdrawn from consideration.
4. In bracket 3, insert either --is-- or --are--.
5. In bracket 4, insert the number(s) of the process claims being rejoined (should correspond to bracket 2 insert).
6. In bracket 5, insert the number(s) of all previously withdrawn claims which are not being rejoined.
7. If rejoinder occurs after the first Office action on the merits and if any of the rejoined claims are unpatentable, e.g., if a rejection under 35 U.S.C. 112, first paragraph is made, then the next Office action may be made final since the new ground of rejection was necessitated by applicant's reply.

See MPEP § 706.02(n) for the applicability of 35 U.S.C. 103(b) to biotechnological processes and compositions of matter.

See MPEP § 2116.01 for guidance on the treatment of process claims which make or use a novel, nonobvious product.

See MPEP § 806.05(c) for rejoinder of restricted combination/subcombination inventions when an evidence claim is found to be unallowable, and see MPEP § 809 and § 809.04 for rejoinder of restricted inventions when a linking claim is found allowable.

## 822 Claims to Inventions That Are Not Distinct in Plural Applications of Same Inventive Entity

The treatment of plural applications of the same inventive entity, none of which has become a patent, is treated in 37 CFR 1.78(b) as follows:

- (b) Where two or more applications filed by the same applicant contain conflicting claims, elimination of such claims from all but one application may be required in the absence of good and sufficient reason for their retention during pendency in more than one application.

See MPEP § 804.03 for conflicting subject matter, different inventors, common ownership.

See MPEP § 706.03(k) for rejection of one claim on another in the same application.

See MPEP § 706.03(w) and § 706.07(b) for *res judicata*.

See MPEP § 709.01 for one application in interference.

See MPEP § 806.04(h) to § 806.04(i) for species and genus in separate applications.

Wherever appropriate, such conflicting applications should be joined. This is particularly true, where the two or more applications are due to, and consonant with, a requirement to restrict which the examiner now considers to be improper.

Form paragraph 8.29 should be used when the conflicting claims are identical or conceded by applicant to be not patentably distinct.

¶ 8.29 *Conflicting Claims, Copending Applications*

Claim [1] of this application conflict with claim [2] of Application No. [3]. 37 CFR 1.78(b) provides that when two or more applications filed by the same applicant contain conflicting claims, elimination of such claims from all but one application may be required in the absence of good and sufficient reason for their retention during pendency in more than one application. Applicant is required to either cancel the conflicting claims from all but one application or maintain a clear line of demarcation between the applications. See MPEP § 822.

**Examiner Note:**

This paragraph is appropriate only when the conflicting claims are patentably distinct.

## 822.01 Copending Before the Examiner

37 CFR 1.78. *Claiming benefit of earlier filing date and cross-references to other applications.*

\*\*\*\*\*

(b) Where two or more applications filed by the same applicant contain conflicting claims, elimination of such claims from all but one application may be required in the absence of good and sufficient reason for their retention during pendency in more than one application.

\*\*\*\*\*

37 CFR 1.130. *Affidavit or declaration to disqualify commonly owned patent or published application as prior art.*

\*\*\*\*\*

(b) When an application or a patent under reexamination claims an invention which is not patentably distinct from an

invention claimed in a commonly owned patent with the same or a different inventive entity, a double patenting rejection will be made in the application or a patent under reexamination. A judicially created double patenting rejection may be obviated by filing a terminal disclaimer in accordance with § 1.321(c).

\*\*\*\*\*

Where claims in one application are unpatentable over claims of another application of the same inventive entity (or different inventive entity with common ownership) because they recite the same invention, a complete examination should be made of the claims of each application and all appropriate rejections should be entered in each application, including rejections based upon prior art. The claims of each application may also be rejected on the grounds of provisional double patenting on the claims of the other application whether or not any claims avoid the prior art. Where appropriate, the same prior art may be relied upon in each of the applications. See also MPEP § 804.01 and § 822.

### ONLY PROVISIONAL DOUBLE PATENTING REJECTION REMAINING IN ONE APPLICATION

The “provisional” double patenting rejection should continue to be made by the examiner in each application as long as there are conflicting claims in more than one application unless that “provisional” double patenting rejection is the only rejection remaining in one of the applications. If the “provisional” double patenting rejection in one application is the only rejection remaining in that application, the examiner should then withdraw that rejection and permit the application to issue as a patent, thereby converting the “provisional” double patenting rejection in the other application(s) into a double patenting rejection at the time the one application issues as a patent. See also MPEP § 804.01 and § 822.

### ONLY PROVISIONAL DOUBLE PATENTING REJECTIONS REMAINING IN BOTH APPLICATIONS

If the “provisional” double patenting rejections in both applications are the only rejections remaining in those applications, the examiner should then withdraw that rejection in one of the applications and permit the application to issue as a patent. The examiner should maintain the double patenting rejection in the

other application as a “provisional” double patenting rejection which will be converted into a double patenting rejection when the one application issues as a patent.

### **823 Unity of Invention Under the Patent Cooperation Treaty**

See Chapter 1800 for a detailed discussion of unity of invention under the Patent Cooperation Treaty (PCT).



MANUAL OF PATENT EXAMINING PROCEDURE

# Chapter 900 Prior Art, Classification, Search

## 901 Prior Art

- 901.01 Canceled Matter in U.S. Patent Files
- 901.02 Abandoned Applications
- 901.03 Pending Applications
- 901.04 U.S. Patents
- 901.04(a) Kind Codes
- 901.05 Foreign Patent Documents
- 901.05(a) Citation Data
- 901.05(b) Other Significant Data
- 901.05(c) Obtaining Copies
- 901.05(d) Translation
- 901.06 Nonpatent Publications
- 901.06(a) Scientific and Technical Information Center (STIC)
- 901.06(b) Borrowed Publications
- 901.06(c) Alien Property Custodian Publications
- 901.06(d) Abstracts, Abbreviations, and Defensive Publications
- 901.07 Arrangement of Art in Technology Centers
- 901.08 Borrowing References
- 901.09 Missing Copies — Replacement

## 902 Search Tools and Classification Information

- 902.01 Manual of Classification
- 902.01(a) Index to the U.S. Patent Classification System
- 902.02 Class and Subclass Definitions
- 902.02(a) Definition Notes
- 902.02(b) Search Cards
- 902.03 Classification Information
- 902.03(a) Patent Classification Home Page on the Internet
- 902.03(b) Patent Classification Home Page on the USPTO Intranet
- 902.03(c) Classification Insight on USPTO Local Area Network (LAN)
- 902.03(d) Patent Information and Search Tools: the Cassis CD-ROM Series
- 902.03(e) Automated Search Tools: EAST and WEST
- 902.04 Classification Orders
- 902.04(a) Reclassification Alert Report

## 903 Classification

- 903.01 Statutory Authority
- 903.02 Basis and Principles of Classification
- 903.02(a) New and Revised Classes
- 903.02(b) Scope of a Class
- 903.02(c) Establishing Subclasses and Cross-Reference Art Collections
- 903.03 Availability of Foreign Patents
- 903.05 Transfer of U.S. Patents
- 903.06 Practice To Be Followed in Ordering Official Cross-References

- 903.07 Classifying and Cross-Referencing at Allowance
- 903.07(a) Cross-Referencing — Keep Systematic Notes During Prosecution
- 903.07(b) Issuing in Another Technology Center Without Transfer
- 903.08 Applications: Assignment and Transfer
- 903.08(a) New Applications
- 903.08(b) Classification and Assignment to Examiner
- 903.08(c) Immediate Inspection of Amendments
- 903.08(d) Transfer Procedure
- 903.08(e) General Guidelines Governing the Assignment of Nonprovisional Applications for Examination
- 903.08(f) Post Classifier's Decision
- 903.08(g) Transfer to Another Technology Center After Decision
- 903.09 International Classification of Patents for Inventions
- 903.09(a) Locarno Classification Designations
- 903.10 Duties of the Post Classifier

## 904 How to Search

- 904.01 Analysis of Claims
- 904.01(a) Variant Embodiments Within Scope of Claim
- 904.01(b) Equivalents
- 904.01(c) Analogous Arts
- 904.02 General Search Guidelines
- 904.02(a) Classified Search
- 904.02(b) Search Tool Selection
- 904.02(c) Internet Searching
- 904.03 Conducting the Search

## 905 Miscellaneous

- 905.02 Soft Copy Orders
- 905.03 Ordering of Patented and Abandoned Provisional and Nonprovisional Application Files
- 905.04 Marking Examiners' Copies of Patents
- 905.05 Application File Location
- 905.06 Patent Family Information

## 901 Prior Art

Note 37 CFR 1.104(a)(1) in MPEP § 707. See also MPEP § 2121- § 2129.

### 901.01 Canceled Matter in U.S. Patent Files

Canceled matter in the application file of a U.S. patent is not a proper reference as of the filing date under 35 U.S.C. 102(e). See *Ex parte Stalego*, 154 USPQ 52, 53 (Bd. App. 1966). However, matter



canceled from the application file wrapper of a U.S. patent may be used as prior art as of the patent date in that it then constitutes prior public knowledge under 35 U.S.C. 102(a). *In re Lund*, 376 F.2d 982, 153 USPQ 625 (CCPA 1967). See also MPEP § 2127 and § 2136.02.

## 901.02 Abandoned Applications

If an abandoned application was previously published under 35 U.S.C. 122(b), that patent application publication is available as prior art under 35 U.S.C. 102(a) and 102(b) as of its patent application publication date because the patent application publication is considered to be a “printed” publication within the meaning of 35 U.S.C. 102(a) and 102(b), even though the patent application publication is disseminated by the U.S. Patent and Trademark Office (Office) using only electronic media. See MPEP § 2128. Additionally, as described in MPEP § 901.03, a patent application publication published under 35 U.S.C. 122(b) is available as prior art under 35 U.S.C. 102(e) as of the earliest effective U.S. filing date of the published application against U.S. applications filed on or after November 29, 2000 and applications filed prior to November 29, 2000 which are voluntarily published. As provided in 37 CFR 1.11(a), unless a redacted copy of the application was used for the patent application publication, the specification, drawings, and all papers relating to the file of an abandoned published application are open to inspection by the public, and copies may be obtained from the Office. The information that is available to the public under 37 CFR 1.11(a) may be used as prior art under 35 U.S.C. 102(a) or 102(b) as of the date the information became publicly available.

Where an abandoned application is referred to in an issued U.S. patent or in one of the types of published or publicly available patent applications described in 37 CFR 1.14(e), access to the abandoned application file may be provided to the public. See 37 CFR 1.14(e)(2). Similarly, a copy of the application-as-filed and/or a copy of the file wrapper and its contents may be publicly available. See 37 CFR 1.14(c). Subject matter from abandoned applications which is available to the public under 37 CFR 1.14(c) or 37 CFR 1.14(e) may be used as prior art against a pending U.S. application under 35 U.S.C. 102(a) or 102(b) as

of the date the subject matter became publicly available.

*In re Heritage*, 182 F.2d 639, 86 USPQ 160 (CCPA 1950), holds that where a patent refers to and relies on the disclosure of a previously copending but subsequently abandoned application, such disclosure is available as a reference. See also *In re Lund*, 376 F.2d 982, 153 USPQ 625 (CCPA 1967).

It has also been held that where the reference patent refers to a previously copending but subsequently abandoned application which discloses subject matter in common with the patent, the effective date of the reference as to the common subject matter is the filing date of the abandoned application. *In re Switzer*, 166 F.2d 827, 77 USPQ 156 (CCPA 1948); *Ex parte Peterson*, 63 USPQ 99 (Bd. App. 1944); and *Ex parte Clifford*, 49 USPQ 152 (Bd. App. 1940). See MPEP § 2127(a).

Published abstracts, abbreviations, defensive publications (MPEP § 901.06(d)), and statutory invention registrations (MPEP Chapter 1100) are references.

## 901.03 Pending Applications

Except as provided in 37 CFR 1.11(b), 37 CFR 1.14(c) and 37 CFR 1.14(e), pending U.S. applications filed before November 29, 2000 which are not voluntarily published and applications filed on or after November 29, 2000 which have not been published are generally preserved in confidence (37 CFR 1.14(a)) and are not available as references. However, claims in one nonprovisional application may be rejected on the claimed subject matter of a copending nonprovisional application of the same inventive entity. See MPEP § 804. For applications having a common assignee and different inventive entities claiming a single inventive concept, see MPEP § 804.03. See also MPEP § 2127, paragraph IV.

The American Inventors Protection Act of 1999 (AIPA) was enacted into law on November 29, 1999. The AIPA amended 35 U.S.C. 122 to provide that, with certain exceptions, applications for patent filed on or after November 29, 2000 shall be published promptly after the expiration of a period of eighteen (18) months from the earliest filing date for which a benefit is sought under title 35, United States Code, and that an application may be published earlier at the request of the applicant. See 35 U.S.C. 122(b) and

37 CFR 1.215 and 1.219. In addition, applications filed prior to November 29, 2000, but pending on November 29, 2000, may be published if a request for voluntary publication is filed. See 37 CFR 1.221. Patent applications filed on or after November 29, 2000, and those including a request for voluntary publication shall be published except for the following enumerated exceptions.

First, an application shall not be published if it is:

- (A) no longer pending;
- (B) subject to a secrecy order under 35 U.S.C. 181 or an application for which publication or disclosure would be detrimental to national security;
- (C) a provisional application filed under 35 U.S.C. 111(b);
- (D) an application for a design patent filed under 35 U.S.C. 171; or
- (E) a reissue application filed under 35 U.S.C. 251.

Second, an application shall not be published if an applicant submits at the time of filing of the application a request for nonpublication, certifying that the invention disclosed in the U.S. application has not and will not be the subject of an application filed in another country, or under a multilateral international agreement, that requires eighteen month publication. See 37 CFR 1.213(a). An applicant may rescind such a request at any time. See 37 CFR 1.213(b). If the applicant who has submitted a nonpublication request subsequently files an application directed to the invention disclosed in the U.S. application, in which the nonpublication request was submitted, in another country, or under a multilateral international agreement, that requires publication of the application eighteen months after filing, the applicant must notify the Office of such filing within forty-five days after the date of the filing of such foreign or international application. See 37 CFR 1.213(c). In addition, if an applicant has filed applications in one or more foreign countries, directly or through a multilateral international agreement, and such foreign-filed applications or the description of the invention in such foreign-filed applications is less extensive than the application or description of the invention in the application filed in the USPTO, the applicant may submit a redacted copy of the application filed in the Office eliminating any part or description of the invention in the U.S.

application that is not also contained in any of the corresponding applications filed in a foreign country. If the redacted copy of the U.S. application is timely received in the Office, the Office may publish only the redacted copy. See 35 U.S.C. 122(b)(2)(B)(v) and 37 CFR 1.217.

U.S. patent application publications are prior art under 35 U.S.C. 102(a) and 102(b) as of the publication date. Under amended 35 U.S.C. 102(e)(1), a U.S. patent application publication is considered to be prior art as of the earliest effective U.S. filing date of the published application. Additionally, a U.S. patent application publication of a National Stage application is considered to be prior art under 35 U.S.C. 102(e) as of the international filing date only if the International Application designated the United States and was published by the International Bureau (IB) in English.

Any new prior art created by the changes to 35 U.S.C. 102(e) may only be applied against applications that are filed on or after November 29, 2000, and against applications filed prior to November 29, 2000 that are pending on November 29, 2000 and are voluntarily published. The new prior art effects created by amended 35 U.S.C. 102(e) will not be applicable to any application filed before November 29, 2000 and not voluntarily published, nor a reexamination of a patent issued on such an application. Additionally, the new prior art effect created by amended 35 U.S.C. 102(e) will not be applicable to any National Stage application, complying with 35 U.S.C. 371(c), whose international filing date is before November 29, 2000 if it is not voluntarily published.

## 901.04 U.S. Patents

The following different series of U.S. patents are being or in the past have been issued. The date of patenting given on the face of each copy is the publication date and is the one usually cited. The filing date, in most instances also given on the face of the patent, is ordinarily the effective date as a reference (35 U.S.C. 102(e)). See MPEP § 2127, paragraph II. The 35 U.S.C. 102(e) date for a nonprovisional application claiming the benefit of a prior provisional application (35 U.S.C. 111(b)) is the filing date of the provisional application.

*X-Series.* These are the approximately 10,000 patents issued between 1790 and July 4, 1836. They were not originally numbered, but have since been assigned numbers in the sequence in which they were issued. The number should *not* be cited. When copies are ordered, the patentee's name and date of issue suffice for identification.

*1836 Series.* The mechanical, electrical, and chemical patents issued since 1836 and frequently designated as "utility" patents are included in this series. A citation by number only is understood to refer to this series. This series comprises the bulk of all U.S. patents issued. Some U.S. patents issued in 1861 bear two numbers but only the larger number should be cited.

*Reissue Series.* Reissue patents (MPEP § 1401) have been given a separate series of numbers preceded by "Re." In citing, the letters and the number must be given, e.g., Re. 1776. The date that it is effective as a reference is the effective date of the original patent application, not the filing date of the reissue application.

Design reissue patents are numbered with the same number series as "utility" reissue patents. The letter prefix does, however, indicate them to be design reissues.

*A.I. Series.* From 1838 to 1861, patents covering an inventor's improvement on his or her own patented device were given a separate series of numbers preceded by "A.I." to indicate Additional Improvement. In citing, the letters and the number must be given, e.g., A.I. 113. About 300 such patents were issued.

*Plant Patent Series.* When the statutes were amended to provide for patenting certain types of plants (see MPEP Chapter 1600) these patents were given a separate series of numbers. In citing, the letters "P.P." and the number must be given, e.g., P.P. 13.

*Design Patents.* Patents for designs (see MPEP Chapter 1500) are issued under a separate series of numbers preceded by "D." In citing, the letter "D" and the number must be given, e.g., D. 140,000.

## **NUMBERS FOR IDENTIFICATION OF BIBLIOGRAPHIC DATA ON THE FIRST PAGE OF PATENT AND LIKE DOCUMENTS (INID NUMBERS)**

The purpose of INID Codes ("INID" is an acronym for "Internationally agreed Numbers for the Identification of (bibliographic) Data") is to provide a means whereby the various data appearing on the first page of patent and like documents can be identified without knowledge of the language used and the laws applied. They are now used by most patent offices and have been applied to U.S. patents since Aug. 4, 1970. Some of the codes are not pertinent to the documents of a particular country and some which are may, in fact, not be used. For a list of INID Codes, see MPEP § 901.05(b).

### **901.04(a) Kind Codes**

On January 2, 2001, the United States Patent and Trademark Office (USPTO) began printing the World Intellectual Property Organization (WIPO) Standard ST.16 code on each of its published patent documents. WIPO Standard ST.16 codes (kind codes) include a letter, and in many cases a number, used to distinguish the kind of patent document (e.g., publication of an application for a utility patent (patent application publication), utility patent, plant patent application publication, plant patent, or design patent) and the level of publication (e.g., first publication, second publication, or corrected publication). Detailed information on Standard ST.16 and the use of kind codes by patent offices throughout the world is available on the WIPO web site at <http://www.wipo.int/scit/en> under the links for WIPO standards and other documentation.

In addition, some kind codes assigned to existing USPTO patent documents were changed because, beginning on March 15, 2001, patent application publications began to be published weekly on Thursdays.

The tables below give a summary of the kind codes which are no longer being used on certain published patent documents as well as a summary of the kind codes which will be used on published patent documents after January 2, 2001. It is recommended that USPTO documents be identified by the following three elements: (A) the two-character country code (US for United States of America); (B) the patent or publication number; and (C) the WIPO ST.16 kind code. For example, "US 7,654,321 B1" for U.S.

Patent No. 7,654,321 where there was no previously-published patent application publication, and “US 2003/1234567 A1” for U.S. Patent Application Publication No. 2003/1234567, in 2003. Each year the numbering of published patent applications will begin

again with the new four digit year and the number 0000001, so the number of a patent application publication must include an associated year.

<b>Summary of USPTO Kind Codes No Longer Used as of January 2, 2001*</b>		
<b>WIPO ST.16 Kind Codes</b>	<b>Kind of document</b>	<b>Comments</b>
A	Patent	Kind code replaced by B1 or B2
P	Plant Patent	Kind code replaced by P2 or P3
B1, B2, B3...	Reexamination Certificate	Kind code replaced by C1, C2, C3...

\*See the table below for the new uses for codes B1 and B2 beginning January 2, 2001.

<b>Summary of USPTO Kind Codes Used on Documents Published Beginning January 2, 2001</b>		
<b>WIPO ST.16 Kind Codes</b>	<b>Kind of document</b>	<b>Comments</b>
A1	Patent Application Publication	Pre-grant publication available March 2001
A2	Patent Application Publication (Republication)	Pre-grant publication available March 2001
A9	Patent Application Publication (Corrected Publication)	Pre-grant publication available March 2001
B1	Patent	No previously published pre-grant publication
B2	Patent	Having a previously published pre-grant publication and available March 2001
C1, C2, C3, ...	Reexamination Certificate	Previously used codes B1 and B2 are now used for granted Patents
E	Reissue Patent	No change
H	Statutory Invention Registration (SIR)	No change
P1	Plant Patent Publication Application	Pre-grant publication available March 2001

<b>Summary of USPTO Kind Codes Used on Documents Published Beginning January 2, 2001</b>		
<b>WIPO ST.16 Kind Codes</b>	<b>Kind of document</b>	<b>Comments</b>
P2	Plant Patent	No previously published pre-grant publication
P3	Plant Patent	Having a previously published pre-grant publication and available March 2001
P4	Plant Patent Application Publication (Republication)	Pre-grant publication available after March 2001
P9	Plant Patent Application Publication (Corrected Publication)	Pre-grant publication available March 2001
S	Design Patent	No change

## 901.05 Foreign Patent Documents

All foreign patents, published applications, and any other published derivative material containing portions or summaries of the contents of published or unpublished patents (e.g., abstracts) which have been disseminated to the public are available to U.S. examiners. See MPEP § 901.06(a), paragraphs I.C. and IV.C. In general, a foreign patent, the contents of its application, or segments of its content should not be cited as a reference until its date of patenting or publication can be confirmed by an examiner's review of a copy of the document. Examiners should remember that in some countries, there is a delay between the date of the patent grant and the date of publication.

Information pertaining to those countries from which the most patent publications are received are given in the following sections and in MPEP § 901.05(a). Additional information can be obtained from the Scientific and Technical Information Center.

See MPEP § 707.05(e) for data used in citing foreign references.

### I. PLACEMENT OF FOREIGN PATENT EQUIVALENTS IN THE SEARCH FILES

There are approximately 25 countries in which the specifications of patents are published in printed form either before or after a patent is granted.

UNTIL OCTOBER 1, 1995, THE FOLLOWING PRACTICE WAS USED IN PLACING FOREIGN PATENT EQUIVALENTS IN THE SEARCH FILES:

When the same invention is disclosed by a common inventor(s) and patented in more than one country, these patents are called a family of patents. Whenever a family of patents or published patent disclosures existed, the Office selected from a prioritized list of countries a single family member for placement in the examiners' search file and selected the patent of the country with the earliest patent date. If the U.S. was one of the countries granting a patent in the "family" of patents, none of the foreign "equivalents" was placed in our search file. See paragraph III., below. However, foreign patents or published patent disclosures within a common family which issued prior to the final highest priority patent (e.g., U.S.) may have been placed in our paper search file and these copies were generally not removed when the higher priority patent was added to our search files at a later date.

Beginning in October 1995, paper copies of foreign patents were no longer classified into the U.S. Classification System by the U.S. Patent and Trademark Office. See MPEP § 901.05(c) for search of recently issued foreign patents.

### II. OVERVIEW OF FOREIGN PATENT LAWS

This section includes some general information on foreign patent laws and summarizes particular features and their terminology. Some additional details on the most commonly cited foreign patent publications may be found under the individual country in

paragraph V., below. Examiners should recall, by way of contrast to the practice in many other countries, under U.S. patent law a number of different events all occur on the issue date of a U.S. patent. These events include the following:

- (A) a patent document, the “letters patent” which grants and thereby creates the legal rights conferred by a patent, is executed and sent to the applicant;
- (B) the patent rights come into existence;
- (C) the patent rights can be exercised;
- (D) the specification of the patent becomes available to the public;
- (E) the patented file becomes available to the public;
- (F) the specification is published in printed form; and
- (G) an issue of an official journal, the *Official Gazette*, containing an announcement of the patent and a claim, is published.

In most foreign countries, various ones of these events occur on different days and some of them may never occur at all.

The following list catalogs some of the most significant foreign variations from U.S. practices:

#### **A. Applicant**

In most countries, the owner of the prospective rights, derived from the inventor, may also apply for a patent in the owner’s name as applicant; in a few, other persons may apply as well or be joined as coapplicants. Hence applicant is not synonymous with inventor, and the applicant may be a company. Some countries require the inventors’ names to be given and regularly print them on the published copies. Other countries may sometimes print the inventors’ names only when available or when requested to do so.

#### **B. Application**

The word “application” is commonly used in the U.S. to refer to the entire set of papers filed when seeking a patent. However, in many countries and in PCT cases, the word application refers only to the paper, usually a printed form, which is to be “accompanied by” or have “attached” to it certain other papers, namely a specification, drawings when necessary, claims, and perhaps other papers. Unless it is otherwise noted in the following portions of this sec-

tion, the term “application” refers to the entire set of papers filed.

#### **C. Publication of Contents of Pending Applications**

In general, pending applications are confidential until a certain stage in the proceedings (e.g., upon patent grant), or until a certain date (e.g., 18 months after filing), as may be specified in a particular law.

Many countries have adopted the practice of publishing the specification, drawing, or claims of pending applications. In these countries, the publication of the contents of the application occurs at a certain time, usually 18 months after filing. The applicant is given certain provisional rights upon publication even though examination has not been completed or in some cases has not even begun at the time of publication.

This publication may take either of two forms. In the first form, some countries publish a notice giving certain particulars in their official journal and thereafter any one may see the papers at the patent office or order copies. This procedure is referred to as “laying open for public inspection.” There is no printed publication of the specification, although an abstract may be published in printed form. If anyone can inspect or obtain copies of the laid open application, then it is sufficiently accessible to the public to constitute a “publication” within the meaning of 35 U.S.C. 102(a) and (b). The full application is thus available as prior art as of either the date of publication of its notice or its laying open to public inspection if this is a later date. *In re Wyer*, 655 F.2d 221, 210 USPQ 790 (CCPA 1981). See MPEP § 2127, paragraph III.

In the second form, several other countries publish the specifications of pending applications in printed form at a specified time, usually 18 months after filing. These documents, of course, constitute references as printed publications.

#### **D. Administrative Systems**

Patent law administration varies from country to country. In some countries, all that is undertaken is an inspection of the papers to determine if they are in proper form. Other countries perform an examination of the merits on the basis of an extensive search of the prior art, as is done in the U.S. The former are referred to as nonexamining or registration countries, although

some systems allow for a rejection on matters apparent on the face of the papers, such as matters of form or statutory subject matter.

Of the examining countries, the extent of the material searched prior to issue varies greatly. Only a few countries include both their own patents and a substantial amount of foreign patent material and non-patent publications in their search files. Some countries specifically limit the search by rule, or lack of facilities, to their own patents with very little or no additional material. An increasing number of countries are requiring applicants to give information concerning references cited in corresponding applications filed in other countries.

### ***E. Opposition***

Some examining countries consider participation by the public an inherent feature of their examining system. When an application is found to be allowable by the examiner, it is “published” for opposition. Then there is a period, usually 3 or 4 months, within which members of the public can oppose the grant of the patent. In some countries, the opposing party can be any person or company. In other countries, only those parties who are affected by the outcome can participate in the opposition. The opposition is an *inter partes* proceeding and the opposing party can ordinarily raise any ground on the basis of which a patent would be refused or held invalid, including any applicable references.

The publication for opposition may take the form of a laying open of the application by the publication of a notice in the official journal with the application being then open to public inspection and the obtaining of copies. Otherwise publication occurs by the issue of the applications in printed form. Either way, these published documents constitute printed publications which are available as references under 35 U.S.C. 102(a) and 102(b).

### ***F. The Patent***

Practices and terminology vary worldwide regarding patents. In some countries, there is no “letters patent” document which creates and grants the rights. In other countries, the examiner grants the patent by signing the required paper. In a few countries, the patent is granted by operation of law after certain events have occurred. The term “granting the patent”

is used here for convenience, but it should be noted that 35 U.S.C. 102(a) and 102(b) do not use this terminology.

A list of granted patents is ordinarily published in each country’s official journal and some of these countries also print an abstract or claims at or after the granting date. Not all countries publish the granted patent. Where the specifications of granted patents are issued in printed form, publication seldom occurs simultaneously with the day of grant; instead, publication occurs a short time thereafter. There also are a few countries in which publication does not take place until several years after the grant.

The length of time for which the patent is enforceable (the patent term) varies from country to country. The term of the patent may start as of the grant of the patent, or as of the filing date of the application.

Most countries require the payment of periodic fees to maintain a patent in force. These fees often start a few years after filing and increase progressively during the term of the patent. If these fees are not paid within the time allowed, the patent lapses and is no longer in force. This lapsing does not affect the use of the patent as a reference.

### ***G. Patents of Addition***

Some countries issue patents of addition, which should be identified as such, and when separately numbered as in France, the number of the addition patent should be cited. “Patents of addition” generally cover improvements of a patented parent invention and can be obtained by the owner of the parent invention. Inventiveness in relation to the parent invention need not be demonstrated and the term is governed by the term of the parent patent.

## **III. CORRESPONDING SPECIFICATIONS IN A FAMILY OF PATENTS**

Since a separate patent must be obtained in each country in which patent rights are desired (except for EP, the European Patent Convention, AP, the African Regional Industrial Property Organization, OA, African Intellectual Property Organization, GC, Patent Office of the Cooperation Council for the Arab States of the Gulf, and EA, Eurasian Patent Office, whose members issue a common patent), there may be a large number of patents issued in different countries

for the same invention. This group of patents is referred to as a family of patents.

All of the countries listed in paragraph V. below are parties to the Paris Convention for the Protection of Industrial Property and provide for the right of priority. If an application is filed in one of these countries, an application for the same invention thereafter filed in another country, within 1 year of the filing of the first application, will be entitled to the benefit of the filing date of the first application on fulfilling various conditions. See MPEP § 201.13. The patents or published specifications of the countries of later filing are required to specify that priority has been claimed and to give the country, date, and number of the priority application. This data serves the purpose, among others, of enabling any patent based on the priority application to be easily located.

In general, the specification of the second application is identical in substance to the specification of the first. In many instances, the second, if in another language, is simply a translation of the first with perhaps some variation in purely formal parts. But in a minority of cases, the two may not be identical. For instance, sometimes two applications filed in one country are combined into one second application which is filed in another country. Alternatively, a second application could be filed for only part of the disclosure of the priority application. The second application may have the relationship to the first which we refer to as a continuation-in-part (e.g., the second application includes additional subject matter discovered after the first was filed). In some instances, the second application could have its disclosure diminished or increased, to meet the requirements or practices of the second country.

Duplicate or substantially duplicate versions of a foreign language specification, in English or some other language known to the examiner, can sometimes be found. It is possible to cite a foreign language specification as a reference, while at the same time citing an English language version of the specification with a later date as a convenient translation if the latter is in fact a translation. Questions as to content in such cases must be settled based on the specification which was used as the reference.

If a U.S. patent being considered as a reference claims the priority of a previously filed foreign application, it may be desirable to determine if the foreign

application has issued or has been published, to see if there is an earlier date. For example, it has occurred that an examiner rejected claims on the basis of a U.S. patent and the applicant filed affidavits to overcome the filing date of the reference; the affidavits were controversial and the case went to appeal, with an extensive brief and an examiner's answer having been filed. After all this work, somebody noticed that the U.S. patent reference claimed the priority of a foreign application filed in a country in which patents were issued fairly soon, checked the foreign application, and discovered that the foreign patent had not only been issued, but also published in printed form, more than 1 year prior to the filing date of the application on appeal.

If a foreign patent or specification claims the priority of a U.S. application, it can be determined whether the latter is abandoned, still pending, or patented. Even if the U.S. case is or becomes patented, however, the foreign documents may still be useful as supplying an earlier printed publication date.

If a foreign patent or specification claims the priority of an application in another foreign country, it may sometimes be desirable to check the latter to determine if the subject matter was patented or published at an earlier date. As an example, if a British specification being considered as a reference claims the priority of an application filed in Belgium, it is known at once that a considerably earlier effective date can be established, if needed, because Belgian patents issue soon after filing. In addition, if the application referred to was filed in one of the countries which publish applications in printed form 18 months after filing, the subject matter of the application will be available as a printed publication as of the 18 month publishing date. These remarks obviously also apply to a U.S. patent claiming a foreign priority.

The determination of whether a foreign patent has been issued or the application published is a comparatively simple matter for some countries, but for some it is quite laborious and time-consuming and may not even be possible from the sources maintained by the Scientific and Technical Information Center. Other sources for this data which are not maintained by the Office do exist and can be utilized for locating corresponding patents. One source is *Chemical Abstracts* which publishes abstracts of patents from a large number of countries. Only one patent or published



specification from a family is abstracted in full and any related family members issued or published are cross-referenced. Chemical Abstract's annual indexes include lists of patent numbers, and also include patentees' and inventors' names in the alphabetical author index. A concordance of corresponding patents appearing during five year periods has also been published. Other sources for this family data are the INPADOC and DERWENT data files.

When an application is filed outside the Paris Convention year from an earlier application, the later application may not refer to the first application. It is hence possible that there will be duplicate specifications published without any indication revealing the fact. These may be detected when the two copies come together in the same subclass. Because the later application is filed outside the convention year, the earlier application may be prior art to the latter if it has been published or issued.

#### IV. VALIDITY OF DATES DISPLAYED ON FACE OF FOREIGN PATENT DOCUMENTS

The examiner is not required to prove either the date or the occurrence of events specified on specifications of patents or applications, or in official journals, of foreign patent offices which the Office has in its possession. In a court action, certified copies of the Office copies of these documents constitute *prima facie* evidence in view of 28 U.S.C. 1745. An applicant is entitled to show the contrary by competent evidence, but this question seldom arises.

The date of receipt of copies by the Office, as shown by Office records or stamped on the copies, need only to be stated by the examiner, when necessary.

#### V. NOTES ON INDIVIDUAL COUNTRIES

The following table gives some data concerning the published patent material of a number of countries to assist in their use and citation as references. The countries listed were selected based on the current level of material provided for the examiner search files. Together, the countries and organizations account for over 98% of the patent material that was added to the examiner files each year. This table reflects only the

most current patent office practice for each foreign country specified and is not applicable for many older foreign patent documents. The Scientific and Technical Information Center staff can help examiners obtain data related to any documents not covered by this table. The citation dates listed in the following table are not necessarily the oldest possible dates. Sometimes an earlier effective date, which is not readily apparent from the face of the document, is available. If an earlier date is important to a rejection, the examiner should consult STIC staff, who will attempt to obtain further information regarding the earliest possible effective date.

#### *How To Use Table*

Each horizontal row of boxes contains information on one or more distinct patent document from a specified country available as a reference under 35 U.S.C. 102(a) and 102(b). If several distinct patent documents are included within a common box of a row, these documents are related to each other and are merely separate documents published at different stages of the same invention's patenting process. Usually, this related group of documents includes a published application which ripens into an issued patent. Within each box of the second column of each row, the top listed document of a related group is the one that is "published" first (e.g., made available for public inspection by laying open application, or application printed and disseminated to the public). Once an examiner determines the country or organization publishing the documents, the name of the document can be located in the second column of the table and the examiner can determine if a document from the related group containing the same or similar disclosure having an earlier date is available as a reference. Usually, the documents within a related group have identical disclosures; sometimes, however, there are differences in the claims or minor differences in the specification. Therefore, examiners should always verify that the earlier related document also includes the subject matter necessary for the rejection. Some countries issue more than one type of patent and for clarity, in these situations, separate rows are provided for each type.

ISSUING/ PUBLISHING COUNTRY OR ORGANIZATION	DOCUMENT NAME IN LANGUAGE OF ISSUING COUNTRY (TYPE OF DOCUMENT)	FOREIGN LANGUAGE NAME DESIGNATING THE DATE USED FOR CITATION PURPOSES (TYPE OF DATE)	GENERAL COMMENTS
<u>EP</u> European Patent Office	European patent application  European patent specifica- tion  New European patent speci- fication (above specification amended)	Date application made available to public  Date published  Date published	Printing of application occurs 18 months after priority date.  EP dates are in day/ month/year order.
<u>FR</u> France	Demande de brevet d'inven- tion (patent application)  Brevet d'invention (patent)	Disposition du public de la demande (date of lay- ing open application)/ date published  Disposition du public du brevet d'invention (date of publication of the notice of patent grant)	Date of laying open the application is the earliest possible date. This usu- ally occurs 18 months after the filing or priority date but can occur earlier at applicant's request. The application is printed a short time after being laid open.  FR dates are in day/ month/year order
<u>FR</u> France	Demande de certificat d'uti- lite (utility certificate appli- cation 1st level publication)  Certificat d'utilite (utility certificate, 2nd publication)	Disposition du public de la demande (date pub- lished)  Disposition du public du certificat d'utilite (date published)	
<u>DE</u> Germany	Offenlegungsschrift (unexam- ined patent application)	Offenlegungstag (date application printed)	Patentschrift are printed (up to four different times) after examination and at various stages of opposition.

ISSUING/ PUBLISHING COUNTRY OR ORGANIZATION	DOCUMENT NAME IN LANGUAGE OF ISSUING COUNTRY (TYPE OF DOCUMENT)	FOREIGN LANGUAGE NAME DESIGNATING THE DATE USED FOR CITATION PURPOSES (TYPE OF DATE)	GENERAL COMMENTS
	Patentschrift (examined patent)	Veræfentlichungstag der patenterteilung (date printed)	DE dates are in day/month/year order
<u>DE</u> Germany	Patentschrift (Ausschließungspatent) (exclusive type patent based on former East German application and published in accordance with E. German laws)	First printing coded "DD" (date of first publication before examination as to novelty)	Several more printings (up to four) occur as examination proceeds and patent is granted. Separate DD numbering series is used.
<u>DE</u> Germany	Patentschrift (Wirtschaftspatent) (economic type patent published in accordance with East German laws)	First printing coded "DD" (date of first printing before examination as to novelty)	Another printing occurs after examination. Separate DD numbering series is used.
<u>DE</u> Germany	Gebrauchsmuster (utility model or petty patent)	Eintragungstag (date laid open after registration as a patent)  Bekanntmachung im patentblatt (date published for public)	Copy is supplied only on request.  Published from No. DE-GM 1 186 500J.
<u>JP</u> Japan	Kôkai Tokkyo kôhô (unexamined patent application) Kôhyo Tokkyo kôhô (unexamined patent application based on international application)	Upper right corner beneath number (date laid open and printed)	INID codes (41)-(47) include first date listed in terms of the year of the Emperor. To convert yrs. prior 1989, add 1925. To convert yrs. after 1988, add 1988.

ISSUING/ PUBLISHING COUNTRY OR ORGANIZATION	DOCUMENT NAME IN LANGUAGE OF ISSUING COUNTRY (TYPE OF DOCUMENT)	FOREIGN LANGUAGE NAME DESIGNATING THE DATE USED FOR CITATION PURPOSES (TYPE OF DATE)	GENERAL COMMENTS
	Tokkyo kôhô (examined patent application)	Upper right corner beneath number (date laid open and printed; 1st publication when Kôkai Tokkyo kôhô or Kôhyo Tokkyo kôhô not published)	Newer documents also include second date following the first given in OUR Gregorian Calendar in year/month/day sequence in Arabic numerals intermixed with their equivalent JP characters.
<u>JP</u> Japan	Tokkyo shinpan seikyû kôkoku (corrected patent specification)	Upper right corner beneath number (date laid open and printed)	
<u>JP</u> Japan          <u>JP</u> Japan	Kôkai jitsuyô shin-an kôhô (unexamined utility model application) or Kôhyo jitsuyô shin-an kôhô (unexamined utility model application based on international)  Jitsuyô shin-an kôhô (examined utility model application)  Tôroku jitsuyô shin-an shinpan seikyû kôkoku (corrected registered utility model)	Upper right corner beneath number (date laid open and printed)  Upper right corner beneath number (date laid open and printed; 1st publication when Kôkai or Kôhyo not published)	
<u>JP</u> Japan	Isyô kôhô (registered design application)		
<u>RU</u> Russian Federation	Zayavka Na Izobretenie (unexamined application for invention) Patent Na Izobreteniye (Patent)	Date application printed (1st publication) Date printed (normally 2nd publication, but 1st publication when application not published)	

<b>ISSUING/ PUBLISHING COUNTRY OR ORGANIZATION</b>	<b>DOCUMENT NAME IN LANGUAGE OF ISSUING COUNTRY (TYPE OF DOCUMENT)</b>	<b>FOREIGN LANGUAGE NAME DESIGNATING THE DATE USED FOR CITATION PURPOSES (TYPE OF DATE)</b>	<b>GENERAL COMMENTS</b>
<u>RU</u> Russian Federation	Svidetelstvo Na Poleznuyu Model (utility model)		Supplied upon request only
<u>RU</u> Russian Federation	Patent Na Promishlenniy Obrazec (design patent)		Supplied upon request only
<u>GB</u> United Kingdom	Published patent application (searched, but unexamined) Patent Specification (granted examined patent)	(date of printing the application) (date of printing)	
<u>GB</u> United Kingdom	Amended or Corrected Patent Specification (amended granted patent)	(date of printing)	
<u>WO</u> World Intellectual Property Organization	International application (PCT patent application)	(date of printing the application)	

**901.05(a) Citation Data**

Foreign patent publications that use Arabic and Roman numerals in lieu of names to indicate the date show in order the day, month, and year, or alternatively, the year, month, and day. Roman numerals always refer to the month.

Japanese patent application publications show the date in Arabic numerals by indicating in order the year of the reign of the Emperor, the month, and the day. To convert the Japanese year of the Emperor to the Western calendar year, for years prior to 1989, add 1925 to the JAPANESE YEAR. For example: 40.3.6 = March 6, 1965. For years after 1988, add 1988 to the JAPANESE YEAR.

Alphabetical lists of the foreign language names of the months and of the names and abbreviations for the United States of America follow. The lists set forth only selected commonly encountered foreign language names and do not include those which are similar to the English language names and thus easily translatable.

In using the lists, identification of the foreign language (except for Russian), is not necessary. The translation into English is ascertained by alphabetically locating the foreign language name on the list.

The list of the foreign language names and abbreviations for the United States is useful in determining whether a foreign language patent publication indicates the filing of a similar application in the United States.

**ALPHABETICAL LIST OF SELECTED FOREIGN LANGUAGE NAMES OF MONTHS**

agosto	August
août	August
augusti	August
avril	April
brezen	March
Cerven	June
Cervenec	July
czerwiec	June
décembre	December
dicembre	December
duben	April
elokuu	August
febbraio	February
Feber [Februar]	February
februari	February
février	February
gennaio	January
giugno	June
grudzieN	December
heinäkuu	July
helmikuu	February
huhtikuu	April
Jänner [Januar]	January
janvier	January
joulukuu	December
juillet	July
juin	June

kesäkuu	June
kvĚten	May
kwiecieN	April
leden	January
lipiec	July
listopad	November
lokakuu	October
luglio	July
luty	February
maaliskuu	March
maart	March
maggio	May
Mai	May
maj	May
maraskuu	November
marzec	March
mars	March
marts	March
März	March
marzo	March
mei	May
ottobre	October
paZdziernik	October
prosinec	December
rĳjna	October
settembre	September
sierpieN	August
srpen	August
styczeN	January
syyskuu	September

tammikuu	January
toukokuu	May
ùnora	February
wrzesieN	September
září	September

**RUSSIAN**

<b>август</b>	August
<b>апрель</b>	April
<b>декабрь</b>	December
<b>июль</b>	July
<b>июнь</b>	June
<b>май</b>	May
<b>март</b>	March
<b>ноябрь</b>	November
<b>октябрь</b>	October
<b>сентябрь</b>	September
<b>февраль</b>	February
<b>январь</b>	January

**LIST OF SELECTED FOREIGN LANGUAGE NAMES AND ABBREVIATIONS FOR THE UNITED STATES OF AMERICA**

Amerikas Förenta Stater;  
 [Förenta Staterna av Amerika]  
 De forenete stater av Amerika  
 De voredede Stater av Amerika  
 EE.UU.  
 E.U.  
 E.U.A.  
 E.U.d Am.  
 Etats-Unis d'Amérique  
 Sp. St. A.  
 Spoj. St. Am.  
 Spojene Staty Americké  
 Stany Zjednoczone Amériki  
 Stati Uniti d'America  
 S.U.A.  
 S.Z.A.  
 V.St.A.  
 V.St.v.A.

Ver. St. v. Am(erika)  
 de Vereinigde Staten van Amerika  
 Vereinigde Staaten van Noord-Amerika  
 Vereinigten Staaten von Amerika  
 Voredede Stater i Amerika

**901.05(b) Other Significant Data****NUMBERS FOR IDENTIFICATION OF BIBLIOGRAPHIC DATA ON THE FIRST PAGE OF PATENT AND LIKE DOCUMENTS INCLUDING INDUSTRIAL DESIGNS (INID NUMBERS)**

The purpose of INID Codes (“INID” is an acronym for “Internationally agreed Numbers for the Identification of (bibliographic) Data”) is to provide a means whereby the various data appearing on the first page of patent and like documents or in patent gazettes can be identified without knowledge of the language used and the laws applied. They are now used by most patent offices and have been applied to U.S. patents since Aug. 4, 1970. Some of the codes are not pertinent to the documents of a particular country and some which are pertinent may, in fact, not be used. INID codes for industrial designs are similar to, but not identical to, those used for patents and like documents. INID codes for industrial designs are provided separately below.

***INID Codes and Minimum Required for the Identification of Bibliographic Data for Patent and Like Documents (based on WIPO Standard ST.9)***

(10) Identification of the patent, SPC or patent document

°(11) Number of the patent, SPC or patent document

°(12) Plain language designation of the kind of document

°(13) Kind of document code according to WIPO Standard ST.16

°(15) Patent correction information

°°(19) WIPO Standard ST.3 code, or other identification, of the office or organization publishing the document

**Notes:**

(i) For an SPC, data regarding the basic patent should be coded by using code (68).

(ii) °° Minimum data element for patent documents only.

(iii) With the proviso that when data coded (11) and (13), or (19), (11) and (13), are used together and on a single line, category (10) can be used, if so desired.

(20) Data concerning the application for a patent or SPC



°(21) Number(s) assigned to the application(s), e.g., “Numéro d’enregistrement national,” “AktENZEICHEN”

°(22) Date(s) of filing the application(s)

°(23) Other date(s), including date of filing complete specification following provisional specification and date of exhibition

(24) Date from which industrial property rights may have effect

(25) Language in which the published application was originally filed

(26) Language in which the application is published

Notes:

(i) Attention is drawn to the Appendix 3 of WIPO Standard ST. 9 which contains information on the term of protection and on the date from which industrial property rights referred to under code (24) may have effect.

(ii) The language under code (25) and (26) should be indicated by using the two-letter language symbol according to International Standard ISO 639:1988.

(30) Data relating to priority under the Paris Convention

°(31) Number(s) assigned to priority application(s)

°(32) Date(s) of filing of priority application(s)

°(33) WIPO Standard ST.3 code identifying the national industrial property office allotting the priority application number or the organization allotting the regional priority application number; for international applications filed under the PCT, the code “WO” is to be used

(34) For priority filings under regional or international arrangements, the WIPO Standard ST.3 code identifying at least one country party to the Paris Convention for which the regional or international application was made

Notes:

(i) With the proviso that when data coded (31), (32), and (33) are presented together, category (30) can be used, if so desired. If an ST.3 code identifying a country for which a regional or international application was made is published, it should be identified as such using INID Code (34) and should be presented separately from elements coded (31), (32) and (33) or (30).

(ii) The presentation of priority application numbers should be as recommended in WIPO Standards ST.10/C and in ST.34.

(40) Date(s) of making available to the public

°°(41) Date of making available to the public by viewing, or copying on request, an unexamined patent document, on which no grant has taken place on or before the said date

°°(42) Date of making available to the public by viewing, or copying on request, an examined patent document, on which no grant has taken place on or before the said date

°°(43) Date of making available to the public by printing or similar process of an unexamined patent document, on which no grant has taken place on or before the said date

°°(44) Date of making available to the public by printing or similar process of an examined patent document, on which no grant or only a provisional grant has taken place on or before the said date

°°(45) Date of making available to the public by printing or similar process of a patent document on which grant has taken place on or before the said date

(46) Date of making available to the public the claim(s) only of a patent document

°°(47) Date of making available to the public by viewing, or copying on request, a patent document on which grant has taken place on or before the said date

°(48) Date of issuance of a corrected patent document

Note:

°°Minimum data element for patent documents only, the minimum data requirement being met by indicating the date of making available to the public the patent document concerned.

(50) Technical information

°(51) International Patent Classification or, in the case of a design patent, as referred to in subparagraph 4(c) of WIPO Standard ST.9, International Classification for Industrial Designs

(52) Domestic or national classification

°(54) Title of the invention

(56) List of prior art documents, if separate from descriptive text

(57) Abstract or claim

(58) Field of search

Notes:

(i) The presentation of the classification symbols of the International Classification for Industrial Designs should be made in accordance with paragraph 4 of WIPO Standard ST.10/C.

(ii) With regard to code (56) attention is drawn to WIPO Standard ST.14 in connection with the citation of references on the front page of patent documents and in search reports attached to patent documents.

(60) References to other legally or procedurally related domestic or previously domestic patent documents including unpublished applications therefor

°(61) Number and, if possible, filing date of the earlier application, or number of the earlier publication, or number of earlier granted patent, inventor's certificate, utility model or the like to which the present document is an addition

°(62) Number and, if possible, filing date of the earlier application from which the present patent document has been divided up

°(63) Number and filing date of the earlier application of which the present patent document is a continuation

°(64) Number of the earlier publication which is “reissued”

(65) Number of a previously published patent document concerning the same application

(66) Number and filing date of the earlier application of which the present patent document is a substitute, i.e., a later application filed after the abandonment of an earlier application for the same invention

(67) Number and filing date of a patent application, or number of a granted patent, on which the present utility model application or registration (or a similar industrial property right, such as a utility certificate or utility innovation) is based

(68) For an SPC, number of the basic patent and/or, where appropriate, the publication number of the patent document

Notes:

(i) Priority data should be coded in category (30).

(ii) Code (65) is intended primarily for use by countries in which the national laws require that republication occur at various procedural stages under different publication numbers and these numbers differ from the basic application numbers.

(iii) Category code (60) should be used by countries which were previously part of another entity for identifying bibliographic data elements relating to applications or grants of patents which data had initially been announced by the industrial property office of that entity.

(70) Identification of parties concerned with the patent or SPC

°°(71) Name(s) of applicant(s)

(72) Name(s) of inventor(s) if known to be such

°°(73) Name(s) of grantee(s), holder(s), assignee(s) or owner(s)

(74) Name(s) of attorney(s) or agent(s)

°°(75) Name(s) of inventor(s) who is (are) also applicant(s)

°°(76) Names(s) of inventor(s) who is (are) also applicant(s) and grantee(s)

Notes:

(i) °°For patent documents for which grant has taken place on or before the date of making available to the public, and gazette entries relating thereto, the minimum data requirement is met by indicating the grantee, and for other documents by indication of the applicant.

(ii) (75) and (76) are intended primarily for use by countries in which the national laws require that the inventor and applicant be normally the same. In other cases (71) or (72) or (71), (72) and (73) should generally be used.

(80) Identification of data related to International Conventions other than the Paris Convention and to legislation

(90) with respect to SPC's

(81) Designated State(s) according to the PCT

(83) Information concerning the deposit of microorganisms, e.g., under the Budapest Treaty

(84) Designated Contracting States under regional patent conventions

(85) Date of commencement of the national phase pursuant to PCT Article 23(1) or 40(1)

(86) Filing data of the PCT international application, i.e., international filing date, international application number, and, optionally, the language in which the published international application was originally filed

(87) Publication data of the PCT international application, i.e., international publication date, international publication number, and, optionally, the language in which the application is published

(88) Date of deferred publication of the search report

(91) Date on which an international application filed under the PCT no longer has an effect in one or several designated or elected States due to failure to enter the national or regional phase or the date on which it has been determined that it had failed to enter the national or regional phase

(92) For an SPC, number and date of the first national authorization to place the product on the market as a medicinal product

(93) For an SPC, number, date and, where applicable, country of origin, of the first authorization to place the product on the market as a medicinal product within a regional economic community

(94) Calculated date of expiry of the SPC or the duration of the SPC

(95) Name of the product protected by the basic patent and in respect of which the SPC has been applied for or granted

(96) Filing date of the regional application, i.e., application filing date, application number, and, optionally, the language in which the published application was originally filed

(97) Publication data of the regional application (or of the regional patent, if already granted), i.e., publication date, publication number, and, optionally, the language in which the application (or, where applicable, the patent) is published

Notes:

(i) The codes (86), (87), (96), and (97) are intended to be used:

- on national documents when identifying one or more of the relevant filing data or publication data of a PCT international application, or of the regional application (or of the regional patent, if already granted), or

- on regional documents when identifying one or more of the relevant filing data or publication data of the PCT international application or of another regional application (or the regional patent, if already granted).

(ii) All data in code (86), (87), (96), or (97) should be presented together and preferably on a single line. The application number or publication number should comprise the three basic elements as shown in the example in paragraph 17 of WIPO Standard ST.10/B, i.e., the two letter code identifying the republishing office, the document number, and the kind of document code.

(iii) When data to be referenced by INID Codes (86) or (87) refer to two or more regional and/or PCT applications, each set of relevant filing or publication data of each such application should be displayed so as to be clearly distinguishable from other sets of relevant data, e.g., by presenting each set on a single line or by presenting the data of each set grouped together on adjacent lines in a column with a blank line between each set. When data to be referenced by codes (86), (87), (96), or (97) refer to two or more PCT international applications and/or regional applications (or regional patents, if already granted), each set of relevant filing or publication data of each such application (or granted patent) should be displayed so as to be clearly distinguishable from other sets of relevant data, e.g., by presenting each set on a single line or by presenting the data of each set grouped together on adjacent lines in a column with a blank line between each set.

(iv) The languages under codes (86), (87), (96), and (97) should be indicated by using the two-letter language symbols according to International Standard ISO 639:1988.

(v) The country of origin in code (93), if mentioned, should be indicated by using the two letter code according to WIPO Standard ST.3.

(vi) Attention is drawn to the Appendix which contains information on the term of protection and on the date from which SPCs referred to under code (94) may have effect.

### **NUMBERS FOR IDENTIFICATION OF BIBLIOGRAPHIC DATA ON THE FIRST PAGE OF INDUSTRIAL DESIGNS (INID NUMBERS)**

INID codes for industrial designs are similar to, but not identical to, those used for patents and like documents. INID codes for industrial designs may be of most interest to design patent examiners.

#### ***INID Codes and Minimum Required for the Identification of Bibliographic Data for Industrial Designs (based on WIPO Standard ST.80)***

- (10) Data concerning the registration/renewal
- °(11) Serial number of the registration and/or number of the design document
- °°(12) Plain language designation of the kind of published document
- °(14) Serial number of the renewal where different from initial registration number
- °(15) Date of the registration/Date of the renewal
- (17) Expected duration of the registration/renewal
- (18) Expected expiration date of the registration/renewal
- °°(19) Identification, using the two-letter code according to WIPO Standard ST.3, of the authority publishing or registering the industrial design.

Note:

- °°Minimum data element for design documents only
- (20) Data concerning the application
- °(21) Serial number of the application
- °(22) Date of filing of the application
- °(23) Name and place of exhibition, and date on which the industrial design was first exhibited there (exhibition priority data)
- (24) Date from which the industrial design right has effect
- (27) Kind of application or deposit (open/sealed)
- (28) Number of industrial designs included in the application
- (29) Indication of the form in which the industrial design is filed, e.g., as a reproduction of the industrial design or as a specimen thereof
- (30) Data relating to priority under the Paris Convention
- °(31) Serial number assigned to the priority application
- °(32) Date of filing of the priority application
- (33) Two-letter code, according to WIPO Standard ST.3, identifying the authority with which the priority application was made

Notes:

- (i) With the proviso that when data coded (31), (32) and (33) are presented together, category code (30) can be used, if so desired.
- (ii) For international deposits made under the Hague Agreement, the two-letter code "WO" is to be used.
- (40) Date(s) of making information available to the public
- (43) Date of publication of the industrial design before examination by printing or similar process, or making it available to the public by any other means
- (44) Date of publication of the industrial design after examination, but before registration, by printing or similar process, or making it available to the public by any other means
- (45) Date of publication of the registered industrial design by printing or similar process, or making it available to the public by any other means
- (46) Date of expiration of deferment
- (50) Miscellaneous Information
- °(51) International Classification for Industrial Designs (class and subclass of the Locarno Classification)
- (52) National classification
- (53) Identification of the industrial design(s) comprised in a multiple application or registration which is (are) affected by a particular transaction when not all are so affected
- °(54) Designation of article ( ) or product ( ) covered by the industrial design or title of the industrial design
- °°(55) Reproduction of the industrial design (e.g., drawing, photograph) and explanations relating to the reproduction
- (56) List of prior art document, if separate from descriptive text

(57) Description of characteristic features of the industrial design including indication of colors

(58) Date of recording of any kind of amendment in the Register (e.g., change in ownership, change in name or address, renunciation to an international deposit, termination of protection)

Notes:

(i) Code (52) should be preceded by the two-letter code, according to WIPO Standard ST.3, identifying the country whose national classification is used (the two-letter code should be indicated within parentheses).

(ii) °°Minimum data element for design documents only.

(60) References to other legally related application(s) and registration(s)

(62) Serial number(s) and, if available, filing date(s) of application(s), registration(s) or document(s) related by division

(66) Serial number(s) of the application, or the registration, of the design(s) which is (are) a variant(s) of the present one

Note:

Category code (60) should be used by countries which were previously part of another entity for identifying bibliographic data elements relating to applications or registrations of industrial designs, which data had initially been announced by the industrial property office of that entity.

(70) Identification of parties concerned with the application or registration

°°(71) Name(s) and address(es) of the applicant(s)

(72) Name(s) of the creator(s) if known to be such

°°(73) Name(s) and address(es) of the owner(s)

(74) Name(s) and address(es) of the representative(s)

(78) Name(s) and address(es) of the new owner(s) in case of change in ownership

Note:

°°If registration has taken place on or before the date of making the industrial design available to the public, the minimum data requirement is met by indicating the owner(s); in other cases, by indicating the applicant(s).

(80) Identification of certain data related to the international deposit of industrial designs under the Hague Agreement Concerning the International Deposit of Industrial Designs and data related to other international conventions.

Designated State(s)/State(s) concerned:

(81) Designated State(s) according to the 1960 Act

(82) State(s) concerned according to the 1934 Act

(84) Designated Contracting State(s) under regional convention.

Information regarding the owner(s):

(86) Nationality of the owner(s)

(87) Residence or headquarters of the owner(s)

(88) State in which the owner(s) has (have) a real and effective industrial or commercial establishment

Note:

The data to be referenced by INID codes (81) to (88) should be indicated by using the two-letter code according to WIPO Standard ST.3.

## 901.05(c) Obtaining Copies

Until October 1, 1995, the U.S. Patent and Trademark Office (Office) received copies of the published specifications of patents and patent applications from nearly all the countries which issue them in printed form. The Office now receives all foreign patents from these countries in the form of CD-ROM disks and other electronic media. The foreign patents so obtained are available to examiners from the USPTO's automated search tools such as the Examiner's Automated Search Tool (EAST), the Web-based Examiner Search Tool (WEST) and the Foreign Patent Access System (FPAS), and from the foreign patents branch of the Scientific and Technical Information Center (STIC). The U.S. has agreements with these countries to exchange patent documentation.

Until October 1995, it was the practice in the Office to classify and place only a single patent family member for each invention in the examiner search files. In addition, all non-English language patent documents placed in the examiner files were accompanied, to the extent possible, by an English language abstract. For countries where the specification is printed twice, once during the application stage and again after the patent has been granted, only the first printing was in general placed in the search files, since the second printing ordinarily does not vary from the first as to disclosure.

Copies of various specifications not included in the search files, whether non-English-language patent documents or documents not printed or available for exchange, may come to the examiner's attention. For example, they may be cited in a motion to dissolve an interference, be cited by applicants, or turn up in an online search. Upon request, STIC will obtain a copy from its extensive collection, or if necessary, from the patent office of the particular country. In the case of unprinted patent documents, STIC will request that the date of granting and the date the specification was made available to the public be indicated on the copies provided by the country of origin.

Examiners can order copies of any foreign patent documents from the Foreign Patent Branch. If examiners so choose, they can make copies themselves. The most current patent documents are accessible

through the USPTO's automated search systems, which allows public and USPTO users to look up, view, and print foreign documents. Older documents can be found on microfilm in the Microfilm Room or in the paper collection in the stacks. Examiners may place a photocopy or translation in the shoes of the class which he or she examines if the patents are particularly relevant. See MPEP § 903.03.

### 901.05(d) Translation

Examiners may consult the translators in the Translation Branch of the Scientific and Technical Information Center (STIC) for oral assistance in translating foreign patents or literature that are possible references for an application being examined. Examiners may also request written translations of pertinent portions of references being considered for citation or already cited in applications. See MPEP § 901.06(a), STIC Services - Translations, and MPEP § 903.03, Availability of Foreign Patents.

Examiners may request written translations at any point in the examination process, at the discretion of the individual examiner, but are encouraged to use oral assistance and/or language reference resources as much as possible in the early phases of examination.

Equivalent versions of foreign specifications, that is, members of the same patent family, are often available in English or other languages known to the examiner. In addition, copies of previously translated documents are stored in the Translation Branch. Before any translation request is processed, the staff of the Translation Branch checks for equivalents or previous translations. The staff of STIC's Foreign Patents Branch or the Translation Branch can assist examiners in locating equivalents or abstracts. See MPEP § 901.06(a), STIC Services - Foreign Patent Services.

### 901.06 Nonpatent Publications

All printed publications may be used as references, the date to be cited being the publication date. See MPEP § 2128 - § 2128.02.

There are some publications kept or circulated in every Technology Center (TC) and each examiner should ascertain which are available in his or her TC and whether or not any of them is likely to bear on any assigned class. See MPEP § 707.05(e) for information on how to cite such publications.

### 901.06(a) Scientific and Technical Information Center (STIC)

The Scientific and Technical Information Center (STIC), formerly known as the Scientific Library, is located at CP3/4, Room 2C01. STIC maintains three additional satellite information centers: the Biotechnology/Chemical Library in CM1, Room 1C19, the Electronic Information Center in CPK2, Room 4B40, and the Lutrelle F. Parker, Sr. Memorial Law Library in CP 3/4, Room 3D62.

#### 35 U.S.C. 7. Library.

The Director shall maintain a library of scientific and other works and periodicals, both foreign and domestic, in the Patent and Trademark Office to aid the officers in the discharge of their duties.

Technical literature, foreign patent documents, and reference and online search services available in STIC are all important resources for the patent examiner to utilize. These resources provide material which must be known or searched to determine whether claims of applications are directly anticipated and therefore unpatentable under the provisions of 35 U.S.C. 102. STIC handbooks, textbooks, periodicals, reports, and other materials assist examiners in deciding the question of patentable invention in cases in which the primary search indicates that there is some novelty as compared to any single reference in the art (35 U.S.C. 103). These resources enable the examiner to determine whether the features novel in the particular combination searched would be obvious to a person skilled in the art from the general state of knowledge as reflected in the technical literature.

#### I. STIC COLLECTIONS

##### A. Books

STIC carefully selects and purchases primarily English-language publications in all fields of applied technology. There is a modest collection in French and German, mostly in the field of chemistry. Collections of books and trade catalogs are also purchased by STIC for permanent location in specific Technology Centers (TCs). For instance, the Design Patent Art Units have a great many manufacturer's catalogs. Books may be ordered by examiners for location in the TCs by addressing a memorandum to the Manager of STIC via the TC Director. STIC is also

developing a collection of materials in electronic formats (i.e., CD-ROM) in order to provide more timely delivery of requested references. The locations of all acquired publications are recorded in STIC so that users will know where to look for a particular publication, be it in the Information Center or in a TC. All publications, regardless of location, are processed in STIC's Technical Services Branch.

Reference works including encyclopedias, dictionaries, handbooks, and abstracting and indexing services are also available in the Information Center to assist examiners in finding information pertinent to the subject matter of a patent application. STIC does not circulate reference materials. Books in the reference collection are so labeled.

The staff of STIC makes every effort to obtain current, useful publications. However, all suggestions for additional purchases that come in from the Examining Corps are welcomed.

### **B. Periodicals**

Approximately 1,300 technical periodical titles are received in STIC, including publications of many important scientific and technical societies. Incorporated into the collection are a number of titles pertinent to the examination of design patent applications and titles of interest to nonexamining areas of the U.S. Patent and Trademark Office (USPTO). Many of the periodical holdings in STIC are in microfilm or CD-ROM formats.

Requests for the purchase of new subscription titles are accepted at any time throughout the year, with subsequent purchase dependent on demonstrated need and availability of funds. STIC staff is alert to new periodical titles and often acquires sample copies which are sent to appropriate TCs for review and recommendation.

Current issues of periodicals are arranged alphabetically and located on shelves near the reference collection. Bound periodicals are interfiled with the book collection by their library classification numbers. Periodicals on microfilm and CD-ROM are housed in cabinets. A list of periodicals is available in STIC.

### **C. Foreign Patent Documents**

The USPTO receives foreign patent documents through exchange agreements with almost all countries that print or otherwise publish their patent docu-

ments. This makes STIC's collection of foreign patent documents the most comprehensive in the United States.

The collection is located in the Foreign Documents Division. The most current part of the collection is made available to examiners and the public through the USPTO's automated search tools which allow users to look up, view and print documents. The documents from the major industrial countries for the period 1969 to 1990 are found on 16 mm microfilm in the Microfilm Room. The earliest patent documents, back as far as 1617, and documents from smaller countries are found in the paper collection in the stacks or at remote sites.

Most foreign countries issue official patent and trademark journals corresponding to the *Official Gazette of the United States Patent and Trademark Office*. These journals are shelved under country name. Most countries issue name indexes; some also issue classified indexes. Indexes are shelved with the journals. Much of the index information is also available on FPAS.

The official journals of a few countries include abstracts of the disclosures of the patents announced or applications published.

In addition, the Foreign Patents Branch acquires English language abstracts of foreign patent documents for selected countries published by Derwent. Holdings are in 16mm format from 1972 to date. Earlier holdings are in paper. The Branch also has unexamined Japanese patent applications abstracted by the Japanese Patent Office, the Patent Abstracts of Japan, from 1977 to date in paper.

Many countries, e.g., China, are providing abstracts of their patent documents on CD-ROM and other electronic media. These abstracts will also be accessible through FPAS.

Many technical abstracting publications include patent literature; the most notable of these is *Chemical Abstracts*. The annual indexes of *Chemical Abstracts* include, in addition to the subject matter index, an author index in which the patentee's and inventor's names appear, and patent number lists; corresponding patents of different countries are identified. Specifications of unprinted, or as yet unprinted, patents may be included in some of these abstracting services.

## **D. Special Collections**

### **Biotechnology/Chemical**

With the formulation of a new biotechnology examining group in 1988 came a mandate to improve STIC resources in this area. The former Chemical Library, located with the biotechnology and chemical examining groups, was replaced by the Biotech/Chemical Library. The library staff has been developing a collection to reflect the needs of the examiners in the biotechnology and chemical arts. Besides the usual journals and books in print, the library has been collecting backfiles of journals in microfilm and in CD-ROM format.

### **Government Publications**

In 1986, STIC was designated a Federal Depository Library which means that it now receives a selected number of documents published by various U.S. government agencies. Many of these publications are on microfiche or CD-ROM. The primary search aids are the *Monthly Catalog of U.S. Government Publications* and the *List of Classes*. All the documents received in the STIC have been cataloged into the STIC's online catalog system and interfiled with the main collection.

### **Project XL Materials**

This collection of books, games, puzzles, and manipulatives relate to the teaching of thinking skills whether they are classified as creative thinking, critical thinking, decision making, innovation and invention, or problem-solving skills. The collection is primarily aimed at, but not limited to, elementary education and is a result of a USPTO initiative in the mid-1980's to emphasize the importance of encouraging creativity in America's youth. Access to the collection is through STIC's online catalog. All Project XL materials are available for loan.

## **II. HOW TO LOCATE MATERIALS IN STIC**

### ***The STIC Online Catalog***

The primary vehicle for locating books and other materials is the STIC online catalog. The online catalog contains a record of all materials held by the STIC collections, including location, call number, and avail-

ability. Workstations for accessing the online catalog are located in the STIC branches.

Materials acquired by the STIC are classified according to the Library of Congress classification system, which employs a combination of letters and numbers. Books and bound periodicals are inter-shelved in the stacks according to this classification system. New unbound periodical issues are shelved in a separate area of each branch, in alphabetical order by title.

## **III. LOAN POLICY**

All STIC materials except noncirculating items may be charged out at the Circulation Desk. (Noncirculating material includes reference publications, foreign patent documents, and microfilm.) Books circulate for a period of 4 weeks and can be renewed on request. Extended loan periods are available on request. Examiners may use the Department of Commerce Libraries as well as other Federal Government libraries in the area. STIC's staff can answer questions regarding the accessibility and lending practices of other libraries. If books are needed from another library for official use, the request should go through the Scientific and Technical Information Center by means of an interlibrary loan request. (See "Interlibrary Loans" under STIC SERVICES.)

## **IV. STIC SERVICES**

### **A. Reference Services**

The staff of the Scientific Reference Branch, the Electronic Information Center, the Lutrelle F. Parker, Sr. Memorial Law Library, and the Biotechnology/Chemical Information Branch assist examiners in the use of the STIC. Upon request, they provide guidance on finding information in the collection. If any problems are encountered in locating materials, using the catalogs or indexing services, or finding answers to informational needs, please check with the staff. They are ready and willing to assist. Queries may be made in person or by telephone.

### **B. Online Searching**

Online computer data base searching is provided by the Scientific Reference Branch, the Electronic Information Center, the Lutrelle F. Parker, Sr. Law Library, and the Biotechnology/Chemical Information Branch.

All branches have access via modems or the in-house system to a number of vendors' commercial data base search systems. These vendors' databases extensively cover the field of knowledge and make it possible for online searchers to retrieve bibliographic information with abstracts, chemical structures, DNA sequences, and sometimes the full text of the articles, depending on the database. This online search service provides a valuable screen of the nonpatent literature for the examiner intending to make a search of the secondary sources of his/her area of interest.

Vendors accessed by STIC staff include DIALOG, ORBIT, DOE/RECON, Chemical Abstracts Services (STN), INPADOC, DataTimes, DATASTAR, DTIC/DROLS, IntelliGenetics, and Mead Data Central. When they are identified as meeting the needs and requirements of the Office, new database vendors are added. A list of the databases offered by each vendor is available in the vendors' manuals located in each STIC branch. Examiners may request a computer search by submitting a request form to the appropriate branch. Searches are usually completed and ready for pickup within 1-2 days.

Examiners are allowed to conduct searches of online commercial databases independently of STIC staff. Training is provided through the Patent Academy and individual assistance is available from the STIC staff, especially for searching chemical structures and DNA sequences.

Online searching of nucleic and amino acid sequences is conducted by the staff of the Biotechnology/Chemical Information Branch through the use of an in-house computer network developed for this purpose. Examiners who wish to access the Automated Biotechnology Sequence Search (ABSS) system located in TC 1600 must apply through their SPE to the Biotechnology/Chemical System Branch for an ID and password. On an as needed basis, introductory classes are conducted by STIC staff to assist examiners in understanding the sequence search results.

### C. Foreign Patent Services

The staff of the Foreign Patents Branch of the Foreign Document Division is available to assist with any problem or informational need regarding foreign patent searching or foreign patent documents.

Online search services on Orbit/Questel and Dialog (on the basis of Derwent databases) or INPADOC are

performed for patent examiners by the Foreign Patents Branch. The services provided include: identification of English-language or preferred-language equivalents; determination of priority dates and publication dates; searches by inventor name or abstract number; other patent family and bibliographic searches; and foreign classification information.

Examiners who choose to perform their own patent searches after receiving appropriate training through the Patent Academy can consult foreign patent experts for difficult searches. In choosing the Derwent or the INPADOC database, examiners should be aware that the systems overlap in coverage and have other similarities, but also differ in format, kinds of searches that can be performed, and patent document and country coverage. Derwent maintains superior coverage of chemical patent documents, while INPADOC includes earlier documents and more countries and has more extensive coverage of mechanical and electrical patent documents than Derwent databases.

The staff of the Foreign Patents Branch can supplement the online searching effort with manual searches of foreign patent journals, including *Official Gazette(s)*, patent concordances, and/or indexes. The staff also provides training in the use of the Foreign Patents Access System (FPAS) and information of use of the foreign patent collections.

SPECIAL NOTE: Members of the public can order copies of foreign patent documents. Procedures are outlined in a brochure entitled, "Foreign Patent Document Copy Orders" available in STIC.

### D. Translations

Examiners may consult the translators in the Translations Branch of STIC's Foreign Document Division for oral assistance in translating foreign language patents and other literature sources that are possible references for applications being examined. Oral translations are performed for the major European languages and for Japanese. Examiners may also request written translations of pertinent portions of references being considered for citation or already cited in applications. Full translations are also made upon request. Written translations can be made from virtually all foreign languages into English.

There is a computerized database located in the Translations Branch listing all translations which have been made by the Branch, and a few others gathered



from miscellaneous sources. This database lists over 30,000 translations of foreign patents and articles, all of which are located in the Translations Branch. Patent translations are indexed by country and patent number; articles are indexed by language and author or title. Any copies of translations coming to examiners from outside the Office should be furnished to the Translations Branch so that it may make copies for its files.

### ***E. Interlibrary Loans***

When needed for official business purposes, STIC will borrow from other libraries materials not available in-house. Requests are initially submitted to the Reference Fulfillment Branch. Those that can be filled by libraries in the metropolitan area are handled by staff who go out on a daily basis to retrieve requested materials. Those that must be filled by libraries elsewhere in the country are requested electronically via numerous networks and commercial vendors. Law books cannot be borrowed by STIC for use by examiners in connection with law courses.

When a book or periodical is borrowed from another library, and cited in an Office action, a photocopy of the portion cited should be placed in an appropriate class and subclass. This class and subclass should be cited in the Office action.

STIC also loans its materials to other libraries around the country so that occasionally an examiner may find that the item he/she desires is unavailable. Materials which are out on interlibrary loan may be recalled for the examiner if required for immediate use.

### ***F. On-Site Photocopying***

For the convenience of the Examining Corps, photocopy machines are available for employee use in STIC. These are to be used for photocopying STIC materials which do not circulate, or for materials which examiners do not wish to checkout.

### ***G. Obtaining Publication Dates***

Requests pertaining to the earliest date of publication or first distribution to the public of publications should be made to the Scientific Reference Branch or the Biotechnology/Chemical Information Branch. For U.S. publications, the staff can obtain the day and month of publication claimed by the copyright owner.

The same information can be obtained for foreign publications through correspondence although it will take a little longer.

### ***H. Tours***

Special tours of the STIC can be arranged for examiners or for outside groups. Contact the Scientific Reference Branch.

### ***I. STIC Brochure***

A brochure detailing location, hours, holdings, telephone numbers, and services of the Scientific and Technical Information Center is available from STIC.

## **901.06(b) Borrowed Publications**

See MPEP § 901.06(a), STIC Services - Interlibrary Loans.

## **901.06(c) Alien Property Custodian Publications**

Applications vested in the Alien Property Custodian during World War II were published in 1943 even though they had not become patents.

Care must be taken not to refer to these publications as patents; they should be designated as A.P.C. published applications.

An A.P.C. published application may be used by the examiner as a basis for rejection only as a printed publication effective from the date of publication, which is printed on each copy.

The manner of citing one of these publications is as follows: A.P.C. Application of ....., Ser. No. ...., Published .....

The Patent Search Room contains a complete set of A.P.C. published applications arranged numerically in bound volumes.

## **901.06(d) Abstracts, Abbreviations, and Defensive Publications**

Abstracts and Abbreviations are U.S. Patent and Trademark Office publications of abandoned applications. Defensive Publications (the O.G. defensive publication and search copy) are U.S. Patent and Trademark Office publications of provisionally abandoned applications wherein the applicant retains his or her rights to an interference for a limited time period of 5 years from the earliest effective U.S. filing

date. On May 8, 1985, the U.S. Patent and Trademark Office stopped accepting Defensive Publication requests and began accepting applications for Statutory Invention Registrations (SIRs), although there was an overlap period where both Defensive Publications and Statutory Invention Registrations were processed; see MPEP § 711.06 and § 711.06(a). Statutory Invention Registrations have now replaced the Defensive Publication program. Statutory Invention Registrations are numbered with document category "H," beginning with "H1." Defensive Publications and Statutory Invention Registrations are included in subclass lists and subscription orders.

Distinct numbers are assigned to all Defensive Publications published December 16, 1969 through October 1980.

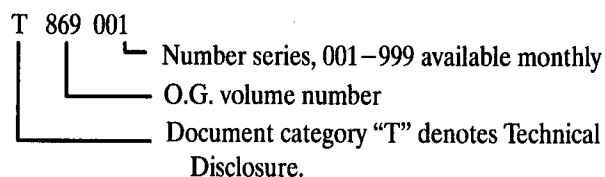

For Defensive Publications published on and after November 4, 1980, a different numbering system is used.

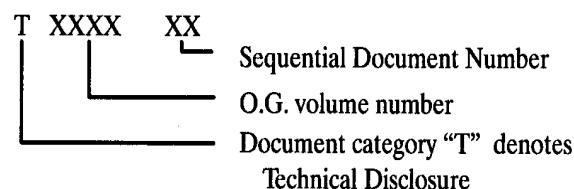

A conversion table from the application serial number to the distinct number for all Defensive Publications published before December 16, 1969 appears at 869 O.G. 687. The distinct numbers are used for all official reference and document copy requirements.

## 901.07 Arrangement of Art in Technology Centers

In the Technology Centers (TCs), the U.S. patents are arranged in shoes bearing appropriate labels, each showing the class, subclass, and usually the lowest and highest numbered patents put in the respective shoe. The patents are arranged in numerical order.

White labels denote U.S. patents, pink labels denote foreign patents filed according to U.S. classifications, blue labels denote non-patent literature, and yellow labels denote foreign patents filed according to IPC classifications.

One copy of a U.S. patent is designated as "original" and is classified in a specific subclass, based on the controlling claim. Other copies may be placed in other subclasses as cross-references, based on additional claimed inventions and/or pertinent unclaimed disclosure. Cross-reference copies are filed in numerical order along with the copies of original patents to simplify the tasks of searching and filing.

Copies of foreign patents are usually kept in shoes separate from and immediately following the U.S. patents.

All foreign patent documents (patents and published applications) involved in a reclassification project issued between January 1, 1974 and October 1, 1995 are filed by a computer-generated sequence number within each subclass. Each such foreign patent document has the year of publication indicated in the upper right-hand corner of the front page.

Nonpatent publications or photocopies thereof containing disclosures for particular subclasses, if numerous, should be filed in shoes following the foreign patents; otherwise, they should be filed at the bottom of the last shoe of foreign patents.

In most reclassification projects undertaken after October 1, 1995, foreign patents associated with the reclassified art have not been reclassified into the new classification schedule created for the U.S. patents. Foreign patents in this category are available for searching in a "foreign patent art collection," which appears at the end of the class which includes the newly created classification schedule. The first subgrouping of art within the "foreign patent art collection" following a given class is identified as "FOR 000" and is titled "CLASS-RELATED FOREIGN DOCUMENTS." The "FOR 000" subclass is a "class-level" collection of foreign patents that concord to the class but not to any particular subclass within the class. The "FOR 000" subclass does not have a definition.

Other subclasses appearing in the "foreign patent art collection" for a given class are characterized by the prefix "FOR" followed immediately by a three-digit number. These "FOR" subclasses maintain the

foreign patents classified in the former classification schedule, i.e., the schedule that was the subject of the reclassification project. In certain instances, one or more unnumbered titles precede these "FOR" subclasses to show the proper hierarchical relationship for the indented foreign art collections. At the end of each "FOR" subclass in the "foreign patent art collection," there appears in parentheses the subclass number under which the foreign patents had been classified prior to the reclassification project. Subclass definitions for the "foreign patent art collection," exactly corresponding to those of said former classification schedule, are maintained.

### 901.08 Borrowing References

The search files in each TC should at all times be complete. Where they are incomplete, the examiners using such files and relying on their completeness may miss valuable references. References removed from the files whether for use in the TC or otherwise should, of course, be promptly returned.

### 901.09 Missing Copies — Replacement

To expedite the handling of requests for replacement copies and thereby ensure the quickest response, the following routing procedures should be adhered to:

(A) Use designated collection drops within each TC for copy orders.

(B) Contract inspectors will visit designated collection drops at least twice each week to pick up PTO-14C orders.

Alternatively, the orders may be mailed or otherwise delivered to the Contract Support Unit, currently located in Crystal Park, Building 2, Room 105.

The attorneys' drop slot at the Public Service Window should not be used nor should the forms be mailed to Copy Fulfillment Services as consequent rerouting to Contract Support for processing will result in unnecessary delay.

All replacement copies ordered through the PTO-14C program are returned to the requesting examiner as notification of order fulfillment. The examiner should then place the copies in the designated file drop location for filing by the contractor in the search file.

<b>C</b>	PATENT NUMBER	NO. OF COPIES
		<b>1</b>
<b>USE A SEPARATE FORM FOR ORDERING EACH MISSING COPY</b>		
EXAMINER'S NAME	ART UNIT	DATE OF ORDER
TO REPLACE MISSING COPY IN		
→	CLASS	SUBCLASS OR DIGEST
CHECK ONE BOX ONLY		
<input type="checkbox"/> OR	<input type="checkbox"/> XR	<input type="checkbox"/> UNKNOWN
PTO-14C (REV. 5-76)		U.S. DEPARTMENT OF COMMERCE PATENT AND TRADEMARK OFFICE
<b>EXAMINER'S ORDER FOR REPLACEMENT COPY</b>		

## 902 Search Tools and Classification Information

### 902.01 Manual of Classification

The Manual of Classification is the key to the U.S. Patent Classification System. It is usually published in full as the Basic Manual every 2 years. Basic Manuals reflect current classifications as of December of even-numbered years. Revisions to the Basic Manual occur at 6-month intervals. Pages of the Manual revisions are inserted as replacements to update the previous versions.

There are over 400 classes in the U.S. Patent Classification System, each having a title descriptive of its subject matter and each being identified by a class number. Each class is subdivided into a number of subclasses. Each subclass bears a descriptive title and is identified by a subclass number. The subclass number may be an integral number or may contain a decimal portion and/or alpha characters. A complete identification of a subclass requires both the class and subclass number and any alpha or decimal designations; e.g., 417/161.1A identifies Class 417, Subclass 161.1A.

The Manual of Classification contains ordered arrangements of the class and subclass titles, referred to as class schedules. These titles are necessarily brief, although they are intended to be as suggestive as possible of subject matter included. Therefore, it is best not to depend exclusively upon titles to delineate

the subject matter encompassed by a class or subclass. Reference to respective definitions and notes is essential. If a search is to be expeditious, accurate, and complete, the Manual of Classification should be used only as a key to the class or subclass definition and appended notes.

The Manual of Classification has the following parts:

(A) A list of classes revised in the most recent revision to the Manual and the reason for the revision to each class.

(B) A list of the contents of the Manual showing the current page date for each class and the year in which the class was originally established.

(C) Overview of the classification system.

(D) A hierarchical arrangement of class titles organized into four main groups by related subject matter. It should be noted that this hierarchy is to be used to determine document placement only as a last resort, i.e., when none of the other classification criteria, such as comprehensiveness, etc., allow placement. This part also includes an exact hierarchical listing of the synthetic resin and chemical compound classes.

(E) A list, in numerical order, by art unit indicating the classification(s) assigned to each.

(F) A list of classifications in numerical order by class number giving the class title, the art unit to which the art is assigned, and the examiner search room in which the art can be found.

(G) A list of classes in alphabetical order by class title with associated class numbers.

(H) The class schedule for PLANTS.

(I) Class schedules for utility patent classes arranged in numerical sequence by class number.

(J) The class schedules for the Design classes.

The Manual of Classification is available to USPTO personnel online from the Classification Data System (CDS) Intranet Homepage which is accessible from the "Patent Examiner's Toolkit" toolbar.

### **902.01(a) Index to the U.S. Patent Classification System**

The Index to the U.S. Patent Classification System is an alphabetic listing of technical and common terms referring to specific classes and subclasses of the U.S. Patent Classification System. It is intended as an initial entry into the system and should not be con-

sidered exhaustive. All appropriate class schedules should be scanned for specifically related subclasses and the definitions and associated notes of the pertinent classifications must also be reviewed, even when the citation found in the Index appears to be restricted to a specific subject matter area.

The Index is published every year reflecting classification as of December of the year. Suggestions or changes to the Index are encouraged and should be directed to the Classification Units in the Technology Centers.

The Index is available to USPTO personnel online from the Classification Data System (CDS) Intranet Homepage which is accessible from the "Patent Examiner's Toolkit" toolbar.

### **902.02 Class and Subclass Definitions**

All of the utility classes (i.e., classes devoted to technology), and the plant class, have definitions. All design classes will also eventually have definitions.

Definitions state the subject matter of the classes and subclasses much more explicitly than it is possible to state in short class and subclass titles. A study of the definitions is essential to determine the proper classification of subject matter within the U.S. Patent Classification System.

A complete, printable set of definitions of all classes and subclasses in the U.S. Classification System is available to USPTO personnel online from the Classification Data System (CDS) Intranet Homepage which is accessible from the "Patent Examiner's Toolkit" toolbar. These definitions are revised every June and every December.

It should be noted that classification orders frequently affect existing definitions. Personal sets of definitions used by examiners should be periodically revised to reflect changes.

### **902.02(a) Definition Notes**

Many of the definitions have accompanying notes. These notes are of two types: (A) notes that supplement definitions by explaining terms or giving examples, and (B) notes referring to related disclosures located in other classes or subclasses.

These latter notes are termed "See or Search" notes and are helpful in explaining the limits of a class or subclass. They generally state the relationship to, and difference from, other identified subject matter

collections. It is intended that each note should help a user reach a decision either to include or exclude an area containing relevant subject matter.

Search notes are not exhaustive and should be regarded as suggestive of additional fields of search, but not as limiting the search. Additionally, since a search note which applies to a particular subclass is rarely repeated for subclasses indented thereunder, it is advisable to review the search notes of all parent subclasses.

### **902.02(b) Search Cards**

Many older subclasses have “search cards” containing the subclass definition in the first shoe of each defined subclass in both the Technology Center and the Patent Search Room.

### **902.03 Classification Information**

Current classification information for U.S. patents is available from the sources indicated below.

#### **902.03(a) Patent Classification Home Page on the Internet**

The new Patent Classification Home Page address on the Internet is <http://www.uspto.gov/classification>. The site is the clearinghouse for classification information published in hyper-text mark-up language (HTML) and Adobe Acrobat Portable Document Format (PDF) by the U.S. Patent and Trademark Office (USPTO). The site currently includes the Index to the U.S. Patent Classification (USPC) system, USPC Manual of Classification (classification schedules) and Classification Definitions in HTML and PDF formats. The site integrates with the Patents-on-the-web site by allowing a search of a subclass by clicking on a patent icon in the classification schedules and definitions which in turn generates a search result in the Patents-on-the-web. Patents-on-the-web provides full-text of all US patents issued since January 1, 1976, and full-page images of each page of every US patent issued since 1790. Therefore it is possible to see every patent in a subclass by browsing the classification schedules using the Classification Home Page in combination with Patents-on-the-web.

#### **902.03(b) Patent Classification Home Page on the USPTO Intranet**

The address for the Patent Classification Home Page on the USPTO Intranet is <http://ptoweb/patents/siradmin/class/>. The Classification Home Page is also accessible from the “Patent Examiner’s Toolkit” toolbar. The site is the intranet clearinghouse for classification information published in hyper-text mark-up language (HTML) and Adobe Acrobat Portable Document Format (PDF) by the U.S. Patent and Trademark Office (USPTO). The site currently links to the classification Internet clearinghouse for the Index to the U.S. Patent Classification (USPC) system, USPC Manual of Classification (classification schedules) and Classification Definitions in HTML and PDF formats. See MPEP 902.03(a). Examiners and the public are provided with access to identical information for the Index, Schedules and Definitions.

The classification intranet site also includes links to information such as USPC-to-IPC(7) Concordance, IPC (7) and IPC (6) Schedules, IPC(7) Guide, WIPO Handbook on Industrial Property Information and Documentation, Classification System Overview, Classification Bulletins, and the Patent Classification Retrieval system (PCRS).

The PCRS provides Original (OR) and Cross-Reference (XR) classification information for individual patents and listings of patents contained in subclasses. This data is updated bimonthly with new issues, withdrawn patents and reclassifications.

#### **902.03(c) Classification Insight on USPTO Local Area Network (LAN)**

The Classification Insight product on the USPTO LAN site is a custom browser containing the following documents in a full-text searchable hyperlinked format. It is accessed from the Patent Examiners Toolkit on their desktop workstation computers.

(A) Index to the U.S. Patent Classification (USPC) system

(B) USPC Manual of Classification (classification schedules) in hyperlinked and PDF formats.

(C) Classification Definitions in hyperlinked and PDF formats.

- (D) USPC-to-IPC(7) Concordance,
- (E) USPC-to-LOCARNO Concordance
- (F) IPC (7) Schedules,
- (G) IPC(7) Catchword Index

The product also includes shortcuts to the Classification Schedules and the Classification Definitions in Adobe Acrobat Portable Document Format (PDF).

### **902.03(d) Patent Information and Search Tools: the Cassis CD-ROM Series**

Access to a great deal of patent information as well as various search tools is available in the Cassis CD-ROM series. These include:

(A) Patents CLASS: Provides a list of all classifications of a patent number and a list of all patent numbers in a classification, showing ORs and XRs.

(B) Patents BIB: Bibliographic information for utility patents issued since 1969 (other patents, since 1977), including issue date, title, current classifications, assignee at time of issue, status (withdrawn, reexamined, extended term, certificate of correction issued or expired due to nonpayment of maintenance fee), and abstracts for the most recent 2 1/2 - 3 years depending on disc space.

(C) Patents ASSIGN: Shows assignment of patent rights recorded at the USPTO from August 1980 to present.

(D) Patents ASSIST: This disc provides a variety of files: Manual of Classification; Manual of Patent Examining Procedure; Index to the U.S. Patent Classification System; Attorneys and Agents Registered to Practice before the U.S. Patent and Trademark Office; Classification Orders Index showing Classes/subclasses abolished or established since 1976; IPC-USPC Concordance; Classification, Art Unit, Supervisory Patent Examiner and Telephone Number (CAST) showing which Art Units examine which art according to classification; Classification Definitions; and Patentee-Assignee File showing assignment of patent rights at time of issue since 1969 for utility patents (other patents, since 1977), and inventor names since 1975.

The above CD-ROMs are text-searchable. Search results can be viewed on-screen, printed, or downloaded to diskette. Patents CLASS and Patents BIB

are updated with new information every two months; Patents ASSIGN and Patents ASSIST are updated every three months.

In addition to the text-searchable discs, USAPat offers full facsimile images on CD-ROM of U.S. patents issued weekly. The backfile includes patents issued since January 1994. Intended as a document delivery system, USAPat allows retrieval of patents by document number only. Excellent printed copies can be obtained using a laser printer.

### **902.03(e) Automated Search Tools: EAST and WEST**

The automated search tools on examiners' desktop computers include the Examiner's Automated Search Tool (EAST), the Web-Based Examiner Search Tool (WEST), and the Foreign Patent Access System (FPAS). EAST and WEST provide examiners with access to the full text of U.S. patents granted since 1970. Additionally, EAST and WEST each provide current classification information and images for all U.S. patents. Images are available for foreign patent documents back to about 1920 and English language abstracts are available for many foreign patent documents published since 1978 using the automated search tools. Specific instructions for gaining access to the various documents available using the automated search tools can be found in the "Patent Automation" folder in Microsoft Outlook on the examiners' desktop computers.

The EAST and WEST products are also available to users in the Patent Search Room at the USPTO.

## **902.04 Classification Orders**

Classification orders issue once a month, each order detailing the changes resulting from a classification project effected that month.

Since classification projects issue monthly throughout the year, orders are used to bridge the gap between the time a project issues and the time the other search tools (Manual of Classification, Index to the USPCS, Classification Definitions) are updated.

The order includes the following:

(A) Either the new class schedules or changes to existing class schedules necessitated by the project;

(B) The changes to the definitions necessary to support the changes in (A), above;

(C) Source and disposition lists showing how the old art has been distributed into the newly established subclasses; and

(D) A revised concordance showing the relationship between the newly established subclasses and their International Patent Classification (IPC) counterparts.

Classification orders are distributed to classifiers and examiners associated with the reclassification project of the order, to Patent Depository Libraries, and to the Patent Search Room. Copies can be obtained through a post classifier within the Technology Center or from the Office of Classification Support.

Much of the information contained in a Classification Order is available to USPTO personnel online from the Classification Home Page, which is accessible from the “Patent Examiner’s Toolkit” toolbar.

### **902.04(a) Reclassification Alert Report**

The Reclassification Alert Report is updated quarterly and is available to USPTO personnel online from the Classification Home Page, which is accessible from the “Patent Examiner’s Toolkit” toolbar. The report numerically lists the classes and subclasses affected by classification orders which issued during the quarter, indicating if the classifications were established, abolished, or had definition changes.

Copies of definitions of any newly established subclasses, definition changes to existing subclasses, or entire classification orders are available from the Office of Classification Support.

## **903 Classification**

### **903.01 Statutory Authority**

The statutory authority for establishing and maintaining a classification system is given in the following statute, which states:

*35 U.S.C. 8. Classification of patents.*

The Director may revise and maintain the classification by subject matter of United States letters patent, and such other patents and printed publications as may be necessary or practicable, for the purpose of determining with readiness and accuracy the novelty of inventions for which applications for patent are filed.

### **903.02 Basis and Principles of Classification**

The basis of classification used in the U.S. Patent and Trademark Office, the principles followed, and the reasons why such principles were adopted are set forth in the booklet, *Development and Use of Patent Classification Systems*, which is available in each art unit. An electronic text file of this booklet is available from the Editorial Division of the Office of Classification Support. Since classification is the basic tool of every examiner, this booklet, particularly as it relates to the present classification system, should be carefully studied. Also available is the “Examiner Handbook to the U.S. Patent Classification System” which can be accessed from either the Classification Data Systems (CDS) Intranet Home Page or the USPTO Home Page.

#### **903.02(a) New and Revised Classes**

The establishment of new classes or subclasses and the revision of old classes are done under the supervision of a patent classifier.

The classifier performing the reclassification is provided with a set of patent copies of the present classification. With these copies, by study and successive groupings, he or she develops an arrangement of the patents which is satisfactory for searching. Usually expert examiner opinion is sought.

The definition of the new class or revised class is written or modified, the lines between the class and other classes are drawn up, and the subclass definitions are established.

The Index to the U.S. Classification System and the Classification Data System files are also updated.

Notification of the new class or subclass is published in a classification order, and supplementary sheets necessary to correct the looseleaf Manual of Classification are published.

Definitions of all revised classes and subclasses are included in classification orders.

#### **903.02(b) Scope of a Class**

In using any classification system, it is necessary to analyze the organization of the class or classes to be included in the search.

The initial analysis should determine which one or ones of the several types of subject matter (manufacture, art, apparatus, or stock material) are contained in the class being considered.

Further, relative to each type of subject matter, it is necessary to consider each of the various combinations and subcombinations set out below:

*Basic Subject Matter Combined with Feature for Some Additional Purpose.* The added purpose is in excess of the scope of the subject matter for the class, as defined in the class definition; e.g., adding a sifter to a stone crusher which gives the added function of separating the crushed stone.

*Basic Subject Matter Combined with Perfecting Feature.* Features may be added to the basic subject matter which do not change the character thereof, but do perfect it for its intended purpose; e.g., an overload release means tends to perfect a stonecrusher by providing means to stop it on overload and thus prevent ruining the machine. However, this perfecting combined feature adds nothing to the basic character of the machine.

*Basic Subject Matter.* The combination of features necessary and essential to the fundamental character of the subject matter treated; e.g., a stonecrusher requires a minimum number of features as essential before it can function as such.

*Subcombinations Specialized to Basic Subject Matter.* Each type of basic subject matter may have subcombinations specialized to use therewith; e.g., the crushing element of a stonecrusher.

*Subcombinations of General Utility.* Each type of basic subject matter may have subcombinations which have utility with other and different types of subject matter; e.g., the machine elements of a stonecrusher. Subcombinations of this character usually are provided for in some general class so that the examiner should determine in each instance where they are classified.

### **903.02(c) Establishing Subclasses and Cross-Reference Art Collections**

When an examiner finds it desirable to create a new subclass or cross-reference art collection, the appropriate post classifier must be consulted before work is begun. The post classifier will assist the examiner in establishing any new subclass or cross-reference art

collection by providing appropriate instructions on how to transfer patents from an existing subclass to a new subclass, obtaining any additional cross-reference copies that might be needed, determining the title of the newly established subclass or cross-reference art collection, and assigning the numeric designation to be placed on the new subclass or cross-reference art collection.

All newly created subclasses will be made official so as to be a part of the defined classification system and will thus appear in both the examiners' and Patent Search Room paper files. The intent is to accomplish this with a minimum amount of disruption to the examiners. Any examiner having the Technology Center (TC) Director's approval to create new subclasses should contact the post classifier for his or her technology. As workload permits, a classifier will be assigned to cooperate with the examiner on the arrangement of the subclasses he or she wishes to establish and the definitions thereof. Then, the examiner will provide a marked-up computer printout of the patents in the subclass or subclasses being affected. On a time available basis, the examiner may be aided in this task by classification personnel.

When all documents have been assigned the appropriate classification, arrangements will be made for contractor processing of first the Patent Search Room copies, then the examiners' copies of the affected patents. New classification data will be added to the Subclass Data File (SDF) and Master Classification File (MCF) as appropriate, patent copies will be relabeled with the new classification information, and the documents will be refiled in the new classification array. Concurrently, all automated classification indices and systems, including the EAST and WEST search tools, will be updated to reflect the new classification changes.

### **903.03 Availability of Foreign Patents**

All foreign patent documents received in the Office before October 1, 1995 were placed in the shoes in the Technology Center (TCs), according to either the United States Patent Classification System or, in relatively few instances, an IPC classification. Foreign patents received by the Office after October 1, 1995 are available on the USPTO's automated search systems and through the Foreign Patent Access System (FPAS).



If the examiner desires to update the classification of a foreign patent by changing, canceling, or adding copies, he or she should forward the patent to his or her post classifier with a request for the desired transaction attached.

The Scientific and Technical Information Center (STIC) retains copies of foreign patents (see MPEP § 901.06(a)) so that foreign patents, known by country, number, and publication date, can be inspected in STIC and so that photocopies can be ordered.

Examiners confronted with language problems in classifying foreign-language patents may call upon the Translation Branch of STIC for assistance (see MPEP § 901.06(a)).

### 903.05 Transfer of U.S. Patents

The transfer of official copies of U.S. patents, either original or cross-reference, from one class or subclass to another requires the approval of a classifier.

Examiners must submit to their Technology Center (TC) post classifier all questions of transfer of patents.

When an examiner desires to transfer official copies of domestic patents to a different class or subclass, he or she should prepare a memorandum list prepared for signature of the primary examiner identifying the numbers of all patents which are to be transferred indicating only the class and subclass into which each is to be placed. Both originals and properly identified official cross-references may be included in the same list and these may involve transfers to or from any number of different classes or subclasses. Additional cross-reference copies of any listed patent may also be requested by merely indicating where the cross reference copies should be placed. The memorandum list with the examiner's copies of the patents is forwarded through each TC involved for its prompt approval or comment and then, upon approval, to the classification unit of each of the TCs involved.

In those instances where a transfer is approved by a patent classifier, the class and subclass designations on both the examiner and Patent Search Room copies of the patents are changed and the classification data files are altered to agree with the new classification. When the transfer is not approved, the copies of the patents will be returned with a notification thereof.

Unauthorized transfers render the subclasses in the Patent Search Room no longer duplicates of those in the examiners' rooms, and also render incorrect the classification data files.

The procedure for transferring an entire class or subclass from one Technology Center to another is given in the Manual of Clerical Operations.

### 903.06 Practice To Be Followed in Ordering Official Cross-References

Patents which are useful as references may be found either in the course of a search or from inspection of the *Official Gazette* each week. All patent copies in official subclasses, cross-reference art collections, and digests are now recorded on the Master Classification File (MCF). In order that the search file be complete as to patent copies and to ensure the accuracy of the MCF, it is necessary that each patent copy subsequently added to the search file be recorded.

The informal placement of cross-references as "Unofficial Patents" into the examiner's search file is prohibited. All patent copies now placed in the examiner's search file are official cross-references. Requests for additional cross-references will be used by the support contractor to ensure the placement of labeled copies in the examiner's search file and the Public Search Room.

To order new or additional cross-references, the examiner should submit a pink-colored form, PTO-14B, completed as follows:

(A) Enter the "DATE OF ORDER," "PATENT NUMBER," "EXAMINER'S NAME," and "ART UNIT" in the appropriate boxes.

(B) Enter the "CLASS" and "SUBCLASS/DIGEST" information for each location where a copy of the requested patent should be placed.

(C) Enter the number of "TOTAL COPIES" requested. This number is determined by multiplying the total number of unique classifications listed times two. This ensures a sufficient number of copies will be obtained to place a labeled copy in both the Examiner Search File and the Public Search Room.

When cross-references for more than three different patent numbers are desired, the examiner can prepare a list of the patent numbers and their associated classi-

fications. One copy of form PTO-14B should be completed to reflect the Date of Order, Art Unit, and Examiner's Name and should be attached to the list.

To expedite the handling of requests for additional cross-references and thereby ensure the quickest response, the following routing procedures should be adhered to:

(A) Designated collection drops within each Technology Center for copy orders should be used. Contract inspectors will visit designated collection drops at least twice each week to pick up PTO-14 orders.

(B) Alternatively, the orders may be mailed or otherwise delivered to the Contract Support Unit, currently located in Crystal Park, Building 2, Room 105.

The attorneys' drop slot at the Public Service Window should not be used, nor should the forms be mailed to Copy Fulfillment Services as consequent rerouting to Contract Support for processing will result in unnecessary delay.

on the blue issue classification slip for series 08/ and earlier applications, of every application passed for issue. Both the blue issue classification slip (PTO-270) and the file wrapper provide space for the full name of the "Primary Examiner" to show that the review has been made.

An examiner with full signatory authority who acts personally on an application and sends it to issue should stamp and sign his or her name on the file wrapper ONLY in the "Primary Examiner" space. A line should be drawn through the "Assistant Examiner" space on the file wrapper or blue issue slip, as appropriate, to make it clear that the absence of information in the box was not an oversight.

The initial classification of pending applications and the drawings thereof will have been indicated in pencil by the supervisory patent examiner. See MPEP § 903.08(b).

However, an application, properly classified at the start of examination, may be classified differently when it is ready for allowance. The allowed claims should be reviewed in order to determine the subject matter covered thereby. It is the disclosed subject matter covered by the allowed claims that determines the original and any mandatory cross-reference classification of U.S. patents.

The procedure for determining the classification of an issuing application is as follows: every claim, whether independent or dependent, must be considered separately for classification. A separate mandatory classification is required for each claim which is classifiable in a different class or subclass; some claims, particularly in chemical areas, may require plural classifications. After all mandatory classifications have been determined, the classification to be designated as the original (OR) is determined. If all mandatory classifications are in the same class, the mandatory classification that appears first (highest) in the class schedule is the original classification; in certain circumstances (e.g., the genus-species array), however, modifications of this rule may apply. See the "Examiner Handbook to the U.S. Patent Classification System" for an explanation of genus-species classification.

If the mandatory classifications are in different classes, the original classification is determined by considering, in turn, the following criteria:

<b>B</b>	DATE OF ORDER	PATENT NUMBER
	1-5-83	3,456,789
<b>USE A SEPARATE ORDER FORM FOR EACH PATENT NUMBER</b>		
EXAMINER'S NAME AND ART UNIT	EXAMINER: Use this space to order two copies for each classification below.	TOTAL COPIES
Catherine Timm Art Unit 1307		6
<b>ONLY ONE CLASSIFICATION PER LINE</b>		
EXAMINER'S NOTES	CLASS	SUBCLASS/DIGEST
	1 364	200
	2 377	1
	3 377	14
	4	
	5	
PTO-14B (REV. 5-76)		U.S. DEPARTMENT OF COMMERCE PATENT AND TRADEMARK OFFICE
<b>EXAMINER'S ORDER — CROSS-REFERENCES FOR SEARCH FILES</b>		

### 903.07 Classifying and Cross-Referencing at Allowance

It is the duty of each primary examiner to personally review the original classification and cross-referencing made by his or her assistants in the issuing classification boxes on the face of the file wrapper, or

(A) selection based on the most comprehensive claim,

(B) selection based on priority of statutory category of invention,

(C) selection based on superiority of types of subject matter, and

(D) selection among classes in the “related subject” listing at the front of the manual of classification.

It should be noted that the criteria, *supra*, may be superseded by

(A) special circumstances, e.g., superconductor technology and biotechnology are superior to all other subject matter,

(B) prior placement of patents for a particular body of art, or

(C) particular class lines and class notes.

Once the controlling class is determined, classification within the class is determined by the hierarchy of the class.

For a more complete discussion of this subject, see the “Plan and Use of the Manual of Classification” on page I-1 *et seq.* of the Manual of Classification, or the “Examiner Handbook to the U.S. Patent Classification System.”

Once the original classification is determined, all remaining mandatory classifications are designated as cross-references, as are any additional discretionary classifications that the examiner wishes to apply to the patent.

Only the correct original classification should be left on the file of each application when passed for issue.

The examiner must legibly fill out the issuing classification boxes on the face of the file wrapper (or a blue issue classification slip (PTO-270) for series 08/ and earlier applications) to indicate the class and subclass in which the patent should be classified as an original and also the classifications in which it should appear as a cross-reference. In those unusual cases involving more than 31 cross references, an addendum issue slip will be used and attached to the left inside of the file wrapper. The examiner should be certain that all subclasses into which cross-references are placed are still valid.

All examiners must include alpha subclass designators in the issuing classification boxes on the file

wrapper or on the blue issue slips (PTO-270) at the time of issue when appropriate. This applies to both the original classification and the cross-reference classification. Any time that a patent is being issued in or cross-referenced to a subclass containing alpha subclasses, the alpha designation for the proper alpha subclass must be included. No other designation is permissible. Inclusion of only the numeric designation of a subclass which includes an alpha subclass designation is an incomplete and improper entry. A numeric subclass from which alpha subclasses have been created is designated with an “R” (denoting residual) and if the patent does not fit an indented alpha subclass, the “R” designation must be included. It is permissible to place multiple copies of a patent into a single set of alpha subclasses.

Digests and cross-reference art collections should also be included in the issuing classification boxes on the face of the file wrapper or on the blue issue slip, but the original classification must never be a digest or cross-reference art collection. The indication for a copy of a patent in a digest or cross-reference art collection must be in the cross-reference area of the issuing classification boxes. A digest must be identified by class number, alpha characters DIG, and appropriate digest number.

U.S. patents cannot be classified in subclasses beginning with “FOR,” since these are exclusively for foreign patents. See also MPEP § 901.07.

## APPLICATIONS IN ISSUE

Where an official classification order affects an application already passed to issue, Classification Operations makes any necessary changes on the file wrapper or the blue slip for series 08/ and earlier applications. Patents issuing from applications which already have been sent to the printer will be reclassified by Classification Operations at the time the patent issues.

### 903.07(a) Cross-Referencing — Keep Systematic Notes During Prosecution

Throughout the examination of an application, systematic notes should be kept as to cross-references needed either due to claimed or unclaimed disclosure. Examiners handling related subject matter should be

consulted during prosecution (whether they handle larger unclaimed combinations or claimed or unclaimed, but disclosed, subcombinations), and asked if cross-references are needed.

Each consultation involving a question of the propriety of the classification of subject matter and/or the need for a cross-reference must be recorded in the SEARCH NOTES box on the file wrapper and must include: the name of each examiner consulted, the date that the consultation took place, and the results of the consultation including the consulted examiners' or examiner's indication of where claimed subject matter is properly classified and where subject matter disclosed but unclaimed is properly classified and whether or not a cross-reference is needed.

A cross-reference MUST be provided for all CLAIMED disclosure where possible and inserted in the issuing classification boxes at time of issue.

### **903.07(b) Issuing in Another Technology Center Without Transfer**

When an examiner issues a prospective patent in another Technology Center (TC), he or she notes in the space provided on the issuing classification area on the face of the file wrapper (or on the blue issue classification slip in series 08/ and earlier applications), *in red ink*, the class and subclass of the other TC, and in parentheses the number of the other TC. A concurring primary examiner from the other TC must initial the area to the right of the original classification. When the primary examiners from the two TCs disagree on the proper original classification of the allowed claims, the application should be submitted for resolution to the post classifier having jurisdiction over the art area to which the application is presently assigned. The post classifier shall give the application a high priority.

Only when both examiners concur in the proposed classification of the patent, or where there has been a ruling by a patent classifier, may patent applications sent to issue from one TC be assigned to classes in another TC. In the latter case, the patent classifier must initial the area to the right of the original classification.

## **903.08 Applications: Assignment and Transfer**

The titles “supervisory patent examiner” and “primary examiner,” as used in this Chapter 900, include in their definition any person designated by them to act on their behalf. It is recognized that authority to accept or refuse the transfer of an application may be delegated when such authority is deserved.

The Technology Center (TC) to which an application is assigned is responsible for its examination until such time as the application is officially transferred to another TC.

The primary examiners have full authority to accept any application submitted to them that they believe is properly classifiable in a class in their art unit.

Applicants may be advised of expected application transfers by using Form Paragraph 5.03.

### *¶ 5.03 Reassignment Affecting Application Location*

The Art Unit location of your application in the USPTO has changed. To aid in correlating any papers for this application, all further correspondence regarding this application should be directed to Art Unit [1].

### **Examiner Note:**

This paragraph should be used in all Office actions when the location of an application is changed due to a reassignment of the art, transfer of the application to a different Art Unit, or transfer of an examiner and the examiner's docket.

## **903.08(a) New Applications**

New nonprovisional applications are assigned to the various Technology Centers (TCs) in the first instance by the Office of Initial Patent Examination (OIPE). Upon receiving an application from the OIPE, the technical support staff in charge of processing new applications should wand the application on the PALM bar code reader to the art unit to which it has been assigned and date stamp the file wrapper on the day the file is to be delivered to the supervisory patent examiner. The complete application (file and drawing) are then given to the appropriate supervisory patent examiner. The technical support staff should not permit these cases to remain overnight before distributing.

The supervisory patent examiner or his/her designee reviews the application to determine whether it properly belongs in his or her art unit. If it does

belong in the art unit, it is processed as a new receipt. See MPEP § 903.08(b).

When a new application is received which, in the opinion of the primary examiner, does not belong to his or her TC, he or she may request transfer of it to another TC. See MPEP § 903.08(d).

Form PTO-447A, "Transfer Request" consists of two copies and is used as a transmittal and notification form.

If the search in connection with the first action develops art showing proper classification elsewhere, the transfer is usually initiated before the first action is prepared and mailed.

### **903.08(b) Classification and Assignment to Examiner**

Every nonprovisional application, new or amended, and including the drawings, if any, when first assigned to a Technology Center (TC) must be classified and assigned to an examiner for examination. The supervisory patent examiner normally assigns the application, noting in lead pencil in the space provided on the face of the file the assigned class and subclass and also the name of the examiner. The application file is then turned over to the technical support staff for processing. Provisional applications are not classified or assigned since they are not examined.

If an examiner other than the supervisory patent examiner is given the responsibility of assigning applications, time so spent may, at the TC Director's discretion, be charged to "Assisting SPE."

### **CLASSIFICATION AND ASSIGNMENT OF APPLICATIONS FILED UNDER THE PATENT COOPERATION TREATY (PCT)**

Applications filed under the Patent Cooperation Treaty (PCT) are normally classified on the basis of the first claimed invention in the application. The following special situations, however, apply:

(A) if a U.S. national application has been acted upon by an examiner to whom the national application was assigned on the basis of the controlling (not necessarily the first) claim, a subsequent PCT application claiming priority of the national application will normally be assigned to the same examiner, or to the examiner's art unit in his/her absence;

(B) in all other situations where a U.S. national application and a corresponding PCT application are copending, irrespective of which application was filed first, every effort should be made to ensure that both applications are assigned for search and examination to the examiner to whom the PCT application would normally be assigned on the basis of the first claimed invention, or to the examiner's art unit in his/her absence;

(C) if a PCT application has been the subject of international search and possibly international preliminary examination outside the U.S., a U.S. national phase application or a U.S. national application claiming benefit of the PCT application will be assigned like any other application, i.e., on the basis of the controlling claim.

The object of having the U.S. national and PCT applications assigned to the same examiner is to promote consistent search and examination results.

Should a PCT application be submitted to a classification unit for resolution of an assignment dispute, the PCT application must:

(A) be hand-carried throughout the dispute resolution process; and

(B) be returned to an examining unit within three working days of receipt in the classification unit.

See MPEP § 903.08(d) for a discussion of transfer procedures.

### **903.08(c) Immediate Inspection of Amendments**

Upon the receipt of an amendment which makes a transfer proper, steps should be taken promptly in accordance with the transfer procedure outlined in MPEP § 903.08(d).

### **903.08(d) Transfer Procedure**

#### **TRANSFER BETWEEN ART UNITS WITHIN THE SAME TECHNOLOGY CENTER**

All transfers within one Technology Center (TC) must be called to the attention of the technical support staff so that the PALM system may be updated to correctly indicate the assignment of the nonprovisional application.

Where there is a difference of opinion among the supervisory patent examiners as to assignment within the same TC, the matter may be submitted to the post classifier assigned to that TC for resolution.

### **TRANSFERS BETWEEN DIFFERENT TECHNOLOGY CENTERS**

Where a supervisory patent examiner (SPE) believes an application, either new or amended, does not belong in his or her art unit, he or she may use form PTO-447A to request transfer of the application from his or her art unit (the “originating” art unit) to another art unit of a different TC (the “receiving” art unit). The supervisory patent examiner of the originating art unit dates and completes Section I of the PTO-447A, giving a full explanation of the reasons for classification in the other art unit.

In the space provided on the form, at least one of the following must be included:

- (A) Identification of the controlling claim examinable in another TC;
- (B) Identification of any existing informal transfer agreement; or
- (C) Other reasons - with full explanation.

Each application must be fully reviewed before it is sent to the receiving art unit of a different TC or a post classifier. In order to ensure that the application has been thoroughly reviewed by the originating TC prior to the transfer, the SPE of the originating art unit requesting the transfer of the application must send the application to an individual designated by his or her TC for review of the application before the application leaves the originating TC. The designated individual will be responsible for ensuring that the written record is clear and that all appropriate areas in the originating TC have been considered with respect to the classification of the application. If the designated individual determines that another area within the TC should be considered before it is sent out of the TC, the application should be forwarded to that area for consideration. Otherwise, the designated individual should initial in the “gatekeeper review” section of the PTO 447A, and forward the application to the appropriate art unit in another TC. The designated individual also reviews applications for patterns of errors in initial patent application routing. If such patterns are found, the patent application assistants in the

Office of Initial Patent Examination (OIPE) should be informed.

In all cases when transfer is initiated, the application must be sent to another art unit. It cannot be sent directly to a classification unit. Even if the application is informal, confusing, or contains unfamiliar subject matter, the examiner must make his or her best judgment as to where the application should be classified and attempt to transfer it there.

Where an application’s claims include a combination of limitations for plural disciplines (chemical, electrical, or mechanical), a primary examiner may request transfer to another discipline, notwithstanding the fact that the controlling claims are properly classified in his or her art unit, on the ground that the application is “best examinable” in the other discipline. In this instance, the examiner requesting transfer should cite art showing the limitations classifiable in his or her discipline. For discussion of the situations in which assignment of an application on a “best examinable” basis may be proper, see MPEP § 903.08(e).

### **PROCESS FOR TRANSFER**

When the supervisory patent examiner or primary examiner determines that transfer is proper, he or she staples the form PTO-447A to the face of the file and gives it to the technical support staff for forwarding for review.

If the receiving examiner agrees to accept the application, he or she classifies and assigns the application and initials the form PTO-447A. The transfer is effected by the technical support staff in the TC which accepts the application for transfer.

If the receiving art unit refuses to accept the application, the reasons for refusal, the date, and the examiner’s name are placed on the form PTO-447A in Section II “DISPOSITION BY RECEIVING TC.” Where an application is refused by the receiving art unit based upon the classification of any claim, the application will be forwarded to a post classifier in the receiving TC for resolution of any classification issues. The post classifier will consider the statements and evidence of both the originating and receiving art units and will assign the application to the art unit which has jurisdiction over the art in which the controlling claims of the application are properly classified. This may be the originating, receiving, or another art unit as appropriate. The post classifier

writes the assigned class and art unit number and his or her initials on the face of the file wrapper or PALM bibliographic data sheet and on form PTO-447A, briefly giving reasons for assignment of the application in the space of the form.

In order for the post classifiers to assign an application outside of their TC, a concurring signature of an SPE or designated examiner or classifier for the particular class or art unit where the application is being assigned will be required. Generally, decisions by post classifiers are final; no reconsiderations are permitted.

Under certain circumstances, a post classifier may, contrary to controlling classification rules, assign an application to a class or TC which in his or her judgment is better equipped to examine the application. This is fully described in paragraphs 6 and 9 of MPEP § 903.08(e).

Any application assignment disputes that cannot be resolved by post classifiers in the TCs will be resolved by a panel which consists of designated representatives from each TC. Where an application assignment dispute cannot be resolved by a post classifier, the post classifier will check the appropriate box on the form PTO-447A and forward the application to a designated panel member of the TC for decision. The decisions of the panel will be final. Request for reconsideration of the decision of the panel will be considered **ONLY** in the event that a TC has not had the opportunity to review the application prior to the decision from the panel. Reconsideration must be requested within 2 calendar weeks of the receipt in an art unit of a decision of the panel.

Every application, no matter how peculiar or confusing, must be assigned somewhere for examination. Thus, in contesting the assignment of an application, an examiner should point out another class that is thought to be a better place to classify the application, rather than simply arguing that the application does not fit the examiner's class.

Where an application is refused by the receiving art unit solely for reasons within the purview of the examining corps, e.g., propriety of a restriction requirement, timeliness of transfer, etc., and there is no dispute as to the classification of any claim, the application should be returned directly to the art unit that raised the issue using the appropriate line in Section II of the PTO-447A.

If an application contains both classification issues and examining corps issues, e.g., a dispute both as to the classification of claims and the propriety of restriction, the examining issues should be resolved first. If thereafter classification issues still need to be addressed, use of Form PTO-447A, as above, is appropriate. For the procedure in the classification groups for applications which contain examining corps issues, see MPEP § 903.08(e), paragraph 13.

The time limits for requesting or refusing transfer are as follows:

(A) In a new application, transfer must be requested within 2 calendar weeks of the TC receipt date of the application.

(B) In an amended application transfer must be requested within 2 calendar weeks of the TC receipt date of the amendment upon which the request for transfer is based.

(C) The time limit for refusal of a transfer request is 2 calendar weeks from the receipt of the transfer request in the receiving art unit.

Exceptions to these time limits are:

(A) All new applications (docketed and undocketed) transferred purely for security reasons.

(B) New reissue applications should be retained in the TC indicated by the notice of filing in the *Official Gazette* for 2 months following the notice before transfer.

(C) PCT applications and other special applications for which a different time limit is set by competent authority.

Failure to fill in the date on the form by either the originating examiner or the receiving examiner may result in the assignment of the application to his or her art unit.

If a request for transfer is not made or refused within the 2-week time limit, the art unit having physical possession of the application must keep it for purposes of examination. However, if the TC Directors having authority over the art units involved agree that strict adherence to the 2-week time limit would not provide the best examination for the application, they may waive the requirement.

The question of need for a restriction requirement does not influence the determination of transfer.

The regular messenger service may be used to effect the transfer of applications, except that applications filed under the Patent Cooperation Treaty and such other special applications designated by competent authority must be hand-carried throughout

the transfer process unless an established practice is in place for expediting the delivery of these applications. If an application is hand-carried at any stage of the transfer process, care must be taken to update the location of the application on the PALM system each time the application is moved.



FORM PTO-447A  
(Rev. 3-98)

Staple to face of Application

U.S. DEPARTMENT OF COMMERCE  
PATENT & TRADEMARK OFFICE

**APPLICATION TRANSFER REQUEST FOR S.N.** \_\_\_\_\_

**Section I. TRANSFER REQUEST BY** (PRINT NAME) \_\_\_\_\_ Date \_\_\_\_\_

**TO:** Art Unit \_\_\_\_\_ Class/sub \_\_\_\_\_ **From:** A.U. \_\_\_\_\_ Class \_\_\_\_\_

**REASON:**

**Gatekeeper concurrence** \_\_\_\_\_ **Hand carried: Personally accepted by** \_\_\_\_\_

**Section II. DISPOSITION BY RECEIVING TC** A.U. \_\_\_\_\_ Date \_\_\_\_\_

**ACCEPTED BY RECEIVING T.C.**

**NOT ACCEPTED**  Forward to Post Classifier  
 Return to Originating Technology Center /AU \_\_\_\_\_

**REASON:**

**DISPOSITION BY RECEIVING TC POST CLASSIFIER**

This dispute was resolved. Forward to Class/Sub \_\_\_\_\_ TC/AU \_\_\_\_\_ Post Classifier \_\_\_\_\_ Date \_\_\_\_\_

Concurring \_\_\_\_\_ Date \_\_\_\_\_

This dispute was not resolved, forward to DISPUTE RESOLUTION PANEL

**Post Classifier Assessment:**

**Gatekeeper Concurrence** \_\_\_\_\_

**Section III. DISPOSITION BY DISPUTE RESOLUTION PANEL** Date \_\_\_\_\_

**Panel Decision:** Forward to Technology Center / Art Unit \_\_\_\_\_ Class/sub \_\_\_\_\_

**REASON:**

Panel Member \_\_\_\_\_ Concurring Panel Member \_\_\_\_\_

This application **MAY** be returned to the dispute resolution panel if reconsideration is desired (use form 447R).

This application **MAY NOT** be returned to the dispute resolution panel. **THIS IS A FINAL DISPOSITION.**

### **903.08(e) General Guidelines Governing the Assignment of Non-provisional Applications for Examination**

This section applies only to nonprovisional applications. It does not apply to provisional applications since such applications are not examined.

The following are only general guides, and exceptions frequently arise because of some unusual condition. Post classifiers as well as the patent examiners are confronted with an already existing classification made up of newly revised classes, those revised years ago and which have somewhat outgrown their definitions and limits, and still others made a generation ago and never changed. Also, these classes are based on different theories and plans, some on art, some on structure, some on functions, some on the material worked upon, and some apparently on no theory or plan at all. The post classifiers cannot change this existing condition as each application comes up for assignment, but must seek to place the cases into this patchwork and try to get the applications where they will be best handled. An application will be assigned as follows:

(A) The assignment of nonprovisional applications follows, as far as possible, the rules or principles governing the classification of patents. Applications are assigned, as far as possible, on the basis of the original classification of the application.

(B) The criteria by which the original classification is determined are set forth in MPEP § 903.07.

(C) The claims and statement of invention are generally taken as they read; however, claims must be read in light of the disclosure (claimed disclosure). Any attempt of a post classifier to go behind the record and decide the case upon what is deemed the “real invention” would, it is believed, introduce more errors than such action would cure. The post classifiers cannot possess the specific knowledge of the state of the art in all the classes that the patent examiners collectively possess. Further, such questions are matters of merit for the examiners to determine and are often open to argument and are subject for appeal.

(D) Within a class, the first coordinate subclass that will take any claim controls classification.

(E) As stated in MPEP § 903.07, the location of the United States patents constituting the prior art is generally controlling over all else. (Note: Where time permits, obvious misplacements of the patents constituting the prior art are corrected, but to straighten all lines as the cases come up for assignment would require the time of several people and would often involve a reclassification of an entire class.)

(F) Ordinarily, an application cannot be assigned to a class which includes one element or part only of several claimed in combination. The claim is treated in its entirety. The question of aggregation is not reviewed by the post classifiers.

(G) The post classifiers are authorized in all cases, where they evaluate the facts as warranting it, to assign applications for examination to the Technology Center (TC) best able to examine the same. Since assignment for examination on this basis will at times be contrary to classification of patents containing the same character of claims, the post classifiers will indicate the proper classification of the patent, if such claims are allowed.

Thus, in cases where there is a claim drawn to hybrid or mixed subject matter and the supervisory patent examiner in one discipline feels that the application requires consideration by, or may be best examined by, a TC in one of the other technical disciplines, chemical, electrical, or mechanical, he or she may submit the application to his or her post classifier who *may* assign the application on a “best examinable” basis, in accordance with this subsection.

Some examples of applications which may be thus submitted include the following:

(1) An application containing a hybrid claim wherein, for instance, a product is defined merely in terms of the process for producing it. See MPEP § 705.01(e), situation (A).

(2) Where an application properly assigned to a mechanical or electrical class contains at least one claim to mixed subject matter, a part of which is chemical, the application *may* be assigned to the appropriate chemical art unit for examination; or where the application is properly assigned to a mechanical class and a claim therein contains electrical subject matter, the application *may* be assigned to the appropriate electrical art unit for examination.

As indicated earlier, when an application which had been assigned for examination in accordance with this subsection ultimately is allowed, it will be classified according to the controlling claim. In effect, assignment for examination may be on a “best examinable” basis, but the patent will issue and be classified according to the rules of superiority in classification; thus, the search file will have a constant set of rules governing placement of patents therein.

Where an application is being reassigned from one examining discipline to another, under the provisions of the “best examinable” practice, the post classifiers are authorized to require the first or transferring examiner to cite references pertinent to the claimed features falling under the jurisdiction of the art within his or her discipline. In those cases wherein the application of the reference(s) is not evident or clear, the transferring examiner should include a brief statement explaining the relation and possible application of the reference(s) to the claim(s); in case of dispute as to the necessity of this procedure, the post classifier has power to require the statement.

(H) See MPEP § 903.08(b) for a discussion of how to properly assign PCT international applications and U.S. national applications associated therewith.

(I) When an application has been taken up by an examiner for action and a requirement to restrict is found necessary, a part of the claims being directed to matter classifiable in the TC where the case is being examined, an action requiring restriction should be made without seeking a transfer of the case to another TC. The action of the applicant in reply to the requirement for restriction may result in making a transfer of the application unnecessary.

(J) Ordinarily, where all the claims of an application are for an article made of a specific composition or alloy with no other structure of the article recited, the application will be assigned to the composition or alloy class.

(K) A class of cases exists in which either no art or a divided art is found and in which no rule or principle is involved. Such cases are placed where, in the judgment of the post classifiers, they will be best searched and adjudicated. It is often impossible to explain a decision in this class of cases as to satisfy, or in any way aid, the examiners interested. Indeed, the reasons for or against sending such cases one place or

another may be so evenly balanced that no reason of any value can be given.

(L) An examiner seeking the transfer of a case may make a search, both of his or her own class and the class to which he or she thinks the case should be transferred, and the examiner in charge of the art unit should exhibit the result of such search to the appropriate Classification Unit. This is the way the expert knowledge of the examiners involved is utilized.

(M) When an application is received in the Classification Unit in which there is a matter under dispute which is not related to the classification of a claim but which is in the purview of the examining corps, e.g., propriety of a restriction requirement, timeliness of submission for transfer, etc., as well as a dispute over the classification of claims, the application will be treated as follows.

The classifier will check the appropriate box on the PTO-447A indicating that the application is being returned (but not assigned) to the TC that originated the transfer in order to resolve the nonclassifying issues involved. The classifier will indicate on the PTO-447A the proper classification of any claims under dispute. If any claims under dispute are outside the jurisdiction of the classifier associated with the originating TC, that classifier will obtain concurrence of an SPE or designated examiner/classifier having jurisdiction of the claims in question, who will sign the PTO-447A as the concurring classifier. Multiple concurrences may be required for an application with claims classifiable in different art areas.

It is important that newly received applications be immediately screened for these situations so that, if necessary, the applications may be promptly returned to the originating TC.

If after resolution of the nonclassifying issues there is still a dispute as to which TC should examine the application, the originating application may be returned to classification for assignment.

### **903.08(f) Post Classifier’s Decision**

A post classifier decides the question of the proper classification of the application, and either (1) returns the application to the TC which submitted it if he or she denied the transfer request, or (2) forwards the application to the TC to which it is transferred. See also MPEP § 903.10.

### 903.08(g) Transfer to Another Technology Center After Decision

If the application is to remain in the Technology Center (TC) which submitted it for classification, no further procedure is necessary. If the application is assigned to another TC, the Classification Unit processes the application as described in the Manual of Clerical Procedures.

If the application is one which has been taken up for action by an examiner according to its effective filing date, it should be treated as special by any examiner, Art Unit, or TC to which it is transferred. See MPEP § 708.01.

### 903.09 International Classification of Patents for Inventions

In accordance with the Strasbourg Agreement Concerning the International Patent Classification, the United States is required to indicate on its issuing documents the classification symbols of the International Patent Classification 1999 (Seventh Edition), hereinafter referred to as “Int. Cl.<sup>7</sup>.”

The complete Int. Cl.<sup>7</sup> symbols must be placed in the indicated space on the face of the file wrapper (or on the Issue Classification Slip (form PTO-270) for series 08/ and earlier applications) when an application is issued.

#### INT. CL.<sup>7</sup>LAYOUT

The layout of the Int.Cl.<sup>7</sup> is explained below with reference to the sample page.

#### Section

The Classification represents the whole body of knowledge which may be regarded as proper to the field of patents for invention, divided into eight sections.

(A) *Section Symbol* — Each section is designated by one of the capital letters A through H.

(B) *Section Title* — The section title is to be considered as a very broad indication of the contents of the section. The eight sections are entitled as follows:

- A. Human Necessities
- B. Performing Operations; Transporting
- C. Chemistry; Metallurgy
- D. Textiles; Paper
- E. Fixed Constructions
- F. Mechanical Engineering; Lighting; Heating; Weapons; Blasting
- G. Physics
- H. Electricity

(C) *Contents of Section* — Each section title is followed by a summary of the titles of its main subdivisions.

(D) *Subsection* — Within sections, informative headings form subsections, which are titles without classification symbols.

Example: Agriculture

#### Class

Each section is subdivided into classes.

(A) *Class Symbol* — Each class symbol consists of the section symbol followed by a two digit number.

Example: A 01

(B) *Class Title* — The class title gives an indication of the content of the class.

Example: A 01 Agriculture; Forestry; Animal Husbandry; Hunting; Trapping; Fishing

#### Subclass

Each class comprises one or more subclasses.

(A) *Subclass Symbol* — Each subclass symbol consists of the class symbol followed by a capital letter.

Example: A 01 B

(B) *Subclass Title* — The subclass title indicates as precisely as possible the content of the subclass.

Example: A 01 B Soil Working in Agriculture or Forestry; Parts, Details, or Accessories of Agricultural Machines or Implements, in General

(C) *Subclass Index* — Some subclasses have an index which is merely an informative summary giving a broad survey of the content of the subclass.

### Group

Each subclass is broken down into subdivisions referred to as “groups,” which are either main groups or subgroups.

(A) *Group Symbol* — Each group symbol consists of the subclass symbol followed by two numbers separated by an oblique stroke.

(B) *Main Group Symbol* — Each main group symbol consists of the subclass symbol followed by a one to three digit number, the oblique stroke, and the number 00.

Example: A 01 B 1/00

(C) *Main Group Title* — The main group title defines a field of subject matter considered to be useful in searching for inventions.

Example: A 01 B 1/00 Hand tools

(D) *Subgroup Symbol* — Subgroups form subdivisions under the main groups. Each subgroup symbol consists of the subclass symbol followed by the one to three digit number of its main group, the oblique stroke, and a number of at least two digits other than 00.

Example: A 01 B 1/02

Any third or fourth digit after the oblique stroke is to be read as a decimal subdivision of the second or third digit, respectively; e.g. 3/426 is to be read as “three slash forty-two point six”, not three slash four hundred and twenty six and is to be found after 3/42 and before 3/43, and 5/1185 is to be read as “five slash eleven point eight five,” and is to be found after 5/118 and before 5/119.

(E) *Subgroup Title* — The subgroup title defines a field of subject matter within the scope of its main group considered to be useful in searching for inventions. The title is preceded by one or more dots indicating the hierarchical position of the subgroup, i.e., indicating that each subgroup forms a subdivision of the nearest group above it having one dot less. The subgroup title is often a complete expression, in which case it begins with a capital letter. A subgroup title begins with a lower case letter if it reads as a continuation of the title of the next higher, less-indented group, i.e., having one dot less. **In all cases, the subgroup title must be read as being dependent upon,**

**and restricted by, the title of the group under which it is indented.**

Examples

A 01 B 1/00 1/24	Hand tools for treating meadows or lawns (The title of 1/24 is to be read as: Hand tools for treating meadows or lawns.)
A 01 B 1/00 1/16	Hand tools Tools for uprooting weeds (The title of 1/16 is a complete expression, but owing to its hierarchical position, the tools for uprooting weeds are restricted to hand tools.)

### Complete Classification Symbol

A complete classification symbol comprises the combined symbols representing the section, class, subclass, and main group or subgroup.

Example:				
A	01	B	1/00	Main group
Section	Class		or	Subgroup
Subclass				
Group				

### Guide Headings

The main groups in each subclass are arranged in a sequence intended to assist the user. It has not however, been found practicable to standardize the sequence. Where several successive main groups relate to common subject matter, it is usual to provide before the first of such main groups a “guide heading” which is underlined, indicating this subject matter (see, for example, the guide heading “**Ploughs**” before group A 01 B 3/00). The series of groups covered by such a heading extends to the next guide heading or to a line in heavy type extending across the column, which is used when the following group or groups relate to different subject matter for which no

guide heading is provided. (See, for example, the line after A 01 B 75/00.)

## CLASSIFYING IN THE INT. CI.<sup>7</sup> SYSTEM

### A. *Selecting Subclasses Corresponding to U.S. Classes*

The effective scope of a subclass is defined by the following, taken together:

(A) The subclass title which describes, as precisely as is possible in a small number of words, the main characteristic of a portion of the whole body of knowledge covered by the Classification, this portion being the field of the subclass to which all its groups relate;

(B) Any references which follow the subclass title or the hierarchically higher class title. These references often indicate certain parts of the field described by the title which are covered by other subclasses and are therefore excluded. These parts may constitute a substantial part of the field described by the title and, thus, the references are in some respects as important as the title itself. For example, in subclass A 47 D — FURNITURE SPECIALLY ADAPTED FOR CHILDREN — a considerable part, namely school benches or desks, of the subject matter covered by the title is excluded in view of a reference to particular groups of subclass A 47 B, thus considerably altering the scope of subclass A 47 D;

(C) Any references which appear in groups or guide headings of a subclass and which refer subject matter to another class or subclass may also affect the scope of the subclass in question. For example, in subclass B 43 K — INSTRUMENTS FOR WRITING; DRAWING-PENS — writing points for indicating or recording apparatus are referred out of group 1/00 to group 15/16 of subclass G 01 D, thereby reducing the scope of the subject matter covered by the title of subclass B 43 K;

(D) Any notes or definitions appearing under the subclass title or its class, subsection or section title. Such notes or definitions may define terms or expressions used in the title, or elsewhere, or clarify the rela-

tion between the subclass and other places. Examples are

(1) Note (1) appearing under the title of the subsection “ENGINES OR PUMPS,” embracing classes F 01 to F 04, which notes define the terms used throughout the subsection,

(2) the notes appearing under the title of subclass F 01 B, which define its scope in relation to subclasses F 01 C to F 01 P, and

(3) the note following the title of section C which defines groups of elements.

### B. *Selecting Main Groups Corresponding to U.S. Mainline Subclasses*

The scope of a main group is to be interpreted only within the effective scope of its subclass (as indicated above). Subject to this, the effective scope of a main group is determined by its title as modified by any relevant references or notes associated with the main group or with any guide heading covering it. For example, a group for “bearings” in a subclass whose title is limited to a particular apparatus must be read as covering only features of bearings peculiar to that apparatus, e.g., the arrangement of bearings in the apparatus. Guide headings are intended to be only informative and, as a rule, do not modify the scope of the groups covered by them, except where it is otherwise clear from the context. By contrast, references in the guide headings modify the scope of the associated groups.

### C. *Selecting Subgroups Corresponding to U.S. Indented Subclasses*

The scope of a subgroup is likewise to be interpreted only within the effective scope of its main group and of any subgroup under which it is indented. Subject to this, the scope of a subgroup is determined by its title as modified by any relevant references or notes associated therewith.

See volume 9 of the International Patent Classification, entitled “Guide, Survey of Classes and Summary of Main Groups” for detailed procedures for classifying into and searching Int. CI.<sup>7</sup>.

Class symbol	Subclass symbol	Subclass index	Main group title	Main group symbol	Subgroup symbols	Subgroup title	Guide heading	Subgroup title with two-part wording	Subsection title	Class title	Subclass title	References following subclass title
A 01 B			AGRICULTURE									
A 01			AGRICULTURE; FORESTRY; ANIMAL HUSBANDRY; HUNTING; TRAPPING; FISHING									
A 01 B			SOIL WORKING IN AGRICULTURE OR FORESTRY; PARTS, DETAILS, OR ACCESSORIES OF AGRICULTURAL MACHINES OR IMPLEMENTS, IN GENERAL									
			5700; machines for harvesting root crops A 01 D; mowers convertible to soil working apparatus or capable of soil working A 01 D 42/04; mowers combined with soil working implements A 01 D 43/12; soil working for engineering purposes E 01 F 02, E 21									
			Subclass Index									
			HAND TOOLS									
			PLOUGHS									
			General construction	1/00								7/00
			Special adaptations	3/00, 5/00, 9/00, 11/00								71/00
			Details	13/00, 17/00								
			HARROWS									
			General construction	19/00, 21/00								59/00 to 71/00
			Special applications	25/00								51/00, 73/00, 75/00
			Details	23/00								47/00, 79/00
			IMPLEMENTS USABLE EITHER AS PLOUGHS OR AS HARROWS OR THE LIKE									
			OTHER MACHINES	27/00 to 45/00, 49/00, 71/00								
			ELEMENTS OR PARTS OF MACHINES OR IMPLEMENTS	59/00 to 71/00								
			TRANSPORT IN AGRICULTURE	51/00, 73/00, 75/00								
			PARTICULAR METHODS FOR WORKING SOIL	47/00, 79/00								
			Hand tools [edge trimmers for lawns A 01 G 3/05]	1/00								
			Spades; Shovels	1/02								
			with teeth	1/04								
			Hoes; Hand cultivators	1/06								
			with a single blade	1/08								
			with two or more blades	1/10								
			with blades provided with teeth	1/12								
			with teeth only	1/14								
			Tools for uprooting weeds	1/16								
			Tong-like tools	1/18								
			Combinations of different kinds of hand tools	1/20								
			Attaching the blades or the like to handles (handles for tools, or their attachment, in general B 25 G); interchangeable or adjustable blades	1/22								
			for treating meadows or lawns [2]	1/24								
			Ploughs									
			Ploughs with fixed plough-blades	3/00								
			Man-driven ploughs	3/02								
			Animal-drawn ploughs	3/04								
			without alternating possibility, i.e. incapable of making an adjacent furrow on return journey	3/06								
			Swing ploughs	3/08								
			Trussed-beam ploughs; Single-wheel ploughs	3/10								
			Two-wheel beam ploughs	3/12								
			Frame ploughs	3/14								
			Alternating ploughs, i.e. capable of making an adjacent furrow on return journey	3/16								
			Turn-wrest ploughs	3/18								
			Balance ploughs	3/20								
			with parallel plough units used alternately	3/22								
			Tractor-drawn ploughs [3/04 takes precedence]	3/24								
			without alternating possibility	3/26								
			Alternating ploughs	3/28								
			Turn-wrest ploughs	3/30								
			Balance ploughs	3/32								
			with parallel plough units used alternately	3/34								
			Ploughs mounted on tractors	3/36								
			without alternating possibility	3/38								
			Alternating ploughs	3/40								
			Turn-wrest ploughs	3/42								
			with a headstock frame made in one piece [2]	3/421								
			with a headstock frame made of two or more parts [2]	3/426								
			Ploughs supported partly by tractor and partly by their own wheels	3/44								
			Self-propelled ploughs	3/46								
			with three or more wheels, or endless tracts	3/50								
			without alternating possibility	3/52								
			Alternating ploughs	3/54								
			with two wheels	3/56								
			Balance ploughs	3/58								
			Cable ploughs; Indicating or signalling devices for cable plough systems	3/60								
			with motor-driven winding apparatus mounted on the plough	3/62								
			Cable systems with one or two engines	3/64								
			Systems with one engine for working uphill	3/66								
			Means for anchoring the cables	3/68								
			Use of electric power for propelling ploughs [electric current collector B 60L 3/00]	3/70								
				3/72								
				3/74								

Int.Cl. 7 (7th edition, 1999) Vol. 1, Section A

### U.S. INT. CL.<sup>7</sup> CONCORDANCE, 1999

The Office of International Patent Classification has prepared a revised Concordance between the U.S. classes and subclasses and the Int. Cl.<sup>7</sup>. In many areas, the two systems are conceptually different. With this in mind, it will be seen that a complete one-to-one correspondence between the two systems cannot be attained. An indication in the Concordance may refer to only one relevant group and not necessarily the only group in which the patent can or should be classified. For some inventions, the Concordance may not indicate any truly relevant group. Accordingly, the Concordance must be recognized as a *guide* to be used in conjunction with the Int. Cl.<sup>7</sup>, and *not* as a translation list.

The printed version of the 1999 Concordance includes all changes in the International Classification corresponding to changes in the United States Classification through August 1999. The electronic Concordance is updated monthly, and is available to USPTO personnel online from the "Patent Examiner's Toolkit" toolbar.

The Concordance may be incomplete or contain errors in some areas. Therefore, if corrections need to be made in the Concordance, members of the examining corps are requested to e-mail suggested changes to the International Liaison Staff (ILS) via their SPE.

### 903.09(a) Locarno Classification Designations

U.S. design patents prepared for issue after June 30, 1996 include a Locarno International Classification designation as part of the bibliographic data. The purpose of the international design classification designation is to enhance accessibility of design patents in foreign design search files as well as commercial databases.

The Locarno International Classification system was developed by members of the Paris Convention for the Protection of Industrial Property and is administered by the International Bureau of the World Intellectual Property Office (WIPO).

A Locarno International Classification designation consists of two pairs of numbers separated by a hyphen. The first pair of numbers designates a design class; the second pair of numbers indicates a particular subclass within the design class. The Locarno

Classification manual, available from WIPO, delineates the individual classes and subclasses and includes: (1) a general list of classes of industrial designs divided into broad subclasses; and (2) an alphabetical list of specific industrial designs with an indication of the classes and subclasses into which they should be classified.

The Locarno designation included with design patent bibliographic data indicates the original classification of the patented design only. There is no provision for cross-reference designations within the Locarno system.

Locarno International Classifications are periodically revised by the Committee of Experts of the World Intellectual Property Organization. The present (seventh) edition of the system which incorporates all the revisions in and before November 1998 became effective on January 1, 1999.

The design patent issue slip (PTO-328) includes an area with the heading "International Classification". A Locarno International Classification designation must be included on the issue slip when a design application is prepared for issue. The Locarno designation is printed on the design patent preceded by INID code [51] in compliance with ST.9 of the International Bureau. The abbreviation "LOC (7) CL." follows INID code [51] and complies with the recommended abbreviation by the International Bureau.

An example Locarno designation as it appears on a U.S. Design Patent is as follows:

[51] LOC (7) CL. 02-02

The Office of International Patent Classification has prepared a Concordance between the U.S. Design Classification classes and subclasses and the seventh edition of the Locarno International Classification. In many areas of design subject matter, the U.S. Design Classification and Locarno Classification systems are parallel. In others, the two systems are conceptually different. For example, there is no specific provision within the Locarno system for designs which are simulative of other objects. The International Classification is generally based on the nature of the design rather than ornamental appearance. Accordingly, a one-to-one relationship between the two classification systems is not always possible.

Each suggested designation in the Concordance refers to a single Locarno International class and sub-



class. This designation, however, is not necessarily the only pertinent class and subclass in which the design could be properly classified since for some U.S. Design Classification designations, there is no direct parallel within the Locarno system.

### 903.10 Duties of the Post Classifier

Examiners should contact their post classifier on all classification problems.

A post classifier is responsible for:

(A) The technical accuracy, adequacy, and completeness of all search systems in his or her group including the monitoring of any need for major and minor reclassification projects including mechanized systems.

(B) The full range of classification administration functions, including the resolution of classification disputes on pending applications, guidance on classification matters to both examiners and the public, outlining fields of search, and answering examiners' requests for advice as to the proper classification of allowed applications.

(C) The inspection of issuing applications to determine the accuracy and adequacy of original and cross-reference classification, including working closely with the supervisory patent examiners and Technology Center (TC) Directors to ensure feedback to correct problem areas.

(D) Determination of the training needs of the personnel in his or her assigned group relative to principles of classification and supplying this training through formal and informal channels.

Generally, the post classifiers are to aid the examiners in the use, maintenance, and perfection of the classification system.

## 904 How to Search

The examiner, after having obtained a thorough understanding of the invention disclosed and claimed in the nonprovisional application, then searches the prior art as disclosed in patents and other published documents, i.e., nonpatent literature (NPL). Any document used in the rejection of a claim is called a reference.

In all continuing applications, the parent applications should be reviewed by the examiner for pertinent prior art. Where the cited prior art of a parent application has been reviewed, this fact should be made of record in accordance with the procedure set forth at paragraph II.(E) of MPEP § 719.05.

The first search should be such that the examiner need not ordinarily make a second search of the prior art, unless necessitated by amendments to the claims by the applicant in the first reply, except to check to determine whether any reference which would appear to be substantially more pertinent than the prior art cited in the first Office action has become available subsequent to the initial prior art search. The first search should cover the invention as described and claimed, including the inventive concepts toward which the claims appear to be directed. It should not be extended merely to add immaterial variants.

In the first action on the merits of an application, the examiner shall make an initial endorsement in black ink, in the space provided on the right outside panel of the file wrapper, of the classes and subclasses of domestic and foreign patents, abstract collections, and publications in which the search for prior art was made. Other information collections and sources in which the search for prior art was made must also be identified by the examiner. The examiner must also indicate the date(s) on which the search was conducted. Note MPEP § 719.05.

In subsequent actions, where the search is brought up to date and/or where a further search is made, the examiner must endorse and initial on the file wrapper that the search has been updated and/or identify the additional field of search. See MPEP § 719.05. Any search updates should include all of the databases and the search queries and classifications employed in the original search.

### 904.01 Analysis of Claims

The breadth of the claims in the application should always be carefully noted; that is, the examiner should be fully aware of what the claims do *not* call for, as well as what they do require. During patent examination, the claims are given the broadest reasonable interpretation consistent with the specification. See *In re Morris*, 127 F.3d 1048, 44 USPQ2d 1023 (Fed. Cir. 1997). See MPEP § 2111 - § 2116.01 for case law pertinent to claim analysis.

### 904.01(a) Variant Embodiments Within Scope of Claim

Substantially, every claim includes within its breadth or scope one or more variant embodiments that are not disclosed in the application, but which would anticipate the claimed invention if found in a reference. The claim must be so analyzed and any such variant encountered during the search should be recognized.

In each type of subject matter capable of such treatment (e.g., a machine or other apparatus), the subject matter as defined by the claim may be sketched or diagrammed in order to clearly delineate the limitations of the claim. Two or more sketches, each of which is as divergent from the particular disclosure as is permitted by claim recitation, will assist the examiner in determining the claim's actual breadth or scope. However, an applicant will not be required to submit such sketches of claim structure. *In re Application filed November 16, 1945*, 89 USPQ 280, 1951 C.D. 1, 646 O.G. 5 (Comm'r Pat. 1951).

### 904.01(b) Equivalents

All subject matter that is the equivalent of the subject matter as defined in the claim, even though specifically different from the definition in the claim, must be considered unless expressly excluded by the claimed subject matter. See MPEP § 2181 - § 2184 for a discussion of equivalents when a claim employs means or step plus function terminology.

### 904.01(c) Analogous Arts

Not only must the art be searched within which the invention claimed is classifiable, but also all analogous arts regardless of where classified.

The determination of what arts are analogous to a particular claimed invention is at times difficult. It depends upon the necessary essential function or utility of the subject matter covered by the claims, and not upon what it is called by the applicant.

For example, for search purposes, a tea mixer and a concrete mixer may both be regarded as relating to the mixing art, this being the necessary function of each. Similarly a brick-cutting machine and a biscuit cutting machine may be considered as having the same necessary function. See MPEP § 2141.01(a) for a discussion of analogous and nonanalogous art in the con-

text of establishing a *prima facie* case of obviousness under 35 U.S.C. 103. See MPEP § 2131.05 for a discussion of analogous and nonanalogous art in the context of 35 U.S.C. 102.

## 904.02 General Search Guidelines

In the examination of an application for patent, an examiner must conduct a thorough search of the prior art. Planning a thorough search of the prior art requires three distinct steps by the examiner: (A) identifying the field of search; (B) selecting the proper tool(s) to perform the search; and (C) determining the appropriate search strategy for each search tool selected. Each step is critical for a complete and thorough search.

When determining the field of search, three reference sources must be considered - domestic patents (including patent application publications), foreign patent documents, and nonpatent literature (NPL). None of these sources can be eliminated from the search unless the examiner has and can justify a reasonable certainty that no references, more pertinent than those already identified, are likely to be found in the source(s) eliminated. The search should cover the claimed subject matter and should also cover the disclosed features which might reasonably be expected to be claimed. The field of search should be prioritized, starting with the area(s) where the invention would most likely be found in the prior art.

Having determined the field of search, the examiner should then determine what search tools should be employed in conducting the search. Examiners are provided access to a wide variety of both manual and automated search tools. Choice of search tools is a key factor in ensuring that the most relevant prior art is found during the search. The choice of search tools to be used is based on the examiner's knowledge of the coverage, strengths and weaknesses of the available search tools that are appropriate for use in an examiner's assigned art. For example, a search tool may cover foreign patent documents; but, if that coverage does not meet the examiner's current search needs, this should be taken into consideration by the examiner who will take recourse to employ other search tools in order to remedy the deficiency.

Search tool knowledge is particularly important for examiners in arts (e.g., very active, high technology) where patent documents may seriously lag invention

and, consequently, represent a reference source of limited value. These examiners must take special care to ensure that their searches include consideration of NPL and employ the effective use of tools specialized to cover NPL pertinent to their search needs.

Search needs in some technologies, e.g., chemical structures, DNA sequences, are very specialized and can only be met through use of specific search tools specially constructed and maintained to respond to those needs. These tools cover all three reference sources - domestic patents (including patent application publications), foreign patent documents, and NPL - and their use may be deemed sufficient for search of claimed inventions in such technologies.

In recognition that there are many available NPL search tools and their use is often complex, examiners have been provided and are encouraged to use the services of trained professional on-line search personnel located in the Technology Centers (Information Technology Resource Person (ITRP)) and in the Scientific and Technical Information Center (STIC) for NPL searching. See MPEP § 901.06(a) for services available in STIC.

In crowded, highly developed arts where most claimed inventions are directed to improvements, patent documents, including patent application publications, may serve as the primary reference source. Search tool selection in such arts may focus heavily on those providing patent document coverage.

Automated search tools covering patent documents usually provide both a classified and text search capability. Text search can be powerful, especially where the art includes well-established terminology and the search need can be expressed with reasonable accuracy in textual terms. However, it is rare that a text search alone will constitute a thorough search of patent documents. Some combination of text search with other criteria, in particular classification, would be a normal expectation in most technologies.

Examiners will recognize that it is sometimes difficult to express search needs accurately in textual terms. This occurs often, though not exclusively, in mechanical arts where, for example, spatial relationships or shapes of mechanical components constitute important aspects of the claimed invention. In such situations, text searching can still be useful by employing broader text terms, with or without classification parameters. The traditional method of brows-

ing all patent documents in one or more classifications will continue to be an important part of the search strategy when it is difficult to express search needs in textual terms.

Having determined what search tool(s) should be used to conduct the search, the examiner should then determine the appropriate search strategy for each search tool selected. The appropriate search strategy should be determined by the examiner on a case-by-case basis along with consultation with other examiners and/or supervisory patent examiners, where appropriate.

In order for examiners to acquire specialized skills needed to determine an appropriate field of search in their specific arts, each Technology Center may develop supplemental specific guidance and training for its examiners. This training will augment general training and information on search tools that is normally provided through the Patent Academy and Search and Information Resources Administration.

#### **904.02(a) Classified Search**

A proper field of search normally includes the subclass in which the claimed subject matter of an application would be properly classified. It is not necessary to search areas in which it could reasonably have been determined that there was a low probability of finding the best reference(s).

In outlining a field of search, the examiner should note every class and subclass under the U.S. Patent Classification system and other organized systems of literature that may have material pertinent to the subject matter as claimed. Every subclass, digest, and cross-reference art collection pertinent to each type of invention claimed should be included, from the largest combination through the various subcombinations to the most elementary part. The field of search should extend to all probable areas relevant to the claimed subject matter and should cover the disclosed features which might reasonably be expected to be claimed. The examiner should consult with other examiners and/or supervisory patent examiners, especially with regard to applications covering subject matter unfamiliar to the examiner.

The areas to be searched should be prioritized so that the most likely areas of finding relevant prior art are searched first.

**904.02(b) Search Tool Selection**

Detailed guidance on the choice and use of specific search tools can be established only within the context of the special requirements of each Technology Cen-

ter (TC). However, a general methodology following a “decision tree” process, set forth below, for making broad decisions in search tool selection is suggested.

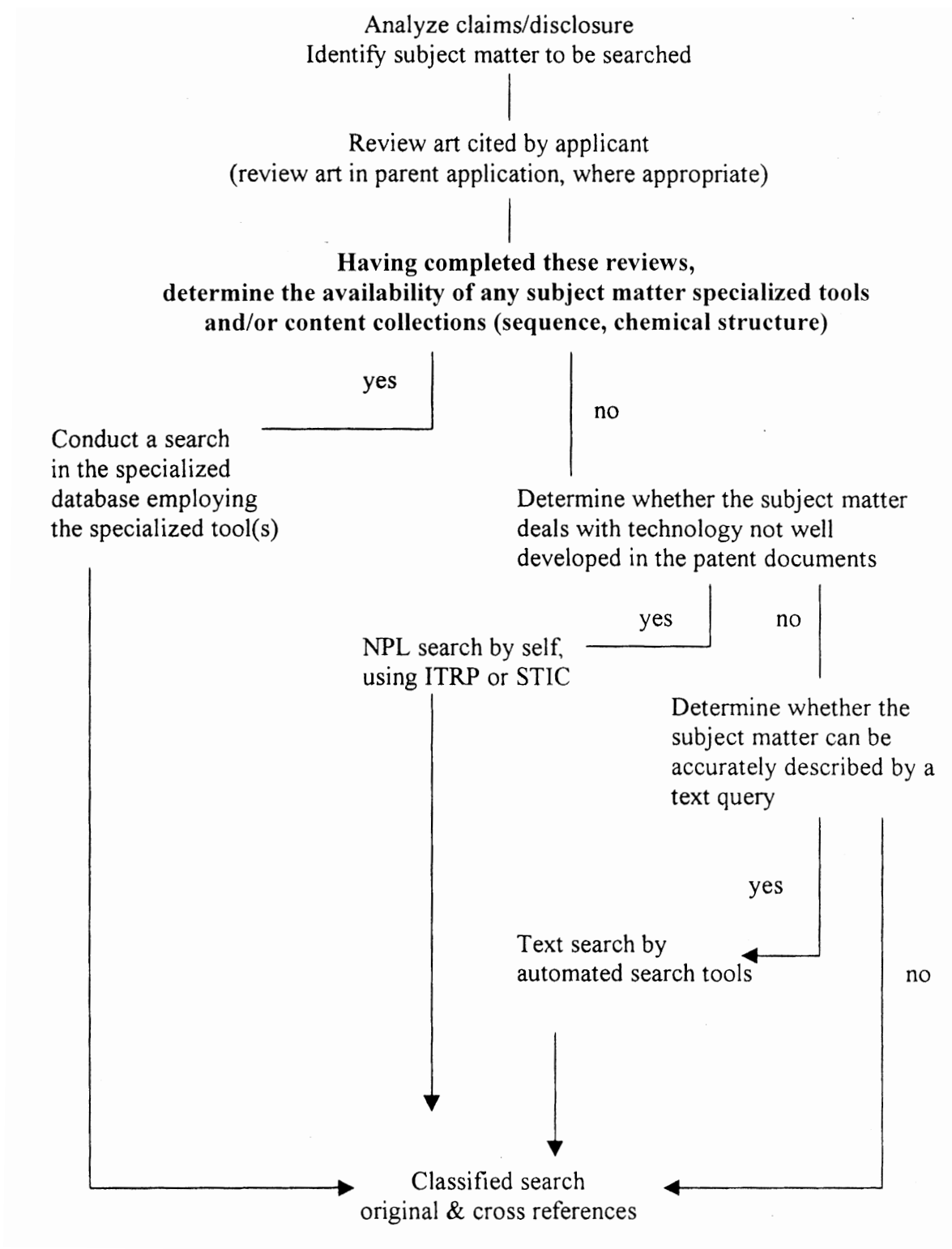

### 904.02(c) Internet Searching

The Office published a Patent Internet Usage Policy to establish a policy for use of the Internet by the Patent Examining Corps and other organizations within the USPTO. See *Internet Usage Policy*, 64 F.R. 33056 (June 21, 1999). The Articles of the Patent Internet Usage Policy pertinent to Internet searching and documenting search strategies are reproduced below. See MPEP § 707.05(e) for information pertaining to the citation of electronic documents and MPEP § 502.03 for information pertaining to communications via electronic mail.

#### INTERNET SEARCHING (ARTICLE 9)

The ultimate responsibility for formulating individual search strategies lies with individual Patent Examiners, Scientific and Technical Information Center (STIC) staff, and anyone charged with protecting proprietary application data. When the Internet is used to search, browse, or retrieve information relating to a patent application which has not been published, other than a reissue application or reexamination proceeding, Patent Organization users **MUST** restrict search queries to the general state of the art unless the Office has established a secure link over the Internet with a specific vendor to maintain the confidentiality of the unpublished patent application. Non-secure Internet search, browse, or retrieval activities that could disclose proprietary information directed to a specific application which has not been published, other than a reissue application or reexamination proceeding, are **NOT** permitted.

This policy also applies to use of the Internet as a communications medium for connecting to commercial database providers.

#### DOCUMENTING SEARCH STRATEGIES (ARTICLE 10)

All Patent Organization users of the Internet for patent application searches shall document their search strategies in accordance with established practices and procedures as set forth in MPEP § 719.05 II.(F).

### 904.03 Conducting the Search

It is a prerequisite to a speedy and just determination of the issues involved in the examination of an

application that a careful and comprehensive search, commensurate with the limitations appearing in the most detailed claims in the case, be made in preparing the first action on the merits so that the second action on the merits can be made final or the application allowed with no further searching other than to update the original search. It is normally not enough that references be selected to meet only the terms of the claims alone, especially if only broad claims are presented; but the search should, insofar as possible, also cover all subject matter which the examiner reasonably anticipates might be incorporated into applicant's amendment. Applicants can facilitate a complete search by including, at the time of filing, claims varying from the broadest to which they believe they are entitled to the most detailed that they would be willing to accept.

In doing a complete search, the examiner should find and cite references that, while not needed for treating the claims, would be useful for forestalling the presentation of claims to other subject matter regarded by applicant as his or her invention, by showing that this other subject matter is old or obvious.

In selecting the references to be cited, the examiner should carefully compare the references with one another and with the applicant's *disclosure* to avoid the citation of an unnecessary number. The examiner is not called upon to cite *all* references that may be available, but only the "best." (37 CFR 1.104(c).) Multiplying references, any one of which is as good as, but no better than, the others, adds to the burden and cost of prosecution and should therefore be avoided. The examiner must fully consider all the prior art references cited in the application, including those cited by the applicant in a properly submitted Information Disclosure Statement.

The best reference should always be the one used. Sometimes the best reference will have a publication date less than a year prior to the application filing date, hence it will be open to being overcome under 37 CFR 1.131. In these cases, if a second reference exists which cannot be so overcome and which, though inferior, is an adequate basis for rejection, the claims should be *additionally* rejected thereon.

In all references considered, including nonpatent, foreign patents, and domestic patents, the examiner should study the specification or description suffi-

ciently to determine the full value of the reference disclosure relative to the claimed or claimable subject matter.

## 905 Miscellaneous

### 905.02 Soft Copy Orders

Soft copies of U.S. patents for the examiner's personal use may be ordered by the examiner on blue-colored order form PTO-14A. These copies are not to be placed in the official search file. To complete the form PTO-14A, the examiner should indicate the number of copies desired in the box marked "NO. OF COPIES" and should also complete the "PATENT NUMBER," "EXAMINER'S NAME," "ART UNIT," and "DATE OF ORDER" boxes.

When soft copies for more than three different patent numbers are desired, the examiner can prepare a list of the patent numbers and attach it to one copy of Form PTO-14A which has been completed to reflect the Examiner's Name, Art Unit, and Date of Order.

To expedite the handling of requests for personal copies and thereby ensure the quickest response, the following routing procedures should be adhered to:

(A) Designated collection drops within each Technology Center (TC) for copy orders should be used.

(B) Clerical personnel from the Office of Classification Support (OCS) will visit designated collection drops at least twice each week to pick up PTO-14 orders.

Alternatively, the orders may be mailed or otherwise delivered to the Contract Support Unit, currently located in Crystal Park, Building 2, Room 105.

The attorneys' drop slot at the Customer Service Window should not be used nor should the forms be mailed to Copy Fulfillment Services as consequent rerouting to the Office of Classification Support for processing will result in unnecessary delay.

Copies provided for personal use will be stamped "DO NOT PLACE IN SEARCH FILE;" any such copy found in the search file will be removed by refiling personnel. Because of the cost of printing copies of patents, economy should be exercised in their use. Personal use soft copies no longer desired by examiners should be destroyed.

In view of the high cost of printing patents with color drawings, orders by examiners for plant patents and other patents with color drawings for personal use will normally not be filled.

<b>A</b>	PATENT NUMBER	NO. OF COPIES
	2,345,678	1
<b>USE A SEPARATE ORDER FORM FOR EACH PATENT NUMBER</b>		
EXAMINER'S NAME	ART UNIT	DATE OF ORDER
HENRY GREEN	3502	10-15-78
EXAMINER'S NOTES		
<small>PTO-14A (REV 5-76) U.S. DEPARTMENT OF COMMERCE PATENT AND TRADEMARK OFFICE</small>		
<b>PATENT ORDER FOR EXAMINER'S USE ONLY</b>		

### 905.03 Ordering of Patented and Abandoned Provisional and Nonprovisional Application Files

In the examination of an application it is sometimes necessary to inspect the application papers of some previously abandoned application (provisional or non-provisional) or granted patent. This is always true in the case of a reissue application and reexamination proceeding.

Patented and abandoned files are stored at the Files Repository located near the other USPTO buildings in Crystal City (Arlington, Virginia). Older files are housed in remote warehouses located in Maryland and Virginia.

Patented and abandoned files are ordered by means of a PALM video display or PALM intranet site transaction. To place such an order, the examiner is required to input his/her PALM location code, employee number, and patent number(s) and/or application number(s) of the file(s) that are needed. After transmission of the request transaction by the examiner, a "response" screen appears on the video display terminal or workstation browser which informs

him/her of the status of the request for each file. The examiner is informed that the request

(A) is accepted;

(B) is accepted, but for which the file is located at a remote warehouse (in which case delivery time is increased);

(C) is not accepted because the file is not located at the repository or warehouse;

(D) is not accepted because a previous request for the file has not yet been filled; or

(E) is not accepted because the patent or application number inputted is not valid.

Periodically each day, personnel at the Files Repository perform a PALM print transaction which produces a list of all accepted requests in patent number order and, for requests for abandoned files, in application number order. The printed record of each request is detached from the list when its associated file is found. It is then stapled to it. Throughout the day, periodic deliveries of files are made directly to the offices of their requesters by Files Repository personnel. Upon delivery of files at the various locations, files that are ready to be returned to the repository are picked up.

With the exception of certain older files, the drawings of patented and abandoned files, if any, are now stored within their respective application file wrappers. Since it is desired not to separate one from the other, both the file and its drawings are delivered when a file is ordered.

#### **905.04 Marking Examiners' Copies of Patents**

When the examiners' copies of patents are sent to their respective art units to be filed, they should be routed across the appropriate examiners' desks prior to placement in the shoes. The assistant examiners who examined the application should mark in pencil on the face of the drawings, or the specifications where there are no drawings, such features as may be deemed advantageous in aiding understanding of the patents in future searches.

#### **905.05 Application File Location**

All files should be returned promptly to their proper location.

Whenever an application file is moved from one PALM location to another; e.g., removed from a Technology Center's (TC) central files or moved from one examiner to another, the PALM record should be updated with its current location. The appropriate bar code transaction should be performed. For example, if the examiner to whom the application is docketed obtains it, he/she should perform PALM transaction 1023 by pressing the F2 key on the bar code reader (BCR) and scanning the bar code label of the file with the light wand of the BCR. If an examiner other than the one to whom the application is docketed obtains the file, he/she should perform transaction 1036 which requires the input of his/her art unit number and his/her employee number before the label is scanned. All files should be returned promptly to their proper location.

#### **905.06 Patent Family Information**

Patent family information is available at the U.S. Patent and Trademark Office (Office) primarily through commercial databases. See MPEP § 901.05 regarding patent family. Examiners have access to this information either directly through the automated search tools such as the Examiner's Automated Search Tool (EAST) and the Web-based Examiner Search Tool (WEST) or indirectly through the search services of the Scientific and Technical Information Center (STIC).

#### **AVAILABLE DATABASES**

Derwent's World Patents Index (WPI) and International Patent Documentation Center (INPADOC) are two databases used for retrieving foreign patent information.

The WPI database is loaded in-house at the Office and is integrated with the Office's automated search system. WPI in-house is used whenever abstracts are needed or when searches in addition to publication date or patent family are required, such as searches on inventor name or IPC (International Patent Classification). WPI in-house is also the first choice for searches for publication dates or patent families because of its ease of use and low cost.



INPADOC is used for quick searches for publication dates or patent families. The Office enjoys cost effective rates for INPADOC due to an agreement between the Office and the International Patent Documentation Center (now part of the European Patent Office) negotiated several years ago. The agreement applies only to INPADOC as accessed directly on the INPADOC computer in Austria, not to INPADOC as available on other commercial database systems such as ORBIT, DIALOG, or STN.

#### **ACCESS TO FOREIGN PATENT INFORMATION**

Patent examiners may directly search WPI in-house or INPADOC or both.

Examiners may also request foreign patent searches through STIC. Trained searchers in both the Reference and Foreign Patents sections of STIC perform patent family searches on demand, with a short turn-around time. The Foreign Patents section can also help examiners get copies of foreign patents found through online searching.



# Chapter 1000 Matters Decided by Various U.S. Patent and Trademark Office Officials

- 1001 Statutory Authority of \*>Director of the USPTO<**
- 1001.01 Modes of Exercising Authority
- 1002 Petitions to the \*>Director of the USPTO<**
- 1002.01 Procedure
- 1002.02 Delegation of Authority To Decide Petitions
- 1002.02(b) Petitions and Requests Decided by the Office of the Deputy Commissioner for Patent Examination Policy
- 1002.02(c) Petitions and Requests Decided by the Technology Center Directors
- 1002.02(c)(1) Petitions Decided by the Director of Technology Center 3640
- 1002.02(c)(2) Petitions Decided by the Director of Technology Center 1600
- 1002.02(c)(3) Petitions Decided by the Director of Technology Center 2900
- 1002.02(d) Petitions and Matters Decided by Supervisory Patent Examiners
- 1002.02(e) Petitions Decided by Primary Examiners
- 1002.02(f) Petitions and Matters Decided by the Chief Administrative Patent Judge of the Board of Patent Appeals and Interferences
- 1002.02(g) Petitions Decided by the Administrative Patent Judges
- 1002.02(i) Petitions Decided by the \* Commissioner for Trademarks
- 1002.02(j) Petitions Decided by the Board of Patent Appeals and Interferences
- 1002.02(k)(1) \*>Petitions and Matters< decided by the General Counsel
- 1002.02(k)(2) Requests decided by the Office of General Law
- 1002.02(k)(3) Petitions decided by the Solicitor
- 1002.02(l) Requests Decided by the Certificates of Correction Branch
- 1002.02(m) Petitions Decided by the Director of Enrollment and Discipline
- 1002.02(o) Petitions and Other Matters Decided by the Deputy \*\*>Director of the USPTO<
- 1002.02(p) Petitions and Matters Decided by the PCT Legal Administrator
- 1002.02(q) Petitions Decided by the Director of Office of Initial Patent Examination
- 1002.02(r) Petitions Decided by the Director of Office of Patent Publication
- 1002.02(s) Petitions and Matters Decided by the Special Program Examiners in the Technology Centers
- 1003 Matters Submitted to Technology Center Directors**

- 1004 Actions Which Require the Attention of a Primary Examiner**
- 1005 Exceptions to Partial Signatory Authority**

## **1001 Statutory Authority of \* >Director of the USPTO< [R-2]**

*35 U.S.C. 2. Powers and duties.*

(a) IN GENERAL.— The United States Patent and Trademark Office, subject to the policy direction of the Secretary of Commerce—

(1) shall be responsible for the granting and issuing of patents and the registration of trademarks; and

(2) shall be responsible for disseminating to the public information with respect to patents and trademarks.

(b) SPECIFIC POWERS.— The Office—

(1) shall adopt and use a seal of the Office, which shall be judicially noticed and with which letters patent, certificates of trademark registrations, and papers issued by the Office shall be authenticated;

(2) may establish regulations, not inconsistent with law, which—

(A) shall govern the conduct of proceedings in the Office;

\*\*>

(B) shall be made in accordance with section 553 of title 5;<

(C) shall facilitate and expedite the processing of patent applications, particularly those which can be filed, stored, processed, searched, and retrieved electronically, subject to the provisions of section 122 relating to the confidential status of applications;

(D) may govern the recognition and conduct of agents, attorneys, or other persons representing applicants or other parties before the Office, and may require them, before being recognized as representatives of applicants or other persons, to show that they are of good moral character and reputation and are possessed of the necessary qualifications to render to applicants or other persons valuable service, advice, and assistance in the presentation or prosecution of their applications or other business before the Office;

(E) shall recognize the public interest in continuing to safeguard broad access to the United States patent system through the reduced fee structure for small entities under section 41(h)(1) of this title; and

(F) provide for the development of a performance-based process that includes quantitative and qualitative measures and standards for evaluating cost-effectiveness and is consistent with the principles of impartiality and competitiveness;

(3) may acquire, construct, purchase, lease, hold, manage, operate, improve, alter, and renovate any real, personal, or mixed property, or any interest therein, as it considers necessary to carry out its functions;

(4)(A) may make such purchases, contracts for the construction, maintenance, or management and operation of facilities, and contracts for supplies or services, without regard to

the provisions of the Federal Property and Administrative Services Act of 1949 (40 U.S.C. 471 et seq.), the Public Buildings Act (40 U.S.C. 601 et seq.), and the McKinney-Vento Homeless Assistance Act (42 U.S.C. 11301 et seq.); and

\*\*>

(B) may enter into and perform such purchases and contracts for printing services, including the process of composition, platemaking, presswork, silk screen processes, binding, microform, and the products of such processes, as it considers necessary to carry out the functions of the Office, without regard to sections 501 through 517 and 1101 through 1123 of title 44;<

(5) may use, with their consent, services, equipment, personnel, and facilities of other departments, agencies, and instrumentalities of the Federal Government, on a reimbursable basis, and cooperate with such other departments, agencies, and instrumentalities in the establishment and use of services, equipment, and facilities of the Office;

(6) may, when the Director determines that it is practicable, efficient, and cost-effective to do so, use, with the consent of the United States and the agency, instrumentality, Patent and Trademark Office, or international organization concerned, the services, records, facilities, or personnel of any State or local government agency or instrumentality or foreign patent and trademark office or international organization to perform functions on its behalf;

(7) may retain and use all of its revenues and receipts, including revenues from the sale, lease, or disposal of any real, personal, or mixed property, or any interest therein, of the Office;

(8) shall advise the President, through the Secretary of Commerce, on national and certain international intellectual property policy issues;

(9) shall advise Federal departments and agencies on matters of intellectual property policy in the United States and intellectual property protection in other countries;

(10) shall provide guidance, as appropriate, with respect to proposals by agencies to assist foreign governments and international intergovernmental organizations on matters of intellectual property protection;

(11) may conduct programs, studies, or exchanges of items or services regarding domestic and international intellectual property law and the effectiveness of intellectual property protection domestically and throughout the world;

(12)(A) shall advise the Secretary of Commerce on programs and studies relating to intellectual property policy that are conducted, or authorized to be conducted, cooperatively with foreign intellectual property offices and international intergovernmental organizations; and

(B) may conduct programs and studies described in subparagraph (A); and

(13)(A) in coordination with the Department of State, may conduct programs and studies cooperatively with foreign intellectual property offices and international intergovernmental organizations; and

(B) with the concurrence of the Secretary of State, may authorize the transfer of not to exceed \$100,000 in any year to the Department of State for the purpose of making special payments to international intergovernmental organizations for studies

and programs for advancing international cooperation concerning patents, trademarks, and other matters.

(c) CLARIFICATION OF SPECIFIC POWERS.—

(1) The special payments under subsection (b)(13)(B) shall be in addition to any other payments or contributions to international organizations described in subsection (b)(13)(B) and shall not be subject to any limitations imposed by law on the amounts of such other payments or contributions by the United States Government.

(2) Nothing in subsection (b) shall derogate from the duties of the Secretary of State or from the duties of the United States Trade Representative as set forth in section 141 of the Trade Act of 1974 (19 U.S.C. 2171).

(3) Nothing in subsection (b) shall derogate from the duties and functions of the Register of Copyrights or otherwise alter current authorities relating to copyright matters.

(4) In exercising the Director's powers under paragraphs (3) and (4)(A) of subsection (b), the Director shall consult with the Administrator of General Services.

(5) In exercising the Director's powers and duties under this section, the Director shall consult with the Register of Copyrights on all copyright and related matters.

(d) CONSTRUCTION.— Nothing in this section shall be construed to nullify, void, cancel, or interrupt any pending request-for-proposal let or contract issued by the General Services Administration for the specific purpose of relocating or leasing space to the United States Patent and Trademark Office.

35 U.S.C. 3. *Officers and employees.*

(a) UNDER SECRETARY AND DIRECTOR.—

(1) IN GENERAL.— The powers and duties of the United States Patent and Trademark Office shall be vested in an Under Secretary of Commerce for Intellectual Property and Director of the United States Patent and Trademark Office (in this title referred to as the "Director"), who shall be a citizen of the United States and who shall be appointed by the President, by and with the advice and consent of the Senate. The Director shall be a person who has a professional background and experience in patent or trademark law.

(2) DUTIES.—

(A) IN GENERAL.— The Director shall be responsible for providing policy direction and management supervision for the Office and for the issuance of patents and the registration of trademarks. The Director shall perform these duties in a fair, impartial, and equitable manner.

\*\*>

(B) CONSULTING WITH THE PUBLIC ADVISORY COMMITTEES.— The Director shall consult with the Patent Public Advisory Committee established in section 5 on a regular basis on matters relating to the patent operations of the Office, shall consult with the Trademark Public Advisory Committee established in section 5 on a regular basis on matters relating to the trademark operations of the Office, and shall consult with the respective Public Advisory Committee before submitting budgetary proposals to the Office of Management and Budget or changing or proposing to change patent or trademark user fees or patent or trademark regulations which are subject to the

requirement to provide notice and opportunity for public comment under section 553 of title 5, as the case may be.<

(3) OATH.— The Director shall, before taking office, take an oath to discharge faithfully the duties of the Office.

(4) REMOVAL.— The Director may be removed from office by the President. The President shall provide notification of any such removal to both Houses of Congress.<

(b) OFFICERS AND EMPLOYEES OF THE OFFICE.—

(1) DEPUTY UNDER SECRETARY AND DEPUTY DIRECTOR.— The Secretary of Commerce, upon nomination by the Director, shall appoint a Deputy Under Secretary of Commerce for Intellectual Property and Deputy Director of the United States Patent and Trademark Office who shall be vested with the authority to act in the capacity of the Director in the event of the absence or incapacity of the Director. The Deputy Director shall be a citizen of the United States who has a professional background and experience in patent or trademark law.

\*\*>

(2) COMMISSIONERS.—

(A) APPOINTMENT AND DUTIES.— The Secretary of Commerce shall appoint a Commissioner for Patents and a Commissioner for Trademarks, without regard to chapter 33, 51, or 53 of title 5. The Commissioner for Patents shall be a citizen of the United States with demonstrated management ability and professional background and experience in patent law and serve for a term of 5 years. The Commissioner for Trademarks shall be a citizen of the United States with demonstrated management ability and professional background and experience in trademark law and serve for a term of 5 years. The Commissioner for Patents and the Commissioner for Trademarks shall serve as the chief operating officers for the operations of the Office relating to patents and trademarks, respectively, and shall be responsible for the management and direction of all aspects of the activities of the Office that affect the administration of patent and trademark operations, respectively. The Secretary may reappoint a Commissioner to subsequent terms of 5 years as long as the performance of the Commissioner as set forth in the performance agreement in subparagraph (B) is satisfactory.

(B) SALARY AND PERFORMANCE AGREEMENT.— The Commissioners shall be paid an annual rate of basic pay not to exceed the maximum rate of basic pay for the Senior Executive Service established under section 5382 of title 5, including any applicable locality-based comparability payment that may be authorized under section 5304(h)(2)(C) of title 5. The compensation of the Commissioners shall be considered, for purposes of section 207(c)(2)(A) of title 18, to be the equivalent of that described under clause (ii) of section 207(c)(2)(A) of title 18. In addition, the Commissioners may receive a bonus in an amount of up to, but not in excess of, 50 percent of the Commissioners' annual rate of basic pay, based upon an evaluation by the Secretary of Commerce, acting through the Director, of the Commissioners' performance as defined in an annual performance agreement between the Commissioners and the Secretary. The annual performance agreements shall incorporate measurable organization and individual goals in key operational areas as delineated in an annual performance plan agreed to by the Commissioners and the Secretary. Payment of a bonus under this sub-

paragraph may be made to the Commissioners only to the extent that such payment does not cause the Commissioners' total aggregate compensation in a calendar year to equal or exceed the amount of the salary of the Vice President under section 104 of title 3.

(C) REMOVAL.— The Commissioners may be removed from office by the Secretary for misconduct or unsatisfactory performance under the performance agreement described in subparagraph (B), without regard to the provisions of title 5. The Secretary shall provide notification of any such removal to both Houses of Congress.<

(3) OTHER OFFICERS AND EMPLOYEES.— The Director shall—

(A) appoint such officers, employees (including attorneys), and agents of the Office as the Director considers necessary to carry out the functions of the Office; and

(B) define the title, authority, and duties of such officers and employees and delegate to them such of the powers vested in the Office as the Director may determine.

The Office shall not be subject to any administratively or statutorily imposed limitation on positions or personnel, and no positions or personnel of the Office shall be taken into account for purposes of applying any such limitation

(4) TRAINING OF EXAMINERS.— The Office shall submit to the Congress a proposal to provide an incentive program to retain as employees patent and trademark examiners of the primary examiner grade or higher who are eligible for retirement, for the sole purpose of training patent and trademark examiners.

(5) NATIONAL SECURITY POSITIONS.— The Director, in consultation with the Director of the Office of Personnel Management, shall maintain a program for identifying national security positions and providing for appropriate security clearances, in order to maintain the secrecy of certain inventions, as described in section 181, and to prevent disclosure of sensitive and strategic information in the interest of national security.

\*\*\*\*\*

**1001.01 Modes of Exercising Authority [R-2]**

The \* authority >of the Director of the USPTO< to review and supervise the work of the Office is exercised by the promulgation of the Rules of Practice; issuance of orders, notices and memoranda stating Office policies and modes for effectuating these policies; decisions on petitions by applicants; and by the designation of particular cases which must be submitted to the \*>Director of the USPTO< or other officials authorized by the \*>Director of the USPTO<. The present Chapter deals with the latter two items.

37 CFR 1.181(g) states, "The \*>Director< may delegate to appropriate Patent and Trademark Office officials the determination of petitions."

The various delegations to various Office officials are set forth in this Chapter.

The delegations set forth in this Chapter do not confer a right to have a matter decided by a specific Office official, rather, such delegations aid in the efficient treatment of petitions by the Office. A delegation of supervisory or higher level review authority over a matter carries with it the authority to decide the matter *ab initio*.

## 1002 Petitions to the \* >Director of the USPTO< [R-2]

\*\*>

37 CFR 1.181. *Petition to the Director.*

(a) Petition may be taken to the Director:<

(1) From any action or requirement of any examiner in the *ex parte* prosecution of an application, or in *ex parte* or *inter partes* prosecution of a reexamination proceeding which is not subject to appeal to the Board of Patent Appeals and Interferences or to the court;

\*\*>

(2) In cases in which a statute or the rules specify that the matter is to be determined directly by or reviewed by the Director; and

(3) To invoke the supervisory authority of the Director in appropriate circumstances. For petitions in interferences, see § 1.644.<

(b) Any such petition must contain a statement of the facts involved and the point or points to be reviewed and the action requested. Briefs or memoranda, if any, in support thereof should accompany or be embodied in the petition; and where facts are to be proven, the proof in the form of affidavits or declarations (and exhibits, if any) must accompany the petition.

\*\*>

(c) When a petition is taken from an action or requirement of an examiner in the *ex parte* prosecution of an application, or in the *ex parte* or *inter partes* prosecution of a reexamination proceeding, it may be required that there have been a proper request for reconsideration (§ 1.111) and a repeated action by the examiner. The examiner may be directed by the Director to furnish a written statement, within a specified time, setting forth the reasons for his or her decision upon the matters averred in the petition, supplying a copy to the petitioner.

(d) Where a fee is required for a petition to the Director the appropriate section of this part will so indicate. If any required fee does not accompany the petition, the petition will be dismissed.

(e) Oral hearing will not be granted except when considered necessary by the Director.<

(f) The mere filing of a petition will not stay any period for reply that may be running against the application, nor act as a stay of other proceedings. Any petition under this part not filed within two months of the mailing date of the action or notice from which

relief is requested may be dismissed as untimely, except as otherwise provided. This two-month period is not extendable.

\*\*>

(g) The Director may delegate to appropriate Patent and Trademark Office officials the determination of petitions.

37 CFR 1.182. *Questions not specifically provided for.*

All situations not specifically provided for in the regulations of this part will be decided in accordance with the merits of each situation by or under the authority of the Director, subject to such other requirements as may be imposed, and such decision will be communicated to the interested parties in writing. Any petition seeking a decision under this section must be accompanied by the petition fee set forth in § 1.17(h).

37 CFR 1.183. *Suspension of rules.*

In an extraordinary situation, when justice requires, any requirement of the regulations in this part which is not a requirement of the statutes may be suspended or waived by the Director or the Director's designee, *sua sponte*, or on petition of the interested party, subject to such other requirements as may be imposed. Any petition under this section must be accompanied by the petition fee set forth in § 1.17(h).<

Petitions on appealable matters ordinarily are not entertained. See MPEP § 1201.

The mere filing of a petition will not stay the period for replying to an examiner's action which may be running against an application, nor act as a stay of other proceedings (37 CFR 1.181(f)). For example, if a petition to vacate a final rejection as premature is filed within 2 months from the date of the final rejection, the period for reply to the final rejection is not extended even if the petition is not reached for decision within that period. However, if the petition is granted and the applicant has filed an otherwise full reply to the rejection *within the period for reply*, the case is not abandoned.

37 CFR 1.181(f) provides that any petition under that rule which is not filed "within two months of the mailing date of the action or notice from which relief is requested may be dismissed as untimely." Often, the "action or notice from which relief is requested," for example, a requirement for a new drawing, is included in the same letter as an action on the merits of the claims, the latter having a 3-month period for reply. Under such circumstances, if applicant requests reconsideration, under 37 CFR 1.111(b), of the requirement for a new drawing, the examiner's action on this request, if adverse, establishes the beginning of the 2-month period for filing the petition. The petition must be filed within this period even though the period for reply to the rejection of the claims may

extend beyond the 2-month period. The 2-month period for filing timely petitions set forth in 37 CFR 1.181(f) applies to any petition under 37 CFR part 1, except as otherwise provided. A number of sections (e.g., 37 CFR 1.377, 37 CFR 1.378, 37 CFR 1.644, and 37 CFR 1.740) specify the time period within which a petition must be filed (or may be dismissed as untimely). The 2-month time period in 37 CFR 1.181(f) applies to a petition under any section (e.g., 37 CFR 1.182 and 37 CFR 1.183) that does not specify the time period within which a petition must be filed. The 2-month period is not extendible under 37 CFR 1.136(a) since the time is within the discretion of the \* >Director of the USPTO<.

Form paragraph 10.20 may be used where an insufficient fee was filed with a petition or a request.

*¶ 10.20 Petition or Request Dismissed, Proper Fee Not Submitted*

Applicant's petition or request under 37 CFR [1] filed [2] is DISMISSED because the proper petition or processing fee of [3] required under 37 CFR 1.17 has not been submitted.

**Examiner Note:**

1. Requests under 37 CFR 1.48 for correcting inventorship require a fee as set forth in 37 CFR 1.17(i).
2. Petitions to suspend action under 37 CFR 1.103(a), and to withdraw an application from issue under 37 CFR 1.313, require a fee as set forth in 37 CFR 1.17(h).
3. Petitions for an extension of time under 37 CFR 1.136(a) require varying fees. See 37 CFR 1.17(a)(1)-(5).
4. Requests to suspend action under 37 CFR 1.103(b) or (c) require a fee set forth in 37 CFR 1.17(i).
5. Requests to defer examination under 37 CFR 1.103(d) require a fee set forth in 37 CFR 1.17(i) and publication fee set forth in 37 CFR 1.18(d).

**1002.01 Procedure**

Petitions, together with the respective application files, are sent to the official having the delegated authority to decide the petition. The petition may be referred to the examiner for a formal statement under 37 CFR 1.181(c) or for an informal memorandum. See MPEP § 711.03(d).

Where a formal statement under 37 CFR 1.181(c) is made, a copy thereof is mailed to the petitioner by the examiner unless the examiner is otherwise directed, and the application file and petition, accompanied by the original copy of his or her statement, are returned to the official handling the petition. If an informal memorandum is requested, no copy thereof is mailed to the petitioner by the examiner.

After the decision has been rendered, the decision is entered on the "Contents" of the application file wrapper which is then returned to the primary examiner, who will act in accordance with the decision.

**1002.02 Delegation of Authority To Decide Petitions [R-2]**

Petitions to the \* >Director of the USPTO< are decided in accordance with the following delegation of authority.

In any case in which the authority to decide the petition has been delegated as indicated in MPEP §§ 1002.02 (b), (f), (g), (j) and (o), a denial of a petition may be viewed as a final agency decision. A dismissal of a petition, a denial of a petition without prejudice, and other interlocutory orders are not final agency decisions.

In accordance with 37 CFR 1.181(g), the authority to decide petitions to the \* >Director of the USPTO< not otherwise delegated, has been delegated to various Office officials. Generally, these officials will decide petitions as specified in the following sections for the effective operation of the Office. Also listed are certain petitions which are not, strictly speaking, to the \* >Director of the USPTO< but have been committed by statute or rule to the designated officials.

The delegation of specific petitions and/or matters \* >to the Technology Center (TC) Directors are identified in the sections below. Unless specifically provided for in the letter of delegation of authority, further delegations are not permitted. Any petitions and/or matters so delegated by the TC Directors may be decided by the TC Directors.<

Authority not herein delegated has been reserved to the \* >Director of the USPTO< and may be delegated to appropriate officials on an ad hoc basis.

**1002.02(b) Petitions and Requests Decided by the Office of the Deputy Commissioner for Patent Examination Policy [R-2]**

All petitions decided by the Office of the Deputy Commissioner for Patent Examination Policy other than by the PCT Legal Administration (see MPEP § 1002.02(p)), and inquiries relating thereto, should be directed to "\*\*\*>Mail Stop Petition, Commissioner for Patents, P.O. Box 1450, Alexandria, Virginia

22313-1450<,” except as otherwise provided. For example, applications for patent term extension under 35 U.S.C. 156 should be directed to \*>Mail Stop< Patent Ext.

1. Petitions to revive an abandoned national, non-provisional or provisional patent application, 37 CFR 1.137 (both unavoidable delay and unintentional delay), MPEP § 711.03(c).

2. Petitions under 37 CFR 1.183 for waiver or suspension of rules not otherwise provided for.

3. Petitions to invoke the supervisory authority of the \*>Director of the USPTO< under 37 CFR 1.181 in matters not otherwise provided for.

4. For utility and plant applications filed on or after November 29, 2000, petitions for an unintentionally delayed foreign priority claim, 37 CFR 1.55(c), MPEP § 201.14(a).

5. For utility and plant applications filed on or after November 29, 2000, petitions for an unintentionally delayed domestic priority claim, 37 CFR 1.78(a)(3) and (a)(6), MPEP § 201.11.

6. Petitions for deferment of issuance of patents, 37 CFR 1.314, MPEP § 1306.01.

7. Petitions for express abandonment of patent applications after payment of the issue fee, MPEP § 711.01 and MPEP § 1308.

8. Petitions relating to assignments and issuance of patents not otherwise provided for.

9. Petitions relating to public use proceedings, 37 CFR 1.292.

10. Petitions for the withdrawal of attorney under 37 CFR 1.36 in patent applications involved in proceedings before the Office of the Deputy Commissioner for Patent Examination Policy.

11. Petitions under 37 CFR 1.182 in matters not otherwise provided for.

12. Requests by the examiner to the Board of Patent Appeals and Interferences for reconsideration of a decision, MPEP § 1214.04.

13. Petitions to review refusal to accept and record maintenance fee payment filed prior to the expiration of a patent, 37 CFR 1.377, MPEP § 2580.

14. Petitions to accept delayed payment of maintenance fee in an expired patent, 37 CFR 1.378, MPEP § 2590.

15. Petitions to review a decision of Technology Center Director, 37 CFR 1.181.

16. Petitions to withdraw a holding of abandonment not otherwise delegated, 37 CFR 1.181.

17. Requests to order a \*>Director< initiated reexamination proceeding, 37 CFR 1.520.

18. Petitions to accept late papers in a reexamination proceeding based upon unavoidable or unintentional delay, 35 U.S.C. 133 and 35 U.S.C. 41(a)(7).

19. Petitions for access to patent applications under 37 CFR 1.14 with the exception of applications involved in or related to a proceeding before the Board of Patent Appeals and Interferences, MPEP § 103, § 104, and § 1901.05.

20. Petitions relating to reexamination proceedings and/or reissue proceedings under 37 CFR 1.182 and 1.183.

21. Petitions relating to merger of reexamination and reissue proceedings.

22. Petitions for acceptance of national applications without participation of one or more inventors under 37 CFR 1.47, MPEP § 409.03.

23. Petitions relating to patent term extension 37 CFR 1.710-1.785.

24. Petitions under 37 CFR 1.181 to review a determination of the length of the patent term extension under 37 CFR 1.701.

25. Requests for reconsideration of the patent term adjustment indicated in the notice of allowance or in the patent, under 37 CFR 1.705.

26. Requests for reinstatement of the period of patent term adjustment reduced pursuant to 37 CFR 1.704(b), under 37 CFR 1.705(c).

27. Petitions relating to the filing date of patent applications under 37 CFR 1.53 and former 37 CFR 1.60 and 1.62, MPEP § 506.02.

28. Petitions relating to filing and/or issuance of divisional reissue applications, 37 CFR 1.177, MPEP § 1451.

29. Petitions to convert a nonprovisional application filed under 37 CFR 1.53(b) to a provisional application under 37 CFR 1.53(c) where the nonprovisional application is before the Office of Petitions or the Office of Patent Legal Administration.

30. Requests to convert a provisional application filed under 37 CFR 1.53(c) to a nonprovisional application under 37 CFR 1.53(b) where the provisional application is before the Office of Petitions or the Office of Patent Legal Administration.

31. Petitions for extensions of time under 37 CFR 1.136(b) in applications before the Office of Petitions or the Office of Patent Legal Administration.

32. Petitions, or requests at the initiative of the \*>USPTO< by someone other than a Technology Center Director, to withdraw patent applications from issue after payment of the issue fee under 37 CFR 1.313(b) \*\*, MPEP § 1308.

>33. Petitions to withdraw patent applications from issue after payment of the issue fee under 37 CFR 1.313(c).

34. Petitions to expunge papers from patent applications or patent files under 37 CFR 1.59 which were not submitted under MPEP § 724.02 or as part of the IDS.<

### **1002.02(c) Petitions and Requests Decided by the Technology Center Directors [R-2]**

1. Petitions or requests to reopen prosecution of patent applications >or to reinstate a rejection< after decision by the Board of Patent Appeals and Interferences under 37 CFR 1.198, where no court action has been filed, MPEP § 1214.04 and § 1214.07.

2. Petitions from a final decision of examiner requiring restriction in patent applications, 37 CFR 1.144, MPEP § 818.03(c), or holding lack of unity of invention in an international application, 37 CFR 1.477 and 1.489, MPEP § 1875.02.

3. Petitions invoking the supervisory authority of the \*>Director of the USPTO< under 37 CFR 1.181 involving any *ex parte* action or requirement in a patent application by the examiner which is not subject to appeal (37 CFR 1.191) and not otherwise provided for, as for example:

(a) prematureness of final rejection, MPEP § 706.07(c);

(b) holding of abandonment, MPEP § 711.03(c);

(c) requirement to cancel “new matter” from specification, MPEP § 608.04(c);

(d) relative to formal sufficiency and propriety of affidavits under 37 CFR 1.131 (MPEP § 715.08), 1.132 (MPEP § 716) and 1.608, MPEP § 2308 - § 2308.02;

(e) refusal to initiate an interference under 37 CFR 1.601(i), MPEP § 2306;

(f) refusal to enter an amendment under 37 CFR 1.312, MPEP § 714.16(d);

(g) refusal to enter an amendment, 37 CFR 1.127, MPEP § 714.19;

(h) refusal to enter an amendment under 37 CFR 1.111 or 37 CFR 1.115, MPEP § 714.03(a);

(i) resetting period for reply, MPEP § 710.06; and

(j) requirement for information under 37 CFR 1.105, MPEP § 704.11.

4. Petitions under 37 CFR 1.113 relating to objections or requirements made by the examiners.

5. Petitions for return of original oaths of patent applications, MPEP § 604.04(a).

6. Requests for extensions of a set shortened statutory period under 37 CFR 1.136(b) in applications pending in the \*\*>Technology Center<, MPEP § 710.02(e).

7. Petitions under 37 CFR 1.193(a) relating to the form of the appeal.

8. Petitions concerning appealed patent applications or *ex parte* reexamination proceedings before transfer of jurisdiction to the Board of Patent Appeals and Interferences (e.g., extension of time under 37 CFR 1.136(b) or 37 CFR 1.550(c) for filing an appeal brief), MPEP § 1206.

9. Request by applicant for a second or subsequent suspension of action in patent applications under 37 CFR 1.103, MPEP § 709.

10. Petitions from refusal to issue a Certificate of Correction for a patent not involved in an interference, 37 CFR 1.181, MPEP § 1480 - § 1485.

11. Petitions to reinstate appeals dismissed in the Technology Center.

12. Petitions from the denial of a request for reexamination, 37 CFR 1.515, MPEP § 2248.

13. Requests for extension of time in >*ex parte*< reexamination proceedings pending in the Technology Center, 37 CFR 1.550 (c).

14. Petitions under 37 CFR 1.129(b)(2) traversing a restriction requirement made in an application which is subject to the transitional restriction provisions, MPEP § 803.03.

15. Petitions to convert a nonprovisional application filed under 37 CFR 1.53(b) to a provisional application under 37 CFR 1.53(c) where the nonprovisional application is before the Technology Center.

16. Requests for interviews with examiner after a patent application has been sent to issue (Notice of Allowability mailed), MPEP § 713.10, or after



transfer of jurisdiction to the Board of Patent Appeals and Interferences.

17. Petitions to expunge papers from patent \*\* >applications or patent files under 37 CFR 1.59 which were submitted under MPEP § 724.02 or as part of an IDS<.

18. Petitions, or requests at the initiative of the USPTO, to withdraw patent applications from issue before payment of the issue fee, 37 CFR 1.313(a).

19. Requests at the initiative of the USPTO to withdraw patent applications from issue after payment of the issue fee under 37 CFR 1.313(b), MPEP § 1308.

>20. Petitions under 37 CFR 1.91 to admit a model or exhibit as part of the record of an application.

21. Requests for the return of models, exhibits, or specimen under 37 CFR 1.94.

22. Requests to withdraw as attorney or agent of record, 37 CFR 1.36 and MPEP § 402.06.<

### **1002.02(c)(1) Petitions Decided by the Director of Technology Center 3640 [R-2]**

In addition to the items delegated to all >Technology Center< Directors under MPEP § 1002.02(c), authority to decide the following is delegated to the Director of Technology Center 3640:

1. All petitions filed under 35 U.S.C. 267 to extend the time for taking action in United States-owned applications wherein the invention is important to the armament or defense of the United States.

2. All petitions under 37 CFR 1.103(f) to suspend action in United States-owned applications wherein the publication of the invention might be detrimental to the public safety or defense.

Any petitions filed under 35 U.S.C. 267 and/or 37 CFR 1.103(f) in any area of the Office must be forwarded to the Director of Technology Center 3640 for decision thereon.

3. Petitions under 37 CFR 5.12(a) for foreign license to file patent applications in foreign countries, MPEP § 140.

4. Petitions for rescission of secrecy order, 37 CFR 5.4, MPEP § 120.

5. Petitions to permit disclosure of subject matter under a secrecy order, 37 CFR 5.5(b), MPEP § 120.

6. Petitions for modification of secrecy order, 37 CFR 5.5(c), MPEP § 120.

7. Petitions for retroactive foreign filing license, 37 CFR 5.25, MPEP § 140.

8. Petitions relating to refusal of request for publication of a Statutory Invention Registration, 37 CFR 1.295, MPEP § 1105.

9. Petitions relating to request for withdrawal of request for publication of a Statutory Invention Registration, 37 CFR 1.296, MPEP § 1109.

10. Petitions relating to DOE property rights statements under 42 U.S.C. 2182.

11. Petitions relating to NASA property rights statements under 42 U.S.C. 2457.

12. Petitions relating to foreign filing licenses under 35 U.S.C. 184.

13. Petitions concerning review of security or government interest matters not otherwise provided for.

14. Petitions relating to any application under a secrecy order pursuant to 35 U.S.C. 181, including petitions to expunge subject matter from the application to overcome the secrecy order.

### **1002.02(c)(2) Petitions Decided by the Director of Technology Center 1600 [R-2]**

In addition to the items delegated to all \*>Technology Center< Directors under MPEP § 1002.02(c), authority to decide the following is delegated to the Director of Technology Center 1600:

1. Petitions regarding sequence rules, 37 CFR 1.821-1.825.

2. Petitions to make biotechnology applications special where applicant is a small entity, MPEP § 708.02, item XII.

### **1002.02(c)(3) Petitions Decided by the Director of Technology Center 2900**

In addition to the items delegated to all Technology Center Directors under MPEP § 1002.02(c), authority to decide the following petitions and requests filed in design applications is delegated to the Director of Technology Center 2900:

1. Petitions to revive an abandoned national application, 37 CFR 1.137 (both unavoidable delay and unintentional delay), MPEP § 711.03(c).

2. Petitions relating to the filing date of patent applications under 37 CFR 1.53 and former 37 CFR 1.60 and 1.62, MPEP § 506.02.

3. Requests for expedited examination of design applications under 37 CFR 1.155, MPEP § 1504.30.

### **1002.02(d) Petitions and Matters Decided by Supervisory Patent Examiners [R-2]**

1. Entry of amendments under 37 CFR 1.312 which embody more than merely the correction of formal matters without changing the scope of any claim, MPEP § 714.16, § 714.16(d).

2. Approval of reopening prosecution after the filing of an appeal brief in order to incorporate any new ground of rejection, MPEP § 1208.01.

3. Requests for a Certificate of Correction submitted under 37 CFR 1.322 or 1.323 unless the error is clearly minor, clerical or typographical, in which case it is handled by the Certificate of Correction Branch.

4. Requests for a Certificate of Correction to correct a claim even if the request is submitted under 37 CFR 1.322.

5. Petitions under 37 CFR 1.324 to correct errors in joining inventors in a patent that is not involved in an interference, MPEP § 1481.

6. Disapproval of preliminary amendments under 37 CFR 1.115 or second (or subsequent) supplemental amendments (3<sup>rd</sup> reply) under 37 CFR 1.111, MPEP § 714.03(a).

7. Letters to an applicant suggesting claims for purposes of interference, or the submission of Form PTO-850, where one or more claims of one application would differ from corresponding claims of another application. See 37 CFR 1.603 and MPEP § 2303.

8. Amendments presented after decision in an appeal by the Board of Patent Appeals and Interferences as to which the primary examiner recommends entry as placing the application in condition for allowance. See MPEP § 1214.07.

\*\*

>9.< Petitions under 37 CFR 1.84 to accept photographs or color drawings in patent applications.

>10.< Withdrawal from appeal of an application remanded by the Board of Patent Appeals and Interferences. See MPEP § 1211.

>11.< Requests for deferral of examination under 37 CFR 1.103(d), MPEP § 709.

### **1002.02(e) Requests Decided by Primary Examiners**

Requests under 37 CFR 1.48 for correction of inventorship in applications.

### **1002.02(f) Petitions and Matters Decided by the Chief Administrative Patent Judge of the Board of Patent Appeals and Interferences**

The Chief Administrative Patent Judge is authorized to redelegate authority to decide any of these petitions or matters to the Vice Chief Administrative Patent Judge of the Board of Patent Appeals and Interferences.

1. Designation of members of the Board of Patent Appeals and Interferences to hear appeals and decide interferences, both initially and on request for reconsideration. 35 U.S.C. 6.

2. Designation of members of the Board of Patent Appeals and Interferences to conduct proceedings in an interference. 37 CFR 1.610(a).

3. Designation of members of the Board of Patent Appeals and Interferences to decide requests for reconsideration. 37 CFR 1.640(c).

4. Requests related to superintending the functions of the Board of Patent Appeals and Interferences, including:

a. Petitions under 37 CFR 1.644 in interferences.

b. Petitions under 37 CFR 1.181, 1.182, and 1.183 from actions of the Board of Patent Appeals and Interferences or of personnel at the Board of Patent Appeals and Interferences.

c. Petitions from a decision under 37 CFR 1.612(a) granting or denying access by a party to an interference to pending and abandoned patent applications. MPEP § 103.

d. Petitions for an extension of time for seeking rehearing in an *ex parte* case before the Board of Patent Appeals and Interferences.

e. Petitions from a decision under 37 CFR 1.615(b) authorizing or declining to authorize continued concurrent prosecution of an application involved in an interference proceeding.

f. Petitions from a decision under 37 CFR 1.613(d) declining to authorize a withdrawal of an attorney or agent from representing a party involved in an interference.

g. Petitions from a decision granting or denying a request for a certificate of correction under 37 CFR 1.322 and 1.323 for a patent involved in an interference.

h. Petitions seeking disqualification of an attorney or agent under 37 CFR 10.130(b) in an *inter partes* case pending before the Board of Patent Appeals and Interferences.

5. Petitions under 35 U.S.C. 135(c):

a. Petitions under 35 U.S.C. 135(c) and 37 CFR 1.666(c) to permit the filing of an agreement or understanding during the 6-month period subsequent to termination of an interference.

b. Petitions under 37 CFR 1.666(b) for access to copies of an interference agreement or understanding filed under 35 U.S.C. 135(c).

### **1002.02(g) Petitions Decided by the Administrative Patent Judges [R-2]**

1. Petitions for access to unopened preliminary statements under 37 CFR 1.631.

2. Petitions under 37 CFR 1.615 for concurrent *ex parte* and *inter partes* prosecution of patent applications, MPEP § 2315.

3. Petitions for the withdrawal of attorney under 37 CFR 1.36 in patent applications involved in interference proceedings under 37 CFR 1.601 - \*1.687< before the Board of Patent Appeals and Interferences, 37 CFR 1.613(d).

4. A request for a Certificate of Correction for a patent that is involved in an interference conducted under 37 CFR 1.601 - \*1.687< presented via a motion under 37 CFR 1.635.

5. Motions to correct errors in joining inventors in proceedings under 37 CFR 1.601 - \*1.687<, 37 CFR 1.634.

See also MPEP § 1002.02(j).

### **1002.02(i) Petitions Decided by the \* Commissioner for Trademarks [R-2]**

Petitions relating to Trademarks are covered in Chapter 1700 of the Trademark Manual of Examining Procedure.

### **1002.02(j) Petitions Decided by the Board of Patent Appeals and Interferences**

Requests under 37 CFR 1.197(b) for a rehearing of a decision of the Board of Patent Appeals and Interferences. MPEP § 1214.03.

### **1002.02(k)(1) \*Petitions and Matters Decided by the General Counsel [R-2]**

>1.< Requests for confidentiality waiver under 35 U.S.C. 122.

>2. Petitions (under 37 CFR 1.304(a)(3) or 37 CFR 2.145(d)) seeking to extend the time for filing a notice of appeal to the U.S. Court of Appeals for the Federal Circuit or for commencing a civil action seeking judicial review of a decision of the Board of Patent Appeals and Interferences or the Trademark Trial and Appeal Board.

3. Petitions under 37 CFR 10.2(c) from a final decision of the Director of Enrollment and Discipline.

4. Appeals under 37 CFR 10.155 of initial decisions of administrative law judges and requests for reconsideration under 37 CFR 10.156 in proceedings under 35 U.S.C. 32 in which the Director of Enrollment and Discipline seeks to exclude or suspend a practitioner from practice before the Patent and Trademark Office.<

### **1002.02(k)(2) Requests Decided by the Office of General Law**

1. Requests filed under the Freedom of Information Act.

2. Petitions requesting review of the FOIA Officer's decision.

### **1002.02(k)(3) Petitions Decided by the Solicitor**

1. Petitions for extension of time in court matters 35 U.S.C. 142, 145, and 146.

2. Petitions relating to *ex parte* questions in cases before the Court of Appeals for the Federal Circuit.

The Office of the Solicitor is available to render legal advice to any deciding official in connection with any petition.

### **1002.02(l) Requests Decided by the Certificates of Correction Branch**

1. Requests for Certificates of Correction under 37 CFR 1.322 or 37 CFR 1.323 except for denials on grounds requiring consideration by the Chief Administrative Patent Judge or the supervisory patent examiners otherwise provided for, MPEP § 1480 - § 1485.
2. Petitions to issue corrected patent, 37 CFR 1.322(b).
3. Request to change inventorship pursuant to court order, 37 CFR 1.324, MPEP § 1481.

### **1002.02(m) Petitions Decided by the Director of Enrollment and Discipline**

1. Petitions relating to registration.
2. Requests for limited recognition under 37 CFR 10.9.
3. Petitions for exceptions to undertakings under 37 CFR 10.10(b)(2), MPEP § 1702.
4. Petitions for regrading of registration examinations under 37 CFR 10.7(c).
5. Petitions for reinstatement under 37 CFR 10.160.
6. Petitions to suspend the rules under 37 CFR 10.170.

### **1002.02(o) Petitions and Other Matters Decided by the Deputy \*\* >Director of the USPTO< [R-2]**

The authority to take the following actions has been delegated to the Deputy \*\* >Director of the USPTO<.

1. Decide petitions to the \* >Director of the USPTO< in patent interference proceedings under 37 CFR 1.644.

2. Decide petitions to the \* >Director of the USPTO< from actions taken by the Board of Patent Appeals and Interferences.

\*\*

If there is a vacancy in the position of Deputy \*\* >Director of the USPTO<, decisions on petitions in patent interference cases will be signed by the \*\* >Director of the USPTO<.

Upon receipt of a petition and without waiting for any opposition, the entire interference file is to be forwarded to the Office of the Solicitor. The Solicitor is directed to promptly cause a review to be made of the

petition and to prepare a draft decision for the Deputy \*\* >Director or Director of the USPTO< as may be appropriate. The Solicitor is authorized to take any interlocutory action, i.e., extending times for filing oppositions and seeking judicial review, obtaining agreement on facts from the parties, etc., as may be necessary to promptly dispose of the petition.

### **1002.02(p) Petitions and Matters Decided by the PCT Legal Administrator [R-2]**

1. Petitions to withdraw the Notice of Acceptance and/or filing receipt and indication of the steps necessary for completion of the national stage in a national application requesting treatment under 35 U.S.C. 371.

2. Petitions for withdrawal of attorney or agent of record in proceedings before PCT Operations and/or the Office of the PCT Legal Administrator, 37 CFR 1.36, MPEP § 402.06.

3. Petitions for access to an international application or a national application (i.e., a national stage application or a national application which is continuing from an international application) pending in PCT Operations and/or the Office of the PCT Legal Administrator.

4. Requests under 37 CFR 1.26 or 1.446 for refund of fees paid in an international application or in a national application (i.e., a national stage application or a national application which is continuing from an international application) before PCT Operations and/or the Office of the PCT Legal Administrator.

5. Petitions under 37 CFR 1.182 to convert a national application which was filed under 35 U.S.C. 371 to an application filed under 35 U.S.C. 111(a) or to convert a national application which was filed under 35 U.S.C. 111(a) to an application filed under 35 U.S.C. 371.

6. Petitions under 37 CFR 1.181 to withdraw the holding of abandonment where the holding was made in PCT Operations or in the PCT Legal Office.

7. Petitions under 37 CFR 1.181 to invoke the supervisory authority of the \* >Director of the USPTO< in circumstances arising in PCT Operations and/or the Office of the PCT Legal Administrator other than the circumstances set forth in paragraph 6, above.

8. Petitions under 37 CFR 1.137 (both unavoidable delay and unintentional delay) to revive an application filed under the Patent Cooperation Treaty (PCT).

9. Petitions under 37 CFR 1.425 to accept the signature in an international application on behalf of an applicant.

10. Petitions under 37 CFR 1.47 or a submission under 37 CFR 1.42 \*\* to accept the signature in a national stage application on behalf of an applicant.

11. Requests under 37 CFR 1.48 or a submission under 37 CFR 1.28 (change of inventorship and small entity status, respectively) in a national stage application prior to entry into the national stage.

12. Petitions under 37 CFR 1.182 or 1.183 filed in an international application relating to filing date matters, drawing problems, priority claim issues, Express Mail problems, Chapter II Demand problems, issues relating to obvious error and issues relating to withdrawal.

13. Petitions under 37 CFR 1.182 or 1.183 dealing with circumstances other than those set forth in paragraph 12, but relating to issues under the PCT.

14. Decisions withdrawing an examiner's office action in an application where the application is not in compliance with the PCT provisions of the Treaty, U.S. Law or the Regulations.

15. Petitions dealing with PCT related issues in an application filed under 35 U.S.C. 111(a) (such as applications where there is a potential claim for benefit under 35 U.S.C. 365).

16. Petitions to convert a nonprovisional application filed under 37 CFR 1.53(b) to a provisional application under 37 CFR 1.53(c) where the nonprovisional application is before PCT Operations and/or the Office of the PCT Legal Administrator.

17. Petitions relating to international applications filed under the Patent Cooperation Treaty not otherwise provided for.

### **1002.02(q) Petitions and Requests Decided by the Director of Office of Initial Patent Examination**

1. Requests under 37 CFR 1.48(d) to add the name of an inventor in a provisional application.

2. Requests under 37 CFR 1.48(e) to delete the name of the person erroneously named as an inventor in a provisional application.

3. Petitions to convert a nonprovisional application filed under 37 CFR 1.53(b) to a provisional application under 37 CFR 1.53(c) where the nonprovisional application is before the Office of Initial Patent Examination or where the nonprovisional application is before the Office of Publications.

4. Requests to convert a provisional application filed under 37 CFR 1.53(c) to a nonprovisional application under 37 CFR 1.53(b) where the provisional application is before the Office of Initial Patent Examination.

5. Petitions under 37 CFR 1.182 to accept omitted page(s) or drawing(s) and be accorded a filing date as of the date of such submission, or to accept drawings for purposes of a patent application publication.

6. Petitions to withdraw holding of abandonment where notices of abandonment were mailed by the Office of Initial Patent Examination.

7. Petitions for extension of time under 37 CFR 1.136(b) in applications before the Office of Initial Patent Examination.

### **1002.02(r) Petitions Decided by the Director of Office of Patent Publication [R-2]**

1. Petitions to withdraw holding of abandonment where \*>a notice< of abandonment \*>has been, or could be< mailed by the Office of Patent Publication.

2. Petitions for express abandonment to avoid publication of the application (should be directed to \*\*>Mail Stop Express Abandonment<), 37 CFR 1.138(c), MPEP § 711.01.

3. Requests to issue patent in name of the assignee after payment of the issue fee, 37 CFR 3.81(b), MPEP § 307.

>4. Petitions to withdraw the holding that a patent has lapsed for failure to pay the balance of the issue fee, 37 CFR 1.317.<

### **1002.02(s) Petitions and Matters Decided by the Special Program Examiners in the Technology Centers [R-2]**

1. Petitions to make patent applications special under 37 CFR 1.102, MPEP § 708.02:

(a) on the ground of applicant's age or state of health, MPEP § 708.02, item III & IV;

(b) a continuation-in-part of an earlier application;

(c) under the Environmental Quality Program, MPEP § 708.02, item V;

(d) under the Energy Program, MPEP § 708.02, item VI;

(e) because the application invokes safety of research in the field of Recombinant DNA, MPEP § 708.02, item VII;

(f) under the Special Examining Procedure for certain new applications - accelerated examination, MPEP § 708.02, item VIII;

(g) superconductivity, MPEP § 708.02, item IX;

(h) inventions relating to HIV/AIDS and cancer, MPEP § 708.02, item X;

(i) relating to inventions for countering terrorism, MPEP § 708.02, item XI;

(j) on the ground of prospective manufacture, MPEP § 708.02, item I;

(k) on the ground of infringement, MPEP § 708.02, item II; and

(\*>I<) for reasons not otherwise provided for.

2. Petitions for withdrawal of attorney from application pending in the Technology Centers, 37 CFR 1.36.

### **1003 Matters Submitted to Technology Center Directors [R-2]**

The following is a list of matters which are submitted to the appropriate Technology Center Director, together with a reference to any section of this manual where such matters are more fully treated.

1. Requests for a Certificate of Correction in which the:

i. request raises a novel issue or about which there is some question;

ii. request is for a patent known to be in litigation; or

iii. request deals with a legal matter (e.g., the insertion of foreign priority data or cross referencing to prior U.S. patent applications) unless the file reflects that the examiner has already ruled on the matter and that failure to print the material was clearly an Office error, in which case it will be handled by the Certificate of Corrections Branch.

2. Return of papers entered on the "Contents" of the file wrapper. See MPEP § 201.14(c), § 604.04(a) and § 719.01.

3. Return of papers containing discourteous remarks. See MPEP § 714.19 and § 714.25.

4. Certain rejections on double patenting of divisional (or parent) case when restriction or election of species has previously been required, MPEP § 804.04.

5. Request for patentability report, MPEP § 705.01(e).

6. Actions which hold unpatentable claims copied from a patent for interference purposes where the grounds relied upon are equally applicable to the patentee, MPEP § 2307.02.

7. Interferences between applications neither of which is in condition for allowance, MPEP § 2303.

8. Letters requesting jurisdiction from Board of Patent Appeals and Interferences of applications involved in appeal or interference.

9. Letters to an applicant suggesting claims for purposes of interference, the adoption of which by the applicant would result in the withdrawal of an application from issue, MPEP § 2305.04.

10. Examiner's answers containing a new interpretation of law. See MPEP § 1208.

11. Proposed interferences between applications whose effective filing dates differ by more than 6 months. See MPEP § 2303.

12. Protests filed against issuance of a patent. See MPEP § 1901.06.

13. Letters suggesting claims to an application in issue for purposes of interference with a patent. See MPEP § 2305.04.

14. Requests by the examiner to the Board for reconsideration of a decision before forwarding to the Office of Petitions, MPEP § 1214.04.

15. Second or subsequent suspension of action in patent application under 37 CFR 1.103 on examiner's initiative. MPEP § 709.

16. Request by the examiner to withdraw an application from issue.

17. An unusual fact situation in a patent that establishes:

- i. there is a “compelling reason” to order reexamination, and
- ii. at least one claim in the patent is *prima facie* unpatentable over prior patents and/or printed publications. See 37 CFR 1.520, MPEP § 2239.

18. Applications containing examiner’s answers lacking the appropriate indication that an appeal conference was held. See MPEP § 1208.

>19. Applications identified by the examiner as containing “offensive” subject matter.<

All unusual questions of practice may be referred to the Technology Center Directors.

### 1004 Actions Which Require the Attention of a Primary Examiner

There are some questions which existing practice requires the primary examiner to be personally responsible for. The following actions fall in this category:

- Final rejection (MPEP § 706.07).
- Proposing an interference (MPEP § 2309).
- Disposition of an amendment in an application in interference looking to the formation of another interference involving that application (MPEP § 2364.01).
- Calling Administrative Patent Judge’s attention to a discovered reference which makes a claim corresponding to a count unpatentable (37 CFR 1.641, MPEP § 2341).
- Rejection of a previously allowed claim (MPEP § 706.04).
- Classification of allowed cases (MPEP § 903.07).
- Holding of abandonment for insufficient reply (MPEP § 711.03(a)).
- Suspension of examiner’s action (MPEP § 709).
- Treatment of newly filed application which obviously fails to comply with 35 U.S.C. 112 (MPEP § 702.01).
- Consideration of the advisability of a patentability report (MPEP § 705.01(a)).
- Withdrawal of final rejection (MPEP § 706.07(d) and § 706.07(e)).
- All examiner’s answers on appeal (MPEP § 1208).
- Decision on reissue oath or declaration (MPEP § 1414).

Decision on affidavits or declarations under 37 CFR 1.131 (MPEP § 715.08) and under 37 CFR 1.132 (MPEP § 716).

Decision as to acceptance of amendments, statements, and oaths or declarations filed under 37 CFR 1.48 (MPEP § 201.03).

International Preliminary Examination Reports (MPEP § 1879).

For a list of actions that are to be submitted to the Technology Center Directors, see MPEP § 1002.02(c) and § 1003.

### 1005 Exceptions to Partial Signatory Authority [R-2]

Examiners who are delegated partial signatory authority are expected to sign their own actions with the exception of the following actions which require the signature of the primary examiner:

- Allowances (MPEP § 1302.13).
- Examiner’s amendments (MPEP § 1302.04).
- Quayle actions (MPEP § 714.14).
- Final rejections (MPEP § 706.07 and § 803.01).
- >Withdrawal of final rejection (MPEP § 706.07(d) and (e)).<
- Actions on amendments submitted after final rejection (MPEP § 714.12).
- Examiner’s answers on appeal (MPEP § 1208).
- Initiation of an interference (MPEP § 2309).
- Actions suggesting claims for interference purposes (MPEP § 2305).
- Actions involving copied patent claims (MPEP § 2307).
- Actions reopening prosecution (MPEP § 1214.07).
- Requests for withdrawal from issue (MPEP § 1308).
- 37 CFR 1.312 amendments (MPEP § 714.16).
- Rejection of previously allowed claim (MPEP § 706.04).
- Final holding of abandonment for insufficient reply (MPEP § 711.03(a)).
- Actions based on affidavit or declaration evidence (37 CFR 1.131 and 1.132 (MPEP § 715.08 and § 716)).
- Suspension of examiner’s action (MPEP § 709).
- Reissue applications (decisions on reissue oath or declaration) (MPEP § 1444).

Requests for an extension of time under 37 CFR  
1.136(b) (MPEP § 710.02(e)).  
Reexamination proceedings (MPEP § 2236).

International Preliminary Examination Reports  
(MPEP § 1879).





# MANUAL OF PATENT EXAMINING PROCEDURE

# Chapter 1100 Statutory Invention Registration (SIR) and Pre-Grant Publication (PG Pub)

- 1101 Request for Statutory Invention Registration (SIR)
- 1103 Examination of a SIR
- 1105 Review of Final Refusal to Publish SIR
- 1107 Preparing a SIR for Publication
- 1109 Withdrawal of SIR Request
- 1111 SIR Publication and Effect
- >1120 Eighteen-Month Publication of Patent Applications
  - 1121 Content of a Patent Application Publication
  - 1122 Requests for Nonpublication
  - 1123 Rescission of a Nonpublication Request
  - 1124 Notice of Foreign Filing
  - 1125 Express Abandonment to Avoid Publication
  - 1126 Publication Fees
  - 1127 Notice of Publication
  - 1128 Availability of Published Applications
  - 1129 Request for Early Publication
  - 1130 Republication and Correction of Patent Application Publications
  - 1132 Requests for Redacted Publication
  - 1133 Requests for Voluntary Publication
  - 1134 Third Party Inquires and Correspondence in a Published Application
- 1134.01 Third Party Submissions under 37 CFR 1.99
- 1135 PGPub Forms<

## 1101 Request for Statutory Invention Registration (SIR) [R-2]

### 35 U.S.C. 157. Statutory invention registration.

(a) Notwithstanding any other provision of this title, the Director is authorized to publish a statutory invention registration containing the specification and drawings of a regularly filed application for a patent without examination if the applicant —

- (1) meets the requirements of section 112 of this title;
- (2) has complied with the requirements for printing, as set forth in regulations of the Director;
- (3) waives the right to receive a patent on the invention within such period as may be prescribed by the Director; and
- (4) pays application, publication, and other processing fees established by the Director.

If an interference is declared with respect to such an application, a statutory invention registration may not be published unless the issue of priority of invention is finally determined in favor of the applicant.

(b) The waiver under subsection (a)(3) of this section by an applicant shall take effect upon publication of the statutory invention registration.

(c) A statutory invention registration published pursuant to this section shall have all of the attributes specified for patents in this title except those specified in section 183 and sections 271 through 289 of this title. A statutory invention registration shall

not have any of the attributes specified for patents in any other provision of law other than this title. A statutory invention registration published pursuant to this section shall give appropriate notice to the public, pursuant to regulations which the Director shall issue, of the preceding provisions of this subsection. The invention with respect to which a statutory invention certificate is published is not a patented invention for purposes of section 292 of this title.

(d) The Director shall report to the Congress annually on the use of statutory invention registrations. Such report shall include an assessment of the degree to which agencies of the federal government are making use of the statutory invention registration system, the degree to which it aids the management of federally developed technology, and an assessment of the cost savings to the Federal Government of the uses of such procedures.

### 37 CFR 1.293. Statutory invention registration.

(a) An applicant for an original patent may request, at any time during the pendency of applicant's pending complete application, that the specification and drawings be published as a statutory invention registration. Any such request must be signed by (1) the applicant and any assignee of record or (2) an attorney or agent of record in the application.

(b) Any request for publication of a statutory invention registration must include the following parts:

- (1) A waiver of the applicant's right to receive a patent on the invention claimed effective upon the date of publication of the statutory invention registration;
- (2) The required fee for filing a request for publication of a statutory invention registration as provided for in § 1.17(n) or (o);

(3) A statement that, in the opinion of the requester, the application to which the request is directed meets the requirements of 35 U.S.C. 112; and

(4) A statement that, in the opinion of the requester, the application to which the request is directed complies with the formal requirements of this part for printing as a patent.

(c) A waiver filed with a request for a statutory invention registration will be effective, upon publication of the statutory invention registration, to waive the inventor's right to receive a patent on the invention claimed in the statutory invention registration, in any application for an original patent which is pending on, or filed after, the date of publication of the statutory invention registration. A waiver filed with a request for a statutory invention registration will not affect the rights of any other inventor even if the subject matter of the statutory invention registration and an application of another inventor are commonly owned. A waiver filed with a request for a statutory invention registration will not affect any rights in a patent to the inventor which issued prior to the date of publication of the statutory invention registration unless a reissue application is filed seeking to enlarge the scope of the claims of the patent. See also § 1.104(c)(5).

A request for a statutory invention registration (SIR) may be filed at the time of filing a nonprovisional application for patent, or may be filed later during pendency of a nonprovisional application. The fee

required (37 CFR 1.17(n) or (o)) depends on when the request is filed. The application to be published as a SIR must be complete as set forth in 37 CFR 1.51(b) including a specification with a claim or claims, an oath or declaration, and drawings when necessary. Applicants should use the format set forth in form PTO/SB/94, Request for Statutory Invention Registration. Form PTO/SB/94 is available from the USPTO website ([www.uspto.gov](http://www.uspto.gov)), and it is reproduced \*\*>at the end of< this section.

A provisional application cannot include a request for a SIR.

Requests for statutory invention registrations, including those submitted in utility, plant, and design applications, are handled in art units 3641 and 3662 of Technology Center (TC) 3600. Accordingly, incoming new applications which include a request for a SIR will be processed like other new applications in the Office of Initial Patent Examination (OIPE) and then forwarded to TC 3600. TC 3600 may be assisted by other Technology Centers when the subject matter of the application makes it necessary or desirable. For example, TC 1600 may handle issues under 35 U.S.C. 112 in applications involving biotechnology.

Applications not already assigned to art unit 3641 or 3662 which receive a request for a SIR (or any other indication that they are to be published as a SIR) should be forwarded with a brief explanation to one of these art units via the technical support staff of the TC to which the application is assigned. The forwarding TC should first determine whether an Office action

has been mailed in the application and issue proper SIR disposal credit to the examiner who prepared any such action where appropriate. Art unit 3662 handles applications including a request for a SIR that are electrical in nature and those that are related to computer science. Accordingly, applications from TCs 2100, 2600, and 2800 should be forwarded to art unit 3662. All other applications including a request for a SIR should be forwarded to art unit 3641. An examiner in art unit 3641 or 3662 will determine whether the request for a SIR is proper. An examiner who is not in one of these two art units should make no comment to the applicant regarding what effect the filing of a request for a SIR may have had on any outstanding rejection.

It should be noted that 37 CFR 1.211 requires the publication of most nonprovisional applications (other than for a design patent filed under 35 U.S.C. 171 and reissue applications filed under 35 U.S.C. 251) filed on or after November 29, 2000. Exceptions to publication are set forth in 35 U.S.C. 122(b)(2) and 37 CFR 1.211. Further, voluntary publication may be requested under 37 CFR 1.221(a) for applications filed before, but pending on, November 29, 2000. An applicant may find publication of an application to be a desirable alternative to requesting a SIR since publication of the application is achieved without any waiver of patent rights. >See MPEP § 1120 *et seq.* for more information pertaining to eighteen months publication of patent applications.<

\*\*>

PTO/SB/94 (05-03)  
 Approved for use through 04/30/2006. OMB 0651-0036  
 U.S. Patent and Trademark Office; U.S. DEPARTMENT OF COMMERCE

Under the Paperwork Reduction Act of 1995, no persons are required to respond to a collection of information unless it displays a valid OMB control number.

## Request for Statutory Invention Registration

Application Number \_\_\_\_\_, or  attached hereto

Filed: \_\_\_\_\_

Titled: \_\_\_\_\_

Applicant(s): \_\_\_\_\_

A. In the above identified patent application, I hereby:

1. Request and authorize the Director of Patent and Trademark Office to publish the above identified regularly filed patent application as a Statutory Invention Registration. (35 U.S.C. 157)
2. Waive the right to receive a United States patent on the same invention claimed in the above identified patent application. These rights, which are waived, include those specified in 35 U.S.C. 183 and 271 through 289 as well as all attributes specified for patents in any other provisions of law other than title 35, United States Code. The waiver includes, but is not limited to, the remedies under 19 U.S.C. 1337 and 1337a, 22 U.S.C. 2356 and 28 U.S.C. 1498. (35 U.S.C. 157(c))
3. Understand that the above waiver will be effective pursuant to 37 CFR 1.293 upon publication of the Statutory Invention Registration to waive the inventor's right to receive a United States patent on the invention claimed in the Statutory Invention Registration. (37 CFR 1.293(b)(1))
4. State that, in my opinion, the disclosure and claims of the above identified patent application meet the requirements of 35 U.S.C. 112. (37 CFR 1.293(b)(3))
5. State that, in my opinion, the above identified patent application complies with the requirements for printing as set forth in the Rules of Practice for Patent Cases, 37 CFR Part 1. (37 CFR 1.293(b)(4))
6. Enclose the fee set forth in 37 CFR 1.17(n) or (o) for requesting publication of a Statutory Invention Registration:

A first Office Action has not been mailed in the above application, 37 CFR 1.17(n) \_\_\_\_\_ \$ \_\_\_\_\_

A first Office Action has been mailed in the above application, 37 CFR 1.17(o) \_\_\_\_\_ \$ \_\_\_\_\_

Request fee \$ \_\_\_\_\_

**MINUS BASIC FILING FEE, IF PREVIOUSLY PAID**

Basic filing fee for utility patent application set forth in 37 CFR 1.16(a);

Basic filing fee for design patent application set forth in 37 CFR 1.16(f); or

Basic filing fee for plant patent application set forth in 37 CFR 1.16(g)

Minus basic filing fee \$ \_\_\_\_\_

Amount due \$ \_\_\_\_\_

Payment charged to credit card \_\_\_\_\_ Form PTO-2038 is attached.

Amount enclosed by check or money order \_\_\_\_\_

Please charge Deposit Account No. \_\_\_\_\_ the amount of \$ \_\_\_\_\_

If payment of any additional fee is required for publication of the Statutory Invention Registration, charge such amount to Deposit Account No. \_\_\_\_\_

\* Where this request is submitted at the time the application is filed, the filing fee is included in the fee.

[Page 1 of 2]

This collection of information is required by 37 CFR 157. The information is required to obtain or retain a benefit by the public which is to file (and by the USPTO to process) an application. Confidentiality is governed by 35 U.S.C. 122 and 37 CFR 1.14. This collection is estimated to take 24 minutes to complete, including gathering, preparing, and submitting the completed application form to the USPTO. Time will vary depending upon the individual case. Any comments on the amount of time you require to complete this form and/or suggestions for reducing this burden, should be sent to the Chief Information Officer, U.S. Patent and Trademark Office, U.S. Department of Commerce, P.O. Box 1450, Alexandria, VA 22313-1450. DO NOT SEND FEES OR COMPLETED FORMS TO THIS ADDRESS. SEND TO: **Commissioner for Patents, P.O. Box 1450, Alexandria, VA 22313-1450.**

*If you need assistance in completing the form, call 1-800-PTO-9199 and select option 2.*

PTO/SB/94 (05-03)

Approved for use through 04/30/2006. OMB 0651-0036

U.S. Patent and Trademark Office; U.S. DEPARTMENT OF COMMERCE

Under the Paperwork Reduction Act of 1995, no persons are required to respond to a collection of information unless it displays a valid OMB control number.

B. For printing of the Statutory Invention Registration front page, if desired, list below the name(s) of not more than 3 registered patent attorneys and agents OR alternatively, the name of a firm having as a member a registered patent attorney or agent. If no name is listed below, no name will be printed on the Statutory Invention Registration.

\_\_\_\_\_  
\_\_\_\_\_

C. Name of assignee, if any, for printing on the Statutory Invention Registration \_\_\_\_\_  
Address (City and State or Country) \_\_\_\_\_  
State of incorporation, if assignee is a corporation \_\_\_\_\_

**WARNING: Information on this form may become public. Credit card information should not be included on this form. Provide credit card information and authorization on PTO-2038.**

\_\_\_\_\_  
Signature(s) (37 CFR 1.293(a))  
 attorney or agent of record  applicant(s) and any assignee



### 1103 Examination of a SIR [R-2]

*37 CFR 1.294. Examination of request for publication of a statutory invention registration and patent application to which the request is directed.*

(a) Any request for a statutory invention registration will be examined to determine if the requirements of § 1.293 have been met. The application to which the request is directed will be examined to determine (1) if the subject matter of the application is appropriate for publication, (2) if the requirements for publication are met, and (3) if the requirements of 35 U.S.C. 112 and § 1.293 of this part are met.

(b) Applicant will be notified of the results of the examination set forth in paragraph (a) of this section. If the requirements of § 1.293 and this section are not met by the request filed, the notification to applicant will set a period of time within which to comply with the requirements in order to avoid abandonment of the application. If the application does not meet the requirements of 35 U.S.C. 112, the notification to applicant will include a rejection under the appropriate provisions of 35 U.S.C. 112. The periods for reply established pursuant to this section are subject to the extension of time provisions of § 1.136. After reply by the applicant, the application will again be considered for publication of a statutory invention registration. If the requirements of § 1.293 and this section are not timely met, the refusal to publish will be made final. If the requirements of 35 U.S.C. 112 are not met, the rejection pursuant to 35 U.S.C. 112 will be made final.

(c) If the examination pursuant to this section results in approval of the request for a statutory invention registration the applicant will be notified of the intent to publish a statutory invention registration.

An examiner in Art Unit 3641 or 3662, where appropriate, will determine whether the application in which a request for a statutory invention registration has been filed is a pending nonprovisional application. If the application was abandoned at the time the request was filed, has been patented, or has been allowed and the issue fee paid, the examiner should return the SIR request to the requester accompanied by a Return of Statutory Invention Registration Request to Requester notice (form \*>SIR-C<).

If the application is pending, the examiner should ascertain whether an Office action with a rejection under 35 U.S.C. 112 has been issued and not replied to. If so, and if there remains any time to reply to the rejection, the examiner should send the applicant a courtesy notice requiring a timely reply. If no time for reply remains, the application is abandoned and the examiner should inform the applicant of this fact.

After the examiner handling the SIR has ascertained that all outstanding rejections under 35 U.S.C. 112 have been replied to, the examiner should verify

that the request for a SIR meets the requirements of 37 CFR 1.293. First, applicant should be notified of any defects in the signature on the SIR request or of any inadequacy of the SIR fee. A 1-month time period should be set for applicant to correct the signature or fee before any further consideration of the SIR request is given. \*\*>A Notice of Improper Request for a Statutory Invention Registration (form SIR-E)< may be used for this purpose. Next, applicant should be given 1 month to correct any other informalities in the SIR request under 37 CFR 1.293 and any informalities in the application under 37 CFR 1.294 using a Notice of Informal Statutory Invention Registration (SIR) Request, form \*>SIR-F<. The examiner should also determine whether the application complies with 35 U.S.C. 112. If not, a rejection with a 3-month shortened statutory period for reply should be made using a Notice of Noncompliance with 35 U.S.C. 112 of application having SIR Request, form \*>SIR-I<. Both form \*>SIR-F< and form \*>SIR-I< can be mailed at the same time. If they are, applicant should be given a 3-month shortened statutory period to reply to both forms.

If applicant's reply to form \*>SIR-F< does not correct the defects, the SIR request should be finally refused using a Notice of Final Refusal of Informal Statutory Invention Registration (SIR) Request, form \*>SIR-G<. If applicant's reply to the rejection set forth on form \*>SIR-I< does not bring the application into compliance with 35 U.S.C. 112, the rejection should be made final.

After the application complies with 37 CFR 1.293, 37 CFR 1.294, and 35 U.S.C. 112, the examiner should determine whether the application is involved in a pending interference. If so, applicant should be notified, using form \*>SIR-J<, that no decision will be made on the SIR request until the interference proceedings are concluded.

If the applicant has lost priority of any claims due to a concluded interference, applicant should be given 1 month, using form \*>SIR-J<, to cancel the lost claims (if a statutory invention registration is still desired with claims on which priority was not lost) or to request withdrawal of the request for statutory invention registration (if further prosecution as to patentability is desired). See MPEP § 1109. If none of the claims in the application was lost in interference, and if the application complies with 37 CFR 1.293,

37 CFR 1.294, and 35 U.S.C. 112, then the application is in condition to be prepared for publication. See MPEP § 1107.

An application under secrecy order will be withheld from publication during such period as the national interest requires, and the applicant should be informed of this fact by using a Notice of Statutory Invention Registration \* Acceptance (Form D-11), form \*>SIR-N (Form D-11)<.

## 1105 Review of Final Refusal to Publish SIR [R-2]

*37 CFR 1.295. Review of decision finally refusing to publish a statutory invention registration.*

\*\*>

(a) Any requester who is dissatisfied with the final refusal to publish a statutory invention registration for reasons other than compliance with 35 U.S.C. 112 may obtain review of the refusal to publish the statutory invention registration by filing a petition to the Director accompanied by the fee set forth in § 1.17(h) within one month or such other time as is set in the decision refusing publication. Any such petition should comply with the requirements of § 1.181(b). The petition may include a request that the petition fee be refunded if the final refusal to publish a statutory invention registration for reasons other than compliance with 35 U.S.C. 112 is determined to result from an error by the Patent and Trademark Office.<

(b) Any requester who is dissatisfied with a decision finally rejecting claims pursuant to 35 U.S.C. 112 may obtain review of the decision by filing an appeal to the Board of Patent Appeals and Interferences pursuant to § 1.191. If the decision rejecting claims pursuant to 35 U.S.C. 112 is reversed, the request for a statutory invention registration will be approved and the registration published if all of the other provisions of § 1.293 and this section are met.

An applicant who is dissatisfied with a final refusal to publish a SIR for reasons other than compliance with 35 U.S.C. 112 may obtain review by filing a petition as set forth in 37 CFR 1.295(a). The petition should be directed to the TC Director responsible for the art unit handling the SIR.

An applicant who is dissatisfied with a decision finally rejecting claims under 35 U.S.C. 112 may obtain review by filing an appeal with the Board of Patent Appeals and Interferences as set forth in 37 CFR 1.295(b).

## 1107 Preparing a SIR for Publication [R-2]

>For Image File Wrapper (IFW) processing, see the IFW Manual.<

In preparing a nonprovisional application with a SIR request for publication, the examiner should fill out the face of the application file wrapper in the same manner as in a non-SIR application. Additionally, the examiner should add the notation “OK for SIR” in the space provided for the primary examiner’s signature and “SIR” should be indicated next to the space for the patent number. A form \*>PTO-SIR-M< is attached to the “LABEL AREA” on the face of the file wrapper to indicate that the application is for a statutory invention registration. An issue classification slip (form PTO-270 or PTO-328) is filled out and attached inside the file wrapper for series 08/ and earlier applications in the normal manner with the additional notation of “SIR” added to the left side of the space allocated for the patent number. The index of claims inside the left flap of the file wrapper is filled out, with the notation “\*” indicating the claims to be published in the SIR. The final official classification of the application and the figure to be published in the *Official Gazette* are indicated, as in non-SIR applications, on the front of the file wrapper.

A Notice of Intent to Publish Statutory Invention Registration, form \*>SIR-L<, is prepared and sent to the applicant. Requirements for corrected or formal drawings and examiner’s amendments may be attached to the Notice of Intent to Publish Statutory Invention Registration as needed. If corrected drawings are required, the examiner should set a 3 month shortened statutory period for submission of the drawings and indicate that the shortened statutory period is not extendable under 37 CFR 1.136(a) or 37 CFR 1.136(b). After the form \*>SIR-L< has been mailed, the application is forwarded to the Office of Patent Publication.

## 1109 Withdrawal of SIR Request [R-2]

*37 CFR 1.296. Withdrawal of request for publication of statutory invention registration.*

A request for a statutory invention registration, which has been filed, may be withdrawn prior to the date of the notice of the intent to publish a statutory invention registration issued pursuant to § 1.294(c) by filing a request to withdraw the request for publication of a statutory invention registration. The request to withdraw

may also include a request for a refund of any amount paid in excess of the application filing fee and a handling fee of \$130.00 which will be retained. Any request to withdraw the request for publication of a statutory invention registration filed on or after the date of the notice of intent to publish issued pursuant to § 1.294(c) must be in the form of a petition pursuant to § 1.183 accompanied by the fee set forth in § 1.17(h).

If a request to withdraw a SIR is filed in a nonprovisional application which contains a SIR request before a Notice of Intent to Publish Statutory Invention Registration has been mailed, the examiner handling the SIR should ascertain whether any outstanding rejection under 35 U.S.C. 112 is present in the application. If so, the examiner should require a timely reply to the rejection using a Response to Request to Withdraw Request for a Statutory Invention Registration, form \*>SIR-K<. After a timely reply to the rejection is received, the request to withdraw the SIR request will ordinarily be granted and the application forwarded for further examination to whichever art unit would ordinarily examine the art area in which the application is classifiable.

Any request to withdraw a SIR filed after the mailing date of the Notice of Intent to Publish Statutory Invention Registration must be in the form of a petition pursuant to 37 CFR 1.183 accompanied by the fee set forth in 37 CFR 1.17(h). The TC Director responsible for the art unit handling the SIR will inform the applicant of the decision on the petition via a form \*>SIR-K< or Response to Petition under 37 CFR 1.295(a), form \*>SIR-H<.

Note that an original SIR application can be abandoned in favor of a continuing application for a patent, claiming the filing date of the earlier filed application, by filing an express abandonment of the original application and a timely request or petition to withdraw the request for a SIR prior to publication of the SIR.

## 1111 SIR Publication and Effect

37 CFR 1.297. *Publication of statutory invention registration.*

(a) If the request for a statutory invention registration is approved the statutory invention registration will be published. The statutory invention registration will be mailed to the requester at the correspondence address as provided for in § 1.33(a). A notice of the publication of each statutory invention registration will be published in the *Official Gazette*.

(b) Each statutory invention registration published will include a statement relating to the attributes of a statutory invention registration. The statement will read as follows:

A statutory invention registration is not a patent. It has the defensive attributes of a patent but does not have the enforceable attributes of a patent. No article or advertisement or the like may use the term patent, or any term suggestive of a patent, when referring to a statutory invention registration. For more specific information on the rights associated with a statutory invention registration see 35 U.S.C. 157.

Published SIRs are sequentially numbered in a separate “H” series, starting with number “H1”. For a description of the “kind codes” used on other documents published by the U.S. Patent and Trademark Office, see MPEP § 901.04(a).

In accordance with 35 U.S.C. 157(c), a published SIR will be treated the same as a U.S. patent for all defensive purposes, usable as a reference as of its filing date in the same manner as a patent. A SIR is a “constructive reduction to practice” under 35 U.S.C. 102(g) and “prior art” under all applicable sections of 35 U.S.C. 102 including section 102(e). SIRs are classified, cross-referenced, and placed in the search files, disseminated to foreign patent offices, stored in U.S. Patent and Trademark Office computer tapes, made available in commercial data bases, and announced in the *Official Gazette*.

The waiver of patent rights to the subject matter claimed in a statutory invention registration takes effect on publication (37 CFR 1.293(c)) and may affect the patentability of claims in related applications without SIR requests, such as divisional or other continuing applications, since the waiver of patent rights is effective for all inventions claimed in the SIR and would effectively waive the right of the inventor to obtain a patent on the invention claimed in the same application or on the same invention claimed in any other application not issued before the publication date of the SIR. If an application containing generic claims is published as a SIR, the waiver in that application applies to any other related applications to the extent that the same invention claimed in the SIR is claimed in the other application. Examiners should apply standards similar to those applied in making “same invention” double patenting determinations to determine whether a waiver by an inventor to claims in a SIR precludes patenting by the same inventor to subject matter in any related application. If the same



subject matter is claimed in an application and in a published statutory invention registration naming a common inventor, the claims in the application should be rejected as being precluded by the waiver in the statutory invention registration. See 37 CFR 1.104(c)(5). A rejection as being precluded by a waiver in a SIR cannot be overcome by a terminal disclaimer.

The holder of a SIR will not be able to file a reissue application to recapture the rights, including the right to exclude others from making, using, selling, offering to sell, or importing the invention, that were waived by the initial publication of the SIR.

&gt;

## 1120 Eighteen-Month Publication of Patent Applications [R-2]

35 U.S.C. 122. *Confidential status of applications; publication of patent applications.*

\*\*\*\*\*

### (b) PUBLICATION.—

#### (1) IN GENERAL.—

(A) Subject to paragraph (2), each application for a patent shall be published, in accordance with procedures determined by the Director, promptly after the expiration of a period of 18 months from the earliest filing date for which a benefit is sought under this title. At the request of the applicant, an application may be published earlier than the end of such 18-month period.

(B) No information concerning published patent applications shall be made available to the public except as the Director determines.

(C) Notwithstanding any other provision of law, a determination by the Director to release or not to release information concerning a published patent application shall be final and nonreviewable.

#### (2) EXCEPTIONS.—

(A) An application shall not be published if that application is—

- (i) no longer pending;
- (ii) subject to a secrecy order under section 181 of this title;
- (iii) a provisional application filed under section 111(b) of this title; or
- (iv) an application for a design patent filed under chapter 16 of this title.

\*\*\*\*\*

&gt;

### 37 CFR 1.211. *Publication of applications.*

(a) Each U.S. national application for patent filed in the Office under 35 U.S.C. 111(a) and each international application in compliance with 35 U.S.C. 371 will be published promptly after the expiration of a period of eighteen months from the earliest filing date for which a benefit is sought under title 35, United States Code, unless:

- (1) The application is recognized by the Office as no longer pending;
- (2) The application is national security classified (see § 5.2(c)), subject to a secrecy order under 35 U.S.C. 181, or under national security review;
- (3) The application has issued as a patent in sufficient time to be removed from the publication process; or
- (4) The application was filed with a nonpublication request in compliance with § 1.213(a).

(b) Provisional applications under 35 U.S.C. 111(b) shall not be published, and design applications under 35 U.S.C. chapter 16 and reissue applications under 35 U.S.C. chapter 25 shall not be published under this section.

(c) An application filed under 35 U.S.C. 111(a) will not be published until it includes the basic filing fee (§ 1.16(a) or 1.16(g)), any English translation required by § 1.52(d), and an executed oath or declaration under § 1.63. The Office may delay publishing any application until it includes a specification having papers in compliance with § 1.52 and an abstract (§ 1.72(b)), drawings in compliance with § 1.84, and a sequence listing in compliance with §§ 1.821 through 1.825 (if applicable), and until any petition under § 1.47 is granted.

(d) The Office may refuse to publish an application, or to include a portion of an application in the patent application publication (§ 1.215), if publication of the application or portion thereof would violate Federal or state law, or if the application or portion thereof contains offensive or disparaging material.

(e) The publication fee set forth in § 1.18(d) must be paid in each application published under this section before the patent will be granted. If an application is subject to publication under this section, the sum specified in the notice of allowance under § 1.311 will also include the publication fee which must be paid within three months from the date of mailing of the notice of allowance to avoid abandonment of the application. This three-month period is not extendable. If the application is not published under this section, the publication fee (if paid) will be refunded. <

## I. IN GENERAL

With certain exceptions, nonprovisional utility and plant applications for patent filed on or after November 29, 2000 are published promptly after the expiration of a period of eighteen months from the earliest filing date for which a benefit is sought under title 35, United States Code (eighteen-month publication or pre-grant publication (PGPub)). See 35 U.S.C. 122(b). The Office will generally publish:

(A) utility and plant applications filed under 35 U.S.C. 111(a) on or after November 29, 2000; and

(B) nonprovisional applications which entered the national stage after compliance with 35 U.S.C. 371 from an international application under 35 U.S.C. 363 filed on or after November 29, 2000 (regardless of whether the international application has been published by the International Bureau (IB) under PCT Article 21 in English).

The Office will not publish the following applications under 35 U.S.C. 122(b):

(A) Provisional applications filed under 35 U.S.C. 111(b) (for more information see subsection II. EXCEPTIONS below);

(B) Design applications filed under 35 U.S.C. 171; and

(C) Reissue applications filed under 35 U.S.C. 251 (because reissue applications are not kept confidential under 35 U.S.C. 122(a)).

Applications will be published after the expiration of a period of eighteen months from the earliest of: (1) the U.S. filing date; (2) the international filing date; or (3) the filing date of an earlier application if the application claims benefit of the earlier application under 35 U.S.C. 119, 120, 121, or 365. Applicants are encouraged to timely submit any desired priority and benefit claims to ensure that their applications will be published on time and to avoid the need to file a petition to accept unintentionally delayed priority or benefit claims under 37 CFR 1.55 or 1.78 and the surcharge set forth in 37 CFR 1.17(t). See MPEP § 201.11 and § 201.13. Applications are normally published based on the application as filed and certain amendments. See MPEP § 1121. A proper continued prosecution application (CPA) for utility or plant patent filed on or after November 29, 2000 will be published based upon the application papers deposited on the filing date of the first prior application. (Note: CPA practice has been eliminated as to utility and plant applications effective July 14, 2003. See MPEP § 201.06(d).) Since a request for continued examination (RCE) under 37 CFR 1.114 is not the filing of a new application, filing an RCE will not cause an application filed before November 29, 2000 to be published. The Office will not mail a paper copy of the patent application publication to the applicant, but will mail a notice to the applicant indicating that the

application has been published. See MPEP § 1127. Patent application publications are available on the USPTO web site ([www.uspto.gov](http://www.uspto.gov)).

## II. EXCEPTIONS

An application will not be published if one of the following exceptions as set forth in 37 CFR 1.211 applies:

(A) The application is recognized by the Office as no longer pending; for information on express abandonment to avoid publication see 37 CFR 1.138(c) and MPEP § 1125;

(B) The application is national security classified (see 37 CFR 5.2(c)), subject to a secrecy order under 35 U.S.C. 181, or under national security review;

(C) The application has issued as a patent in sufficient time to be removed from the publication process; or

(D) The application was filed with a nonpublication request in compliance with 37 CFR 1.213(a). See MPEP §§ 1122-1124.

The Office will not publish applications that are recognized as no longer pending. See 37 CFR 1.211(a)(1). An application is not “recognized by the Office as no longer pending” when the period for reply (either the shortened statutory period for reply or the maximum extendable period for reply) to an Office action has expired, but the Office has not yet entered the change of status (to abandoned) of the application in the Office’s Patent Application Locating and Monitoring (PALM) system and mailed a notice of abandonment. An application will remain in the publication process until the PALM system indicates that the application is abandoned. Once the PALM system indicates that an application is abandoned, the Office will attempt to remove the application from the publication process and avoid dissemination of the application information.

Unless an applicant has received a notice of abandonment at least 4 weeks prior to the projected publication date, an applicant who wants to abandon the application to avoid publication must file a petition under 37 CFR 1.138(c) to expressly abandon the application and avoid publication. See MPEP § 1125. An applicant who seeks to avoid publication by permitting an application to become abandoned (for failure to reply to an Office action) and passively waiting

for the Office to recognize that the application has become abandoned bears the risk that the Office will not recognize that the application has become abandoned and change the status of the application in the PALM system in sufficient time to avoid publication.

The Office will not publish applications that have issued as patents in sufficient time to be removed from the publication process. See 37 CFR 1.211(a)(3). If the pre-grant publication process coincides with the patent issue process, the Office will continue with the pre-grant publication process until a patent actually issues. This is because there are many instances in which the Office mails a notice of allowance in an application but the application does not issue as a patent in regular course (e.g., abandonment due to failure to pay the issue fee, or withdrawal from issue). Therefore, the Office will not discontinue the pre-grant publication process until a patent has actually issued. Since the Office cannot discontinue the pre-grant publication process during the last two to four weeks of the publication process, this will result in a few applications being issued as patents and subsequently being published as patent application publications.

The Office may refuse to publish an application, or to include a portion of an application in the publication, if publication of the application or portion thereof would violate Federal or state law, or if the application or portion thereof contains offensive or disparaging material. See 37 CFR 1.211(d). The Office may require a substitute specification to delete the portion of the application that would violate Federal or state law, or that contains offensive or disparaging material.

Converting a nonprovisional application to a provisional application will not avoid the publication of the nonprovisional application unless the request to convert is recognized in sufficient time to permit the appropriate officials to remove the nonprovisional application from the publication process. The Office cannot ensure that it can remove an application from the publication process or avoid publication of application information any time after the publication process for the application has been initiated. Technical preparations for publication of an application generally begin four months prior to the projected publication date. The projected publication date is indicated on the filing receipt for the patent application.

### III. APPLICATION MUST BE COMPLETE

In accordance with 37 CFR 1.211(c), publication will not occur or will be delayed in certain circumstances. The Office will not publish an application until the application includes:

- (A) the basic filing fee;
- (B) an English translation if the application is in a language other than English; and
- (C) an executed oath or declaration under 37 CFR 1.63.

The Office may delay publication until the application includes:

- (A) a specification in compliance with 37 CFR 1.52;
- (B) an abstract in compliance with 37 CFR 1.72(b);
- (C) drawings (if any) in compliance with 37 CFR 1.84; and
- (D) a sequence listing in compliance with 37 CFR 1.821 through 1.825 (if applicable).

The Office may also delay publication until any petition under 37 CFR 1.47 is granted.

If an application does not contain the content specified in 37 CFR 1.211(c) and papers or drawings of sufficient quality to create a patent application publication by eighteen months from the earliest filing date for which benefit is claimed, the Office will publish the application as soon as practical after these deficiencies are corrected. For example, publication of the patent application publication may be delayed if the application papers submitted on the filing date of the application do not include the content needed (e.g., an abstract or an executed oath or declaration) or the specification (including claims) or drawings are not of sufficient quality to be used to create a patent application publication. In such a situation, the Office will issue a preexamination notice requiring a substitute specification or replacement drawings. The applicant's reply (e.g., substitute specification or replacement drawings) to the notice will be used for creating the patent application publication. If the application on filing includes papers that are of sufficient quality to create the publication, the Office will publish the application using the originally filed application papers.

Applicants who attempt to delay publication by intentionally delaying the submission of the application content necessary for publication may encounter a reduction in any patent term adjustment under 35 U.S.C. 154(b). See 35 U.S.C. 154(b)(2)(C)(ii) and 37 CFR 1.704(b).

#### IV. PROJECTED PUBLICATION DATE

Once the application is complete, the Office will provide applicants the projected publication date of the application on a filing receipt. The projected publication date normally will be the later of: (1) eighteen months from the earliest filing date claimed; or (2) fourteen weeks from the mailing date of the filing receipt. The publication process takes about fourteen weeks. Publication occurs on Thursday of each week.

Applicants should carefully and promptly review their filing receipts. Applicants should contact the Pre-Grant Publication Division (see MPEP § 1730) if the projected publication date is incorrect or if a projected publication date has been assigned to an application that should not be published. Applicants should also promptly check any priority or benefit claims provided on the filing receipt and timely file any desired priority or benefit claims if the filing receipt does not include the desired claims. This will avoid the need to file a petition under 37 CFR 1.55 or 1.78 to accept unintentionally delayed claims and the surcharge under 37 CFR 1.17(t). See MPEP §§ 201.11 and 201.13. <

>

### 1121 Content of a Patent Application Publication [R-2]

#### *37 CFR 1.215. Patent application publication*

(a) The publication of an application under 35 U.S.C. 122(b) shall include a patent application publication. The date of publication shall be indicated on the patent application publication. The patent application publication will be based upon the application papers deposited on the filing date of the application, as well as the executed oath or declaration submitted to complete the application, and any application papers or drawings submitted in reply to a preexamination notice requiring a title and abstract in compliance with § 1.72, application papers in compliance with § 1.52, drawings in compliance with § 1.84, or a sequence listing in compliance with §§ 1.821 through 1.825, except as otherwise provided in this section. The patent application publication will not include any amendments, including preliminary amendments, unless applicant supplies a copy of the application containing the amendment pursuant to paragraph (c) of this section.

(b) If applicant wants the patent application publication to include assignee information, the applicant must include the assignee information on the application transmittal sheet or the application data sheet (§ 1.76). Assignee information may not be included on the patent application publication unless this information is provided on the application transmittal sheet or application data sheet included with the application on filing. Providing this information on the application transmittal sheet or the application data sheet does not substitute for compliance with any requirement of part 3 of this chapter to have an assignment recorded by the Office.

(c) At applicant's option, the patent application publication will be based upon the copy of the application (specification, drawings, and oath or declaration) as amended during examination, provided that applicant supplies such a copy in compliance with the Office electronic filing system requirements within one month of the actual filing date of the application or fourteen months of the earliest filing date for which a benefit is sought under title 35, United States Code, whichever is later.

(d) If the copy of the application submitted pursuant to paragraph (c) of this section does not comply with the Office electronic filing system requirements, the Office will publish the application as provided in paragraph (a) of this section. If, however, the Office has not started the publication process, the Office may use an untimely filed copy of the application supplied by the applicant under paragraph (c) of this section in creating the patent application publication.

A patent application publication includes a front page containing information similar to that contained on the front page of a patent, the drawings (if any), and the specification (including claims). The patent application publication will generally be based upon the following:

(A) The patent application papers and drawings deposited on the filing date of the application;

(B) The executed oath or declaration submitted to complete the application;

(C) Any subsequently filed application papers and drawings submitted in reply to a preexamination notice requiring a title and abstract in compliance with 37 CFR 1.72, application papers in compliance with 37 CFR 1.52, drawings in compliance with 37 CFR 1.84, or a sequence listing in compliance with 37 CFR 1.821 through 1.825; and

(D) The correspondence address for the application according to Office records at the time the publication process was initiated.

The patent application publication may also be based upon amendments that expedite the publication process, provided that such amendments are submitted in sufficient time to be entered into the application

file before technical preparations for publication of the application have begun (generally four months prior to the projected publication date). For example, the patent application publication may also be based upon:

(A) Amendments to the specification that are reflected in a substitute specification under 37 CFR 1.125(b);

(B) An amendment to the abstract under 37 CFR 1.121(b);

(C) Amendments to the claims that are reflected in a complete claim listing under 37 CFR 1.121(c); and

(D) Amendments to drawings under 37 CFR 1.121(d).

The patent application publication of an application that has entered the national stage under 35 U.S.C. 371 may also include amendments made during the international stage, such as: amendments under Article 34 and 19; rectifications; corrections of physical defects under PCT Rule 26; and an abstract rewritten by the International Searching Authority.

If an applicant wants the publication to include drawings other than those submitted with the application as filed (e.g., better quality or amended drawings), applicant may file the replacement drawings in sufficient time to be entered into the application file before four months prior to the projected publication date. The Office cannot guarantee that the latest amendment or any particular amendment will be included in the patent application publication. If applicant wishes to have a particular amended specification (including claims) and drawings to be included in the publication, applicants must submit the amended specification (including claims) and drawings via the electronic filing system (EFS) within one month of the mailing date of the first Office correspondence (e.g., filing receipt) including a confirmation number for the application or fourteen months of the earliest filing date for which a benefit is sought under title 35, United States Code, whichever is later (see 37 CFR 1.215(c) and *Assignment of Confirmation Number and Time Period for Filing a Copy of an Application by EFS for Eighteen-Month Publication Purposes*, 1241 *Off. Gaz. Pat. Office* 97 (December 12, 2000)). See also III. AMENDED APPLICATION FILED VIA EFS, below. The Office will use the elec-

tronic copy provided by the applicant to create the publication. A proper continued prosecution application (CPA) filed on or after November 29, 2000 (but before July 14, 2003) will be published based upon the application papers deposited on the filing date of the first prior application.

Applicants may review the bibliographic information contained in the Office's database, and application papers that have been scanned into the Image File Wrapper system, via the Office's Patent Application Information Retrieval (PAIR) system. Applicants should bring any errors to the Office's attention before technical preparations for publication of the application have begun (generally four months prior to the projected publication date).

Long nucleotide and/or amino acid sequences or large numbers of such sequences are very difficult for the Office to publish as part of patent application publications. Therefore, long sequence listings will only be published in electronic form on the USPTO sequence homepage (<http://seqdata.uspto.gov>) as an ASCII text file. The patent application publication will include a statement that the application contains a lengthy sequence listing section and a hyperlink to the web page containing the sequence listing. See *Notice of Change in Publishing of Patents and Patent Application Publications With Sequence Listings*, 1250 *Off. Gaz. Pat. Office* 70 (September 11, 2001).

## I. AMENDMENTS

The patent application publication will be based on certain amendments, including preliminary amendments as discussed above (e.g., amended application filed via EFS). To avoid submitting preliminary amendments, applicants should incorporate any desired amendments into the text of the specification including a new set of claims, even where the application is a continuation or divisional application of a previously-filed patent application. In such a continuation or divisional application, a new specification (e.g., reflecting amendments made in the parent application) may be submitted together with a copy of the oath or declaration from the previously filed application so long as no new matter is included in the specification. See 37 CFR 1.63(d)(1)(iii). Additionally, applications with poor quality text, which may be acceptable for scanning and examination purposes, may lead to errors in the patent application publica-

tion. Correction of these errors and inclusion of any desired amendments into the text of the originally-filed specification and drawings will only occur if applicant files a request for republication under 37 CFR 1.221(a). They will not be corrected by the Office in a corrected publication under 37 CFR 1.221(b). See MPEP § 1130.

**II. APPENDICES**

Appendices, other than those containing sequence listings or certain tables, are not printed if they are contained on pages located after the claims. If the application includes multiple claim sets in the specification, the Office may treat pages located after the first set of claims as appendices. Note that computer program listings may be printed if they are included in the specification before the claims, but that computer program listings that are provided on compact disc in accordance with 37 CFR 1.96(c) and 1.52(e) are not printed as part of the patent or patent application publication.

**III. AMENDED APPLICATION FILED VIA EFS**

At applicant’s option, a patent application publication may be based upon an amended specification (including claims) and drawings filed via the Electronic Filing System (EFS). See 37 CFR 1.215(c). If applicant files a replacement copy of the specification (including claims) and drawings through EFS within one month of the filing date of the application or fourteen months of the earliest filing date for which a benefit is sought under title 35, United States Code, whichever is later, the replacement copy will be used in printing the patent application publication. Since a confirmation number must be used when submitting an EFS copy of the application for publication, the Office will accept an EFS copy of the application submitted within one month of the mailing date of the first Office correspondence containing a confirmation number (e.g., filing receipt). See *Assignment of Confirmation Number and Time Period for Filing a Copy of an Application by EFS for Eighteen-Month Publication Purposes*, 1241 *Off. Gaz. Pat. Office* 97 (December 12, 2000). If the replacement copy is submitted outside the time period, it may still be used to create the patent application publication so long as it is received before the Office has started the publica-

tion process. For further information about EFS, see the Electronic Business Center on the USPTO web site ([www.uspto.gov](http://www.uspto.gov)).

**IV. ASSIGNEE INFORMATION**

If the applicant would like the assignee data to be published, the information should be provided on the application transmittal letter or the application data sheet (ADS) filed with the application. The applicant may also submit the information via PAIR using the “Bib-Data Review Prior to Publication” screens or submit a letter to the Office requesting that the assignee’s name be included on the patent application publication, and request a corrected filing receipt acknowledging the request. Requests to include assignment data that are submitted after the filing date of the application will only result in the patent application publication including the assignment data if it is received and entered before the publication process has begun. If the assignee data is recorded with the Assignment Division only, the information will not be published as part of the patent application publication.

Errors in assignee information printed on the publication are not considered material mistakes by the Office under 37 CFR 1.221(b) (e.g., errors in the assignee’s name). See MPEP § 1130. Thus, these assignment errors and applicant’s failure to include assignment data may only be corrected if applicant files a request for republication under 37 CFR 1.221(a).<

>

**1122 Requests for Nonpublication [R-2]**

35 U.S.C. 122. *Confidential status of applications; publication of patent applications.*

\*\*\*\*\*

(b) PUBLICATION.—

\*\*\*\*\*

(2) EXCEPTIONS.—

\*\*\*\*\*

(B)(i) If an applicant makes a request upon filing, certifying that the invention disclosed in the application has not and will not be the subject of an application filed in another country, or under a multilateral international agreement, that requires publication of applications 18 months after filing, the application shall not be published as provided in paragraph (1).

\*\*\*\*\*

*37 CFR 1.213. Nonpublication request.*

(a) If the invention disclosed in an application has not been and will not be the subject of an application filed in another country, or under a multilateral international agreement, that requires publication of applications eighteen months after filing, the application will not be published under 35 U.S.C. 122(b) and § 1.211 provided:

(1) A request (nonpublication request) is submitted with the application upon filing;

(2) The request states in a conspicuous manner that the application is not to be published under 35 U.S.C. 122(b);

(3) The request contains a certification that the invention disclosed in the application has not been and will not be the subject of an application filed in another country, or under a multilateral international agreement, that requires publication at eighteen months after filing; and

(4) The request is signed in compliance with § 1.33(b).

\*\*\*\*\*

If the invention disclosed in an application filed under 35 U.S.C. 111(a) has not been and will not be the subject of a foreign or international application filed in another country, or under a multilateral international agreement, that requires publication of applications eighteen months after filing (e.g., a counterpart PCT application), applicants may request that the application filed under 35 U.S.C. 111(a) not be published by filing a nonpublication request under 37 CFR 1.213(a). The Office will not publish an application filed under 35 U.S.C. 111(a) with a nonpublication request in compliance with the following:

(A) The request for nonpublication under 37 CFR 1.213(a) must be submitted with the application **upon filing** (this is a statutory requirement and cannot be waived);

(B) The request for nonpublication must state in a **conspicuous** manner that the application is not to be published under 35 U.S.C. 122(b) (see Form PTO/SB/35 in MPEP § 1135);

(C) The request must contain a certification that the invention disclosed in the application **has not been and will not** be the subject of an application filed in another country, or under a multilateral international agreement, that requires eighteen-month publication. Before making the certification, the person who signs the certification must make an **actual inquiry** to determine whether the certification under 35 U.S.C. 122(b)(2)(B)(i) and 37 CFR 1.213(a)(3) can be appropriately made (see I. REQUIREMENTS PRIOR TO FILING A NONPUBLICATION REQUEST, below); and

(D) The request is signed in compliance with 37 CFR 1.33(b).

If applicant filed a nonpublication request and later decides to file a counterpart foreign or international application in another country, or under a multilateral agreement, that requires eighteen-month publication, applicant must either: (1) rescind the nonpublication request before filing such foreign or international application; or (2) notify the Office of such filing no later than 45 days after the filing date of the counterpart foreign or international application. See MPEP §§ 1123 and 1124.

## I. REQUIREMENTS PRIOR TO FILING A NONPUBLICATION REQUEST

A nonpublication request is not appropriate unless the person who is signing the nonpublication request has made an actual inquiry consistent with the requirements of 37 CFR 10.18(b) to determine that:

(A) The application under 35 U.S.C. 111(a) has not been the subject of a foreign or international application filed in another country, or under a multilateral international agreement, that requires publication of applications at eighteen months after filing (e.g., a counterpart PCT application); and

(B) The applicant's intent at the time the nonpublication request is being filed is that the application under 35 U.S.C. 111(a) will not be the subject of a foreign or international application filed in another country, or under a multilateral international agreement, that requires publication of applications at eighteen months after filing.

Only when both conditions are satisfied, can applicants file a nonpublication request under 37 CFR 1.213(a). A nonpublication request is not appropriate if applicants have already filed a counterpart foreign or international application in another country, or under a multilateral international agreement, that requires publication of applications at eighteen months after filing. A nonpublication request is not proper even if the foreign or international application is abandoned before the foreign or international application is published.

A nonpublication request also is not appropriate if the applicant has not yet made a decision whether to file a counterpart application in a foreign country, or under a multilateral international agreement, that

requires publication of applications at eighteen months after filing. A certification under 37 CFR 1.213(a)(3) cannot be made based on a lack of knowledge of the applicant's plans concerning the filing of any counterpart application that would be subject to eighteen-month publication or the applicant's past practices or tendencies with respect to the filing of foreign counterpart applications. The fact that a particular applicant has a tendency to file counterpart applications for fewer than fifty percent of its U.S. applications is not alone an adequate basis for filing all or any of the U.S. applications with a nonpublication request. The applicant must have an affirmative intent not to file a counterpart application, and not just the absence of any intent or plan concerning the filing of any counterpart application that would be subject to eighteen-month publication. A nonpublication request is only appropriate if the applicant's intent at the time the nonpublication request is being filed is not to file a counterpart foreign or international application that would be subject to eighteen-month publication.

## II. FILING A NONPUBLICATION REQUEST

Applicants should use the format set forth in form PTO/SB/35, Nonpublication Request under 35 U.S.C. 122(b)(2)(B)(i), to ensure that the certification includes the proper language required by the statute and the request is stated in a conspicuous manner. Form PTO/SB/35 is available from the USPTO website ([www.uspto.gov](http://www.uspto.gov)), and is reproduced in MPEP § 1135. A nonpublication request that does not include the language required by 35 U.S.C. 122(b)(2)(B)(i) (i.e., certifying that the "invention disclosed in the application has not and will not be the subject of an application filed in another country, or under a multilateral international agreement, that requires publication of applications 18 months after filing") will not be accepted. A nonpublication request must be included with the application on filing. This is a statutory requirement and cannot be waived. If the Office mistakenly accepts an improper nonpublication request, applicants should notify the Pre-Grant Publication Division and rescind the request immediately. See MPEP § 1730 for contact information.

A request for nonpublication may not be recognized unless it is conspicuous. See 37 CFR 1.213(a)(2). Providing text as one paragraph among

numerous other paragraphs with no highlighting of the request for non-publication is not conspicuous, and thus the Office's assignment of a publication date would be appropriate.

When the Office recognizes the nonpublication request, the filing receipt will not include a projected publication date. If applicant includes a nonpublication request as specified by 35 U.S.C. 122(b)(2)(B)(i) and the filing receipt reflects a projected publication date, applicant should promptly contact the Office and determine whether the nonpublication request was overlooked.

## III. INAPPROPRIATE NONPUBLICATION REQUEST

If prior to filing a U.S. application under 35 U.S.C. 111(a), applicants have filed a counterpart foreign or international application in a foreign country, or under a multilateral international agreement, that requires publication of applications 18 months after filing, a nonpublication request would not be appropriate in the U.S. application. If applicants filed a nonpublication request in a U.S. application that claims the benefit to an earlier foreign or international application, the Office will not accept the nonpublication request and will assign a projected publication date. The applicant will be notified that the certification is inconsistent with the priority claim. The notice will provide a non-extendable time period of 30 days from the mail date of the notice for applicant to provide a satisfactory explanation as to how the certification submitted is valid in light of the priority claim. If applicants fail to provide a satisfactory explanation, the Office will publish the U.S. application.

If an applicant files a PCT application, abandons the PCT application before the International Bureau publishes the PCT application, and thereafter files a corresponding U.S. application under 35 U.S.C. 111(a) with a non-publication request under 37 CFR 1.213, the nonpublication request is improper. The mere filing of the PCT application precludes the proper use of a nonpublication request, since the invention disclosed in the U.S. application was the subject of an application that was filed under an international agreement requiring publication at 18 months (the PCT application). 35 U.S.C. 122(b)(2)(B)(i) states that an application will not be published "[i]f an applicant makes a request upon filing, certifying that



the invention disclosed in the application has not and will not be the subject of an application filed in another country, or under a multilateral international agreement, that requires publication of applications 18 months after filing, . . . .” The trigger in the statute is not whether the other application will be published, but rather the trigger is the act of filing where eighteen-month publication of patent applications is required. Abandonment of the foreign application, or the application under a multilateral international agreement, prior to foreign publication at 18-months has no bearing on the propriety of requesting nonpublication of the U.S. application.

Where a foreign or PCT application is filed first, and a U.S. application is filed thereafter with an (improper) nonpublication request, the Office will not consider the U.S. application as abandoned for having made the nonpublication request. This is because the statute only provides for an application to be regarded as abandoned when the applicant fails to notify the Office within 45 days of a subsequently filed application that is directed to the same subject as the invention of the U.S. application in another country, or under a multilateral international agreement, that requires eighteen-month publication of applications. 35 U.S.C. 122(b)(2)(B)(iii) does not apply to the situation where the applicant has made an improper certification subsequent to the foreign filing. A petition to revive under 37 CFR 1.137(b)/(f) is inappropriate and not necessary in the above-noted situation because the U.S. application is pending (unless the application is abandoned for other reasons). If a petition to revive under 37 CFR 1.137(b)/(f) is filed, the Office will dismiss the petition as inappropriate but retain the petition fee because the Office was required to evaluate the merits of the petition before being able to determine that the petition was not appropriate.

Applicants and their representatives should make sure that the certification is proper before signing and filing it with the Office. While applicants should rescind any improper nonpublication request as soon as possible, 35 U.S.C. 122(b)(2)(B)(i)-(iv) does not include any provision for “correction” of an improper certification. Any applicant or applicant’s representative who makes a false statement (e.g., an improper certification) may be in violation of 37 CFR 10.18(b). In addition, false statements by registered patent prac-

tioners may also violate other Disciplinary Rules (see 37 CFR Part 10).

While applicant cannot undo the fact that an improper certification was made, any applicant who has made such a mistake should promptly file a rescission of the nonpublication request and note that the original certification was improper.<

>

## 1123 Rescission of a Nonpublication Request [R-2]

35 U.S.C. 122. *Confidential status of applications; publication of patent applications*

\*\*\*\*\*

(b) PUBLICATION.—

\*\*\*\*\*

(2) EXCEPTIONS.—

\*\*\*\*\*

(B)(i) If an applicant makes a request upon filing, certifying that the invention disclosed in the application has not and will not be the subject of an application filed in another country, or under a multilateral international agreement, that requires publication of applications 18 months after filing, the application shall not be published as provided in paragraph (1).

(ii) An applicant may rescind a request made under clause (i) at any time.

(iii) An applicant who has made a request under clause (i) but who subsequently files, in a foreign country or under a multilateral international agreement specified in clause (i), an application directed to the invention disclosed in the application filed in the Patent and Trademark Office, shall notify the Director of such filing not later than 45 days after the date of the filing of such foreign or international application. A failure of the applicant to provide such notice within the prescribed period shall result in the application being regarded as abandoned, unless it is shown to the satisfaction of the Director that the delay in submitting the notice was unintentional.

(iv) If an applicant rescinds a request made under clause (i) or notifies the Director that an application was filed in a foreign country or under a multilateral international agreement specified in clause (i), the application shall be published in accordance with the provisions of paragraph (1) on or as soon as is practical after the date that is specified in clause (i).

(v) If an applicant has filed applications in one or more foreign countries, directly or through a multilateral international agreement, and such foreign filed applications corresponding to an application filed in the Patent and Trademark Office or the description of the invention in such foreign filed applications is less extensive than the application or description of the invention in the application filed in the Patent and Trademark Office, the applicant may submit a redacted copy of the application filed in

the Patent and Trademark Office eliminating any part or description of the invention in such application that is not also contained in any of the corresponding applications filed in a foreign country. The Director may only publish the redacted copy of the application unless the redacted copy of the application is not received within 16 months after the earliest effective filing date for which a benefit is sought under this title. The provisions of section 154(d) shall not apply to a claim if the description of the invention published in the redacted application filed under this clause with respect to the claim does not enable a person skilled in the art to make and use the subject matter of the claim.

\*\*\*\*\*

*37 CFR 1.213. Nonpublication request.*

\*\*\*\*\*

(b) The applicant may rescind a nonpublication request at any time. A request to rescind a nonpublication request under paragraph (a) of this section must:

- (1) Identify the application to which it is directed;
- (2) State in a conspicuous manner that the request that the application is not to be published under 35 U.S.C. 122(b) is rescinded; and
- (3) Be signed in compliance with § 1.33(b).

\*\*\*\*\*

An applicant may rescind a previously-filed nonpublication request at any time. See 35 U.S.C. 122(b)(2)(B)(ii). Form PTO/SB/36 (revision April 2001 or later) may be used to both rescind a nonpublication request and provide notice of foreign filing. The form is reproduced in MPEP § 1135. If applicant makes a nonpublication request under 35 U.S.C. 122(b)(2)(B)(i) and then rescinds the nonpublication request before or on the date a foreign or international application (hereinafter “foreign filing” or “counterpart application”) directed to the invention disclosed in the U.S. application filed under 35 U.S.C. 111(a) in the USPTO is filed in a foreign country, or under a multilateral international agreement, that requires eighteen-month publication, the nonpublication request under 35 U.S.C. 122(b)(2)(B)(i) will be treated as annulled and the application will be treated as if the nonpublication request was never made. Thus, if applicant filed a nonpublication request and then decided to file a counterpart application, applicant must file either: (1) a request to rescind the nonpublication request before filing the counterpart application; or (2) a notice of foreign filing no later than 45 days after the filing date of the counterpart

application, to avoid abandonment of the application (35 U.S.C. 122(b)(2)(B)(iii) and 37 CFR 1.213(c)).

The mere filing of a request under 37 CFR 1.213(b) to rescind the previously filed nonpublication request does not comply with the notice of foreign filing requirement of 35 U.S.C. 122(b)(2)(B)(iii) and 37 CFR 1.213(c) (for applicants who submitted a nonpublication request but before filing the request to rescind, also filed a counterpart application in another country, or under a multilateral international agreement, that requires eighteen-month publication of applications). Applicants are strongly encouraged to provide a notice of foreign filing whenever rescinding a nonpublication request in anticipation of filing a counterpart application in an eighteen-month publication country. Form PTO/SB/36 (revision April 2001 or later) provides both a rescission and notice of foreign filing. See MPEP § 1135. No benefit can be given to a certificate of mailing or transmission under 37 CFR 1.8 on a request to rescind a nonpublication request in determining whether there has been a rescission of a nonpublication request before or on the date a counterpart application is filed in an eighteen-month publication country. A rescission of a nonpublication request is not a paper required to be filed in the USPTO as provided for in 37 CFR 1.8(a). Thus, the provisions of 37 CFR 1.8 by their terms do not apply in this situation, and the USPTO must use the actual date of receipt in the USPTO as defined in 37 CFR 1.6 as the date of the rescission to determine whether the nonpublication request has been rescinded before or on the date of the filing of a counterpart application such that the application may be considered an application in which no nonpublication request under 35 U.S.C. 122(b)(1)(B)(i) was made. Since a notice of foreign filing is required by the statute and 37 CFR 1.215(c), the benefit of a certificate of mailing or transmission under 37 CFR 1.8 will be given to a notice of foreign filing.

After either a rescission of a nonpublication request or a notice of foreign filing is received by the Office, the Office will enter the rescission or notice of foreign filing into the Office Pre-Examination System to schedule the application for publication. A notice (e.g., a “Notice Regarding Rescission Of Nonpublication Request and Notice of Foreign Filing”) should be sent to inform the applicant of the projected publication date. The application will be published promptly

after the expiration of a period of 18 months from the earliest filing date for which a benefit is sought under title 35, United States Code, or as soon as practicable after mailing this notice. See 35 U.S.C. 122(b)(2)(B)(iv).

An applicant should not rescind a nonpublication request or provide a notice of foreign filing unless a nonpublication request was actually made, because filing a rescission when one is not needed leads to a waste of Office resources and may delay prosecution in the application. Furthermore, filing a rescission of a nonpublication request where a nonpublication request was not originally made may result in a reduction to any patent term adjustment under 35 U.S.C. 154(b).<

>

## 1124 Notice of Foreign Filing [R-2]

35 U.S.C. 122. *Confidential status of applications; publication of patent applications.*

\*\*\*\*\*

(b) PUBLICATION.—

\*\*\*\*\*

(2) EXCEPTIONS.—

\*\*\*\*\*

(B)(iii)An applicant who has made a request under clause (i) but who subsequently files, in a foreign country or under a multilateral international agreement specified in clause (i), an application directed to the invention disclosed in the application filed in the Patent and Trademark Office, shall notify the Director of such filing not later than 45 days after the date of the filing of such foreign or international application. A failure of the applicant to provide such notice within the prescribed period shall result in the application being regarded as abandoned, unless it is shown to the satisfaction of the Director that the delay in submitting the notice was unintentional.

(iv) If an applicant rescinds a request made under clause (i) or notifies the Director that an application was filed in a foreign country or under a multilateral international agreement specified in clause (i), the application shall be published in accordance with the provisions of paragraph (1) on or as soon as is practical after the date that is specified in clause (i).

\*\*\*\*\*

37 CFR 1.213. *Nonpublication request.*

\*\*\*\*\*

(c) If an applicant who has submitted a nonpublication request under paragraph (a) of this section subsequently files an application directed to the invention disclosed in the application in

which the nonpublication request was submitted in another country, or under a multilateral international agreement, that requires publication of applications eighteen months after filing, the applicant must notify the Office of such filing within forty-five days after the date of the filing of such foreign or international application. The failure to timely notify the Office of the filing of such foreign or international application shall result in abandonment of the application in which the nonpublication request was submitted (35 U.S.C. 122(b)(2)(B)(iii)).

Applicants must timely file a notice of foreign filing to avoid abandonment of a U.S. application if:

(A) applicant filed a nonpublication request in the U.S. application filed under 35 U.S.C. 111(a) (see MPEP § 1122);

(B) applicant subsequently filed a foreign or international application directed to the invention disclosed in the U.S. application in a foreign country, or under a multilateral international agreement, that requires publication of applications 18 months after filing (foreign filing or counterpart application); and

(C) applicant did not rescind the nonpublication request before filing the foreign or international application (see MPEP § 1123).

The notice of foreign filing must be filed not later than 45 days after the filing date of the counterpart application. The requirement for notice of foreign filing is set forth in 35 U.S.C. 122(b)(2)(B)(iii) which provides that an applicant who has made a nonpublication request under 35 U.S.C. 122(b)(2)(B)(i) in a U.S. application filed under 35 U.S.C. 111(a), but who subsequently files an application in a foreign country or under a multilateral international agreement that requires eighteen-month publication, must notify the USPTO of the foreign filing not later than forty-five days after the date of such foreign filing. Form PTO/SB/36 (revision April 2001 or later) may be used to both rescind a nonpublication request and provide notice of foreign filing. The form is reproduced in MPEP § 1135. 35 U.S.C. 122(b)(2)(B)(iii) further provides that failure of the applicant to provide the required notice within this forty-five (45) day period shall result in abandonment of the application. Accordingly, if at the time the foreign filing is made, the applicant still has an operative nonpublication request (i.e., the applicant has not rescinded the nonpublication request), a notice of foreign filing must be made within 45 days of the foreign filing or the U.S.

application with the nonpublication request will become abandoned.

Since the notice of foreign filing is required by the statute, the benefit of a certificate of mailing or transmission under 37 CFR 1.8 will be given to a notice of foreign filing. See 37 CFR 1.8(a). Form PTO/SB/36 includes a certificate of mailing. If the end of the 45 day period falls on a Saturday, Sunday or Federal holiday within the District of Columbia, a notice of foreign filing filed on the next succeeding secular or business day is timely. See 35 U.S.C. 21(b).

After either a rescission of a nonpublication request or a notice of foreign filing is received by the Office, the Office will enter the rescission or notice of foreign filing into the Office Pre-Examination System to schedule the application for publication. A notice (e.g., a “Notice Regarding Rescission Of Nonpublication Request and Notice of Foreign Filing”) should be sent to inform the applicant of the projected publication date. The application will be published promptly after the expiration of a period of 18 months from the earliest filing date for which a benefit is sought under title 35, United States Code, or as soon as practicable after mailing this notice. See 35 U.S.C. 122(b)(2)(B)(iv).

**ABANDONMENT FOR FAILURE TO PROVIDE TIMELY NOTICE**

*37 CFR 1.137. Revival of abandoned application, terminated reexamination proceeding, or lapsed patent*

\*\*\*\*\*

(b) *Unintentional.* If the delay in reply by applicant or patent owner was unintentional, a petition may be filed pursuant to this paragraph to revive an abandoned application, a reexamination proceeding terminated under §§ 1.550(d) or 1.957(b) or (c), or a lapsed patent. A grantable petition pursuant to this paragraph must be accompanied by:

(c) *Reply.* In a nonprovisional application abandoned for failure to prosecute, the required reply may be met by the filing of a continuing application. In a nonprovisional utility or plant application filed on or after June 8, 1995, and abandoned for failure to prosecute, the required reply may also be met by the filing of a request for continued examination in compliance with § 1.114. In an application or patent, abandoned or lapsed for failure to pay the issue fee or any portion thereof, the required reply must include payment of the issue fee or any outstanding balance. In an application, abandoned for failure to pay the publication fee, the required reply must include payment of the publication fee.

\*\*\*\*\*

(f) *Abandonment for failure to notify the Office of a foreign filing:* A nonprovisional application abandoned pursuant to 35 U.S.C. 122(b)(2)(B)(iii) for failure to timely notify the Office of the filing of an application in a foreign country or under a multinational treaty that requires publication of applications eighteen months after filing, may be revived only pursuant to paragraph (b) of this section. The reply requirement of paragraph (c) of this section is met by the notification of such filing in a foreign country or under a multinational treaty, but the filing of a petition under this section will not operate to stay any period for reply that may be running against the application.

\*\*\*\*\*

35 U.S.C. 122(b)(2)(B)(iii) provides that failure of the applicant to provide the required notice of foreign filing within 45 days of the subsequent filing of a counterpart application shall result in abandonment of the application. When an application is abandoned by the operation of 35 U.S.C. 122(b)(2)(B)(iii), applicant’s sole remedy to restore the application to pending status is by filing a petition under 37 CFR 1.137(b) to revive the abandoned application on the basis of unintentional delay, and not on the basis of unavoidable delay. See 37 CFR 1.137(f). By statute, such a petition to revive requires payment of the petition fee specified in 37 CFR 1.17(m) (35 U.S.C. 41(a)(7)), and that the delay in submitting the notice of foreign filing was unintentional. Form PTO/SB/64a may be used for such a petition to revive. See also MPEP § 711.03(c). In addition, if, after filing a counterpart application, an applicant merely rescinds a nonpublication request but does not file a notice of foreign filing within forty-five days of the subsequent filing of a counterpart application, applicant must file a petition under 37 CFR 1.137(b) to revive the abandoned U.S. application (37 CFR 1.137(f)).

Abandonment occurs by operation of the statute, and the Office is unlikely to recognize when applicant has filed a counterpart application in a foreign country or under a multilateral agreement contrary to their certification to the Office. The Office would not be able to change the status of the application from pending to abandoned in the PALM system and send applicant a notice of abandonment. As a result, if applicant failed to file a notice of foreign filing when it was required, prosecution of the application will continue and the application may issue as a patent, even though the application has become abandoned by operation of the statute. Applicants who determine that a required notice of foreign filing was not timely provided

should promptly file a petition to revive under 37 CFR 1.137(b). See 37 CFR 1.137(f). The reply requirement of 37 CFR 1.137(c) is met by the notification of the filing in a foreign country or under a multinational treaty, but the filing of a petition to revive will not operate to stay any period for reply that may be running against the application.<

&gt;

## 1125 Express Abandonment to Avoid Publication [R-2]

37 CFR 1.138. *Express abandonment*

\*\*\*\*\*

(c) An applicant seeking to abandon an application to avoid publication of the application (see § 1.211(a)(1)) must submit a declaration of express abandonment by way of a petition under this section including the fee set forth in § 1.17(h) in sufficient time to permit the appropriate officials to recognize the abandonment and remove the application from the publication process. Applicant should expect that the petition will not be granted and the application will be published in regular course unless such declaration of express abandonment and petition are received by the appropriate officials more than four weeks prior to the projected date of publication.

Applicants seeking to abandon an application to avoid publication of the application are urged to do so by filing a petition under 37 CFR 1.138(c) and submitting a declaration of express abandonment and the fee set forth in 37 CFR 1.17(h) in sufficient time to permit the appropriate officials (Pre-Grant Publication Division) to recognize the abandonment and remove the application from the publication process. Applicants may use form PTO/SB/24A (see MPEP § 1135) and mail the petition to **Mail Stop Express Abandonment**, or transmit the petition via facsimile to Pre-Grant Publication Division at **(703) 305-8568** (see MPEP § 1730) to increase the chances of such petition being received by the appropriate officials in sufficient time to avoid publication of an application.

Any applicant seeking to abandon the application for the purpose of avoiding publication must take appropriate action well prior to the projected publication date. If the application is not expressly abandoned at least four weeks prior to the projected publication date, the Office will probably not be able to avoid publication of the application. This does not imply that a request to expressly abandon an application to avoid publication filed prior to this four-week

time frame will ensure that the Office will be able to remove an application from publication. The Office simply cannot ensure that it can remove an application from publication or avoid publication of application information any time after the publication process for the application is initiated (about 4 months prior to the projected publication date).

The petition for express abandonment to avoid publication will be granted when it is recognized in sufficient time to avoid publication and will be denied when it is not recognized in sufficient time to avoid publication of the application. This will avert the situation in which an applicant files a letter of express abandonment to avoid publication, the letter of express abandonment is not recognized in sufficient time to avoid publication, upon publication the applicant wishes to rescind the letter of express abandonment, and the Office cannot revive the application (once the letter of express abandonment is recognized) because the application was expressly and intentionally abandoned by the applicant.<

&gt;

## 1126 Publication Fees [R-2]

37 CFR 1.211. *Publication of applications.*

\*\*\*\*\*

(e) The publication fee set forth in § 1.18(d) must be paid in each application published under this section before the patent will be granted. If an application is subject to publication under this section, the sum specified in the notice of allowance under § 1.311 will also include the publication fee which must be paid within three months from the date of mailing of the notice of allowance to avoid abandonment of the application. This three-month period is not extendable. If the application is not published under this section, the publication fee (if paid) will be refunded.

The publication fee set forth in 37 CFR 1.18(d) must be paid in each application published under 35 U.S.C. 122(b) before a patent will be granted on the application. The publication fee will be required with the Notice of Allowance and Fee(s) Due, unless the publication fee was previously paid. If an application becomes abandoned without being allowed, no publication fee is required. The small entity discount is not available for the publication fee. The sum specified in the Notice of Allowance and Fee(s) Due will also include the publication fee which must be paid within three months from the date of mailing of the Notice of Allowance and Fee(s) Due to avoid abandonment of

the application. This three-month period is not extendable.

Applicant is required to pay the publication fee to avoid abandonment of the application even if the application has not yet been published at the time when the publication fee is due. The Office will continue with the pre-grant publication process until a patent actually issues. This is because there are many instances in which the Office mails a notice of allowance in an application but the application does not issue as a patent in regular course. Therefore, the Office will not discontinue the pre-grant publication process until a patent has actually issued. Since the Office cannot discontinue the pre-grant publication process during the last two to four weeks of the publication process, this will result in a few applications being issued as patents and subsequently being published as patent application publications. The Office will refund the publication fee (if paid) if the application is not published as a patent application publication, but will not refund the publication fee if the application is published as a patent application publication, even if it is published after the patent issues.

Accordingly, applicant may file a request for a refund of the publication fee after 4 weeks from the issue date of the patent. A request for refund filed before 4 weeks from the issue date is premature and will be disregarded. Requests for a refund of the publication fee should be directed to the Pre-Grant Publication Division of the Office of Publications at Mail Stop PGPUB.

If applicant files a request for continued examination (RCE) under 37 CFR 1.114 after a Notice of Allowance and Fee(s) Due is mailed (but before the expiration of the three-month time period set forth in the Notice of Allowance and Fee(s) Due), the Office will suspend the due date for the publication fee until three months from the mail date of the new Notice of Allowance and Fee(s) Due for the application (if and when a new Notice is mailed). See *Time Period for Paying Publication Fee if a Request for Continued Examination is Filed After a Notice of Allowance is Mailed*, 1249 *Off. Gaz. Pat. Office* 81 (Aug. 21, 2001). For more information on RCE practice, see MPEP § 706.07(h).<

&gt;

## 1127 Notice of Publication [R-2]

Applicants will be informed of the projected publication date assigned to the application on the filing receipt. The Office will not mail a paper copy of the patent application publication to the applicant, but will mail a “Notice of Publication” to the applicant indicating that the application has been published when the application is published. Copies of patent application publications are available on the USPTO web site ([www.uspto.gov](http://www.uspto.gov)).

A “Notice of New or Revised Publication Date” may be mailed if the publication date changes by more than six weeks due to processing delays, if a secrecy order is removed, or subsequent to the revival of an abandoned application. If applicant adds or deletes a benefit or priority claim so that the 18-month publication date is changed, applicant will be mailed a notice (e.g., a corrected filing receipt), informing applicant of the newly assigned publication date.<

&gt;

## 1128 Availability of Published Applications [R-2]

*37 CFR 1.14. Patent applications preserved in confidence.*

(a) Confidentiality of patent application information. Patent applications that have not been published under 35 U.S.C. 122(b) are generally preserved in confidence pursuant to 35 U.S.C. 122(a). Information concerning the filing, pendency, or subject matter of an application for patent, including status information, and access to the application, will only be given to the public as set forth in § 1.11 or in this section.

(1) Records associated with patent applications (see paragraph (g) for international applications) may be available in the following situations:

\*\*\*\*\*

(iii) Published pending applications. A copy of the application-as-filed, the file contents of the application, or a specific document in the file of a pending application that has been published as a patent application publication may be provided to any person upon request, and payment of the appropriate fee set forth in § 1.19(b). If a redacted copy of the application was used for the patent application publication, the copy of the specification, drawings, and papers may be limited to a redacted copy. The Office will not provide access to the paper file of a pending application that has been published, except as provided in paragraph (c) or (h) of this section.

(iv) Unpublished abandoned applications (including provisional applications) that are identified or relied upon.

The file contents of an unpublished, abandoned application may be made available to the public if the application is identified in a U.S. patent, a statutory invention registration, a U.S. patent application publication, or an international patent application publication of an international application that was published in accordance with PCT Article 21(2). An application is considered to have been identified in a document, such as a patent, when the application number or serial number and filing date, first named inventor, title and filing date or other application specific information are provided in the text of the patent, but not when the same identification is made in a paper in the file contents of the patent and is not included in the printed patent. Also, the file contents may be made available to the public, upon a written request, if benefit of the abandoned application is claimed under 35 U.S.C. 119(e), 120, 121, or 365 in an application that has issued as a U.S. patent, or has published as a statutory invention registration, a U.S. patent application publication, or an international patent application that was published in accordance with PCT Article 21(2). A copy of the application-as-filed, the file contents of the application, or a specific document in the file of the application may be provided to any person upon written request, and payment of the appropriate fee (§ 1.19(b)).

\*\*\*\*\*

## I. ELECTRONIC ACCESS

Patent application publications are available electronically on the USPTO web site ([www.uspto.gov](http://www.uspto.gov)). Any member of the public may obtain status information concerning any published application via the Office's Patent Application Information Retrieval (PAIR) system. See MPEP § 1730. Published applications that have been scanned into the Image File Wrapper (IFW) system may be available electronically via PAIR.

## II. COPIES OF PUBLISHED APPLICATIONS

Any member of the public may submit a request under 37 CFR 1.14(a)(1)(ii) or (iii) and the fee set forth in 37 CFR 1.19(b) to the Office of Public Records or electronically on the USPTO web site ([www.uspto.gov](http://www.uspto.gov)) for:

(A) a copy of the complete file wrapper and contents of, or a copy of a specific paper in, any published application, provided that no redacted copy was timely submitted for publication; or

(B) an appropriately redacted copy of the file wrapper and contents of, or a copy of a specific paper in, any published application for which a redacted copy was timely submitted for publication.

## III. PHYSICAL ACCESS TO PUBLISHED APPLICATIONS

Any member of the public cannot obtain physical access to any **pending** published application because permitting physical inspection of pending published applications would interfere with the Office's ability to act on the applications. Any member of the public may, however, physically inspect (subject to the same conditions that apply to inspection of patented files) the file of any **abandoned** published application, provided that no redacted copy was timely submitted for publication, through the File Information Unit (FIU). See MPEP § 1730.

## IV. STATUS INFORMATION

Any member of the public may obtain status information concerning any published application via the Office's PAIR system or contact the FIU. See MPEP § 1730. Status information is defined to include identification of whether the application has been published under 35 U.S.C. 122(b), as well as whether the application is pending, abandoned, or patented, and the application number. Status information may also be provided when the application is referred to by its application number in a U.S. patent application publication as well as a U.S. patent or a published international application. The public may obtain continuity data for applications that have been published as a U.S. patent application publication or as a U.S. patent. See also MPEP § 102.<

>

## 1129 Request for Early Publication [R-2]

*37 CFR 1.219. Early publication.*

Applications that will be published under § 1.211 may be published earlier than as set forth in § 1.211(a) at the request of the applicant. Any request for early publication must be accompanied by the publication fee set forth in § 1.18(d). If the applicant does not submit a copy of the application in compliance with the Office electronic filing system requirements pursuant to § 1.215(c), the Office will publish the application as provided in § 1.215(a). No consideration will be given to requests for publication on a certain date, and such requests will be treated as a request for publication as soon as possible.

If an applicant wishes to have an application published earlier than the date that is eighteen months after the earliest filing date for which benefit is claimed, applicant may submit a request in compli-

ance with 37 CFR 1.219 and the publication fee set forth in 37 CFR 1.18(d). The Office will publish the application as soon as possible if the application is otherwise ready for publication. The publication process takes approximately 14 weeks and does not begin until the application is complete and ready for publication (e.g., an executed oath or declaration has been filed and the filing fee has been paid). See MPEP § 1120. The Office will not give any consideration to requests for publication on a certain date. Note that if early publication is requested, and the publication fee paid, applicant will not be required to pay the publication fee at allowance.<

>

## 1130 Republication and Correction of Patent Application Publications [R-2]

*37 CFR 1.221. Voluntary publication or republication of patent application publication*

(a) Any request for publication of an application filed before, but pending on, November 29, 2000, and any request for republication of an application previously published under § 1.211, must include a copy of the application in compliance with the Office electronic filing system requirements and be accompanied by the publication fee set forth in § 1.18(d) and the processing fee set forth in § 1.17(i). If the request does not comply with the requirements of this paragraph or the copy of the application does not comply with the Office electronic filing system requirements, the Office will not publish the application and will refund the publication fee.

(b) The Office will grant a request for a corrected or revised patent application publication other than as provided in paragraph (a) of this section only when the Office makes a material mistake which is apparent from Office records. Any request for a corrected or revised patent application publication other than as provided in paragraph (a) of this section must be filed within two months from the date of the patent application publication. This period is not extendable.

If an applicant wishes to correct errors in a patent application publication, or republish the application with an amended specification (including amended claims) and/or replacement drawings, applicant may file a request for republication pursuant to 37 CFR 1.221(a). The request for republication must include:

(A) a copy of the application in compliance with the Office Electronic Filing System (EFS) requirements (for more information on EFS see MPEP § 1730 and the USPTO web site, [www.uspto.gov](http://www.uspto.gov));

(B) the publication fee set forth in 37 CFR 1.18(d); and

(C) the processing fee set forth in 37 CFR 1.17(i).

If the applicant submits a request that does not meet the EFS requirements, the request will be dismissed. If the fees are not paid, the USPTO will send the applicant a letter requiring the fees and republication of the application will be delayed. While there is no set time limit for requesting republication, the application must still be pending.

If the application is **recognized** by the Office as abandoned, or has issued as a patent, the application may be removed from the publication process and not republished, even if the Office accepted the request.

## CORRECTION OF MATERIAL MISTAKE MADE BY THE OFFICE

If the Office made a material mistake in a patent application publication that is apparent from the Office records and applicant wishes to correct the material mistake, applicant may file a request for corrected publication pursuant to 37 CFR 1.221(b). Prior to submitting a request for a corrected publication under 37 CFR 1.221(b), applicant must check applicant's records (or PAIR) to determine that the application papers submitted to the Office did not contain the alleged material error made by the Office. If applicant submitted a specification that includes illegible text, the Office will not grant a request for corrected publication under 37 CFR 1.221(b) based on errors arising from misinterpretation of such text.

The request for a corrected publication under 37 CFR 1.221(b) must:

(A) be filed within two months from the date of the patent application publication; and

(B) identify the Office's material mistake in the publication.

The two-month time period is not extendable. A request for corrected publication should include a listing of the alleged material errors made by the Office, marked up copies of the relevant pages of the publication and an indication of where in the specification as filed the relevant text appears. If the period has expired or the mistake is caused by the applicants, applicants may correct the mistakes by filing a request for republication under 37 CFR 1.221(a), and should



not file a request for corrected publication under 37 CFR 1.221(b).

#### A. *Material Mistake*

The Office will grant a request for a corrected publication under 37 CFR 1.221(b) only when the Office makes a material mistake which is apparent from Office records. A material mistake means a mistake that affects the public's ability to appreciate the technical disclosure of the patent application publication or determine the scope of the provisional rights that an applicant may seek to enforce upon issuance of a patent. An error in the claims, the (effective) filing date of the application, or a serious error in the written description or drawings that is necessary to support the claims may be a material error. The following are examples of material mistake:

(A) The publication did not include claims that were included in the originally-filed specification and not canceled by a preliminary amendment.

(B) The publication did not include a part of the specification that provides support for the published claims.

(C) The publication did not include any of the drawings submitted.

(D) The publication did not include the benefit claim to a prior-filed nonprovisional application where the specific reference was timely submitted in the first sentence of the specification or application data sheet (ADS).

#### B. *Non-Material Mistake*

Applicants should not file requests for corrected publication that include no material error made by the Office. Errors in the correspondence address, the assignment information or missing assignment information, minor typographical errors or missing section headings are not material mistakes. A failure to include an amendment is not an Office error, because amendments are not reflected in the patent application publication. See MPEP § 1121. For example, applicants should not file a request for a corrected publication under 37 CFR 1.221(b) for the following situations:

(A) The publication did not include assignment information.

(B) The publication shows the wrong assignee or the name of the assignee is misspelled.

(C) The publication did not include a benefit or priority claim to a prior application. For example, where either the claim was not timely filed or the reference to the prior application under 37 CFR 1.78 was not properly submitted in the first sentence of the specification or in an application data sheet (ADS). See MPEP § 201.11.

(D) The publication did not include claims or changes submitted in an amendment.

(E) The publication includes typographical errors that do not affect the interpretation of the published claims.

A request for corrected publication under 37 CFR 1.221(b) may result in a patent term adjustment reduction where the Office made only non-material errors (especially those listed above).<

>

### 1132 Requests for Redacted Publication [R-2]

35 U.S.C. 122. *Confidential status of applications; publication of patent applications.*

\*\*\*\*\*

(b) PUBLICATION.—

\*\*\*\*\*

(2) EXCEPTIONS.—

\*\*\*\*\*

(B)(v)If an applicant has filed applications in one or more foreign countries, directly or through a multilateral international agreement, and such foreign filed applications corresponding to an application filed in the Patent and Trademark Office or the description of the invention in such foreign filed applications is less extensive than the application or description of the invention in the application filed in the Patent and Trademark Office, the applicant may submit a redacted copy of the application filed in the Patent and Trademark Office eliminating any part or description of the invention in such application that is not also contained in any of the corresponding applications filed in a foreign country. The Director may only publish the redacted copy of the application unless the redacted copy of the application is not received within 16 months after the earliest effective filing date for which a benefit is sought under this title. The provisions of section 154(d) shall not apply to a claim if the description of the invention published in the redacted application filed under this clause with respect to the claim does not enable a person skilled in the art to make and use the subject matter of the claim.

\*\*\*\*\*

*37 CFR 1.217. Publication of a redacted copy of an application*

(a) If an applicant has filed applications in one or more foreign countries, directly or through a multilateral international agreement, and such foreign-filed applications or the description of the invention in such foreign-filed applications is less extensive than the application or description of the invention in the application filed in the Office, the applicant may submit a redacted copy of the application filed in the Office for publication, eliminating any part or description of the invention that is not also contained in any of the corresponding applications filed in a foreign country. The Office will publish the application as provided in § 1.215(a) unless the applicant files a redacted copy of the application in compliance with this section within sixteen months after the earliest filing date for which a benefit is sought under title 35, United States Code.

(b) The redacted copy of the application must be submitted in compliance with the Office electronic filing system requirements. The title of the invention in the redacted copy of the application must correspond to the title of the application at the time the redacted copy of the application is submitted to the Office. If the redacted copy of the application does not comply with the Office electronic filing system requirements, the Office will publish the application as provided in § 1.215(a).

(c) The applicant must also concurrently submit in paper (§ 1.52(a)) to be filed in the application:

(1) A certified copy of each foreign-filed application that corresponds to the application for which a redacted copy is submitted;

(2) A translation of each such foreign-filed application that is in a language other than English, and a statement that the translation is accurate;

(3) A marked-up copy of the application showing the redactions in brackets; and

(4) A certification that the redacted copy of the application eliminates only the part or description of the invention that is not contained in any application filed in a foreign country, directly or through a multilateral international agreement, that corresponds to the application filed in the Office.

(d) The Office will provide a copy of the complete file wrapper and contents of an application for which a redacted copy was submitted under this section to any person upon written request pursuant to § 1.14(c)(2), unless applicant complies with the requirements of paragraphs (d)(1), (d)(2), and (d)(3) of this section.

(1) Applicant must accompany the submission required by paragraph (c) of this section with the following:

(i) A copy of any Office correspondence previously received by applicant including any desired redactions, and a second copy of all Office correspondence previously received by applicant showing the redacted material in brackets; and

(ii) A copy of each submission previously filed by the applicant including any desired redactions, and a second copy of each submission previously filed by the applicant showing the redacted material in brackets.

(2) In addition to providing the submission required by paragraphs (c) and (d)(1) of this section, applicant must:

(i) Within one month of the date of mailing of any correspondence from the Office, file a copy of such Office correspondence including any desired redactions, and a second copy of such Office correspondence showing the redacted material in brackets; and

(ii) With each submission by the applicant, include a copy of such submission including any desired redactions, and a second copy of such submission showing the redacted material in brackets.

(3) Each submission under paragraph (d)(1) or (d)(2) of this paragraph must also be accompanied by the processing fee set forth in § 1.17(i) and a certification that the redactions are limited to the elimination of material that is relevant only to the part or description of the invention that was not contained in the redacted copy of the application submitted for publication.

(e) The provisions of § 1.8 do not apply to the time periods set forth in this section.

If an application filed in the USPTO and subject to publication under 35 U.S.C. 122(b) includes description that is more extensive than any previously filed corresponding foreign applications, applicant may request for redacted publication under 37 CFR 1.217, eliminating any part or description of the invention that is not also contained in any of the corresponding applications filed in a foreign country. The Office will publish the redacted (less extensive) copy of the application instead of the full description of the invention disclosed in the U.S. application (as provided in 37 CFR 1.215(a)) if applicant timely files a request for redacted publication in compliance with 37 CFR 1.217 which requires the following:

(A) A redacted copy of the application in compliance with the Office electronic filing system (EFS) requirements within sixteen (16) months after the earliest filing date for which a benefit is sought under title 35, United States Code;

(B) A certified copy of each foreign-filed application that corresponds to the U.S. application for which a redacted copy is submitted;

(C) A translation of each such foreign-filed application that is in a language other than English, and a statement that the translation is accurate;

(D) A marked-up copy of the application showing the redactions in brackets; and

(E) A certification that the redacted copy of the application eliminates only the part or description of the invention that is not contained in any application filed in a foreign country, directly or through a multi-lateral international agreement, that corresponds to the application filed in the Office.

Items (B)– (E) above must be submitted in paper concurrently with the EFS submission of the redacted copy of the application.

The 16-month period is provided by statute (35 U.S.C. 122(b)(2)(B)(v)), and as such, requests for waiver of this 16-month period will be denied. The title of the invention in the redacted copy of the application must correspond to the title of the application at the time the redacted copy of the application is submitted to the Office. If the redacted copy of the application does not comply with the Office electronic filing system requirements, the Office will publish the full description of the invention disclosed in the U.S. application as provided in 37 CFR 1.215(a).

Once an application has been published, a member of the public may request a copy of the complete file wrapper and contents of, or a copy of a specific paper in, the published application, provided that no redacted copy was timely submitted for publication. If a redacted copy of the application was used for publication, the copy of the specification, drawings, and papers may be limited to a redacted copy, provided that the applicant submits the following:

(A) A copy of any Office correspondence previously received by applicant including any desired redactions, and a second copy of all Office correspondence previously received by applicant showing the redacted material in brackets, at the time of filing the request for redacted publication;

(B) A copy of each submission previously filed by the applicant including any desired redactions, and a second copy of each submission previously filed by the applicant showing the redacted material in brackets, at the time of filing the request for redacted publication;

(C) Within one month of the date of mailing of any correspondence from the Office, a copy of such Office correspondence including any desired redac-

tions, and a second copy of such Office correspondence showing the redacted material in brackets;

(D) With each submission by the applicant, a copy of such submission including any desired redactions, and a second copy of such submission showing the redacted material in brackets; and

(E) The processing fee set forth in 37 CFR 1.17(i), and a certification that the redactions are limited to the elimination of material that is relevant only to the part or description of the invention that was not contained in the redacted copy of the application submitted for publication for each submission in (A)-(D).

Papers submitted for redaction are not entitled to the benefit of the certificate of mailing practice under 37 CFR 1.8. If applicant fails to provide the required redacted and marked up copies of the correspondence in compliance with 37 CFR 1.217(d), the Office will provide a copy of the complete file wrapper and contents of the application to any person upon written request pursuant to 37 CFR 1.14.<

>

### 1133 Voluntary Publication [R-2]

*37 CFR 1.221. Voluntary publication or republication of patent application publication.*

(a) Any request for publication of an application filed before, but pending on, November 29, 2000, and any request for republication of an application previously published under § 1.211, must include a copy of the application in compliance with the Office electronic filing system requirements and be accompanied by the publication fee set forth in § 1.18(d) and the processing fee set forth in § 1.17(i). If the request does not comply with the requirements of this paragraph or the copy of the application does not comply with the Office electronic filing system requirements, the Office will not publish the application and will refund the publication fee.

\*\*\*\*\*

Utility and plant applications filed before November 29, 2000 will not be published under 35 U.S.C. 122(b). If an applicant wishes the Office to publish a utility or plant application filed before November 29, 2000 under 35 U.S.C. 122(b), applicant may file a request for voluntary publication under 37 CFR 1.221. The application must be pending and the request for voluntary publication must include:

(A) a copy of the application in compliance with the Office Electronic Filing System (EFS) requirements;

(B) the publication fee set forth in 37 CFR 1.18(d); and

(C) the processing fee set forth in 37 CFR 1.17(i).

If the applicant submits a request that does not meet the EFS requirements, the request will be dismissed. Since the Office does not intend to publish abandoned applications, applications that **are recognized** by the Office as abandoned will not be published. Thus, if applicant submits a request for a voluntary publication of an application, but the application is later abandoned before the application publishes, the application may not be published even if the Office has accepted the request.<

>

### **1134 Third Party Inquiries and Correspondence in a Published Application [R-2]**

*35 U.S.C. 122. Confidential status of applications; publication of patent applications.*

\*\*\*\*\*

(c) PROTEST AND PRE-ISSUANCE OPPOSITION.—

The Director shall establish appropriate procedures to ensure that no protest or other form of pre-issuance opposition to the grant of a patent on an application may be initiated after publication of the application without the express written consent of the applicant.

\*\*\*\*\*

35 U.S.C. 122(c) provides that the Office “shall establish appropriate procedures to ensure that no protest or other form of pre-issuance opposition to the grant of a patent on an application may be initiated after publication of the application without the express written consent of the applicant.” Accordingly, the Office prohibits third parties from submitting any protests under 37 CFR 1.291 or initiating any public use proceedings under 37 CFR 1.292 (without the express written consent of the applicant) after publication of an application. These are the only forms of third party protest or pre-issuance opposition to a pending application permitted by the rules of practice. For more information on protest see MPEP § 1901; for public use proceedings see MPEP § 720. Third parties may submit patents or publications for consideration in a pending published application, with no further comment or explanation, pursuant to 37 CFR 1.99. See MPEP § 1134.01.

Despite the provisions of 35 U.S.C. 122(c), the Office occasionally receives third-party inquiries or submissions (other than under 37 CFR 1.99) regarding applications that have been published under the eighteen-month publication provisions of 35 U.S.C. 122(b). For example, third parties have inquired into the timing of future actions on an application, and some third parties have insisted that the Office withdraw an application from issue under 37 CFR 1.313 on the basis of unpatentability of a claim. The Office considers inappropriate any third-party inquiry, or submission that is not provided for in 37 CFR 1.99, in a published application in which the applicant has not provided an express written consent to protest or pre-issuance opposition. Any submission filed by a third party (e.g., a protest) in an application published under 35 U.S.C. 122(b) (without the express written consent of the applicant) that does not comply with the requirements of 37 CFR 1.99 will be disregarded and not entered into the application file. For example: a protest under 37 CFR 1.291 filed after publication of the application under 35 U.S.C. 122(b) (without the express written consent of the applicant) will be reviewed to determine if it is in compliance with 37 CFR 1.99 and, if it is not in compliance with 37 CFR 1.99, it will be discarded before the application is forwarded to the examiner. Petitions to institute public use proceedings under 37 CFR 1.292, including those that are filed after publication of an application under 35 U.S.C. 122(b), should be forwarded to the Office of Patent Legal Administration. See MPEP § 720.

Office personnel (including the Patent Examining Corps) are instructed to: (1) not reply to any third-party inquiry or other submission in a published pending application; (2) not act upon any third-party inquiry or other submission in a published application, except for written submissions that are provided for in 37 CFR 1.99 and written submissions in applications in which the applicant has provided an express written consent to protest or pre-issuance opposition; and (3) decline to accept oral or telephone comments or submissions about published applications from third parties. When refusing third-party telephone or oral discussions, examiners may call the party’s attention to the statutory prohibition on initiating protests, or 37 CFR 1.2 (all Office business should be transacted in writing), as appropriate. See *Third Party Attempts to Protest or Otherwise Oppose the Grant of*

a *Published Application*, 1269 *Off. Gaz. Pat. Office* 179 (April 22, 2003). The Office may also refer third-party inquiries, or submissions not provided for in 37 CFR 1.99, by registered practitioners in published applications in which the applicant has not provided an express written consent to protest, or pre-issuance opposition, to the Office of Enrollment and Discipline for appropriate action.

The provisions of 35 U.S.C. 122(c) and 37 CFR 1.99, 1.291, and 1.292 limit a third party's ability to protest, oppose the grant of, or have information entered and considered in an application pending before the Office. However, these provisions do not limit the Office's authority to independently re-open the prosecution of a pending application on the Office's own initiative and consider information deemed relevant to the patentability of any claim in the application. See *Blacklight Power, Inc. v. Rogan*, 295 F.3d 1269, 63 USPQ2d 1534 (Fed. Cir. 2002).<

>

### 1134.01 Third Party Submissions Under 37 CFR 1.99 [R-2]

37 CFR 1.99. *Third-party submission in published application.*

(a) A submission by a member of the public of patents or publications relevant to a pending published application may be entered in the application file if the submission complies with the requirements of this section and the application is still pending when the submission and application file are brought before the examiner.

(b) A submission under this section must identify the application to which it is directed by application number and include:

- (1) The fee set forth in § 1.17(p);
- (2) A list of the patents or publications submitted for consideration by the Office, including the date of publication of each patent or publication;
- (3) A copy of each listed patent or publication in written form or at least the pertinent portions; and
- (4) An English language translation of all the necessary and pertinent parts of any non-English language patent or publication in written form relied upon.

(c) The submission under this section must be served upon the applicant in accordance with § 1.248.

(d) A submission under this section shall not include any explanation of the patents or publications, or any other information. The Office will not enter such explanation or information if included in a submission under this section. A submission under this section is also limited to ten total patents or publications.

(e) A submission under this section must be filed within two months from the date of publication of the application (§ 1.215(a)) or prior to the mailing of a notice of allowance (§ 1.311), whichever is earlier. Any submission under this section not filed within this period is permitted only when the patents or publications could not have been submitted to the Office earlier, and must also be accompanied by the processing fee set forth in § 1.17(i). A submission by a member of the public to a pending published application that does not comply with the requirements of this section will not be entered.

(f) A member of the public may include a self-addressed postcard with a submission to receive an acknowledgment by the Office that the submission has been received. A member of the public filing a submission under this section will not receive any communications from the Office relating to the submission other than the return of a self-addressed postcard. In the absence of a request by the Office, an applicant has no duty to, and need not, reply to a submission under this section.

To balance the mandate of 35 U.S.C. 122(c) and the Office's authority and responsibility under 35 U.S.C. 131 and 151 to issue a patent only if "it appears that the applicant is entitled to a patent under the law," the Office permits third parties to submit patents and publications (i.e., prior art documents that are public information and which the Office would discover on its own with an ideal prior art search) during a limited (2 month) period after publication of an application in compliance with 37 CFR 1.99. However, 37 CFR 1.99 prohibits third parties from submitting any explanation of the patents or publications, or submitting any other information.

Third parties may submit patents and publications relevant to the published application, with no further comment or explanation, pursuant to 37 CFR 1.99. The patents and publications may be entered in the application file if the submission complies with the requirements of 37 CFR 1.99 and the application is still pending when the submission and application file are brought before the examiner. For Image File Wrapper (IFW) processing, see IFW Manual, Section 2.1. The submission must be served upon the applicant in accordance with 37 CFR 1.248 prior to the filing of the submission in the Office.

To ensure that a third-party submission under 37 CFR 1.99 does not amount to a protest or pre-grant opposition without express consent of the applicant, the third party does not have the right to insist that the examiner consider any of the patents or publications submitted.

If the submission is not in compliance with 37 CFR 1.99, information filed in the submission may be

removed prior to the examiner receiving the submission and application file. The Office will screen third-party submissions to determine whether they are limited to patents and publications, and to remove any explanations or information (other than patents and publications) from the submission before the submission is placed in the application file and forwarded to the examiner. For IFW processing, see IFW Manual, Section 2.1. If the explanations cannot be separated from the patents or publications, such patents or publications will be discarded. By the time the examiner receives the application file and submission, some or all patents or publications in the submission may have been discarded.

If the applicant wants to ensure that the information in a third-party submission is considered by the examiner, the applicant should submit such information in an IDS in compliance with 37 CFR 1.97 and 1.98. Since the third party is required to serve the applicant a copy of the submission, applicant may file the IDS prior to the Office receiving or acting on the submission. Furthermore, an individual who has a duty to disclose under 37 CFR 1.56 should submit any material information contained in a third-party submission to the Office in an IDS in compliance with 37 CFR 1.97 and 1.98 to ensure such material information is properly disclosed to the examiner, if the examiner has not indicated that the reference has been considered.

## I. TIMELINESS REQUIREMENT

37 CFR 1.99(e) specifies that a submission under 37 CFR 1.99 must be filed within two months from the date of publication of the application (37 CFR 1.215(a)), or prior to the mailing of a notice of allowance (37 CFR 1.311), whichever is earlier. Republication of an application under 37 CFR 1.221 does not restart the two-month period specified in 37 CFR 1.99(e).

In determining the timeliness of a third-party submission, the publication date of an application filed under 35 U.S.C. 111(a) is the date that the application published under 35 U.S.C. 122(b). However, the publication date of an application which entered the national stage of an international application after compliance with 35 U.S.C. 371 is the publication date of the World Intellectual Property Organization (WIPO) publication, if the international application is

filed on or after November 29, 2000. The WIPO publication of an international application designating the United States filed on or after November 29, 2000 under PCT Article 21(2) is deemed a publication under 35 U.S.C. 122(b) except as provided in 35 U.S.C. 102(e) and 154(d). See 35 U.S.C. 374.

Any submission not filed within the time period specified in 37 CFR 1.99(e) is permitted only when the patents or publications could not have been submitted to the Office earlier (e.g., an amendment submitted in the application after publication changes the scope of the claims to an extent that could not reasonably have been anticipated by a person reviewing the published application during the period specified in 37 CFR 1.99(e)). Submissions after the time period specified in 37 CFR 1.99(e) must be accompanied by (1) a statement that the patents or publications being submitted in the submission could not have been submitted to the Office earlier, and (2) the processing fee as set forth in 37 CFR 1.17(i).

## II. CONTENTS REQUIREMENTS FOR A THIRD-PARTY SUBMISSION

The submission should be clearly labeled as a third-party submission under 37 CFR 1.99 and not as a protest, an IDS or a pre-issuance opposition. Prior to filing a submission under 37 CFR 1.99, the patents or publications being submitted must be served upon the applicant pursuant to 37 CFR 1.248. A submission under 37 CFR 1.99 must identify the application to which it is directed by the application number and must include:

- (A) the fee set forth in 37 CFR 1.17(p);
- (B) a listing of the patents or publications submitted for consideration by the Office (including the date of publication of each patent or publication);
- (C) a copy of each listed patent or publication in written form or at least the pertinent portions thereof;
- (D) an English language translation of all pertinent parts of any non-English language patent or publication in written form; and
- (E) a certification that the third party has served the information being submitted upon the applicant in compliance with 37 CFR 1.248(b).

Pursuant to 37 CFR 1.99(d), a submission **cannot** include any of the following:

- (A) more than ten total references (patents or publications);
- (B) explanations of the patents or publications;
- (C) documents other than patents or publications (e.g., the submission cannot include any affidavits or declarations); or
- (D) markings or highlights on the patents or publications.

The third party may, however, submit redacted versions of a patent or publication containing only the most relevant portions of the patent or publication. The Office will review submissions to determine whether they are limited to patents and publications and remove any explanations or documents other than patents and publications from the submission before the submission is placed in the file of the application and forwarded to the examiner. The Office will dispose of such explanations or documents if included in a submission. Furthermore, if the explanation cannot be readily removed from the patents or publications (e.g., highlights), the patents or publications will be discarded.

### III. NO THIRD-PARTY PARTICIPATION

The involvement of a third party in filing a submission under 37 CFR 1.99 ends with the filing of the submission. A third party may include a self-addressed postcard with a submission filed under 37 CFR 1.99 to receive an acknowledgment by the Office that the submission has been received. The third party filing the submission will not receive any communications from the Office relating to the submission other than the return of the self-addressed postcard. The third party should not contact the Office or submit any other inquiries. See MPEP § 1134.

### IV. TREATMENT OF A THIRD-PARTY SUBMISSION

#### A. *Procedures for Technical Support Staff*

Technical support staff in the Technology Center (TC) will initially process third party submissions under 37 CFR 1.99. Once the technical support personnel recognizes a prior art submission as a third party submission under 37 CFR 1.99, he or she will enter the third party submission into PALM and into the application file. For Image File Wrapper (IFW) processing, see IFW Manual, Section 2.1. The techni-

cal support personnel will verify that the fee for a submission under 37 CFR 1.99 (i.e., the fee set forth in 37 CFR 1.17(p)) has been paid and, if appropriate, collect the fee(s) that may have been authorized in the third party submission. If the fee has not been paid (and there is no authorization to charge the fee contained in the third party submission), technical support personnel are **not** to charge applicant's deposit account for the requisite fee since the submission is being submitted by a third party and not the applicant. The technical support personnel will review the listing of patents and publications to verify that it is clearly identified as a submission under 37 CFR 1.99. If the listing is not identified as a submission under 37 CFR 1.99, the technical support personnel will write on the listing "Submission under 37 CFR 1.99" followed by his or her initials and the date of entry. The technical support personnel will then forward the submission and the application file to the Supervisory Patent Examiner (SPE) or Special Program Examiner (SPRE) responsible for screening submissions under 37 CFR 1.99. Occasionally, a third party may file a correspondence that is not properly labeled as a third party submission under 37 CFR 1.99 in a published application (e.g., the paper may be labeled as an IDS or a protest). Such paper should be processed as a third-party submission under 37 CFR 1.99 and the designated screener should review the paper as a submission under 37 CFR 1.99.

#### B. *Procedures for Screeners*

Once the third party submission and application file have been forwarded to the SPE or SPRE who is responsible for screening submissions under 37 CFR 1.99, the SPE or SPRE will screen the third party submission to determine whether the submission is in compliance with the timeliness requirements noted in subsection I. above and the content requirements noted in subsection II. above. Submissions under 37 CFR 1.99 that do not comply with the timeliness or content requirements will be discarded. Only those submissions that comply with 37 CFR 1.99 will be forwarded to the examiner along with the application file for consideration. For IFW processing, see IFW Manual, Section 2.1.

If the entire submission or parts of the submission need to be discarded, the screener should place the cover letter or the first page of the submission (trans-

mittal) and parts of the submission that are in compliance with the requirements of 37 CFR 1.99 in the application file and discard the rest of the submission. The screener should write on the transmittal that 'the third party submission (or the list of items) has been discarded,' and include the reason(s) why the submission or the items have been discarded (e.g., the submission was not timely filed or copies of items 1, 2, & 3 are not provided). The screener should also include his or her initials, and the date of entry.

If a patent or publication has been discarded (e.g., because it contained highlighted portions), there is nothing to preclude the screener from separately obtaining a clean copy of the patent or publication. After the submission has been reviewed for compliance with all the requirements of 37 CFR 1.99, the submission and the application file will be forwarded to the examiner for consideration.

### **C. Procedures for Examiners**

Once the third-party submission and the application file have been forwarded to the examiner, the examiner should act on the submission immediately. If an Office action is outstanding, the examiner may treat the submission when preparing the Office action. If an Office action is not outstanding, the examiner should treat the submission immediately on a separate Office communication (i.e., a PTOL-90).

The examiner should not initial any patents or publications on the listing of patents or publications submitted in a third-party submission. The examiner may request applicant's comments on any patent or publication in the submission.

The examiner should notify applicant of the Office treatment of the third-party submission using form paragraph 6.56. If any patent or publication in the submission under 37 CFR 1.99 has been determined by the examiner to be relevant to the patentability of the claims in the published application, the examiner should list the patent or publication on form PTO-892 and provide an explanation of its relevance unless the patent or publication has been used in a rejection. If

the examiner considers it desirable, or necessary, to obtain applicant's comments on the patents or publications submitted before further action, the examiner will offer applicant an opportunity to file comments. If the examiner has specific questions or requests for information from the applicant regarding any of the patents or publications, the examiner may make a requirement for information under 37 CFR 1.105. See MPEP § 704.<

>

## **1135 PGPub Forms [R-2]**

The following PGPub forms are available on the USPTO web site ([www.uspto.gov](http://www.uspto.gov)) and are reproduced at the end of this section:

Form PTO/SB/24A, "Petition for Express Abandonment to Avoid Publication Under 37 CFR 1.138(c)," may be used by applicant for filing a petition for express abandonment to avoid publication under 37 CFR 1.138(c). See MPEP § 1125. Form PTO/SB/35, "Nonpublication Request Under 35 U.S.C. 122(b)(2)(B)(i)," may be used by applicant for filing a request for nonpublication and the certification under 35 U.S.C. 122(b)(2)(B)(i) upon the filing of an application. See MPEP § 1122. Form PTO/SB/36 (revision April 2001 or later), "Rescission of Previous Nonpublication Request (35 U.S.C. 122(b)(2)(B)(ii)) and, if Applicable, Notice of Foreign Filing (35 U.S.C. 122(b)(2)(B)(iii))," may be used by applicant for filing a request for rescinding a previously filed nonpublication request and/or for filing a notice of foreign filing. The certificate of mailing or transmission only applies when applicant is filing a notice of foreign filing. See MPEP §§ 1123 and 1124. Form PTO/SB/64a, "Petition for Revival of an Application for Patent Abandoned for Failure to Notify the Office of a Foreign or International Filing (37 CFR 1.137(f))," may be used by applicant for filing a petition to revive an application abandoned for failure to notify the Office of a foreign filing. See MPEP § 1124.



PTO/SB/24A (04-04)

Approved for use through 07/31/2006. OMB 0651-0031

U.S. Patent and Trademark Office; U.S. DEPARTMENT OF COMMERCE

Under the Paperwork Reduction Act of 1995, no persons are required to respond to a collection of information unless it displays a valid OMB control number.

<p align="center"><b>PETITION FOR EXPRESS ABANDONMENT TO AVOID PUBLICATION UNDER 37 CFR 1.138(c)</b></p> <hr/> <p>Fax the petition directly to the Pre-Grant Publication Division at (703) 305-8568 Or Mail the petition to: <b>Mail Stop Express Abandonment</b> Commissioner for Patents P.O. Box 1450, Alexandria, VA 22313-1450</p>	<b>Application Number</b>	
	<b>Filing Date</b>	
	<b>First Named Inventor</b>	
	<b>Art Unit</b>	
	<b>Examiner Name</b>	
	<b>Attorney Docket Number</b>	

**Petition for Express Abandonment to Avoid Publication under 37 CFR 1.138(c)**

I hereby petition to expressly abandon the above-identified application to avoid publication.

**Petition Fee** – must be filed with petition to avoid delays in recognizing the petition.

a.  The Director is hereby authorized to charge the petition fee under 37 CFR 1.17(h) to Deposit Account No. \_\_\_\_\_.

b.  Check in the amount of \$ \_\_\_\_\_ is enclosed.

c.  Payment by credit card (Form PTO-2038 is enclosed).

**NOTE:** A paper requesting express abandonment of an application is not effective unless and until an appropriate USPTO official recognizes and acts on the paper. See the Manual of Patent Examining Procedure (MPEP), section 711.01. In addition, the paper will not stop publication of the application unless a petition under 37 CFR 1.138(c) is recognized and acted on by the Pre-Grant Publication Division in sufficient time to avoid publication (e.g., more than four (4) weeks prior to the projected publication date).

I am the:  applicant.

assignee of record of the entire interest. See 37 CFR 3.71.  
Statement under 37 CFR 3.73(b) is enclosed. (Form PTO/SB/96)

attorney or agent of record. Registration Number \_\_\_\_\_

\_\_\_\_\_  
Signature

\_\_\_\_\_  
Date

\_\_\_\_\_  
Typed or printed name

\_\_\_\_\_  
Telephone Number

Note: Signatures of all the inventors or assignees of record of the entire interest or their representative(s) are required. Submit multiple forms if more than one signature is required, see below.

Total of \_\_\_\_\_ forms are submitted.

This collection of information is required by 37 CFR 1.138(c). The information is required to obtain or retain a benefit by the public which is to file (and by the USPTO to process) an application. Confidentiality is governed by 35 U.S.C. 122 and 37 CFR 1.14. This collection is estimated to take 12 minutes to complete, including gathering, preparing, and submitting the completed application form to the USPTO. Time will vary depending upon the individual case. Any comments on the amount of time you require to complete this form and/or suggestions for reducing this burden, should be sent to the Chief Information Officer, U.S. Patent and Trademark Office, U.S. Department of Commerce, P.O. Box 1450, Alexandria, VA 22313-1450. DO NOT SEND FEES OR COMPLETED FORMS TO THIS ADDRESS. SEND TO: Mail Stop Express Abandonment, Commissioner for Patents, P.O. Box 1450, Alexandria, VA 22313-1450.

If you need assistance in completing the form, call 1-800-PTO-9199 and select option 2.

PTO/SB/35 (08-03)

Approved for use through 07/31/2008. OMB 0651-0031

U.S. Patent and Trademark Office; U. S. DEPARTMENT OF COMMERCE

Under the Paperwork Reduction Act of 1995, no persons are required to respond to a collection of information unless it displays a valid OMB control number.

<b>NONPUBLICATION REQUEST UNDER 35 U.S.C. 122(b)(2)(B)(i)</b>	First Named Inventor	
	Title	
	Attorney Docket Number	

I hereby certify that the invention disclosed in the attached application **has not and will not be** the subject of an application filed in another country, or under a multilateral agreement, that requires publication at eighteen months after filing.

I hereby request that the attached application not be published under 35 U.S.C. 122(b).

_____	_____
Date	Signature
_____	_____
Telephone number	Typed or printed name

This request must be signed in compliance with 37 CFR 1.33(b) and submitted with the application **upon filing**.

Applicant may rescind this nonpublication request at any time. If applicant rescinds a request that an application not be published under 35 U.S.C. 122(b), the application will be scheduled for publication at eighteen months from the earliest claimed filing date for which a benefit is claimed.

If applicant subsequently files an application directed to the invention disclosed in the attached application in another country, or under a multilateral international agreement, that requires publication of applications eighteen months after filing, the applicant **must** notify the United States Patent and Trademark Office of such filing within forty-five (45) days after the date of the filing of such foreign or international application. **Failure to do so will result in abandonment of this application (35 U.S.C. 122(b)(2)(B)(iii)).**

This collection of information is required by 37 CFR 1.213(a). The information is required to obtain or retain a benefit by the public which is to file (and by the USPTO to process) an application. Confidentiality is governed by 35 U.S.C. 122 and 37 CFR 1.14. This collection is estimated to take 8 minutes to complete, including gathering, preparing, and submitting the completed application form to the USPTO. Time will vary depending upon the individual case. Any comments on the amount of time you require to complete this form and/or suggestions for reducing this burden, should be sent to the Chief Information Officer, U.S. Patent and Trademark Office, U.S. Department of Commerce, P.O. Box 1450, Alexandria, VA 22313-1450. DO NOT SEND FEES OR COMPLETED FORMS TO THIS ADDRESS. SEND TO: Commissioner for Patents, P.O. Box 1450, Alexandria, VA 22313-1450.

If you need assistance in completing the form, call 1-800-PTO-9199 (1-800-786-9199) and select option 2.

PTO/SB/36 (08-03)

Approved for use through 07/31/2006. OMB 0651-0031

U.S. Patent and Trademark Office; U.S. DEPARTMENT OF COMMERCE

Under the Paperwork Reduction Act of 1995, no persons are required to respond to a collection of information unless it displays a valid OMB control number.

<p align="center"><b>RESCISSION OF PREVIOUS NONPUBLICATION REQUEST</b> (35 U.S.C. 122(b)(2)(B)(ii)) <b>AND, IF APPLICABLE, NOTICE OF FOREIGN FILING</b> (35 U.S.C. 122(b)(2)(B)(iii))</p> <p>Send completed form to: <b>Mail Stop PG Pub</b> Commissioner for Patents P.O. Box 1450 Alexandria, VA 22313-1450 FAX: (703) 305-8568</p>	Application Number	
	Filing Date	
	First Named Inventor	
	Title	
	Atty Docket Number	
	Group Art Unit	
	Examiner	

A request that the above-identified application not be published under 35 U.S.C. 122(b) (nonpublication request) was included with the above-identified application on filing pursuant to 35 U.S.C. 122(b)(2)(B)(i). I hereby **rescind** the previous nonpublication request.

If a notice of foreign or international filing is or will be required by 35 U.S.C. 122(b)(2)(B)(iii) and 37 CFR 1.213(c), I hereby provide such notice. This notice is being provided no later than forty-five (45) days after the date of such foreign or international filing.

*If a notice of subsequent foreign or international filing required by 35 U.S.C. 122(b)(2)(B)(iii) and 37 CFR 1.213(c) was not filed within forty-five (45) days after the date of filing of the foreign or international application, the application is ABANDONED, and a petition to revive under 37 CFR 1.137(b) is required. See 37 CFR 1.137(f).*

\_\_\_\_\_

Date

\_\_\_\_\_

Signature

\_\_\_\_\_

Telephone Number

\_\_\_\_\_

Typed or printed name

**This request must be signed in compliance with 37 CFR 1.33(b).**

If information or assistance is needed in completing this form, please contact the Pre-Grant Publication Division at (703) 605-4283 or by e-mail at [PGPub@USPTO.gov](mailto:PGPub@USPTO.gov).

**CERTIFICATE OF MAILING OR TRANSMISSION**

I hereby certify that this correspondence is being deposited with the United States Postal Service with sufficient postage as first class mail in an envelope addressed to: Mail Stop PG Pub, Commissioner For Patents, P.O. Box 1450, Alexandria, VA 22313-1450, or facsimile ((703) 305-8568) transmitted to the U.S. Patent and Trademark Office on the date shown below.

Name (Print/Type)	
Signature	Date

Burden Hour Statement: This collection of information is required by 37 CFR 1.213(b). The information is used by the public to rescind a previously filed request that an application not be published under 35 U.S.C. 122(b) (and the PTO to process that rescission). Confidentiality is governed by 35 U.S.C. 122 and 37 CFR 1.14. This form is estimated to take 6 minutes to complete. This time will vary depending upon the needs of the individual case. Any comments on the amount of time you are required to complete this form should be sent to the Chief Information Officer, U.S. Patent and Trademark Office, P.O. Box 1450, Alexandria, VA 22313-1450. DO NOT SEND FEES OR COMPLETED FORMS TO THIS ADDRESS. **SEND TO: Mail Stop PG Pub, Commissioner for Patents, P.O. Box 1450, Alexandria, VA 22313-1450.**

*If you need assistance in completing the form, call 1-800-PTO-9199 and select option 2.*

PTO/SB/64a (11-03)  
 Approved for use through 07/31/2006. OMB 0651-0031  
 U.S. Patent and Trademark Office; U.S. DEPARTMENT OF COMMERCE

Under the Paperwork Reduction Act of 1995, no persons are required to respond to a collection of information unless it displays a valid OMB control number.

<p><b>PETITION FOR REVIVAL OF AN APPLICATION FOR PATENT ABANDONED FOR FAILURE TO NOTIFY THE OFFICE OF A FOREIGN OR INTERNATIONAL FILING (37 CFR 1.137(f))</b></p>	<p>Docket Number (Optional)</p>
<p>First named inventor:</p> <p>Application No.: _____ Art Unit: _____</p> <p>Filed: _____ Examiner: _____</p> <p>Title: _____</p> <p>Attention: Office of Petitions  <b>Mail Stop Petition</b>                  Commissioner for Patents                  P.O. Box 1450                  Alexandria, VA 22313-1450                  FAX: (703) 872-9306</p> <p style="text-align: center;">NOTE: If information or assistance is needed in completing this form, please contact Petitions Information at (703) 305-9282.</p> <p>The above-identified application became abandoned pursuant to 35 U.S.C. 122(b)(2)(B)(iii) for failure to timely notify the Office of the filing of an application in a foreign country or under a multinational international treaty that requires publication of applications eighteen months after filing. The date of abandonment is the day after the expiration date of the forty-five (45) day period set in 35 U.S.C. 122(b)(2)(B)(iii).</p> <p style="text-align: center;">PURSUANT TO 37 CFR 1.137(f), APPLICANT HEREBY PETITIONS FOR REVIVAL OF THIS APPLICATION UNDER 37 CFR 1.137(b)</p> <p>1. Petition fee</p> <p><input type="checkbox"/> Small entity-fee \$ _____ (37 CFR 1.17(m)). Applicant claims small entity status. See 37 CFR 1.27.</p> <p><input type="checkbox"/> Other than small entity - fee \$ _____ (37 CFR 1.17(m))</p> <p>2. Notice of Foreign or International Filing (35 U.S.C. 122(b)(2)(B)(iii) and 37 CFR 1.213(c))</p> <p>Subsequent to the filing of the above-identified application, an application was filed in another country, or under a multinational international treaty (e.g., filed under the Patent Cooperation Treaty), that requires publication of applications eighteen months after filing. The filing date of the subsequently-filed foreign or international application is _____.</p>	

[Page 1 of 2]

This collection of information is required by 37 CFR 1.137. The information is required to obtain or retain a benefit by the public which is to file (and by the USPTO to process) an application. Confidentiality is governed by 35 U.S.C. 122 and 37 CFR 1.14. This collection is estimated to take 1.0 hour to complete, including gathering, preparing, and submitting the completed application form to the USPTO. Time will vary depending upon the individual case. Any comments on the amount of time you require to complete this form and/or suggestions for reducing this burden, should be sent to the Chief Information Officer, U.S. Patent and Trademark Office, U.S. Department of Commerce, P.O. 1450, Alexandria, VA 22313-1450. DO NOT SEND FEES OR COMPLETED FORMS TO THIS ADDRESS. **SEND TO: Commissioner for Patents, P.O. Box 1450, Alexandria, VA 22313-1450.**

If you need assistance in completing the form, call 1-800-PTO-9199 and select option 2.

MANUAL OF PATENT EXAMINING PROCEDURE

PTO/SB/64a (11-03)

Approved for use 07/31/2006, OMB 0651-0031

U.S. Patent and Trademark Office; U.S. DEPARTMENT OF COMMERCE

Under the Paperwork Reduction Act of 1995, no persons are required to respond to a collection of information unless it displays a valid OMB control number.

STATEMENT: The entire delay in filing the required notice of a foreign or international filing from the due date for the required notice until the filing of a grantable petition under 37 CFR 1.137(b) was unintentional.  
[NOTE: The United States Patent and Trademark Office may require additional information if there is a question as to whether either the abandonment or the delay in filing a petition under 37 CFR 1.137(b) was unintentional (MPEP 711.03(c), subsections (III)(C) and (D))].

**WARNING: Information on this form may become public. Credit card information should not be included on this form. Provide credit card information and authorization on PTO-2038.**

_____	_____
Date	Signature
Telephone Number: _____	_____
	Typed or printed name
	_____
	Address
	_____

- Enclosures:  Fee Payment  
 Additional sheets containing statements establishing unintentional delay  
 Other: \_\_\_\_\_

CERTIFICATE OF MAILING OR TRANSMISSION [37 CFR 1.8(a)]

I hereby certify that this correspondence is being:

deposited with the United States Postal Service on the date shown below with sufficient postage as first class mail in an envelope addressed to: Mail Stop Petition, Commissioner for Patents, P.O. Box 1450, Alexandria, VA 22313-1450.

transmitted by facsimile on the date shown below to the United States Patent and Trademark Office at (703) 872-9306.

_____	_____
Date	Signature
	_____
	Type or printed name of person signing certificate

# Chapter 1200 Appeal

- 1201 Introduction**
- 1203 Composition of Board**
- 1204 Administrative Handling**
- 1205 Notice of Appeal**
- 1206 Appeal Brief**
- 1207 Amendment Filed With or After Appeal**
- 1208 Examiner's Answer**
  - 1208.01 Prohibition Against Entry of New Ground of Rejection in Examiner's Answer
  - 1208.02 Reopening of Prosecution After Appeal
  - 1208.03 Reply Brief
- 1209 Oral Hearing**
- 1210 Actions Subsequent to Examiner's Answer but Before Board's Decision**
  - 1210.01 Order for Compliance
- 1211 Remand by Board**
  - 1211.01 Remand by Board To Consider Amendment
  - 1211.02 Remand by Board To Consider Affidavits or Declarations
  - 1211.03 Remand by Board for Further Search
- 1212 Board Requires Appellant to Address Matter**
- 1213 Decision by Board**
  - 1213.01 Statement of Allowability by Board
  - 1213.02 New Grounds of Rejection by Board
  - 1213.03 Publication of Board Decision
- 1214 Procedure Following Decision by Board**
  - 1214.01 Procedure Following New Ground of Rejection by Board
  - 1214.03 Rehearing
  - 1214.04 Examiner Reversed
  - 1214.05 Cancellation of Withdrawn Claims
  - 1214.06 Examiner Sustained in Whole or in Part
  - 1214.07 Reopening of Prosecution
- 1215 Withdrawal or Dismissal of Appeal**
  - 1215.01 Withdrawal of Appeal
  - 1215.02 Claims Standing Allowed
  - 1215.03 Partial Withdrawal
  - 1215.04 Dismissal of Appeal
- 1216 Judicial Review**
  - 1216.01 Appeals to the Federal Circuit
  - 1216.02 Civil Suits Under 35 U.S.C. 145

## 1201 Introduction

The United States Patent and Trademark Office (Office) in administering the Patent Laws makes many decisions of a discretionary nature which the applicant may feel deny him or her the patent protection to which he or she is entitled. The differences of opinion on such matters can be justly resolved only by

prescribing and following judicial procedures. Where the differences of opinion concern the denial of patent claims because of prior art or material deficiencies in the disclosure set forth in the application, the questions thereby raised are said to relate to the merits, and appeal procedure within the Office and to the courts has long been provided by statute.

The line of demarcation between appealable matters for the Board of Patent Appeals and Interferences (Board) and petitionable matters for the Commissioner of Patents and Trademarks should be carefully observed. The Board will not ordinarily hear a question which it believes should be decided by the Commissioner, and the Commissioner will not ordinarily entertain a petition where the question presented is an appealable matter. However, since 37 CFR 1.181(f) states that any petition not filed within 2 months from the action complained of may be dismissed as untimely and since 37 CFR 1.144 states that petitions from restriction requirements must be filed no later than appeal, petitionable matters will rarely be present in a case by the time it is before the Board for a decision. *In re Watkinson*, 900 F.2d 230, 14 USPQ2d 1407 (Fed. Cir. 1990).

## 1203 Composition of Board

35 U.S.C. 6 provides for a Board of Patent Appeals and Interferences as follows:

*35 U.S.C. 6. Board of Patent Appeals and Interferences.*

(a) ESTABLISHMENT AND COMPOSITION.— There shall be in the United States Patent and Trademark Office a Board of Patent Appeals and Interferences. The Director, the Commissioner for Patents, the Commissioner for Trademarks, and the administrative patent judges shall constitute the Board. The administrative patent judges shall be persons of competent legal knowledge and scientific ability who are appointed by the Director.

(b) DUTIES.— The Board of Patent Appeals and Interferences shall, on written appeal of an applicant, review adverse decisions of examiners upon applications for patents and shall determine priority and patentability of invention in interferences declared under section 135(a). Each appeal and interference shall be heard by at least three members of the Board, who shall be designated by the Director. Only the Board of Patent Appeals and Interferences may grant rehearings.

If subsequent to the hearing, but prior to the decision, an administrative patent judge who heard the appeal becomes unable to participate in the decision or any subsequent action for some reason, the Chief Administrative Patent Judge of the Board, at his or her

discretion, may without a rehearing substitute a different Board member for the one who is unavailable, or may offer the appellant the opportunity for a rehearing. See *In re Bose Corp.*, 772 F.2d 866, 227 USPQ 1 (Fed. Cir. 1985).

Should a member die or otherwise become unavailable (for example, retirement) to reconsider a decision, normally another member will be designated by the Chief Administrative Patent Judge as a substitute for the absent member.

## 1204 Administrative Handling

*Ex parte* appeals to the Board, and all papers relating thereto, are forwarded to the Technology Center (TC) for docketing. All appeal papers, such as the notice of appeal, appeal brief, and request for extension of time to file the brief, are processed by the appropriate TC.

To ensure that all records are current, memorandum form PTO-262 is attached to the file wrapper when it is remanded by the Board. It is important that this memorandum be promptly completed and forwarded by the TC if the application is allowed, the prosecution is reopened, a continuation application is filed, or if the appeal is discontinued for any other reason.

If the brief is not filed within the time designated by 37 CFR 1.192, the applicant will be notified that the appeal stands dismissed.

### “SPECIAL CASE”

Subject alone to diligent prosecution by the applicant, an application for patent that once has been made special and advanced out of turn by the United States Patent and Trademark Office (Office) for examination will continue to be special throughout its entire course of prosecution in the Office, including appeal, if any, to the Board. See MPEP § 708.02.

A petition to make an application special after the appeal has been forwarded to the Board may be addressed to the Board. However, no such petition will be granted unless the brief has been filed and applicant has made the same type of showing required by the Commissioner under 37 CFR 1.102. Therefore, diligent prosecution is essential to a favorable decision on a petition to make special.

## 1205 Notice of Appeal

*35 U.S.C. 134. Appeal to the Board of Patent Appeals and Interferences.*

(a) PATENT APPLICANT.— An applicant for a patent, any of whose claims has been twice rejected, may appeal from the decision of the administrative patent judge to the Board of Patent Appeals and Interferences, having once paid the fee for such appeal.

(b) PATENT OWNER.— A patent owner in any reexamination proceeding may appeal from the final rejection of any claim by the administrative patent judge to the Board of Patent Appeals and Interferences, having once paid the fee for such appeal.

(c) THIRD-PARTY.— A third-party requester in an inter partes proceeding may appeal to the Board of Patent Appeals and Interferences from the final decision of the administrative patent judge favorable to the patentability of any original or proposed amended or new claim of a patent, having once paid the fee for such appeal. The third-party requester may not appeal the decision of the Board of Patent Appeals and Interferences.

*35 U.S.C. 41. Patent fees; patent and trademark search systems*

(a) The Director shall charge the following fees:

\*\*\*\*\*

(6)(A) On filing an appeal from the examiner to the Board of Patent Appeals and Interferences, \$300.

(B) In addition, on filing a brief in support of the appeal, \$300, and on requesting an oral hearing in the appeal before the Board of Patent Appeals and Interferences, \$260.

\*\*\*\*\*

*37 CFR 1.191. Appeal to Board of Patent Appeals and Interferences.*

(a) Every applicant for a patent or for reissue of a patent, and every owner of a patent under *ex parte* reexamination filed under § 1.510 for a patent that issued from an original application filed in the United States before November 29, 1999, any of whose claims has been twice or finally (§ 1.113) rejected, may appeal from the decision of the examiner to the Board of Patent Appeals and Interferences by filing a notice of appeal and the fee set forth in § 1.17(b) within the time period provided under §§ 1.134 and 1.136 for reply. Notwithstanding the above, for an *ex parte* reexamination proceeding filed under § 1.510 for a patent that issued from an original application filed in the United States on or after November 29, 1999, no appeal may be filed until the claims have been finally rejected (§ 1.113). Appeals to the Board of Patent Appeals and Interferences in *inter partes* reexamination proceedings filed under § 1.913 are controlled by §§ 1.959 through 1.981. Sections 1.191 through 1.198 are not applicable to appeals in *inter partes* reexamination proceedings filed under § 1.913.

(b) The signature requirement of § 1.33 does not apply to a notice of appeal filed under this section.

(c) An appeal when taken must be taken from the rejection of all claims under rejection which the applicant or patent owner proposes to contest. Questions relating to matters not affecting the

merits of the invention may be required to be settled before an appeal can be considered.

(d) The time periods set forth in §§ 1.191 and 1.192 are subject to the provisions of § 1.136 for patent applications and § 1.550(c) for reexamination proceedings. The time periods set forth in §§ 1.193, 1.194, 1.196 and 1.197 are subject to the provisions of § 1.136(b) for patent applications or § 1.550(c) for reexamination proceedings. See § 1.304(a) for extensions of time for filing a notice of appeal to the U.S. Court of Appeals for the Federal Circuit or for commencing a civil action.

(e) Jurisdiction over the application or patent under reexamination passes to the Board of Patent Appeals and Interferences upon transmittal of the file, including all briefs and examiner's answers, to the Board. Prior to the entry of a decision on the appeal, the Commissioner may *sua sponte* order the application remanded to the examiner.

### APPEAL BY PATENT APPLICANT

Under 37 CFR 1.191(a), an applicant for a patent dissatisfied with the primary examiner's decision in the second or final rejection of his or her claims may appeal to the Board for review of the examiner's rejection by filing a notice of appeal and the required fee set forth in 37 CFR 1.17(b) within the time period provided under 37 CFR 1.134 and 1.136. A notice of appeal may be filed after any of the claims has been twice rejected, regardless of whether the claim(s) has/have been finally rejected. The limitation of "twice or finally...rejected" does not have to be related to a particular application. For example, if any claim was rejected in a parent application, and the claim is again rejected in a continuing application, then applicant will be entitled to file an appeal in the continuing application, even if the claim was rejected only once in the continuing application.

Although the rules no longer require that the notice of appeal identify the rejected claim(s) appealed, or be signed, applicants should continue to file notices of appeal which identify the appealed claims and are signed. The requirement was eliminated from 37 CFR 1.191 as being redundant of the requirements of 37 CFR 1.192 and to avoid the delay and expense to both applicant and the United States Patent and Trademark Office (Office) which is involved in treating a defective notice of appeal. It should be noted that the elimination of the requirement to sign a notice of appeal does not affect the requirements for other papers (such as an amendment under 37 CFR 1.116) submitted with the notice, or for other actions contained within the notice, e.g., an authorization to

charge fees to a deposit account or to a credit card. See MPEP § 509. Thus, failure to sign the notice of appeal may have unintended adverse consequences; for example, if an unsigned notice of appeal contains an (unsigned) authorization to charge the appeal fee to a deposit account, the notice of appeal will be unacceptable because the appeal fee is lacking.

The notice of appeal must be filed within the period for reply set in the last Office action, which is normally 3 months for applications. See MPEP § 714.13. Failure to remove all grounds of rejection and otherwise place an application in condition for allowance or to file an appeal after final rejection will result in the application becoming abandoned, even if one or more claims have been allowed, except where claims suggested for interference have been copied. The notice of appeal and appropriate fee may be filed up to 6 months from the date of the final rejection, so long as an appropriate petition and fee for an extension of time is filed either prior to or with the notice of appeal.

### APPEAL BY PATENT OWNER

37 CFR 1.191 provides for appeal to the Board by the patent owner from any decision in an *ex parte* reexamination proceeding adverse to patentability, in accordance with 35 U.S.C. 306 and 35 U.S.C. 134. See also MPEP § 2273.

In an *ex parte* reexamination of a patent that issued from an original application filed before November 29, 1999, the patent owner may appeal to the Board either (A) after final rejection of the claims, or (B) after the second rejection of the claims. This is based on the version of 35 U.S.C. 134 in existence prior to the amendment of the reexamination statute on November 29, 1999 by Public Law 106-113.

In an *ex parte* reexamination of a patent that issued from an original application filed on or after November 29, 1999, the patent owner may appeal to the Board only after the final rejection of one or more claims in the particular reexamination proceeding for which appeal is sought. See the current version of 35 U.S.C. 134.

The fee for filing the notice of appeal by a patent owner is set forth in 37 CFR 1.17(b), and the time period to pay the fee is determined as provided in 37 CFR 1.134 and 37 CFR 1.136.



Failure to file an appeal in an *ex parte* reexamination proceeding will result in issuance of the reexamination certificate under 37 CFR 1.570.

Appeals to the Board of Patent Appeals and Interferences in *inter partes* reexamination proceedings filed under 35 U.S.C. 311 are governed by 37 CFR

1.959 through 1.981. 37 CFR 1.191 through 1.198 are not applicable to appeals in *inter partes* reexamination proceedings.

The use of a separate letter containing the notice of appeal is strongly recommended. Form PTO/SB/31 may be used for filing a notice of appeal.

PTO/SB/31 (02-01)  
 Approved for use through 10/31/2002. OMB 0651-0031  
 U.S. Patent and Trademark Office; U.S. DEPARTMENT OF COMMERCE

Under the Paperwork Reduction Act of 1995, no persons are required to respond to a collection of information unless it displays a valid OMB control number.

<b>NOTICE OF APPEAL FROM THE EXAMINER TO THE BOARD OF PATENT APPEALS AND INTERFERENCES</b>	Docket Number (Optional)						
I hereby certify that this correspondence is being deposited with the United States Postal Service with sufficient postage as first class mail in an envelope addressed to "Assistant Commissioner for Patents, Washington D.C. 20231" on _____  Signature _____ Typed or printed name _____	In re Application of  <table border="1" style="width: 100%; border-collapse: collapse;"> <tr> <td style="width: 60%;">Application Number</td> <td style="width: 40%;">Filed</td> </tr> <tr> <td colspan="2">For</td> </tr> <tr> <td>Group Art Unit</td> <td>Examiner</td> </tr> </table>	Application Number	Filed	For		Group Art Unit	Examiner
Application Number	Filed						
For							
Group Art Unit	Examiner						
Applicant hereby <b>appeals</b> to the Board of Patent Appeals and Interferences from the last decision of the examiner.  The fee for this Notice of Appeal is (37 CFR 1.17(b)) \$ _____  <input type="checkbox"/> Applicant claims small entity status. See 37 CFR 1.27. Therefore, the fee shown above is reduced by half, and the resulting fee is: \$ _____ <input type="checkbox"/> A check in the amount of the fee is enclosed. <input type="checkbox"/> Payment by credit card. Form PTO-2038 is attached. <input type="checkbox"/> The Commissioner has already been authorized to charge fees in this application to a Deposit Account. I have enclosed a duplicate copy of this sheet. <input type="checkbox"/> The Commissioner is hereby authorized to charge any fees which may be required, or credit any overpayment to Deposit Account No. _____. I have enclosed a duplicate copy of this sheet. <input type="checkbox"/> A petition for an extension of time under 37 CFR 1.136(a) (PTO/SB/22) is enclosed.  <p style="text-align: center;"><b>WARNING: Information on this form may become public. Credit card information should not be included on this form. Provide credit card information and authorization on PTO-2038.</b></p> I am the <input type="checkbox"/> applicant/inventor. <input type="checkbox"/> assignee of record of the entire interest. See 37 CFR 3.71. Statement under 37 CFR 3.73(b) is enclosed. (Form PTO/SB/96) <input type="checkbox"/> attorney or agent of record. <input type="checkbox"/> attorney or agent acting under 37 CFR 1.34(a). Registration number if acting under 37 CFR 1.34(a) _____							
<table style="width: 100%;"> <tr> <td style="width: 60%;"></td> <td style="width: 40%; text-align: center;">_____ Signature</td> </tr> <tr> <td></td> <td style="text-align: center;">_____ Typed or printed name</td> </tr> <tr> <td></td> <td style="text-align: center;">_____ Date</td> </tr> </table> <p>NOTE: Signatures of all the inventors or assignees of record of the entire interest or their representative(s) are required. Submit multiple forms if more than one signature is required, see below*.</p>			_____ Signature		_____ Typed or printed name		_____ Date
	_____ Signature						
	_____ Typed or printed name						
	_____ Date						
<input type="checkbox"/> *Total of _____ forms are submitted.							

Burden Hour Statement: This form is estimated to take 0.2 hours to complete. Time will vary depending upon the needs of the individual case. Any comments on the amount of time you are required to complete this form should be sent to the Chief Information Officer, U.S. Patent and Trademark Office, Washington, DC 20231. DO NOT SEND FEES OR COMPLETED FORMS TO THIS ADDRESS. SEND TO: Assistant Commissioner for Patents, Washington, DC 20231.

## MATTERS HANDLED CONCURRENTLY WITH APPEAL

The Office does not acknowledge receipt of a notice of appeal by separate letter. However, if a self-addressed postcard is included with the notice of appeal, it will be date stamped and mailed.

Form paragraphs 12.01-12.04 may be used to indicate defects in a notice of appeal.

### ¶ 12.01 Notice of Appeal Unacceptable - Fee Unpaid

The notice of appeal filed on [1] is not acceptable because the appeal fee required under 37 CFR 1.17(b) was not filed, or was not timely filed.

Applicant may obtain an extension of time under 37 CFR 1.136(a) to file the appropriate appeal fee. The date on which the notice of appeal, the appeal fee, the petition under 37 CFR 1.136(a), and the petition fee are filed will be the date of the reply and also the date for determining the period of extension and the corresponding amount of the fee. In no case may an applicant reply later than the maximum SIX MONTH statutory period or obtain an extension pursuant to 37 CFR 1.136(a) for more than FIVE MONTHS beyond the date of reply set in an Office action.

### ¶ 12.02 Notice of Appeal Unacceptable - No 2nd Rejection

The notice of appeal filed on [1] is not acceptable under 37 CFR 1.191(a) because [2].

### Examiner Note:

In bracket 2, insert the following wording, as appropriate:

--there has been no second or final rejection in this patent application--;

--there has been no second or final rejection in this *ex parte* reexamination proceeding on a patent that issued from an original application filed in the United States before November 29, 1999--; or

--there has been no final rejection (37 CFR 1.113) of the claims in this *ex parte* reexamination proceeding on a patent that issued from an original application filed in the United States on or after November 29, 1999--.

### ¶ 12.03 Notice of Appeal Unacceptable - Not Timely Filed

The notice of appeal filed on [1] is not acceptable because it was filed after the expiration of the period set in the prior Office action. This application will become abandoned unless applicant obtains an extension under 37 CFR 1.136(a). The date on which the notice of appeal, the appeal fee, the petition under 37 CFR 1.136(a), and the petition fee under 37 CFR 1.17(a) are filed will be the date of the reply and also the date for determining the period of extension and the corresponding amount of the fee. In no case may an applicant reply later than the maximum SIX MONTH statutory period or obtain an extension pursuant to 37 CFR 1.136(a) for more than FIVE MONTHS beyond the date of reply set in an Office action.

### ¶ 12.04 Notice of Appeal Unacceptable - Claims Allowed

The notice of appeal filed on [1] is not acceptable because a notice of allowability was mailed by the Office on [2].

## 1206 Appeal Brief

### 37 CFR 1.192. Appellant's brief.

(a) Appellant must, within two months from the date of the notice of appeal under § 1.191 or within the time allowed for reply to the action from which the appeal was taken, if such time is later, file a brief in triplicate. The brief must be accompanied by the fee set forth in § 1.17(c) and must set forth the authorities and arguments on which appellant will rely to maintain the appeal. Any arguments or authorities not included in the brief will be refused consideration by the Board of Patent Appeals and Interferences, unless good cause is shown.

(b) On failure to file the brief, accompanied by the requisite fee, within the time allowed, the appeal shall stand dismissed.

(c) The brief shall contain the following items under appropriate headings and in the order indicated below unless the brief is filed by an applicant who is not represented by a registered practitioner:

(1) *Real party in interest.* A statement identifying the real party in interest, if the party named in the caption of the brief is not the real party in interest.

(2) *Related appeals and interferences.* A statement identifying by number and filing date all other appeals or interferences known to appellant, the appellant's legal representative, or assignee which will directly affect or be directly affected by or have a bearing on the Board's decision in the pending appeal.

(3) *Status of claims.* A statement of the status of all the claims, pending or cancelled, and identifying the claims appealed.

(4) *Status of amendments.* A statement of the status of any amendment filed subsequent to final rejection.

(5) *Summary of invention.* A concise explanation of the invention defined in the claims involved in the appeal, which shall refer to the specification by page and line number, and to the drawing, if any, by reference characters.

(6) *Issues.* A concise statement of the issues presented for review.

(7) *Grouping of claims.* For each ground of rejection which appellant contests and which applies to a group of two or more claims, the Board shall select a single claim from the group and shall decide the appeal as to the ground of rejection on the basis of that claim alone unless a statement is included that the claims of the group do not stand or fall together and, in the argument under paragraph (c)(8) of this section, appellant explains why the claims of the group are believed to be separately patentable. Merely pointing out differences in what the claims cover is not an argument as to why the claims are separately patentable.

(8) *Argument.* The contentions of appellant with respect to each of the issues presented for review in paragraph (c)(6) of this section, and the basis therefor, with citations of the authorities, statutes, and parts of the record relied on. Each issue should be treated under a separate heading.

(i) For each rejection under 35 U.S.C. 112, first paragraph, the argument shall specify the errors in the rejection and how the first paragraph of 35 U.S.C. 112 is complied with, including, as appropriate, how the specification and drawings, if any,

(A) Describe the subject matter defined by each of the rejected claims,

(B) Enable any person skilled in the art to make and use the subject matter defined by each of the rejected claims, and

(C) Set forth the best mode contemplated by the inventor of carrying out his or her invention.

(ii) For each rejection under 35 U.S.C. 112, second paragraph, the argument shall specify the errors in the rejection and how the claims particularly point out and distinctly claim the subject matter which applicant regards as the invention.

(iii) For each rejection under 35 U.S.C. 102, the argument shall specify the errors in the rejection and why the rejected claims are patentable under 35 U.S.C. 102, including any specific limitations in the rejected claims which are not described in the prior art relied upon in the rejection.

(iv) For each rejection under 35 U.S.C. 103, the argument shall specify the errors in the rejection and, if appropriate, the specific limitations in the rejected claims which are not described in the prior art relied on in the rejection, and shall explain how such limitations render the claimed subject matter unobvious over the prior art. If the rejection is based upon a combination of references, the argument shall explain why the references, taken as a whole, do not suggest the claimed subject matter, and shall include, as may be appropriate, an explanation of why features disclosed in one reference may not properly be combined with features disclosed in another reference. A general argument that all the limitations are not described in a single reference does not satisfy the requirements of this paragraph.

(v) For any rejection other than those referred to in paragraphs (c)(8)(i) to (iv) of this section, the argument shall specify the errors in the rejection and the specific limitations in the rejected claims, if appropriate, or other reasons, which cause the rejection to be in error.

(9) *Appendix*. An appendix containing a copy of the claims involved in the appeal.

(d) If a brief is filed which does not comply with all the requirements of paragraph (c) of this section, appellant will be notified of the reasons for non-compliance and provided with a period of one month within which to file an amended brief. If appellant does not file an amended brief during the one-month period, or files an amended brief which does not overcome all the reasons for non-compliance stated in the notification, the appeal will stand dismissed.

Where the brief is not filed, but within the period allowed for filing the brief an amendment is presented which places the application in condition for allowance, the amendment may be entered since the application retains its pending status during said period. Amendments should not be included in the appeal

brief. Amendments should be filed as separate papers. See MPEP § 1207, § 1215.01, and § 1215.02.

### TIME FOR FILING APPEAL BRIEF

37 CFR 1.192(a) provides 2 months from the date of the notice of appeal for the appellant to file an appeal brief. In an *ex parte* reexamination proceeding, the time period can be extended only under the provisions of 37 CFR 1.550(c). See also MPEP § 2274.

The usual period of time in which appellant must file his or her brief is 2 months from the date of appeal. The Office date of receipt of the notice of appeal (and not the date indicated on any Certificate of Mailing under 37 CFR 1.8) is the date from which this 2 month time period is measured. See MPEP § 512. However, 37 CFR 1.192(a) alternatively permits the brief to be filed “within the time allowed for reply to the action from which the appeal was taken, if such time is later.” These time periods may be extended under 37 CFR 1.136(a), and if 37 CFR 1.136(a) is not available, under 37 CFR 1.136(b) for extraordinary circumstances.

In the event that the appellant finds that he or she is unable to file a brief within the time period allotted by the rules, he or she may file a petition, with fee, to the Technology Center (TC), requesting additional time under 37 CFR 1.136(a). Additional time in excess of 5 months will not be granted unless extraordinary circumstances are involved under 37 CFR 1.136(b). The time extended is added to the calendar day of the original period, as opposed to being added to the day it would have been due when said last day is a Saturday, Sunday, or Federal holiday.

If after an appeal has been filed, but prior to the date for submitting a brief, an interference is declared, appellant’s brief need not be filed while the interference is pending, unless the administrative patent judge has consented to prosecution of the application concurrently with the interference. See MPEP § 2315. Absent such concurrent prosecution, the examiner may, after the interference has terminated and the files have been returned to him or her, (A) set a 2-month period for filing the brief, or (B) withdraw the final rejection of the appealed claims in order to enter an additional rejection on a ground arising out of the interference. See, for example, MPEP § 2363.03. Also, if the appellant was the losing party in the interference, claims which were designated as

corresponding to the lost count or counts will stand finally disposed of under 37 CFR 1.663.

When an application is revived after abandonment for failure on the part of the appellant to take appropriate action after final rejection, and the petition to revive was accompanied by a notice of appeal, appellant has 2 months, from the mailing date of the Commissioner's affirmative decision on the petition, in which to file the appeal brief. The time period for filing the appeal brief may be extended under 37 CFR 1.136.

With the exception of a declaration of an interference or suggestion of claims for an interference and timely copying of claims for an interference, the appeal ordinarily will be dismissed if the brief is not filed within the period provided by 37 CFR 1.192(a) or within such additional time as may be properly extended.

A brief must be filed to preserve appellant's right to the appealed claims, notwithstanding circumstances such as:

(A) the possibility or imminence of an interference involving the subject application, but not resulting in withdrawal of the final rejection prior to the brief's due date;

(B) the filing of a petition to invoke the supervisory authority of the Commissioner under 37 CFR 1.181;

(C) the filing of an amendment, even if it is one which the examiner previously has indicated may place one or more claims in condition for allowance, unless the examiner, in acting on the amendment, disposes of all issues on appeal;

(D) the receipt of a letter from the examiner stating that prosecution is suspended, without the examiner withdrawing the final rejection from which appeal has been taken or suggesting claims for an interference, and without an administrative patent judge declaring an interference with the subject application.

Although failure to file the brief within the permissible time will result in dismissal of the appeal, if any claims stand allowed, the application does not become abandoned by the dismissal, but is returned to the examiner for action on the allowed claims. See MPEP § 1215.04. If there are no allowed claims, the applica-

tion is abandoned as of the date the brief was due. Claims which have been objected to as dependent from a rejected claim do not stand allowed. In a reexamination proceeding failure to file the brief will result in the issuance of the certificate under 37 CFR 1.570.

If the time for filing a brief has passed and the application has consequently become abandoned, the applicant may petition to revive the application, as in other cases of abandonment, and to reinstate the appeal; if the appeal is dismissed, but the application is not abandoned, the petition would be to reinstate the claims and the appeal, but a showing equivalent to that in a petition to revive under 37 CFR 1.137 is required. In either event, a proper brief must be filed before the petition will be considered on its merits.

Where the dismissal of the appeal is believed to be in error, filing a petition, pointing out the error, may be sufficient.

A fee under 37 CFR 1.17(c) is required when the brief is filed. 37 CFR 1.192(a) requires the submission of three copies of the appeal brief.

## APPEAL BRIEF CONTENT

The brief, as well as every other paper relating to an appeal, should indicate the number of the Technology Center (TC) to which the application or patent under reexamination is assigned and the application or reexamination control number. When the brief is received, it is forwarded to the TC where it is entered in the file, and referred to the examiner.

An appellant's brief must be responsive to every ground of rejection stated by the examiner.

Where an appeal brief fails to address any ground of rejection, appellant shall be notified by the examiner that he or she must correct the defect by filing a brief (in triplicate) in compliance with 37 CFR 1.192(c). See 37 CFR 1.192(d). Form paragraphs 12.76-12.76.06 and 12.78, or form PTOL-462, "Notification of Non-Compliance with 37 CFR 1.192(c)," may be used to notify the appellant of the deficiency. Oral argument at a hearing will not remedy such deficiency of a brief. The fact that appellant may consider a ground to be clearly improper does not justify a failure to point out to the Board the reasons for that belief.

The mere filing of paper entitled as a brief will not necessarily be considered to be in compliance with 37 CFR 1.192(c). The rule requires that the brief must set forth the authorities and arguments relied upon. Since it is essential that the Board should be provided with a brief fully stating the position of the appellant with respect to each issue involved in the appeal so that no search of the record is required in order to determine that position, 37 CFR 1.192(c) requires that the brief contain specific items, as discussed below.

An exception to the requirement that all the items specified in 37 CFR 1.192(c) be included in the brief is made if the application or reexamination proceeding is being prosecuted by the appellant *pro se*, i.e., there is no attorney or agent of record, and the brief was neither prepared nor signed by a registered attorney or agent. The brief of a *pro se* appellant which does not contain all of the items, (1) to (9), specified in 37 CFR 1.192(c) will be accepted as long as it substantially complies with the requirements of items (1), (2), and (8). If the brief of a *pro se* appellant is accepted, it will be presumed that all the claims of a rejected group of claims stand or fall together unless an argument is included in the brief that presents reasons as to why the appellant considers one or more of the claims in the rejected group to be separately patentable from the other claims in the group.

A distinction must be made between the lack of any argument and the presentation of arguments which carry no conviction. In the former case, notification of a defective appeal brief is in order, while in the latter case, the application or reexamination is forwarded to the Board for a decision on the merits. As noted above, the examiner may use form paragraphs 12.76-12.76.06 and 12.78, or form PTOL-462, "Notification of Non-Compliance with 37 CFR 1.192(c)," to notify appellant that the appeal brief is defective.

If in his or her brief, appellant relies on some reference, he or she is expected to provide the Board with three copies of it.

The specific items required by 37 CFR 1.192(c) are:

(1) *Real party in interest*. A statement identifying the real party in interest, if the party named in the caption of the brief is not the real party in interest. If appellant does not name a real party in interest, the examiner will assume that the party named in the cap-

tion of the brief is the real party in interest, i.e., the owner at the time the brief is being filed.

The identification of the real party in interest will allow members of the Board to comply with ethics regulations associated with working in matters in which the member has a financial interest to avoid any potential conflict of interest. While the examiner will assume that the real party in interest is the individual or individuals identified in the caption when the real party in interest is not explicitly set out in the brief, nevertheless, the Board may require the appellant to explicitly name the real party in interest. See MPEP § 1210.01.

(2) *Related appeals and interferences*. A statement identifying by application number and filing date all other appeals or interferences known to appellant, the appellant's legal representative, or assignee which will directly affect or be directly affected by or have a bearing on the Board's decision in the pending appeal. The appeal or interference number should also be listed. The statement is not limited to copending applications. If appellant does not identify any other appeals or interferences, the examiner will presume that there are none. While the examiner will assume that there are no related cases when no related case is explicitly set out in the brief, nevertheless, the Board may require the appellant to explicitly identify any related case. See MPEP § 1210.01.

(3) *Status of Claims*. A statement of the status of all the claims in the application, or patent under reexamination, i.e., for each claim in the case, appellant must state whether it is cancelled, allowed, rejected, etc. Each claim on appeal must be identified.

(4) *Status of Amendments*. A statement of the status of any amendment filed subsequent to final rejection, i.e., whether or not the amendment has been acted upon by the examiner, and if so, whether it was entered, denied entry, or entered in part. This statement should be of the status of the amendment as understood by the appellant.

Items (3) and (4) are included in 37 CFR 1.192(c) to avoid confusion as to which claims are on appeal, and the precise wording of those claims, particularly where the appellant has sought to amend claims after final rejection. The inclusion of items (3) and (4) in the brief will advise the examiner of what the appellant considers the status of the claims and post-final rejection amendments to be, allowing any

disagreement on these questions to be resolved before the appeal is taken up for decision by the Board.

(5) *Summary of Invention.* A concise explanation of the invention defined in the claims involved in the appeal. This explanation is required to refer to the specification by page and line number, and, if there is a drawing, to the drawing by reference characters. Where applicable, it is preferable to read the appealed claims on the specification and any drawing. While reference to page and line number of the specification may require somewhat more detail than simply summarizing the invention, it is considered important to enable the Board to more quickly determine where the claimed subject matter is described in the application.

(6) *Issues.* A concise statement of the issues presented for review. Each stated issue should correspond to a separate ground of rejection which appellant wishes the Board of Patent Appeals and Interferences to review. While the statement of the issues must be concise, it should not be so concise as to omit the basis of each issue. For example, the statement of an issue as “Whether claims 1 and 2 are unpatentable” would not comply with 37 CFR 1.192(c)(6). Rather, the basis of the alleged unpatentability would have to be stated, e.g., “Whether claims 1 and 2 are unpatentable under 35 U.S.C. 103 over Smith in view of Jones,” or “Whether claims 1 and 2 are unpatentable under 35 U.S.C. 112, first paragraph, as being based on a nonenabling disclosure.” The statement would be limited to the issues presented, and should not include any argument concerning the merits of those issues.

(7) *Grouping of Claims.* For each ground of rejection which appellant contests and which applies to a group of two or more claims, the Board shall select a single claim from the group and shall decide the appeal as to the ground of rejection on the basis of that claim alone, unless a statement is included that the claims of the group do not stand or fall together and, in the argument section of the brief (37 CFR 1.192(c)(8)), appellant explains why the claims of the group are believed to be separately patentable. Merely pointing out differences in what the claims cover is not an argument as to why the claims are separately patentable. If an appealed ground of rejection applies to more than one claim and appellant considers the rejected claims to be separately patentable, 37 CFR 1.192(c)(7) requires appellant to state that the claims

do not stand or fall together, and to present in the appropriate part or parts of the argument under 37 CFR 1.192(c)(8) the reasons why they are considered separately patentable.

The absence of such a statement and argument is a concession by the applicant that, if the ground of rejection were sustained as to any one of the rejected claims, it will be equally applicable to all of them. 37 CFR 1.192(c)(7) is consistent with the practice of the Court of Appeals for the Federal Circuit indicated in such cases as *In re Young*, 927 F.2d 588, 18 USPQ2d 1089 (Fed. Cir. 1991); *In re Nielson*, 816 F.2d 1567, 2 USPQ2d 1525 (Fed. Cir. 1987); *In re King*, 801 F.2d 1324, 231 USPQ 136 (Fed. Cir. 1986); and *In re Sernaker*, 702 F.2d 989, 217 USPQ 1 (Fed. Cir. 1983). 37 CFR 1.192(c)(7) requires the inclusion of reasons in order to avoid unsupported assertions of separate patentability. The reasons may be included in the appropriate portion of the “Argument” section of the brief. For example, if claims 1 to 4 are rejected under 35 U.S.C. 102 and appellant considers claim 4 to be separately patentable from claims 1 to 3, he or she should so state in the “Grouping of claims” section of the brief, and then give the reasons for separate patentability in the 35 U.S.C. 102 portion of the “Argument” section (i.e., under 37 CFR 1.192(c) (8) (iii)).

In the absence of a separate statement that the claims do not stand or fall together, the Board panel assigned to the case will normally select the broadest claim in a group and will consider only that claim, even though the group may contain two broad claims, such as “ABCDE” and “ABCDEF.” The same would be true in a case where there are both broad method and apparatus claims on appeal in the same group. The rationale behind the rule, as amended, is to make the appeal process as efficient as possible. Thus, while the Board will consider each separately argued claim, the work of the Board can be done in a more efficient manner by selecting a single claim from a group of claims when the appellant does not meet the requirements of 37 CFR 1.192(c)(7).

It should be noted that 37 CFR 1.192(c)(7) requires the appellant to perform two affirmative acts in his or her brief in order to have the separate patentability of a plurality of claims subject to the same rejection considered. The appellant must (A) state that the claims do not stand or fall together and (B) present arguments why the claims subject to the same rejec-

tion are separately patentable. Where the appellant does neither, the claims will be treated as standing or falling together. Where, however, the appellant (A) omits the statement required by 37 CFR 1.192(c)(7) yet presents arguments in the argument section of the brief, or (B) includes the statement required by 37 CFR 1.192(c)(7) to the effect that one or more claims do not stand or fall together (i.e., that they are separately patentable) yet does not offer argument in support thereof in the "Argument" section of the brief, the appellant should be notified of the noncompliance as per 37 CFR 1.192(d). *Ex parte Schier*, 21 USPQ2d 1016 (Bd. Pat. App. & Int. 1991); *Ex parte Ohsumi*, 21 USPQ2d 1020 (Bd. Pat. App. & Int. 1991).

(8) *Argument*. The appellant's contentions with respect to each of the issues presented for review in 37 CFR 1.192(c) (6), and the basis for those contentions, including citations of authorities, statutes, and parts of the record relied on, should be presented in this section.

Included in this paragraph are five subparagraphs, (i) to (v). Subparagraphs (i) to (iv) concern the grounds of rejection most commonly involved in *ex parte* appeals, namely, 35 U.S.C. 112, first and second paragraphs, 35 U.S.C. 102, and 35 U.S.C. 103. Subparagraph (v) is a general provision concerning grounds of rejection not covered by subparagraphs (i) to (iv).

The purpose of subparagraphs (i) to (iv) is to ensure that the appellant's argument concerning each appealed ground of rejection will include a discussion of the questions relevant to that ground. Compliance with the requirements of the particular subparagraphs which are pertinent to the grounds of rejection involved in an appeal will be beneficial both to the U. S. Patent and Trademark Office and appellants. It will not only facilitate a decision by the Board of Patent Appeals and Interferences by enabling the Board to determine more quickly and precisely the appellant's position on the relevant issues, but also will help appellants to focus their arguments on those issues.

For each rejection not falling under subparagraphs (i) to (iv), subparagraph (v) provides that the argument should specify the specific limitations in the rejected claims, if appropriate, or other reasons, which cause the rejection to be in error. This language recognizes that for some grounds of rejection, it may not be

necessary to specify particular claim limitations, for example, a rejection under 35 U.S.C. 101, on the ground that the claims are directed to nonstatutory subject matter, as in *Ex parte Hibberd*, 227 USPQ 443 (Bd. Pat. App. & Inter. 1985).

37 CFR 1.192(a) contains the following sentence:

Any arguments or authorities not included in the brief will be refused consideration by the Board of Patent Appeals and Interferences, unless good cause is shown.

This sentence emphasizes that all arguments and authorities which an appellant wishes the Board to consider should be included in the brief. It should be noted that arguments not presented in the brief and made for the first time at the oral hearing are not normally entitled to consideration. *In re Chiddix*, 209 USPQ 78 (Comm'r Pat. 1980); *Rosenblum v. Hiroshima*, 220 USPQ 383 (Comm'r Pat. 1983).

37 CFR 1.192(a) is not intended to preclude the filing of a supplemental paper if new authority should become available or relevant after the brief was filed. An example of such circumstances would be where a pertinent decision of a court or other tribunal was not published until after the brief was filed.

(9) *Appendix*. An appendix containing a copy of the claims involved in the appeal.

The copy of the claims required in the brief Appendix by 37 CFR 1.192(c)(9) should be a clean copy and should not include any markings such as brackets or underlining. See MPEP § 1454 for the presentation of the copy of the claims in a reissue application.

The copy of the claims should be double spaced and the appendix should start on a new page.

37 CFR 1.192(c) merely specifies the minimum requirements for a brief, and does not prohibit the inclusion of any other material which an appellant may consider necessary or desirable, for example, a list of references, table of contents, table of cases, etc. A brief is in compliance with 37 CFR 1.192(c) as long as it includes items (1) to (9) in the order set forth (with the appendix, item (9), at the end).

## REVIEW OF BRIEF BY EXAMINER

The question of whether a brief complies with the rule is a matter within the jurisdiction of the examiner. 37 CFR 1.192(d) provides that if a brief is filed which does not comply with all the requirements of paragraph (c), the appellant will be notified of the reasons for noncompliance. Appellant will be given the long-



est of any of the following time periods to correct the defect(s):

(A) 1 month or 30 days from the mailing of the notification of non-compliance, whichever is longer;

(B) within the time period for reply to the action from which appeal has been taken; or

(C) within 2 months from the date of the notice of appeal under 37 CFR 1.191.

Extensions of time may be granted under 37 CFR 1.136(a) or 1.136(b). The examiner may use the form paragraphs set forth below or form PTOL-462, "Notification of Non-Compliance with 37 CFR 1.192(c)," to notify appellant that the appeal brief is defective. The appeal will be dismissed if the appellant does not timely file an amended brief, or files an amended brief which does not overcome all the reasons for noncompliance of which the appellant was notified.

Under 37 CFR 1.192(d), the appellant may file an amended brief to correct any deficiencies in the original brief. Moreover, if appellant disagrees with the examiner's holding of noncompliance, a petition under 37 CFR 1.181 may be filed.

Once the brief has been filed, a petition to suspend proceedings may be considered on its merits, but will be granted only in exceptional cases, such as where the writing of the examiner's answer would be fruitless or the proceedings would work an unusual hardship on the appellant.

For a reply brief, see MPEP § 1208.03.

Form paragraphs 12.08-12.13, 12.16, 12.17, and 12.69-12.78, or Form PTOL-462, "Notification of Non-Compliance with 37 CFR 1.192(c)," may be used concerning the appeal brief.

¶ *12.08 Appeal Dismissed - Brief Fee Unpaid, No Allowed Claims*

The appeal under 37 CFR 1.191 is dismissed because the fee for filing the brief, as required under 37 CFR 1.17(c) was not submitted or timely submitted and the period for obtaining an extension of time to file the brief under 37 CFR 1.136(a) has expired.

As a result of this dismissal, the application is ABANDONED since there are no allowed claims.

**Examiner Note:**

Claims which have been indicated as containing allowable subject matter, but are objected to as being dependent upon a rejected claim, are to be considered as if they were rejected. See MPEP § 1215.04.

¶ *12.09 Appeal Dismissed - Brief Fee Unpaid, Allowed Claims*

The appeal under 37 CFR 1.191 is dismissed because the fee for filing the appeal brief, as required under 37 CFR 1.17(c), was not submitted or timely submitted and the period for obtaining an extension of time to file the brief under 37 CFR 1.136(a) has expired.

As a result of this dismissal, the application will be further processed by the examiner since it contains allowed claims. Prosecution on the merits remains CLOSED.

**Examiner Note:**

Claims which have been indicated as containing allowable subject matter, but are objected to as being dependent upon a rejected claim, are to be considered as if they were rejected. See MPEP § 1215.04.

¶ *12.09.01 Appeal Dismissed - Allowed Claims, Formal Matters Remaining*

In view of applicant's failure to file a brief within the time prescribed by 37 CFR 1.192(a), the appeal stands dismissed and the proceedings as to the rejected claims are considered terminated. See 37 CFR 1.197(c).

This application will be passed to issue on allowed claim [1] provided the following formal matters are corrected. Prosecution is otherwise closed.

[2]

Applicant is required to make the necessary corrections within a shortened statutory period set to expire ONE MONTH or THIRTY DAYS, whichever is longer, from the mailing date of this letter. Extensions of time may be granted under 37 CFR 1.136.

**Examiner Note:**

1. This form paragraph should only be used if the formal matters cannot be handled by examiner's amendment. See MPEP § 1215.04.
2. In bracket 2, insert a description of the formal matters to be corrected.
3. Claims which have been indicated as containing allowable subject matter but are objected to as being dependent upon a rejected claim are to be considered as if they were rejected. See MPEP § 1215.04.

¶ *12.10 Extension To File Brief - Granted*

The request for an extension of time under 37 CFR 1.136(b) for filing the appeal brief under 37 CFR 1.192 filed on [1] has been **approved** for [2].

**Examiner Note:**

This form paragraph should only be used when 37 CFR 1.136(a) is not available or has been exhausted, such as in litigation reissues.

¶ *12.11 Extension To File Brief - Denied*

The request for an extension of time under 37 CFR 1.136(b) for filing the appeal brief under 37 CFR 1.192 filed on [1] has been **disapproved** because no sufficient cause for the extension has been shown.

**Examiner Note:**

This form paragraph should only be used when 37 CFR 1.136(a) is not available or has been exhausted, such as in litigation reissues.

**¶ 12.12 Brief Defective - Unsigned**

The appeal brief filed on [1] is defective because it is unsigned. 37 CFR 1.33. A ratification properly signed is required.

To avoid dismissal of the appeal, appellant must ratify the appeal brief within the longest of any of the following TIME PERIODS: (1) ONE MONTH or THIRTY DAYS from the mailing of this communication, whichever is longer; (2) within the time period for reply to the action from which appeal has been taken; or (3) within two months from the date of the notice of appeal under 37 CFR 1.191. Extensions of these time periods may be granted under 37 CFR 1.136.

**¶ 12.13 Brief Defective - Three Copies Lacking**

The appeal brief filed on [1] is defective because the three copies of the Brief required under 37 CFR 1.192(a) have not been submitted.

To avoid dismissal of the appeal, appellant must submit the necessary additional copies of the appeal brief within the longest of any of the following TIME PERIODS: (1) ONE MONTH or THIRTY DAYS, whichever is longer, from the mailing of this communication; (2) within the time period for reply to the action from which appeal has been taken; or, (3) within two months from the date of the notice of appeal under 37 CFR 1.191. Extensions of these time periods may be granted under 37 CFR 1.136.

**¶ 12.16 Brief Unacceptable - Fee Unpaid**

The appeal brief filed on [1] is unacceptable because the fee required under 37 CFR 1.17(c) was not timely filed.

This application will become abandoned unless appellant obtains an extension of time under 37 CFR 1.136(a) and files the required appeal brief fee. The date on which the brief, the fee for filing the brief, the petition under 37 CFR 1.136(a), and the petition fee under 37 CFR 1.17(a) are filed will be the date of the reply and also the date for determining the period of extension and the corresponding amount of the fee. In no case may an appellant obtain an extension for more than FIVE MONTHS under 37 CFR 1.136(a) beyond the TWO MONTH period for filing the appeal brief.

**¶ 12.17 Brief Unacceptable - Not Timely Filed**

The appeal brief filed on [1] is unacceptable because it was filed after the expiration of the required period for reply.

This application will become abandoned unless appellant obtains an extension of time under 37 CFR 1.136(a). The date on which the appeal brief, the fee for filing the brief, the petition under 37 CFR 1.136(a), and the petition fee under 37 CFR 1.17(a) are filed will be the date of the reply and also the date for determining the period of extension and the corresponding amount of the fee. In no case may an appellant obtain an extension for more than FIVE MONTHS under 37 CFR 1.136(a) beyond the TWO MONTH period for filing the appeal brief.

Form paragraph 12.69, followed by one or more of from paragraphs 12.69.01-12.78 may be used for noting noncompliance with 37 CFR 1.192(c).

**¶ 12.69 Heading for Notice Under 37 CFR 1.192(c)**

NOTIFICATION OF NON-COMPLIANCE WITH THE REQUIREMENTS OF 37 CFR 1.192(c)

**Examiner Note:**

Use form PTOL-90 and follow with one or more of form paragraphs 12.69.01 to 12.77 and conclude with form paragraph 12.78.

**¶ 12.69.01 Statement in Brief That Claims Do Not Stand or Fall Together - Supporting Reasons Lacking**

The brief includes a statement that claims [1] do not stand or fall together, but fails to present reasons in support thereof as required under 37 CFR 1.192(c)(7). MPEP § 1206.

**Examiner Note:**

1. This form paragraph should be used only when no supporting reasons are presented in the brief. If reasons are presented, even if they are not agreed with, use form paragraph 12.55.02 instead of this form paragraph. Reasons for disagreement are discussed in either the “Grounds of Rejection” or in the “Response to Argument” portion of the Examiner’s Answer.

2. If the brief contains neither a statement that claims do not stand or fall together nor reasons in support thereof, use form paragraph 12.55.01 in the Examiner’s Answer.

**¶ 12.70 Missing Section Headings**

The brief does not contain the items of the brief required by 37 CFR 1.192(c) under the appropriate headings and/or in the order indicated. [1]

**Examiner Note:**

In bracket 1, insert an indication of the missing headings or errors in the order of items.

**¶ 12.70.01 Defect in Statement of Real Party in Interest**

The brief does not contain a heading identifying the real party in interest as required by 37 CFR 1.192(c)(1).

**¶ 12.70.02 Defect in Statement of Related Appeals and Interferences**

The brief does not contain a heading identifying the related appeals and interferences directly affected by or having a bearing on the decision in the pending appeal as required by 37 CFR 1.192(c)(2).

**¶ 12.71 Defect in Statement of Status of Claims**

The brief does not contain a statement of the status of all the claims, pending or canceled, and identify the claims appealed as required by 37 CFR 1.192(c)(3). [1]

**Examiner Note:**

In bracket 1, insert an indication of the missing claim status information.

¶ *12.72 Defect in Statement of Status of Amendment Filed After Final Rejection*

The brief does not contain a statement of the status of an amendment filed subsequent to the final rejection as required by 37 CFR 1.192(c)(4). [1]

**Examiner Note:**

In bracket 1, insert an identification of the amendment for which the status is missing.

¶ *12.73 Defect in Explanation of the Invention*

The brief does not contain a concise explanation of the invention defined in the claims involved in the appeal, which refers to the specification by page and line number, and to the drawing, if any, by reference characters as required by 37 CFR 1.192(c)(5). [1]

**Examiner Note:**

In bracket 1, insert an indication of the missing explanation.

¶ *12.74 Defect in Statement of the Issues*

The brief does not contain a concise statement of the issues presented for review as required by 37 CFR 1.192(c)(6). [1]

**Examiner Note:**

In bracket 1, insert an indication of the missing concise statement of the issues presented for review.

¶ *12.76 Defect in the Arguments of the Appellant*

The brief does not contain arguments of the appellant with respect to each of the issues presented for review in 37 CFR 1.192(c)(6), and the basis therefor, with citations of the authorities, statutes, and parts of the record relied on as required by 37 CFR 1.192(c)(8).

**Examiner Note:**

Include one or more of form paragraphs 12.76.01 to 12.76.06 which apply.

¶ *12.76.01 Separate Heading for Each Issue*

Each issue should be treated under a separate heading.

¶ *12.76.02 Defect in 112, First Paragraph, Rejection Argument*

The brief does not contain, for each rejection under 35 U.S.C. 112 (first paragraph), an argument which specifies the errors in the rejection and how the first paragraph of 35 U.S.C. 112 is complied with, including how the specification and drawings, if any, [1].

**Examiner Note:**

In bracket 1, insert the following wording, as appropriate:

(a)--describe the subject matter defined by each of the rejected claims--,

(b)--enable any person skilled in the art to make and use the subject matter defined by each of the rejected claims--, or

(c)--set forth the best mode contemplated by the inventor of carrying out his/her invention--.

¶ *12.76.03 Defect in 112, Second Paragraph, Rejection Argument*

The brief does not contain, for each rejection under 35 U.S.C. 112 (second paragraph), an argument which specifies the errors in the rejection and how the claims particularly point out and distinctly claim the subject matter which applicant regards as the invention.

¶ *12.76.04 Defect in 102 Rejection Argument*

The brief does not contain, for each rejection under 35 U.S.C. 102, an argument which specifies the errors in the rejection and why the rejected claims are patentable under 35 U.S.C. 102, including any specific limitations in the rejected claims which are not described in the prior art relied upon in the rejection.

**Examiner Note:**

Specify claim(s) for which no argument of error was specified.

¶ *12.76.05 Defect in 103 Rejection Argument*

The brief does not contain, for each rejection under 35 U.S.C. 103, an argument which specifies the errors in the rejection and, if appropriate, the specific limitations in the rejected claims which are not described in the prior art relied upon in the rejection, and an explanation how such limitations render the claimed subject matter unobvious over the prior art. If the rejection is based upon a combination of references, the argument must explain why the references, taken as a whole do not suggest the claimed subject matter, and shall include, as may be appropriate, an explanation of why features disclosed in one reference may not be properly combined with features disclosed in another reference. A general argument that all the limitations are not described in a single reference does not satisfy the requirements of 37 CFR 1.192(c)(8)(iv).

**Examiner Note:**

Specify claim(s) for which no argument of error was specified.

¶ *12.76.06 For Any Rejection Other Than Those Referred to in Paragraphs (c)(8)(i) to (iv) of 37 CFR 1.192 for Which No Argument or Error Was Specified*

The brief does not contain an argument which specifies the errors in the rejection and the specific limitations in the rejected claims, if appropriate, or other reasons, which cause the rejection to be in error.

**Examiner Note:**

Specify claim(s) for which for which no argument of error was specified.

¶ *12.77 No Copy of Appealed Claims in Appendix*

The brief does not contain a copy of the claims involved in the appeal in the Appendix.

¶ *12.78 Period For Response Under 37 CFR 1.192(d)*

Appellant is required to comply with provisions of 37 CFR 1.192(c). To avoid dismissal of the appeal, Appellant must comply with the provisions of 37 CFR 1.192(c) within the longest of any of the following TIME PERIODS: (1) ONE MONTH or THIRTY DAYS, whichever is longer, from the mailing of this communication; (2) within the time period for reply to the action from which

appeal has been taken; or (3) within two months from the date of the notice of appeal under 37 CFR 1.191. Extensions of these time periods may be granted under 37 CFR 1.136.

**Examiner Note:**

This paragraph has limited application. To notify applicant of non-compliance with 37 CFR 1.192(c) examiner must use form PTOL-462.

## 1207 Amendment Filed With or After Appeal

To expedite the resolution of cases under final rejection, an amendment filed at any time after final rejection, but before jurisdiction has passed to the Board (see MPEP § 1210), may be entered upon or after filing of an appeal brief provided that the amendment conforms to the requirements of 37 CFR 1.116. For example, if the amendment necessitates a new search, raises the issue of new matter, presents additional claims without cancelling a corresponding number of finally rejected claims, or otherwise introduces new issues, it will not be entered. A new amendment, new affidavit, or other new evidence must be submitted in a paper separate from the appeal brief. Entry of a new amendment, new affidavit, or other new evidence in an application on appeal is not a matter of right. The entry of an amendment (which may or may not include a new affidavit, declaration, or exhibit) submitted in an application on appeal continues to be governed by 37 CFR 1.116, and the entry of a new affidavit or other new evidence in an application on appeal is governed by 37 CFR 1.195. Examiners must respond to all nonentered amendments after final rejection, and indicate the status of each claim of record or proposed, including the designation of claims that would be entered on the filing of an appeal if filed in a separate paper. If the examiner indicates (in the advisory action) that a proposed amendment of the claim(s) would be entered for purposes of appeal, it is imperative for the examiner to also state (in the same advisory action) how the individual rejection(s) set forth in the final Office action will be used to reject the added or amended claim(s) in the examiner's answer. See 37 CFR 1.193(a)(2) and MPEP § 1208.01. Except where an amendment merely cancels claims and/or adopts examiner suggestions, removes issues from appeal, or in some other way requires only a cursory review by the examiner, compliance with the requirement of a showing under 37

CFR 1.116 will be expected of all amendments after final rejection.

If, after appeal has been taken, a paper is presented which *on its face* clearly places the application in condition for allowance, such paper should be entered and a Notice of Allowability form PTOL-37 promptly sent to applicant.

In accordance with the above, the brief must be directed to the claims and to the record of the case as they appeared at the time of the appeal, but it may, of course, withdraw from consideration on appeal any claims or issues as desired by appellant. Even if the appeal brief withdraws from consideration any claims or issues (i.e., appellant acquiesces to any rejection), the examiner must continue to make the rejection in the examiner's answer, unless an amendment obviating the rejection has been previously proposed and entered.

A timely filed brief will be referred to the examiner for consideration of its propriety as to the appeal issues and for preparation of an examiner's answer if the brief is proper and the application is not allowable. The examiner's answer may withdraw the rejection of claims, if appropriate. The examiner may also determine that it is necessary to reopen prosecution to enter a new ground of rejection. Note MPEP § 1208.02. No new ground of rejection, however, is permitted in an examiner's answer. 37 CFR 1.193(a)(2). See MPEP § 714.13 for procedure on handling amendments filed after final action and before appeal.

An amendment received after jurisdiction has passed to the Board should not be considered by the examiner unless remanded by the Board for such purpose. See MPEP § 1210 and § 1211.01.

Note that 37 CFR 1.192(c)(4) requires a statement as to the status of any amendment filed subsequent to the final rejection. See also MPEP § 1206.

## 1208 Examiner's Answer

*37 CFR 1.193. Examiner's answer and reply brief.*

(a)(1) The primary examiner may, within such time as may be directed by the Commissioner, furnish a written statement in answer to appellant's brief including such explanation of the invention claimed and of the references and grounds of rejection as may be necessary, supplying a copy to appellant. If the primary examiner finds that the appeal is not regular in form or does not relate to an appealable action, the primary examiner shall so state.

(2) An examiner's answer must not include a new ground of rejection, but if an amendment under § 1.116 proposes to add or amend one or more claims and appellant was advised that the

amendment under § 1.116 would be entered for purposes of appeal and which individual rejection(s) set forth in the action from which the appeal was taken would be used to reject the added or amended claim(s), then the appeal brief must address the rejection(s) of the claim(s) added or amended by the amendment under § 1.116 as appellant was so advised and the examiner's answer may include the rejection(s) of the claim(s) added or amended by the amendment under § 1.116 as appellant was so advised. The filing of an amendment under § 1.116 which is entered for purposes of appeal represents appellant's consent that when so advised any appeal proceed on those claim(s) added or amended by the amendment under § 1.116 subject to any rejection set forth in the action from which the appeal was taken.

(b)(1) Appellant may file a reply brief to an examiner's answer or a supplemental examiner's answer within two months from the date of such examiner's answer or supplemental examiner's answer. See § 1.136(b) for extensions of time for filing a reply brief in a patent application and § 1.550(c) for extensions of time for filing a reply brief in a reexamination proceeding. The primary examiner must either acknowledge receipt and entry of the reply brief or withdraw the final rejection and reopen prosecution to respond to the reply brief. A supplemental examiner's answer is not permitted, unless the application has been remanded by the Board of Patent Appeals and Interferences for such purpose.

(2) Where prosecution is reopened by the primary examiner after an appeal or reply brief has been filed, appellant must exercise one of the following two options to avoid abandonment of the application:

- (i) File a reply under § 1.111, if the Office action is not final, or a reply under § 1.113, if the Office action is final; or
- (ii) Request reinstatement of the appeal. If reinstatement of the appeal is requested, such request must be accompanied by a supplemental appeal brief, but no new amendments, affidavits (§§ 1.130, 1.131 or 1.132) or other evidence are permitted.

## APPEAL CONFERENCE

An appeal conference is mandatory in all cases in which an acceptable brief (MPEP § 1206) has been filed. However, if the examiner charged with the responsibility of preparing the examiner's answer reaches a conclusion that the appeal should not go forward and the supervisory patent examiner (SPE) approves, then no appeal conference is necessary.

The participants of the appeal conference should include (1) the examiner charged with preparation of the examiner's answer, (2) a supervisory patent examiner (SPE), and (3) another examiner, known as a conferee, having sufficient experience to be of assistance in the consideration of the merits of the issues on appeal. During the appeal conference, consideration should be given to the possibility of dropping cumula-

tive art rejections and eliminating technical rejections of doubtful value.

The examiner responsible for preparing the examiner's answer should weigh the arguments of the other examiners presented during the appeal conference. If it is determined that the rejection(s) should be maintained, the examiner responsible for preparing the examiner's answer will prepare the examiner's answer.

On the examiner's answer, below the primary examiner's signature, the word "Conferees:" should be included, followed by the typed or printed names of the other two appeal conference participants. These two appeal conference participants must place their initials next to their name. This will make the record clear that an appeal conference has been held.

Upon receipt of the appeal case by the Board of Patent Appeals and Interferences (Board), the Board should review the application prior to assigning an appeal number to determine whether an appeal conference has been held. If the examiner's answer does not contain the appropriate indication that an appeal conference has been held (i.e., including the names of the conferees and identifying themselves as the conferees along with their initials), the Board should return the application directly to the appropriate Technology Center (TC) Director for corrective action. This return procedure by the Board should not be considered as a remand of the application. This procedure applies to all examiner's answers received by the Board on or after November 1, 2000.

Before preparing the answer, the examiner should make certain that all amendments approved for entry have in fact been physically entered. The Clerk of the Board will return to the TC any application in which approved amendments have not been entered.

## ANSWER

The examiner should furnish the appellant with a written statement in answer to the appellant's brief within 2 months after the receipt of the brief by the examiner.

The answer should contain a response to the allegations or arguments in the brief and should call attention to any errors in appellant's copy of the claims. If any rejection is withdrawn, the withdrawal should be clearly stated in the examiner's answer under "Issues." Grounds of rejection not argued in the

examiner's answer are usually treated as having been dropped, but may be considered by the Board if it desires to do so. The examiner should treat affidavits, declarations, or exhibits filed with or after the notice of appeal in accordance with 37 CFR 1.195. If an affidavit, declaration, or exhibit was refused entry under 37 CFR 1.195, the examiner should not comment on it in the examiner's answer. Likewise, it would be improper for appellant to rely on an affidavit, declaration, or exhibit, which was refused entry, in an appeal brief. If appellant has grounds for challenging the non-entry of an affidavit, declaration, or exhibit, he or she should file a timely petition seeking supervisory review of the non-entry. Any affidavits or declarations in the file swearing behind a patent should be clearly identified by the examiner as being considered under either 37 CFR 1.131 or 37 CFR 1.608(b).

If the brief fails to address any or all grounds of rejection advanced by the examiner, or comply with 37 CFR 1.192(c), the indicated procedure for handling such briefs set forth in MPEP § 1206 under "Review of Brief by Examiner" should be followed.

Because of the practice of the U.S. Patent and Trademark Office in entering amendments after final action under justifiable circumstances for purposes of appeal, many cases coming before the Board for consideration contain claims which are not the claims treated in the examiner's final rejection. They are either entirely new claims or amended versions of the finally rejected claims or both. Where an amendment under 37 CFR 1.116 would be entered for appeal purposes, the examiner must identify (in an advisory action) how one or more individual rejections set forth in the final rejection would be used to reject the added or amended claim(s). See 37 CFR 1.193(a)(2) and MPEP § 1208.01. It is important to note that if more than a mere reference to one or more individual rejections set forth in the final rejection is necessary to explain how the added or amended claims would be rejected, then the amendment should not be entered because it raises new issues requiring further consideration and/or search. Furthermore, the mere fact that an amendment under 37 CFR 1.116 could fall within the operation of 37 CFR 1.193(a)(2) does not mean that the amendment must be entered by the examiner. That is, the provisions of 37 CFR 1.116 (and not 37 CFR 1.193(a)(2)) control as to whether an amendment under 37 CFR 1.116 is entitled to entry.

It also frequently happens that an examiner will state a position in the answer in a manner that represents a shift from the position stated in the final rejection without indicating that the last stated position supersedes the former. Such a situation confuses the issue and likewise poses difficulties for the Board since it is not clear exactly what the examiner's ultimate position is.

If there is a complete and thorough development of the issues at the time of final rejection, it is possible to save time in preparing the examiner's answer required by 37 CFR 1.193 by taking any of the following steps:

(A) Examiners may incorporate in the answer their statement of the grounds of rejection merely by reference to the final rejection (or a single other action on which it is based, MPEP § 706.07). Only those statements of grounds of rejection appearing in a *single* prior action may be incorporated by reference. An examiner's answer should not refer, either directly or indirectly, to more than one prior Office action. Statements of grounds of rejection appearing in actions other than the aforementioned single prior action should be *quoted* in the answer. The page and paragraph of the final action or other single prior action which it is desired to incorporate by reference should be explicitly identified. Of course, if the examiner feels that some further explanation of the rejection is necessary, he or she should include it in the answer but ordinarily he or she may avoid another recital of the issues and another elaboration of the grounds of rejection. The answer should also include any necessary rebuttal of arguments presented in the appellant's brief if the final action does not adequately meet the arguments.

(B) If the appellant fails to describe the invention, as required by 37 CFR 1.192, the examiner is not required to provide these omissions under 37 CFR 1.192(d). The examiner should, however, clarify the description and explanation in the answer if he or she feels it necessary to present properly and effectively his or her case to the Board.

The examiner should reevaluate his or her position in the light of the arguments presented in the brief, and should expressly withdraw any rejections not adhered to, especially if the rejection was made in an action which is incorporated by reference. This should be done even though any rejection not repeated and

discussed in the answer may be taken by the Board as having been withdrawn. *Ex parte Emm*, 118 USPQ 180 (Bd. App. 1957).

A new ground of rejection is no longer permitted in an examiner's answer. For a discussion of what constitutes a new ground of rejection, see MPEP § 1208.01. If a new ground of rejection is necessary, prosecution must be reopened. The examiner must obtain approval from the supervisory patent examiner prior to reopening prosecution after an appeal. See MPEP § 1002.02(d).

All correspondence with the Board, whether by the examiner or the appellant, must be on the record. No unpublished decisions which are unavailable to the general public by reason of 35 U.S.C. 122(a) can be cited by the examiner or the appellant except that either the examiner or the appellant has the right to cite an unpublished decision in an application having common ownership with the application on appeal.

When files are forwarded, soft copies and prints of references therein should remain in the file wrapper.

If an examiner's answer is believed to contain a new interpretation or application of the existing patent law, the examiner's answer, application file, and an explanatory memorandum should be forwarded to the TC Director for consideration. See MPEP § 1003. If approved by the TC Director, the examiner's answer should be forwarded to the Office of the Deputy Commissioner for Patent Examination Policy for final approval.

Briefs must comply with 37 CFR 1.192, and all examiner's answers filed in response to such briefs must comply with the guidelines set forth below.

(A) REQUIREMENTS FOR EXAMINER'S ANSWER. The examiner's answer is required to include, under appropriate headings, in the order indicated, the following items:

(1) *Real Party in Interest*. A statement acknowledging the identification of the real party in financial interest or indicating that the party named in the caption of the brief is the real party in interest, or if the brief contains a proper heading but no real party in interest is identified, a statement that it is presumed that the party named in the caption of the brief is the real party in interest. While the examiner will make this presumption, the Board has discretion to require an explicit statement on this item from appellant.

(2) *Related Appeals and Interferences*. A statement acknowledging appellant's identification of related cases which will directly affect or be directly affected by or have a bearing on the decision in the pending appeal, or if the appellant sets forth the required heading but does not identify any related appeals or interferences, a statement that it is presumed that there are none. While the examiner will make this presumption, the Board has discretion to require an explicit statement on this item from appellant.

(3) *Status of Claims*. A statement of whether the examiner agrees or disagrees with the statement of the status of claims contained in the brief and a correct statement of the status of all the claims pending or cancelled, if necessary. If the examiner considers that some or all of the finally rejected claims are allowable, see MPEP § 1208.02.

(4) *Status of Amendments*. A statement of whether the examiner disagrees with the statement of the status of amendments contained in the brief, and an explanation of any disagreement.

(5) *Summary of Invention*. A statement of whether the examiner disagrees with the summary of invention contained in the brief, an explanation of why the examiner disagrees, and a correct summary of invention, if necessary.

(6) *Issues*. A statement of whether the examiner disagrees with the statement of the issues in the brief and an explanation of why the examiner disagrees, including:

(a) identification of any issues which are petitionable rather than appealable, and

(b) identification of any issues or grounds of rejection on appeal which the examiner no longer considers applicable.

(7) *Grouping of Claims*. A statement of whether the examiner disagrees with any statement in the brief that certain claims do not stand or fall together, and, if the examiner disagrees, an explanation as to why those claims are not separately patentable.

(8) *Claims Appealed*. A statement of whether the copy of the appealed claims contained in the appendix to the brief is correct and, if not, a correct copy of any incorrect claim.

(9) *References of Record.* A listing of the references of record relied on, and, in the case of nonpatent references, the relevant page or pages.

(10) *Grounds of Rejection.* For each ground of rejection applicable to the appealed claims, an explanation of the ground of rejection, or reference to a final rejection or other single prior action for a clear exposition of the rejection.

(a) For each rejection under 35 U.S.C. 112, first paragraph, the examiner's answer, or the single prior action, shall explain how the first paragraph of 35 U.S.C. 112 is not complied with, including, as appropriate, how the specification and drawings, if any,

(i) do not describe the subject matter defined by each of the rejected claims,

(ii) would not enable any person skilled in the art to make and use the subject matter defined by each of the rejected claims without undue experimentation, and (c) do not set forth the best mode contemplated by the appellant of carrying out his or her invention.

(b) For each rejection under 35 U.S.C. 112, second paragraph, the examiner's answer, or single prior action, shall explain how the claims do not particularly point out and distinctly claim the subject matter which applicant regards as the invention.

(c) For each rejection under 35 U.S.C. 102, the examiner's answer, or single prior action, shall explain why the rejected claims are anticipated or not patentable under 35 U.S.C. 102, pointing out where all of the specific limitations recited in the rejected claims are found in the prior art relied upon in the rejection.

(d) For each rejection under 35 U.S.C. 103, the examiner's answer, or single prior action, shall:

(i) state the ground of rejection and point out where each of the specific limitations recited in the rejected claims is found in the prior art relied on in the rejection,

(ii) identify any difference between the rejected claims and the prior art relied on, and

(iii) explain how and why the claimed subject matter is rendered unpatentable over the prior art. If the rejection is based upon a combination of references, the examiner's answer, or single prior action, shall explain the rationale for making the combination.

(e) For each rejection under 35 U.S.C. 102 or 103 where there are questions as to how limitations in the claims correspond to features in the prior art even after the examiner complies with the requirements of paragraphs (c) and (d) of this section, the examiner shall compare at least one of the rejected claims feature by feature with the prior art relied on in the rejection. The comparison shall align the language of the claim side-by-side with a reference to the specific page, line number, drawing reference number, and quotation from the prior art, as appropriate.

(f) For each rejection, other than those referred to in paragraphs (a) to (e) of this section, the examiner's answer, or single prior action, shall specifically explain the basis for the particular rejection.

(11) *Response to Argument.* A statement of whether the examiner disagrees with each of the contentions of appellant in the brief with respect to the issues presented and an explanation of the reasons for disagreement with any such contention. If any ground of rejection is not argued and replied to by appellant, the response shall point out each claim affected.

(B) FORM PARAGRAPHS. A form suitable for the examiner's answer is as follows:

¶ 12.49 *Examiner's Answer Cover Sheet*

BEFORE THE BOARD OF PATENT APPEALS  
AND INTERFERENCES

Paper No. [1]

Application Number: [2]

Filing Date: [3]

Appellant(s): [4]

\_\_\_\_\_

[5]

For Appellant  
EXAMINER'S ANSWER

This is in response to the appeal brief filed [6].

**Examiner Note:**

1. This form paragraph includes the USPTO Letterhead and should be used only if typing your own action. Answers prepared in draft form for typing by a typist should use form paragraph 12.50.
2. In bracket 1, insert the Paper No. of the examiner's answer.
3. In bracket 2, insert the application number of the appealed application.
4. In bracket 3, insert the filing date of the appealed application.
5. In bracket 4, insert the name(s) of the appellant.
6. In bracket 5, insert the name of the registered representative of the appellant.



7. In bracket 6, indicate the date on which the brief was filed, and also indicate if any supplemental appeal brief was filed, as well as the date on which the supplemental appeal brief was filed.

8. Form paragraph 12.50 should NOT follow use of this form paragraph as it is already incorporated herein.

¶ *12.50 Heading For Examiner's Answer*

This is in response to the brief on appeal filed [1].

**Examiner Note:**

1. Use this form paragraph only when having the Examiner's Answer prepared without using form paragraph 12.49.

2. In bracket 1, indicate the date on which the brief was filed, and also indicate if any supplemental appeal brief was filed, as well as the date on which the supplemental appeal brief was filed.

¶ *12.50.01 Real Party in Interest*

*(1) Real Party in Interest*

**Examiner Note:**

Follow this form paragraph with form paragraph 12.50.02 or 12.50.03.

¶ *12.50.02 Acknowledgment of Appellant's Identification of a Real Party in Interest in the Brief*

A statement identifying the real party in interest is contained in the brief.

¶ *12.50.03 No Identification of a Real Party in Interest in the Brief*

The brief does not contain a statement identifying the Real Party in Interest. Therefore, it is presumed that the party named in the caption of the brief is the Real Party in Interest, i.e., the owner at the time the brief was filed. The Board, however, may exercise its discretion to require an explicit statement as to the Real Party in Interest.

¶ *12.50.04 Related Appeals and Interferences*

*(2) Related Appeals and Interferences*

**Examiner Note:**

Follow this form paragraph with form paragraph 12.50.05 or 12.50.06.

¶ *12.50.05 Acknowledgment of Appellant's Statement Identifying the Related Appeals and Interferences*

A statement identifying the related appeals and interferences which will directly affect or be directly affected by or have a bearing on the decision in the pending appeal is contained in the brief.

¶ *12.50.06 No Related Appeals and Interferences Identified*

The brief does not contain a statement identifying the related appeals and interferences which will directly affect or be directly affected by or have a bearing on the decision in the pending appeal. Therefore, it is presumed that there are none. The Board may, however, exercise its discretion to require an explicit statement as to the existence of any related appeals and interferences.

¶ *12.51 Status of Claims*

*(3) Status of Claims*

**Examiner Note:**

Follow this form paragraph with one or more of form paragraphs 12.51.01 to 12.51.10.

¶ *12.51.01 Agreement With Statement of Status of Claims*

The statement of the status of claims contained in the brief is correct.

¶ *12.51.02 Disagreement With Statement of Status of Claims*

The statement of the status of claims contained in the brief is incorrect. A correct statement of the status of the claims is as follows:

**Examiner Note:**

1. Indicate the area of disagreement and the reasons for the disagreement.

2. One or more of form paragraphs 12.51.03 to 12.51.10 must follow this paragraph.

¶ *12.51.03 Claims On Appeal*

This appeal involves claim [1].

**Examiner Note:**

1. In bracket 1, all the claims still on appeal should be specified. Do not list claims which are no longer rejected.

2. Also use form paragraphs 12.51.04 to 12.51.06 when appropriate to clarify the status of the claims on appeal that were incorrectly listed in the brief.

¶ *12.51.04 Status of Claims on Appeal - Substituted*

Claim [1] been substituted for the finally rejected claims.

**Examiner Note:**

All substituted claims on appeal must be identified if the brief incorrectly lists any substituted claims. In bracket 1, insert the claim number(s) corresponding to the substitute claims, followed by --has-- or --have--, as appropriate.

¶ *12.51.05 Status of Claims on Appeal - Amended*

Claim [1] been amended subsequent to the final rejection.

**Examiner Note:**

All claims amended after final rejection must be identified if the brief incorrectly lists any claims amended after final rejection. In bracket 1, identify the claim number(s) corresponding to the claim(s) which have been amended, followed by --has-- or --have-- , as appropriate.

¶ *12.51.07 Claims Allowed*

Claim [1] allowed.

**Examiner Note:**

All allowed claims must be identified if the brief incorrectly lists any allowed claims.

¶ *12.51.08 Claims Objected To*

Claim [1] objected to as being dependent upon a rejected base claim, but would be allowable if rewritten in independent form including all of the limitations of the base claim and any intervening claims.

**Examiner Note:**

All objected to claims must be identified if the brief incorrectly lists any claims objected to.

¶ *12.51.09 Claims Withdrawn From Consideration*

Claim [1] withdrawn from consideration as not directed to the elected [2].

**Examiner Note:**

All withdrawn claims must be identified if the brief incorrectly lists any withdrawn claims.

¶ *12.51.10 Claims Canceled*

Claim [1] been canceled.

**Examiner Note:**

All canceled claims must be identified if the brief incorrectly lists any canceled claims.

¶ *12.52 Status of Amendments After Final*

*(4) Status of Amendments After Final*

**Examiner Note:**

Identify status of all amendments submitted after final rejection. Use one or more of form paragraphs 12.52.01 to 12.52.04, if appropriate.

¶ *12.52.01 Agreement With Appellant's Statement of the Status of Amendments After Final*

The appellant's statement of the status of amendments after final rejection contained in the brief is correct.

¶ *12.52.02 Disagreement With Appellant's Statement of the Status of Amendments After Final*

The appellant's statement of the status of amendments after final rejection contained in the brief is incorrect.

**Examiner Note:**

Form paragraphs 12.52.03 and/or 12.52.04 must follow this form paragraph to explain the reasons for disagreeing with appellant's statement of the status of the amendments.

¶ *12.52.03 Amendment After Final Entered*

The amendment after final rejection filed on [1] has been entered.

**Examiner Note:**

1. In bracket 1, insert the filing date of any entered after final amendment.
2. Use this form paragraph for each after final amendment which has been entered.

¶ *12.52.04 Amendment After Final Not Entered*

The amendment after final rejection filed on [1] has not been entered.

**Examiner Note:**

1. In bracket 1, insert the date of any after final amendment denied entry.
2. Use this form paragraph for each after final amendment which has been denied entry.

¶ *12.52.05 No Amendments After Final*

No amendment after final has been filed.

¶ *12.53 Summary of Invention*

*(5) Summary of Invention*

**Examiner Note:**

Follow this form paragraph with either of form paragraphs 12.53.01 or 12.53.02.

¶ *12.53.01 Agreement With the Summary of Invention*

The summary of invention contained in the brief is correct.

¶ *12.53.02 Disagreement With the Summary of Invention*

The summary of invention contained in the brief is deficient because [1].

**Examiner Note:**

In bracket 1, explain the deficiency of the appellant's summary of the invention. Include a correct summary of the invention if necessary for a clear understanding of the claimed invention.

¶ *12.54 Issues*

*(6) Issues*

**Examiner Note:**

Follow this form paragraph with form paragraphs 12.54.01, 12.54.02, or 12.54.03.

¶ *12.54.01 Agreement With Appellant's Statement of the Issues*

The appellant's statement of the issues in the brief is correct.

¶ *12.54.02 Disagreement With Appellant's Statement of the Issues*

The appellant's statement of the issues in the brief is substantially correct. The changes are as follows: [1]

**Examiner Note:**

In bracket 1, explain the changes with respect to the appellant's statement of the issues in the brief including:

- (i) an identification of any issues which are petitionable rather than appealable, and/or
- (ii) an identification of any issues or grounds of rejection on appeal which the examiner no longer considers applicable, and/or
- (iii) any change not covered in (i) or (ii).

¶ *12.54.03 Non-Appealable Issue in Brief*

Appellant's brief presents arguments relating to [1]. This issue relates to petitionable subject matter under 37 CFR 1.181 and not to appealable subject matter. See MPEP § 1002 and § 1201.

¶ *12.55 Grouping of Claims*  
*(7) Grouping of Claims*

**Examiner Note:**

Follow this form paragraph with either form paragraph 12.55.01, 12.55.02 or 12.55.04 for each grouping of claims (i.e., each ground of rejection which appellant contests).

¶ *12.55.01 No Statement and Reasons in Brief That Claims Do Not Stand or Fall Together*

The rejection of claims [1] stand or fall together because appellant's brief does not include a statement that this grouping of claims does not stand or fall together and reasons in support thereof. See 37 CFR 1.192(c)(7).

**Examiner Note:**

1. Use this form paragraph for each grouping of claims (i.e., ground of rejection which appellant contests) wherein the brief includes neither a statement that a grouping of claims does not stand or fall together nor reasons in support thereof.
2. If the brief includes a statement that a grouping of claims does not stand or fall together but does not provide reasons, as set forth in 37 CFR 1.192(c)(7), notify appellant of the non-compliance using form paragraphs 12.69, 12.69.01 and 12.78.

¶ *12.55.02 No Agreement With Brief Why Claims Do Not Stand or Fall Together*

The appellant's statement in the brief that certain claims do not stand or fall together is not agreed with because [1].

**Examiner Note:**

In bracket 1, explain why the claim grouping listed in the brief is not agreed with by the examiner and why, if appropriate, e.g., the claims as listed by the appellant are not separately patentable.

¶ *12.55.04 Brief Gives Reasons Why Claims Do Not Stand or Fall Together*

Appellant's brief includes a statement that claims [1] do not stand or fall together and provides reasons as set forth in 37 CFR 1.192(c)(7) and (c)(8).

¶ *12.56 Claims Appealed*  
*(8) Claims Appealed*

**Examiner Note:**

Follow this form paragraph with form paragraph 12.56.01, 12.56.02 or 12.56.03.

¶ *12.56.01 Copy of the Appealed Claims in Appendix Is Correct*

The copy of the appealed claims contained in the Appendix to the brief is correct.

¶ *12.56.02 Copy of the Appealed Claims in Appendix Is Substantially Correct*

A substantially correct copy of appealed claim [1] appears on page [2] of the Appendix to the appellant's brief. The minor errors are as follows: [3]

**Examiner Note:**

1. In bracket 1, indicate the claim or claims with small errors.
2. In bracket 3, indicate the nature of the errors.

¶ *12.56.03 Copy of the Appealed Claims in Appendix Contain Substantial Errors*

Claim [1] contain(s) substantial errors as presented in the Appendix to the brief. Accordingly, claim [2] correctly written in the Appendix to the Examiner's Answer.

**Examiner Note:**

1. Appellant should include a correct copy of all appealed claims in the Appendix to the brief. See 37 CFR 1.192(c)(9).
2. Attach a correct copy of any incorrect claims as an Appendix to the Examiner's Answer and draw a diagonal line in pencil through the incorrect claim in the Appendix of the appellant's appeal brief.
3. Rather than using this form paragraph, if the errors in the claim(s) are significant, appellant should be required to submit a corrected brief using form paragraphs 12.69, 12.77 and 12.78, as well as any other paragraphs 12.70 to 12.76 as may be appropriate. Where the brief includes arguments directed toward the errors, a corrected brief should always be required.

¶ *12.57 Prior Art of Record*  
*(9) Prior Art of Record*

**Examiner Note:**

Follow this form paragraph with either form paragraph 12.57.01 or 12.57.02.

¶ *12.57.01 No Prior Art Relied Upon*

No prior art is relied upon by the examiner in the rejection of the claims under appeal.

¶ *12.57.02 Listing of the Prior Art of Record Relied Upon*

The following is a listing of the prior art of record relied upon in the rejection of claims under appeal.

**Examiner Note:**

1. Use the following format for providing information on each reference cited:  
 Number Name Date  
 2,717,847 VERAINE 9-1955  
 1,345,890 MUTHER (Fed. Rep. of Germany) 7-1963  
 (Figure 2 labeled as Prior Art in this document)
2. The following are example formats for listing reference citations:
3. See MPEP § 707.05(e) for additional examples.

¶ *12.59 Grounds of Rejection*  
*(10) Grounds of Rejection*

The following ground(s) of rejection are applicable to the appealed claims:

**Examiner Note:**

Explain each ground of rejection or refer to the single prior Office action which clearly sets forth the rejection and complies with appropriate paragraphs i - vi below:

(i) For each rejection under 35 U.S.C. 112, first paragraph, the Examiner's Answer or a single prior action, shall explain how the first paragraph of 35 U.S.C. 112 is not complied with, including, as appropriate, how the specification and drawings, if any, (a) do not describe the subject matter defined by each of the rejected claims, (b) would not enable any person skilled in the art to make and use the subject matter defined by each of the rejected claims, and (c) do not set forth the best mode contemplated by the appellant of carrying out his/her invention.

(ii) For each rejection under 35 U.S.C. 112, second paragraph, the Examiner's Answer or single prior action, shall explain how the claims do not particularly point out and distinctly claim the subject matter which appellant regards as the invention.

(iii) For each rejection under 35 U.S.C. 102, the Examiner's Answer or single prior action, shall explain why the rejected claims are anticipated or not patentable under 35 U.S.C. 102, pointing out where all of the specific limitations recited in the rejected claims are found in the prior art relied upon in the rejection.

(iv) For each rejection under 35 U.S.C. 103, the Examiner's Answer or single prior action, shall state the ground of rejection and point out where each of the specific limitations recited in the rejected claims is found in the prior art relied upon in the rejection, shall identify any difference between the rejected claims and the prior art relied on and shall explain how the claimed subject matter is rendered unpatentable over the prior art. If the rejection is based upon a combination of references, the Examiner's Answer, or single prior action, shall explain the rationale for making the combination.

(v) For each rejection under 35 U.S.C. 102 or 103 where there may be questions as to how limitations in the claims correspond to features in the prior art, the examiner, in addition to the requirements of (ii), (iii) and (iv) above, should compare at least one of the rejected claims feature by feature with the prior art relied on in the rejection. The comparison shall align the language of the claim side by side with a reference to the specific page, line number, drawing reference number and quotation from the prior art, as appropriate.

(vi) For each rejection, other than those referred to in paragraphs (i) to (v) for this section, the Examiner's Answer, or single prior action, shall specifically explain the basis for the particular rejection.

¶ *12.59.01 Reference to Rejection in Prior Office Action*

Claim [1] rejected under 35 U.S.C. [2]. This rejection is fully set forth in prior Office action, Paper No. [3].

**Examiner Note:**

1. In bracket 1, insert the claims subject to this ground of rejection.
2. In bracket 2, insert the section of 35 U.S.C. under which the claims are rejected.
3. In bracket 3, insert the Paper No. of the Office action in which the rejection is set forth in detail.

¶ *12.61 Response to Argument*

**(11) Response to Argument**

**Examiner Note:**

1. If an issue raised by appellant was fully responded to under the "Grounds of Rejection" portion, no additional response is required here.
2. If an issue has been raised by appellant that was not fully responded to under "Grounds of Rejection," a full response must be provided after this form paragraph.

¶ *12.63 Request to Present Oral Arguments*

The examiner requests the opportunity to present arguments at the oral hearing.

**Examiner Note:**

1. Use this form paragraph only if an oral hearing has been requested by appellant and the primary examiner intends to present an oral argument.
2. If appellant's request for an oral hearing has been made before or with the brief, this form paragraph may be included at the end of the Examiner's Answer.
3. If appellant's request for an oral hearing has been made after the Examiner's Answer, this form paragraph may be included in an acknowledgment of reply brief (see form paragraph 12.47), or in a separate letter on a form PTOL-90.

¶ *12.79 Examiner's Answer, Conclusion*

For the above reasons, it is believed that the rejections should be sustained.

Respectfully submitted,  
[1]

Conferees:  
[2]

[3]

**Examiner Note:**

1. In bracket 1, insert initials of the examiner and the date.
2. In bracket 2, insert names of the conferees. The conferees must also place their initials next to their names.
3. In bracket 3, insert correspondence address of record.

For a case having a patentability report, see MPEP § 705.01(a).

If the examiner requests an oral hearing, the request should appear in the last paragraph of the examiner's answer. See the "Participation by Examiner" discussion in MPEP § 1209.

Up to two examiners are permitted to attend any one hearing as observers, where the case is related to the examiners' field of technology. Such attendance by examiners is considered to be desirable for the experience and educational benefits to the examiners.

If the appellant has requested an oral hearing, and the examiner wishes to attend as an observer, the

examiner should include a statement that he/she will attend the hearing: (A) as the last paragraph of the examiner's answer, if appellant's request for an oral hearing has been made before or with the brief, or (B) in an acknowledgement of the reply brief or in a separate letter on form PTOL-90, if appellant's request for an oral hearing has been made after the examiner's answer. Also, the examiner should make a notation "Examiner will attend (but not participate in) hearing" on the face of the file wrapper below the box for the examiner's name.

### **1208.01 Prohibition Against Entry of New Ground of Rejection in Examiner's Answer**

37 CFR 1.193(a)(2) prohibits the entry of a new ground of rejection in an examiner's answer. At the time of preparing the answer to an appeal brief, however, the examiner may decide that he or she should apply a new ground of rejection against some or all of the appealed claims. In such an instance where a new ground of rejection is necessary, the examiner should reopen prosecution. The examiner must obtain supervisory approval in order to reopen prosecution after an appeal. See MPEP § 1002.02(d).

There is no new ground of rejection when the basic thrust of the rejection remains the same such that an appellant has been given a fair opportunity to react to the rejection. See *In re Kronig*, 539 F.2d 1300, 1302-03, 190 USPQ 425, 426-27 (CCPA 1976). Where the statutory basis for the rejection remains the same, and the evidence relied upon in support of the rejection remains the same, a change in the discussion of, or rationale in support of, the rejection does not necessarily constitute a new ground of rejection. *Id.* at 1303, 190 USPQ at 427 (reliance upon fewer references in affirming a rejection under 35 U.S.C. 103 does not constitute a new ground of rejection).

37 CFR 1.193(a)(2) also provides that if:

(A) an amendment under 37 CFR 1.116 proposes to add or amend one or more claims;

(B) appellant was advised (through an advisory action) that the amendment would be entered for purposes of appeal; and

(C) the advisory action indicates which individual rejection(s) set forth in the action from which appeal

has been taken would be used to reject the added or amended claims, then

(1) the appeal brief must address the rejection(s) of the added or amended claim(s) and

(2) the examiner's answer may include the rejection(s) of the added or amended claims.

The filing of such an amendment represents appellant's consent to proceed with the appeal process. For example, when an amendment under 37 CFR 1.116 cancels a claim (the "canceled claim") and incorporates its limitations into the claim upon which it depends or rewrites the claim as a new independent claim (the "appealed claim"), the appealed claim contains the limitations of the canceled claim (i.e., the only difference between the appealed claim and the canceled claim is the claim number). In such situations, the appellant has been given a fair opportunity to react to the ground of rejection (albeit to a claim having a different claim number). Thus, such a rejection does not constitute a "new ground of rejection" within the meaning of 37 CFR 1.193(a)(2).

The phrase "individual rejections" in 37 CFR 1.193(a)(2) addresses situations such as the following: the action contains a rejection of claim 1 under 35 U.S.C. 102 on the basis of Reference A, a rejection of claim 2 (which depends upon claim 1) under 35 U.S.C. 103 on the basis of Reference A in view of Reference B and a rejection of claim 3 (which depends upon claim 1) under 35 U.S.C. 103 on the basis of Reference A in view of Reference C. In this situation, the action contains the following "individual rejections": (1) 35 U.S.C. 102 on the basis of Reference A; (2) 35 U.S.C. 103 on the basis of Reference A in view of Reference B; and (3) 35 U.S.C. 103 on the basis of Reference A in view of Reference C. The action, however, does not contain any rejection on the basis of A in view of B and C. If an amendment under 37 CFR 1.116 proposes to combine the limitations of claims 1 and 2 together into new claim 4 (or add the limitations of claim 2 to claim 1), 37 CFR 1.193(a)(2) would authorize a rejection of claim 4 (or amended claim 1) under 35 U.S.C. 103 on the basis of Reference A in view of Reference B, provided the applicant was advised that this rejection would be applied to claim 4 (or amended claim 1). Likewise, if an amendment under 37 CFR 1.116 proposes to combine the limitations of claims 1 and 3 together into new claim 4 (or add the limitations of claim 3 to claim 1),

37 CFR 1.193(a)(2) would authorize a rejection of claim 4 (or amended claim 1) under 35 U.S.C. 103 on the basis of Reference A in view of Reference C, provided the applicant was advised that this rejection would be applied to claim 4 (or amended claim 1). If, however, an amendment under 37 CFR 1.116 proposes to combine the limitations of claims 1, 2, and 3 together into new claim 4 (or add the limitations of claims 2 and 3 to claim 1), 37 CFR 1.193(a)(2) would **not** authorize a rejection of claim 4 (or amended claim 1) under 35 U.S.C. 103 on the basis of Reference A in view of Reference B and Reference C, even if the applicant is advised that this rejection would be applied to claim 4 (or amended claim 1). Of course, as a claim including the limitations of both claim 2 and claim 3 is a newly proposed claim in the application raising a new issue (*i.e.*, a new ground of rejection), such an amendment under 37 CFR 1.116 may properly be refused entry as raising new issues.

It must be emphasized that amended 37 CFR 1.193(a)(2) does not change the existing practice with respect to amendment after final rejection practice (37 CFR 1.116). The fact that 37 CFR 1.193(a)(2) would authorize the rejection in an examiner's answer of a claim sought to be added or amended in an amendment under 37 CFR 1.116 has no effect on whether the amendment under 37 CFR 1.116 is entitled to entry. The provisions of 37 CFR 1.116 control whether an amendment under 37 CFR 1.116 is entitled to entry; the provisions of 37 CFR 1.193(a)(2) control the rejections to which a claim added or amended in an amendment under 37 CFR 1.116 may be subject in an examiner's answer.

A new prior art reference cited for the first time in an examiner's answer generally will constitute a new ground of rejection. If the citation of a new prior art reference is necessary to support a rejection, it must be included in the statement of rejection, which would be considered to introduce a new ground of rejection. Even if the prior art reference is cited to support the rejection in a minor capacity, it should be positively included in the statement of rejection. *In re Hoch*, 428 F.2d 1341, 1342 n.3, 166 USPQ 406, 407 n. 3 (CCPA 1970). However, where a newly cited reference is added merely as evidence of the prior well known statement made by the examiner, the citation of the reference in the examiner's answer would not consti-

tute a new ground of rejection within the meaning of 37 CFR 1.192(a)(2). See also MPEP § 2144.03.

Any allegation that an examiner's answer contains an impermissible new ground of rejection is waived if not timely (37 CFR 1.181(f)) raised by way of a petition under 37 CFR 1.181(a).

## 1208.02 Reopening of Prosecution After Appeal

The examiner may, with approval from the supervisory patent examiner, reopen prosecution to enter a new ground of rejection after appellant's brief or reply brief has been filed. The Office action containing a new ground of rejection may be made final if the new ground of rejection was (A) necessitated by amendment, or (B) based on information presented in an information disclosure statement under 37 CFR 1.97(c) where no statement under 37 CFR 1.97(e) was filed. See MPEP § 706.07(a).

Form paragraph 12.81 may be used when reopening prosecution:

¶ 12.81 *Reopening of Prosecution - New Ground of Rejection After Appeal or Examiner's Rebuttal of Reply Brief*

In view of the [1] filed on [2], PROSECUTION IS HEREBY REOPENED. [3] set forth below.

To avoid abandonment of the application, appellant must exercise one of the following two options:

- (1) file a reply under 37 CFR 1.111 (if this Office action is non-final) or a reply under 37 CFR 1.113 (if this Office action is final); or,
- (2) request reinstatement of the appeal.

If reinstatement of the appeal is requested, such request must be accompanied by a supplemental appeal brief, but no new amendments, affidavits (37 CFR 1.130, 1.131 or 1.132) or other evidence are permitted. See 37 CFR 1.193(b)(2).

### Examiner Note:

1. Use this form paragraph to reopen prosecution in order to make a new ground of rejection of claims or to enter a rebuttal to the reply brief. The finality or non-finality of an Office action following a reopening of prosecution depends on whether the action could have been properly made final had it been entered prior to the appeal.
2. In bracket 1, insert --appeal brief--, --supplemental appeal brief--, --reply brief-- or --supplemental reply brief--.
3. In bracket 2, insert the date on which the brief was filed.
4. In bracket 3, insert --A new ground of rejection is--, --New grounds of rejection are-- or --A rebuttal to the Reply Brief is--.

After reopening of prosecution, appellant must exercise one of the following options to avoid abandonment of the application:

(A) file a reply under 37 CFR 1.111, if the Office action is non-final;

(B) file a reply under 37 CFR 1.113, if the Office action is final; or

(C) request reinstatement of the appeal.

See 37 CFR 1.193(b)(2). Whether appellant elects to continue prosecution or to request reinstatement of the appeal, if prosecution was reopened prior to a decision on the merits by the Board of Patent Appeals and Interferences, the fee paid for the notice of appeal, appeal brief, and request for oral hearing (if applicable) will be applied to a later appeal on the same application.

If reinstatement of the appeal is requested, the request must be accompanied by a supplemental appeal brief; however, no new amendments, affidavits (37 CFR 1.130, 1.131, or 1.132), or other evidence is permitted. The supplemental appeal brief must comply with the requirements of 37 CFR 1.192(c), but in doing so may incorporate by reference such parts of the previously-filed brief as may still be applicable. The arguments presented in the supplemental appeal brief need only be those relevant to the new ground(s) of rejection raised in the Office action that reopened prosecution, but the appellant should also identify all previously-raised issues and/or arguments which are still considered to be relevant. If the examiner does not consider that the supplemental appeal brief complies with the foregoing requirements, appellant should be given a 1-month time period within which to file an amended supplemental brief under 37 CFR 1.192(d). See MPEP § 1206.

After the supplemental appeal brief is filed, the examiner may issue an answer thereto, and appellant may file a reply brief. It is also possible that, after reading the brief, the examiner may be convinced that some or all of the finally rejected claims are allowable. Where the examiner is of the opinion that some of the claims are allowable, he or she should so specify in the examiner's answer and confine the arguments to the remaining rejected claims. If the examiner finds, upon reconsideration, that all the rejected claims are allowable, or where the appellant in the brief withdraws the appeal as to some of the

rejected claims by submitting an appropriate amendment and the examiner finds the remaining claims to be allowable, the examiner should allow the application.

In applications where an interference has resulted from the applicant provoking an interference with the patent which provided the basis for final rejection, the rejection based on that patent should be withdrawn and the appeal dismissed as to the involved claims.

### 1208.03 Reply Brief

*37 CFR 1.193. Examiner's answer and reply brief.*

\*\*\*\*\*

(b)(1) Appellant may file a reply brief to an examiner's answer or a supplemental examiner's answer within two months from the date of such examiner's answer or supplemental examiner's answer. See § 1.136(b) for extensions of time for filing a reply brief in a patent application and § 1.550(c) for extensions of time for filing a reply brief in a reexamination proceeding. The primary examiner must either acknowledge receipt and entry of the reply brief or withdraw the final rejection and reopen prosecution to respond to the reply brief. A supplemental examiner's answer is not permitted, unless the application has been remanded by the Board of Patent Appeals and Interferences for such purpose.

(2) Where prosecution is reopened by the primary examiner after an appeal or reply brief has been filed, appellant must exercise one of the following two options to avoid abandonment of the application:

(i) File a reply under § 1.111, if the Office action is not final, or a reply under § 1.113, if the Office action is final; or

(ii) Request reinstatement of the appeal. If reinstatement of the appeal is requested, such request must be accompanied by a supplemental appeal brief, but no new amendments, affidavits (§§ 1.130, 1.131 or 1.132) or other evidence are permitted.

Under 37 CFR 1.193(b)(1), appellant may file a reply brief as a matter of right within 2 months from the mailing date of the examiner's answer or supplemental examiner's answer. Extensions of time to file the reply brief may be granted pursuant to 37 CFR 1.136(b) or 1.550(c). The primary examiner must then either: (A) acknowledge receipt and entry of the reply brief by using form paragraph 12.47 on form PTOL-90; or (B) reopen prosecution to respond to the reply brief. See MPEP § 1208.02. A supplemental examiner's answer is not permitted unless the application has been remanded by the Board for such purpose.

Amendments, affidavits, and/or other evidence must be submitted in papers separate from the reply brief, and the entry of such papers is subject to the provisions of 37 CFR 1.116 and 37 CFR 1.195. A paper that contains an amendment (or evidence) is not a reply brief within the meaning of 37 CFR 1.193(b). Such a paper will not be entitled to entry simply because it is characterized as a reply brief.

While 37 CFR 1.193(b)(1) prohibits a supplemental examiner's answer (in the absence of a remand from the Board of Patent Appeals and Interference for such purpose), an examiner may (with supervisory patent examiner approval) respond to a reply brief by reopening prosecution. The acknowledgment of receipt and entry of a reply brief under 37 CFR 1.193(b)(1) is an indication by the examiner that no further response by the examiner is deemed necessary. Thus, a remand by the Board of Patent Appeals and Interference under 37 CFR 1.193(b)(1) in an application containing an acknowledgment of receipt and entry of a reply brief under 37 CFR 1.193(b)(1) for the express purpose of a response by the examiner to the reply brief (a supplemental examiner's answer) should rarely, if ever, be necessary.

It should also be noted that an indication of a change in status of claims (e.g., that certain rejections have been withdrawn as a result of the reply brief) is not a supplemental examiner's answer and is of course permitted. Such an indication of a change in status of claims may be made on form PTOL-90.

For procedure where prosecution is reopened after a reply brief has been filed, see MPEP § 1208.02.

Form paragraph 12.47 may be used to acknowledge receipt and entry of a reply brief.

#### ¶ 12.47 Acknowledgment of Reply Brief

Application No. [1]

Art Unit [2]

The reply brief filed [3] has been entered and considered. The application has been forwarded to the Board of Patent Appeals and Interferences for decision on the appeal.

#### Examiner Note:

1. This form paragraph is to be printed on a blank page for attachment to a PTOL-90 or PTO-90C.
2. If an amendment, an affidavit and/or a declaration has/have been filed with the reply brief, the examiner must notify the appellant in writing whether it has been entered. Unless the amendment, affidavit, and/or declaration place(s) the application in condition for allowance, entry should not be permitted. See 37 CFR 1.116 and 37 CFR 1.195. This is particularly important since a supplemental examiner's answer is not permitted, unless

the application has been remanded by the Board of Patent Appeals and Interferences for such purpose. See 37 CFR 1.193(b)(1).

## 1209 Oral Hearing

### 37 CFR 1.194. Oral hearing.

(a) An oral hearing should be requested only in those circumstances in which appellant considers such a hearing necessary or desirable for a proper presentation of the appeal. An appeal decided without an oral hearing will receive the same consideration by the Board of Patent Appeals and Interferences as appeals decided after oral hearing.

(b) If appellant desires an oral hearing, appellant must file, in a separate paper, a written request for such hearing accompanied by the fee set forth in § 1.17(d) within two months from the date of the examiner's answer. If appellant requests an oral hearing and submits therewith the fee set forth in § 1.17(d), an oral argument may be presented by, or on behalf of, the primary examiner if considered desirable by either the primary examiner or the Board. See § 1.136(b) for extensions of time for requesting an oral hearing in a patent application and § 1.550(c) for extensions of time for requesting an oral hearing in a reexamination proceeding.

(c) If no request and fee for oral hearing have been timely filed by appellant, the appeal will be assigned for consideration and decision. If appellant has requested an oral hearing and has submitted the fee set forth in § 1.17(d), a day of hearing will be set, and due notice thereof given to appellant and to the primary examiner. A hearing will be held as stated in the notice, and oral argument will be limited to twenty minutes for appellant and fifteen minutes for the primary examiner unless otherwise ordered before the hearing begins. If the Board decides that a hearing is not necessary, the Board will so notify appellant.

37 CFR 1.194(b) provides that an appellant who desires an oral hearing before the Board must request the hearing by filing, in a separate paper, a written request therefor, accompanied by the appropriate fee set forth in 37 CFR 1.17(d), within 2 months after the date of the examiner's answer. This time period may only be extended by filing a request under either 37 CFR 1.136(b) or, if the appeal involves an *ex parte* reexamination proceeding, under 37 CFR 1.550(c).

A notice of hearing, stating the date, the time, and the docket, is forwarded to the appellant in due course. If appellant fails to confirm within the time required in the notice of hearing, the appeal will be removed from the hearing docket and assigned on brief in due course. No refund of the fee for requesting an oral hearing will be made. Similarly, after confirmation, if no appearance is made at the scheduled hearing, the appeal will be decided on brief. Since failure to notify the Board of waiver of hearing in advance of the assigned date results in a waste of the Board's resources, appellant should inform the Board



of a change in plans at the earliest possible opportunity. If the Board determines that a hearing is not necessary (e.g., a remand to the examiner is necessary or it is clear that the rejection(s) cannot be sustained), appellant will be notified.

If appellant has any special request, such as for a particular date or day of the week, this will be taken into consideration in setting the hearing, if made known to the Board in advance, as long as such request does not unduly delay a decision in the case and does not place an undue administrative burden on the Board.

The appellant may also file a request, in a paper addressed to the Chief Clerk of the Board, to present his/her arguments via telephone. The appellant making the request will be required to bear the cost of the telephone call.

If the time set in the notice of hearing conflicts with prior commitments or if subsequent events make appearance impossible, the hearing may be rescheduled on written request. However, in view of the administrative burden involved in rescheduling hearings and the potential delay which may result in the issuance of any patent based on the application on appeal, postponements are discouraged and will not be granted in the absence of convincing reasons in support of the requested change.

Normally, 20 minutes are allowed for appellant to explain his or her position. If appellant believes that additional time will be necessary, a request for such time should be made well in advance and will be taken into consideration in assigning the hearing date. The final decision on whether additional time is to be granted rests within the discretion of the senior member of the panel hearing the case.

### **PARTICIPATION BY EXAMINER**

If the appellant has requested an oral hearing and the primary examiner wishes to appear and present an oral argument before the Board, a request to present oral argument must be included as the last paragraph of the examiner's answer, using form paragraph 12.63. See MPEP § 1208. If the appellant's request for a hearing is filed after the examiner's answer, then the examiner's request must be in an acknowledgment of reply brief, if applicable, or in a separate letter on form PTOL-90. In either case, the examiner should also make a notation "Examiner Requests an

Oral Hearing" on the face of the file wrapper below the box for the examiner's name.

In those appeals in which an oral hearing has been confirmed and either the primary examiner or the Board has indicated a desire for the examiner to participate in the oral argument, oral argument may be presented by the examiner whether or not appellant appears.

After the oral hearing has been confirmed and the date set as provided in 37 CFR 1.194(c), the application file will be delivered to the examiner via the appropriate Technology Center Director at least 2 weeks prior to the date of the hearing and the examiner will be notified of the date of the hearing. In those cases where the Board requests the presentation of an oral argument by or on behalf of the primary examiner, the Board's request may, where appropriate, indicate specific points or questions to which the argument should be particularly directed. The application file must be returned to the Board at least 2 working days before the hearing.

In any appeal where oral argument is to be presented by, or on behalf of, the primary examiner, the appellant will be given due notice of that fact.

At the hearing, after the appellant has made his or her presentation, the examiner will be allowed 15 minutes to reply as well as to present a statement which clearly sets forth his or her position with respect to the issues and rejections of record. Appellant may utilize any allotted time not used in the initial presentation for rebuttal.

If the examiner wishes to attend the oral hearing as an observer but not to present oral argument, see MPEP § 1208.

### **1210 Actions Subsequent to Examiner's Answer but Before Board's Decision**

#### **JURISDICTION OF BOARD**

The application file and jurisdiction of the application are normally transferred from the Technology Centers to the Board at one of the following times:

(A) After 2 months from the examiner's answer, plus mail room time, if no reply brief has been timely filed.

(B) After a supplemental examiner's answer, pursuant to a remand from the Board, has been mailed.

(C) After the examiner has notified the appellant by written communication that the reply brief has been entered and considered and that the application will be forwarded to the Board (for example, by mailing a PTOL-90 with form paragraph 12.47, as described in MPEP § 1208.03).

Any amendment, affidavit, or other paper relating to the appeal, filed thereafter but prior to the decision of the Board, may be considered by the examiner only in the event the case is remanded by the Board for that purpose.

### **DIVIDED JURISDICTION**

Where appeal is taken from the second or final rejection only of one or more claims presented for the purpose of provoking an interference, jurisdiction of the rest of the case remains with the examiner, and prosecution of the remaining claims may proceed as though the entire case was under his or her jurisdiction. Also, where the examiner certifies in writing that there is no conflict of subject matter and the administrative patent judge in charge of the interference approves, an appeal to the Board may proceed concurrently with an interference. See MPEP § 2315.

### **ABANDONMENT OF APPEAL: APPLICATION REFILED OR ABANDONED**

To avoid the rendering of decisions by the Board in applications which have already been refiled as continuations, appellants should promptly inform the clerk of the Board in writing as soon as they have positively decided to refile or to abandon an application containing an appeal awaiting a decision. Failure to exercise appropriate diligence in this matter may result in the Board's refusing an otherwise proper request to vacate its decision.

See MPEP § 1215.01 - § 1215.03 concerning the withdrawal of appeals.

#### **1210.01 Order for Compliance**

While the examiner will assume that the real party in interest is the individual or individuals identified in the caption when the real party in interest is not explicitly set out in the brief, the Board may require

the appellant to explicitly name the real party in interest. Likewise, while the examiner will assume that there are no related cases when no related case is explicitly set out in the brief, the Board may require the appellant to explicitly identify any related case. When the Board elects to require an explicit statement, an order for compliance with the rule will be entered setting a 1 - month period for reply to the Board's requirement (37 CFR 1.192(d)). Extensions of time are only available under 37 CFR 1.136(b). An entire new brief need not, and should not, be filed. Rather, a simple paper identifying the real party in interest or explicitly stating that the appellant is the real party in interest will suffice. Failure to timely respond to the Board's requirement may result in dismissal of the appeal. See MPEP § 1215.04 and MPEP § 711.02(b).

#### **1211 Remand by Board**

The Board has authority to remand a case to the examiner when it deems it necessary. For example, the Board may remand for a fuller description of the claimed invention and, in the case of a machine, a statement of its mode of operation. In certain cases where the pertinence of the references is not clear, the Board may call upon the examiner for a further explanation. In the case of multiple rejections of a cumulative nature, the Board may also remand for selection of the preferred or best ground. The Board may also remand a case to the examiner for further search where it feels that the most pertinent art has not been cited, or to consider an amendment, affidavit, or declaration. See MPEP § 1211.01, § 1211.02, and § 1211.03. Furthermore, the Board may remand an application to the examiner to prepare a supplemental examiner's answer in response to a reply brief. The following form paragraph may be used in preparing the supplemental examiner's answer after a remand from the Board:

##### *¶ 12.80 Supplemental Examiner's Answer - On Remand*

Pursuant to the Remand under 37 CFR 1.193(b)(1) by the Board of Patent Appeals and Interferences on [1], a supplemental Examiner's Answer is set forth below: [2].

##### **Examiner Note:**

1. Insert the date of the Remand.
2. Provide reasons supporting the rejections set forth in the supplemental Examiner's Answer.

The supervisory patent examiner should approve and the Board should be notified whenever a remanded application is withdrawn from appeal under any circumstance. See MPEP § 706.07(e) and § 1002.02(d).

### **1211.01 Remand by Board To Consider Amendment**

There is no obligation resting on the Board to consider new or amended claims submitted while it has jurisdiction of the appeal. *In re Sweet*, 136 F.2d 722, 58 USPQ 327 (CCPA 1943). However, a proposed amendment, affidavit, declaration, or other paper may be remanded for such consideration as the examiner may see fit to give. Such an amendment will be treated as an amendment filed after appeal. See MPEP § 1207.

If the proposed amendment is in effect an abandonment of the appeal, e.g., by canceling the appealed claims, the amendment should be entered and the clerk of the Board notified in order that the case may be removed from the Board's docket.

### **1211.02 Remand by Board To Consider Affidavits or Declarations**

*37 CFR 1.195. Affidavits or declarations after appeal.*

Affidavits, declarations, or exhibits submitted after the case has been appealed will not be admitted without a showing of good and sufficient reasons why they were not earlier presented.

Affidavits or declarations filed with or after the filing of a notice of appeal but before jurisdiction passes to the Board (see MPEP § 1210) will be considered for entry only if the appellant makes the necessary showing under 37 CFR 1.195 as to why they were not earlier presented. Authority from the Board is not necessary to consider such affidavits or declarations. Affidavits or declarations filed after a final rejection and prior to a notice of appeal are handled as provided in MPEP § 715.09, § 716, and § 716.01.

In the case of affidavits or declarations filed after the application has been forwarded to the Board, but before a decision thereon by the Board, the examiner is without authority to consider the same in the absence of a remand by the Board. When an application is remanded to the examiner for the consideration of such affidavits or declarations, the examiner, after having given such consideration as the facts in the

case require, will return the application to the Board with his or her supplemental examiner's answer on remand, a copy of which should be forwarded to the appellant. If such an affidavit or declaration is not accompanied by the showing required under 37 CFR 1.195, the examiner will not consider its merits. If the delay in filing such affidavit or declaration is satisfactorily explained, the examiner will admit the same and consider its merits.

It is not the custom of the Board to remand affidavits or declarations offered in connection with a request for rehearing of its decision where no rejection has been made under 37 CFR 1.196(b). Affidavits or declarations submitted for this purpose, not remanded to the examiner, are considered only as arguments. *In re Martin*, 154 F.2d 126, 69 USPQ 75 (CCPA 1946).

For remand to the examiner to consider appellant's response relating to a 37 CFR 1.196(b) rejection, see MPEP § 1214.01.

### **1211.03 Remand by Board for Further Search**

It should be rare for the Board to remand a case to the examiner for further search. A remand to the examiner extends the total pendency of an application and may necessitate an extension of the patent term under 35 U.S.C. 154(b). See MPEP § 2710. When such a remand is necessary, the Board should conduct a search (on-line or otherwise) of at least one subclass and cite art from that subclass to demonstrate the basis on which it concludes that a search of this area would be productive. The art cited need not be art upon which a rejection can be made.

### **1212 Board Requires Appellant to Address Matter**

*37 CFR 1.196. Decision by the Board of Patent Appeals and Interferences.*

\*\*\*\*\*

(d) The Board of Patent Appeals and Interferences may require appellant to address any matter that is deemed appropriate for a reasoned decision on the pending appeal. Appellant will be given a non-extendable time period within which to respond to such a requirement.

\*\*\*\*\*

37 CFR 1.196(d) authorizes the Board to require an appellant to clarify the record by addressing any matter deemed appropriate for a reasoned decision on the appeal. This may include, for example: (A) the applicability of particular case law that has not been previously identified as relevant to an issue in the appeal; or (B) the applicability of prior art that has not been made of record.

The rule further provides that the appellant will be given a non-extendable time period within which to respond to the requirement. Failure to respond within the time period set by the Board will result in dismissal of the appeal.

The making of a requirement under 37 CFR 1.196(d) is discretionary with the Board. The authority granted in 37 CFR 1.196(d) does not affect the Board's authority to remand a case to the examiner in a situation where the Board considers action by the examiner in the first instance to be necessary or desirable. See MPEP § 1211. Also, after an appellant has replied to a requirement under 37 CFR 1.196(d), a remand to the examiner may be deemed to be appropriate.

## 1213 Decision by Board

*37 CFR 1.196. Decision by the Board of Patent Appeals and Interferences.*

(a) The Board of Patent Appeals and Interferences, in its decision, may affirm or reverse the decision of the examiner in whole or in part on the grounds and on the claims specified by the examiner or remand the application to the examiner for further consideration. The affirmance of the rejection of a claim on any of the grounds specified constitutes a general affirmance of the decision of the examiner on that claim, except as to any ground specifically reversed.

\*\*\*\*\*

(e) Whenever a decision of the Board of Patent Appeals and Interferences includes or allows a remand, that decision shall not be considered a final decision. When appropriate, upon conclusion of proceedings on remand before the examiner, the Board of Patent Appeals and Interferences may enter an order otherwise making its decision final.

\*\*\*\*\*

After consideration of the record including appellant's brief and the examiner's answer, the Board

writes its decision, affirming the examiner in whole or in part, or reversing the examiner's decision, sometimes also setting forth a new ground of rejection.

37 CFR 1.196(e) provides that a decision of the Board which includes a remand will not be considered as a final decision in the case. The Board, following conclusion of the proceedings before the examiner, will either adopt its earlier decision as final or will render a new decision based on all appealed claims, as it considers appropriate. In either case, final action by the Board will give rise to the alternatives available to an appellant following a decision by the Board.

On occasion, the Board has refused to consider an appeal until after the conclusion of a pending civil action or appeal to the Court of Appeals for the Federal Circuit involving issues identical with and/or similar to those presented in the later appeal. Such suspension of action, postponing consideration of the appeal until the Board has the benefit of a court decision which may be determinative of the issues involved, has been recognized as sound practice. An appellant is not entitled, after obtaining a final decision by the U.S. Patent and Trademark Office on an issue in a case, to utilize the prolonged pendency of a court proceeding as a means for avoiding *res judicata* while relitigating the same or substantially the same issue in another application.

An applicant may request that the decision be withheld to permit the refiling of the application at any time prior to the mailing of the decision. Up to 30 days may be granted, although the time is usually limited as much as possible. The Board will be more prone to entertain the applicant's request where the request is filed early, obviating the necessity for an oral hearing or even for the setting of the oral hearing date. If the case has already been set for oral hearing, the petition should include a request to vacate the hearing date, *not* to postpone it.

In a situation where a withdrawal of the appeal is filed on the same day that the decision is mailed, a petition to vacate the decision will be denied.

See MPEP § 1214.01 concerning the procedure following a new ground of rejection by the Board under 37 CFR 1.196(b).

## 1213.01 Statement of Allowability by Board

*37 CFR 1.196. Decision by the Board of Patent Appeals and Interferences.*

\*\*\*\*\*

(c) Should the decision of the Board of Patent Appeals and Interferences include an explicit statement that a claim may be allowed in amended form, appellant shall have the right to amend in conformity with such statement, which shall be binding on the examiner in the absence of new references or grounds of rejection.

\*\*\*\*\*

If the Board's decision includes an explicit statement that a claim may be allowed in amended form, appellant may amend the claim in conformity with the statement and the statement would be binding on the examiner in the absence of new prior art references or grounds of rejection. The examiner should make certain that the amendment does in fact conform to the statement in the Board's decision.

The making of a statement under 37 CFR 1.196(c) is discretionary with the Board. In the absence of an express statement, a remark by the Board that a certain feature does not appear in a claim is not to be taken as a statement that the claim may be allowed if the feature is supplied by amendment. *Ex parte Norlund*, 1913 C.D. 161, 192 O.G. 989 (Comm'r Pat. 1913).

Appellant's right to amend in conformity with the statement under 37 CFR 1.196(c) may only be exercised within the period allowed for seeking court review under 37 CFR 1.304. See MPEP § 1216.

## 1213.02 New Grounds of Rejection by Board

*37 CFR 1.196. Decision by the Board of Patent Appeals and Interferences.*

\*\*\*\*\*

(b) Should the Board of Patent Appeals and Interferences have knowledge of any grounds not involved in the appeal for rejecting any pending claim, it may include in the decision a statement to that effect with its reasons for so holding, which statement constitutes a new ground of rejection of the claim. A new ground of rejection shall not be considered final for purposes of judicial review. When the Board of Patent Appeals and Interferences makes a new ground of rejection, the appellant, within two

months from the date of the decision, must exercise one of the following two options with respect to the new ground of rejection to avoid termination of proceedings (§ 1.197(c)) as to the rejected claims:

(1) Submit an appropriate amendment of the claims so rejected or a showing of facts relating to the claims so rejected, or both, and have the matter reconsidered by the examiner, in which event the application will be remanded to the examiner. The new ground of rejection is binding upon the examiner unless an amendment or showing of facts not previously of record be made which, in the opinion of the examiner, overcomes the new ground of rejection stated in the decision. Should the examiner reject the claims, appellant may again appeal pursuant to §§ 1.191 through 1.195 to the Board of Patent Appeals and Interferences.

(2) Request that the application be reheard under § 1.197(b) by the Board of Patent Appeals and Interferences upon the same record. The request for rehearing must address the new ground of rejection and state with particularity the points believed to have been misapprehended or overlooked in rendering the decision and also state all other grounds upon which rehearing is sought. Where request for such rehearing is made, the Board of Patent Appeals and Interferences shall rehear the new ground of rejection and, if necessary, render a new decision which shall include all grounds of rejection upon which a patent is refused. The decision on rehearing is deemed to incorporate the earlier decision for purposes of appeal, except for those portions specifically withdrawn on rehearing, and is final for the purpose of judicial review, except when noted otherwise in the decision.

\*\*\*\*\*

(f) See § 1.136(b) for extensions of time to take action under this section in a patent application and § 1.550(c) for extensions of time in a reexamination proceeding.

Under 37 CFR 1.196(b), the Board may, in its decision, make a new rejection of one or more of any of the claims pending in the case, including claims which have been allowed by the examiner.

While 37 CFR 1.196(b) now authorizes the Board to reject allowed claims, this authorization is not intended as an instruction to the Board to examine every allowed claim in every appealed application. It is, rather, intended to give the Board express authority to act when it becomes apparent, during the consideration of rejected claims, that one or more allowed claims may be subject to rejection on either the same or on different grounds from those applied against the rejected claims. Since the exercise of authority under 37 CFR 1.196(b) is discretionary, no inference should be drawn from a failure to exercise that discretion.

See MPEP § 1214.01 for the procedure following a new ground of rejection under 37 CFR 1.196(b).

### 1213.03 Publication of Board Decision

Decisions of the Board may be published at the discretion of the Commissioner. Requests by members of the public or applicants to publish a decision of the Board should be referred to the Office of the Solicitor. A decision in a pending or abandoned application will be published in accordance with 37 CFR 1.14(g).

Decisions of the Board which are open to the public are available in electronic form on the USPTO website (<http://www.uspto.gov>).

### 1214 Procedure Following Decision by Board

37 CFR 1.197. *Action following decision.*

(a) After decision by the Board of Patent Appeals and Interferences, the application will be returned to the examiner, subject to appellant's right of appeal or other review, for such further action by appellant or by the examiner, as the condition of the application may require, to carry into effect the decision.

\*\*\*\*\*

After an appeal to the Board has been decided, a copy of the decision is mailed to the appellant and the original placed in the file. The clerk of the Board notes the decision on the file wrapper and in the record of appeals, and then forwards the file to the examiner through the office of the Technology Center Director immediately if all rejections are reversed, and after about 10 weeks if any rejection is affirmed or after a decision on a request for rehearing is rendered.

### 1214.01 Procedure Following New Ground of Rejection by Board

When the Board makes a new rejection under 37 CFR 1.196(b), the appellant, as to each claim so rejected, has the option of:

- (A) submitting an appropriate amendment and/or a showing of facts (37 CFR 1.196(b)(1)); or
- (B) requesting rehearing (37 CFR 1.196(b)(2)).

The amendment and/or showing of facts under 37 CFR 1.196(b)(1), or the request for rehearing under 37 CFR 1.196(b)(2), must be filed within 2 months from the date of the Board's decision. In

accordance with 37 CFR 1.196(f), this 2-month time period may not be extended by the filing of a petition and fee under 37 CFR 1.136(a), but only under the provisions of 37 CFR 1.136(b), or under 37 CFR 1.550(c) if the appeal involves an *ex parte* reexamination proceeding.

If an appellant files an appropriate amendment or showing of facts (see paragraph I below) as to less than all of the claims rejected by the Board under 37 CFR 1.196(b), and a request for rehearing (see paragraph II below) as to the remainder of the claims so rejected, the examiner will not consider the claims for which rehearing was requested. The request for rehearing will be considered by the Board after prosecution before the examiner with respect to the first group of claims is terminated. Argument as to any of the claims rejected by the Board which is not accompanied by an appropriate amendment or showing of facts as to those claims will be treated as a request for rehearing as to those claims.

#### I. SUBMISSION OF AMENDMENT OR SHOWING OF FACTS

37 CFR 1.196(b)(1) provides that the application will be remanded to the examiner for reconsideration if the appellant submits "an appropriate amendment" of the claims rejected by the Board, "or a showing of facts relating to the claims so rejected, or both." An amendment is "appropriate" under the rule if it amends one or more of the claims rejected, or substitutes new claims to avoid the art or reasons adduced by the Board. *Ex parte Burrowes*, 110 O.G. 599, 1904 C.D. 155 (Comm'r Pat. 1904). Such amended or new claims must be directed to the same subject matter as the appealed claims. *Ex parte Comstock*, 317 O.G. 4, 1923 C.D. 82 (Comm'r Pat. 1923). An amendment which adds new claims without either amending the rejected claims, or substituting new claims for the rejected claims, is not appropriate. The new claims will not be entered, and the examiner should return the application file to the Board for consideration of the amendment as a request for rehearing under 37 CFR 1.196(b)(2), if it contains any argument concerning the Board's rejection. The "showing of facts" under the rule may be a showing under 37 CFR 1.130, 1.131 or 1.132, as may be appropriate.

If the appellant submits an argument without either an appropriate amendment or a showing of facts as to any of the claims rejected by the Board, it will be treated as a request for rehearing under 37 CFR 1.196(b)(2).

The new ground of rejection raised by the Board does not reopen the prosecution except as to that subject matter to which the new rejection was applied. If the Board's decision in which the rejection under 37 CFR 1.196(b) was made includes an affirmance of the examiner's rejection, the basis of the affirmed rejection is not open to further prosecution. If the appellant elects to proceed before the examiner with regard to the new rejection, the Board's affirmance of the examiner's rejection will be treated as nonfinal for purposes of seeking judicial review, and no request for reconsideration of the affirmance need be filed at that time. Prosecution before the examiner of the 37 CFR 1.196(b) rejection can incidentally result in overcoming the affirmed rejection even though the affirmed rejection is not open to further prosecution. Therefore, it is possible for the application to be allowed as a result of the limited prosecution before the examiner of the 37 CFR 1.196(b) rejection. If the application becomes allowed, the application should not be returned to the Board. Likewise, if the application is abandoned for any reason, the application should not be returned to the Board. If the rejection under 37 CFR 1.196(b) is not overcome, the applicant can file a second appeal (as discussed below). Such appeal must be limited to the 37 CFR 1.196(b) rejection and may not include the affirmed rejection. If the application does not become allowed or abandoned as discussed above, once prosecution of the claims which were rejected under 37 CFR 1.196(b) is terminated before the examiner, the application file must be returned to the Board so that a decision making the original affirmance final can be entered.

The time for filing a request for rehearing on the affirmance or seeking court review runs from the date of the decision by the Board making the original affirmance final. See MPEP § 1214.03 and § 1216.

If the examiner does not consider that the amendment and/or showing of facts overcomes the rejection, he or she will again reject the claims. If appropriate, the rejection will be made final.

An applicant in whose application such a final rejection has been made by the examiner may mistake

only believe that he or she is entitled to review by the Board of the rejection by virtue of the previous appeal, but under the provisions of 37 CFR 1.196(b)(1), after such a final rejection, an applicant who desires further review of the matter must file a new appeal to the Board. Such an appeal from the subsequent rejection by the examiner will be an entirely new appeal involving a different ground and will require a new notice of appeal, appeal brief, and the payment of the appropriate fees.

## II. REQUEST FOR REHEARING

Instead of filing an amendment and/or showing of facts under 37 CFR 1.196(b)(1), an appellant may elect to proceed under 37 CFR 1.196(b)(2) and file a request for rehearing of the Board's new rejection. The rule requires that the request for rehearing "must address the new ground of rejection and state with particularity the points believed to have been misapprehended or overlooked in rendering the decision and also state all other grounds upon which rehearing is sought." By proceeding in this manner, the appellant waives his or her right to further prosecution before the examiner. *In re Greenfield*, 40 F.2d 775, 5 USPQ 474 (CCPA 1930). A request for rehearing accompanied by an appropriate amendment of the claims rejected by the Board, and/or by an affidavit or declaration containing a showing of facts, does not constitute a proper request for rehearing under 37 CFR 1.196(b)(2), and will be treated as a submission under 37 CFR 1.196(b)(1).

If the Board's decision also includes an affirmance of the examiner's rejection, a request for rehearing of the affirmance (see MPEP § 1214.03 and MPEP § 1214.06, paragraph IV) should be filed in a separate paper to facilitate consideration.

### 1214.03 Rehearing

*37 CFR 1.197. Action following decision.*

\*\*\*\*\*

(b) Appellant may file a single request for rehearing within two months from the date of the original decision, unless the original decision is so modified by the decision on rehearing as to become, in effect, a new decision, and the Board of Patent Appeals and Interferences so states. The request for rehearing must state with particularity the points believed to have been misapprehended or overlooked in rendering the decision and also state all other grounds upon which rehearing is sought. See

§ 1.136(b) for extensions of time for seeking rehearing in a patent application and § 1.550(c) for extensions of time for seeking rehearing in a reexamination proceeding.

\*\*\*\*\*

The term “rehearing” is used in 37 CFR 1.197(b) for consistency with the language of 35 U.S.C. 6(b). It should not be interpreted as meaning that an appellant is entitled to an oral hearing on the request for rehearing, but only to a rehearing on the written record. It is not the normal practice of the Board to grant rehearings in the sense of another oral hearing. *Ex parte Argoudelis*, 157 USPQ 437, 441 (Bd. App. 1967), *rev'd. on other grounds*, 434 F.2d 1390, 168 USPQ 99 (CCPA 1970).

37 CFR 1.197(b) provides that any request for rehearing must specifically state the points believed to have been misapprehended or overlooked in the Board’s decision. Experience has shown that many requests for rehearing are nothing more than reargument of appellant’s position on appeal. In response, the rule was revised to limit requests to the points of law or fact which appellant feels were overlooked or misapprehended by the Board.

The 2-month period provided by 37 CFR 1.197(b) for filing a request for rehearing can only be extended under the provisions of 37 CFR 1.136(b) or under 37 CFR 1.550(c) if the appeal involves an *ex parte* reexamination proceeding.

All copies of references in the file wrapper should be retained therein.

For extension of time to appeal to the Court of Appeals for the Federal Circuit or commence a civil action under 37 CFR 1.304(a), see MPEP § 1216 and § 1002.02(o).

For requests for reconsideration by the examiner, see MPEP § 1214.04.

#### **1214.04 Examiner Reversed**

A complete reversal of the examiner’s rejection brings the case up for immediate action by the examiner. If the reversal does not place an application in condition for immediate allowance (e.g., the Board has entered a new ground of rejection under 37 CFR 1.196(b)), the examiner should refer to the situations outlined in MPEP § 1214.06 for appropriate guidance.

The examiner should never regard such a reversal as a challenge to make a new search to uncover other and better references. This is particularly so where the application or *ex parte* reexamination proceeding has meanwhile been transferred or assigned to an examiner other than the one who rejected the claims leading to the appeal. The second examiner should give full faith and credit to the prior examiner’s search.

If the examiner has specific knowledge of the existence of a particular reference or references which indicate nonpatentability of any of the appealed claims as to which the examiner was reversed, he or she should submit the matter to the Technology Center (TC) Director for authorization to reopen prosecution under 37 CFR 1.198 for the purpose of entering the new rejection. See MPEP § 1002.02(c) and MPEP § 1214.07. The TC Director’s approval is placed on the action reopening prosecution.

The examiner may request rehearing of the Board decision. Such a request should normally be made within 2 months of the receipt of the Board decision in the TC. The TC Director’s secretary should therefore date stamp all Board decisions upon receipt in the TC.

All requests by the examiner to the Board for rehearing of a decision must be approved by the TC Director and must also be forwarded to the Office of the Deputy Commissioner for Patent Examination Policy for approval before mailing.

The request should set a period of 1 month for the appellant to file a reply.

If approved, the Office of the Deputy Commissioner for Patent Examination Policy will mail a copy of the request for rehearing to the appellant. After the period set for appellant to file a reply (plus mailing time) has expired, the application file will be forwarded to the Board.

#### **1214.05 Cancellation of Withdrawn Claims**

Where an appellant withdraws some of the appealed claims, and the Board reverses the examiner on the remaining appealed claims, the withdrawal is treated as an authorization to cancel the withdrawn claims. It is not necessary to notify the appellant of the cancellation of the withdrawn claims.



## 1214.06 Examiner Sustained in Whole or in Part

37 CFR 1.197. Action following decision.

\*\*\*\*\*

(c) Termination of proceedings. Proceedings are considered terminated by the dismissal of an appeal or the failure to timely file an appeal to the court or a civil action (§ 1.304) except: (1) Where claims stand allowed in an application or (2) Where the nature of the decision requires further action by the examiner. The date of termination of proceedings is the date on which the appeal is dismissed or the date on which the time for appeal to the court or review by civil action (§ 1.304) expires. If an appeal to the court or a civil action has been filed, proceedings are considered terminated when the appeal or civil action is terminated. An appeal to the U.S. Court of Appeals for the Federal Circuit is terminated when the mandate is received by the Office. A civil action is terminated when the time to appeal the judgment expires.

The time for seeking review of a decision of the Board by the Court of Appeals for the Federal Circuit or the U.S. District Court for the District of Columbia is the same for both tribunals, that is, 2 months, or 2 months with the extension provided by 37 CFR 1.304 in the event a request for rehearing is timely filed before the Board, or as extended by the Commissioner. See MPEP § 1216. When the time for seeking court review (plus 2 weeks to allow for information as to the filing of an appeal or civil action, if any, to reach the examiner) has passed without such review being sought, the examiner must take up the application for consideration. The situations which can arise will involve one or more of the following circumstances:

### I. NO CLAIMS STAND ALLOWED

The proceedings in an application or *ex parte* reexamination proceeding are terminated as of the date of the expiration of the time for filing court action. The application is no longer considered as pending. It is to be stamped abandoned and sent to abandoned files. In an *ex parte* reexamination proceeding, a reexamination certificate should be issued under 37 CFR 1.570.

Claims indicated as allowable prior to appeal except for their dependency from rejected claims will be treated as if they were rejected. The following examples illustrate the appropriate approach to be taken by the examiner in various situations:

(A) If claims 1-2 are pending, and the Board affirms a rejection of claim 1 and claim 2 was objected to prior to appeal as being allowable except for its dependency from claim 1, the examiner should hold the application abandoned.

(B) If the Board or court affirms a rejection against an independent claim and reverses all rejections against a claim dependent thereon, the examiner, after expiration of the period for further appeal, should proceed in one of two ways:

(1) Convert the dependent claim into independent form by examiner's amendment, cancel all claims in which the rejection was affirmed, and issue the application; or

(2) Set a 1-month time limit in which appellant may rewrite the dependent claim(s) in independent form. Extensions of time under 37 CFR 1.136(a) will not be permitted. If no timely reply is received, the examiner will cancel all rejected and objected to claims and issue the application with the allowed claims only.

The following language may be used where appropriate:

Claim(s) \_\_\_\_\_ is/are incomplete because the claim(s) on which it/they depend(s) from has/have been cancelled by the examiner in accordance with MPEP §1214.06. Applicant is given a ONE MONTH TIME LIMIT from the date of this letter in which to present claim(s) \_\_\_\_\_ in independent form. NO EXTENSIONS OF TIME UNDER 37 CFR 1.136(a) WILL BE GRANTED. Failure to comply with this deadline will result in cancellation of claim(s) \_\_\_\_\_ and this application will be:

i. allowed with claim(s) \_\_\_\_\_ (if other claims are allowed), or

ii. abandoned (if there are no allowed claims).

### II. CLAIMS STAND ALLOWED

The appellant is not required to file a reply. The examiner issues the application or *ex parte* reexamination certificate on the claims which stand allowed. A red-ink line should be drawn through the refused claims and the notion "Board Decision" written in the margin in red ink.

If the Board affirms a rejection of claim 1, claim 2 was objected to prior to appeal as being allowable except for its dependency from claim 1 and

independent claim 3 is allowed, the examiner should cancel claims 1 and 2 and issue the application or *ex parte* reexamination certificate with claim 3 only.

If uncorrected matters of form which cannot be handled without written correspondence remain in the application, the examiner should take appropriate action but prosecution is otherwise closed. Note paragraph I of this section for handling of claims dependent on rejected claims. A letter such as that set forth in form paragraph 12.20 is suggested:

¶ 12.20 *Period For Seeking Court Review Has Lapsed*

The period for seeking court review of the decision by the Board of Patent Appeals and Interferences rendered [1] has expired and no further action has been taken by appellant. The proceedings as to the rejected claims are considered terminated; see 37 CFR 1.197(c).

The application will be passed to issue on allowed claim [2] provided the following formal matters are promptly corrected: [3]. Prosecution is otherwise closed.

Applicant is required to make the necessary corrections addressing the outstanding formal matters within a shortened statutory period set to expire ONE MONTH or THIRTY DAYS, whichever is longer, from the mailing date of this letter. Extensions of time may be granted under 37 CFR 1.136.

**Examiner Note:**

1. In bracket 1, enter the date of the decision.
2. In bracket 2, identify the allowed claims.
3. In bracket 3, identify the formal matters that need correction.

### III. CLAIMS REQUIRE ACTION

If the decision of the Board is an affirmance in part and includes a reversal of a rejection that brings certain claims up for action on the merits, such as a decision reversing the rejection of generic claims in an application or *ex parte* reexamination proceeding containing claims to nonelected species not previously acted upon, the examiner will take up the application or reexamination proceeding for appropriate action on the matters thus brought up. However, the application or reexamination proceeding is not considered open to further prosecution except as to such matters.

### IV. 37 CFR 1.196(b) REJECTION

Where the Board makes a new rejection under 37 CFR 1.196(b) and no action is taken with reference thereto by appellant within 2 months, the examiner should proceed in the manner indicated in paragraphs

I-III of this section as appropriate. See MPEP § 1214.01.

If the Board affirms the examiner's rejection, but also enters a new ground of rejection under 37 CFR 1.196(b), the subsequent procedure depends upon the action taken by the appellant with respect to the 37 CFR 1.196(b) rejection.

(A) If the appellant elects to proceed before the examiner with regard to the new rejection (see MPEP § 1214.01, paragraph I) the Board's affirmance will be treated as nonfinal, and no request for rehearing of the affirmance need be filed at that time. Prosecution before the examiner of the 37 CFR 1.196(b) rejection can incidentally result in overcoming the affirmed rejection even though the affirmed rejection is not open to further prosecution. Therefore, it is possible for the application to be allowed as a result of the limited prosecution before the examiner of the 37 CFR 1.196(b) rejection. If an application becomes allowed, it should not be returned to the Board. Likewise, if an application is abandoned for any reason, it should not be returned to the Board. If the rejection under 37 CFR 1.196(b) is not overcome, the applicant (or patent owner in an *ex parte* reexamination proceeding) can file a second appeal (as discussed below). Such appeal must be limited to the 37 CFR 1.196(b) rejection and may not include the affirmed rejection. If an application does not become allowed or abandoned as discussed above, once prosecution of the claims which were rejected under 37 CFR 1.196(b) is terminated before the examiner, the application file must be returned to the Board so that a decision making the original affirmance final can be entered. Similarly, the file of any *ex parte* reexamination proceeding including rejections affirmed by the Board but made nonfinal for purposes of judicial review must be returned to the Board so that the affirmance can be made final by the Board. The time for filing a request for rehearing on the affirmance or seeking court review runs from the date of the decision by the Board making the original affirmance final. See MPEP § 1214.03 and § 1216.

(B) If the appellant elects to request rehearing of the new rejection (see MPEP § 1214.01, paragraph II), the request for rehearing of the new rejection and of the affirmance must be filed within 2 months from the date of the Board's decision.

## V. APPEAL DISMISSED

Where the appeal has been dismissed for failure to argue a ground of rejection involving all the appealed claims, see MPEP § 1215.04.

The practice under the situations identified in paragraphs I-III of this section is similar to the practice after a decision of the court outlined in MPEP § 1216.01.

In view of the above practice, examiners must be very careful that case files which come back from the Board are not overlooked because every case, except applications in which all claims stand rejected after the Board's decision, is up for action by the examiner in the event no court review has been sought. Consequently, when a file is received after decision by the Board, it must be examined and appropriate precautions taken to indicate the presence of allowed claims, if any. This may be done by writing the notation "Allowed Claims" or "Rejection Reversed" on the "Contents" page of the file wrapper immediately below the endorsement "Decision by Board."

See MPEP § 1216.01 and § 1216.02 for procedure where court review is sought.

### 1214.07 Reopening of Prosecution

*37 CFR 1.198. Reopening after decision.*

Cases which have been decided by the Board of Patent Appeals and Interferences will not be reopened or reconsidered by the primary examiner except under the provisions of § 1.114 or § 1.196 without the written authority of the Commissioner, and then only for the consideration of matters not already adjudicated, sufficient cause being shown.

Sometimes an amendment is filed after the Board's decision which does not carry into effect any recommendation made by the Board and which presents a new or amended claim or claims. In view of the fact that the prosecution is closed, the appellant is not entitled to have such amendment entered as a matter of right. However, if the amendment is submitted with a request for continued examination (RCE) under 37 CFR 1.114 and the fee set forth in 37 CFR 1.17(e), the prosecution of the application will be reopened and the amendment will be entered. See MPEP § 706.07(h), paragraph XI. Note that the RCE practice under 37 CFR 1.114 does not apply to utility or plant patent applications filed before June 8, 1995 or to design applications. See 37 CFR 1.114(d) and MPEP § 706.07(h), paragraph I. If the amendment obviously

places an application in condition for allowance, regardless of whether the amendment is filed with an RCE, the primary examiner should recommend that the amendment be admitted, and with the concurrence of the supervisory patent examiner, the amendment will be entered. Note MPEP § 1002.02(d).

Where the amendment cannot be entered, the examiner should write to the appellant indicating that the amendment cannot be entered and stating the reason why. The refusal may not be arbitrary or capricious.

Form paragraph 12.19 should be used:

*¶ 12.19 Amendment After Board Decision, Entry Refused*

The amendment filed [1] after a decision by the Board of Patent Appeals and Interferences is not entered because prosecution is closed and the proposed claim(s) raise new issues which require further consideration or search (37 CFR 1.116(c)). See also 37 CFR 1.198.

[2]

**Examiner Note:**

1. In bracket 2, identify the new issues.
2. This form paragraph is not to be used where a 37 CFR 1.196 (b) rejection has been made by the Board of Patent Appeals and Interferences.

In the event that claims stand allowed in the application under the conditions set forth in MPEP § 1214.06, paragraph II, the application should be passed to issue.

Petitions under 37 CFR 1.198 to reopen or reconsider prosecution of a case after decision by the Board, where no court action has been filed, are decided by the Technology Center Director, MPEP § 1002.02(c).

The Commissioner also entertains petitions under 37 CFR 1.198 to reopen certain cases in which an appellant has sought review under 35 U.S.C. 141 or 145. This procedure is restricted to cases which have been decided by the Board and which are amenable to settlement without the need for going forward with the court proceeding. Such petitions will ordinarily be granted only in the following categories of cases:

(A) When the decision of the Board asserts that the rejection of the claims is proper because the claims do not include a disclosed limitation or because they suffer from some other curable defect, and the decision reasonably is suggestive that claims including the limitation or devoid of the defect will be allowable;

(B) When the decision of the Board asserts that the rejection of the claims is proper because the record does not include evidence of a specified character, and is reasonably suggestive that if such evidence were presented, the appealed claims would be allowable, and it is demonstrated that such evidence presently exists and can be offered; or

(C) When the decision of the Board is based on a practice, rule, law, or judicial precedent which, since the Board's decision, has been rescinded, repealed, or overruled.

Such petitions will not be ordinarily entertained after the filing of the Commissioner's brief in cases in which review has been sought under 35 U.S.C. 141, or after trial in a 35 U.S.C. 145 case.

In the case of an appeal under 35 U.S.C. 141, if the petition is granted, steps will be taken to request the court to remand the case to the U. S. Patent and Trademark Office. If so remanded, the proposed amendments, evidence, and arguments will be entered of record in the application file for consideration, and further action will be taken by the Board in the first instance or by the examiner as may be appropriate. In the case of civil action under 35 U.S.C. 145, steps will be taken for obtaining dismissal of the action without prejudice to consideration of the proposals.

## **1215 Withdrawal or Dismissal of Appeal**

### **1215.01 Withdrawal of Appeal**

Except in those instances where a withdrawal of an appeal would result in abandonment of an application, an attorney not of record in an application or reexamination proceeding may file a paper under 37 CFR 1.34(a) withdrawing an appeal. In instances where no allowable claims appear in an application, the withdrawal of an appeal is in fact an express abandonment that does not comply with 37 CFR 1.138 except where a continuing application is being filed on the same date.

Where, after an appeal has been filed and before decision by the Board, an applicant withdraws the appeal after the period for reply to the final rejection has expired, the application is to be considered abandoned as of the date on which the appeal was withdrawn unless there are allowed claims in the case.

Where a letter abandoning the application is filed in accordance with 37 CFR 1.138, the effective date of

abandonment is the date of recognition of the letter by an appropriate official of the Office or a different date, if so specified in the letter itself. See MPEP § 711.01.

If a brief has been filed within the time permitted by 37 CFR 1.192 (or any extension thereof) and an answer mailed and appellant withdraws the appeal, the application is returned to the examiner.

Prior to a decision by the Board, if an applicant wishes to withdraw an application from appeal and to reopen the prosecution of the application, applicant can file a request for continued examination (RCE) under 37 CFR 1.114, accompanied by a submission (i.e., a reply responsive within the meaning of 37 CFR 1.111 to the last outstanding Office action) and the RCE fee set forth under 37 CFR 1.17(e). Note that the RCE practice under 37 CFR 1.114 does not apply to utility or plant patent applications filed before June 8, 1995, design applications, or reexamination proceedings. See 37 CFR 1.114(d) and MPEP § 706.07(h), paragraph X, for more details. An appeal brief or reply brief (or related papers) is not a submission under 37 CFR 1.114, unless the transmittal letter of the RCE contains a statement that incorporates by reference the arguments in a previously filed appeal brief or reply brief. See MPEP § 706.07(h), paragraph II. The filing of an RCE will be treated as a withdrawal of the appeal by the applicant, regardless of whether the RCE includes the appropriate fee or a submission. Therefore, when an RCE is filed without the appropriate fee or a submission in an application that has no allowed claims, the application will be considered abandoned. To avoid abandonment, the RCE should be filed in compliance with 37 CFR 1.114. See MPEP § 706.07(h), paragraphs I-II.

To avoid the rendering of decisions by the Board in applications which have already been refiled as continuations, applicants should promptly inform the clerk of the Board in writing as soon as they have positively decided to refile or to abandon an application containing an appeal awaiting a decision. Applicants also should advise the Board when an RCE is filed in an application containing an appeal awaiting decision. Failure to exercise appropriate diligence in this matter may result in the Board refusing an otherwise proper request to vacate its decision.

Applications having no allowed claims will be abandoned. Claims which are allowable except for their dependency from rejected claims will be treated

as if they were rejected. The following examples illustrate the appropriate approach to be taken by the examiner in various situations:

(A) Claim 1 is allowed; claims 2 and 3 are rejected. The examiner should cancel claims 2 and 3 and issue the application with claim 1 only.

(B) Claims 1 - 3 are rejected. The examiner should hold the application abandoned.

(C) Claim 1 is rejected and claim 2 is objected to as being allowable except for its dependency from claim 1. The examiner should hold the application abandoned.

(D) Claim 1 is rejected and claim 2 is objected to as being allowable except for its dependency from claim 1; independent claim 3 is allowed. The examiner should cancel claims 1 and 2 and issue the application with claim 3 only.

In an *ex parte* reexamination proceeding, an *ex parte* reexamination certificate should be issued under 37 CFR 1.570.

### 1215.02 Claims Standing Allowed

If an application contains allowed claims, as well as claims on appeal, the withdrawal of the appeal does not operate as an abandonment of the application, but is considered a withdrawal of the appeal as to those claims and authority to the examiner to cancel the same. An amendment canceling the appealed claims is equivalent to a withdrawal of the appeal.

### 1215.03 Partial Withdrawal

A withdrawal of the appeal as to some of the claims on appeal operates as an authorization to cancel those claims from the application or reexamination proceeding and the appeal continues as to the remaining claims. The withdrawn claims will be canceled from an application by direction of the examiner at the conclusion of the appeal proceedings, if necessary (e.g., the examiner is reversed as to the rejection of the remaining claims on appeal), without further action by the applicant.

### 1215.04 Dismissal of Appeal

If no brief is filed within the time prescribed by 37 CFR 1.192, the appeal stands dismissed by operation of the rule. Form PTOL-461 "Notification of

Defective Notice of Appeal or Defective Brief," or form paragraph 12.17 notifying the appellant that the appeal stands dismissed is not an action in the case and does not start any period for reply. If no claims stand allowed, an application is considered as abandoned on the date the brief was due. If claims stand allowed in an application, the failure to file a brief and consequent dismissal of the appeal is to be treated as a withdrawal of the appeal and of any claim not standing allowed. The application should be passed to issue forthwith. Unless appellant specifically withdraws the appeal as to rejected claims, the appeal should not be dismissed until the extended period (5 months under 37 CFR 1.136(a)) to file the brief has expired.

Applications having no allowed claims will be abandoned. Claims which are allowable except for their dependency from rejected claims will be treated as if they were rejected. The following examples illustrate the appropriate approach to be taken by the examiner in various situations:

(A) Claim 1 is allowed; claims 2 and 3 are rejected. The examiner should cancel claims 2 and 3 and issue the application with claim 1 only.

(B) Claims 1 - 3 are rejected. The examiner should hold the application abandoned.

(C) Claim 1 is rejected and claim 2 is objected to as being allowable except for its dependency from claim 1. The examiner should hold the application abandoned.

(D) Claim 1 is rejected and claim 2 is objected to as being allowable except for its dependency from claim 1; independent claim 3 is allowed. The examiner should cancel claims 1 and 2 and issue the application with claim 3 only.

However, if formal matters remain to be attended to, the examiner should take appropriate action on such matters, setting a shortened period for reply, but the application or reexamination proceeding is to be considered closed to further prosecution except as to such matters. Form paragraph 12.09.01 may be used for this purpose. See MPEP § 1206.

An appeal will also be dismissed if an applicant fails to timely and fully reply to a notice of noncompliance with 37 CFR 1.192(c). See MPEP § 1206 and 37 CFR 1.192(d). As in examples (B)-(C) above, if no allowed claims remain in an application, the application is abandoned as of the date the reply to the

notice was due. The applicant may petition to revive the application as in other cases of abandonment, and to reinstate the appeal. If the appeal is dismissed, but allowed claims remain in the application, as in examples (A) and (D) above, the application is not abandoned; to reinstate the claims cancelled by the examiner because of the dismissal, the applicant must petition to reinstate the claims and the appeal, but a showing equivalent to a petition to revive under 37 CFR 1.137 is required. In either event, a proper reply to the notice of noncompliance must be filed before the petition will be considered on its merits.

## 1216 Judicial Review

### *35 U.S.C. 141. Appeal to the Court of Appeals for the Federal Circuit.*

An applicant dissatisfied with the decision in an appeal to the Board of Patent Appeals and Interferences under section 134 of this title may appeal the decision to the United States Court of Appeals for the Federal Circuit. By filing such an appeal the applicant waives his or her right to proceed under section 145 of this title. A patent owner in any reexamination proceeding dissatisfied with the final decision in an appeal to the Board of Patent Appeals and Interferences under section 134 may appeal the decision only to the United States Court of Appeals for the Federal Circuit. A party to an interference dissatisfied with the decision of the Board of Patent Appeals and Interferences on the interference may appeal the decision to the United States Court of Appeals for the Federal Circuit, but such appeal shall be dismissed if any adverse party to such interference, within twenty days after the appellant has filed notice of appeal in accordance with section 142 of this title, files notice with the Director that the party elects to have all further proceedings conducted as provided in section 146 of this title. If the appellant does not, within thirty days after filing of such notice by the adverse party, file a civil action under section 146, the decision appealed from shall govern the further proceedings in the case.

### *35 U.S.C. 145. Civil action to obtain patent.*

An applicant dissatisfied with the decision of the Board of Patent Appeals and Interferences in an appeal under section 134(a) of this title may, unless appeal has been taken to the United States Court of Appeals for the Federal Circuit, have remedy by civil action against the Director in the United States District Court for the District of Columbia if commenced within such time after such decision, not less than sixty days, as the Director appoints. The court may adjudge that such applicant is entitled to receive a patent for his invention, as specified in any of his claims involved in the decision of the Board of Patent Appeals and Interferences, as the facts in the case may appear, and such adjudication shall authorize the Director to issue such patent on compliance with the requirements of law. All the expenses of the proceedings shall be paid by the applicant.

### *35 U.S.C. 146. Civil action in case of interference.*

Any party to an interference dissatisfied with the decision of the Board of Patent Appeals and Interferences may have remedy by civil action, if commenced within such time after such decision, not less than sixty days, as the Director appoints or as provided in section 141 of this title, unless he has appealed to the United States Court of Appeals for the Federal Circuit, and such appeal is pending or has been decided. In such suits the record in the Patent and Trademark Office shall be admitted on motion of either party upon the terms and conditions as to costs, expenses, and the further cross-examination of the witnesses as the court imposes, without prejudice to the right of the parties to take further testimony. The testimony and exhibits of the record in the Patent and Trademark Office when admitted shall have the same effect as if originally taken and produced in the suit.

Such suit may be instituted against the party in interest as shown by the records of the Patent and Trademark Office at the time of the decision complained of, but any party in interest may become a party to the action. If there be adverse parties residing in a plurality of districts not embraced within the same state, or an adverse party residing in a foreign country, the United States District Court for the District of Columbia shall have jurisdiction and may issue summons against the adverse parties directed to the marshal of any district in which any adverse party resides. Summons against adverse parties residing in foreign countries may be served by publication or otherwise as the court directs. The Director shall not be a necessary party but he shall be notified of the filing of the suit by the clerk of the court in which it is filed and shall have the right to intervene. Judgment of the court in favor of the right of an applicant to a patent shall authorize the Director to issue such patent on the filing in the Patent and Trademark Office of a certified copy of the judgment and on compliance with the requirements of law.

### *35 U.S.C. 306. Appeal.*

The patent owner involved in a reexamination proceeding under this chapter may appeal under the provisions of section 134 of this title, and may seek court review under the provisions of sections 141 to 145 of this title, with respect to any decision adverse to the patentability of any original or proposed amended or new claim of the patent.

### *37 CFR 1.301. Appeal to U.S. Court of Appeals for the Federal Circuit.*

Any applicant or any owner of a patent involved in any *ex parte* reexamination proceeding filed under § 1.510, dissatisfied with the decision of the Board of Patent Appeals and Interferences, and any party to an interference dissatisfied with the decision of the Board of Patent Appeals and Interferences, may appeal to the U.S. Court of Appeals for the Federal Circuit. The appellant must take the following steps in such an appeal: In the U.S. Patent and Trademark Office, file a written notice of appeal directed to the Commissioner (see §§ 1.302 and 1.304); and in the Court, file a copy of the notice of appeal and pay the fee for appeal as provided by the rules of the Court. For *inter partes* reexamination proceedings filed under § 1.913, § 1.983 is controlling.

*37 CFR 1.303. Civil action under 35 U.S.C. 145, 146, 306.*

(a) Any applicant or any owner of a patent involved in an *ex parte* reexamination proceeding filed under §1.510 for a patent that issues from an original application filed in the United States before November 29, 1999, dissatisfied with the decision of the Board of Patent Appeals and Interferences, and any party to an interference dissatisfied with the decision of the Board of Patent Appeals and Interferences may, instead of appealing to the U.S. Court of Appeals for the Federal Circuit (§ 1.301), have remedy by civil action under 35 U.S.C. 145 or 146, as appropriate. Such civil action must be commenced within the time specified in § 1.304.

(b) If an applicant in an *ex parte* case or an owner of a patent involved in an *ex parte* reexamination proceeding filed under §1.510 for a patent that issues from an original application filed in the United States before November 29, 1999, has taken an appeal to the U.S. Court of Appeals for the Federal Circuit, he or she thereby waives his or her right to proceed under 35 U.S.C. 145.

(c) If any adverse party to an appeal taken to the U.S. Court of Appeals for the Federal Circuit by a defeated party in an interference proceeding files notice with the Commissioner within twenty days after the filing of the defeated party's notice of appeal to the court (§ 1.302), that he or she elects to have all further proceedings conducted as provided in 35 U.S.C. 146, the notice of election must be served as provided in § 1.646.

(d) For an *ex parte* reexamination proceeding filed under § 1.510 for a patent that issues from an original application filed in the United States on or after November 29, 1999, and for an *inter partes* reexamination proceeding filed under § 1.913, no remedy by civil action under 35 U.S.C. 145 is available.

*37 CFR 1.304. Time for appeal or civil action.*

(a)(1)The time for filing the notice of appeal to the U.S. Court of Appeals for the Federal Circuit (§ 1.302) or for commencing a civil action (§ 1.303) is two months from the date of the decision of the Board of Patent Appeals and Interferences. If a request for rehearing or reconsideration of the decision is filed within the time period provided under § 1.197(b), § 1.658(b), or § 1.979(a), the time for filing an appeal or commencing a civil action shall expire two months after action on the request. In interferences the time for filing a cross-appeal or cross-action expires:

(i) Fourteen days after service of the notice of appeal or the summons and complaint; or

(ii) Two months after the date of decision of the Board of Patent Appeals and Interferences, whichever is later.

(2) The time periods set forth in this section are not subject to the provisions of § 1.136, § 1.550(c), § 1.956, or § 1.645(a) or (b).

(3) The Commissioner may extend the time for filing an appeal or commencing a civil action:

(i) For good cause shown if requested in writing before the expiration of the period for filing an appeal or commencing a civil action, or

(ii) Upon written request after the expiration of the period for filing an appeal or commencing a civil action upon a showing that the failure to act was the result of excusable neglect.

(b) The times specified in this section in days are calendar days. The time specified herein in months are calendar months except that one day shall be added to any two-month period which includes February 28. If the last day of the time specified for appeal or commencing a civil action falls on a Saturday, Sunday or Federal holiday in the District of Columbia, the time is extended to the next day which is neither a Saturday, Sunday nor a Federal holiday.

(c) If a defeated party to an interference has taken an appeal to the U.S. Court of Appeals for the Federal Circuit and an adverse party has filed notice under 35 U.S.C. 141 electing to have all further proceedings conducted under 35 U.S.C. 146 (§ 1.303(c)), the time for filing a civil action thereafter is specified in 35 U.S.C. 141. The time for filing a cross-action expires 14 days after service of the summons and complaint.

**JUDICIAL REVIEW OF PATENT APPLICATIONS**

An applicant for a patent who is dissatisfied with a decision of the Board may seek judicial review either by an appeal to the U.S. Court of Appeals for the Federal Circuit (35 U.S.C. 141 and 37 CFR 1.301) or by a civil action in the U.S. District Court for the District of Columbia (35 U.S.C. 145 and 37 CFR 1.303(a)). By filing an appeal to the Federal Circuit, the applicant waives the right to seek judicial review by a civil action under 35 U.S.C. 145. See 35 U.S.C. 141 and 37 CFR 1.303(b).

**JUDICIAL REVIEW OF EX PARTE REEXAMINATION PROCEEDINGS**

A patent owner involved in an *ex parte* reexamination proceeding filed under 35 U.S.C. 302 for a patent that issued from an original application filed in the United States before November 29, 1999 (or from an international application designating the United States filed before November 29, 1999) who is dissatisfied with a decision of the Board may seek judicial review either by an appeal to the U.S. Court of Appeals for the Federal Circuit or by a civil action in the U.S. District Court for the District of Columbia.

Public Law 106-113, enacted on November 29, 1999, amended 35 U.S.C. 141 and 35 U.S.C. 145 to read as they have been reproduced above. However, former versions of 35 U.S.C. 141 and 145 remain applicable in the case of an *ex parte* reexamination proceeding for a patent that issued from an original application filed before November 29, 1999. The former statutes provided for appeal to the Court of Appeals for the Federal Circuit (35 U.S.C. 141), or

alternatively, for a civil action against the Commissioner in the United States District Court for the District of Columbia (35 U.S.C. 145). Former 35 U.S.C. 141 further provided that by filing an appeal to the Court of Appeals for the Federal Circuit under 35 U.S.C. 141, a patent owner waived his/her right to proceed to file a civil action under 35 U.S.C. 145. See 37 CFR 1.303(a)-(b).

The amended versions of 35 U.S.C. 141 and 145 that went into effect on November 29, 1999 provide that a patent owner may appeal only to the United States Court of Appeals for the Federal Circuit. Accordingly, a patent owner involved in the *ex parte* reexamination of a patent that issued from an original application filed in the United States on or after November 29, 1999 (or from an international application designating the United States filed on or after November 29, 1999) may seek judicial review only in the United States Court of Appeals for the Federal Circuit. See 37 CFR 1.303(d).

For judicial review of an *inter partes* reexamination proceeding, see 35 U.S.C. 315. Because *inter partes* reexamination procedures are found in Chapter 31 (and not in Chapter 30) of Title 35 of the United States Code, 35 U.S.C. 306 does not apply to an *inter partes* reexamination proceeding.

## JUDICIAL REVIEW OF INTERFERENCE PROCEEDINGS

Any party to an interference who is dissatisfied with a decision of the Board may seek judicial review either by an appeal to the Federal Circuit (35 U.S.C. 141; 37 CFR 1.301) or, if no 35 U.S.C. 141 appeal is pending or has been decided, by a civil action in an appropriate district court (35 U.S.C. 146; 37 CFR 1.303(a)). Furthermore, a 35 U.S.C. 141 appeal to the Federal Circuit by a dissatisfied party in an interference will be dismissed if any adverse party in the interference, within 20 days after the appellant has filed a notice of appeal according to 35 U.S.C. 142, files notice with the Commissioner that such adverse party elects to have all further proceedings conducted in accordance with 35 U.S.C. 146. See 35 U.S.C. 141; 37 CFR 1.303(c). If, within 30 days after filing of such notice of election by an adverse party, the appellant does not file a civil action under 35 U.S.C. 146, the decision appealed from shall govern the further proceedings in the case. 35 U.S.C. 141. Copies of

such notice of election, which must be served as provided in 37 CFR 1.646, will be transmitted by the Solicitor to the Federal Circuit for such action as may be necessary (37 CFR 1.303(c)).

## TIME FOR FILING NOTICE OF APPEAL OR COMMENCING CIVIL ACTION

The time for filing a notice of a 35 U.S.C. 141 appeal to the Federal Circuit or for commencing a civil action under 35 U.S.C. 145 or 146 is within 2 months of the Board's decision. 37 CFR 1.304(a). However, if a request for rehearing or reconsideration of the Board's decision is filed within the time provided under 37 CFR 1.197(b) (*ex parte* appeals) or 37 CFR 1.658(b) (*inter partes* appeals), the time for filing a notice of appeal to the Federal Circuit or for commencing a civil action expires 2 months after a decision on a request for rehearing or reconsideration (37 CFR 1.304(a)).

These 2-month periods meet the 60-day requirement of 35 U.S.C. 142, 145, and 146 except for time periods which include February 28. In order to comply with the 60-day requirement, 37 CFR 1.304(b) provides that an additional day shall be added to any 2-month period for initiating review which includes February 28. Appeals will always be timely if the judicial review is initiated within 2 months of the final decision.

The times specified in 37 CFR 1.304 are calendar days. If the last day of the time specified for appeal or commencing a civil action falls on a Saturday, Sunday, or a Federal holiday in the District of Columbia, the time is extended to the next day which is neither a Saturday, Sunday, nor a Federal holiday (37 CFR 1.304(b)).

## TIME FOR FILING CROSS-APPEAL OR CROSS-ACTION

37 CFR 1.304(a) specifies that the time for filing a cross-appeal or a cross-action expires (A) 14 days after service of the notice of appeal or the summons and complaint or (B) 2 months after the decision to be reviewed, whichever is later.

37 CFR 1.304(a) provides that the time for filing a cross-action expires 14 days after service of the summons and complaint. The district court will determine whether any cross-action was timely filed since



neither the complaint nor cross-action is filed in the U.S. Patent and Trademark Office.

### **EXTENSION OF TIME TO SEEK JUDICIAL REVIEW**

In 37 CFR 1.304(a), the Office has adopted a standard which is similar to the standard used in the Federal courts for granting extensions. Under the rule, the Commissioner may extend the time (A) for good cause if requested before the expiration of the time provided for initiating judicial review or (B) upon a showing of excusable neglect in failing to initiate judicial review if requested after the expiration of the time period. This standard is applicable once the “last” decision has been entered, i.e., either the decision (in circumstances where no timely rehearing or reconsideration is sought), the decision on rehearing of the Board in an *ex parte* appeal, or the decision on reconsideration of the Board in an interference. Extensions of time under 37 CFR 1.136(b) and 1.550(c) and fee extensions under 37 CFR 1.136(a) are not available to extend the time for the purpose of judicial review once a decision or a decision on rehearing or reconsideration has been entered. 37 CFR 1.304(a)(2) states that the provisions of 37 CFR 1.136 and 1.550(c) are not available to extend the time to initiate judicial review.

Requests for extension of time to seek judicial review under 37 CFR 1.304 should be addressed as follows:

Box 8  
Commissioner of Patents and Trademarks  
Washington, DC 20231  
Attention: Office of The Solicitor

Requests may also be hand-carried to the Office of the Solicitor.

### **APPLICATION UNDER JUDICIAL REVIEW**

The administrative file of an application under judicial review, even though carried to a court, will not be opened to the public by the U.S. Patent and Trademark Office, unless it is otherwise available to the public under 37 CFR 1.11.

During judicial review, the involved application or reexamination is not under the jurisdiction of the examiner or the Board, unless remanded to the U.S. Patent and Trademark Office by the court. Any

amendment, such as one copying claims from a patent for interference purposes, can be admitted only under the provisions of 37 CFR 1.198. See MPEP § 1214.07.

### **SERVICE OF COURT PAPERS ON THE COMMISSIONER**

Rule 5(b) of the Federal Rules of Civil Procedure provides in pertinent part:

Whenever under these rules service is required or permitted to be made upon a party represented by an attorney the service shall be made upon the attorney unless service upon the party is ordered by the court. Service upon the attorney . . . shall be made by delivering a copy to the attorney or party or by mailing it to the attorney or party at the attorney’s or party’s last known address . . . .

Similarly, Rule 25(b) of the Federal Rules of Appellate Procedure provides that “[s]ervice on a party represented by counsel must be made on the party’s counsel.”

Accordingly, all service copies of papers filed in court proceedings in which the Commissioner of Patents and Trademarks is a party must be served on the Solicitor of the Patent and Trademark Office. Service on the Solicitor may be effected in either of the following ways:

(A) By hand between 8:30 A.M. and 5:00 P.M. EST at the Office of the Solicitor

(B) By mail in an envelope addressed as follows:

Office of the Solicitor  
P.O. Box 15667  
Arlington, VA 22215

While the above mail service address may be supplemented to include the name of the particular attorney assigned to the court case, it must not be supplemented to refer to either the Commissioner of Patents and Trademarks or the U.S. Patent and Trademark Office.

Any court papers mailed to an address other than the above mail service address or delivered by hand to the U.S. Patent and Trademark Office are deemed to have been served on the Commissioner when actually received in the Office of the Solicitor.

The above mail service address should not be used for filing a notice of appeal to the Federal Circuit. See

MPEP § 1216.01. Nor should the above mail service address be used for noncourt papers, i.e., papers which are intended to be filed in the U.S. Patent and Trademark Office in connection with an application or other proceeding pending in the U.S. Patent and Trademark Office. ANY NONCOURT PAPERS WHICH ARE MAILED TO THE ABOVE MAIL SERVICE ADDRESS WILL BE RETURNED TO THE SENDER. NO EXCEPTIONS WILL BE MADE TO THIS POLICY.

## 1216.01 Appeals to the Federal Circuit

### *35 U.S.C. 142. Notice of appeal.*

When an appeal is taken to the United States Court of Appeals for the Federal Circuit, the appellant shall file in the Patent and Trademark Office a written notice of appeal directed to the Director, within such time after the date of the decision from which the appeal is taken as the Director prescribes, but in no case less than 60 days after that date.

### *35 U.S.C. 143. Proceedings on appeal.*

With respect to an appeal described in section 142 of this title, the Director shall transmit to the United States Court of Appeals for the Federal Circuit a certified list of the documents comprising the record in the Patent and Trademark Office. The court may request that the Director forward the original or certified copies of such documents during the pendency of the appeal. In any reexamination case, the Director shall submit to the court in writing the grounds for the decision of the Patent and Trademark Office, addressing all the issues involved in the appeal. The court shall, before hearing an appeal, give notice of the time and place of the hearing to the Director and the parties in the appeal.

### *35 U.S.C. 144. Decision on appeal.*

The United States Court of Appeals for the Federal Circuit shall review the decision from which an appeal is taken on the record before the Patent and Trademark Office. Upon its determination the court shall issue to the Director its mandate and opinion, which shall be entered of record in the Patent and Trademark Office and shall govern the further proceedings in the case.

### *37 CFR 1.302. Notice of appeal.*

(a) When an appeal is taken to the U.S. Court of Appeals for the Federal Circuit, the appellant shall give notice thereof to the Commissioner within the time specified in § 1.304.

(b) In interferences, the notice must be served as provided in § 1.646.

(c) A notice of appeal, if mailed to the Office, shall be addressed as follows: Box 8, Commissioner of Patents and Trademarks, Washington, DC 20231.

Filing an appeal to the Federal Circuit requires that the applicant, the owner of a patent involved in a reexamination proceeding, or a party to an interference

proceeding: (A) file in the U.S. Patent and Trademark Office a written notice of appeal (35 U.S.C. 142) directed to the Commissioner and (B) file with the Clerk of the Federal Circuit a copy of the notice of appeal and pay the docket fee for the appeal, as provided by Federal Circuit Rule 52. 37 CFR 1.301.

For a notice of appeal to be considered timely filed in the U.S. Patent and Trademark Office, it must: (A) actually reach the U.S. Patent and Trademark Office within the time specified in 37 CFR 1.304 (including any extensions) or (B) be mailed within the time specified in 37 CFR 1.304 (including any extensions) by “Express Mail” in accordance with 37 CFR 1.10.

A Notice of Appeal to the Federal Circuit should not be mailed to the Commissioner, the Board or the examiner. Nor should it be mailed to the Solicitor’s mail service address for court papers given in MPEP § 1216. Instead, it should be filed in the U.S. Patent and Trademark Office in any one of the following ways:

(A) By mail addressed as follows, in which case the notice of appeal must actually reach the U.S. Patent and Trademark Office by the due date:

Commissioner of Patents and Trademarks  
Box 8  
Washington, DC 20231  
Attention: Office of the Solicitor

(B) By “Express Mail” (U.S. Postal Service only) under 37 CFR 1.10 addressed as follows, in which case the notice of appeal is deemed filed on the “date-in” on the “Express Mail” mailing label:

Commissioner of Patents and Trademarks  
Box 8  
Washington, DC 20231  
Attention: Office of the Solicitor

(C) By hand to the Office of the Solicitor, 2121 Crystal Drive, Suite 714, Arlington, VA 22202.

A copy of the notice of appeal and the docket fee should be filed with the Clerk of the Federal Circuit, whose mailing and actual address is:

U.S. Court of Appeals for the Federal Circuit  
717 Madison Place, N.W.  
Washington, DC 20439

The Solicitor, prior to a decision by the Federal Circuit, may request that the case be remanded to the U.S. Patent and Trademark Office and prosecution reopened. See MPEP § 1214.07.

### STANDARDS OF REVIEW BY THE FEDERAL CIRCUIT

In light of the Supreme Court decision in *Dickinson v. Zurko*, 527 U.S. 150, 50 USPQ2d 1930 (1999), holding that the Federal Circuit must apply one of the standards set forth in the Administrative Procedure Act (“APA”), the Federal Circuit adopted the “substantial evidence” standard for reviewing factfinding by the Board of Patent Appeals and Interferences. *In re Gartside*, 203 F.3d 1305, 53 USPQ2d 1769 (Fed. Cir. 2000). The “substantial evidence” standard asks whether the agency action, findings, and conclusions were supported by substantial evidence, or, in other words, whether a reasonable factfinder could have arrived at the agency’s decision. The Supreme Court has described “substantial evidence” as “more than a mere scintilla. It means such relevant evidence as a reasonable mind might accept as adequate to support a conclusion. . . . Mere uncorroborated hearsay or rumor does not constitute substantial evidence.” *Consolidated Edison Co. v. NLRB*, 305 U.S. 197, 229-30 (1938)(citations omitted).

The Federal Circuit uses the *de novo* standard for reviewing questions of law. See e.g., *In re Rouffet*, 149 F.3d 1350, 1355, 47 USPQ2d 1453, 1455 (Fed. Cir. 1998).

When the issue to be decided is a question of law based on underlying findings of fact (e.g., obviousness under 35 U.S.C. 103, enablement under 35 U.S.C. 112, first paragraph, or conception of an invention for purposes of 35 U.S.C. 102(g)), the Board’s legal conclusion is reviewed without formal deference, while the subsidiary factual findings are reviewed for substantial evidence.

### OFFICE PROCEDURE FOLLOWING DECISION BY THE FEDERAL CIRCUIT

After the Federal Circuit has heard and decided the appeal, an uncertified copy of the decision is sent to the U.S. Patent and Trademark Office and to the appellant and appellee (if any).

In due course, the Clerk of the Federal Circuit forwards to the U.S. Patent and Trademark Office a certi-

fied copy of the court’s decision. This certified copy is known as the “mandate.” The mandate is entered in the file of the application, reexamination or interference which was the subject of the appeal. The date of receipt of the mandate by the U.S. Patent and Trademark Office marks the conclusion of the appeal, i.e., the termination of proceedings as that term is used in 35 U.S.C. 120. See 37 CFR 1.197(c), or “termination of the interference” as that term is used in 35 U.S.C. 135(c).

The Federal Circuit’s opinion may or may not be precedential. Whether or not the opinion is precedential, the U.S. Patent and Trademark Office will not give the public access to the administrative record of an involved application, or to the file of an interference, unless it is otherwise available to the public under 37 CFR 1.11. However, since the court record in a 35 U.S.C. 141 appeal generally includes a copy of at least part of the application, such may be inspected at the Federal Circuit. *In re Mosher*, 248 F.2d 956, 115 USPQ 140 (CCPA 1957).

In an *ex parte* appeal, after the mandate is entered in the application or reexamination file, the file is then returned to the appropriate U.S. Patent and Trademark Office official for further proceedings consistent with the mandate. See MPEP § 1214.06 for handling of claims dependent on rejected claims.

#### A. All Claims Rejected

If all claims in the case stand rejected, proceedings in the case are considered terminated on the date of receipt of the Federal Circuit’s mandate. Because the case is no longer considered pending, it is ordinarily not open to subsequent amendment and prosecution by the applicant. *Continental Can Company v. Schuyler*, 326 F. Supp. 283, 168 USPQ 625 (D.D.C. 1970). However, exceptions may occur where the mandate clearly indicates that further action in the U.S. Patent and Trademark Office is to be taken in accordance with the Federal Circuit’s opinion.

#### B. Some Claims Allowed

Where the case includes one or more allowed claims, including claims allowed by the examiner prior to appeal and claims whose rejections were reversed by either the Board or the court, the proceedings are considered terminated only as to any claims which still stand rejected. It is not necessary for the

applicant or patent owner to cancel the rejected claims, since they may be canceled by the examiner in an examiner's amendment or by an appropriate notation in the margin of the claims, to avoid confusion to the printer. Thus, if no formal matters remain to be attended to, the examiner will pass the application to issue forthwith on the allowed claims or, in the case of a reexamination, will issue a "Notice of Intent to Issue a Reexamination Certificate and/or Examiner's Amendment." See MPEP § 2287. The examiner should set forth the reasons for allowance, referring to and incorporating a copy of the appellate brief and the court decision. See MPEP § 1302.14.

If formal matters remain to be attended to, the examiner promptly should take appropriate action on such matters, such as by an examiner's amendment or by an Office action setting a 1-month (but not less than 30-day) shortened statutory period for reply. However, the application or reexamination proceeding is considered closed to further prosecution except as to such matters.

### C. Remand

Where the decision of the court brings up for action on the merits claims which were not previously considered on the merits (such as a decision reversing a rejection of generic claims in an application containing claims to nonelected species), the examiner will take the case up for appropriate action on the matters thus brought up.

### D. Reopening of Prosecution

In rare situations it may be necessary to reopen prosecution of an application after a decision by the Federal Circuit. Any Office action proposing to reopen prosecution after a decision by the Federal Circuit must be forwarded to the Office of the Deputy Commissioner for Patent Examination Policy for written approval, which will be indicated on the Office action.

## DISMISSAL OF APPEAL

After an appeal is docketed in the Federal Circuit, failure to prosecute the appeal, such as by appellant's failure to file a brief, may result in dismissal of the appeal by the court. Under particular circumstances, the appeal also may be dismissed by the court on motion of the appellant and/or the Commissioner.

The court proceedings are considered terminated as of the date of the mandate. After dismissal, the action taken by the examiner will be the same as set forth above under the heading "Office Procedure Following Decision by the Federal Circuit."

In the event of a dismissal for a reason other than failure to prosecute the appeal, the status of the application, reexamination proceeding or interference must be determined according to the circumstances leading to the dismissal.

## 1216.02 Civil Suits Under 35 U.S.C. 145

A 35 U.S.C. 145 civil action is commenced by filing a complaint in the U.S. District Court for the District of Columbia within the time specified in 37 CFR 1.304 (see MPEP § 1216). Furthermore, copies of the complaint and summons must be served in a timely manner on the Solicitor, the U.S. Attorney for the District of Columbia, and the Attorney General in the manner set forth in Rule 4(i) of the Federal Rules of Civil Procedure. Regarding timely service, see *Walsdorf v. Comm'r*, 229 USPQ 559 (D.D.C. 1986) and *Hodge v. Rostker*, 501 F. Supp. 332 (D.D.C. 1980). When a 35 U.S.C. 145 civil action is filed, a notice thereof is placed in the application or reexamination file, which ordinarily will be kept in the Solicitor's Office pending termination of the civil action.

In an action under 35 U.S.C. 145, the plaintiff may introduce evidence not previously presented to the U.S. Patent and Trademark Office. However, plaintiff will be precluded from presenting new issues, at least in the absence of some reason of justice put forward for failure to present the issue to the U.S. Patent and Trademark Office. *DeSeversky v. Brenner*, 424 F.2d 857, 858, 164 USPQ 495, 496 (D.C. Cir. 1970); *MacKay v. Quigg*, 641 F. Supp. 567, 570, 231 USPQ 907, 908 (D.D.C. 1986). Furthermore, new evidence is not admissible in district court where it was available to the parties but was withheld from the U.S. Patent and Trademark Office as a result of fraud, bad faith, or gross negligence. *DeSeversky*, 424 F.2d at 858 n.5, 164 USPQ at 496 n.5; *California Research Corp. v. Ladd*, 356 F.2d 813, 821 n.18, 148 USPQ 404, 473 n.18 (D.C. Cir. 1966); *MacKay*, 641 F. Supp. at 570, 231 USPQ at 908; *Monsanto Company v. Kamp*, 269 F. Supp. 818, 822, 154 USPQ 259, 260 (D.D.C. 1967); *Killian v. Watson*, 121 USPQ 507, 507 (D.D.C. 1958).

Upon termination of the civil action, a statement of the court's final disposition of the case is placed in the application or reexamination file, which is then returned to the examiner for action in accordance with the same procedures as follow termination of a 35 U.S.C. 141 appeal. See MPEP § 1216.01. 37 CFR 1.197(c) provides that a civil action is terminated when the time to appeal the judgment expires. Where the exact date when the civil action was terminated is material, the date may be ascertained from the Solicitor's Office.

The procedures to be followed in the U.S. Patent and Trademark Office after a decision, remand, or dismissal of the case by the district court are the same as the procedures followed with respect to 35 U.S.C. 141 appeals. See MPEP § 1216.01.

Where a civil action involving an application has been dismissed before coming to trial, the application will not be opened to the public unless it is otherwise available to the public under 37 CFR 1.11. However, the complaint and any other court papers not under a protective order are open to the public and may be inspected at the Office of the Clerk for the U.S. District Court for the District of Columbia, located in the U.S. Courthouse, 333 Constitution Avenue, N.W., Washington, DC 20001. The court papers in the Office of the Solicitor are not generally made available for public inspection.

Any subpoena by the district court for an application or reexamination file should be hand-carried to the Office of the Solicitor.



# Chapter 1300 Allowance and Issue

- 1301 Substantially Allowable Application, Special**
- 1302 Final Review and Preparation for Issue**
  - 1302.01 General Review of Disclosure
  - 1302.02 Requirement for a Rewritten Specification
  - 1302.03 Notice of Allowability
  - 1302.04 Examiner's Amendments and Changes
    - 1302.04(a) Title of Invention
    - 1302.04(b) Cancellation of Nonstatutory Claim
    - 1302.04(c) Cancellation of Claims to Nonelected Invention
    - 1302.04(d) Cancellation of Claim Lost in Interference
    - 1302.04(e) Cancellation of Rejected Claims Following Appeal
    - 1302.04(f) Data of Copending Application Referred to Should Be Brought Up-to-Date
    - 1302.04(g) Identification of Claims
  - 1302.05 Correction of Drawing
    - 1302.05(a) Original Drawings Cannot Be Located
  - 1302.06 Prior Foreign Application
  - 1302.07 Use of Retention Labels to Preserve Abandoned Companion Applications
  - 1302.08 Interference Search
  - 1302.09 \*\*>Classification, Print Figure, and Other Notations<
  - 1302.10 Issue Classification Notations
  - 1302.11 Reference to Assignment Division
  - 1302.12 Listing of References
  - 1302.13 Signing
  - 1302.14 Reasons for Allowance
- 1303 Notice of Allowance**
  - 1303.01 Amendment Received After Allowance
  - 1303.02 Undelivered
  - 1303.03 Not Withheld Due to Death of Inventor
- 1304 Amendments After D-10 Notice**
  - 1304.01 Withholding From Issue of "Secrecy Order" Applications
- 1305 Jurisdiction**
- 1306 Issue Fee**
  - 1306.01 Deferring Issuance of a Patent
  - 1306.02 Simultaneous Issuance of Patents
  - 1306.03 Practice After Payment of Issue Fee
- 1307 Change in Classification of Cases Which Are in Issue**
- 1308 Withdrawal From Issue**
  - 1308.01 Rejection After Allowance
  - 1308.02 For Interference Purposes
  - 1308.03 Quality Review Program for Examined Patent Applications
- 1309 Issue of Patent**
  - 1309.02 "Query/Printer Waiting" Cases

## 1301 Substantially Allowable Application, Special

When an application is in condition for allowance, except as to matters of form, the application will be considered special and prompt action taken to require correction of formal matters. See MPEP § 710.02(b).

## 1302 Final Review and Preparation for Issue

### 1302.01 General Review of Disclosure [R-2]

When an application is apparently ready for allowance, it should be reviewed by the examiner to make certain that the whole application meets all formal and substantive (i.e., statutory) requirements and that the language of the claims is enabled by, and finds adequate descriptive support in, the application disclosure as originally filed. Neglect to give due attention to these matters may lead to confusion as to the scope of the patent.

Frequently, the invention as originally described and claimed was of much greater scope than that defined in the claims as allowed. Some or much of the subject matter disclosed may be entirely outside the bounds of the claims accepted by the applicant. In such case, the examiner should require the applicant to modify the brief summary of the invention and restrict the descriptive matter so as to be in harmony with the claims. However valuable for reference purposes the examiner may consider the matter which is extraneous to the claimed invention, patents should be confined in their disclosures to the respective inventions patented (see 37 CFR 1.71 and 1.73). Of course, enough background should be included to make the invention clearly understandable. See MPEP § 608.01(c) and § 608.01(d). Form paragraphs 13.07 and 13.08 may be used.

#### ¶ 13.07 Disclosure To Be Limited to Claimed Invention

Applicant is required to modify the brief summary of the invention and to restrict the descriptive matter so that they are confined to and in harmony with the invention to which the allowed claims are directed. See MPEP § 1302.01. For example, [1].

#### Examiner Note:

An example should be given as to the specific sheets or drawing figures and portions of the specification which should be can-

celled. If drawing figures are to be cancelled, applicant should be reminded that subsequent figures must be renumbered.

¶ *13.08 Disclosed Subject Matter Outside the Bounds of the Claims*

The application contains disclosure entirely outside the bounds of the allowed claims. Applicant is required to modify the brief summary of the invention and restrict the descriptive matter so as to be in harmony with the claims (MPEP § 1302.01).

There should be clear support or antecedent basis in the specification for the terminology used in the claims. Usually, the original claims follow the nomenclature of the specification; but sometimes in amending the claims or in adding new claims, applicant employs terms that do not appear in the specification. This may result in uncertainty as to the interpretation to be given such terms. See MPEP § 608.01(o). It should be noted, however, that exact terms need not be used *in haec verba* to satisfy the written description requirement of the first paragraph of 35 U.S.C. 112. *Eiselstein v. Frank*, 52 F.3d 1035, 1038, 34 USPQ2d 1467, 1470 (Fed. Cir. 1995); *In re Wertheim*, 541 F.2d 257, 265, 191 USPQ 90, 98 (CCPA 1976). See also 37 CFR 1.121(e) which merely requires *substantial* correspondence between the language of the claims and the language of the specification.

Where a copending application is referred to in the specification, the examiner should ascertain whether it has matured into a patent or has become abandoned, and “now abandoned” or the patent number should be added to the specification. >If the application is an Image File Wrapper (IFW) application, the amendment must be made by way of a formal examiner’s amendment.<

The claims should be renumbered as required by 37 CFR 1.126, and particular attention should be given to claims dependent on previous claims to see that the numbering is consistent. An examiner’s amendment should be prepared if the order of the claims is changed. See MPEP § 608.01(j), § 608.01(n), and § 1302.04(g).

The abstract should be checked for an adequate and clear statement of the disclosed invention. See MPEP § 608.01(b). The length of the abstract should be limited to 150 words. >For changes to the abstract by examiner’s amendment, see MPEP § 1302.04.<

The title should also be checked. It should be as short and specific as possible. However, the title

should be descriptive of the invention claimed, even though a longer title may result. If a satisfactory title is not supplied by the applicant, the examiner may change the title on or after allowance. See MPEP § 606 and § 606.01.

No pencil notes should be made in the application file by the examiner. Any notes in the file must be erased when the application is passed to issue.

All amendments should be reviewed to assure that they were timely filed.

## 1302.02 Requirement for a Rewritten Specification

Whenever interlineations or cancellations have been made in the specification or amendments which would lead to confusion and mistake, the examiner should require the entire portion of specification affected to be rewritten before passing the application to issue. See 37 CFR 1.125 and MPEP § 608.01(q).

Form paragraph 13.01 should be used when making such a requirement.

¶ *13.01 Requirement for Rewritten Specification*

The interlineations or cancellations made in the specification or amendments to the claims could lead to confusion and mistake during the issue and printing processes. Accordingly, the portion of the specification or claims as identified below is required to be rewritten before passing the case to issue. See 37 CFR 1.125 and MPEP § 608.01(q).

**Examiner Note:**

1. Specific discussion of the sections of the specification or claims required to be rewritten must be set forth.
2. See form paragraph 6.28.01 for a substitute specification.

## 1302.03 Notice of Allowability [R-2]

A Notice of Allowability form PTOL-37 is used whenever an application has been placed in condition for allowance. The date of any communication and/or interview which resulted in the allowance should be included in the notice.

In *all* instances, both before and after final rejection, in which an application is placed in condition for allowance, applicant should be notified promptly of allowability of the claims by a Notice of Allowability PTOL-37. If delays in processing the Notice of Allowability are expected, e.g., because an extensive examiner’s amendment must be entered, and the end of a statutory period for reply is near, the examiner should notify applicant by way of an interview that

the application has been placed in condition for allowance, and an Interview Summary PTO-413 should be mailed. Prompt notice to applicant is important

because it may avoid an unnecessary appeal and act as a safeguard against a holding of abandonment.



>

<b>Notice of Allowability</b>	<b>Application No.</b>	<b>Applicant(s)</b>	
	<b>Examiner</b>	<b>Art Unit</b>	

**-- The MAILING DATE of this communication appears on the cover sheet with the correspondence address--**

All claims being allowable, PROSECUTION ON THE MERITS IS (OR REMAINS) CLOSED in this application. If not included herewith (or previously mailed), a Notice of Allowance (PTOL-85) or other appropriate communication will be mailed in due course. **THIS NOTICE OF ALLOWABILITY IS NOT A GRANT OF PATENT RIGHTS.** This application is subject to withdrawal from issue at the initiative of the Office or upon petition by the applicant. See 37 CFR 1.313 and MPEP 1308.

1.  This communication is responsive to \_\_\_\_\_.
2.  The allowed claim(s) is/are \_\_\_\_\_.
3.  The drawings filed on \_\_\_\_\_ are accepted by the Examiner.
4.  Acknowledgment is made of a claim for foreign priority under 35 U.S.C. § 119(a)-(d) or (f).
  - a)  All    b)  Some\*    c)  None    of the:
    1.  Certified copies of the priority documents have been received.
    2.  Certified copies of the priority documents have been received in Application No. \_\_\_\_\_.
    3.  Copies of the certified copies of the priority documents have been received in this national stage application from the International Bureau (PCT Rule 17.2(a)).
  - \* Certified copies not received: \_\_\_\_\_.

Applicant has THREE MONTHS FROM THE "MAILING DATE" of this communication to file a reply complying with the requirements noted below. Failure to timely comply will result in ABANDONMENT of this application.  
**THIS THREE-MONTH PERIOD IS NOT EXTENDABLE.**

5.  A SUBSTITUTE OATH OR DECLARATION must be submitted. Note the attached EXAMINER'S AMENDMENT or NOTICE OF INFORMAL PATENT APPLICATION (PTO-152) which gives reason(s) why the oath or declaration is deficient.
6.  CORRECTED DRAWINGS ( as "replacement sheets") must be submitted.
  - (a)  including changes required by the Notice of Draftsperson's Patent Drawing Review ( PTO-948) attached
    - 1)  hereto or 2)  to Paper No./Mail Date \_\_\_\_\_.
  - (b)  including changes required by the attached Examiner's Amendment / Comment or in the Office action of Paper No./Mail Date \_\_\_\_\_.

**Identifying indicia such as the application number (see 37 CFR 1.84(c)) should be written on the drawings in the front (not the back) of each sheet. Replacement sheet(s) should be labeled as such in the header according to 37 CFR 1.121(d).**
7.  DEPOSIT OF and/or INFORMATION about the deposit of BIOLOGICAL MATERIAL must be submitted. Note the attached Examiner's comment regarding REQUIREMENT FOR THE DEPOSIT OF BIOLOGICAL MATERIAL.

**Attachment(s)**

<ol style="list-style-type: none"> <li>1. <input type="checkbox"/> Notice of References Cited (PTO-892)</li> <li>2. <input type="checkbox"/> Notice of Draftsperson's Patent Drawing Review (PTO-948)</li> <li>3. <input type="checkbox"/> Information Disclosure Statements (PTO-1449 or PTO/SB/08), Paper No./Mail Date _____</li> <li>4. <input type="checkbox"/> Examiner's Comment Regarding Requirement for Deposit of Biological Material</li> </ol>	<ol style="list-style-type: none"> <li>5. <input type="checkbox"/> Notice of Informal Patent Application (PTO-152)</li> <li>6. <input type="checkbox"/> Interview Summary (PTO-413), Paper No./Mail Date _____</li> <li>7. <input type="checkbox"/> Examiner's Amendment/Comment</li> <li>8. <input type="checkbox"/> Examiner's Statement of Reasons for Allowance</li> <li>9. <input type="checkbox"/> Other _____</li> </ol>
---	---

<

## 1302.04 Examiner's Amendments and Changes [R-2]

Except by formal examiner's amendment duly signed or as hereinafter provided, no corrections, erasures, or interlineations may be made in the body of written portions of the specification or any other paper filed in the application for patent. (See 37 CFR 1.121.)

\*>If the application file is a paper file, an< informal examiner's amendment may be used for the correction of the following obvious errors and omissions only in the body of the written portions of the specification and may only be made with pen by the examiner of the application who will then initial in the margin and assume full responsibility for the change:

- (A) Misspelled words.
- (B) Disagreement of a noun with its verb.
- (C) Inconsistent "case" of a pronoun.
- (D) Disagreement between a reference character as used in the description and on the drawing. The character may be corrected in the description but only when the examiner is certain of the propriety of the change.
- (E) Entry of "Patent No....." or "Patent Application Publication No....." to identify a patent which has been granted on a U.S. application> or the publication of a U.S. application, respectively,< referred to by application number in the specification if the >domestic< priority reference is not in an application data sheet.
- (F) Entry of "abandoned" if a U.S. patent application referred to by application number in the specification, or in the application data sheet has become abandoned.

(G) Correction of reversed figure numbers. *Garrett v. Cox*, 233 F.2d 343, 345, 110 USPQ 52, 54 (CCPA 1956).

(H) Entry of "Patent Application No. ...." to identify a patent application in an otherwise allowable application filed under former 37 CFR 1.60 or 37 CFR 1.62 (see MPEP § 201.11).

(I) Other obvious minor grammatical errors such as misplaced or omitted commas, improper parentheses, quotation marks, etc.

(J) Obvious informalities in the application, other than the ones noted above, or of purely grammatical nature.

\*\*>Informal examiner's amendments are not permitted if the application is an Image File Wrapper (IFW) application. Any amendment of an IFW application must be by way of a formal examiner's amendment or be an amendment made by the applicant.<

For continuing applications filed under 37 CFR 1.53(b), where a reference to the parent application has been inadvertently omitted by the applicant, an examiner should not add a reference to the prior application without the approval of the applicant and a formal examiner's amendment since applicant may decide to delete the priority claim in the application filed under 37 CFR 1.53(b). \*\*>Furthermore, a petition under 37 CFR 1.78 to accept an unintentionally delayed benefit claim may be required if the application is a utility or plant application filed on or after November 29, 2000. See MPEP § 201.11.<

When correcting *originally filed* papers > of applications with a paper application file wrapper<, clean red ink *must* be used (not blue or black ink).

A formal examiner's amendment may be used to correct all other informalities in the body of the written portions of the specification as well as all errors and omissions in the claims, but such corrections must be made by a formal examiner's amendment, signed by the primary examiner, placed in the file and a copy sent to applicant. The changes specified in the amendment are entered by the technical support staff in the regular way. A formal examiner's amendment should include form paragraph 13.02 and form paragraph 13.02.01. Form paragraph 13.02.02 should be used if an extension of time is required.

### ¶ 13.02 Formal Examiner's Amendment

An examiner's amendment to the record appears below. Should the changes and/or additions be unacceptable to applicant, an amendment may be filed as provided by 37 CFR 1.312. To ensure consideration of such an amendment, it MUST be submitted no later than the payment of the issue fee.

### Examiner Note:

This form paragraph is NOT to be used in a reexamination proceeding (use form paragraph 22.06 instead).

### ¶ 13.02.01 Examiner's Amendment Authorized

Authorization for this examiner's amendment was given in a telephone interview with [1] on [2].

\*\*>

¶ 13.02.02 *Extension of Time and Examiner's Amendment Authorized by Telephone*

An extension of time under 37 CFR 1.136(a) is required in order to make an examiner's amendment which places this application in condition for allowance. During a telephone conversation conducted on [1], [2] requested an extension of time for [3] MONTH(S) and authorized the Director to charge Deposit Account No. [4] the required fee of \$ [5] for this extension and authorized the following examiner's amendment. Should the changes and/or additions be unacceptable to applicant, an amendment may be filed as provided by 37 CFR 1.312. To ensure consideration of such an amendment, it MUST be submitted no later than the payment of the issue fee.

**Examiner Note:**

See MPEP § 706.07(f), item (J) which explains when an extension of time is needed in order to make amendments to place the application in condition for allowance.

<

Although 37 CFR 1.121 has been amended to require amendments to the specification/claims to be made \*\*>in compliance with 37 CFR 1.121(b)(1), (b)(2), or (c), where appropriate<, 37 CFR 1.121(g) permits the Office to make amendments to the specification, including the claims, by examiner's amendments without \*\*>the need to comply with the requirements of 37 CFR 1.121(b)(1), (b)(2), or (c)< in the interest of expediting prosecution and reducing cycle time. Examiners may continue to make additions or deletions of subject matter in the specification, including the claims, in examiner's amendments by instructions to make the change at a precise location in the specification and/or the claims.

As an alternative, the examiner's amendment utilizing paragraph/claim replacement can be created by the examiner with authorization from the applicant. The examiner's amendment can also be created from a facsimile transmission or e-mailed amendment received by the examiner and referenced in the examiner's amendment and attached thereto. Any subject matter, in clean version form (containing no brackets or underlining), to be added to the specification/claims should be set forth separately by applicant in the e-mail or facsimile submission apart from the remainder of the submission. A clean version of a paragraph/claim, or portion of a paragraph/claim, submitted by applicant in a fax or e-mail, should be printed and attached to the examiner's amendment and may be relied on as part of the examiner's amend-

ment. The examiner should mark "requested" on the entire attachment to indicate that the fax or e-mail was requested by the examiner, so as to not lead to a reduction in patent term adjustment (37 CFR 1.704(c)(8)). As the attachment is made part of the examiner's amendment, it does not get a separate PALM code and will not trigger any reduction in patent term adjustment. A paper copy of the entire e-mail or facsimile submission should be entered in the application file. Examiners are not required to electronically save any e-mails once any e-mails or attachments thereto are printed and become part of an application file record. The e-mail practice that is an exception for examiner's amendments is restricted to e-mails to the examiner from the applicant and should not be generated by the examiner to the applicant unless such e-mails are in compliance with all of the requirements set out in MPEP § 502.03.

The amendment or cancellation of claims by formal examiner's amendment is permitted when passing an application to issue where these changes have been authorized by applicant (or his/her attorney or agent) in a telephone or personal interview. The examiner's amendment should indicate that the changes were authorized, the date and type (personal or telephone) of interview, and with whom it was held.

The examiner's amendment practice may be used to make charges against deposit accounts or credit cards under special conditions.

An examiner's amendment can be used to make a charge against a deposit account, provided prior approval is obtained from the applicant, attorney or agent, in order to expedite the issuance of a patent on an application otherwise ready for allowance. When such an examiner's amendment is prepared, the prior approval is indicated by identification of the name of the authorizing party, the date and type (personal or telephone) of authorization, the purpose for which the charge is made (additional claims, etc.), and the deposit account number.

Charges can also be made against a credit card in an examiner's amendment. Once the examiner has informed applicant of the required charges, applicant must submit by facsimile, a properly completed and signed PTO-2038, authorizing the necessary charges. After completion of processing in the Office of Finance, form PTO-2038 will be removed from the record. Office employees may not accept oral (tele-

phonic) instructions to complete the Credit Card Payment Form or otherwise charge a patent process or trademark process fee (as opposed to information product or service fees) to a credit card. Further identifying data, if deemed necessary and requested by the applicant, should also be included in the examiner's amendment.

Form paragraph 13.06 may be used to charge an extension of time fee in an examiner's amendment.

\*\*>

#### ¶ 13.06 Extension of Time by Examiner's Amendment

An extension of time under 37 CFR 1.136(a) is required to place this application in condition for allowance. During a telephone conversation conducted on [1], [2] requested an extension of time for [3] MONTH(S) and authorized the Director to charge Deposit Account No. [4] the required fee of \$ [5] for this extension.

#### Examiner Note:

1. See MPEP § 706.07(f), item J which explains when an extension of time is needed in order to make amendments to place the application in condition for allowance.
2. When an examiner's amendment is also authorized, use form paragraph 13.02.02 instead.

<

\*\*>At the time of allowance, substantive changes made by the examiner to the abstract must be done by a formal examiner's amendment after first obtaining approval from the applicant. As noted by the court in recent decisions, the abstract may be used to determine the meaning of claims. See *Pandrol USA, LP v. Airboss Railway Products, Inc.*, 320 F.3d 1354, 1363 n.1, 65 USPQ2d 1985, 1996 n.1 (Fed. Cir. 2003), *Hill-Rom Co. v. Kinetic Concepts, Inc.*, 209 F.3d 1337, 1341 n.1, 54 USPQ2d 1437, 1443 n.1 (Fed. Cir. 2000). Since the abstract may be relied upon to determine the scope of the claimed invention, examiners should review the abstract for compliance with 37 CFR 1.72(b) and point out defects noted to the applicant in the first Office action, or at the earliest point in the prosecution that the defect is noted, so that applicant may make the necessary changes to the abstract.

No examiner's amendment, whether formal or informal, may make substantive changes to the written portions of the specification, including the abstract, without first obtaining applicant's approval.<

The fact that applicant is entitled to an earlier U.S. effective filing date under 35 U.S.C. 120, 121, or 365(c) or 35 U.S.C. 119(e) is sometimes overlooked. To minimize this possibility, >and for the claim to the benefit of the earlier filing date to be proper,< the statement that, "This is a division (continuation, continuation-in-part) of Application Number -/---, filed --" should appear as the first sentence of the \*>specification<, or in an application data sheet of applications other than CPAs claiming priority under 35 U.S.C. 120, except in the case of design applications where it should appear as set forth in MPEP § 1504.20. The request for a CPA >(note that effective July 14, 2003, CPA practice has been eliminated as to utility and plant applications)< filed under 37 CFR 1.53(d) is itself the specific reference, as required by 35 U.S.C. 120 and 37 CFR 1.78(a)(2), to every application assigned the same application number identified in the request. In the case of an application filed under 37 CFR 1.53(b) as a division, continuation or continuation-in-part of a CPA, there would be only one reference to the series of applications assigned the same application number with the filing date cited being that of the original non-continued application. In applications claiming priority under 35 U.S.C. 119(e), a statement such as "This application claims the benefit of U.S. Provisional Application No. 60/ - --, filed - --" should appear as the first sentence of the \*>specification< or in an application data sheet. In addition, for an application which is claiming the benefit under 35 U.S.C. 120 of a prior application which in turn claims the benefit of a provisional application under 35 U.S.C. 119(e), a suitable reference would read, "This application is a continuation of U.S. Application No. 08/ - --, filed - --, now abandoned, which claims the benefit of U.S. Provisional Application No. 60/ - --, filed - --." The status (whether patented or abandoned) of the nonprovisional application(s) for which priority is claimed should also be included. Any such statements appearing elsewhere in the specification should be relocated or made in an application data sheet. \*\*

References cited as being of interest by examiners when passing an application to issue will not be supplied to applicant. The references will be cited as usual on form PTO-892, a copy of which will be attached to the Notice of Allowability, form PTOL-37.

Where an application is ready for issue except for a slight defect in the drawing not involving a change in structure, the examiner will prepare a letter indicating the change to be made and \*\*, if necessary, including a marked-up copy of the drawing showing the addition or alteration to be made. See MPEP § 608.02(w).

No other changes may be made by any person in any record of the U.S. Patent and Trademark office without the written approval of the >Director of the United States Patent and Trademark Office<.

In reviewing the application, all errors should be carefully noted. It is not necessary that the language be the best; it is, however, essential that it be clear in meaning, and free from errors in syntax. Any necessary examiner's amendment is usually made at the time an application is being prepared for issue by the examiner \*\*> and a < copy of any formal examiner's amendment is sent to >the< applicant \*\*> as an attachment to the Notice of Allowability, PTOL-37<.

Examiners will not cancel claims on the basis of an amendment which argues for certain claims and, alternatively, purports to authorize their cancellation by the examiner if other claims are allowed. See generally *In re Willingham*, 282 F.2d 353, 356, 127 USPQ 211, 215 (CCPA 1960).

In all instances, both before and after final rejection, in which an application is placed in condition for allowance as by an interview or amendment, applicant should be notified promptly of this fact by means of a Notice of Allowability (PTOL-37). See MPEP § 714.13 and § 1302.03.

If after reviewing, screening, or surveying an allowed application in the Office of Patent Quality \*>Assurance<, an error or omission of the type noted in items (A) through (I) under the second paragraph of this section is noted, the error or omission may be corrected by the \*\*>Review Quality Assurance Specialist< in the same manner as set forth in the second paragraph. Since all other obvious informalities may only be corrected by a formal examiner's amendment, if the Office of Patent Quality \*>Assurance< discovers any such informality, the \*\*>Review Quality Assurance Specialist< will return the application to the Technology Center (TC) personnel via the TC Director suggesting, as appropriate, specific changes for approval and correction by the examiner through the use of an examiner's amendment.

### **1302.04(a) Title of Invention**

Where the title of the invention is not specific to the invention as claimed, see MPEP § 606.01.

### **1302.04(b) Cancellation of Nonstatutory Claim**

When a case is otherwise in condition for allowance the examiner may cancel an obviously nonstatutory claim such as one to “A device substantially as shown and described.” Applicant should be notified of the cancellation of the claim by an examiner's amendment.

### **1302.04(c) Cancellation of Claims to Non-elected Invention**

See MPEP § 821.01 and § 821.02.

### **1302.04(d) Cancellation of Claim Lost in Interference**

See MPEP § 2363.03.

### **1302.04(e) Cancellation of Rejected Claims Following Appeal**

See MPEP § 1214.06, § 1215.03, and § 1215.04.

### **1302.04(f) Data of Copending Application Referred to Should Be Brought Up-to-Date [R-2]**

Where a patent application which is ready for issue refers by application number to a U.S. nonprovisional application which has matured into a patent, the examiner is authorized to enter the patent number without a formal examiner's amendment>, except where the application is an Image File Wrapper (IFW) application, in which case the amendment must be made by way of a formal examiner's amendment<. This entry should be in the following form: “, Patent No. ....”. \*>For applications with a paper file wrapper (non-IFW applications), the< entry is to be initialed and dated in the margin by the examiner to fix responsibility for the same. The entry and the initials should be in red ink.

If the nonprovisional application referred to has become abandoned, the entry “abandoned” should be made in red ink, and initialed and dated by the examiner in the margin >if the application is in a paper file wrapper (non-IFW application)<. A formal examiner’s amendment is not required >except where the application is an IFW application, in which case the amendment must be made by way of a formal examiner’s amendment<.

### **1302.04(g) Identification of Claims**

To identify a claim, a formal examiner’s amendment should refer to it by the original number and, if renumbered in the allowed application, also by the new number.

### **1302.05 Correction of Drawing [R-2]**

Where an application otherwise ready for issue requires correction of the drawing, the application is processed for allowance in the Technology Center and then forwarded to the Publishing Division. Any papers subsequently filed by the applicant, including corrected drawings, are forwarded to the Publishing Division in order to be matched with the application file. >If the drawings that are received are still not acceptable for publishing, the Publishing Division will mail a “Notice to File Corrected Application Papers,” giving the applicant a non-extendable period in which to file the corrected drawings.<

### **1302.05(a) Original Drawings Cannot Be Located [R-2]**

When the original drawings cannot be located and the application is otherwise in condition for allowance, no “Official Search” need be undertaken. A replacement drawing should be obtained from the Office of Initial Patent Examination’s records of the application as originally filed. If the reproduced drawings are not acceptable for publishing, applicant should be required to submit corrected drawings. An attachment to the Notice of Allowability should explain the problem and require the corrected drawings. >If such an attachment is not included with the Notice of Allowability, the Publishing Division will mail a “Notice to File Corrected Application Papers,” giving the applicant a non-extendable period in which to file the corrected drawings.<

### **1302.06 Prior Foreign Application**

See MPEP § 201.14(c) and § 202.03.

### **1302.07 Use of Retention Labels to Preserve Abandoned Companion Applications**

Related applications referred to in patent specifications are preserved from destruction by a retention label (form PTO-150) which is attached to the outside of the file wrapper. The technical support staff of the Technology Center (TC) prepares such a label for use as indicated below on each application (which has not become a patent) which is referred to in the specification, oath, or declaration of the application ready for allowance (or in any Office letter therein).

If the application referred to is:

(A) Still pending: Fill in and paste label on the face of the pending file wrapper in the space provided. Make no change in specification of the allowable application.

(B) Abandoned for failure to pay issue fee: If file has been forwarded to Files Repository, fill in label and send it to Files Repository for attachment to the wrapper. If not forwarded, treat the same as pending case.

(C) Abandoned: If file has been forwarded to the Files Repository, fill in label and send it to Files Repository for attachment to the wrapper. If not forwarded, treat the same as pending case. Add “abandoned” in red ink and initials to the allowable application.

(D) Already patented: No label is required. Insert patent number in specification if not already present. Formal examiner’s amendment not necessary if this is only change.

(E) In issue: Fill in label. Make no change in the specification of the allowable application.

Examiners are reminded that only one retention label is necessary. Thus, if a retention label is already present, it is sufficient to merely add “et al.” to the application number cited thereon.

### **1302.08 Interference Search**

Assuming that the application is ready for issue, the examiner makes an interference search and notes the

date and class and subclasses searched in the file wrapper. To do this, the examiner inspects all the pending prints and drawings (or all the claims if the invention is not susceptible of illustration) in the interference files of the relevant subclasses of the class in which the application is classified, and all other pertinent classes, whether in his or her Technology Center (TC) or elsewhere, in order to ascertain whether any other applicant is claiming substantially the same subject matter as is being allowed in the case in hand. When any of the drawings or claims shows such a condition to be likely, the corresponding file is reviewed.

Note also MPEP § 2301.01(b).

If the search does not disclose any interfering application, the examiner should prepare the application for issue.

An interference search may be required in TC Working Group 3640. Inspection of pertinent prints, drawings, brief cards, and applications in TC Working Group 3640 will be done on request by an examiner in TC Working Group 3640.

### **1302.09 \*\* >Classification, Print Figure, and Other Notations< [R-2]**

The examiner preparing the application for issue fills out, \*>using< black ink, the appropriate spaces on the face of the file wrapper >for applications in a paper file wrapper (non-Image File Wrapper (IFW) applications). If the application is an IFW application, the Issue Classification sheet is to be completed<.

ALLOWANCE AND ISSUE

1302.09

<b>Issue Classification</b> 	<b>Application No.</b> 09/17/00	<b>Applicant(s)</b> FETH ET AL
	<b>Examiner</b> Heather R Hamdon	<b>Art Unit</b> 2126

ISSUE CLASSIFICATION					
ORIGINAL			CROSS REFERENCE(S)		
CLASS	SUBCLASS	CLASS	SUBCLASS (ONE SUBCLASS PER BLOCK)		
INTERNATIONAL CLASSIFICATION					
(Assistant Examiner) (Date)		(Primary Examiner) (Date)		Total Claims Allowed: _____	
(Legal Instruments Examiner) (Date)				D. O. Print Claim(s)	D. O. Print Fig.

Claims renumbered in the same order as presented by applicant												CPA	T.D.	R.1.47	
Final	Original	Final	Original	Final	Original	Final	Original	Final	Original	Final	Original	Final	Original	Final	Original
211	241	271	301	331	361	391									
212	242	272	302	332	362	392									
213	243	273	303	333	363	393									
214	244	274	304	334	364	394									
215	245	275	305	335	365	395									
216	246	276	306	336	366	396									
217	247	277	307	337	367	397									
218	248	278	308	338	368	398									
219	249	279	309	339	369	399									
220	250	280	310	340	370	400									
221	251	281	311	341	371	401									
222	252	282	312	342	372	402									
223	253	283	313	343	373	403									
224	254	284	314	344	374	404									
225	255	285	315	345	375	405									
226	256	286	316	346	376	406									
227	257	287	317	347	377	407									
228	258	288	318	348	378	408									
229	259	289	319	349	379	409									
230	260	290	320	350	380	410									
231	261	291	321	351	381	411									
232	262	292	322	352	382	412									
233	263	293	323	353	383	413									
234	264	294	324	354	384	414									
235	265	295	325	355	385	415									
236	266	296	326	356	386	416									
237	267	297	327	357	387	417									
238	268	298	328	358	388	418									
239	269	299	329	359	389	419									
240	270	300	330	360	390	420									



To aid the Publishing Division and the printers, examiners should write the class and subclass on the outside of the file wrapper >for non-IFW applications< as carefully and legibly as possible. Each numeral should be distinct and any decimal point should be shown clearly and in its proper position.

Spaces are provided on the file wrapper label or PALM bib-data sheet for identifying data of a prior abandoned application for which the instant application is a substitute, and of parent application(s) and prior provisional and foreign application(s). Examiners must review the data regarding prior U.S. applications to make sure that the information is correct when preparing the application for issue. If any claim to >domestic< priority under 35 U.S.C. >119(e),< 120, 121, or 365(c) is added, deleted, and/or modified during prosecution of the application and such addition, deletion, and/or modification has been approved, the examiner must make sure that the information on the file wrapper label or PALM bib-data sheet and in the PALM data base are current and up to date. If the PALM system has not been updated, the application must be forwarded >(A)< to the Office of Initial Patent Examination Customer Corrections, accompanied by a completed Application Branch Data Base Routing Slip, >if the application has a file jacket label and is a 08/ or earlier series, or (B) to the Technology Center (TC) Legal Instrument Examiner,< with an explanation of the correction to be made >(e.g., with a marked-up copy of the bib-data sheet), if the application is an IFW application or is a 09/ or later series. A copy of the corrected bib-data sheet should be added to the file<. Examiners should also review the data regarding prior provisional and foreign applications for accuracy.

The class and subclass and the name of the examiner which are written in pencil on \*> any paper< file wrapper should correspond to the class and subclass in which the patent will issue and to the name of the examiner preparing the application for issue.

See MPEP § 202.02 for notation as to parent or prior U.S. application, including provisional application, to be placed on file wrapper.

See MPEP § 202.03 for notation as to foreign patent application to be placed on file wrapper.

See MPEP § 1302.13 for name of examiner.

Examiners, when preparing \* >a non-IFW< application for issue, are to record the number of the claim

selected for printing in the *Official Gazette* in the box labeled “PRINT CLAIM” on the face of the file wrapper>, or if the application is an IFW application, on the Issue Classification sheet<.

The claim or claims should be selected in accordance with the following instructions:

(A) The broadest claim should be selected.

(B) Examiners should ordinarily designate but one claim on each invention, although when a plurality of inventions are claimed in an application, additional claims up to a maximum of five may be designated for publication.

(C) A dependent claim should not be selected unless the independent claim on which it depends is also printed. In the case where a multiple dependent claim is selected, the entire chain of claims for one embodiment should be listed.

(D) In reissue applications, the broadest claim with changes or the broadest additional reissue claim should be selected for printing.

When recording this information in the box provided, the following items should be kept in mind:

(A) Write the claim number clearly in black ink.

(B) If multiple claims are selected, the claim numbers should be separated by commas.

(C) The claim designated must be referred to by using the renumbered patent claim number rather than the original application claim number.

Examiners, when preparing \*>a non-IFW< application for issue, are to record the figure selected for printing in the *Official Gazette* in the box labeled “**Print Fig.**” on the face of the file wrapper>, or if the application is an IFW application, on the Issue Classification sheet<. It is no longer necessary for drawings to be stamped approved or for the examiner to write this information in the space provided by the Draftsperson’s stamp on the margin of the sheet of drawing.

Ordinarily a single figure is selected for printing. This figure should be consistent with the claim to be printed in the *Official Gazette*. The figure to be printed in the *Official Gazette* must not be one that is labeled “prior art.” If there is no figure illustrative of or helpful in understanding the claimed invention, no figure need be selected. “None” may be written in the box labeled “**Print Fig.**” on the face of the file

wrapper>, or if the application is an IFW application, on the Issue Classification sheet<.

### 1302.10 Issue Classification Notations [R-2]

See MPEP § 903.07, § 903.07(b) and § 903.09 for notations to be applied in the issuing classification boxes on the face of the file wrapper, or on the blue issue classification slip for series 08/ and earlier applications>, or if the application is an IFW application, on the Issue Classification sheet<.

In all reissue applications, the number of the original patent which is being reissued should be placed in the box provided therefor below the box for the applicant's name.

### 1302.11 Reference to Assignment Division

The practice of referring certain applications to the Assignment Division when passing them to issue is no longer followed. See MPEP § 303.

### 1302.12 Listing of References [R-2]

All references which have been cited by the examiner during the prosecution, including those appearing in Board of Patent Appeals and Interferences decisions or listed in the reissue oath, must be listed on either a form PTO-892 or \* >on an Information Disclosure Statement (PTO/SB/08, old PTO-1449) and initialed<. All such reference citations will be printed in the patent. References listed by a patent examiner on a "Notice of References Cited," form PTO-892, will be indicated with an asterisk in the "References Cited" section of the front page of a patent document. An example of how the "References Cited" section of the patent will appear is as follows:

#### [56] References Cited

##### U.S. PATENT DOCUMENTS

2,234,192 * 7/1955 Greene.....	75/507
4,991,048 8/1990 Larkin.....	206/207
5,000,186 12/1991 Amis.....	267/340
5,000,993 * 12/1991 Thomas et al.....	75/507

##### FOREIGN PATENT DOCUMENTS

9500000 * 6/1995 Belgium.....	75/507
200000 * 6/1990 Japan .....	75/507
9400000 9/1994 United Kingdom.	

### OTHER PUBLICATIONS

Hill, "Ferrous Precipitation," *Journal of the American Defenestration Association*, Jan. 1989, Pages 34–46.\* Clymerhill-Irons, "Ferrous Ascension for the Eighties," *Proceedings of the International Ferrous Ascension Society*, Jan.– Mar. 1979, Pages 1111–1163.

\* cited by examiner

Indication of whether a reference was listed by the examiner will be helpful in compiling statistical data related to prior art submissions so that the USPTO can better consider whether changes are required to the rules governing prior art statements.

Indication of a reference with an asterisk should not be considered to reflect any significance other than that the reference was listed on a "Notice of References Cited," form PTO-892. When an examiner lists references on a form PTO-892, the examiner lists references that are relied upon in a prior art rejection or mentioned as pertinent. See MPEP § 707.05(c). The examiner does not list references which were previously cited by the applicant (and initialed by an examiner) on an Information Disclosure Statement, for example, on a \*>PTO/SB/08<. See MPEP § 609 and § 707.05(b), (c) and (d). No distinction will be made in the "References Cited" section for other sources of references. Thus, references cited in a protest, by an attorney or agent not acting in a representative capacity but on behalf of a single inventor, and by the applicant will not be distinguished.

At time of allowance, the examiner may cite pertinent art in an examiner's amendment or statement of reasons for allowance. Such pertinent art should be listed as usual on form PTO-892, a copy of which is attached to the Notice of Allowability form PTOL-37. Such pertinent art, other than foreign patent documents and nonpatent literature, is not sent to the applicant. Such citation of art is important in the case of continuing applications where significant prior art is often of record in the parent case. In the rare instance where no art is cited in a continuation application, all the references cited during the prosecution of the parent application will be listed at allowance for printing in the patent. See MPEP § 707.05 and § 707.05(a).

When preparing an application for allowance, the technical support staff will verify that there is at least one list of references (PTO-892 or \*>PTO/SB/08 (oldPTO-1449)<) in the application. >The technical

support staff will also verify that each reference on the Information Disclosure Statement has either been initialed by the examiner or lined-through by the examiner. All lists of references are maintained in the center section of any paper file wrapper.

In the first action after termination of an interference, the examiner should make of record in each application all references not already of record which were pertinent to any preliminary motions and which were discussed in the decision on motion.

In any application, otherwise ready for issue, in which an erroneous citation has not been formally corrected in an official paper, the examiner is directed to correct the citation by an examiner's amendment. See MPEP § 707.05(g).

Any new reference cited when the application is in issue, under the practice of MPEP § 1308.01, should be added by way of a PTO-892 or PTO/SB/08.

All copies of references placed in the file wrapper during prosecution should be retained therein when the allowed application is forwarded to the Publishing Division.

### 1302.13 Signing [R-2]

The primary examiner and the assistant examiner involved in the allowance of an application will print or stamp their names on the file wrapper in the appropriate boxes, or if the application is an IFW application, type their names on the Issue Classification sheet. The assistant examiner shall place his or her initials after his or her typed, printed, or stamped name. The primary examiner will place his or her signature in the appropriate box on the file wrapper, or if the application is an IFW application, on the Issue Classification sheet so that the typed, stamped, or printed name can still be easily read. A primary examiner who prepares an application for issue types, prints, or stamps his or her name and signs the file wrapper only in the "Primary Examiner" box, or if the application is an IFW application, on the Issue Classification sheet. A line should be drawn through the "Assistant Examiner" box to make it clear that the absence of a name in the box was not an oversight.

Only the names of the primary examiner and the assistant examiner appearing on the face of the application file wrapper or the Issue Classification Sheet will be listed in the printed patent.

### 1302.14 Reasons for Allowance [R-2]

37 CFR 1.104. Nature of examination.

\*\*\*\*\*

(e) *Reasons for allowance.* If the examiner believes that the record of the prosecution as a whole does not make clear his or her reasons for allowing a claim or claims, the examiner may set forth such reasoning. The reasons shall be incorporated into an Office action rejecting other claims of the application or patent under reexamination or be the subject of a separate communication to the applicant or patent owner. The applicant or patent owner may file a statement commenting on the reasons for allowance within such time as may be specified by the examiner. Failure by the examiner to respond to any statement commenting on reasons for allowance does not give rise to any implication.

#### REASONS FOR ALLOWANCE

One of the primary purposes of 37 CFR 1.104(e) is to improve the quality and reliability of issued patents by providing a complete file history which should clearly reflect, as much as is reasonably possible, the reasons why the application was allowed. Such information facilitates evaluation of the scope and strength of a patent by the patentee and the public and may help avoid or simplify litigation of a patent.

The practice of stating the reasons for allowance is not new, and the rule merely formalizes the examiner's existing authority to do so and provides applicants or patent owners an opportunity to comment upon any such statement of the examiner.

It should be noted that the setting forth of reasons for allowance is not mandatory on the examiner's part. However, in meeting the need for the application file history to speak for itself, it is incumbent upon the examiner in exercising his or her responsibility to the public, to see that the file history is as complete as is reasonably possible.

When an application is finally acted upon and allowed, the examiner is expected to determine, at the same time, whether the reasons why the application is being allowed are evident from the record.

Prior to allowance, the examiner may also specify allowable subject matter and provide reasons for indicating such allowable subject matter in an Office communication.

In determining whether reasons for allowance should be recorded, the primary consideration lies in the first sentence of 37 CFR 1.104(e) which states:

If the examiner believes that the record of the prosecution *as a whole* does not make clear his or her reasons for allowing a claim or claims, the examiner may set forth such reasoning. (Emphasis added).

In most cases, the examiner's actions and the applicant's replies make evident the reasons for allowance, satisfying the "record as a whole" proviso of the rule. This is particularly true when applicant fully complies with 37 CFR 1.111 (b) and (c) and 37 CFR 1.133(b). Thus, where the examiner's actions clearly point out the reasons for rejection and the applicant's reply explicitly presents reasons why claims are patentable over the reference, the reasons for allowance are in all probability evident from the record and **no** statement should be necessary. Conversely, where the record is not explicit as to reasons, but allowance is in order, then a logical extension of 37 CFR 1.111 and 1.133 would dictate that the examiner should make reasons of record and such reasons should be specific.

Where specific reasons are recorded by the examiner, care must be taken to ensure that statements of reasons for allowance (or indication of allowable subject matter) are accurate, precise, and do not place unwarranted interpretations, whether broad or narrow, upon the claims. The examiner should keep in mind the possible misinterpretations of his or her statement that may be made and its possible \* effects. Each statement should include at least (1) the major difference in the claims not found in the prior art of record, and (2) the reasons why that difference is considered to define patentably over the prior art if either of these reasons for allowance is not clear in the record. The statement is not intended to necessarily state all the reasons for allowance or all the details why claims are allowed and should not be written to specifically or impliedly state that all the reasons for allowance are set forth. Where the examiner has a large number of reasons for allowing a claim, it may suffice to state only the major or important reasons, being careful to so couch the statement. For example, a statement might start: "The primary reason for the allowance of the claims is the inclusion of the limitation, in all the claims which is not found in the prior art references," with further amplification as necessary.

Stock paragraphs with meaningless or uninformative statements of the reasons for the allowance should not be used. >It is improper to use a statement of reasons for allowance to attempt to narrow a claim

by providing a special definition to a claim limitation which is argued by applicant, but not supported by a special definition in the description in cases where the ordinary meaning of the term in the prior art demonstrates that the claim remains unpatentable for the reasons of record, and where such claim narrowing is only tangential to patentability. Cf. *Festo Corp. v. Shoketsu Kinzoku Kogyo Kabushiki Co.*, 535 U.S. 722, 741, 62 USPQ2d 1705, 1714 (2002).< The statement of reasons for allowance by the examiner is intended to provide information equivalent to that contained in a file in which the examiner's Office actions and the applicant's replies make evident the examiner's reasons for allowing claims.

Examiners are urged to carefully carry out their responsibilities to see that the application file contains a complete and accurate picture of the Office's consideration of the patentability of the application.

Under the rule, the examiner must make a judgment of the individual record to determine whether or not reasons for allowance should be set out in that record. These guidelines, then, are intended to aid the examiner in making that judgment. They comprise illustrative examples as to applicability and appropriate content. They are not intended to be exhaustive.

#### **EXAMPLES OF WHEN IT IS LIKELY THAT A STATEMENT SHOULD BE ADDED TO THE RECORD**

(A) Claims are allowed on the basis of one (or some) of a number of arguments and/or affidavits presented, and a statement is necessary to identify which of these were persuasive, for example:

(1) When the arguments are presented in an appeal brief.

(2) When the arguments are presented in an ordinary reply, with or without amendment of claims.

(3) When both an affidavit under 37 CFR 1.131 and arguments concerning rejections under 35 U.S.C. 102 and 103 are presented.

(B) First action issue:

(1) Of a noncontinuing application, wherein the claims are very close to the cited prior art and the differences have not been discussed elsewhere.

(2) Of a continuing application, wherein reasons for allowance are not apparent from the record in the parent case or clear from preliminary filed matters.

(C) Withdrawal of a rejection for reasons not suggested by applicant, for example:

(1) As a result of an appeal conference.

(2) When applicant's arguments have been misdirected or are not persuasive alone and the examiner comes to realize that a more cogent argument is available.

(3) When claims are amended to avoid a rejection under 35 U.S.C. 102, but arguments (if any) fail to address the question of obviousness.

(D) Allowance after remand from the Board of Patent Appeals and Interferences.

(E) Allowance coincident with the citation of newly found references that are very close to the claims, but claims are considered patentable thereover:

(1) When reference is found and cited (but not argued) by applicant.

(2) When reference is found and cited by examiner.

(F) Where the reasons for allowance *are* of record but, in the examiner's judgment, are unclear (e.g., spread throughout the file history) so that an unreasonable effort would be required to collect them.

(G) Allowance based on a claim interpretation which might not be readily apparent, for example:

(1) Article claims in which method limitations impart patentability.

(2) Method claims in which article limitations impart patentability.

(3) Claim is so drafted that "nonanalogous" art is not applicable.

(4) Preamble or functional language "breathes life" into claim.

(H) Allowance following decision by the United States Court of Appeals for the Federal Circuit or District Court of the District of Columbia.

The reasons for allowance should refer to and incorporate the briefs and the court decision.

>

(I) Where the claims are considered patentable over the X and/or Y references cited in a search report of a corresponding PCT application and the reasons for allowance are not apparent from the record.<

## EXAMPLES OF STATEMENTS OF SUITABLE CONTENT

(A) The primary reason for allowance of the claims is the inclusion of .03 to .05 percent nickel in all of the claims. Applicant's second affidavit in example 5 shows unexpected results from this restricted range.

(B) During two telephonic interviews with applicant's attorney, Mr..... on 5/6 and 5/10/77, the examiner stated that applicant's remarks about the placement of the primary teaching's grid member were persuasive, but he pointed out that applicant did not claim the member as being within the reactor. Thus, an amendment doing such was agreed to.

(C) The \* >claims in the< application \* >are< deemed to be directed to a nonobvious improvement over the invention patented in Pat. No. 3,953,224. The \*\*>claims comprise< baffle means 12 whose effective length in the extraction tower may be varied so as to optimize and to control the extraction process.

(D) Upon reconsideration, this application has been awarded the effective filing date of application number -/---. Thus the rejection under 35 U.S.C. 102(d) and 103 over Belgium Patent No. 757,246 is withdrawn.

(E) The specific limitation as to the pressure used during compression was agreed to during the telephone interview with applicants' attorney. During said interview, it was noted that applicants contended in their amendment that a process of the combined applied teachings could not result in a successful article within a particular pressure range (see page 3, bottom, of applicant's amendment). The examiner agreed and allowed the application after incorporating the pressure range into the claim.

(F) In the examiner's opinion, it would not have been obvious to a person of ordinary skill in the art first to eliminate one of top members 4, second to eliminate plate 3, third to attach remaining member 4 directly to tube 2 and finally to substitute this modified handle for the handle 20 of Nania (see Fig. 1) especially in view of applicant's use of term "consisting."

(G) The application is allowable for the reasons set forth on page -- of the decision of the Court of Appeals for the Federal Circuit, which is hereby incorporated by reference. As noted therein, and as argued on page -- of Appellant's brief, the claimed

invention requires a one piece tubular member whereas the closest prior art requires a multiple piece assembly which does not teach or suggest the claimed invention.

### EXAMPLES OF STATEMENTS THAT ARE NOT SUITABLE AS TO CONTENT

(A) The 3-roll press couple has an upper roll 36 which is swingably adjustable to vary the pressure selectively against either of the two lower rolls. (NOTE: The significance of this statement may not be clear if no further explanation is given.)

(B) The main reasons for allowance of these claims are applicant's remarks in the appeal brief and an agreement reached in the appeal conference.

(C) The instant composition is a precursor in the manufacture of melamine resins. A thorough search of the prior art did not bring forth any composition which corresponds to the instant composition. The examiner in the art also did not know of any art which could be used against the instant composition.

(D) Claims 1-6 have been allowed because they are believed to be both novel and nonobvious.

The examiner should *not* include in his or her statement any matter which does not relate directly to the reasons for allowance. For example:

(E) Claims 1 and 2 are allowed because they are patentable over the prior art. If applicants are aware of better art than that which has been cited, they are required to call such to the attention of the examiner.

(F) The reference Jones discloses and claims an invention similar to applicant's. However, a comparison of the claims, as set forth below, demonstrates the conclusion that the inventions are noninterfering.

Most instances when the examiner finds a need to place in the file a statement of the reasons for allowing a claim or claims will come at the time of allowance. In such cases, the examiner should (a) check the appropriate box on the form PTOL-37 and (b) attach thereto a paper containing the examiner's statement of reasons for allowance. Such a statement should be typewritten. The paper should identify the application number and be clearly labeled "Statement of Reasons for Allowance." It should also specify that comments may be filed by the applicant on the statement and should preferably be submitted with the payment of the issue fee so as not to delay processing of the appli-

cation and in any event no later than payment of the issue fee.

Form paragraph 13.03 may be used for this purpose.

\*\*>

#### ¶ 13.03 Reasons for Allowance

The following is an examiner's statement of reasons for allowance: [1]

Any comments considered necessary by applicant must be submitted no later than the payment of the issue fee and, to avoid processing delays, should preferably accompany the issue fee. Such submissions should be clearly labeled "Comments on Statement of Reasons for Allowance."

#### Examiner Note:

1. Do not use this form paragraph in reexamination proceedings, see form paragraph 22.16.
2. In bracket 1, provide a detailed statement of the reason(s) certain claim(s) have been indicated as being allowable or as containing allowable subject matter.

<

A statement may be sent to applicant with other communications, where appropriate, but should be clearly labeled as a "Statement of Reasons for Allowance" and contain the data indicated above.

Form paragraph 13.13.01 may be used to specify the reasons for indicating allowable subject matter in a communication prior to allowance.

#### ¶ 13.03.01 Reasons for Indication of Allowable Subject Matter

The following is a statement of reasons for the indication of allowable subject matter: [1]

#### Examiner Note:

1. This form paragraph is for use in an Office action prior to allowance of the application. Use form paragraph 13.03 in the Notice of Allowability.
2. In bracket 1, provide a detailed statement of the reason(s) certain claim(s) have been indicated as being allowable or as containing allowable subject matter.

### APPLICANT'S COMMENTS ON THE REASONS FOR ALLOWANCE

The examiner's statement of reasons for allowance is an important source of prosecution file history. See *Zenith Labs., Inc. v. Bristol-Myers Squibb Co.*, 19 F.3d 1418, 30 USPQ2d 1285 (Fed. Cir. 1996). \*\*>The examiner's statement of reasons for allowance is the personal opinion of the examiner as to why the claims are allowable. The examiner's statement should not create an *estoppel*. Only applicant's state-

ments should create an *estoppel*. The failure of applicant to comment on the examiner's statement of reasons for allowance should not be treated as acquiescence to the examiner's statement. Any inferences or presumption are to be determined on a case-by-case basis by a court reviewing the patent, the USPTO examining the patent in a reissue application or a reexamination proceeding, the Board of Patent Appeals and Interferences reviewing the patent in an interference proceeding, etc. Applicant may set forth his or her position if he or she disagrees with the examiner's reasons for allowance.

Comments filed by the applicant on the examiner's statement of reasons for allowance, should preferably be submitted no later than the payment of the issue fee, to avoid processing delays. Such submissions should be clearly labeled "Comments on Statement of Reasons for Allowance." Comments will be entered in the application file by the Office of Publication with an appropriate notation on the "Contents" list on the file wrapper.

The application file generally will not be returned to the examiner after the entry of such comments made by applicant on the examiner's statement of reasons for allowance. Therefore, the absence of an examiner's response to applicant's comments does not mean that the examiner agrees with or acquiesces in the reasoning of such comments. See 37 CFR 1.104(e). While the examiner may review and comment upon such a submission, the examiner has no obligation to do so.

### 1303 Notice of Allowance [R-2]

37 CFR 1.311. *Notice of Allowance.*

\*\*>

(a) If, on examination, it appears that the applicant is entitled to a patent under the law, a notice of allowance will be sent to the applicant at the correspondence address indicated in § 1.33. The notice of allowance shall specify a sum constituting the issue fee which must be paid within three months from the date of mailing of the notice of allowance to avoid abandonment of the application. The sum specified in the notice of allowance may also include the publication fee, in which case the issue fee and publication fee (§ 1.211(e)) must both be paid within three months from the date of mailing of the notice of allowance to avoid abandonment of the application. This three-month period is not extendable.<

(b) An authorization to charge the issue fee or other post-allowance fees set forth in § 1.18 to a deposit account may be filed in an individual application only after mailing of the notice of allowance. The submission of either of the following after the

mailing of a notice of allowance will operate as a request to charge the correct issue fee to any deposit account identified in a previously filed authorization to charge fees:

- (1) An incorrect issue fee; or
- (2) A completed Office-provided issue fee transmittal form (where no issue fee has been submitted).

A Notice of Allowance is prepared and mailed, and the mailing date appearing thereon is recorded on the >paper or image< file wrapper >table of contents<.

\*\*>If< an application is subject to publication under 37 CFR 1.211, the Notice of Allowance will require both the issue fee and the publication fee. See 37 CFR 1.211(e). \*\*>The Notice of Allowance and Issue Fee Due form (PTOL-85) has been revised and the revised form is entitled "Notice of Allowance and Fee(s) Due." Revision of the form was necessary to include the amount of any required publication fee, as provided in 37 CFR 1.211(e) and 1.311, and to more clearly communicate the amount of any patent term extension or adjustment earned under 35 U.S.C. 154(b). As revised, the PTOL-85 form is three pages long, with all three pages being mailed to the applicant and a duplicate being retained in the application file. The first two pages of the revised form include an indication that the publication fee is due, if the application was subject to publication and the publication fee has not already been paid. Part B of the revised form (PTOL-85B) should be returned to the Office with the payment of the issue fee. The PTOL-85B is labeled at the bottom of the form "TRANSMIT THIS FORM WITH FEE(S)." Applicants are reminded to transmit an extra copy of the PTOL-85B when payment of the issue fee is by way of authorization to debit a Deposit Account. See MPEP § 509.01.

There are three versions of page three of the revised PTOL-85 form, depending upon the filing date of the application:

(A) For applications filed before June 8, 1995, page three will state that "This application was filed prior to June 8, 1995, thus no Patent Term Extension or Adjustment applies." Utility and plant applications filed before June 8, 1995 are eligible for a 17 year term and thus are not eligible for patent term extension or adjustment under 35 U.S.C. 154(b).

(B) For applications filed on or after June 8, 1995 and before May 29, 2000, page three will state that "The patent term extension is \_ days. Any patent to issue from the above identified application will

include an indication of the \_ extension on the front page. If a continued prosecution application (CPA) was filed in the above identified application, the filing date that determines patent term extension is the filing date of the most recent CPA.” Utility and plant applications filed on or after June 8, 1995 and before May 29, 2000 may be eligible for patent term extension. See 35 U.S.C. 154(b), effective June 8, 1995, and 37 CFR 1.701.

(C) For applications filed on or after May 29, 2000, page three will state that “The patent term adjustment to date is \_ days. If the issue fee is paid on a date that is three months after the mailing date of this notice, and the patent issues on the Tuesday before the date that is 28 weeks (six and a half

months) after the mailing date of this notice, the term adjustment will be \_ days. If a continued prosecution application (CPA) was filed in the above identified application, the filing date that determines patent term extension is the filing date of the most recent CPA.” Utility and plant applications filed on or after May 29, 2000 may be eligible for patent term adjustment. See 35 U.S.C. 154(b), effective May 29, 2000, and 37 CFR 1.702 - 1.705, especially 37 CFR 1.705(a).

For more information about eighteen month publication, publication fees, and patent term adjustment, visit the USPTO Internet web site at [www.uspto.gov](http://www.uspto.gov).<



\*\*>



UNITED STATES PATENT AND TRADEMARK OFFICE

UNITED STATES DEPARTMENT OF COMMERCE  
 United States Patent and Trademark Office  
 Address: COMMISSIONER FOR PATENTS  
 P.O. Box 1450  
 Alexandria, Virginia 22313-1450  
 www.uspto.gov

**NOTICE OF ALLOWANCE AND FEE(S) DUE**

EXAMINER
----------

ART UNIT	PAPER NUMBER
----------	--------------

DATE MAILED:

APPLICATION NO.	FILING DATE	FIRST NAMED INVENTOR	ATTORNEY DOCKET NO.	CONFIRMATION NO.
-----------------	-------------	----------------------	---------------------	------------------

TITLE OF INVENTION:

APPLN. TYPE	SMALL ENTITY	ISSUE FEE	PUBLICATION FEE	TOTAL FEE(S) DUE	DATE DUE
-------------	--------------	-----------	-----------------	------------------	----------

**THE APPLICATION IDENTIFIED ABOVE HAS BEEN EXAMINED AND IS ALLOWED FOR ISSUANCE AS A PATENT. PROSECUTION ON THE MERITS IS CLOSED. THIS NOTICE OF ALLOWANCE IS NOT A GRANT OF PATENT RIGHTS. THIS APPLICATION IS SUBJECT TO WITHDRAWAL FROM ISSUE AT THE INITIATIVE OF THE OFFICE OR UPON PETITION BY THE APPLICANT. SEE 37 CFR 1.313 AND MPEP 1308.**

**THE ISSUE FEE AND PUBLICATION FEE (IF REQUIRED) MUST BE PAID WITHIN THREE MONTHS FROM THE MAILING DATE OF THIS NOTICE OR THIS APPLICATION SHALL BE REGARDED AS ABANDONED. THIS STATUTORY PERIOD CANNOT BE EXTENDED. SEE 35 U.S.C. 151. THE ISSUE FEE DUE INDICATED ABOVE REFLECTS A CREDIT FOR ANY PREVIOUSLY PAID ISSUE FEE APPLIED IN THIS APPLICATION. THE PTOL-85B (OR AN EQUIVALENT) MUST BE RETURNED WITHIN THIS PERIOD EVEN IF NO FEE IS DUE OR THE APPLICATION WILL BE REGARDED AS ABANDONED.**

**HOW TO REPLY TO THIS NOTICE:**

I. Review the SMALL ENTITY status shown above.

If the SMALL ENTITY is shown as YES, verify your current SMALL ENTITY status:

A. If the status is the same, pay the TOTAL FEE(S) DUE shown above.

B. If the status is changed, pay the PUBLICATION FEE (if required) and twice the amount of the ISSUE FEE shown above and notify the United States Patent and Trademark Office of the change in status, or

If the SMALL ENTITY is shown as NO:

A. Pay TOTAL FEE(S) DUE shown above, or

B. If applicant claimed SMALL ENTITY status before, or is now claiming SMALL ENTITY status, check the box below and enclose the PUBLICATION FEE and 1/2 the ISSUE FEE shown above.

Applicant claims SMALL ENTITY status.  
 See 37 CFR 1.27.

II. PART B - FEE(S) TRANSMITTAL should be completed and returned to the United States Patent and Trademark Office (USPTO) with your ISSUE FEE and PUBLICATION FEE (if required). Even if the fee(s) have already been paid, Part B - Fee(s) Transmittal should be completed and returned. If you are charging the fee(s) to your deposit account, section "4b" of Part B - Fee(s) Transmittal should be completed and an extra copy of the form should be submitted.

III. All communications regarding this application must give the application number. Please direct all communications prior to issuance to Mail Stop ISSUE FEE unless advised to the contrary.

**IMPORTANT REMINDER: Utility patents issuing on applications filed on or after Dec. 12, 1980 may require payment of maintenance fees. It is patentee's responsibility to ensure timely payment of maintenance fees when due.**

**PART B - FEE(S) TRANSMITTAL**

**Complete and send this form, together with applicable fee(s), to: Mail** **Mail Stop ISSUE FEE**  
**Commissioner for Patents**  
**P.O. Box 1450**  
**Alexandria, Virginia 22313-1450**  
**or Fax** **(703) 746-4000**

INSTRUCTIONS: This form should be used for transmitting the ISSUE FEE and PUBLICATION FEE (if required). Blocks 1 through 4 should be completed where appropriate. All further correspondence including the Patent, advance orders and notification of maintenance fees will be mailed to the current correspondence address as indicated unless corrected below or directed otherwise in Block 1, by (a) specifying a new correspondence address; and/or (b) indicating a separate "FEE ADDRESS" for maintenance fee notifications.

CURRENT CORRESPONDENCE ADDRESS (Note: Use Block 1 for any change of address)

Note: A certificate of mailing can only be used for domestic mailings of the Fee(s) Transmittal. This certificate cannot be used for any other accompanying papers. Each additional paper, such as an assignment or formal drawing, must have its own certificate of mailing or transmission.

**Certificate of Mailing or Transmission**

I hereby certify that this Fee(s) Transmittal is being deposited with the United States Postal Service with sufficient postage for first class mail in an envelope addressed to the Mail Stop ISSUE FEE address above, or being facsimile transmitted to the USPTO (703) 746-4000, on the date indicated below.

(Depositor's name)
(Signature)
(Date)

APPLICATION NO.	FILING DATE	FIRST NAMED INVENTOR	ATTORNEY DOCKET NO.	CONFIRMATION NO.
-----------------	-------------	----------------------	---------------------	------------------

TITLE OF INVENTION:

APPLN. TYPE	SMALL ENTITY	ISSUE FEE	PUBLICATION FEE	TOTAL FEE(S) DUE	DATE DUE
EXAMINER	ART UNIT	CLASS-SUBCLASS			

<p>1. Change of correspondence address or indication of "Fee Address" (37 CFR 1.363).</p> <p><input type="checkbox"/> Change of correspondence address (or Change of Correspondence Address form PTO/SB/122) attached.</p> <p><input type="checkbox"/> "Fee Address" indication (or "Fee Address" Indication form PTO/SB/47; Rev 03-02 or more recent) attached. Use of a Customer Number is required.</p>	<p>2. For printing on the patent front page, list (1) the names of up to 3 registered patent attorneys or agents OR, alternatively, (2) the name of a single firm (having as a member a registered attorney or agent) and the names of up to 2 registered patent attorneys or agents. If no name is listed, no name will be printed.</p> <p>1 _____</p> <p>2 _____</p> <p>3 _____</p>
--	---

3. ASSIGNEE NAME AND RESIDENCE DATA TO BE PRINTED ON THE PATENT (print or type)

PLEASE NOTE: Unless an assignee is identified below, no assignee data will appear on the patent. Inclusion of assignee data is only appropriate when an assignment has been previously submitted to the USPTO or is being submitted under separate cover. Completion of this form is NOT a substitute for filing an assignment.

(A) NAME OF ASSIGNEE \_\_\_\_\_ (B) RESIDENCE: (CITY and STATE OR COUNTRY) \_\_\_\_\_

Please check the appropriate assignee category or categories (will not be printed on the patent):  individual  corporation or other private group entity  government

<p>4a. The following fee(s) are enclosed:</p> <p><input type="checkbox"/> Issue Fee</p> <p><input type="checkbox"/> Publication Fee (No small entity discount permitted)</p> <p><input type="checkbox"/> Advance Order - # of Copies _____</p>	<p>4b. Payment of Fee(s):</p> <p><input type="checkbox"/> A check in the amount of the fee(s) is enclosed.</p> <p><input type="checkbox"/> Payment by credit card. Form PTO-2038 is attached.</p> <p><input type="checkbox"/> The Director is hereby authorized by charge the required fee(s), or credit any overpayment, to Deposit Account Number _____ (enclose an extra copy of this form).</p>
--	---

The Director of the USPTO is requested to apply the Issue Fee and Publication Fee (if any) or to re-apply any previously paid issue fee to the application identified above.

(Authorized Signature) \_\_\_\_\_ (Date) \_\_\_\_\_

NOTE: The Issue Fee and Publication Fee (if required) will not be accepted from anyone other than the applicant, a registered attorney or agent, or the assignee or other party in interest as shown by the records of the United States Patent and Trademark Office.

This collection of information is required by 37 CFR 1.311. The information is required to obtain or retain a benefit by the public which is to file (and by the USPTO to process) an application. Confidentiality is governed by 35 U.S.C. 122 and 37 CFR 1.14. This collection is estimated to take 12 minutes to complete, including gathering, preparing, and submitting the completed application form to the USPTO. Time will vary depending upon the individual case. Any comments on the amount of time you require to complete this form and/or suggestions for reducing this burden, should be sent to the Chief Information Officer, U.S. Patent and Trademark Office, U.S. Department of Commerce, P.O. Box 1450, Alexandria, Virginia 22313-1450. DO NOT SEND FEES OR COMPLETED FORMS TO THIS ADDRESS. SEND TO: Commissioner for Patents, P.O. Box 1450, Alexandria, Virginia 22313-1450.

Under the Paperwork Reduction Act of 1995, no persons are required to respond to a collection of information unless it displays a valid OMB control number.

TRANSMIT THIS FORM WITH FEE(S)



UNITED STATES PATENT AND TRADEMARK OFFICE

UNITED STATES DEPARTMENT OF COMMERCE  
United States Patent and Trademark Office  
Address: COMMISSIONER FOR PATENTS  
P.O. Box 1450  
Alexandria, Virginia 22313-1450  
www.uspto.gov

APPLICATION NO.	FILING DATE	FIRST NAMED INVENTOR	ATTORNEY DOCKET NO.	CONFIRMATION NO.
-----------------	-------------	----------------------	---------------------	------------------

EXAMINER

ART UNIT	PAPER NUMBER
----------	--------------

DATE MAILED:

**Determination of Patent Term Extension or Adjustment under 35 U.S.C. 154 (b)**  
(application filed prior to June 8, 1995)

This patent application was filed prior to June 8, 1995, thus no Patent Term Extension or Adjustment applies.

Any questions regarding the patent term extension or adjustment determination should be directed to the Office of Patent Legal Administration at (703)305-1383.



UNITED STATES PATENT AND TRADEMARK OFFICE

UNITED STATES DEPARTMENT OF COMMERCE  
 United States Patent and Trademark Office  
 Address: COMMISSIONER FOR PATENTS  
 P.O. Box 1450  
 Alexandria, Virginia 22313-1450  
 www.uspto.gov

APPLICATION NO.	FILING DATE	FIRST NAMED INVENTOR	ATTORNEY DOCKET NO.	CONFIRMATION NO.
-----------------	-------------	----------------------	---------------------	------------------

EXAMINER
----------

ART UNIT	PAPER NUMBER
----------	--------------

DATE MAILED:

**Determination of Patent Term Extension under 35 U.S.C. 154 (b)**  
 (application filed after June 7, 1995 but prior to May 29, 2000)

The patent term extension is “\_\_\_\_” days. Any patent to issue from the above identified application will include an indication of the “\_\_\_\_” day extension on the front page.

If a continued prosecution application (CPA) was filed in the above- identified application, the filing date that determines patent term extension is the filing date of the most recent CPA.

Applicant will be able to obtain more detailed information by accessing the Patent Application Information Retrieval (PAIR) system. (<http://pair.uspto.gov>)

Any questions regarding the patent term extension or adjustment determination should be directed to the Office of Patent Legal Administration at (703) 305-1383.

PTOL-85C (REV. 06-03) Approved for use through 04/30/2004.



UNITED STATES PATENT AND TRADEMARK OFFICE

UNITED STATES DEPARTMENT OF COMMERCE  
 United States Patent and Trademark Office  
 Address: COMMISSIONER FOR PATENTS  
 P.O. Box 1450  
 Alexandria, Virginia 22313-1450  
 www.uspto.gov

APPLICATION NO.	FILING DATE	FIRST NAMED INVENTOR	ATTORNEY DOCKET NO.	CONFIRMATION NO.
-----------------	-------------	----------------------	---------------------	------------------

EXAMINER

ART UNIT      PAPER NUMBER

DATE MAILED:

**Determination of Patent Term Adjustment under 35 U.S.C. 154 (b)**  
 (application filed on or after May 29, 2000)

The Patent Term Adjustment to date is “ \_\_\_\_ ” day(s). If the issue fee is paid on the date that is three months after the mailing date of this notice and the patent issues on the Tuesday before the date that is 28 weeks (six and a half months) after the mailing date of this notice, the Patent Term Adjustment will be “ \_\_\_\_ ” day(s).

If a Continued Prosecution Application (CPA) was filed in the above- identified application, the filing date that determines Patent Term Adjustment is the filing date of the most recent CPA.

Applicant will be able to obtain more detailed information by accessing the Patent Application Information Retrieval (PAIR) system. (<http://pair.uspto.gov>).

Any questions regarding the Patent Term Extension or Adjustment determination should be directed to the Office of Patent Legal Administration at (703) 305-1383. Questions relating to issue and publication fee payments should be directed to the Customer Service Center of the Office of Patent Publication at (703) 305-8283.

&lt;

### **1303.01 Amendment Received After Allowance [R-2]**

If the amendment is filed under 37 CFR 1.312, see MPEP § 714.15 to § 714.16(e). If the amendment contains claims copied from a patent, see MPEP § 2307.03.

Reference to an Issue Batch Number is no longer necessary because the Office no longer stores and tracks applications according to issue batches.

Any paper filed after receiving the Issue Notification should include the indicated patent number, unless the application has been withdrawn from issue.

### **1303.02 Undelivered [R-2]**

In case a Notice of Allowance is returned, and a new notice is sent (see MPEP § 707.13), the date of sending the notice must be changed in the file to agree with the date of such remailing. If the application is an Image File Wrapper (IFW) application, the original document, a copy of the returned document with any markings, and the remailed document should be retained in the application so that the file history is clear.

### **1303.03 Not Withheld Due to Death of Inventor**

The Notice of Allowance will not be withheld due to death of the inventor if the executor or administrator has not intervened. See MPEP § 409.01(f).

### **1304 Amendments After D-10 Notice**

For amendments received after D-10 Notice, see MPEP § 130.

#### **1304.01 Withholding From Issue of “Secrecy Order” Applications**

“Secrecy Order” applications are not sent to issue even when all of the claims have been allowed. Instead of mailing a Notice of Allowance, a D-10 Notice is sent. See MPEP § 130.

If the “Secrecy Order” in an application is withdrawn after the D-10 notice is mailed, the application should then be treated like an ordinary application in condition for allowance.

### **1305 Jurisdiction [R-2]**

Jurisdiction of the application remains with the primary examiner until the Notice of Allowance is mailed. However, the examiner may make examiner’s amendments correcting obvious errors, as when brought to the attention of the examiner by the printer, and also may admit amendments under 37 CFR 1.312 which are confined to matters of form in the specification or claims, or to the cancellation of a claim or claims. The examiner’s action on other amendments under 37 CFR 1.312 consists of a recommendation to the Director.

To regain jurisdiction over the application, the examiner must write a letter to the Director requesting it. See MPEP § 1308 and § 1308.02.

Once the patent has been granted, the U.S. Patent and Trademark Office can take no action concerning it, except as provided in 35 U.S.C. 135, 35 U.S.C. 251 through 256, 35 U.S.C. 302 through 307 and 35 U.S.C. 311 through 316.

### **1306 Issue Fee [R-2]**

The issue fee and any required publication fee are due 3 months from the date of the Notice of Allowance. The amount of the issue fee and any required publication fee are shown on the Notice of Allowance, which will reflect any issue fee previously paid in the application. For example, if the application was allowed and the issue fee paid, but applicant withdrew the application from issue and filed a Request for Continued Examination (RCE) and the application was later allowed, the Notice of Allowance will reflect an issue fee amount that is due that is the difference between the current issue fee amount and the issue fee that was previously paid. Had applicant filed a Continued Prosecution Application (CPA) instead of an RCE, the issue fee required would be the current issue fee amount and would not reflect any issue fee paid before the CPA was filed because the issue fee was paid in a prior application. Note that because the amount of the fees due is determined by the fees set forth in 37 CFR 1.18 which are in effect as of the date of submission of payment of the fees, the amount due at the time the fees are paid may differ from the amount indicated on the Notice of Allowance. Accordingly, applicants

are encouraged, at the time of submitting payment of the **Fee(s)**, to determine whether the amount of the issue fee due **or** any required publication fee has changed to avoid the patent lapsing for failure to pay the balance of the issue fee due (37 CFR 1.317) or becoming abandoned for failure to pay the publication fee. The amounts due under 35 U.S.C. 41(a) (i.e., the issue fee, but not the publication fee) are reduced by 50 per centum for small entities.

Applicants and their attorneys or agents are urged to use the **Fee(s) Transmittal** form (PTOL-85B) provided with the Notice of Allowance when submitting their payments. **Unless otherwise directed**, all post allowance correspondence should be addressed **Mail Stop Issue Fee**.

**Where it is clear that an applicant actually intends to pay the issue fee and required publication fee, but the proper fee payment is not made, for example, an incorrect issue fee amount is supplied, or a PTOL-85B Fee(s) Transmittal form is filed without payment of the issue fee, a general authorization to pay fees or a specific authorization to pay the issue fee, submitted prior to the mailing of a notice of allowance, will be allowed to act as payment of the correct issue fee.** 37 CFR 1.311(b). In addition, where the deposit account information is added to the **Fee(s) Transmittal** form (PTOL-85B), but the check box authorizing that the deposit account be charged the issue fee is not checked, the deposit account will still be charged the required issue fee and any required publication fee.

Technology Center personnel should forward all post allowance correspondence to the **Office of Initial Patent Examination (OIPE)**. The papers received by the **OIPE** will be scanned and matched with the appropriate application and the entire application will be forwarded to the appropriate Technology Center for processing.

The payment of the issue fee due may be simplified by using a U.S. Patent and Trademark Office Deposit Account or a credit card payment with form PTO-2038 for such a fee. See MPEP § 509 However, any such payment must be specifically authorized by reference to the “issue fee” or “fees due under 37 CFR 1.18.”

The **fee(s) due** will be accepted from the applicant, assignee, or a registered attorney or agent, either of record or under 37 CFR 1.34(a).

The **Director** has no authority to extend the time for paying the issue fee. Intentional failure to pay the issue fee within the 3 months permitted by 35 U.S.C. 151 does not amount to unavoidable or unintentional delay in making payment.

### **1306.01 Deferring Issuance of a Patent [R-2]**

*37 CFR 1.314. Issuance of patent.*

If applicant timely pays the issue fee, the Office will issue the patent in regular course unless the application is withdrawn from issue (§ 1.313) or the Office defers issuance of the patent. To request that the Office defer issuance of a patent, applicant must file a petition under this section including the fee set forth in § 1.17(h) and a showing of good and sufficient reasons why it is necessary to defer issuance of the patent.

There is a public policy that the patent will issue in regular course once the issue fee is timely paid. 37 CFR 1.314. It has been the policy of the U.S. Patent and Trademark Office to defer issuance of a patent, upon request, for a period of up to 1 month only, in the absence of extraordinary circumstances or requirement of the regulations (e.g., 37 CFR 1.177) which would dictate a longer period. Situations like negotiation of licenses, time for filing in foreign countries, collection of data for filing a continuation-in-part application, or a desire for simultaneous issuance of related applications are not considered to amount to extraordinary circumstances.

A petition to defer issuance of a patent is not appropriate until the issue fee is paid. Issuance of a patent cannot be deferred after an allowed application receives a patent number and issue date unless the application is withdrawn from issue under 37 CFR 1.313(b) **or** (c). The petition to defer is considered at the time the petition is correlated with the application file before the appropriate deciding official (MPEP § 1002.02(b)). In order to facilitate consideration of a petition for deferment of issue, the petition should be firmly attached to the Issue Fee Transmittal form (PTOL-85B) and clearly labeled as a Petition to Defer Issue; Attention: Office of **Petitions**.

### **1306.02 Simultaneous Issuance of Patents [R-2]**

Where applications have been allowed and a Notice of Allowance and **Fee(s) Due** (PTOL-85) has been mailed in each application, a request for simulta-

neous issuance will be granted. Unless all the applications have reached this stage of processing, or a specific requirement of the regulations is involved (e.g., 37 CFR 1.177), a request for simultaneous issuance generally will not be granted.

Applicants and their attorneys who desire the simultaneous issue of allowed applications must submit the request to: **>Mail Stop Issue Fee, Commissioner for Patents, P.O. Box 1450, Alexandria, VA 22313-1450<**, Attention: Office of Patent Publication.

The request must contain the following information about *each* allowed application for which simultaneous issue is requested:

- (A) Application number,
- (B) Filing date,
- (C) Name(s) of inventor(s),
- (D) Title of invention, and
- (E) Date of allowance.

Separate copies of the request must accompany *each* **>Fee(s)< Transmittal (PTOL-85B)**.

### **1306.03 Practice After Payment of Issue Fee [R-2]**

Under the current publication process, utility and reissue patents are issued within about four weeks after the issue fee **>**and any required publication fee are **<** received in the Office. A patent number and issue date will be assigned to an application and an Issue Notification will be mailed after the issue fee has been paid and processed by the USPTO. Because the Issue Notification may be mailed less than two weeks before the application is expected to issue as a patent, applicants are advised to file any continuing application before receiving the Issue Notification to avoid loss of copendency.

Since the Office cannot ensure that any paper filed after payment of the issue fee will reach the appropriate USPTO official before the date the application issues as a patent, applicants are also encouraged to file any necessary amendments, assignments, petitions, information disclosure statements, or other papers prior to the date of issue fee payment, preferably within one month after the Notice of Allowance has been mailed. See MPEP § 502 for post allowance correspondence.

In order to minimize disruptions and delays in the printing process, the application is **not** available after

the Notice of Allowance has been mailed unless necessary for “Query Printer Waiting”, amendments submitted under 37 CFR 1.312, information disclosure statements, and petitions. Corrected filing receipts will not be mailed after the date of mailing of the Notice of Allowance unless special circumstances exist. Duplicate filing of papers is not recommended **>**(and may be treated as a failure to engage in reasonable efforts to conclude prosecution pursuant to 37 CFR 1.704(c)(10))**<**. The same correspondence should not be mailed and faxed to the Office unless the duplication has been specifically required by the Office. See MPEP § 719.01(a).

### **ORDERING OF ALLOWED APPLICATIONS**

Examining corps personnel must submit a request to the Office of Patent Publications **>**Image Assistance **<** Center when ordering an allowed application file. **\*\***

### **1307 Change in Classification of Cases Which Are in Issue**

See MPEP § 903.07.

### **1308 Withdrawal From Issue [R-2]**

*37 CFR 1.313. Withdrawal from issue.*

(a) Applications may be withdrawn from issue for further action at the initiative of the Office or upon petition by the applicant. To request that the Office withdraw an application from issue, applicant must file a petition under this section including the fee set forth in § 1.17(h) and a showing of good and sufficient reasons why withdrawal of the application from issue is necessary. A petition under this section is not required if a request for continued examination under § 1.114 is filed prior to payment of the issue fee. If the Office withdraws the application from issue, the Office will issue a new notice of allowance if the Office again allows the application.

(b) Once the issue fee has been paid, the Office will not withdraw the application from issue at its own initiative for any reason except:

- (1) A mistake on the part of the Office;
- (2) A violation of § 1.56 or illegality in the application;
- (3) Unpatentability of one or more claims; or
- (4) For interference.

(c) Once the issue fee has been paid, the application will not be withdrawn from issue upon petition by the applicant for any reason except:

- (1) Unpatentability of one or more claims, which petition must be accompanied by an unequivocal statement that one or more claims are unpatentable, an amendment to such claim or



claims, and an explanation as to how the amendment causes such claim or claims to be patentable;

(2) Consideration of a request for continued examination in compliance with § 1.114; or

(3) Express abandonment of the application. Such express abandonment may be in favor of a continuing application.

(d) A petition under this section will not be effective to withdraw the application from issue unless it is actually received and granted by the appropriate officials before the date of issue. Withdrawal of an application from issue after payment of the issue fee may not be effective to avoid publication of application information.

>

## I. < WITHDRAWAL FROM ISSUE AT THE INITIATIVE OF THE APPLICANT

>

### A. < Prior to the Payment of Issue Fee

If the applicant wishes to have an application withdrawn from issue, he or she must petition the \*>Director< under 37 CFR 1.313(a) or file a request for continued examination (RCE) under 37 CFR 1.114 with a submission and the fee set forth in 37 CFR 1.17(e). A submission may be an information disclosure statement (37 CFR 1.97 and 1.98) or an amendment. The RCE practice does not apply to utility or plant applications filed before June 8, 1995 and design applications. See MPEP § 706.07(h), subsections I, II and IX. If an applicant files a RCE (with the fee and a submission), the applicant need not pay the issue fee to avoid abandonment of the application. Applicants are cautioned against filing a RCE prior to payment of the issue fee and subsequently paying the issue fee (before the Office acts on the RCE) because doing so may result in issuance of a patent without consideration of the RCE (if the RCE is not matched with the application before the application is processed into a patent).

Petitions under 37 CFR 1.313(a) to have an application withdrawn from issue should be directed to the Technology Center (TC) Director to which the application is assigned (see MPEP § 1002.02(c)). Unless applicant receives a written communication from the Office that the application has been withdrawn from issue, the issue fee must be timely submitted to avoid abandonment.

Applicant may also file a continuing application on or before the day the issue fee is due and permit the

parent application to become abandoned for failure to pay the issue fee (35 U.S.C. 151).

>

### B. < After the Payment of Issue Fee

Once the issue fee is paid, withdrawal is permitted only for the reasons stated in 37 CFR 1.313(c). The status of the application at the time the petition is filed is determinative of whether the petition is considered under 37 CFR 1.313(a) or 37 CFR 1.313(c). Petitions under 37 CFR 1.313(c) to have an application withdrawn after payment of the issue fee should be directed to the Office of Petitions (see MPEP § 1002.02(b)).

In addition to the specific reasons identified in 37 CFR 1.313(c)(1)-(3) applicant should identify some specific and significant defect in the allowed application before the application will be withdrawn from issue. A petition under 37 CFR 1.313(c) based on the reason specified in 37 CFR 1.313(c)(2) can only be filed in utility or plant applications filed on or after June 8, 1995 because the request for continued examination (RCE) practice does not apply to these types of applications filed before June 8, 1995 and design applications. See MPEP § 706.07(h), subsections I and IX. Such a petition along with the petition fee set forth in 37 CFR 1.17(h) must include a request for continued examination in compliance with 37 CFR 1.114 (e.g., a submission and the fee set forth in 37 CFR 1.17(e)). The continued prosecution application (CPA) practice under 37 CFR 1.53(d) \*\*>only applies to design applications<. See MPEP § 201.06(d). To withdraw from issue a utility or plant application \*\*, an applicant may wish to file a petition under 37 CFR 1.313(c)(2) with a RCE or under 37 CFR 1.313(c)(3) for the express abandonment of the application in favor of a continuing application under 37 CFR 1.53(b), but not a CPA under 37 CFR 1.53(d).

Any petition filed under 37 CFR 1.313(\*>c<) to withdraw an application from issue after payment of the issue fee should be clearly marked “Petition under \*\*>37 CFR 1.313(c).” Petitions to withdraw an application from issue under 37 CFR 1.313(c) may be:

(A) mailed to “Mail Stop Petitions, Commissioner for Patents, P.O. Box 1450, Alexandria, VA 22313-1450”;

(B) transmitted by facsimile to the Central Facsimile Number (703) 872-9306; or

(C) hand-carried to the Office of Petitions (see MPEP § 1730 for the location).

Applicants are strongly advised to hand-carry the petition to the Office of Petitions to allow sufficient time to process the petition and if the petition can be granted, withdraw the application from issue. While a petition to withdraw an application from issue may be granted as late as one day prior to the patent issue date, to avoid publication and dissemination, the petition decision must be granted at least 3 weeks prior to the issue date.<

The Office cannot ensure that any petition under 37 CFR 1.313(c) will be acted upon prior to the date of patent grant. See *Filing of Continuing Applications, Amendments, or Petitions after Payment of Issue Fee*, Notice, 1221 *Off. Gaz. Pat. Office* 14 (April 6, 1999). Since a RCE (unlike a CPA under 37 CFR 1.53(d)) is not any type of new application filing, the Office cannot grant a petition to convert an untimely RCE to a continuing application under 37 CFR 1.53(b). Therefore, applicants are strongly cautioned to file any desired RCE prior to payment of issue fee. In addition, applicants considering filing a RCE after payment of the issue fee are strongly cautioned to call the Office of Petitions to determine whether sufficient time remains before the patent issue date to consider (and grant) a petition under 37 CFR 1.313(c) and what steps are needed to ensure that a grantable petition under 37 CFR 1.313(c) is before an appropriate official in the Office of Petitions in sufficient time to grant the petition before the patent is issued

>

## II. < WITHDRAWAL FROM ISSUE AT THE INITIATIVE OF THE OFFICE

The \* >Director< may withdraw an application from issue under 37 CFR 1.313 on his or her own initiative. See *Harley v. Lehman*, 981 F. Supp. 9, 12, 44 USPQ2d 1699, 1702 (D.D.C. 1997) (adoption of 37 CFR 1.313(b) permitting applications to be withdrawn from issue under certain narrow circumstances not directly covered by the statute was not unreasonable). 35 U.S.C. 151 provides that upon payment of the issue fee, “the patent shall issue.” Thus, an application cannot be withdrawn from issue after payment

of the issue fee consistent with 35 U.S.C. 151 unless there has been a determination that at least one of the conditions specified at 37 CFR 1.313(b)(1) through (4) exist such that the applicant is no longer “entitled to a patent under the law” as provided in 35 U.S.C. 151. See *Harley v. Lehman*, 981 F. Supp. at 11-12, 44 USPQ2d at 1701-02 (D.D.C. 1997)(Commissioner may adopt rules permitting applications to be withdrawn from issue after payment of the issue fee in situations in which the applicant is not entitled to a patent under the law); and see *Sampson v. Dann*, 466 F. Supp. 965, 973-74, 201 USPQ 15, 22 (D.D.C. 1978)(Commissioner not authorized to withdraw an application from issue after payment of the issue fee on an *ad hoc* basis, but only in situations which meet the conditions of 37 CFR 1.313(b)).

The authority to withdraw an application from issue at the initiative of the USPTO after payment of the issue fee under 37 CFR 1.313(b) has been delegated to TC Directors (see MPEP § 1002.02(c)). The Office of Petitions has also been delegated the authority to withdraw an application from issue after payment of the issue fee in those situations in which the request for withdrawal from issue is at the initiative of the USPTO by someone other than a TC Director (see MPEP § 1002.02(b)).

35 U.S.C. 151 and 37 CFR 1.313(b) do not authorize the USPTO to withdraw an application from issue after payment of the issue fee for any reason **except**:

- (1) a mistake on the part of the Office;
- (2) a violation of 37 CFR 1.56 or illegality in the application;
- (3) unpatentability of one or more claims; or
- (4) for interference.

See 37 CFR 1.313(b).

Examples of reasons that do **not** warrant withdrawing an application from issue after payment of the issue fee at the initiative of the Office are:

- (A) to permit the examiner to consider an information disclosure statement;
- (B) to permit the examiner to consider whether one or more claims are unpatentable; or
- (C) to permit the applicant to file a continuing application (including a CPA).

An application may be removed from the Office of Patent Publication, without it being withdrawn from

issue under 37 CFR 1.313(b), to permit the examiner to consider an information disclosure statement or whether one or more claims are unpatentable. Only if such consideration results in a determination that one or more claims are unpatentable does 37 CFR 1.313(b) authorize the application to be withdrawn from issue. If uncertainty exists as to whether prosecution will in fact be re-opened, the uncertainty must be resolved before the application is withdrawn from issue. If there is a question whether an application must be withdrawn from issue and no TC Director is available to decide whether withdrawal from issue is appropriate and to sign the withdrawal Notice, the application should be hand-carried to the Office of Petitions for decision on whether withdrawal from issue is appropriate and to effect the withdrawal.

Any notice withdrawing an application from issue after payment of the issue fee must specify which of the conditions set forth in 37 CFR 1.313(b)(1) through (4) exists and thus warrants withdrawal of the application from issue. Any petition under 37 CFR 1.181 to review the decision of a TC Director to withdraw an application from issue after payment of the issue fee will be decided by the Deputy Commissioner for Patent Examination Policy.

### ***Procedure to be followed when an application is withdrawn from issue***

The procedure set forth below is to be followed when a TC Director withdraws an application from issue. This processing is to be done in the Technology Center without the need to send the application to the Office of Patent Publication.

First, determine (via \*\* PALM) whether the issue fee has been paid, and whether the application has been assigned a patent number and issue date.

#### **1. Withdrawal From Issue Before Payment of Issue Fee**

If the issue fee **has not** been paid and the deadline for payment has not expired:

(A) Prepare, date stamp, and mail a “Withdrawal from Issue” letter signed by the TC Director to the applicant to effectuate the withdrawal from issue, using form paragraph 10.01. A copy of the “Withdrawal from Issue” letter should be sent to the Office of Patent Publication.

(B) Change the status of the application to status code 066 (Previous Action Withdrawn - Awaiting Further Action). Enter the Withdrawal from Issue letter in the application file and make it of record on the application file contents.

(C) Stick an Issue Information Label (Form 2016) on the file wrapper over the filled in boxes on the file wrapper that contain issue information. >If the application is an Image File Wrapper (IFW) application, this step is not done; instead a new Issue Classification sheet will be completed if the application is subsequently allowed.<

(D) Forward the application to the examiner for **prompt** appropriate action (*e.g.*, reopen prosecution, initiate interference proceedings).

\*\*>

#### **¶ 10.01 Withdrawal From Issue, Fee Not Paid**

In re Application of [1] :  
 Appl. No.: [2] : **WITHDRAWAL FROM ISSUE**  
 Filed: [3] : 37 CFR 1.313  
 For: [4] :

The purpose of this communication is to inform you that the above identified application is being withdrawn from issue pursuant to 37 CFR 1.313.

The application is being withdrawn to permit reopening of prosecution. The reasons therefor will be communicated to you by the examiner.

U.S. Patent and Trademark Office records reveal that the issue fee and the publication fee have not been paid. If the issue fee and the publication fee have been submitted, the applicant may request a refund, or may request that the fee be credited to a deposit account. However, applicant may wait until the application is either again found allowable or held abandoned. If the application is allowed, upon receipt of a new Notice of Allowance and Fee(s) Due, applicant may request that the previously submitted issue fee and publication fee be applied toward payment of the issue fee and publication fee in the amount identified on the new Notice of Allowance and Fee(s) Due. If the application is abandoned, applicant may request either a refund or a credit to a specified Deposit Account.

The application is being forwarded to the examiner for action.

[5]  
 Director,  
 Technology Center [6]  
 [7]

#### **Examiner Note:**

1. This letter is printed with the USPTO letterhead and must be signed by the TC Director.
2. DO NOT use this form letter if the issue fee and publication fee have been paid.

3. In bracket 7, insert the correspondence address of record.

<

## 2. Withdrawal From Issue After Payment of Issue Fee

If the issue fee **has** been paid:

(A) Prepare, sign, date stamp, and mail a “Notice of Withdrawal From Issue under 37 CFR 1.313(b)” to the applicant indicating that the application has been withdrawn from issue (using one of the form letters WDR-TCB1, WDR-TCB2, WDR-TCB3, or WDR-TCB4).

(B) If the application has been assigned a patent number and issue date:

(1) Prepare a “Withdrawal from Issue of” memorandum using the form memorandum WDR-MEMO. E-mail the memorandum to the Director of the Office of Patent Publication and the persons copied on the memorandum to inform them that the application has been withdrawn from issue.

(2) The “Notice of Withdrawal From Issue under 37 CFR 1.313(b)” letter to applicant must be signed, date stamped, and mailed no later than the Monday before the issue date to be effective to withdraw the application from issue.

(3) Remove the patent number from the file wrapper.

(C) Change the status of the application to status code 066 (Previous Action Withdrawn - Awaiting Further Action) by using PALM transaction code 1040. Enter the “Notice of Withdrawal From Issue under 37 CFR 1.313(b)” and the “Withdrawal from Issue of” memorandum, if applicable, in the application file and make it of record on the application file contents.

(D) Stick an Issue Information Label (Form 2016) on the file wrapper over the filled-in boxes on the file wrapper that contain issue information. >If the application is an IFW application, this step is not done; instead a new Issue Classification sheet will be completed if the application is subsequently allowed.<

(E) Forward the application to the examiner for prompt appropriate action (*e.g.*, reopen prosecution, initiate interference proceedings).

## 1308.01 Rejection After Allowance [R-2]

A claim noted as allowable shall thereafter be rejected only with the approval of the primary examiner. Great care should be exercised in authorizing such rejection. See MPEP § 706.04.

When a new reference is discovered, which obviously is applicable to one or more of the allowed claims in an application in issue, a \* >memorandum< is addressed to the Technology Center (TC) Director, requesting that the application be withdrawn from issue for the purpose of applying the new reference. This \*>memorandum< should cite the reference, and, if need be, briefly state its application. The \*>memorandum< should be submitted with the reference and the file wrapper>, if the application file is in paper<. If the examiner’s proposed action is not approved, the \* >memorandum< requesting withdrawal from issue should not be placed in the file.

If the request to withdraw from issue is approved, the \*\* >TC Director should withdraw the application from issue as explained in MPEP § 1308. After the TC Director has withdrawn the application from issue, the examiner will prepare< an Office action stating that the application has been withdrawn from issue, citing the new reference, and rejecting the claims met thereby.

The action is given a paper number and placed in the file. >For Image File Wrapper (IFW) processing, see IFW Manual.<

If the issue fee has already been paid and prosecution is reopened, the applicant may request a refund or request that the fee be credited to a deposit account. However, applicant may wait until the application is either found allowable or held abandoned. If allowed, upon receipt of a new Notice of Allowance, applicant may request that the previously submitted issue fee be applied >(the Notice of Allowance will reflect an issue fee amount that is due that is the difference between the current issue fee amount and the issue fee that was previously paid)<. If abandoned, applicant may request refund or credit to a deposit account.

\*\*

## 1308.02 For Interference Purposes

It may be necessary to withdraw a case from issue for reasons connected with an interference. For the

procedure to be followed, see MPEP § 2305.04 and § 2307.03.

### 1308.03 Quality Review Program for Examined Patent Applications [R-2]

The Office of Patent Quality *Quality Assurance* administers a program for reviewing the quality of the examination of patent applications. The general purpose of the program is to improve patent quality and increase the likelihood of patents being found to be valid.

The quality review is conducted by *Review Quality Assurance Specialists* on a randomly selected sample of allowed applications from each *examiner*. The sample is computer generated under the office-wide computer system (PALM), which selects a predetermined number of allowed applications from each *examiner* per year for review. A subsample of the selected allowed applications are both reviewed and independently searched by the reviewers. The only applications excluded from the sample are those in which there has been a decision by the Board of Patent Appeals and Interferences, or by a court.

The *Review Quality Assurance Specialist* independently reviews each sampled application assigned to his or her docket to determine whether any claims may be unpatentable. The *Review Quality Assurance Specialist* may consult with, discuss, or review an application with any other reviewer or professional in the examining corps, except the professional who acted on the application. The review will, with or without additional search, provide the examining corps personnel with information which will assist in improving the quality of issued applications. The program shall be used as an educational tool to aid in identifying problem areas in the examining Technology Centers (TCs).

Reviewed applications may be returned to the examining TCs for consideration of the reviewer's question(s) as to adequacy of the search and/or patentability of a claim(s).

If, during the quality review process, it is determined that one or more claims of a reviewed application are unpatentable, the prosecution of the application will be reopened. The Office action should contain, as an opening, form paragraph 13.04.

#### ¶ 13.04 Reopen Prosecution - After Notice of Allowance

Prosecution on the merits of this application is reopened on claim [1] considered unpatentable for the reasons indicated below:

[2]

#### Examiner Note:

1. This paragraph should be used when a rejection is made on any previously allowed claim(s) which for one reason or another is considered unpatentable after the Notice of Allowance (PTOL-85) has been mailed.
2. Make appropriate rejection(s) as in any other action.
3. In bracket 1, identify claim(s) that are considered unpatentable.
4. In bracket 2, state all appropriate rejections for each claim considered unpatentable.

If the issue fee has already been paid in the application, the application must be withdrawn from issue by the Office of Patent Publication, and the action should contain not only the above quoted paragraph, but also form paragraph 13.05.

#### ¶ 13.05 Reopen Prosecution - Vacate Notice of Allowance

Applicant is advised that the Notice of Allowance mailed [1] is vacated. If the issue fee has already been paid, applicant may request a refund or request that the fee be credited to a deposit account. However, applicant may wait until the application is either found allowable or held abandoned. If allowed, upon receipt of a new Notice of Allowance, applicant may request that the previously submitted issue fee be applied. If abandoned, applicant may request refund or credit to a specified Deposit Account.

#### Examiner Note:

1. This form paragraph must be used when the prosecution is reopened after the mailing of the Notice of Allowance.
2. In bracket 1, insert date of the Notice of Allowance.

Quality *Quality Assurance* forms and papers are *not* to be included with Office actions, nor should such forms or papers be retained in the file of any reviewed application whether or not prosecution is to be reopened. The application record should *not* indicate that a review has been conducted by Quality *Quality Assurance*.

Whenever an application has been returned to the TC under the Quality *Quality Assurance* Program, the TC should promptly decide what action is to be taken in the application and inform the Office of Patent Quality *Quality Assurance* of the nature of that action by use of the appropriate form. If prosecution is to be reopened or other corrective action taken, only the forms should be returned to the Office of Patent Quality *Quality Assurance* initially, with the application being returned to the Office of Patent Quality *Quality Assurance* when

action is completed. In all other instances, both the application and the forms should be returned to the Office of Patent Quality Assurance.

### 1309 Issue of Patent [R-2]

Under the current publication process, electronic capture of most of the information to be printed in a patent will begin as soon as an allowed application is received in the Office of Patent Publication, immediately after the Notice of Allowance has been mailed. The Office of Patent Publication forwards the allowed applications to the printer for Initial Data Capture (IDC). This IDC process takes approximately five weeks to accomplish and during this time the application, if in a paper file, is not available to examiners or for purposes of making copies of the application (copies of the application files that have been published may be ordered from the Office of Public Records, upon payment of the fee, but the applications will not be removed from the publication process for purposes of making copies). After IDC is completed, the application is returned to the Office of Patent Publication, and the file will be available to examiners and the Office of Public Records.

When the issue fee is paid and all other requirements have been met (e.g., drawings) within the time allowed by law, the application is forwarded to the printer for Final Data Capture (FDC) and final issue preparation. At this point, the application can only be retrieved if it is withdrawn from issue. The application is assigned a patent number and issue date about ten days before the application issues as a patent, and an Issue Notification is mailed to inform the applicant of the patent number and issue date. A bond paper copy of the patent grant is ribboned, sealed, and mailed by the Office of Patent Publication.

All allowed applications ready for printing will be selected by chronological sequence based on the date the issue fee was paid. Special handling will be given to the following applications in these categories:

(A) Allowed cases which were made special by the Director (including those under the Special Examining Procedure).

(B) Allowed cases that have a U.S. effective filing date more than 5 years old.

(C) Allowed reissue applications.

(D) Allowed applications having an effective filing date earlier than that required for declaring an interference with a copending application claiming the same subject matter.

(E) Allowed application of a party involved in a terminated interference.

To ensure that any application falling within the scope of the categories outlined above and identified by (A) to (E) receives special treatment, the examiner should e-mail or otherwise contact the Image Assistance Center in the Office of Patent Publication for special treatment. The examiner should state the special treatment category outlined above.

35 U.S.C. 2. Powers and duties.

\*\*\*\*\*

(b) SPECIFIC POWERS.— The Office—

(1) shall adopt and use a seal of the Office, which shall be judicially noticed and with which letters patent, certificates of trademark registrations, and papers issued by the Office shall be authenticated;

\*\*\*\*\*

35 U.S.C. 153. How issued.

\*\*>

Patents shall be issued in the name of the United States of America, under the seal of the Patent and Trademark Office, and shall be signed by the Director or have his signature placed thereon and shall be recorded in the Patent and Trademark Office.

<

>

#### I. < PRINTING NAMES OF PRACTITIONERS AND FIRM ON PATENTS

The Fee(s) Transmittal form provides a space (item 2) for the person submitting the base issue fee to indicate, for printing, (1) the names of up to three registered patent attorneys or agents or, alternatively, (2) the name of a single firm, which has as a member at least one registered patent attorney or agent, and the names of up to two registered patent attorneys or agents. If the person submitting the issue fee desires that no name of practitioner or firm be printed on the patent, the space on the Fee(s) Transmittal form should be left blank. If no name is listed on the form, no name will be printed on the patent.

>

**II. < ASSIGNMENT PRINTED ON PATENT**

The **>Fee(s)<** Transmittal form portion (PTOL - 85B) of the Notice of Allowance provides a space (item 3) for assignment data which should be completed in order to comply with 37 CFR 3.81. Unless an assignee’s name and address are identified in item 3 of the **>Fee(s)<** Transmittal form PTOL-85B, the patent will issue to the applicant. Assignment data printed on the patent will be based solely on the information so supplied. See MPEP § 307. >Recording of the assignment, or submission of the assignment for recordation as set forth in 37 CFR 3.11 is required for a Patent to issue to an assignee. See 37 CFR 3.81(a).

**III. < ASSIGNEE NAMES**

Only the first appearing name of an assignee will be printed on the patent where multiple names for the *same* party are identified on the **>Fee(s)<** Transmittal form, PTOL-85B. Such multiple names may occur when both a legal name and an “also known as” or “doing business as” name is also included. This printing practice will not, however, affect the practice of recording assignments with the Office in the Assignment Division. The assignee entry on form PTOL-85B should still be completed to indicate the assignment data as recorded in the Office. For example, the assignment filed in the Office and therefore the PTOL-85B assignee entry might read “Smith Company doing business as (d.b.a.) Jones Company.” The assignee entry on the printed patent will read “Smith Company.”

\*\*

**1309.02 “Query/Printer Waiting” Cases [R-2]**

When the printer finds an apparent error in an application, the file is returned to the Office with an

attached “Query/Printer Waiting” slip noting the supposed error.

The Publishing Division forwards such “query/printer waiting” applications to the Technology Center (TC) Director’s secretary. The secretary acts as a control center in each TC and forwards the applications to the examiner by the appropriate route. The application should be taken up and acted on immediately and returned to the TC Director’s secretary within 72 hours (excluding weekends and holidays). Either necessary corrective action should be taken or an indication should be made that the application is considered to be correct as it stands. >A copy of the query form is entered into the application file, and the response from the examiner should be clear from the record.<

If the examiner concurs in the criticisms, the errors should, if possible, be corrected in clean red ink and initialed or be corrected by examiner’s amendment >(note that in an Image File Wrapper (IFW) application, an examiner’s amendment must be made by way of a formal examiner’s amendment)<. See MPEP § 1302.04.

Delays in making corrections may sometimes be avoided if the applicant or his or her representative is telephoned immediately, and the error is corrected by amendment under 37 CFR 1.312, where appropriate.

**>Applications with a paper file wrapper<** are picked up from the **>TC Director’s<** office by the messenger and returned to the Publishing Division for forwarding to the printer.

**THESE APPLICATIONS SHOULD NOT BE MAILED TO THE PUBLISHING DIVISION.**

>A similar process exists for IFW applications, with the query form being placed into the IFW, and the response from the examiner also made part of the record. For IFW processing, see IFW Manual.<



# Chapter 1400 Correction of Patents

- 1400.01 Introduction
  - 1401 Reissue**
  - 1402 Grounds for Filing**
  - 1403 Diligence in Filing**
  - 1404 Submission of Papers Where Reissue Patent Is in Litigation**
  - >**1405 Reissue and Patent Term**
  - 1406 Citation and Consideration of References Cited in Original Patent<**
  - 1410 Content of Reissue Application**
  - 1410.01 Reissue Applicant, Oath or Declaration, and Consent of All Assignees
  - 1411 Form of Specification**
  - 1411.01 Certificate of Correction or Disclaimer in Original Patent
  - 1411.02 New Matter
  - 1412 Content of Claims**
  - 1412.01 Reissue Claims Must Be for Same General Invention
  - 1412.02 Recapture of Canceled Subject Matter
  - 1412.03 Broadening Reissue Claims
  - 1412.04 Correction of Inventorship
  - 1413 Drawings**
  - 1414 Content of Reissue Oath/Declaration**
  - 1414.01 Supplemental Reissue Oath/ Declaration
  - 1415 Reissue Filing Fees**
  - 1415.01 Maintenance Fees on the Original Patent
  - 1416 Offer to Surrender and Return of Original Patent**
  - 1417 Claim for Benefit Under 35 U.S.C. 119(a)-(d)**
  - 1418 Notification of Prior/Concurrent Proceedings and Decisions Thereon, And of Information Known To Be Material To Patentability**
  - 1430 Reissue Files Open to the Public and, Notice of Filing Reissue Announced in, *Official Gazette***
  - \*\*
  - 1440 Examination of Reissue Application**
  - 1441 Two-Month Delay Period**
  - 1441.01 Protest in Reissue Applications
  - 1442 Special Status**
  - 1442.01 Litigation-Related Reissues
  - 1442.02 Concurrent Litigation
  - 1442.03 Litigation Stayed
  - 1442.04 Litigation Involving Patent
  - 1442.05 \*\*>Court Ordered Filing of Reissue Application<
  - \*\*
  - 1443 Initial Examiner Review**
  - 1444 Review of Reissue Oath/Declaration**
  - 1445 Reissue Application Examined in Same Manner as Original Application**
  - 1448 Fraud, Inequitable Conduct, or Duty of Disclosure Issues**
  - 1449 Protest Filed in Reissue Where Patent Is in Interference**
  - 1449.01 Concurrent Office Proceedings
  - 1449.02 Interference in Reissue
  - 1450 Restriction and Election of Species >Made in Reissue Application<**
  - 1451 Divisional Reissue Applications; Continuation Reissue Applications Where the Parent is Pending**
  - 1452 Request for Continued Examination of Reissue Application**
  - 1453 Amendments to Reissue Applications**
  - 1454 Appeal Brief**
  - 1455 Allowance and Issue**
  - 1456 Reissue Review**
  - >**1457 Design Reissue Applications and Patents<**
  - 1460 Effect of Reissue**
  - 1470 Public Access of Reissue Applications**
  - 1480 Certificates of Correction — Office Mistake**
  - >1480.01 Expedited Issuance of Certificates of Correction — Error Attributable to Office<
  - 1481 >Certificates of Correction – < Applicant’s Mistake**
  - 1485 Handling of Request for Certificates of Correction**
  - 1490 Disclaimers**
- 1400.01 Introduction [R-2]**
- A patent may be corrected or amended in four ways, namely:
- (A) by reissue,
  - (B) by the issuance of a certificate of correction which becomes a part of the patent,
  - (C) by disclaimer, and
  - (D) by reexamination.
- The first three ways are discussed in this chapter while the fourth way (reexamination) is discussed in MPEP Chapter 2200 >for *ex parte* reexamination and MPEP Chapter 2600 for *inter partes* reexamination<.
- 1401 Reissue**
- 35 U.S.C. 251. Reissue of defective patents.*
- Whenever any patent is, through error without any deceptive intention, deemed wholly or partly inoperative or invalid, by reason of a defective specification or drawing, or by reason of the patentee claiming more or less than he had a right to claim in the



patent, the Director shall, on the surrender of such patent and the payment of the fee required by law, reissue the patent for the invention disclosed in the original patent, and in accordance with a new and amended application, for the unexpired part of the term of the original patent. No new matter shall be introduced into the application for reissue.

The Director may issue several reissued patents for distinct and separate parts of the thing patented, upon demand of the applicant, and upon payment of the required fee for a reissue for each of such reissued patents.

The provisions of this title relating to applications for patent shall be applicable to applications for reissue of a patent, except that application for reissue may be made and sworn to by the assignee of the entire interest if the application does not seek to enlarge the scope of the claims of the original patent.

No reissued patent shall be granted enlarging the scope of the claims of the original patent unless applied for within two years from the grant of the original patent.

The provisions of 35 U.S.C. 251 permit the reissue of a patent to correct an error in the patent made without any deceptive intention and provide criteria for the reissue. 37 CFR 1.171 through 1.179 are rules directed to reissue.

## 1402 Grounds for Filing [R-2]

A reissue application is filed to correct an error in the patent which was made without any deceptive intention, where, as a result of the error, the patent is deemed wholly or partly inoperative or invalid. An error in the patent arises out of an error in conduct which was made in the preparation and/or prosecution of the application which became the patent.

There must be at least one error in the patent to provide grounds for reissue of the patent. If there is no error in the patent, the patent will not be reissued. The present section provides a discussion of what may be considered an error in the patent upon which to base a reissue application.

In accordance with 35 U.S.C. 251, the error upon which a reissue is based must be one which causes the patent to be “deemed wholly or partly inoperative or invalid, by reason of a defective specification or drawing, or by reason of the patentee claiming more or less than he had a right to claim in the patent.” Thus, an error under 35 U.S.C. 251 *has not been presented* where the correction to the patent is one of spelling, or grammar, or a typographical, editorial or clerical error which does not cause the patent to be deemed wholly or partly inoperative or invalid for the reasons specified in 35 U.S.C. 251. These corrections

to a patent do not provide a basis for reissue (although these corrections may also be included in a reissue application, where a 35 U.S.C. 251 error is already present).

These corrections may be made via a certificate of correction; see MPEP § 1481.

The most common bases for filing a reissue application are:

- (A) the claims are too narrow or too broad;
- (B) the disclosure contains inaccuracies;
- (C) applicant failed to or incorrectly claimed foreign priority; and
- (D) applicant failed to make reference to or incorrectly made reference to prior copending applications.

An attorney’s failure to appreciate the full scope of the invention was held to be an error correctable through reissue in *In re Wilder*, 736 F.2d 1516, 222 USPQ 369 (Fed. Cir. 1984). The correction of misjoinder of inventors in divisional reissues has been held to be a ground for reissue. See *Ex parte Scudder*, 169 USPQ 814 (Bd. App. 1971). The Board of Appeals held in *Ex parte Scudder*, 169 USPQ at 815, that 35 U.S.C. 251 authorizes reissue application to correct misjoinder of inventors where 35 U.S.C. 256 is inadequate.

Reissue may no longer be necessary under the facts in *Ex parte Scudder, supra*, in view of 35 U.S.C. 116 which provides, *inter alia*, that:

“Inventors may apply for a patent jointly even though . . .  
(3) each did not make a contribution to the subject matter of every claim in the patent.”

See also 37 CFR 1.45(b)(3).

If the only change being made in the patent is correction of the inventorship, this can be accomplished by filing a request for a certificate of correction under the provisions of 35 U.S.C. 256 and 37 CFR 1.324. See MPEP § 1412.04 and § 1481. A Certificate of Correction will be issued if all parties are in agreement and the inventorship issue is not contested.

A reissue was granted in *Brenner v. State of Israel*, 400 F.2d 789, 158 USPQ 584 (D.C. Cir. 1968), where the only ground urged was failure to file a certified copy of the original foreign application to obtain the right of foreign priority under 35 U.S.C. 119(a)-(d) before the patent was granted.

In *Brenner*, the claim for priority had been made in the prosecution of the original patent, and it was only

necessary to submit a certified copy of the priority document in the reissue application to perfect priority. Reissue is also available to convert the “error” in failing to take any steps to obtain the right of foreign priority under 35 U.S.C. 119(a)-(d) before the patent was granted. In a situation where it is necessary to submit for the first time both the claim for priority and the certified copy of the priority document in the reissue application, \*\* and the patent to be reissued resulted from a utility or plant application which became the patent to be reissued was filed on or after November 29, 2000, the reissue applicant \*\* must (where it is necessary to submit for the first time the claim for priority) also file a petition for an unintentionally delayed priority claim under 37 CFR 1.55(c) in addition to filing a reissue application. See MPEP § 201.14(a).

\*\*

The courts have not addressed the question of correction of the failure to adequately claim \* benefit under 35 U.S.C. 119(e) in the application (which became the patent to be reissued) via reissue. If the application which became the patent to be reissued was filed prior to November 29, 2000, correction as to \* benefit under 35 U.S.C. 119(e) would be permitted in a manner somewhat analogous to that of the priority correction discussed above. Under no circumstances, however, can a reissue be employed to correct an applicant’s mistake by adding or correcting a \* benefit claim under 35 U.S.C. 119(e) where the application, which became the patent to be reissued, was filed on or after November 29, 2000.

Section 4503 of the American Inventors Protection Act of 1999 (AIPA) amended 35 U.S.C. 119(e)(1) to state that:

No application shall be entitled to the benefit of an earlier filed provisional application under this subsection unless an amendment containing the specific reference to the earlier filed provisional application is submitted at such time during the pendency of the application as required by the Director. The Director may consider the failure to submit such an amendment within that time period as a waiver of any benefit under this subsection. The Director may establish procedures, including the payment of a surcharge, to accept an unintentionally delayed submission of an amendment under this section *during the pendency of the application*.

35 U.S.C. 119(e)(1), as amended by the AIPA, clearly prohibits the addition or correction of \* bene-

fit claims under 35 U.S.C. 119(e) when the application is no longer pending, e.g., an issued patent. Therefore, a reissue is not a valid mechanism for adding or correcting a \* benefit claim under 35 U.S.C. 119(e) after a patent has been granted.

Correction of failure to adequately claim priority under 35 U.S.C. 120 in an earlier filed copending U.S. Patent application was held a proper ground for reissue. *Sampson v. Comm’r Pat.*, 195 USPQ 136, 137 (D.D.C. 1976). If the utility or plant application which became the patent to be reissued was filed on or after November 29, 2000, the reissue applicant must file a petition for an unintentionally delayed priority claim under 37 CFR 1.78(a)(3) and (a)(6) in addition to filing a reissue application. See MPEP § 201.11. For treatment of an error involving disclaimer of a priority claim under 35 U.S.C. 120, see MPEP 1405.

A reissue applicant’s failure to timely file a divisional application covering the non-elected invention(s) following a restriction requirement is not considered to be error causing a patent granted on elected claims to be partially inoperative by reason of claiming less than the applicant had a right to claim. Thus, such applicant’s error is not correctable by reissue of the original patent under 35 U.S.C. 251. \*\* See MPEP § 1412.01.

A reissue may be based on a drawing correction that is substantive in nature, because such a correction qualifies as correcting an “error” under 35 U.S.C. 251 that may properly be deemed to render the patent wholly or partly inoperative. A reissue application cannot be based on a non-substantive drawing change, such as a reference numeral correction or addition, the addition of shading, or even the addition of an additional figure merely to “clarify” the disclosure. Non-substantive drawing changes may, however, be included in a reissue application that corrects at least one substantive “error” under 35 U.S.C. 251.

## 1403 Diligence in Filing [R-2]

When a reissue application is filed within 2 years from the date of the original patent, a rejection on the grounds of lack of diligence or delay in filing the reissue should not normally be made. *Ex parte Lafferty*, 190 USPQ 202 (Bd. App. 1975); but see *Rohm & Haas Co. v. Roberts Chemical Inc.*, 142 F. Supp. 499, 110 USPQ 93 (S.W. Va. 1956), *rev’d on other*

*grounds*, 245 F.2d 693, 113 USPQ 423 (4th Cir. 1957).

The fourth paragraph of 35 U.S.C. 251 states:

“No reissued patent shall be granted enlarging the scope of the claims of the original patent unless applied for within two years from the grant of the original patent.”

Where any broadening reissue application is filed within two years from the date of the original patent, 35 U.S.C. 251 presumes diligence, and the examiner should not inquire why applicant failed to file the reissue application earlier within the two year period.

See MPEP § 1412.03 for broadening reissue practice. See also *In re Graff*, 111 F.3rd 874, 42 USPQ2d 1471 (Fed. Cir. 1997); *In re Bennett*, 766 F.2d 524, 528, 226 USPQ 413, 416 (Fed. Cir. 1985); *In re Fotland*, 779 F.2d 31, 228 USPQ 193 (Fed. Cir. 1985).

A reissue application that is filed on the 2-year anniversary date of the patent grant is considered as being filed within 2 years. See *Switzer v. Sockman*, 333 F.2d 935, 142 USPQ 226 (CCPA 1964) (a similar rule in interferences).

A reissue application can be granted a filing date without an oath or declaration, or without the filing fee being present. See 37 CFR 1.53(f). Applicant will be given a period of time to provide the missing parts and to pay the surcharge under 37 CFR 1.16(e). See MPEP § 1410.01.

#### 1404 Submission of Papers Where Reissue Patent Is in Litigation [R-2]

Marking of envelope: Applicants and protestors (see MPEP § 1901.03) submitting papers for entry in reissue applications of patents involved in litigation are requested to mark the outside envelope and the top right-hand portion of the papers with the words “REISSUE LITIGATION” and with the art unit or other area of the United States Patent and Trademark Office in which the reissue application is located, e.g., Commissioner for Patents, Board of Patent Appeals and Interferences, Office of Patent Legal Administration, Technology Center, Office of Patent Publication, etc. \*\* Marking of papers: Any “Reissue Litigation” papers mailed to the Office should be so marked. The markings preferably should be written in a bright color with a felt point marker. Papers marked “REISSUE LITIGATION” will be given special attention and expedited handling. (For IFW pro-

cessing, see IFW Manual.)< See MPEP § 1442.01 through § 1442.04 for examination of litigation-related reissue applications. >Protestor’s participation, including the submission of papers, is limited in accordance with 37 CFR 1.291(c).<

>

#### 1405 Reissue and Patent Term [R-2]

35 U.S.C. 251 prescribes the effect of reissue on the patent term by stating that “the Director shall... reissue the patent... for the unexpired term of the original patent.”

The maximum term of the original patent is fixed at the time the patent is granted. While the term may be subsequently shortened, e.g., through the filing of a terminal disclaimer, it cannot be extended through the filing of a reissue. Accordingly, a deletion in a reissue application of an earlier-obtained benefit claim under 35 U.S.C. 120 will not operate to lengthen the term of the patent to be reissued.

When a reissue application has been filed in an attempt to delete an earlier-obtained benefit claim under 35 U.S.C. 120, it should be treated as follows:

(A) More than one “error” (as defined by 35 U.S.C. 251) is described in a reissue declaration, and one of the errors identified is the failure to delete a 35 U.S.C. 120 benefit claim in the original patent, or the erroneous making of a claim for 35 U.S.C. 120 benefit.

If one of the errors identified is the presence of the claim for 35 U.S.C. 120 benefit in the patent, and patentee (1) states a belief that this error renders the original patent wholly or partly inoperative or invalid, and (2) is seeking to eliminate this error via the reissue proceeding, the Office will permit entry of an accompanying amendment deleting the benefit claim in the continuity data, and will not object to or reject the reissue declaration. Assuming the reissue declaration appropriately identifies or describes at least one other error being corrected, the reissue declaration would not be objected to for failure to comply with the requirements of 37 CFR 1.175.

Where the reissue declaration states that the patentee is making this correction in order to extend the term of the original patent, the examiner’s Office action will merely refer to the statement in the declaration and then point out with respect to such state-

ment that 35 U.S.C. 251 only permits reissue “... for the unexpired part of the term of the original patent.”

(B) Only one “error” (as defined by 35 U.S.C. 251) is described in a reissue declaration, and that error is the failure to delete a 35 U.S.C. 120 benefit claim in the original patent, or the erroneous making of a claim for 35 U.S.C. 120 benefit.

(1) If the only error identified in the reissue declaration is stated to be the correction or adjustment of the patent term by deleting the 35 U.S.C. 120 benefit claim, a rejection under 35 U.S.C. 251 should be made, based on the lack of an appropriate error for reissue and failure to comply with 37 CFR 1.175.

(2) If the only error identified in the reissue declaration is the need to delete a 35 U.S.C. 120 benefit claim, which the patentee seeks to now delete in the reissue application, (and no reference is made as to increasing the term of the patent), the examiner should not make a rejection under 35 U.S.C. 251 based on lack of an appropriate error for reissue and failure to comply with 37 CFR 1.175. The examiner should examine the reissue application in accordance with 37 CFR 1.176 (MPEP § 1440). A statement should, however, be made in an Office action pointing out the lack of effect (of the change in the patent) on the patent term because 35 U.S.C. 251 only permits reissue “... for the unexpired part of the term of the original patent.”<

>

## 1406 Citation and Consideration of References Cited in Original Patent [R-2]

In a reissue application, the examiner should consider and list on a PTO-892 form all references that have been cited during the original prosecution of the patent. See MPEP § 1455. An exception to this practice might be where the references cited in the original patent may no longer be relevant, e.g., in view of a narrowing of the claim scope in the reissue application.

Should applicants wish to ensure that all of the references which were cited in the original patent are considered and cited in the reissue application, an information disclosure statement (IDS) in compliance with 37 CFR 1.97 and 1.98 should be filed in the reissue application. See MPEP § 609. Note that the waiver of the 37 CFR 1.98(a)(2)(i) requirement for

submitting copies of U.S. patents and U.S. patent application publications applies to a reissue application that is filed after June 30, 2003, even though the underlying patent to be reissued resulted from an application filed before June 30, 2003. See the notice entitled 'Information Disclosure Statements May Be Filed Without Copies of U.S. Patents and Published Applications in Patent Applications filed after June 30, 2003' published on August 5, 2003 in 1273 OG 55. Note also that the Office imposes no responsibility on a reissue applicant to resubmit, in a reissue application, all the “References Cited” in the patent for which reissue is sought. Rather, applicant has a continuing duty under 37 CFR 1.56 to timely apprise the Office of any information which is material to the patentability of the claims under consideration in the reissue application. See MPEP § 1418.

Where a copy of a reference is not available and cannot be obtained through any source other than the reissue applicant (who has not submitted the copy), the examiner will not indicate on PTO-892 or an SB/08 submitted by applicant that a reference has been considered.<

## 1410 Content of Reissue Application [R-2]

*37 CFR 1.171. Application for reissue.*

An application for reissue must contain the same parts required for an application for an original patent, complying with all the rules relating thereto except as otherwise provided, and in addition, must comply with the requirements of the rules relating to reissue applications.

*37 CFR 1.173. Reissue specification, drawings, and amendments.*

(a) *Contents of a reissue application.* An application for reissue must contain the entire specification, including the claims, and the drawings of the patent. No new matter shall be introduced into the application. No reissue patent shall be granted enlarging the scope of the claims of the original patent unless applied for within two years from the grant of the original patent, pursuant to 35 U.S.C. 251.

(1) *Specification, including claims.* The entire specification, including the claims, of the patent for which reissue is requested must be furnished in the form of a copy of the printed patent, in double column format, each page on only one side of a single sheet of paper. If an amendment of the reissue application is to be included, it must be made pursuant to paragraph (b) of this section. The formal requirements for papers making up the reissue application other than those set forth in this section are set out in § 1.52. Additionally, a copy of any disclaimer (§ 1.321), certificate of correction (§§ 1.322 through 1.324), or reexamination certifi-

cate (§ 1.570) issued in the patent must be included. (See also § 1.178).

(2) *Drawings.* Applicant must submit a clean copy of each drawing sheet of the printed patent at the time the reissue application is filed. If such copy complies with § 1.84, no further drawings will be required. Where a drawing of the reissue application is to include any changes relative to the patent being reissued, the changes to the drawing must be made in accordance with paragraph (b)(3) of this section. The Office will not transfer the drawings from the patent file to the reissue application.

\*\*\*\*\*

The specification (including the claims and any drawings) of the reissue application is the copy of the printed patent for which reissue is requested that is submitted by applicant as part of the initial application papers. The copy of the printed patent must be submitted in double column format, each page of double column format being on only one side of the piece of paper. It should be noted that a re-typed specification is not acceptable in a reissue application; the full copy of the printed patent must be used. In addition, an applicant for reissue is required to file a reissue oath or declaration which, in addition to complying with 37 CFR 1.63, must comply with 37 CFR 1.175. Where the patent has been assigned, the reissue applicant must also provide a consent of assignee to the reissue and evidence of ownership. Where the patent has not been assigned, the reissue applicant should affirmatively state that the patent is not assigned.

An amendment may be submitted at the time of filing of a reissue application. The amendment may be made either by:

(A) physically incorporating the changes within the specification by cutting the column of the printed patent and inserting the added material and rejoining the remainder of the column; or

(B) providing a separate amendment paper with the reissue application.

In either case, the amendment must be made pursuant to 37 CFR 1.173(b) and must comply with all the provisions of 37 CFR 1.173(b)–(e) and (g).

Pursuant to 37 CFR 1.173(a)(1), applicant is required to include a copy of any disclaimer (37 CFR 1.321), certificate of correction (37 CFR 1.322 – 1.324), or reexamination certificate (37 CFR 1.520) issued in the patent for which reissue is requested. It should also be noted that 37 CFR 1.178(b) requires reissue applicants to call to the attention of the Office

any prior or concurrent proceedings in which the patent (for which reissue is requested) is or was involved, such as interferences, reissues, reexaminations, or litigation (litigation covers any papers filed in the court or issued by the court, such as, for example, motions, pleadings, and court decisions including court orders) and the results of such proceedings. This duty to submit such information is a continuing duty, and runs from the time the reissue application is filed until the reissue application is abandoned or issues as a reissue patent.

It is no longer required that the reissue applicant should file an offer to surrender the original patent, see MPEP § 1416; it is only necessary that the patent be surrendered before the application is allowed.

Where appropriate, the reissue applicant may provide a claim for priority >benefit< under 35 U.S.C. 119 or 120, and may also file an Information Disclosure Statement.

The initial contents of a reissue application are discussed in detail in MPEP § 1410.01 through § 1418.

For expedited processing, new and continuing reissue application filings under 37 CFR 1.53(b) may be addressed to \*\* >: Mail Stop REISSUE, Commissioner for Patents, P.O. Box 1450, Alexandria, VA 22313-1450. Mail Stop< REISSUE should only be used for the initial filing of reissue applications, and should \* >not< be used for any subsequently filed correspondence in reissue applications. >All new reissue filings should include a copy of a completed Reissue Patent Application Transmittal Form (PTO/SB/50) to ensure that the filing of the new application will be recognized as being for a reissue application.<

The oath or declaration, any matters ancillary thereto (such as the consent of assignee), and the filing fee may be submitted after the filing date pursuant to 37 CFR 1.53(f).

The requirement for the assignee to consent to filing a reissue no longer includes a requirement for applicant to order a title report with the filing of the reissue application. Rather, the assignee entity is established by a statement on behalf of all the assignees under 37 CFR 1.172(a) and 37 CFR 3.73(b). See MPEP § 1410.01.

Form PTO/SB/50, Reissue Patent Application Transmittal, may be used for filing reissue applications.

PTO/SB/50 (04-04)  
Approved for use through 04/30/2007. OMB 0651-0033  
U.S. Patent and Trademark Office; U.S. DEPARTMENT OF COMMERCE

Under the Paperwork Reduction Act of 1995, no persons are required to respond to a collection of information unless it displays a valid OMB control number.

<b>REISSUE PATENT APPLICATION TRANSMITTAL</b>																			
Address to:  <b>Mail Stop Reissue Commissioner for Patents P.O. Box 1450 Alexandria, VA 22313-1450</b>	Attorney Docket No. First Named Inventor Original Patent Number Original Patent Issue Date (Month/Day/Year) Express Mail Label No.																		
<b>APPLICATION FOR REISSUE OF:</b> (Check applicable box) <input type="checkbox"/> Utility Patent <input type="checkbox"/> Design Patent <input type="checkbox"/> Plant Patent																			
<b>APPLICATION ELEMENTS (37 CFR 1.173)</b>		<b>ACCOMPANYING APPLICATION PARTS</b>																	
1. <input type="checkbox"/> Fee Transmittal Form (PTO/SB/56) (Submit an original, and a duplicate for fee processing) 2. <input type="checkbox"/> Applicant claims small entity status. See 37 CFR 1.27. 3. <input type="checkbox"/> Specification and Claims in double column copy of patent format (amended, if appropriate) 4. <input type="checkbox"/> Drawing(s) (proposed amendments, if appropriate) 5. <input type="checkbox"/> Reissue Oath/Declaration (original or copy) (37 CFR 1.175) (PTO/SB/51 or 52) 6. <input type="checkbox"/> Power of Attorney 7. <input type="checkbox"/> Original U.S. Patent currently assigned? <input type="checkbox"/> Yes <input type="checkbox"/> No (If Yes, check applicable box(es)) <input type="checkbox"/> Written Consent of all Assignees (PTO/SB/53) <input type="checkbox"/> 37 CFR 3.73(b) Statement (PTO/SB/96) 8. <input type="checkbox"/> CD-ROM or CD-R in duplicate, Computer Program (Appendix) or large table 9. Nucleotide and/or Amino Acid Sequence Submission (if applicable, all of the following are necessary) a. <input type="checkbox"/> Computer Readable Form (CFR) b. Specification Sequence Listing on: i. <input type="checkbox"/> CD-ROM (2 copies) or CD-R (2 copies); or ii. <input type="checkbox"/> paper c. <input type="checkbox"/> Statements verifying identity of above copies		10. <input type="checkbox"/> Statement of status and support for all changes to the claims. See 37 CFR 1.173(c). 11. <input type="checkbox"/> Original Patent Grant <input type="checkbox"/> Ribbioned Original Patent Grant <input type="checkbox"/> Statement of Loss (PTO/SB/55) 12. <input type="checkbox"/> Foreign Priority Claim (35 U.S.C. 119) (if applicable) 13. <input type="checkbox"/> Information Disclosure Statement (IDS)/PTO-1449 <input type="checkbox"/> Copies of IDS Citations 14. <input type="checkbox"/> English Translation of Reissue Oath/Declaration (if applicable) 15. <input type="checkbox"/> Preliminary Amendment 16. <input type="checkbox"/> Return Receipt Postcard (MPEP 503) (Should be specifically itemized) 17. Other: _____ _____ _____																	
<b>18. CORRESPONDENCE ADDRESS</b>																			
<input type="checkbox"/> Customer Number: _____ OR <input type="checkbox"/> Correspondence address below																			
<table border="1" style="width: 100%; border-collapse: collapse;"> <tr> <td style="width: 20%;">Name</td> <td colspan="3"></td> </tr> <tr> <td>Address</td> <td colspan="3"></td> </tr> <tr> <td>City</td> <td style="width: 20%;">State</td> <td style="width: 20%;">Zip Code</td> <td></td> </tr> <tr> <td>Country</td> <td>Telephone</td> <td>Fax</td> <td></td> </tr> </table>				Name				Address				City	State	Zip Code		Country	Telephone	Fax	
Name																			
Address																			
City	State	Zip Code																	
Country	Telephone	Fax																	
Name (Print/Type)		Registration No. (Attorney/Agent)																	
Signature		Date																	

This collection of information is required by 37 CFR 1.173. The information is required to obtain or retain a benefit by the public which is to file (and by the USPTO to process) an application. Confidentiality is governed by 35 U.S.C. 122 and 37 CFR 1.14. This collection is estimated to take 12 minutes to complete, including gathering, preparing, and submitting the completed application form to the USPTO. Time will vary depending upon the individual case. Any comments on the amount of time you require to complete this form and/or suggestions for reducing this burden, should be sent to the Chief Information Officer, U.S. Patent and Trademark Office, U.S. Department of Commerce, P.O. Box 1450, Alexandria, VA 22313-1450. DO NOT SEND FEES OR COMPLETED FORMS TO THIS ADDRESS. SEND TO: **Mail Stop Reissue, Commissioner for Patents, P.O. Box 1450, Alexandria, VA 22313-1450.**  
 If you need assistance in completing the form, call 1-800-PTO-9199 and select option 2.

## 1410.01 Reissue Applicant, Oath or Declaration, and Consent of all Assignees [R-2]

### 37 CFR 1.172. Applicants, assignees.

(a) A reissue oath must be signed and sworn to or declaration made by the inventor or inventors except as otherwise provided (see §§ 1.42, 1.43, 1.47), and must be accompanied by the written consent of all assignees, if any, owning an undivided interest in the patent, but a reissue oath may be made and sworn to or declaration made by the assignee of the entire interest if the application does not seek to enlarge the scope of the claims of the original patent. All assignees consenting to the reissue must establish their ownership interest in the patent by filing in the reissue application a submission in accordance with the provisions of § 3.73(b) of this chapter.

(b) A reissue will be granted to the original patentee, his legal representatives or assigns as the interest may appear.

### 37 CFR 3.73. Establishing right of assignee to take action.

\*\*\*\*\*

\*\*>

(b)(1) In order to request or take action in a patent or trademark matter, the assignee must establish its ownership of the patent or trademark property of paragraph (a) of this section to the satisfaction of the Director. The establishment of ownership by the assignee may be combined with the paper that requests or takes the action. Ownership is established by submitting to the Office a signed statement identifying the assignee, accompanied by either:<

(i) Documentary evidence of a chain of title from the original owner to the assignee (*e.g.*, copy of an executed assignment). The documents submitted to establish ownership may be required to be recorded pursuant to § 3.11 in the assignment records of the Office as a condition to permitting the assignee to take action in a matter pending before the Office; or

(ii) A statement specifying where documentary evidence of a chain of title from the original owner to the assignee is recorded in the assignment records of the Office (*e.g.*, reel and frame number).

(2) The submission establishing ownership must show that the person signing the submission is a person authorized to act on behalf of the assignee by:

(i) Including a statement that the person signing the submission is authorized to act on behalf of the assignee; or

(ii) Being signed by a person having apparent authority to sign on behalf of the assignee, *e.g.*, an officer of the assignee.

(c) For patent matters only:

(1) Establishment of ownership by the assignee must be submitted prior to, or at the same time as, the paper requesting or taking action is submitted.

(2) If the submission under this section is by an assignee of less than the entire right, title and interest, such assignee must

indicate the extent (by percentage) of its ownership interest, or the Office may refuse to accept the submission as an establishment of ownership.

The reissue oath must be signed and sworn to by all the inventors, or declaration made by all the inventors, except as otherwise provided in 37 CFR 1.42, 1.43, and 1.47 (see MPEP § 409). Pursuant to 37 CFR 1.172, where the reissue application does *not* seek to enlarge the scope of any of the claims of the original patent, the reissue oath may be made and sworn to, or declaration made, by the assignee of the entire interest. Depending on the circumstances, either Form PTO/SB/51, Reissue Application Declaration by the Inventor, or Form PTO/SB/52, Reissue Application Declaration by the Assignee, may be used to prepare a declaration in a reissue application. These forms are reproduced in MPEP § 1414.

>If an inventor is to be added in a reissue application, a proper reissue oath or declaration including the signatures of all of the inventors is required. If one or more inventors are being deleted in a reissue application, an oath or declaration must be supplied over the signatures of the remaining inventors. Note that although an inventor being deleted in a reissue application need not sign the oath or declaration, if that inventor to be deleted has any ownership interest in the patent (*e.g.*, that inventor did not assign away his/her rights to the patent), the signature of that inventor must be supplied in the consent to filing the reissue application. See MPEP § 1412.04 as to correction of inventorship via reissue.<

## CONSENT TO THE REISSUE

Where no assignee exists, applicant should affirmatively state that fact. >This can be done by simply checking the 'NO' box of item 7 of Form PTO/SB/50 (which form may be signed by the inventors, or by a registered practitioner).< If the file record is silent as to the existence of an assignee, it will be presumed that *an assignee does exist*. This presumption should be set forth by the examiner in the first Office action alerting applicant to the requirement. It should be noted that the mere filing of a written assertion of small entity status in no way relieves applicant of the requirement to affirmatively state that no assignee exists.

Where a written assertion of small entity status, or other paper in file indicates that the application/patent is assigned, and there is no consent by the assignee named in the written assertion of small entity, the examiner should make inquiry into the matter in an Office action, even if the record otherwise indicates that the application/patent is not assigned.

The reissue oath or declaration must be accompanied by the written consent of all assignees. 35 U.S.C. 111(a) and 37 CFR 1.53(b) provide, however, for according an application a filing date if filed with a specification, including claim(s), and any required drawings. Thus, where an application is filed without an oath or declaration, or without the consent of all assignees, if the application otherwise complies with 37 CFR 1.53(b) and the reissue rules, the Office of Initial Patent Examination (OIPE) will accord a filing date and send out a notice of missing parts setting a period of time for filing the missing part and for payment of any surcharge required under 37 CFR 1.53(f) and 1.16(e). If the reissue oath or declaration is filed but the assignee consent is lacking, the surcharge is required because, until the consent is filed, the reissue oath or declaration is defective, since it is not apparent that the signatures thereon are proper absent an indication that the assignees have consented to the filing.

The consent of assignee must be signed by a party authorized to act on behalf of the assignee. See MPEP § 324 for a discussion of parties authorized to act on behalf of the assignee. The consent to the reissue application may use language such as:

The XYZ Corporation, assignee of U.S. Patent No. 9,999,999, consents to the filing of reissue application No. 09/999,999 (or the present application, if filed with the initial application papers) for the reissue of U.S. Patent No. 9,999,999.

---

Lilly M. Schor

Vice President,

XYZ Corporation

Where the written consent of all the assignees to the filing of the reissue application cannot be obtained, applicant may under appropriate circumstances petition to the Office of Petitions (MPEP § 1002.02(b)) for a waiver under 37 CFR 1.183 of the requirement

of 37 CFR 1.172, to permit the acceptance of the filing of the reissue application. The petition fee under 37 CFR 1.17(h) must be included with the petition.

The reissue application can then be examined, but will not be allowed or issued without the consent of all the assignees as required by 37 CFR 1.172. *See N. B. Fassett*, 1877 C.D. 32, 11 O.G. 420 (Comm'r Pat. 1877); *James D. Wright*, 1876 C.D. 217, 10 O.G. 587 (Comm'r Pat. 1876).

>Where a **continuation** reissue application is filed with a copy of the assignee consent from the parent reissue application, and the parent reissue application is not to be abandoned, the copy of the consent should not be accepted. Where a **divisional** reissue application is filed with a copy of the assignee consent from the parent reissue application, regardless of whether or not the parent reissue application is to be abandoned, the copy of the consent should not be accepted. The copy of the consent from the parent does not indicate that the assignee has consented to the addition of the new invention of the divisional reissue application to the original patent, or to the addition of the new error correction of the continuation reissue application. (Presumably, a new correction has been added via the continuation, since the parent is still pending.) As noted above, OIPE will accord a filing date and send out a notice of missing parts stating that there is no proper consent and setting a period of time for filing the missing part and for payment of any surcharge required under 37 CFR 1.53(f) and 1.16(e)

Where a continuation reissue application is filed with a copy of the assignee consent from the parent reissue application, and the parent reissue application is, or will be abandoned, the copy of the consent should be accepted by the Office<

Form paragraph 14.15 may be used to indicate that the consent of the assignee is lacking.

\*\*>

*¶ 14.15 Consent of Assignee to Reissue Lacking*

This application is objected to under 37 CFR 1.172(a) as lacking the written consent of all assignees owning an undivided interest in the patent. The consent of the assignee must be in compliance with 37 CFR 1.172. See MPEP § 1410.01.

A proper assent of the assignee in compliance with 37 CFR 1.172 and 3.73 is required in reply to this Office action.

**Examiner Note:**

1. This form paragraph may be used in an Office action which rejects any of the claims on other grounds.



2. If a consent document/statement has been submitted but is insufficient (e.g., not by all the assignees) or is otherwise ineffective (e.g., a conditional consent, or a copy of the consent from the parent reissue application was filed in this continuation reissue application and the parent reissue application is not being abandoned), an explanation of such is to be included following this form paragraph.

3. If the case is otherwise ready for allowance, this form paragraph should be followed by form paragraph 7.51 (insert the phrase --See above-- in bracket 1 of form paragraph 7.51).

<

## PROOF OF OWNERSHIP OF ASSIGNEE

The assignee that consents to the filing of the reissue application (as discussed above) must also establish that it is the assignee, *i.e.*, the owner, of the patent. See 37 CFR 1.172. *Accordingly, a 37 CFR 3.73(b) paper establishing the ownership of the assignee should be submitted at the time of filing the reissue application, in order to support the consent of the assignee.* The assignee must establish its ownership in accordance with 37 CFR 3.73(b) by:

(A) filing in the reissue application documentary evidence of a chain of title from the original owner to the assignee; or

(B) specifying in the record of the reissue application where such evidence is recorded in the Office (e.g., reel and frame number, etc.).

Documents that are submitted to establish ownership may be required to be recorded. Compliance with 37 CFR 3.73(b) may be provided as part of the same paper in which the consent by assignee is provided.

Upon initial receipt of a reissue application, the examiner should inspect the application to determine whether the submission under 37 CFR 1.172 and 37 CFR 3.73(b) establishing the ownership of the assignee is present and sufficient.

If an assignment document is attached with the 37 CFR 3.73(b) submission, the assignment should be reviewed to ensure that the named assignee is the same for the assignment document and the 37 CFR 3.73(b) statement, and that the assignment document is an assignment of the patent to be reissued to the assignee. If an assignment document is not attached with the 37 CFR 3.73(b) statement, but rather the reel and frame number where the assignment document is recorded in the USPTO is referenced in the 37 CFR 3.73(b) statement, it will be presumed that the assign-

ment recorded in the USPTO supports the statement identifying the assignee. It will not be necessary for the examiner to obtain a copy of the recorded assignment document. If the submission under 37 CFR 1.172 and 37 CFR 3.73(b) is not present, form paragraph 14.16 may be used to indicate that the assignee has not provided evidence of ownership.

### ¶ 14.16 Failure of Assignee To Establish Ownership

This application is objected to under 37 CFR 1.172(a) as the assignee has not established its ownership interest in the patent for which reissue is being requested. An assignee must establish its ownership interest *in order to support the consent to a reissue application required by 37 CFR 1.172(a)*. The assignee's ownership interest is established by:

(a) filing in the reissue application evidence of a chain of title from the original owner to the assignee, or

(b) specifying in the record of the reissue application where such evidence is recorded in the Office (e.g., reel and frame number, etc.).

The submission with respect to (a) and (b) to establish ownership must be signed by a party authorized to act on behalf of the assignee. See MPEP § 1410.01.

An appropriate paper satisfying the requirements of 37 CFR 3.73 must be submitted in reply to this Office action.

### Examiner Note:

1. This form paragraph may be used in an Office action which rejects any of the claims on other grounds.
2. If otherwise ready for allowance, this form paragraph should be followed by form paragraph 7.51 (insert the phrase --See above-- in bracket 1 of form paragraph 7.51).

Just as the consent of assignee must be signed by a party authorized to act on behalf of the assignee, the submission with respect to 37 CFR 3.73(b) to establish ownership must be signed by a party authorized to act on behalf of the assignee. The signature of an attorney or agent registered to practice before the Office is not sufficient, unless that attorney or agent is authorized to act on behalf of the assignee.

If the submission under 37 CFR 3.73(b) to establish ownership is not signed by a party authorized to act on behalf of the assignee, the appropriate paragraphs of form paragraphs 14.16.01 through 14.16.06 may be used.

### ¶ 14.16.01 Establishment of Ownership Not Signed by Appropriate Party

This application is objected to under 37 CFR 1.172(a) as the assignee has not established its ownership interest in the patent for which reissue is being requested. An assignee must establish its ownership interest *in order to support the consent to a reissue application required by 37 CFR 1.172(a)*. The submission establishing the ownership interest of the assignee is informal. There is

no indication of record that the party who signed the submission is an appropriate party to sign on behalf of the assignee. 37 CFR 3.73(b)

A proper submission establishing ownership interest in the patent, pursuant to 37 CFR 1.172(a), is required in response to this action.

**Examiner Note:**

1. This form paragraph should be followed: (a) by one of form paragraphs 14.16.02 through 14.16.04, (b) then by form paragraph 14.16.05, (c) then optionally by form paragraph 14.16.06.
2. See MPEP § 1410.01.

\*\*>

*¶ 14.16.02 Failure To State Capacity To Sign*

The person who signed the submission establishing ownership interest has failed to state his/her capacity to sign for the corporation or other business entity, and he/she has not been established as being authorized to act on behalf of the assignee. See MPEP § 324.

**Examiner Note:**

1. This form paragraph is to be used when the person signing the submission establishing ownership interest does not state his/her capacity (e.g., as a recognized officer) to sign for the assignee, and is not established as being authorized to act on behalf of the assignee.
2. Use form paragraph 14.16.06 to explain how an official, other than a recognized officer, may properly sign a submission establishing ownership interest.

<

*¶ 14.16.03 Lack of Capacity To Sign*

The person who signed the submission establishing ownership interest is not recognized as an officer of the assignee, and he/she has not been established as being authorized to act on behalf of the assignee. See MPEP § 324.

\*\*>

*¶ 14.16.04 Attorney/Agent of Record Signs*

The submission establishing ownership interest was signed by applicant's [I]. An attorney or agent of record is not authorized to sign a submission establishing ownership interest, unless he/she has been established as being authorized to act on behalf of the assignee. See MPEP § 324.

**Examiner Note:**

1. This form paragraph is to be used when the person signing the submission establishing ownership interest is an attorney or agent of record who is not an authorized officer as defined in MPEP § 324 and has not been established as being authorized to act on behalf of the assignee.
2. Use form paragraph 14.16.06 to explain how an official, other than a recognized officer, may properly sign a submission establishing ownership interest.
3. In bracket 1, insert either --attorney-- or --agent--.

*¶ 14.16.06 Criteria To Accept When Signed by a Non-Recognized Officer*

It would be acceptable for a person, other than a recognized officer, to sign a submission establishing ownership interest, provided the record for the application includes a duly signed statement that the person is empowered to sign a submission establishing ownership interest and/or act on behalf of the assignee.

Accordingly, a new submission establishing ownership interest which includes such a statement above, will be considered to be signed by an appropriate official of the assignee. A separately filed paper referencing the previously filed submission establishing ownership interest and containing a proper empowerment statement would also be acceptable.

**Examiner Note:**

1. This form paragraph MUST be preceded by form paragraphs 14.16.02, 14.16.03 or 14.16.04.
2. When one of form paragraphs 14.16.02, 14.16.03 or 14.16.04 is used to indicate that a submission establishing ownership interest is not proper because it was not signed by a recognized officer, this form paragraph should be used to point out one way to correct the problem.
3. While an indication of the person's title is desirable, its inclusion is not mandatory when this option is employed.

<

Where the submission establishes the assignee's ownership as to the patent, ownership as to the reissue application will be presumed. Accordingly, a submission as to the ownership of the patent will be construed to satisfy the 37 CFR 1.172 (and 37 CFR 3.73(b)) requirements for establishing ownership of the application. Thus, a terminal disclaimer can be filed in a reissue application where ownership of the patent has been \* >established,< without the need for a separate submission under 37 CFR 3.73(b) showing ownership of the reissue application.

Even if the submission states that it is establishing ownership of the reissue application (rather than the patent), the submission should be accepted by the examiner as also establishing ownership in the patent. The documentation in the submission establishing ownership of the reissue application \* >must,< of \* >necessity,< include chain of title as to the patent.

**COMPARISON OF ASSIGNEE THAT CONSENTS TO ASSIGNEE SET FORTH IN SUBMISSION ESTABLISHING OWNERSHIP INTEREST**

The examiner must inspect both the consent and documentary evidence of ownership to determine whether the requirements of 37 CFR 1.172 have been

met. The assignee \* >identified< by the documentary evidence must be the same assignee which signed the consent. Also, the person who signs the consent for the assignee and the person who signs the submission of evidence of ownership for the assignee must both be persons having authority to do so. See also MPEP § 324.

The reissue patent will be granted to the original patentee, his or her legal representatives or assigns as the interest may appear.

## 1411 Form of Specification [R-2]

*37 CFR 1.173. Reissue specification, drawings, and amendments.*

(a) *Contents of a reissue application.* An application for reissue must contain the entire specification, including the claims, and the drawings of the patent. No new matter shall be introduced into the application. No reissue patent shall be granted enlarging the scope of the claims of the original patent unless applied for within two years from the grant of the original patent, pursuant to 35 U.S.C. 251.

(1) *Specification, including claims.* The entire specification, including the claims, of the patent for which reissue is requested must be furnished in the form of a copy of the printed patent, in double column format, each page on only one side of a single sheet of paper. If an amendment of the reissue application is to be included, it must be made pursuant to paragraph (b) of this section. The formal requirements for papers making up the reissue application other than those set forth in this section are set out in § 1.52. Additionally, a copy of any disclaimer (§ 1.321), certificate of correction (§§ 1.322 through 1.324), or reexamination certificate (§ 1.570) issued in the patent must be included. (See also § 1.178).

(2) *Drawings.* Applicant must submit a clean copy of each drawing sheet of the printed patent at the time the reissue application is filed. If such copy complies with § 1.84, no further drawings will be required. Where a drawing of the reissue application is to include any changes relative to the patent being reissued, the changes to the drawing must be made in accordance with paragraph (b)(3) of this section. The Office will not transfer the drawings from the patent file to the reissue application.

\*\*\*\*\*

The file wrappers of all /08 and earlier series reissue applications are stamped “REISSUE” above the application number on the front of the file. “Reissue” also appears below the application number on the printed label on the file wrapper of the application with 08/ and earlier series.

Reissue applications filed after July of 1998 (09/ series and later) are placed in an orange and white striped file wrapper and can be easily identified as

reissue applications. >(For IFW Processing, see IFW Manual.)<

Reissue applications filed prior to November 7, 2000 should be furnished in the form of cut-up soft copies of the original patent, with only a single column of the printed patent securely mounted on a separate sheet of paper.

For reissue applications filed on or after November 7, 2000, 37 CFR 1.173(a)(1) requires that the application specification, including the claims, >must< be furnished in the form of a copy of the printed patent in double column format (so that the patent can be simply copied without cutting). \*\* >Applicants are required to submit a clean copy of each drawing sheet of the printed patent at the time the reissue application is filed (37 CFR 1.173(a)(2)). Any changes to the drawings must be made in accordance with 37 CFR 1.173(b)(3). Thus, a full copy of the printed patent (including the front page) is used to provide the abstract, drawings, specification, and claims of the patent for the reissue application. Each< page of the patent \* >must appear< on only one side of each individual page of the specification of the reissue application >; a two sided copy of the patent is not proper<. It should be noted that a re-typed specification is not acceptable in a reissue application; the full copy of the printed patent must be used. \*\* >If, however, the changes to be made to the patent are so extensive/ numerous that reading and understanding the specification is extremely difficult and error-prone, a clean copy of the specification may be submitted if accompanied by a grantable petition under 37 CFR 1.183 for waiver of 37 CFR 1.125(d) and 37 CFR 1.173(a)(1)<.

Pursuant to 37 CFR 1.173(b), amendments may be made **at the time of filing** of a reissue application. The amendment may be made either by:

(A) physically incorporating the changes within the specification by cutting the column of the printed patent and inserting the added material and rejoining the remainder of the column; or

(B) providing a preliminary amendment (a separate amendment paper) directing that specified changes be made to the copy of the printed patent.

The presentation of the insertions or deletions as part of the original reissue specification is an amendment under 37 CFR 1.173(b). An amendment of the reissue application made at the time of filing of the

reissue application must be made in accordance with 37 CFR 1.173(b)-(e) and (g); see MPEP § 1453. Thus, as required by 37 CFR 1.173(c), an amendment of the claims made at the time of filing of a reissue application must include a separate paper setting forth the status of all claims (i.e., pending or canceled), and an explanation of the support in the disclosure of the patent for the changes made to the claims.

If a chart, table, or chemical formula is amended and it spans two columns of the patent, it should not be split. Rather, the chart, table, or chemical formula should be provided in its entirety *as part of the column of the patent to which it pertains*, in order to provide a continuity of the description. When doing so, the chart, table, or chemical formula may extend beyond the width of the column. Change in only a part of a word or chemical formula is not permitted. Entire words or chemical formulas must be shown as being changed. Deletion of a chemical formula should be shown by brackets which are substantially larger and darker than any in the formula.

>Where a terminal disclaimer was filed in the application for the patent to be reissued, a copy of that terminal disclaimer is not needed in the reissue application file. (The face of the file wrapper of the reissue application should, however, be marked in order to indicate that a terminal disclaimer has been filed for the patent (and will be effective for the patent as it will be reissued)). (For IFW processing, see IFW Manual.)<

Twice reissued patent:

Examples of the form for a twice-reissued patent are found in Re. 23,558 and Re. 28,488. Double underlining and double bracketing are used in the second reissue application, while **bold**-faced type and double bracketing appear in the printed patent (the second reissue patent) to indicate further insertions and deletions, respectively, in the second reissue patent.

When a copy of a first reissue patent is used as the specification of a second reissue application (filed as a reissue of a reissue), additions made by the first reissue will already be printed in italics, and should remain in such format. Thus, applicants need only present additions to the specification/claims in the second reissue application as double underlined text. Subject matter to be deleted from the first reissue

patent should be presented in the second reissue application within sets of double brackets.

### 1411.01 Certificate of Correction or Disclaimer in Original Patent [R-2]

The applicant should include any changes, additions, or deletions that were made by a Certificate of Correction to the original patent grant in the reissue application without underlining or bracketing. The examiner should \* make certain that all Certificate of Correction changes in the patent have been properly incorporated into the reissue application.

Certificate of Correction changes and disclaimer of claim(s) under 37 CFR 1.321(a) should be made without using underlining or brackets. Since these are part of the original patent and were made before the reissue was filed, they should show up in the printed reissue >patent< document as part of the original patent, i.e., not in italics or bracketed. If the changes are extensive and/or applicant has submitted them improperly with underlining and brackets, a clean copy of the specification with the Certificate of Correction changes in it may be requested by the examiner. >In order for the clean copy to be entered as a substitute specification, the reissue applicant must file a grantable petition under 37 CFR 1.183 for waiver of 37 CFR 1.125(d) and 37 CFR 1.173(a)(1). The examiner's request for the clean copy will generally serve as sufficient basis for granting the petition.<

### 1411.02 New Matter

New matter, that is, matter not present in the patent sought to be reissued, is excluded from a reissue application in accordance with 35 U.S.C. 251.

The claims in the reissue application must be for subject matter which the applicant had the right to claim in the original patent. Any change in the patent made via the reissue application should be checked to ensure that it does not introduce new matter. Note that new matter may exist by virtue of the omission of a feature or of a step in a method. See *United States Industrial Chemicals, Inc. v. Carbide & Carbon Chemicals Corp.*, 315 U.S. 668, 53 USPQ 6 (1942).

Form paragraph 14.22.01 may be used where new matter has been added anywhere in "the application for reissue" as prohibited by 35 U.S.C. 251.

¶ 14.22.01 *Rejection, 35 U.S.C. 251, New Matter*

Claim [1] rejected under 35 U.S.C. 251 as being based upon new matter added to the patent for which reissue is sought. The added material which is not supported by the prior patent is as follows: [2]

**Examiner Note:**

1. In bracket 2, fill in the applicable page and line numbers and provide an explanation of your position, as appropriate.
2. A rejection under 35 U.S.C. 112, first paragraph, should also be made if the new matter is added to the claims or is added to the specification and affects the claims. If new matter is added to the specification and does not affect the claims, an objection should be made based upon 35 U.S.C. 132 using form paragraph 7.28.

## 1412 Content of Claims

The content of claims in a reissue application is somewhat limited, as is indicated in MPEP § 1412.01 through MPEP § 1412.03.

### 1412.01 Reissue Claims Must Be for Same General Invention [R-2]

The reissue claims must be for the same invention as that \* >**disclosed**< as being the invention in the original patent, as required by 35 U.S.C. 251. This does *not* mean that the invention claimed in the reissue must have been claimed in the original patent, although this is evidence that applicants considered it their invention. The entire disclosure, not just the claim(s), is considered in determining what the patentee objectively intended as his or her invention. The proper test as to whether reissue claims are for the same invention as that disclosed as being the invention in the original patent is “an essentially factual inquiry confined to the objective intent manifested by the **original patent.**” *In re Amos*, 953 F.2d 613, 618, 21 USPQ2d 1271, 1274 (Fed. Cir. 1991) (quoting *In re Rowand*, 526 F.2d 558, 560, 187 USPQ 487, 489 (CCPA 1975)) (emphasis added). See also *In re Mead*, 581 F.2d 257, 198 USPQ 412 (CCPA 1978). The “original patent” requirement of 35 U.S.C. 251 must be understood in light of *In re Amos*, *supra*, where the Court of Appeals for the Federal Circuit stated:

We conclude that, under both *Mead* and *Rowand*, a claim submitted in reissue may be rejected under the “original patent” clause if the original specification demonstrates, to one skilled in the art, an absence of disclosure sufficient to indicate that a patentee could have claimed the subject matter. Merely finding that the subject matter was “not originally claimed, not an object of the original patent,

and not depicted in the drawing,” does not answer the essential inquiry under the “original patent” clause of § 251, which is whether one skilled in the art, reading the specification, would identify the subject matter of the new claims as invented and disclosed by the patentees. In short, the absence of an “intent,” even if objectively evident from the earlier claims, the drawings, or the original objects of the invention is simply not enough to establish that the new claims are not drawn to the invention disclosed in the original patent.

953 F.2d at 618-19, 21 USPQ2d at 1275. Claims presented in a reissue application are considered to satisfy the requirement of 35 U.S.C. 251 that the claims be “for the invention disclosed in the original patent” where:

(A) the claims presented in the reissue application are described in the original patent specification and enabled by the original patent specification such that 35 U.S.C. 112 first paragraph is satisfied; and

(B) nothing in the original patent specification indicates an intent not to claim the subject matter of the claims presented in the reissue application.

>The presence of< some disclosure (description and enablement) in the original patent should evidence that applicant intended to claim or that applicant considered the material now claimed to be his or her invention.

The original patent specification would indicate an intent not to claim the subject matter of the claims presented in the reissue application in a situation analogous to the following:

The original patent specification discloses that composition X is not suitable (or not satisfactory) for molding an item because composition X fails to provide quick drying. After the patent issues, it is found that composition X would be desirable for the molding in spite of the failure to provide quick drying, because of some other newly recognized benefit from composition X. A claim to composition X or a method of use thereof would not be permitted in a reissue application, because the original patent specification contained an explicit statement of intent *not* to claim composition X or a method of use thereof.

In most instances, however, the mere failure to claim a disclosed embodiment in the original patent (absent an explicit statement in the original patent specification of unsuitability of the embodiment)

would **not** be grounds for prohibiting a claim to that embodiment in the reissue.

### >FAILURE TO TIMELY FILE A DIVISIONAL APPLICATION PRIOR TO ISSUANCE OF ORIGINAL PATENT

Where a restriction requirement was made in an application and applicant permitted the elected invention to issue as a patent without the filing of a divisional application on the non-elected invention(s), the non-elected invention(s) cannot be recovered by filing a reissue application. A reissue applicant's failure to timely file a divisional application covering the non-elected invention(s) in response to a restriction requirement is not considered to be error causing a patent granted on the elected claims to be partially inoperative by reason of claiming less than the applicant had a right to claim. Accordingly, such error is not correctable by reissue of the original patent under 35 U.S.C. 251. *In re Watkinson*, 900 F.2d 230, 14 USPQ2d 1407 (Fed. Cir. 1990); *In re Orita*, 550 F.2d 1277, 1280, 193 USPQ 145, 148 (CCPA 1977). See also *In re Mead*, 581 F.2d 251, 198 USPQ 412 (CCPA 1978). In this situation, the reissue claims should be rejected under 35 U.S.C. 251 for lack of defect in the original patent and lack of error in obtaining the original patent. Compare with *In re Doyle*, 293 F.3d 1355, 63 USPQ2d 1161 (Fed. Cir. 2002) where the court permitted the patentee to file a reissue application to present a so-called linking claim, a claim broad enough to read on or link the invention elected (and patented) together with the invention not elected. The non-elected invention(s) were inadvertently not filed as a divisional application.<

## 1412.02 Recapture of Canceled Subject Matter [R-2]

\*\* >A reissue will not be granted to 'recapture' claimed subject matter which was surrendered in an application to obtain the original patent. *Pannu v. Storz Instruments Inc.*, 258 F.3d 1366, 59 USPQ2d 1597 (Fed. Cir. 2001); *Hester Industries, Inc. v. Stein, Inc.*, 142 F.3d 1472, 46 USPQ2d 1641 (Fed. Cir. 1998); *In re Clement*, 131 F.3d 1464, 45 USPQ2d 1161 (Fed. Cir. 1997); *Ball Corp. v. United States*, 729 F.2d 1429, 1436, 221 USPQ 289, 295 (Fed. Cir. 1984); *In re Wadlinger*, 496 F.2d 1200, 181 USPQ

826 (CCPA 1974); *In re Richman*, 409 F.2d 269, 276, 161 USPQ 359, 363-364 (CCPA 1969); *In re Willingham*, 282 F.2d 353, 127 USPQ 211 (CCPA 1960).

### I. THREE STEP TEST FOR RECAPTURE:

*In Clement*, 131 F.3d at 1468-70, 45 USPQ2d at 1164-65, the Court of Appeals for the Federal Circuit set forth a three step test for recapture analysis. In *Pannu*, 258 F.3d at 1371, 59 USPQ2d at 1600, the court restated this test as follows:

Application of the recapture rule is a three-step process.

The **first step** is to 'determine whether and in what aspect the reissue claims are broader than the patent claims.'....

'The **second step** is to determine whether the broader aspects of the reissued claim related to surrendered subject matter' ....

**Finally**, the court must determine whether the reissued claims were materially narrowed in other respects to avoid the recapture rule. [Emphasis added]

#### A. *The First Step - Was There Broadening?*

In every reissue application, the examiner must first review each claim for the presence of broadening, as compared with the scope of the claims of the patent to be reissued. A reissue claim is broadened where some limitation of the patent claims is no longer required in the reissue claim; see MPEP § 1412.03 for guidance as to the nature of a 'broadening claim.' If the reissue claim is not broadened in any respect as compared to the patent claims, the analysis ends; there is no recapture.

#### B. *The Second Step - Does Any Broadening Aspect of the Reissued Claim Relate to Surrendered Subject Matter?*

Where a claim in a reissue application is broadened in some respect as compared to the patent claims, the examiner must next determine whether the broadening aspect(s) of that reissue claim relate(s) to subject matter that applicant previously surrendered during the prosecution of the original application (which became the patent to be reissued). Each limitation of the patent claims, which is omitted or broadened in the reissue claim, must be reviewed for this determination. This involves two sub-steps:

## 1. The Two Sub-Steps:

(A) It must first be determined whether there was any surrender of subject matter made in the prosecution of the original application which became the patent to be reissued.

If an original patent claim limitation now being omitted or broadened in the present reissue application was originally relied upon by applicant in the original application to make the claims allowable over the art, the omitted limitation relates to subject matter previously surrendered by applicant. The reliance by applicant to define the original patent claims over the art can be by way of presentation of new/amended claims to define over the art, or an argument/statement by applicant that a limitation of the claim(s) defines over the art. To determine whether such reliance occurred, the examiner must review the prosecution history of the original application file (of the patent to be reissued) for recapture. The prosecution history includes the rejections and applicant's arguments made therein.

If there was no surrender of subject matter made in the prosecution of the original application, again the analysis ends and there is no recapture.

(B) If there was a surrender of subject matter in the original application prosecution, it must then be determined whether any of the broadening of the reissue claims is in the area of the surrendered subject matter. All of the broadening aspects of reissue claims must be analyzed to determine if any of the omitted/broadened limitation(s) are directed to limitations relied upon by applicant in the original application to make the claims allowable over the art.

## 2. Examples of the *Pannu* Second Step Analysis:

### (A) Example (1) - Argument without amendment:

In *Hester, supra*, the Federal Circuit held that the surrender which forms the basis for impermissible recapture "can occur through arguments alone". 142 F.3d at 1482, 46 USPQ2d at 1649. For example, assume that limitation A of the patent claims is omitted in the reissue claims. This omission provides a broadening aspect in the reissue claims, as compared to the claims of the patent. If the omitted limitation A was argued in the original application to make the application claims allowable over the art in the appli-

cation, then the omitted limitation relates to subject matter previously surrendered in the original application, and recapture will exist. Accordingly, where claims are broadened in a reissue application, the examiner should review the prosecution history of the original patent file for recapture, even where the claims were never amended during the prosecution of the application which resulted in the patent.

Note: The argument that the claim limitation defined over the rejection must have been specific as to the limitation relied upon, rather than a general statement regarding the claims as a whole. A general 'boiler plate' sentence in the original application will not, by itself, be sufficient to establish surrender and recapture.

An example of a general "boiler plate" sentence of argument is:

"In closing, it is argued that the limitations of claims 1-7 distinguish the claims from the teachings of the prior art, and claims 1-7 are thus patentable."

An argument that merely states that all the limitations of the claims define over the prior art will also not, by itself, be sufficient to establish surrender and recapture. An example is:

"Claims 1-5 set forth a power-train apparatus which comprises the combination of A+B+C+D+E. The prior art of record does not disclose or render obvious a motivation to provide for a material-transfer apparatus as defined by the limitations of claim 1, including an A member and a B member, both connected to a C member, with all three being aligned with the D and E members."

This statement is simply a restatement of the entirety of claim 1 as allowed. No measure of surrender could be gleaned from such a statement of reasons for allowance. See *Ex parte Yamaguchi*, 61 USPQ2d 1043 (Bd. Pat. App. & Inter. 2001)(reported but unpublished, precedential).

In both of the above examples, the argument does not provide an indication of what specific limitations, e.g., specific element or step of the claims, cooperative effect, or other aspect of the claims, are being relied upon for patentability. Thus, applicant has not surrendered anything.

### (B) Example (2) - Amendment of the claims without argument:

The limitation omitted in the reissue claim(s) was added in the original application claims for the pur-

pose of making the application claims allowable over a rejection or objection made in the application. Even though applicant made no argument on the record that the limitation was added to obviate the rejection, the nature of the addition to the claim can show that the limitation was added in direct reply to the rejection. This too will establish the omitted limitation as relating to subject matter previously surrendered. To illustrate this, note the following example:

The original application claims recite limitations A+B+C, and the Office action rejection combines two references to show A+B+C. In the amendment replying to the Office action, applicant adds limitation D to A+B+C in the claims, but makes no argument as to that addition. The examiner then allows the claims. Even though there is no argument as to the addition of limitation D, it must be presumed that the D limitation was added to obviate the rejection. The subsequent deletion of (omission of) limitation D in the reissue claims would be presumed to be a broadening in an aspect of the reissue claims related to surrendered subject matter. Accordingly, the reissued claims would be barred by the recapture doctrine.

The above result would be the same whether the addition of limitation D in the original application was by way of applicant's amendment or by way of an examiner's amendment with authorization by applicant.

(C) Example (3) - Who can make the surrendering argument?

Assume that the limitation A omitted in the reissue claims was present in the claims of the original application. The examiner's reasons for allowance in the original application stated that it was that limitation A which distinguished over a potential combination of references X and Y. Applicant did not present on the record a counter statement or comment as to the examiner's reasons for allowance, and permitted the claims to issue.

*Ex parte Yamaguchi*, supra, held that a surrender of claimed subject matter cannot be based solely upon an applicant's failure to respond to, or failure to challenge, an examiner's statement made during the prosecution of an application. Applicant is bound only by applicant's revision of the application claims or a positive argument/statement by *applicant*. An applicant's failure to present on the record a counter statement or comment as to an examiner's reasons for allowance

does not give rise to any implication that applicant agreed with or acquiesced in the examiner's reasoning for allowance. Thus, the failure to present a counter statement or comment as to the examiner's statement of reasons for allowance does not give rise to any finding of surrender. **The examiner's statement of reasons for allowance in the original application cannot, by itself, provide the basis for establishing surrender and recapture.**

It is only in the situation where applicant does file comments on the statement of reasons for allowance, that surrender may have occurred. Note the following two scenarios in which an applicant files comments:

*Scenario 1- There is Surrender:* The examiner's statement of reasons for allowance in the original application stated that it was limitation C (of the combination of ABC) which distinguished over a potential combining of references X and Y, in that limitation C provided increased speed to the process. Applicant filed comments on the examiner's statement of reasons for allowance essentially supporting the examiner's reasons. The limitation C is thus established as relating to subject matter previously surrendered.

*Scenario 2- There is No Surrender:* On the other hand, if applicant's comments on the examiner's statement of reasons for allowance contain a counter statement that it is limitation B (of the combination of ABC), rather than C, which distinguishes the claims over the art, then limitation B would constitute surrendered subject matter, and limitation C has not been surrendered.

**C. *The Third Step - Were the reissued claims materially narrowed in other respects to compensate for the broadening in the area of surrender, and thus avoid the recapture rule?***

As pointed out above, the third prong of the recapture determination set forth in *Pannu* is directed to analysis of the broadening and narrowing effected via the reissue claims, and of the significance of the claim limitations added and deleted, using the prosecution history of the patent (to be reissued), to determine whether the reissue claims should be barred as recapture.

The following discussion addresses analyzing the reissue claims, and *which claims* are to be compared to the reissue claims in determining the issue of surrender (for reissue recapture).



When analyzing a reissue claim for the possibility of impermissible recapture, there are two different types of analysis that must be performed. If the reissue claim 'fails' either analysis, recapture exists.

First, the reissue claim must be compared to any claims canceled or amended during prosecution of the original application. It is impermissible recapture for a reissue claim to be as broad or broader in scope than any claim that was canceled or amended in the original prosecution to define over the art. Claim scope that was canceled or amended is deemed surrendered and therefore barred from reissue. *In re Clement, supra*.

Second, it must be determined whether the reissue claim entirely omits any limitation that was added/argued during the original prosecution to overcome an art rejection. Such an omission in a reissue claim, even if it includes other limitations making the reissue claim narrower than the patent claim in other aspects, is impermissible recapture. *Pannu v. Storz Instruments Inc., supra*. However, if the reissue claim recites a broader form of the key limitation added/argued during original prosecution to overcome an art rejection (and therefore not entirely removing that key limitation), then the reissue claim may not be rejected under the recapture doctrine. *Ex Parte Eggert*, 67 USPQ2d 1716 (Bd. Pat. App. & Inter. 2003) (precedential). For example, if the key limitation added to overcome an art rejection was "an orange peel," and the reissue claim instead recites "a citrus fruit peel", the reissue claim may not be rejected on recapture grounds.

The following discussion is provided for analyzing the reissue claims.

### 1. Comparison of Reissue Claims Narrowed/Broadened Vis-à-vis the Canceled Claims

DEFINITION: "Canceled claims," in the context of recapture case law, are claims canceled from the original application to obtain the patent for which reissue is now being sought. The claims

(A) can simply be canceled and not replaced by others, or

(B) can be canceled and replaced by other claims which are more specific than the canceled claims in at least one aspect (to thereby define over the art of record). The "replacement claims" can be new claims which are narrower than the canceled claims, or can

be the same claims amended to be narrower than the canceled version of the claims.

#### (a) **Reissue Claims are Same or Broader in Scope Than Canceled Claims in All Aspects:**

The recapture rule bars the patentee from acquiring, through reissue, claims that are in all aspects (A) of the same scope as, or (B) broader in scope than, those claims canceled from the original application to obtain a patent. *In re Ball Corp. v. United States*, 729 F.2d at 1436, 221 USPQ at 295.

#### (b) **Reissue Claims are Narrower in Scope Than Canceled Claims in at Least One Aspect:**

If the reissue claims are equal in scope to, or narrower than, the claims of the original patent (as opposed to the claims "canceled from the application") in all aspects, then there can never be recapture. The discussion that follows is not directed to that situation. It is rather directed to the situation where the *reissue claims are narrower than the claims 'canceled' from the application in some aspect, but are broader than the claims of the original patent in some other aspect*.

If the reissue claims are narrower in scope than the claims canceled from the original application by inclusion of *the limitation added to define the original application claims over the art*, there will be no recapture, even if the reissue claims are broader than the canceled claims in some other aspect (i.e., an aspect not related to the surrender made in the original application).

Assume combination AB was originally presented in the application, and was amended in response to an art rejection to add element C and thus provide ABC (after which the patent issued). The reissue claims are then directed to combination AB<sub>broadened</sub>C. The AB<sub>broadened</sub>C claims are *narrower* in scope when compared with the canceled claim subject matter AB *in respect to the addition of C* (which was added in the application to overcome the art), and there is no recapture.

As another example, assume combination ABZ was originally presented in the application, and was amended in response to an art rejection to add element C and thus provide ABZC (after which the patent issued). The reissue claims are then directed to combination ABC (i.e., element Z is deleted from the can-

celed claims, while element C remains present). The ABC claims of the reissue are *narrower* in scope as compared to the canceled-from-the-original-application claim subject matter ABZ *in respect to the addition of C* (which was added in the application to overcome the art), and there is thus no recapture.

## 2. Comparison of Reissue Claims Narrowed/Broadened *Via-à-vis* the Patent Claims

The 'patent claims,' in the context of recapture case law, are claims which issued in the original patent for which reissue is now being sought. As pointed out above, where the reissue claims are narrower than the claims of the original patent in all aspects, then there can never be recapture. If reissue claims are equal in scope to the patent claims, there is no recapture as to those reissue claims. Where, however, reissue claims are both broadened and narrowed as compared with the original patent claims, the nature of the broadening and narrowing must be examined to determine whether the reissue claims are barred as being recapture of surrendered subject matter. If the claims are 'broader than they are narrower in a manner directly pertinent to the subject matter... surrendered during prosecution' (*Clement*, 131 F.3d at 1471, 45 USPQ2d at 1166), then recapture will bar the claims. This narrowing/broadening *vis-à-vis* the patent is broken down into four possibilities that will now be addressed.

The "limitation" presented, argued, or stated to make the claims patentable over the art (in the application) "generates" the surrender of claimed subject matter. For the sake of simplification, this limitation will be referred to throughout this section as the *surrender-generating limitation*. If a claim is presented in a reissue application that omits, in its entirety, the surrender-generating limitation, that claim impermissibly recaptures what was previously surrendered, and that claim is barred under 35 U.S.C. 251. This terminology will be used in the discussion of the four categories of narrowing/broadening *vis-à-vis* the **patent** that follows.

### (a) **Reissue Claims are Narrower in Scope Than Patent Claims, in Area Not Directed to Amendment/Argument Made to Overcome Art Rejection in Original Prosecution; are Broader in Scope by Omitting Limitation(s) Added/Argued To Overcome Art Rejection in Original Prosecution:**

In this case, there is recapture.

This situation is where the patent claims are directed to combination ABC and the reissue claims are directed to ABD. Element C was either a limitation added to AB to obtain allowance of the original patent, or was argued by applicant to define over the art (or both). Thus, addition of C (and/or argument as to C) has resulted in the surrender of any combination of A & B that does not include C; this is the surrendered subject matter. Element D, on the other hand, is not related to the surrendered subject matter. Thus, the reissue claim, which no longer contains C, is broadened in an area related to the surrender, and the narrowing via the addition of D does not save the claim from recapture since D is not related to the surrendered subject matter.

Reissue claims that are broader than the original patent claims by not including the surrender-generating limitation (element C, in the example given) will be barred by the recapture rule even though there is narrowing of the claims not related to the surrender-generating limitation. As stated in the decision of *In re Clement*, 131 F.3d at 1470, 45 USPQ2d at 1165, if the reissue claim is broader in an aspect germane to a prior art rejection, but narrower in another aspect completely unrelated to the rejection, the recapture rule bars the claim. *Pannu v. Storz Instruments Inc.*, *supra*, then brings home the point by providing an actual fact situation in which this scenario was held to be recapture.

### (b) **Reissue Claims are Narrower or Equal in Scope, in Area Directed to Amendment/Argument Made to Overcome Art Rejection in Original Prosecution; are Broader in Scope in Area Not Directed to Amendment/Argument:**

In this case, there is no recapture.

This situation is where the patent claims are directed to combination ABCDE and the reissue claims are directed to ABDE (element C is omitted).

Assume that the combination of ABCD was present in the original application as it was filed, and element E was later added to define over that art. No argument was ever presented as to elements A-C defining over the art.

In this situation, the ABCDE combination of the patent can be broadened (in the reissue application) to omit element C, and thereby claim the combination of ABDE, where element E (the surrender generating limitation) is not omitted. There would be no recapture in this instance. (If an argument had been presented as to element C defining over the art, in addition to the addition of element E, then the ABCDE combination could not be broadened to omit element C and thereby claim combination of ABDE. This would be recapture; see the above discussion as to surrender and recapture based upon argument.)

Additionally, the reissue claims are certainly permitted to recite combination ABDE<sub>specific</sub> (where surrender-generating element E is narrowed). The patent claims have been broadened in an area not directed to the surrender (by omitting element C) and narrowed in the area of surrender (by narrowing element E to E<sub>specific</sub>). This is clearly permitted.

As another example, assume limitation C was added to application claims AB to obtain the patent to ABC, and now the reissue application presents claims to AC or AB<sub>broad</sub>C. Such reissue claims avoid the effect of the recapture rule because they are broader in a way that does not attempt to reclaim what was surrendered earlier. *Mentor Corp. v. Coloplast, Inc.*, 998 F.2d 992, 994, 27 USPQ2d 1521, 1525 (Fed. Cir. 1993). Such claims are considered to be broader in an aspect not 'germane to a prior art rejection,' and thus are not barred by recapture. Note *In re Clement*, 131 F.3d at 1470, 45 USPQ2d at 1165.

Reissue claims that are broader than the original patent claims by deletion of a limitation or claim requirement other than the "surrender-generating limitation" will avoid the effect of the recapture rule, regardless of the nature of the narrowing in the claims, and even if the claims are not narrowed at all from the scope of the patent claims.

**(c) Reissue Claims are Narrower in Scope in Area Not Directed to Amendment/Argument Made to Overcome Art Rejection in Original Prosecution; are Broader in Scope in Area Not Directed to the Amendment/Argument:**

In this instance, there is clearly no recapture. In the reissue application, there has been no change in the claims related to the matter surrendered in the original application for the patent.

In this instance, element C was added to the AB combination to provide ABC and define over the art, and the patent was issued. The reissue omits element B and adds element Z, to thus claim ACZ. There is no recapture since the surrender generating element C has not been modified in any way. (Note, however, that if, when element C was added to AB, applicant argued that the association of newly added C with B provides a synergistic (unexpected) result to thus define over the art, then neither B nor C could be omitted in the reissue application.)

**(d) Reissue Claims Broader in Scope in Area Directed to Amendment/Argument Made to Overcome Art Rejection in Original Prosecution; but Reissue Claims Retain, in Broadened Form, the Limitation(s) Argued/Added to Overcome Art Rejection in Original Prosecution:**

Assume the combination AB was originally claimed in the application, and was amended in reply to an art rejection to add element C and thus provide the combination ABC (after which the patent issued). A reissue application is then filed, and the reissue application claims are directed to the combination ABC<sub>broadened</sub>. The ABC<sub>broadened</sub> claims are narrowed in scope when compared with the canceled claim subject matter AB, because of the addition of C<sub>broadened</sub>. Thus, the claims retain, in broadened form, the limitation argued/added to overcome art rejection in original prosecution. There is no recapture, since ABC<sub>broadened</sub> is narrower than canceled claim subject matter AB in an area related to the surrender. This is so, because it was element C that was added in the application to overcome the art. See *Ex Parte Eggert, supra*.

## II. < REISSUE TO TAKE ADVANTAGE OF 35 U.S.C. 103(b):

A patentee may file a reissue application to permit consideration of process claims which qualify for 35 U.S.C. 103(b) treatment if a patent is granted on an application entitled to the benefit of 35 U.S.C. 103(b), without an election having been made as a result of error without deceptive intent. See MPEP § 706.02(n). **This is not to be considered a recapture.** The addition of process claims, however, will generally be considered to be a *broadening* of the invention (*Ex parte Wikdahl*, 10 USPQ2d 1546 (Bd. Pat. App. & Inter. 1989)), and such addition must be applied for within two years of the grant of the original patent. See also MPEP § 1412.03 as to broadened claims.

>

## III. < REISSUE FOR ARTICLE CLAIMS WHICH ARE FUNCTIONAL DESCRIPTIVE MATERIAL STORED ON A COMPUTER-READABLE MEDIUM:

A patentee may file a reissue application to permit consideration of article of manufacture claims which are functional descriptive material stored on a computer-readable medium, where these article claims correspond to the process or machine claims which have been patented. The error in not presenting claims to this statutory category of invention (the “article” claims) must have been made as a result of error without deceptive intent. The addition of these “article” claims will generally be considered to be a *broadening* of the invention (*Ex parte Wikdahl*, 10 USPQ2d 1546 (Bd. Pat. App. & Inter. 1989)), and such addition must be applied for within two years of the grant of

the original patent. See also MPEP § 1412.03 as to broadened claims.

>

## IV. < REJECTION BASED UPON RECAPTURE:

Reissue claims which recapture surrendered subject matter should be rejected using form paragraph 14.17.

\*\*>

### ¶ 14.17 Rejection, 35 U.S.C. 251, Recapture

Claim[1] rejected under 35 U.S.C. 251 as being an improper recapture of broadened claimed subject matter surrendered in the application for the patent upon which the present reissue is based. See *Pannu v. Storz Instruments Inc.*, 258 F.3d 1366, 59 USPQ2d 1597 (Fed. Cir. 2001); *Hester Industries, Inc. v. Stein, Inc.*, 142 F.3d 1472, 46 USPQ2d 1641 (Fed. Cir. 1998); *In re Clement*, 131 F.3d 1464, 45 USPQ2d 1161 (Fed. Cir. 1997); *Ball Corp. v. United States*, 729 F.2d 1429, 1436, 221 USPQ 289, 295 (Fed. Cir. 1984). A broadening aspect is present in the reissue which was not present in the application for patent. The record of the application for the patent shows that the broadening aspect (in the reissue) relates to subject matter that applicant previously surrendered during the prosecution of the application. Accordingly, the narrow scope of the claims in the patent was not an error within the meaning of 35 U.S.C. 251, and the broader scope surrendered in the application for the patent cannot be recaptured by the filing of the present reissue application.

[2]

### Examiner Note:

In bracket 2, the examiner should explain the specifics of why recapture exists, including an identification of the omitted/broadened claim limitations in the reissue which provide the “broadening aspect” to the claim(s), and where in the original application the narrowed claim scope was presented/argued to obviate a rejection/objection. See MPEP § 1412.02.

See the recapture-analysis flow chart which follows for assistance in determining whether recapture is present, consistent with the case law discussed above.

>

**Reissue Recapture - Determining its presence or absence**

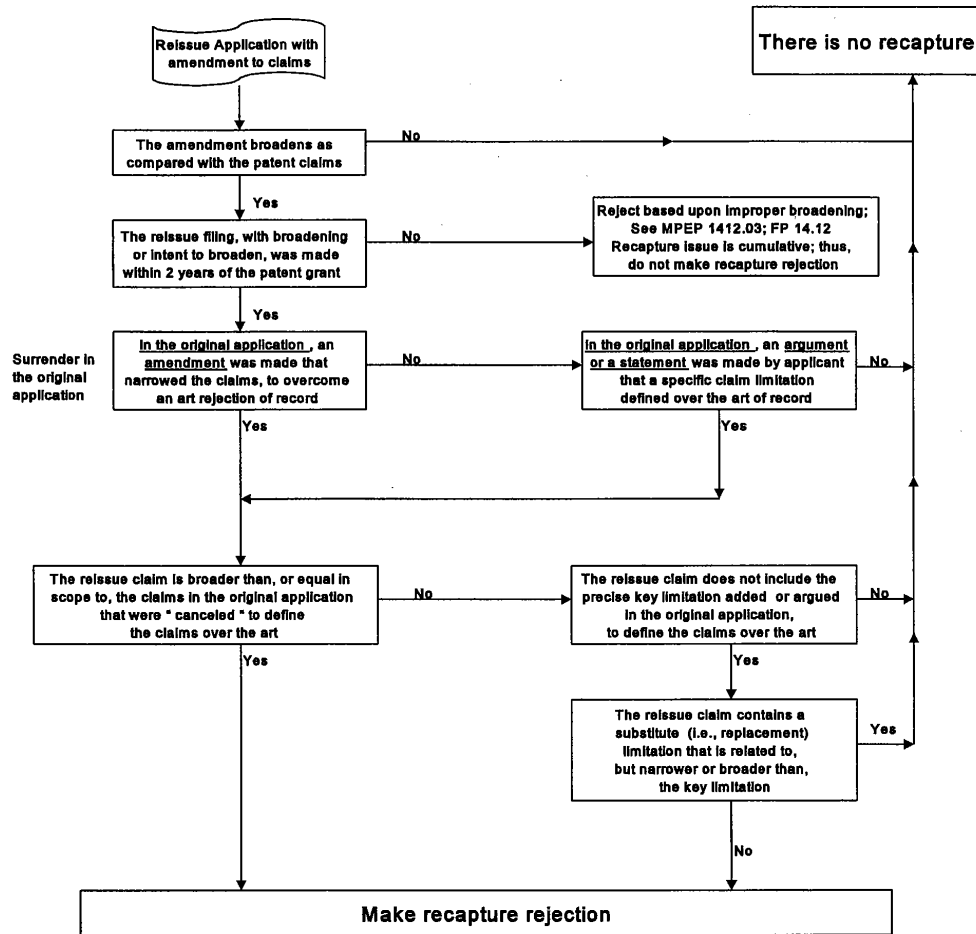

<

### 1412.03 Broadening Reissue Claims [R-2]

35 U.S.C. 251 prescribes a 2-year limit for filing applications for broadening reissues:

No reissue patent shall be granted enlarging the scope of the original patent unless applied for within two years from the grant of the original patent.

#### MEANING OF “BROADENED REISSUE CLAIM”

A broadened reissue claim is a claim which enlarges the scope of the claims of the patent, *i.e.*, a claim which is greater in scope than each and every claim of the original patent. If a disclaimer is filed in the patent prior to the filing of a reissue application, the disclaimed claims are not part of the “original patent” under 35 U.S.C. 251. The Court in *Vectra Fitness Inc. v. TNWK Corp.*, 49 USPQ2d 1144, 1147, 162 F.3d 1379, 1383 (Fed. Cir. 1998) held that a reissue application violated the statutory prohibition under 35 U.S.C. 251 against broadening the scope of the patent more than 2 years after its grant because the reissue claims are broader than the claims that remain after the disclaimer, even though the reissue claims are narrower than the claims that were disclaimed by the patentee before reissue. The reissue application was bounded by the claims remaining in the patent after a disclaimer is filed. A claim of a reissue application enlarges the scope of the claims of the patent if it is broader in *at least one* respect, even though it may be narrower in other respects.

A claim in the reissue which includes subject matter not covered by the patent claims enlarges the scope of the patent claims. For example, if any amended or newly added claim in the reissue contains within its scope any conceivable product or process which would not have infringed the patent, then that reissue claim would be broader than the patent claims. *Tillotson, Ltd. v. Walbro Corp.*, 831 F.2d 1033, 1037 n.2, 4 USPQ2d 1450, 1453 n.2 (Fed. Cir. 1987); *In re Ruth*, 278 F.2d 729, 730, 126 USPQ 155, 156 (CCPA 1960); *In re Rogoff*, 261 F.2d 601, 603, 120 USPQ 185, 186 (CCPA 1958). A claim which reads on something which the original claims do not is a broadened claim. A claim would be considered a broadening claim if the patent owner would be able to sue any party for infringement who previously could not have been

sued for infringement. Thus, where the original patent claims only the process, and the reissue application adds (for the first time) product claims, the scope of the claims has been broadened since a party could not be sued for infringement of the product based on the claims of the original patent.

The addition of combination claims in a reissue application where only subcombination claims were present in the original patent could be a broadening of the invention. The question which must be resolved in this case is whether the combination claims added in the reissue would be for “the invention as claimed” in the original patent. See *Ex parte Wikdahl*, 10 USPQ2d at 1549. The newly added combination claims should be analyzed to determine whether they contain every limitation of the subcombination of any claim of the original patent. If the combination claims (added in the reissue) contain every limitation of the subcombination (which was claimed in the original application), then infringement of the combination must also result in infringement of the subcombination. Accordingly, the patent owner **could not**, if a reissue patent issues with the combination claims, **sue any new party** for infringement who could not have been sued for infringement of the original patent. Therefore, **broadening does not exist**, in spite of the addition of the combination.

\*\*

#### SCOPE OF DEPENDENT CLAIM ENLARGED-NOT BROADENING

As pointed out above, a claim will be considered a broadened reissue claim when it is greater in scope than **each and every** claim of the patent to be reissued. A corollary of this is that a claim which has been *broadened in a reissue as compared to its scope in the patent* is not a broadened reissue claim if it is narrower than, or equal in scope to, any other claim which appears in the patent. A common example of this is where dependent claim 2 is broadened via the reissue (other than the addition of a process step to convert an intermediate to a final product as discussed in the preceding subsection), but independent claim 1 on which it is based is not broadened. Since a dependent claim is construed to contain all the limitations of the claim upon which it depends, claim 2 must be at least as narrow as claim 1 and is thus not a broadened reissue claim.

### NEW CATEGORY OF INVENTION ADDED IN REISSUE - >GENERALLY NOT< BROADENING

The addition of process claims as a new category of invention to be claimed in the patent (*i.e.*, where there were no method claims present in the original patent) is generally considered as being a broadening of the invention. See *Ex parte Wikdahl*, 10 USPQ2d 1546 (Bd. Pat. App. & Inter. 1989). >A situation may arise, however, where the reissue application adds a limitation (or limitations) to process A of making the product A claimed in the original patent claims. For example:

- (1) a process of using the product A (made by the process of the original patent) to make a product B, disclosed but not claimed in the original patent; or
- (2) a process of using the product A to carry out a process B disclosed but not claimed in the original patent.

Although this amendment of the claims adds a method of making product B or adds a method of using product A, this is not broadening (*i.e.*, this is not an enlargement of the scope of the original patent) because the 'newly claimed invention' contains all the limitations of the original patent claim(s).<

### WHEN A BROADENED CLAIM CAN BE PRESENTED

A broadened claim can be presented within two years from the grant of the original patent in a reissue application. In addition, a broadened claim can be presented *after* two years from the grant of the original patent in a broadening reissue which was filed *within* two years from the grant. Where any intent to broaden is indicated in the reissue application within the two years from the patent grant, a broadened claim can subsequently be presented in the reissue after the two year period. Finally, if intent to broaden is indicated in a parent reissue application within the two years, a broadened claim can be presented in a continuing reissue application after the two year period. In any other situation, a broadened claim cannot be presented, and the examiner should check carefully for the improper presentation of broadened claims.

A reissue application filed on the 2-year anniversary date from the patent grant is considered to be

filed within 2 years of the patent grant. See *Switzer v. Sockman*, 333 F.2d 935, 142 USPQ 226 (CCPA 1964) for a similar rule in interferences.

See also the following cases which pertain to broadened reissues:

*In re Graff*, 111 F.3d 874, 877, 42 USPQ2d 1471, 1473-74 (Fed. Cir. 1997) (Broadened claims in a continuing reissue application were properly rejected under 35 U.S.C. 251 because the proposal for broadened claims was not made (in the parent reissue application) within two years from the grant of the original patent and the public was not notified that broadened claims were being sought until after the two-year period elapsed.);

*In re Fotland*, 779 F.2d 31, 228 USPQ 193 (Fed. Cir. 1985), *cert. denied*, 476 U.S. 1183 (1986) (The failure by an applicant to include *an oath or declaration indicating a desire to seek broadened claims* within two years of the patent grant will bar a subsequent attempt to broaden the claims after the two year limit. Under the former version of 37 CFR 1.175 (the former 37 CFR 1.175(a)(4)), applicant timely sought a "no-defect" reissue, but the Court did not permit an attempt made beyond the two year limit to convert the reissue into a broadening reissue. In this case, applicant did not indicate any intent to broaden within the two years.);

*In re Bennett*, 766 F.2d 524, 528, 226 USPQ 413, 416 (Fed. Cir. 1985) (*en banc*) (A reissue application with broadened claims was filed within two years of the patent grant; however, the declaration was executed by the assignee rather than the inventor. The Federal Circuit permitted correction of the improperly executed declaration to be made more than two years after the patent grant.);

*In re Doll*, 419 F.2d 925, 928, 164 USPQ 218, 220 (CCPA 1970) (If the reissue application is timely filed within two years of the original patent grant and the applicant indicates in the oath or declaration that the claims will be broadened, then applicant may subsequently broaden the claims in the pending reissue prosecution even if the additional broadening occurs beyond the two year limit.).

Form paragraphs 14.12 and 14.13 may be used in rejections based on improper broadened reissue claims.

¶ 14.12 Rejection, 35 U.S.C. 251, Broadened Claims After Two Years

Claim [1] rejected under 35 U.S.C. 251 as being broadened in a reissue application filed outside the two year statutory period. [2] A claim is broader in scope than the original claims if it contains within its scope any conceivable product or process which would not have infringed the original patent. A claim is broadened if it is broader in any one respect even though it may be narrower in other respects.

**Examiner Note:**

The claim limitations that broaden the scope should be identified and explained in bracket 2. See MPEP §§ 706.03(x) and 1412.03.

¶ 14.13 Rejection, 35 U.S.C. 251, Broadened Claims Filed by Assignee

Claim [1] rejected under 35 U.S.C. 251 as being improperly broadened in a reissue application made and sworn to by the assignee and not the patentee. [2] A claim is broader in scope than the original claims if it contains within its scope any conceivable product or process which would not have infringed the original patent. A claim is broadened if it is broader in any one respect even though it may be narrower in other respects.

**Examiner Note:**

The claim limitations that broaden the scope should be identified and explained in bracket 2. See MPEP §§ 706.03(x) and 1412.03.

**BROADENING REISSUE - OATH/DECLARATION REQUIREMENTS**

A broadening reissue application must be applied for by all of the inventors (patentees), that is, the original reissue oath or declaration must be signed by all of the inventors. See also MPEP § 1414. If a supplemental oath or declaration in a broadening reissue application is needed in the application in order to fulfill the requirements of 37 CFR 1.175, the supplemental reissue oath or declaration must be signed by all of the inventors. See *In re Hayes*, 53 USPQ2d 1222 (Comm'r Pat. 1999) and MPEP § 1414.01.

**1412.04 Correction of Inventorship [R-2]**

The correction of misjoinder of inventors has been held to be a ground for reissue. See *Ex parte Scudder*, 169 USPQ 814, 815 (Bd. App. 1971) wherein the Board held that 35 U.S.C. 251 authorizes reissue applications to correct misjoinder of inventors where 35 U.S.C. 256 is inadequate. See also *A.F. Stoddard & Co. v. Dann*, 564 F.2d 556, 567 n.16, 195 USPQ 97, 106 n.16 (D.C. Cir. 1977) wherein correction of inventorship from sole inventor A to sole inventor B

was permitted in a reissue application. The court noted that reissue by itself is a vehicle for correcting inventorship in a patent.

**CERTIFICATE OF CORRECTION AS A VEHICLE FOR CORRECTING INVENTORSHIP**

While reissue is a vehicle for correcting inventorship in a patent, correction of inventorship should be effected under the provisions of 35 U.S.C. 256 and 37 CFR 1.324 by filing a request for a Certificate of Correction if:

- (A) the only change being made in the patent is to correct the inventorship; and
- (B) all parties are in agreement and the inventorship issue is not contested.

See MPEP § 1481 for the procedure to be followed to obtain a Certificate of Correction for correction of inventorship.

**REISSUE AS A VEHICLE FOR CORRECTING INVENTORSHIP**

Where the provisions of 35 U.S.C. 256 and 37 CFR 1.324 do not apply, a reissue application is the appropriate vehicle to correct inventorship. The failure to name the correct inventive entity is an error in the patent which is correctable under 35 U.S.C. 251. The reissue oath or declaration pursuant to 37 CFR 1.175 must state that the applicant believes the original patent to be wholly or partly inoperative or invalid through error of a person being incorrectly named in an issued patent as the inventor, or through error of an inventor incorrectly not named in an issued patent, and that such error arose without any deceptive intention on the part of the applicant. The reissue oath or declaration must, as stated in 37 CFR 1.175, also comply with 37 CFR 1.63.

The correction of inventorship does not enlarge the scope of the patent claims. Where a reissue application does not seek to enlarge the scope of the claims of the original patent, the reissue oath may be made and sworn to, or the declaration made, by the assignee of the entire interest under 37 CFR 1.172. An assignee of part interest may not file a reissue application to correct inventorship where the other co-owner did not join in the reissue application and has not consented to the reissue proceeding. See *Baker Hughes Inc. v. Kirk*, 921 F. Supp. 801, 809, 38 USPQ2d 1885,



(D.D.C. 1995). See 35 U.S.C. 251, third paragraph. Thus, the signatures of the inventors are not needed on the reissue oath or declaration where the assignee of the entire interest signs the reissue oath/declaration. Accordingly, an assignee of the entire interest can add or delete an inventor by reissue (*e.g.*, correct inventorship from inventor A to inventors A and B) without the original inventor's consent. See also 37 CFR 3.71(a) ("One or more assignees as defined in paragraph (b) of this section may, after becoming of record pursuant to paragraph (c) of this section, conduct prosecution of a national patent application or reexamination proceeding **to the exclusion of either the inventive entity**, or the assignee(s) previously entitled to conduct prosecution." Emphasis added). Thus, the assignee of the entire interest can file a reissue to change the inventorship to one which the assignee believes to be correct, even though an inventor might disagree. The protection of the assignee's property rights in the application and patent are statutorily based in 35 U.S.C. 118.

Where a reissue to correct inventorship also changes the claims to enlarge the scope of the patent claims, the signature of all the inventors *is needed*. However, if an inventor refuses to sign the reissue oath or declaration because he or she believes the change in inventorship (to be effected) is not correct, the reissue application can still be filed with a petition under 37 CFR 1.47 without that inventor's signature. It is the assignee who controls correction of inventorship.

The reissue application with its reissue oath or declaration under 37 CFR 1.175 provides a complete mechanism to correct inventorship. See *A.F. Stoddard & Co. v. Dann*, 564 F.2d at 567, 195 USPQ at 106. A request under 37 CFR 1.48 or a petition under 37 CFR 1.324 cannot be used to correct the inventorship of a reissue application. If a request under 37 CFR 1.48 or a petition under 37 CFR 1.324 is filed in a reissue application, the request or petition should be dismissed and the processing or petition fee refunded. The material submitted with the request or petition should then be considered to determine if it complies with 37 CFR 1.175. If the material submitted with the request or petition does comply with the requirements of 37 CFR 1.175 (and the reissue application is otherwise in order), the correction of inventorship will be

permitted as a correction of an error in the patent under 35 U.S.C. 251.

Where a reissue application seeks to correct inventorship in the patent and the inventors are required to sign the reissue oath or declaration (rather than an assignee of the entire interest under 37 CFR 1.172) due to a broadening of any claims of the original patent, the correct inventive entity must sign the reissue oath or declaration. Where an inventor **is being added** in a reissue application to correct inventorship in a patent, the inventor being added must sign the reissue oath or declaration together with the inventors previously designated on the patent. For example, a reissue application is filed to correct the inventorship from inventors A and B (listed as inventors on the patent) to inventors A, B, and C. Inventor C is the inventor being added. In such a case, A, B, and C are the correct inventors, and accordingly, each of A, B, and C must sign the reissue oath or declaration. Where an inventor **is being deleted** in a reissue application to correct inventorship in a patent and the inventors are required to sign the oath or declaration due to a broadening of any claims of the original patent, the inventor being deleted need not sign the reissue oath or declaration. The reissue oath or declaration must be signed by the correct inventive entity. For example, a reissue application is filed to correct inventorship from inventors A, B, and C (listed as inventors on the patent) to inventors A and B. Inventor C is being deleted as a named inventor. In such a case, A and B are the correct inventors, and accordingly, inventors A and B must sign the reissue oath or declaration but inventor C need not sign the reissue oath or declaration.

## 1413 Drawings [R-2]

37 CFR 1.173. *Reissue specification, drawings, and amendments.*

\*\*\*\*\*

(a)(2) Drawings. Applicant must submit a clean copy of each drawing sheet of the printed patent at the time the reissue application is filed. If such copy complies with § 1.84, no further drawings will be required. Where a drawing of the reissue application is to include any changes relative to the patent being reissued, the changes to the drawing must be made in accordance with paragraph (b)(3) of this section. The Office will not transfer the drawings from the patent file to the reissue application.

\*\*\*\*\*

A clean copy (e.g., good quality photocopies free of any extraneous markings) of each drawing sheet of the printed patent must be supplied by the applicant at the time of filing of the reissue application. If the copies meet the requirements of 37 CFR 1.84, no further formal drawings will be required. New drawing sheets are not to be submitted, unless some change is made in the original patent drawings. Such changes must be made in accordance with 37 CFR 1.173(b)(3).

The prior reissue practice of transferring drawings from the patent file has been eliminated, since clean photocopies of the printed patent drawings are acceptable for use in the printing of the reissue patent.

### AMENDMENT OF DRAWINGS

*37 CFR 1.173. Reissue specification, drawings, and amendments.*

\*\*\*\*\*

\*\*>

(b)(3) *Drawings.* One or more patent drawings shall be amended in the following manner: Any changes to a patent drawing must be submitted as a replacement sheet of drawings which shall be an attachment to the amendment document. Any replacement sheet of drawings must be in compliance with § 1.84 and shall include all of the figures appearing on the original version of the sheet, even if only one figure is amended. Amended figures must be identified as “Amended,” and any added figure must be identified as “New.” In the event that a figure is canceled, the figure must be surrounded by brackets and identified as “Canceled.” All changes to the drawing(s) shall be explained, in detail, beginning on a separate sheet accompanying the papers including the amendment to the drawings.<

\*\*\*\*\*

The provisions of 37 CFR 1.173(b)(3) govern the manner of making amendments (changes) to the drawings in a reissue application. The following guidance is provided as to the procedure for amending drawings:

(A) Amending the original or printed patent drawing sheets by physically changing or altering them is not permitted. Any request to do so should be denied.

(B) Where a change to the drawings is desired, \*\*>applicant must submit a replacement sheet for each sheet of drawings containing a Figure to be revised. Any replacement sheet must comply with 37 CFR 1.84 and include all of the figures appearing on the original version of the sheet, even if only one figure is being amended. Each figure that is amended must be

identified by placing the word “Amended” at the bottom of that figure. Any added figure must be identified as “New.” In the event that a figure is canceled, the figure must be identified as “Canceled” and also surrounded by brackets. All changes to the figure(s) must be explained, in detail, beginning on a separate sheet which accompanies the papers including the amendment to the drawings.

(C) If desired, applicant may include a marked-up copy of any amended drawing figure, including annotations indicating the changes made. Such a marked-up copy must be clearly labeled as “Annotated Marked-up Drawings”, and it must be presented in the amendment or remarks section that explains the change to the drawings.

In addition, the examiner may desire a marked-up copy of any amended drawing figure, and so state in an Office action. A marked-up copy of any amended drawing figure, including annotations indicating the changes made, must be provided when required by the examiner.<

(D) For each proper new drawing sheet being added, the new sheet should be inserted after the existing drawing sheets. For each proper \* drawing sheet >being added< which replaces an existing drawing sheet, the existing sheet should be canceled by placing the sheet face down in the file and placing a large "X" on the back of the sheet. The new sheet should be inserted in place of the turned over existing sheet.

(E) If any drawing change \* is not \* >approved,< or if any submitted sheet of formal drawings is not entered, the examiner will so inform the reissue applicant in the next Office action, and the examiner will set forth the reasons for same.

### 1414 Content of Reissue Oath/Declaration [R-2]

*37 CFR 1.175. Reissue oath or declaration.*

(a) The reissue oath or declaration in addition to complying with the requirements of § 1.63, must also state that:

(1) The applicant believes the original patent to be wholly or partly inoperative or invalid by reason of a defective specification or drawing, or by reason of the patentee claiming more or less than the patentee had the right to claim in the patent, stating at least one error being relied upon as the basis for reissue; and

(2) All errors being corrected in the reissue application up to the time of filing of the oath or declaration under this paragraph arose without any deceptive intention on the part of the applicant.

(b)(1) For any error corrected, which is not covered by the oath or declaration submitted under paragraph (a) of this section, applicant must submit a supplemental oath or declaration stating that every such error arose without any deceptive intention on the part of the applicant. Any supplemental oath or declaration required by this paragraph must be submitted before allowance and may be submitted:

(i) With any amendment prior to allowance; or

(ii) In order to overcome a rejection under 35 U.S.C. 251 made by the examiner where it is indicated that the submission of a supplemental oath or declaration as required by this paragraph will overcome the rejection.

(2) For any error sought to be corrected after allowance, a supplemental oath or declaration must accompany the requested correction stating that the error(s) to be corrected arose without any deceptive intention on the part of the applicant.

(c) Having once stated an error upon which the reissue is based, as set forth in paragraph (a)(1), unless all errors previously stated in the oath or declaration are no longer being corrected, a subsequent oath or declaration under paragraph (b) of this section need not specifically identify any other error or errors being corrected.

(d) The oath or declaration required by paragraph (a) of this section may be submitted under the provisions of § 1.53(f).

The reissue oath/declaration is an essential part of a reissue application and must be filed with the application, or within the time period set under 37 CFR 1.53(f) along with the required surcharge as set forth in 37 CFR 1.16(e) in order to avoid abandonment.

The question of the sufficiency of the reissue oath/declaration filed under 37 CFR 1.175 must in each case be reviewed and decided personally by the primary examiner.

Reissue oaths or declarations must contain the following:

(A) A statement that the applicant believes the original patent to be wholly or partly inoperative or invalid—

(1) by reason of a defective specification or drawing, or

(2) by reason of the patentee claiming more or less than patentee had the right to claim in the patent;

(B) A statement of at least one error which is relied upon to support the reissue application, *i.e.*, as the basis for the reissue;

(C) A statement that all errors which are being corrected in the reissue application up to the time of filing of the oath/declaration arose without any deceptive intention on the part of the applicant; and

(D) The information required by 37 CFR 1.63.

These elements will now be discussed:

**I. A STATEMENT THAT THE APPLICANT BELIEVES THE ORIGINAL PATENT TO BE WHOLLY OR PARTLY INOPERATIVE OR INVALID BY REASON OF A DEFECTIVE SPECIFICATION OR DRAWING, OR BY REASON OF THE PATENTEE CLAIMING MORE OR LESS THAN PATENTEE HAD THE RIGHT TO CLAIM IN THE PATENT.**

In order to satisfy this requirement, a declaration can state:

“Applicant believes the original patent to be partly inoperative or invalid by reason of a defective specification or drawing.”

Alternatively, a declaration can state:

“Applicant believes the original patent to be partly inoperative or invalid by reason of the patentee claiming more or less than patentee had the right to claim in the patent.”

Where the specification or drawing is defective and patentee claimed more or less than patentee had the right to claim in the patent, then *both* statements should be included in the reissue oath/declaration. See MPEP § 1412.04 for an exemplary declaration statement when the error being corrected is an error in inventorship.

The above examples will be sufficient to satisfy this requirement without any further statement.

Form paragraph 14.01 may be used where the reissue oath/declaration does not provide the required statement as to applicant’s belief that the original patent is wholly or partly inoperative or invalid.

*¶ 14.01 Defective Reissue Oath/Declaration, 37 CFR 1.175(a)(1) - No Statement of Defect in the Patent*

The reissue oath/declaration filed with this application is defective because it fails to contain the statement required under 37 CFR 1.175(a)(1) as to applicant’s belief that the original patent is wholly or partly inoperative or invalid. See 37 CFR 1.175(a)(1) and see MPEP § 1414. [1]

**Examiner Note:**

1. Use this form paragraph when applicant: (a) fails to allege that the original patent is inoperative or invalid and/or (b) fails to state the reason of a defective specification or drawing, or of patentee claiming more or less than patentee had the right to claim in

the patent . In bracket 1, point out the specific defect to applicant by using the language of (a) and/or (b), as it is appropriate.

2. Form paragraph 14.14 must follow this form paragraph.

## II. A STATEMENT OF AT LEAST ONE ERROR WHICH IS RELIED UPON TO SUPPORT THE REISSUE APPLICATION (I.E., THE BASIS FOR THE REISSUE).

>

(A) < A reissue applicant must acknowledge the existence of an error in the specification, drawings, or claims, which error causes the original patent to be defective. *In re Wilder*, 736 F.2d 1516, 222 USPQ 369 (Fed. Cir. 1984). A change or departure from the original specification or claims represents an “error” in the original patent under 35 U.S.C. 251. See MPEP § 1402 for a discussion of grounds for filing a reissue that may constitute the “error” required by 35 U.S.C. 251. Not all changes with respect to the patent constitute the “error” required by 35 U.S.C. 251.

>

(B) < Applicant need only specify in the reissue oath/declaration one of the errors upon which reissue is based. Where applicant specifies one such error, this requirement of a reissue oath/declaration is satisfied. Applicant may specify more than one error.

Where more than one error is specified in the oath/declaration and some of the designated “errors” are found to not be “errors” under 35 U.S.C. 251, any remaining error which is an error under 35 U.S.C. 251 will still support the reissue.

The “at least one error” which is relied upon to support the reissue application must be set forth in the oath/declaration. It is not necessary, however, to point out how (or when) the error arose or occurred. Further, it is not necessary to point out how (or when) the error was discovered. If an applicant chooses to point out these matters, the statements directed to these matters will not be reviewed by the examiner, and the applicant should be so informed in the next Office action. All that is needed for the oath/declaration statement as to error is the identification of “at least one error” relied upon.

In identifying the error, it is sufficient that the reissue oath/declaration identify a single word, phrase, or expression in the specification or in an original claim, and how it renders the original patent wholly or partly inoperative or invalid. The corresponding corrective action which has been taken to

correct the original patent need not be identified in the oath/declaration. If the initial reissue oath/declaration “states at least one error” in the original patent, and, *in addition*, recites the specific corrective action taken in the reissue application, the oath/declaration would be considered acceptable, even though the corrective action statement is not required.

>

(C) < It is not sufficient for an oath/declaration to merely state “this application is being filed to correct errors in the patent which may be noted from the changes made in the disclosure.” Rather, the oath/declaration must specifically identify an error. In addition, it is not sufficient to merely reproduce the claims with brackets and underlining and state that such will identify the error. See *In re Constant*, 827 F.2d 728, 729, 3 USPQ2d 1479 (Fed. Cir.), *cert. denied*, 484 U.S. 894 (1987). Any error in the claims must be identified by reference to the specific claim(s) and the specific claim language wherein lies the error.

>

(D) Where a continuation reissue application is filed with a copy of the reissue oath/declaration from the parent reissue application, and the parent reissue application is not to be abandoned, the reissue oath/declaration should be accepted by the Office of Initial Patent Examination without further evaluation, since it is an oath/declaration, albeit improper under 35 U.S.C. 251. The examiner should reject the claims of the continuation reissue application under 35 U.S.C. 251 as being based on an oath/declaration that does not identify an error being corrected by the continuation reissue application, and should require a new oath/declaration.

Where a continuation reissue application is filed with a copy of the reissue oath/declaration from the parent reissue application, and the parent reissue application is, or will be abandoned, the copy of the reissue oath/declaration should be accepted by OIPE, and the examiner should check to ensure that the oath/declaration identifies an error which is still being corrected in the continuation application. If a preliminary amendment was filed with the continuation reissue application, the examiner should check for the need of a supplemental reissue oath/declaration. Pursuant to 37 CFR 1.175 (b)(1) , for any error corrected via the preliminary amendment which is not covered by the oath or declaration submitted in the parent reissue

application, applicant must submit a supplemental oath/declaration stating that such error arose without any deceptive intention on the part of the applicant. See MPEP § 1414.01.<

Where a divisional reissue application is filed with a copy of the reissue oath/declaration from the parent reissue application, the reissue oath/declaration should be accepted by OIPE, since it is an oath/declaration, though it may be improper under 35 U.S.C. 251. The examiner should check the copy of the oath/declaration to ensure that it identifies an error being corrected by the divisional reissue application. The copy of the oath/declaration from the parent reissue application may or may not cover an error being corrected by the divisional reissue application since the divisional reissue application is (by definition) directed to a new invention. If it does not, the examiner should reject the claims of the divisional reissue application under 35 U.S.C. 251 as being based on an oath/declaration that does not identify an error being corrected by the divisional reissue application, and require a new oath/declaration. If the copy of the reissue oath/declaration from the parent reissue application does in fact cover an error being corrected in the divisional reissue application, no such rejection should be made. However, since a new invention is being added by the filing of the divisional reissue application, a supplemental reissue oath/declaration pursuant to 37 CFR 1.175 (b)(1) will be required. See MPEP § 1414.01.

Form paragraph 14.01.01 may be used where the reissue oath/declaration does not identify an error.

*¶ 14.01.01 Defective Reissue Oath/Declaration, 37 CFR 1.175(a)(1) - No Statement of a Specific Error*

The reissue oath/declaration filed with this application is defective because it fails to identify at least one error which is relied upon to support the reissue application. See 37 CFR 1.175(a)(1) and MPEP § 1414.

**Examiner Note:**

1. Use this form paragraph when the reissue oath or declaration does not contain any statement of an error which is relied upon to support the reissue application.
2. This form paragraph can be used where the reissue oath or declaration does not even mention error. It can also be used where the reissue oath or declaration contains some discussion of the concept of error but never in fact identifies a specific error to be relied upon. For example, it is not sufficient for an oath or declaration to merely state “this application is being filed to correct

errors in the patent which may be noted from the changes made in the disclosure.”

3. Form paragraph 14.14 must follow this form paragraph.

Where the reissue oath/declaration does identify an error or errors, the oath/declaration must be checked carefully to ensure that at least one of the errors identified is indeed an “error” which will support the filing of a reissue, i.e., an “error” that will provide grounds for reissue of the patent. See MPEP § 1402. If the error identified in the oath/declaration is not an appropriate error upon which a reissue can be based, then the oath/declaration must be indicated to be defective in the examiner’s Office action.

Form paragraphs 14.01.02 and 14.01.03 may be used where the reissue oath/declaration fails to provide at least one error upon which a reissue can be based.

*¶ 14.01.02 Defective Reissue Oath/Declaration, 37 CFR 1.175(a)(1)-The Identified “Error” Is Not Appropriate Error*

The reissue oath/declaration filed with this application is defective because the error which is relied upon to support the reissue application is not an error upon which a reissue can be based. See 37 CFR 1.175(a)(1) and MPEP § 1414.

**Examiner Note:**

1. Use this form paragraph when the reissue oath/declaration identifies only one error which is relied upon to support the reissue application, and that one error is not an appropriate error upon which a reissue can be based.
2. Form paragraph 14.14 must follow this form paragraph.

*¶ 14.01.03 Defective Reissue Oath/Declaration, 37 CFR 1.175(a)(1) - Multiple Identified “Errors” Not Appropriate Errors*

The reissue oath/declaration filed with this application is defective because none of the errors which are relied upon to support the reissue application are errors upon which a reissue can be based. See 37 CFR 1.175(a)(1) and MPEP § 1414.

**Examiner Note:**

1. Use this form paragraph when the reissue oath/declaration identifies more than one error relied upon to support the reissue application, and none of the errors are appropriate errors upon which a reissue can be based.
2. Note that if the reissue oath/declaration identifies more than one error relied upon, and at least one of the errors is an error upon which reissue can be based, this form paragraph should not be used, despite the additional reliance by applicant on “errors” which do not support the reissue. Only one appropriate error is needed to support a reissue.
3. Form paragraph 14.14 must follow this form paragraph.

**III. A STATEMENT THAT ALL ERRORS WHICH ARE BEING CORRECTED IN THE REISSUE APPLICATION UP TO THE TIME OF \* >SIGNING< OF THE OATH/DECLARATION AROSE WITHOUT ANY DECEPTIVE INTENTION ON THE PART OF THE APPLICANT.**

In order to satisfy this requirement, the following statement may be included in an oath or declaration:

“All errors \*\* in the present reissue application up to the time of \* >signing< of this >oath/<declaration >, or errors which are being corrected by a paper filed concurrently with this oath/declaration which correction of errors I/we have reviewed,< arose without any deceptive intention on the part of the applicant.”

Nothing more is required. The examiner will determine only whether the reissue oath/declaration contains the required averment; the examiner will not make any comment as to whether it appears that there was in fact deceptive intention (see MPEP § 2022.05). >It is noted that a reissue oath/declaration will not be effective for any errors which are corrected by a filing made after the execution of the reissue oath/declaration, unless it is clear from the record that the parties executing the document were aware of the nature of the correction when they executed the document. Further, a reissue oath/declaration with an early date of execution cannot be filed after a correction made later in time, to cover the correction made after the execution date. This is so, even if the reissue oath/declaration states that *all errors up to the filing of the oath/declaration* arose without any deceptive intention on the part of the applicant.<

Form paragraph 14.01.04 may be used where the reissue oath/declaration does not provide the required statement as to “without any deceptive intention on the part of the applicant.”

*¶ 14.01.04 Defective Reissue Oath/Declaration, 37 CFR 1.175- Lack of Statement of “Without Any Deceptive Intention”*

The reissue oath/declaration filed with this application is defective because it fails to contain a statement that all errors which are being corrected in the reissue application up to the time of filing of the oath/declaration arose without any deceptive intention on the part of the applicant. See 37 CFR 1.175 and MPEP § 1414.

**Examiner Note:**

1. Use this form paragraph when the reissue oath/declaration does not contain the statement required by 37 CFR 1.175 that all errors being corrected in the reissue application arose without any deceptive intention on the part of the applicant.
2. This form paragraph is appropriate to use for a failure by applicant to comply with the requirement, as to any of 37 CFR 1.175(a)(2), 37 CFR 1.175(b)(1), or 37 CFR 1.175(b)(2).
3. Form paragraph 14.14 must follow.

**IV. THE REISSUE OATH/DECLARATION MUST COMPLY WITH 37 CFR 1.63.**

The reissue oath/declaration must include the averments required by 37 CFR 1.63(a) and (b), *e.g.*, that applicants for reissue

(A) have reviewed and understand the contents of the specification, including the claims, as amended by any amendment specifically referred to in the oath/declaration;

(B) believe the named inventor or inventors to be the original and the first inventor or inventors of the subject matter which is claimed and for which a patent is sought; and

(C) acknowledge the duty to disclose to the Office all information known to the person to be material to patentability as defined in 37 CFR 1.56. See also the discussion regarding the requirements of an oath/declaration beginning at MPEP § 602.

The examiner should check carefully to ensure that all the requirements of 37 CFR 1.63 are met. Form paragraph 14.01.05 should be used in conjunction with the content of form paragraphs 6.03 through 6.09 as appropriate, where the reissue oath/declaration fails to comply with the requirements of 37 CFR 1.63.

*¶ 14.01.05 Defective Reissue Oath/Declaration, 37 CFR 1.175 - General*

The reissue oath/declaration filed with this application is defective (see 37 CFR 1.175 and MPEP § 1414) because of the following:

**Examiner Note:**

1. Use this form paragraph when the reissue oath/declaration does not comply with 37 CFR 1.175, and none of form paragraphs 14.01 - 14.01.04 or 14.05.02 apply.
2. This form paragraph must be followed by an explanation of why the reissue oath/declaration is defective.
3. Form paragraph 14.14 must follow the explanation of the defect.

See MPEP § 1414.01 for a discussion of the requirements for a supplemental reissue oath/declaration.

Depending on the circumstances, either form PTO/SB/51, Reissue Application Declaration By The

Inventor, or form PTO/SB/52, Reissue Application Declaration By The Assignee may be used to prepare a declaration in a reissue application.

CORRECTION OF PATENTS

1414

\*\*>

PTO/SB/51 (04-04)

Approved for use through 04/30/2007. OMB 0651-0033

U.S. Patent and Trademark Office; U.S. DEPARTMENT OF COMMERCE

Under the Paperwork Reduction Act of 1995, no persons are required to respond to a collection of information unless it displays a valid OMB control number.

<b>REISSUE APPLICATION DECLARATION BY THE INVENTOR</b>	Docket Number (Optional)
<p>I hereby declare that:                  Each inventor's residence, mailing address and citizenship are stated below next to their name.                  I believe the inventors named below to be the original and first inventor(s) of the subject matter which is described and claimed in patent number _____, granted _____ and for which a reissue patent is sought on the invention entitled _____                  _____                  the specification of which</p> <p><input type="checkbox"/> is attached hereto.</p> <p><input type="checkbox"/> was filed on _____ as reissue application number _____                  and was amended on _____                  (If applicable)</p> <p>I have reviewed and understand the contents of the above-identified specification, including the claims, as amended by any amendment referred to above.                  I acknowledge the duty to disclose information which is material to patentability as defined in 37 CFR 1.56.</p> <p><input type="checkbox"/> I hereby claim foreign priority benefits under 35 U.S.C. 119(a)-(d) or (f), or 365(b). Attached is form PTO/SB/02B (or equivalent) listing the foreign applications.</p> <p>I verily believe the original patent to be wholly or partly inoperative or invalid, for the reasons described below. (Check all boxes that apply.)</p> <p><input type="checkbox"/> by reason of a defective specification or drawing.</p> <p><input type="checkbox"/> by reason of the patentee claiming more or less than he had the right to claim in the patent.</p> <p><input type="checkbox"/> by reason of other errors.</p> <p>At least one error upon which reissue is based is described below. If the reissue is a broadening reissue, such must be stated with an explanation as to the nature of the broadening:</p>	

[Page 1 of 2]

This collection of information is required by 37 CFR 1.175. The information is required to obtain or retain a benefit by the public which is to file (and by the USPTO to process) an application. Confidentiality is governed by 35 U.S.C. 122 and 37 CFR 1.14. This collection is estimated to take 30 minutes to complete, including gathering, preparing, and submitting the completed application form to the USPTO. Time will vary depending upon the individual case. Any comments on the amount of time you require to complete this form and/or suggestions for reducing this burden, should be sent to the Chief Information Officer, U.S. Patent and Trademark Office, U.S. Department of Commerce, P.O. Box 1450, Alexandria, VA 22313-1450. DO NOT SEND FEES OR COMPLETED FORMS TO THIS ADDRESS. SEND TO: Commissioner for Patents, P.O. Box 1450, Alexandria, VA 22313-1450.

If you need assistance in completing the form, call 1-800-PTO-9199 and select option 2.



PTO/SB/51 (04-04)  
 Approved for use through 04/30/2007. OMB 0651-0033  
 U.S. Patent and Trademark Office; U.S. DEPARTMENT OF COMMERCE

Under the Paperwork Reduction Act of 1995, no persons are required to respond to a collection of information unless it displays a valid OMB control number.

(REISSUE APPLICATION DECLARATION BY THE INVENTOR, page 2)		Docket Number (Optional)	
All errors corrected in this reissue application arose without any deceptive intention on the part of the applicant.			
Note: To appoint a power of attorney, use form PTO/SB/81.			
Correspondence Address: Direct all communications about the application to:			
<input type="checkbox"/> Customer Number:			
<b>OR</b>			
<input type="checkbox"/> Firm or Individual Name			
Address			
Address			
City		State	Zip
Country			
Telephone		Fax	
I hereby declare that all statements made herein of my own knowledge are true and that all statements made on information and belief are believed to be true; and further that these statements were made with the knowledge that willful false statements and the like so made are punishable by fine and imprisonment, or both, under 18 U.S.C. 1001, and that such willful false statements may jeopardize the validity of the application, any patent issuing thereon, or any patent to which this declaration is directed.			
Full name of sole or first inventor (given name, family name)			
Inventor's signature		Date	
Residence		Citizenship	
Mailing Address			
Full name of second joint inventor (given name, family name)			
Inventor's signature		Date	
Residence		Citizenship	
Mailing Address			
Full name of third joint inventor (given name, family name)			
Inventor's signature		Date	
Residence		Citizenship	
Mailing Address			
<input type="checkbox"/> Additional joint inventors or legal representative(s) are named on separately numbered sheets forms PTO/SB/02A or 02LR attached hereto.			

CORRECTION OF PATENTS

1414

\*\*>

PTO/SB/52 (04-04)  
Approved for use through 04/30/2007. OMB 0651-0033  
U.S. Patent and Trademark Office, U.S. DEPARTMENT OF COMMERCE

Under the Paperwork Reduction Act of 1995, no persons are required to respond to a collection of information unless it displays a valid OMB control number.

<b>REISSUE APPLICATION DECLARATION BY THE ASSIGNEE</b>		Docket Number (optional)
<p>I hereby declare that:</p> <p>The residence, mailing address and citizenship of the inventors are stated below.</p> <p>I am authorized to act on behalf of the following assignee: _____</p> <p>and the title of my position with said assignee is: _____</p> <p>The entire title to the patent identified below is vested in said assignee.</p>		
Inventor	Citizenship	
Residence/Mailing Address		
Inventor	Citizenship	
Residence/Mailing Address		
<input type="checkbox"/> Additional Inventors are named on separately numbered sheets attached hereto.		
Patent Number	Date of Patent Issued	
Title of Invention		
<p>I believe said inventor(s) to be the original and first inventor(s) of the subject matter which is described and claimed in said patent, for which a reissue patent is sought on the invention entitled:</p> <p>_____</p> <p>the specification of which</p> <p><input type="checkbox"/> is attached hereto.</p> <p><input type="checkbox"/> was filed on _____ as reissue application number _____ / _____</p> <p>and was amended on _____</p> <p style="text-align: center;">(If applicable)</p> <p>I have reviewed and understand the contents of the above identified specification, including the claims, as amended by any amendment referred to above.</p> <p>I acknowledge the duty to disclose information which is material to patentability as defined in 37 CFR 1.56.</p> <p><input type="checkbox"/> I hereby claim foreign priority benefits under 35 U.S.C. 119(a)-(d) or (f), or 365(b). Attached is form PTO/SB/02B (or equivalent) listing the foreign applications.</p> <p>I verify believe the original patent to be wholly or partly inoperative or invalid, for the reasons described below. (Check all boxes that apply.)</p> <p><input type="checkbox"/> by reason of a defective specification or drawing.</p> <p><input type="checkbox"/> by reason of the patentee claiming more or less than he had the right to claim in the patent.</p> <p><input type="checkbox"/> by reason of other errors.</p>		

[Page 1 of 2]

This collection of information is required by 37 CFR 1.175. The information is required to obtain or retain a benefit by the public which is to file (and by the USPTO to process) an application. Confidentiality is governed by 35 U.S.C. 122 and 37 CFR 1.14. This collection is estimated to take 30 minutes to complete, including gathering, preparing, and submitting the completed application form to the USPTO. Time will vary depending upon the individual case. Any comments on the amount of time you require to complete this form and/or suggestions for reducing this burden, should be sent to the Chief Information Officer, U.S. Patent and Trademark Office, U.S. Department of Commerce, P.O. Box 1450, Alexandria, VA 22313-1450. DO NOT SEND FEES OR COMPLETED FORMS TO THIS ADDRESS. SEND TO: Commissioner for Patents, P.O. Box 1450, Alexandria, VA 22313-1450.

*If you need assistance in completing the form, call 1-800-PTO-9199 and select option 2.*

PTO/SB/52 (04-04)  
 Approved for use through 04/30/2007. OMB 0651-0033  
 U.S. Patent and Trademark Office; U.S. DEPARTMENT OF COMMERCE  
 Under the Paperwork Reduction Act of 1995, no persons are required to respond to a collection of information unless it displays a valid OMB control number.

<b>REISSUE APPLICATION DECLARATION BY THE ASSIGNEE</b>		Docket Number (Optional)	
At least one error upon which reissue is based is described as follows:  <div style="text-align: center;">[Attach additional sheets, if needed.]</div> All errors corrected in this reissue application arose without any deceptive intention on the part of the applicant.			
I hereby appoint:			
<input type="checkbox"/> Practitioners at Customer Number:			
<b>OR</b>			
<input type="checkbox"/> Practitioner(s) named below:			
Name		Registration Number	
as my/our attorney(s) or agent(s) to prosecute the application identified above, and to transact all business in the United States Patent and Trademark Office connected therewith.			
Correspondence Address: Direct all communications about the application to:			
<input type="checkbox"/> Customer Number:			
<b>OR</b>			
<input type="checkbox"/> Firm or Individual Name			
Address			
Address			
City	State	Zip	
Country			
Telephone	Fax		
I hereby declare that all statements made herein of my own knowledge are true and that all statements made on information and belief are believed to be true; and further that these statements were made with the knowledge that willful false statements and the like so made are punishable by fine and imprisonment, or both, under 18 U.S.C. 1001, and that such willful false statements may jeopardize the validity of the application, any patent issuing thereon, or any patent to which this declaration is directed.			
Full name of person signing (given name, family name)			
Signature		Date	
Address of Assignee			



### 1414.01 Supplemental Reissue Oath/Declaration [R-2]

If additional defects or errors are corrected in the reissue after the filing of the application and the original reissue oath or declaration, a supplemental reissue oath/declaration must be filed, unless all additional errors corrected are spelling, grammar, typographical, editorial or clerical errors which are not errors under 35 U.S.C. 251 (see MPEP § 1402). In other words, a supplemental oath/declaration is required where any “error” under 35 U.S.C. 251 has been corrected and the error was not identified in the original reissue oath/declaration.

The supplemental reissue oath/declaration must state that every error which was corrected in the reissue application not covered by the prior oath(s)/declaration(s) submitted in the application arose without any deceptive intention on the part of the applicant.

An example of acceptable language is as follows:

“Every error in the patent which was corrected in the present reissue application, and is not covered by the prior declaration submitted in this application, arose without any deceptive intention on the part of the applicant.”

>A supplemental reissue oath/declaration will not be effective for any errors which are corrected by a filing made after the execution of the supplemental reissue oath/declaration, unless it is clear from the record that the parties executing the document were aware of the nature of the correction when they executed the document. Further, a supplemental reissue oath/declaration with an early date of execution cannot be filed after a correction made later in time, to cover the correction made after the execution date. This is so, even if the supplemental reissue oath/declaration states that *all errors up to the filing of the supplemental reissue oath/declaration oath or declaration* arose without any deceptive intention on the part of the applicant.<

#### WHEN AN ERROR MUST BE STATED IN THE SUPPLEMENTAL OATH/DECLARATION

In the supplemental reissue oath/declaration, there is **no need to state an error** which is relied upon to support the reissue application **if**:

(A) an error to support a reissue has been previously and properly stated in a reissue oath/declaration in the application; and

(B) that error is still being corrected in the reissue application.

If applicant chooses to state any further error at this point (even though such is not needed), the examiner should not review the statement of the further error.

The supplemental reissue oath/declaration must state an error which is relied upon to support the reissue application only where one of the following is true:

(A) the prior reissue oath/declaration failed to state an error;

(B) the prior reissue oath/declaration attempted to state an error but did not do so properly; or

(C) all errors under 35 U.S.C. 251 stated in the prior reissue oath(s)/declaration(s) are no longer being corrected in the reissue application.

#### WHEN A SUPPLEMENTAL OATH/DECLARATION MUST BE SUBMITTED

The supplemental oath/declaration in accordance with 37 CFR 1.175(b)(1) must be submitted before allowance. See MPEP § 1444 for a discussion of the action to be taken by the examiner to obtain the supplemental oath/declaration in accordance with 37 CFR 1.175(b)(1), where such is needed.

Where applicant seeks to correct an error after allowance of the reissue application, a supplemental reissue oath/declaration must accompany the requested correction stating that the error(s) to be corrected arose without any deceptive intention on the part of the applicant. The supplemental reissue oath/declaration submitted after allowance will be directed to the error applicant seeks to correct after allowance. This supplemental oath/declaration need not cover any earlier errors, since all earlier errors should have been covered by a reissue oath/declaration submitted prior to allowance.

#### SUPPLEMENTAL OATH/DECLARATION IN BROADENING REISSUE

A broadening reissue application must be applied for by all of the inventors (patentees), that is, the original reissue oath/declaration must be signed by all of the inventors. See MPEP § 1414. If a supplemental

oath/declaration in a broadening reissue application is subsequently needed in the application in order to fulfill the requirements of 37 CFR 1.175, the supplemental reissue oath/declaration must be signed by all of the inventors. *In re Hayes*, 53 USPQ2d 1222, 1224 (Comm'r Pat. 1999) (“37 CFR 1.175(b)(1), taken in conjunction with Section 1.172, requires a supplemental declaration be signed by all of the inventors. This is because all oaths or declarations necessary to fulfill the rule requirements in a reissue application are taken together collectively as a single oath or declaration. Thus, each oath and declaration must bear the appropriate signatures of all the inventors.”).

If a joint inventor refuses or cannot be found or reached to sign a supplemental oath/declaration, a supplemental oath/declaration listing all the inventors, and signed by all the available inventors may be filed provided it is accompanied by a petition under 37 CFR 1.183 along with the petition fee, requesting waiver of the signature requirement of the nonsigning inventor.

Form PTO/SB/51S, Supplemental Declaration For Reissue Patent Application To Correct “Errors” Statement (37 CFR 1.175), may be used to prepare a supplemental reissue declaration.

CORRECTION OF PATENTS

1414.01

\*\*>

PTO/SB/51S (04-04)

Approved for use through 4/30/2007. OMB 0651-0033  
U.S. Patent and Trademark Office; U.S. DEPARTMENT OF COMMERCE

Under the Paperwork Reduction Act of 1995, no persons are required to respond to a collection of information unless it contains a valid OMB control number.

<b>SUPPLEMENTAL DECLARATION FOR REISSUE PATENT APPLICATION TO CORRECT "ERRORS" STATEMENT (37 CFR 1.175)</b>	<b>Attorney Docket Number</b>	
	<b>First Named Inventor</b>	
	<b>COMPLETE</b>	
	Application Number	
	Filing Date	
	Art Unit	
Examiner Name		

**I/We hereby declare that:**

**Every error in the patent which was corrected in the present reissue application, and which is not covered by the prior oath(s) and/or declaration(s) submitted in this application, arose without any deceptive intention on the part of the applicant.**

**I/We hereby declare that all statements made herein of my/our own knowledge are true and that all statements made on information and belief are believed to be true; and further that these statements were made with the knowledge that willful false statements and the like so made are punishable by fine or imprisonment, or both, under 18 U.S.C. 1001 and that such willful false statements may jeopardize the validity of the application or any patent issued thereon.**

<b>Name of Sole or First Inventor:</b>		<input type="checkbox"/> A petition has been filed for this unsigned inventor
Given Name (first and middle [if any])		Family Name or Surname
Inventor's Signature		Date
<b>Name of Second Inventor:</b>		<input type="checkbox"/> A petition has been filed for this unsigned inventor
Given Name (first and middle [if any])		Family Name or Surname
Inventor's Signature		Date
<b>Name of Third Inventor:</b>		<input type="checkbox"/> A petition has been filed for this unsigned inventor
Given Name (first and middle [if any])		Family Name or Surname
Inventor's Signature		Date
<b>Name of Fourth Inventor:</b>		<input type="checkbox"/> A petition has been filed for this unsigned inventor
Given Name (first and middle [if any])		Family Name or Surname
Inventor's Signature		Date

Additional inventors or legal representatives(s) are being named on the \_\_\_\_\_ supplemental sheets PTO/SB/02A or 02LR attached hereto.

This collection of information is required by 37 CFR 1.175. The information is required to obtain or retain a benefit by the public which is to file (and by the USPTO to process) an application. Confidentiality is governed by 35 U.S.C. 122 and 37 CFR 1.14. This collection is estimated to take 1.8 minutes to complete, including gathering, preparing, and submitting the completed application form to the USPTO. Time will vary depending upon the individual case. Any comments on the amount of time you require to complete this form and/or suggestions for reducing this burden, should be sent to the Chief Information Officer, U.S. Patent and Trademark Office, U.S. Department of Commerce, P.O. Box 1450, Alexandria, VA 22313-1450. DO NOT SEND FEES OR COMPLETED FORMS TO THIS ADDRESS. SEND TO: Commissioner for Patents, P.O. Box 1450, Alexandria, VA 22313-1450.

If you need assistance in completing the form, call 1-800-PTO-9199 and select option 2.

**1415 Reissue Filing and Issue Fees [R-2]**

The reissue applicant is permitted to present every claim that was issued in the original patent for the basic filing fee. In addition to the basic filing fee, the filing or later presentation of each independent claim which is in excess of the number of independent claims in the original patent requires a fee. In addition, the filing or later presentation of each claim

(whether independent or dependent) in excess of 20, and also in excess of the number of claims in the original patent, requires a fee. Fees for claims in reissue continued prosecution applications are calculated in the same manner as outlined above. The Office has prepared Form PTO/SB/56, Reissue Application Fee Transmittal Form which is designed to assist in the correct calculation of reissue filing fees.

\*\*>

PTO/SB/56 (04-04)  
 Approved for use through 04/30/2007. OMB 0651-0033  
 U.S. Patent and Trademark Office: U.S. DEPARTMENT OF COMMERCE  
 Under the Paperwork Reduction Act of 1995, no persons are required to respond to a collection of information unless it displays a valid OMB control number.

REISSUE APPLICATION FEE TRANSMITTAL FORM							Docket Number (Optional)	
Claims as Filed -- Part 1								
	(1) Claims in Patent	(2) Number Filed in Reissue Application	(3) Number Extra	Small Entity		Other than a Small Entity		
				Rate	Fee		Rate	Fee
Total Claims (37 CFR 1.16(j))	(A)	(B)	**** =	x \$ ____ =		or	x \$ ____ =	
Independent claims (37 CFR 1.16(i))	(C)	(D)	* =	x \$ ____ =			x \$ ____ =	
					Basic Fee (37 CFR 1.16(h))	\$ ____		
					Total Filing Fee	\$ ____	OR	\$ ____
Claims as Amended -- Part 2								
	(1) Claims Remaining After Amendment		(2) Highest Number Previously Paid For	(3) Extra Claims Present	Small Entity		Other than a Small Entity	
					Rate	Fee	Rate	Fee
Total Claims (37 CFR 1.16(j))	***	MINUS	**	* =	x \$ ____ =		x \$ ____ =	
Independent Claims (37 CFR 1.16(i))	***	MINUS	*****	=	x \$ ____ =		x \$ ____ =	
					Total Additional Fee	\$	OR	\$
<p>* If the entry in (D) is less than the entry in (C), Write "0" in column 3.</p> <p>** If the "Highest Number of Total Claims Previously Paid For" is less than 20, Write "20" in this space.</p> <p>*** After any cancellation of claims.</p> <p>**** If "A" is greater than 20, use (B - A); if "A" is 20 or less, use (B - 20).</p> <p>***** "Highest Number of Independent Claims Previously Paid For" or Number of Independent Claims in Patent (C).</p> <p><input type="checkbox"/> Applicant claims small entity status. See 37 CFR 1.27.</p> <p><input type="checkbox"/> Please charge Deposit Account Number _____ in the amount of _____. A duplicate copy of this sheet is enclosed.</p> <p><input type="checkbox"/> The Director is hereby authorized to charge any additional fees under 37 CFR 1.16 or 1.17 which may be required, or credit any overpayment to Deposit Account Number _____. A duplicate copy of this sheet is enclosed.</p> <p><input type="checkbox"/> A check in the amount of \$ _____ to cover the filing/additional fee is enclosed.</p> <p><input type="checkbox"/> Payment by credit card. Form PTO-2038 is attached.</p> <p style="text-align: center;"><b>WARNING: Information on this form may become public. Credit card information should not be included on this form. Provide credit card information and authorization on PTO-2038.</b></p>								
				Date	Signature of Applicant, Attorney or Agent of Record			
				Registration Number, if applicable	Typed or printed name			

This collection of information is required by 37 CFR 1.16. The information is required to obtain or retain a benefit by the public which is to file (and by the USPTO to process) an application. Confidentiality is governed by 35 U.S.C. 122 and 37 CFR 1.14. This collection is estimated to take 12 minutes to complete, including gathering, preparing, and submitting the completed application form to the USPTO. Time will vary depending upon the individual case. Any comments on the amount of time you require to complete this form and/or suggestions for reducing this burden, should be sent to the Chief Information Officer, U.S. Patent and Trademark Office, U.S. Department of Commerce, P.O. Box 1450, Alexandria, VA 22313-1450. DO NOT SEND FEES OR COMPLETED FORMS TO THIS ADDRESS. SEND TO: **Commissioner for Patents, P.O. Box 1450, Alexandria, VA 22313-1450**  
 If you need assistance in completing the form, call 1-800-PTO-9199 and select option 2.

<



### 1415.01 Maintenance Fees on the Original Patent [R-2]

The filing of a reissue application does not alter the schedule of payments of maintenance fees on the original patent. If maintenance fees have not been paid on the original patent as required by 35 U.S.C. 41(b) and 37 CFR 1.20, and the patent has expired, no reissue patent can be granted. 35 U.S.C. 251, first paragraph, only authorizes the granting of a reissue patent for the unexpired term of the original patent. Once a patent has expired, the \* >Director of the USPTO< no longer has the authority under 35 U.S.C. 251 to reissue the patent. See *In re Morgan*, 990 F.2d 1230, 26 USPQ2d 1392 (Fed. Cir. 1993).

The examiner should determine whether all required maintenance fees have been paid *prior to conducting an examination* of a reissue application. In addition, during the process of preparing the reissue application for issue, the examiner should again determine whether all required maintenance fees have been paid up to date.

\*\* >The history of maintenance fees is determined by the following, all of which should be used (to provide a check on the search made):

(A) Go to the USPTO Intranet (<http://ptoweb/pto-intranet/index.htm>) and select the PALM screen, then the “General Information” screen, type in the patent number and then select the “Fees” screen.

(B) Go to the USPTO Intranet and then the “Revenue Accounting and Management” screen, then the “File History” screen. Then type in the patent number.

(C) Go to the USPTO Intranet Site (<http://www.uspto.gov>) and select “eBusiness”, then the “Patent Electronic Business Center” screen, then the “Patent Application Information Retrieval (PAIR)” screen (<http://pair.uspto.gov/cgi-bin/final/home.pl>), and type in the patent number and select the “view Maint. Statement” screen.<

If the window for the maintenance fee due has closed (maintenance fees are due by the day of the 4th, 8th and 12th year anniversary of the grant of the patent), but the maintenance fee has not been paid, then the reissue should be \*\* >forwarded to the Office of Patent Legal Administration (OPLA) to consider vacating and terminating the reissue proceeding (with subsequent abandonment of the reissue application)<. However, if time remains for applicant to pay the

maintenance fee, then the application should not be rejected under 35 U.S.C. 251 and it may be passed to issue when it is in condition for allowance, because the patent has not expired. >The issuance of one or more reissue patents does not alter the schedule of payments of maintenance fees on the original patent. Thus, if a patentee obtains a reissue patent and then a continuation/divisional of the reissue patent issues as a second reissue patent, a separate maintenance fee is **not** due on the second reissue patent. 35 U.S.C. 41 does not provide for the charging of more than one maintenance fee for plural reissues.<

See MPEP Chapter 2500 for additional information pertaining to maintenance fees.

### 1416 Offer to Surrender and Return Original Patent [R-2]

*37 CFR 1.178. Original patent; continuing duty of applicant.*

(a) The application for a reissue should be accompanied by either an offer to surrender the original patent, or the original patent itself, or if the original is lost or inaccessible, by a statement to that effect. The application may be accepted for examination in the absence of the original patent or the statement, but one or the other must be supplied before the application is allowed. If a reissue application is refused, the original patent, if surrendered, will be returned to applicant upon request.

\*\*\*\*\*

An examination on the merits of the reissue application is made even though the \*\* actual surrender, or a statement to the effect that the original is lost or inaccessible, has not been received. Either the original patent, or a statement as to loss or inaccessibility of the original patent, must >,however,< be received before the examiner can allow the reissue application >(i.e., pass the reissue application to issue)<.

Form paragraph 14.05.01 may be used to notify applicant that the original patent or an affidavit or declaration as to loss is required before allowance >of the reissue application<.

#### *¶ 14.05.01 Original Patent Required Prior to Allowance*

The original patent, or a statement as to loss or inaccessibility of the original patent, must be received before this reissue application can be allowed. See 37 CFR 1.178.

#### **Examiner Note:**

1. This form paragraph may be used in an Office action to remind applicant of the requirement for submission of the original patent before allowance.

2. It may also be used in an *Ex parte Quayle* action to require such submission.
3. Do not use this form paragraph in an examiner's amendment. The original patent or a statement of loss must be filed prior to mailing of the "Notice of Allowability".

If the original patent has been surrendered in the reissue application, and applicant requests the return of the surrendered original patent upon abandonment of the reissue application, the original patent will be sent to the applicant by the Technology Center.

An applicant may request that a surrendered original patent be transferred from an abandoned reissue application to a continuation or divisional reissue application. The technical support staff making the transfer should note the transfer on the "Contents" of the abandoned application. The application number and filing date of the reissue application to which it is

transferred must be included in the notation. Even where the original patent grant is submitted together with the reissue application as filed, patentee must include a copy of the printed original patent to serve as the specification of the reissue application. See 37 CFR 1.172(a) and MPEP § 1411.

Form PTO/SB/55, Reissue Patent Application Statement As To Loss Of Original Patent, may be used by applicant for filing a statement to the effect that the original patent is lost or inaccessible. >The form, or an equivalent statement (where the form is not used), may be signed by the inventors, by an officer of the assignee, by an authorized party acting on behalf of the assignee with a proper 37 CFR 3.73(b) statement, or by a registered practitioner representing the reissue applicant.<

\*\*>

PTO/SB/55 (05-03)  
 Approved for use through 01/31/2004. OMB 0651-0033  
 U.S. Patent and Trademark Office; U.S. DEPARTMENT OF COMMERCE

Under the Paperwork Reduction Act of 1995, no persons are required to respond to a collection of information unless it displays a valid OMB control number.

<b>REISSUE PATENT APPLICATION STATEMENT AS TO LOSS OF ORIGINAL PATENT</b>		Docket Number (Optional)
I hereby state that:		
I am the applicant for a reissue patent based on the original patent identified below.		
Name of Inventor(s)/Assignee(s)		
Patent Number		
Title of Invention		
Reissue application number (if known)		
The ribboned original patent grant is lost or inaccessible.		
Signature		
Typed or printed name	Date	
Title (e.g., inventor(s), officer of assignee)		

This collection of information is required by 37 CFR 1.178. The information is required to obtain or retain a benefit by the public which is to file (and by the USPTO to process) an application. Confidentiality is governed by 35 U.S.C. 122 and 37 CFR 1.14. This collection is estimated to take 3 minutes to complete, including gathering, preparing, and submitting the completed application form to the USPTO. Time will vary depending upon the individual case. Any comments on the amount of time you require to complete this form and/or suggestions for reducing this burden, should be sent to the Chief Information Officer, U.S. Patent and Trademark Office, U.S. Department of Commerce, P.O. Box 1450, Alexandria, VA 22313-1450. DO NOT SEND FEES OR COMPLETED FORMS TO THIS ADDRESS. **SEND TO: Commissioner for Patents, P.O. Box 1450, Alexandria, VA 22313-1450.**

*If you need assistance in completing the form, call 1-800-PTO-9199 and select option 2.*

## 1417 Claim for Benefit Under 35 U.S.C. 119(a)-(d) [R-2]

### PRIORITY UNDER 35 U.S.C. 119(a)-(d) WAS PERFECTED IN THE ORIGINAL PATENT

A “claim” for the benefit of an earlier filing date in a foreign country under 35 U.S.C. 119(a)-(d) must be made in a reissue application, even though such a claim was previously made in the application \*\* >for< the original patent \*\* >to be reissued<. However, no additional certified copy of the foreign application is necessary. The procedure is similar to that for “Continuing Applications” in MPEP § 201.14(b).

In addition, 37 CFR 1.63 requires that in *any* application in which a claim for foreign priority is made pursuant to 37 CFR 1.55, the oath or declaration must identify the foreign application for patent or inventors’ certificate on which priority is claimed unless supplied on an application data sheet (37 CFR 1.76), and any foreign applications having a filing date before that of the application on which priority is claimed, by specifying:

(A) the application number of the foreign application;

(B) the foreign country or intellectual property authority; and

(C) the day, month, and year of the filing of the foreign application.

The examiner should note that the heading on printed copies of the patent will not be carried forward to the reissue from the original patent. Therefore, it is important that the bibliographic data sheet reprint (for series 09/ and later applications) or the front face of the reissue file wrapper (for series 08/ and earlier applications) be endorsed by the examiner under “FOREIGN APPLICATIONS.” >(For IFW processing, see IFW Manual.)<

### PRIORITY UNDER 35 U.S.C. 119(a)-(d) IS NEWLY PERFECTED IN THE REISSUE APPLICATION

A reissue was granted in *Brenner v. State of Israel*, 400 F.2d 789, 158 USPQ 584 (D.C. Cir. 1968), where the only ground urged was failure to file a certified copy of the original foreign application to obtain the right of foreign priority under 35 U.S.C. 119(a)-(d)

before the patent was granted. In *Brenner*, the claim for priority had been made in the prosecution of the original patent, and it was only necessary to submit a certified copy of the priority document in the reissue application to perfect priority >(the claim for priority must be repeated in the reissue application). Reissue is also available to correct the “error” in failing to take any steps to obtain the right of foreign priority under 35 U.S.C. 119(a)-(d) before the original patent was granted<. In a situation where it is necessary to submit for the first time both the claim for priority and the certified copy of the priority document in the reissue application and the >patent to be reissued resulted from a< utility or plant application \*\* filed on or after November 29, 2000, the reissue applicant will have to file a petition for an unintentionally delayed priority claim under 37 CFR 1.55(c) in addition to filing a reissue application. See MPEP § 201.14(a).

## 1418 Notification of Prior/Concurrent Proceedings and Decisions Thereon, and of Information Known to be Material to Patentability [R-2]

37 CFR 1.178. *Original patent; continuing duty of applicant.*

\*\*\*\*\*

(b) In any reissue application before the Office, the applicant must call to the attention of the Office any prior or concurrent proceedings in which the patent (for which reissue is requested) is or was involved, such as interferences, reissues, reexaminations, or litigations and the results of such proceedings (see also § 1.173(a)(1)).

37 CFR 1.178(b) requires reissue applicants to call to the attention of the Office any prior or concurrent proceeding in which the patent (for which reissue is requested) is or was involved and the results of such proceedings. These proceedings would include interferences, reissues, reexaminations, and litigations. Litigation would encompass any papers filed in the court or issued by the court, which may include, for example, motions, pleadings, and court decisions. This duty to submit information is continuing, and runs from the time the reissue application is filed until the reissue application is abandoned or issues as a reissue patent.

In addition, a reissue application is subject to the same duty of disclosure requirements as is any other nonprovisional application. The provisions of 37 CFR 1.63 require acknowledgment in the reissue oath or declaration of the “duty to disclose to the Office all information known to the [applicants] to be material to patentability as defined in § 1.56.” >Note that the Office imposes no responsibility on a reissue applicant to resubmit, in a reissue application, all the ‘References Cited’ in the patent for which reissue is sought. Rather, applicant has a continuing duty under 37 CFR 1.56 to timely apprise the Office of any information which is material to the patentability of the claims under consideration in the reissue application.

37 CFR 1.97 and 37 CFR 1.98 provide a mechanism to submit information known to applicants to be material to patentability. Information submitted in compliance with 37 CFR 1.97 and 37 CFR 1.98 will be considered by the Office. See MPEP § 609. Although a reissue applicant may utilize 37 CFR 1.97 and 37 CFR 1.98 to comply with the duty of disclosure required by 37 CFR 1.56, this does not relieve applicant of the duties under 37 CFR 1.175 of, for example, stating “at least one error being relied upon.”

While 37 CFR 1.97(b) provides for the filing of an information disclosure statement within 3 months of the filing of an application or before the mailing date of a first Office action, reissue applicants are encouraged to file information disclosure statements at the time of filing of the reissue application so that such statements will be available to the public during the 2-month period provided in MPEP § 1441.< Form paragraph 14.11.01 may be used to remind applicant of the duty to disclose any litigation information which is material to patentability.

¶ *14.11.01 Reminder of Duties Imposed by 37 CFR 1.178(b) and 37 CFR 1.56*

Applicant is reminded of the continuing obligation under 37 CFR 1.178(b), to timely apprise the Office of any prior or concurrent proceeding in which Patent No. [I] is or was involved. These proceedings would include interferences, reissues, reexaminations, and litigation.

Applicant is further reminded of the continuing obligation under 37 CFR 1.56, to timely apprise the Office of any information which is material to patentability of the claims under consideration in this reissue application.

These obligations rest with each individual associated with the filing and prosecution of this application for reissue. See also MPEP §§ 1404, 1442.01 and 1442.04.

**Examiner Note:**

1. This form paragraph is to be used in the first action in a reissue application.
2. In bracket [1], insert the patent number of the original patent for which reissue is requested.

\*\*

**1430 Reissue Files Open to the Public and, Notice of Filing Reissue Announced in, *Official Gazette* [R-2]**

*37 CFR 1.11. Files open to the public.*

\*\*\*\*\*

(b) All reissue applications, all applications in which the Office has accepted a request to open the complete application to inspection by the public, and related papers in the application file, are open to inspection by the public, and copies may be furnished upon paying the fee therefor. The filing of reissue applications, other than continued prosecution applications under § 1.53(d) of reissue applications, will be announced in the *Official Gazette*. The announcement shall include at least the filing date, reissue application and original patent numbers, title, class and subclass, name of the inventor, name of the owner of record, name of the attorney or agent of record, and examining group to which the reissue application is assigned.

\*\*\*\*\*

Under 37 CFR 1.11(b) all reissue applications filed after March 1, 1977, are open to inspection by the general public, and copies may be furnished upon paying the fee therefor. The filing of reissue applications (except for continued prosecution applications (CPA's) filed under 37 CFR 1.53(d)) will be announced in the *Official Gazette*. The announcement gives interested members of the public an opportunity to submit to the examiner information pertinent to the patentability of the reissue application. The announcement includes the filing date, reissue application and original patent numbers, title, class and subclass, name of the inventor, name of the owner of record, name of the attorney or agent of record, and the Technology Center (TC) to which the reissue application is initially assigned. A TC Director or other appropriate Office official may, under appropriate circumstances, postpone access to or the making of copies of a reissue application, such as, for example, to avoid interruption of the examination or other review of the application by an examiner. Those reissue applications already on file prior to March 1, 1977 are not automatically open to inspection, but a liberal policy

is followed by the Office of Patent Legal Administration and by the Board of Patent Appeals and Interferences (see MPEP § 1002.02(b), item 19) in granting petitions for access to such applications. >(For IFW reissues, see IFW Manual for the manner in which such electronic files will be made available to the public.)<

A notice of a reissue application in the *Official Gazette* should be published prior to any examination of the application. If an inadvertent failure to publish notice of the filing of the reissue application in the *Official Gazette* is recognized later in the examination, action should be taken to have the notice published as quickly as possible, and action on the application may be delayed until two months after the publication, allowing for any protests to be filed. >For a discussion of protests, see MPEP Chapter 1900.<

The filing of a continued prosecution application (CPA) under 37 CFR 1.53(d) of a reissue application will not be announced in the *Official Gazette*. Although the filing of a CPA of a reissue application constitutes the filing of a reissue application, the announcement of the filing of such CPA would be redundant in view of the announcement of the filing of the prior reissue application in the *Official Gazette* and the fact that the same application number and file will continue to be used for the CPA.

If applicant files a Request for Continued Examination (RCE) of the reissue application under 37 CFR 1.114 (which can be filed on or after May 29, 2000 for a reissue application filed on or after June 8, 1995), such filing will not be announced in the *Official Gazette*. An RCE continues prosecution of the existing reissue application and is not a filing of a new application.

For those reissue applications filed on or after March 1, 1977, the following procedure will be observed:

(A) The filing of all reissue applications, except for CPAs filed under 37 CFR 1.53(d), >(note that effective July 14, 2003, CPA practice has been eliminated as to utility and plant application)< will be announced in the *Official Gazette* and will include certain identifying data as specified in 37 CFR 1.11(b). Any member of the general public may request access to a particular reissue application filed after March 1, 1977. >(For IFW Processing, see IFW

Manual.)< Since no record of such request is intended to be kept, an oral request will suffice.

(B) The reissue application files will be maintained in the TCs and inspection thereof will be supervised by TC personnel. Although no general limit is placed on the amount of time spent reviewing the files, the Office may impose limitations, if necessary, e.g., where the application is actively being processed. >(For IFW Processing, see IFW Manual.)<

(C) Where the reissue application has left the TC for administrative processing, requests for access should be directed to the appropriate supervisory personnel where the application is currently located. >(For IFW Processing, see IFW Manual.)<

(D) Requests for copies of papers in the reissue application file must be in writing and addressed to the \*\* >Mail Stop Document Services, Director of the United States Patent and Trademark Office, P.O. Box 1450, Alexandria, VA 22313-1450. Such requests< may be either mailed or delivered to the Office Customer Service Window (See MPEP § 502). The price for copies made by the Office is set forth in 37 CFR 1.19.

\*\*

## 1440 Examination of Reissue Application [R-2]

37 CFR 1.176. *Examination of reissue.*

(a) A reissue application will be examined in the same manner as a non-reissue, non-provisional application, and will be subject to all the requirements of the rules related to non-reissue applications. Applications for reissue will be acted on by the examiner in advance of other applications.

(b) Restriction between subject matter of the original patent claims and previously unclaimed subject matter may be required (restriction involving only subject matter of the original patent claims will not be required). If restriction is required, the subject matter of the original patent claims will be held to be constructively elected unless a disclaimer of all the patent claims is filed in the reissue application, which disclaimer cannot be withdrawn by applicant.

37 CFR 1.176 provides that an original claim, if represented in a reissue application, will be fully examined in the same manner, and subject to the same rules as if being presented for the first time in an original non-reissue, nonprovisional application, except that division will not be required by the examiner. See MPEP § 1450 and § 1451. Reissue applications are normally examined by the same examiner who issued

the patent for which reissue is requested. In addition, the application will be examined with respect to compliance with 37 CFR 1.171-1.179 relating specifically to reissue applications, for example, the reissue oath or declaration will be carefully reviewed for compliance with 37 CFR 1.175. See MPEP § 1444 for handling applications in which the oath or declaration lacks compliance with 37 CFR 1.175. Reissue applications with related litigation will be acted on by the examiner before any other special applications, and will be acted on immediately by the examiner, subject only to a 2-month delay after publication for examining reissue applications; see MPEP § 1441.

The original patent file wrapper >/file history< should always be \* >obtained< and reviewed when examining a reissue application thereof.

### 1441 Two-Month Delay Period [R-2]

37 CFR 1.176 provides that reissue applications will be acted on by the examiner in advance of other applications, i.e., “special.” Generally, a reissue application will not be acted on sooner than 2 months after announcement of the filing of the reissue has appeared in the *Official Gazette*. The 2-month delay is provided in order that members of the public may have time to review the reissue application and submit pertinent information to the Office before the examiner’s action. The pertinent information is submitted in the form of a protest under 37 CFR 1.291(a). > For a discussion as to protests under 37 CFR 1.291(a) in reissue applications, see MPEP § 1441.01.< As set forth in MPEP § 1901.04, the public should be aware that such submissions should be made as early as possible, since >,< under certain circumstances >,< the 2-month delay period will not be employed. For example, the Office \* >may< act on >a< continuation \* >or a< divisional reissue \* >application< prior to the expiration of the 2-month period after announcement. Additionally, the Office will entertain \* >a petition< under 37 CFR 1.182 which \* >is< accompanied by the required petition fee (37 CFR 1.17(h)) to act on a reissue application without delaying for 2 months. Accordingly, protestors to reissue applications (see MPEP § 1441.01) cannot automatically assume that a full 2-month delay period will always be available. Appropriate reasons for requesting that the 2-month delay period not be employed include that litigation has been stayed to permit the filing of the reissue

application. Such petitions are decided by the Office of Patent Legal Administration.

### 1441.01 Protest in Reissue Applications [R-2]

>Since reissue applications are not published under 35 U.S.C. 122, pursuant to 37 CFR 1.291(a)(1), a protest may be filed throughout the pendency of a reissue application prior to the date of mailing of a notice of allowance subject to the timing constraints of the examination, as set forth in MPEP § 1901.04.<

A protest with regard to a reissue application should be filed within the 2-month period following the announcement of the filing of the reissue application in the *Official Gazette*. If the protest of a reissue application cannot be filed within the 2-month delay period, the protest can be submitted at a later time. Where the protest is submitted after the 2-month period, no petition for entry of the protest under 37 CFR 1.182 is needed with respect to the protest being submitted after the 2 months >,< unless a final rejection has been issued or prosecution on the merits has been closed for the reissue application.

Where the protest is submitted after the 2-month period, the protest may be received after the first Office action by the examiner, since reissue applications are taken up “special.” Once the first Office action is mailed (after the 2-month period), a member of the public may still submit pertinent information in the form of a protest under 37 CFR 1.291(a), and the examiner will consider the information submitted in the next Office action, to the extent that such consideration is appropriate. See MPEP § 1901.04 and § 1901.06 for the timeliness and content criteria as to when a protest is considered.

The Technology Center (TC) to which the reissue application is assigned is listed in the *Official Gazette* notice of filing of the reissue application. Accordingly, the indicated TC should retain the reissue application file for 2 months after the date of the *Official Gazette* notice before transferring the reissue application under the procedure set forth in MPEP § 903.08(d). >(For IFW processing, see IFW Manual.<

The publication of a notice of a reissue application in the *Official Gazette* should be done prior to any examination of the reissue application. If an inadvertent failure to publish notice of the filing of the reissue

application in the *Official Gazette* is recognized later in the examination, action should be taken to have the notice published as quickly as possible, and action on the reissue application may be delayed until 2 months after the publication, allowing for any protests to be filed.

See MPEP § 1901.06 for general procedures on examiner treatment of protests in reissue applications.

## 1442 Special Status

All reissue applications are taken up “special,” and remain “special” even though applicant does not respond promptly.

All reissue applications, except those under suspension because of litigation, will be taken up for action ahead of other “special” applications; this means that all issues not deferred will be treated and responded to immediately. Furthermore, reissue applications involved in litigation will be taken up for action in advance of other reissue applications.

### 1442.01 Litigation-Related Reissues

During initial review, the examiner should determine whether the patent for which the reissue has been filed is involved in litigation, and if so, the status of that litigation. If the examiner becomes aware of litigation involving the patent sought to be reissued during examination of the reissue application, and applicant has not made the details regarding that litigation of record in the reissue application, the examiner, in the next Office action, will inquire regarding the specific details of the litigation.

Form paragraph 14.06 may be used for such an inquiry.

#### ¶ 14.06 *Litigation-Related Reissue*

The patent sought to be reissued by this application [1] involved in litigation. Any documents and/or materials which would be material to patentability of this reissue application are required to be made of record in response to this action.

Due to the related litigation status of this application, EXTENSIONS OF TIME UNDER THE PROVISIONS OF 37 CFR 1.136(a) WILL NOT BE PERMITTED DURING THE PROSECUTION OF THIS APPLICATION.

#### **Examiner Note:**

In bracket 1, insert either —is— or —has been—.

If additional details of the litigation appear to be material to examination of the reissue application, the examiner may make such additional inquiries as necessary and appropriate.

If the existence of litigation has not already been noted, the examiner should place a prominent notation on the application file to indicate the litigation (1) at the bottom of the face of the file in the box just to the right of the box for the retention label, and (2) on the pink Reissue Notice Card form.

Applicants will normally be given 1 month to reply to Office actions in all reissue applications which are being examined during litigation, or after litigation had been stayed, dismissed, etc., to allow for consideration of the reissue by the Office. This 1-month period may be extended only upon a showing of *clear justification* pursuant to 37 CFR 1.136(b). The Office action will inform applicant that the provisions of 37 CFR 1.136(a) are not available. Of course, up to 3 months may be set for reply if the examiner determines such a period is clearly justified.

### 1442.02 Concurrent Litigation [R-2]

In order to avoid duplication of effort, action in reissue applications in which there is an indication of concurrent litigation will be suspended automatically unless and until it is evident to the examiner, or the applicant indicates, that any one of the following applies:

- (A) a stay of the litigation is in effect;
- (B) the litigation has been terminated;
- (C) there are no significant overlapping issues between the application and the litigation; or
- (D) it is applicant’s desire that the application be examined at that time.

Where any of (A) - (D) above apply, form paragraphs 14.08-14.10 may be used to deny a suspension of action in the reissue, i.e., to deny a stay of the reissue proceeding.

#### ¶ 14.08 *Action in Reissue Not Stayed — Related Litigation Terminated*

Since the litigation related to this reissue application is terminated and final, action in this reissue application will NOT be stayed. Due to the related litigation status of this reissue application, EXTENSIONS OF TIME UNDER THE PROVISIONS OF 37 CFR 1.136(a) WILL NOT BE PERMITTED.



¶ 14.09 *Action in Reissue Not Stayed — Related Litigation Not Overlapping*

While there is concurrent litigation related to this reissue application, action in this reissue application will NOT be stayed because there are no significant overlapping issues between the application and that litigation. Due to the related litigation status of this reissue application, EXTENSIONS OF TIME UNDER THE PROVISIONS OF 37 CFR 1.136(a) WILL NOT BE PERMITTED.

¶ 14.10 *Action in Reissue Not Stayed — Applicant's Request*

While there is concurrent litigation related to this reissue application, action in this reissue application will NOT be stayed because of applicant's request that the application be examined at this time. Due to the related litigation status of this reissue application, EXTENSIONS OF TIME UNDER THE PROVISIONS OF 37 CFR 1.136(a) WILL NOT BE PERMITTED.

Where none of (A) through (D) above apply, action in the reissue application in which there is an indication of concurrent litigation will be suspended by the examiner. The examiner should consult with the Group Special Program Examiner prior to suspending action in the reissue. Form paragraph 14.11 may be used to suspend action, i.e., stay action, in a reissue application with concurrent litigation.

¶ 14.11 *Action in Reissue Stayed - Related Litigation*

In view of concurrent litigation, and in order to avoid duplication of effort between the two proceedings, action in this reissue application is STAYED until such time as it is evident to the examiner that (1) a stay of the litigation is in effect, (2) the litigation has been terminated, (3) there are no significant overlapping issues between the application and the litigation, or (4) applicant requests that the application be examined.

If the reissue application has been merged with \* >an *ex parte*< reexamination proceeding, the merged proceeding generally will **not** be stayed where there is litigation. In a merged >*ex parte*< reexamination/reissue proceeding, the >*ex parte*< reexamination will control because of the *statutory* (35 U.S.C. 305) requirement that >*ex parte*< reexamination proceedings be conducted with special dispatch. See MPEP § 2285 and § 2286. >As to a stay or suspension where reissue proceedings are merged with *inter partes* reexamination proceedings, see 37 CFR 1.937 and MPEP § 2686.<

### 1442.03 Litigation Stayed

All reissue applications, except those under suspension because of litigation, will be taken up for action

ahead of other “special” applications; this means that all issues not deferred will be treated and responded to *immediately*. Furthermore, reissue applications involved in “stayed litigation” will be taken up for action in advance of other reissue applications. Great emphasis is placed on the expedited processing of such reissue applications. The courts are especially interested in expedited processing in the Office where litigation is stayed.

In reissue applications with “stayed litigation,” the Office will entertain petitions under 37 CFR 1.182, which are accompanied by the fee under 37 CFR 1.17(h), to not apply the 2-month delay period stated in MPEP § 1441. Such petitions are decided by the Office of Patent Legal Administration.

Time-monitoring systems have been put into effect which will closely monitor the time used by applicants, protestors, and examiners in processing reissue applications of patents involved in litigation in which the court has stayed further action. Monthly reports on the status of reissue applications with related litigation are required from each Technology Center (TC). Delays in reissue processing are to be followed up. The TC Special Program Examiner is responsible for oversight of reissue applications with related litigation.

The purpose of these procedures and those deferring consideration of certain issues, until all other issues are resolved or the application is otherwise ready for consideration by the Board of Patent Appeals and Interferences (note MPEP § 1448), is to reduce the time between filing of the reissue application and final action thereon, while still giving all parties sufficient time to be heard.

Requests for stays or suspension of action in reissues where litigation has been stayed may be answered with form paragraph 14.07.

¶ 14.07 *Action in Reissue Not Stayed or Suspended — Related Litigation Stayed*

While there is a stay of the concurrent litigation related to this reissue application, action in this reissue application will NOT be stayed or suspended because a stay of that litigation is in effect for the purpose of awaiting the outcome of these reissue proceedings. Due to the related litigation status of this reissue application, EXTENSIONS OF TIME UNDER THE PROVISIONS OF 37 CFR 1.136(a) WILL NOT BE PERMITTED.

**1442.04 Litigation Involving Patent [R-2]**

37 CFR 1.178. *Original patent; continuing duty of applicant.*

\*\*\*\*\*

(b) In any reissue application before the Office, the applicant must call to the attention of the Office any prior or concurrent proceedings in which the patent (for which reissue is requested) is or was involved, such as interferences, reissues, reexaminations, or litigations and the results of such proceedings (see also § 1.173(a)(1)).

Where the patent for which reissue is being sought is, or has been, involved in litigation, the applicant should bring the existence of such litigation to the attention of the Office. 37 CFR 1.178(b). This should be done at the time of, or shortly after, the applicant files the application, either in the reissue oath or declaration, or in a separate paper, preferably accompanying the application as filed. Litigation begun after filing of the reissue application also should be promptly brought to the attention of the Office.

Litigation encompasses any papers filed in the court or issued by the court. This may include, for example, motions, pleadings, and court decisions, as well as the results of such proceedings. When applicant notifies the Office of the existence of the litigation, enough information should be submitted so that the Office can reasonably evaluate the need for asking for further materials in the litigation. Note that the existence of supporting materials which may substantiate allegations of invalidity should, at least, be fully described, and preferably submitted. The Office is not interested in receiving voluminous litigation materials which are not relevant to the Office's consideration of the reissue application. The status of the litigation should be updated in the reissue application as soon as significant events happen in the litigation.

When a reissue application is filed, the examiner should determine whether the original patent has been adjudicated by a court. The decision(s) of the court, and also other papers in the suit, may provide information essential to the examination of the reissue. Examiners should inform the applicant of the duty to supply information as to litigation involving the patent. Form paragraph 14.11.01 may be used for this purpose. See MPEP § 1418.

Additionally, the patented file will contain notices of the filing and termination of infringement suits on

the patent. Such notices are required by law to be filed by the clerks of the Federal District Courts. These notices do not indicate if there was an opinion by the court, nor whether a decision was published. *Shepard's Federal Citations* and the cumulative digests of the *United States Patents Quarterly*, both of which are in the Lutrelle F. Parker, Sr., Memorial Law Library, contain tables of patent numbers giving the citation of published decisions concerning the patent.

A litigation computer search by the Scientific and Technical Information Center (STIC) should be requested by the examiner to determine whether the patent has been, or is, involved in litigation. The "Search Notes" box on the application file wrapper can then be completed to indicate that the review was conducted. A copy of the STIC search should be hole-punched and placed in the reissue file. >(For IFW processing, see IFW Manual.)<

Additional information or guidance as to making a litigation search may be obtained from the library of the Office of the Solicitor. Where papers are not otherwise conveniently obtainable, the applicant may be requested to supply copies of papers and records in suits, or the Office of the Solicitor may be requested to obtain them from the court. The information thus obtained should be carefully considered for its bearing on the proposed claims of the reissue, particularly when the reissue application was filed in view of the holding of a court.

If the examiner becomes aware of litigation involving the patent sought to be reissued during examination of the reissue application, and applicant has not made the details regarding that litigation of record in the reissue application, the examiner, in the next Office action, should inquire regarding the same. Form paragraph 14.06 may be used for such an inquiry. See MPEP § 1442.01.

If the additional details of the litigation appear to be material to patentability of the reissue application, the examiner may make such additional inquiries as necessary and appropriate.

**1442.05 \*\* >Court Ordered Filing of Reissue Application< [R-2]**

\*\*.

In most instances, the reissue-examination procedure is instituted by a patent owner who voluntarily files a reissue application as a consequence of related

patent litigation. \*\*>Some district courts in earlier decisions have required a patentee-litigant to file a reissue application as a consequence of the patent litigation. However, the Court of Appeals for the Federal Circuit held in *Green v. The Rich Iron Co.*, 944 F.2d 852, 853, 20 USPQ2d 1075, 1076 (Fed. Cir. 1991) that a district court in an infringement case could not compel a patentee to seek reissue by the USPTO.<

It is to be noted that only a patentee or his or her assignee may file a reissue patent application. An order >by a court< for a different party to file a reissue will not be binding on the Office.

\*\*

### 1443 Initial Examiner Review [R-2]

As part of an examiner's preparation for the examination of a reissue application, the Examiner Reissue Guide and Checklist should be consulted for basic guidance and suggestions for handling the prosecution. The Technology Center (TC) Special Program Examiners (SPREs) should make the Guide and Checklist available at the time a reissue application is docketed to an examiner.

On initial receipt of a reissue application, the examiner should inspect the submission under 37 CFR 1.172 as to documentary evidence of a chain of title from the original owner to the assignee to determine whether the consent requirement of 37 CFR 1.172 has been met. The examiner will compare the consent and documentary evidence of ownership; the assignee indicated by the documentary evidence must be the same assignee which signed the consent. Also, the person who signs the consent for the assignee and the person who signs the submission of evidence of ownership for the assignee must both be persons having authority to do so. See also MPEP § 324.

Where the application is assigned, and there is no submission under 37 CFR 1.172 as to documentary evidence in the application, the examiner should require the submission using form paragraph 14.16. Once the submission under 37 CFR 1.172 as to documentary evidence is received, it must be compared with the consent to determine whether the assignee indicated by the documentary evidence is the same assignee which signed the consent. See MPEP § 1410.01 for further discussion as to the required consent and documentary evidence.

Where there is a statement of record that the application is **not** assigned, there should be no submission under 37 CFR 1.172 as to documentary evidence of ownership in the application, and none should be required by the examiner.

The filing of all reissue applications, except for continued prosecution applications (CPAs) filed under 37 CFR 1.53(d), must be announced in the *Official Gazette*. Accordingly, for any reissue application other than a CPA, the examiner should determine if the filing of the reissue application has been announced in the *Official Gazette* as provided in 37 CFR 1.11(b), especially where the reissue is a file wrapper continuation under former 37 CFR 1.62. The date of the *Official Gazette* notice can usually be found on the pink "REISSUE" tag which protrudes from the top of the application file of 08/ or earlier series. >(For IFW processing, see IFW Manual.)< Where the date is missing from the tag, or where the tag itself is missing, the >contents entry on the< PALM screen (2952) should be checked for the presence of an "NRE" entry in the contents. For 09/ and later series reissue applications, the *Official Gazette* publication date appears on the face of the file wrapper. >(For IFW processing, see IFW Manual.) < If the filing of the reissue application has not been announced in the *Official Gazette*, the reissue application should be returned to the Office of Initial Patent Examination (Special Processing) to handle the announcement. The examiner should not further act on the reissue until 2 months after announcement of the filing of the reissue has appeared in the *Official Gazette*. See MPEP § 1440.

The examiner should determine if there is concurrent litigation, and if so, the status thereof (MPEP § 1442.01), and whether the reissue file >wrapper/file history< has been appropriately marked. Note MPEP § 1404. >(For IFW processing, see IFW Manual.)<

The examiner should determine if a protest has been filed, and if so, it should be handled as set forth in MPEP § 1901.06. >For a discussion of protests under 37 CFR 1.291(a) in reissue applications, see MPEP § 1441.01.<

The examiner should determine whether the patent is involved in an interference, and if so, should refer to MPEP § 1449.01 before taking any action on the reissue application.

The examiner should check that an offer to surrender the original patent, or a statement to the effect that the original is lost or inaccessible, has been received. An examination on the merits is made even though the above has not been received. See MPEP § 1416.

The examiner should verify that all Certificate of Correction changes have been properly incorporated into the reissue application. See MPEP § 1411.01.

The examiner should verify that the patent on which the reissue application is based has not expired, either because its term has run or because required maintenance fees have not been paid. Once a patent has expired, the \* >Director of the USPTO< no longer has the authority under 35 U.S.C. 251 to reissue the patent. See *In re Morgan*, 990 F.2d 1230, 26 USPQ2d 1392 (Fed. Cir. 1992). See also MPEP § 1415.01.

## 1444 Review of Reissue Oath/Declaration

In accordance with 37 CFR 1.175, the following is required in the reissue oath/declaration:

(A) A statement that the applicant believes the original patent to be wholly or partly inoperative or invalid-

(1) by reason of a defective specification or drawing, or

(2) by reason of the patentee claiming more or less than patentee had the right to claim in the patent;

(B) A statement of at least one error which is relied upon to support the reissue application, i.e., which provides a basis for the reissue;

(C) A statement that all errors which are being corrected in the reissue application up to the time of filing of the oath/declaration arose without any deceptive intention on the part of the applicant; and

(D) The information required by 37 CFR 1.63.

MPEP § 1414 contains a discussion of each of the above elements (i.e., requirements of a reissue oath/declaration). The examiner should carefully review the reissue oath/declaration in conjunction with that discussion, in order to ensure that each element is provided in the oath/declaration. If the examiner's review of the oath/declaration reveals a lack of compliance with any of the requirements of 37 CFR 1.175, a rejection of all the claims under 35 U.S.C. 251 should be made on the basis that the reissue oath/declaration is insufficient.

In preparing an Office action, the examiner should use form paragraphs 14.01 through 14.01.04 to state the objection(s) to the oath/declaration, i.e., the defects in the oath/declaration. These form paragraphs are reproduced in MPEP § 1414. The examiner should then use form paragraph 14.14 to reject the claims under 35 U.S.C. 251, based upon the improper oath/declaration.

### ¶ 14.14 Rejection, Defective Reissue Oath or Declaration

Claim [1] rejected as being based upon a defective reissue [2] under 35 U.S.C. 251 as set forth above. See 37 CFR 1.175.

The nature of the defect(s) in the [3] is set forth in the discussion above in this Office action.

### Examiner Note:

1. In bracket 1, list all claims in the reissue application. See MPEP § 706.03(x).

2. This paragraph should be preceded by at least one of the paragraphs 14.01 to 14.01.04.

3. In brackets 2 and 3, insert either --oath-- or --declaration--.

A lack of signature on a reissue oath/declaration (except as otherwise provided in 37 CFR 1.42, 1.43, and 1.47 and in 37 CFR 1.172) would be considered a lack of compliance with 37 CFR 1.175(a) and result in a rejection, including final rejection, of all the claims on the basis that the reissue oath/declaration is insufficient. If the unsigned reissue oath/declaration is submitted as part of a reply which is otherwise properly signed and responsive to the outstanding Office action, the reply should be accepted by the examiner as proper and responsive, and the oath/declaration considered fully in the next Office action. The reply should not be treated as an unsigned or improperly signed amendment (see MPEP § 714.01(a)), nor do the holdings of *Ex parte Quayle* apply in this situation. The lack of signature, along with any other oath/declaration deficiencies, should be noted in the next Office action *rejecting* the claims as being based upon an insufficient reissue oath/declaration.

## HANDLING OF THE REISSUE OATH/DECLARATION DURING THE REISSUE PROCEEDING

An initial reissue oath/declaration is submitted with the reissue application (or within the time period set for filing the oath/declaration in a Notice To File Missing Parts under 37 CFR 1.53(f)). Where the reissue oath/declaration fails to comply with 37 CFR 1.175(a), the examiner will so notify the applicant in an Office action, rejecting the claims under 35 U.S.C.

251 as discussed above. In reply to the Office action, a supplemental reissue oath/declaration should be submitted dealing with the noted defects in the reissue oath/declaration.

Where the initial reissue oath/declaration (1) failed to provide *any* error statement, or (2) attempted to provide an error statement, but failed to identify any error under 35 U.S.C. 251 upon which reissue can be based (see MPEP § 1402), the examiner should reject all the claims as being based upon a defective reissue oath/declaration under 35 U.S.C. 251. To support the rejection, the examiner should specifically point out the failure of the initial oath/declaration to comply with 37 CFR 1.175 because an “error” under 35 U.S.C. 251 upon which reissue can be based was not identified therein. In reply to the rejection under 35 U.S.C. 251, a supplemental reissue oath/declaration must be submitted stating an error under 35 U.S.C. 251 which can be relied upon to support the reissue application. Submission of this supplemental reissue oath/declaration to obviate the rejection cannot be deferred by applicant until the application is otherwise in condition for allowance. In this instance, a proper statement of error *was never provided in the initial reissue oath/declaration*, thus a supplemental oath/declaration is required *in reply to the Office action* in order to properly establish grounds for reissue.

A different situation may arise where the initial reissue oath/declaration does properly identify one or more errors under 35 U.S.C. 251 as being the basis for reissue, however, because of changes or amendments made during prosecution, none of the identified errors are relied upon any more. A supplemental oath/declaration will be needed to identify at least one error *now* being relied upon as the basis for reissue, even though the prior oath/declaration was earlier found proper by the examiner. The supplemental oath/declaration need *not* also indicate that the error(s) identified in the prior oath(s)/declaration(s) is/are no longer being corrected. In this instance, applicant’s submission of the supplemental reissue oath/declaration to obviate the rejection under 35 U.S.C. 251 can, at applicant’s option, be deferred until the application is otherwise in condition for allowance. The submission can be deferred because a proper statement of error was provided in the initial reissue oath/declaration. Applicant need only request that submission of the supplemental re-

sue oath/declaration be deferred until allowance, and such a request will be considered a complete reply to the rejection.

#### **SUPPLEMENTAL REISSUE OATH/DECLARATION UNDER 37 CFR 1.175(b)(1):**

Once the reissue oath/declaration is found to comply with 37 CFR 1.175(a), it is not required, nor is it suggested, that a new reissue oath/declaration be submitted together with each new amendment and correction of error in the patent. During the prosecution of a reissue application, amendments are often made and additional errors in the patent are corrected. A supplemental oath/declaration need not be submitted with each amendment and additional correction. Rather, it is suggested that the reissue applicant wait until the case is in condition for allowance, and then submit a cumulative supplemental reissue oath/declaration pursuant to 37 CFR 1.175(b)(1).

See MPEP § 1414.01 for a discussion of the required content of a supplemental reissue oath/declaration under 37 CFR 1.175(b)(1).

A supplemental oath/declaration under 37 CFR 1.175(b)(1) must be submitted before allowance. It may be submitted with any reply prior to allowance. It may be submitted to overcome a rejection under 35 U.S.C. 251 made by the examiner, where it is indicated that the submission of the supplemental oath/declaration will overcome the rejection.

A supplemental oath/declaration under 37 CFR 1.175(b)(1) will be required where:

(A) the application is otherwise (other than the need for this supplemental oath/declaration) in condition for allowance;

(B) amendments or other corrections of errors in the patent have been made subsequent to the last oath/declaration filed in the application; and

(C) at least one of the amendments or other corrections corrects an error under 35 U.S.C. 251.

When a supplemental oath/declaration under 37 CFR 1.175(b)(1) directed to the amendments or other corrections of error is required, the examiner is encouraged to telephone the applicant and request the submission of the supplemental oath/declaration by fax. If the circumstances do not permit making a telephone call, or if applicant declines or is unable to promptly submit the oath/declaration, the examiner

should issue a final Office action (final rejection) and use form paragraph 14.05.02 where the action issued is a second or subsequent action on the merits.

*¶ 14.05.02 Supplemental Oath or Declaration Required Prior to Allowance*

In accordance with 37 CFR 1.175(b)(1), a supplemental reissue oath/declaration under 37 CFR 1.175(b)(1) must be received before this reissue application can be allowed.

Claim [1] rejected as being based upon a defective reissue [2] under 35 U.S.C. 251. See 37 CFR 1.175. The nature of the defect is set forth above.

Receipt of an appropriate supplemental oath/declaration under 37 CFR 1.175(b)(1) will overcome this rejection under 35 U.S.C. 251. An example of acceptable language to be used in the supplemental oath/declaration is as follows:

“Every error in the patent which was corrected in the present reissue application, and is not covered by a prior oath/declaration submitted in this application, arose without any deceptive intention on the part of the applicant.”

**Examiner Note:**

1. In bracket 1, list all claims in the reissue application.
2. In bracket 2, insert either --oath-- or --declaration--.
3. This form paragraph is used in an Office action to: (a) remind applicant of the requirement for submission of the supplemental reissue oath/declaration under 37 CFR 1.175(b)(1) before allowance and (b) at the same time, reject all the claims since the reissue application is defective until the supplemental oath/declaration is submitted.
4. Do not use this form paragraph if no amendments (or other corrections of the patent) have been made subsequent to the last oath/declaration filed in the case; instead allow the case.
5. This form paragraph cannot be used in an *Ex parte Quayle* action to require the supplemental oath/declaration, because the rejection under 35 U.S.C. 251 is more than a matter of form.
6. Do not use this form paragraph in an examiner's amendment. The supplemental oath/declaration must be filed prior to mailing of the Notice of Allowability.

As noted above, the examiner will issue a final Office action where the application is otherwise in condition for allowance, and amendments or other corrections of error in the patent have been made subsequent to the last oath/declaration filed in the application. The examiner will be introducing (via form paragraph 14.05.02) a rejection into the case for the first time in the prosecution, when the claims have been determined to be otherwise allowable. This introduction of a new ground of rejection under 35 U.S.C. 251 will not prevent the action from being made final on a second or subsequent action because of the following factors:

(A) The finding of the case in condition for allowance is the first opportunity that the examiner has to make the rejection;

(B) The rejection is being made in reply to, i.e., was caused by, an amendment of the application (to correct errors in the patent);

(C) All applicants are on notice that this rejection will be made upon finding of the case otherwise in condition for allowance where errors have been corrected subsequent to the last oath/declaration filed in the case, so that the rejection should have been expected by applicant; and

(D) The rejection will not prevent applicant from exercising any rights to cure the rejection, since applicant need only submit a supplemental oath/declaration with the above-described language, and it will be entered to cure the rejection.

Where the application is in condition for allowance and **no amendments or other corrections of error in the patent have been made subsequent to the last oath/declaration** filed in the application, a supplemental reissue oath/declaration under 37 CFR 1.175(b)(1) **should not be required by the examiner**. Instead, the examiner should issue a Notice of Allowability indicating allowance of the claims.

**AFTER ALLOWANCE**

Where applicant seeks to correct an error after allowance of the application, any amendment of the patent correcting the error must be submitted in accordance with 37 CFR 1.312. As set forth in 37 CFR 1.312, no amendment may be made as a matter of right in an application after the mailing of the notice of allowance. An amendment filed under 37 CFR 1.312 must be filed before or with the payment of the issue fee and may be entered on the recommendation of the primary examiner, and approved by the supervisory patent examiner, without withdrawing the case from issue.

Because the amendment seeks to correct an error in the patent, the amendment will affect the disclosure, the scope of a claim, or add a claim. Thus, in accordance with MPEP § 714.16, the remarks accompanying the amendment must fully and clearly state:

(A) why the amendment is needed;

(B) why the proposed amended or new claims require no additional search or examination;

- (C) why the claims are patentable; and
- (D) why they were not presented earlier.

A supplemental reissue oath/declaration must accompany the amendment. The supplemental reissue oath/declaration must state that the error(s) to be corrected arose without any deceptive intention on the part of the applicant. The supplemental reissue oath/declaration submitted after allowance must be directed to the error(s) applicant seeks to correct after allowance. This oath/declaration need not cover any earlier errors, since all earlier errors should have been covered by a reissue oath/declaration submitted prior to allowance.

Occasionally correcting an error after allowance does not include an amendment of the specification or claims of the patent. For example, the correction of the error could be the filing of a certified copy of the original foreign application (prior to the payment of the issue fee - see 37 CFR 1.55(a)(2)) to obtain the right of foreign priority under 35 U.S.C. 119 (see *Brenner v. State of Israel*, 400 F.2d 789, 158 USPQ 584 (D.C. Cir. 1968)) where the claim for foreign priority had been timely made in the application for the original patent. In such a case, the requirements of 37 CFR 1.312 must still be met. This is so, because the correction of the patent is an amendment of the patent, even though no amendment is physically entered into the case. Thus, for a reissue oath/declaration submitted after allowance to correct an additional error (or errors), the reissue applicant must comply with 37 CFR 1.312 in the manner discussed above.

#### **1445 Reissue Application Examined in Same Manner as Original Application**

As stated in 37 CFR 1.176, a reissue application, including all the claims therein, is subject to “be examined in the same manner as a non-reissue, non-provisional application.” Accordingly, the claims in a reissue application are subject to any and all rejections which the examiner deems appropriate. It does not matter whether the claims are identical to those of the patent or changed from those in the patent. It also does not matter that a rejection was not made in the prosecution of the patent, or could have been made, or was in fact made and dropped during prosecution of the patent; the prior action in the prosecution of the

patent does not prevent that rejection from being made in the reissue application. Claims in a reissue application enjoy no “presumption of validity.” *In re Doyle*, 482 F.2d 1385, 1392, 179 USPQ 227, 232-233 (CCPA 1973); *In re Sneed*, 710 F.2d 1544, 1550 n.4, 218 USPQ 385, 389 n.4 (Fed. Cir. 1983). Likewise, the fact that during prosecution of the patent the examiner considered, may have considered, or should have considered information such as, for example, a specific prior art document, does not have any bearing on, or prevent, its use as prior art during prosecution of the reissue application.

#### **1448 Fraud, Inequitable Conduct, or Duty of Disclosure Issues [R-2]**

The Office no longer investigates and rejects reissue applications under 37 CFR 1.56. The Office will not comment upon duty of disclosure issues which are brought to the attention of the Office in reissue applications except to note in the application, in appropriate circumstances, that such issues are no longer considered by the Office during its examination of patent applications. Examination as to the lack of deceptive intent requirement in reissue applications will continue but without any investigation of fraud, inequitable conduct, or duty of disclosure issues. Applicant’s statement in the reissue oath or declaration of lack of deceptive intent will be accepted as dispositive except in special circumstances such as an admission or judicial determination of fraud, inequitable conduct, or violation of the duty of disclosure.

#### **ADMISSION OR JUDICIAL DETERMINATION**

An admission or judicial determination of fraud, inequitable conduct, or violation of the duty of disclosure is a special circumstance, because no investigation need be made. Accordingly, after consulting with the Technology Center (TC) Special Program Examiner (SPRE), a rejection should be made using the appropriate one of form paragraphs 14.21.09 or 14.22 as reproduced below.

Any admission of fraud, inequitable conduct or violation of the duty of disclosure must be explicit, unequivocal, and not subject to other interpretation. Where a rejection is made based upon such an admission (see form paragraph 14.22 below) and applicant responds with any reasonable interpretation of the facts that would not lead to a conclusion of fraud,

inequitable conduct or violation of the duty of disclosure, the rejection should be withdrawn. Alternatively, if applicant argues that the admission noted by the examiner was not in fact an admission, the rejection should also be withdrawn.

Form paragraph 14.21.09 should be used where the examiner becomes aware of a judicial determination of fraud, inequitable conduct or violation of the duty of disclosure on the part of the applicant **independently of the record of the case**, i.e., the examiner has external knowledge of the judicial determination.

Form paragraph 14.22 should be used where, **in the application record**, there is (a) an explicit, unequivocal admission by applicant of fraud, inequitable conduct or violation of the duty of disclosure which is not subject to other interpretation, or (b) information as to a judicial determination of fraud, inequitable conduct or violation of the duty of disclosure on the part of the applicant. External information which the examiner believes to be an *admission* by applicant should never be used by the examiner, and such external information should never be made of record in the reissue application.

*¶ 14.21.09 Rejection, 35 U.S.C. 251, No Error Without Deceptive Intention - External Knowledge*

Claims [1] rejected under 35 U.S.C. 251 since error “without any deceptive intention” has not been established. In view of the judicial determination in [2] of [3] on the part of applicant, a conclusion that any error was “without deceptive intention” cannot be supported. [4]

**Examiner Note:**

1. In bracket 1, list all claims in the reissue application.
2. In bracket 2, list the Court or administrative body which made the determination of fraud or inequitable conduct on the part of applicant.
3. In bracket 3, insert --fraud--, --inequitable conduct-- and/or --violation of duty of disclosure--.
4. In bracket 4, point out where in the opinion (or holding) of the Court or administrative body the determination of fraud, inequitable conduct or violation of duty of disclosure is set forth. Page number, column number, and paragraph information should be given as to the opinion (or holding) of the Court or administrative body. The examiner may add explanatory comments.

\*\*>

*¶ 14.22 Rejection, 35 U.S.C. 251, No Error Without Deceptive Intention-Evidence in the Application*

Claims [1] rejected under 35 U.S.C. 251 since error “without any deceptive intention” has not been established. In view of the reply filed on [2], a conclusion that any error was “without deceptive intention” cannot be supported.

[3]

**Examiner Note:**

1. In bracket 1, list all claims in the reissue application.
2. In bracket 2, insert the filing date of the reply which provides an admission of fraud, inequitable conduct or violation of duty of disclosure, or that there was a judicial determination of same.
3. In bracket 3, insert a statement that there has been an admission or a judicial determination of fraud, inequitable conduct or violation of duty of disclosure which provide circumstances why applicant’s statement in the oath or declaration of lack of deceptive intent should not be taken as dispositive. Any admission of fraud, inequitable conduct or violation of duty of disclosure must be explicit, unequivocal, and not subject to other interpretation.

<

See MPEP § 2012 for additional discussion as to fraud, inequitable conduct or violation of duty of disclosure in a reissue application.

## 1449 Protest Filed in Reissue Where Patent Is in Interference [R-2]

If a protest (see MPEP Chapter 1900) is filed in a reissue application related to a patent involved in a pending interference proceeding, the reissue application should be referred to the Office of Patent Legal Administration (OPLA) before considering the protest and acting on the reissue application.

The OPLA will check to see that:

- (A) all parties to the interference are aware of the filing of the reissue; and
- (B) the Office does not allow claims in the reissue which are unpatentable over the pending interference count(s), or found unpatentable in the interference proceeding. >After the reissue application has been reviewed by the OPLA, the reissue application with the protest will be returned to the examiner. See MPEP § 1441.01 for a discussion as to protests under 37 CFR 1.291(a) in reissue applications.<

## 1449.01 Concurrent Office Proceedings [R-2]

>

### I. CONCURRENT REEXAMINATION PROCEEDINGS:<

37 CFR 1.565(d) provides that if “a reissue application and an *ex parte* reexamination proceeding on which an order pursuant to 37 CFR 1.525 has been



mailed are pending concurrently on a patent, a decision will normally be made to merge the two proceedings or to suspend one of the two proceedings.” \*\* >37 CFR 1.991 provides that if “a reissue application and an *inter partes* reexamination proceeding on which an order pursuant to 37 CFR 1.931 has been mailed are pending concurrently on a patent, a decision may be made to merge the two proceedings or to suspend one of the two proceedings”.< If an examiner becomes aware that a reissue application and \* >an *ex parte* or *inter partes*< reexamination proceeding are both pending for the same patent, he or she should inform the Technology Center (TC) Special Program Examiner (SPRE) immediately.

Where a reissue application and a reexamination proceeding are pending concurrently on a patent, *and an order granting reexamination has been issued* for the reexamination proceeding, the files for the reissue application and the reexamination will be forwarded to the Office of Patent Legal Administration (OPLA) for a decision whether to merge the reissue and the reexamination, or stay one of the two. >(For IFW processing, see IFW Manual.)< See *In re Onda*, 229 USPQ 235 (Comm’r Pat. 1985). See also MPEP § 2285.

>Where a reissue application and a reexamination proceeding are pending concurrently on a patent, the patent owner, i.e., the reissue applicant, has a responsibility to notify the Office of the concurrent proceeding. 37 CFR § 1.178(b), 37 CFR 1.565(a), and 37 CFR 1.985(a). The patent owner should file in the reissue application, as early as possible, a Notification of Concurrent Proceedings pursuant to 37 CFR 1.178(b) in order to alert the Office of the existence of the reexamination proceeding on the same patent. See MPEP § 1418. In addition, the patent owner should file in the reexamination proceeding, as early as possible, a Notification of Concurrent Proceedings pursuant to 37 CFR 1.565(a) or 1.985(a) (depending on whether the reexamination proceeding is an *ex parte* reexamination proceeding or an *inter partes* reexamination proceeding) to provide a notification to the Office in the reexamination proceeding of the existence of the two concurrent proceedings.

The patent owner may file a petition under 37 CFR 1.182 in a reissue application to merge the reissue application with the reexamination proceeding, or to stay one of the proceedings because of the other. This

petition must be filed after the issuance of the order to reexamine (37 CFR 1.525, 37 CFR 1.931) in the reexamination proceeding. If the petition is filed prior to the reexamination order, it will not be considered, and will be returned to the patent owner by the TC Director. If the petition is filed after the issuance of the order to reexamine, the petition and the files for the reissue application and the reexamination proceeding will be forwarded to OPLA for decision.

## II. CONCURRENT INTERFERENCE PROCEEDINGS:<

If the original patent is involved in an interference, the examiner must consult the administrative patent judge in charge of the interference before taking any action on the reissue application. It is particularly important that the reissue application not be granted without the administrative patent judge's approval. See MPEP § 2360.

>

## III. CONCURRENT REISSUE PROCEEDINGS

Where more than one reissue applications are pending concurrently on the same patent, see MPEP §§ 1450 and 1451.<

### 1449.02 Interference in Reissue

In appropriate circumstances, a reissue application may be placed into interference with a patent or pending application. A patentee may provoke an interference with a patent or pending application by filing a reissue application, if the reissue application includes an appropriate reissue error as required by 35 U.S.C. 251. Reissue error must be based upon applicant error; a reissue cannot be based solely on the error of the Office for failing to declare an interference or to suggest copying claims for the purpose of establishing an interference. See *In re Keil*, 808 F.2d 830, 1 USPQ2d 1427 (Fed. Cir. 1987); *In re Dien*, 680 F.2d 151, 214 USPQ 10 (CCPA 1982); *In re Bostwick*, 102 F.2d 886, 888, 41 USPQ 279, 281 (CCPA 1939); and *In re Guastavino*, 83 F.2d 913, 916, 29 USPQ 532, 535 (CCPA 1936). See also *Slip Track Systems, Inc. v. Metal Lite, Inc.*, 159 F.3d 1337, 48 USPQ2d 1055 (Fed. Cir. 1998) (Two patents issued claiming the same patentable subject matter, and the patentee with the earlier filing date requested reexamination of the

patent with the later filing date (Slip Track's patent). A stay of litigation in a priority of invention suit under 35 U.S.C. 291, pending the outcome of the reexamination, was reversed. The suit under 35 U.S.C. 291 was the only option available to Slip Track to determine priority of invention. Slip Track could not file a reissue application solely to provoke an interference proceeding before the Office because it did not assert that there was any error as required by 35 U.S.C. 251 in the patent.). A reissue application can be employed to provoke an interference if the reissue application:

(A) adds copied claims which are not present in the original patent;

(B) amends claims to correspond to those of the patent or application with which an interference is sought; or

(C) contains at least one error (not directed to provoking an interference) appropriate for the reissue.

In the first two situations, the reissue oath/declaration must assert that applicant erred in failing to include claims of the proper scope to provoke an interference in the original patent application. Note that in *In re Metz*, 1998 U.S. App. LEXIS 23733 (Fed. Cir. 1998)(unpublished), the Federal Circuit permitted a patentee to file a reissue application to copy claims from a patent in order to provoke an interference with that patent. Furthermore, the subject matter of the copied or amended claims in the reissue application must be supported by the disclosure of the original patent under 35 U.S.C. 112, first paragraph. See *In re Molins*, 368 F.2d 258, 261, 151 USPQ 570, 572 (CCPA 1966) and *In re Spencer*, 273 F.2d 181, 124 USPQ 175 (CCPA 1959).

A reissue applicant cannot present added or amended claims to provoke an interference, if the claims were deliberately omitted from the patent. If there is evidence that the claims were not inadvertently omitted from the original patent, e.g., the subject matter was described in the original patent as being undesirable, the reissue application may lack proper basis for the reissue. See *In re Bostwick*, 102 F.2d at 889, 41 USPQ at 282 (CCPA 1939)(reissue lacked a proper basis because the original patent pointed out the disadvantages of the embodiment that provided support for the copied claims).

The issue date of the patent, or the publication date of the application publication (whichever is applicable

under 35 U.S.C. 135(b)), with which an interference is sought must be less than 1 year prior to the presentation of the copied or amended claims in the reissue application. See 35 U.S.C. 135(b) and MPEP § 715.05 and § 2307. If the reissue application includes broadened claims, the reissue application must be filed within two years from the issue date of the original patent. See 35 U.S.C. 251 and MPEP § 1412.03.

### **REISSUE APPLICATION FILED WHILE PATENT IS IN INTERFERENCE**

If a reissue application is filed while the original patent is in an interference proceeding, the reissue applicant is required to notify the Board of Patent Appeals and Interferences of the filing of the reissue application within 10 days from the filing date. See 37 CFR 1.660(b) and MPEP § 2360.

### **1450 Restriction and Election of Species >Made in Reissue Application< [R-2]**

*37 CFR 1.176. Examination of reissue.*

(a) A reissue application will be examined in the same manner as a non-reissue, non-provisional application, and will be subject to all the requirements of the rules related to non-reissue applications. Applications for reissue will be acted on by the examiner in advance of other applications.

(b) Restriction between subject matter of the original patent claims and previously unclaimed subject matter may be required (restriction involving only subject matter of the original patent claims will not be required). If restriction is required, the subject matter of the original patent claims will be held to be constructively elected unless a disclaimer of all the patent claims is filed in the reissue application, which disclaimer cannot be withdrawn by applicant.

37 CFR 1.176(b) permits the examiner to require restriction in a reissue application between claims newly added in a reissue application and the original patent claims, where the added claims are directed to an invention which is separate and distinct from the invention(s) defined by the original patent claims. The criteria for making a restriction requirement in a reissue application between the newly added claims and the original claims are the same as that applied in a non-reissue application. See MPEP §§ 806 through 806.05(i). The authority to make a "restriction" requirement under 37 CFR 1.176(b) extends to and includes the authority to make an election of species.

Where a restriction requirement is made by the examiner, the original patent claims will be held to be constructively elected (except for the limited situation where a disclaimer is filed as discussed in the next paragraph). Thus, the examiner will issue an Office action >in the reissue application< (1) providing notification of the restriction requirement, (2) holding the added claims to be constructively non-elected and withdrawn from consideration, \* (3) treating the original patent claims on the merits >, and (4) informing applicant that if the original claims are found allowable, and a divisional application has been filed for the non-elected claims, further action in the application will be suspended, pending resolution of the divisional application.<

If a disclaimer of all the original patent claims is filed in the reissue application containing newly added claims that are separate and distinct from the original patent claims, only the newly added claims will be present for examination. In this situation, the examiner's Office action will treat the newly added claims in the reissue application on the merits. The disclaimer of all the original patent claims must be filed in the reissue application prior to the issuance of the examiner's Office action containing the restriction requirement, in order for the newly added claims to be treated on the merits. Once the examiner has issued the Office action providing notification of the restriction requirement and treating the patent claims on the merits, it is too late to obtain an examination on the added claims in the reissue application by filing a disclaimer of all the original patent claims. If reissue applicant wishes to have the newly added claims be treated on the merits, a divisional reissue application must be filed to obtain examination of the added claims. Reissue applicants should carefully note that once a disclaimer of the patent claims is filed, it cannot be withdrawn. It does not matter whether the reissue application is still pending, or whether the reissue application has been abandoned or issued as a reissue patent. For all these situations, 37 CFR 1.176(b) states that the disclaimer cannot be withdrawn; the disclaimer will be given effect.

Claims elected pursuant to a restriction requirement will receive a complete examination on the merits, while the non-elected claims (to any added invention(s)) will be held in abeyance in a withdrawn status, and will only be examined if filed in a divisional

reissue application. If the reissue application containing only original unamended claims becomes allowable first (and no "error" under 35 U.S.C. 251 exists), further action in that reissue application will be suspended to await examination in the divisional reissue application(s) containing the added claims. >Multiple suspensions (usually six-month periods) may be necessary.< The Office will not \* >permit< claims >to issue< in a reissue application which >application< does not correct any error in the original patent. Once a divisional reissue application containing the added claims is examined and becomes allowable, \*\* >the examiner will issue a requirement under 37 CFR 1.177(c) for applicant to merge the claims of the suspended first reissue application with the allowable claims of the divisional reissue application into a single application, by placing all of the claims in one of the applications and expressly abandoning the other. The Office action making this requirement will set a two-month period for compliance with the requirement. If applicant fails to timely respond to the Office action, or otherwise refuses to comply with the requirement made, then the divisional reissue application (claiming the invention which was non-elected in the now-suspended first reissue application) will be passed to issue alone, since the claims of the divisional reissue application, by themselves, do correct an error in the original patent. Prosecution will be reopened in the suspended first reissue application, and a rejection based on a lack of error under 35 U.S.C. 251 will then be made. This rejection may be made final, since applicant is on notice of the consequences of not complying with the merger requirement.

If the divisional reissue application becomes abandoned, prosecution will be reopened in the suspended first reissue application, and a rejection based on a lack of error under 35 U.S.C. 251 will then be made in the first reissue application. Since no error in the original patent is being corrected in the first reissue application, no reissue patent will issue.<

As stated in 37 CFR 1.176(b), **the examiner is not permitted to require restriction among original claims of the patent** (i.e., among claims that were in the patent prior to filing the reissue application). Even where the original patent contains claims to different inventions which the examiner considers independent or distinct, and the reissue application claims the same

inventions, a restriction requirement would be improper. If such a restriction requirement is made, it must be withdrawn.

Restriction between multiple inventions recited **in the newly added claims** will be permitted provided the added claims are drawn to several separate and distinct inventions. In such a situation, the original patent claims would be examined in the first reissue application, and applicant is permitted to file a divisional reissue application for each of the several separate and distinct inventions identified in the examiner's restriction requirement.

A situation will sometimes arise where the examiner makes an election of species requirement between the species claimed in the original patent claims and a species of claims added in the reissue application. In such a situation, if (1) the non-elected claims to the added species depend from (or otherwise include all limitations of) a generic claim which embraces all species claims, and (2) the generic claim is found allowable, then the non-elected claims of the added species must be rejoined with the elected claims of the original patent. See MPEP § 809.02(c).

\*\*

## **1451 Divisional Reissue Applications; Continuation Reissue Applications Where the Parent is Pending [R-2]**

*35 U.S.C. 251. Reissue of defective patents.*

\*\*\*\*\*

The Director may issue several reissued patents for distinct and separate parts of the thing patented, upon demand of the applicant, and upon payment of the required fee for a reissue for each of such reissued patents.

\*\*\*\*\*

*37 CFR 1.177. Issuance of multiple reissue patents.*

(a) The Office may reissue a patent as multiple reissue patents. If applicant files more than one application for the reissue of a single patent, each such application must contain or be amended to contain in the first sentence of the specification a notice stating that more than one reissue application has been filed and identifying each of the reissue applications by relationship, application number and filing date. The Office may correct by certificate of correction under § 1.322 any reissue patent resulting from an application to which this paragraph applies that does not contain the required notice.

(b) If applicant files more than one application for the reissue of a single patent, each claim of the patent being reissued must be presented in each of the reissue applications as an amended,

unamended, or canceled (shown in brackets) claim, with each such claim bearing the same number as in the patent being reissued. The same claim of the patent being reissued may not be presented in its original unamended form for examination in more than one of such multiple reissue applications. The numbering of any added claims in any of the multiple reissue applications must follow the number of the highest numbered original patent claim.

(c) If any one of the several reissue applications by itself fails to correct an error in the original patent as required by 35 U.S.C. 251 but is otherwise in condition for allowance, the Office may suspend action in the allowable application until all issues are resolved as to at least one of the remaining reissue applications. The Office may also merge two or more of the multiple reissue applications into a single reissue application. No reissue application containing only unamended patent claims and not correcting an error in the original patent will be passed to issue by itself.

The court in *In re Graff*, 111 F.3d 874, 876-77, 42 USPQ2d 1471, 1473 (Fed. Cir. 1997) stated that “[t]he statute does not prohibit divisional or continuation reissue applications, and does not place stricter limitations on such applications when they are presented by reissue, provided of course that the statutory requirements specific to reissue applications are met.” Following the decision in *Graff*, the Office has adopted a policy of treating continuations and divisionals of reissue applications, to the extent possible, in the same manner as continuations and divisionals of non-reissue applications.

Questions relating to the propriety of divisional reissue applications and continuation reissue applications should be referred via the Technology Center (TC) Special Program Examiner to the Office of Patent Legal Administration.

## **DIVISIONAL REISSUE APPLICATIONS**

37 CFR 1.176(b) permits the examiner to require restriction in a reissue application between the original claims of the patent and any newly added claims which are directed to a separate and distinct invention(s). See also MPEP § 1450. As a result of such a restriction requirement, divisional applications may be filed for each of the inventions identified in the restriction requirement.

In addition, applicant may initiate a division of the claims by filing more than one reissue application in accordance with 37 CFR 1.177. The multiple reissue applications which are filed may contain different groups of claims from among the original patent claims, or some of the reissue applications may con-

tain newly added groups (not present in the original patent). There is no requirement that the claims of the multiple reissue applications be independent and distinct from one another; if they are not independent and distinct from one another, the examiner must apply the appropriate double patenting rejections.

There is no requirement that a family of divisional reissue applications issue at the same time; however, it is required that they contain a cross reference to each other in the specification. 37 CFR 1.177(a) requires that all multiple reissue applications resulting from a single patent must include as the first sentence of their respective specifications a cross reference to the other reissue application(s). Accordingly, the first sentence of each reissue specification must provide notice stating that more than one reissue application has been filed, and it must identify each of the reissue applications and their relationship within the family of reissue applications, and to the original patent. An example of the suggested language to be inserted is as follows:

Notice: More than one reissue application has been filed for the reissue of Patent No. 9,999,999. The reissue applications are application numbers 09/999,994 (the present application), 09/999,995, and 09/999,998, all of which are divisional reissues of Patent No. 9,999,999.

The examiner should object to the specification and require an appropriate amendment if applicant fails to include such a cross reference to the other reissue applications in the first sentence of the specification of each of the reissue applications.

Where one of the divisional applications of the family has issued without the required cross reference to the other reissue application(s), the examiner will refer the matter to his/her Supervisory Patent Examiner (SPE). The SPE will initiate a certificate of correction under 37 CFR 1.322 to include the appropriate cross reference in the already issued first reissue patent before passing the pending reissue application to issue. Form paragraph 10.19 may be used for such purpose. After the SPE prepares the memorandum as per form paragraph 10.19, the patent file with the memorandum should be forwarded to the Certificates of Correction Branch for issuance of a certificate. >The examiner should make a reference in the pending divisional reissue application to the fact that an actual request for a Certificate of Correction has been

initiated in the first reissue patent pursuant to 37 CFR 1.177(a), e.g., by an entry in the search notes or in an examiner's amendment.<

*¶ 10.19 Memorandum - Certificate of Correction (Cross-Reference to Other Reissues in Family)*

DATE: [1]

TO: Certificates of Correction Branch

FROM: [2], SPE, Art Unit [3]

SUBJECT: Request for Certificate of Correction

Please issue a Certificate of Correction in U. S. Letters Patent No. [4] as specified on the attached Certificate.

---

[5], SPE

Art Unit [6]

**UNITED STATES PATENT AND TRADEMARK OFFICE  
CERTIFICATE**

Patent No. [7]

Patented: [8]

The present reissue patent issued from an application that is one of a family of divisional reissue applications resulting from Patent No. [9]. The present reissue patent has issued without the cross reference to the other reissue application(s) of the family which is required pursuant to 37 CFR 1.177(a). Accordingly, insert in the first sentence of the specification as follows:

Notice: More than one reissue application has been filed for the reissue of patent [9]. The reissue applications are [10].

---

[11], Supervisory Patent Examiner

Art Unit [12]

**Examiner Note:**

- 1 In bracket 9, insert the patent number of the patent for which multiple reissue divisional applications have been filed.
- 2 This is an internal memo and must not be mailed to the applicant. This memo should accompany the patented file to the Certificates of Correction Branch as noted in form paragraphs 10.13 and 10.14.
- 3 In brackets 5 and 11, insert the name of SPE and provide the signature of the SPE above each line.
- 4 In brackets 6 and 12, insert the Art Unit number.
- 5 Two separate pages of USPTO letterhead will be printed when using this form paragraph.
- 6 In bracket 10, identify each of the reissue applications (including the present application) and their relationship within the family of reissue applications, and to the original patent.

In addition to the amendment to the first sentence of the specification, the reissue application cross references will also be reflected in the file by way of the bibliographic data sheet reprint (for 09/ and later series), or the front face of the reissue file wrapper (for 08/ and earlier series), for all the multiple reissue applications, so that adequate notice is provided that

more than one reissue application has been filed for a single original patent. >(For IFW processing, see IFW Manual.)<

Pursuant to 37 CFR 1.177(b) all of the claims of the patent to be reissued must be presented in each reissue application in some form, i.e., as amended, as unamended or as canceled. Further, the same patent claim cannot be presented in more than one of the reissue applications, as a pending claim, in its original unamended version for examination. Finally, any added claims must be numbered beginning with the next highest number following the last patent claim.

If the same or similar claims are presented in more than one of the multiple reissue applications, the possibility of statutory double patenting (35 U.S.C. 101) or non-statutory (judicially created doctrine) double patenting should be considered by the examiner during examination, and the appropriate rejections made. A terminal disclaimer may be filed to overcome an obviousness type double patenting rejection. The terminal disclaimer is necessary in order to ensure common ownership of the reissue patents throughout the remainder of the unexpired term of the original patent. >Whenever a divisional reissue application is filed with a copy of the oath/declaration and assignee consent from the parent reissue application, the copy of the assignee consent from the parent reissue application should not be accepted. *The copy of the consent from the parent reissue application does not indicate that the assignee has consented to the addition of the new invention of the divisional reissue application to the original patent.* The Office of Initial Patent Examination (OIPE) should accord a filing date and send out a notice of missing parts stating that there is no proper consent and setting a period of time for filing the missing part and for payment of any surcharge required under 37 CFR 1.53(f) and 1.16(e). See MPEP § 1410.01. The copy of the reissue oath/declaration should be accepted by OIPE, since it is an oath/declaration, even though it may be improper under 35 U.S.C. 251. The examiner should check the copy of the oath/declaration to ensure that it identifies an error being corrected by the divisional reissue application. The copy of the oath/declaration from the parent reissue application may or may not cover the error being corrected by the divisional reissue application since the divisional reissue application is (by definition) directed to a new invention. If it does not, the exam-

iner should reject the claims of the divisional reissue application under 35 U.S.C. 251 as being based on an oath/declaration that does not identify an error being corrected by the divisional reissue application, and require a new oath/declaration. See MPEP § 1414. If the copy of the reissue oath/declaration from the parent reissue application does in fact cover an error being corrected in the divisional reissue application, no such rejection should be made. However, since a new invention is being added by the filing of the divisional reissue application, a supplemental reissue oath/declaration pursuant to 37 CFR 1.175 (b)(1) will be required. See MPEP § 1414.01.<

Situations yielding divisional reissues occur infrequently and usually involve only two such files. It should be noted, however, that in rare instances in the past, there have been more than two (and as many as five) divisional reissues of a patent. >For treatment of a plurality of divisional reissue applications resulting from a requirement to restrict to distinct inventions or a requirement to elect species, see MPEP § 1450.<

## CONTINUATION REISSUE APPLICATIONS

A continuation of a reissue is not ordinarily filed “for distinct and separate parts of the thing patented” as called for in the second paragraph of 35 U.S.C. 251. The decision of *In re Graff*, 111 F.3d 874, 42 USPQ2d 1471 (Fed. Cir. 1997) interprets 35 U.S.C. 251 to permit multiple reissue patents to issue even where the multiple reissue patents are not for “distinct and separate parts of the thing patented.” The court stated:

Section 251[2] is plainly intended as enabling, not as limiting. Section 251[2] has the effect of assuring that a different burden is not placed on divisional or continuation reissue applications, compared with divisions and continuations of original applications, by codifying the Supreme Court decision which recognized that more than one patent can result from a reissue proceeding. Thus § 251[2] places no greater burden on Mr. Graff’s continuation reissue application than upon a continuation of an original application; § 251[2] neither overrides, enlarges, nor limits the statement in § 251[3] that the provisions of Title 5 apply to reissues.

111 F.3d at 877, 42 USPQ2d at 1473. Accordingly, prosecution of a continuation of a reissue application will be permitted (despite the existence of the pending parent reissue application) where the continuation complies with the rules for reissue.

The parent and the continuation reissue applications should be examined together if possible. An appropriate amendment to the continuing data entries must be made to the first sentence of the specification, (see the discussion above under the heading “Divisional Reissue Applications”), and to the bibliographic data sheet reprint (for 09/ and later series) or to the front face of the reissue file wrapper (for 08/ and earlier series), for *both the parent and the continuation* reissue applications, so that the parent-continuation relationship of the reissue applications is specifically identified and notice is provided of both reissue applications. >(For IFW processing, see IFW Manual.<

Where the parent reissue application issues prior to the examination of the continuation, the claims of the continuation should be carefully reviewed for double patenting over the claims of the parent. Where the parent and the continuation reissue applications are examined together, a provisional double patenting rejection should be made in both cases as to any overlapping claims. See MPEP § 804 - § 804.04 as to double patenting rejections. Any terminal disclaimer filed to obviate an obviousness-type double patenting rejection ensures common ownership of the reissue patents throughout the remainder of the unexpired term of the original patent.

If the parent reissue application issues without any cross reference to the continuation, amendment of the parent reissue patent to include a cross-reference to the continuation must be effected at the time of allowance of the continuation application by Certificate of Correction. See the discussion above under the heading “Divisional Reissue Applications” as to how the Certificate of Correction is to be provided.

>Again, the examiner should make reference in the pending divisional reissue application to the fact that an actual request for a Certificate of Correction has been generated in the first reissue patent pursuant to 37 CFR 1.177(a), e.g., by an entry in the search notes or in an examiner’s amendment.

Where a continuation reissue application is filed with a copy of the oath/declaration and assignee consent from the parent reissue application, and the parent reissue application is not to be abandoned, the copy of the consent of the parent reissue application should not be accepted. *The copy of the consent of the parent reissue application does not indicate that the*

*assignee has consented to the addition of the new error correction of the continuation reissue application to the original patent. Presumably, a new correction has been added, since the parent reissue application is still pending. OIPE should accord a filing date and send out a notice of missing parts stating that there is no proper consent and setting a period of time for filing the missing part and for payment of any surcharge required under 37 CFR 1.53(f) and 1.16(e). See MPEP § 1410.01. The copy of the reissue oath/declaration should be accepted by OIPE, since it is a oath/declaration, albeit improper under 35 U.S.C. 251. The examiner should reject the claims of the continuation reissue application under 35 U.S.C. 251 as being based on an oath/declaration that does not identify an error being corrected by the continuation reissue application, and should require a new oath/declaration. See MPEP § 1414.*

Where a continuation reissue application is filed with a copy of the oath/declaration and assignee consent from the parent reissue application, and the parent reissue application is, or will be abandoned, the copy of the consent should be accepted by both OIPE and the examiner. The reissue oath/declaration should be accepted by OIPE, and the examiner should check to ensure that the oath/declaration identifies an error that is being corrected in the continuation reissue application. See MPEP § 1414. If a preliminary amendment was filed with the continuation reissue application, the examiner should check for the need of a supplemental reissue oath/declaration. Pursuant to 37 CFR 1.175 (b)(1), for any error corrected via the preliminary amendment which is not covered by the oath or declaration submitted in the parent reissue application, applicant must submit a supplemental oath/declaration stating that every such error arose without any deceptive intention on the part of the applicant. See MPEP § 1414 and § 1414.01.<

## **1452 Request for Continued Examination of Reissue Application**

A request for continued examination (RCE) under 37 CFR 1.114 is available for a reissue application. Effective May 29, 2000, an applicant in a reissue application may file a request for continued examination of the reissue application, if the reissue application was filed on or after June 8, 1995. This applies

even where the application, which resulted in the original patent, was filed prior to June 8, 1995.

An RCE continues the prosecution of the existing reissue application and is not a filing of a new reissue application. Thus, the filing of an RCE will not be announced in the *Official Gazette*. Additionally, if a reissue application is merged with a reexamination proceeding (see MPEP § 1449.01), the filing of an RCE will not dissolve the merger, since the reissue application does not become abandoned.

## 1453 Amendments to Reissue Applications [R-2]

37 CFR 1.121. *Manner of making amendments in application.*

\*\*> \*\*\*\*\*

(i) *Amendments in reissue applications.* Any amendment to the description and claims in reissue applications must be made in accordance with § 1.173.<

\*\*\*\*\*

37 CFR 1.173. *Reissue specification, drawings, and amendments.*

\*\*\*\*\*

(b) *Making amendments in a reissue application.* An amendment in a reissue application is made either by physically incorporating the changes into the specification when the application is filed, or by a separate amendment paper. If amendment is made by incorporation, markings pursuant to paragraph (d) of this section must be used. If amendment is made by an amendment paper, the paper must direct that specified changes be made.

(1) *Specification other than the claims.* Changes to the specification, other than to the claims, must be made by submission of the entire text of an added or rewritten paragraph, including markings pursuant to paragraph (d) of this section, except that an entire paragraph may be deleted by a statement deleting the paragraph without presentation of the text of the paragraph. The precise point in the specification must be identified where any added or rewritten paragraph is located. This paragraph applies whether the amendment is submitted on paper or compact disc (see §§ 1.52(e)(1) and 1.821(c), but not for discs submitted under § 1.821(e)).

(2) *Claims.* An amendment paper must include the entire text of each claim being changed by such amendment paper and of each claim being added by such amendment paper. For any claim changed by the amendment paper, a parenthetical expression “amended,” “twice amended,” *etc.*, should follow the claim number. Each changed patent claim and each added claim must include markings pursuant to paragraph (d) of this section, except that a patent claim or added claim should be canceled by a statement canceling the claim without presentation of the text of the claim.

>

(3) *Drawings.* One or more patent drawings shall be amended in the following manner: Any changes to a patent drawing must be submitted as a replacement sheet of drawings which shall be an attachment to the amendment document. Any replacement sheet of drawings must be in compliance with § 1.84 and shall include all of the figures appearing on the original version of the sheet, even if only one figure is amended. Amended figures must be identified as “Amended,” and any added figure must be identified as “New.” In the event that a figure is canceled, the figure must be surrounded by brackets and identified as “Canceled.” All changes to the drawing(s) shall be explained, in detail, beginning on a separate sheet accompanying the papers including the amendment to the drawings.

(i) A marked-up copy of any amended drawing figure, including annotations indicating the changes made, may be included. The marked-up copy must be clearly labeled as “Annotated Marked-up Drawings” and must be presented in the amendment or remarks section that explains the change to the drawings.

(ii) A marked-up copy of any amended drawing figure, including annotations indicating the changes made, must be provided when required by the examiner.

(c) *Status of claims and support for claim changes.* Whenever there is an amendment to the claims pursuant to paragraph (b) of this section, there must also be supplied, on pages separate from the pages containing the changes, the status (*i.e.*, pending or canceled), as of the date of the amendment, of all patent claims and of all added claims, and an explanation of the support in the disclosure of the patent for the changes made to the claims.<

(d) *Changes shown by markings.* Any changes relative to the patent being reissued which are made to the specification, including the claims, upon filing, or by an amendment paper in the reissue application, must include the following markings:

(1) The matter to be omitted by reissue must be enclosed in brackets; and

(2) The matter to be added by reissue must be underlined, except for amendments submitted on compact discs (§§ 1.96 and 1.821(c)). Matter added by reissue on compact discs must be preceded with “<U>” and end with “</U>” to properly identify the material being added.

(e) *Numbering of patent claims preserved.* Patent claims may not be renumbered. The numbering of any claim added in the reissue application must follow the number of the highest numbered patent claim.

(f) *Amendment of disclosure may be required.* The disclosure must be amended, when required by the Office, to correct inaccuracies of description and definition, and to secure substantial correspondence between the claims, the remainder of the specification, and the drawings.

(g) *Amendments made relative to the patent.* All amendments must be made relative to the patent specification, including the claims, and drawings, which are in effect as of the date of filing of the reissue application.

The provisions of 37 CFR 1.173(b)-(g) and those of 37 CFR 1.121>(i)< apply to amendments in reissue applications. Any amendments submitted in a reissue



application \*\* must comply with 37 CFR 1.173(b) \*\*,.

\*\*

Amendments submitted in a reissue application, including preliminary amendments (i.e., amendments filed as a separate paper to accompany the filing of a reissue application), must comply with the practice outlined below in this section; however, for examiner's amendments to the specification and claims, 37 CFR 1.121(g) provides certain exceptions to that practice in the interest of expediting prosecution. The exceptions set forth in 37 CFR 1.121(g) also apply in reissue applications.

Pursuant to 37 CFR 1.173(a), no amendment in a reissue application may enlarge the scope of the claims, unless "applied for within two years from the grant of the original patent." Further, the amendment may not introduce new matter. See MPEP § 1412.03 for further discussion as to the time limitation on enlarging the scope of the patent claims in a reissue application.

All amendment changes must be made relative to the patent to be reissued. Pursuant to 37 CFR 1.173(d), any such changes which are made to the specification, including the claims, must be shown by employing the following "markings:"

(A) The matter to be omitted by reissue must be enclosed in brackets; and

(B) The matter to be added by reissue must be underlined, except for amendments submitted on compact discs (pursuant to 37 CFR 1.96 for computer printouts or programs, and 37 CFR 1.825 for sequence listings). Matter added by reissue on compact discs must be preceded with "<U>" and end with "</U>" to properly identify the material being added.

## THE SPECIFICATION

37 CFR 1.173(b)(1) relates to the manner of making amendments to the specification other than the claims. It is not to be used for making amendments to the claims or the drawings.

All amendments which include any deletions or additions must be made by submission of the entire text of each added or rewritten paragraph with markings (as defined above), except that an entire paragraph of specification text may be deleted by a statement deleting the paragraph without presentation of the text of the paragraph. Applicant must indicate

the precise point where each amendment is made. All bracketing and underlining is made in comparison to the original patent, not in comparison to any prior amendment in the reissue application. Thus, all paragraphs which are newly *added* to the specification of the original patent must be submitted as completely underlined each time they are re-submitted in the reissue application.

## THE CLAIMS

37 CFR 1.173(b)(2) relates to the manner of making amendments to the claims in reissue applications. It is not to be used for making amendments to the remainder of the specification or to the drawings. 37 CFR 1.173(b)(2) requires that:

(A) For each claim that is being amended *by the amendment being submitted* (the current amendment), the entire text of the claim must be presented with markings as defined above;

(B) For each new claim added to the reissue *by the amendment being submitted* (the current amendment), the entire text of the added claim must be presented completely underlined;

(C) A patent claim should be canceled by a direction to cancel that claim, there is no need to present the patent claim surrounded by brackets; and

(D) A new claim (previously added in the reissue) should be canceled by a direction to cancel that claim.

Original patent claims are never to be renumbered; see 37 CFR 1.173(e). A patent claim retains its number even if it is canceled in the reissue proceeding, and the numbering of any added claims must begin after the last original patent claim.

Pursuant to 37 CFR 1.173(c), each amendment submitted must set forth the status of all patent claims and all added claims as of the date of the submission. The status to be set forth is whether the claim is pending or canceled. The failure to submit the claim status will generally result in a notification to applicant that the amendment *prior to final rejection* is not completely responsive (see 37 CFR 1.135(c)). Such an amendment *after final rejection* will not be entered.

Also pursuant to 37 CFR 1.173(c), each claim amendment must be accompanied by an explanation of the support in the disclosure of the patent for the amendment (i.e., support for all changes made in the claim(s), whether insertions or deletions). The failure

to submit an explanation will generally result in a notification to applicant that the amendment *prior to final rejection* is not completely responsive (see 37 CFR 1.135(c)). Such an amendment *after final rejection* will not be entered.

## THE DRAWINGS

\*\*

37 CFR 1.173(a)(2) states that amendments to the original patent drawings are not permitted, and that any change to the drawings must be by way of 37 CFR 1.173(b)(3). \*\* >See MPEP § 1413 for the manner of making amendments to the drawings in a reissue application.<

Form paragraph 14.20.01 may be used to advise applicant of the proper manner of making amendments in a reissue application.

### ¶ 14.20.01 Amendments To Reissue-37 CFR 1.173(b)

Applicant is notified that any subsequent amendment to the specification and/or claims must comply with 37 CFR 1.173(b).

#### Examiner Note:

This form paragraph may be used in the first Office action to advise applicant of the proper manner of making amendments.

Form paragraph 14.21.01 may be used to notify applicant that proposed amendments **filed prior to final rejection** in the reissue application do not comply with 37 CFR 1.173(b).

### ¶ 14.21.01 Improper Amendment To Reissue - 37 CFR 1.173(b)

The amendment filed [1] proposes amendments to [2] that do not comply with 37 CFR 1.173(b), which sets forth the manner of making amendments in reissue applications. A supplemental paper correctly amending the reissue application is required.

A shortened statutory period for reply to this letter is set to expire ONE MONTH or THIRTY DAYS, whichever is longer, from the mailing date of this letter.

#### Examiner Note:

1. This form paragraph may be used for any 37 CFR 1.173(b) informality as to an amendment submitted in a reissue application prior to final rejection. After final rejection, applicant should be informed that the amendment will not be entered by way of an Advisory Office action.

2. In bracket 2, specify the proposed amendments that are not in compliance.

Note that if an informal amendment is submitted **after final rejection**, form paragraph 14.21.01 should not be used. Rather, an advisory Office action should be issued using Form PTO-303 indicating that the amendment was not entered because it does not com-

ply with 37 CFR 1.173(b), which sets forth the manner of making amendments in reissue applications.

## ALL CHANGES ARE MADE VIS-À-VIS THE PATENT TO BE REISSUED

When a reissue patent is printed, all underlined matter is printed in *italics* and all brackets are printed as inserted in the application, in order to show exactly which additions and deletions have been made to the patent being reissued. Therefore, all underlining and bracketing in the reissue application should be made relative to the text of the patent, as follows. In accordance with 37 CFR 1.173(g), all amendments in the reissue application must be made relative to (i.e., *vis-à-vis*) the patent specification in effect as of the date of the filing of the reissue application. The patent specification includes the claims and drawings. If there was a prior change to the patent (made via a prior concluded reexamination certificate, reissue of the patent, certificate of correction, etc.), the first amendment of the subject reissue application must be made relative to the patent specification as changed by the prior proceeding or other mechanism for changing the patent. All amendments subsequent to the first amendment must also be made relative to the patent specification in effect as of the date of the filing of the reissue application, and **not** relative to the prior amendment.

### *The Subject Patent Already Has Underlining or Bracketing*

If the original (or previously changed) patent includes a formula or equation already having underlining or bracketing therein as part of the formula or equation, any amendment of such formula or equation should be made by bracketing the entire formula and rewriting and totally underlining the amended formula in the re-presented paragraph of the specification or rewritten claim in which the changed formula or equation appears. Amendments of segments of a formula or equation should not be made. If the original patent includes bracketing and underlining from an earlier reexamination or reissue, double brackets and double underlining should be used in the subject reissue application to identify and distinguish the present changes being made. The subject reissue, when printed, would include double brackets (indicating

deletions made in the subject reissue) and boldface type (indicating material added in the subject reissue).

### EXAMPLES OF PROPER AMENDMENTS

A substantial number of problems arise in the Office because of improper submission of amendments in reissue applications. The following examples are provided to assist in preparation of proper amendments to reissue applications.

#### *Original Patent Description or Patent Claim Amended*

##### **Example (1)**

If it is desired to change the specification at column 4 line 23, to replace “is” with --are--, submit a copy of the entire paragraph of specification of the patent being amended with underlining and bracketing, and point out where the paragraph is located, e.g.,

Replace the paragraph beginning at column 4, line 23 with the following:

Scanning [is] are controlled by clocks which are, in turn, controlled from the display tube line synchronization. The signals resulting from scanning the scope of the character are delivered in parallel, then converted into serial mode through a shift register wherein the shift signal frequency is controlled by a clock that is, in turn, controlled from the display tube line synchronization.

##### **Example (2)**

For changes to the claims, one must submit a copy of the entire patent claim with the amendments shown by underlining and bracketing, e.g.,

Amend claim 6 as follows:

Claim 6 (Amended). The apparatus of claim [5] l wherein the [first] second piezoelectric element is parallel to the [second] third piezoelectric element.

If the dependency of any original patent claim is to be changed by amendment, it is proper to make that original patent claim dependent upon a later filed higher numbered claim.

#### *Cancellation of Claim(s)*

##### **Example (3)**

To cancel an original patent claim, in writing, direct cancellation of the patent claim, e.g.,

Cancel claim 6.

##### **Example (4)**

To cancel a new claim (previously added in the reissue), in writing, direct cancellation of the new claim, e.g.,

Cancel claim 15.

#### *Presentation of New Claims*

##### **Example (5)**

Each new claim (i.e., a claim not found in the patent, that is newly presented in the reissue application) should be presented with underlining throughout the claim, e.g.,

Add claim 7 as follows:

Claim 7. The apparatus of claim 5 further comprising electrodes attaching to said opposite faces of the first and second piezoelectric elements.

Even though original claims may have been canceled, the numbering of the original claims does not change. Accordingly, any added claims are numbered beginning with the number next higher than the number of claims in the original patent. If new claims have been added to the reissue application which are later canceled prior to issuance of the reissue patent, the examiner will renumber any remaining new claims in numerical order to follow the number of claims in the original patent.

#### *Amendment of New Claims*

An amendment of a “new claim” (i.e., a claim not found in the patent, that was previously presented in the reissue application) must be done by presenting the amended “new claim” containing the amendatory material, and completely underlining the claim. The presentation cannot contain any bracketing or other indication of what was in the previous version of the claim. This is because all changes in the reissue are made *vis-à-vis* the original patent, and not in comparison to the prior amendment. Although the presentation of the amended claim does not contain any indication of what is changed from the previous version of the claim, applicant must point out what is changed in the “Remarks” portion of the amendment. Also, per 37 CFR 1.173(c), each change made in the claim must be accompanied by an explanation of the support in the disclosure of the patent for the change.

### ***Amendment of Original Patent Claims More Than Once***

The following illustrates proper claim amendment of original patent claims in reissue applications:

A. Patent claim.

Claim 1. A cutting means having a handle portion and a blade portion.

B. Proper first amendment format.

Claim 1 (Amended). A [cutting means] knife having a bone handle portion and a notched blade portion.

C. Proper second amendment format.

Claim 1 (Twice Amended). A [cutting means] knife having a handle portion and a serrated blade portion.

Note that the second amendment must include the changes previously presented in the first amendment, i.e., [cutting means] knife, as well as the new changes presented in the second amendment, i.e., serrated.

The word bone was presented in the first amendment and is now to be deleted in the second amendment. The word “bone” is NOT to be shown in brackets in the second amendment. Rather, the word “bone” is simply omitted from the claim, since “bone” never appeared in the patent. An explanation of the deletion should appear in the remarks.

The word notched which was presented in the first amendment is replaced by the word serrated in the second amendment. The word notched is being deleted in the second amendment and did not appear in the patent; accordingly, “notched” is not shown in any form in the claim. The word serrated is being added in the second amendment, and accordingly “serrated” is added to the claim and is underlined.

In the second amendment, the deletions of “notched” and “bone” are not changes from the original patent claim text and therefore are not shown in brackets in the second amendment. In both the first and the second amendments, the entire claim is presented only with the changes from the original patent text.

### **>ADDITIONAL EXAMPLES**

(A) For a reissue application, where the patent was previously reissued:

As per MPEP § 1411, double underlining and double bracketing are used in the second reissue application to show amendments made relative to the first reissued patent

(B) For a reissue application, where the patent was previously reexamined and a reexamination certificate has issued for the patent:

An amendment in the reissue application must be presented as if the changes made to the original patent text via the reexamination certificate are a part of the original patent. Thus, all italicized text of the reexamination certificate is presented in the amendment (made in the reissue application) without italics. Further, any text found in brackets in the reexamination certificate is omitted in the amendment (made in the reissue application).

(C) For a reissue application, where a certificate of correction has issued for the patent:

An amendment in the reissue application must be presented as if the changes made to the original patent text via the certificate of correction are a part of the original patent. Thus, all text added by certificate of correction is presented in the amendment (made in the reissue application) without italics. Further, any text deleted by certificate of correction is entirely omitted in the amendment (made in the reissue application).

(D) For a reissue application, where a statutory disclaimer has issued for the patent:

Any claim statutorily disclaimed is no longer in the patent, and such a claim cannot be amended. The statutorily disclaimed claim(s) should be lined through, and not surrounded by brackets.<

## **1454 Appeal Brief**

The requirements for an appeal brief are set forth in 37 CFR 1.192 and MPEP § 1206, and they apply to a reissue application in the same manner that they apply to a non-reissue application. There is, however, a difference in practice as to presentation of the copy of the claims in the appeal brief for a reissue application. The claims on appeal presented in an appeal brief for a reissue application should include all underlining and bracketing necessary to reflect the changes made to the patent claims during the prosecution of the reissue application. In addition, any new claims added in the reissue application should be completely underlined.

## 1455 Allowance and Issue [R-2]

### “BLUE SLIP”

In all reissue applications prepared for issue where a blue slip is needed (i.e., 08/ and earlier series), the patent number of the original patent which is being reissued should be placed in the box provided therefor below the box for the applicant’s name on the blue Issue Classification Slip (form PTO-270) or design Issue Classification Slip (form PTO-328). Otherwise, the Issue Classification Slip is prepared in the same manner as for a non-reissue application. >(For IFW processing, see IFW Manual.)<

For 09/ and later series applications, the patent number of the original patent which is being reissued should be placed on the face of the file wrapper above the box “PREPARED AND APPROVED FOR ISSUE” just after “(Exr. Initials)” in the line reading “SURRENDER OF ORIGINAL PATENT \_\_\_\_\_ (Exr. Initials).” >(For IFW processing, see IFW Manual.)<

### CHANGES TO THE ORIGINAL PATENT

The specifications of reissue patents will be printed in such a manner as to show the changes over the original patent text by enclosing any material omitted by the reissue in heavy brackets [ ] and printing material added by the reissue in *italics*. 37 CFR 1.173 (see MPEP § 1411) requires the specification of a reissue application to be presented in a specified form, specifically designed to facilitate this different manner of printing, as well as for other reasons.

The printed reissue patent specification will carry the following heading, which will be added by the Publishing Division of the Office of Patent Publication:

“Matter enclosed in heavy brackets [ ] appears in the original patent but forms no part of this reissue specification; matter printed in italics indicates the additions made by reissue.”

The examiners should see that the specification is in proper form for printing. Examiners should carefully check the entry of all amendments to ensure that the changes directed by applicant will be accurately printed in any reissue patent that may ultimately issue. Matter appearing in the original patent which is omit-

ted by reissue should be enclosed in brackets, while matter added by reissue should be underlined.

Any material added by amendment in the reissue application (as underlined text) which is later canceled should be crossed through, *and not bracketed*. Material cancelled from the original patent should be enclosed in brackets, *and not lined through*.

All the claims of the original patent should appear in the reissue patent, with canceled patent claims being enclosed in brackets.

### CLAIM NUMBERING

No renumbering of the original patent claims is permitted, even if the dependency of a dependent patent claim is changed by reissue so that it is to be dependent on a subsequent higher numbered claim.

When a dependent claim in a reissue application depends upon a claim which has been canceled, and the dependent claim is not thereafter made dependent upon a pending claim, such a dependent claim must be rewritten in independent form.

New claims added during the prosecution of the reissue application should follow the number of the highest numbered patent claim and should be completely underlined to indicate they are to be printed in italics >on the printed patent<. Often, as a result of the prosecution and examination, some new claims are canceled while other new claims remain. When the reissue >application< is allowed, any claims remaining which are additional to the patent claims (i.e., claims added via the reissue >application<) should be renumbered in sequence starting with the number next higher than the number of \* >the last claim< in the original patent >(the printed patent)<. Therefore, the number of claims allowed will not necessarily correspond to the number of the last claim in the reissue application, as allowed. >The number of claims appearing in the “CLAIMS ALLOWED - Total Claims” box on the lower right of the file wrapper face at the time of allowance should be consistent with the number of claims indicated as allowable on the Notice of Allowability (Form PTOL-37). (For IFW processing, see IFW Manual.)<

### CLAIM DESIGNATED FOR PRINTING

At least one claim of an allowable reissue application must be designated for printing in the *Official Gazette*. Whenever at least one claim has been

amended or added in the reissue, the claim (claims) designated for printing must be (or include) a claim which has been changed or added by the reissue. A canceled claim is not to be designated as the claim for the *Official Gazette*.

If there is no change in the claims of the allowable reissue application (i.e., when they are the same as the claims of the original patent) or, if the only change in the claims is the cancellation of claims, then the most representative pending *allowed* claim is designated for printing in the *Official Gazette*.

### PROVIDING PROPER FORMAT

Where a reissue application has not been prepared in the above-indicated manner, the examiner may obtain from the applicant a clean copy of the reissue specification prepared in the indicated form, or a proper submission of a previously improperly submitted amendment. However, if the deletions from the original patent are small, the reissue application can be prepared for issue by putting the bracketed inserts at the appropriate places and suitably numbering the added claims.

When applicant submits a clean copy of the reissue specification, or a proper submission of a previous improper amendment, a supplemental reissue declaration should **not** be provided to address this submission, because the correction of format does not correct a 35 U.S.C. 251 error in the patent.

### PARENT APPLICATION DATA

All parent application data on the front face of the original patent file wrapper should be placed on the bibliographic data sheet reprint for 09/ and later series applications or on the front face of the reissue file wrapper for 08/ and earlier series applications, if it is still proper. >(For IFW processing, see IFW Manual.)<

It sometimes happens that the reissue is a continuation of another reissue application, and there is also original-patent parent application data. The examiner should ensure that the parent application data on the original patent is properly combined with the parent application data of the reissue, in the text of the specification and on the bibliographic data sheet reprint for 09/ and later series applications or on the front face of

the reissue file wrapper for 08/ and earlier series applications. >(For IFW processing, see IFW Manual.)< The combined statement as to parent application data should be checked carefully for proper bracketing and underlining.

### REFERENCES CITED AND PRINTED

The list of references to be printed in the reissue patent \*\* >includes all< the references cited during the prosecution of the reissue application, >It is noted that the Office will not print in the reissue patent 'References Cited' section any reference cited in the patent but not again cited in the reissue application.< A patent cannot be reissued solely for the purpose of adding citations of additional prior art.

### EXAMINER'S AMENDMENT AND SUPPLEMENTAL DECLARATION

When it is necessary to amend the reissue application in order to place the application in condition for allowance, the examiner may:

(A) request that applicant provide the amendments (e.g., by facsimile transmission or by hand-carry); or

(B) make the amendments, with the applicant's approval, by a formal examiner's amendment.

If the changes are made by a formal examiner's amendment, the *entire* paragraph(s) or claim(s) being amended need not be presented in rewritten form for any deletions or additions. Changes to the specification including the claims of an application made by the Office in an examiner's amendment may be made by specific instructions to insert or delete subject matter set forth in the examiner's amendment by identifying the precise point in the specification or the claim(s) where the insertion or deletion is to be made. 37 CFR 1.121(g).

If it is necessary to amend a claim or the specification in order to correct an "error" under 35 U.S.C. 251 and thereby place the application in condition for allowance, then a supplemental oath or declaration will be required. See MPEP § 1444. The examiner should telephone applicant and request the supplemental oath or declaration, which must be filed before the application can be counted as an allowance.

## FINAL REVIEW OF THE REISSUE APPLICATION BY THE EXAMINER

Prior to forwarding a reissue application to the Technology Center (TC) Special Program Examiner (SPRE) for final review, the examiner should complete and initial an Examiner \* >Reissue< Checklist. A copy of the checklist should be available from the SPRE or from the Paralegal Specialist of the TC.

### 1456 Reissue Review [R-2]

All reissue applications are monitored and reviewed in the Technology Centers (TCs) by the Office of TC Special Program Examiner>s< (which includes >TC< SPRE>s<, paralegal>s< or other technical support who might be assigned as backup) at several stages during the prosecution.>The review by the Office of the TC SPREs is made to check that practice and procedure unique to reissue has been carried out for the reissue application. In addition to the SPRE review of the reissue applications, a patentability review is made in a sample of reissue applications by the TC Quality Assurance Specialist (QAS) in the manner previously carried out by the former Office of Patent Quality Review.< In order to ensure that SPREs are aware of the reissue applications in their TCs, a pair of terminal-specific PALM flags have been created which must be set by the SPRE before certain PALM transactions can be completed. First, when a new reissue application enters the TC, \*\* >a SPRE must set a PALM “flag” by entering the reissue application number in an Office-wide computer grouping< before a docketing transaction will be accepted. By having to set this first flag, the SPRE is made aware of the assignment of the reissue application to the TC and can take steps, as may be appropriate, to instruct the examiner on reissue-specific procedures before the examination process begins, as well as throughout the period that the examiner is handling the reissue application. \*\* >Second, the SPRE must remove the above-described PALM “flag”< before a Notice of Allowance can be generated or the PALM transaction for an issue revision can be entered, thereby ensuring that the SPRE is made aware of when the reissue application is being allowed so that the SPRE may be able to conduct a final review of the reissue application, if appropriate.

When the reissue application has been reviewed and is ready to be released to issue, the TC SPRE

should initial the face of the file wrapper, and forward the reissue file to the Office of Patent Legal Administration (OPLA). >(For IFW processing, see IFW Manual.)< Along with the reissue file, the file for the original patent should be forwarded to OPLA. >(For IFW processing, see IFW Manual.)<

After leaving the TC, all reissue applications go through a screening process which is currently performed in OPLA. The screening process which includes review of the reissue oath or declaration for compliance with 37 CFR 1.175, review of the presentation and entry of reissue amendments for compliance with 37 CFR 1.173(b), and review of other matters to ensure adherence to current reissue practices. \*\* >The above identified review processes< are appropriate vehicles for correcting errors, identifying problem areas and recognizing trends, providing information on the uniformity of practice, and providing feedback to the \* >TC personnel responsible for processing and examining reissue applications<.

>

### 1457 Design Reissue Applications and Patents [R-2]

A reissue application can be filed for a design patent in the same manner that a reissue application is filed for a utility patent. There are, however, a few aspects of a design reissue application that are addressed as follows:

#### 1. EXPEDITED EXAMINATION PROCEDURE

Design reissue applications requesting expedited examination and complying with the requirements of 37 CFR 1.155 are examined with priority and undergo expedited processing throughout the entire course of prosecution in the Office, including appeal, if any, to the Board of Patent Appeals and Interferences. All processing is expedited from the date the request is granted.

Design reissue applicants seeking expedited examination may file a design reissue application in the Office together with a corresponding request under 37 CFR 1.155 pursuant to the guidelines set forth in MPEP § 1504.30.

The design reissue application and the request are processed by the Office of Initial Patent Examination (OIPE). OIPE affixes a pink tag to the design reissue

application file wrapper specifying when notice of the design reissue application will be published in the *Official Gazette* (see MPEP § 1441). (For IFW processing, see IFW Manual.) After processing in OIPE, the design reissue application and the request are forwarded to the Design TC Director's Office. Upon a decision by the Design TC Director to grant the request for expedited examination, fees are immediately processed, and the application papers are promptly assigned an application number. The design reissue application file is then forwarded to the Office of Patent Legal Administration (OPLA) for a decision under 37 CFR 1.182 to *sua sponte* waive the requirement for delaying action in the application until 2 months after announcement of the design reissue application filing is published in the *Official Gazette* (see MPEP § 1441). Once the decision under 37 CFR 1.182 is mailed, the design reissue application file will be returned to the Design TC Director's Office. In accordance with the waiver, the Design Group will begin expedited examination of the application under 37 CFR 1.155 promptly after the return of the design reissue application file from OPLA, rather than delay examination until after 2 months from the date the announcement is published in the *Official Gazette* and the applicant will be notified that examination is being expedited. The decision under 37 CFR 1.182 will require that no Notice of Allowance be mailed in the design reissue application until after 2 months from the date the announcement is published in the *Official Gazette*. For example, if the design reissue application is allowed on the first Office action, then the application will be held in the TC, and the Notice of Allowance will not be mailed until the expiration of 2 months after publication of the filing of the design reissue application in the *Official Gazette* (plus time for matching any protest filed with the application). (For IFW processing, see IFW Manual.) The examiner will check (A) the pink tag affixed to the design reissue application file wrapper as to when notice of the reissue application is to be published in the *Official Gazette*, and (B) the PALM contents to ascertain when publication actually occurred. The delay in the mailing of the Notice of Allowance is to ensure that any potential protests complying with 37 CFR 1.291 submitted within the 2-month delay period will be considered by the Office. (see MPEP § 1441.01).

The expedited examination procedure under 37 CFR 1.155 occurs through initial examination processing and throughout the entire prosecution in the Office. Once a request for expedited examination is granted, prosecution of the design reissue application will proceed according to the procedure under 37 CFR 1.155, and there is no provision for "withdrawal" from expedited examination procedure.

## II. DESIGN REISSUE FEE

The design reissue application fee is set forth for in 37 CFR 1.16(h). Note that the additional fees in 37 CFR 1.16(i) and 37 CFR 1.16(j) do not apply for a design reissue application since more than one claim is not permitted in a design application pursuant to the last sentence of 37 CFR 1.153(a).

The fee for issuing a design reissue patent is set forth in 37 CFR 1.18(b). Note that 37 CFR 1.18(a) which sets the fee for a utility reissue patent specifically excludes a design reissue patent.

## III. MULTIPLE DESIGN REISSUE APPLICATIONS

The design reissue application can be filed based on the "error" of failing to include a design for a patentably distinct segregable part of the design claimed in the original patent or a patentably distinct subcombination of the claimed design. A reissue design application claiming both the entire article and the patentably distinct subcombination or segregable part would be proper under 35 U.S.C. 251, if such a reissue application is filed within two years of the issuance of the design patent, since it is considered a broadening of the scope of the patent claim. Restriction will be required under 37 CFR 1.176(b) in such a reissue design application, and the added design to the segregable part or subcombination will be held to be constructively non-elected and withdrawn from consideration. See MPEP § 1450. In the Office action containing the restriction requirement, the examiner should suggest to the applicant that a divisional design reissue application directed to the constructively non-elected segregable part or subcombination subject matter may be filed. The claim to the patented design for the entire article will then be examined and, if found allowable without change from the patent, a rejection will be made under 35 U.S.C. 251 based on the fact that there is no "error" in the non-amended



original patent claim. In the Office action making this rejection, applicant should be advised that a proper response to the rejection must include (A) a request to suspend action in this original reissue application pending completion of examination of a divisional reissue application directed to the constructively non-elected segregable part or subcombination subject matter, (B) the filing of the divisional reissue application, or a statement that one has already been filed (identifying it at least by application number), and (C) an argument that a complete response to the rejection has been made based upon the filing of the divisional reissue application and the request for suspension. Action in the original design reissue application will then be suspended, and the divisional will be examined.

If, after examination, the divisional design reissue application is also determined to be allowable, a requirement must be made in the divisional design reissue application to submit a petition under 37 CFR 1.183 requesting waiver of 37 CFR 1.153 in order to permit the rejoining of the designs to the entire article (of the original application) and the segregable part or subcombination (of the divisional) under a single claim into a single design reissue application for issuance, the single application being the first design reissue application.

It should be noted that the filing of a design reissue application would not be proper if applicant did in fact include the design for a segregable part or subcombination thereof in the original design patent application, a restriction was thus made, and then applicant failed to file a divisional reissue application for a non-elected invention that was canceled in view of a restriction requirement (prior to issue of the original application. See *In re Watkinson*, 900 F.2d 230, 14 USPQ2d 1407 (Fed. Cir. 1990); *In re Orita*, 550 F.2d 1277, 1280, 193 USPQ 145, 148 (CCPA 1977).

#### IV. CONVERSION TO UTILITY PATENT

A design patent cannot be converted to a utility patent via reissue.

Converting a design patent to a utility patent will, in most instances, involve the introduction of new matter into the patent. The disclosure of a design patent is not directed to how the invention is made and used, and the introduction of new matter is

required to bridge this gap and provide support for the utility patent. Accordingly, the examiner should consider rejections based on the introduction of new matter under 35 U.S.C. 251, first paragraph, and lack of enablement and/or description under 35 U.S.C. 112, first paragraph, when a reissue application is filed to convert a design patent to a utility patent.

Further, the term of a design patent may not be extended by reissue. *Ex parte Lawrence*, 70 USPQ 326 (Comm'r Pat. 1946). Thus, any reissue application filed to convert a design patent to a utility patent, which conversion would thereby extend the term of the patent, should be rejected as failing to comply with 35 U.S.C. 251, first paragraph, which permits reissue only "for the unexpired part of the term of the original patent." The statute requires that the reissued patent shall not extend the term of the original patent.<

#### 1460 Effect of Reissue [R-2]

35 U.S.C. 252. *Effect of reissue.*

The surrender of the original patent shall take effect upon the issue of the reissued patent, and every reissued patent shall have the same effect and operation in law, on the trial of actions for causes thereafter arising, as if the same had been originally granted in such amended form, but in so far as the claims of the original and reissued patents are substantially identical, such surrender shall not affect any action then pending nor abate any cause of action then existing, and the reissued patent, to the extent that its claims are substantially identical with the original patent, shall constitute a continuation thereof and have effect continuously from the date of the original patent.

A reissued patent shall not abridge or affect the right of any person or that person's successors in business who, prior to the grant of a reissue, made, purchased, offered to sell, or used within the United States, or imported into the United States, anything patented by the reissued patent, to continue the use of, to offer to sell, or to sell to others to be used, offered for sale, or sold, the specific thing so made, purchased, offered for sale, used, or imported unless the making, using, offering for sale, or selling of such thing infringes a valid claim of the reissued patent which was in the original patent. The court before which such matter is in question may provide for the continued manufacture, use, offer for sale, or sale of the thing made, purchased, offered for sale, used, or imported as specified, or for the manufacture, use, offer for sale, or sale in the United States of which substantial preparation was made before the grant of the reissue, and the court may also provide for the continued practice of any process patented by the reissue that is practiced, or for the practice of which substantial preparation was made, before the grant of the reissue, to the extent and under such terms as the court deems equitable for the protection of investments made or business commenced before the grant of the reissue.

The effect of the reissue of a patent is stated in 35 U.S.C. 252. With respect to the Office treatment of the reissued patent, the reissued patent will be viewed as if the original patent had been originally granted in the amended form provided by the reissue. >With respect to intervening rights resulting from the reissue of an original patent, the second paragraph of 35 U.S.C. 252 provides for two separate and distinct defenses to patent infringement under the doctrine of intervening rights:

“Absolute” intervening rights are available for a party that “prior to the grant of a reissue, made, purchased, offered to sell, or used within the United States, or imported into the United States, anything patented by the reissued patent,” and “equitable” intervening rights may be provided where “substantial preparation was made before the grant of the reissue.” See *BIC Leisure Prods., Inc., v. Windsurfing Int’l, Inc.*, 1 F.3d 1214, 1220, 27 USPQ2d 1671, 1676 (Fed. Cir. 1993).<

## 1470 Public Access of Reissue Applications [R-2]

37 CFR 1.11(b) opens all reissue applications filed after March 1, 1977, to inspection by the general public. 37 CFR 1.11(b) also provides for announcement of the filings of reissue applications in the *Official Gazette* (except for continued prosecution applications filed under 37 CFR 1.53(d)). This announcement will give interested members of the public an opportunity to submit to the examiner information pertinent to patentability of the reissue application.

The filing of a continued prosecution application under 37 CFR 1.53(d) of a reissue application will not be announced in the *Official Gazette*. Although the filing of a continued prosecution application of a reissue application constitutes the filing of a reissue application, the announcement of the filing of such continued prosecution application would be redundant in view of the announcement of the filing of the prior reissue application in the *Official Gazette*.

37 CFR 1.11(b) is applicable only to those reissue applications filed on or after March 1, 1977. Those reissue applications previously on file will not be automatically open to inspection but a liberal policy will be followed in granting petitions for access to such applications.

For those reissue applications filed on or after March 1, 1977, the following procedure will be observed: >(For IFW processing, see IFW Manual for each of (A) thru (D)).<

(A) The filing of reissue applications will be announced in the *Official Gazette* (except for continued prosecution applications filed under 37 CFR 1.53(d)) and will include certain identifying data as specified in 37 CFR 1.11(b). Any member of the general public may request access to a particular reissue application filed after March 1, 1977. Since no record of such request is intended to be kept, an oral request will suffice. In the File Information Unit (Record Room), only the regular application charge card need be completed and submitted. The charge card will not be made part of a pending or abandoned reissue application;

(B) The pending reissue application files will be maintained in the Technology Centers (TCs) and inspection thereof will be supervised by TC personnel. Although no general limit is placed on the amount of time spent reviewing the files, the Office may impose limitations, if necessary. No access will be permitted while the application is actively being processed;

(C) After a reissue application has left the TC for administrative processing, requests for access should be directed to the appropriate supervisory personnel in the division or branch where the application is currently located;

(D) A reissue application file is not available to the public once the reissue application file has been released and forwarded by the TC for publication of the reissue patent. This would include any reissue application files which have been selected for a \*\* >post-allowance screening at the Office of Patent Legal Administration<. Unless prosecution is reopened pursuant to \*\* >the screening<, the reissue application files are not available to the public until the reissue patent issues. This is because the reissue application file has been put into a special format for printing purposes and public access at this stage would disrupt the publication process;

(E) Requests for copies of papers in the reissue application file must be in writing addressed to \*\* >Mail Stop Document Services, Director of the U.S. Patent and Trademark Office, P.O. Box 1450, Alexandria, VA 22313-1450. Such requests< may be either

mailed or delivered to the Customer Service Window. The price for a copy of an application as filed is set forth in 37 CFR 1.19(b)(1). Since no useful purpose is seen for retaining such written requests for copies of papers in reissue applications, the request(s) should be destroyed after the order has been completed.

See also MPEP § 103.

## 1480 Certificates of Correction — Office Mistake [R-2]

*35 U.S.C. 254. Certificate of correction of Patent and Trademark Office mistake.*

Whenever a mistake in a patent, incurred through the fault of the Patent and Trademark Office, is clearly disclosed by the records of the Office, the Director may issue a certificate of correction stating the fact and nature of such mistake, under seal, without charge, to be recorded in the records of patents. A printed copy thereof shall be attached to each printed copy of the patent, and such certificate shall be considered as part of the original patent. Every such patent, together with such certificate, shall have the same effect and operation in law on the trial of actions for causes thereafter arising as if the same had been originally issued in such corrected form. The Director may issue a corrected patent without charge in lieu of and with like effect as a certificate of correction.

*37 CFR 1.322. Certificate of correction of Office mistake.*

\*\*>

(a)(1) The Director may issue a certificate of correction pursuant to 35 U.S.C. 254 to correct a mistake in a patent, incurred through the fault of the Office, which mistake is clearly disclosed in the records of the Office:<

- (i) At the request of the patentee or the patentee's assignee;
- (ii) Acting *sua sponte* for mistakes that the Office discovers; or
- (iii) Acting on information about a mistake supplied by a third party.

(2)(i) There is no obligation on the Office to act on or respond to a submission of information or request to issue a certificate of correction by a third party under paragraph (a)(1)(iii) of this section.

(ii) Papers submitted by a third party under this section will not be made of record in the file that they relate to nor be retained by the Office.

(3) If the request relates to a patent involved in an interference, the request must comply with the requirements of this section and be accompanied by a motion under § 1.635.

(4) The Office will not issue a certificate of correction under this section without first notifying the patentee (including any assignee of record) at the correspondence address of record as

specified in § 1.33(a) and affording the patentee or an assignee an opportunity to be heard.

\*\*>

(b) If the nature of the mistake on the part of the Office is such that a certificate of correction is deemed inappropriate in form, the Director may issue a corrected patent in lieu thereof as a more appropriate form for certificate of correction, without expense to the patentee.<

Mistakes incurred through the fault of the Office may be the subject of Certificates of Correction under 37 CFR 1.322. The Office, however, has discretion under 35 U.S.C. 254 to decline to issue a Certificate of Correction even though an Office mistake exists. If Office mistakes are of such a nature that the meaning intended is obvious from the context, the Office may decline to issue a certificate and merely place the correspondence in the patented file, where it serves to call attention to the matter in case any question as to it subsequently arises. Such is the case, even where a correction is requested by the patentee or patentee's assignee.

In order to expedite all proper requests, a Certificate of Correction should be requested only for errors of consequence. Instead of a request for a Certificate of Correction, letters making errors of record should be utilized whenever possible. >Thus, where errors are of a minor typographical nature, or are readily apparent to one skilled in the art, a letter making the error(s) of record can be submitted in lieu of a request for a Certificate of Correction. There is no fee for the submission of such a letter.

It is strongly advised that the text of the correction requested be submitted on a Certificate of Correction form, PTO/SB/44 (also referred to as PTO 1050). Submission of this form in duplicate is not necessary. The location of the error in the printed patent should be identified on form PTO/SB/44 by column and line number or claim and line number. See MPEP § 1485 for a discussion of the preparation and submission of a request for a Certificate of Correction.

A request for a Certificate of Correction should be addressed to:

ATTN: Certificate of Correction Branch  
 Commissioner for Patents  
 P.O. Box 1450  
 Alexandria, VA 22313-1450

<

### THIRD PARTY INFORMATION ON MISTAKES IN PATENT

Third parties do not have standing to demand that the Office issue, or refuse to issue, a Certificate of Correction. *See Hallmark Cards, Inc. v. Lehman*, 959 F. Supp. 539, 543-44, 42 USPQ2d 1134, 1138 (D.D.C. 1997). 37 CFR 1.322(a)(2) makes it clear that third parties do not have standing to demand that the Office act on, respond to, issue, or refuse to issue a Certificate of Correction. The Office is, however, cognizant of the need for the public to have correct information about published patents and may therefore accept information about mistakes in patents from third parties. 37 CFR 1.322(a)(1)(iii). Where appropriate, the Office may issue certificates of correction based on information supplied by third parties, whether or not such information is accompanied by a specific request for issuance of a Certificate of Correction.

While third parties are permitted to submit information about mistakes in patents which information will be reviewed, the Office need not act on that information nor deny any accompanying request for issuance of a Certificate of Correction. Accordingly, a fee for submission of the information by a third party has not been imposed. The Office may, however, choose to issue a Certificate of Correction on its own initiative based on the information supplied by a third party, if it desires to do so. Regardless of whether the third party information is acted upon, the information will not be made of record in the file that it relates to, nor be retained by the Office. 37 CFR 1.322(a)(2)(ii).

When such third party information (about mistakes in patents) is received by the Office, the Office will not correspond with third parties about the information they submitted either (1) to inform the third parties of whether it intends to issue a Certificate of Correction, or (2) to issue a denial of any request for issuance of a Certificate of Correction that may accompany the information. The Office will confirm to the party submitting such information that the Office has in fact received the information if a stamped, self-addressed post card has been submitted. See MPEP § 503.

### PUBLICATION IN THE OFFICIAL GAZETTE

Each issue of the *Official Gazette* (patents section) numerically lists all United States patents having Certificates of Correction. The list appears under the

heading "Certificates of Correction for the week of (date)."

>

### 1480.01 Expedited Issuance of Certificates of Correction - Error Attributable to Office [R-2]

In an effort to reduce the overall time required in processing and granting Certificate of Correction requests, the Office will expedite processing and granting of patentee requests where such requests are accompanied by evidence to show that the error is attributable solely to the Office (i.e., requests filed pursuant to 37 CFR 1.322 only).

The following requirements must be met for consideration of expedited issuance of Certificates of Correction:

The text of the correction requested should be submitted on a Certificate of Correction form, PTO/SB/44 (also referred to as PTO 1050). Submission of this form in duplicate is not necessary. The location of the error in the printed patent should be identified on form PTO/SB/44 by column and line number or claim and line number. See also MPEP § 1485.

Where the correction requested was incurred through the fault of the Office, and the matter is clearly disclosed in the records of the Office, and is accompanied by documentation that unequivocally supports the patentee's assertion(s), a Certificate of Correction will be expeditiously issued. Such supporting documentation can consist of relevant photocopied receipts, manuscript pages, correspondence dated and received by the Office, photocopies of Examiners' responses regarding entry of amendments, or any other validation that supports the patentee's request so that the request can be processed without the patent file.

Where only part of a request can be approved, the appropriate modifications will be made on the form PTO/SB/44 and the patentee then notified by mail. Further consideration will be given to initially rejected requests upon a request for reconsideration. In this instance, however, or in the case where it is determined that the Office was not responsible for the error(s) cited by the patentee, accelerated issuance of Certificates of Correction cannot be anticipated

(although the Office will make every effort to process the request expeditiously).

As in the case of a request for a Certificate of Correction, a Request for Expedited Issuance of Certificate of Correction should be addressed to:

ATTN: Certificate of Correction Branch  
Commissioner for Patents  
P.O. Box 1450  
Alexandria, VA 22313-1450

### 1481 >Certificates of Correction -< Applicant's Mistake [R-2]

*35 U.S.C. 255. Certificate of correction of applicant's mistake.*

Whenever a mistake of a clerical or typographical nature, or of minor character, which was not the fault of the Patent and Trademark Office, appears in a patent and a showing has been made that such mistake occurred in good faith, the Director may, upon payment of the required fee, issue a certificate of correction, if the correction does not involve such changes in the patent as would constitute new matter or would require reexamination. Such patent, together with the certificate, shall have the same effect and operation in law on the trial of actions for causes thereafter arising as if the same had been originally issued in such corrected form.

*37 CFR 1.323. Certificate of correction of applicant's mistake.*

The Office may issue a certificate of correction under the conditions specified in 35 U.S.C. 255 at the request of the patentee or the patentee's assignee, upon payment of the fee set forth in § 1.20(a). If the request relates to a patent involved in an interference, the request must comply with the requirements of this section and be accompanied by a motion under § 1.635.

37 CFR 1.323 relates to the issuance of Certificates of Correction for the correction of errors which were not the fault of the Office. Mistakes in a patent which are not correctable by Certificate of Correction may be correctable via filing a reissue application (see MPEP § 1401 - § 1460). >See *Novo Industries, L.P. v. Micro Molds Corporation*, 350 F.3d 1348, 69 USPQ2d 1128 (Fed. Cir. 2003) (The Federal Circuit stated that when Congress in 1952 defined USPTO authority to make corrections with prospective effect, it did not deny correction authority to the district courts. A court, however, can correct only if '(1) the correction is not subject to reasonable debate based on consideration of the claim language and the specification and (2) the prosecution history does not suggest a different interpretation...').<

*In re Arnott*, 19 USPQ2d 1049, 1052 (Comm'r Pat. 1991) specifies the criteria of 35 U.S.C. 255 (for a Certificate of Correction) as follows:

Two separate statutory requirements must be met before a Certificate of Correction for an applicant's mistake may issue. The first statutory requirement concerns the nature, i.e., type, of the mistake for which a correction is sought. The mistake must be:

- (1) of a clerical nature,
- (2) of a typographical nature, or
- (3) a mistake of minor character.

The second statutory requirement concerns the nature of the proposed correction. The correction must not involve changes which would:

- (1) constitute new matter or
- (2) require reexamination.

If the above criteria are not satisfied, then a Certificate of Correction for an applicant's mistake will not issue, and reissue must be employed as the vehicle to "correct" the patent. Usually, any mistake affecting claim scope must be corrected by reissue.

A mistake is not considered to be of the "minor" character required for the issuance of a Certificate of Correction if the requested change would materially affect the scope or meaning of the patent. See also MPEP § 1412.04 as to correction of inventorship via certificate of correction or reissue.

The fee for providing a correction of applicant's mistake, other than inventorship, is set forth in 37 CFR 1.20(a). The fee for correction of inventorship in a patent is set forth in 37 CFR 1.20(b).

### CORRECTION OF ASSIGNEES' NAMES

The Issue Fee Transmittal Form portion (PTOL-85B) of the Notice of Allowance provides a space (item 3) for assignment data which should be completed in order to comply with 37 CFR 3.81. Unless an assignee's name and address are identified in the appropriate space for specifying the assignee, (i.e., item 3 of the Issue Fee Transmittal Form PTOL-85B), the patent will issue to the applicant. Assignment data printed on the patent will be based solely on the information so supplied.

A request for a Certificate of Correction under 37 CFR 1.323 arising from incomplete or erroneous assignee's name furnished in item 3 of PTOL-85B will not be granted unless a petition under 37 CFR 1.183 has been granted. Any such petition under 37

CFR 1.183 should be directed to the Office of Petitions and should include:

- (A) the petition fee required by 37 CFR 1.17(h);
- (B) a request that 37 CFR 3.81(a) be waived to permit the correct name of the assignee to be provided after issuance of the patent;
- (C) a statement that the failure to include the correct assignee name on the PTOL-85B was inadvertent; and
- (D) a copy of the Notice of Recordation of Assignment Document.

### CORRECTION OF INVENTORS' NAMES

#### *35 U.S.C. 256. Correction of named inventor.*

Whenever through error a person is named in an issued patent as the inventor, or through error an inventor is not named in an issued patent and such error arose without any deceptive intention on his part, the Director may, on application of all the parties and assignees, with proof of the facts and such other requirements as may be imposed, issue a certificate correcting such error.

The error of omitting inventors or naming persons who are not inventors shall not invalidate the patent in which such error occurred if it can be corrected as provided in this section. The court before which such matter is called in question may order correction of the patent on notice and hearing of all parties concerned and the Director shall issue a certificate accordingly.

In requesting the Office to effectuate a court order correcting inventorship in a patent pursuant to 35 U.S.C. 256, a copy of the court order and a Certificate of Correction under 37 CFR 1.323 should be submitted to the Certificates of Corrections Branch.

#### *37 CFR 1.324. Correction of inventorship in patent, pursuant to 35 U.S.C. 256.*

\*\*>

(a) Whenever through error a person is named in an issued patent as the inventor, or through error an inventor is not named in an issued patent and such error arose without any deceptive intention on his or her part, the Director may, on petition, or on order of a court before which such matter is called in question, issue a certificate naming only the actual inventor or inventors. A petition to correct inventorship of a patent involved in an interference must comply with the requirements of this section and must be accompanied by a motion under § 1.634.<

(b) Any petition pursuant to paragraph (a) of this section must be accompanied by:

(1) Where one or more persons are being added, a statement from each person who is being added as an inventor that the inventorship error occurred without any deceptive intention on his or her part;

(2) A statement from the current named inventors who have not submitted a statement under paragraph (b)(1) of this sec-

tion either agreeing to the change of inventorship or stating that they have no disagreement in regard to the requested change;

(3) A statement from all assignees of the parties submitting a statement under paragraphs (b)(1) and (b)(2) of this section agreeing to the change of inventorship in the patent, which statement must comply with the requirements of § 3.73(b) of this chapter; and

(4) The fee set forth in § 1.20(b).

(c) For correction of inventorship in an application see §§ 1.48 and 1.497, and in an interference see § 1.634.

The petition to correct inventorship under 37 CFR 1.324 must include the statements and fee required by 37 CFR 1.324(b).

Under 37 CFR 1.324(b)(1), a statement is required from each person who is being added as an inventor that the inventorship error occurred without any deceptive intention on their part. In order to satisfy this, a statement such as the following is sufficient:

“The inventorship error of failing to include John Smith as an inventor of the patent occurred without any deceptive intention on the part of John Smith.”

Nothing more is required. The examiner will determine only whether the statement contains the required language; the examiner will not make any comment as to whether or not it appears that there was in fact deceptive intention (see MPEP § 2022.05).

Under 37 CFR 1.324(b)(2), all current inventors who did not submit a statement under 37 CFR 1.324(b)(1) must submit a statement either agreeing to the change of inventorship, or stating that they have no disagreement with regard to the requested change. “Current inventors” include the inventor(s) being retained as such and the inventor(s) to be deleted. These current inventors need not make a statement as to whether the inventorship error occurred without deceptive intention.

If an inventor is not available, or refuses, to submit a statement, the assignee of the patent may wish to consider filing a reissue application to correct inventorship, since the inventor’s statement is not required for a non-broadening reissue application to correct inventorship. See MPEP § 1412.04.

Under 37 CFR 1.324(b)(3), a statement is required from the assignee(s) of the patent agreeing to the change of inventorship in the patent. The assignee statement agreeing to the change of inventorship must be accompanied by a proper statement under 37 CFR 3.73(b) establishing ownership, unless a proper 37 CFR 3.73(b) statement is already in the file. See

MPEP § 324 as to the requirements of a statement under 37 CFR 3.73(b).

While a request under 37 CFR 1.48\* is appropriate to correct inventorship in a nonprovisional *application*, a petition under 37 CFR 1.324 is the appropriate vehicle to correct inventorship in a *patent*. If a request under 37 CFR 1.48(a)>, (b), or (c)< is inadvertently filed in a patent, the request may be treated as a petition under 37 CFR 1.324, and if it is grantable, form paragraph 10.14 set forth below should be used.

Similarly, if a request under 37 CFR 1.48(a)>, (b), or (c)< is filed in a pending application but not acted upon until after the application becomes a patent, the request may be treated as a petition under 37 CFR 1.324, and if it is grantable, form paragraph 10.14 set forth below should be used.

The statutory basis for correction of inventorship in a patent under 37 CFR 1.324 is 35 U.S.C. 256. It is important to recognize that 35 U.S.C. 256 is stricter than 35 U.S.C. 116, the statutory basis for corrections of inventorship in applications under 37 CFR 1.48. 35 U.S.C. 256 requires “on application of all the parties and assignees,” while 35 U.S.C. 116 does not have the same requirement. Under 35 U.S.C. 116 and 37 CFR 1.48, waiver requests under 37 CFR 1.183 may be submitted (see, e.g., MPEP § 201.03, under the heading “Statement of Lack of Deceptive Intention”). This is not possible under 35 U.S.C. 256 and 37 CFR 1.324. In correction of inventorship in a nonprovisional application under 37 CFR 1.48(a), the requirement for a statement by each originally named inventor may be waived pursuant to 37 CFR 1.183; however, correction of inventorship in a patent under 37 CFR 1.324 requires petition of all the parties, i.e., originally named inventors and assignees, in accordance with statute (35 U.S.C. 256) and thus the requirement cannot be waived. Correction of inventorship requests under 37 CFR 1.324 should be directed to the Supervisory Patent Examiner whose unit handles the subject matter of the patent. Form paragraphs 10.13 through 10.18 may be used.

\*\*>

¶ 10.13 *Petition Under 37 CFR 1.324, Granted*

In re Patent No. [1] :  
 Issue Date: [2] : **DECISION**  
 Appl. No.: [3] : **GRANTING**  
 Filed: [4] : **PETITION**  
 For: [5] : 37 CFR 1.324

This is a decision on the petition filed [6] to correct inventorship under 37 CFR 1.324.

The petition is granted.

The patented file is being forwarded to Certificate of Corrections Branch for issuance of a certificate naming only the actual inventor or inventors.

[7]  
 Supervisory Patent Examiner,  
 Art Unit [8],  
 Technology Center [9]  
 [10]

**Examiner Note:**

1. Petitions to correct inventorship of an issued patent are decided by the Supervisory Patent Examiner, as set forth in the Commissioner’s memorandum dated June 2, 1989.
2. In bracket 10, insert the correspondence address of record.
3. This form paragraph is printed with the USPTO letterhead.
4. Prepare Certificate using form paragraph 10.15.

¶ 10.14 *Treatment of Request Under 37 CFR 1.48 Petition Under 37 CFR 1.324, Petition Granted*

In re Patent No. [1] :  
 Issue Date: [2] : **DECISION**  
 Appl. No.: [3] : **GRANTING**  
 Filed: [4] : **PETITION**  
 For: [5] : 37 CFR 1.324

This is a decision on the request under 37 CFR 1.48, filed [6]. In view of the fact that the patent has already issued, the request under 37 CFR 1.48 has been treated as a petition to correct inventorship under 37 CFR 1.324.

The petition is granted.

The patented file is being forwarded to Certificate of Corrections Branch for issuance of a certificate naming only the actual inventor or inventors.

[7]  
 Supervisory Patent Examiner,  
 Art Unit [8],  
 Technology Center [9]  
 [10]

**Examiner Note:**

1. Petitions to correct inventorship of an issued patent are decided by the Supervisory Patent Examiner, as set forth in the Commissioner’s memorandum dated June 2, 1989.
2. This form paragraph is printed with the USPTO letterhead.
3. Prepare Certificate using form paragraph 10.15.
4. In bracket 10, insert the correspondence address of record.

<

¶ 10.15 *Memorandum - Certificate of Correction (Inventorship)*

DATE: [1]  
 TO: Certificates of Correction Branch

FROM: [2], SPE, Art Unit [3]  
SUBJECT: Request for Certificate of Correction

Please issue a Certificate of Correction in U. S. Letters Patent No. [4] as specified on the attached Certificate.

[5], SPE  
Art Unit [6]

**UNITED STATES PATENT AND TRADEMARK OFFICE  
CERTIFICATE**

Patent No. [7]  
Patented: [8]

On petition requesting issuance of a certificate for correction of inventorship pursuant to 35 U.S.C. 256, it has been found that the above identified patent, through error and without deceptive intent, improperly sets forth the inventorship. Accordingly, it is hereby certified that the correct inventorship of this patent is:

[9]

[10], Supervisory Patent Examiner  
Art Unit [11]

**Examiner Note:**

1. In bracket 9, insert the full name and residence (City, State) of each actual inventor.
2. This is an internal memo, not to be mailed to applicant, which accompanies the patented file to Certificates of Correction Branch as noted in form paragraphs 10.13 and 10.14.
3. In brackets 5 and 10, insert name of SPE; in brackets 6 and 11 the Art Unit and sign above each line.
4. Two separate pages of USPTO letterhead will be printed when using this form paragraph.

\*\*>

*¶ 10.16 Petition Under 37 CFR 1.324, Dismissed*

In re Patent No. [1] :  
Issue Date: [2] : **DECISION**  
Appl. No.: [3] : **DISMISSING**  
Filed: [4] : **PETITION**  
For: [5] : 37 CFR 1.324

This is a decision on the petition filed [6] to correct inventorship under 37 CFR 1.324.

The petition is dismissed.

A petition to correct inventorship as provided by 37 CFR 1.324 requires (1) a statement from each person who is being added as an inventor that the inventorship error occurred without any deceptive intention on their part, (2) a statement from the current named inventors (including any "inventor" being deleted) who have not submitted a statement as per "(1)" either agreeing to the change of inventorship or stating that they have no disagreement in regard to the requested change, (3) a statement from all assignees of the parties submitting a statement under "(1)" and "(2)" agreeing to the change of inventorship in the patent; such statement must comply with the requirements of 37 CFR 3.73(b); and

(4) the fee set forth in 37 CFR 1.20(b). This petition lacks item(s) [7].

[8]  
Supervisory Patent Examiner,  
Art Unit [9],  
Technology Center [10]  
[11]

**Examiner Note:**

1. If each of the four specified items has been submitted but one or more is insufficient, the petition should be denied. See paragraph 10.17. However, if the above noted deficiency can be cured by the submission of a renewed petition, a dismissal would be appropriate.
2. If the petition includes a request for suspension of the rules (37 CFR 1.183) of one or more provisions of 37 CFR 1.324 that are required by the statute (35 U.S.C. 256), form paragraph 10.18 should follow this form paragraph.
3. In bracket 7, pluralize as necessary and insert the item number(s) which are missing.
4. In bracket 11, insert correspondence address of record.
5. This form paragraph is printed with the USPTO letterhead.

<

*¶ 10.17 Petition Under 37 CFR 1.324, Denied*

In re Patent No. [1] :  
Issue Date: [2] : **DECISION DENYING PETITION**  
Appl. No.: [3] : 37 CFR 1.324  
Filed: [4] :  
For: [5] :

This is a decision on the petition filed [6] to correct inventorship under 37 CFR 1.324.

The petition is denied.

[7]

[8]  
Supervisory Patent Examiner,  
Art Unit [9],  
Technology Center [10]  
[11]

**Examiner Note:**

1. In bracket 7, a full explanation of the deficiency must be provided.
2. If the petition lacks one or more of the required parts set forth in 37 CFR 1.324, it should be dismissed using form paragraph 10.14 or 10.20, rather than being denied.
3. In bracket 11, insert correspondence address of record.
4. This form paragraph is printed with the USPTO letterhead.

*¶ 10.18 Waiver of Requirements of 37 CFR 1.324 Under 37 CFR 1.183, Dismissed*

Suspension of the rules under 37 CFR 1.183 may be granted for any requirement of the regulations which is not a requirement of the statutes. In this instance, 35 U.S.C. 256 requires [1].



Accordingly, the petition under 37 CFR 1.183 is dismissed as moot.

**Examiner Note:**

1. This form paragraph should follow form paragraph 10.16 whenever the petition requests waiver of one or more of the provisions of 37 CFR 1.324 that are also requirements of 35 U.S.C. 256.

2. If the petition requests waiver of requirements of 37 CFR 1.324 that are not specific requirements of the statute (i.e., the fee or the oath or declaration by all inventors), the application must be forwarded to a petitions attorney in the Office of the Deputy Commissioner for Patent Examination Policy for decision.

**CORRECTION TO PERFECT CLAIM FOR 35 U.S.C. 119 (a)-(d) >AND (f)< BENEFITS**

See MPEP § 201.16 for a discussion of when 35 U.S.C. 119 (a)-(d) >and (f)< benefits can be perfected by certificate of correction.

**CORRECTION AS TO 35 U.S.C. 120 AND 35 U.S.C. 119(e) BENEFITS**

***For Applications Filed Prior to November 29, 2000***

For applications filed prior to November 29, 2000, it is the version of 37 CFR 1.78, which was in effect as of November 29, 2000, that applies. The pre-November 29, 2000 version reads as follows:

*37 CFR 1.78. Claiming benefit of earlier filing date and cross-references to other applications.*

(a)(1) A nonprovisional application may claim an invention disclosed in one or more prior filed copending nonprovisional applications or copending international applications designating the United States of America. In order for a nonprovisional application to claim the benefit of a prior filed copending nonprovisional application or copending international application designating the United States of America, each prior application must name as an inventor at least one inventor named in the later filed nonprovisional application and disclose the named inventor's invention claimed in at least one claim of the later filed nonprovisional application in the manner provided by the first paragraph of 35 U.S.C. 112. In addition, each prior application must be:

(i) An international application entitled to a filing date in accordance with PCT Article 11 and designating the United States of America; or

(ii) Complete as set forth in § 1.51(b); or

(iii) Entitled to a filing date as set forth in § 1.53(b) or § 1.53(d) and include the basic filing fee set forth in § 1.16; or

(iv) Entitled to a filing date as set forth in § 1.53(b) and have paid therein the processing and retention fee set forth in § 1.21(l) within the time period set forth in § 1.53(f).

(2) Except for a continued prosecution application filed under § 1.53(d), any nonprovisional application claiming the benefit of one or more prior filed copending nonprovisional applications or international applications designating the United States of America must contain a reference to each such prior application, identifying it by application number (consisting of the series code and serial number) or international application number and international filing date and indicating the relationship of the applications. Unless the reference required by this paragraph is included in an application data sheet (§ 1.76), the specification must contain or be amended to contain such reference in the first sentence following any title. The request for a continued prosecution application under § 1.53(d) is the specific reference required by 35 U.S.C. 120 to the prior application. The identification of an application by application number under this section is the specific reference required by 35 U.S.C. 120 to every application assigned that application number. Cross-references to other related applications may be made when appropriate (see § 1.14(a)).

(3) A nonprovisional application other than for a design patent may claim an invention disclosed in one or more prior filed copending provisional applications. In order for a nonprovisional application to claim the benefit of one or more prior filed copending provisional applications, each prior provisional application must name as an inventor at least one inventor named in the later filed nonprovisional application and disclose the named inventor's invention claimed in at least one claim of the later filed nonprovisional application in the manner provided by the first paragraph of 35 U.S.C. 112. In addition, each prior provisional application must be entitled to a filing date as set forth in § 1.53(c), have any required English-language translation filed therein within the time period set forth in § 1.52(d), and have paid therein the basic filing fee set forth in § 1.16(k) within the time period set forth in § 1.53(g).

(4) Any nonprovisional application claiming the benefit of one or more prior filed copending provisional applications must contain a reference to each such prior provisional application, identifying it as a provisional application, and including the provisional application number (consisting of series code and serial number). Unless the reference required by this paragraph is included in an application data sheet (§ 1.76), the specification must contain or be amended to contain such reference in the first sentence following any title.

\*\*\*\*\*

Under certain conditions specified below, a Certificate of Correction can be used, with respect to 35 U.S.C. 120 and 119(e) priority, to correct:

(A) the failure to make reference to a prior copending application pursuant to 37 CFR 1.78(a)(2) and (a)(4); or

(B) an incorrect reference to a prior copending application pursuant to 37 CFR 1.78(a)(2) and (a)(4).

For all situations other than where priority is based upon 35 U.S.C. 365(c), the conditions are as follows:

(A) for 35 U.S.C. 120 priority, all requirements set forth in 37 CFR 1.78(a)(1) must have been met in the application which became the patent to be corrected;

(B) for 35 U.S.C. 119(e) priority, all requirements set forth in 37 CFR 1.78(a)(3) must have been met in the application which became the patent to be corrected;

(C) it must be clear from the record of the patent and the parent application(s) that priority is appropriate. See MPEP § 201.11 for requirements under 35 U.S.C. 119(e) and 120.

Where 35 U.S.C. 120 and 365(c) priority based on an international application is to be asserted or corrected in a patent via a Certificate of Correction, the following conditions must be satisfied:

(A) all requirements set forth in 37 CFR 1.78(a)(1) must have been met in the application which became the patent to be corrected;

(B) it must be clear from the record of the patent and the parent application(s) that priority is appropriate (see MPEP § 201.11); and

>

(C) the patentee must submit with the request for the certificate copies of documentation showing designation of states and any other information needed to make it clear from the record that the 35 U.S.C. 120 priority is appropriate. See MPEP § 201.13(b) as to the requirements for 35 U.S.C. 120 priority based on an international application.

If all the above-stated conditions are satisfied, a Certificate of Correction can be used to amend the patent to make reference to a prior copending application, or to correct an incorrect reference to the prior copending application. Note *In re Schuurs*, 218 USPQ 443 (Comm'r Pat. 1983) which suggests that a Certificate of Correction is an appropriate remedy for correcting, in a patent, reference to a prior copending application. Also, note *In re Lambrech*, 202 USPQ 620 (Comm'r Pat. 1976), citing *In re Van Esdonk*, 187 USPQ 671 (Comm'r Pat. 1975).

If any of the above-stated conditions is not satisfied, the filing of a reissue application (see MPEP § 1401 - § 1460) would be appropriate to pursue the desired correction of the patent.

### ***For Applications Filed on or After November 29, 2000***

For applications filed on or after November 29, 2000, the version of 37 CFR 1.78 reproduced below applies (note that amendments to 37 CFR 1.78 took effect on November 29, 2000, December 28, 2001, May 1, 2003, and January 21, 2004).

#### *37 CFR 1.78. Claiming benefit of earlier filing date and cross-references to other applications.*

(a)(1) A nonprovisional application or international application designating the United States of America may claim an invention disclosed in one or more prior-filed copending nonprovisional applications or international applications designating the United States of America. In order for an application to claim the benefit of a prior-filed copending nonprovisional application or international application designating the United States of America, each prior-filed application must name as an inventor at least one inventor named in the later-filed application and disclose the named inventor's invention claimed in at least one claim of the later-filed application in the manner provided by the first paragraph of 35 U.S.C. 112. In addition, each prior-filed application must be:

(i) An international application entitled to a filing date in accordance with PCT Article 11 and designating the United States of America; or

(ii) Complete as set forth in § 1.51(b); or

(iii) Entitled to a filing date as set forth in § 1.53(b) or § 1.53(d) and include the basic filing fee set forth in § 1.16; or

(iv) Entitled to a filing date as set forth in § 1.53(b) and have paid therein the processing and retention fee set forth in § 1.21(l) within the time period set forth in § 1.53(f).

(2)(i) Except for a continued prosecution application filed under § 1.53(d), any nonprovisional application claiming the benefit of one or more prior-filed copending nonprovisional applications or international applications designating the United States of America must contain or be amended to contain a reference to each such prior-filed application, identifying it by application number (consisting of the series code and serial number) or international application number and international filing date and indicating the relationship of the applications. Cross references to other related applications may be made when appropriate (see § 1.14).

(ii) This reference must be submitted during the pendency of the later-filed application. If the later-filed application is an application filed under 35 U.S.C. 111(a), this reference must also be submitted within the later of four months from the actual filing date of the later-filed application or sixteen months from the filing date of the prior-filed application. If the later-filed application is a nonprovisional application which entered the national stage from an international application after compliance with 35 U.S.C. 371, this reference must also be submitted within the later of four months from the date on which the national stage commenced under 35 U.S.C. 371 (b) or (f) in the later-filed international application or sixteen months from the filing date of the prior-filed application. These time periods are not extendable.

Except as provided in paragraph (a)(3) of this section, the failure to timely submit the reference required by 35 U.S.C. 120 and paragraph (a)(2)(i) of this section is considered a waiver of any benefit under 35 U.S.C. 120, 121, or 365(c) to such prior-filed application. The time periods in this paragraph do not apply if the later-filed application is:

(A) An application for a design patent;

(B) An application filed under 35 U.S.C. 111 (a) before November 29, 2000; or

(C) A nonprovisional application which entered the national stage after compliance with 35 U.S.C. 371 from an international application filed under 35 U.S.C. 363 before November 29, 2000.

(iii) If the later-filed application is a nonprovisional application, the reference required by this paragraph must be included in an application data sheet (§ 1.76), or the specification must contain or be amended to contain such reference in the first sentence following the title.

(iv) The request for a continued prosecution application under § 1.53(d) is the specific reference required by 35 U.S.C. 120 to the prior-filed application. The identification of an application by application number under this section is the identification of every application assigned that application number necessary for a specific reference required by 35 U.S.C. 120 to every such application assigned that application number.

(3) If the reference required by 35 U.S.C. 120 and paragraph (a)(2) of this section is presented after the time period provided by paragraph (a)(2)(ii) of this section, the claim under 35 U.S.C. 120, 121, or 365(c) for the benefit of a prior-filed copending nonprovisional application or international application designating the United States of America may be accepted if the reference identifying the prior-filed application by application number or international application number and international filing date was unintentionally delayed. A petition to accept an unintentionally delayed claim under 35 U.S.C. 120, 121, or 365(c) for the benefit of a prior-filed application must be accompanied by:

(i) The reference required by 35 U.S.C. 120 and paragraph (a)(2) of this section to the prior-filed application, unless previously submitted;

(ii) The surcharge set forth in § 1.17(t); and

(iii) A statement that the entire delay between the date the claim was due under paragraph (a)(2)(ii) of this section and the date the claim was filed was unintentional. The Director may require additional information where there is a question whether the delay was unintentional.

(4) A nonprovisional application, other than for a design patent, or an international application designating the United States of America may claim an invention disclosed in one or more prior-filed provisional applications. In order for an application to claim the benefit of one or more prior filed provisional applications, each prior-filed provisional application must name as an inventor at least one inventor named in the later-filed application and disclose the named inventor's invention claimed in at least one claim of the later-filed application in the manner provided by the first paragraph of 35 U.S.C. 112. In addition, each prior-filed provisional application must be entitled to a filing date

as set forth in § 1.53(c), and the basic filing fee set forth in § 1.16(k) must be paid within the time period set forth in § 1.53(g).

(5)(i) Any nonprovisional application or international application designating the United States of America claiming the benefit of one or more prior-filed provisional applications must contain or be amended to contain a reference to each such prior-filed provisional application, identifying it by the provisional application number (consisting of series code and serial number).

(ii) This reference must be submitted during the pendency of the later-filed application. If the later-filed application is an application filed under 35 U.S.C. 111(a), this reference must also be submitted within the later of four months from the actual filing date of the later-filed application or sixteen months from the filing date of the prior-filed provisional application. If the later-filed application is a nonprovisional application which entered the national stage from an international application after compliance with 35 U.S.C. 371, this reference must also be submitted within the later of four months from the date on which the national stage commenced under 35 U.S.C. 371(b) or (f) in the later-filed international application or sixteen months from the filing date of the prior-filed provisional application. These time periods are not extendable. Except as provided in paragraph(a)(6) of this section, the failure to timely submit the reference is considered a waiver of any benefit under 35 U.S.C. 119(e) to such prior-filed provisional application. The time periods in this paragraph do not apply if the later-filed application is:

(A) An application filed under 35 U.S.C. 111(a) before November 29, 2000; or

(B) A nonprovisional application which entered the national stage after compliance with 35 U.S.C. 371 from an international application filed under 35 U.S.C. 363 before November 29, 2000.

(iii) If the later-filed application is a nonprovisional application, the reference required by this paragraph must be included in an application data sheet (§ 1.76), or the specification must contain or be amended to contain such reference in the first sentence following the title.

(iv) If the prior-filed provisional application was filed in a language other than English and an English-language translation of the prior-filed provisional application and a statement that the translation is accurate were not previously filed in the prior-filed provisional application or the later-filed nonprovisional application, applicant will be notified and given a period of time within which to file an English-language translation of the non-English-language prior-filed provisional application and a statement that the translation is accurate. In a pending nonprovisional application, failure to timely reply to such a notice will result in abandonment of the application.

(6) If the reference required by 35 U.S.C. 119(e) and paragraph (a)(5) of this section is presented in a nonprovisional application after the time period provided by paragraph (a)(5)(ii) of this section, the claim under 35 U.S.C. 119(e) for the benefit of a prior filed provisional application may be accepted during the pendency of the later-filed application if the reference identifying the prior-filed application by provisional application number was unintentionally delayed. A petition to accept an unintentionally

delayed claim under 35 U.S.C. 119(e) for the benefit of a prior filed provisional application must be accompanied by:

(i) The reference required by 35 U.S.C. 119(e) and paragraph (a)(5) of this section to the prior-filed provisional application, unless previously submitted;

(ii) The surcharge set forth in § 1.17(t); and

(iii) A statement that the entire delay between the date the claim was due under paragraph (a)(5)(ii) of this section and the date the claim was filed was unintentional. The Director may require additional information where there is a question whether the delay was unintentional.

(b) Where two or more applications filed by the same applicant contain conflicting claims, elimination of such claims from all but one application may be required in the absence of good and sufficient reason for their retention during pendency in more than one application.

(c) If an application or a patent under reexamination and at least one other application naming different inventors are owned by the same party and contain conflicting claims, and there is no statement of record indicating that the claimed inventions were commonly owned or subject to an obligation of assignment to the same person at the time the later invention was made, the Office may require the assignee to state whether the claimed inventions were commonly owned or subject to an obligation of assignment to the same person at the time the later invention was made, and, if not, indicate which named inventor is the prior inventor.<

Under no circumstances can a Certificate of Correction be employed to correct an applicant's mistake by adding or correcting a priority claim under 35 U.S.C. 119(e) for an application filed on or after November 29, 2000.

Section 4503 of the American Inventors Protection Act of 1999 (AIPA) amended 35 U.S.C. 119(e)(1) to state that:

No application shall be entitled to the benefit of an earlier filed provisional application under this subsection unless an amendment containing the specific reference to the earlier filed provisional application is submitted at such time during the pendency of the application as required by the Director. The Director may consider the failure to submit such an amendment within that time period as a waiver of any benefit under this subsection. The Director may establish procedures, including the payment of a surcharge, to accept an unintentionally delayed submission of an amendment under this section *during the pendency of the application*. (emphasis added)

35 U.S.C. 119(e)(1), as amended by the AIPA, clearly prohibits the addition or correction of priority claims under 35 U.S.C. 119(e) when the application is not pending, e.g., an issued patent. Therefore, a Certificate of Correction is no longer a valid mechanism for adding or correcting a priority claim under 35

U.S.C. 119(e) after a patent has been granted on an application filed on or after November 29, 2000.

Under certain conditions as specified below, however, a Certificate of Correction can still be used, with respect to 35 U.S.C. 120 priority, to correct:

(A) the failure to make reference to a prior copending application pursuant to 37 CFR 1.78(a)(2); or

(B) an incorrect reference to a prior copending application pursuant to 37 CFR 1.78(a)(2).

Where priority is based upon 35 U.S.C. 120 to a **national application**, the following conditions must be satisfied:

(A) all requirements set forth in 37 CFR 1.78(a)(1) must have been met in the application which became the patent to be corrected;

(B) \*\* it must be clear from the record of the patent and the parent application(s) that priority is appropriate >(see MPEP § 201.11)<; and

\*>

(C) < a grantable petition to accept an unintentionally delayed claim for the benefit of a prior application must be filed, including a surcharge as set forth in 37 CFR 1.17(t), as required by 37 CFR 1.78(a)(3).

Where 35 U.S.C. 120 and 365(c) priority based on an **international application** is to be asserted or corrected in a patent via a Certificate of Correction, the following conditions must be satisfied:

(A) all requirements set forth in 37 CFR 1.78(a)(1) must have been met in the application which became the patent to be corrected;

(B) \*\* it must be clear from the record of the patent and the parent application(s) that priority is appropriate >(see MPEP § 201.11)<;

\*>

(C) < the patentee must submit >together with the request for the certificate,< copies of documentation showing designation of states and any other information needed to make it clear from the record that the 35 U.S.C. 120 priority is appropriate (see MPEP § 201.13(b) as to the requirements for 35 U.S.C. 120 priority based on an international application; \*\*>and<

(D) > a grantable petition to accept an unintentionally delayed claim for the benefit of a prior appli-

cation must be filed, including a surcharge as set forth in 37 CFR 1.17(t), as required by 37 CFR 1.78(a)(3).

If all the above-stated conditions are satisfied, a Certificate of Correction can be used to amend the patent to make reference to a prior copending application, or to correct an incorrect reference to the prior copending application, for benefit claims under 35 U.S.C. 120 and 365(c).

If any of the above-stated conditions is not satisfied, the filing of a reissue application (see MPEP § 1401 - § 1460) may be appropriate to pursue the desired correction of the patent for benefit claims under 35 U.S.C. 120 and 365(c).

### **1485 Handling of Request for Certificates of Correction [R-2]**

A request for a Certificate of Correction should be addressed to \*\* >:

ATTN: Certificate of Correction Branch  
Commissioner for Patents  
P.O. Box 1450  
Alexandria, VA 22313-1450<

Requests for Certificates of Correction will be forwarded to the Certificate of Correction Branch of the Office of Patent Publication, where they will be listed in a permanent record book.

If the patent is involved in an interference, a Certificate of Correction under 37 CFR 1.324 will not be issued unless a corresponding motion under 37 CFR 1.634 has been granted by the administrative patent judge. Otherwise, determination as to whether an error has been made, the responsibility for the error, if any, and whether the error is of such a nature as to justify the issuance of a Certificate of Correction will be made by the Certificate of Correction Branch. If a report is necessary in making such determination, the case will be forwarded to the appropriate group with a request that the report be furnished. If no certificate is to issue, the party making the request is so notified and the request, report, if any, and copy of the communication to the person making the request are placed in the file and entered thereon under "Contents" by the Certificate of Correction Branch. The case is then returned to the patented files. >(For IFW processing, see IFW Manual.)< If a certificate is to issue, it will be prepared and forwarded to the person

making the request by the Office of Patent Publication. In that case, the request, the report, if any, and a copy of the letter transmitting the Certificate of Correction to the person making the request will be placed in the file and entered thereon under "Contents". >(For IFW processing, see IFW Manual.)<

Applicants, or their attorneys or agents, are urged to submit the text of the correction on a special Certificate of Correction form, PTO/SB/44 (also referred to as Form PTO-1050), which can serve as the camera copy for use in direct offset printing of the Certificate of Correction.

Where only a part of a request can be approved, or where the Office discovers and includes additional corrections, the appropriate alterations are made on the form PTO/SB/44 by the Office. The patentee is notified of the changes on the Notification of Approval-in-part form PTOL-404. The certificate is issued approximately 6 weeks thereafter.

Form PTO/SB/44 should be used exclusively regardless of the length or complexity of the subject matter. Intricate chemical formulas or page of specification or drawings may be reproduced and mounted on a blank copy of PTO/SB/44. Failure to use the form has frequently delayed issuance since the text must be retyped by the Office onto a PTO/SB/44.

The exact page and line number where the errors occur in the application file should be identified on the request. However, on form PTO/SB/44, only the column and line number in the printed patent should be used.

The patent grant should be retained by the patentee. The Office does not attach the Certificate of Correction to patentee's copy of the patent. The patent grant will be returned to the patentee if submitted.

Below is a sample form illustrating a variety of corrections and the suggested manner of setting out the format. Particular attention is directed to:

(A) Identification of the exact point of error by reference to column and line number of the printed patent >for changes in the specification< or to claim number and line where a claim is involved.

(B) Conservation of space on the form by typing single space, beginning two lines down from the printed message.

(C) Starting the correction to each separate column as a sentence, and using semicolons to separate

corrections within >the same< column, where possible.

(D) >Leaving a< two-inch space \* blank at bottom of the last sheet for >the< signature of >the< attesting officer.

(E) >Using< \* quotation marks to enclose the exact subject matter to be deleted or corrected; \* >using< \* double hyphens (-- --) to enclose subject matter to be added, except for formulas.

(F) Where a formula is involved, setting out only that portion thereof which is to be corrected or, if necessary, pasting a photocopy onto form PTO/SB/44.

UNITED STATES PATENT AND TRADEMARK  
OFFICE CERTIFICATE OF CORRECTION

\*\*

>Patent No. 9,999,999

Dated May 1, 2002

Eli Y. Rosenthal

It is certified that error appears in the above-identified patent and that said Letters Patent is hereby corrected as shown below:

In the drawings, Sheet 3, Fig. 3, the reference numeral 225 should be applied to the plate element attached to the support member 207:

Column 2, line 68 and column 3, lines 3, 8 and 13, for the claim reference numeral '2', each occurrence, should read -1-.

Column 7, lines 45 to 49, the left-hand formula should appear as follows:

-R<sub>3</sub> -CHF

Column 8, Formula XVII, that portion of the formula reading "-CHClCH-" should read --CHFCH<sub>2</sub> --; line 5, "chlorine" should be changed to --fluorine--.

Column 10, line 29, cancel the text beginning with "12. A sensor device" to and ending "active strips." in column 11, line 10, and insert the following claim:

12. A control circuit of the character set forth in claim 4 and for an automobile having a convertible top, and including; means for moving the top between a raised and lowered retracted position; and control means responsive to a sensor relay for energizing the top moving means for moving said top from a retracted position to a raised position.<

**ELECTRONIC PUBLICATION OF CERTIFICATES OF CORRECTION WITH LATER LISTING IN THE OFFICIAL GAZETTE**

\*\* >Effective August 2001, the U.S. Patent and Trademark Office (USPTO) publishes< on the USPTO web site at <http://www.uspto.gov/web/patents/certofcorrect> a listing by patent number of the patents for which certificates of correction are being issued.

The USPTO is now automating the publication process for certificates of correction. This new process will result in certificates of correction being published quicker electronically on the USPTO's web site as compared to their paper publication and the listing of the certificates of correction in the *Official Gazette*. Under the newly automated process, each issue of certificates of correction will be electronically published on the USPTO web site at <http://www.uspto.gov/web/patents/certofcorrect>, and will also subsequently be listed in the *Official Gazette* (and in the *Official Gazette Notices* posted at <http://www.uspto.gov/web/offices/com/sol/og>) approximately three weeks thereafter. The listing of certificates of correction in the *Official Gazette* will include the certificate's date of issuance.

On the date on which the listing of certificates of correction is electronically published on the USPTO web site: (A) the certificate of correction will be entered into the file wrapper of the patent and will be available to the public; >(For IFW processing, see IFW Manual.)< (B) a printed copy of the certificate of correction will be mailed to the patentee or the patent's assignee; and (C) an image of the printed certificate of correction will be added to the image of the patent on the patent database at <http://www.uspto.gov.patft>. Dissemination of all other paper copies of the certificate of correction will occur shortly thereafter.

The date on which the USPTO makes the certificate of correction available to the public (e.g., by adding the certificate of correction to the file wrapper>/file history<) will be regarded as the date of issuance of the certificate of correction, not the date of the certificate of correction appearing in the *Official Gazette*. >(For IFW processing, see IFW Manual.)< Certificates of correction published in the above-described manner will provide the public with prompt notice and access>,< and >this< is consistent with the legis-

lative intent behind the American Inventors Protection Act of 1999. See 35 U.S.C. 10(a) (authorizing the USPTO to publish in electronic form).

The listing of certificates of correction can be electronically accessed on the day of issuance at <http://www.uspto.gov/web/patents/certofcorrect>. The elec-

tronic image of the printed certificate of correction can be accessed on the patent database at <http://www.uspto.gov/patft> and the listing of the certificates of correction, as published in the *Official Gazette* three weeks later, will be electronically accessible at <http://www.uspto.gov/web/offices/com/sol/og>.

\*\*>

PTO/SB/44 (04-04)  
Approved for use through 04/30/2007. OMB 0651-0033  
U.S. Patent and Trademark Office; U.S. DEPARTMENT OF COMMERCE  
Under the Paperwork Reduction Act of 1995, no persons are required to respond to a collection of information unless it displays a valid OMB control number.  
(Also Form PTO-1050)

**UNITED STATES PATENT AND TRADEMARK OFFICE  
CERTIFICATE OF CORRECTION**

PATENT NO. :  
DATED :  
INVENTOR(S) :

It is certified that error appears in the above-identified patent and that said Letters Patent is hereby corrected as shown below.

MAILING ADDRESS OF SENDER:

PATENT NO. \_\_\_\_\_

No. of additional copies



This collection of information is required by 37 CFR 1.322, 1.323, and 1.324. The information is required to obtain or retain a benefit by the public which is to file (and by the USPTO to process) an application. Confidentiality is governed by 35 U.S.C. 122 and 37 CFR 1.14. This collection is estimated to take 1.0 hour to complete, including gathering, preparing, and submitting the completed application form to the USPTO. Time will vary depending upon the individual case. Any comments on the amount of time you require to complete this form and/or suggestions for reducing this burden, should be sent to the Chief Information Officer, U.S. Patent and Trademark Office, U.S. Department of Commerce, P.O. Box 1450, Alexandria, VA 22313-1450. DO NOT SEND FEES OR COMPLETED FORMS TO THIS ADDRESS. SEND TO: **Attention Certificate of Corrections Branch, Commissioner for Patents, P.O. Box 1450, Alexandria, VA 22313-1450.**

*If you need assistance in completing the form, call 1-800-PTO-9199 and select option 2.*



## 1490 Disclaimers [R-2]

### 35 U.S.C. 253. Disclaimer.

Whenever, without any deceptive intention, a claim of a patent is invalid the remaining claims shall not thereby be rendered invalid. A patentee, whether of the whole or any sectional interest therein, may, on payment of the fee required by law, make disclaimer of any complete claim, stating therein the extent of his interest in such patent. Such disclaimer shall be in writing, and recorded in the Patent and Trademark Office; and it shall thereafter be considered as part of the original patent to the extent of the interest possessed by the disclaimant and by those claiming under him.

In like manner any patentee or applicant may disclaim or dedicate to the public the entire term, or any terminal part of the term, of the patent granted or to be granted.

### 37 CFR 1.321. Statutory disclaimers, including terminal disclaimers.

(a) A patentee owning the whole or any sectional interest in a patent may disclaim any complete claim or claims in a patent. In like manner any patentee may disclaim or dedicate to the public the entire term, or any terminal part of the term, of the patent granted. Such disclaimer is binding upon the grantee and its successors or assigns. A notice of the disclaimer is published in the *Official Gazette* and attached to the printed copies of the specification. The disclaimer, to be recorded in the Patent and Trademark Office, must:

- (1) be signed by the patentee, or an attorney or agent of record;
- (2) identify the patent and complete claim or claims, or term being disclaimed. A disclaimer which is not a disclaimer of a complete claim or claims, or term, will be refused recordation;
- (3) state the present extent of patentee's ownership interest in the patent; and
- (4) be accompanied by the fee set forth in § 1.20(d).

(b) An applicant or assignee may disclaim or dedicate to the public the entire term, or any terminal part of the term, of a patent to be granted. Such terminal disclaimer is binding upon the grantee and its successors or assigns. The terminal disclaimer, to be recorded in the Patent and Trademark Office, must:

- (1) be signed:
  - (i) by the applicant, or
  - (ii) if there is an assignee of record of an undivided part interest, by the applicant and such assignee, or
  - (iii) if there is an assignee of record of the entire interest, by such assignee, or
  - (iv) by an attorney or agent of record;
- (2) specify the portion of the term of the patent being disclaimed;
- (3) state the present extent of applicant's or assignee's ownership interest in the patent to be granted; and
- (4) be accompanied by the fee set forth in § 1.20(d).

(c) A terminal disclaimer, when filed to obviate a judicially created double patenting rejection in a patent application or in a reexamination proceeding, must:

(1) Comply with the provisions of paragraphs (b)(2) through (b)(4) of this section;

(2) Be signed in accordance with paragraph (b)(1) of this section if filed in a patent application or in accordance with paragraph (a)(1) of this section if filed in a reexamination proceeding; and

(3) Include a provision that any patent granted on that application or any patent subject to the reexamination proceeding shall be enforceable only for and during such period that said patent is commonly owned with the application or patent which formed the basis for the rejection.

A disclaimer is a statement filed by an owner (in part or in entirety) of a patent or of a patent to be granted (i.e., an application), in which said owner relinquishes certain legal rights to the patent. There are two types of disclaimers: a statutory disclaimer and a terminal disclaimer. The owner of a patent or an application is the original inventor(s) or the assignee of the original inventor(s). The patent or application is assigned by one assignment or by multiple assignments which establish a chain of title from the inventor(s) to the assignee(s). The owner of the patent or application can sign a disclaimer, and a person empowered by the owner to sign the disclaimer can also sign it. Per 37 CFR 1.321(b)(1)(iv), an attorney or agent of record is permitted to sign the disclaimer. For a disclaimer to be accepted, it must be signed by the proper party as follows:

(A) A disclaimer filed in an application must be signed by

- (1) the applicant where the application has not been assigned,
- (2) the applicant and the assignee where each owns a part interest in the application,
- (3) the assignee where assignee owns the entire interest in the application, or
- (4) an attorney or agent of record.

(B) A disclaimer filed in a patent or a reexamination proceeding must be signed by either

- (1) the patentee (the assignee, the inventor(s) if the patent is not assigned, or the assignee and the inventors if the patent is assigned-in-part), or
- (2) an attorney or agent of record.

(C) Where the assignee (of an application or of a patent being reexamined or to be reissued) signs the disclaimer, there is a requirement to comply with 37 CFR 3.73(b) in order to satisfy 37 CFR 1.321, unless an attorney or agent of record signs the disclaimer. In

order to comply with 37 CFR 3.73(b), the assignee's ownership interest must be established by:

(1) filing in the application or patent evidence of a chain of title from the original owner to the assignee, or

(2) specifying in the record of the application or patent where such evidence is recorded in the Office (e.g., reel and frame number, etc.).

The submission with respect to 37 CFR 3.73(b) to establish ownership must be signed by a party authorized to act on behalf of the assignee. See also MPEP § 324 as to compliance with 37 CFR 3.73(b). A copy of the "Statement Under 37 CFR 3.73 (b)," which is reproduced in MPEP § 324, may be sent by the examiner to applicant to provide an acceptable way to comply with the requirements of 37 CFR 3.73 (b).

(D) Where the attorney or agent of record signs the disclaimer, **there is no need** to comply with 37 CFR 3.73(b).

(E) The signature on the disclaimer need not be an original signature. Pursuant to 37 CFR 1.4(d)(2), the submitted disclaimer can be a copy, such as a photocopy or facsimile transmission of an original disclaimer.

## STATUTORY DISCLAIMERS

Under 37 CFR 1.321(a) the owner of a patent may disclaim a complete claim or claims of his or her patent. This may result from a lawsuit or because he or she has reason to believe that the claim or claims are too broad or otherwise invalid. If the patent is involved in an interference, see 37 CFR 1.662(c).

>As noted above, a statutory disclaimer is a statement in which a patent owner relinquishes legal rights to one or more claims of a patent. A statutory disclaimer is not, however, a vehicle for adding or amending claims, since there is no provision for such in the statute (35 U.S.C. 253) nor the rules (37 CFR 1.321). Thus, claims of a patent cannot be disclaimed in favor of new claims to be added to the patent or an amendment to existing claims.<

## TERMINAL DISCLAIMERS

37 CFR 1.321(a) also provides for the filing by an applicant or patentee of a terminal disclaimer which disclaims or dedicates to the public the entire term or

any portion of the term of a patent or patent to be granted.

37 CFR 1.321(c) specifically provides for the filing of a terminal disclaimer in an application or a reexamination proceeding for the purpose of overcoming a judicially created double patenting rejection. See MPEP § 804.02.

## PROCESSING

### >Certificate of Correction Branch<

The Certificate of Correction Branch is responsible for the handling of all statutory disclaimers filed under the first paragraph of 35 U.S.C. 253, whether the case is pending or patented, and all terminal disclaimers (filed under the second paragraph of 35 U.S.C. 253) except for those filed in an application pending in a Technology Center (TC). This involves:

(A) Determining >the< compliance >of the disclaimer< with 35 U.S.C. 253 and 37 CFR 1.321 and 3.73;

(B) Notifying applicant or patentee when the disclaimer is informal and thus not acceptable;

(C) Recording the disclaimers >in the record of the application file<; and

(D) Providing the disclaimer data for printing >in the *Official Gazette*<.

## TERMINAL DISCLAIMER IN PENDING APPLICATION PRACTICE >IN THE TECHNOLOGY CENTERS<

Where a terminal disclaimer is filed in an application pending in a TC, it will be processed by the paralegal of the Office of the Special Program Examiner of the TC having responsibility for the application. The paralegal will:

(A) Determine compliance with 35 U.S.C. 253 and 37 CFR 1.321 and 3.73, and ensure that the appropriate terminal disclaimer fee set forth in 37 CFR 1.20(d) >is/<was applied \*\*;

(B) Notify the examiner having charge of the application whether the terminal disclaimer is acceptable or not;

(C) Where the terminal disclaimer is not acceptable, indicate the nature of the informalities so that the examiner can inform applicant in the next Office action;

(D) Where the terminal disclaimer is acceptable, record the terminal disclaimer \* >in the record of the application as set forth below.<

\*\*

The paralegal will \* >record< a terminal disclaimer as being present in an application by:

For applications with 08/ and earlier series code

(A) Attaching a green label to the file wrapper;

(B) Stamping a notice on the file of the term which has been disclaimed >(note that the blanks on the stamped notice for entering information on the patent(s) being disclaimed are no longer filled in)<;

(C) Endorsing the paper containing the terminal disclaimer submission on the “Contents” flap of the application file; and

(D) Entering the terminal disclaimer into the PALM system records, for the application.

>(For IFW processing, see IFW Manual for (A)-(C).)<

For applications with 09/ and later series code

(A) Checking a box on the file wrapper which states that the terminal disclaimer has been filed

>(Any blanks for entering information on the patent(s) being disclaimed are no longer filled in. Note that applications with 10/ and later series codes no longer have such blanks to complete)<;

(B) Endorsing the paper containing the terminal disclaimer submission on the “Contents” flap of the application file; and

(C) Entering the terminal disclaimer into the PALM system records, for the application.

>(For IFW processing, see IFW Manual for (A)-(B).)<

The paralegal completes a Terminal Disclaimer Informal Memo to notify the examiner of the nature of any informalities in the terminal disclaimer. The examiner should notify the applicant of the informalities in the next Office action, or by interview with applicant if such will expedite prosecution of the application. Further, the examiner should initial and date the Terminal Disclaimer Informal Memo and return it to the paralegal to indicate that the examiner has appropriately notified applicant about the terminal disclaimer. The paralegal will then discard the Terminal Disclaimer Informal Memo.

**T. D. INFORMAL MEMO: DO NOT MAIL THIS MEMO TO APPLICANT**

DATE: \_\_\_\_\_

TO: EXAMINER \_\_\_\_\_

APPL. S.N.: \_\_\_\_\_

FROM: \_\_\_\_\_  
PARALEGAL SPECIALIST

ART UNIT: \_\_\_\_\_

SUBJECT: Decision on Terminal Disclaimer (T.D.) filed: \_\_\_\_\_

INSTRUCTIONS: I have reviewed the submitted T.D. with the results as set forth below. If you agree, please use the appropriate form paragraphs identified by this informal memo in your next Office action to notify applicant of the T.D. If you disagree or have any questions, please see me or the Special Program Examiner. THIS IS AN INFORMAL, INTERNAL MEMO ONLY. IT MUST NOT BE (1) MAILED TO APPLICANT OR (2) PLACED OF RECORD IN THE APPLICATION FILE. When your action is complete, please initial, date and return this memo to me. THANK YOU.

- The T.D. is PROPER and has been recorded (see ¶14.23).
- The T.D. is NOT PROPER and has not been accepted for the reason(s) checked below (see ¶14.24):
- The recording fee of \$ \_\_\_\_\_ has not been submitted nor is there any authorization in the application file for the use of a deposit account (see ¶14.26.07).
- The T.D. does not satisfy Rule 321 in that the person who has signed the T.D. has not stated the extent of his/her interest (and/or the extent of the interest of the business entity represented by the signature) in the application/patent (see ¶¶14.26 & 14.26.01).
- The T.D. lacks the enforceable only during common ownership clause - needed to overcome a double patenting rejection, Rule 321(b) (see ¶14.27.01)
- The T.D. is directed to a particular claim(s), which is not acceptable since "the disclaimer must be a terminal portion of the term of the entire patent to be granted." (MPEP 1490) (see ¶¶14.26 & 14.26.02).
- The person who signed the T.D.:
- is not an attorney "of record" (see ¶¶14.29 and 14.29.01).
- has failed to state his/her capacity to sign for the business entity (see ¶14.28),
- is not recognized as an officer of the assignee (see ¶¶14.29 & possibly 14.29.02).
- No documentary evidence of a chain of title from the original inventor(s) to assignee has been submitted, nor is the reel and frame number specified as to where such evidence is recorded in the Office (see 37 CFR 3.73(b) and 1140 O.G. 72). NOTE: This documentary evidence or the specifying of the reel and frame number may be found in the T.D. or in a separate paper of record in the application (see ¶14.30).
- The T.D. is not signed (see ¶¶14.26 & 14.26.03).
- The serial number of the application (or the number of the patent) which forms the basis for the double patenting rejection is missing or incorrect (see ¶14.32).
- The serial number of this application (or the number of the patent in reexam or reissue cases being disclaimed is missing or incorrect (see ¶¶14.26, 14.26.04 or 14.26.05).
- The period disclaimed is incorrect or not specified (see ¶¶14.26, 14.27.02 or 14.27.03).
- Other:
- Suggestion to request refund (see ¶14.36). NOTE: If already authorized, credit refund to deposit account and do not check this item.

I have appropriately notified applicant(s) of the status of the Terminal Disclaimer filed in this case.

Ex. Initials: \_\_\_\_\_ Date: \_\_\_\_\_

**RETURN THIS MEMO TO CPK2-2D25.**

(Rev. 5/98)

## OTHER MATTERS DIRECTED TO TERMINAL DISCLAIMERS

### *Requirements of Terminal Disclaimers*

A proper terminal disclaimer must disclaim the terminal part of the statutory term of any patent granted on the application being examined which would extend beyond the expiration date of the full statutory term, shortened by any terminal disclaimer, of the patent (or of any patent granted on the application) to which the disclaimer is directed. Note the exculpatory language in the second paragraph of the sample terminal disclaimer forms, PTO/SB/25 and PTO/SB/26, provided at the end of this Chapter. That language (“In making the above disclaimer, the owner does not disclaim...”) is permissible in a terminal disclaimer.

The terminal disclaimer must state that any patent granted on the application being examined will be enforceable only for and during the period that it and the patent to which the disclaimer is directed or the patent granted on the application to which the disclaimer is directed are commonly owned. See MPEP § 706.02(1)(2) for examples of common ownership, or lack thereof.

The terminal disclaimer must state that the agreement is to run with any patent granted on the application being examined and is to be binding upon the grantee, its successors, or assigns.

A statement of assignee interest in a terminal disclaimer that “A and B are the owners of 100% of the instant application...” is sufficient to satisfy the 37 CFR 1.321(b)(3) requirement that a terminal disclaimer “state the present extent of applicant’s or assignee’s ownership interest in the patent to be granted.” Although the quoted statement does not identify what specific percentage is owned by A and what specific percentage is owned by B, the statement does provide consent to the terminal disclaimer by the entirety of the ownership of the application (A and B own all of the invention, regardless of the individual percentages they own).

The appropriate one of form paragraphs 14.27.04 and 14.27.06 (reproduced below) may be used to provide applicant or patent owner with an example of acceptable terminal disclaimer language. Additionally, copies of forms PTO/SB/25 and PTO/SB/26 (provided at the end of this Chapter) may be attached to

the Office action to provide sample terminal disclaimers.

\* Pursuant to the last sentence of 35 U.S.C. 253, “any patentee or applicant may disclaim or dedicate to the public... any terminal part of the term, of the patent granted or to be granted”. Accordingly, the disclaimer must be of a terminal portion of the term of the entire patent to be granted. A disclaimer of a terminal portion of the term of an individual claim, or individual claims will not be accepted. It is further noted that a disclaimer of the term of individual claims would not be appropriate since the claims of pending application or proceeding are subject to cancellation, amendment, or renumbering. The statute does not provide for conditional disclaimers and accordingly, a proposed disclaimer which is made contingent on the allowance of certain claims cannot be accepted. The disclaimer should identify the disclaimant and his or her interest in the application and should specify the date when the disclaimer is to become effective.

### *Effect of Disclaimers in Continuing Applications and in Reissues*

A terminal disclaimer filed to obviate a double patenting rejection is effective only with respect to the application identified in the disclaimer unless by its terms it extends to continuing applications. For example, a terminal disclaimer filed in a parent application normally has no effect on a continuing application claiming filing date benefits of the parent application under 35 U.S.C. 120. A terminal disclaimer filed in a parent application to obviate a double patenting rejection does, however, carry over to a continued prosecution application (CPA) filed under 37 CFR 1.53(d) (effective July 14, 2003, CPAs are only available in design applications). The terminal disclaimer filed in the parent application carries over because the CPA retains the same application number as the parent application, i.e., the application number to which the previously filed terminal disclaimer is directed. If applicant does not want the terminal disclaimer to carry over to the CPA, applicant must file a petition under 37 CFR 1.182, along with the required petition fee, requesting the terminal disclaimer filed in the parent application not be carried over to the CPA; see below “Withdrawing a Terminal Disclaimer” (paragraph “A. Before Issuance of Patent”). If applicant

files a Request for Continued Examination (RCE) of an application under 37 CFR 1.114 (which can be filed on or after May 29, 2000 for an application filed on or after June 8, 1995), any terminal disclaimer present will continue to operate, since a new application has not been filed, but rather prosecution has been continued in the existing application. A petition under 37 CFR 1.182, along with the required petition fee, may be filed, if withdrawal of the terminal disclaimer is to be requested.

>Reissue applications: Where a terminal disclaimer was filed in an original application, a copy of that terminal disclaimer is not required be filed by applicant in the reissue. The face of the file wrapper of the reissue application should, however, be marked by the examiner in order to indicate that a terminal disclaimer has been filed for the patent (and will be effective for the patent as it will be reissued). Further, a copy of the terminal disclaimer should be placed in the reissue file by the Technology Center. (For IFW processing, see IFW Manual.)

#### ***Disclaimer Identifies the Wrong Target Application or Patent***

In some instances a terminal disclaimer filed to obviate an obviousness type double patenting rejection will identify the wrong target application or patent (i.e., an application or patent which is not the basis for the double patenting rejection). In these instances, a replacement terminal disclaimer identifying the correct target application or patent would be required by the examiner. Once a correct replacement terminal disclaimer is received, the next Office action should make it clear that 'the second terminal disclaimer replaces the first terminal disclaimer, and the first terminal disclaimer is thus void.' A second terminal disclaimer fee should not be assessed/charged, since the first fee is applied to the second terminal disclaimer.<

#### ***Two or More Copending Applications***

If two (or more) pending applications are filed >,< in *each* of which a rejection of one claimed invention over the other on the ground of >provisional< obviousness-type double patenting >(ODP)< is proper, the >(ODP)< rejection will be made in each application. \* >If the ODP rejection is the only rejection remaining in the earlier filed of the two pending applications,

(but the later-filed application is rejectable on other grounds), the examiner should then withdraw that rejection and permit the earlier-filed application to issue as a patent without a terminal disclaimer. If the ODP rejection is the only rejection remaining in the later-filed application, (while the earlier-filed application is rejectable on other grounds), a terminal disclaimer must be required in the later-filed application, before the ODP rejection can be withdrawn.

If the ODP rejections in both applications are the only rejections remaining in those applications, the examiner should then withdraw the ODP rejection in the earlier filed application thereby permitting that application to issue without need of a terminal disclaimer. A terminal disclaimer must be required in the later-filed application before the ODP rejection can be withdrawn and the application be permitted to issue.

*If both applications are filed on the same day*, the examiner should determine which application claims the base invention and which application claims the improvement (added limitations). The ODP rejection in the base application can be withdrawn without a terminal disclaimer, while the ODP rejection in the improvement application cannot be withdrawn without a terminal disclaimer.

Where there are three applications containing claims that conflict such that an ODP rejection is made in each application based upon the other two, it is not sufficient to file a terminal disclaimer in only one of the applications addressing the other two applications. Rather, an< appropriate terminal disclaimer must be filed in \*\* >at least two of the applications to link all three together<. This is because a terminal disclaimer filed to obviate a double patenting rejection is effective only with respect to the application \* in >which< the >terminal< disclaimer >is filed; it is not effective to link the other two applications to each other<. \*\*

#### **FORM PARAGRAPHS**

The following form paragraphs may be used to inform the applicant (or patent owner) of the status of a submitted terminal disclaimer.

##### *¶ 14.23 Terminal Disclaimer Proper*

The terminal disclaimer filed on [1] disclaiming the terminal portion of any patent granted on this application which would

extend beyond the expiration date of [2] has been reviewed and is accepted. The terminal disclaimer has been recorded.

**Examiner Note:**

1. In bracket 1, insert the date the terminal disclaimer was filed.
2. In bracket 2, list the Patent Number and/or Application Number (including series code and serial no.). Where an Application Number is listed, it must be preceded by the phrase --any patent granted on Application Number--.
3. If an assignment is submitted to support the terminal disclaimer, also use form paragraph 14.34 to suggest that the assignment be separately submitted for recording in the Office.
4. See MPEP § 1490 for discussion of requirements for a proper terminal disclaimer.
5. Use form paragraph 14.23.01 for reexamination proceedings.
6. For improper terminal disclaimers, see form paragraphs 14.24 *et seq.*

¶ 14.23.01 *Terminal Disclaimer Proper (Reexamination Only)*

The terminal disclaimer filed on [1] disclaiming the terminal portion of the patent being reexamined which would extend beyond the expiration date of [2] has been reviewed and is accepted. The terminal disclaimer has been recorded.

**Examiner Note:**

1. In bracket 1, insert the date the terminal disclaimer was filed.
2. In bracket 2, list the Patent Number and/or Application Number (including series code and serial no.). Where an Application Number is listed, it must be preceded by the phrase --any patent granted on Application Number--.
3. If an assignment is submitted to support the terminal disclaimer, also use 14.34 to suggest that the assignment be separately submitted for recording in the Office.
4. See MPEP § 1490 for discussion of requirements for a proper terminal disclaimer.
5. For improper terminal disclaimers, see the form paragraphs which follow.

¶ 14.24 *Terminal Disclaimer Not Proper - Introductory Paragraph*

The terminal disclaimer filed on [1] disclaiming the terminal portion of any patent granted on this application which would extend beyond the expiration date of [2] has been reviewed and is NOT accepted.

**Examiner Note:**

1. In bracket 1, insert the date the terminal disclaimer was filed.
2. In bracket 2, list the Patent Number and/or Application Number (including series code and serial no.). Where an Application Number is listed, it must be preceded by the phrase --any patent granted on Application Number--.
3. One or more of the appropriate form paragraphs 14.26 to 14.32 MUST follow this form paragraph to indicate why the terminal disclaimer is not accepted.
4. Form paragraph 14.33 includes the full text of rule 37 CFR 3.73 and may be included in the Office action when deemed appropriate.

5. Form paragraph 14.35 may be used to inform applicant that an additional disclaimer fee will not be required for the submission of a replacement or supplemental terminal disclaimer.

6. Do not use in reexamination proceedings, use form paragraph 14.25 instead.

¶ 14.25 *Terminal Disclaimer Not Proper - Introductory Paragraph (Reexamination Only)*

The terminal disclaimer filed on [1] disclaiming the terminal portion of the patent being reexamined which would extend beyond the expiration date of [2] has been reviewed and is NOT accepted.

**Examiner Note:**

1. In bracket 1, insert the date the terminal disclaimer was filed.
2. In bracket 2, list the Patent Number and/or the Application Number (including series code and serial no.). Where an Application Number is listed, it must be preceded by the phrase --any patent granted on Application Number--.
3. One or more of the appropriate form paragraphs 14.26 to 14.32 MUST follow this form paragraph to indicate why the terminal disclaimer is not accepted.
4. Form paragraph 14.33 includes the full text of rule 37 CFR 3.73 and may be included in the Office action when deemed appropriate.
5. Form paragraph 14.35 may be used to inform applicant that an additional disclaimer fee will not be required for the submission of a replacement or supplemental terminal disclaimer.

¶ 14.26 *Does Not Comply With 37 CFR 1.321(b) and/or (c) "Sub-Heading" Only*

The terminal disclaimer does not comply with 37 CFR 1.321(b) and/or (c) because:

**Examiner Note:**

1. This form paragraph MUST be preceded by form paragraphs 14.24 or 14.25 and followed by one or more of the appropriate form paragraphs 14.26.01 to 14.27.03.

¶ 14.26.01 *Extent of Interest Not Stated*

The person who has signed the disclaimer has not stated the extent of his/her interest, or the business entity's interest, in the application/patent. See 37 CFR 1.321(b)(3).

**Examiner Note:**

This form paragraph MUST be preceded by form paragraph 14.24 or 14.25 AND 14.26.

¶ 14.26.02 *Directed to Particular Claim(s)*

It is directed to a particular claim or claims, which is not acceptable, since "the disclaimer must be of a terminal portion of the term of the entire [patent or] patent to be granted." See MPEP § 1490.

**Examiner Note:**

This form paragraph MUST be preceded by form paragraphs 14.24 or 14.25 AND 14.26.

*¶ 14.26.03 Not Signed*

The terminal disclaimer was not signed.

**Examiner Note:**

1. This form paragraph MUST be preceded by form paragraphs 14.24 or 14.25 AND 14.26.

*¶ 14.26.04 Application/Patent Not Identified*

The application/patent being disclaimed has not been identified.

**Examiner Note:**

1. This form paragraph MUST be preceded by form paragraphs 14.24 or 14.25 AND 14.26.

*¶ 14.26.05 Application/Patent Improperly Identified*

The application/patent being disclaimed has been improperly identified since the number used to identify the [1] being disclaimed is incorrect. The correct number is [2].

**Examiner Note:**

1. This form paragraph MUST be preceded by form paragraphs 14.24 or 14.25 AND 14.26.
2. In bracket 1, insert --application-- or --patent--.
3. In bracket 2, insert the correct Application Number (including series code and serial no.) or the correct Patent Number being disclaimed.
4. A terminal disclaimer is acceptable if it includes the correct Patent Number or the correct Application Number or the serial number together with the proper filing date or the proper series code.

*¶ 14.26.06 Not Signed by All Owners*

It was not signed by all owners and, therefore, supplemental terminal disclaimers are required from the remaining owners.

**Examiner Note:**

1. This form paragraph MUST be preceded by form paragraphs 14.24 or 14.25 AND 14.26.

*¶ 14.26.07 No Disclaimer Fee Submitted*

The disclaimer fee of \$ [1] in accordance with 37 CFR 1.20(d) has not been submitted, nor is there any authorization in the application file to charge a specified Deposit Account or credit card.

**Examiner Note:**

1. In bracket 1, insert the fee for a disclaimer.
2. This form paragraph MUST be preceded by form paragraphs 14.24 or 14.25 AND 14.26. If the disclaimer fee was paid for a terminal disclaimer which was not accepted, applicant does not have to pay another disclaimer fee when submitting a replacement or supplemental terminal disclaimer, and this form paragraph should not be used.

*¶ 14.27.01 Lacks Clause of Enforceable Only During Period of Common Ownership*

It does not include a recitation that any patent granted shall be enforceable only for and during such period that said patent is commonly owned with the application(s) or patent(s) which

formed the basis for the double patenting rejection. See 37 CFR 1.321(c)(3).

**Examiner Note:**

This form paragraph MUST be preceded by form paragraphs 14.24 or 14.25 AND 14.26.

*¶ 14.27.02 Fails To Disclaim Terminal Portion of Any Patent Granted On Subject Application*

It fails to disclaim the terminal portion of any patent granted on the subject application.

**Examiner Note:**

1. This form paragraph MUST be preceded by form paragraph 14.24 or 14.25 AND 14.26.
2. Use this form paragraph when the period disclaimed is not the correct period or when no period is specified at all.
3. When using this form paragraph, give an example of proper terminal disclaimer language using form paragraph 14.27.04 following this or the series of statements concerning the defective terminal disclaimer.

*¶ 14.27.03 Fails To Disclaim Terminal Portion of Subject Patent*

It fails to disclaim the terminal portion of the subject patent.

**Examiner Note:**

1. This form paragraph MUST be preceded by form paragraph 14.24 or 14.25 AND 14.26.
2. Use this form paragraph in a reissue application or reexamination proceeding when the period disclaimed is not the correct period or when no period is specified at all.

*¶ 14.27.04 Examples of Acceptable Terminal Disclaimer Language in Patent To Be Granted*

Examples of acceptable language for making the disclaimer of the terminal portion of any patent granted on the subject application follow:

I. If a Provisional Obviousness-Type Double Patenting Rejection Over A Pending Application was made, use:

Petitioner hereby disclaims, except as provided below, the terminal part of any patent granted on the instant application, which would extend beyond the expiration date of any patent granted on Application No. \_\_\_/\_\_\_\_\_, filed on \_\_\_\_\_, as shortened by any terminal disclaimer. Petitioner hereby agrees that any patent so granted on the instant application shall be enforceable only for and during such period that it and any patent granted on the above-listed application are commonly owned. This agreement runs with any patent granted on the instant application and is binding upon the grantee, its successors, or assigns.

II. If an Obviousness-Type Double Patenting Rejection Over A Prior Patent was made, use:

Petitioner hereby disclaims, except as provided below, the terminal part of any patent granted on the instant application, which would extend beyond the expiration date of



Patent No. \_\_\_\_\_, as presently shortened by any terminal disclaimer. Petitioner hereby agrees that any patent so granted on the instant application shall be enforceable only for and during such period that it and the above listed patent are commonly owned. This agreement runs with any patent granted on the instant application and is binding upon the grantee, its successors, or assigns.

Alternatively, Form PTO/SB/25 may be used for situation I, and Form PTO/SB/26 may be used for situation II; a copy of each form may be found at the end MPEP Chapter 1400.

*¶ 14.27.06 Examples of Acceptable Terminal Disclaimer Language in Patent (Reexamination Situation)*

Examples of acceptable language for making the disclaimer of the terminal portion of the patent being reexamined follow:

I. If a Provisional Obviousness-Type Double Patenting Rejection Over A Pending Application was made, use:

Petitioner hereby disclaims, except as provided below, the terminal part of the patent being reexamined, which would extend beyond the expiration date of any patent granted on Application No. \_\_\_/\_\_\_\_\_, filed on \_\_\_\_\_, as shortened by any terminal disclaimer. Petitioner hereby agrees that the patent being reexamined shall be enforceable only for and during such period that it and any patent granted on the above-listed application are commonly owned. This agreement is binding upon the patent owner, its successors, or assigns.

II. If an Obviousness-Type Double Patenting Rejection Over A Prior Patent was made, use:

Petitioner hereby disclaims, except as provided below, the terminal part of the patent being reexamined, which would extend beyond the expiration date of Patent No. \_\_\_\_\_, as presently shortened by any terminal disclaimer. Petitioner hereby agrees that the patent for which a reexamination certificate is issued as a result of this proceeding shall be enforceable only for and during such period that it and the above listed patent are commonly owned. This agreement is binding upon the patent owner, its successors, or assigns.

*¶ 14.28 Failure To State Capacity To Sign*

The person who signed the terminal disclaimer has failed to state his/her capacity to sign for the corporation or other business entity, and he/she has not been established as being authorized to act on behalf of the assignee.

**Examiner Note:**

1. This form paragraph MUST be preceded by form paragraph 14.24 or 14.25 AND 14.26.

\*\*>

*¶ 14.29 Not Recognized as Officer of Assignee - "Sub-Heading" Only*

The person who signed the terminal disclaimer is not recognized as an officer of the assignee, and he/she has not been established as being authorized to act on behalf of the assignee. See MPEP § 324.

**Examiner Note:**

1. This form paragraph is to be used when the person signing the terminal disclaimer is not an authorized officer as defined in MPEP § 324.
2. This form paragraph MUST be preceded by form paragraphs 14.24 or 14.25 and followed by form paragraphs 14.29.01 and/or 14.29.02 when appropriate. An attorney or agent of record is always authorized to sign the terminal disclaimer, even though there is no indication that he or she is an officer of the assignee.
3. Use form paragraph 14.29.02 to explain how an official, other than a recognized officer, may properly sign a terminal disclaimer.

*¶ 14.29.01 Attorney/Agent Not of Record*

An attorney or agent, not of record, is not authorized to sign a terminal disclaimer in the capacity as an attorney or agent acting in a representative capacity as provided by 37 CFR 1.34 (a). See 37 CFR 1.321(b) and/or (c).

**Examiner Note:**

1. This form paragraph MUST be preceded by form paragraphs 14.24 or 14.25 AND 14.29.
2. An attorney or agent, however, may sign a terminal disclaimer provided he/she is an attorney or agent of record or is established as an appropriate official of the assignee. To suggest to the attorney or agent, not of record, how he/she may establish status as an appropriate official of the assignee to sign a terminal disclaimer, use form paragraph 14.29.02.

*¶ 14.29.02 Criteria To Accept Terminal Disclaimer When Signed by a Non-Recognized Officer*

It would be acceptable for a person, other than a recognized officer, to sign a terminal disclaimer, provided the record for the application includes a statement that the person is empowered to sign terminal disclaimers and/or act on behalf of the assignee.

Accordingly, a new terminal disclaimer which includes the above empowerment statement will be considered to be signed by an appropriate official of the assignee. A separately filed paper referencing the previously filed terminal disclaimer and containing a proper empowerment statement would also be acceptable.

**Examiner Note:**

1. This form paragraph MUST be preceded by form paragraphs 14.24 or 14.25 AND 14.29.
2. When form paragraph 14.29 is used to indicate that a terminal disclaimer is denied because it was not signed by a recognized officer nor by an attorney or agent of record, this form paragraph should be used to point out one way to correct the problem.
3. While an indication of the person's title is desirable, its inclusion is not mandatory when this option is employed.

4. A sample terminal disclaimer should be sent with the Office action.

<

¶ 14.30 *No Evidence of Chain of Title to Assignee - Application*

The assignee has not established its ownership interest in the application, in order to support the terminal disclaimer. There is no submission in the record establishing the ownership interest by either (a) providing documentary evidence of a chain of title from the original inventor(s) to the assignee, or (b) specifying (by reel and frame number) where such documentary evidence is recorded in the Office (37 CFR 3.73(b)).

**Examiner Note:**

1. This form paragraph MUST be preceded by form paragraph 14.24 or 14.25.
2. Where an attorney or agent of record signs a terminal disclaimer, there is no need to provide a statement under 37 CFR 3.73(b). Thus, this form paragraph should not be used.
3. It should be noted that the documentary evidence or the specifying of reel and frame number may be found in the terminal disclaimer itself or in a separate paper.

¶ 14.30.01 *No Evidence of Chain of Title to Assignee - Patent*

The assignee has not established its ownership interest in the patent, in order to support the terminal disclaimer. There is no submission in the record establishing the ownership interest by either (a) providing documentary evidence of a chain of title from the original inventor(s) to the assignee, or (b) specifying (by reel and frame number) where such documentary evidence is recorded in the Office (37 CFR 3.73(b)).

**Examiner Note:**

1. This form paragraph MUST be preceded by form paragraph 14.24 or 14.25.
2. Where an attorney or agent of record signs a terminal disclaimer, there is no need to provide a statement under 37 CFR 3.73(b). Thus, this form paragraph should not be used.
3. It should be noted that the documentary evidence or the specifying of reel and frame number may be found in the terminal disclaimer itself or in a separate paper in the application.

¶ 14.30.02 *Evidence of Chain of Title to Assignee - Submission Not Signed by Appropriate Party - Terminal Disclaimer Is Thus Not Entered*

The submission establishing the ownership interest of the assignee is informal. There is no indication of record that the party who signed the submission establishing the ownership interest is authorized to sign the submission (37 CFR 3.73(b)).

**Examiner Note:**

1. This form paragraph MUST be preceded by form paragraph 14.24 or 14.25.

2. Where an attorney or agent of record signs a terminal disclaimer, there is no need to provide any statement under 37 CFR 3.73(b). Thus, this form paragraph should not be used.

3. This form paragraph should be followed by one of form paragraphs 14.16.02 or 14.16.03. In rare situations where BOTH form paragraphs 14.16.02 and 14.16.03 do not apply and thus cannot be used, the examiner should instead follow this form paragraph with a detailed statement of why there is no authorization to sign.

4. Use form paragraph 14.16.06 to point out one way to correct the problem.

¶ 14.32 *Application/Patent Which Forms Basis for Rejection Not Identified*

The application/patent which forms the basis for the double patenting rejection is not identified in the terminal disclaimer.

**Examiner Note:**

1. This form paragraph MUST be preceded by form paragraph 14.24 or 14.25.
2. Use this form paragraph when no information is presented. If incorrect information is contained in the terminal disclaimer, use form paragraphs 14.26 and 14.26.05.

\*\*>

¶ 14.33 *37 CFR 3.73 - Establishing Right of Assignee To Take Action*

The following is a statement of 37 CFR 3.73:

37 CFR 3.73 Establishing right of assignee to take action.

(a) The inventor is presumed to be the owner of a patent application, and any patent that may issue therefrom, unless there is an assignment. The original applicant is presumed to be the owner of a trademark application or registration, unless there is an assignment.

(b)(1) In order to request or take action in a patent or trademark matter, the assignee must establish its ownership of the patent or trademark property of paragraph (a) of this section to the satisfaction of the Director. The establishment of ownership by the assignee may be combined with the paper that requests or takes the action. Ownership is established by submitting to the Office a signed statement identifying the assignee, accompanied by either:

(i) Documentary evidence of a chain of title from the original owner to the assignee (*e.g.*, copy of an executed assignment). The documents submitted to establish ownership may be required to be recorded pursuant to § 3.11 in the assignment records of the Office as a condition to permitting the assignee to take action in a matter pending before the Office; or

(ii) A statement specifying where documentary evidence of a chain of title from the original owner to the assignee is recorded in the assignment records of the Office (*e.g.*, reel and frame number).

(2) The submission establishing ownership must show that the person signing the submission is a person authorized to act on behalf of the assignee by:

(i) Including a statement that the person signing the submission is authorized to act on behalf of the assignee; or

(ii) Being signed by a person having apparent authority to sign on behalf of the assignee, *e.g.*, an officer of the assignee.

(c) For patent matters only:

(1) Establishment of ownership by the assignee must be submitted prior to, or at the same time as, the paper requesting or taking action is submitted.

(2) If the submission under this section is by an assignee of less than the entire right, title and interest, such assignee must indicate the extent (by percentage) of its ownership interest, or the Office may refuse to accept the submission as an establishment of ownership.

<

#### ¶ 14.34 Suggestion To Record Assignment Submitted With Terminal Disclaimer

The assignment document filed on [1] is acceptable as the documentary evidence required by 37 CFR 3.73. If the assignment document is not already recorded with the United States Patent and Trademark Office, it is suggested that the assignment document be submitted for recording among the Office assignment records. See 37 CFR 3.11 and MPEP § 302.

#### Examiner Note:

1. In bracket 1, insert the date the assignment document was filed.
2. This form paragraph should be used when an assignment document (an original, facsimile, or copy) is submitted to satisfy 37 CFR 3.73(b) but does not appear to have been recorded among the assignment records of the Office.

#### ¶ 14.35 Disclaimer Fee Not Required Twice - Applicant

It should be noted that applicant is not required to pay another disclaimer fee as set forth in 37 CFR 1.20(d) when submitting a replacement or supplemental terminal disclaimer.

#### Examiner Note:

1. This form paragraph can be used to notify an applicant that another disclaimer fee will not be required when a replacement or supplemental terminal disclaimer is submitted.
2. Use form paragraph 14.35.01 for providing notification to patent owner, rather than an applicant.

#### ¶ 14.35.01 Disclaimer Fee Not Required Twice - Patent Owner

It should be noted that patent owner is not required to pay another disclaimer fee as set forth in 37 CFR 1.20(d) when submitting a replacement or supplemental terminal disclaimer.

#### Examiner Note:

This form paragraph can be used to notify a patent owner that another disclaimer fee will not be required when a replacement or supplemental terminal disclaimer is submitted.

\*\*>

#### ¶ 14.36 Suggestion That "Applicant" Request a Refund

Since the required fee for the terminal disclaimer was previously paid, applicant's payment of an additional terminal disclaimer fee is not required. Applicant may request a refund of this additional terminal disclaimer fee by submitting a written request for a refund and a copy of this Office action to: Mail Stop 16, Director of the United States Patent and Trademark Office, P.O. Box 1450, Alexandria, Virginia 22313-1450.

#### Examiner Note:

1. This form paragraph should be used to notify applicant that a refund can be obtained if another terminal disclaimer fee was paid when a replacement or supplemental terminal disclaimer was submitted.
2. **Note** - If applicant has authorized or requested a fee refund to be credited to a specific Deposit Account or credit card, then an appropriate credit should be made to that Deposit Account or credit card and this paragraph should NOT be used.
3. Use form paragraph 14.36.01 for providing notification to patent owner, rather than an applicant.

#### ¶ 14.36.01 Suggestion That "Patent Owner" Request a Refund

Since the required fee for the terminal disclaimer was previously paid, patent owner's payment of an additional terminal disclaimer fee is not required. Patent owner may request a refund of this additional terminal disclaimer fee by submitting a written request for a refund and a copy of this Office action to: Mail Stop 16, Director of the United States Patent and Trademark Office, P.O. Box 1450, Alexandria, Virginia 22313-1450.

#### Examiner Note:

1. This form paragraph should be used to notify patent owner that a refund can be obtained if another terminal disclaimer fee was paid when a replacement or supplemental terminal disclaimer was submitted.
2. **Note** - If patent owner has authorized or requested a fee refund to be credited to a specific Deposit Account or credit card, then an appropriate credit should be made to that Deposit Account or credit card and this form paragraph should NOT be used.

<

#### ¶ 14.37 Samples of a Terminal Disclaimer Over a Pending Application and Assignee Statement Enclosed

Enclosed with this Office action is a sample terminal disclaimer which is effective to overcome a provisional obviousness-type double patenting rejection over a pending application (37 CFR 1.321(b) and (c)).

Also enclosed is a sample Statement Under 37 CFR 3.73(b) (Form PTO/SB/96) which an assignee may use in order to ensure compliance with the rule. Part A of the Statement is used when there is a single assignment from the inventor(s). Part B of the Statement is used when there is a chain of title. The “Copies of assignments...” box should be checked when the assignment document(s) (set forth in part A or part B) is/are not recorded in the Office, and a copy of the assignment document(s) is/are attached. When the “Copies of assignments...” box is checked, either the part A box or the part B box, as appropriate, must be checked, and the “Reel\_\_\_\_, Frame\_\_\_\_” entries should be left blank. If the part B box is checked, and copies of assignments are not included, the “From:\_\_\_\_ To:\_\_\_\_” blank(s) must be filled in. This statement should be used the first time an assignee seeks to take action in an application under 37 CFR 3.73(b), e.g., when signing a terminal disclaimer or a power of attorney.

#### **Examiner Note:**

1. This form paragraph can be used to provide applicant samples of a terminal disclaimer which contains the necessary clauses to overcome a provisional obviousness-type double patenting rejection over a pending application and a Statement to be signed by an assignee to ensure compliance with 37 CFR 3.73(b).

2. Note that the requirements for compliance with 37 CFR 3.73(b) have been made more liberal, such that certain specifics of the sample statement are no longer required. At present, in order to comply with 37 CFR 3.73(b), the assignee’s ownership interest must be established by (a) filing in the application or patent evidence of a chain of title from the original owner to the assignee, or (b) specifying in the record of the application or patent where such evidence is recorded in the Office (e.g., reel and frame number, etc.). The submission with respect to (a) and (b) to establish ownership must be signed by a party authorized to act on behalf of the assignee.

(See your Group Paralegal or Special Program Examiner for copies of the sample terminal disclaimer and Statement Under 37 CFR 3.73(b) to enclose with the Office action. Alternatively, it is permissible to copy the sample terminal disclaimer found after MPEP § 1490 and the Sample Statement Under 37 CFR 3.73(b) found after MPEP § 324.)

#### *¶ 14.38 Samples of a Terminal Disclaimer Over a Prior Patent and Assignee Statement Enclosed*

Enclosed with this Office action is a sample terminal disclaimer which is effective to overcome an obviousness-type double patenting rejection over a prior patent (37 CFR 1.321(b) and (c)).

Also enclosed is a sample Statement Under 37 CFR 3.73(b) (Form PTO/SB/96) which an assignee may use in order to ensure compliance with the rule. Part A of the Statement is used when there is a single assignment from the inventor(s). Part B of the Statement is used when there is a chain of title. The “Copies of assignments...” box should be checked when the assignment document(s) (set forth in part A or part B) is/are not recorded in the Office, and a copy of the assignment document(s) is/are attached. When the “Copies of assignments...” box is checked, either the part A box or the part B box, as appropriate, must be checked, and the “Reel\_\_\_\_, Frame\_\_\_\_” entries should be left blank. If the

part B box is checked, and copies of assignments are not included, the “From:\_\_\_\_ To:\_\_\_\_” blank(s) must be filled in. This statement should be used the first time an assignee seeks to take action in an application under 37 CFR 3.73(b), e.g., when signing a terminal disclaimer or a power of attorney.

#### **Examiner Note:**

1. This form paragraph can be used to provide applicant samples of a terminal disclaimer which contains the necessary clauses to overcome an obviousness-type double patenting rejection over a prior patent and a Statement to be signed by an assignee to ensure compliance with 37 CFR 3.73(b).

2. Note that the requirements for compliance with 37 CFR 3.73(b) have been made more liberal, such that certain specifics of the sample statement are no longer required. At present, in order to comply with 37 CFR 3.73(b), the assignee’s ownership interest must be established by (a) filing in the application or patent evidence of a chain of title from the original owner to the assignee, or (b) specifying in the record of the application or patent where such evidence is recorded in the Office (e.g., reel and frame number, etc.). The submission with respect to (a) and (b) to establish ownership must be signed by a party authorized to act on behalf of the assignee.

(See your Group Paralegal or Special Program Examiner for copies of the sample terminal disclaimer and Statement Under 37 CFR 3.73(b) to enclose with the Office action. Alternatively, it is permissible to copy the sample terminal disclaimer found after MPEP § 1490 and the Sample Statement Under 37 CFR 3.73(b) found after MPEP § 324.)

#### *¶ 14.39 Sample Assignee Statement Under 37 CFR 3.73(b) Enclosed*

Enclosed with this Office action is a sample Statement under 37 CFR 3.73(b) which an assignee may use in order to ensure compliance with the Rule. Part A of the Statement is used when there is a single assignment from the inventor(s). Part B of the Statement is used when there is a chain of title. The “Copies of assignments...” box should be checked when the assignment document(s) (set forth in part A or part B) is/are not recorded in the Office, and a copy of the assignment document(s) is/are attached. When the “Copies of assignments...” box is checked, either the part A box or the part B box, as appropriate, must be checked, and the “Reel\_\_\_\_, Frame\_\_\_\_” entries should be left blank. If the part B box is checked, and copies of assignments are not included, the “From:\_\_\_\_ To:\_\_\_\_” blank(s) must be filled in. This statement should be used the first time an assignee seeks to take action in an application under 37 CFR 3.73(b).

#### **Examiner Note:**

1. This form paragraph can be used to provide applicant a sample of a Statement to be signed by an assignee to ensure compliance with 37 CFR 3.73(b).

2. Note that the requirements for compliance with 37 CFR 3.73(b) have been made more liberal, such that certain specifics of the sample statement are no longer required. At present, in order to comply with 37 CFR 3.73(b), the assignee’s ownership interest must be established by (a) filing in the application or patent evidence of a chain of title from the original owner to the assignee, or

(b) specifying in the record of the application or patent where such evidence is recorded in the Office (e.g., reel and frame number, etc.). The submission with respect to (a) and (b) to establish ownership must be signed by a party authorized to act on behalf of the assignee.

(See your Group Paralegal or Special Program Examiner for a copy of the sample Statement Under 37 CFR 3.73(b) to enclose with the Office action. Alternatively, it is permissible to copy the sample Statement Under 37 CFR 3.73(b) found after MPEP § 324.)

## **WITHDRAWING A RECORDED TERMINAL DISCLAIMER**

If timely requested, a recorded terminal disclaimer may be withdrawn before the application in which it is filed issues as a patent, or in a reexamination proceeding, before the reexamination certificate issues. After a patent or reexamination certificate issues, it is unlikely that a recorded terminal disclaimer will be nullified.

### **A. Before Issuance Of Patent**

While the filing and recordation of an unnecessary terminal disclaimer has been characterized as an “unhappy circumstance” in *In re Jentoft*, 392 F.2d 633, 157 USPQ 363 (CCPA 1968), there is no statutory prohibition against nullifying or otherwise canceling the effect of a recorded terminal disclaimer which was erroneously filed before the patent issues. Since the terminal disclaimer would not take effect until the patent is granted, and the public has not had the opportunity to rely on the terminal disclaimer, relief from this unhappy circumstance may be available by way of petition or by refiling the application (other than by refiling it as a CPA).

Under appropriate circumstances, consistent with the orderly administration of the examination process, the nullification of a recorded terminal disclaimer may be addressed by filing a petition under 37 CFR 1.182 requesting withdrawal of the recorded terminal disclaimer. Petitions seeking to reopen the question of the propriety of the double patenting rejection that prompted the filing of the terminal disclaimer have not been favorably considered. The filing of a continuing application other than a CPA, while abandoning the application in which the terminal disclaimer has been filed, will typically nullify the effect of a terminal disclaimer. The filing of a Request for Continued Examination (RCE) of an application under 37

CFR 1.114 will not nullify the effect of a terminal disclaimer, since a new application has not been filed, but rather prosecution has been continued in the existing application.

### **B. After Issuance Of Patent**

The mechanisms to correct a patent — Certificate of Correction (35 U.S.C. 255), reissue (35 U.S.C. 251), and reexamination (35 U.S.C. 305) — are not available to withdraw or otherwise nullify the effect of a recorded terminal disclaimer. As a general principle, public policy does not favor the restoration to the patent owner of something that has been freely dedicated to the public, particularly where the public interest is not protected in some manner — e.g., intervening rights in the case of a reissue patent. See, e.g., *Altoona Publix Theatres v. American Tri-Ergon Corp.*, 294 U.S. 477, 24 USPQ 308 (1935).

Certificates of Correction (35 U.S.C. 255) are available for the correction of an applicant’s mistake. The scope of this remedial provision is limited in two ways — by the nature of the mistake for which correction is sought and the nature of the proposed correction. *In re Arnott*, 19 USPQ2d 1049 (Comm’r Pat. 1991). The nature of the mistake for which correction is sought is limited to those mistakes that are:

- (A) of a clerical nature,
- (B) of a typographical nature, or
- (C) of a minor character.

The nature of the proposed correction is limited to those situations where the correction does not involve changes which would:

- (A) constitute new matter, or
- (B) require reexamination.

A mistake in filing a terminal disclaimer does not fall within any of the categories of mistake for which a certificate of correction of applicant’s mistake is permissible, and any attempt to remove or nullify the effect of the terminal disclaimer would typically require reexamination of the circumstances under which it was filed.

Although the remedial nature of reissue (35 U.S.C. 251) is well recognized, reissue is not available to correct all errors. It has been the Office position that reissue is not available to withdraw or otherwise nullify the effect of a terminal disclaimer recorded in an

issued patent. First, the reissue statute only authorizes the \* >Director of the USPTO< to reissue a patent “for the unexpired part of the term of the original patent.” Since the granting of a reissue patent without the effect of a recorded terminal disclaimer would result in extending the term of the original patent, reissue under these circumstances would be contrary to the statute. Second, the principle against recapturing something that has been intentionally dedicated to the public dates back to *Leggett v. Avery*, 101 U.S. 256 (1879). The attempt to restore that portion of the patent term that was dedicated to the public to secure the grant of the original patent would be contrary to this recapture principle. Finally, applicants have the opportunity to challenge the need for a terminal disclaimer during the prosecution of the application that issues as a patent. “Reissue is not a substitute for Patent Office appeal procedures.” *Ball Corp. v. United States*, 729 F.2d 1429, 1435, 221 USPQ 289, 293

(Fed. Cir. 1984). Where applicants did not challenge the propriety of the examiner’s obvious-type double patenting rejection, but filed a terminal disclaimer to avoid the rejection, the filing of the terminal disclaimer did not constitute error within the meaning of 35 U.S.C. 251. *Ex parte Anthony*, 230 USPQ 467 (Bd. App. 1982), *aff’d*, No. 84-1357 (Fed. Cir. June 14, 1985).

Finally, the nullification of a recorded terminal disclaimer would not be appropriate in a reexamination proceeding. There is a prohibition (35 U.S.C. 305) against enlarging the scope of a claim during a reexamination proceeding. As noted by the Board in *Anthony, supra*, if a terminal disclaimer was nullified, “claims would be able to be sued upon for a longer period than would the claims of the original patent. Therefore, the vertical scope, as opposed to the horizontal scope (where the subject matter is enlarged), would be enlarged.”

\*\*>

PTO/SB/43 (08-03)

Approved for use through 07/31/2006. OMB 0651-0031

U.S. Patent and Trademark Office; U.S. DEPARTMENT OF COMMERCE

Under the Paperwork Reduction Act of 1995, no persons are required to respond to a collection of information unless it displays a valid OMB control number.

<b>DISCLAIMER IN PATENT UNDER 37 CFR 1.321(a)</b>	
Name of Patentee	Docket Number (Optional)
Patent Number	Date Patent Issued
Title of invention	
I hereby disclaim the following complete claims in the above identified patent: _____	
The extent of my interest in said patent is (if assignee of record, state liber and page, or reel and frame, where assignment is recorded): _____	
The fee for this disclaimer is set forth in 37 CFR 1.20(d).	
<input type="checkbox"/> Patentee claims small entity status. See 37 CFR 1.27. <input type="checkbox"/> Small entity status has already been established in this case, and is still proper. <input type="checkbox"/> A check in the amount of the fee is enclosed. <input type="checkbox"/> Payment by credit card. Form PTO-2038 is attached. <input type="checkbox"/> The Director is hereby authorized to charge any fees which may be required or credit any overpayment to Deposit Account No. _____. I have enclosed a duplicate copy of this sheet.	
<b>WARNING: Information on this form may become public. Credit card information should not be included on this form. Provide credit card information and authorization on PTO-2038.</b>	
Signed at _____, State of _____, this _____ day of _____ 20____.	
Signature _____	
Typed or printed name of patentee/ attorney or agent of record _____	Telephone Number _____
Address _____	
City, State, Zip Code or Foreign Country as applicable _____	

This collection of information is required by 37 CFR 1.321. The information is required to obtain or retain a benefit by the public which is to file (and by the USPTO to process) an application. Confidentiality is governed by 35 U.S.C. 122 and 37 CFR 1.14. This collection is estimated to take 12 minutes to complete, including gathering, preparing, and submitting the completed application form to the USPTO. Time will vary depending upon the individual case. Any comments on the amount of time you require to complete this form and/or suggestions for reducing this burden, should be sent to the Chief Information Officer, U.S. Patent and Trademark Office, U.S. Department of Commerce, P.O. Box 1450, Alexandria, VA 22313-1450. DO NOT SEND FEES OR COMPLETED FORMS TO THIS ADDRESS. SEND TO: **Commissioner for Patents, P.O. Box 1450, Alexandria, VA 22313-1450.**

*If you need assistance in completing the form, call 1-800-PTO-9199 and select option 2.*

PTO/SB/25 (10-03)

Approved for use through 07/31/2006. OMB 0651-0031

U.S. Patent and Trademark Office; U.S. DEPARTMENT OF COMMERCE

Under the Paperwork Reduction Act of 1995, no persons are required to respond to a collection of information unless it displays a valid OMB control number.

<b>TERMINAL DISCLAIMER TO OBTAIN A PROVISIONAL DOUBLE PATENTING REJECTION OVER A PENDING SECOND APPLICATION</b>	Docket Number (Optional)
---	--------------------------

In re Application of:  
 Application No.:  
 Filed:  
 For:

The owner\*, \_\_\_\_\_, of \_\_\_\_\_ percent interest in the instant application hereby disclaims, except as provided below, the terminal part of the statutory term of any patent granted on the instant application, which would extend beyond the expiration date of the full statutory term defined in 35 U.S.C. 154 and 173 as shortened by any terminal disclaimer filed prior to the grant of any patent granted on pending second Application Number \_\_\_\_\_, filed on \_\_\_\_\_, of any patent on the pending second application. The owner hereby agrees that any patent so granted on the instant application shall be enforceable only for and during such period that it and any patent granted on the second application are commonly owned. This agreement runs with any patent granted on the instant application and is binding upon the grantee, its successors or assigns.

In making the above disclaimer, the owner does not disclaim the terminal part of any patent granted on the instant application that would extend to the expiration date of the full statutory term as defined in 35 U.S.C. 154 and 173 of any patent granted on the second application, as shortened by any terminal disclaimer filed prior to the patent grant, in the event that any such granted patent: expires for failure to pay a maintenance fee, is held unenforceable, is found invalid by a court of competent jurisdiction, is statutorily disclaimed in whole or terminally disclaimed under 37 CFR 1.321, has all claims canceled by a reexamination certificate, is reissued, or is in any manner terminated prior to the expiration of its full statutory term as shortened by any terminal disclaimer filed prior to its grant.

Check either box 1 or 2 below, if appropriate.

- 1.  For submissions on behalf of an organization (e.g., corporation, partnership, university, government agency, etc.), the undersigned is empowered to act on behalf of the organization.

I hereby declare that all statements made herein of my own knowledge are true and that all statements made on information and belief are believed to be true; and further that these statements were made with the knowledge that willful false statements and the like so made are punishable by fine or imprisonment, or both, under Section 1001 of Title 18 of the United States Code and that such willful false statements may jeopardize the validity of the application or any patent issued thereon.

- 2.  The undersigned is an attorney or agent of record.

Signature	Date
Typed or printed name	
Telephone Number	

- Terminal disclaimer fee under 37 CFR 1.20(d) is included.

**WARNING: Information on this form may become public. Credit card information should not be included on this form. Provide credit card information and authorization on PTO-2038.**

\*Statement under 37 CFR 3.73(b) is required if terminal disclaimer is signed by the assignee (owner).  
 Form PTO/SB/96 may be used for making this statement. See MPEP § 324.

This collection of information is required by 37 CFR 1.321. The information is required to obtain or retain a benefit by the public which is to file (and by the USPTO to process) an application. Confidentiality is governed by 35 U.S.C. 122 and 37 CFR 1.14. This collection is estimated to take 12 minutes to complete, including gathering, preparing, and submitting the completed application form to the USPTO. Time will vary depending upon the individual case. Any comments on the amount of time you require to complete this form and/or suggestions for reducing this burden, should be sent to the Chief Information Officer, U.S. Patent and Trademark Office, U.S. Department of Commerce, P.O. Box 1450, Alexandria, VA 22313-1450. DO NOT SEND FEES OR COMPLETED FORMS TO THIS ADDRESS. SEND TO: Commissioner for Patents, P.O. Box 1450, Alexandria, VA 22313-1450.



PTO/SB/26 (10-03)

Approved for use through 07/31/2006. OMB 0651-0031

U.S. Patent and Trademark Office; U.S. DEPARTMENT OF COMMERCE

Under the Paperwork Reduction Act of 1995, no persons are required to respond to a collection of information unless it displays a valid OMB control number.

<b>TERMINAL DISCLAIMER TO OBTAIN A DOUBLE PATENTING REJECTION OVER A PRIOR PATENT</b>	Docket Number (Optional)
<p>In re Application of:          Application No.:          Filed:          For:</p> <p>The owner*, _____, of _____percent interest in the instant application hereby disclaims, except as provided below, the terminal part of the statutory term of any patent granted on the instant application, which would extend beyond the expiration date of the full statutory term defined in 35 U.S.C. 154 and 173, as presently shortened by any terminal disclaimer, of prior Patent No. _____. The owner hereby agrees that any patent so granted on the instant application shall be enforceable only for and during such period that it and the prior patent are commonly owned. This agreement runs with any patent granted on the instant application and is binding upon the grantee, its successors or assigns.</p> <p>In making the above disclaimer, the owner does not disclaim the terminal part of any patent granted on the instant application that would extend to the expiration date of the full statutory term as defined in 35 U.S.C. 154 and 173 of the prior patent, as presently shortened by any terminal disclaimer, in the event that it later: expires for failure to pay a maintenance fee, is held unenforceable, is found invalid by a court of competent jurisdiction, is statutorily disclaimed in whole or terminally disclaimed under 37 CFR 1.321, has all claims canceled by a reexamination certificate, is reissued, or is in any manner terminated prior to the expiration of its full statutory term as presently shortened by any terminal disclaimer.</p> <p>Check either box 1 or 2 below, if appropriate.</p> <p>1. <input type="checkbox"/> For submissions on behalf of an organization (e.g., corporation, partnership, university, government agency, etc.), the undersigned is empowered to act on behalf of the organization.</p> <p>I hereby declare that all statements made herein of my own knowledge are true and that all statements made on information and belief are believed to be true; and further that these statements were made with the knowledge that willful false statements and the like so made are punishable by fine or imprisonment, or both, under Section 1001 of Title 18 of the United States Code and that such willful false statements may jeopardize the validity of the application or any patent issued thereon.</p> <p>2. <input type="checkbox"/> The undersigned is an attorney or agent of record.</p> <div style="text-align: right; margin-right: 100px;"> <p>_____ Signature</p> <p>_____ Date</p> <p>_____ Typed or printed name</p> <p>_____ Telephone Number</p> </div> <p><input type="checkbox"/> Terminal disclaimer fee under 37 CFR 1.20(d) included.</p> <p style="text-align: center;"><b>WARNING: Information on this form may become public. Credit card information should not be included on this form. Provide credit card information and authorization on PTO-2038.</b></p> <p style="font-size: small;">*Statement under 37 CFR 3.73(b) is required if terminal disclaimer is signed by the assignee (owner).          Form PTO/SB/96 may be used for making this certification. See MPEP § 324.</p>	

This collection of information is required by 37 CFR 1.321. The information is required to obtain or retain a benefit by the public which is to file (and by the USPTO to process) an application. Confidentiality is governed by 35 U.S.C. 122 and 37 CFR 1.14. This collection is estimated to take 12 minutes to complete, including gathering, preparing, and submitting the completed application form to the USPTO. Time will vary depending upon the individual case. Any comments on the amount of time you require to complete this form and/or suggestions for reducing this burden, should be sent to the Chief Information Officer, U.S. Patent and Trademark Office, U.S. Department of Commerce, P.O. Box 1450, Alexandria, VA 22313-1450. DO NOT SEND FEES OR COMPLETED FORMS TO THIS ADDRESS. **SEND TO: Commissioner for Patents, P.O. Box 1450, Alexandria, VA 22313-1450.**

If you need assistance in completing the form, call 1-800-PTO-9199 and select option 2.



# Chapter 1500 Design Patents

- 1501 Statutes and Rules Applicable**
- 1502 Definition of a Design**
  - 1502.01 Distinction Between Design and Utility Patents
- 1503 Elements of a Design Patent Application**
  - 1503.01 Specification
  - 1503.02 Drawing
- \*\*
- 1504 Examination**
  - 1504.01 Statutory Subject Matter for Designs
    - 1504.01(a) Computer-Generated Icons
    - 1504.01(b) Design Comprising Multiple Articles or Multiple Parts Embodied in a Single Article
    - 1504.01(c) Lack of Ornamentality
    - 1504.01(d) Simulation
    - 1504.01(e) Offensive Subject Matter
  - 1504.02 Novelty
  - 1504.03 Nonobviousness
  - 1504.04 Considerations Under 35 U.S.C. 112
  - 1504.05 Restriction
  - 1504.06 Double Patenting
  - 1504.10 Priority Under 35 U.S.C. 119 (a)-(d)
  - 1504.20 Benefit Under 35 U.S.C. 120
  - 1504.30 Expedited Examination
- 1505 Allowance and Term of Design Patent**
- 1509 Reissue of a Design Patent**
- 1510 Reexamination**
- 1511 Protest**
- 1512 Relationship Between Design Patent, Copyright, and Trademark**
- 1513 Miscellaneous**

## 1501 Statutes and Rules Applicable

The right to a patent for a design stems from:

*35 U.S.C. 171. Patents for designs.*

Whoever invents any new, original and ornamental design for an article of manufacture may obtain a patent therefor, subject to the conditions and requirements of this title.

The provisions of this title relating to patents for inventions shall apply to patents for designs, except as otherwise provided.

*37 CFR 1.151. Rules applicable.*

The rules relating to applications for patents for other inventions or discoveries are also applicable to applications for patents for designs except as otherwise provided.

37 CFR 1.152-1.155, which relate only to design patents, are reproduced in the sections of this chapter.

It is noted that design patent applications are not included in the Patent Cooperation Treaty (PCT), and the procedures followed for PCT international applications are not to be followed for design patent applications.

The practices set forth in other chapters of this *Manual of Patent Examining Procedure* (MPEP) are to be followed in examining applications for design patents, except as particularly pointed out in the chapter.

## 1502 Definition of a Design [R-2]

In a design patent application, the subject matter which is claimed is the design embodied in or applied to an article of manufacture (or portion thereof) and not the article itself. *Ex parte Cady*, 1916 C.D. 62, 232 O.G. 621 (Comm'r Pat. 1916). “[35 U.S.C.] 171 refers, not to the design of an article, but to the design for an article, and is inclusive of ornamental designs of all kinds including surface ornamentation as well as configuration of goods.” *In re Zahn*, 617 F.2d 261, 204 USPQ 988 (CCPA 1980).

The design for an article consists of the visual characteristics embodied in or applied to an article.

Since a design is manifested in appearance, the subject matter of a design patent application may relate to the configuration or shape of an article, to the surface ornamentation applied to an article, or to the combination of configuration and surface ornamentation.

Design is inseparable from the article to which it is applied and cannot exist alone merely as a scheme of surface ornamentation. It must be a definite, preconceived thing, capable of reproduction and not merely the chance result of a method.

### ¶ 15.42 Visual Characteristics

The design for an article consists of the visual characteristics or aspect displayed by the article. It is the appearance presented by the article which creates an impression through the eye upon the mind of the observer.

### ¶ 15.43 Subject Matter of Design Patent

Since a design is manifested in appearance, the subject matter of a Design Patent may relate to the configuration or shape of an article, to the surface ornamentation on an article, or to both.

>

### ¶ 15.44 Design Inseparable From Article to Which Applied

Design is inseparable from the article to which it is applied, and cannot exist alone merely as a scheme of ornamentation. It

must be a definite preconceived thing, capable of reproduction, and not merely the chance result of a method or of a combination of functional elements (35 U.S.C. 171; 35 U.S.C. 112, first and second paragraphs). See *Blisscraft of Hollywood v. United Plastics Co.*, 189 F. Supp. 333, 127 USPQ 452 (S.D.N.Y. 1960), 294 F.2d 694, 131 USPQ 55 (2d Cir. 1961).

<

### 1502.01 Distinction Between Design and Utility Patents [R-2]

In general terms, a “utility patent” protects the way an article is used and works (35 U.S.C. 101), while a “design patent” protects the way an article looks (35 U.S.C. 171). The ornamental appearance for an article includes its shape/configuration or surface ornamentation \*>applied to< the article, or both. Both design and utility patents may be obtained on an article if invention resides both in its utility and ornamental appearance.

While utility and design patents afford legally separate protection, the utility and ornamentality of an article may not be easily separable. \*\* >Articles of manufacture may possess both functional and ornamental characteristics.<

Some of the more common differences between design and utility patents are summarized below:

(A) The term of a utility patent on an application filed on or after June 8, 1995 is 20 years measured from the U.S. filing date; or if the application contains a specific reference to an earlier application under 35 U.S.C. 120, 121, or 365(c), 20 years from the earliest effective U.S. filing date, while the term of a design patent is 14 years measured from the date of grant (see 35 U.S.C. 173).

(B) Maintenance fees are required for utility patents (see 37 CFR 1.20), while no maintenance fees are required for design patents.

(C) Design patent applications include only a single claim, while utility patent applications can have multiple claims.

(D) Restriction between plural, distinct inventions is discretionary on the part of the examiner in utility patent applications (see MPEP § 803), while it is mandatory in design patent applications (see MPEP § 1504.05).

(E) An international application naming various countries may be filed for utility patents under the

Patent Cooperation Treaty (PCT), while no such provision exists for design patents.

(F) Foreign priority under 35 U.S.C. 119(a)-(d) can be obtained for the filing of utility patent applications up to 1 year after the first filing in any country subscribing to the Paris Convention, while this period is only 6 months for design patent applications (see 35 U.S.C. 172).

(G) Utility patent applications may claim the benefit of a provisional application under 35 U.S.C. 119(e) whereas design patent applications may not. See 35 U.S.C. 172 and 37 CFR 1.78 (a)(4).

(H) A Request for Continued Examination (RCE) under 37 CFR 1.114 may only be filed in utility and plant applications filed under 35 U.S.C. 111(a) on or after June 8, 1995, while RCE is not available for design applications (see 37 CFR 1.114(e)).

(I) \* >Effective July 14, 2003, continued< prosecution application (CPA) practice under 37 CFR 1.53(d) is >only< available for design applications \*\*>(see 37 CFR 1.53(d)(1)(i)). Prior to July 14, 2003, CPA practice was< available for utility and plant applications only where the prior application has a filing date prior to May 29, 2000 \*\*.

(J) Utility patent applications filed on or after November 29, 2000 are subject to application publication under 35 U.S.C. 122(b)(1)(A), whereas design applications are not subject to application publication (see 35 U.S.C. 122(b)(2)).

Other distinctions between design and utility patent practice are detailed in this chapter. Unless otherwise provided, the rules for applications for utility patents are equally applicable to applications for design patents (35 U.S.C. 171 and 37 CFR 1.151).

### 1503 Elements of a Design Patent Application [R-2]

A design patent application has essentially the elements required of an application for a utility patent filed under 35 U.S.C. 101 (see Chapter 600). The arrangement of the elements of a design patent application and the sections of the specification are as specified in 37 CFR 1.154.

A claim in a specific form is a necessary element of a design patent application. See MPEP § \*>1503.01, subsection III<.

A drawing is an essential element of a design patent application. See MPEP § 1503.02 for requirements for drawings.

### 1503.01 Specification [R-2]

*37 CFR 1.153. Title, description and claim, oath or declaration.*

(a) The title of the design must designate the particular article. No description, other than a reference to the drawing, is ordinarily required. The claim shall be in formal terms to the ornamental design for the article (specifying name) as shown, or as shown and described. More than one claim is neither required nor permitted.

(b) The oath or declaration required of the applicant must comply with § 1.63.

*37 CFR 1.154. Arrangement of application elements in a design application.*

(a) The elements of the design application, if applicable, should appear in the following order:

- (1) Design application transmittal form.
- (2) Fee transmittal form.
- (3) Application data sheet (see § 1.76).
- (4) Specification.
- (5) Drawings or photographs.
- (6) Executed oath or declaration (see § 1.153(b)).

(b) The specification should include the following sections in order:

- (1) Preamble, stating the name of the applicant, title of the design, and a brief description of the nature and intended use of the article in which the design is embodied.
- (2) Cross-reference to related applications (unless included in the application data sheet).
- (3) Statement regarding federally sponsored research or development.
- (4) Description of the figure or figures of the drawing.
- (5) Feature description.
- (6) A single claim.

(c) The text of the specification sections defined in paragraph (b) of this section, if applicable, should be preceded by a section heading in uppercase letters without underlining or bold type.

#### ¶ 15.05 Design Patent Specification Arrangement

The following order or arrangement should be observed in framing a design patent specification:

- (1) Preamble, stating name of the applicant, title of the design, and a brief description of the nature and intended use of the article in which the design is embodied.
- (2) Cross-reference to related applications unless included in the application data sheet.
- (3) Statement regarding federally sponsored research or development.
- (4) Description of the figure or figures of the drawing.
- (5) Feature Description, if any.
- (6) A single claim.

### I. PREAMBLE AND TITLE

A preamble, if included, should state the name of the applicant, the title of the design, and a brief description of the nature and intended use of the article in which the design is embodied (37 CFR 1.154).

The title of the design identifies the article in which the design is embodied by the name generally known and used by the public but it does not define the scope of the claim. See MPEP § 1504.04, subsection I.A. The title may be directed to the entire article embodying the design while the claimed design shown in full lines in the drawings may be directed to only a portion of the article. However, the title may not be directed to less than the claimed design shown in full lines in the drawings. A title descriptive of the actual article aids the examiner in developing a complete field of search of the prior art and further aids in the proper assignment of new applications to the appropriate class, subclass, and patent examiner, and the proper classification of the patent upon allowance of the application. It also helps the public in understanding the nature and use of the article embodying the design after the patent has been issued. For example, a broad title such as “Adapter Ring” provides little or no information as to the nature and intended use of the article embodying the design. If a broad title is used, the description of the nature and intended use of the design may be incorporated into the preamble. Absent an amendment requesting deletion of the description, it would be printed on any patent that would issue.

When a design is embodied in an article having multiple functions or comprises multiple independent parts or articles that interact with each other, the title must clearly define them as a single entity, for example, combined or combination, set, pair, unit assembly.

Since 37 CFR 1.153 requires that the title must designate the particular article, and since the claim must be in formal terms to the “ornamental design for the article (specifying name) as shown, or as shown and described,” the title and claim must correspond. When the title and claim do not correspond, the title should be objected to under 37 CFR 1.153 as not corresponding to the claim.

However, it is emphasized that, under the second paragraph of 35 U.S.C. 112, the claim defines “the subject matter which the applicant regards as his invention” (emphasis added); that is, the ornamental

design to be embodied in or applied to an article. Thus, the examiner should afford the applicant substantial latitude in the language of the title/claim. The examiner should only require amendment of the title/claim if the language is clearly misdescriptive, inaccurate, or unclear (i.e., the language would result in a rejection of the claim under 35 U.S.C. 112, second paragraph; see MPEP § 1504.04, subsection \*>III<). The use of language such as “or the like” or “or similar article” in the title when directed to the environment of the article embodying the design will not be the basis for a rejection of the claim under 35 U.S.C. 112\*>< second paragraph. Such language is improper only when used to broaden the article, *per se*, which embodies the design. An acceptable title would be “door for cabinets, houses, or the like,” while the title “door or the like” would be unacceptable and the claim will be rejected under 35 U.S.C. 112, second paragraph. *Ex parte Pappas*, 23 USPQ2d 1636 (Bd. Pat. App. & Inter. 1992). See also MPEP § 1504.04; subsection \*>III<.

Amendments to the title, whether directed to the article in which the design is embodied or its environment, must have antecedent basis in the original disclosure and may not introduce new matter. *Ex parte Strijland*, 26 USPQ2d 1259 (Bd. Pat. App. & Inter. 1992). If an amendment to the title is directed to the environment in which the design is used and the amendment would introduce new matter, the amendment to the title must be objected to under 35 U.S.C. 132. If an amendment to the title is directed to the article in which the design is embodied and the amendment would introduce new matter, in addition to the objection under 35 U.S.C. 132, the claim must be rejected under 35 U.S.C. 112, first paragraph.

Any amendment to the language of the title should also be made at each occurrence thereof throughout the application, except in the oath or declaration. If the title of the article is not present in the original figure descriptions, it is not necessary to incorporate the title into the descriptions as part of any amendment to the language of the title.

#### ¶ 15.05.01 Title of Design Invention

The title of a design being claimed must correspond to the name of the article in which the design is embodied or applied to. See MPEP § 1503.01.

#### ¶ 15.59 Amend Title

For [1], the title [2] amended throughout the application, original oath or declaration excepted, to read: [3]

#### Examiner Note:

1. In bracket 1, insert reason.
2. In bracket 2, insert --should be-- or --has been--.

## II. DESCRIPTION

No description of the design in the specification beyond a brief description of the drawing is generally necessary, since as a rule the illustration in the drawing views is its own best description. However, while not required, such a description is not prohibited and may be incorporated, at applicant's option, into the specification or may be provided in a separate paper. Descriptions of the figures are not required to be written in any particular format, however, if they do not describe the views of the drawing clearly and accurately, the examiner should object to the unclear and/or inaccurate descriptions and suggest language which is more clearly descriptive of the views.

In addition to the figure descriptions, the following types of statements are permissible in the specification:

(A) Description of the appearance of portions of the claimed design which are not illustrated in the drawing disclosure. Such a description, if provided, must be in the design application as originally filed, and may not be added by way of amendment after the filing of the application as it would be considered new matter.

(B) Description disclaiming portions of the article not shown in the drawing as forming no part of the claimed design.

(C) Statement indicating the purpose of broken lines in the drawing, for example, environmental structure or boundaries that form no part of the design to be patented.

(D) Description denoting the nature and environmental use of the claimed design, if not included in the preamble pursuant to 37 CFR 1.154 and MPEP § 1503.01, subsection I.

It is the policy of the Office to attempt to resolve questions about the nature and intended use of the claimed design prior to examination by making a telephone inquiry at the time of initial docketing of the application. This will enable the application to be

properly classified and docketed to the appropriate examiner and to be searched when the application comes up for examination in its normal course without the need for a rejection under 35 U.S.C. 112 prior to a search of the prior art. Explanation of the nature and intended use of the article may be added to the specification provided it does not constitute new matter. It may alternately, at applicant's option, be submitted in a separate paper without amendment of the specification.

(E) A "characteristic features" statement describing a particular feature of the design that is considered by applicant to be a feature of novelty or nonobviousness over the prior art (37 CFR 1.71(c)).

This type of statement may not serve as a basis for determining patentability by an examiner. In determining the patentability of a design, it is the overall appearance of the claimed design which must be taken into consideration. *In re Rosen*, 673 F.2d 388, 213 USPQ 347 (CCPA 1982); *In re Leslie*, 547 F.2d 116, 192 USPQ 427 (CCPA 1977). Furthermore, the inclusion of such a statement in the specification is at the option of applicant and will not be suggested by the examiner.

\*\*>

#### ¶ 15.47 Characteristic Feature Statement

A "characteristic features" statement describing a particular feature of novelty or nonobviousness in the claimed design may be permissible in the specification. Such a statement should be in terms such as "The characteristic feature of the design resides in [1]," or if combined with one of the Figure descriptions, in terms such as "the characteristic feature of which resides in [2]." While consideration of the claim goes to the total or overall appearance, the use of a "characteristic feature" statement may serve later to limit the claim (*McGrady v. Aspenglas Corp.*, 487 F. Supp. 859, 208 USPQ 242 (S.D.N.Y. 1980)).

#### Examiner Note:

In brackets 1 and 2, insert brief but accurate description of the feature of novelty or nonobviousness of the claimed design.

<

#### ¶ 15.47.01 Feature Statement Caution

The inclusion of a feature statement in the specification is noted. However, the patentability of the claimed design is not based on the specified feature but rather on a comparison of the overall appearance of the design with the prior art. *In re Leslie*, 547 F.2d 116, 192 USPQ 427 (CCPA 1977).

The following types of statements are not permissible in the specification:

(A) A disclaimer statement directed to any portion of the claimed design that is shown in solid lines in the drawings is not permitted in the specification of an issued design patent. However, the disclaimer statement may be included in the design application as originally filed to provide antecedent basis for a future amendment. See *Ex parte Remington*, 114 O.G. 761, 1905 C.D. 28 (Comm'r Pat. 1904); *In re Blum*, 374 F.2d 904, 153 USPQ 177 (CCPA 1967).

(B) Statements which describe or suggest other embodiments of the claimed design which are not illustrated in the drawing disclosure, except one that is a mirror image of that shown >or has a shape and appearance that would be evident from the one shown<, are not permitted in the specification of an issued design patent. However, such statements may be included in the design application as originally filed to provide antecedent basis for a future amendment. In addition, statements which attempt to broaden the scope of the claimed design beyond that which is shown in the drawings are not permitted.

(C) Statements describing matters which are directed to function unrelated to the design.

>

#### ¶ 15.41 Functional, Structural Features Not Considered

Attention is directed to the fact that design patent applications are concerned solely with the ornamental appearance of an article of manufacture. The functional and/or structural features stressed by applicant in the papers are of no concern in design cases, and are neither permitted nor required. Function and structure fall under the realm of utility patent applications.

<

#### ¶ 15.46.01 Impermissible Special Description

The special description included in the specification is impermissible because [1]. See MPEP § 1503.01, subsection II. Therefore, the description should be canceled as any description of the design in the specification, other than a brief description of the drawing, is generally not necessary, since as a general rule, the illustration in the drawing views is its own best description.

#### Examiner Note:

In bracket 1, insert the reason why the special description is improper.

#### ¶ 15.60 Amend All Figure Descriptions

For [1], the figure descriptions [2] amended to read: [3]

**Examiner Note:**

1. In bracket 1, insert reason.
2. In bracket 2, insert --should be-- or --have been--.
3. In bracket 3, insert amended text.

## ¶ 15.61 Amend Selected Figure Descriptions

For [1], the description(s) of Fig(s). [2] [3] amended to read: [4]

**Examiner Note:**

1. In bracket 1, insert reason.
2. In bracket 2, insert selected Figure descriptions.
3. In bracket 3, insert --should be-- or --have been--.
4. In bracket 4, insert amended text.

&gt;

**III. DESIGN CLAIM**

The requirements for utility claims specified in 37 CFR 1.75 do not apply to design claims. Instead, the form and content of a design claim is set forth in 37 CFR 1.153:

*37 CFR 1.153. ... claim...*

(a) ... The claim shall be in formal terms to the ornamental design for the article (specifying name) as shown or as shown and described. More than one claim is neither required nor permitted.

\*\*\*\*\*

A design patent application may only include a single claim. The single claim should normally be in formal terms to “The ornamental design for (the article which embodies the design or to which it is applied) as shown.” The description of the article in the claim should be consistent in terminology with the title of the invention. See MPEP § 1503.01, subsection I.

When the specification includes a proper special description of the design (see MPEP § 1503.01, subsection II), or a proper showing of modified forms of the design or other descriptive matter has been included in the specification, the words “and described” must be added to the claim following the term “shown”; i.e., the claim must read “The ornamental design for (the article which embodies the design or to which it is applied) as shown and described.”

The claimed design is shown by full lines in the drawing. It is not permissible to show any portion of the claimed design in broken lines. There are no portions of the claimed design which are immaterial or unimportant, and elements shown in broken lines in the drawing are not part of the claim. See MPEP

§ 1503.02, subsection III, and In re Blum, 374 F.2d 904, 153 USPQ 177 (CCPA 1967).

## ¶ 15.62 Amend Claim “As Shown”

For proper form (37 CFR 1.153), the claim [1] amended to read: “[2] claim: The ornamental design for [3] as shown.”

**Examiner Note:**

1. In bracket 1, insert --must be--.
2. In bracket 2, insert --I-- or --We--.
3. In bracket 3, insert title of the article in which the design is embodied or applied.

## ¶ 15.63 Amend Claim “As Shown and Described”

For proper form (37 CFR 1.153), the claim [1] amended to read: “[2] claim: The ornamental design for [3] as shown and described.”

**Examiner Note:**

1. In bracket 1, insert --must be--.
2. In bracket 2, insert --I-- or --We--.
3. In bracket 3, insert title of the article in which the design is embodied or applied.

## ¶ 15.64 Addition of “And Described” to Claim

Because of [1] -- and described -- [2] added to the claim after “shown.”

**Examiner Note:**

1. In bracket 1, insert reason.
2. In bracket 2, insert --must be--.

&lt;

**1503.02 Drawing [R-2]***37 CFR 1.152. Design drawings.*

The design must be represented by a drawing that complies with the requirements of § 1.84 and must contain a sufficient number of views to constitute a complete disclosure of the appearance of the design. Appropriate and adequate surface shading should be used to show the character or contour of the surfaces represented. Solid black surface shading is not permitted except when used to represent the color black as well as color contrast. Broken lines may be used to show visible environmental structure, but may not be used to show hidden planes and surfaces that cannot be seen through opaque materials. Alternate positions of a design component, illustrated by full and broken lines in the same view are not permitted in a design drawing. Photographs and ink drawings are not permitted to be combined as formal drawings in one application. Photographs submitted in lieu of ink drawings in design patent applications must not disclose environmental structure but must be limited to the design claimed for the article.

Every design patent application must include either a drawing or a photograph of the claimed design. As the drawing or photograph constitutes the entire visual disclosure of the claim, it is of utmost importance that the drawing or photograph be clear and

complete, and that nothing regarding the design sought to be patented is left to conjecture.

When inconsistencies are found among the views, the examiner should object to the drawings and request that the views be made consistent. *Ex parte Asano*, 201 USPQ 315, 317 (Bd. Pat. App. & Inter. 1978); *Hadco Products, Inc. v. Lighting Corp. of America Inc.*, 312 F. Supp. 1173, 1182, 165 USPQ 496, 503 (E.D. Pa. 1970), *vacated on other grounds*, 462 F.2d 1265, 174 USPQ 358 (3d Cir. 1972). When the inconsistencies are of such magnitude that the overall appearance of the design is unclear, the claim should be rejected under 35 U.S.C. 112, first >and second paragraphs<, as >nonenabling and indefinite<. See MPEP § 1504.04, subsection I.A.

>

#### ¶ 15.05.03 Drawing/Photograph Disclosure Objected To

The drawing/photograph disclosure is objected to [1].

#### Examiner Note:

In bracket 1, insert statutory or regulatory basis for objection and an explanation.

#### ¶ 15.05.04 Replacement Drawing Sheets Required

Corrected drawing sheets are required in reply to the Office action to avoid abandonment of the application. Any amended replacement drawing sheet should include all of the figures appearing on the immediate prior version of the sheet, even if only one figure is being amended. The figure or figure number of an amended drawing should not be labeled as amended. If a drawing figure is to be canceled, the appropriate figure must be removed from the replacement sheet, and where necessary, the remaining figures must be renumbered and appropriate changes made to the brief description of the several views of the drawings for consistency. Additional replacement sheets may be necessary to show the renumbering of the remaining figures. The replacement sheet(s) should be labeled Replacement Sheet in the page header (as per 37 CFR 1.84(c)) so as not to obstruct any portion of the drawing figures. If the changes are not accepted by the examiner, the applicant will be notified and informed of any required corrective action in the next Office action.

#### ¶ 15.05.05 Drawing Correction Required Prior to Appeal

Any appeal of the design claim must include the correction of the drawings approved by the examiner in accordance with *Ex parte Bevan*, 142 USPQ 284 (Bd. App. 1964).

#### Examiner Note:

This form paragraph can be used in a FINAL rejection where an outstanding requirement for a drawing correction has not been satisfied.

#### ¶ 15.07 Avoidance of New Matter

When preparing new drawings in compliance with the requirement therefor, care must be exercised to avoid introduction of

anything which could be construed to be new matter prohibited by 35 U.S.C. 132 and 37 CFR 1.121.

<

Form paragraph 15.48 may be used to notify applicant of the necessity for good drawings.

#### ¶ 15.48 Necessity for Good Drawings

The necessity for good drawings in a design patent application cannot be overemphasized. As the drawing constitutes the whole disclosure of the design, it is of utmost importance that it be so well executed both as to clarity of showing and completeness, that nothing regarding the design sought to be patented is left to conjecture. An insufficient drawing may be fatal to validity (35 U.S.C. 112, first paragraph). Moreover, an insufficient drawing may have a negative effect with respect to the effective filing date of a continuing application.

In addition to the criteria set forth in 37 CFR 1.81-1.88, design drawings must also comply with 37 CFR 1.152 as follows:

### I. VIEWS

The drawings or photographs should contain a sufficient number of views to disclose the complete appearance of the design claimed, which may include the front, rear, top, bottom and sides. Perspective views are suggested and may be submitted to clearly show the appearance of three dimensional designs. If a perspective view is submitted, the surfaces shown would normally not be required to be illustrated in other views if these surfaces are clearly understood and fully disclosed in the perspective.

Views that are merely duplicative of other views of the design or that are flat and include no >surface ornamentation< may be omitted from the drawing if the specification makes this explicitly clear. See MPEP § 1503.01, subsection II. For example, if the left and right sides of a design are identical or a mirror image, a view should be provided of one side and a statement made in the drawing description that the other side is identical or a mirror image. If the design has a flat bottom, a view of the bottom may be omitted if the specification includes a statement that the bottom is flat and >devoid of surface ornamentation<. The term “unornamented” should not be used to describe visible surfaces which include structure that is clearly not flat. *Philco Corp. v. Admiral Corp.*, 199 F. Supp. 797, 131 USPQ 413 (D. Del. 1961).

Sectional views presented solely for the purpose of showing the internal construction or functional/



mechanical features are unnecessary and may lead to confusion as to the scope of the claimed design. *Ex parte Tucker*, 1901 C.D. 140, 97 O.G. 187 (Comm'r Pat. 1901); *Ex parte Kohler*, 1905 C.D. 192, 116 O.G. 1185 (Comm'r Pat. 1905). Such views should be objected to under 35 U.S.C. 112, second paragraph, and their cancellation should be required. However, where the exact contour or configuration of the exterior surface of a claimed design is not apparent from the views of the drawing, and no attempt is made to illustrate features of internal construction, a sectional view may be included to clarify the shape of said design. *Ex parte Lohman*, 1912 C.D. 336, 184 O.G. 287 (Comm'r Pat. 1912). When a sectional view is added during prosecution, the examiner must determine whether there is antecedent basis in the original disclosure for the material shown in hatching in the sectional view (37 CFR 1.84(h)(3) and MPEP § 608.02).

## II. SURFACE SHADING

While surface shading is not required under 37 CFR 1.152, it may be necessary in particular cases to shade the figures to show clearly the character and contour of all surfaces of any 3-dimensional aspects of the design. Surface shading is also necessary to distinguish between any open and solid areas of the article. However, surface shading should not be used on unclaimed subject matter, shown in broken lines, to avoid confusion as to the scope of the claim.

Lack of appropriate surface shading in the drawing as filed may render the design nonenabling and indefinite under 35 U.S.C. 112, first and second paragraphs. Additionally, if the surface shape is not evident from the disclosure as filed, the addition of surface shading after filing may comprise new matter. Solid black surface shading is not permitted except when used to represent the color black as well as color contrast. Oblique line shading must be used to show transparent, translucent and highly polished or reflective surfaces, such as a mirror. A contrast in materials may be shown by using line shading and stippling to differentiate between the areas; such technique broadly claims this surface treatment without being limited to specific colors or materials.

Form paragraph 15.49 may be used to notify applicant that surface shading is necessary.

### ¶ 15.49 Surface Shading Necessary

The drawing figures should be appropriately and adequately shaded to show clearly the character and/or contour of all surfaces represented. See 37 CFR 1.152. This is of particular importance in the showing of three (3) dimensional articles where it is necessary to delineate plane, concave, convex, raised, and/or depressed surfaces of the subject matter, and to distinguish between open and closed areas. Solid black surface shading is not permitted except when used to represent the color black as well as color contrast.

## III. BROKEN LINES

The two most common uses of broken lines are to disclose the environment related to the claimed design and to define the bounds of the claim. Structure that is not part of the claimed design, but is considered necessary to show the environment in which the design is associated, may be represented in the drawing by broken lines. This includes any portion of an article in which the design is embodied or applied to that is not considered part of the claimed design. *In re Zahn*, 617 F.2d 261, 204 USPQ 988 (CCPA 1980). A broken line showing is for illustrative purposes only and forms no part of the claimed design or a specified embodiment thereof. A boundary line may be shown in broken lines if it is not intended to form part of the claimed design. Applicant may choose to define the bounds of a claimed design with broken lines when the boundary does not exist in reality in the article embodying the design. It would be understood that the claimed design extends to the boundary but does not include the boundary. Where no boundary line is shown in a design application as originally filed, but it is clear from the design specification that the boundary of the claimed design is a straight broken line connecting the ends of existing full lines defining the claimed design, applicant may amend the drawing(s) to add a straight broken line connecting the ends of existing full lines defining the claimed subject matter. Any broken line boundary other than a straight broken line may constitute new matter prohibited by 35 U.S.C. 132 and 37 CFR 1.121(f).

However, broken lines are not permitted for the purpose of indicating that a portion of an article is of less importance in the design. *In re Blum*, 374 F.2d 904, 153 USPQ 177 (CCPA 1967). Broken lines may not be used to show hidden planes and surfaces which cannot be seen through opaque materials. The use of broken lines indicates that the environmental structure or the portion of the article depicted in broken lines

forms no part of the design, and is not to indicate the relative importance of parts of a design.

In general, when broken lines are used, they should not intrude upon or cross the showing of the claimed design and should not be of heavier weight than the lines used in depicting the claimed design. When broken lines cross over the full line showing of the claimed design and are defined as showing environment, it is understood that the surface which lies beneath the broken lines is part of the claimed design. When the broken lines crossing over the design are defined as boundaries, it is understood that the area within the broken lines is not part of the claimed design. Therefore, when broken lines are used which cross over the full line showing of the design, it is critical that the description of the broken lines in the specification explicitly identifies their purpose so that the scope of the claim is clear. As it is possible that broken lines with different purposes may be included in a single application, the description must make a visual distinction between the two purposes; such as --The broken lines immediately adjacent the shaded areas represent the bounds of the claimed design while all other broken lines are >directed to environment and are< for illustrative purposes only; the broken lines form no part of the claimed design.-- Where a broken line showing of environmental structure must necessarily cross or intrude upon the representation of the claimed design and obscures a clear understanding of the design, such an illustration should be included as a separate figure in addition to the other figures which fully disclose the subject matter of the design. Further, surface shading should not be used on unclaimed subject matter shown in broken lines to avoid confusion as to the scope of the claim.

The following form paragraphs may be used, where appropriate, to notify applicant regarding the use of broken lines in the drawings.

¶ 15.50 Design Claimed Shown in Full Lines

The ornamental design which is being claimed must be shown in solid lines in the drawing. Dotted lines for the purpose of indicating unimportant or immaterial features of the design are not permitted. There are no portions of a claimed design which are immaterial or unimportant. See *In re Blum*, 374 F.2d 904, 153 USPQ 177 (CCPA 1967) and *In re Zahn*, 617 F.2d 261, 204 USPQ 988 (CCPA 1980).

¶ 15.50.01 Use of Broken Lines in Drawing

Environmental structure may be illustrated by broken lines in the drawing if clearly designated as environment in the specification. See 37 CFR 1.152 and MPEP § 1503.02, subsection III.

¶ 15.50.02 Description of Broken Lines

The following statement must be used to describe the broken lines on the drawing (MPEP § 1503.02, subsection III):

-- The broken line showing of [1] is for illustrative purposes only and forms no part of the claimed design. --

The above statement [2] inserted in the specification preceding the claim.

**Examiner Note:**

1. In bracket 1, insert name of structure.
2. In bracket 2, insert --must be-- or --has been--.

¶ 15.50.03 Objectionable Use of Broken Lines In Drawings

Dotted lines or broken lines used for environmental structure should not cross or intrude upon the representation of the claimed design for which design protection is sought. Such dotted lines may obscure the claimed design and render the disclosure indefinite (35 U.S.C. 112).

¶ 15.50.04 Proper Drawing Disclosure With Use of Broken Lines

Where broken lines showing environmental structure obscure the full line disclosure of the claimed design, a separate figure showing the broken lines must be included in the drawing in addition to the figures showing only claimed subject matter, 35 U.S.C. 112, first paragraph.

¶ 15.50.05 Description of Broken Lines as Boundary of Design

The following statement must be used to describe the broken line boundary of a design (MPEP § 1503.02, subsection III):

-- The broken line(s) which define the bounds of the claimed design form no part thereof.--

#### IV. SURFACE TREATMENT

The ornamental appearance of a design for an article includes its shape and configuration as well as any indicia, contrasting color or materials, graphic representations, or other ornamentation applied to the article ("surface treatment"). Surface treatment must be applied to or embodied in an article of manufacture. Surface treatment, *per se* (i.e., not applied to or embodied in a specific article of manufacture), is not proper subject matter for a design patent under 35 U.S.C. 171. Surface treatment may either be disclosed with the article to which it is applied or in which it is embodied and must be shown in full lines or in broken lines (if unclaimed) to meet the statutory requirement. See MPEP § 1504.01. The guidelines that apply for

disclosing computer-generated icons apply equally to all types of surface treatment. See MPEP § 1504.01(a).

A disclosure of surface treatment in a design drawing or photograph will normally be considered as *prima facie* evidence that the inventor considered the surface treatment shown as an integral part of the claimed design. An amendment canceling two-dimensional surface treatment or reducing it to broken lines will be permitted if it is clear from the application that applicant had possession of the underlying configuration of the basic design without the surface treatment at the time of filing of the application. See *In re Daniels*, 144 F.3d 1452, 1456-57, 46 USPQ2d 1788, 1790 (Fed. Cir. 1998). Applicant may remove surface treatment shown in a drawing or photograph of a design without such removal being treated as new matter, provided that the surface treatment does not obscure or override the underlying design. The removal of three-dimensional surface treatment that is an integral part of the configuration of the claimed design, for example, removal of beading, grooves, and ribs, will introduce prohibited new matter as the underlying configuration revealed by this amendment would not be apparent in the application as originally filed. See MPEP § 1504.04, subsection II.

## V. PHOTOGRAPHS AND COLOR DRAWINGS

Drawings are normally required to be submitted in black ink on white paper. See 37 CFR 1.84(a)(1). Photographs are acceptable only in applications in which the invention is not capable of being illustrated in an ink drawing or where the invention is shown more clearly in a photograph (e.g., photographs of ornamental effects are acceptable). See also 37 CFR 1.81(c) and 1.83(c), and MPEP § 608.02.

Photographs submitted in lieu of ink drawings must comply with 37 CFR 1.84(b). Only one set of black and white photographs is required. Color photographs and color drawings may be submitted in design applications if filed with a petition under 37 CFR 1.84(a)(2). Petitions to accept color photographs or color drawings will be considered by the Primary Examiners as delegated by the TC Director. A grantable petition under 37 CFR 1.84(a)(2) must explain that color drawings or color photographs are necessary because color is an integral part of the

claimed design. Any other explanation as to why color drawings or color photographs are necessary will normally not be acceptable. A grantable petition must also be accompanied by: (1) the fee set forth in 37 CFR 1.17(h); (2) three sets of the color photographs or color drawings; and (3) an amendment to the specification inserting the following statement --The file of this patent contains at least one drawing/photograph executed in color. Copies of this patent with color drawing(s)/photograph(s) will be provided by the Office upon request and payment of the necessary fee.-- See 37 CFR 1.84(a)(2)(iv) and MPEP § 608.02. The U.S. Patent and Trademark Office has waived 37 CFR 1.84(a)(2)(iii), and is no longer requiring a black and white photocopy of any color drawing or photograph. See 1246 O.G. 106 (May 22, 2001). If the photographs are not of sufficient quality so that all details in the photographs are reproducible, this will form the basis of subsequent objection to the quality of the photographic disclosure. No application will be issued until objections directed to the quality of the photographic disclosure have been resolved and acceptable photographs have been submitted and approved by the examiner. If the details, appearance and shape of all the features and portions of the design are not clearly disclosed in the photographs, this would form the basis of a rejection of the claim under 35 U.S.C. 112, first and second paragraphs, as nonenabling and indefinite.

Photographs and ink drawings must not be combined in a formal submission of the visual disclosure of the claimed design in one application. The introduction of both photographs and ink drawings in a design application would result in a high probability of inconsistencies between corresponding elements on the ink drawings as compared with the photographs.

When filing informal photographs or informal drawings with the original application, a disclaimer included in the specification or on the photographs themselves may be used to disclaim any surface ornamentation, logos, written matter, etc. which form no part of the claimed design. See also MPEP § 1504.04, subsection II.

Color photographs and color drawings may be submitted in design applications if filed with a petition under 37 CFR 1.84(a)(2). Color may also be shown in pen and ink drawings by lining the surfaces of the design for color in accordance with the symbols in

MPEP § 608.02. If the formal drawing in an application is lined for color, the following statement should be inserted in the specification for clarity and to avoid possible confusion that the lining may be surface treatment --The drawing is lined for color.-- However, lining a surface for color may interfere with a clear showing of the design as required by 35 U.S.C. 112, first paragraph, as surface shading cannot be used to define the contours of the design.

If color photographs or color drawings are filed with the original application, color will be considered an integral part of the disclosed and claimed design. The omission of color in later filed formal photographs or drawings will be permitted if it is clear from the application that applicant had possession of the >underlying configuration of the< basic design without the color at the time of filing of the application. See *In re Daniels*, 144 F.3d 1452, 1456-57, 46 USPQ2d 1788, 1790 (Fed. Cir. 1998) and MPEP 1504.04, subsection \*>II<. Note also 37 CFR 1.152, which requires that the disclosure in formal photographs be limited to the design for the article claimed.

\*\*

¶ 15.05.041 *Informal Color Drawing(s)/Photograph(s) Submitted*

Informal color photographs or drawings have been submitted for the purposes of obtaining a filing date. When formal drawings are submitted, any showing of color in a black and white drawing is limited to the symbols used to line a surface to show color (MPEP § 608.02). Lining entire surfaces of a design to show color(s) may interfere with a clear showing of the design as required by 35 U.S.C. 112 because surface shading cannot be used simultaneously to define the contours of those surfaces. However, a surface may be partially lined for color with a description that the color extends across the entire surface; this technique would allow for the use of shading on the rest of the surface showing the contours of the design (37 CFR 1.152). In the alternative, a separate view, properly shaded to show the contours of the design but omitting the color(s), may be submitted if identified as shown only for clarity of illustration.

In any drawing lined for color, the following special description must be inserted in the specification (the specific colors may be identified for clarity):

--The drawing is lined for color.--

However, some designs disclosed in informal color photographs/drawings cannot be depicted in black and white drawings lined for color. For example, a design may include multiple shades of a single color which cannot be accurately represented by the single symbol for a specific color. Or, the color may be a shade other than a true primary or secondary color as represented by the drafting symbols and lining the drawing with one of the

drafting symbols would not be an exact representation of the design as originally disclosed. In these situations, applicant may file a petition to accept formal color drawings or color photographs under 37 CFR 1.84(a)(2).

\*\*>

¶ 15.45 *Color Photographs/Drawings As Informal Drawings*

For filing date purposes, in those design patent applications containing color photographs/drawings contrary to the requirement for ink drawings or black and white photographs, the Office of Initial Patent Examination has been authorized to construe the color photographs/drawings as informal drawings rather than to hold the applications incomplete as filed. By so doing, the Patent and Trademark Office can accept the applications without requiring applicants to file petitions to obtain the original deposit date as the filing date. However, color photographs or color drawings are not permitted in design applications in the absence of a grantable petition pursuant to 37 CFR 1.84(a)(2). Before the color photographs or color drawings in this application can be treated as formal drawings, applicant must submit [1].

**Examiner Note:**

In bracket 1, insert --a petition--, --the fee--, --statement in the specification--, --explanation of why color disclosure is necessary--, and -- three full sets of color photographs or color drawings--.

<

\*\*

## 1504 Examination [R-2]

In design patent applications, ornamentality, novelty\*>< nonobviousness >enablement and definiteness< are necessary prerequisites to the grant of a patent. The inventive novelty or unobviousness resides in the ornamental shape or configuration of the article in which the design is embodied or the surface ornamentation which is applied to or embodied in the design.

Novelty and nonobviousness of a design claim must generally be determined by a search in the pertinent design classes. It is also mandatory that the search be extended to the mechanical classes encompassing inventions of the same general type. Catalogs and trade journals >as well as available foreign patent databases< are also to be consulted.

If the examiner determines that the claim of the design patent application does not satisfy the statutory requirements, the examiner will set forth in detail, and may additionally summarize, the basis for all rejec-

tions in an Official action. \*>If a reply to an Office action overcomes a rejection either by way of an amendment to the claim or by providing convincing arguments that the rejection should be withdrawn, that rejection must be indicated as withdrawn in the next Office action, unless such action is a notice of allowability. Likewise, any amendment to the specification or claim, or new drawing or drawing correction submitted in reply to an objection or objections in an Office action must be acknowledged in the next Office action, unless such action is a notice of allowability. When< an examiner determines that the claim in a design application is patentable under all statutory requirements, but formal matters still need to be addressed and corrected prior to allowance, an *Ex parte Quayle* action will be sent to applicant indicating allowability of the claim and identifying the necessary corrections.

¶ 15.19.01 *Summary Statement of Rejections*

The claim stands rejected under [1].

**Examiner Note:**

1. Use as summary statement of rejection(s) in Office action.
2. In bracket 1, insert appropriate basis for rejection, i.e., statutory provisions, etc.

¶ 15.58 *Claimed Design Is Patentable (Ex parte Quayle Actions)*

The claimed design is patentable over the references cited.

¶ 15.72 *Quayle Action*

This application is in condition for allowance except for the following formal matters: [1].

Prosecution on the merits is closed in accordance with the practice under *Ex parte Quayle*, 1935 C.D. 11, 453 O.G. 213.

A shortened statutory period for reply to this action is set to expire TWO MONTHS from the mailing date of this letter.

>If it is determined that a rejection of the claim should be given after a reply to a Quayle action, the indication of allowability set forth in the previous action must be withdrawn and prosecution reopened using the following form paragraph:

¶ 15.90 *Indication of allowability withdrawn*

The indication of allowability set forth in the previous action is withdrawn and prosecution is reopened in view of the following new ground of rejection.

<

With respect to *pro se* design applications, the examiner should notify applicant in the first Office action that it may be desirable for applicant to employ

the services of a registered patent attorney or agent to prosecute the application. Applicant should also be notified that the U.S. Patent and Trademark Office cannot aid in the selection of an attorney or agent. If it appears that patentable subject matter is present and the disclosure of the claimed design complies with the requirements of 35 U.S.C.112, the examiner should include a copy of the “Guide To Filing A Design Patent Application” with the first Office action and notify applicant that it may be desirable to employ the services of a professional patent draftsman familiar with design practice to prepare the formal drawings. Applicant should also be notified that the U.S. Patent and Trademark Office cannot aid in the selection of a draftsman. The following form paragraph, where appropriate, may be used.

¶ 15.66 *Employ Services of Patent Attorney or Agent (Design Application Only)*

As the value of a design patent is largely dependent upon the skillful preparation of the drawings and specification, applicant might consider it desirable to employ the services of a registered patent attorney or agent. The U.S. Patent and Trademark Office cannot aid in the selection of an attorney or agent.

Applicant is advised of the availability of the publication “Attorneys and Agents Registered to Practice Before the U.S. Patent and Trademark Office.” This publication is for sale by the Superintendent of Documents, U.S. Government Printing Office, Washington, D.C. 20402.

¶ 15.66.01 *Employ Services of Professional Patent Draftsman (Design Application Only)*

As the value of a design patent is largely dependent upon the skillful preparation of the drawings, applicant might consider it desirable to employ the services of a professional patent draftsman familiar with design practice. The U.S. Patent and Trademark Office cannot aid in the selection of a draftsman.

**Examiner Note:**

This form paragraph should only be used in *pro se* applications where it appears that patentable subject matter is present and the disclosure of the claimed design complies with the requirements of 35 U.S.C. 112.

## 1504.01 Statutory Subject Matter for Designs

### 35 U.S.C. 171. Patents for designs.

Whoever invents any new, original, and ornamental design for an article of manufacture may obtain a patent therefor, subject to the conditions and requirements of this title.

The provisions of this title relating to patents for inventions shall apply to patents for designs, except as otherwise provided.

The language “new, original and ornamental design for an article of manufacture” set forth in 35 U.S.C. 171 has been interpreted by the case law to include at least three kinds of designs:

(A) a design for an ornament, impression, print, or picture applied to or embodied in an article of manufacture (surface indicia);

(B) a design for the shape or configuration of an article of manufacture; and

(C) a combination of the first two categories.

See *In re Schnell*, 46 F.2d 203, 8 USPQ 19 (CCPA 1931); *Ex parte Donaldson*, 26 USPQ2d 1250 (Bd. Pat. App. & Int. 1992).

A picture standing alone is not patentable under 35 U.S.C. 171. The factor which distinguishes statutory design subject matter from mere picture or ornamentation, *per se* (i.e., abstract design), is the embodiment of the design in an article of manufacture. Consistent with 35 U.S.C. 171, case law and USPTO practice, the design must be shown as applied to or embodied in an article of manufacture.

A claim to a picture, print, impression, etc. *per se*, that is not applied to or embodied in an article of manufacture should be rejected under 35 U.S.C. 171 as directed to nonstatutory subject matter. The following paragraphs may be used.

¶ 15.07.01 *Statutory Basis, 35 U.S.C. 171*

The following is a quotation of 35 U.S.C. 171:

Whoever invents any new, original, and ornamental design for an article of manufacture may obtain a patent therefor, subject to the conditions and requirements of this title.

The provisions of this title relating to patents for inventions shall apply to patents for designs, except as otherwise provided.

¶ 15.09 *35 U.S.C. 171 Rejection*

The claim is rejected under 35 U.S.C. 171 as directed to non-statutory subject matter because the design is not shown embodied in or applied to an article.

**Examiner Note:**

This rejection should be used when the claim is directed to surface treatment which is not shown with an article in either full or broken lines.

¶ 15.44 *Design Inseparable From Article to Which Applied*

Design is inseparable from the article to which it is applied, and cannot exist alone merely as a scheme of ornamentation. It

must be a definite preconceived thing, capable of reproduction, and not merely the chance result of a method or of a combination of functional elements (35 U.S.C. 171; 35 U.S.C. 112, first and second paragraphs). See *Blisscraft of Hollywood v. United Plastics Co.*, 189 F. Supp. 333, 127 USPQ 452 (S.D.N.Y. 1960), 294 F.2d 694, 131 USPQ 55 (2d Cir. 1961).

Form paragraphs 15.38 and 15.40 may be used in a second or subsequent action, where appropriate (see MPEP § 1504.02).

## 1504.01(a) Computer-Generated Icons

To be directed to statutory subject matter, design applications for computer-generated icons must comply with the “article of manufacture” requirement of 35 U.S.C. 171.

### I. GUIDELINES FOR EXAMINATION OF DESIGN PATENT APPLICATIONS FOR COMPUTER-GENERATED ICONS

The following guidelines have been developed to assist USPTO personnel in determining whether design patent applications for computer-generated icons comply with the “article of manufacture” requirement of 35 U.S.C. 171.

#### A. *General Principle Governing Compliance With the “Article of Manufacture” Requirement*

Computer-generated icons, such as full screen displays and individual icons, are 2-dimensional images which alone are surface ornamentation. See, e.g., *Ex parte Strijland*, 26 USPQ2d 1259 (Bd. Pat. App. & Int. 1992) (computer-generated icon alone is merely surface ornamentation). The USPTO considers designs for computer-generated icons embodied in articles of manufacture to be statutory subject matter eligible for design patent protection under 35 U.S.C. 171. Thus, if an application claims a computer-generated icon shown on a computer screen, monitor, other display panel, or a portion thereof, the claim complies with the “article of manufacture” requirement of 35 U.S.C. 171. Since a patentable design is inseparable from the object to which it is applied and cannot exist alone merely as a scheme of surface ornamentation, a computer-generated icon must be embodied in a computer screen, monitor, other display panel, or portion thereof, to satisfy 35 U.S.C. 171. See MPEP § 1502.

“We do not see that the dependence of the existence of a design on something outside itself is a reason for holding it is not a design ‘for an article of manufacture.’ ” *In re Hruby*, 373 F.2d 997, 1001, 153 USPQ 61, 66 (CCPA 1967) (design of water fountain patentable design for an article of manufacture). The dependence of a computer-generated icon on a central processing unit and computer program for its existence itself is not a reason for holding that the design is not for an article of manufacture.

**B. Procedures for Evaluating Whether Design Patent Applications Drawn to Computer-Generated Icons Comply With the “Article of Manufacture” Requirement**

USPTO personnel shall adhere to the following procedures when reviewing design patent applications drawn to computer-generated icons for compliance with the “article of manufacture” requirement of 35 U.S.C. 171.

(A) Read the entire disclosure to determine what the applicant claims as the design and to determine whether the design is embodied in an article of manufacture. 37 CFR 1.71 and 1.152-1.154.

Since the claim must be in formal terms to the design “as shown, or as shown and described,” the drawing provides the best description of the claim. 37 CFR 1.153.

(1) Review the drawing to determine whether a computer screen, monitor, other display panel, or portion thereof, is shown. 37 CFR 1.152.

Although a computer-generated icon may be embodied in only a portion of a computer screen, monitor, or other display panel, the drawing “must contain a sufficient number of views to constitute a complete disclosure of the appearance of the article.” 37 CFR 1.152. In addition, the drawing must comply with 37 CFR 1.84.

(2) Review the title to determine whether it clearly describes the claimed subject matter. 37 CFR 1.153.

The following titles do not adequately describe a design for an article of manufacture under 35 U.S.C. 171: “computer icon”; or “icon.” On the other hand, the following titles do adequately describe a design for an article of manufacture under 35 U.S.C. 171: “computer screen with an icon”; “display panel with a computer icon”; “portion of a computer screen with

an icon image”; “portion of a display panel with a computer icon image”; or “portion of a monitor displayed with a computer icon image.”

(3) Review the specification to determine whether a characteristic feature statement is present. 37 CFR 1.71. If a characteristic feature statement is present, determine whether it describes the claimed subject matter as a computer-generated icon embodied in a computer screen, monitor, other display panel, or portion thereof. See *McGrady v. Aspenglas Corp.*, 487 F.2d 859, 208 USPQ 242 (S.D.N.Y. 1980) (descriptive statement in design patent application narrows claim scope).

(B) If the drawing does not depict a computer-generated icon embodied in a computer screen, monitor, other display panel, or a portion thereof, in either solid or broken lines, reject the claimed design under 35 U.S.C. 171 for failing to comply with the article of manufacture requirement.

(1) If the disclosure as a whole does not suggest or describe the claimed subject matter as a computer-generated icon embodied in a computer screen, monitor, other display panel, or portion thereof, indicate that:

(a) The claim is fatally defective under 35 U.S.C. 171; and

(b) Amendments to the written description, drawings and/or claim attempting to overcome the rejection will ordinarily be entered, however, any new matter will be required to be canceled from the written description, drawings and/or claims. If new matter is added, the claim should be rejected under 35 U.S.C. 112, first paragraph.

(2) If the disclosure as a whole suggests or describes the claimed subject matter as a computer-generated icon embodied in a computer screen, monitor, other display panel, or portion thereof, indicate that the drawing may be amended to overcome the rejection under 35 U.S.C. 171. Suggest amendments which would bring the claim into compliance with 35 U.S.C. 171.

(C) Indicate all objections to the disclosure for failure to comply with the formal requirements of the Rules of Practice in Patent Cases. 37 CFR 1.71, 1.81-1.85, and 1.152-1.154. Suggest amendments which would bring the disclosure into compliance with the formal requirements of the Rules of Practice in Patent Cases.

(D) Upon reply by applicant:

(1) Enter any amendments; and

(2) Review all arguments and the entire record, including any amendments, to determine whether the drawing, title, and specification clearly disclose a computer-generated icon embodied in a computer screen, monitor, other display panel, or portion thereof.

(E) If, by a preponderance of the evidence (see *In re Oetiker*, 977 F.2d 1443, 1445, 24 USPQ2d 1443, 1444 (Fed. Cir. 1992) (“After evidence or argument is submitted by the applicant in response, patentability is determined on the totality of the record, by a preponderance of evidence with due consideration to persuasiveness of argument.”)), the applicant has established that the computer-generated icon is embodied in a computer screen, monitor, other display panel, or portion thereof, withdraw the rejection under 35 U.S.C. 171.

## II. EFFECT OF THE GUIDELINES ON PENDING DESIGN APPLICATIONS DRAWN TO COMPUTER-GENERATED ICONS

USPTO personnel shall follow the procedures set forth above when examining design patent applications for computer-generated icons pending in the USPTO as of April 19, 1996.

## III. TREATMENT OF TYPE FONTS

Traditionally, type fonts have been generated by solid blocks from which each letter or symbol was produced. Consequently, the USPTO has historically granted design patents drawn to type fonts. USPTO personnel should not reject claims for type fonts under 35 U.S.C. 171 for failure to comply with the “article of manufacture” requirement on the basis that more modern methods of typesetting, including computer-generation, do not require solid printing blocks.

### 1504.01(b) Design Comprising Multiple Articles or Multiple Parts Embodied in a Single Article

While the claimed design must be embodied in an article of manufacture as required by 35 U.S.C. 171, it may encompass multiple articles or multiple parts within that article. *Ex parte Gibson*, 20 USPQ 249

(Bd. App. 1933). Multiple independent parts forming the claimed design may be disclosed in the drawing with or without the article being shown in broken lines. If the article is not disclosed in broken lines in the drawing, then the title must disclose the article in which the design is embodied and the association of the claimed parts must be shown by a bracket. In either case, the title must clearly define the articles or parts as a single entity, for example, set, pair, combination, unit, assembly, etc. See MPEP § 1503.01.

### 1504.01(c) Lack of Ornamentality [R-2]

#### I. FUNCTIONALITY VS. ORNAMENTALITY

An ornamental feature or design has been defined as one which was “created for the purpose of ornamenting” and cannot be the result or “merely a by-product” of functional or mechanical considerations. *In re Carletti*, 328 F.2d 1020, 140 USPQ 653, 654 (CCPA 1964); *Blisscraft of Hollywood v. United Plastic Co.*, 189 F. Supp. 333, 337, 127 USPQ 452, 454 (S.D.N.Y. 1960), *aff’d*, 294 F.2d 694, 131 USPQ 55 (2d Cir. 1961). It is clear that the ornamentality of the article must be the result of a conscious act by the inventor, as 35 U.S.C. 171 requires that a patent for a design be given only to “whoever *invents* any new, original, and ornamental design for an article of manufacture.” Therefore, for a design to be ornamental within the requirements of 35 U.S.C. 171, it must be “created for the purpose of ornamenting.” *In re Carletti*, 328 F.2d 1020, 1022, 140 USPQ 653, 654 (CCPA 1964).

To be patentable, a design must be “primarily ornamental.” “In determining whether a design is *primarily functional or primarily ornamental* the claimed design is viewed in its entirety, for the ultimate question is not the functional or decorative aspect of each separate feature, but the overall appearance of the article, in determining whether the claimed design is dictated by the utilitarian purpose of the article.” *L. A. Gear Inc. v. Thom McAn Shoe Co.*, 988 F.2d 1117, 1123, 25 USPQ2d 1913, 1917 (Fed. Cir. 1993). The court in *Norco Products, Inc. v. Mecca Development, Inc.*, 617 F.Supp. 1079, 1080, 227 USPQ 724, 725 (D. Conn. 1985), held that a “primarily functional invention is not patentable” as a design.



A determination of ornamentality is not a quantitative analysis based on the size of the ornamental feature or features but rather a determination based on their ornamental contribution to the design as a whole.

While ornamentality must be based on the entire design, “[i]n determining whether a design is primarily functional, the purposes of the particular elements of the design necessarily must be considered.” *Power Controls Corp. v. Hybrinetics, Inc.*, 806 F.2d 234, 240, 231 USPQ 774, 778 (Fed. Cir. 1986). The court in *Smith v. M & B Sales & Manufacturing*, 13 USPQ2d 2002, 2004 (N. D. Cal. 1990), states that if “significant decisions about how to put it [the item] together and present it in the marketplace were informed by primarily ornamental considerations”, this information may establish the ornamentality of a design.

“However, a distinction exists between the *functionality of an article* or features thereof and the *functionality of the particular design of such article* or features thereof that perform a function.” *Avia Group International Inc. v. L. A. Gear California Inc.*, 853 F.2d 1557, 1563, 7 USPQ2d 1548, 1553 (Fed. Cir. 1988). The distinction must be maintained between the ornamental design and the article in which the design is embodied. The design for the article cannot be assumed to lack ornamentality merely because the article of manufacture would seem to be primarily functional.

\*\*>

## II. < ESTABLISHING A *PRIMA FACIE* BASIS FOR REJECTIONS UNDER 35 U.S.C. 171

To properly reject a claimed design under 35 U.S.C. 171 on the basis of a lack of ornamentality, an examiner must make a *prima facie* showing that the claimed design lacks ornamentality and provide a sufficient evidentiary basis for factual assumptions relied upon in such showing. The court in *In re Oetiker*, 977 F.2d 1443, 1445, 24 USPQ2d 1443, 1444 (Fed. Cir. 1992), stated that “the examiner bears the initial burden, on review of the prior art or on any other ground, of presenting a *prima facie* case of unpatentability.”

>The proper evidentiary basis for a rejection under 35 U.S.C. 171 that a claim is lacking in ornamentality is *an evaluation of the appearance of the design itself*. The examiner’s knowledge of the art, a reply to a letter of inquiry, a brochure emphasizing the functional/

mechanical features of the design, the specification of an analogous utility patent (the applicant’s or another inventor), or information provided in the specification may be used to *supplement* the analysis of the design. If a design is embodied in a specific mechanical article, the analysis that the design lacks ornamentality because its appearance is dictated by functional requirements should be supported by reference to utility patents or some other source of information about the function of the design. If the design is embodied in an article that has a more general use, such as a clip, the analysis and explanation as to why the design lacks ornamentality should be detailed and specific. The examiner’s contention that the specific appearance of the claimed design lacks ornamentality may be supported by the holding of the court in *In re Carletti et al.*, 328 F.2d 1020, 140 USPQ 653 (CCPA 1964), that a design to be patentable must be “created for the purpose of ornamenting” the article in which it is embodied. The presence or lack of ornamentality must be made on a case by case basis.

Knowledge that the article would be hidden during its end use based on the examiner’s experience in a given art or information that may have been submitted in the application itself would **not** be considered *prima facie* evidence of the functional nature of the design. See *Seiko Epson Corp v. Nu-Kote Int’l Inc.*, 190 F.3d 1360, 52 USPQ2d 1011 (Fed. Cir. 1999). “Visibility during an article’s ‘normal use’ is not a statutory requirement of §171, but rather a guideline for courts to employ in determining whether the patented features are ‘ornamental’.” *Larson v. Classic Corp.*, 683 F. Supp. 1202, 7 USPQ2d 1747 (N.D. Ill. 1988). If there is sufficient evidence to show that a specific design “is clearly intended to be noticed during the process of sale and equally clearly intended to be completely hidden from view in the final use,” it is not necessary that a rejection be made under 35 U.S.C. 171. *In re Webb*, 916 F.2d 1553, 1558, 16 USPQ2d 1433, 1436 (Fed. Cir. 1990). The mere fact that an article would be hidden during its ultimate end use is **not** the basis for a rejection under 35 U.S.C. 171, but this information provides additional evidence to be used in support of the contention that the design lacks ornamentality. The only basis for rejecting a claim under 35 U.S.C. 171 as lacking in ornamentality is **an evaluation of the design itself** in light of additional information, such as that identified above.<

Examples of proper evidentiary basis for a rejection under 35 U.S.C. 171 that a claim is lacking in ornamentality would be: (A) common knowledge in the art; (B) the appearance of the design itself; (C) the specification of a related utility patent; >or< (D) information provided in the specification\*\*.

A rejection under 35 U.S.C. 171 for lack of ornamentality must be supported by evidence and rejections should not be made in the absence of such evidence.

\*>

### III. < REJECTIONS MADE UNDER 35 U.S.C. 171

Rejections under 35 U.S.C. 171 for lack of ornamentality based on a proper *prima facie* showing fall into two categories:

(A) a design visible in its ultimate end use which is primarily functional based on the evidence of record; or

(B) a design not visible in its \*\* >normal and intended use as evidence that its appearance is not a matter of concern.< *In re Stevens*, 173 F.2d 1015, 81 USPQ 362 (CCPA 1949) \*\* >;< *In re Webb*, 916 F.2d 1553, 1558, 16 USPQ2d 1433, 1436 (Fed. Cir. 1990).

When the examiner has established a proper *prima facie* case of lack of ornamentality, “the burden of coming forward with evidence or argument shifts to the applicant.” *In re Oetiker*, 977 F.2d 1443, 1445, 24 USPQ2d 1443, 1444 (Fed. Cir. 1992). A rejection under 35 U.S.C. 171 for lack of ornamentality may be overcome by providing evidence from the inventor himself or a representative of the company that commissioned the design that there was an intent to create a design for the “purpose of ornamenting.” *In re Carletti*, 328 F.2d 1020, 1022, 140 USPQ 653, 654 (CCPA 1964). >Attorney’s arguments are not a substitute for evidence. Once a proper *prima facie* case of lack of ornamentality is established by the examiner, it is incumbent upon applicant to come forth with countervailing evidence to rebut the rejection made by the examiner. Evidence may be provided by the applicant or a representative of the company which commissioned the design to establish the ornamentality of the design by providing evidence of the motivation behind the creation of a design. *Ex parte Webb*, 30 USPQ2d 1064, 1067-68 (Bd. Pat.

App. & Int. 1993).< Form paragraph 15.08 or 15.08.01, where appropriate, may be used to reject a claim under 35 U.S.C. 171 for lack of ornamentality. \*\*>

#### ¶ 15.08 Lack of Ornamentality (Article Visible in End Use)

The claim is rejected under 35 U.S.C. 171 as being directed to nonstatutory subject matter in that it lacks ornamentality. To be patentable, a design must be “created for the purpose of ornamenting” the article in which it is embodied. See *Seiko Epson Corp. v. Nu-Kote Int’l Inc.*, 190 F.3d 1360, 52 USPQ2d 1011 (Fed. Cir. 1999); *Best Lock Corp. v. Ilco Unican Corp.*, 94 F.3d 1563, 40 USPQ2d 1048 (Fed. Cir. 1996); *Avia Group International Inc. v. L. A. Gear California Inc.*, 853 F.2d 1557, 7 USPQ2d 1548 (Fed. Cir. 1988); *Power Controls Corp. v. Hybrinetics, Inc.*, 806 F.2d 234, 231 USPQ 774 (Fed. Cir. 1986); *In re Carletti*, 328 F.2d 1020, 140 USPQ 653 (CCPA 1964); *Hygienic Specialties Co. v. H.G. Salzman, Inc.*, 302 F.2d 614, 133 USPQ 96 (2d Cir. 1962); *A & H Manufacturing Co. v. Contempo Card Co.*, 576 F. Supp. 894, 221 USPQ 67 (D. R.I. 1983); *Blisscraft of Hollywood v. United Plastic Co.*, 189 F.Supp. 333, 127 USPQ 452 (S.D.N.Y. 1960), 294 F.2d 694, 131 USPQ 55 (2d Cir. 1961); *Jones v. Progress Ind. Inc.*, 163 F.Supp. 824, 119 USPQ 92 (D. R.I. 1958); and *Ex parte Webb*, 30 USPQ2d 1064 (Bd. Pat. App. & Inter. 1993) .

The following evidence establishes a *prima facie* case of a lack of ornamentality: [1]

An affidavit/declaration under 37 CFR 1.132 may be submitted from applicant or a representative of the company, which commissioned the design, explaining specifically and in depth, which features or area of the claim were created with a concern for the appearance of the design not dictated by function.

Within the above affidavit/declaration, possible alternative ornamental designs which could have served the same function may also be submitted as evidence that the appearance of the claimed design was the result of ornamental considerations. *L. A. Gear v. Thom McAn Shoe Co.*, 988 F.2d 1117, 25 USPQ2d 1913 (Fed. Cir. 1993). Advertisements which emphasize the ornamentality of the article embodying the claimed design may also be submitted as evidence to rebut this rejection. *Berry Sterling Corp. v. Pescor Plastics Inc.*, 122 F.3d 1452, 43 USPQ2d 1953 (Fed. Cir. 1997). Evidence that the appearance of the design is ornamental may be shown by distinctness from the prior art as well as an attempt to develop or to maintain consumer recognition of the article embodying the design. *Seiko Epson Corp. v. Nu-Kote Int’l Inc.*, 190 F.3d 1360, 52 USPQ2d 1011 (Fed. Cir. 1999).

Attorney arguments are not a substitute for evidence to establish the ornamentality of the claim. *Ex parte Webb*, 30 USPQ2d 1064, 1067-68 (Bd. Pat. App. & Inter. 1993).

Evidence may be provided by the applicant or a representative of the company which commissioned the design to establish the ornamentality of the design by providing evidence of the motivating factors behind the creation of the design. This information will enable the examiner to determine if the design as a whole was created with “thought of ornament” meeting the requirement of 35 U.S.C. 171 that a design be ornamental. *In re Carletti*, 328 F.2d 1020, 140 USPQ 653 (CCPA 1964); *Ex parte Webb*, 30 USPQ2d 1064 (Bd. Pat. App. & Int. 1993).

**Examiner Note:**

In bracket 1, insert source of evidence of lack of ornamentality, for example, a utility patent, a brochure, a response to a letter of inquiry, etc.

¶ 15.08.01 *Lack of Ornamentality (Article Not Visible in its Normal and Intended Use)*

The claim is rejected under 35 U.S.C. 171 as being directed to nonstatutory subject matter in that the design lacks ornamentality. To be patentable, a design must be “created for the purpose of ornamenting” the article in which it is embodied. The fact that the claim is hidden during its normal and intended use establishes that the design would be “primarily functional” and its appearance would not be a matter of concern. See *Seiko Epson Corp. v. Nu-Kote Int’l Inc.*, 190 F.3d 1360, 52 USPQ2d 1011 (Fed. Cir. 1999); *In re Webb*, 916 F.2d 1553, 16 USPQ 2d 1433 (Fed. Cir. 1990); *In re Carletti*, 328 F.2d 1020, 140 USPQ 653 (CCPA 1964); *In re Cornwall*, 230 F.2d 457, 109 USPQ 57 (CCPA 1956); *In re Stevens*, 173 F.2d 1015, 81 USPQ 362 (CCPA 1949); *Larson v. ClassicCorp.*, 683 F. Supp. 1202, 7 USPQ2d 1747 (N.D. Ill. 1988); *Norco Products, Inc. v. Mecca Development, Inc.*, 617 F. Supp. 1079, 227 USPQ 724 (D. Conn. 1985); *C & M Fiberglass Septic Tanks, Inc. v. T & N Fiberglass Mfg. Co.*, 214 USPQ 159 (D. S.C. 1981); *Blisscraft of Hollywood v. United Plastic Co.*, 189 F.Supp. 333, 127 USPQ 452 (S.D.N.Y. 1960), 294 F.2d 694, 131 USPQ 55 (2d Cir. 1961); and *Ex parte Webb*, 30 USPQ 2d 1064 (Bd. Pat. App. & Inter. 1993).

The following evidence establishes a *prima facie* case of lack of ornamentality: [1]

In an attempt to establish that the appearance of the design is a “matter of concern” during the period between its manufacture and its ultimate end use, applicant may submit a showing that the ornamental appearance of the article was of concern to prospective customers/users or an affidavit/declaration from actual customers/users attesting to their concern with the design of the article. The “normal use” of a design during its commercial life is “limited to the ordinary function for which it was designed ... items are not designed for sale, display, replacement or repair”, *Norco Products, inc. v. Mecca Development, Inc.*, 617 F. Supp. 1079, 227 USPQ 724 (D. Conn. 1985). Visibility during sale, display, replacement or repair does not demonstrate that the design is visible during normal use and will not avoid the requirement that applicant must establish that its ornamental appearance is of concern during its commercial life. Unless applicant is directly involved with the sale of the design or works with users of the design, he cannot provide factual evidence as to the reasons for the purchase/selection of the article embodying the design.

It would then be necessary to establish that during this period of visibility the design as a whole was created for the “purpose of ornamenting” or with “thought of ornament,” and therefore, that the design is “primarily ornamental.”

An affidavit/declaration under 37 CFR 1.132 may be submitted from applicant or a representative of the company, which commissioned the design, explaining specifically and in depth, which features or area of the claim were created with a concern for the appearance of the design not dictated by function.

Within the above affidavit/declaration, possible alternative ornamental designs which could have served the same function may also be submitted as evidence that the appearance of the claimed design was the result of ornamental considerations. *L. A. Gear v. Thom McAn Shoe Co.*, 988 F.2d 1117, 25 USPQ2d 1913 (Fed. Cir. 1993). Advertisements which emphasize the ornamentality of the article embodying the claimed design may also be submitted as evidence to rebut this rejection. *Berry Sterling Corp. v. Pescor Plastics Inc.*, 122 F.3d 1452, 43 USPQ2d 1953 (Fed. Cir. 1997). Evidence that the appearance of the design is ornamental may be shown by distinctness from the prior art as well as an attempt to develop or to maintain consumer recognition of the article embodying the design. *Seiko Epson Corp. v. Nu-Kote Int’l Inc.*, 190 F.3d 1360, 52 USPQ2d 1011 (Fed. Cir. 1999).

Attorney arguments are insufficient to establish the ornamentality of the claim as only the applicant or a representative of the company which commissioned the design can provide evidence of the motivating factors behind the creation of the design. *Power Controls Corp. v. Hybrinetics, Inc.*, 806 F.2d 234, 231 USPQ 774 (Fed. Cir. 1986); *Ex parte Webb*, 30 USPQ2d 1064 (Bd. Pat. App. & Inter. 1993).

This information will enable the examiner to determine if the design as a whole was created with “thought of ornament” meeting the requirement of 35 U.S.C. 171 that a design be ornamental. (*In re Carletti*, 328 F.2d 1020, 140 USPQ 653 (CCPA 1964); *Ex parte Webb*, 30 USPQ2d 1064 (Bd. Pat. App. & Int. 1993)).

**Examiner Note:**

In bracket 1, insert source of evidence of design lacking ornamentality, for example, an analysis of the design and a utility patent, a brochure, a response to a letter of inquiry.

<

\*>

#### IV. < EVALUATION OF EVIDENCE SUBMITTED TO OVERCOME A REJECTION UNDER 35 U.S.C. 171

In order to overcome a rejection of the claim under 35 U.S.C. 171 as lacking in ornamentality, applicant must provide evidence that he or she created the design claimed for the “purpose of ornamenting” as required by the court in *In re Carletti*, 328 F.2d 1020, 1022, 140 USPQ 653, 654 (CCPA 1964). This information must be submitted in the form of an affidavit or declaration under 37 CFR 1.132 over applicant’s signature clearly explaining, specifically and in depth, which areas of the claimed design were created for primarily ornamental reasons. This may be demonstrated by showing that the creation of specific features was done with “thought of ornament.” *In re Carletti*, 328 F.2d 1020, 1022, 140 USPQ 653, 655 (CCPA 1964). Evidence to show ornamentality

may also be submitted by way of an affidavit or declaration under 37 CFR 1.132 from a representative of the company which commissioned the design, as these sources could establish the intent behind the creation of the design. Applicant may also show that the functional features of the design can be equally accomplished in other ways by giving specific examples which establish that design choice was the basis for the selection of features. *Best Lock Corp. v. Ilco Unican Corp.*, 94 F.3d 1563, 40 USPQ2d 1048 (Fed. Cir. 1996); *Ex parte Webb*, 30 USPQ2d 1064 (Bd. Pat. App. & Inter. 1993). Attorney arguments are insufficient to establish such intent, as only the applicant can know the motivation behind the creation of a design. *Power Controls Corp. v. Hybrinetics, Inc.*, 806 F.2d 234, 231 USPQ 774 (Fed. Cir. 1986); *Ex parte Webb*, 30 USPQ2d 1064 (Bd. Pat. App. & Inter. 1993).

The mere display of the article embodying the design at trade shows or its inclusion in catalogs is insufficient to establish ornamentality. *Ex parte Webb*, 30 USPQ2d 1064 (Bd. Pat. App. & Inter. 1993). There must be some clear and specific indication of the ornamentality of the design in this evidence for it to be given probative weight in overcoming the *prima facie* lack of ornamentality. *Berry Sterling Corp. v. Pescor Plastics Inc.*, 122 F.3d 1452, 43 USPQ2d 1953 (Fed. Cir. 1997).

The examiner must then evaluate this evidence in light of the design as a whole to decide if the claim is primarily ornamental. It is important to be aware that this determination is not based on the size or amount of the features identified as ornamental but rather on their influence on the overall appearance of the design.

In a rejection of a claim under 35 U.S.C. 171 in which >some of< the evidentiary basis for the rejection is that the design would be hidden during its end use, the applicant must establish that the “article’s design is a ‘matter of concern’ because of the nature of its visibility at some point between its manufacture or assembly and its ultimate use.” *In re Webb*, 916 F.2d 1553, 1558, 16 USPQ2d 1433, 1436 (Fed. Cir. 1990). >This concern may be shown by the submission of evidence that the appearance of the article was of concern during its period of commercial life by declarations from prospective/actual customers/users attesting that the ornamentality of the article was of

concern to them. Unless applicant is directly involved with the sale of the design or works with users of the design, he or she cannot provide factual evidence as to the reasons for the purchase/selection of the article embodying the design.<

Once applicant has proven that there is a period of visibility during which the ornamentality of the design is a “matter of concern,” it is then necessary to determine whether the claimed design was primarily ornamental during that period. *Larson v. Classic Corp.*, 683 F. Supp. 1202, 7 USPQ2d 1747 (N. D. Ill. 1988). The fact that a design would be visible during its commercial life is not sufficient evidence that the design was “created for the purpose of ornamenting” as required by the court in *In re Carletti*, 328 F.2d 1020, 1022, 140 USPQ 653, 654 (CCPA 1964). Examiners should follow the standard for determining ornamentality as outlined above.

“The possibility of encasing a heretofore concealed design element in a transparent cover for no reason other than to avoid this rule cannot avoid the visibility [guideline]... , lest it become meaningless.” *Norco Products Inc. v. Mecca Development Inc.*, 617 F. Supp. 1079, 1081, 227 USPQ 724, 726 (D. Conn. 1985). Applicant cannot rely on mere possibilities to provide factual evidence of ornamentality for the claimed design.

The requirements >for< visibility >of< the design **and** that it was created for the “purpose of ornamenting” must be met for a rejection under 35 U.S.C. 171 to be overcome if the design would be hidden during its end use.<

### 1504.01(d) Simulation

35 U.S.C. 171 requires that a design to be patentable be “original.” Clearly, a design which simulates an existing object or person is not original as required by the statute. The Supreme Court in *Gorham Manufacturing Co. v. White*, 81 U.S. (14 Wall) 511 (1871), described a design as “the thing invented or produced, for which a patent is given.” “The arbitrary chance selection of a form of a now well known and celebrated building, to be applied to toys, inkstands, paper - weights, etc. does not, in my opinion, evince the slightest exercise of invention...” *Bennage v. Phillippi*, 1876 C.D. 135, 9 O.G. 1159 (Comm’r Pat. 1876). This logic was reinforced by the CCPA in *In re Smith*, 25 USPQ 359, 360, 1935 C.D. 565, 566

(CCPA 1935), which stated that “to take a natural form, in a natural pose, ... does not constitute invention” when affirming the rejection of a claim to a baby doll. This premise was also applied in *In re Smith*, 25 USPQ 360, 362, 1935 C.D. 573, 575 (CCPA 1935), which held that a “baby doll simulating the natural features...of a baby without embodying some grotesqueness or departure from the natural form” is not patentable.

Therefore, a claim directed to a design for an article which simulates a well known or naturally occurring object or person should be rejected under 35 U.S.C. 171 as nonstatutory subject matter in that the claimed design lacks originality. Form paragraph 15.08.02 should be used. However, when a claim is rejected on this basis, examiners should provide evidence, if possible, of the appearance of the object, person or naturally occurring form in question so that a comparison may be made to the claimed design. Form paragraph 15.08.03 should be used. It would also be appropriate, if the examiner has prior art which anticipates or renders the claim obvious, to reject the claim under either 35 U.S.C. 102 or 103(a) concurrently. *In re Wise*, 340 F.2d 982, 144 USPQ 354 (CCPA 1965).

¶ 15.08.02 *Simulation (Entire Article)*

The claim is rejected under 35 U.S.C. 171 as being directed to nonstatutory subject matter in that the design lacks originality. The design is merely simulating [1] which applicant himself did not invent. See *In re Smith*, 25 USPQ 359, 1935 C.D. 565 (CCPA 1935); *In re Smith*, 25 USPQ 360, 1935 C.D. 573 (CCPA 1935); and *Bennage v. Phillippi*, 1876 C.D. 135, 9 O.G. 1159.

**Examiner Note:**

1. In bracket 1, insert the name of the article or person being simulated, e.g., the White House, Marilyn Monroe, an animal which is not stylized or caricatured in any way, a rock or shell to be used as paperweight, etc.
2. This form paragraph should be followed by form paragraph 15.08.03 when evidence has been cited to show the article or person being simulated.

¶ 15.08.03 *Explanation of evidence cited in support of simulation rejection*

Applicant's design has in no way departed from the natural appearance of [1]. This reference is not relied on in this rejection but is supplied merely as representative of the usual or typical appearance of [2] in order that the claim may be compared to that which it is simulating.

**Examiner Note:**

1. In bracket 1, insert name of article or person being simulated and source (patent, publication, etc.).

2. In bracket 2, insert name of article or person being simulated.

## 1504.01(e) Offensive Subject Matter

Design applications which disclose subject matter which could be deemed offensive to any race, religion, sex, ethnic group, or nationality, such as those which include caricatures or depictions, should be rejected as nonstatutory subject matter under 35 U.S.C. 171. See also MPEP § 608. Form paragraph 15.10 should be used.

¶ 15.10 *Offensive Subject Matter*

The disclosure, and therefore the claim in this application, is rejected as being offensive and therefore improper subject matter for design patent protection under 35 U.S.C. 171. Such subject matter does not meet the statutory requirements of 35 U.S.C. 171. Moreover, since 37 CFR 1.3 proscribes the presentation of papers which are lacking in decorum and courtesy, and this includes depictions of caricatures in the disclosure, drawings, and/or a claim which might reasonably be considered offensive, such subject matter as presented herein is deemed to be clearly contrary to 37CFR 1.3. See MPEP § 608.

## 1504.02 Novelty [R-2]

35 U.S.C. 102. *Conditions for patentability; novelty and loss of right to patent.*

A person shall be entitled to a patent unless —

- (a) the invention was known or used by others in this country, or patented or described in a printed publication in this or a foreign country, before the invention thereof by the applicant for patent, or
- (b) the invention was patented or described in a printed publication in this or a foreign country or in public use or on sale in this country, more than one year prior to the date of the application for patent in the United States, or
- (c) he has abandoned the invention, or
- (d) the invention was first patented or caused to be patented, or was the subject of an inventor's certificate, by the applicant or his legal representatives or assigns in a foreign country prior to the date of the application for patent in this country on an application for patent or inventor's certificate filed more than twelve months before the filing of the application in the United States, or

\*\*>

- (e) the invention was described in — (1) an application for patent, published under section 122(b), by another filed in the United States before the invention by the applicant for patent or (2) a patent granted on an application for patent by another filed in the United States before the invention by the applicant for patent, except that an international application filed under the treaty defined in section 351(a) shall have the effects for the purposes of this subsection of an application filed in the United States only if the international application designated the United States and was

published under Article 21(2) of such treaty in the English language; or<

(f) he did not himself invent the subject matter sought to be patented, or

(g)(1)during the course of an interference conducted under section 135 or section 291, another inventor involved therein establishes, to the extent permitted in section 104, that before such person's invention thereof the invention was made by such other inventor and not abandoned, suppressed, or concealed, or (2) before such person's invention thereof, the invention was made in this country by another inventor who had not abandoned, suppressed, or concealed it. In determining priority of invention under this subsection, there shall be considered not only the respective dates of conception and reduction to practice of the invention, but also the reasonable diligence of one who was first to conceive and last to reduce to practice, from a time prior to conception by the other.

### 35 U.S.C. 172. Right of priority.

The right of priority provided for by subsections (a) through (d) of section 119 of this title and the time specified in section 102(d) shall be six months in the case of designs. The right of priority provided for by section 119(e) of this title shall not apply to designs.

The standard for determining novelty under 35 U.S.C. 102 was set forth by the court in *In re Bartlett*, 300 F.2d 942, 133 USPQ 204 (CCPA 1962). "The degree of difference [from the prior art] required to establish novelty occurs when the average observer takes the new design for a different, and not a modified, already-existing design." 300 F.2d at 943, 133 USPQ at 205 (quoting Shoemaker, Patents For Designs, page 76). In design patent applications, the factual inquiry in determining anticipation over a prior art reference is the same as in utility patent applications. That is, the reference "must be identical in all material respects." *Hupp v. Siroflex of America Inc.*, 122 F.3d 1456, 43 USPQ2d 1887 (Fed. Cir. 1997).

The "average observer" test does not require that the claimed design and the prior art be from analogous arts when evaluating novelty. *In re Glavas*, 230 F.2d 447, 450, 109 USPQ 50, 52 (CCPA 1956). Insofar as the "average observer" under 35 U.S.C. 102 is not charged with knowledge of any art, the issue of analogousness of prior art need not be raised. This distinguishes 35 U.S.C. 102 from 35 U.S.C. 103(a) which requires determination of whether the claimed design would have been obvious to "a person of ordinary skill in the art."

When a claim is rejected under 35 U.S.C. 102 as being unpatentable over prior art, those features of the

design which are functional and/or hidden during end use may not be relied upon to support patentability. *In re Cornwall*, 230 F.2d 447, 109 USPQ 57 (CCPA 1956); *Jones v. Progress Ind. Inc.*, 119 USPQ 92 (D. R.I. 1958). Further, in a rejection of a claim under 35 U.S.C. 102, mere differences in functional considerations do not negate a finding of anticipation when determining design patentability. *Black & Decker, Inc. v. Pittway Corp.*, 636 F.2d 1193, 231 USPQ 252 (N.D. Ill. 1986).

It is not necessary for the examiner to cite or apply prior art to show that functional and/or hidden features are old in the art as long as the examiner has properly relied on evidence to support the *prima facie* lack of ornamentality of these individual features. If applicant wishes to rely on functional or hidden features as a basis for patentability, the same standard for establishing ornamentality under 35 U.S.C. 171 must be applied before these features can be given any patentable weight. See MPEP § 1504.01(c).

In evaluating a statutory bar based on 35 U.S.C. 102(b), the experimental use exception to a statutory bar for public use or sale (see MPEP § 2133.03(e)) does not usually apply for design patents. See *In re Mann*, 861 F.2d 1581, 8 USPQ2d 2030 (Fed. Cir. 1988). However, *Tone Brothers, Inc. v. Sysco Corp.*, 28 F.3d 1192, 1200, 31 USPQ2d 1321, 1326 (Fed. Cir. 1994) held that "experimentation directed to functional features of a product also containing an ornamental design may negate what otherwise would be considered a public use within the meaning of section 102(b)." See MPEP § 2133.03(e)(6).

Registration of a design abroad is considered to be equivalent to patenting under 35 U.S.C. 119(a)-(d) and 35 U.S.C. 102(d), whether or not the foreign grant is published. (See *Ex parte Lancaster*, 151 USPQ 713 (Bd. App. 1965); *Ex parte Marinissen*, 155 USPQ 528 (Bd. App. 1966); *Appeal No. 239-48, Decided April 30, 1965*, 151 USPQ 711, (Bd. App. 1965); *Ex parte Appeal decided September 3, 1968*, 866 O.G. 16 (Bd. App. 1966). The basis of this practice is that if the foreign applicant has received the protection offered in the foreign country, no matter what the protection is called ("patent," "Design Registration," etc.), if the United States application is timely filed, a claim for priority will vest. If, on the other hand, the U.S. application is not timely filed, a statutory bar arises under 35 U.S.C. 102(d) as modified by 35 U.S.C. 172.

In order for the filing to be timely for priority purposes and to avoid possible statutory bars, the U.S. design patent application must be made within 6 months of the foreign filing. See also MPEP § 1504.10.

The laws of each foreign country vary in one or more respects.

The following table sets forth the dates on which design rights can be enforced in a foreign country (INID Code (24)) and thus, are also useable in a 35 U.S.C. 102(d) rejection as modified by 35 U.S.C. 172. It should be noted that in many countries the date of registration or grant is the filing date.

Country or Organization	Date(s) Which Can Also Be Used for 35 U.S.C. 102(d) Purposes <sup>1</sup> (INID Code (24))	Comment
AT-Austria	Protection starts on the date of publication of the design in the official gazette	
AU-Australia	Date of registration or grant which is the filing date	
BG-Bulgaria	Date of registration or grant which is the filing date	
BX-Benelux (Belgium, Luxembourg, and the Netherlands)	Date on which corresponding application became complete and regular according to the criteria set by the law	
CA-Canada	Date of registration or grant	
CH-Switzerland	Date of registration or grant which is the filing date	Minimum requirements: deposit application, object, and deposit fee
CL-Chile	Date of registration or grant	
CU-Cuba	Date of registration or grant which is the filing date	
CZ-Czech Republic	Date of registration or grant which is the filing date	
DE-Germany	Date of registration or grant	The industrial design right can be enforced by a court from the date of registration although it is in force earlier (as from the date of filing—as defined by law).
DK-Denmark	Date of registration or grant which is the filing date	
EG-Egypt	Date of registration or grant which is the filing date	
ES-Spain	Date of registration or grant	
FI-Finland	Date of registration or grant which is the filing date	
FR-France	Date of registration or grant which is the filing date	



Country or Organization	Date(s) Which Can Also Be Used for 35 U.S.C. 102(d) Purposes <sup>1</sup> (INID Code (24))	Comment
GB-United Kingdom	Date of registration or grant which is the filing date	Protection arises automatically under the Design Right provision when the design is created. Proof of the date of the design creation needs to be kept in case the design right is challenged. The protection available to designs can be enforced in the courts following the date of grant of the Certificate of Registration as of the date of registration which stems from the date of first filing of the design in the UK or, if a priority is claimed under the Convention, as another country.
HU-Hungary	Date of registration or grant	With retroactive effect as from the filing date
JP-Japan	Date of registration or grant	
KR-Republic of Korea	Date of registration or grant	
MA-Morocco	Date of registration or grant which is the filing date	
MC-Monaco	Date of registration or grant which is the filing date	Date of prior disclosure declared on deposit
NO-Norway	Date of registration or grant which is the filing date	
OA-African Intellectual Property Organization (OAPI) (Benin, Burkina Faso, Cameroon, Central African Republic, Chad, Congo, Cote d'Ivoire, Gabon, Guinea, Mali, Mauritania, Niger, Senegal, and Togo)	Date of registration or grant which is the filing date	
PT-Portugal	Date of registration or grant	
RO-Romania	Date of registration or grant which is the filing date	
RU-Russian Federation	Date of registration or grant which is the filing date	

Country or Organization	Date(s) Which Can Also Be Used for 35 U.S.C. 102(d) Purposes <sup>1</sup> (INID Code (24))	Comment
SE-Sweden	Date of registration or grant	
TN-Tunisia	Date of registration or grant which is the filing date	
TT-Trinidad and Tobago	Date of registration or grant which is the filing date	
WO-World Intellectual Property Organization (WIPO)		Subject to Rule 14.2 of the Regulations (on defects), the International Bureau enters the international deposit in the International Register on the date on which it has in its possession the application together with the items required. Reproductions, samples, or models pursuant to Rule 12, and the prescribed fees.

<sup>1</sup>Based on information taken from the “Survey of Filing Procedures and Filing Requirements, as well as of Examination Methods and Publication Procedures, Relating to Industrial Designs” as adopted by the PCIPI Executive Coordination Committee of the World Intellectual Property Organization (WIPO) at its fifteenth session on November 25, 1994.

Rejections under 35 U.S.C. 102(d) as modified by 35 U.S.C. 172 should only be made when the examiner knows that the application for foreign registration/patent has actually issued before the U. S. filing date based on an application filed more than six (6) months prior to filing the application in the United States. If the grant of a registration/patent based on the foreign application is not evident from the record of the U. S. application or from information found within the preceding charts, then the statement below should be included in the first action on the merits of the application:

*¶ 15.03.01 Foreign Filing More Than 6 Months Before U.S. Filing*

Acknowledgment is made of the [1] application identified in the declaration which was filed more than six months prior to the filing date of the present application. Applicant is reminded that if the [2] application matured into a form of patent protection before the filing date of the present application it would constitute a statutory bar to the issuance of a design patent in the United States under 35 U.S.C. 102(d) in view of 35 U.S.C. 172.

**Examiner Note:**

In brackets 1 and 2, insert the name of country where application was filed.

Form paragraphs for use in rejections under 35 U.S.C. 102 are set forth below.

*¶ 15.11 35 U.S.C. 102(a) Rejection*

The claim is rejected under 35 U.S.C. 102(a) as being clearly anticipated by [1] because the invention was known or used by others in this country, or patented or described in a printed publication in this or a foreign country before the invention thereof by the applicant for patent.

*¶ 15.12 35 U.S.C. 102(b) Rejection*

The claim is rejected under 35 U.S.C. 102(b) as being clearly anticipated by [1] because the invention was patented or described in a printed publication in this or a foreign country, or in public use or on sale in this country more than one (1) year prior to the application for patent in the United States.

*¶ 15.13 35 U.S.C. 102(c) Rejection*

The claim is rejected under 35 U.S.C. 102(c) because the invention has been abandoned.

*¶ 15.14 35 U.S.C. 102(d)/172 Rejection*

The claim is rejected under 35 U.S.C. 102(d), as modified by 35 U.S.C. 172, as being clearly anticipated by [1] because the invention was first patented or caused to be patented, or was the subject of an inventor's certificate by the applicant, or his/her legal representatives or assigns in a foreign country prior to the date of the application for patent in this country on an application for patent or inventor's certificate filed more than six (6) months before the filing of the application in the United States.

*¶ 15.15 35 U.S.C. 102(e) Rejection*

The claim is rejected under 35 U.S.C. 102(e) as being clearly anticipated by [1] because the invention was described in a patented or published application for patent by another filed in the United States before the invention thereof by the applicant for patent.

*¶ 15.16 35 U.S.C. 102(f) Rejection*

The claim is rejected under 35 U.S.C. 102(f) because applicant did not himself invent the subject matter sought to be patented.

*¶ 15.17 35 U.S.C. 102(g) Rejection*

The claim is rejected under 35 U.S.C. 102(g) because, before the applicant's invention thereof, the invention was made in this country by another who had not abandoned, suppressed or concealed it.

\*\*>

*¶ 15.24.05 Identical Claim: Common Assignee*

The claim is directed to the same invention as that of the claim of commonly assigned copending Application No. [1]. The issue of priority under 35 U.S.C. 102(g) and possibly 35 U.S.C. 102(f) of this single invention must be resolved. Since the U.S. Patent and Trademark Office normally will not institute an interference between applications or a patent and an application of common ownership (see MPEP § 2302), the assignee is required to state which entity is the prior inventor of the conflicting subject matter. A terminal disclaimer has no effect in this situation since the basis for refusing more than one patent is priority of invention under 35 U.S.C. 102(f) or (g) and not an extension of monopoly. Failure to comply with this requirement will result in a holding of abandonment of this application.

The following form paragraph should be included after the form paragraph setting forth the rejection under 35 U.S.C. 102 (a), (b), (d) or (e) to provide an explanation of the applied reference.

*¶ 15.15.01 Explanation of rejection under 35 U.S.C. 102(a), (b), (d), or (e)*

The shape and appearance of [1] is identical in all material respects to that of the claimed design, *Hupp v. Siroflex of America Inc.*, 122 F.3d 1456, 43 USPQ2d 1887 (Fed. Cir. 1997).

**Examiner Note:**

1. This paragraph should be included after paragraph 15.11, 15.12, 15.14 or 15.15 to explain the basis of the rejection.
2. In bracket [1], identify the reference applied against the claimed design.

The following form paragraphs may be used to reject a claim under 35 U.S.C. 102(e) over an application or patent having an earlier effective U.S. filing date with a common inventor and/or assignee, or that discloses but does not claim the design.

\*\*>

*¶ 15.15.02 Provisional 35 U.S.C. 102(e) rejection - design disclosed but not claimed in another application with common inventor and/or assignee*

The claim is provisionally rejected under 35 U.S.C. 102(e) as being anticipated by copending Application No. [1] which has a common [2] with the instant application.

Based upon the different inventive entity and the earlier effective U.S. filing date of the copending application, it would constitute prior art under 35 U.S.C. 102(e), if published under 35 U.S.C. 122(b) or patented. This provisional rejection under 35 U.S.C. 102(e) is based upon a presumption of future publication or patenting of the copending application.

Since the design claimed in the present application is not the same invention claimed in the [3] application, the examiner suggests overcoming this provisional rejection in one of the following ways: (A) a showing under 37 CFR 1.132 that the design in the reference was derived from the designer of this application and is thus not the invention 'by another;' (B) a showing of a date of invention for the instant application prior to the effective U.S. filing date of the reference under 37 CFR 1.131; (C) Perfecting a claim to priority under 35 U.S.C. 119 that antedates the reference by filing a certified priority document in the application that satisfies the enablement and description requirements of 35 U.S.C. 112, first paragraph; or (D) Perfecting priority under 35 U.S.C. 120 by amending the specification of the application to contain a specific reference to a prior application or by filing an application data sheet under 37 CFR 1.76 which contains a specific reference to a prior application in accordance with 37 CFR 1.78(a) and establishing that the prior application satisfies the enablement and description requirements of 35 U.S.C. 112, first paragraph.

This rejection may not be overcome by the filing of a terminal disclaimer. See *In re Bartfeld*, 925 F.2d 1450, 17 USPQ2d 1885 (Fed. Cir. 1991).

**Examiner Note:**

1. This form paragraph is used to provisionally reject over a copending application (utility or design) with an earlier filing date that discloses (but does not claim) the claimed invention which has not been patented or published under 35 U.S.C. 122. The copending application must have either a common assignee or at least one common inventor.
2. Use 35 U.S.C. 102(e) as amended by the American Inventor's Protection Act (form paragraph 7.12) to determine the reference's prior art date, unless the reference is a U.S. patent issued directly, or indirectly, from an international application which has an international filing date prior to November 29, 2000. Use pre-AIPA 35 U.S.C. 102(e) (form paragraph 7.12.01) only if the reference is a U.S. patent issued directly or indirectly from either a national stage of an international application (application under 35 U.S.C. 371) which has an international filing date prior to November 29, 2000 or a continuing application claiming benefit under 35 U.S.C. 120, 121, or 365 (c) to an international application having an international filing date prior to November 29, 2000. See the Examiner Notes for form paragraphs 7.12 and 7.12.01 to assist in the determination of the 35 U.S.C. 102(e) date.

3. In bracket 2, insert inventor or assignee.

*¶ 15.15.03 Provisional 35 U.S.C. 102(e) rejection - design claimed in an earlier filed design patent application with common inventor and/or assignee*

The claim is provisionally rejected under 35 U.S.C. 102(e) as being anticipated by the claim in copending Design Patent Application No. [1] which has a common [2] with the instant application.

Based upon the different inventive entity and the earlier effective U.S. filing date of the copending application, it would constitute prior art under 35 U.S.C. 102(e), if patented. This provisional rejection under 35 U.S.C. 102(e) is based upon a presumption of future patenting of the copending application. The rejection may be overcome by abandoning the earlier filed copending application.

**Examiner Note:**

1. In bracket 2, insert inventor or assignee.
2. This form paragraph must be preceded by form paragraph 15.24.05 to notify the applicant that the question of patentability under 35 U.S.C. 102(f)/(g) also exists.

<

*¶ 15.15.04 35 U.S.C. 102(e) rejection - design disclosed but not claimed in a patent*

The claim is rejected under 35 U.S.C. 102(e) as being anticipated by patent [1].

Based upon the different inventive entity and the earlier effective U.S. filing date of the reference, it constitutes prior art under 35 U.S.C. 102(e).

Since the design claimed in the present application is not the same invention claimed in patent [2], the examiner suggests overcoming this rejection in one of the following ways: A) a showing under 37 CFR 1.132 that the design in the reference was derived from the designer of this application and is thus not the invention "by another;" (B) a showing of a date of invention for the instant application prior to the effective U.S. filing date of the reference under 37 CFR 1.131; (C) Perfecting a claim to priority under 35 U.S.C. 119 that antedates the reference by filing a certified priority document in the application that satisfies the enablement and description requirements of 35 U.S.C. 112, first paragraph; or (D) Perfecting priority under 35 U.S.C. 120 by amending the specification of the application to contain a specific reference to a prior application or by filing an application data sheet under 37 CFR 1.76 which contains a specific reference to a prior application in accordance with 37 CFR 1.78(a) and establishing that the prior application satisfies the enablement and description requirements of 35 U.S.C. 112, first paragraph

This rejection may not be overcome by the filing of a terminal disclaimer. See *In re Bartfeld*, 925 F.2d 1450, 17 USPQ2d 1885 (Fed. Cir. 1991).

**Examiner Note:**

1. This form paragraph should be used when the claimed design in the application being examined is disclosed in the drawings of an earlier filed design or utility patent but is not claimed therein.

When the design claimed in the application being examined is disclosed in the drawings of an earlier filed design patent, it would most often be in the form of subcombination subject matter, (part or portion of an article), that is patentably distinct from the claim for the design embodied by the combination or whole article. It may also be unclaimed subject matter depicted in broken lines in the earlier filed application.

2. In brackets 1 and 2, insert number of patent.

<

The following form paragraphs may be used in a second or subsequent action, where appropriate.

¶ 15.38 *Rejection Maintained*

The arguments presented have been carefully considered, but are not persuasive that the rejection of the claim under [1] should be withdrawn.

**Examiner Note:**

In bracket 1, insert basis of rejection.

\*\*>

¶ 15.40.01 *Final Rejection Under Other Statutory Provisions*

The claim is again and FINALLY REJECTED under [1] as [2].

**Examiner Note:**

1. In bracket 1, insert statutory basis.
2. In bracket 2, insert reasons for rejection.
3. See paragraphs in MPEP Chapter 700, for “Action is Final” and “Advisory after Final” paragraphs.

<

### 1504.03 Nonobviousness [R-2]

35 U.S.C. 103. *Conditions for patentability; non-obvious subject matter.*

(a) A patent may not be obtained though the invention is not identically disclosed or described as set forth in section 102 of this title, if the differences between the subject matter sought to be patented and the prior art are such that the subject matter as a whole would have been obvious at the time the invention was made to a person having ordinary skill in the art to which said subject matter pertains. Patentability shall not be negated by the manner in which the invention was made.

\*\*\*\*\*

(c) Subject matter developed by another person, which qualifies as prior art only under one or more of subsections (e), (f), and (g) of section 102 of this title, shall not preclude patentability under this section where the subject matter and the claimed invention were, at the time the invention was made, owned by the same person or subject to an obligation of assignment to the same person.

A claimed design that meets the test of novelty must additionally be evaluated for nonobviousness under 35 U.S.C. 103(a).

#### I. GATHERING THE FACTS

The basic factual inquiries guiding the evaluation of obviousness, as outlined by the Supreme Court in *Graham v. John Deere Co.*, 383 U.S. 1, 148 USPQ 459 (1966), are applicable to the evaluation of design patentability:

- (A) Determining the scope and content of the prior art;
- (B) Ascertaining the differences between the claimed invention and the prior art;
- (C) Resolving the level of ordinary skill in the art; and
- (D) Evaluating any objective evidence of nonobviousness (i.e., so-called “secondary considerations”).

##### A. *Scope of the Prior Art*

The scope of the relevant prior art for purposes of evaluating obviousness under 35 U.S.C. 103(a) extends to all “analogous arts.”

While the determination of whether arts are analogous is basically the same for both design and utility inventions (see MPEP § 904.01(c) and § 2141.01(a)), *In re Glavas*, 230 F.2d 447, 450 109 USPQ 50, 52 (CCPA 1956) provides specific guidance for evaluating analogous arts in the design context, which should be used to supplement the general requirements for analogous art as follows:

The question in design cases is not whether the references sought to be combined are in analogous arts in the mechanical sense, but whether they are so related that the appearance of certain ornamental features in one would suggest the application of those features to the other.

Thus, if the problem is merely one of giving an attractive appearance to a surface, it is immaterial whether the surface in question is that of wall paper, an oven door, or a piece of crockery. . . .

On the other hand, when the proposed combination of references involves material modifications of the basic form of one article in view of another, the nature of the article involved is a definite factor in determining whether the proposed change involves [patentable] invention.

Therefore, where the differences between the claimed design and the prior art are limited to the application of ornamentation to the surface of an arti-

cle, any prior art reference which discloses substantially the same surface ornamentation would be considered analogous art. Where the differences are in the shape or form of the article, the nature of the articles involved must also be considered.

### **B. Differences Between the Prior Art and the Claimed Design**

In determining patentability under 35 U.S.C. 103(a), it is the overall appearance of the design that must be considered. *In re Leslie*, 547 F.2d 116, 192 USPQ 427 (CCPA 1977). The mere fact that there are differences between a design and the prior art is not alone sufficient to justify patentability. *In re Lamb*, 286 F.2d 610, 128 USPQ 539 (CCPA 1961).

All differences between the claimed design and the closest prior art reference should be identified in any rejection of the design claim under 35 U.S.C. 103(a). If any differences are considered *de minimis* or inconsequential from a design viewpoint, the rejection should so state.

### **C. Level of Ordinary Skill in the Art**

In order to be unpatentable, 35 U.S.C. 103(a) requires that an invention must have been obvious to a designer having “ordinary skill in the art” to which the subject matter sought to be patented pertains. The “level of ordinary skill in the art” from which obviousness of a design claim must be evaluated under 35 U.S.C. 103(a) has been held by the courts to be the perspective of the “designer of . . . articles of the types presented.” *In re Nalbandian*, 661 F.2d 1214, 1216, 211 USPQ 782, 784 (CCPA 1981); *In re Carter*, 673 F.2d 1378, 213 USPQ 625 (CCPA 1982).

### **D. Objective Evidence of Nonobviousness (Secondary Considerations)**

Secondary considerations, such as commercial success and copying of the design by others, are relevant to the evaluation of obviousness of a design claim. Evidence of nonobviousness may be present at the time a *prima facie* case of obviousness is evaluated or it may be presented in rebuttal of a prior obviousness rejection.

## **II. PRIMA FACIE OBVIOUSNESS**

Once the factual inquiries mandated under *Graham v. John Deere Co.*, 383 U. S. 1, 148 USPQ 459 (1966), have been made, the examiner must determine whether they support a conclusion of *prima facie* obviousness. To establish *prima facie* obviousness, all the claim limitations must be taught or suggested by the prior art.

In determining *prima facie* obviousness, the proper standard is whether the design would have been obvious to a designer of ordinary skill with the claimed type of article. *In re Nalbandian*, 661 F.2d 1214, 211 USPQ 782 (CCPA 1981).

As a whole, a design must be compared with something in existence, and not something brought into existence by selecting and combining features from prior art references. *In re Jennings*, 182 F.2d 207, 86 USPQ 68 (CCPA 1950). The “something in existence” referred to in *Jennings* has been defined as “...a reference... the design characteristics of which are basically the same as the claimed design...” *In re Rosen*, 673 F.2d 388, 391, 213 USPQ 347, 350 (CCPA 1982) (the primary reference did “...not give the same visual impression...” as the design claimed but had a “...different overall appearance and aesthetic appeal...”.) Hence, it is clear that “design characteristics” means overall visual appearance. This definition of “design characteristics” is reinforced in the decision of *In re Harvey*, 12 F.3d 1061, 1063, 29 USPQ2d 1206, 1208 (Fed. Cir. 1993), and is supported by the earlier decisions of *In re Yardley*, 493 F.2d 1389, 181 USPQ 331, 334 (CCPA 1974) and *In re Leslie*, 547 F.2d 116, 192 USPQ 427, 431 (CCPA 1977). Specifically, in the *Yardley* decision, it was stated that “[t]he basic consideration in determining the patentability of designs over prior art is similarity of appearance.” 493 F.2d at 1392-93, 181 USPQ at 334. Therefore, in order to support a holding of obviousness, a basic reference must be more than a design concept; it must have an appearance substantially the same as the claimed design. *In re Harvey*, 12 F.3d 1061, 29 USPQ2d 1206 (Fed. Cir. 1993). Absent such a reference, no holding of obviousness under 35 U.S.C. 103(a) can be made, whether based on a single reference alone or in view of modifications suggested by secondary prior art.

A rejection under 35 U.S.C. 103(a) based on a single non-analogous reference would not be proper. The

reason is that under 35 U.S.C. 103(a), a designer of ordinary skill would not be charged with knowledge of prior art that is not analogous to the claimed design.

Examiners are advised that differences between the claimed design and a basic reference may be held to be minor in nature and unrelated to the overall aesthetic appearance of the design with or without the support of secondary references. *In re Nalbandian*, 661 F.2d 1214, 211 USPQ 782 (CCPA 1981). If such differences are shown by secondary references, they should be applied so as to leave no doubt that those differences would have been obvious to a designer of ordinary skill in the art. *In re Sapp*, 324 F.2d 1021, 139 USPQ 522 (CCPA 1963).

When a claim is rejected under 35 U.S.C. 103(a) as being unpatentable over prior art, features of the design which are functional and/or hidden during end use may not be relied upon to support patentability. “[A] design claim to be patentable must also be ornamental; and functional features or forms cannot be relied upon to support its patentability.” *Jones v. Progress, Ind. Inc.*, 119 USPQ 92, 93 (D. R.I. 1958). “It is well settled that patentability of a design cannot be based on elements which are concealed in the normal use of the device to which the design is applied.” *In re Cornwall*, 230 F.2d 457, 459, 109 USPQ 57, 58 (CCPA 1956); *In re Garbo*, 287 F.2d 192, 129 USPQ 72 (CCPA 1961). It is not necessary that prior art be relied upon in a rejection under 35 U.S.C. 103(a) to show similar features to be functional and/or hidden in the art. However, examiners must provide evidence to support the *prima facie* functionality of such features. Furthermore, hidden portions or functional features cannot be relied upon as a basis for patentability. If applicant wishes to rely on functional or hidden features as a basis for patentability, then the same standard for establishing ornamentality under 35 U.S.C. 171 must be applied before these features can be given any patentable weight. See MPEP § 1504.01(c).

#### A. Combining Prior Art References

A rejection under 35 U.S.C. 103(a) would be appropriate if a designer of ordinary skill would have been motivated to modify a basic reference by deleting features thereof or by interchanging with or adding features from pertinent secondary references. In order for secondary references to be considered, there

must be some suggestion in the prior art to modify the basic design with features from the secondary references. *In re Borden*, 90 F.3d 1570, 1572, 39 USPQ2d 1524, 1526 (Fed. Cir. 1996). The long-standing test for properly combining references has been “...whether they are so related that the appearance of certain ornamental features in one would suggest the application of those features to the other.” *In re Glavas*, 230 F.2d 447, 450, 109 USPQ 50, 52 (CCPA 1956).

The prohibition against destroying the function of the design is inherent in the logic behind combining references to render a claimed invention obvious under 35 U.S.C. 103(a). If the proposed combination of the references so alters the primary reference that its broad function can no longer be carried out, the combination of the prior art would not have been obvious to a designer of ordinary skill in the art. It is permissible to modify the primary reference to the extent that the specific function of the article may be affected while the broad function is not affected. For example, a primary reference to a cabinet design claimed as airtight could be modified to no longer be airtight so long as its function as a cabinet would not be impaired.

#### 1. Analogous Art

When a modification to a basic reference involves a change in configuration, both the basic and secondary references must be from analogous arts. *In re Glavas*, 230 F.2d 447, 109 USPQ 50 (CCPA 1956). The reason for this is two-fold. First, a designer of ordinary skill is only charged with knowledge of art related to that of the claimed design. Second, the ornamental features of the references must be closely related in order for a designer of ordinary skill to have been motivated to have modified one in view of the other. Hence, when modifying a basic reference, a designer of ordinary skill would have looked at design features of other related references for precisely the purpose of observing the ornamental characteristics they disclosed.

Analogous art can be more broadly interpreted when applied to a claim that is directed to a design with a portion simulating a well known or naturally occurring object or person. The simulative nature of that portion of the design is *prima facie* evidence that

art which simulates that portion would be within the level of ordinary skill under 35 U.S.C. 103(a).

## 2. Non-analogous Art

When modifying the surface of a basic reference so as to provide it with an attractive appearance, it is immaterial whether the secondary reference is analogous art, since the modification does not involve a change in configuration or structure and would not have destroyed the characteristics (appearance and function) of the basic reference. *In re Glavas*, 230 F.2d 447, 109 USPQ 50 (CCPA 1956).

## III. REBUTTAL OF THE PRIMA FACIE CASE

Once a *prima facie* case of obviousness has been established, the burden shifts to the applicant to rebut it, if possible, with objective evidence of nonobviousness. Examples of secondary considerations are commercial success, expert testimony and copying of the design by others. Any objective evidence of nonobviousness or rebuttal evidence submitted by applicant, including affidavits or declarations under 37 CFR 1.132, must be considered by examiners in determining patentability under 35 U.S.C. 103(a).

When evidence of commercial success is submitted, examiners must evaluate it to determine whether there is objective evidence of success, and whether the success can be attributed to the ornamental design. *Litton System, Inc. v. Whirlpool Corp.*, 728 F.2d 1423, 221 USPQ 97 (Fed. Cir. 1984); *In re Nalbandian*, 661 F.2d 1214, 211 USPQ 782 (CCPA 1981). An affidavit or declaration under 37 CFR 1.132 has minimal evidentiary value on the issue of commercial success if there is no nexus or connection between the sales of the article in which the design is embodied and the ornamental features of the design. *Avia Group Int'l Inc. v. L.A. Gear*, 853 F.2d 1557, 7 USPQ2d 1548 (Fed. Cir. 1988).

Submission of expert testimony must establish the professional credentials of the person signing the affidavit or declaration, and should not express an opinion on the ultimate legal issue of obviousness since this conclusion is one of law. *Avia Group Int'l Inc. v. L.A. Gear*, 853 F.2d 1557, 7 USPQ2d 1548 (Fed. Cir. 1988); *Panduit Corp. v. Dennison Mfg. Co.*, 774 F.2d 1082, 227 USPQ 337 (Fed. Cir. 1985).

With regard to evidence submitted showing that competitors in the marketplace are copying the

design, more than the mere fact of copying is necessary to make that action significant because copying may be attributable to other factors such as lack of concern for patent property or indifference with regard to the patentee's ability to enforce the patent. *Cable Electric Products, Inc. v. Genmark, Inc.*, 770 F.2d 1015, 226 USPQ 881 (Fed. Cir. 1985).

"A *prima facie* case of obviousness can be rebutted if the applicant...can show that the art in any material respect 'taught away' from the claimed invention...A reference may be said to teach away when a person of ordinary skill, upon reading the reference...would be led in a direction divergent from the path that was taken by the applicant." *In re Haruna*, 249 F.3d 1327, 58USPQ2d 1517 (Fed. Cir. 2001).

For additional information regarding the issue of objective evidence of nonobviousness, attention is directed to MPEP § 716 through § 716.06.

The following form paragraph may be used in an obviousness rejection under 35 U.S.C. 103(a), where appropriate.

### ¶ 15.18 35 U.S.C. 103(a) Rejection (Single Reference)

The claim is rejected under 35 U.S.C. 103(a) as being unpatentable over [1]. Although the invention is not identically disclosed or described as set forth in 35 U.S.C. 102, if the differences between the subject matter sought to be patented and the prior art are such that the subject matter as a whole would have been obvious at the time the invention was made to a designer having ordinary skill in the art to which said subject matter pertains, the invention is not patentable.

### ¶ 15.70 Preface, 35 U.S.C. 103(a) Rejection

It would have been obvious to a designer of ordinary skill in the art at the time the invention was made to [1].

### Examiner Note:

Insert explanation of the use of the reference applied in bracket 1.

### ¶ 15.67 Rationale for 35 U.S.C. 103(a) Rejection (Single Reference)

It is well settled that it is unobviousness in the overall appearance of the claimed design, when compared with the prior art, rather than minute details or small variations in design as appears to be the case here, that constitutes the test of design patentability. See *In re Frick*, 275 F.2d 741, 125 USPQ 191 (CCPA 1960) and *In re Lamb*, 286 F.2d 610, 128 USPQ 539 (CCPA 1961).

### ¶ 15.19 35 U.S.C. 103(a) Rejection (Multiple References)

The claim is rejected under 35 U.S.C. 103(a) as being unpatentable over [1] in view of [2].

Although the invention is not identically disclosed or described as set forth in 35 U.S.C. 102, if the differences between the sub-



ject matter sought to be patented and the prior art are such that the subject matter as a whole would have been obvious at the time the invention was made to a designer of ordinary skill in the art to which said subject matter pertains, the invention is not patentable.

¶ *15.68 Rationale for 35 U.S.C. 103(a) Rejection (Multiple References)*

This modification of the basic reference in light of the secondary prior art is proper because the applied references are so related that the appearance of features shown in one would suggest the application of those features to the other. See *In re Rosen*, 673 F.2d 388, 213 USPQ 347 (CCPA 1982); *In re Carter*, 673 F.2d 1378, 213 USPQ 625 (CCPA 1982), and *In re Glavas*, 230 F.2d 447, 109 USPQ 50 (CCPA 1956). Further, it is noted that case law has held that a designer skilled in the art is charged with knowledge of the related art; therefore, the combination of old elements, herein, would have been well within the level of ordinary skill. See *In re Antle*, 444 F.2d 1168, 170 USPQ 285 (CCPA 1971) and *In re Nalbandian*, 661 F.2d 1214, 211 USPQ 782 (CCPA 1981).

\*\*>

The following form paragraphs may be used when making a rejection under 35 U.S.C. 103(a), where the reference application or patent is prior art under 35 U.S.C. 102(e).

¶ *15.19.02 Preface 35 U.S.C. 102(e)/103(a) rejection - Different inventors, common assignee, obvious designs, no evidence of common ownership at time later design was made*

The claim is directed to a design not patentably distinct from the design of commonly assigned [1]. Specifically, the claimed design is different from the one in [2] in that [3]. These differences are considered obvious and do not patentably distinguish the overall appearance of the claimed design over the design in [4].

The commonly assigned [5], discussed above, has a different inventive entity from the present application. Therefore, it qualifies as prior art under 35 U.S.C. 102(e), (f) or (g) and forms the basis for a rejection of the claim in the present application under 35 U.S.C. 103(a) if the conflicting design claims were not commonly owned at the time the design in this application was made. In order to resolve this issue, the applicant, assignee or attorney of record can state that the conflicting designs were commonly owned at the time the design in this application was made, or the assignee can name the prior inventor of the conflicting subject matter.

A showing that the designs were commonly owned at the time the design in this application was made will overcome a rejection under 35 U.S.C. 103(a) based upon the commonly assigned case as a reference under 35 U.S.C. 102(f) or (g), or 35 U.S.C. 102(e) for applications filed on or after November 29, 1999.

**Examiner Note:**

1. This form paragraph should be used when the application being examined is commonly assigned with a conflicting applica-

tion or patent, but there is no indication that they were commonly assigned at the time the invention was actually made.

2. If the conflicting claim is in a patent with an earlier U.S. filing date, a rejection under 35 U.S.C. 102(e)/103(a) should be made.

3. If the conflicting claim is in a commonly assigned, copending application with an earlier filing date, a provisional rejection under 35 U.S.C. 102(e)/103(a) should be made.

4. An obviousness double patenting rejection may also be included in the action.

5. In brackets 1, 2, 4 and 5, insert patent and number, or copending application and serial number.

6. In bracket 3, identify differences between design claimed in present application and that claimed in earlier filed patent or copending application.

7. This form paragraph should only be used ONCE in an Office action.

8. If the rejection relies upon prior art under 35 U.S.C. 102(e), use 35 U.S.C. 102(e) as amended by the American Inventor's Protection Act to determine the reference's prior art date, unless the reference is a U.S. patent issued directly, or indirectly, from an international application which has an international filing date prior to November 29, 2000. Use pre-AIPA 35 U.S.C. 102(e) only if the reference is a U.S. patent issued directly or indirectly from either a national stage of an international application (application under 35 U.S.C. 371) which has international filing date prior to November 29, 2000 or a continuing application claiming benefit under 35 U.S.C. 120, 121, or 365(c) to an international application having an international filing date prior to November 29, 2000. See the Examiner Notes for form paragraphs 7.12 and 7.12.01 to assist in the determination of the reference's 35 U.S.C. 102(e) date.

¶ *15.19.03 Provisional 35 U.S.C. 102(e)/103(a) rejection - design disclosed but not claimed in another application with common inventor and/or assignee*

The claim is provisionally rejected under 35 U.S.C. 103(a) as being obvious over copending Application No. [1] which has a common [2] with the instant application. Based upon the different inventive entity and the earlier effective U.S. filing date of the copending application, it would constitute prior art under 35 U.S.C. 102(e) if published under 35 U.S.C. 122(b) or patented. This provisional rejection under 35 U.S.C. 103(a) is based upon a presumption of future publication or patenting of the conflicting application.

Although the invention is not identically disclosed or described as set forth in 35 U.S.C. 102, if the differences between the subject matter sought to be patented and the prior art are such that the subject matter as a whole would have been obvious at the time the invention was made to a designer having ordinary skill in the art to which said subject matter pertains, the invention is not patentable.

[3]

Since the design claimed in the present application is not the same invention claimed in the [4] application, this provisional rejection may be overcome by a showing under 37 CFR 1.132 that

the design in the reference was derived from the designer of this application and is thus not the invention “by another,” or by a showing of a date of invention for the instant application prior to the effective U.S. filing date of the reference under 37 CFR 1.131. For applications filed on or after November 29, 1999, this rejection might also be overcome by showing that the subject matter of the reference and the claimed invention were, at the time the invention was made, owned by the same person or subject to an obligation of assignment to the same person. See MPEP § 706.02(1)(1) and § 706.02(1)(2).

#### Examiner Note:

1. This form paragraph should be used when the claimed design in the application being examined is obvious over subject matter disclosed in the drawings of an earlier filed design or utility application but is not claimed therein. The design claimed in the application being examined can be an obvious version of subject matter disclosed in the drawings of an earlier filed design application. This subject matter may be depicted in broken lines, or may be in the form of a subcombination (part or portion of an article) that is patentably distinct from the claim for the design embodied by the combination or whole article.
2. In brackets 1 and 4 insert serial number of copending application.
3. In bracket 2, insert inventor or assignee.
4. In bracket 3, provide explanation of obviousness including differences and follow the explanation with form paragraphs 15.70 and 15.67 or 15.68.
5. This form paragraph must be preceded by form paragraph 15.19.02.
6. Use 35 U.S.C. 102(e) as amended by the American Inventor’s Protection Act to determine the reference’s prior art date, unless the reference is a U.S. patent issued directly, or indirectly, from an international application which has an international filing date prior to November 29, 2000. Use pre-AIPA 35 U.S.C. 102(e) only if the reference is a U.S. patent issued directly or indirectly from either a national stage of an international application (application under 35 U.S.C. 371) which has an international filing date prior to November 29, 2000 or a continuing application claiming benefit under 35 U.S.C. 120, 121, or 365(c) to an international application having an international filing date prior to November 29, 2000. See the Examiner Notes for form paragraphs 7.12 and 7.12.01 to assist in the determination of the reference’s 35 U.S.C. 102(e) date.

#### ¶ 15.19.04 Provisional 35 U.S.C. 102(e)/103(a) rejection - design claimed in an earlier filed design patent application with common inventor and/or assignee

The claim is provisionally rejected under 35 U.S.C. 103(a) as being obvious over the claim in copending Design Patent Application No. [1] which has a common [2] with the instant application. Based upon the different inventive entity and the earlier effective U.S. filing date of the copending application, it would constitute prior art under 35 U.S.C. 102(e) if patented. This provisional rejection under 35 U.S.C. 103(a) is based upon a presumption of future patenting of the conflicting application.

Although the invention is not identically disclosed or described as set forth in 35 U.S.C. 102, if the differences between the subject matter sought to be patented and the prior art are such that the subject matter as a whole would have been obvious at the time the invention was made to a person having ordinary skill in the art to which said subject matter pertains, the invention is not patentable.

[3]

Since the design claimed in the present application is not patentably distinct from the design claimed in the [4] application, this provisional rejection may be overcome by merging the two applications into a single continuation-in-part and abandoning the separate parent applications. For applications filed on or after November 29, 1999, this rejection might also be overcome by showing that the subject matter of the reference and the claimed invention were, at the time the invention was made, owned by the same person or subject to an obligation of assignment to the same person. See MPEP § 706.02(1)(1) and § 706.02(1)(2).

#### Examiner Note:

1. This form paragraph should be used when the claimed design in the application being examined is obvious over the design claimed in an earlier filed copending application.
2. A provisional obviousness-type double patenting rejection must also be included in the action.
3. In brackets 1 and 4, insert serial number of copending application.
4. In bracket 2, insert inventor or assignee.
5. In bracket 3, provide explanation of obviousness including differences and follow the explanation with form paragraphs 15.70 and 15.67 or 15.68.
6. This form paragraph must be preceded by form paragraph 15.19.02.

#### ¶ 15.19.05 35 U.S.C. 102(e)/103(a) rejection - design disclosed but not claimed

The claim is rejected under 35 U.S.C. 103(a) as being obvious over [1].

Based upon the different inventive entity and the earlier effective U.S. filing date of the reference, it constitutes prior art under 35 U.S.C. 102(e).

Although the invention is not identically disclosed or described as set forth in 35 U.S.C. 102, if the differences between the subject matter sought to be patented and the prior art are such that the subject matter as a whole would have been obvious at the time the invention was made to a designer having ordinary skill in the art to which said subject matter pertains, the invention is not patentable.

[2]

Since the design claimed in the present application is not the same invention claimed in the [3] patent, this rejection may be overcome by a showing under 37 CFR 1.132 that the design in the reference was derived from the designer of this application and is thus not the invention ‘by another,’ or by a showing of a date of invention for the instant application prior to the effective U.S. filing date of the reference under 37 CFR 1.131. For applications filed on or after November 29, 1999, this rejection might also be overcome by showing that the subject matter of the reference and the claimed invention were, at the time the invention was made,

owned by the same person or subject to an obligation of assignment to the same person. See MPEP § 706.02(1)(1) and § 706.02(1)(2).

**Examiner Note:**

1. This form paragraph should be used when the claimed design in the application being examined is obvious over subject matter disclosed in the drawings of an earlier filed design or utility patent, or application publication, but is not claimed therein. The design claimed in the application being examined can be an obvious version of subject matter disclosed in the drawings of an earlier filed design application. This subject matter may be depicted in broken lines, or may be in the form of a subcombination (part or portion of an article) that is patentably distinct from the claim for the design embodied by the combination or whole article.

2. In brackets 1 and 3, insert number of the U.S. patent, U.S. patent application publication, or the WIPO publication of an international application that qualifies as prior art under 35 U.S.C. 102(e). See note 5 below.

3. In bracket 2, provide explanation of obviousness including differences and follow the explanation with form paragraphs 15.70 and 15.67 or 15.68.

4. This form paragraph must be preceded by form paragraph 15.19.02.

5. Use 35 U.S.C. 102(e) as amended by the American Inventor's Protection Act to determine the reference's prior art date, unless the reference is a U.S. patent issued directly, or indirectly, from an international application which has an international filing date prior to November 29, 2000. Use pre-AIPA 35 U.S.C. 102(e) only if the reference is a U.S. patent issued directly or indirectly from either a national stage of an international application (application under 35 U.S.C. 371) which has an international filing date prior to November 29, 2000 or a continuing application claiming benefit under 35 U.S.C. 120, 121, or 365(c) to an international application having an international filing date prior to November 29, 2000. See the Examiner Notes for form paragraphs 7.12 and 7.12.01 to assist in the determination of the reference's 35 U.S.C. 102(e) date.

¶ *15.19.06 35 U.S.C. 102(e)/103(a) rejection - design claimed in a design patent with an earlier effective filing date and common assignee*

The claim is rejected under 35 U.S.C. 103(a) as being obvious over the claim in design patent [1].

Based upon the different inventive entity and the earlier effective U.S. filing date of the reference, it constitutes prior art under 35 U.S.C. 102(e).

Although the invention is not identically disclosed or described as set forth in 35 U.S.C. 102, if the differences between the subject matter sought to be patented and the prior art are such that the subject matter as a whole would have been obvious at the time the invention was made to a designer having ordinary skill in the art to which said subject matter pertains, the invention is not patentable.

[2]

Since the design claimed in the present application is not patentably distinct from the design claimed in the [3] patent, this rejection may be overcome by submitting an oath or declaration

under 37 CFR 1.130 stating that this application and the reference are currently owned by the same party and that the inventor named in this application is the prior inventor of the subject matter in the reference under 35 U.S.C. 104. In addition, a terminal disclaimer in accordance with 37 CFR 1.321(c) is also required. For applications filed on or after November 29, 1999, this rejection might also be overcome by showing that the subject matter of the reference and the claimed invention were, at the time the invention was made, owned by the same person or subject to an obligation of assignment to the same person. See MPEP § 706.02(1)(1) and § 706.02(1)(2)

**Examiner Note:**

1. This form paragraph should be used when the claimed design in the application being examined is obvious over the design claimed in a design patent having an earlier effective date and a common assignee.

2. An obviousness-type double patenting rejection must also be included in the action.

3. In brackets 1 and 3, insert number of patent.

4. In bracket 2, provide explanation of obviousness including differences and follow the explanation by form paragraphs 15.70 and 15.67 or 15.68.

5. This form paragraph must be preceded by form paragraph 15.19.02.

¶ *15.19.07 35 U.S.C. 102(e)/103(a) rejection - design claimed in a design patent having an earlier effective filing date and no common assignee*

The claim is rejected under 35 U.S.C. 103(a) as being obvious over the claim in design patent [1].

Based upon the different inventive entity and the earlier effective U.S. filing date of the reference, it constitutes prior art under 35 U.S.C. 102(e).

Although the invention is not identically disclosed or described as set forth in 35 U.S.C. 102, if the differences between the subject matter sought to be patented and the prior art are such that the subject matter as a whole would have been obvious at the time the invention was made to a designer having ordinary skill in the art to which said subject matter pertains, the invention is not patentable.

[2]

**Examiner Note:**

1. This form paragraph should be used when the claimed design in the application being examined is obvious over the design claimed in a design patent having an earlier effective filing date.

2. In bracket 2, provide explanation of obviousness including differences and follow explanation with form paragraphs 15.70 and 15.67 or 15.68.

<

The following form paragraphs may be used in a second or subsequent action where appropriate.

¶ *15.38 Rejection Maintained*

The arguments presented have been carefully considered, but are not persuasive that the rejection of the claim under [1] should be withdrawn.

**Examiner Note:**

In bracket 1, insert basis of rejection.

¶ 15.39 *Obviousness Under 35 U.S.C. 103(a) Repeated*

It remains the examiner's position that the [1] design claimed is obvious under 35 U.S.C. 103(a) over [2].

**Examiner Note:**

In bracket 1, insert name of design.

¶ 15.39.01 *35 U.S.C. 103(a) Rejection Repeated (Multiple References)*

It remains the examiner's position that the claim is obvious under 35 U.S.C. 103(a) over [1] in view of [2].

\*\*>

¶ 15.39.02 *Final Rejection Under 35 U.S.C. 103(a) (Single Reference)*

The claim is again and FINALLY REJECTED under 35 U.S.C. 103(a) over [1].

**Examiner Note:**

See form paragraphs in MPEP Chapter 700, for "Action is Final" and "Advisory after Final" paragraphs.

¶ 15.40 *Final Rejection Under 35 U.S.C. 103(a) (Multiple References)*

The claim is again and FINALLY REJECTED under 35 U.S.C. 103(a) as being unpatentable over [1] in view of [2].

**Examiner Note:**

See form paragraphs in MPEP Chapter 700 for "Action is Final" and "Advisory after Final" paragraphs.

<

\*\*

## 1504.04 Considerations Under 35 U.S.C. 112 [R-2]

### 35 U.S.C. 112. *Specification.*

The specification shall contain a written description of the invention, and of the manner and process of making and using it, in such full, clear, concise, and exact terms as to enable any person skilled in the art to which it pertains, or with which it is most nearly connected, to make and use the same, and shall set forth the best mode contemplated by the inventor of carrying out his invention.

The specification shall conclude with one or more claims particularly pointing out and distinctly claiming the subject matter which the applicant regards as his invention.

\*\*\*\*\*

The drawing in a design application is incorporated into the claim by use of the claim language "as shown."

Additionally, the drawing disclosure can be supplemented by narrative description in the specification (see MPEP § 1503.01, subsection II). This description is incorporated into the claim by use of the language "as shown and described." See MPEP § 1503.01, subsection III.

### I. 35 U.S.C. 112, FIRST AND SECOND PARAGRAPH

#### \* Enablement and Scope of Protection

Any analysis for compliance with 35 U.S.C. 112 should begin with a determination of whether the claims satisfy the requirements of the second paragraph before moving on to the first paragraph. See *In re Moore*, 439 F.2d 1232, 169 USPQ 236 (CCPA 1971). Therefore, before any determination can be made as to whether the disclosure meets the requirements of 35 U.S.C. 112, first paragraph, for enablement, a determination of the scope of protection sought by the claim must be made. However, since the drawing disclosure and any narrative description in the specification are incorporated into the claim by the use of the language "as shown and described," any determination of the scope of protection sought by the claim is also a determination of the subject matter that must be enabled by the disclosure. Hence, if the appearance and shape or configuration of the design for which protection is sought cannot be determined or understood due to an inadequate visual disclosure, then the claim, which incorporates the visual disclosure, fails to particularly point out and distinctly claim the subject matter applicant regards as their invention, in violation of the second paragraph of 35 U.S.C. 112. Furthermore, such disclosure fails to enable a designer of ordinary skill in the art to reproduce the shape and appearance of the design for which protection is sought. In such case, a rejection of the claim under both the first and second paragraphs of 35 U.S.C. 112 would be warranted. An evaluation of the scope of the claim under 35 U.S.C. 112, second paragraph, to determine whether the disclosure of the design meets the enablement requirement of 35 U.S.C. 112, first paragraph, cannot be based on the drawings alone. The scope of a claimed design is understood to be limited to those surfaces or portions of the article shown in the drawing in full lines in combination with any additional written description

in the specification. The title does not define the scope of the claimed design but merely identifies the article in which it is embodied. See MPEP § 1503.01, subsection I. It is assumed that the claim has been crafted to protect that which the applicant “regards as his invention.” *In re Zahn*, 617 F.2d 261, 204 USPQ 988 (CCPA 1980). Therefore, when visible portions of the article embodying the design are not shown, it is because they form no part of the claim to be protected. It is *prima facie* evidence that the scope of the claimed design is limited to those surfaces “as shown” in the application drawing(s) in the absence of any additional written disclosure. See MPEP § 1503.01, subsection II. “[T]he adequacy of the disclosure must be determined by reference to the scope asserted.” *Philco Corp. v. Admiral Corp.*, 199 F. Supp. 797, 131 USPQ 413, 418 (D. Del. 1961). However, it should be understood that when a surface or portion of an article is disclosed in full lines in the drawing it is considered part of the claimed design and its shape and appearance must be clearly and accurately depicted in order to satisfy the requirements of the first and second paragraphs of 35 U.S.C. 112.<

Only those surfaces of the article that are visible at the point of sale or during use must be disclosed to meet the requirement of 35 U.S.C. 112, first \*and second paragraphs<. “The drawing should illustrate the design as it will appear to purchasers and users, since the appearance is the only thing that lends patentability to it under the design law.” *Ex parte Kohler*, 1905 C.D. 192, 192, 116 O.G. 1185, 1185 (Comm’r Pat. 1905). The lack of disclosure of those surfaces of the article which are hidden during sale or use does not violate the \* requirements of the first >and second< paragraph>s< of 35 U.S.C. 112 because the “patented ornamental design has no use other than its visual appearance....” *In re Harvey*, 12 F.3d 1061, 1064, 29 USPQ2d 1206, 1208 (Fed. Cir. 1993). Therefore, to make the “visual appearance” of the design merely involves the reproduction of what is shown in the drawings; it is not necessary that the functionality of the article be reproduced as this is not claimed. The function of a design is “that its appearance adds attractiveness, and hence commercial value, to the article embodying it.” *Ex parte Cady*, 1916 C.D. 57, 61, 232 O.G. 619, 621 (Comm’r Pat. 1916).

The undisclosed surfaces not seen during sale or use are not required to be described in the specifica-

tion even though the title of the design is directed to the complete article because the design is embodied only in those surfaces which are visible. *Ex parte Salisbury*, 38 USPQ 149, 1938 C.D. 6 (Comm’r Pat. 1938). While it is not necessary to show in the drawing those visible surfaces that are flat and \* >devoid of surface ornamentation<, they should be described in the specification by way of a special description if they are considered part of the claimed design. *Ex parte Salisbury*, 38 USPQ 149, 1938 C.D. 6 (Comm’r Pat. 1938). Such special description may not be used to describe visible surfaces which include structure that is clearly not flat. *Philco Corp. v. Admiral Corp.*, 199 F. Supp. 797, 131 USPQ 413 (D. Del. 1961). See also MPEP § 1503.02.

Applications filed in which the title (in the claim) defines an entire article but the drawings and the specification fail to disclose portions or surfaces of the article that would be visible either during use or on sale, will not be considered to violate the \* requirements of the first >and second< paragraph>s< of 35 U.S.C. 112. Therefore, amendment to the title will not be required in such applications. However, examiners should include a statement in the first Office action on the merits (including a notice of allowability) indicating that the surface(s) or portion(s) of the article that would be normally visible but are not shown in the drawing or described in the specification are understood to form no part of the claimed design and therefore, the determination of patentability of the claimed design is based on the views of the article shown in the drawing and the description in the specification. Form paragraph 15.85 may be used for this purpose.

>When a claim is rejected under 35 U.S.C. 112, first and second paragraphs, as nonenabling and indefinite due to an insufficient drawing disclosure, examiners must specifically identify in the Office action what the deficiencies are in the drawing. A mere statement that the claim is nonenabling and indefinite due to the poor quality of the drawing is not a sufficient explanation of the deficiencies in the drawing disclosure. Examiners must specifically point out those portions of the drawing that are insufficient to permit an understanding of the shape and appearance of the design claimed, and, if possible, suggest how the rejection may be overcome. Form paragraphs 15.21 and 15.20.02 may be used.<

When inconsistencies between the views of the drawings are so great that the overall appearance of the design is unclear, the claim should be rejected under 35 U.S.C. 112, first and second paragraphs, as nonenabling and indefinite, and the rejection should specifically identify all of the inconsistencies between the views of the drawing. Otherwise, inconsistencies between drawing views will be objected to by the examiner and correction required by the applicant. See MPEP § 1503.02.

If the visual disclosure of the claimed design as originally filed is of such poor quality that its overall shape and appearance cannot be understood, applicant should be advised that the claim might be fatally defective by using form paragraph 15.65.

As indicated above, a narrative description in the specification can supplement the drawing disclosure to define the scope of protection sought by the claim. Furthermore, such description is incorporated into the claim by the use of the language “and described” therein. However, if a description in the specification refers to embodiments or modified forms not shown in the drawing, or includes vague and nondescriptive words such as “variations” and “equivalents,” or a statement indicating that the claimed design is not limited to the exact shape and appearance shown in the drawing, the claim should be rejected under 35 U.S.C. 112, first and second paragraphs, as nonenabling and indefinite. The reason being the description fails to enable a designer of ordinary skill in the art to reproduce the shape and appearance of those other embodiments, modified forms or “variations” and “equivalents” referred to in the description in the absence of additional drawing views. Furthermore, in the absence of additional drawing views, the description, which is incorporated into the claim, fails to particularly point out and distinctly claim the shape and appearance of those other embodiments, modified forms or “variations” and “equivalents” that applicants regard as their invention. Form paragraph 15.21 may be used to reject a claim for the above reasons.

**¶ 15.85 Undisclosed visible surface(s)/portion(s) of article not forming part of the claimed design**

As the decision of *In re Zahn*, 617 F.2d 261, 204 USPQ 988 (CCPA 1980) holds that an ornamental design may be embodied in less than a complete article, it is understood that the surface(s) or portion(s) of the article that would normally be visible but are not shown in the drawing or described in the specification of the

present application form(s) no part of the claimed design. Therefore, the determination of patentability of the claimed design is based on the views of the article shown in the drawing and the description in the specification.

**Examiner Note:**

In an examiner’s amendment, the above statement should be included after form paragraph 13.02.

>

**¶ 15.21 Rejection, 35 U.S.C. 112, First And Second Paragraphs**

The claim is rejected under 35 U.S.C. 112, first and second paragraphs, as the claimed invention is not described in such full, clear, concise and exact terms as to enable any person skilled in the art to make and use the same, and fails to particularly point out and distinctly claim the subject matter which applicant regards as the invention.

The claim is indefinite and nonenabling [1].

**Examiner Note:**

1. This form paragraph should not be used when it is appropriate to make one or more separate rejections under the first and/or the second paragraph of 35 U.S.C. 112.
2. In bracket 1, a complete explanation of the basis for the rejection should be provided.

<

\*\*>

**¶ 15.20.02 Suggestion To Overcome Rejection Under 35 U.S.C. 112, First and Second Paragraphs**

It is suggested that applicant may submit large, clear informal drawings or photographs which show [1] in order that the examiner may be in a position to determine if the claim may be clarified without the addition of new matter (35 U.S.C. 132, 37 CFR 1.121). In the alternative, applicant may disclaim the areas or portions of the design which are considered indefinite and nonenabling by converting them to broken lines and amend the specification to include a statement that the portions of the [2] shown in broken lines form no part of the claimed design.

**Examiner Note:**

1. In bracket 1, identify the areas or portions of the design which are unclear.
2. In bracket 2, insert title of the article.

<

**¶ 15.65 Amendment May Not Be Possible**

The claim might be fatally defective; that is, it might not be possible to [1] without introducing new matter (35 U.S.C. 132, 37 CFR 1.121).

**Examiner Note:**

In bracket 1, identify portion of the claimed design which is insufficiently disclosed.

\*\*>

¶ 15.73 *Corrected Drawing Sheets Required*

Failure to submit replacement correction sheets overcoming all of the deficiencies in the drawing disclosure set forth above, or an explanation why the drawing corrections or additional drawing views are not necessary will result in the rejection of the claim under 35 U.S.C. 112, first and second paragraphs, being made FINAL in the next Office action.

<

\* *New Matter*

New matter is subject matter which has no antecedent basis in the original specification, drawings or claim (MPEP § 608.04). An amendment to the claim must have antecedent basis in the original disclosure. 35 U.S.C. 132; 37 CFR 1.121(f). Prior to final action, all amendments will be entered in the \*>application< and will be considered by the examiner. *Ex parte Hanback*, 231 USPQ 739 (Bd. Pat. App. & Inter. 1986). An amendment to the claim which has no antecedent basis in the specification and/or drawings as originally filed introduces new matter because that subject matter is not described in the application as originally filed. The claim must be rejected under 35 U.S.C. 112, first paragraph. An amendment to the disclosure not affecting the claim (such as environment in the title or in broken lines in the drawings), which has no antecedent basis in the application as originally filed, must be objected to under 35 U.S.C. 132 as lacking support in the application as originally filed and a requirement must be made to cancel the new matter.

The scope of a design claim is defined by what is shown in full lines in the application drawings. *In re Mann*, 861 F.2d 1581, 8 USPQ2d 2030 (Fed. Cir. 1988). The claim may be amended by broadening or narrowing its scope within the bounds of the disclosure as originally filed.

A change in the configuration of the claimed design is considered a departure from the original disclosure and introduces prohibited new matter (37 CFR 1.121(f)). See *In re Salmon*, 705 F.2d 1579, 217 USPQ 981 (Fed. Cir. 1983). This includes the removal of three-dimensional surface treatment that is an integral part of the configuration of the claimed design, for example, beading, grooves, and ribs. The underlying configuration revealed by such an amendment would not be apparent in the application as filed and, therefore, it could not be established that applicant was in possession of this amended configuration

at the time the application was filed. >However, an amendment that changes the scope of a design by either reducing certain portions of the drawing to broken lines or converting broken line structure to solid lines is not a change in configuration as defined by the court in *Salmon*. The reason for this is because applicant was in possession of everything disclosed in the drawing at the time the application was filed and the mere reduction of certain portions to broken lines or conversion of broken line structure to solid lines is not a departure from the original disclosure. Examiners are cautioned that if broken line structure is converted to solid lines by way of amendment, the shape and configuration of that structure must have been fully disclosed and enabling at the time the application was filed.< An amendment which alters the appearance of the claimed design by removing two-dimensional, superimposed surface treatment may be permitted if it is clear from the application that applicant had possession of the underlying configuration of the design without the surface treatment at the time of filing of the application. See *In re Daniels*, 144 F.3d 1452, 1456-57, 46 USPQ2d 1788, 1790 (Fed. Cir. 1998).

Amendments to the title must have antecedent basis in the original application to be permissible. If an amendment to the title directed to the article in which the design is embodied has no antecedent basis in the original application, the claim will be rejected under 35 U.S.C. 112, first paragraph, as failing to comply with the written description requirement thereof. *Ex parte Strijland*, 26 USPQ2d 1259 (Bd. Pat. App. & Inter. 1992). If an amendment to the title directed to the environment in which the design is used has no antecedent basis in the original application, it will be objected to under 35 U.S.C. 132 as introducing new matter into the disclosure. See MPEP § 1503.01, subsection I.

Examples of permissible amendments filed with the original application include: (A) a preliminary amendment filed simultaneously with the application papers, that is specifically identified in the original oath/declaration as required by 37 CFR 1.63 and MPEP § 608.04(b); and (B) the inclusion of a disclaimer in the original specification or on the drawings/photographs as filed. See 37 CFR 1.152 and MPEP § 1503.01 and § 1503.02.

An example of a permissible amendment submitted after the filing of the application would be an amend-

ment that does not involve a departure from the configuration of the original disclosure (37 CFR 1.121(f)).

An example of an impermissible amendment which introduces new matter would be an amendment to the claim without antecedent basis in the original disclosure which would change the configuration or surface appearance of the original design by the addition of previously undisclosed subject matter. *In re Berkman*, 642 F.2d 427, 209 USPQ 45 (CCPA 1981).

When an amendment affecting the claim is submitted that introduces new matter into the drawing, specification or title and a rejection under 35 U.S.C. 112, first paragraph is made, the examiner should specifically identify in the Office action the subject matter which is not considered to be supported by the original disclosure. A statement by the examiner that merely generalizes that the amended drawing, specification or title contains new matter is not sufficient. Examiners should specifically identify the differences or changes made to the claimed design that are considered to introduce new matter into the original disclosure, and if possible, suggest how the amended drawing, specification or title can be corrected to overcome the rejection. Form paragraph 15.51 may be used.

If an amendment that introduces new matter into the claim is the result of a rejection under 35 U.S.C. 112, first and second paragraph for lack of enablement and indefiniteness, and it is clear that the disclosure of the claimed design as originally filed cannot be corrected without the introduction of new matter, the record of the application should reflect that the claim is seen to be fatally defective. Form paragraph 15.65 may be used to set forth this position.

¶ 15.51 35 U.S.C. 112, First Paragraph Rejection (New Matter)

The claim is rejected under 35 U.S.C. 112, first paragraph as failing to comply with the description requirement thereof since the [1] introduces new matter not supported by the original disclosure. The original disclosure does not reasonably convey to a designer of ordinary skill in the art that applicant was in possession of the design now claimed at the time the application was filed. See *In re Daniels*, 144 F.3d 1452, 46 USPQ2d 1788 (Fed. Cir. 1998); *In re Rasmussen*, 650 F.2d 1212, 211 USPQ 323 (CCPA 1981).

Specifically, there is no support in the original disclosure [2].

To overcome this rejection, applicant may attempt to demonstrate that the original disclosure establishes that he or she was in possession of the amended claim or [3].

**Examiner Note:**

1. In bracket 1, specify whether new drawing or amendment to the drawing, title or specification.
2. In bracket 2, specifically identify what is new matter so that the basis for the rejection is clear.
3. In bracket 3, insert specific suggestion how rejection may be overcome depending on the basis; such as, “the bracket in figures 3 and 4 of the new drawing may be corrected to correspond to the original drawing” or “the specification may be amended by deleting the special description.”

¶ 15.65 Amendment May Not Be Possible

The claim might be fatally defective; that is, it might not be possible to [1] without introducing new matter (35 U.S.C. 132, 37 CFR 1.121).

**Examiner Note:**

In bracket 1, identify portion of the claimed design which is insufficiently disclosed.

¶ 15.51.01 Amendment to Disclosure Not Affecting Claim - 35 U.S.C. 132 Objection (New Matter)

The [1] is objected to under 35 U.S.C. 132 and 37 CFR 1.121 as introducing new matter not supported by the original disclosure. The original disclosure does not reasonably convey to a designer of ordinary skill in the art that applicant was in possession of the amended subject matter at the time the application was filed. See *In re Rasmussen*, 650 F.2d 1212, 211 USPQ 323 (CCPA 1981).

Specifically, there is no support in the original disclosure [2].

To overcome this objection, applicant may attempt to demonstrate that the original disclosure establishes that he or she was in possession of the amended subject matter or [3].

**Examiner Note:**

1. In bracket 1, specify whether new drawing or amendment to the drawing, title or specification.
2. In bracket 2, specifically identify what is new matter so that the basis for the objection is clear.
3. In bracket 3, insert specific suggestion how the objection may be overcome depending on the basis; such as, “the broken line showing of environmental structure in Fig. 1 of the new drawing may be omitted to correspond to the original drawing” or “the title may be amended by deleting the reference to environmental structure”.

\*->

### III. < 35 U.S.C. 112, SECOND PARAGRAPH

Defects in claim language give rise to a rejection of the claim under the second paragraph of 35 U.S.C. 112. The fact that claim language, including terms of degree, may not be precise, does not automatically render the claim indefinite under 35 U.S.C. 112, sec-



ond paragraph. “[T]he definiteness of the language employed must be analyzed – not in a vacuum, but always in light of the teachings of the prior art and of the particular application disclosure as it would be interpreted by one possessing the ordinary level of skill in the pertinent art.” *In re Moore*, 439 F.2d 1232, 1235, 169 USPQ 236, 238 (CCPA 1971). A claim may appear indefinite when read in a vacuum, but may be definite upon reviewing the application disclosure or prior art teachings. Moreover, an otherwise definite claim in a vacuum may be uncertain when reviewing the application disclosure and prior art. *Moore*, 439 F.2d at 1235 n.2, 169 USPQ at 238 n.2. See also MPEP § 2173.05(b).

Use of \* phrases in the claim such as “or similar article,” “or the like,” or equivalent terminology has been held to be indefinite. See *Ex parte Pappas*, 23 USPQ2d 1636 (Bd. Pat. App. & Inter. 1992). However, the use of broadening language such as “or the like,” or “or similar article” in the title when directed to the environment of the article embodying the design should not be the basis for a rejection under 35 U.S.C. 112, second paragraph. See MPEP § 1503.01, subsection I.

Examiners are reminded that there is no *per se* rule, and that the definiteness of claim language must be evaluated on the facts and circumstances of each application. The following form paragraphs may be used.

¶ 15.22.02 *Rejection, 35 U.S.C. 112, 2nd Paragraph (“Or the Like” In Claim)*

The claim is rejected under 35 U.S.C. 112, second paragraph, as being indefinite for failing to particularly point out and distinctly claim the subject matter which applicant regards as the invention. The claim is indefinite because of the use of the phrase “[1]” following the title. Cancellation of said phrase in the claim and each occurrence of the title throughout the papers, except the oath or declaration, will overcome the rejection. See *Ex parte Pappas*, 23 USPQ2d 1636 (Bd. Pat. App. & Inter. 1992) and 37 CFR 1.153.

**Examiner Note:**

1. This rejection should be used where there is another rejection in the Office action. For issue with an examiner’s amendment, see form paragraph 15.69.01.
2. In bracket 1, insert --or the like-- or --or similar article--.
3. This form paragraph should not be used when “or the like” or “or similar article” in the title is directed to the environment of the article embodying the design.

¶ 15.69.01 *Remove Indefinite Language (“Or The Like”)*  
by Examiner’s Amendment

The phrase [1] in the claim following the title renders the claim indefinite. By authorization of [2] in a telephone interview on [3], the phrase has been cancelled from the claim and at each occurrence of the title throughout the papers, except the oath or declaration (35 U.S.C. 112, second paragraph, and 37 CFR 1.153). See *Ex parte Pappas*, 23 USPQ2d 1636 (Bd. Pat. App. & Inter. 1992).

**Examiner Note:**

In bracket 1, insert objectionable phrase, e.g., --or the like--, --or similar article--, etc.

>Rejections under 35 U.S.C. 112, second paragraph, should be made when the scope of protection sought by the claim cannot be determined from the disclosure. For instance, a drawing disclosure in which the boundaries between claimed (solid lines) and unclaimed (broken lines) portions of an article are not defined or cannot be understood may be enabling under 35 U.S.C. 112, first paragraph, in that the shape and appearance of the article can be reproduced, but such disclosure fails to particularly point out and distinctly claim the subject matter that applicant regards as the invention. Form paragraph 15.22 may be used.

¶ 15.22 *Rejection, 35 U.S.C. 112, 2nd Paragraph*

The claim is rejected under 35 U.S.C. 112, second paragraph, as being indefinite for failing to particularly point out and distinctly claim the subject matter which applicant regards as the invention.

The claim is indefinite [1].

**Examiner Note:**

1. Use this form paragraph when the scope of the claimed design cannot be determined.
2. In bracket 1, provide a full explanation of the basis for the rejection.

<

The claim should be rejected as indefinite when it cannot be determined from the designation of the design as shown in the drawing, referenced in the title and described in the specification what article of manufacture is being claimed, e.g., a design claimed as a “widget” which does not identify a known or recognizable article of manufacture. The following form paragraphs may be used.

\*\*>

¶ 15.22.03 *Rejection, 35 U.S.C. 112, Second Paragraph (Title Fails to Specify a Known Article of Manufacture)*

The claim is rejected under 35 U.S.C. 112, second paragraph, as indefinite in that the title, as set forth in the claim, fails to iden-

tify an article of manufacture and the drawing disclosure does not inherently identify the article in which the design is embodied. *Ex parte Strijland*, 26 USPQ2d 1259, 1263 (Bd. Pat. App. & Int. 1992). Therefore, any attempt to clarify the title by specifying the article in which the design is embodied may introduce new matter. See 35 U.S.C. 132 and 37 CFR 1.121.

<

¶ 15.21.01 *Rejection, 35 U.S.C. 112 (Second Paragraph) (Information Requested)*

The claim is rejected for failing to particularly point out and distinctly claim the invention as required in 35 U.S.C. 112, second paragraph. The title of the article in which the design is embodied or applied is too ambiguous and therefore indefinite for the examiner to make a proper examination of the claim under 37 CFR 1.104.

Applicant is therefore required to provide a sufficient explanation of the nature and intended use of the article in which the claimed design is embodied or applied, so that a proper classification and reliable search can be made. See 37 CFR 1.154(b)(1); MPEP 1503.01. Additional information, if available, regarding analogous fields of search, pertinent prior art, advertising brochures and the filing of copending utility applications would also prove helpful. If a utility application has been filed, please furnish its application number.

This information should be submitted in the form of a separate paper, and should not be inserted in the specification (37 CFR 1.56). See also 37 CFR 1.97, 1.98 and 1.99.

\*\*

Where the design claim would otherwise be patentable but for the presence of any rejection under 35 U.S.C. 112, first and/or second paragraphs, form paragraph 15.58.01 may be used.

¶ 15.58.01 *Claimed Design Is Patentable (35 U.S.C. 112 Rejections)*

The claimed design is patentable over the references cited. However, a final determination of patentability will be made upon resolution of the above rejection.

Form paragraphs 15.38 and 15.40.01 may be used in a second or subsequent action, where appropriate (see MPEP § 1504.02).

## 1504.05 Restriction [R-2]

General principles of utility restriction are set forth in Chapter 800 of the MPEP. These principles are also applicable to design restriction practice with the exception of those differences set forth in this section.

Unlike a utility patent application, which can contain plural claims directed to plural inventions, a design patent application may only have a single claim and thus must be limited to patentably indistinct

designs. Therefore, the examiner will require restriction in each design application which contains more than one patentably distinct design.

Restriction will be required under 35 U.S.C. 121 if a design patent application discloses multiple designs that are either independent or patentably distinct from each other and cannot be supported by a single claim. The issue of whether a search and examination of an entire application can be made without serious burden to an examiner (as noted in MPEP § 803) is not applicable to design applications when determining whether a restriction requirement should be made. >Clear admission on the record by the applicant that the embodiments are not patentably distinct will not overcome a requirement for restriction if the embodiments do not have overall appearances that are basically the same as each other.< If multiple designs are held to be patentably indistinct and can be covered by a single claim, any rejection of one over prior art will apply equally to all. *Ex parte Appeal No. 315-40*, 152 USPQ 71 (Bd. App. 1965).

### I. INDEPENDENT INVENTIONS

Design inventions are independent if there is no apparent relationship between two or more disparate articles disclosed in the drawings; for example, a pair of eyeglasses and a door handle; a bicycle and a camera; an automobile and a bathtub. Also note examples in MPEP § 806.04. Restriction in such cases is clearly proper. This situation may be rarely presented since design patent applications are seldom filed containing disclosures of independent articles.

### II. DISTINCT INVENTIONS

Design inventions are distinct if the overall appearance of two or more embodiments of an article as disclosed in the drawings are different in appearance or scope; for example, two embodiments of a brush, and their appearances are patentable (novel and unobvious) over each other. Restriction in such cases is also clearly proper. Distinct designs may constitute either multiple embodiments of the same article or they may be related as a combination and subcombination of the overall design. In addition, applications that include one or more embodiments disclosing all surfaces of an article as well as other embodiments disclosing only a portion of an article must be evaluated to determine whether the differences in scope patent-

ably distinguish the overall appearance of the fully disclosed embodiments over the partially disclosed embodiments. If the differences in scope between the embodiments render them patentably distinct, then restriction would be proper. In determining the question of patentable distinctness under 35 U.S.C. 121 in a design patent application, a search of the prior art may be necessary.

#### A. *Multiple Embodiments - Difference in Appearance*

It is permissible to illustrate more than one embodiment of a design invention in a single application. However, such embodiments may be presented only if they involve a single inventive concept and are not patentably distinct from one another. See *In re Rubinfeld*, 270 F.2d 391, 123 USPQ 210 (CCPA 1959). Embodiments that are patentably distinct over one another do not constitute a single inventive concept and thus may not be included in the same design application. *In re Platner*, 155 USPQ 222 (Comm'r Pat. 1967). The disclosure of plural embodiments does not require or justify more than a single claim, which claim must be in the formal terms stated in MPEP § 1503.01, subsection III. The specification should make clear that multiple embodiments are disclosed and should particularize the differences between the embodiments. If the disclosure of any embodiment relies on the disclosure of another embodiment for completeness to satisfy the requirements of 35 U.S.C. 112, first paragraph, the differences between the embodiments must be identified either in the figure descriptions or by way of a special description in the specification of the application as filed. For example, the second embodiment of a cabinet discloses a single view showing only the difference in the front door of the cabinet of the first embodiment; the figure description should state that this view “is a second embodiment of Figure 1, the only difference being the configuration of the door, it being understood that all other surfaces are the same as those of the first embodiment.” This type of statement in the description is understood to incorporate the disclosure of the first embodiment to complete the disclosure of the second embodiment. However, in the absence of such a statement in the specification of an application as filed, the disclosure of one embodiment will normally not be permitted to pro-

vide antecedent basis for any written or visual amendment to the disclosure of other embodiments.

The obviousness standard under 35 U.S.C. 103(a) must be applied in determining whether multiple embodiments may be retained in a single application. See MPEP § 1504.03. That is, it must first be determined whether the embodiments have overall appearances that are basically the same as each other. If the appearances of the embodiments are considered to be basically the same, then it must be determined whether the differences are either minor between the embodiments and not a patentable distinction, or obvious to a designer of ordinary skill in view of the analogous prior art. If embodiments meet both of the above criteria they may be retained in a single application. If embodiments do not meet either one of the above criteria, restriction must be required. It should be noted, that if the embodiments do not have overall appearances that are basically the same, restriction must be required since their appearances are patentably distinct. In such case it doesn't matter for restriction purposes, if the differences between the appearances of the embodiments are shown to be obvious in view of analogous prior art.

Form paragraph 15.27.02 or 15.27.03, if appropriate, may be used to notify applicant that restriction is not required because the embodiments are not patentably distinct.

\*\*>

#### ¶ 15.27.02 *Restriction Not Required - Change In Appearance (First Action - Non Issue)*

This application discloses the following embodiments:

Embodiment 1 - Figs. [1]

Embodiment 2 - Figs. [2]

[3]

Multiple embodiments of a single inventive concept may be included in the same design application only if they are patentably indistinct. See *In re Rubinfeld*, 270 F.2d 391, 123 USPQ 210 (CCPA 1959). Embodiments that are patentably distinct from one another do not constitute a single inventive concept and thus may not be included in the same design application. See *In re Platner*, 155 USPQ 222 (Comm'r Pat. 1967).

The above identified embodiments are considered by the examiner to present overall appearances that are basically the same. Furthermore, the differences between the appearances of the embodiments are considered minor and patentably indistinct, or are shown to be obvious in view of analogous prior art cited. Accordingly, they are deemed to be obvious variations and are being retained and examined in the same application. Any rejection of one embodiment over prior art will apply equally to all other embodiments. See *Ex parte Appeal No. 315-40*, 152 USPQ

71 (Bd. App. 1965). No argument asserting patentability based on the differences between the embodiments will be considered once the embodiments have been determined to comprise a single inventive concept. Failure of applicant to traverse this determination in reply to this action will be considered an admission of lack of patentable distinction between the above identified embodiments.

**Examiner Note:**

In bracket 3, add embodiments as necessary.

¶ 15.27.03 *Restriction Not Required - Change In Appearance (First Action Issue)*

This application discloses the following embodiments:

Embodiment 1 - Figs. [1]

Embodiment 2 - Figs. [2]

[3]

Multiple embodiments of a single inventive concept may be included in the same design application only if they are patentably indistinct. See *In re Rubinfeld*, 270 F.2d 391, 123 USPQ 210 (CCPA 1959). Embodiments that are patentably distinct from one another do not constitute a single inventive concept and thus may not be included in the same design application. See *In re Platner*, 155 USPQ 222 (Comm'r Pat. 1967).

The above identified embodiments are considered by the examiner to present overall appearances that are basically the same. Furthermore, the differences between the appearances of the embodiments are considered minor and patentably indistinct, or are shown to be obvious in view of analogous prior art cited. Accordingly, they are deemed to be obvious variations and are being retained and examined in the same application.

**Examiner Note:**

In bracket 3, add embodiments as necessary.

<

The following form paragraphs may be used in a restriction requirement. >Examiners must include a brief explanation of the differences between the appearances of the embodiments that render them patentably distinct.

¶ 15.27 *Restriction Under 35 U.S.C. 121*

This application discloses the following embodiments:

Embodiment 1 - Figs. [1]

Embodiment 2 - Figs. [2]

[3]

Multiple embodiments of a single inventive concept may be included in the same design application only if they are patentably indistinct. See *In re Rubinfeld*, 270 F.2d 391, 123 USPQ 210 (CCPA 1959). Embodiments that are patentably distinct from one another do not constitute a single inventive concept and thus may not be included in the same design application. See *In re Platner*, 155 USPQ 222 (Comm'r Pat. 1967). The [4] create(s) patentably distinct designs.

Because of the differences identified, the embodiments are considered to either have overall appearances that are **not** basically the same, or if they are basically the same, the differences

are **not** minor and patentably indistinct or are **not** shown to be obvious in view of analogous prior art.

The above embodiments divide into the following patentably distinct groups of designs:

Group I: Embodiment [5]

Group II: Embodiment [6]

[7]

Restriction is required under 35 U.S.C. 121 to one of the above identified patentably distinct groups of designs.

A reply to this requirement must include an election of a single group for prosecution on the merits, even if this requirement is traversed, 37 CFR 1.143. Any reply that does not include election of a single group will be held nonresponsive. Applicant is also requested to direct cancellation of all drawing figures and the corresponding descriptions which are directed to the nonelected groups.

Should applicant traverse this requirement on the grounds that the groups are not patentably distinct, applicant should present evidence or identify such evidence now of record showing the groups to be obvious variations of one another. If the groups are determined not to be patentably distinct and they remain in this application, any rejection of one group over prior art will apply equally to all other embodiments. See *Ex parte Appeal No. 315-40*, 152 USPQ 71 (Bd. App. 1965). No argument asserting patentability based on the differences between the groups will be considered once the groups have been determined to comprise a single inventive concept.

In view of the above requirement, action on the merits is deferred pending compliance with the requirement in accordance with *Ex parte Heckman*, 135 USPQ 229 (P.O. Super. Exam. 1960).

**Examiner Note:**

1. In bracket 3, add embodiments as necessary.
2. In bracket 4, insert an explanation of the difference(s) between the embodiments.
3. In bracket 7, add groups as necessary.

¶ 15.27.01 *Restriction Under 35 U.S.C. 121 (Obvious Variations Within Group)*

This application discloses the following embodiments:

Embodiment 1 - Figs. [1]

Embodiment 2 - Figs. [2]

[3]

Multiple embodiments of a single inventive concept may be included in the same design application only if they are patentably indistinct. See *In re Rubinfeld*, 270 F.2d 391, 123 USPQ 210 (CCPA 1959). Embodiments that are patentably distinct from one another do not constitute a single inventive concept and thus may not be included in the same design application. See *In re Platner*, 155 USPQ 222 (Comm'r Pat. 1967).

The above embodiments divide into the following patentably distinct groups of designs:

Group I: Embodiment [4]

Group II: Embodiment [5]

[6]

The embodiments disclosed within each group have overall appearances that are basically the same. Furthermore, the differ-

ences between them are considered minor and patentably indistinct, or are shown to be obvious in view analogous prior art cited. Therefore, they are considered by the examiner to be obvious variations of one another within the group. These embodiments thus comprise a single inventive concept and are grouped together. However, the [7] patentably distinguishes each group from the other(s).

Because of the differences identified, the embodiments of each Group are considered to either have overall appearances that are **not** basically the same, or if they are basically the same, the differences are **not** minor and patentably indistinct or are **not** shown to be obvious in view of analogous prior art.

Restriction is required under 35 U.S.C. 121 to one of the patentably distinct groups of the designs.

A reply to this requirement must include an election of a single group for prosecution on the merits, even if this requirement is traversed, 37 CFR 1.143. Any reply that does not include election of a single group will be held nonresponsive. Applicant is also requested to direct cancellation of all drawing figures and the corresponding descriptions which are directed to the nonelected groups.

Should applicant traverse this requirement on the grounds that the groups are not patentably distinct, applicant should present evidence or identify such evidence now of record showing the groups to be obvious variations of one another. If the groups are determined not to be patentably distinct and they remain in this application, any rejection of one group over prior art will apply equally to all other groups. See *Ex parte Appeal No. 315-40*, 152 USPQ 71 (Bd. App. 1965). No argument asserting patentability based on the differences between the groups will be considered once the groups have been determined to comprise a single inventive concept.

In view of the above requirement, action on the merits is deferred pending compliance with the requirement in accordance with *Ex parte Heckman*, 135 USPQ 229 (P.O. Super. Exam. 1960).

#### Examiner Note:

1. In bracket 3, add embodiments as necessary.
2. In bracket 6, add groups as necessary.
3. In bracket 7, insert an explanation of the difference(s) between the groups.

#### ¶ 15.28 Telephone Restriction Under 35 U.S.C. 121

This application discloses the following embodiments:

Embodiment 1 - Figs. [1]

Embodiment 2 - Figs. [2]

[3]

Multiple embodiments of a single inventive concept may be included in the same design application only if they are patentably indistinct. See *In re Rubinfeld*, 123 USPQ 210 (CCPA 1959). Embodiments that are patentably distinct from one another do not constitute a single inventive concept and thus may not be included in the same design application. See *In re Platner*, 155 USPQ 222 (Comm'r Pat. 1967). The [4] create(s) patentably distinct designs. See *In re Platner*, 155 USPQ 222 (Comm'r Pat. 1967).

Because of the differences identified, the embodiments of each Group are considered to either have overall appearances that are **not** basically the same, or, if they are basically the same, the differences are **not** minor and patentably indistinct or are **not** shown to be obvious in view of analogous prior art.

The above disclosed embodiments divide into the following patentably distinct groups of designs:

Group I: Embodiment [5]

Group II: Embodiment [6]

[7]

Restriction is required under 35 U.S.C. 121 to one of the patentably distinct groups of designs.

During a telephone discussion with [8] on [9], a provisional election was made [10] traverse to prosecute the design(s) of group [11]. Affirmation of this election should be made by applicant in replying to this Office action.

Group [12] is withdrawn from further consideration by the examiner, 37 CFR 1.142(b), as being for a nonelected design(s).

#### Examiner Note:

1. In bracket 3, add embodiments as necessary.
2. In bracket 4, insert an explanation of the difference(s) between the embodiments.
3. In bracket 7, add groups as necessary.
4. In bracket 10, insert --with-- or --without--.

#### ¶ 15.28.01 Telephone Restriction Under 35 U.S.C.121 (Obvious Variations Within Group)

This application discloses the following embodiments:

Embodiment 1 – Figs. [1]

Embodiment 2 – Figs. [2]

[3]

Multiple embodiments of a single inventive concept may be included in the same design application only if they are patentably indistinct. See *In re Rubinfeld*, 270 F.2d 391, 123 USPQ 210 (CCPA 1959). Embodiments that are patentably distinct from one another do not constitute a single inventive concept and thus may not be included in the same design application. See *In re Platner*, 155 USPQ 222 (Comm'r Pat. 1967).

The above embodiments divide into the following patentably distinct groups of designs:

Group I: Embodiment [4]

Group II: Embodiment [5]

[6]

The embodiments disclosed within each group have overall appearances that are basically the same. Furthermore, the differences between them are considered minor and patentably indistinct, or are shown to be obvious in view of analogous prior art cited. Therefore, they are considered by the examiner to be obvious variations of one another within the group. These embodiments thus comprise a single inventive concept and are grouped together. However, the [7] patentably distinguishes each group from the other(s).

Because of the differences identified, the embodiments of each Group are considered to either have overall appearances that are **not** basically the same, or if they are basically the same, the differ-

ences are **not** minor and patentably indistinct or are **not** shown to be obvious in view of analogous prior art.

Restriction is required under 35 U.S.C. 121 to one of the patentably distinct groups of designs.

During a telephone discussion with [8] on [9], a provisional election was made [10] traverse to prosecute the design(s) of group [11]. Affirmation of this election should be made by applicant in replying to this Office action.

Group [12] is withdrawn from further consideration by the examiner, 37 CFR 1.142(b), as being for a nonelected design(s).

#### Examiner Note:

1. In bracket 3, add embodiments as necessary.
2. In bracket 6, add groups as necessary.
3. In bracket 7, insert an explanation of the differences between the groups.
4. In bracket 10, insert --with--or --without--.

<

#### ¶ 15.31 Provisional Election Required (37 CFR 1.143)

Applicant is advised that the **reply** to be complete must include a provisional election of one of the enumerated designs, even though the requirement may be traversed (37 CFR 1.143).

#### B. Combination/Subcombination - Difference in Scope

A design claim covers the entire design as a whole. **\*\*>**Furthermore, claim protection to the whole design does not extend to any individual part or portion thereof. See *KeyStone Retaining Wall Systems Inc. v. Westrock Inc.*, 997 F.2d 1444, 27 USPQ2d 1297 (Fed. Cir. 1993). Embodiments directed to a design as a whole (combination) as well as individual parts or portions (subcombination) thereof may not be included in a single application if the appearances are patentably distinct. In such instance restriction would be required since patentably distinct combination/subcombination subject matter must be supported by separate claims.< However, a design claim may cover embodiments of different scope directed to the same inventive concept within a single application if the designs are not patentably distinct. *In re Rubinfield*, 270 F.2d 391, 123 USPQ 210 (CCPA 1959). The court held that the inventive concept of a design is not limited to its embodiment in a single specific article, and as long as the various embodiments are not patentably distinct, they may be protected by a single claim. *Blumcraft of Pittsburgh v. Ladd*, 144 USPQ 562 (D.D.C. 1965). The determination that the design of the subcombination/element is patentably indistinct

from the combination means that the designs are not patentable (novel and unobvious) over each other and may remain in the same application. If the embodiments are patentably distinct, the designs are considered to be separate inventions which require separate claims, and restriction to one or the other is necessary. See *In re Kelly*, 200 USPQ 560 (Comm'r Pat. 1978); *Ex parte Sanford*, 1914 C.D. 69, 204 O.G. 1346 (Comm'r Pat. 1914); *Ex parte Heckman*, 135 USPQ 229 (P.O. Super. Exam. 1960). >In determining whether embodiments of different scope can be retained in a single application they must have overall appearances that are basically the same, and the difference in scope must be minor and not a patentable distinction. That is, they must, by themselves, be considered obvious over each other under 35 U.S.C. 103(a) without the aid of analogous prior art. The reason for this, as stated above, is because claim protection to the whole design does not extend to any individual part or portion thereof. Therefore, if the difference in scope between embodiments has an impact on the overall appearance that distinguishes one over the other, they must be restricted since the difference in scope creates patentably distinct designs that must be supported by separate claims.< Form paragraph 15.27.04 or **\*\*>**15.27.05<, if appropriate, may be used to notify applicant that restriction is not required because the embodiments required are not patentably distinct.

**\*\*>**

#### ¶ 15.27.04 Restriction Not Required – Change In Scope (First Action – Non Issue)

This application discloses the following embodiments:

Embodiment 1 – Figs. [1]

Embodiment 2 – Figs. [2]

[3]

Designs which involve a change in scope may be included in the same design application only if they are patentably indistinct. However, design patent protection does not extend to patentably distinct segregable parts of a design. *Ex parte Sanford*, 1914 C.D. 69, 204 O.G. 1346 (Comm'r Pat. 1914); *Blumcraft of Pittsburgh v. Ladd*, 144 USPQ 562 (D.D.C. 1965).

The above identified embodiments are considered by the examiner to present overall appearances that are basically the same. Furthermore, the difference in scope between embodiments is considered minor and patentably indistinct. Accordingly, they are deemed to be obvious variations and are being retained and examined in the same application. Any rejection of one embodiment over prior art will apply equally to all other embodiments. *Ex parte Appeal No. 315-40*, 152 USPQ 71 (Bd. App. 1965). No argument asserting patentability based on the differences between

the embodiments will be considered once the embodiments have been determined to comprise a single inventive concept. Failure of applicant to traverse this determination in reply to this Office action will be considered an admission of lack of patentable distinction between the embodiments.

**Examiner Note:**

In bracket 3, add embodiments as necessary.

¶ 15.27.05 *Restriction Not Required – Change In Scope (First Action Issue)*

This application discloses the following embodiments:

Embodiment 1 – Figs. [1]

Embodiment 2 – Figs. [2]

[3]

Designs which involve a change in scope may be included in the same design application only if they are patentably indistinct. However, design patent protection does not extend to patentably distinct segregable parts of a design. *Ex parte Sanford*, 1914 C.D. 69, 204 O.G. 1346 (Comm’r Pat. 1914); *Blumcraft of Pittsburgh v. Ladd*, 144 USPQ 562 (D.D.C. 1965).

The above identified embodiments are considered by the examiner to present overall appearances that are basically the same. Furthermore, the difference in scope between embodiments is considered minor and patentably indistinct. Accordingly, they are deemed to be obvious variations and are being retained and examined in the same application.

**Examiner Note:**

In bracket 3, add embodiments as necessary.

<

Form paragraph 15.29 or 15.30, if appropriate, may be used to make a restriction requirement.

¶ 15.29 *Restriction Under 35 U.S.C. 121 (Segregable Parts or Combination/Subcombination)*

This application discloses the following embodiments:

Embodiment 1 – Figs. [1] drawn to a [2].

Embodiment 2 – Figs. [3] drawn to a [4].

[5]

Restriction to one of the following inventions is required under 35 U.S.C. 121:

Group I – Embodiment [6]

Group II – Embodiment [7]

[8]

The designs as grouped are distinct from each other since under the law a design patent covers only the invention disclosed as an entirety, and does not extend to patentably distinct segregable parts; the only way to protect such segregable parts is to apply for separate patents. See *Ex parte Sanford*, 1914 CD 69, 204 OG 1346 (Comm’r Pat. 1914); and *Blumcraft of Pittsburgh v. Ladd*, 144 USPQ 562 (D.D.C. 1965). It is further noted that patentably distinct combination/subcombination subject matter must be supported by separate claims, whereas only a single claim is permissible in a design patent application. See *In re Rubinfeld*, 270 F.2d 391, 123 USPQ 210 (CCPA 1959).

[9]

Because the designs are distinct for the reason(s) given above, and have acquired separate status in the art, restriction for examination purposes as indicated is proper (35 U.S.C. 121).

A reply to this requirement must include an election of a single group for prosecution on the merits, even if this requirement is traversed. 37 CFR 1.143. Any reply that does not include an election of a single group will be held nonresponsive. Applicant is also requested to direct cancellation of all drawing figures and the corresponding descriptions which are directed to the nonelected groups.

Should applicant traverse this requirement on the grounds that the groups are not patentably distinct, applicant should present evidence or identify such evidence now of record showing the groups to be obvious variations of one another. If the groups are determined not to be patentably distinct and they remain in this application, any rejection of one group over the prior art will apply equally to all other groups. See *Ex parte Appeal No. 315-40*, 152 USPQ 71 (Bd. App. 1965). No argument asserting patentability based on the differences between the groups will be considered once the groups have been determined to comprise a single inventive concept.

In view of the above requirement, action on the merits is deferred pending compliance with the requirement in accordance with *Ex parte Heckman*, 135 USPQ 229 (P.O. Super. Exam. 1960).

**Examiner Note:**

1. In bracket 5, add embodiments as necessary.
2. In bracket 8, add groups as necessary.
3. In bracket 9, add comments, if necessary.

¶ 15.30 *Telephone Restriction Under 35 U.S.C. 121 (Segregable Parts or Combination/Subcombination)*

This application discloses the following embodiments:

Embodiment 1 – Figs. [1] drawn to a [2].

Embodiment 2 – Figs. [3] drawn to a [4].

[5]

Restriction to one of the following inventions is required under 35 U.S.C. 121:

Group I – Embodiment [6]

Group II – Embodiment [7]

[8]

The designs as grouped are distinct from each other since under the law a design patent covers only the invention disclosed as an entirety, and does not extend to patentably distinct segregable parts; the only way to protect such segregable parts is to apply for separate patents. See *Ex parte Sanford*, 1914 CD 69, 204 OG 1346 (Comm’r Pat. 1914); and *Blumcraft of Pittsburgh v. Ladd*, 144 USPQ 562 (D.D.C. 1965). It is further noted that patentably distinct combination/subcombination subject matter must be supported by separate claims, whereas only a single claim is permissible in a design patent application. See *In re Rubinfeld*, 270 F.2d 391, 123 USPQ 210 (CCPA 1959).

[9]

During a telephone discussion with [10] on [11], a provisional election was made [12] traverse to prosecute the invention of Group [13]. Affirmation of this election should be made by applicant in replying to this Office action.

Group [14] withdrawn from further consideration by the examiner, 37 CFR 1.142(b) as being for a nonelected invention.

**Examiner Note:**

1. In bracket 5, add embodiments as necessary.
2. In bracket 8, add groups as necessary.
3. In bracket 9, insert additional comments, if necessary.

Form paragraph 15.27.06 or 15.27.07, if appropriate, may be used to notify applicant that restriction is not required because the designs are not patentably distinct.

\*\*>

¶ 15.27.06 *Restriction Not Required (Change in Appearance and Scope – First Action Non Issue)*

This application discloses the following embodiments:

Embodiment 1 - Figs. [1] drawn to a [2].

Embodiment 2 - Figs. [3] drawn to a [4].

[5]

Embodiments [6] involve a difference in appearance. Multiple embodiments of a single inventive concept may be included in the same design application only if they are patentably indistinct. *In re Rubinfeld*, 270 F.2d 391, 123 USPQ 210 (CCPA 1959). Embodiments that are patentably distinct from one another do not constitute a single inventive concept and thus may not be included in the same design application. *In re Platner*, 155 USPQ 222 (Comm'r Pat. 1967).

Embodiment(s) [7] directed to the combination(s) in relation to Embodiment(s) [8] directed to the subcombination(s)/element(s). Designs which involve a change in scope may be included in the same design application only if they are patentably indistinct. However, design protection does not extend to patentably distinct segregable parts of a design. *Ex parte Sanford*, 1914 C.D. 69, 204 O.G. 1346 (Comm'r Pat. 1914); *Blumcraft of Pittsburgh v. Ladd*, 144 USPQ 562 (D.D.C.1965).

The above identified embodiments are considered by the examiner to present overall appearances that are basically the same. Furthermore, the differences between embodiments are considered minor and patentably indistinct, or are shown to be obvious in view of analogous prior art cited. Accordingly, they are deemed to be obvious variations and are being retained and examined in the same application. Any rejection of one embodiment over prior art will apply equally to all other embodiments. *Ex parte Appeal No. 315-40*, 152 USPQ 71 (Bd. App. 1965). No argument asserting patentability based on the differences between the embodiments will be considered once the embodiments have been determined to comprise a single inventive concept. Failure of applicant to traverse this determination in reply to this action will be considered an admission of lack of patentable distinction between the embodiments.

**Examiner Note:**

1. In bracket 5, add embodiments as necessary.
2. Insert an explanation of the differences between the designs in the explanations of the embodiments; for example, Figs. 1 – 5 directed to a cup and saucer; Figs. 6 – 9 directed to a saucer.

3. It is possible and proper that embodiments may be listed in both explanatory paragraphs.

¶ 15.27.07 *Restriction Not Required (Change in Appearance and Scope – First Action Issue)*

This application discloses the following embodiments:

Embodiment 1 – Figs. [1] drawn to a [2].

Embodiment 2 – Figs. [3] drawn to a [4].

[5]

Embodiment(s) [6] involve a difference in appearance. Multiple embodiments of a single inventive concept may be included in the same design application only if they are patentably indistinct. *In re Rubinfeld*, 270 F.2d 391, 123 USPQ 210 (CCPA 1959). Embodiments that are patentably distinct from one another do not constitute a single inventive concept and thus may not be included in the same design application. *In re Platner*, 155 USPQ 222 (Comm'r Pat. 1967).

Embodiment(s) [7] directed to the combination(s) in relation to Embodiment(s) [8] directed to the subcombination(s)/element(s). Designs which involve a change in scope may be included in the same design application only if they are patentably indistinct. However, design protection does not extend to patentably distinct segregable parts of a design. *Ex parte Sanford*, 1914 C.D. 69, 204 O.G. 1346 (Comm'r Pat. 1914); *Blumcraft of Pittsburgh v. Ladd*, 144 USPQ 562 (D.D.C.1965).

The above identified embodiments are considered by the examiner to present overall appearances that are basically the same. Furthermore, the differences between embodiments are considered minor and patentably indistinct, or are shown to be obvious in view of analogous prior art cited. Accordingly, they were deemed to be obvious variations and are being retained and examined in the same application. Accordingly, they were deemed to comprise a single inventive concept and have been examined together.

**Examiner Note:**

1. In bracket 5, add embodiments as necessary.
2. Insert an explanation of the differences between the designs in the explanations of the embodiments; for example, Figs. 1 – 5 directed to a cup and saucer; Figs. 6 – 9 directed to a saucer.
3. It is possible and proper that embodiments may be listed in both explanatory paragraphs.

<

The following form paragraphs may be used in a restriction requirement.

\*\*>

Examiners must include a brief explanation of the differences between embodiments that render them patentably distinct.

¶ 15.27.08 *Restriction with Differences in Appearance and Scope*

This application discloses the following embodiments:

Embodiment 1: Figs. [1] drawn to a [2].

Embodiment 2: Figs. [3] drawn to a [4].

[5]



The above embodiments divide into the following patentably distinct groups of designs:

Group I: Embodiment [6]

Group II: Embodiment [7]

[8]

Group(s) [9] involve a difference in appearance. Multiple embodiments of a single inventive concept may be included in the same design application only if they are patentably indistinct. *In re Rubinfeld*, 270 F.2d 391, 123 USPQ 210 (CCPA 1959). Embodiments that are patentably distinct from one another do not constitute a single inventive concept and thus may not be included in the same design application. *In re Platter*, 155 USPQ 222 (Comm'r Pat. 1967). The [10] creates patentably distinct designs.

Because of the differences identified, the embodiments are considered to either have overall appearances that are **not** basically the same, or if they are basically the same, the differences are **not** minor and patentably indistinct or are **not** shown to be obvious in view of analogous prior art.

Group(s) [11] directed to the combination(s) in relation to Group(s) [12] directed to the subcombination(s)/element(s). The designs as grouped are distinct from each other since under the law a design patent covers only the design disclosed as an entirety, and does not extend to patentably distinct segregable parts; the only way to protect such segregable parts is to apply for separate patents. *Ex parte Sanford*, 1914 C.D. 69, 204 O.G. 1346 (Comm'r Pat. 1914); *Blumcraft of Pittsburgh v. Ladd*, 144 USPQ 562 (D.D.C.1965). It is further noted that combination/subcombination subject matter, if patentably distinct, must be supported by separate claims, whereas only a single claim is permissible in a design patent application. *In re Rubinfeld*, 270 F.2d 391, 123 USPQ 210 (CCPA 1959).

In any groups that include multiple embodiments, the embodiments are considered by the examiner to be obvious variations of one another within the group and, therefore, patentably indistinct. These embodiments thus comprise a single inventive concept and are grouped together.

Restriction is required under 35 U.S.C. 121 to one of the patentably distinct groups of designs.

A reply to this requirement must include an election of a single group for prosecution on the merits even if this requirement is traversed. 37 CFR 1.143. Any reply that does not include an election of a single group will be held nonresponsive. Applicant is also requested to direct cancellation of all drawing figures and the corresponding descriptions which are directed to the nonelected groups.

Should applicant traverse this requirement on the grounds that the groups are not patentably distinct, applicant should present evidence or identify such evidence now of record showing the groups to be obvious variations of one another. If the groups are determined not to be patentably distinct and they remain in this application, any rejection of one group over prior art will apply equally to all other groups. *Ex parte Appeal No. 315-40*, 152 USPQ 71 (Bd. App. 1965). No argument asserting patentability based on the differences between the groups will be considered once the groups have been determined to comprise a single inventive concept.

In view of the above requirement, action on the merits is deferred pending compliance with the requirement in accordance with *Ex parte Heckman*, 135 USPQ 229 (P.O. Super. Exam. 1960).

#### Examiner Note:

1. In bracket 5, add embodiments as necessary.
2. In bracket 8, add embodiments as necessary.
3. Insert an explanation of the differences between the designs in the explanations of the embodiments; for example, Figs. 1 – 5 directed to a cup and saucer; Figs. 6 – 9 directed to a saucer.
4. It is possible and proper that embodiments may be listed in both explanatory paragraphs.
5. In bracket 10, insert an explanation of the differences between the designs.

#### ¶ 15.28.02 Telephone Restriction with Differences in Appearance and Scope

This application discloses the following embodiments:

Embodiment 1: Figs. [1] drawn to a [2].

Embodiment 2: Figs. [3] drawn to a [4].

[5]

The above embodiments divide into the following patentably distinct groups of designs:

Group I: Embodiment [6]

Group II: Embodiment [7]

[8]

Group(s) [9] involve a difference in appearance. Multiple embodiments of a single inventive concept may be included in the same design application only if they are patentably indistinct. *In re Rubinfeld*, 270 F.2d 391, 123 USPQ 210 (CCPA 1959). Embodiments that are patentably distinct from one another do not constitute a single inventive concept and thus may not be included in the same design application. *In re Platter*, 155 USPQ 222 (Comm'r Pat. 1967). The [10] creates patentably distinct designs.

Because of the differences identified, the embodiments are considered to either have overall appearances that are **not** basically the same, or if they are basically the same, the differences are **not** minor and patentably indistinct or are **not** shown to be obvious in view of analogous prior art.

Group(s) [11] directed to the combination(s) in relation to Group(s) [12] directed to the subcombination(s)/element(s). The designs as grouped are distinct from each other since under the law a design patent covers only the design disclosed as an entirety, and does not extend to patentably distinct segregable parts; the only way to protect such segregable parts is to apply for separate patents. *Ex parte Sanford*, 1914 C.D. 69, 204 O.G. 1346 (Comm'r Pat. 1914); *Blumcraft of Pittsburg v. Ladd*, 144 USPQ 562 (D.D.C.1965). It is further noted that combination/subcombination subject matter, if patentably distinct, must be supported by separate claims, whereas only a single claim is permissible in a design patent application. *In re Rubinfeld*, 270 F.2d 391, 123 USPQ 210 (CCPA 1959).

In any groups that include multiple embodiments, the embodiments are considered by the examiner to be obvious variations of one another within the group and, therefore, patentably indistinct. These embodiments thus comprise a single inventive concept and are grouped together.

Restriction is required under 35 U.S.C. 121 to one of the patentably distinct groups of designs.

During a telephone discussion with [13] on [14], a provisional election was made [15] traverse to prosecute the invention of Group [16]. Affirmation of this election should be made by applicant in replying to this Office action.

Group [17] is withdrawn from further consideration by the examiner, 37 CFR 1.142(b), as being for a nonelected invention.

#### Examiner Note:

1. In bracket 5, add embodiments as necessary.
2. In bracket 8, add groups as necessary.
3. Insert an explanation of the differences between the designs in the explanations of the embodiments; for example, Figs. 1 – 5 directed to a cup and saucer; Figs. 6 – 9 directed to a saucer.
4. It is possible and proper that embodiments may be listed in both explanatory paragraphs.
5. In bracket 10, insert an explanation of the differences between the designs.
6. In bracket 15, insert --with-- or --without--.

<

#### ¶ 15.33 *Qualifying Statement To Be Used In Restriction When A Common Embodiment Is Included In More Than One Group*

The common embodiment is included in more than a single group as it is patentably indistinct from the other embodiment(s) in those groups and to give applicant the broadest possible choices in his or her election. If the common embodiment is elected in this application, then applicant is advised that the common embodiment should not be included in any continuing application to avoid a rejection on the ground of double patenting under 35 U.S.C. 171 in the new application.

The following form paragraphs may be used to notify applicant that the nonelected invention(s) are withdrawn from consideration.

\*\*>

#### ¶ 15.34 *Groups Withdrawn From Consideration After Traverse*

Group [1] withdrawn from further consideration by the examiner, 37 CFR 1.142(b), as being for a nonelected design, the requirement having been traversed in the reply filed on [2].

#### ¶ 15.35 *Cancel Nonelected Design (Traverse)*

The restriction requirement maintained in this application is or has been made final. Applicant must cancel Group [1] directed to the design(s) nonelected with traverse in the reply filed on [2], or take other timely appropriate action (37 CFR 1.144).

#### ¶ 15.36 *Groups Withdrawn From Consideration Without Traverse*

Group [1] withdrawn from further consideration by the examiner, 37 CFR 1.142(b), as being for the nonelected design. Election was made without traverse in the reply filed on [2].

#### ¶ 15.37 *Cancellation of Nonelected Groups, No Traverse*

In view of the fact that this application is in condition for allowance except for the presence of Group [1] directed to a design or designs nonelected without traverse in the reply filed on [2], and without the right to petition, such Group(s) have been canceled.

<

>

### III. TRAVERSAL OF RESTRICTION REQUIREMENT

If a response to a restriction requirement includes an election with traverse on the grounds that the groups are not patentably distinct, applicant must present evidence or identify such evidence of record showing the groups to be obvious variations of one another. Traversal of a restriction requirement alone without an explanation in support thereof will be treated as an election without traverse. See MPEP § 818.03(a) and form paragraph 8.25.02.

A traversal of a restriction requirement based on there being no serious burden to an examiner to search and examine an entire application (as noted in MPEP § 803) is not applicable to design patent applications. The fact that the embodiments may be searched together cannot preclude a requirement for restriction if their appearances are considered patentably distinct, since patentably distinct embodiments cannot be supported by a single formal design claim. Also, clear admission on the record by the applicant that the embodiments are not patentably distinct (as noted in MPEP § 809.02(a)) will not overcome a requirement for restriction if the embodiments do not have overall appearances that are basically the same as each other.

When a traversal specifically points out the supposed errors in a restriction, examiners must reevaluate the requirement in view of these remarks. If the restriction requirement is to be maintained, it must be repeated and made final in the next Office action and the arguments answered. See MPEP § 821.01. No application should be allowed on the next Office action where a response to a restriction requirement includes an election with traverse, unless the traversal is withdrawn in view of a telephone interview, or the examiner withdraws the restriction requirement.<

## 1504.06 Double Patenting [R-2]

There are generally two types of double patenting rejections. One is the “same invention” type double patenting rejection based on 35 U.S.C. 171 which states in the singular that an inventor “may obtain a patent.” The second is the “nonstatutory-type” double patenting rejection based on a judicially created doctrine grounded in public policy and which is primarily intended to prevent prolongation of the patent term by prohibiting claims in a second patent not patentably distinct from claims in a first patent. Nonstatutory double patenting includes rejections based on one-way determination of obviousness, and two-way determination of obviousness.

The charts in MPEP § 804 outline the procedure for handling all double patenting rejections.

Double patenting rejections are based on a comparison of the claims in a patent and an application or between two applications; the disclosure of the patent or application may be relied upon only to define the claim. 35 U.S.C. 171 specifically states that “a patent” may be obtained if certain conditions are met; this use of the singular makes it clear that only one patent may issue for a design.

Determining if a double patenting rejection is appropriate involves \* answering the following inquiries: Is the same design being claimed twice? If the answer is yes, then a rejection under 35 U.S.C. 171 should be given on the grounds of “same invention” type double patenting. If not, are the designs directed to patentably indistinct variations of the same inventive concept? If the answer is yes, then a rejection based on the nonstatutory type double patenting should be given.

Double patenting rejections are based on a comparison of claims. While there is a direct correlation between the drawings in a design application and the claim, examiners must be aware that no such correlation is necessary in a utility application or patent. Several utility patents may issue with the identical drawing disclosure but with claims directed to different inventions. So any consideration of possible double patenting rejections between a utility application or patent with a design application cannot be based on the utility drawing disclosure alone. *Anchor Hocking Corp. v. Eyelet Specialty Co.*, 377 F. Supp. 98, 183 USPQ 87 (D. Del. 1974). The examiner must be

able to recreate the design claimed from the utility claims without any reliance whatsoever on the drawings.

If a provisional double patenting rejection (of any type) is the only rejection remaining in two conflicting applications, the examiner should withdraw that rejection in one of the applications (e.g., the application with the earlier filing date) and permit the application to issue as a patent. The examiner should maintain the provisional double patenting rejection in the other application which rejection will be converted into a double patenting rejection when the first application issues as a patent. If more than two applications conflict with each other and one is allowed, the remaining applications should be cross rejected against the others as well as the allowed application. For this type of rejection to be appropriate, there must be either at least one inventor in common, or a common assignee. If the claims in copending design applications or a design patent and design applications have a common assignee but different inventive entities, rejections under 35 U.S.C. 102(e), (f) and (g)/103(a) must be considered in addition to the double patenting rejection. See MPEP § 804, § 2136, § 2137 and § 2138.

### I. “SAME INVENTION” DOUBLE PATENTING REJECTIONS

A design - design statutory double patenting rejection based on 35 U.S.C. 171 prevents the issuance of a second patent for a design already patented. For this type of double patenting rejection to be proper, identical designs with identical scope must be twice claimed. *In re Goodman*, 11 F.3d 1046, 29 USPQ2d 2010 (Fed. Cir. 1993). A design - utility “same invention” double patenting rejection is based on judicial doctrine as there is no statutory basis for this rejection because neither 35 U.S.C. 101 nor 35 U.S.C. 171 can be applied against both claims. *In re Thornton*, 418 F.2d 528, 163 USPQ 644 (CCPA 1969). The “same invention” type of double patenting rejection, whether statutory or nonstatutory, cannot be overcome by a terminal disclaimer. *In re Swett*, 145 F.2d 631, 172 USPQ 72 (CCPA 1971).

#### ¶ 15.23.02 Summary for “Same Invention” – Type Double Patenting Rejections

Applicant is advised that a terminal disclaimer may not be used to overcome a “same invention” type double patenting rejection.

*In re Thorington*, 418 F.2d 528, 163 USPQ 644 (CCPA 1969); MPEP § 804.02.

**Examiner Note:**

This form paragraph should follow all “same invention” type double patenting rejections.

¶ 15.23 35 U.S.C. 171 Double Patenting Rejection (Design-Design)

The claim is rejected under 35 U.S.C. 171 on the ground of double patenting since it is claiming the same design as that claimed in United States Design Patent No. [1].

**Examiner Note:**

Form paragraph 15.23.02 should follow all “same invention” type double patenting rejections.

¶ 15.23.01 35 U.S.C. 171 Provisional Double Patenting Rejection (Design-Design)

The claim is provisionally rejected under 35 U.S.C. 171 on the ground of double patenting since it is claiming the same design as that claimed in copending Application No. [1]. This is a provisional double patenting rejection since the conflicting claims have not in fact been patented.

**Examiner Note:**

Form paragraph 15.23.02 should follow all “same invention” type double patenting rejections.

¶ 15.24.07 Double Patenting Rejection (Design-Utility)

The claim is rejected under the judicially created doctrine of double patenting as being directed to the same invention as that set forth in claim [1] of United States Patent No. [2]. See *In re Thorington*, 418 F.2d 528, 163 USPQ 644 (CCPA 1969).

**Examiner Note:**

Form paragraph 15.23.02 should follow all “same invention” type double patenting rejections.

¶ 15.24.08 Provisional Double Patenting Rejection (Design-Utility)

The claim is provisionally rejected under the judicially created doctrine of double patenting as being directed to the same invention as that set forth in claim [1] of copending Application No. [2]. See *In re Thorington*, 418 F.2d 528, 163 USPQ 644 (CCPA 1969).

This is a provisional double patenting rejection because the claims have not in fact been patented.

**Examiner Note:**

Form paragraph 15.23.02 should follow all “same invention” type double patenting rejections.

\*\*

## II. NONSTATUTORY DOUBLE PATENTING REJECTIONS

A rejection based on nonstatutory double patenting is based on a judicially created doctrine grounded in

public policy so as to prevent the unjustified or improper timewise extension of the right to exclude granted by a patent. *In re Goodman*, 11 F.3d 1046, 29 USPQ2d 2010 (Fed. Cir. 1993).

A nonstatutory double patenting rejection of the obviousness-type applies to claims directed to the *same inventive concept with different appearances or differing scope which are patentably indistinct from each other*. Nonstatutory categories of double patenting rejections which are not the “same invention” type may be overcome by the submission of a terminal disclaimer.

An obviousness-type double patenting rejection must be based on the obviousness standard of 35 U.S.C. 103(a). That is, >the conflicting designs must have overall appearances that are basically the same, and the< differences between \*\*>them< must either be \*\*>minor and patentably indistinct< or \*\* obvious to a designer of ordinary skill in the art \*\* in view of \*>analogous< prior art or case law. If the claims are considered obvious under 35 U.S.C. 103(a), an obviousness-type double patenting rejection must be made. While the earlier patent (if less than a year older than the application) or application is not technically “prior art,” the principle involved is the same. *In re Zickendraht*, 319 F.2d 225, 138 USPQ 22 (CCPA 1963)(see concurring opinion of Judge Rich).

In determining whether to make an obviousness-type double patenting rejection between designs having differing scope, the examiner should compare the reference claim with the application claim. A rejection is appropriate if:

(A) The difference in scope is \*\*>minor and patentably indistinct between< the claims being compared;

(B) Patent protection for the design, fully disclosed in and covered by the claim of the reference, would be extended by the allowance of the claim in the later filed application; and

(C) No terminal disclaimer has been filed.

This kind of obviousness-type double patenting rejection in designs will occur between designs which may be characterized as a combination (narrow claim) and a subcombination/element thereof (broad claim). >See discussion in MPEP § 1504.05, subsection II, B.< If the designs are patentably indistinct and are

directed to the same inventive concept the examiner must determine whether the subject matter of the narrower claim is fully disclosed in and covered by the broader claim of the reference. If the reference does *not* fully disclose the narrower claim, then a double patenting rejection should not be made. The additional disclosure necessary to establish that the applicant was in possession of the narrower claim at the time the broader claim was filed may be in a title or special description as well as in a broken line showing in the drawings. If the broader claim of the reference does not disclose the additional subject matter claimed in the narrower claim, then applicant could not have claimed the narrower claim at the time the application with the broader claim was filed and a rejection under nonstatutory double patenting would be inappropriate.

A nonstatutory double patenting rejection may be made between a patent and an application or provisionally between applications. Such rejection over a patent should only be given if the patent issued less than a year before the filing date of the application. If the patent is more than a year older than the application, the patent is considered to be “prior art” which may be applied in a rejection under 35 U.S.C. 102(b)/103(a). The purpose of a terminal disclaimer is to obviate a double patenting rejection by removing potential harm to the public by issuing a second patent. See MPEP § 804.

If the issue of double patenting is raised between a patent and a *continuing* application, examiners are reminded that this ground of rejection can only be made when the filing of the continuing application is voluntary and not the direct, unmodified result of restriction requirement under 35 U.S.C. 121. See MPEP § 804.01.

Examiners should particularly note that a design-design nonstatutory double patenting rejection does not *always* have to be made in both of the conflicting applications. For the most part, these rejections will be made in each of the conflicting applications; but, if the rejection is only appropriate in one direction, it is proper to reject only one application. The criteria for determining whether a one-way obviousness determination is necessary or a two-way obviousness determination is necessary is set forth in MPEP § 804. However, in design-utility situations, a two-way obviousness determination is necessary for the rejection to

be proper. *In re Dembiczak*, 175 F.3d 994, 50 USPQ2d 1614 (Fed. Cir. 1999).

The following form paragraphs may be used in making a double patenting rejection. >Explanation should be provided in the appropriate brackets.<

¶ 15.24.06 *Basis for Nonstatutory Double Patenting, “Heading Only”*

The non-statutory double patenting rejection is based on a judicially created doctrine grounded in public policy (a policy reflected in the statute) so as to prevent the unjustified or improper timewise extension of the “right to exclude” granted by a patent and to prevent possible harassment by multiple assignees. See *In re Goodman*, 11 F.3d 1046, 29 USPQ2d 2010 (Fed. Cir. 1993); *In re Longi*, 759 F.2d 887, 225 USPQ 645 (Fed. Cir. 1985); *In re Van Ornum*, 686 F.2d 937, 214 USPQ 761 (CCPA 1982); *In re Vogel*, 422 F.2d 438, 164 USPQ 619 (CCPA 1970); and *In re Thorington*, 418 F.2d 528, 163 USPQ 644 (CCPA 1969).

A timely filed terminal disclaimer in compliance with 37 CFR 1.321(c) may be used to overcome an actual or provisional rejection based on a nonstatutory double patenting ground provided the conflicting application or patent is shown to be commonly owned with this application. See 37 CFR 1.130(b).

Effective January 1, 1994, a registered attorney or agent of record may sign a terminal disclaimer. A terminal disclaimer signed by the assignee must fully comply with 37 CFR 3.73(b).

**Examiner Note:**

This form paragraph must precede all nonstatutory double patenting rejections as a heading, except “same invention” type.

\*\*>

¶ 15.24 *Obviousness-type Double Patenting Rejection (Single Reference)*

The claim is rejected under the judicially created doctrine of the obviousness-type double patenting of the claim in United States Patent No. [1]. Although the conflicting claims are not identical, they are not patentably distinct from each other because [2].

**Examiner Note:**

1. In bracket 1, insert prior U.S. Patent Number.
2. In bracket 2, the differences between the conflicting claims must be identified and indicated as being minor and not distinguishing the overall appearance of one over the other.
3. This form paragraph must be preceded by form paragraph 15.24.06 and followed by form paragraph 15.67.

¶ 15.24.03 *Provisional Obviousness-Type Double Patenting Rejection (Single Reference)*

The claim is provisionally rejected under the judicially created doctrine of the obviousness-type double patenting of the claim of copending Application No. [1]. Although the conflicting claims are not identical, they are not patentably distinct from each other because [2]. This is a provisional obviousness-type double pat-

enting rejection because the conflicting claims have not in fact been patented.

**Examiner Note:**

1. In bracket 1, insert conflicting application number.
2. In bracket 2, the differences between the conflicting claims must be identified and indicated as being minor and not distinguishing the overall appearance of one over the other.
3. This form paragraph must be preceded by form paragraph 15.24.06 and followed by form paragraph 15.67.

<

¶ 15.67 *Rationale for 35 U.S.C. 103(a) Rejection (Single Reference)*

It is well settled that it is unobviousness in the overall appearance of the claimed design, when compared with the prior art, rather than minute details or small variations in design as appears to be the case here, that constitutes the test of design patentability. See *In re Frick*, 275 F.2d 741, 125 USPQ 191 (CCPA 1960) and *In re Lamb*, 286 F.2d 610, 128 USPQ 539 (CCPA 1961).

\*\*>

¶ 15.25 *Obviousness-Type Double Patenting Rejection (Multiple References)*

The claim is rejected under the judicially created doctrine of the obviousness-type double patenting of the claim(s) in United States Patent No. [1] in view of [2]. At the time applicant made the design, it would have been obvious to a designer of ordinary skill in the art to [3] as demonstrated by [4].

**Examiner Note:**

1. In bracket 1, insert conflicting patent number.
2. In bracket 2, insert secondary reference(s).
3. In bracket 3, insert an explanation of how the conflicting claim in the patent is modified.
4. In bracket 4, identify the secondary reference(s) teaching the modification(s).
5. This form paragraph must be preceded by form paragraph 15.24.06 and followed by form paragraph 15.68.

¶ 15.24.04 *Provisional Obviousness-Type Double Patenting Rejection (Multiple References)*

The claim is provisionally rejected under the judicially created doctrine of the obviousness-type double patenting of the claim of copending Application No. [1] in view of [2]. At the time applicant made the design, it would have been obvious to a designer of ordinary skill in the art to [3] as demonstrated by [4]. This is a provisional obviousness-type double patenting rejection because the conflicting claims have not in fact been patented.

**Examiner Note:**

1. In bracket 1, insert conflicting application number.
2. In bracket 2, insert secondary reference(s).
3. In bracket 3, insert an explanation of how the conflicting claim in the copending application is modified.
4. In bracket 4, identify the secondary reference(s) teaching the modification(s).

5. This form paragraph must be preceded by form paragraph 15.24.06 and followed by form paragraph 15.68.

<

¶ 15.68 *Rationale for 35 U.S.C. 103(a) Rejection (Multiple References)*

This modification of the basic reference in light of the secondary prior art is proper because the applied references are so related that the appearance of features shown in one would suggest the application of those features to the other. See *In re Rosen*, 673 F.2d 388, 213 USPQ 347 (CCPA 1982); *In re Carter*, 673 F.2d 1378, 213 USPQ 625 (CCPA 1982), and *In re Glavas*, 230 F.2d 447, 109 USPQ 50 (CCPA 1956). Further, it is noted that case law has held that a designer skilled in the art is charged with knowledge of the related art; therefore, the combination of old elements, herein, would have been well within the level of ordinary skill. See *In re Antle*, 444 F.2d 1168, 170 USPQ 285 (CCPA 1971) and *In re Nalbandian*, 661 F.2d 1214, 211 USPQ 782 (CCPA 1981).

## 1504.10 Priority Under 35 U.S.C. 119(a)-(d) [R-2]

### 35 U.S.C. 172. Right of priority.

The right of priority provided for by subsections (a) through (d) of section 119 of this title and the time specified in section 102(d) shall be six months in the case of designs. The right of priority provided for by section 119(e) of this title shall not apply to designs.

The provisions of 35 U.S.C. 119(a)-(d) apply to design patent applications. However, in order to obtain the benefit of an earlier foreign filing date, the United States application must be filed within 6 months of the earliest date on which any foreign application for the same design was filed. Design applications may not make a claim for priority of a provisional application under 35 U.S.C. 119(e).

### ¶ 15.01 *Conditions Under 35 U.S.C. 119(a)-(d)*

Applicant is advised of conditions as specified in 35 U.S.C. 119(a)-(d). An application for a design patent for an invention filed in this country by any person who has, or whose legal representatives have previously filed an application for a design patent, or equivalent protection for the same design in a foreign country which offers similar privileges in the case of applications filed in the United States or in a WTO member country, or to citizens of the United States, shall have the same effect as the same application would have if filed in this country on the date on which the application for patent for the same invention was first filed in such foreign country, if the application in this country is filed within six (6) months from the earliest date on which such foreign application was filed.

>

¶ 15.01.01 *Conditions Under 35 U.S.C. 172 Not Met*

The claim for priority under 35 U.S.C. 119(a)-(d) to the [1] application is acknowledged, however, the claim for priority cannot be based on such application since it was filed more than six (6) months before the filing of the application in the United States. 35 U.S.C. 172.

**Examiner Note:**

1. In bracket, insert the name of the foreign country.

<

\*\*>

¶ 15.03 *Untimely Priority Papers*

Receipt is acknowledged of the filing on [1] of a certified copy of the [2] application referred to in the oath or declaration. A claim for priority cannot be based on said application, since the United States application was filed more than six (6) months thereafter (35 U.S.C. 172).

<

The United States will recognize claims for the right of priority under 35 U.S.C. 119(a)-(d) based on applications filed under such bilateral or multilateral treaties as the “Hague Agreement Concerning the International Deposit of Industrial Designs>,<” \*\* “Uniform Benelux Act on Designs and Models” >and “European Community Design.”< In filing a claim for priority of a foreign application previously filed under such a treaty, certain information must be supplied to the United States Patent and Trademark Office. In addition to the application number and the date of filing of the foreign application, the following information is required:

(A) the name of the treaty under which the application was filed,

(B) the name of at least one country other than the United States in which the application has the effect of, or is equivalent to, a regular national filing and

(C) the name and location of the national or inter-governmental authority which received the application.

\*\*>

¶ 15.02 *Right of Priority Under 35 U.S.C. 119(b)*

No application for design patent shall be entitled to the right of priority under 35 U.S.C. 119(b) unless a claim therefor and a certified copy of the original foreign application, specification and drawings upon which it is based are filed in the United States Patent and Trademark Office before the issue fee is paid, or at such time during the pendency of the application as required by the Director not earlier than six (6) months after the filing of the application in this country. Such certification shall be made by the Patent Office, or other proper authority of the foreign country

in which filed, and show the date of the application and of the filing of the specification and other papers. The Director may require a translation of the papers filed if not in the English language, and such other information as deemed necessary.

<

The notation requirement on design patent application file wrappers when foreign priority is claimed is set forth in MPEP § 202.03.

\*\*>

¶ 15.04 *Priority Under Bilateral or Multilateral Treaties*

The United States will recognize claims for the right of priority under 35 U.S.C. 119(a)-(d) based on applications filed under such bilateral or multilateral treaties as the Hague Agreement Concerning the International Deposit of Industrial Designs, the Benelux Designs Convention and European Community Design. In filing a claim for priority of a foreign application previously filed under such a treaty, certain information must be supplied to the United States Patent and Trademark Office. In addition to the application number and the date of filing of the application, the following information is requested: (1) the name of the treaty under which the application was filed; (2) the name of at least one country other than the United States in which the application has the effect of, or is equivalent to, a regular national filing; and (3) the name and location of the national or international governmental authority which received such application.

¶ 15.52 *Examination of Priority Papers*

While the U.S. Patent and Trademark Office does not normally examine the priority papers to determine whether the applicant is in fact entitled to the right of priority, in the case of a Design Patent application, the priority papers will normally be inspected to determine that the foreign application is in fact for the same invention as the application in the United States (35 U.S.C. 119). Inspection of the papers herein indicates that the prior foreign application was not for the same invention as claimed in this application. Accordingly, the priority claim is improper.

<

Attention is also directed to the paragraphs dealing with the requirements where an actual model was originally filed in Germany (MPEP § 201.14(b)).

See MPEP Chapter 200 and 37 CFR 1.55 for further discussion of the practice and procedure under 35 U.S.C. 119(a)-(d).

**1504.20 Benefit Under 35 U.S.C. 120 [R-2]**

*35 U.S.C. 120. Benefit of earlier filing date in the United States.*

An application for patent for an invention disclosed in the manner provided by the first paragraph of section 112 of this title in an application previously filed in the United States, or as provided by section 363 of this title, which is filed by an inventor or inventors

named in the previously filed application shall have the same effect, as to such invention, as though filed on the date of the prior application, if filed before the patenting or abandonment of or termination of proceedings on the first application or on an application similarly entitled to the benefit of the filing date of the first application and if it contains or is amended to contain a specific reference to the earlier filed application. No application shall be entitled to the benefit of an earlier filed application under this section unless an amendment containing the specific reference to the earlier filed application is submitted at such time during the pendency of the application as required by the Director. The Director may consider the failure to submit such an amendment within that time period as a waiver of any benefit under this section. The Director may establish procedures, including the payment of a surcharge, to accept an unintentionally delayed submission of an amendment under this section.

If applicant is entitled under 35 U.S.C. 120 to the benefit of an earlier U.S. filing date, the statement that, “This is a division [continuation] of design Application No. — — — —, filed — — —.” should appear in the first sentence of the specification. As set forth in 37 CFR 1.78(a)(2), the specification must contain or be amended to contain such a reference in the first sentence following the title unless the reference is included in an application data sheet (37 CFR 1.76). The failure to timely submit such a reference is considered a waiver of any benefit under 35 U.S.C. 120.

>Form paragraph 15.26 may be used to remind applicant that a reference to the prior application must be included in the first sentence of the specification or in an application data sheet.

¶ 15.26 *Identification of Prior Application(s) in Nonprovisional Applications - Benefit of Priority Claimed*

Applicant is reminded of the following requirement:

In a continuation or divisional application (other than a continued prosecution application filed under 37 CFR 1.53(d)), the first sentence of the specification or the application data sheet (37 CFR 1.76) should include a reference to the prior application(s) from which benefit of priority is claimed. See 37 CFR 1.78. The following format is suggested: “This is a continuation (or division) of Application No. \_\_\_\_\_, filed \_\_\_\_\_, now (abandoned, pending or U.S. Patent No. \_\_\_\_\_).”

<

Attention is directed to the requirements for “continuing” applications set forth in MPEP § 201.07, § 201.08, and § 201.11. Applicants are entitled to claim the benefit of the filing date of earlier applications for later claimed inventions under 35 U.S.C. 120

only when the earlier application discloses that invention in the manner required by 35 U.S.C. 112, first paragraph. In all continuation and divisional applications, a determination must be made by the examiner as to whether the conditions for priority under 35 U.S.C. 120 have been met. The disclosure of the claimed design in a continuation and divisional application must be the same as that of the original application. If this condition is not met, \*>the application< is not entitled to the benefit of the earlier filing date and the examiner should notify applicant accordingly by specifying the reasons why applicant is not entitled to claim the benefit under 35 U.S.C. 120. Form paragraphs 2.09 and 2.10 may be used >followed by a specific explanation as to why the later filed application fails to comply with the requirements of 35 U.S.C. 120<. The examiner should also require applicant to cancel the claim for priority in the first sentence of the specification.

In the absence of a statement in the application as originally filed incorporating by reference the disclosure of an earlier filed application, the disclosure in a continuing application may not be amended to conform to that of the earlier filed application for which priority is claimed. A mere statement that an application is a continuation or division of an earlier filed application is not an incorporation of anything into the application containing such reference for purposes of satisfying the disclosure requirements of 35 U.S.C. 112, first paragraph. *In re de Seversky*, 474 F.2d 671, 177 USPQ 144 (CCPA 1973). See also MPEP 608.01(p).

When the first application is found to be fatally defective under 35 U.S.C. 112 because of insufficient disclosure to support an allowable claim and such position has been made of record by the examiner, a second design patent application filed as an alleged “continuation-in-part” of the first application to supply the deficiency is not entitled to the benefit of the earlier filing date. See *Hunt Co. v. Mallinckrodt Chemical Works*, 177 F.2d 583, 83 USPQ 277 (F2d Cir. 1949) and cases cited therein. Also, a design application filed as a “continuation-in-part” that changes the shape or configuration of a design disclosed in an earlier application is not entitled to the benefit of the filing date of the earlier application. See *In re Salmon*, 705 F.2d 1579, 217 USPQ 981 (Fed. Cir. 1983). >However, a later filed application that



changes the scope of a design claimed in an earlier filed application by reducing certain portions of the drawing to broken lines is not a change in configuration as defined by the court in *Salmon*. See MPEP § 1504.04, subsection II.<

Unless the filing date of an earlier application is actually needed, for example, in the case of an interference or to avoid an intervening reference, there is no need for the examiner to make a determination in a continuation-in-part application as to whether the requirement of 35 U.S.C. 120 is met. Note the holdings in *In re Corba*, 212 USPQ 825 (Comm'r Pat. 1981).

Form paragraph 15.74 may be used in a first Office action on the merits in any application >identified as a continuation-in-part< which claims priority under 35 U.S.C. 120 to a prior application.

¶ 15.74 *Continuation-In-Part Caution*

Reference to this design application as a continuation-in-part under 35 U.S.C. 120 is acknowledged. Applicant is advised that design case law holds that any change to the shape or configuration of a design disclosed in an earlier application constitutes an entirely new design that cannot rely upon the earlier one for priority. See *In re Salmon*, 705 F.2d 1579, 217 USPQ 981 (Fed. Cir. 1983). Therefore, a later filed application that changes the shape or configuration of a design disclosed in a prior application does not satisfy the written description requirement of 35 U.S.C. 112, first paragraph, under 35 U.S.C. 120 and is not entitled to benefit of the earlier filing date. In addition, where an application is found to be fatally defective under 35 U.S.C. 112 because of an inadequate disclosure to support an allowable claim, a second design patent application filed as an alleged "continuation-in-part" of the first application to supply the deficiency is not entitled to the benefit of the earlier filing date. See *Hunt Co. v. Mallinckrodt Chemical Works*, 177 F.2d 583, 83 USPQ 277 (Fed. Cir. 1949). However, unless the filing date of the earlier application is actually needed, such as to avoid intervening prior art, the entitlement to priority in this CIP application will not be considered. See *In re Corba*, 212 USPQ 825 (Comm'r Pat. 1981).

**Examiner Note:**

This form paragraph should be used in the first action on the merits in any application which claims priority under 35 U.S.C. 120 as a continuation-in-part.

Where a continuation-in-part application claims benefit under 35 U.S.C. 120 of the filing date of an earlier application, a determination as to the propriety of this claim must be made if the earlier application claims the benefit of a foreign application under 35 U.S.C. 119(a) - (d). To determine the status of the foreign application, the charts in MPEP § 1504.02 should be used. If the conditions of 35 U.S.C. 120 are

not met, then the claim for benefit of the earlier filing date under 35 U.S.C. 120 as a continuation-in-part should be denied and the claim for priority under 35 U.S.C. 119(a) - (d) should also be denied. If the foreign application for patent/registration has matured into a form of patent protection and would anticipate or render the claim in the alleged CIP application obvious, the design shown in the foreign application papers would qualify as prior art under 35 U.S.C. 102(d)/172 and the claim should be rejected under 35 U.S.C. 102/103. Form paragraph 15.75 may be used.

¶ 15.75 *Preface to Rejection in Alleged CIP Based on 35 U.S.C. 102(d)/172*

Reference to this design application as a continuation-in-part under 35 U.S.C. 120 is acknowledged. Applicant is advised that design case law holds that any change to the shape or configuration of a design disclosed in an earlier application constitutes an entirely new design that cannot rely upon the earlier one for priority. See *In re Salmon*, 705 F.2d 1579, 217 USPQ 981 (Fed. Cir. 1983). Therefore, a later filed application that changes the shape or configuration of a design disclosed in a prior application, as in the present case, does not satisfy the written description requirement of 35 U.S.C. 112, first paragraph, under 35 U.S.C. 120 and is not entitled to benefit of the earlier filing date.

The parent application claimed foreign priority under 35 U.S.C. 119(a) - (d). Insofar as the foreign application has matured into a patent/registration more than six months before the filing date of the present application, it qualifies as prior art under 35 U.S.C. 102(d)/172.

**Examiner Note:**

This form paragraph should be followed with a rejection under 35 U.S.C. 102 or 103(a) depending on the difference(s) between this claim and the design shown in the priority papers.

>If the status of the foreign application cannot be determined the following form paragraph should be used instead.

¶ 15.75.01 *C-I-P Caution, Claim to Foreign Priority in Earlier Filed Application*

Reference to this application as a continuation-in-part under 35 U.S.C. 120 is acknowledged. Applicant is advised that design case law holds that any change to the shape or configuration of a design disclosed in an earlier application constitutes an entirely new design that cannot rely upon the earlier one for priority. See *In re Salmon et al.*, 705 F.2d 1579, 217 USPQ 981 (Fed. Cir. 1983). Therefore, a later filed application that changes the shape or configuration of a design disclosed in a prior application does not satisfy the written description requirement of 35 U.S.C. 112, first paragraph, under 35 U.S.C. 120 and is not entitled to benefit of the earlier filing date.

However, unless the filing date of the earlier application is actually needed, such as to avoid intervening prior art, entitlement

to priority in this CIP application will not be considered. See *In re Corba*, 212 USPQ 825 (Comm'r Pat. 1981).

The parent application claimed foreign priority under 35 U.S.C. 119(a) - (d). Applicant is reminded that if the foreign application to which priority was claimed matured into a form of patent protection prior to the filing of this application it qualifies as prior art under 35 U.S.C. 102(d)/172.

<

Where the conditions of 35 U.S.C. 120 are met, a design application may be considered a continuing application of an earlier utility application. Conversely, this also applies to a utility application relying on the benefit of the filing date of an earlier filed design application. See *In re Chu*, 66 F.3d 292, 36 USPQ2d 1089 (Fed. Cir. 1995); *In re Salmon*, 705 F.2d 1579, 217 USPQ 981 (Fed. Cir. 1983). In addition, a design application may claim benefit from an earlier filed PCT application under 35 U.S.C. 120 if the U.S. was designated in the PCT application.

Note also *In re Berkman*, 642 F.2d 427, 209 USPQ 45 (CCPA 1981) where the benefit of a design patent application filing date requested under 35 U.S.C. 120 was denied in the later filed utility application of the same inventor. The Court of Customs and Patent Appeals took the position that the design application did not satisfy 35 U.S.C. 112, first paragraph, as required under 35 U.S.C. 120.

\*\*

### 1504.30 Expedited Examination [R-2]

37 CFR 1.155. *Expedited examination of design applications*

(a) The applicant may request that the Office expedite the examination of a design application. To qualify for expedited examination.

(1) The application must include drawings in compliance with § 1.84;

(2) The applicant must have conducted a preexamination search; and

(3) The applicant must file a request for expedited examination including:

(i) The fee set forth in § 1.17(k); and

(ii) A statement that a preexamination search was conducted. The statement must also indicate the field of search and include an information disclosure statement in compliance with § 1.98.

(b) The Office will not examine an application that is not in condition for examination (*e.g.*, missing basic filing fee) even if the applicant files a request for expedited examination under this section.

37 CFR 1.155 establishes an expedited procedure for design applications. This expedited procedure became effective on September 8, 2000 and is available to all design applicants who first conduct a preliminary examination search and file a request for expedited treatment accompanied by the fee specified in 37 CFR 1.17(k). This expedited treatment is intended to fulfill a particular need by affording rapid design patent protection that may be especially important where marketplace conditions are such that new designs on articles are typically in vogue for limited periods of time.

A design application may qualify for expedited examination provided the following requirements are met:

(A) A request for expedited examination is filed (Form PTO/SB/27 may be used);

(B) The design application is complete and it includes drawings in compliance with 37 CFR 1.84 (see 37 CFR 1.154 and MPEP § 1503 concerning the requirements for a complete design application);

(C) A statement is filed indicating that a preexamination search was conducted (a search made by a foreign patent office satisfies this requirement). The statement must also include a list of the field of search such as by U.S. Class and Subclass (including domestic patent documents, foreign patent documents and nonpatent literature);

(D) An information disclosure statement in compliance with 37 CFR 1.98 is filed;

(E) The basic design application filing fee set forth in 37 CFR 1.16(f) is paid; and

(F) The fee for expedited examination set forth in 37 CFR 1.17(k) is paid.

#### EXPEDITED EXAMINATION PROCEDURE

Design applications requesting expedited examination and complying with the requirements of 37 CFR 1.155 are examined with priority and undergo expedited processing throughout the entire course of prosecution in the Office, including appeal, if any, to the Board of Patent Appeals and Interferences. All processing is expedited from the date the request is granted.

Design applicants seeking expedited examination may file a design application in the Office together with a corresponding request under 37 CFR 1.155 by hand-delivering the application papers and the request directly to the Design Technology Center (TC) Director's Office. For applicants who choose to file a design application and the corresponding request under 37 CFR 1.155 by mail, the envelope should be addressed to:

\*\*>

Mail Stop Expedited Design  
Commissioner for Patents  
P.O. Box 1450  
Alexandria, VA 22313-1450  
<

\*>Mail Stop< Expedited Design should only be used for the initial filing of design applications accompanied by a corresponding request for expedited examination under 37 CFR 1.155. \*>Mail Stop< Expedited Design should NOT be used for a request under 37 CFR 1.155 filed subsequent to the filing of the corresponding design application. Instead, a subsequently filed request under 37 CFR 1.155 should be made by facsimile transmission to the \*\*>centralized facsimile number 703-872-9306 with the notation "SPECIAL PROCEDURES SUBMISSION" included at the top of the first page and< the corresponding application number >identified<.

Design application filings addressed to \* >Mail Stop< Expedited Design will be forwarded immediately to the Design TC Director's office. Whether an application requesting expedited examination is hand-delivered to the Design TC Director's office or mailed to \* >Mail Stop< Expedited Design, expedited processing is initiated at the Design TC Director's office provided the application (including the design application filing fee) is in condition for examination and a complete request under 37 CFR 1.155 (including the fee specified at 37 CFR 1.17(k)) qualifies the application for expedited examination.

Upon a decision by the Design TC Director to grant the request for expedited examination, >the< fees are immediately processed, the application papers are promptly assigned an application number, and the application is dispatched to an examiner for expedited examination. In addition, the applicant is

notified that examination is being expedited. The expedited treatment under 37 CFR 1.155 occurs through initial examination processing and throughout the entire prosecution in the Office. Whereas, an application granted special status pursuant to a successful "petition to make special" under MPEP § 708.02 is prioritized while it is on the examiner's docket so that the application will be examined out of turn responsive to each successive communication from the applicant requiring Office action. For a patentable design application, the expedited treatment under 37 CFR 1.155 would be a streamlined filing-to-issuance procedure. This procedure further expedites design application processing by decreasing clerical processing time as well as the time spent routing the application between processing steps.

Although a request under 37 CFR 1.155 may be filed subsequent to the filing of the design application, it is recommended that the request and the corresponding design application be filed together in order to optimize expeditious processing.

If an application requesting expedited examination is incomplete (not in condition for examination), an appropriate notice will be mailed to the applicant identifying the reasons why the application is incomplete and requiring correction thereof. The Office will not examine an application that is not in condition for examination even if the applicant files a request for expedited examination.

If an application requesting expedited examination fails to comply with one or more of the requirements for expedited examination under 37 CFR 1.155, but the application is otherwise complete, the applicant will be promptly notified and required to comply with all requirements under 37 CFR 1.155 within a shortened time period extendable under 37 CFR 1.136(a). Unless all requirements under 37 CFR 1.155 are timely met, the application will await action in its regular turn.

Once a request under 37 CFR 1.155 is granted, examiners will expedite examination by examining the application out-of-turn. Examiners are strongly encouraged to use telephone interviews to resolve minor problems. Clerical processing of the application will be expedited as well.

If the overall appearance of two or more patentably distinct embodiments of an article as disclosed in the drawings are different in appearance or scope,

restriction will be required in accordance with MPEP § 1504.05. If applicant refuses to make an election without traverse, the application will not be further examined at that time, and the application will await action in its regular turn. Divisional applications directed to nonelected inventions will not qualify for expedited examination unless the divisional application meets on its own all requirements for expedited examination under 37 CFR 1.155. Similarly, expedited status will not carry over to a continuing application, including a CPA, unless the continuing application meets on its own all requirements for expedited examination under 37 CFR 1.155.

Once a request for expedited examination is granted, prosecution will proceed according to the procedure under 37 CFR 1.155. There is no provision for “withdrawal” from expedited examination procedure.

## 1505 Allowance and Term of Design Patent

35 U.S.C. 173. *Term of design patent.*

Patents for designs shall be granted for the term of fourteen years from the date of grant.

## 1509 Reissue of a Design Patent [R-2]

See MPEP Chapter 1400 for practice and procedure in reissue applications. >See also MPEP § 1457 regarding design reissue applications.<

For design reissue application fee, see 37 CFR 1.16(h). For fee for issuing a reissue design patent, see 37 CFR 1.18(b).

The term of a design patent may not be extended by reissue. *Ex parte Lawrence*, 70 USPQ 326 (Comm’r Pat. 1946). >If a reissue application is filed for the purpose of correcting the drawing of a design patent, either by canceling views, amending views or adding new views, the provisions of 37 CFR 1.173(b)(3) must be followed. All changes to the patent drawing shall be explained, in detail, beginning on a separate sheet accompanying the papers including the amendment to the drawing. A marked-up copy of any amended drawing figure, including annotations indicating the changes made, should be submitted. The marked-up copy must be clearly labeled as “Annotated Marked-up Drawings” and it must be presented

in the amendment or remarks section that explains the change to the drawing.

A reissue application must be filed with a copy of all drawing views of the design patent regardless of whether certain views are being cancelled or amended in the reissue application. Inasmuch as the drawing is the primary means for showing the design being claimed, it is important for purposes of comparison that the reissue of the design patent shows a changed drawing view in both its canceled and amended versions and/or show a previously printed drawing view that has been canceled but not replaced. In addition to drawing views that are unchanged from the original design patent, the drawing in the reissue application may include the following views, all of which will be printed as part of the design reissue patent:

(1) CANCELED drawing view. Such a drawing view must be surrounded by brackets and must be labeled as “Canceled.” For example, FIG. 3 (Canceled). If a drawing view is canceled but not replaced the corresponding figure description in the reissue specification must also be cancelled. However, if a drawing view is cancelled and replaced by an amended drawing view the corresponding figure description in the reissue specification may or may not need to be amended.

(2) AMENDED drawing view. Such a drawing view must be labeled as “Amended.” For example, FIG. 3 (Amended). When an amended drawing view is present, there may or may not be a corresponding canceled drawing view. If there is such a corresponding canceled drawing view, the amended and canceled drawing views should have the same figure number. The specification of the reissue application need not indicate that there is both a canceled version and an amended version of the drawing view.

(3) NEW drawing view. Such a drawing view must be labeled as “New” For example, FIG. 5 (New). The new drawing view should have a new figure number, that is, a figure number that did not appear in the original design patent. The specification of the reissue application must include a figure description of the new drawing view.

If a drawing view includes both a cancelled and amended version, and the change in the amended version is for the purpose of converting certain solid lines to broken lines, the reissue specification must include

a statement indicating the purpose of the broken lines.<

## 1510 Reexamination

See MPEP Chapter 2200 for practice and procedure for reexamination applications.

## 1511 Protest

See MPEP Chapter 1900 for practice and procedure in protest.

## 1512 Relationship Between Design Patent, Copyright, and Trademark [R-2]

### I. DESIGN PATENT/COPYRIGHT OVERLAP

There is an area of overlap between copyright and design patent statutes where the author/inventor can secure both a copyright and a design patent. Thus an ornamental design may be copyrighted as a work of art and may also be subject matter of a design patent. The author/inventor may not be required to elect between securing a copyright or a design patent. See *In re Yardley*, 493 F.2d 1389, 181 USPQ 331. In *Mazer v. Stein*, 347 U.S. 201, 100 USPQ 325 (1954), the Supreme Court noted the election of protection doctrine but did not express any view on it since a design patent had been secured in the case and the issue was not before the Court.

See form paragraph 15.55 which repeats this information.

### II. INCLUSION OF COPYRIGHT NOTICE

It is the policy of the U.S. Patent and Trademark Office to permit the inclusion of a copyright notice in a design patent application, and thereby any patent issuing therefrom, under the following conditions.

(A) A copyright notice must be placed adjacent to the copyright material and, therefore, may appear at any appropriate portion of the patent application disclosure including the drawing. However, if appearing on the drawing, the notice must be limited in print size from 1/8 inch to 1/4 inch and must be placed within the “sight” of the drawing immediately below the figure representing the copyright material. If placed on a drawing in conformance with these provisions, the

notice will not be objected to as extraneous matter under 37 CFR 1.84.

(B) The content of the copyright notice must be limited to only those elements required by law. For example, “© 1983 John Doe” would be legally sufficient under 17 U.S.C. 401 and properly limited.

(C) Inclusion of a copyright notice will be permitted only if the following waiver is included at the beginning (preferably as the first paragraph) of the specification to be printed for the patent:

A portion of the disclosure of this patent document contains material to which a claim for copyright is made. The copyright owner has no objection to the facsimile reproduction by anyone of the patent document or the patent disclosure, as it appears in the Patent and Trademark Office patent file or records, but reserves all other copyright rights whatsoever.

(D) Inclusion of a copyright notice after a Notice of Allowance has been mailed will be permitted only if the criteria of 37 CFR 1.312 have been satisfied.

Any departure from these conditions may result in a refusal to permit the desired inclusion. If the waiver required under condition (C) above does not include the specific language “(t)he copyright owner has no objection to the facsimile reproduction by anyone of the patent document or the patent disclosure, as it appears in the U.S. Patent and Trademark Office patent file or records....”, the copyright notice will be objected to as improper.

See form paragraph 15.55 which repeats this information.

>

#### ¶ 15.55 Design Patent-Copyright Overlap

There is an area of overlap between Copyright and Design Patent Statutes where an author/inventor can secure both a Copyright and a Design Patent. Thus, an ornamental design may be copyrighted as a work of art and may also be the subject matter of a Design Patent. The author/inventor may not be required to elect between securing a copyright or a design patent. See *In re Yardley*, 181 USPQ 331 (CCPA 1974). In *Mazer v. Stein*, 100 USPQ 325 (U.S. 1954), the Supreme Court noted the election of protection doctrine but did not express any view on it since a Design Patent had been secured in the case and the issue was not before the Court.

It is the policy of the Patent and Trademark Office to permit the inclusion of a copyright notice in a Design Patent application, and thereby any patent issuing therefrom, under the following conditions:

(1) A copyright notice must be placed adjacent to the copyright material and, therefore, may appear at any appropriate por-

tion of the patent application disclosure including the drawing. However, if appearing on the drawing, the notice must be limited in print size from 1/8 inch to 1/4 inch and must be placed within the “sight” of the drawing immediately below the figure representing the copyright material. If placed on a drawing in conformance with these provisions, the notice will not be objected to as extraneous matter under 37 CFR 1.84.

(2) The content of the copyright notice must be limited to only those elements required by law. For example, “© 1983 John Doe” would be legally sufficient under 17 U.S.C. 401 and properly limited.

(3) Inclusion of a copyright notice will be permitted only if the following waiver is included at the beginning (preferably as the first paragraph) of the specification to be printed for the patent:

A portion of the disclosure of this patent document contains material to which a claim for copyright is made. The copyright owner has no objection to the facsimile reproduction by anyone of the patent document or the patent disclosure, as it appears in the Patent and Trademark Office patent file or records, but reserves all other copyrights whatsoever.

(4) Inclusion of a copyright notice after a Notice of Allowance has been mailed will be permitted only if the criteria of 37 CFR 1.312 have been satisfied.

Any departure from these conditions may result in a refusal to permit the desired inclusion. If the waiver required under condition (3) above does not include the specific language “(t)he copyright owner has no objection to the facsimile reproduction by anyone of the patent document or the patent disclosure, as it appears in the Patent and Trademark Office patent file or records...,” the copyright notice will be objected to as improper.

<

The files of design patents D-243,821, D-243,824, and D-243,920 show examples of an earlier similar procedure.

### III. DESIGN PATENT/TRADEMARK OVERLAP

A design patent and a trademark may be obtained on the same subject matter. The CCPA, in *In re Mogen David Wine Corp.*, 328 F.2d 925, 140 USPQ 575 (CCPA 1964), later reaffirmed by the same court at 372 F.2d 539, 152 USPQ 593 (CCPA 1967), held that the underlying purpose and essence of patent rights are separate and distinct from those pertaining to trademarks, and that no right accruing from one is dependent or conditioned by the right concomitant to the other.

See form paragraph 15.55.01 which repeats this information.

>

#### ¶ 15.55.01 Design Patent - Trademark Overlap

A design patent and a trademark may be obtained on the same subject matter. The Court of Customs and Patent Appeals, in *In re Mogen David Wine Corp.*, 328 F.2d 925, 140 USPQ 575 (CCPA 1964), later reaffirmed by the same court at 372 F.2d 539, 152 USPQ 593 (CCPA 1967), has held that the underlying purpose and essence of patent rights are separate and distinct from those pertaining to trademarks, and that no right accruing from the one is dependent upon or conditioned by any right concomitant to the other.

<

## IV. INCLUSION OF TRADEMARKS IN DESIGN PATENT APPLICATIONS

### A. Specification

The use of trademarks in design patent application specifications is permitted under limited circumstances. See MPEP § 608.01(v). This section assumes that the proposed use of a trademark is a legal use under Federal trademark law.

### B. Title

It is improper to use a trademark alone or coupled with the word “type” (e.g., Band-Aid type Bandage) in the title of a design. Examiners must object to the use of a trademark in the title of a design application and require its deletion therefrom.

### C. Drawings

When a trademark is used in the drawing disclosure of a design application, the specification must include a statement preceding the claim identifying the trademark material forming part of the claimed design and the name of the owner of the registered trademark. Form paragraph 15.76 may be used.

#### ¶ 15.76 Trademark in Drawing

The [1] forming part of the claimed design is a registered trademark of [2]. The specification must be amended to include a statement preceding the claim identifying the trademark material forming part of the claimed design and the name of the owner of the trademark.

#### Examiner Note:

1. In bracket 1, identify the trademark material.
2. In bracket 2, identify the trademark owner.

Any derogatory use of a trademark in a design application is prohibited and will result in a rejection of the claim under 35 U.S.C. 171 as being offensive

and, therefore, improper subject matter for design patent protection. Cf. *Dallas Cowboys Cheerleaders, Inc. v. Pussycat Cinema, Ltd.*, 604 F.2d 200, 203 USPQ 161 (2d Cir. 1979) and *Coca-Cola Co. v. Gemini Rising Inc.*, 346 F. Supp. 1183, 175 USPQ 56 (E.D.N.Y. 1972).

### 1513 Miscellaneous

With respect to copies of references being supplied to applicant in a design patent application, see MPEP § 707.05(a).

Effective May 8, 1985, the Statutory Invention Registration (SIR), 35 U.S.C. 157, and 37 CFR 1.293 - 1.297 replaced the former Defensive Publication Program. The Statutory Invention Registration (SIR) Program applies to utility, plant, and design applications. See MPEP Chapter 1100.



# Chapter 1600 Plant Patents

<b>1601</b>	<b>Introduction: The Act, Scope, Type of Plants Covered</b>
<b>1602</b>	<b>Rules Applicable</b>
<b>1603</b>	<b>Elements of a Plant Application</b>
<b>1604</b>	<b>Applicant, Oath or Declaration</b>
<b>1605</b>	<b>Specification and Claim</b>
<b>1606</b>	<b>Drawings</b>
<b>1607</b>	<b>Specimens</b>
<b>1608</b>	<b>Examination</b>
<b>1609</b>	<b>Report of Agricultural Research Service</b>
<b>1610</b>	<b>The Action</b>
<b>1611</b>	<b>Issue</b>
<b>1612</b>	<b>UPOV Convention</b>
<b>1613</b>	<b>Right of Priority Based Upon Application for Plant Breeder's Rights</b>

## 1601 Introduction: The Act, Scope, Type of Plants Covered

The right to a plant patent stems from:

*35 U.S.C. 161. Patents for plants.*

Whoever invents or discovers and asexually reproduces any distinct and new variety of plant, including cultivated sports, mutants, hybrids, and newly found seedlings, other than a tuber propagated plant or a plant found in an uncultivated state, may obtain a patent therefor, subject to the conditions and requirements of this title.

The provisions of this title relating to patents for inventions shall apply to patents for plants, except as otherwise provided.

Asexually propagated plants are those that are reproduced by means other than from seeds, such as by the rooting of cuttings, by layering, budding, grafting, inarching, etc. Plants capable of sexual reproduction are not excluded from consideration if they have also been asexually reproduced.

With reference to tuber propagated plants, for which a plant patent cannot be obtained, the term "tuber" is used in its narrow horticultural sense as meaning a short, thickened portion of an underground branch. Such plants covered by the term "tuber propagated" are the Irish potato and the Jerusalem artichoke. This exception is made because this group alone, among asexually reproduced plants, is propagated by the same part of the plant that is sold as food.

The term "plant" has been interpreted to mean "plant" in the ordinary and accepted sense and not in the strict scientific sense and thus excludes bacteria. *In re Arzberger*, 112 F. 2d 834, 46 USPQ 32 (CCPA 1940). The term "plant" thus does not include asexual propagating material, *per se*. *Ex parte Hibberd*, 227 USPQ 443, 447 (Bd. Pat. App. & Int. 1985).

An asexually reproduced plant may alternatively be protected under 35 U.S.C. 101, as the Plant Patent Act (35 U.S.C. 161) is not an exclusive form of protection which conflicts with the granting of utility patents to plants. *Ex parte Hibberd*, 227 USPQ 443 (Bd. Pat. App. & Int. 1985). Inventions claimed under 35 U.S.C. 101 may include the same asexually reproduced plant which is claimed under 35 U.S.C. 161, as well as plant materials and processes involving plant materials. The filing of a terminal disclaimer may be used in appropriate situations to overcome an obviousness-type double patenting rejection based on claims to the asexually reproduced plant and/or fruit and propagating material thereof in an application under 35 U.S.C. 101 and the claim to the same asexually reproduced plant in an application under 35 U.S.C. 161.

*35 U.S.C. 163. Grant.*

In the case of a plant patent, the grant shall include the right to exclude others from asexually reproducing the plant, and from using, offering for sale, or selling the plant so reproduced, or any of its parts, throughout the United States, or from importing the plant so reproduced, or any parts thereof, into the United States.

As provided in 35 U.S.C. 161, the rights associated with a plant patent include the rights associated with a utility patent, and the "right to exclude" has additional terms provided in 35 U.S.C. 163. A plant patent issuing from an application filed after June 7, 1995 has a term which expires 20 years after the filing date of the application, or any earlier filing date claimed under 35 U.S.C. 120, 121 or 365(c). See MPEP § 2701. Plant patent applications will be published pursuant to 35 U.S.C. 122(b).

## 1602 Rules Applicable

*37 CFR 1.161. Rules applicable.*

The rules relating to applications for patent for other inventions or discoveries are also applicable to applications for patents for plants except as otherwise provided.



**1603 Elements of a Plant Application**

37 CFR 1.163. *Specification and arrangement of application elements in a plant application.*

\*\*\*\*\*

(b) The elements of the plant application, if applicable, should appear in the following order:

- (1) Plant application transmittal form.
- (2) Fee transmittal form.
- (3) Application data sheet (see § 1.76).
- (4) Specification.
- (5) Drawings (in duplicate).
- (6) Executed oath or declaration (§ 1.162).

\*\*\*\*\*

An application for a plant patent consists of the same parts as other applications. For information pertaining to the oath or declaration, specification and claim, or drawings, see MPEP § 1604, § 1605, or § 1606, respectively.

**1604 Applicant, Oath or Declaration**

37 CFR 1.162. *Applicant, oath or declaration.*

The applicant for a plant patent must be the person who has invented or discovered and asexually reproduced the new and distinct variety of plant for which a patent is sought (or as provided in §§ 1.42, 1.43 and 1.47). The oath or declaration required of the applicant, in addition to the averments required by § 1.63, must state that he or she has asexually reproduced the plant. Where the plant is a newly found plant, the oath or declaration must also state that it was found in a cultivated area.

A Plant Patent Application (35 U.S.C. 161) Declaration, Form PTO/SB/03, may be used to submit a declaration. Form PTO/SB/81 may be used to appoint an attorney or agent. See MPEP § 402.

In an application for a plant patent, there can be joint inventors. See *Ex parte Kluis*, 70 USPQ 165 (Bd. App. 1945).

Type a plus sign (+) inside this box →

PTO/SB/03 (10-00)  
 Approved for use through 10/31/2002. OMB 0651-0032  
 U.S. Patent and Trademark Office; U.S. DEPARTMENT OF COMMERCE

Under the Paperwork Reduction Act of 1995, no persons are required to respond to a collection of information unless it displays a valid OMB control number.

<b>PLANT PATENT                  APPLICATION (35 U.S.C. 161)                  DECLARATION                  (37 CFR 1.63)</b>	Attorney Docket Number	
	First Named Inventor	
	<b>COMPLETE IF KNOWN</b>	
	Application Number	/
	Filing Date	
	Group Art Unit	
<input type="checkbox"/> Declaration Submitted with Initial Filing <input type="checkbox"/> Declaration Submitted after Initial Filing (surcharge (37 CFR 1.16 (e)) required)		Examiner Name

**As a below named inventor, I hereby declare that:**

My residence, mailing address, and citizenship are as stated below next to my name.

I believe I am the original, first and sole inventor (if only one name is listed below) or an original, first and joint inventor (if plural names are listed below) of the new and distinct variety of:

plant named:

which is claimed and for which a plant patent is sought, the specification of which

is attached hereto OR  was filed on (MM/DD/YYYY)  as United States

Application Number  and was amended on (MM/DD/YYYY)  (if applicable).

I hereby state that I have reviewed and understand the contents of the above identified specification, including the claim, as amended by any amendment specifically referred to above.

I have asexually reproduced the plant to which this application applies.

Said plant was found in a cultivated area (check this box for newly found plant only)

I acknowledge the duty to disclose information which is material to patentability as defined in 37 CFR 1.56, including for continuation-in-part applications, material information which became available between the filing date of the prior application and the National or PCT International filing date of the continuation-in-part.

I hereby claim foreign priority benefits under 35 U.S.C. 119(a)-(d) or 365(b) of any foreign application(s) for patent or inventor's certificate, or 365(a) of any PCT international application which designated at least one country other than the United States of America, listed below and have also identified below, by checking the box, any foreign application for patent or inventor's certificate, or any PCT international application having a filing date before that of the application on which priority is claimed.

Prior Foreign Application Number(s)	Country	Foreign Filing Date (MM/DD/YYYY)	Check Only If Priority Not Claimed	Certified Copy Attached?	
				YES	NO
			<input type="checkbox"/>	<input type="checkbox"/>	<input type="checkbox"/>
			<input type="checkbox"/>	<input type="checkbox"/>	<input type="checkbox"/>
			<input type="checkbox"/>	<input type="checkbox"/>	<input type="checkbox"/>
			<input type="checkbox"/>	<input type="checkbox"/>	<input type="checkbox"/>

Additional foreign application numbers are listed on a supplemental priority data sheet PTO/SB/02B attached hereto:

Burden Hour Statement: This form is estimated to take 21 minutes to complete. Time will vary depending upon the needs of the individual case. Any comments on the amount of time you are required to complete this form should be sent to the Chief Information Officer, U.S. Patent and Trademark Office, Washington, DC 20231. DO NOT SEND FEES OR COMPLETED FORMS TO THIS ADDRESS. SEND TO: Assistant Commissioner for Patents, Washington, DC 20231.

Type a plus sign (+) inside this box →

PTO/SB/03 (10-00)

Approved for use through 10/31/2002. OMB 0651-0032

U.S. Patent and Trademark Office, U.S. DEPARTMENT OF COMMERCE

Under the Paperwork Reduction Act of 1995, no persons are required to respond to a collection of information unless it displays a valid OMB control number.

## DECLARATION – Plant Patent Application

I hereby claim the benefit under 35 U.S.C. 119(e) of any United States provisional application(s) listed below.

<b>Application Number(s)</b>	<b>Filing Date (MM/DD/YYYY)</b>	<input type="checkbox"/> Additional provisional application numbers are listed on a supplemental priority data sheet PTO/SB/02B attached hereto.
------------------------------	---------------------------------	--

Direct all correspondence to:  Customer Number or Bar Code Label  OR  Correspondence address below

**Name**

**Address**

**Address**

**City**

**State**

**ZIP**

**Country**

**Telephone**

**Fax**

I hereby declare that all statements made herein of my own knowledge are true and that all statements made on information and belief are believed to be true; and further that these statements were made with the knowledge that willful false statements and the like so made are punishable by fine or imprisonment, or both, under 18 U.S.C. 1001 and that such willful false statements may jeopardize the validity of the application or any patent issued thereon.

**NAME OF SOLE OR FIRST INVENTOR:**

A petition has been filed for this unsigned inventor

**Given Name**

**Family Name or Surname**

**Inventor's Signature**

**Date**

**Residence: City**

**State**

**Country**

**Citizenship**

**Mailing Address**

**Mailing Address**

**City**

**State**

**Zip**

**Country**

**NAME OF SECOND INVENTOR:**

A petition has been filed for this unsigned inventor

**Given Name**

**Family Name or Surname**

**Inventor's Signature**

**Date**

**Residence: City**

**State**

**Country**

**Citizenship**

**Mailing Address**

**Mailing Address**

**City**

**State**

**Zip**

**Country**

Additional inventors are being named on the \_\_\_ supplemental Additional Inventor(s) sheet(s) PTO/SB/02A attached hereto.

[Page 2 of 2]

## 1605 Specification and Claim

### 35 U.S.C. 162. *Description, claim.*

No plant patent shall be declared invalid for noncompliance with section 112 of this title if the description is as complete as is reasonably possible.

The claim in the specification shall be in formal terms to the plant shown and described.

### 37 CFR 1.163. *Specification and arrangement of application elements in a plant application.*

(a) The specification must contain as full and complete a disclosure as possible of the plant and the characteristics thereof that distinguish the same over related known varieties, and its antecedents, and must particularly point out where and in what manner the variety of plant has been asexually reproduced. For a newly found plant, the specification must particularly point out the location and character of the area where the plant was discovered.

(b) The elements of the plant application, if applicable, should appear in the following order:

- (1) Plant application transmittal form.
- (2) Fee transmittal form.
- (3) Application data sheet (see § 1.76).
- (4) Specification.
- (5) Drawings (in duplicate).
- (6) Executed oath or declaration (§ 1.162).

(c) The specification should include the following sections in order:

(1) Title of the invention, which may include an introductory portion stating the name, citizenship, and residence of the applicant.

(2) Cross-reference to related applications (unless included in the application data sheet).

(3) Statement regarding federally sponsored research or development.

(4) Latin name of the genus and species of the plant claimed.

- (5) Variety denomination.
- (6) Background of the invention.
- (7) Brief summary of the invention.
- (8) Brief description of the drawing.
- (9) Detailed botanical description.
- (10) A single claim.
- (11) Abstract of the disclosure.

(d) The text of the specification or sections defined in paragraph (c) of this section, if applicable, should be preceded by a section heading in upper case, without underlining or bold type.

### 37 CFR 1.164. *Claim.*

The claim shall be in formal terms to the new and distinct variety of the specified plant as described and illustrated, and may also recite the principal distinguishing characteristics. More than one claim is not permitted.

The specification should include a complete detailed description of the plant and the characteristics thereof that distinguish the same over related known varieties, and its antecedents, expressed in botanical terms in the general form followed in standard botanical textbooks or publications dealing with the varieties of the kind of plant involved (evergreen tree, dahlia plant, rose plant, apple tree, etc.), rather than a mere broad nonbotanical characterization such as commonly found in nursery or seed catalogs. The specification should also include the origin or parentage and the genus and species designation of the plant variety sought to be patented. The Latin name of the genus and species of the plant claimed should be stated and preceded by the heading set forth in 37 CFR 1.163(c)(4). The specification must particularly point out where, e.g., location or place of business, and in what manner the variety of plant has been asexually reproduced.

Form Paragraphs 16.01, 16.09, and 16.10 may be used to object to the disclosure under 37 CFR 1.163(a).

#### ¶ 16.01 *Specification, Manner of Asexually Reproducing*

The application is objected to under 37 CFR 1.163(a) because the specification does not “particularly point out where and in what manner the variety of plant has been asexually reproduced”. Correction is required.

#### ¶ 16.09 *Specification, Less Than Complete Description*

The disclosure is objected to under 37 CFR 1.163(a) because the specification presents less than a full and complete botanical description and the characteristics which distinguish over related known varieties. More specifically: [1].

#### ¶ 16.10 *Specification, Location of Plant Not Disclosed*

The disclosure is objected to under 37 CFR 1.163(a) because the specification does not particularly point out the location and character of the area where the plant was discovered.

Where color is a distinctive feature of the plant, the color should be positively identified in the specification by reference to a designated color as given by a recognized color dictionary or color chart.

Form Paragraphs 16.02 and 16.03 may be used to object to the disclosure or reject the claim, respectively, because of a lack of a clear and complete disclosure with regard to colors.

¶ *16.02 Colors Specified Do Not Correspond With Those Shown*

The disclosure is objected to under 35 U.S.C. 112, first paragraph, because the [1] colors specified fail to correspond with those shown.

¶ *16.03 Rejection, 35 U.S.C. 112, 1st Paragraph, Non-Support for Colors*

The claim is rejected under 35 U.S.C. 112, first paragraph, as being unsupported by a clear and complete disclosure with regard to [1] colors, for the following reasons: [2].

If the written description of a plant is deficient in certain respects (see, e.g., *In re Greer*, 484 F.2d 488, 179 USPQ 301 (CCPA 1973)), a clarification or additional description of the plant, or even a wholesale substitution of the original description so long as not totally inconsistent and unrelated to the original description and photograph of the plant may be submitted in reply to an Office action. Such submission will not constitute new matter under 35 U.S.C. 132. *Jessel v. Newland*, 195 USPQ 678, 684 (Dep. Comm'r Pat. 1977).

The rules on Deposit of Biological Materials, 37 CFR 1.801-1.809, do not apply to plant patent applications in view of the reduced disclosure requirements of 35 U.S.C. 162, even where a deposit of a plant has been made in conjunction with a utility application (35 U.S.C. 101).

A plant patent is granted only on the entire plant. It, therefore, follows that only one claim is necessary and only one is permitted. A method claim in a plant patent application is improper. An example of a proper claim would be "A new and distinct variety of hybrid tea rose plant, substantially as illustrated and described herein."

## 1606 Drawings

### *37 CFR 1.165. Plant drawings.*

(a) Plant patent drawings should be artistically and competently executed and must comply with the requirements of § 1.84. View numbers and reference characters need not be employed unless required by the examiner. The drawing must disclose all the distinctive characteristics of the plant capable of visual representation.

(b) The drawings may be in color. The drawing must be in color if color is a distinguishing characteristic of the new variety.

Two copies of color drawings or photographs and a black and white photocopy that accurately depicts, to the extent possible, the subject matter shown in the color drawing or photograph must be submitted.

If the drawings or photographs are in color, two color copies of each drawing or photograph are required. If the required copies of the drawings are not included, the application will be accorded a filing date, but correction will be required before the application is forwarded for examination. The requirement under 37 CFR 1.165(b) for a black and white photocopy of any color drawing or photograph has been waived. See 1246 O.G. 106 (May 22, 2001).

### *37 CFR 1.84. Standards for drawings.*

\*\*\*\*\*

(c) *Identification of drawings.* Identifying indicia, if provided, should include the title of the invention, inventor's name, and application number, or docket number (if any) if an application number has not been assigned to the application. If this information is provided, it must be placed on the front of each sheet and centered within the top margin.

\*\*\*\*\*

(e) *Type of paper.* Drawings submitted to the Office must be made on paper which is flexible, strong, white, smooth, non-shiny, and durable. All sheets must be reasonably free from cracks, creases, and folds. Only one side of the sheet may be used for the drawing. Each sheet must be reasonably free from erasures and must be free from alterations, overwritings, and interlineations. Photographs must be developed on paper meeting the sheet-size requirements of paragraph (f) of this section and the margin requirements of paragraph (g) of this section. See paragraph (b) of this section for other requirements for photographs.

(f) *Size of paper.* All drawing sheets in an application must be the same size. One of the shorter sides of the sheet is regarded as its top. The size of the sheets on which drawings are made must be:

- (1) 21.0 cm. by 29.7 cm. (DIN size A4), or
- (2) 21.6 cm. by 27.9 cm. (8 1/2 by 11 inches).

(g) *Margins.* The sheets must not contain frames around the sight (*i.e.*, the usable surface), but should have scan target points (*i.e.*, cross-hairs) printed on two cater-corner margin corners. Each sheet must include a top margin of at least 2.5 cm. (1 inch), a left side margin of at least 2.5 cm. (1 inch), a right side margin of at least 1.5 cm. (5/8 inch), and a bottom margin of at least 1.0 cm. (3/8 inch), thereby leaving a sight no greater than 17.0 cm. by 26.2 cm. on 21.0 cm. by 29.7 cm. (DIN size A4) drawing sheets, and a sight no greater than 17.6 cm. by 24.4 cm. (6 15/16 by 9 5/8 inches) on 21.6 cm. by 27.9 cm. (8 1/2 by 11 inch) drawing sheets.

\*\*\*\*\*

(i) *Arrangement of views.* One view must not be placed upon another or within the outline of another. All views on the same sheet should stand in the same direction and, if possible, stand so that they can be read with the sheet held in an upright position. If views wider than the width of the sheet are necessary for the clearest illustration of the invention, the sheet may be turned on its side so that the top of the sheet, with the appropriate top margin to be used as the heading space, is on the right-hand side. Words must appear in a horizontal, left-to-right fashion when the page is either upright or turned so that the top becomes the right side, except for graphs utilizing standard scientific convention to denote the axis of abscissas (of X) and the axis of ordinates (of Y).

\*\*\*\*\*

(t) *Numbering of sheets of drawings.* The sheets of drawings should be numbered in consecutive Arabic numerals, starting with 1, within the sight as defined in paragraph (g) of this section. These numbers, if present, must be placed in the middle of the top of the sheet, but not in the margin. The numbers can be placed on the right-hand side if the drawing extends too close to the middle of the top edge of the usable surface. The drawing sheet numbering must be clear and larger than the numbers used as reference characters to avoid confusion. The number of each sheet should be shown by two Arabic numerals placed on either side of an oblique line, with the first being the sheet number and the second being the total number of sheets of drawings, with no other marking.

(u) *Numbering of views.*

(1) The different views must be numbered in consecutive Arabic numerals, starting with 1, independent of the numbering of the sheets and, if possible, in the order in which they appear on the drawing sheet(s). Partial views intended to form one complete view, on one or several sheets, must be identified by the same number followed by a capital letter. View numbers must be preceded by the abbreviation "FIG." Where only a single view is used in an application to illustrate the claimed invention, it must not be numbered and the abbreviation "FIG." must not appear.

(2) Numbers and letters identifying the views must be simple and clear and must not be used in association with brackets, circles, or inverted commas. The view numbers must be larger than the numbers used for reference characters.

\*\*\*\*\*

(x) *Holes.* No holes should be made by applicant in the drawing sheets.

Form Paragraphs 16.06, 16.06.01, 16.07, and 16.11 may be used to object to the drawing disclosure.

¶ *16.06 Drawings Must Be in Duplicate*

The disclosure is objected to under 37 CFR 1.165(b) because applicant has not provided copies of the drawing in duplicate. Correction is required.

¶ *16.07 Drawing Figures Not Competently Executed*

The disclosure is objected to under 37 CFR 1.165(a) because Fig. [1] not artistically and/or competently executed.

¶ *16.11 Drawings in Improper Scale*

The disclosure is objected to under 37 CFR 1.165(a) because the drawings are of an inadequate scale to show the distinguishing features of the plant.

## 1607 Specimens

*37 CFR 1.166. Specimens.*

The applicant may be required to furnish specimens of the plant, or its flower or fruit, in a quantity and at a time in its stage of growth as may be designated, for study and inspection. Such specimens, properly packed, must be forwarded in conformity with instructions furnished to the applicant. When it is not possible to forward such specimens, plants must be made available for official inspection where grown.

Specimens of the plant variety, its flower or fruit, should not be submitted unless specifically called for by the examiner.

Form Paragraph 16.13 may be used to require specimens.

¶ *16.13 Specimens Are Required*

Applicant [1] required to submit [2] in accordance with 37 CFR 1.166.

## 1608 Examination

*37 CFR 1.167. Examination.*

Applications may be submitted by the Patent and Trademark Office to the Department of Agriculture for study and report.

The authority for submitting plant applications to the Department of Agriculture for report is given in:

*Executive Order No. 5464, October 17, 1930. Facilitating the consideration of applications for plant patents.*

I, Herbert Hoover, President of the United States of America, under the authority conferred upon me by act of May 23, 1930 (Public No. 245) [now 35 U.S.C. 164], entitled "An act to provide for plant patents," and by virtue of all other powers vested in me relating thereto, do hereby direct the Secretary of Agriculture: (1) to furnish the Commissioner of Patents such available information of the Department of Agriculture, or (2) to conduct through the appropriate bureau or division of the department such research upon special problems, or (3) to detail to the Commissioner of Patents such officers and employees of the department, as the Commissioner may request for the purpose of carrying said act into effect.

*35 U.S.C. 164. Assistance of Department of Agriculture.*

The President may by Executive order direct the Secretary of Agriculture, in accordance with the requests of the Director, for the purpose of carrying into effect the provisions of this title with respect to plants (1) to furnish available information of the Department of Agriculture, (2) to conduct through the appropriate bureau or division of the Department research upon special problems, or (3) to detail to the Director officers and employees of the Department.

Plant applications are subject to the same examination process as any other national application. As such, the statutory provisions with regard to patentable subject matter, utility, novelty, obviousness, disclosure, and claim specificity requirements apply (35 U.S.C. 101, 102, 103, and 112). The sole exception in terms of applicability of these statutory provisions is set forth in 35 U.S.C. 162.

The prior art considered by the examiner is developed by a search of appropriate subclasses of the United States patent classification system as well as patent and nonpatent literature data bases. Where appropriate, a report may be obtained from the Agricultural Research Service, Horticultural Research Branch, Department of Agriculture.

### **1609 Report of Agricultural Research Service**

Where the examiner considers it necessary to the examination of the plant patent application, a copy of the file and drawing of the application are forwarded to the National Program Leader for Horticultural Crops, Agricultural Research Service (ARS), U.S. Department of Agriculture, along with a request for a report as to whether the plant variety disclosed is new and distinct over known plant varieties. As the report is merely advisory to the Office, it is placed in the file but is not given a paper number. The copy of the report is customarily utilized by the examiner in the preparation of his or her action on the application.

The report may embody criticisms and objections to the disclosure, may offer suggestions for correction of such, or the report may merely state that:

“Examination of the specification submitted indicates that the variety described is not identical with others with which our specialists are familiar.”

### **1610 The Action**

The action on the application by the examiner will include all matters as provided for in other types of patent applications. See 37 CFR 1.161.

With reference to the examination of the claim, the language must be such that it is directed to the “new and distinct variety of plant.” This is important as under no circumstance should the claim be directed to a new variety of flower or fruit in contradistinction to the plant bearing the flower or the tree bearing the fruit. This is in spite of the fact that it is accepted and general botanical parlance to say “A variety of apple or a variety of blackberry” to mean a variety of apple tree or a variety of blackberry plant.

Where the application is otherwise allowable, a claim which recites, for example “A new variety of apple characterized by,” may be amended by the insertion of — tree — after “apple” by an examiner’s amendment.

By the same token, the title of the invention must relate to the entire plant and not to its flower or fruit, thus: Apple Tree, Rose Plant.

Care should also be exercised that the specification does not contain unwarranted advertising, for example, “the disclosed plant being grown in the XYZ Nurseries of Topeka, Kansas.” It follows, also, that in the drawings any showing in the background of a plant, as a sign carrying the name of an individual, nursery, etc., is objectionable and deletion thereof is required. Nor should the specification include laudatory expressions, such as, “The rose is prettier than any other rose.” Such expressions are wholly irrelevant. Where the fruit is described, statements in the specification as to the character and quality of products made from the fruit are not necessary and should be deleted.

The Office action may include so much of any report of the ARS as the examiner deems necessary, or may embody no part of it. In the event of an interview, the examiner, in his or her discretion, may show the entire report to the inventor or attorney.

Form Paragraph 16.12 may be used to reference portions of the ARS report.

¶ *16.12 Report From U.S. Dept. of Agriculture*

This application has been submitted to the U.S. Department of Agriculture for a report. Pertinent portions follow: [1]

The report of the ARS is not in the nature of a publication and matters raised therein within the personal knowledge of the specialists of the ARS are not sufficient basis for a rejection unless it is first ascertained by the examiner that the same can be supported by affidavits by said specialists (37 CFR 1.104(d)(2)). See *Ex parte Rosenberg*, 46 USPQ 393 (Bd. App. 1939).

Form Paragraphs 16.04 and 16.08, as appropriate, may be used to reject the claim.

¶ *16.04 Rejection, 35 U.S.C. 102*

The claim is rejected under 35 U.S.C. 102 as failing to patentably distinguish over [1].

¶ *16.08 Rejection, 35 U.S.C. 112*

The claim is rejected under 35 U.S.C. 112 [1] because [2].

## 1611 Issue

The preparation of a plant patent application for issue involves the same procedure as for other applications (37 CFR 1.161), with the exception that where there are color drawings, the better one of the two judged, for example, by its sharpness or cleanliness is selected to be printed in the patent.

The International Patent Classification symbols, most recent edition, should be placed in the issuing classification boxes on the file wrapper or on the Issue Classification slip of all plant patent applications being sent to issue.

All plant patent applications should contain an abstract when forwarded to the Office of Patent Publication.

## 1612 UPOV Convention

On November 8, 1981, the 1978 text of the “International Convention for the Protection of New Varieties of Plants” (generally known by its French acronym as the UPOV Convention) took effect in the United States and two other states that had not been party to the 1961 text, Ireland and New Zealand. As of September 24, 2000, 46 states were party to the UPOV Convention: Argentina, Australia, Austria, Belgium, Bolivia, Brazil, Bulgaria, Canada, Chile,

China, Colombia, Czech Republic, Denmark, Ecuador, Estonia, Finland, France, Germany, Hungary, Ireland, Israel, Italy, Japan, Kenya, Kyrgyzstan, Mexico, Netherlands, New Zealand, Norway, Panama, Paraguay, Poland, Portugal, Republic of Moldova, Russian Federation, Slovakia, Slovenia, South Africa, Spain, Sweden, Switzerland, Trinidad and Tobago, Ukraine, United Kingdom, United States of America, and Uruguay. Most states adhere to the 1978 text. The United States adheres to the 1991 text, and has a reservation under Article 35(2) of the text (which allows plant patents rather than breeder’s rights certificates to be granted).

The 1961, 1978, and 1991 texts guarantee to plant breeders in each member state both national treatment and the right of priority in all other member states. In many states, new plant varieties are protected by breeders’ rights laws rather than patent laws. Accordingly, the Paris (Industrial Property) Convention cannot always be relied on to provide these and other rights.

Insofar as the patenting of asexually reproduced plants in the United States is concerned, both national treatment and the right of priority have been accorded to foreign plant breeders since enactment of the plant patent law in 1930 (now 35 U.S.C. 161-164). See MPEP § 1613 for the right of priority based upon an application for plant breeder’s rights.

Application of the UPOV Convention in the United States does not affect the examination of plant patent applications, except in one instance. It is now necessary as a condition for receiving a plant patent to register a variety denomination for that plant. Inclusion of the variety denomination in the patent comprises its registration.

The registration process in general terms consists of inclusion of a proposed variety denomination in the plant patent application. The examiner must evaluate the proposed denomination in light of UPOV Convention, Article 13. Basically, this Article requires that the proposed variety denomination not be identical with or confusingly similar to other names utilized in the United States or other UPOV member countries for the same or a closely related species. In addition, the proposed denomination must not mislead the average consumer as to the characteristics, value, or identity of the patented plant. Ordinarily, the denomination proposed for registration in the United States



must be the same as the denomination registered in another member state of UPOV.

Form Paragraph 16.05 may be used to object to the disclosure as lacking a common or market name or “denomination” of the plant.

¶ 16.05 *Name or Denomination for Plant Missing*

The disclosure is objected to under 37 CFR 1.121(e) because no “variety denomination” of the instant plant has been set forth in the disclosure. 37 CFR 1.163(c)(4). Correction by adding such a name is required.

¶ 16.05.01 *Latin Name of Genus and Species of the Plant Claimed Missing*

The disclosure is objected to under 37 CFR 1.121(e) because the Latin name of the genus and species of the instant plant has

not been set forth in the disclosure. 37 CFR 1.163(c)(4). Correction by adding such a name is required.

**1613 Right of Priority Based upon Application for Plant Breeder’s Rights**

Pursuant to 35 U.S.C. 119(f), an application for a plant patent may rely upon an application for plant breeder’s rights filed in a WTO member country (or in a foreign UPOV Contracting Party) for priority under 35 U.S.C. 119(a) through (c).



## Chapter 1700 Miscellaneous

### 1701 Office Personnel Not To Express Opinion on Validity or Patentability of Patent

\*\*

- 1701.01 Office Personnel Not To Testify
- 1702 Restrictions on Former Examiners
- 1703 The *Official Gazette*
- 1704 Application Records and Reports
- 1705 Examiner Docket, Time, and Activity Recordation
- 1706 Disclosure Documents
- 1711 U.S.-Philippines Search Exchange
- 1720 Dissemination of Court and Board of Patent Appeals and Interferences Decisions
- 1721 Treatment of Court and Board of Patent Appeals and Interferences Decisions Affecting Patent and Trademark Office Policy and Practice
- 1730 Information Sources

### 1701 Office Personnel Not To Express Opinion on Validity or Patentability of Patent

Every patent is presumed to be valid. 35 U.S.C. 282, first sentence. Public policy demands that every employee of the United States Patent and Trademark Office (USPTO) refuse to express to any person any opinion as to the validity or invalidity of, or the patentability or unpatentability of any claim in any U.S. patent, except to the extent necessary to carry out

- (A) an examination of a reissue application of the patent,
- (B) a reexamination proceeding to reexamine the patent, or
- (C) an interference involving the patent.

The question of validity or invalidity is otherwise exclusively a matter to be determined by a court. Members of the patent examining corps are cautioned to be especially wary of any inquiry from any person outside the USPTO, including an employee of another U.S. Government agency, the answer to which might indicate that a particular patent should not have issued. No USPTO employee may pursue a bounty offered by a private sector source for identifying prior art. The acceptance of payments from outside sources

for prior art search activities may subject the employee to administrative disciplinary action.

When a field of search for an invention is requested, examiners should routinely inquire whether the invention has been patented in the United States. If the invention has been patented, no field of search should be suggested.

Employees of the USPTO, particularly patent examiners who examined an application which matured into a patent or a reissued patent or who conducted a reexamination proceeding, should not discuss or answer inquiries from any person outside the USPTO as to whether or not a certain reference or other particular evidence was considered during the examination or proceeding and whether or not a claim would have been allowed over that reference or other evidence had it been considered during the examination or proceeding. Likewise, *employees* are cautioned against answering any inquiry concerning any entry in the patent or reexamination file, including the extent of the field of search and any entry relating thereto. The record of the file of a patent or reexamination proceeding must speak for itself.

Practitioners can be of material assistance in this regard by refraining from making improper inquiries of members of the patent examining corps. Inquiries from members of the public relating to the matters discussed above must of necessity be refused and such refusal should not be considered discourteous or an expression of opinion as to validity or patentability.

### 1701.01 Office Personnel Not To Testify [R-2]

It is the policy of the United States Patent and Trademark Office (USPTO) that its employees, including patent examiners, will not appear as witnesses or give testimony in legal proceedings, except under the conditions specified in \*\*>37 CFR Part 104, Subpart C<. Any employee who testifies contrary to this policy will be *dismissed or removed*. \*\*

Whenever an employee of the USPTO, including a patent examiner, is asked to testify or receives a subpoena, the employee shall immediately notify the Office of the USPTO General Counsel. Inquiries requesting testimony shall be also referred immediately to the Office of the USPTO General Counsel.

Patent examiners and other USPTO employees performing or assisting in the performance of quasi-judicial functions, are forbidden to testify as experts or to express opinions as to the validity of any patent.

Any individual desiring the testimony of an employee of the USPTO, including the testimony of a patent examiner or other quasi-judicial employee, must comply with the provisions of 37 CFR Part 104, Subpart C.

A request by a third party to take deposition testimony of a patent examiner in a pending *ex parte* reexamination proceeding will generally be denied in view of the *ex parte* nature of the reexamination proceeding.

A request for testimony of an employee of the USPTO should be made to the Office of the USPTO General Counsel at least **10 working days** prior to the date of the expected testimony.

If an employee is authorized to testify, the employee will be limited to testifying about facts within the employee's personal knowledge. Employees are prohibited from giving expert or opinion testimony. *Fischer & Porter Co. v. Corning Glass Works*, 61 F.R.D. 321, 181 USPQ 329 (E.D. Pa. 1974). Likewise, employees are prohibited from answering hypothetical or speculative questions. *In re Mayewsky*, 162 USPQ 86, 89 (E.D. Va. 1969) (deposition of an examiner must be restricted to relevant matters of fact and must avoid any hypothetical or speculative questions or conclusions based thereon); *Shaffer Tool Works v. Joy Mfg. Co.*, 167 USPQ 170 (S.D. Tex. 1970) (deposition of examiner should be limited to matters of fact and must not go into hypothetical or speculative areas or the bases, reasons, mental processes, analyses, or conclusions of the examiner in acting upon a patent application). Employees will not be permitted to give testimony with respect to subject matter which is privileged. Several court decisions limit testimony with respect to quasi-judicial functions performed by employees. Those decisions include *United States v. Morgan*, 313 U.S. 409, 422 (1941) (improper to inquire into mental processes of quasi-judicial officer or to examine the manner and extent to which the officer considered an administrative record); *Western Electric Co. v. Piezo Technology, Inc.*, 860 F.2d 428, 8 USPQ2d 1853 (Fed. Cir. 1988) (patent examiner may not be compelled to answer questions which probe the examiner's techni-

cal knowledge of the subject matter of a patent); *McCulloch Gas Processing Co. v. Department of Energy*, 650 F.2d 1216, 1229 (Temp. Emer. Ct. App. 1981) (discovery of degree of expertise of individuals performing governmental functions not permitted); *In re Nilssen*, 851 F.2d 1401, 7 USPQ2d 1500 (Fed. Cir. 1988) (technical or scientific qualifications of examiners-in-chief are not legally relevant in appeal under 35 U.S.C. 134 since board members need not be skilled in the art to render obviousness decision); *Lange v. Commissioner*, 352 F. Supp. 166, 176 USPQ 162 (D.D.C. 1972) (technical qualifications of examiners-in-chief not relevant in 35 U.S.C. 145 action).

In view of the discussion above, if an employee is authorized to testify in connection with the employee's involvement or assistance in a quasi-judicial proceeding which took place before the USPTO, the employee will not be permitted to give testimony in response to questions that the Office determines are impermissible. Impermissible questions include, but are not limited to, questions directed to discovering the mental processes or expertise of a quasi-judicial official, such as:

- (A) Information about that employee's:
  - (1) Background;
  - (2) Expertise;
  - (3) Qualifications to examine or otherwise consider a particular patent or trademark application;
  - (4) Usual practice or whether the employee followed a procedure set out in any Office manual of practice (including the MPEP or TMEP) in a particular case;
  - (5) Consultation with another Office employee;
  - (6) Understanding of:
    - (a) A patented invention, an invention sought to be patented, or patent application, patent, reexamination or interference file;
    - (b) Prior art;
    - (c) Registered subject matter, subject matter sought to be registered, or a trademark application, registration, opposition, cancellation, interference, or concurrent use file;
    - (d) Any Office manual of practice;
    - (e) Office regulations;
    - (f) Patent, trademark, or other law; or
    - (g) The responsibilities of another Office employee;

(7) Reliance on particular facts or arguments;

(B) To inquire into the manner in and extent to which the employee considered or studied material in performing a quasi-judicial function; or

(C) To inquire into the bases, reasons, mental processes, analyses, or conclusions of that Office employee in performing the quasi-judicial function.

Any request for testimony addressed or delivered to the Office of the USPTO General Counsel shall comply with 37 CFR 104.22(c). All requests must be in *writing*. The need for a subpoena may be obviated where the request complies with 37 CFR 104.22(c) if the party requesting the testimony further meets the following conditions:

(A) The party requesting the testimony identifies the civil action or other legal proceeding for which the testimony is being taken. The identification shall include the:

- (1) Style of the case;
- (2) Civil action number;
- (3) District in which the civil action is pending;
- (4) Judge assigned to the case; and
- (5) Name, address, and telephone number of counsel for all parties in the civil action.

(B) The party agrees not to ask questions seeking information which is precluded by 37 CFR 104.23;

(C) The party shall comply with applicable provisions of the Federal Rules of Civil Procedure, including Rule 30, and give 10 working days notice to the Office of the USPTO General Counsel prior to the date a deposition is desired. Fifteen working days notice is required for any deposition which is desired to be taken between November 15 and January 15;

(D) The party agrees to notice the deposition at a place convenient to the USPTO. The Conference Room in the Office of the USPTO General Counsel is deemed to be a place convenient to the Office; and

(E) The party agrees to supply a copy of the transcript of the deposition to the USPTO for its records.

Absent a written agreement meeting the conditions specified in paragraphs (A) through (E), a party must comply with the precise terms of 37 CFR 104.22(c) and the USPTO will not permit a deposition without issuance of a subpoena.

## 1702 Restrictions on Former Examiners

*37 CFR 10.10. Restrictions on practice in patent cases.*

(a) Only practitioners who are registered under § 10.6 or individuals given limited recognition under § 10.9 will be permitted to prosecute patent applications of others before the Office.

(b) No individual who has served in the patent examining corps of the Office may practice before the Office after termination of his or her service, unless he or she signs a written undertaking,

(1) Not to prosecute or aid in any manner in the prosecution of any patent application pending in any patent examining group during his or her period of service therein and

(2) Not to prepare or prosecute or to assist in any manner in the preparation or prosecution of any patent application of another (i) assigned to such group for examination and (ii) filed within two years after the date he or she left such group, without written authorization of the Director. Associated and related classes in other patent examining groups may be required to be included in the undertaking or designated classes may be excluded from the undertaking. When an application for registration is made after resignation from the Office, the applicant will not be registered if he or she has prepared or prosecuted or assisted in the preparation or prosecution of any patent application as indicated in the paragraph. Knowingly preparing or prosecuting or providing assistance in the preparation or prosecution of any patent application contrary to the provisions of this paragraph shall constitute misconduct under § 10.23(c)(13) of this part.

(c) A practitioner who is an employee of the Office cannot prosecute or aid in any manner in the prosecution of any patent application before the Office.

(d) Practice before the Office by Government employees is subject to any applicable conflict of interest laws, regulations or codes of professional responsibility.

See also MPEP § 309.

## 1703 The Official Gazette [R-2]

The *Official Gazette of the United States Patent and Trademark Office (Official Gazette)* is published >electronically< every Tuesday in two sections, the *Official Gazette – Patents* and the *Official Gazette – Trademarks*. \*\*

The *Official Gazette — Patents* reports the reexamination certificates, reissues, plant patents, utility patents, and design patents issued and statutory invention registrations (if any) published on that day. \*\*>The *Official Gazette — Patents* (eOG:P) allows browsing through the issued patents for the week. The eOG:P can be browsed by classification or type of patent, for example, utility, design, and plant. Specific patents can be accessed by class/subclass or patentee name. Links are provided to the various pages of the eOG:P:

(A) *Browse by Class/Subclass* page to access patents by a specific classification;

(B) *Classification of Patents* page with links to patents by a range of classifications;

(C) *Browse Granted Patents* page to access a patent by patent number or link to patents by type;

(D) *Index of Patentees* page to browse by names of inventors and assignees in either a cumulative alphabetical index or individual indexes by type of patent. Each patentee listing contains a link to the patent;

(E) *Geographical Index of Inventors* to link to patents by the state or country of residence of the first listed inventor; and

(F) *Notices* page containing the text of important notices for the week.<

As to each patent, the following information is given:

- (A) Patent number;
- (B) Title of the invention;
- (C) Applicant's name;
- (D) Applicant's city and state of residence and, if unassigned, applicant's mailing address;
- (E) Assignee's name, city and state of residence, if assigned;
- (F) U.S. or PCT parent application data, if any;
- (G) Filing date;
- (H) Application number;
- (I) Foreign priority application data, if any;
- (J) International classification;
- (K) U.S. classification by class and subclass;
- (L) Number of claims;
- (M) Selected figure of the drawing, if any \*\*;
- (N) A claim or claims; \*
- (O) For reissue patents, the original patent number and issue date, and the original application number and filing date>; and
- (P) Patent Application Publication Number and Publication date, if any.<

The *Official Gazette – Trademarks* >is published electronically and< contains \*\* an illustration of each trademark published for opposition, an alphabetical list of registered trademarks, a classified list of registered trademarks, an index of registrants, a list of can-

celed trademark registrations, and a list of renewed trademark registrations.

\*\*The information in the *Official Gazette* pertaining to each issued patent and each trademark registration can be obtained from the Patent Grants Database and the U.S. Trademark Electronic Search System (TESS) respectively, both also available on the USPTO web site.

>Regular and special notices of the United States Patent and Trademark Office are published in the *Official Gazette Notices*, both as part of the *Official Gazette – Patents* (eOG:P) and as a separate publication. The notices that are included in this publication include notices of patent and trademark suits, disclaimers filed, Certificates of Correction issued, lists of applications and patents available for license or sale, notices of 37 CFR 1.47 applications, and general information such as orders, notices, changes in rules, changes in classification, certain adverse decisions in interferences, the condition of work in the Office, registration of attorneys and agents, reprimands, suspensions, and exclusions of registered attorneys and agents, and notices to parties not reached by mail. The *Official Gazette Notices* are available on the United States Patent and Trademark Office web site (www.uspto.gov).< Paper copies of the *Official Gazette* \*\* *Notices* are available from the Government Printing Office. Orders >for the *Official Gazette Notices*< should be addressed and subscriptions should be made payable to the Superintendent of Documents, Government Printing Office, Washington, D.C. 20402.

## 1704 Application Records and Reports [R-2]

The PALM (Patent Application Locating and Monitoring) System is the automated data management system used by the United States Patent and Trademark Office (USPTO) for the retrieval and/or online updating of the computer record of each patent application. The PALM System also maintains examiner time, activity, docket, and technical support staff backlog records.

Information retrieval from PALM is by means of \*\* the PALM intranet. \*\*>Transactions are< entered via bar code readers>, by keyed entries, or by making an appropriate choice in a drop down menu<. Among other items, classification, examiner docket, attorney,

inventor, and prosecution history data as well as the location of each application can be retrieved and updated online with PALM.

>

## **I. < DOCKET REPORTS**

The recording of changes to examiner dockets is accomplished by PALM simultaneously with the recording of incoming and outgoing communications, transfers of applications to and from dockets, and other types of updating of the application record. The status of each examiner's docket can be determined by means of \*\* the PALM intranet and is supplemented by periodic printed reports. Docket reports that are generated by PALM include the individual examiner new, special, and amended docket which lists applications in priority order; the individual examiner rejected application docket; the individual examiner new application profile, which lists the totals of new applications in each docket, sorted by month of filing; and various summaries of the above reports at the art unit, Technology Center (TC), and corps levels.

>

## **II. < BIWEEKLY TIME AND ACTIVITY REPORTS**

All reporting of examiner time and activity is on a biweekly basis. Each examiner's examining and non-examining time, as listed on the examiner's Biweekly Time Worksheet, PTO-690E, is entered into PALM for use in the computation of productivity data. The biweekly reports produced include the individual Biweekly Examiner Time and Activity Report which lists, by application number, all applications for which actions have been counted during the biweekly period. The type of action counted for each application is also indicated on the report. This report also includes examiner time data, an action summary, and cumulative summaries to date for the current quarter and fiscal year. Various summary reports at the Art Unit, TC, and Corps levels are also produced.

## **1705 Examiner Docket, Time, and Activity Recordation [R-2]**

Actions prepared by examiners are submitted to their respective legal instrument examiners for processing in accordance with the procedures set forth below.

>

### **I. < PROCEDURES FOR REPORTING AN EXAMINER'S ACTION**

(A) The examiner completes an Examiner's Case Action Worksheet, Form PTO-1472, which identifies the type of action prepared. The worksheet is attached to the application >if the application is maintained in a paper file, or placed in an Action folder with the Office action if the application is an Image File Wrapper (IFW) application< for processing by the legal instrument examiner;

(B) The legal instrument examiner checks the worksheet to verify that the examiner provided all necessary information relating to that action;

(C) The legal instrument examiner enters the type of action and the count date thereof on the Contents flap of the file wrapper >if the application is maintained in a paper file, or has the action added to the IFW (see IFW Manual)<; and

(D) The legal instrument examiner enters the examiner's action for the application directly into PALM \*\*.

Each examiner's action that is counted and reported to the PALM system will be listed by application number on the Biweekly Examiner Time and Activity Report. The examiner should check his/her Biweekly Examiner Time and Activity Report to verify that all applications worked on for the biweekly report period are properly listed.

Examples of examiner's actions that are reported to PALM by the legal instrument examiner, but are not listed on the Biweekly Examiner Time and Activity Report, include examiner's amendments, actions in reexamination proceedings, interview summaries, transfers of applications, and supplemental Office actions and miscellaneous Office letters which do not set a period for reply.

\*\*>

FORM PTO-1472  
(Rev. 4-2002)

**U.S. DEPARTMENT OF COMMERCE**  
**PATENT AND TRADEMARK OFFICE**

**EXAMINER'S CASE ACTION WORKSHEET**

Application No. _____	Legal Instrument Examiner _____
-----------------------	---------------------------------

CHECK TYPE OF ACTION

DATE OF COUNT

<input type="checkbox"/> Non-Final Rejection	<input type="checkbox"/> Restriction/Election Only	<input type="checkbox"/> Final Rejection
<input type="checkbox"/> Ex Parte Quayle	<input type="checkbox"/> Allowance	<input type="checkbox"/> Advisory Action
<input type="checkbox"/> Examiner's Answer	<input type="checkbox"/> Reply Brief Noted	<input type="checkbox"/> Non-Entry of Reply Brief
<input type="checkbox"/> Defective Notice of Appeal	<input type="checkbox"/> Interference Disposal SPE _____ <small>(Approval for Disposal)</small>	<input type="checkbox"/> Suspension (Examiner-Initiated) SPE _____ <small>(initial)</small>
<input type="checkbox"/> Defective Appeal Brief	<input type="checkbox"/> SIR Disposal <small>(use only after FAOM)</small>	<input type="checkbox"/> Supplemental Examiner's Amendment
<input type="checkbox"/> Miscellaneous Office Letter <small>(With Shortened Statutory Period Set)</small>	<input type="checkbox"/> Notice of Non-Responsive Amendment <small>(With One Month Time Period set)</small>	<input type="checkbox"/> Miscellaneous Office Letter <small>(No Response Period Set)</small>
<input type="checkbox"/> Abandonment after BPAI Decision	<input type="checkbox"/> Supplemental Action <small>(excluding Examiner's Answer)</small>	<input type="checkbox"/> Response to Rule 312 Amendment
<input type="checkbox"/> Letter Restarting Period for Response (e.g., Missing References)	<input type="checkbox"/> Interview Summary	<input type="checkbox"/> Authorization to Change Previous Office Action SPE: _____ <small>(initial)</small>
<input type="checkbox"/> Abandonment	<input type="checkbox"/> Express Abandonment Date: _____	<input type="checkbox"/> Other Specify: _____

**Examiner's Name:**

**AU:**

## II. < COUNTING OF FIRST ACTION ON THE MERITS (FAOM) >

Office actions on the merits consist of rejections (final and non-final), *Ex parte Quayle* actions, and allowances.

The first time an examiner performs one of the above merit actions, he/she receives credit for a First Action on the Merits (FAOM) on the production reports.

A second/subsequent but FAOM usually occurs when the first action is a restriction/election action and the second action is an action on the merits. The examiner indicates the type of second action on the Examiner's Case Action Worksheet, and the PALM system will automatically determine if it is a FAOM. If the second action is a FAOM, the action will be listed and credited on the Biweekly Examiner Time and Activity Report as a Second/Subsequent FAOM.

>

## III. < COUNTING OF DISPOSALS

An examiner receives a "disposal" count for the following actions:

- (A) Allowance;
- (B) Abandonment;
- (C) Examiner's Answer;
- (D) International Preliminary Examination Report;
- (E) Statutory Invention Registration (SIR) disposal (only after a FAOM; see MPEP § 1101); and
- (F) Interference wherein the application would be in condition for allowance but for the interference.

These same items constitute the "disposals" for performance evaluation of examining art units and TCs. However, disposals at the Office level consist only of allowances and abandonments.

For either an allowance or an abandonment after an Examiner's Answer or decision by a court or the Board of Patent Appeals and Interferences, no disposal credit is received, though these actions are indicated on the Biweekly Examiner Time and Activity Report.

## IV. < CORRECTION INFORMATION

(A) If any information is either missing from or incorrect on the Biweekly Examiner Time and Activity Report, the examiner should promptly notify the legal instrument examiner by providing all the pertinent information necessary to make the changes to the PALM system (e.g., examining hours, application number, type of action, etc.).

(B) The legal instrument examiner will report the necessary changes and corrections directly into PALM. These changes will be listed on the next Biweekly Examiner Time and Activity Report.

(C) If any information is missing from the last Biweekly Examiner Time and Activity Report of a quarter (except at the end of a fiscal year) or is incorrect, the examiner should promptly notify the legal instrument examiner and his/her supervisory patent examiner (SPE). The legal instrument examiner will make the appropriate changes directly into the PALM system. The changes will be listed on the next Biweekly Examiner Time and Activity Report. However, these changes will not be reflected in the last Quarter's Report; the examiner's SPE may manually make an adjustment to the records to show these changes.

(D) In order to ensure that all PALM reports are correct at the end of the fiscal year (rating period), a special correction cycle is provided on the PALM system. If any information is missing from or is incorrect on the last Biweekly Examiner Time and Activity Report, the examiner should immediately notify the legal instrument examiner and his/her SPE. These changes will be reflected in the examiner's final biweekly report for the entire fiscal year.

## 1706 Disclosure Documents [R-2]

A service provided by the United States Patent and Trademark Office (USPTO) is the acceptance and preservation for two years of "Disclosure Documents" as evidence of the date of conception of an invention. >However, inventors are strongly encouraged to file a provisional patent application instead of a Disclosure Document. A provisional application for patent is a U.S. national application for patent filed in the USPTO under 35 U.S.C. 111(b). It allows filing without a formal patent claim, oath or declaration, or any



information disclosure (prior art) statement. It provides the means to establish an early effective filing date in a non-provisional patent application filed under 35 U.S.C. 111(a). It also allows the term "Patent Pending" to be applied to products for which a patent application has been filed. A provisional application has a pendency lasting 12 months from the date the provisional application is filed. The 12-month pendency period cannot be extended. Unlike a Disclosure Document, the benefit of the filing date of the provisional application may be relied upon pursuant to 35 U.S.C. 119(e) in a corresponding non-provisional application or for foreign priority purposes when filing a patent application on the invention in other countries. See MPEP § 201.04(b) and § 601.01(b).

## I. < THE PROGRAM

A paper disclosing an invention (called a Disclosure Document) and signed by the inventor or inventors may be forwarded to the USPTO by the inventor (or by any one of the inventors when there are joint inventors), by the owner of the invention, or by the attorney or agent of the inventor(s) or owner. The Disclosure Document will be retained for two years, and then be destroyed unless it is referred to in a separate letter in a related patent application filed within those two years.

**THE DISCLOSURE DOCUMENT IS NOT A PATENT APPLICATION, AND THE DATE OF ITS RECEIPT IN THE USPTO WILL NOT BECOME THE EFFECTIVE FILING DATE OF ANY PATENT APPLICATION SUBSEQUENTLY FILED. THESE DOCUMENTS WILL BE KEPT IN CONFIDENCE BY THE USPTO.**

This program does not diminish the value of the conventional, witnessed, permanently bound, and page-numbered laboratory notebook or notarized records as evidence of conception of an invention.

>

## II. < CONTENT OF DISCLOSURE

The benefits afforded by the Disclosure Document will depend directly upon the adequacy of the disclosure. It is strongly recommended that the document contain a clear and complete explanation of the manner and process of making and using the invention in

sufficient detail to enable a person having ordinary knowledge in the field of the invention to make and use the invention. When the nature of the invention permits, a drawing or sketch should be included. The use or utility of the invention should be described, especially in chemical inventions. Where the invention is directed to a design, the appearance presented by the object should be described.

>

## III. < PREPARATION OF THE DOCUMENT

A standard format for the Disclosure Document is required to facilitate the USPTO's electronic data capture and storage. The Disclosure Document (including drawings or sketches) must be on white letter-size (8 1/2 by 11-inch) or A4 (21.0 by 29.7 cm) paper, written on one side only, with each page numbered. Text and drawings must be sufficiently dark to permit reproduction with commonly used office copying machines. Oversized papers, even if foldable to the above dimensions, will not be accepted. Attachments such as videotapes and working models will not be accepted and will be returned.

>

## IV. < OTHER ENCLOSURES

The Disclosure Document must be accompanied by a separate cover letter signed by the inventor stating that he or she is the inventor and requesting that the material be received under the Disclosure Document Program. The inventor's request may take the following form:

The undersigned, being the inventor of the disclosed invention, requests that the enclosed papers be accepted under the Disclosure Document Program, and that they be preserved for a period of two years.

A Disclosure Document Deposit Request form (PTO/SB/95) can also be used as a cover letter. This form is available at the USPTO's Internet site or by calling the USPTO General Information Services Division (see MPEP § 1730).

A notice with an identifying number and date of receipt in the USPTO will be mailed to the customer, indicating that the Disclosure Document may be relied upon only as evidence of conception and that a

patent application should be diligently filed if patent protection is desired. The USPTO prefers that applicants send two copies of the cover letter or Disclosure Document Deposit Request form and one copy of the Disclosure Document, along with a self-addressed stamped envelope. The second copy of the cover letter or form will be returned with the notice. It is not necessary to submit more than one copy of the document in order for it to be accepted under the Disclosure Document Program.

>

## V. < DISPOSITION

The Disclosure Document will be preserved by the USPTO for two years after its receipt. It will then be destroyed unless it is referred to in a separate letter in a related patent application filed within the two-year period. The separate letter filed in the related patent application must identify not only the patent application, but also the Disclosure Document by its title, number, and date of receipt in the USPTO. Acknowledgment of such letters will be made in the next official communication or in a separate letter from the USPTO.

>

## VI. < ACKNOWLEDGMENT

When a paper referring to a Disclosure Document is filed in a patent application within 2 years after the filing of a Disclosure Document, the examining Technology Center (TC) technical support staff member will prepare either (1) a memorandum indicating that a reference to Disclosure Document No. -- has been made in Patent Application No. --, or (2) a copy of the paper filed in the application referring to the Disclosure Document. The memorandum or copy is forwarded to the Customer Contact Team of the Office of Initial Patent Examination (OIPE).

Upon receipt, the Customer Service Branch of the OIPE prepares a retention label (PTO-150) and attaches it to the Disclosure Document, and indicates such on the forwarded memo or copy, and returns the memo or copy to the TC. The returned memo or copy is stapled to the inside left flap of the file wrapper >if the application is maintained in a paper file, or added to the Image File Wrapper (IFW) if the application is

an IFW application,< so that the examiner's attention is directed to it when the next Office action is prepared. If prosecution before the examiner has been concluded, a separate letter indicating that the Disclosure Document will be retained should be sent to the applicant by the examining TC technical support staff member.

After the acknowledging letter is mailed, the paper number of the acknowledgment is noted in the application file. The returned memo or copy is \*\* retained with the original paper referring to the Disclosure Document in the file wrapper.

>

## VII. < FEE

A fee of \$10, as set forth in 37 CFR 1.21(c), in the form of a check or money order made payable to “\* Commissioner for Patents” must accompany the Disclosure Document when it is submitted to the USPTO. Documents not accompanied by the full fee will be returned. Mail the Disclosure Document along with the fee to:

\*\*>Mail Stop DD  
Commissioner for Patents  
P.O. Box 1450  
Alexandria, VA 22313-1450<

Applicants can request a copy of their Disclosure Document as filed in the USPTO if they are the original submitters of the document. The request must be made in writing and accompanied by a fee for \$25.

Fees are subject to change annually. To confirm current fees, contact the General Information Services Division or visit the USPTO's Internet site (see MPEP § 1730).

>

## VIII. < NOTICE TO INVENTORS

The two-year retention period is not a “grace period” during which the inventor can wait to file his or her patent application without possible loss of benefits. >As explained above, it may be advisable to file a provisional application instead of a Disclosure Document.< It must be recognized that, in order to establish priority of invention, an affidavit or testimony referring to a Disclosure Document must usually also

establish diligence in completing the invention or in filing the patent application after the filing of the Disclosure Document.

**Inventors are also reminded that any public use or sale in the United States or publication of the invention anywhere in the world more than one year prior to the filing of a patent application on that invention will prohibit the granting of a U.S. patent on it. See 35 U.S.C. 102(b). Foreign patent laws in this regard may be much more restrictive than U.S. laws.**

The USPTO advises inventors who are not familiar with the requirements of U.S. patent law and procedures to consult an attorney or agent registered to practice before the USPTO. A list of *Attorneys and Agents Registered to Practice Before the U.S. Patent and Trademark Office* can be found at the USPTO's Internet site. See MPEP § 1730 for additional sources of this list.

As a service to USPTO's customers, the three Partnership Patent and Trademark Depository Libraries (PTDLs) listed below have been authorized to act as USPTO's "agent" in accepting documents under the Disclosure Document Program. This service provides customers with a completed transaction on-site, eliminating the wait for USPTO notification of acceptance. The documents are stamped with an identifying number and date at the time of receipt by the PTDL. Original documents are sent to the USPTO for processing and retention.

**\*\*>Texas Intellectual Property Partnership (TIP2)**

Texas A&M University Libraries

Sterling C. Evans Library Annex

College Station, TX 77843-5000

979-485-1819

Fax: 979-458-1802<

Great Lakes Patent and Trademark Center at the Detroit Public Library (GLPTC)

5201 Woodward Avenue (second level)

Detroit, MI 48202

313-833-3379 or 800-547-0619

Fax: 313-833-6481

South Central Intellectual Property Partnership at Rice University (SCIPPR)  
Fondren Library - MS220  
6100 South Main Street  
Houston, TX 77521-1892  
713-285-5196  
Fax: 713-737-6341

To locate a Patent and Trademark Depository Library (PTDL) near you, consult the complete listing of PTDLs found in every issue of the *Official Gazette*, call the USPTO General Information Services Division, or access the USPTO's Internet site (see MPEP § 1730). The nationwide network of PTDLs has collections of patents and patent-related reference materials available to the public, including automated access to USPTO data bases. Contact the PTDL prior to your visit to learn about its collections, services, and hours.

## 1711 U.S.-Philippines Search Exchange

The United States-Philippines search exchange program involves patent applications filed in the United States which are subsequently followed by corresponding applications filed in the Republic of the Philippines and patent applications filed in the Philippines subsequently followed by corresponding applications filed in the United States.

The program operates as follows:

The applicant files his or her application in the United States Patent and Trademark Office (USPTO) which will process the application in the normal manner and examine the application in the usual time sequence.

If the applicant should later file a corresponding application in the Philippines Patent Office, he or she may elect to use the special filing procedure. Under this special filing procedure, applicant files his or her application in the Philippines accompanied by a notice of election to participate in the special procedure, which notice of election contains a certification that the description (excluding references to related applications), claims, and drawings are identical to those of the corresponding application originally filed in the United States. The earlier filed application must be fully identified, and, in applications without a claim of priority, a certified copy of the earlier filed U.S. application must be submitted to the Philippines

Patent Office. In addition, applicant must also agree that all amendments to his or her U.S. application will also be made with respect to his or her application filed in the Philippines.

In the USPTO, applicant will regularly file two copies of each amendment. One copy must be marked "Copy for Philippines Patent Office." Upon termination of prosecution, the USPTO shall remove all copies so marked from the U.S. file and promptly forward the same to the Philippines Patent Office.

Election forms for participation in this special program must be signed in duplicate and simultaneously accompany the application to be filed in the Philippines.

Upon receipt of properly filed notice of election, the Philippines Patent Office will notify the USPTO of the election by forwarding one copy of the election forms to the USPTO. The Philippines Patent Office will defer action on the Philippines application pending receipt of information as to the disposition of the application by the USPTO. If no such information is received by the Philippines Office within a reasonable amount of time from the date of filing in the Philippines, the Philippines Office may, either on its own initiative, or at applicant's request, inquire as to the status of the U.S. application and, if desired, proceed with its own independent examination.

Upon disposal of the application by the USPTO, appropriate information will be sent to the Philippines Patent Office which will include all necessary identifying data, whether allowed or abandoned, notice of allowance, copies of documents cited during examination, a copy of the last office action and, when necessary, any earlier actions which may be included by reference in the last action. The Philippines Office will then make its own complete office action based upon the claims as amended with USPTO, performing whatever checks desired and searching for copending interfering applications. Alternatively, the Philippines may request applicant to show cause why the results of the U.S. examination should not be accepted in the Philippines. All avenues of appeal will remain open to the applicant.

Where copending applications are cited and applied during examination in the USPTO full examination will not be forwarded to the Philippines Patent Office, and the fact that a U.S. copending application was

cited would be noted as a matter of information, since such references are inapplicable in the Philippines.

Where the application originates in the Philippines Patent Office and is subsequently filed in the USPTO, a similar procedure as outlined above, consonant with U.S. law, will be followed.

It is believed that this program will facilitate the handling of U.S. origin applications filed in the Republic of the Philippines resulting in a savings in time and expense of prosecution to U.S. applicants.

## **1720 Dissemination of Court and Board of Patent Appeals and Interferences Decisions [R-2]**

>

### **I. < COURT DECISIONS**

The Office of the Solicitor forwards to the Office of the \* Commissioner for Patents copies of all recent court decisions in patent cases where a precedential opinion is issued. The Office of the \* Commissioner for Patents will routinely \*\*>forward< these opinions to TC Directors, the Patent Academy, and the Director of the Office of Patent Quality \* >Assurance<.

TC Directors, in turn, are to make copies available to supervisors and other individuals as the TC Director determines to be appropriate. TC Directors are encouraged to discuss the contents of the opinions in their staff meetings, particularly where such meetings are being held to reinforce examination quality.

>

### **II. < BOARD OF PATENT APPEALS AND INTERFERENCES DECISIONS**

A decision rendered by the Board of Patent Appeals and Interferences (Board) is returned to the examiner through the TC Director and the examiner's supervisor. The examiner takes action consistent with the decision rendered by the Board unless rehearing of the Board decision will be requested (MPEP § 1214.04). The TC Director may circulate and discuss the decision among some or all of the supervisors in the TC, and the supervisors, in turn, may circulate the decision among the examiners in their art units, depending on the subject matter or issues in the decisions.

## 1721 Treatment of Court and Board of Patent Appeals and Interferences Decisions Affecting Patent and Trademark Office Policy and Practice [R-2]

In the event the Board of Patent Appeals and Interferences (Board) or court decision is one that significantly adds to the body of law by, for example, addressing a new legal or procedural issue, or providing a new interpretation of a prior decision, such a decision may result in an internal United States Patent and Trademark Office (USPTO) memorandum pointing out the significance of the decision to the examination process.

When any examiner or supervisor in the Patent Examining Corps concludes that a recent decision of the Board or a court affects existing USPTO policy or practice, he or she should bring the matter to the attention of his/her TC Director through normal chain-of-command procedures.

When the TC Director believes that guidance to the Corps is warranted as a result of a decision, the TC Director should consult with the Deputy Commissioner for Patent Examination Policy and provide a draft of the guidance that is recommended as appropriate under the circumstances. The Deputy \* Commissioner for Patent Examination Policy will then consult appropriate Office officials, as necessary, to formulate a recommendation to the \* Commissioner for Patents on the policy implications of the opinion.

It may be necessary for the \*>Director<, General Counsel, Solicitor, Chief Administrative Patent Judge, \*>Commissioner< for Patents, Deputy \*>Commissioner< for Patent Examination Policy, Deputy \*>Commissioner< for \*>Patent Operations< and TC Director making the recommendation to meet to review and discuss the policy ramifications of the \*\*>opinion and recommended guidance to enable< the \*>Director< to decide how the USPTO will proceed.

Communication of the decision on the policy implications of the court or Board decision will normally take place by either notice in the *Official Gazette* and/or via memorandum to USPTO personnel. Ultimately, the policy implications of the decision will be officially incorporated into the Manual of Patent Examining Procedure and Patent Academy curriculum

materials during the next update cycle for these reference materials.

## 1730 Information Sources [R-2]

>

### I. < IN GENERAL

General information about patents, trademarks, products and services offered by the United States Patent and Trademark Office (USPTO), and other related information is available by contacting the USPTO's General Information Services Division at:

800-PTO-9199 or 703-308-HELP  
(FAX) 703-305-7786  
(TDD) 703-305-7785

An automated message system is available 7 days a week, 24 hours a day providing informational responses to frequently asked questions and the ability to order certain documents. Customer service representatives are available to answer questions, send materials or connect customers with other offices of the USPTO from 8:30 a.m. - 8:00 p.m. EST/EDT, Monday-Friday excluding federal holidays.

For other technical patent information needs, the \*>Inventors< Assistance Center can be reached through customer service representatives at the above numbers, Monday through Friday (except federal holidays) from 8:30 a.m. to 5:00 p.m. EST/EDT.

For questions or concerns relating to other technical trademark matters, the Trademark Assistance Center can be reached at 703-308-9000 or by facsimile at 703-308-7016.

General information brochures can also be obtained in person from the Patent Search Room located in Crystal Plaza 3, Room 1A03, 2021 South Clark Place, Arlington, VA 22202.

>

### II. < USPTO INTERNET SITE

>

#### A. < General Information

The USPTO web site (<http://www.uspto.gov> or <ftp.uspto.gov>) provides a wealth of information to all users. The USPTO web site offers links to news and

notices (such as announcements, press releases, *Official Gazette* Notices and *Federal Register* Notices), USPTO contacts and addresses, activities and education related pages (such as the PTDL and Independent Inventor programs and the Kids Pages), patent specific information (such as issued patents and published patent applications, general information pertaining to applying for a patent, electronic filing of patent applications, and reference materials such as the MPEP and examination guidelines), and trademark specific information (such as the Trademark Manual of Examining Procedure and the U.S. Trademark Electronic Search System (TESS)). In addition, the web site allows downloading of a variety of USPTO forms (including PCT forms), ordering copies of patents and trademarks, accessing a list of all current fees, paying patent maintenance fees, replenishing deposit accounts, accessing various legal materials, linking to related web sites, etc.

&gt;

### **B. < Patent Related Databases**

The USPTO web site offers two patent database collections which provide the public with flexible and powerful search capabilities. The Patent Grants Database provides access to the full-text of all U.S. patents issued since 1976, and to the full-page images of all U.S. patents issued since 1790. The Patent Applications Database provides both full-text and full-page images of all U.S. patent applications published since March 15, 2001.

&gt;

### **C. < Patent Electronic Business Center**

The Patent Electronic Business Center (EBC) allows USPTO customers to retrieve data, check the status of pending actions, and submit information and applications. The tools currently available in the Patent EBC are Patent Application Information Retrieval (PAIR) and the Electronic Filing System (EFS). >The hours of operation of the EBC are Monday to Friday 6 am - Midnight Eastern Standard time. The EBC can be reached by telephone at (866-217-9197) (toll-free), 703-305-3028, or 703-308-6845. The EBC may be reached by e-mail at [ebc@uspto.gov](mailto:ebc@uspto.gov).

PAIR (<http://pair.uspto.gov>) provides customers direct secure access to their own patent application \* information >, and, if available, the Image File Wrapper (IFW) of the application (Private PAIR)<, as well as to general patent information publicly available >(Public PAIR). Private PAIR allows customers access to their own patent application when a Customer Number is associated with the correspondence address for the patent application and the customer is associated with the customer number. *Pro se* inventors and registered patent attorneys and patent agents can be associated with a Customer Number. See MPEP § 403 for Customer Number practice. Questions about IFW images viewed in PAIR should be directed to the Patent EBC. Public PAIR provides access to patent application information related to applications that have been published as patent application publications or issued as patents. For example, Public PAIR provides information on the patent term adjustment calculation, as well as the maintenance fee payment information for a patent<.

EFS allows customers to electronically file patent application documents securely via the Internet. EFS is a system for submitting new utility patent applications and pre-grant publication submissions in electronic publication-ready form. EFS includes software to help customers prepare submissions in eXtensible Markup Language (XML) format and to assemble the various parts of the application as an electronic submission package. EFS \* allows the submission of Computer Readable Format (CRF) sequence listings >and electronic information disclosure statements< for pending \* patent applications which were filed in paper form. >EFS can also be used to submit provisional applications as well as assignment documents for patent applications and patents.

### **III. < PCT**

For questions and information concerning the Patent Cooperation Treaty (PCT), the PCT Help Desk is available to provide assistance and may be reached by telephone at (703) 305-3257 between the hours of 9:00 am and 4:30 pm (EST/EDT), Monday through Friday, or by facsimile at (703) 305-2919, 24 hours a day. In addition, helpful information is available through the internet at the >Office of< PCT Legal \*>Administration< page of the USPTO web site and

at the World Intellectual Property Office web site (<http://www.wipo.org/>).

>

#### IV. < USPTO SEARCH AND INFORMATION RESOURCE FACILITIES

The following USPTO search and information resource facilities are accessible to the public:

(A) Patent Search Room (Crystal Plaza 3, 1A03) at **\*\*>(703) 308-0044<**

(Hours: Weekdays, 8:00 a.m. to 8:00 p.m., EST/EDT);

(B) **\*\*Patent Assignment Search Room** (Crystal Plaza 3, **\*\*>1A03**) at 703-308-0044<

(Hours: Weekdays, 8:30 a.m. to 5:00 p.m., EST/EDT); and

**\*>**

(C) < Scientific and Technical Information Center

**\*\*>(1) Main Library** (Crystal Plaza 3/4, 2C08) at (703) 308-1076

(2) Biotech/Chemical Library (Remsen 1D58) at (571) 272-2520<

(Hours: Weekdays, 8:30 a.m. to 5:00 p.m., EST/EDT).

>

#### V. < REGISTERED PRACTITIONERS

The USPTO cannot recommend any particular attorney or agent, or aid in the selection of an attorney or agent. A list of *Attorneys and Agents Registered to Practice Before the U.S. Patent and Trademark Office* may be purchased **\*\*>on DVD-ROM<** from the USPTO's Office of Electronic Information Products and Services (703-306-2600). **\*>The DVD-ROM<** is also available on the USPTO web site **>(http://www.uspto.gov)** from the "Products and Services Catalog"<.

To obtain a list of registered patent attorneys and agents for a particular area, customers may either **\*\*** contact a customer service representative through the USPTO's General Information Services Division (see "In General" above), or acquire the information from the USPTO web site. The attorneys and agents list may be examined without charge at Patent and Trade-

mark Depository Libraries (PTDLs) and at many other libraries throughout the U.S. Many large cities also have associations of patent attorneys and agents which may be consulted.

>

#### VI. < MISCELLANEOUS

>

##### A. < *Recently Filed Applications*

For information and questions concerning recently filed patent applications and filing receipts, contact the Customer Service Center of the Office of Initial Patent Examination at (703) 308-1202 (hours: weekdays, 8:30 a.m. to 5:00 p.m., EST/EDT; the Customer Service Center hours for receipt of mail are weekdays, 8:30 a.m. to 12 midnight, EST/EDT).

>

##### B. *Pre-Grant Publication*

For inquiries concerning projected pre-grant publication dates, contact the Pre-Grant Publication Division at (703) 605-4823.

##### C. < *Status Information*

For information on the status of a patent application, **>patent applicants who have access to PAIR should check PAIR. Alternatively, applicants may<** contact the File Information Unit at (703) 308-2733.

>

##### D. *Correspondence*

For information pertaining to mail, facsimile, or hand-delivery of correspondence to the USPTO, see MPEP §§ 502 - 502.01.

##### E. < *Copies of Documents*

Inquiries regarding certified copies of documents, including patent applications-as-filed, patent related file wrappers, patent copies, and reproduced copies of individual replacement pages or previous revisions of the MPEP, should be directed to the Certification Division at (703) 308-9726 or 1-800-972-6382. Orders for certified copies may be placed by facsimile

when paying by VISA®, MasterCard®, American Express®, Discover®, or USPTO Deposit Account at (703) 308-7048. Orders for uncertified copies of patents may be placed by phone at (703) 305-8716\*,< by fax at (703) 305-8759>, or on the USPTO web site<. To order file histories for self-service copying, contact the File Information Unit at (703) 308-2733.

>

**F. < Maintenance Fees**

Information regarding maintenance fees may be obtained \*\*>from the Patent Application Information Retrieval (PAIR) system on the USPTO web site, or by contacting the Maintenance Fee Branch< at (703) 308-5068 \*\*. Status requests can also be faxed to the \*\*>Maintenance Fee Branch< at (703) 308-5077.

>

**G < Assignments**

For questions pertaining to filing assignments or other documents affecting title, contact the Assign-

ment Division at (703) 308-9723. Documents may be submitted to the Assignment Division by facsimile at (703) 306-5995. See MPEP § 302.09 for additional information.

>

**H. < Petitions**

For matters decided by the Office of Petitions, the appropriate USPTO personnel may be reached at (703) 305-9282 or by facsimile at \*\*>(703) 872-9306<.

>

**I. < PatentIn**

For information regarding orders for the PatentIn software program, call the Office of Electronic Information Products and Services at (703) 306-2600. For assistance using PatentIn, \*\*>contact the Patent Electronic Business Center, see paragraph II.C., above<.





MANUAL OF PATENT EXAMINING PROCEDURE

# Chapter 1800 Patent Cooperation Treaty

<b>1801</b>	<b>Basic Patent Cooperation Treaty (PCT) Principles</b>	>1843.01	Prior Art for Chapter I Processing
<b>1802</b>	<b>PCT Definitions</b>	1843.02	Certain Subject Matter Need Not Be Searched
<b>1803</b>	<b>Reservations Under the PCT Taken by the United States of America</b>	1843.03	No Search Required if Claims Are Unclear
<b>1805</b>	<b>Where to File an International Application</b>	1843.04	Procedure for Claims Not Required To Be Searched and for Claims That Are Unclear
<b>1807</b>	<b>Agent or Common Representative and General Power of Attorney</b>	1843.05	Time Limit for Establishing the International Search Report and the Written Opinion of the International Searching Authority<
<b>1808</b>	<b>Change in or Revocation of the Appointment of an Agent or a Common Representative</b>	<b>1844</b>	<b>The International Search Report</b>
<b>1810</b>	<b>Filing Date Requirements</b>	1844.01	* >Preparing < the International Search Report >(Form PCT/ISA/210)<
<b>1812</b>	<b>Elements of the International Application</b>	<b>&gt;1845</b>	<b>Written Opinion of the International Searching Authority</b>
<b>1817</b>	<b>PCT Member States</b>	1845.01	Preparing the Written Opinion of the International Searching Authority (Form PCT/ISA/237)
1817.01	>Designation of States in International Applications Having an International Filing Date on or After January 1, 2004	1845.02	Notification of Transmittal of the International Search Report and the Written Opinion of the International Searching Authority, or the Declaration (Form PCT/ISA/220)<
1817.01(a)	<Designation of States and Precautionary Designations in >International Applications Having an International Filing Date Before January 1, 2004<	<b>1846</b>	<b>Sections of the Articles, Regulations, and Administrative Instructions Under the PCT Relevant to the International *&gt;Searching Authority&lt;</b>
1817.02	Continuation or Continuation-in-Part Indication in the Request	<b>1847</b>	<b>Refund of International Search Fee</b>
1819	Earlier International or International-Type Search	<b>1848</b>	<b>Sequence Listings and Tables Related to Sequence Listings</b>
1820	Signature of Applicant	**	
<b>1821</b>	<b>The Request</b>	<b>1850</b>	<b>Unity of Invention Before the International Searching Authority</b>
<b>1823</b>	<b>The Description</b>	<b>1851</b>	<b>Identification of Patent Documents</b>
1823.01	Reference to Deposited Biological Material	<b>1852</b>	<b>International-Type Search</b>
1823.02	Nucleotide and/or Amino Acid Sequence Listings, and Tables Related to Sequence Listings	<b>1853</b>	<b>Amendment Under PCT Article 19</b>
1824	The Claims	<b>1857</b>	<b>International Publication</b>
1825	The Drawings	1857.01	Prior Art Effect of the International Publication
1826	The Abstract	<b>1859</b>	<b>Withdrawal of International Application&gt;,&lt; * Designations&gt;, or Priority Claims&lt;</b>
<b>1827</b>	<b>Fees</b>	<b>1860</b>	<b>&gt;International Preliminary Examination Procedure for Applications Having an International Filing Date On or After January 1, 2004</b>
<b>1828</b>	<b>Priority Claim and Document</b>	<b>1860.01</b>	<b>&lt; International Preliminary Examination &gt;Procedure for Applications Having an International Filing Date Before January 1, 2004&lt;</b>
<b>1830</b>	<b>International Application Transmittal Letter</b>	<b>1862</b>	<b>Agreement With the International Bureau To Serve as an International Preliminary *&gt;Examining&lt; Authority</b>
<b>1832</b>	<b>License Request for Foreign Filing Under the PCT</b>	<b>1864</b>	<b>The Demand and Preparation for Filing of Demand</b>
<b>1834</b>	<b>Correspondence</b>		
1834.01	Use of Telegraph, Teleprinter, Facsimile Machine		
1834.02	Irregularities in the Mail Service		
<b>1836</b>	<b>Rectification of Obvious Errors</b>		
<b>1840</b>	<b>The International Searching Authority</b>		
1840.01	The European Patent Office as an International Searching Authority		
<b>1842</b>	<b>Basic Flow Under the PCT</b>		
<b>1843</b>	<b>The International Search</b>		

MANUAL OF PATENT EXAMINING PROCEDURE

- 1864.01 Amendments Filed >Under PCT Article 34< \*\*
- 1864.02 Applicant's Right To File a Demand
- 1864.03 States Which May Be Elected
- 1864.04 Agent's Right To Act
- 1865 Filing of Demand**
- 1865.01 The European Patent Office as an International Preliminary Examining Authority
- 1866 Filing in of Headings on Chapter II Forms**
- 1867 Preliminary Examination Fees**
- 1868 Correction of Defects in the Demand**
- 1869 Notification to International Bureau of Demand**
- 1870 Priority Document and Translation Thereof**
- 1871 >Processing Amendments Filed Under Article 19 and Article 34 Prior to or at the Start of International Preliminary Examination in International Applications Having an International Filing Date on or After January 1, 2004**
- 1871.01< Processing Amendments Filed Under Article 19 and Article 34 Prior to or at the Start of International Preliminary Examination >in International Applications Having an International Filing Date Before January 1, 2004<**
- 1872 Transmittal of Demand to the Examining Corps \*\***
- 1874 Determination if International Preliminary Examination Is Required and Possible**
- 1875 Unity of Invention Before the International Preliminary Examining Authority**
- 1875.01 Preparation of Invitation Concerning Unity
- 1875.02 Reply to Invitation Concerning Lack of Unity of Invention
- 1876 Notation of Errors and Informalities by the Examiner**
- 1876.01 Request for Rectification and Notification of Action Thereon
- 1877 Nucleotide and/or Amino Acid Sequence Listings During the International Preliminary Examination**
- 1878 >Preparation of the Written Opinion of the International Preliminary Examining Authority in International Applications Having an International Filing Date on or After January 1, 2004**
- 1878.01< Preparation of the Written Opinion >in International Applications Having an International Filing Date Before January 1, 2004<**
- \*\*
- 1878.01(a) Prior Art \*\*>for Purposes of the Written Opinion and the International Preliminary Examination Report<
- 1878.01(a)(1) Novelty \*\*>for Purposes of the Written Opinion and the International Preliminary Examination Report<
- 1878.01(a)(2) Inventive Step \*\*>for Purposes of the Written Opinion and the International Preliminary Examination Report<
- 1878.01(a)(3) Industrial Applicability \*\*>for Purposes of the Written Opinion and the International Preliminary Examination Report<
- 1878.02 Reply to the Written Opinion >of the ISA or IPEA<
- 1879 Preparation of the International Preliminary Examination Report**
- 1879.01 >Time Limit for Preparing Report in International Applications Having an International Filing Date On or After January 1, 2004
- 1879.01(a)< Time Limit for Preparing Report >in International Applications Having an International Filing Date Before January 1, 2004<
- 1879.03 Translations
- 1879.04 Confidential Nature of the Report
- 1880 Withdrawal of Demand or Election**
- 1881 Receipt of Notice of Election >and Preliminary Examination Report< by the >United States< Patent and Trademark Office**
- \*\*
- 1893 National Stage (U.S. National Application Filed Under 35 U.S.C. 371)**
- 1893.01 Commencement and Entry
- 1893.01(a) Entry via the U.S. Designated or Elected Office
- 1893.01(a)(1) Submissions Required by 30 Months from the Priority Date
- 1893.01(a)(2) Article 19 Amendment (Filed With the International Bureau)
- 1893.01(a)(3) Article 34 Amendments (Filed with the International Preliminary Examining Authority)
- 1893.01(c) Fees
- 1893.01(d) Translation
- 1893.01(e) Oath/Declaration
- 1893.02 Abandonment
- 1893.03 Prosecution of U.S. National Stage Applications Before the Examiner
- 1893.03(a) How To Identify That an Application Is a U.S. National Stage Application

- 1893.03(b) The Filing Date of a U.S. National Stage Application
- 1893.03(c) The Priority Date, Priority Claim, and Priority Papers for a U.S. National Stage Application
- 1893.03(d) Unity of Invention
- 1893.03(e) Papers Received from the International Bureau and Placed in a U.S. National Stage Application File
- 1893.03(f) Drawings and PCT Rule 11
- 1893.03(g) Information Disclosure Statement in a National Stage Application

**1895 A Continuation>, Divisional,< or Continuation-in-Part Application of a PCT Application Designating the United States**

- 1895.01 Handling of and Considerations in the Handling of \*\* Continuations>, Divisions,< and Continuations-in-Part of \* PCT \*>Applications<

**1896 The Differences Between a National Application Filed Under 35 U.S.C. 111(a) and a National Stage Application Submitted Under 35 U.S.C. 371**

## INTRODUCTION

This chapter is designed to be a guide for patent examiners in searching and examining applications filed under the Patent Cooperation Treaty (PCT). Applicants desiring additional information for filing international applications should obtain a copy of the PCT Applicant's Guide from the World Intellectual Property Organization (WIPO) in Geneva, Switzerland.

The Articles and Regulations under the PCT are reproduced in Appendix T of this Manual and the Administrative Instructions are reproduced in Appendix AI of this Manual. The text of the *PCT Applicant's Guide*, the monthly *PCT Newsletter*, the weekly *PCT Gazette*, downloadable PCT forms, and additional information about the processing of international applications are available from WIPO's website ([www.wipo.int/pct](http://www.wipo.int/pct)).

PCT applications are processed by the International Application Processing Division within the U.S. Patent and Trademark Office.

## 1801 Basic Patent Cooperation Treaty (PCT) Principles [R-2]

### MAJOR CONCEPTS OF THE PCT

The Patent Cooperation Treaty (PCT) enables the U.S. applicant to file one application, "an international application," in a standardized format in English in the U.S. Receiving Office (the U.S. Patent and Trademark Office), and have that application acknowledged as a regular national >or regional< filing in as many \*\*>Contracting States< to the PCT as the applicant "designates" or "elects," that is, names, as countries >or regions< in which patent protection is desired. >(For international applications filed on or after January 1, 2004, the filing of an international application will automatically constitute the designation of all contracting countries to the PCT on that filing date.)< In the same manner, the PCT enables foreign applicants to file a PCT international application, designating the United States of America, in their home language in their home patent office and have the application acknowledged as a regular U.S. national filing. The PCT also provides for \*\*>an international search report and written opinion (for international applications filed on or after January 1, 2004) that are established normally at 16 months from the priority date,< and publication >of the international application< after 18 months from the priority date. Upon payment of national fees and the furnishing of any required translation, usually 30 months after the filing of any priority application for the invention, or the international filing date if no priority is claimed, the application will be subjected to national procedures for granting of patents in each of the designated countries. For \*>any< countries >remaining< whose national laws are not compatible with the 30 month period set forth in PCT Article 22(1), the filing of a demand for an international preliminary examination electing such countries within 19 months from the priority date will result in an extension of the period for entering the national stage to 30 months from the priority date. >An up-to-date list of such countries may be found on WIPO's web site ([www.wipo.int/pct/en/index.html](http://www.wipo.int/pct/en/index.html)).< A brief description of the basic flow under the PCT is provided in MPEP § 1842.

The PCT offers an alternative route to filing patent applications directly in the patent offices of those

countries which are *>Contracting States<* of the PCT. It does not preclude taking advantage of the priority rights and other advantages provided under the Paris Convention and the WTO administered Agreement on Trade-Related Aspects of Intellectual Property (TRIPS Agreement). The PCT provides an additional and optional foreign filing route to patent applicants.

The filing, search and publication procedures are provided for in Chapter I of the PCT. Additional procedures for a preliminary examination of PCT international applications are provided for in optional PCT Chapter II.

In most instances a national U.S. application *\** is filed first. An international application for the same subject matter will then be filed subsequently within the priority year provided by the Paris Convention and the priority benefit of the U.S. national application filing date will be claimed.

### RECEIVING OFFICE (RO)

The international application (IA) must be filed in the prescribed receiving Office (RO) (PCT Article 10). The United States Patent and Trademark Office will act as a receiving Office for United States residents and nationals (35 U.S.C. 361(a)). Under PCT Rule 19.1(a)(iii), the International Bureau of the World Intellectual Property Organization will also act as a Receiving Office for U.S. residents and nationals. The receiving Office functions as the filing and formalities review organization for international applications. International applications must contain upon filing the designation of at least one *>Contracting State<* in which patent protection is desired and must meet certain standards for completeness and formality (PCT Articles 11(1) and 14(1)).

Where a priority claim is made, the date of the earlier filed national application is used as the date for determining the timing of international processing, including the various transmittals, the payment of certain international and national fees, and publication of the application. Where no priority claim is made, the international filing date will be considered to be the "priority date" for timing purposes (PCT Article 2(xi)).

The international application is subject to the payment of certain fees *\*\** within 1 month *\*\*>*from the date of filing<. The receiving Office will grant an

international filing date to the application, collect fees, handle informalities by direct communication with the applicant, and monitor all corrections (35 U.S.C. 361(d)). By 13 months from the priority date, the receiving Office should prepare and transmit a copy of the international application, called the search copy (SC), to the International Searching Authority (ISA); and forward the original, called the record copy (RC), to the International Bureau (IB) (PCT Rules 22.1 and 23). A second copy of the international application, the home copy (HC), remains in the receiving Office (PCT Article 12(1)). Once the receiving Office has transmitted copies of the application, the International Searching Authority becomes the focus of international processing.

### INTERNATIONAL SEARCHING AUTHORITY (ISA)

The basic *>functions<* of the International Searching Authority (ISA) *>are<* to conduct a prior art search of inventions claimed in international applications; it does this by searching in at least the minimum documentation defined by the Treaty (PCT Articles 15 and 16 and PCT Rule 34)>, and for international applications filed on or after January 1, 2004, to issue a written opinion (PCT Rule 43<sup>bis</sup>) which will normally be considered to be the first written opinion of the International Preliminary Examining Authority where international preliminary examination is demanded. See PCT Rule 66.1<sup>bis</sup><.

For most applications filed with the United States Receiving Office, the applicant may choose (in the Request form) either the U.S. Patent and Trademark Office or the European Patent Office to act as the International Searching Authority. However, the European Patent Office *\*\*>*may not be< competent to act as an International Searching Authority for certain applications filed by nationals or residents of the United States. See MPEP § 1840.01 for a discussion of applications and subject matter that will not be searched by the European Patent Office. The International Searching Authority is also responsible for checking the content of the title and abstract (PCT Rules 37.2 and 38.2).

An international search report (ISR)>, and for international applications filed on or after January 1, 2004, a written opinion,< will normally be issued by the International Searching Authority within 3 months

from the receipt of the search copy (usually about 16 months after the priority date) (PCT Rule 42). Copies of the international search report and prior art cited will be sent to the applicant by the ISA (PCT Rules 43 and 44.1). The international search report will contain a listing of documents found to be relevant and will identify the claims in the application to which they are pertinent. \*\*>In applications filed on or after January 1, 2004, the ISA will normally issue a written opinion as to whether each claim appears to satisfy the PCT Article 33 criteria of “novelty,” “inventive step,” and “industrially applicable.” The written opinion may also indicate defects in the form or content of the international application under the PCT articles and regulations, as well as any observations the ISA wishes to make on the clarity of the claims, the description, and the drawings, or on the question of whether the claims are fully supported by the description.

Once the international search report and written opinion are established, the ISA transmits one copy of each to the applicant and the International Bureau, and international processing continues before the International Bureau.<

### **INTERNATIONAL BUREAU (IB)**

The basic functions of the International Bureau (IB) are to maintain the master file of all international applications and to act as the publisher and central coordinating body under the Treaty. The World Intellectual Property Organization (WIPO) in Geneva, Switzerland performs the duties of the International Bureau.

If the applicant has not filed a certified copy of the priority document in the receiving Office with the international application, or requested upon filing that the receiving Office prepare and transmit to the International Bureau a copy of the prior U.S. national application, the priority of which is claimed, the applicant must submit such a document directly to the International Bureau or the receiving Office not later than 16 months after the priority date (PCT Rule 17). The \*\*>request (Form PCT/RO/101)< contains a box which can be checked requesting that the receiving Office prepare the certified copy. This is only possible, of course, if the receiving Office is a part of the same national Office where the priority application was filed.

The applicant has normally 2 months from the date of transmittal of the international search report to amend the claims by filing an amendment >and may file a brief statement explaining the amendment< directly with the International Bureau (PCT Article 19 and PCT Rule 46). The International Bureau will then normally publish the international application along with the search report and any amended claims \* at the expiration of 18 months from the priority date (PCT Article 21). >The written opinion, on the other hand, will not be made publicly available until the expiration of 30 months from the priority date. See PCT Rule 44<sup>ter</sup>.< The international publication is in pamphlet form with a front page containing bibliographical data, the abstract, and a figure of the drawing (PCT Rule 48). The pamphlet also contains the search report and any amendments to the claims submitted by the applicant. If the application is published in a language other than English, the search report and abstract are also published in English. The International Bureau publishes a *PCT Gazette* in the French and English languages which contains information similar to that on the front pages of published international applications, as well as various indexes and announcements (PCT Rule 86). The International Bureau also transmits copies of the international application to all the designated Offices (PCT Article 20 and PCT Rule 47).

### **DESIGNATED OFFICE (DO) and ELECTED OFFICE (EO)**

The designated Office is the national Office (for example, the USPTO) acting for the state or region designated under Chapter I. Similarly, the elected Office is the national Office acting for the state or region elected under Chapter II.

PCT Article 22(1) was amended, effective April 1, 2002, to specify that a copy of the international application, a translation thereof (as prescribed), and the national fee are due to the designated Office not later than at the expiration of 30 months from the priority date. Accordingly, the time period for filing the copy of the international application, the translation, and the fee under PCT Article 22 is now the same as the 30 month time period set forth in PCT Article 39. >The USPTO has adopted the 30 month time limit set forth in PCT Article 22(1).< However, not all Contracting States have changed their national laws for

consistency with PCT Article 22(1) as amended. Accordingly, if no “Demand” for international preliminary examination has been filed within 19 months of the priority date, the applicant may be required to complete the requirements for entering the national stage within 20 months from the priority date of the international application in some national or regional offices. When entering the national stage following Chapter I, the applicant has the right to amend the application within the time limit set forth in PCT Rule 52.1. After this time limit has expired (PCT Article 28 and PCT Rule 52), each designated Office will make its own determination as to the patentability of the application based upon its own specific national or regional laws (PCT Article 27(5)).

If the applicant desires to obtain the benefit of delaying the entry into the national stage until 30 months from the priority date in one or more countries \*\*>where< the 30 month time limit set forth in PCT Article 22(1) as amended >does not apply<, a Demand for international preliminary examination must be filed with an appropriate International Preliminary Examining Authority within 19 months of the priority date. Those states in which the Chapter II procedure is desired must be “elected” in the Demand. >For international applications filed on or after January 1, 2004, the applicant should file the demand with the competent International Preliminary Examining Authority (IPEA) before the expiration of the later of the following time limits: (A) three months from the date of transmittal to the applicant of the international search report and written opinion under PCT Rule 43<sup>bis</sup>.1, or of the declaration referred to in PCT Article 17(2)(a); or (B) 22 months from the priority date of the international application. However, applicant may still desire to file the demand by 19 months from the priority date for those countries that have not yet adopted PCT Article 22(1) as amended.<

The original Demand is forwarded to the International Bureau by the \*\*>IPEA<. The International Bureau then notifies the various elected Offices that the applicant has entered Chapter II >and sends a copy of any amendments filed under PCT Article 19 and any statement explaining the amendments to the IPEA. See PCT Rule 62. In applications filed on or after January 1, 2004, the International Bureau also sends the IPEA a copy of the written opinion established by the International Searching Authority unless

the International Searching Authority is also acting as IPEA. See PCT Rule 62.1(i)<.

\*\*>

### **INTERNATIONAL PRELIMINARY EXAMINING AUTHORITY (IPEA)**

The International Preliminary Examining Authority (IPEA) normally starts the examination process when it is in possession of the demand, the amount due, and if the applicant is required to furnish a translation under PCT Rule 55.2, that translation and either the international search report (and the written opinion established under PCT Rule 43<sup>bis</sup>.1 if the international application has a filing date on or after January 1, 2004) or a notice of the declaration by the International Searching Authority (ISA) that no international search report will be established. However, for international applications having an international filing date on or after January 1, 2004, the IPEA shall not start the international preliminary examination before the expiration of the later of three months from the transmittal of the international search report and written opinion or of the declaration that no international search report will be established; or the expiration of 22 months from the priority date unless the applicant expressly requests an earlier start, with the exception of the situations provided for in PCT Rule 69.1(b)-(e).

The written opinion of the ISA is usually considered the first written opinion of the IPEA unless the IPEA has notified the International Bureau that written opinions established by specified International Searching Authorities shall not be considered a written opinion for this purpose. See PCT Rule 66.1<sup>bis</sup>. Also, the IPEA may, at its discretion issue further written opinions provided sufficient time is available. See PCT Rule 66.4.

The IPEA establishes the international preliminary examination report (entitled “international preliminary report on patentability” for applications having an international filing date on or after January 1, 2004),< which presents the examiner’s final position as to whether each claim is “novel,” involves “inventive step,” and is “industrially applicable” by 28 months from the priority date. A copy of the international preliminary examination report is sent to the applicant and to the International Bureau. The International Bureau then communicates a copy of the

international preliminary examination report to each elected Office.

The applicant must complete the requirements for entering the national stage by the expiration of 30 months from the priority date to avoid any question of withdrawal of the application as to that elected Office, however, some elected Offices provide a longer period to complete the requirements.

A listing of all national and regional offices, and the corresponding time limits for entering the national stage after PCT Chapter I and PCT Chapter II, may be found on WIPO's web site at: <http://www.wipo.int/pct/en/index.html>.

## 1802 PCT Definitions [R-1]

The PCT contains definitions in PCT Article 2 and in PCT Rule 2, which are found in MPEP Appendix T. Additional definitions are in 35 U.S.C. 351, found in MPEP Appendix L, in 37 CFR 1.9 and 1.401, found in MPEP Appendix R, and in PCT Administrative Instructions Section 101, found in MPEP Appendix AI.

## 1803 Reservations Under the PCT Taken by the United States of America

The United States of America had originally declared that it was not bound by Chapter II (PCT Article 64 (1)), but withdrew that reservation on July 1, 1987.

It has also declared that, as far as the United States of America is concerned, international publication is not required (PCT Article 64 (3)). Accordingly, under PCT Article 64(3)(b), if the United States is the only PCT Contracting State designated in an international application, the international application will not be published by the International Bureau (IB) at 18 months. Even though the United States Patent and Trademark Office has begun pre-grant publication under 35 U.S.C. 122(b), the United States has not removed its reservation under PCT Article 64(3) because not all United States patent applications are published. See 35 U.S.C. 122(b)(2). The application will, however, be published under 35 U.S.C. 122(b) if it enters the national stage in the United States. It will be published again if it is allowed to issue as a United States patent.

The United States of America also made a reservation under PCT Article 64(4) which relates to the

prior art effective date of a U.S. patent issuing from an international application. See 35 U.S.C. 102(e) and 363.

The above reservations under PCT Article 64(3) and (4) are still in effect.

The U.S. Receiving Office continues to accept applications only in English. See 35 U.S.C. 361(c). PCT Rules 20.4(c), 26.3<sup>ter</sup>(a) and 26.3<sup>ter</sup>(c) permit an international filing date to be accorded even though portions of an international application are in a language not acceptable to the Receiving Office. PCT Rules 20.4(c), 26.3<sup>ter</sup>(a) and 26.3<sup>ter</sup>(c) are not compatible with the national law applied by the United States Patent and Trademark Office (USPTO) as Receiving Office. Thus, the USPTO has taken a reservation on adherence to these Rules pursuant to PCT Rules 20.4(d), 26.3<sup>ter</sup>(b) and 26.3<sup>ter</sup>(d). As a result, PCT Rules 20.4(c), 26.3<sup>ter</sup>(a) and 26.3<sup>ter</sup>(c) shall not apply to the USPTO as Receiving Office for as long as the aforementioned incompatibility exists.

Also, PCT Rules 49.5(c<sup>bis</sup>) and 49.5(k) continue not to be compatible with the national law applied by the USPTO as a Designated Office. See 35 U.S.C. 371(c)(2). As a result, PCT Rules 49.5(c<sup>bis</sup>) and 49.5(k) shall not apply to the USPTO as Designated Office for as long as the aforementioned incompatibility exists. See the International Bureau's notice published in *PCT Gazette* No. 07/1992.

## 1805 Where To File an International Application [R-2]

35 U.S.C. 361. *Receiving Office.*

(a) The Patent and Trademark Office shall act as a Receiving Office for international applications filed by nationals or residents of the United States. In accordance with any agreement made between the United States and another country, the Patent and Trademark Office may also act as a Receiving Office for international applications filed by residents or nationals of such country who are entitled to file international applications.

\*\*\*\*\*

See 37 CFR 1.421 - 1.423 as to who can file an international application.

Only if at least one of the applicants is a resident or national of the United States of America may an international application be filed in the United States Receiving Office (PCT Article 9(1) and (3), PCT Rules 19.1 and 19.2, 35 U.S.C. 361(a) and 37 CFR



1.412(a), 1.421). The concepts of residence and nationality are defined in PCT Rule 18.1. For the purpose of filing an international application, the applicant may be either the inventor or the successor in title of the inventor (assignee or owner). However, the laws of the various designated States regarding the requirements for applicants must also be considered when filing an international application. For example, the patent law of the United States of America requires that, for the purposes of designating the United States of America, the applicant(s) must be the inventor(s) (35 U.S.C. 373, PCT Article 27(3)).

The United States Receiving Office is located in Crystal Plaza, Building 2, 8th floor, 2011 South Clark Place, Arlington, Virginia. International applications and related papers may be deposited directly with the United States Receiving Office or be mailed to: \*\*>Mail Stop PCT, Commissioner for Patents, P.O. Box 1450, Alexandria, Virginia 22313-1450<. It should be noted that the “Express Mail” provisions of 37 CFR 1.10 apply to the filing of all applications and papers filed in the U.S. Patent and Trademark Office, including PCT international applications and related papers and fees. It should be further noted, however, that PCT international applications and papers relating to international applications are specifically excluded from the Certificate of Mailing or Transmission procedures under 37 CFR 1.8. \*\*>See MPEP § 1834.< If 37 CFR 1.8 is improperly used, the date to be accorded the paper will be the date of actual receipt in the Office unless the receipt date falls on a Saturday, Sunday, or Federal holiday in which case the date of receipt will be the next succeeding day which is not a Saturday, Sunday, or Federal holiday (37 CFR 1.6).

Irrespective of the Certification practice under 37 CFR 1.8(a), facsimile transmission (without the benefit of the certificate under 37 CFR 1.8(a)) may be used to submit certain papers in international applications. However, facsimile transmission may not be used for the filing of an international application, the filing of drawings under 37 CFR 1.437, or the filing of a copy of the international application, and the basic national fee to enter the U.S. national stage under 35 U.S.C. 371. See 37 CFR 1.6(d)(3) and (4), 1.8(a)(2)(i)(D), and 1.8(a)(2)(i)(F). The Demand for international preliminary examination may be filed by facsimile transmission. See MPEP § 1834.01.

The United States Receiving Office staff is available to offer guidance on PCT requirements and procedures. See MPEP § 1730 for information on contacting the staff and other available means for obtaining information.

**WARNING** - although the United States patent law at 35 U.S.C. 21(a) authorizes the \*>Director< to prescribe by rule that any paper or fee required to be filed in the Patent and Trademark Office will be considered filed in the Office on the date on which it was deposited with the United States Postal Service, PCT Rule 20.1(a) provides for marking the “date of actual receipt on the request.” Although the “Express Mail” provisions under 37 CFR 1.10 have not been contested to date regarding PCT applications, applicants should be aware of a possible different interpretation by foreign authorities.

PCT Rule 19.4 provides for transmittal of an international application to the International Bureau as Receiving Office in certain instances. For example, when the international application is filed with the United States Receiving Office and the language in which the international application is filed is not accepted by the United States Receiving Office, or if the applicant does not have the requisite residence or nationality, the application may be forwarded to the International Bureau for processing in its capacity as a Receiving Office. See 37 CFR 1.412(c)(6). The Receiving Office of the International Bureau will consider the international application to be received as of the date accorded by the United States Receiving Office. This practice will avoid the loss of a filing date in those instances where the United States Receiving Office is not competent to act, but where the international application indicates an applicant to be a national or resident of a PCT Contracting state or is in a language accepted under PCT Rule 12.1(a) by the International Bureau as a Receiving Office. Of course, where questions arise regarding residence or nationality, i.e., the U.S. is not clearly competent, the application will be forwarded to the International Bureau as Receiving Office. Note, where no residence or nationality is indicated, the U.S. is not competent, and the application will be forwarded to the International Bureau as Receiving Office so long as the necessary fee is paid. The fee is an amount equal to the transmittal fee.

If all of the applicants are indicated to be residents or nationals of non-PCT Contracting States, PCT Rule 19.4 does not apply, and the application is denied an international filing date.

**1807 Agent or Common Representative and General Power of Attorney [R-2]**

*37 CFR 1.455. Representation in international applications.*

(a) Applicants of international applications may be represented by attorneys or agents registered to practice before the Patent and Trademark Office or by an applicant appointed as a common representative (PCT Art. 49, Rules 4, 8 and 90 and § 10.10). If applicants have not appointed an attorney or agent or one of the applicants to represent them, and there is more than one applicant, the applicant first named in the request and who is entitled to file in the U.S. Receiving Office shall be considered to be the common representative of all the applicants. An attorney or agent having the right to practice before a national office with which an international application is filed and for which the United States is an International Searching Authority or International Preliminary Examining Authority may be appointed to represent the applicants in the international application before that authority. An attorney or agent may appoint an associate attorney or agent who shall also then be of record (PCT Rule 90.1(d)). The appointment of an attorney or agent, or of a common representative, revokes any earlier appointment unless otherwise indicated (PCT Rule 90.6(b) and (c)).

\*\*>

(b) Appointment of an agent, attorney or common representative (PCT Rule 4.8) must be effected either in the Request form, signed by applicant, in the Demand form, signed by applicant, or in a separate power of attorney submitted either to the United States Receiving Office or to the International Bureau.<

(c) Powers of attorney and revocations thereof should be submitted to the United States Receiving Office until the issuance of the international search report.

(d) The addressee for correspondence will be as indicated in section 108 of the Administrative Instructions.

>

*PCT Rule 90.  
Agents and Common Representatives*

\*\*\*\*\*

*90.4.Manner of Appointment of Agent or Common Representative*

(a) The appointment of an agent shall be effected by the applicant signing the request, the demand, or a separate power of attorney. Where there are two or more applicants, the appointment of a common agent or common representative shall be effected by

each applicant signing, at his choice, the request, the demand or a separate power of attorney.

(b) Subject to Rule 90.5, a separate power of attorney shall be submitted to either the receiving Office or the International Bureau, provided that, where a power of attorney appoints an agent under Rule 90.1(b), (c), or (d)(ii), it shall be submitted to the International Searching Authority or the International Preliminary Examining Authority, as the case may be.

(c) If the separate power of attorney is not signed, or if the required separate power of attorney is missing, or if the indication of the name or address of the appointed person does not comply with Rule 4.4, the power of attorney shall be considered nonexistent unless the defect is corrected.

(d) Subject to paragraph (e), any receiving Office, any International Searching Authority, any International Preliminary Examining Authority and the International Bureau may waive the requirement under paragraph (b) that a separate power of attorney be submitted to it, in which case paragraph (c) shall not apply.

(e) Where the agent or the common representative submits any notice of withdrawal referred to in Rules 90<sup>bis</sup>.1 to 90<sup>bis</sup>.4, the requirement under paragraph (b) for a separate power of attorney shall not be waived under paragraph (d).

\*\*\*\*\*

<

Where an appointment of an agent or common representative is effected by a separate power of attorney, that power of attorney must be submitted to either the receiving Office or the International Bureau. However, a power of attorney appointing an agent or sub-agent to represent the applicant specifically before the International Searching Authority or the International Preliminary Examining Authority must be submitted directly to that Authority. >See PCT Rule 90.4(b).<

**“GENERAL” POWER OF ATTORNEY**

>

*PCT Rule 90.  
Agents and Common Representatives*

\*\*\*\*\*

*90.5.General Power of Attorney*

(a) Appointment of an agent in relation to a particular international application may be effected by referring in the request, the demand, or a separate notice to an existing separate power of attorney appointing that agent to represent the applicant in relation to any international application which may be filed by that applicant (i.e., a “general power of attorney”), provided that:

(i) the general power of attorney has been deposited in accordance with paragraph (b), and

(ii) a copy of it is attached to the request, the demand or the separate notice, as the case may be; that copy need not be signed.

(b) The general power of attorney shall be deposited with the receiving Office, provided that, where it appoints an agent under Rule 90.1(b), (c), or (d)(ii), it shall be deposited with the International Searching Authority or the International Preliminary Examining Authority, as the case may be.

(c) Any receiving Office, any International Searching Authority and any International Preliminary Examining Authority may waive the requirement under paragraph (a)(ii) that a copy of the general power of attorney is attached to the request, the demand or the separate notice, as the case may be.

(d) Notwithstanding paragraph (c), where the agent submits any notice of withdrawal referred to in Rules 90bis.1 to 90bis.4 to the receiving Office, the International Searching Authority or the International Preliminary Examining Authority, a copy of the general power of attorney shall be submitted to that Office or Authority.

\*\*\*\*\*

<

“General” powers of attorney are recognized for the purpose of filing and prosecuting an international application before the international authorities. \*\*>See PCT Rule 90.5.<

Any general power of attorney must be filed with the receiving Office if the appointment was for the purposes of the international phase generally, or with the International Searching Authority or International Preliminary Examining Authority if the appointment was specifically to represent the applicant before that Authority. The appointment will then be effective in relation to any particular application filed by that applicant provided that the general power of attorney is referred to in the request, the Demand or a separate notice, and that a copy of the general power of attorney is attached to that request, Demand or separate notice. That copy of the signed original need not, itself, be separately signed. \*\*

#### >WAIVER OF REQUIREMENT FOR A POWER OF ATTORNEY

Pursuant to new PCT Rules 90.4(d) and 90.5(c), which are applicable to international applications having an international filing date on or after January 1, 2004, the receiving Office, International Bureau, International Searching Authority and International Preliminary Examining Authority may waive the requirement for a separate power of attorney or copy of the general power of attorney in all cases except

with respect to notice of withdrawals under PCT Rule 90<sup>bis</sup> (i.e., notices withdrawing international applications, designations, priority claims, demands or elections). The USPTO, when acting in its capacity as a receiving Office, International Searching Authority, or International Preliminary Examining Authority, will in most cases waive the requirement for a separate power of attorney and copy of the general power of attorney in international applications having an international filing date on or after January 1, 2004. However, a separate power of attorney or copy of the general power of attorney may still be required in certain cases, e.g., where an agent’s authority to act on behalf of the applicant is in doubt.

Model power of attorney and general power of attorney forms are available online from WIPO’s web site ([www.wipo.int/pct/en/index.html](http://www.wipo.int/pct/en/index.html)).<

### 1808 Change in or Revocation of the Appointment of an Agent or a Common Representative [R-2]

*PCT Rule 90.*

*Agents and Common Representatives*

\*\*\*\*\*

#### 90.6.Revocation and Renunciation

(a) Any appointment of an agent or common representative may be revoked by the persons who made the appointment or by their successors in title, in which case any appointment of a subagent under Rule 90.1(d) by that agent shall also be considered as revoked. Any appointment of a subagent under Rule 90.1(d) may also be revoked by the applicant concerned.

(b) The appointment of an agent under Rule 90.1(a) shall, unless otherwise indicated, have the effect of revoking any earlier appointment of an agent made under that Rule.

(c) The appointment of a common representative shall, unless otherwise indicated, have the effect of revoking any earlier appointment of a common representative.

(d) An agent or a common representative may renounce his appointment by a notification signed by him.

(e) Rule 90.4(b) and (c) shall apply, *mutatis mutandis*, to a document containing a revocation or renunciation under this Rule.

#### 37 CFR 1.455. Representation in international applications.

(a) Applicants of international applications may be represented by attorneys or agents registered to practice before the Patent and Trademark Office or by an applicant appointed as a common representative (PCT Art. 49, Rules 4, 8 and 90 and § 10.10). If applicants have not appointed an attorney or agent or one of the applicants to represent them, and there is more than one

applicant, the applicant first named in the request and who is entitled to file in the U.S. Receiving Office shall be considered to be the common representative of all the applicants. An attorney or agent having the right to practice before a national office with which an international application is filed and for which the United States is an International Searching Authority or International Preliminary Examining Authority may be appointed to represent the applicants in the international application before that authority. An attorney or agent may appoint an associate attorney or agent who shall also then be of record (PCT Rule 90.1(d)). The appointment of an attorney or agent, or of a common representative, revokes any earlier appointment unless otherwise indicated (PCT Rule 90.6(b) and (c)).

\*\*>

(b) Appointment of an agent, attorney or common representative (PCT Rule 4.8) must be effected either in the Request form, signed by applicant, in the Demand form, signed by applicant, or in a separate power of attorney submitted either to the United States Receiving Office or to the International Bureau.<

(c) Powers of attorney and revocations thereof should be submitted to the United States Receiving Office until the issuance of the international search report.

(d) The addressee for correspondence will be as indicated in section 108 of the Administrative Instructions.

The appointment of an agent or a common representative can be revoked. The document containing the revocation must be signed by the persons who made the appointment or by their successors in title. The appointment of a sub-agent may also be revoked by the applicant concerned. If the appointment of an agent is revoked, any appointment of a sub-agent by that agent is also considered revoked.

The appointment of an agent for the international phase in general automatically has the effect, unless otherwise indicated, of revoking any earlier appointment of an agent. The appointment of a common representative similarly has the effect, unless otherwise indicated, of revoking any earlier appointment of a common representative.

\*\*

Renunciation of an appointment may be made by means of a notification signed by the agent or common representative. \*\* The applicant is informed of the renunciation by the International Bureau.

>The rules for signing and submission of a power of attorney set forth in PCT Rule 90.4(b) and (c) also apply to a revocation or renunciation of an appointment. See PCT Rule 90.6(e).<

U.S. attorneys or agents wishing to withdraw from representation in international applications may request to do so. To expedite the handling of requests for permission to withdraw as attorney, the request

should be submitted \*\* to \*>Mail Stop< PCT and should indicate the present mailing addresses of the attorney who is withdrawing and of the applicant. Because the United States Patent and Trademark Office (USPTO) does not recognize law firms, each attorney of record must sign the notice of withdrawal, or the notice of withdrawal must contain a clear indication of one attorney signing on behalf of another.

The USPTO usually requires that there be at least 30 days between approval of withdrawal and the expiration date of a time response period so that the applicant will have sufficient time to obtain other representation or take other action. If less than 30 days remains in a running response period, a request to withdraw is normally disapproved.

For withdrawal of attorney or agent in the national stage, see MPEP § 402.06.

## 1810 Filing Date Requirements [R-2]

### *PCT Article 11.*

#### *Filing Date and Effects of the International Application*

(1) The receiving Office shall accord as the international filing date the date of receipt of the international application, provided that that Office has found that, at the time of receipt:

(i) the applicant does not obviously lack, for reasons of residence or nationality, the right to file an international application with the receiving Office,

(ii) the international application is in the prescribed language,

(iii) the international application contains at least the following elements:

(a) an indication that it is intended as an international application,

(b) the designation of at least one Contracting State,

(c) the name of the applicant, as prescribed,

(d) a part which on the face of it appears to be a description,

(e) a part which on the face of it appears to be a claim or claims.

\*\*\*\*\*

#### *35 U.S.C. 363. International application designating the United States: Effect.*

An international application designating the United States shall have the effect, from its international filing date under article 11 of the treaty, of a national application for patent regularly filed in the Patent and Trademark Office except as otherwise provided in section 102(e) of this title.

#### *35 U.S.C. 373. Improper Applicant.*

An international application designating the United States, shall not be accepted by the Patent and Trademark Office for the

national stage if it was filed by anyone not qualified under chapter 11 of this title to be an applicant for the purpose of filing a national application in the United States. Such international applications shall not serve as the basis for the benefit of an earlier filing date under section 120 of this title in a subsequently filed application, but may serve as the basis for a claim of the right of priority under subsections (a) through (d) of section 119 of this title, if the United States was not the sole country designated in such international application.

*37 CFR 1.431. International application requirements.*

(a) An international application shall contain, as specified in the Treaty and the Regulations, a Request, a description, one or more claims, an abstract, and one or more drawings (where required). (PCT Art. 3(2) and Section 207 of the Administrative Instructions.)

(b) An international filing date will be accorded by the United States Receiving Office, at the time of receipt of the international application, provided that:

(1) At least one applicant is a United States resident or national and the papers filed at the time of receipt of the international application so indicate (35 U.S.C. 361(a), PCT Art. 11(1)(i)).

(2) The international application is in the English language (35 U.S.C. 361(c), PCT Art. 11(1)(ii)).

\*\*>

(3) The international application contains at least the following elements (PCT Art. 11(1)(iii)):

(i) An indication that it is intended as an international application (PCT Rule 4.2);

(ii) The designation of at least one Contracting State of the International Patent Cooperation Union (§ 1.432);

(iii) The name of the applicant, as prescribed (note §§ 1.421-1.423);

(iv) A part which on the face of it appears to be a description; and

(v) A part which on the face of it appears to be a claim.

(c) Payment of the international filing fee (PCT Rule 15.2) and the transmittal and search fees (§ 1.445) may be made in full at the time the international application papers required by paragraph (b) of this section are deposited or within one month thereafter. The international filing, transmittal, and search fee payable is the international filing, transmittal, and search fee in effect on the receipt date of the international application.

(1) If the international filing, transmittal and search fees are not paid within one month from the date of receipt of the international application and prior to the sending of a notice of deficiency which imposes a late payment fee, applicant will be notified and given one month within which to pay the deficient fees plus the late payment fee. Subject to paragraph (c)(2) of this section, the late payment fee will be equal to the greater of:

- (i) Fifty percent of the amount of the deficient fees; or
- (ii) An amount equal to the transmittal fee.

(2) The late payment fee shall not exceed an amount equal to fifty percent of the international filing fee not taking into

account any fee for each sheet of the international application in excess of thirty sheets (PCT Rule 16<sup>bis</sup>).

(3) The one-month time limit set pursuant to paragraph (c) of this section to pay deficient fees may not be extended.

(d) If the payment needed to cover the transmittal fee, the international filing fee, the search fee, and the late payment fee pursuant to paragraph (c) of this section is not timely made in accordance with PCT Rule 16<sup>bis</sup>.1(e), the Receiving Office will declare the international application withdrawn under PCT Article 14(3)(a).<

## THE “INTERNATIONAL FILING DATE”

An international filing date is accorded \*\*>to the earliest date on which the requirements under PCT Article 11(1) were satisfied. If the requirements under PCT Article 11(1) are not satisfied as of the date of initial receipt of the international application papers, the receiving Office will invite applicant to correct the deficiency within a set time limit. See PCT Article 11(2) and PCT Rule 20.6. In such case, the international filing date will be the date on which a timely filed correction is received by the receiving Office. If the defect under PCT Article 11(1) is not timely corrected, the receiving Office will promptly notify the applicant that the application is not and will not be treated as an international application. See PCT Rule 20.7.< Where all the sheets pertaining to the same international application are not received on the same day by the receiving Office, in most instances, the date of receipt of the application will be amended to reflect the date on which the last missing sheets were received. As an amended date of receipt may cause the priority claim to be forfeited, applicants should assure that all sheets of the application are deposited with the receiving Office on the same day. For particulars see PCT Rule 20.2.

An all too common occurrence is that applicants will file an international application in the U.S. Receiving Office and no applicant has a U.S. residence or nationality. Applicants are cautioned to be sure that at least one applicant is a resident or national of the U.S. before filing in the U.S. Receiving Office. Where no applicant indicated on the request papers is a resident or national of the United States, the USPTO is not a competent receiving Office for the international application under PCT Rule 19.1(a). Nonetheless, the date the international application was filed in the USPTO will not be lost as a filing date for the international application if at least one applicant is a

resident or national of any PCT Contracting State. Under PCT Rule 19.4, the USPTO will receive the application on behalf of the International Bureau as receiving Office (PCT Rule 19.4(a)) and, upon payment of a fee equal to the transmittal fee, the USPTO will promptly transmit the international application to the International Bureau under PCT Rule 19.4(b). However, if all of the applicants are indicated to be both residents and nationals of non-PCT Contracting States, PCT Rule 19.4 does not apply, and the application is denied an international filing date.

The USPTO is also not competent to receive international applications that are not in the English language and, upon payment of a fee equal to the transmittal fee, the USPTO will forward such applications to the International Bureau under PCT Rule 19.4 provided they are in a language accepted by the International Bureau as receiving Office.

A discussion of PCT Rule 19.4 is also included in MPEP § 1805.

## 1812 Elements of the International Application [R-2]

### *PCT Article 3.*

#### *The International Application*

(1) Applications for the protection of inventions in any of the Contracting States may be filed as international applications under this Treaty.

(2) An international application shall contain, as specified in this Treaty and the Regulations, a request, a description, one or more claims, one or more drawings (where required), and an abstract.

(3) The abstract merely serves the purpose of technical information and cannot be taken into account for any other purpose, particularly not for the purpose of interpreting the scope of the protection sought.

(4) The international application shall:

- (i) be in a prescribed language;
- (ii) comply with the prescribed physical requirements;
- (iii) comply with the prescribed requirement of unity of invention;
- (iv) be subject to the payment of the prescribed fees.

Any international application must contain the following elements: request, description, claim or claims, abstract and one or more drawings (where drawings are necessary for the understanding of the invention (PCT Article 3(2) and PCT Article 7(2)). The elements of the international application are to be arranged in the following order: the request, the description (other than any sequence listing part thereof), the claims, the abstract, the drawings, and the sequence listing part of the description (where applicable) (Administrative Instructions Section 207(a)). All the sheets contained in the international application must be numbered in consecutive Arabic numerals by using the following separate series of numbers: a first series applying to the request; a second series to the description, claims and abstract; a third series to the drawings (where applicable); and a further series to the sequence listing part of the description (where applicable) (PCT Rule 11.7 and Administrative Instructions Section 207(b)). Only one copy of the international application need be filed in the United States Receiving Office (37 CFR 1.433(a)). The request is made on a standardized form (Form PCT/RO/101), copies of which can be obtained from the USPTO or online from WIPO's web site ([www.wipo.int/pct/en/index.html](http://www.wipo.int/pct/en/index.html)). The "Request" form can also be presented as a computer printout prepared using the PCT-SAFE software. This software can be downloaded from the PCT-SAFE web site ([www.wipo.int/pct-safe](http://www.wipo.int/pct-safe)). The details of a computer generated Request form are provided in Administrative Instructions Section 102<sup>bis</sup>.

## 1817 PCT Member States [R-2]

An updated list of PCT Contracting States is available from WIPO's web site ([www.wipo.int/pct/guide/en/gdvol1/annexes/annexa/ax\\_a.pdf](http://www.wipo.int/pct/guide/en/gdvol1/annexes/annexa/ax_a.pdf)). The following list of PCT Contracting States was updated at the time of publication of the MPEP:

State	Ratification, Accession or Declaration	Date of Ratification, Accession or Declaration	Date From Which State May Be Designated
(1) Central African Republic <sup>o</sup>	Accession	15 September 1971	01 June 1978
(2) Senegal <sup>o</sup>	Ratification	08 March 1972	01 June 1978
(3) Madagascar	Ratification	27 March 1972	01 June 1978
(4) Malawi	Accession	16 May 1972	01 June 1978
(5) Cameroon <sup>o</sup>	Accession	15 March 1973	01 June 1978
(6) Chad <sup>o</sup>	Accession	12 February 1974	01 June 1978
(7) Togo <sup>o</sup>	Ratification	28 January 1975	01 June 1978
(8) Gabon <sup>o</sup>	Accession	06 March 1975	01 June 1978
(9) United States of America	Ratification	26 November 1975	01 June 1978
(10) Germany <sup>oo</sup>	Ratification	19 July 1976	01 June 1978
(11) Congo <sup>o</sup>	Accession	08 August 1977	01 June 1978
(12) Switzerland <sup>oo</sup>	Ratification	14 September 1977	01 June 1978
(13) United Kingdom <sup>oo</sup>	Ratification	24 October 1977	01 June 1978
(14) France <sup>oo</sup>	Ratification	25 November 1977	01 June 1978
(15) Russian Federation	Ratification	29 December 1977	01 June 1978
(16) Brazil	Ratification	09 January 1978	01 June 1978
(17) Luxembourg <sup>oo</sup>	Ratification	31 January 1978	01 June 1978
(18) Sweden <sup>oo</sup>	Ratification	17 February 1978	01 June 1978
(19) Japan	Ratification	01 July 1978	01 October 1978
(20) Denmark <sup>oo</sup>	Ratification	01 September 1978	01 December 1978
(21) Austria <sup>oo</sup>	Ratification	23 January 1979	23 April 1979
(22) Monaco <sup>oo</sup>	Ratification	22 March 1979	22 June 1979
(23) Netherlands <sup>oo</sup>	Ratification	10 April 1979	10 July 1979
(24) Romania <sup>oo</sup>	Ratification	23 April 1979	23 July 1979
(25) Norway	Ratification	01 October 1979	01 January 1980
(26) Liechtenstein <sup>oo</sup>	Accession	19 December 1979	19 March 1980

State	Ratification, Accession or Declaration	Date of Ratification, Accession or Declaration	Date From Which State May Be Designated
(27) Australia	Accession	31 December 1979	31 March 1980
(28) Hungary °°	Ratification	27 March 1980	27 June 1980
(29) Democratic People's Republic of Korea (North Korea )	Accession	08 April 1980	08 July 1980
(30) Finland °°	Ratification	01 July 1980	01 October 1980
(31) Belgium °°	Ratification	14 September 1981	14 December 1981
(32) Sri Lanka	Accession	26 November 1981	26 February 1982
(33) Mauritania °	Accession	13 January 1983	13 April 1983
(34) Sudan	Accession	16 January 1984	16 April 1984
(35) Bulgaria °°	Accession	21 February 1984	21 May 1984
(36) Republic of Korea (South Korea)	Accession	10 May 1984	10 August 1984
(37) Mali °	Accession	19 July 1984	19 October 1984
(38) Barbados	Accession	12 December 1984	12 March 1985
(39) Italy °°	Ratification	28 December 1984	28 March 1985
(40) Benin °	Accession	26 November 1986	26 February 1987
(41) Burkina Faso °	Accession	21 December 1988	21 March 1989
(42) Spain °°	Accession	16 August 1989	16 November 1989
(43) Canada	Ratification	02 October 1989	02 January 1990
(44) Greece °°	Accession	09 July 1990	09 October 1990
(45) Poland > °° <	Accession	25 September 1990	25 December 1990
(46) Côte d'Ivoire °	Ratification	31 January 1991	30 April 1991
(47) Guinea °	Accession	27 February 1991	27 May 1991
(48) Mongolia	Accession	27 February 1991	27 May 1991
(49) Czech Republic °°	Declaration	18 December 1992	01 January 1993
(50) Ireland °°	Ratification	01 May 1992	01 August 1992
(51) Portugal °°	Accession	24 August 1992	24 November 1992
(52 ) New Zealand	Accession	01 September 1992	01 December 1992



State	Ratification, Accession or Declaration	Date of Ratification, Accession or Declaration	Date From Which State May Be Designated
(53) Ukraine	Declaration	21 September 1992	25 December 1991
(54) Viet Nam	Accession	10 December 1992	10 March 1993
(55) Slovakia °°	Declaration	30 December 1992	01 January 1993
(56) Niger°	Accession	21 December 1992	21 March 1993
(57) Kazakhstan	Declaration	16 February 1993	25 December 1991
(58) Belarus	Declaration	14 April 1993	25 December 1991
(59) Latvia	Accession	07 June 1993	07 September 1993
(60) Uzbekistan	Declaration	18 August 1993	25 December 1991
(61) China	Accession	01 October 1993	01 January 1994
(62) Slovenia °°	Accession	01 December 1993	01 March 1994
(63) Trinidad and Tobago	Accession	10 December 1993	10 March 1994
(64) Georgia	Declaration	18 January 1994	25 December 1991
(65) Kyrgyzstan	Declaration	14 February 1994	25 December 1991
(66) Republic of Moldova	Declaration	14 February 1994	25 December 1991
(67) Tajikistan	Declaration	14 February 1994	25 December 1991
(68) Kenya	Accession	08 March 1994	08 June 1994
(69) Lithuania	Accession	05 April 1994	05 July 1994
(70) Armenia	Declaration	17 May 1994	25 December 1991
(71) Estonia °°	Accession	24 May 1994	24 August 1994
(72) Liberia	Accession	27 May 1994	27 August 1994
(73) Swaziland	Accession	20 June 1994	20 September 1994
(74) Mexico	Accession	01 October 1994	01 January 1995
(75) Uganda	Accession	09 November 1994	09 February 1995
(76) Singapore	Accession	23 November 1994	23 February 1995
(77) Iceland	Accession	23 December 1994	23 March 1995
(78) Turkmenistan	Declaration	01 March 1995	25 December 1991
(79) The former Yugoslov Republic of Macedonia	Accession	10 May 1995	10 August 1995

State	Ratification, Accession or Declaration	Date of Ratification, Accession or Declaration	Date From Which State May Be Designated
(80) Albania	Accession	04 July 1995	04 October 1995
(81) Lesotho	Accession	21 July 1995	21 October 1995
(82) Azerbaijan	Accession	25 September 1995	25 December 1995
(83) Turkey <sup>oo</sup>	Accession	01 October 1995	01 January 1996
(84) Israel	Ratification	01 March 1996	01 June 1996
(85) Cuba	Accession	16 April 1996	16 July 1996
(86) Saint Lucia	Accession	30 May 1996	30 August 1996
(87) Bosnia and Herzegovina	Accession	07 June 1996	07 September 1996
(88) *>Serbia and Montenegro<	Ratification	01 November 1996	01 February 1997
(89) Ghana	Accession	26 November 1996	16 February 1997
(90) Zimbabwe	Accession	11 March 1997	11 June 1997
(91) Sierra Leone	Accession	17 March 1997	17 June 1997
(92) Indonesia	Accession	05 June 1997	05 September 1997
(93) Gambia	Accession	09 September 1997	09 December 1997
(94) Guinea-Bissau <sup>o</sup>	Accession	12 September 1997	12 December 1997
(95) Cyprus <sup>oo</sup>	Accession	01 January 1998	01 April 1998
(96) Croatia	Accession	01 April 1998	01 July 1998
(97) Grenada	Accession	22 June 1998	22 September 1998
(98) India	Accession	07 September 1998	07 December 1998
(99) United Arab Emirates	Accession	10 December 1998	10 March 1999
(100) South Africa	Accession	16 December 1998	16 March 1999
(101) Costa Rica	Accession	03 May 1999	03 August 1999
(102) Dominica	Accession	07 May 1999	07 August 1999
(103) United Republic of Tanzania	Accession	14 June 1999	14 September 1999
(104) Morocco	Accession	08 July 1999	08 October 1999
(105) Algeria	Ratification	08 December 1999	08 March 2000
(106) Antigua and Barbuda	Accession	17 December 1999	17 March 2000

State	Ratification, Accession or Declaration	Date of Ratification, Accession or Declaration	Date From Which State May Be Designated
(107) Mozambique	Accession	18 February 2000	18 May 2000
(108) Belize	Accession	17 March 2000	17 June 2000
(109) Colombia	Accession	29 November 2000	28 February 2001
(110) Ecuador	Accession	07 February 2001	07 May 2001
(111) Equatorial Guinea <sup>o</sup>	Accession	17 April 2001	17 July 2001
(112) Philippines	Ratification	17 May 2001	17 August 2001
(113) Oman	Accession	26 July 2001	26 October 2001
(114) Zambia	Accession	15 August 2001	15 November 2001
(115) Tunisia	Accession	10 September 2001	10 December 2001
(116) Saint Vincent and the Grenadines	Accession	06 May 2002	06 August 2002
(117) Seychelles	Accession	07 August 2002	07 November 2002
(118) Nicaragua	Accession	06 December 2002	06 March 2003
>(119) Papua New Guinea	Accession	14 March 2003	14 June 2003
(120) Syrian Arab Republic	Accession	26 March 2003	26 June 2003
(121) Egypt	Ratification	06 June 2003	06 September 2003
(122) Botswana	Accession	30 July 2003	30 October 2003
(123) Namibia	Accession	01 October 2003	01 January 2004<
<p><sup>o</sup>Members of Africa Intellectual Property Organization (OAPI) regional patent system. Only regional patent protection is available for OAPI member states. A designation of any state is an indication that all OAPI states have been designated. Note: only one designation fee is due regardless of the number of OAPI member states designated.</p>			
<p><sup>oo</sup>Members of European Patent Convention (EPC) regional patent system. Either national patents or European patents for member States are available through PCT, except for Belgium, Cyprus, France, Greece, Ireland, Italy, Monaco, Netherlands, and Slovenia, for which only European patents are available if the PCT is used. Note: only one PCT designation fee is due if European patent protection is sought for one, several, or all EPC member countries.</p>			

State	Ratification, Accession or Declaration	Date of Ratification, Accession or Declaration	Date From Which State May Be Designated
<p>The following states are members of African Regional Industrial Property Organization (ARIPO) regional patent system and are Contracting States of both the Harare Protocol and the PCT: (4) Malawi, (34) Sudan, (68) Kenya, (73) Swaziland, (75) Uganda, (81) Lesotho, (89) Ghana, (90) Zimbabwe, (91) Sierra Leone, (93) Gambia, (103) United Republic of Tanzania, (107) Mozambique, (114) Zambia, and (122) Botswana. Note that with the accession of Botswana to the PCT, all 14 States party to the Harare Protocol are now also Contracting States of the PCT. State (73) Swaziland can only be designated for the purposes of an ARIPO patent and not for the purposes of a national patent. All other PCT Contracting States which are also party to the Harare Protocol can be designated either for a national or an ARIPO patent, or both a national and an ARIPO patent.</p>			
<p>The following states are members of the Eurasian Patent Organization (EAPO) regional patent system: (15) Russian Federation, (57) Kazakhstan, (58) Belarus, (65) Kyrgyzstan, (66) Republic of Moldova, (67) Tajikistan, (70) Armenia, (78) Turkmenistan, and (82) Azerbaijan. All PCT Contracting States which are also party to the Eurasian Patent Convention can be designated either for a national or a Eurasian patent, or both a national and a Eurasian patent. Note, however, that it is not possible to designate only some of these States for a Eurasian patent and that any designation of one or more States for a Eurasian patent will be treated as a designation of all the States which are party to both the Convention and the PCT for a Eurasian patent.</p>			

### **1817.01 >Designation of States in International Applications Having an International Filing Date On or After January 1, 2004 [R-2]**

[Note: The regulations under the PCT were changed effective January 1, 2004. A corresponding change was made to Title 37 of the Code of Federal Regulations. See *January 2004 Revision of Patent Cooperation Treaty Application Procedure*, 68 FR 59881 (Oct. 20, 2003), 1276 O.G. 6 (Nov. 11, 2003). All international applications having an international filing date before January 1, 2004, will continue to be processed under the procedures in effect on the international filing date. For the designation of states in international applications having an international filing date before January 1, 2004, see MPEP § 1817.01(a) for the information that previously appeared in this section].

*37 CFR 1.432. Designation of States by filing an international application.*

The filing of an international application request shall constitute:

(a) The designation of all Contracting States that are bound by the Treaty on the international filing date;

(b) An indication that the international application is, in respect of each designated State to which PCT Article 43 or 44 applies, for the grant of every kind of protection which is available by way of the designation of that State; and

(c) An indication that the international application is, in respect of each designated State to which PCT Article 45(1) applies, for the grant of a regional patent and also, unless PCT Article 45(2) applies, a national patent.

For international applications having an international filing date on or after January 1, 2004, the filing of an international application request constitutes: (A) the designation of all Contracting States that are bound by the Treaty on the international filing date; (B) an indication that the international application is, in respect of each designated State to which PCT Article 43 or 44 applies, for the grant of every kind of protection which is available by way of the designation of that State; and (C) an indication that the international application is, in respect of each designated State to which PCT Article 45(1) applies, for the grant of a regional patent and also, unless PCT Article 45(2) applies, a national patent. See 37 CFR 1.432 and PCT Rule 4.9. This automatic indication of all designations and all types of protection possible overcomes a pit-

fall in the designation system in effect for applications having an international filing prior to January 1, 2004, where applicants inadvertently omitted a designation or type of protection and failed to timely satisfy the requirements under former PCT Rule 4.9(b) to perfect a precautionary designation.

### **APPLICANT FOR PURPOSES OF EACH DESIGNATION**

Where there is but a single applicant, the right to file an international application and to designate Contracting States or regions exists if the applicant is a resident or national of a PCT Contracting State. The applicant can be an individual, corporate entity or other concern. In the case where there are several applicants who are different for different designated states, the right to file an international application and to designate Contracting States or regions exists if at least one of them is a resident or national of a Contracting State. If entry into the U.S. national phase is desired, inventors must be indicated as applicants at least for purposes of the United States.

### **1817.01(a) < Designation of States and Precautionary Designations >in International Applications Having an International Filing Date Before January 1, 2004< [R-2]**

[Note: For the designation of States in applications having an international filing date on or after January 1, 2004, see MPEP § 1817.01.]

*Former<*

*37 CFR 1.432. Designation of States and payment of designation and confirmation fees.*

(a) The designation of States including an indication that applicant wishes to obtain a regional patent, where applicable, shall appear in the Request upon filing and must be indicated as set forth in PCT Rule 4.9 and section 115 of the Administrative Instructions. Applicant must specify at least one national or regional designation on filing of the international application for a filing date to be granted.

(b) If the fees necessary to cover all the national and regional designations specified in the Request are not paid by the applicant within one year from the priority date or within one month from the date of receipt of the international application if that month expires after the expiration of one year from the priority date, applicant will be notified and given one month within which to pay the deficient designation fees plus a late payment fee. The late payment fee shall be equal to the greater of fifty percent of the

amount of the deficient fees up to a maximum amount equal to the basic fee, or an amount equal to the transmittal fee (PCT Rule 16<sup>bis</sup>). The one-month time limit set in the notification of deficient designation fees may not be extended. Failure to timely pay at least one designation fee will result in the withdrawal of the international application.

(1) The one designation fee must be paid:

(i) Within one year from the priority date;

(ii) Within one month from the date of receipt of the international application if that month expires after the expiration of one year from the priority date; or

(iii) With the late payment fee defined in this paragraph within the time set in the notification of the deficient designation fees or in accordance with PCT Rule 16<sup>bis</sup>.1(e).

(2) If after a notification of deficient designation fees the applicant makes timely payment, but the amount paid is not sufficient to cover the late payment fee and all designation fees, the Receiving Office will, after allocating payment for the basic, search, transmittal and late payment fees, allocate the amount paid in accordance with PCT Rule 16<sup>bis</sup>.1(c) and withdraw the unpaid designations. The notification of deficient designation fees pursuant to this paragraph may be made simultaneously with any notification pursuant to § 1.431(c).

(c) The amount payable for the designation fee set forth in paragraph (b) is:

(1) The designation fee in effect on the filing date of the international application, if such fee is paid in full within one month from the date of receipt of the international application;

(2) The designation fee in effect on the date such fee is paid in full, if such fee is paid in full later than one month from the date of receipt of the international application but within one year from the priority date;

(3) The designation fee in effect on the date one year from the priority date, if the fee was due one year from the priority date, and such fee is paid in full later than one month from the date of receipt of the international application and later than one year from the priority date; or

(4) The designation fee in effect on the international filing date, if the fee was due one month from the international filing date and after one year from the priority date, and such fee is paid in full later than one month from the date of receipt of the international application and later than one year from the priority date.

(d) On filing the international application, in addition to specifying at least one national or regional designation under PCT Rule 4.9(a), applicant may also indicate under PCT Rule 4.9(b) that all other designations permitted under the Treaty are made.

(1) Indication of other designations permitted by the Treaty under PCT Rule 4.9(b) must be made in a statement on the Request that any designation made under this paragraph is subject to confirmation (PCT Rule 4.9(c)) not later than the expiration of 15 months from the priority date by:

(i) Filing a written notice with the United States Receiving Office specifying the national and/or regional designations being confirmed;

(ii) Paying the designation fee for each designation being confirmed; and

(iii) Paying the confirmation fee specified in § 1.445(a)(4).

(2) Unconfirmed designations will be considered withdrawn. If the amount submitted is not sufficient to cover the designation fee and the confirmation fee for each designation being confirmed, the Receiving Office will allocate the amount paid in accordance with any priority of designations specified by applicant. If applicant does not specify any priority of designations, the allocation of the amount paid will be made in accordance with PCT Rule 16<sup>bis</sup>.1(c).

The designation of States is the indication, in Box No. V of the request (except in the last sub-box of that Box), of the specific regional patents, national patents, and/or other kinds of protection the applicant is seeking. Specific designations for the purpose of obtaining national and regional patents are effected by indicating each Contracting State or region concerned. On the printed form, this is accomplished by marking the appropriate check-boxes next to the names of the States or regions. For detailed instructions regarding “specific” designations, see the “Notes to the Request Form (PCT/RO/101),” available from WIPO’s website at [www.wipo.int/pct/en/index.html](http://www.wipo.int/pct/en/index.html).

All designations must be made in the international application on filing; none may be added later. However, there is a safety net designed to protect applicants who make mistakes or omissions among the specific designations, by way of making a precautionary designation of all other States which have not been specifically designated in the Request whose designation would be permitted under the Treaty.

In addition to specific designations described above, the applicant may, under PCT Rule 4.9(b), indicate in the request that all designations which would be permitted under the PCT are also made, provided that at least one specific designation is made and that the request also contains a statement relating to the confirmation of any precautionary designations so made. That statement must declare that any such designation is subject to confirmation (as provided in Rule 4.9(c)), and that any such designation which is not so confirmed before the expiration of 15 months from the priority date is to be regarded as withdrawn by the applicant at the expiration of that time limit.

Precautionary designations are effected in practice by including the necessary statement in the last sub-box of Box No. V of the request (the statement is set out in the printed request form). Since the precaution-

ary designations are designed particularly to enable applicants to correct omissions and mistakes in the original list of specific designations, it is strongly recommended that applicants make the precautionary designations indication (by leaving the pre-printed statement in the printed form, if that form is used) unless there is a particular reason for doing otherwise. The request form makes provision for the applicant to omit designations if that is desired. It should be noted that no fees are payable in respect of precautionary designations except where the applicant later decides to confirm them.

Precautionary designations will be regarded as withdrawn by the applicant unless they are confirmed, but the applicant is not obliged to confirm them. The precautionary designation procedure enables the applicant to make, in the request, all designations permitted by the PCT in addition to those made specifically. For this purpose, the request must also contain a statement that any precautionary designations so made are subject to confirmation as provided in Rule 4.9(c) and that any designation which is not so confirmed before the expiration of 15 months from the priority date is to be regarded as withdrawn by the applicant at the expiration of that time limit. Noting that the confirmation of designations is entirely at the applicant's discretion, no notification is sent to the applicant reminding him or her that the time limit for confirming precautionary designations is about to expire. Applicants are cautioned that in order for the confirmation of a designation of the U.S. to be valid, the inventor must have been named in the application papers as filed, 37 CFR 1.421(b).

#### **APPLICANT FOR PURPOSES OF EACH DESIGNATION**

Where there is but a single applicant, the right to file an international application and to designate contracting states or regions exists if the applicant is a resident or national of a contracting state. The applicant can be an individual, corporate entity or other concern. If the United States is to be designated, it is particularly important to note that the applicant must also be the inventor.

In the case where there are several applicants who are different for different designated states, the right to file an international application and to designate contracting states or regions exists if at least one of

them is a resident or national of a contracting state. If the United States is to be designated, it is important to note that the applicant must also be the inventor. If the inventor is not also the applicant, the designation of the United States is invalid.

### **1817.02 Continuation or Continuation-in-Part Indication in the Request [R-2]**

*PCT Rule 4.  
The Request (Contents)*

\*\*\*\*\*

\*\*>

#### *4.11. Reference to Earlier Search, Continuation or Continuation-in-Part, or Parent Application or Grant*

(a) If:

\*\*\*\*\*

(iv) the applicant intends to make an indication under Rule 49<sup>bis</sup>.1(d) of the wish that the international application be treated, in any designated State, as an application for a continuation or a continuation-in-part of an earlier application;

the request shall so indicate and shall, as the case may be, identify the application in respect of which the earlier search was made or otherwise identify the search, or indicate the relevant parent application or parent patent or other parent grant.

\*\*\*\*\*

The Supplemental Box of the request form should be used where the applicant has an earlier pending United States nonprovisional application or international application designating the U.S. and wishes the later filed international application to be treated as a continuation or continuation-in-part of such earlier application. To properly identify the parent application, the specific reference must identify the parent application by application number and indicate the relationship to the parent application (i.e., "continuation" or "continuation-in-part"). The specific reference must also indicate the filing date of the parent application if the parent application is an international application. See 37 CFR 1.78(a).

Identification of the parent application in the request does not relieve applicants from having to perfect the benefit claim upon entry into the U.S. national stage by including a proper claim in an application data sheet or in the first sentence of the speci-

cation (see 37 CFR 1.78(a)(2)). However, inclusion of a proper reference to the parent application in the international phase does provide certain benefits to applicants, e.g., where applicant chooses to file a continuing application claiming benefit under 35 U.S.C. 365(c) to the international application (i.e., a bypass application) rather than entering the U.S. national phase under 35 U.S.C. 371.<

**1819 Earlier International or International-Type Search [R-2]**

*PCT Rule 4.  
Request (Contents)*

\*\*\*\*\*

*>4.11.Reference to Earlier Search, Continuation or Continuation-in-Part, or Parent Application or Grant*

(a) If:

(i) an international or international-type search has been requested on an application under Article 15(5);

\*\*\*\*\*

the request shall so indicate and shall, as the case may be, identify the application in respect of which the earlier search was made or otherwise identify the search, or indicate the relevant parent application or parent patent or other parent grant.

\*\*\*\*\*

*37 CFR 1.445. International application filing, processing and search fees.*

(a) The following fees and charges for international applications are established by the Director under the authority of 35 U.S.C. 376:

\*\*\*\*\*

(2) A search fee (see 35 U.S.C. 361(d)and PCT Rule 16):

(i) If a corresponding prior United States National application filed under 35 U.S.C. 111(a) with the filing fee under § 1.16(a) has been filed and the corresponding prior United States National application is identified by application number, if known, or if the application number is not known by the filing date, title, and name of applicant(and preferably the application docket number), in the international application or accompanying papers at the time of filing the international application.....\$300.00

\*\*\*\*\*

<

Certain International Searching Authorities refund part or all of the international search fee or reduce the amount of the international search fee where the international search can be based wholly or partly on an earlier search (whether an international, international-type, or other search) made by them. The United States provides for a reduced search fee where there is a corresponding prior U.S. \* nonprovisional application >and such application is adequately identified in the international application or accompanying papers at the time of filing the international application. Applicants must identify the prior nonprovisional application by the U.S. application number or, if such number is not yet known, by filing date, title, and name of applicant (and preferably the application docket number). See 37 CFR 1.445(a)(2)(i)<.

Where the earlier search by the International Searching Authority was made in relation to a national, regional (for instance, European) or international application, that application must be identified in >the request. Applicants should identify the application in< Box No. VII of the request by an indication of the country of filing (or the European Patent Office), and the number and filing date of that application. \*\* Where the earlier search was made independently of a patent granting procedure (for instance, a standard search by the European Patent Office), a reference must be made to the date of the request for that search and the number given to the request by the International Searching Authority.

The United States Patent and Trademark Office performs an international-type search on all U.S. national applications filed on and after 1 June 1978. No specific request by the applicant is required and no number identifying the international-type search is assigned by the Office. \*\*>See 37 CFR 1.104(a)(3).<

**1820 Signature of Applicant [R-2]**

>

*PCT Article 14.  
Certain Defects in the International Application*

(1)(a)The receiving Office shall check whether the international application contains any of the following defects, that is to say

(i) it is not signed as provided in the Regulations;

\*\*\*\*\*

<



*PCT Rule 4.  
The Request (Contents)*

\*\*\*\*\*

*4.15. Signature*

(a) Subject to paragraph (b), the request shall be signed by the applicant or, if there is more than one applicant, by all of them.

(b) Where two or more applicants file an international application which designates a State whose national law requires that national applications be filed by the inventor and where an applicant for that designated State who is an inventor refused to sign the request or could not be found or reached after diligent effort, the request need not be signed by that applicant if it is signed by at least one applicant and a statement is furnished explaining, to the satisfaction of the receiving Office, the lack of the signature concerned.

\*\*\*\*\*

>

*PCT Rule 26.*

*Checking by, and Correcting Before, the Receiving Office  
of Certain Elements of the International Application*

\*\*\*\*\*

*26.2<sup>bis</sup>. Checking of Requirements Under Article 14(1)(a)(i)  
and (ii)*

(a) For the purposes of Article 14(1)(a)(i), if there is more than one applicant, it shall be sufficient that the request be signed by one of them.

(b) For the purposes of Article 14(1)(a)(ii), if there is more than one applicant, it shall be sufficient that the indications required under Rule 4.5(a)(ii) and (iii) be provided in respect of one of them who is entitled according to Rule 19.1 to file the international application with the receiving Office.<

**SIGNATURE OF APPLICANT OR AGENT**

\*>Pursuant to PCT Rule 4.15, the< international application must be signed in Box No. IX of the request by the applicant, or, where there are two or more applicants, by all of them. \*\*>However, under new PCT Rule 26.2<sup>bis</sup>, which is applicable to international applications having an international filing date on or after January 1, 2004, it is sufficient for purposes of PCT Article 14(1)(a)(i) that the application is signed by only one of the applicants. Thus, for international applications having an international filing date on or after January 1, 2004, the United States Receiving Office will not issue an invitation to applicants to furnish missing signatures where the request

is signed by at least one of the applicants. Notwithstanding PCT Rule 26.2<sup>bis</sup>, any designated/elected office, in accordance with its national law, can still require confirmation of the international application by the signature of any applicant for such state who has not signed the request. PCT Rule 51<sup>bis</sup>(a)(vi).< Pursuant to 37 CFR 1.4(d), the request filed may be either an original, or a copy thereof. \*\*

The international application may be signed by an agent\*\*>.

For international applications having an international filing date on or after January 1, 2004, the requirement for the submission of a separate power of attorney may be waived by the receiving Office. The United States Receiving Office will, in most cases, waive the requirement for a separate power of attorney. See MPEP § 1807.

If the international application has an international filing date before January 1, 2004, then< the agent must be appointed as such by the applicant in a separate power of attorney signed by the applicant. If there are two or more applicants, the request may be signed by an agent on behalf of all or only some of them; in that case the agent must be appointed as such in one or more powers of attorney signed by the applicants on whose behalf the agent signs the application. Where a power of attorney appointing an agent who signs an international application >having an international filing date prior to January 1, 2004< is missing, the signature is treated as missing until the power of attorney is submitted.

The signature should be executed in black indelible ink. The name of each person signing the international application should be indicated (preferably typewritten) next to the signature. Where a person signs on behalf of a legal entity (an organization such as a corporation, university, nonprofit organization, or governmental agency), his or her name and the capacity in which he or she signs should be indicated. Proof of the person's authority to sign on behalf of the legal entity will be required if that person does not possess apparent authority to sign on behalf of the legal entity >and that person has not submitted a statement that he or she is authorized to sign on behalf of the legal entity (discussed below)<. An officer (President, Vice-President, Secretary, Treasurer, Chief Executive Officer, Chief Operating Officer or Chief Financial Officer) of an organization is presumed to have

authority to sign on behalf of that organization. The signature of the chairman of the board is also acceptable, but not the signature of an individual director. Variations of these titles (such as vice-president for sales, executive vice-president, assistant treasurer, vice-chairman of the board of directors) are acceptable. \*>In general, a< person having a title (manager, director, administrator, general counsel) that does not clearly set forth that person as an officer of the organization is not presumed to be an officer or to have the authority to sign on behalf of the organization. >However, an exception is made with respect to foreign juristic applicants. This is because in foreign countries, a person who holds the title “Manager” or “Director” is normally an officer or the equivalent thereof; therefore, those terms are generally acceptable as indicating proper persons to sign applications for foreign applicants. However, titles such as “Manager of Patents,” suggesting narrowly limited duties, are not acceptable.< An attorney does not generally have apparent authority to sign on behalf of an organization.

Proof that a person has the authority to sign on behalf of a legal entity may take the form of a copy of a resolution of the board of directors, a provision of the bylaws, or a copy of a paper properly delegating authority to that person to sign the international application on behalf of the legal entity.

It is \* acceptable to have a person sign the international application on behalf of a legal entity if that person submits a statement that the person has the authority to sign the international application on behalf of the legal entity. This statement should be on a separate paper and must not appear on the Request (or Demand) form itself. The statement must include a clause such as “The undersigned (whose title is supplied below) is empowered to sign the Request on behalf of the applicant.”

\*\*>The international application can be filed without applicant’s signature on the request. The lack of any required signature on the request< is a correctable defect under PCT Article 14(1)(a)(i) and (b), and can be remedied by filing a copy of the request (or, where the request has been signed by an agent, of a power of attorney) duly signed by the applicant within the time limit fixed by the receiving Office for the correction of this defect.

## **APPLICANT INVENTOR UNAVAILABLE OR UNWILLING TO SIGN THE INTERNATIONAL APPLICATION \*\***

\*\* PCT Rule 4.15(b) >provides< that, where an applicant inventor for the designation of \*\*>of a State whose national law requires that national applications be filed by the inventor (the United States of America is the only Contracting State to have such a requirement in its national law)< refused to sign the request or could not be found or reached after diligent effort, the request need not be signed by that applicant inventor if it is signed by at least one applicant and a statement is furnished explaining, to the satisfaction of the receiving Office, the lack of the signature concerned. \*\*>The significance of PCT Rule 4.15(b) has been greatly diminished with respect to international applications having an international filing date on or after January 1, 2004, in light of new PCT Rule 26.2<sup>bis</sup>(a), which provides that where there is more than one applicant, the signature requirements for purposes of PCT Article 14(1)(a)(i) will be considered to have been satisfied if the request is signed by one of the applicants.

For international applications having an international filing date prior to January 1, 2004, if the requisite statement under PCT Rule 4.15(b)< is furnished to the satisfaction of the receiving Office, the international application complies with the requirements of PCT Article 14(1)(a)(i) for the purposes of all designated States (including the United States of America) without adverse consequences in the international phase. However, additional proofs may be required by the United States Patent and Trademark Office after entry into the national phase if the required oath or declaration by the inventor is not signed by all the applicant inventors.

\*\*

## **\* INVENTOR DECEASED**

*37 CFR 1.422. When the inventor is dead.*

In case of the death of the inventor, the legal representative (executor, administrator, etc.) of the deceased inventor may file an international application which designates the United States of America.

\*\*>A legal representative of a deceased inventor may be indicated in the international application as an applicant for the purposes of the United States. In such case, the indication in the request (in Box II or

III, as appropriate) for the legal representative should be made as follows: SMITH, Alfred, legal representative of JONES, Bernard (deceased), followed by indications of the address, nationality and residence of the legal representative. The legal representative should be indicated as an “applicant only” except where the legal representative is also an inventor, in which case the legal representative should be indicated as an “applicant and inventor.” The name of the deceased inventor should also appear in a separate box (in Box III) with the indication of “deceased” (e.g., “JONES, Bernard (deceased)”) and identified as an “inventor only” and not as an applicant.<

## 1821 The Request [R-2]

A general overview of certain aspects of the request follows.

37 CFR 1.434. *The request.*

\*\*>

(a) The request shall be made on a standardized form (PCT Rules 3 and 4). Copies of printed Request forms are available from the United States Patent and Trademark Office. Letters requesting printed forms should be marked “Mail Stop PCT.”<

(b) The Check List portion of the Request form should indicate each document accompanying the international application on filing.

(c) All information, for example, addresses, names of States and dates, shall be indicated in the Request as required by PCT Rule 4 and Administrative Instructions 110 and 201.

\*\*>

(d) For the purposes of the designation of the United States of America, an international application shall include:

(1) The name of the inventor; and;

(2) A reference to any prior-filed national application or international application designating the United States of America, if the benefit of the filing date for the prior-filed application is to be claimed.

(e) An international application may also include in the Request a declaration of the inventors as provided for in PCT Rule 4.17(iv).<

The request must either be made on a printed form to be filled in with the required indications or be presented as a computer printout complying with the Administrative Instructions. Any prospective applicant may obtain copies of the printed request form, free of charge, from the receiving Office with which he/she plans to file his/her international application\*\*. >Applicants may obtain an English language request form from the United States Patent and Trademark Office using the following address: Mail Stop PCT,

Commissioner for Patents, P.O. Box 1450, Alexandria, Virginia 22313-1450. Forms may also be obtained from the World Intellectual Property Organization (WIPO) web site ([www.wipo.int/pct/en/forms/index.htm](http://www.wipo.int/pct/en/forms/index.htm)).< Details of the requirements for the request if presented as a computer printout are set out in Administrative Instructions Section 102<sup>bis</sup>.

As provided in Administrative Instructions Section 102<sup>bis</sup>(c), reduced fees are payable in respect of an international application containing the request in PCT-EASY format filed, together with a PCT-EASY diskette, with a receiving Office which, under paragraph (a), accepts the filing of such international applications. \*\*>To prepare a request in PCT-EASY format and the PCT-EASY diskette, applicants must use PCT-SAFE software, which is available for downloading at WIPO’s web site ([www.wipo.int/pct-safe](http://www.wipo.int/pct-safe)). For technical support and assistance with the software, the web site also provides contact information for the PCT-SAFE Help Desk.<

The request contains a petition for the international application to be processed according to the PCT and must also contain certain indications. It must contain the title of the invention. It must identify the applicant \*\* and the agent (if any), and must contain the designation of at least one Contracting State. \*\*>For international applications having an international filing date on or after January 1, 2004, the filing of an international application request constitutes the designation of all Contracting States that are bound by the PCT on the international filing date. See MPEP § 1817.01. The request must contain an indication of any wish of the applicants to obtain a European patent rather than, or in addition to, a national patent in respect of a designated State.

The request may not contain any matter that is not specified in PCT Rules 4.1 to 4.17 or permitted under PCT Rule 4.18(a) by the Administrative Instructions. Any additional material will be deleted *ex officio*. See PCT Rule 4.18(b) and Administrative Instructions Section 303.<

## DATES

Each date appearing in the international application or in any correspondence must be indicated by the Arabic number of the day, the name of the month and the Arabic number of the year, in that order. In the request, after, below or above that indication, the date

should be repeated in parentheses with a two-digit Arabic numeral each for the number of the day \*\*>and for the number of the month and followed by the number of the year in four digits, in that order and separated by periods, slashes or hyphens after the digit pairs of the day and of the month, for example, “20 March 2004 (20.03.2004),” “20 March 2004 (20/03/2004),” or “20 March 2004 (20-03-2004).” See Administrative Instructions Section 110.<

### **SUPPLEMENTAL BOX**

This box is used for any material which cannot be placed in one of the previous boxes because of space limitations. The supplemental information placed in this box should be clearly entitled with the Box number from which it is continued, e.g., “Continuation of Box No. IV.”

### **FILE REFERENCE**

The applicant or his/her agent may indicate a file reference in the box provided for \*>this< purpose on the first sheet of the request form, on each page of the other elements of the international application, on the first sheet of the demand form, and in any other correspondence relating to the international application. PCT Rule 11.6(f) indicates that the file reference may be included in the top margin of the sheets of the international application. As provided in Administrative Instructions Section 109, the file reference may be composed either of letters of the Latin alphabet or Arabic numerals, or both. It may not exceed 12 characters >including spaces. If the file reference exceeds 12 characters, the receiving Office may *ex officio* truncate the reference number to 12 characters and notify the applicant<. The receiving Office, the International Bureau, the International Searching Authority and the International Preliminary Examining Authority (International Authorities) will use the file reference in correspondence with the applicant. \*\*

### **TITLE OF INVENTION**

The Request must contain the title of the invention; the title must be short (preferably 2 to 7 words) and precise (PCT Rule 4.3). The title in Box No. I of the Request is considered to be the title of the application. The title appearing on the first page of the description (PCT Rule 5.1(a)) and on the page containing the

abstract should be consistent with the title indicated in Box No. I of the Request form.

A title should not be changed by the examiner merely because it contains words which are not considered descriptive of the invention. Words, for example, such as “improved” or “improvement of” are acceptable. If the title is otherwise not descriptive of the invention, a change to a more descriptive title should be made and the applicant informed thereof in the search report.

Where the title is missing or is inconsistent with the title in the description, the receiving Office invites the applicant to correct the missing or inconsistent title.

### **APPLICANT**

Any resident or national of a Contracting State may file an international application. Where there are two or more applicants, at least one of them must be a national or a resident of a PCT Contracting State.

The question whether an applicant is a resident or national of a Contracting State depends on the national law of that State and is decided by the receiving Office. Also, possession of a real and effective industrial or commercial establishment in a Contracting State may be considered residence in that State, and a legal entity constituted according to the national law of a Contracting State is considered a national of that State.

The applicant must be identified by the indication of his/her name and address and by marking next to that indication, the check-box “This person is also inventor” in Box No. II, or “applicant and inventor” in Box No. III, where the applicant is also the inventor or one of the inventors, or the check-box “applicant only” where the applicant is not the inventor or one of the inventors. Where the applicant is a corporation or other legal entity (that is, not a natural person), the check-box “applicant only” must be marked. The applicant’s nationality and residence must also be indicated.

### **NAMES**

The names of a natural person must be indicated by the family name followed by the given name(s). Academic degrees or titles or other indications which are not part of the person’s name must be omitted. The family name should preferably be written in capital letters.

The name of a legal entity must be indicated by its full official designation (preferably in capital letters).

## ADDRESSES

Addresses must be indicated in such a way as to satisfy the requirements for prompt postal delivery at the address indicated and must consist of all the relevant administrative units up to and including the house number (if any). The address must also include the country.

### 1823 The Description [R-2]

*PCT Article 5.  
The Description*

The description shall disclose the invention in a manner sufficiently clear and complete for the invention to be carried out by a person skilled in the art.

*PCT Rule 5.  
The Description*

#### 5.1. Manner of the Description

(a) The description shall first state the title of the invention as appearing in the request and shall:

(i) specify the technical field to which the invention relates;

(ii) indicate the background art which, as far as known to the applicant, can be regarded as useful for the understanding, searching and examination of the invention, and, preferably, cite the documents reflecting such art;

(iii) disclose the invention, as claimed, in such terms that the technical problem (even if not expressly stated as such) and its solution can be understood, and state the advantageous effects, if any, of the invention with reference to the background art;

(iv) briefly describe the figures in the drawings, if any;

(v) set forth at least the best mode contemplated by the applicant for carrying out the invention claimed; this shall be done in terms of examples, where appropriate, and with reference to the drawings, if any; where the national law of the designated State does not require the description of the best mode but is satisfied with the description of any mode (whether it is the best contemplated or not), failure to describe the best mode contemplated shall have no effect in that State;

\*\*>

(vi) indicate explicitly, when it is not obvious from the description or nature of the invention, the way in which the invention is capable of exploitation in industry and the way in which it can be made and used, or, if it can only be used, the way in which it can be used; the term "industry" is to be understood in its broadest sense as in the Paris Convention for the Protection of Industrial Property.<

(b) The manner and order specified in paragraph (a) shall be followed except when, because of the nature of the invention, a different manner or a different order would result in a better understanding and a more economic presentation.

(c) Subject to the provisions of paragraph (b), each of the parts referred to in paragraph (a) shall preferably be preceded by an appropriate heading as suggested in the Administrative Instructions.

*PCT Administrative Instruction Section 204.  
Headings of the Parts of the Description*

The headings of the parts of the description should be as follows:

(i) for matter referred to in Rule 5.1(a)(i), "Technical Field";  
(ii) for matter referred to in Rule 5.1(a)(ii), "Background Art";

(iii) for matter referred to in Rule 5.1(a)(iii), "Disclosure of Invention";

(iv) for matter referred to in Rule 5.1(a)(iv), "Brief Description of Drawings";

(v) for matter referred to in Rule 5.1(a)(v), "Best Mode for Carrying Out the Invention," or, where appropriate, "Mode(s) for Carrying Out the Invention";

(vi) for matter referred to in Rule 5.1(a)(vi), "Industrial Applicability";

(vii) for matter referred to in Rule 5.2(a), "Sequence Listing";

(viii) for matter referred to in Rule 5.2(b), "Sequence Listing Free Text."

*PCT Administrative Instruction Section 209.  
Indications as to Deposited Biological Material on a Separate Sheet*

(a) To the extent that any indication with respect to deposited biological material is not contained in the description, it may be given on a separate sheet. Where any such indication is so given, it shall preferably be on Form PCT/RO/134 and, if furnished at the time of filing, the said Form shall, subject to paragraph (b), preferably be attached to the request and referred to in the check list referred to in Rule 3.3 (a)(ii).

\*\*>

(b) For the purposes of the Israel Patent Office, the Japan Patent Office, the Korean Intellectual Property Office, the Mexican Institute of Industrial Property, and the Turkish Patent Institute as designated Offices, paragraph (a) applies only to the extent that the said Form or sheet is included as one of the sheets of the description of the international application at the time of filing.<

#### 37 CFR 1.435. The description.

(a) The application must meet the requirements as to the content and form of the description set forth in PCT Rules 5, 9, 10, and 11 and sections 204 and 208 of the Administrative Instructions.

(b) In international applications designating the United States the description must contain upon filing an indication of the best mode contemplated by the inventor for carrying out the claimed invention.

The description must disclose the invention in a manner sufficiently clear and complete for it to be carried out by a person skilled in the art. It must start with the title of the invention as appearing in Box No. I of the request. PCT Rule 5 contains detailed requirements as to the manner and order of the description, which, generally, should be in six parts. Those parts should have the following headings: “Technical Field,” “Background Art,” “Disclosure of Invention,” “Brief Description of Drawings,” “Best Mode for Carrying Out the Invention” or, where appropriate, “Mode(s) for Carrying Out the Invention,” “Industrial Applicability,” “Sequence Listing,” and “Sequence Listing Free Text,” where applicable.

The details required for the disclosure of the invention so that it can be carried out by a person skilled in the art depend on the practice of the national Offices. It is therefore recommended that due account be taken of national practice in the United States of America when the description is drafted.

The need to amend the description during the national phase may thus be avoided.

This applies likewise to the need to indicate the “best mode for carrying out the invention.” If at least one of the designated Offices requires the indication of the best mode (for instance, the United States Patent and Trademark Office), that best mode must be indicated in the description.

A description drafted with due regard to what is said in these provisions will be accepted by all the designated Offices. It might require more care than the drafting of a national patent application, but certainly much less effort than the drafting of multiple applications, which is necessary where the PCT route is not used for filing in several countries.

## 1823.01 Reference to Deposited Biological Material [R-2]

### *PCT Rule 13<sup>bis</sup>.*

#### *Inventions Relating to Biological Material*

##### *13<sup>bis</sup>.1. Definition*

For the purposes of this Rule, “reference to deposited biological material” means particulars given in an international application with respect to the deposit of a biological material with a depositary institution or to the biological material so deposited.

##### *13<sup>bis</sup>.2. References (General)*

Any reference to deposited biological material shall be made in accordance with this Rule and, if so made, shall be considered as satisfying the requirements of the national law of each designated State.

##### *13<sup>bis</sup>.3. References: Contents; Failure to Include Reference or Indication*

(a) A reference to deposited biological material shall indicate:

(i) the name and address of the depositary institution with which the deposit was made;

(ii) the date of deposit of the biological material with that institution;

(iii) the accession number given to the deposit by that institution; and

(iv) any additional matter of which the International Bureau has been notified pursuant to Rule 13<sup>bis</sup>.7(a)(i), provided that the requirement to indicate that matter was published in the Gazette in accordance with Rule 13<sup>bis</sup>.7(c) at least two months before the filing of the international application.

(b) Failure to include a reference to deposited biological material or failure to include, in a reference to deposited biological material, an indication in accordance with paragraph (a), shall have no consequence in any designated State whose national law does not require such reference or such indication in a national application.

##### *13<sup>bis</sup>.4. References: Time Limit for Furnishing Indications*

(a) Subject to paragraphs (b) and (c), if any of the indications referred to in Rule 13<sup>bis</sup>.3(a) is not included in a reference to deposited biological material in the international application as filed but is furnished to the International Bureau:

(i) within 16 months from the priority date, the indication shall be considered by any designated Office to have been furnished in time;

(ii) after the expiration of 16 months from the priority date, the indication shall be considered by any designated Office to have been furnished on the last day of that time limit if it reaches the International Bureau before the technical preparations for international publication have been completed.

(b) If the national law applicable by a designated Office so requires in respect of national applications, that Office may require that any of the indications referred to in Rule 13<sup>bis</sup>.3(a) be furnished earlier than 16 months from the priority date, provided that the International Bureau has been notified of such requirement pursuant to Rule 13<sup>bis</sup>.7(a)(ii) and has published such requirement in the Gazette in accordance with Rule 13<sup>bis</sup>.7(c) at least two months before the filing of the international application.

(c) Where the applicant makes a request for early publication under Article 21(2)(b), any designated Office may consider any indication not furnished before the technical preparations for international publication have been completed as not having been furnished in time.

(d) The International Bureau shall notify the applicant of the date on which it received any indication furnished under paragraph (a), and

(i) if the indication was received before the technical preparations for international publication have been completed, indicate that date, and include the relevant data from the indication, in the pamphlet published under Rule 48;

(ii) if the indication was received after the technical preparations for international publication have been completed, notify that date and the relevant data from the indication to the designated Offices.

*13<sup>bis</sup>.5. References and Indications for the Purposes of One or More Designated States; Different Deposits for Different Designated States; Deposits with Depositary Institutions Other Than Those Notified*

(a) A reference to deposited biological material shall be considered to be made for the purposes of all designated States, unless it is expressly made for the purposes of certain of the designated States only; the same applies to the indications included in the reference.

(b) References to different deposits of the biological material may be made for different designated States.

(c) Any designated Office may disregard a deposit made with a depositary institution other than one notified by it under Rule 13<sup>bis</sup>.7(b).

*13<sup>bis</sup>.6. Furnishing of Samples*

Pursuant to Articles 23 and 40, no furnishing of samples of the deposited biological material to which a reference is made in an international application shall, except with the authorization of the applicant, take place before the expiration of the applicable time limits after which national processing may start under the said Articles. However, where the applicant performs the acts referred to in Articles 22 or 39 after international publication but before the expiration of the said time limits, the furnishing of samples of the deposited biological material may take place, once the said acts have been performed. Notwithstanding the previous provision, the furnishing of samples of the deposited biological material may take place under the national law applicable by any designated Office as soon as, under that law, the international publication has the effects of the compulsory national publication of an unexamined national application.

*13<sup>bis</sup>.7. National Requirements: Notification and Publication*

(a) Any national Office may notify the International Bureau of any requirement of the national law:

(i) that any matter specified in the notification, in addition to those referred to in Rule 13<sup>bis</sup>.3(a)(i), (ii) and (iii), is required to be included in a reference to deposited biological material in a national application;

(ii) that one or more of the indications referred to in Rule 13<sup>bis</sup>.3(a) are required to be included in a national application as

filed or are required to be furnished at a time specified in the notification which is earlier than 16 months after the priority date.

(b) Each national Office shall notify the International Bureau of the depositary institutions with which the national law permits deposits of biological materials to be made for the purposes of patent procedure before that Office or, if the national law does not provide for or permit such deposits, of that fact.

(c) The International Bureau shall promptly publish in the Gazette requirements notified to it under paragraph (a) and information notified to it under paragraph (b).

*PCT Administrative Instruction Section 209.  
Indications as to Deposited Biological Material on a Separate Sheet*

(a) To the extent that any indication with respect to deposited biological material is not contained in the description, it may be given on a separate sheet. Where any such indication is so given, it shall preferably be on Form PCT/RO/134 and, if furnished at the time of filing, the said Form shall, subject to paragraph (b), preferably be attached to the request and referred to in the check list referred to in Rule 3.3 (a)(ii).

\*\*>

(b) For the purposes of the Israel Patent Office, the Japan Patent Office, the Korean Intellectual Property Office, the Mexican Institute of Industrial Property, and the Turkish Patent Institute as designated Offices, paragraph (a) applies only to the extent that the said Form or sheet is included as one of the sheets of the description of the international application at the time of filing.<

**REFERENCES TO DEPOSITED BIOLOGICAL MATERIAL IN THE CASE OF MICROBIOLOGICAL INVENTIONS**

The PCT does not require the inclusion of a reference to a biological material and/or to its deposit with a depositary institution in an international application; it merely prescribes the contents of any “reference to deposited biological material” (defined as “particulars given... with respect to the deposit of biological material... or to the biological material so deposited”) which is included in an international application, and when such a reference must be furnished. It follows that the applicant may see a need to make such a reference only when it is required for the purpose of disclosing the invention claimed in the international application in a manner sufficient for the invention to be carried out by a person skilled in the art that is, when the law of at least one of the designated States provides for the making, for this purpose, of a reference to a deposited biological material if the invention involves the use of a biological material that is not available to the public. Any reference to a deposited biological material furnished separately from the

description will be included in the pamphlet containing the published international application.

A reference to a deposited biological material made in accordance with the requirements of the PCT must be regarded by each of the designated Offices as satisfying the requirements of the national law applicable in that Office with regard to the contents of such references and the time for furnishing them.

A reference may be made for the purposes of all designated States or for one or only some of the designated States. A reference is considered to be made for the purpose of all designated States unless it is expressly made for certain designated States only. References to different deposits may be made for the purposes of different designated States.

There are two kinds of indication which may have to be given with regard to the deposit of the biological material, namely:

(A) indications specified in the PCT Regulations themselves; and

(B) additional indications by the national (or regional) Office of (or acting for) a State designated in the international application and which have been published in the *PCT Gazette*; these additional indications may relate not only to the deposit of the biological material but also to the biological material itself.

The indications in the first category are:

- (1) the name and address of the depository institution with which the deposit was made;
- (2) the date of the deposit with that institution; and
- (3) the accession number given to the deposit by that institution.

U.S. requirements include the name and address of the depository institution at the time of filing, the date of the deposit or a statement that the deposit was made on or before the priority date of the international application and, to the extent possible, a taxonomic description of the biological material. See Annex L of the PCT Applicant's Guide.

The national laws of some of the national (or regional) Offices require that, besides indications concerning the deposit of a biological material, an indication be given concerning the biological material itself, such as, for example, a short description of its characteristics, at least to the extent that this information is available to the applicant. These requirements must be met in the case of international applications for which

any such Office is a designated Office, provided that the requirements have been published in the *PCT Gazette*. Annex L of the PCT Applicant's Guide indicates, for each of the national (or regional) Offices, the requirements (if any) of this kind which have been published.

If any indication is not included in a reference to a deposited biological material contained in the international application as filed, it may be furnished to the International Bureau within 16 months after the priority date unless the International Bureau has been notified (and, at least 2 months prior to the filing of the international application, it has published in the *PCT Gazette*) that the national law requires the indication to be furnished earlier. However, if the applicant makes a request for early publication, all indications should be furnished by the time the request is made, since any designated Office may regard any indication not furnished when the request is made as not having been furnished in time.

No check is made in the international phase to determine whether a reference has been furnished within the prescribed time limit. However, the International Bureau notifies the designated Offices of the date(s) on which indications, not included in the international application as filed, were furnished to it. Those dates are also mentioned in the pamphlet containing the published international application. Failure to include a reference to a deposited biological material (or any indication required in such a reference) in the international application as filed, or failure to furnish it (or the indication) within the prescribed time limit, has no consequence if the national law does not require the reference (or indication) to be furnished in a national application. Where there is a consequence, it is the same as that which applies under the national law.

To the extent that indications relating to the deposit of a biological material are not given in the description, because they are furnished later, they may be given in the "optional sheet" provided for that purpose. If the sheet is submitted when the international application is filed, a reference to it should be made in the check list contained on the last sheet of the request form. Should >Israel,< Japan>, Korea, Mexico, or Turkey< be designated, such a sheet must, if used, be included as one of the sheets of the description at the time of filing; otherwise the indications given in it



will not be taken into account by the respective patent offices of those designated States in the national phase. If the sheet is furnished to the International Bureau later, it must be enclosed with a letter.

Each national (or regional) Office whose national law provides for deposits of biological material for the purposes of patent procedure notifies the International Bureau of the depositary institutions with which the national law permits such deposits to be made. Information on the institutions notified by each of those Offices is published by the International Bureau in the *PCT Gazette*.

A reference to a deposit cannot be disregarded by a designated Office for reasons pertaining to the institution with which the biological material was deposited if the deposit referred to is one made with a depositary institution notified by that Office. Thus, by consulting the *PCT Gazette* or Annex L of the PCT Applicant's Guide, the applicant can be sure that he has deposited the biological material with an institution which will be accepted by the designated Office.

International Searching Authorities and International Preliminary Examining Authorities are not expected to request access to deposited biological material. However, in order to retain the possibility of access to a deposited biological material referred to in an international application which is being searched or examined by such an Authority, the PCT provides that the Authorities may, if they fulfill certain conditions, ask for samples. Thus, an Authority may only ask for samples if it has notified the International Bureau (in a general notification) that it may require samples and the International Bureau has published the notification in the *PCT Gazette*. The only Authority which has made such a notification (and thus the only Authority which may request samples) is the Japan Patent Office. If a sample is asked for, the request is directed to the applicant, who then becomes responsible for making the necessary arrangements for the sample to be provided.

The furnishing of samples of a deposit of a biological material to third persons is governed by the national laws applicable in the designated Offices. PCT Rule 13<sup>bis</sup>.6(b), however, provides for the delay-

ing of any furnishing of samples under the national law applicable in each of the designated (or elected) Offices until the start of the national phase, subject to the ending of this "delaying effect" brought about by the occurrence of either of the following two events:

(A) the applicant has, after international publication of the international application, taken the steps necessary to enter the national phase before the designated Office.

(B) international publication of the international application has been effected, and that publication has the same effects, under the national law applicable in the designated Office, as the compulsory national publication of an unexamined national application (in other words, the international application has qualified for the grant of "provisional protection").

## 1823.02 Nucleotide and/or Amino Acid Sequence Listings, and Tables Related to Sequence Listings [R-2]

*PCT Rule 5.*

*The Description*

\*\*\*\*\*

### 5.2. Nucleotide and/or Amino Acid Sequence Disclosure

(a) Where the international application contains disclosure of one or more nucleotide and/or amino acid sequences, the description shall contain a sequence listing complying with the standard prescribed by the Administrative Instructions and presented as a separate part of the description in accordance with that standard.

(b) Where the sequence listing part of the description contains any free text as defined in the standard provided for in the Administrative Instructions, that free text shall also appear in the main part of the description in the language thereof.

*PCT Rule 13<sup>ter</sup>.*

*Nucleotide and/or Amino Acid Sequence Listings*

### 13<sup>ter</sup>.1. Sequence Listing for International Authorities

(a) Where the International Searching Authority finds that the international application contains disclosure of one or more nucleotide and/or amino acid sequences but:

(i) the international application does not contain a sequence listing complying with the standard provided for in the Administrative Instructions, that Authority may invite the applicant to furnish to it, within a time limit fixed in the invitation, a sequence listing complying with that standard;

(ii) the applicant has not already furnished a sequence listing in computer readable form complying with the standard provided for in the Administrative Instructions, that Authority may invite the applicant to furnish to it, within a time limit fixed in the invitation, a sequence listing in such a form complying with that standard.

(b) *[Deleted]*

(c) If the applicant does not comply with an invitation under paragraph (a) within the time limit fixed in the invitation, the International Searching Authority shall not be required to search the international application to the extent that such noncompliance has the result that a meaningful search cannot be carried out.

(d) Where the International Searching Authority finds that the description does not comply with Rule 5.2(b), it shall invite the applicant to file the required correction. Rule 26.4 shall apply *mutatis mutandis* to any correction offered by the applicant. The International Searching Authority shall transmit the correction to the receiving Office and to the International Bureau.

(e) Paragraphs (a) and (c) shall apply *mutatis mutandis* to the procedure before the International Preliminary Examining Authority.

(f) Any sequence listing not contained in the international application as filed shall not, subject to Article 34, form part of the international application.

### *13<sup>ter</sup>.2.Sequence Listing for Designated Office*

Once the processing of the international application has started before a designated Office, Rule 13<sup>ter</sup>.1(a) shall apply *mutatis mutandis* to the procedure before that Office. No designated Office shall require the applicant to furnish to it a sequence listing other than a sequence listing complying with the standard provided for in the Administrative Instructions.

#### *PCT Administrative Instruction Section 208.*

##### *Sequence Listings*

Any nucleotide and/or amino acid sequence listing ("sequence listing") filed as part of the international application, or furnished together with the international application or subsequently (whether in printed form or computer readable form), shall comply with Annex C.

## **I. REQUIREMENTS FOR SEQUENCE LISTINGS**

Where an international application discloses one or more nucleotide and/or amino acid sequences, the description must contain a sequence listing complying with the standard specified in the Administrative

Instructions. The standard is set forth in detail in Annex C - Standard for the Presentation of Nucleotide and Amino Acid Sequence Listings in International Patent Applications Under the PCT. The standard allows the applicant to draw up a single sequence listing which is acceptable to all receiving Offices, International Searching and Preliminary Examining Authorities for the purposes of the international phase, and to all designated and elected Offices for the purposes of the national phase. The International Searching Authority and the International Preliminary Examining Authority may, in some cases, invite the applicant to furnish a listing complying with that standard. The applicant may also be invited to furnish a listing in a computer readable form provided for in the PCT Administrative Instructions. It is advisable for the applicant to submit a listing of the sequence in computer readable form, if such a listing is required by the competent International Searching Authority or International Preliminary Examining Authority, together with the international application rather than to wait for an invitation by the International Searching Authority or International Preliminary Examining Authority.

The computer readable form is not mandatory in international applications to be searched by the United States International Searching Authority or examined by the United States International Preliminary Examining Authority. However, if a computer readable form of a sequence listing is not provided, a search or examination will be performed only to the extent possible in the absence of the computer readable form. The U.S. sequence rules (37 CFR 1.821 - 1.825) and the PCT sequence requirements are substantively consistent. In this regard, full compliance with the requirements of the U.S. rules will ensure compliance with the applicable PCT requirements. For a detailed discussion of the U.S. sequence rules, see MPEP § 2420 - § 2421.04. Note that the European Patent Office (EPO) is not a competent International Searching Authority (ISA) or International Preliminary Examining Authority (IPEA) for many international applications directed to the field of biotechnology and filed by residents or nationals of the United States. See MPEP §§ 1840.01 and 1865.01.

## II. QUALIFYING FOR POTENTIALLY REDUCED BASIC FEE BY FILING SEQUENCE LISTING AND/OR TABLES ON COMPACT DISC RATHER THAN ON PAPER

*PCT Administrative Instruction Section 801.*

*Filing of International Applications Containing Sequence Listings and/or Tables*

(a) Pursuant to Rules 89<sup>bis</sup> and 89<sup>ter</sup>, where an international application contains disclosure of one or more nucleotide and/or amino acid sequence listings ("sequence listings"), the receiving Office may, if it is prepared to do so, accept that the sequence listing part of the description, as referred to in Rule 5.2(a) and/or any table related to the sequence listing(s) ("sequence listings and/or tables"), be filed, at the option of the applicant:

(i) only on an electronic medium in the computer readable form referred to in Section 802; or

(ii) both on an electronic medium in that computer readable form and on paper in the written form referred to in Section 802;

provided that the other elements of the international application are filed as otherwise provided for under the Regulations and these Instructions.

(b) Any receiving Office which is prepared to accept the filing in computer readable form of the sequence listings and/or tables under paragraph (a) shall notify the International Bureau accordingly. The notification shall specify the electronic media on which the receiving Office will accept such filings. The International Bureau shall promptly publish any such information in the Gazette.

(c) A receiving Office which has not made a notification under paragraph (b) may nevertheless decide in a particular case to accept an international application the sequence listings and/or tables of which are filed with it under paragraph (a).

(d) Where the sequence listings and/or tables are filed in computer readable form under paragraph (a) but not on an electronic medium specified by the receiving Office under paragraph (b), that Office shall, under Article 14(1)(a)(v), invite the applicant to furnish to it replacement sequence listings and/or tables on an electronic medium specified under paragraph (b).

(e) Where an international application containing sequence listings and/or tables in computer readable form is filed under paragraph (a) with a receiving Office which is not prepared, under paragraph (b) or (c), to accept such filings, Section 333(b) and (c) shall apply.

Part 8 of the Administrative Instructions became effective January 11, 2001. Under Administrative Instructions Section 801(a), applicants may file the nucleotide and/or amino acid sequence listing part of the description of an international application on an electronic medium in computer readable form with certain receiving Offices. As of September 6, 2002,

Part 8 of the Administrative Instructions was expanded to include tables related to sequence listings. At the present time, the United States Receiving Office (RO/US) has not notified the International Bureau (IB) under Administrative Instructions Section 801(b) that it will be generally accepting the filing of international applications under Administrative Instructions Section 801(a). The RO/US will, however, accept such applications in a particular case pursuant to Administrative Instructions Section 801(c), provided that applicant follows the Guidelines set forth below in subsection II. A.

*PCT Administrative Instruction Section 803.*

*\*\*>Calculation of International Filing Fee for International Applications Containing Sequence Listings and/or Tables*

Where sequence listings and/or tables are filed in electronic form under Section 801(a), the international filing fee payable in respect of that application shall include the following two components:

(i) a basic component calculated as provided in the Schedule of Fees in respect of all pages filed on paper (that is, all pages of the request, description (excluding sequence listings and/or tables if also filed on paper), claims, abstract and drawings), and

(ii) an additional component, in respect of the sequence listings and/or tables, equal to 400 times the fee per sheet as referred to in item 1 of the Schedule of Fees, regardless of the actual length of the sequence listings and/or tables filed in computer readable form and regardless of the fact that sequence listings and/or tables may have been filed both in written form and in computer readable form.<

Applicants will usually achieve a significant fee savings by filing international applications under Administrative Instructions Section 801(a) in situations where the sequence listings and/or tables consume over four hundred (400) combined pages. The potentially reduced *>*international filing< fee described in Administrative Instructions Section 803 is available to applications filed pursuant to the Guidelines below. Applicants who do not wish to file under Administrative Instructions Section 801(a) may submit the sequence listing part and any related tables under conventional filing procedures but will not be eligible for the potentially reduced *>*international filing< fee described in Administrative Instructions Section 803.

When filing an international application under Administrative Instructions Section 801(a) in the RO/US, applicant should not submit a paper copy of the

Sequence Listing part and/or tables. If both a sequence listing part and a tables part are filed under Administrative Instructions Section 801(a), the sequence listing part and the tables part must not be filed on the same electronic medium. With specific regard to tables, only tables which are related to sequence listings, as referred to in PCT Rule 5.2(a), are covered under Part 8 of the Administrative Instructions. Currently, other types of table data may not be filed on electronic media.

**A. Guidelines on Qualifying for Potentially Reduced \*>International Filing< Fee Under PCT Administrative Instructions Section 803**

**1. What To Submit**

The applicant is required to submit a complete copy of the international application, wherein the sequence listing part and/or tables part of the application is submitted on electronic media rather than on paper. The application is to be accompanied by a transmittal letter entitled "Compact Disc Transmittal Sheet For Submission Of Sequence Listing and/or Tables To the United States Receiving Office Under PCT Administrative Instructions - Part 8."

**(a) Complete International Application With Sequence Listing Part and/or Tables Part on Electronic Media**

Applicant shall submit a paper copy of the complete international application, with the exception that the sequence listing part and/or tables part is provided on electronic media rather than on paper. Four (4) copies of the sequence listing part and/or three (3) copies of the tables part are to be included with the application, each copy on an electronic medium or set of electronic media if additional capacity is needed. One copy of the sequence listing part, called the "computer readable form" (CRF) copy required by the Administrative Instructions (see Annex C of the Administrative Instructions, paragraphs 39-46), may be submitted on any acceptable medium under 37 CFR 1.824(c), although compact disc (CD) media is preferred. All other copies must be submitted only on CD media as specified below:

(1) CD-R

Type: 120mm Compact Disc Recordable

Specification: ISO 9660, 650MB; or

(2) CD-ROM

Type: ISO/IEC 10149:1995, 120mm Compact Disc Read Only Memory

Specification: ISO 9660, 650MB

Each electronic medium shall be enclosed in a hard protective case within a padded envelope. If a sequence listing file is included, the four (4) sequence listing part copies shall be labeled as follows:

- (1) "COPY 1 – SEQUENCE LISTING PART"
- (2) "COPY 2 – SEQUENCE LISTING PART"
- (3) "COPY 3 – SEQUENCE LISTING PART"
- (4) "CRF"

If tables file(s) are included, the three (3) tables part copies shall be labeled as follows:

- (1) "COPY 1 – TABLES PART"
- (2) "COPY 2 – TABLES PART"
- (3) "COPY 3 – TABLES PART"

Additionally, the labeling shall contain the following information:

- (1) Name of Applicant
- (2) Title of Invention
- (3) Applicant's or Agent's File Reference Number
- (4) Date of Recording
- (5) Computer Operating System Used
- (6) Name of the Competent Authority (i.e. the RO/US)
- (7) Indication that the sequence listing part and/or tables part is being filed under Administrative Instructions Section 801(a)
- (8) If the sequence listing file and/or tables file(s) consumes more than one CD, an indication such as "DISK 1/3", "DISK 2/3", and "DISK 3/3"
- (9) For a CD containing tables, an indication such as "TABLES 1 to 450"

Examples of properly labeled electronic media appear below.

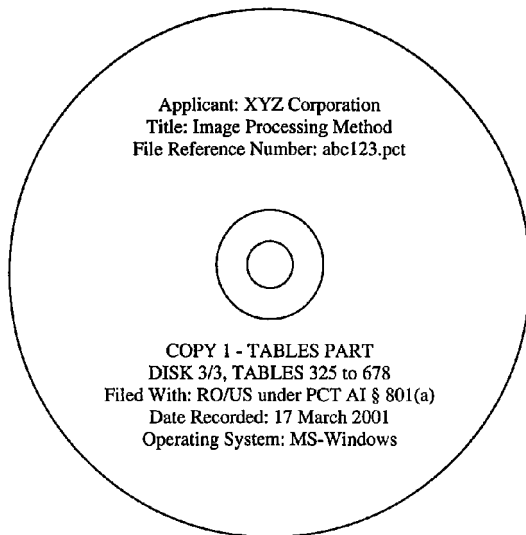

**Important Notes:**

The electronic medium itself must be neatly labeled with the required information. Labeling of the protective case is recommended, but not required. Sequence listings or tables submitted for correction, rectification, or amendment must satisfy the additional labeling requirements of Administrative Instructions Section 802(d).

Each CD shall contain either: (1) only a sequence listing part or (2) only a tables part. A sequence listing part and a tables part must not reside together on the same CD. Furthermore, each file in the tables part

must have a file name which indicates the name of the table contained therein, e.g., “table-1.txt”, “table-2.txt”, etc. In addition, no programs or any explanatory files shall appear on any CD.

The sequence listing file and/or tables file(s) must be in compliance with the American Standard Code for Information Interchange (ASCII) and formatted in accordance with Administrative Instructions Annex C, paragraph 41 and Administrative Instructions Annex C-<sup>bis</sup>. No copy protection or encryption techniques are permitted. File compression is acceptable for the sequence listing part, so long as the compressed file is in a self-extracting format and uses the compression method described in Administrative Instructions Part 7, Annex F, Section 4.1.1. File Compression is not permitted for the tables part.

**(b) Compact Disc Transmittal Sheet for Submission of Sequence Listing and/or Tables to the United States Receiving Office Under PCT Administrative Instructions - Part 8.**

If applicant desires for an application to be accepted pursuant to Administrative Instructions Section 801(c), the application must be submitted with a document entitled “Compact Disc Transmittal Sheet For Submission Of Sequence Listing and/or Tables To The United States Receiving Office Under PCT Administrative Instructions - Part 8.” This document is available as a PDF sheet that may be downloaded from <http://www.uspto.gov/web/offices/pac/dapps/pct/part8translett.pdf>. The PDF sheet includes the following information:

- (1) Name of Applicant
- (2) Applicant’s or Agent’s File Reference Number
- (3) Title of Invention
- (4) Name of Sequence Listing File and/or Tables File(s) (as per CD directory)
- (5) Size of Sequence Listing File and/or Tables File(s) (in bytes or kilobytes as per CD directory)
- (6) Date of Sequence Listing File and/or Tables File(s) (as per CD directory)
- (7) Statement that the four (4) submitted copies of the Sequence Listing Part and/or three (3) submitted copies of the Tables Part are identical
- (8) Contact information

- (a) Name of Contact
- (b) Telephone Number
- (c) Facsimile Number
- (9) Signature of Applicant, Agent, or Common Representative

Important Note: The “Compact Disc Transmittal Sheet For Submission Of Sequence Listing and/or Tables To The United States Receiving Office Under PCT Administrative Instructions - Part 8” is separate

and apart from any other transmittal letter. The Transmittal Sheet requirement cannot be satisfied by incorporating the above information into any other document. A sample copy of a “Compact Disc Transmittal Sheet for Submission of Sequence Listing To the United States Receiving Office Under PCT Administrative Instructions - Part 8” is reproduced on the following page.

<b>COMPACT DISC TRANSMITTAL SHEET FOR SUBMISSION OF SEQUENCE LISTING AND/OR TABLES TO THE UNITED STATES RECEIVING OFFICE UNDER PCT ADMINISTRATIVE INSTRUCTIONS - PART 8</b>	
<i>For Receiving Office Use Only</i>	<i>For Receiving Office Use Only</i>
<i>For Receiving Office Use Only</i>	<b>International Application Number</b> <i>For Receiving Office Use Only</i>
Date of transmission back to applicant	Date of receipt in RO/US <span style="float: right;"># CDs recvd.</span>

<b>INTERNATIONAL APPLICATION DATA</b>
Applicant: _____
File Reference: _____
Title: _____

<b>APPLICANT'S CONTACT INFORMATION</b>
Name of Contact: _____
Telephone Number: _____
Facsimile Number: _____

<b>SEQUENCE LISTING FILE</b>
Name of File (as per CD directory): _____
Size of File (in bytes or kilobytes): _____
Date of File (as per CD directory): _____

<b>TABLES FILE(S) (use continuation box below if necessary)</b>
Name of File(s) (as per CD directory): _____
Size of File(s) (in bytes or kilobytes): _____
Date of File(s) (as per CD directory): _____

<b>STATEMENT</b>
I hereby certify that the four copies of the sequence listing part and/or the three copies of the tables part submitted herewith are identical.
Name of Person Signing: _____
Signature of Applicant, Agent, or Common Representative: _____

<b>CONTINUATION OF TABLES FILE(S) (attach additional sheets if necessary)</b>

This sheet offers a sample or suggested format for a Compact Disc Transmittal Sheet For Submission Of Sequence Listing and/or Tables To The United States Receiving Office Under PCT Administrative Instructions - Part 8. This sample sheet is not an OMB officially approved form.

**2. Where To Submit****(a) United States Postal Service (Express Mail, Priority Mail, First Class Mail, etc.)**

If deposited with the United States Postal Service, the entire international application, including all applicable items set forth in MPEP § 1823.02 paragraph \*>II.A.1.< above, should be addressed to:

\*\*>Mail Stop PCT

Commissioner for Patents

P.O. Box 1450

Alexandria, VA 22313-1450<

**(b) Federal Express, United Parcel Service, or Other Delivery Service**

If deposited with a private delivery service, the entire international application, including all applicable items set forth in MPEP § 1823.02 paragraph I.A.1. above, should be addressed to:

U.S. Patent and Trademark Office

2011 South Clark Place

Customer Window, Box PCT

Crystal Plaza Two, Lobby, Room 1B03

Arlington, VA 22202

**(c) Hand-Carried**

If hand-carried directly to the USPTO, the entire international application, including all applicable items set forth in MPEP § 1823.02 paragraph \*>II.A.1.< above, should be delivered to either location specified below:

Customer Window, \*>Mail Stop< PCT

2011 South Clark Place

Crystal Plaza Two, Lobby, Room 1B03

Arlington, VA 22202

OR

PCT Operations Receptionist

2011 South Clark Place

Crystal Plaza Two - 8<sup>th</sup> Floor

Arlington, VA 22202

**1824 The Claims [R-1]**

*PCT Article 6.*

*The Claims*

The claim or claims shall define the matter for which protection is sought. Claims shall be clear and concise. They shall be fully supported by the description.

*PCT Rule 6.*

*The Claims*

**6.1. Number and Numbering of Claims**

(a) The number of the claims shall be reasonable in consideration of the nature of the invention claimed.

(b) If there are several claims, they shall be numbered consecutively in Arabic numerals.

(c) The method of numbering in the case of the amendment of claims shall be governed by the Administrative Instructions.

**6.2. References to Other Parts of the International Application**

(a) Claims shall not, except where absolutely necessary, rely, in respect of the technical features of the invention, on references to the description or drawings. In particular, they shall not rely on such references as: "as described in part ... of the description," or "as illustrated in figure ... of the drawings."

(b) Where the international application contains drawings, the technical features mentioned in the claims shall preferably be followed by the reference signs relating to such features. When used, the reference signs shall preferably be placed between parentheses. If inclusion of reference signs does not particularly facilitate quicker understanding of a claim, it should not be made. Reference signs may be removed by a designated Office for the purposes of publication by such Office.

**6.3. Manner of Claiming**

(a) The definition of the matter for which protection is sought shall be in terms of the technical features of the invention.

(b) Whenever appropriate, claims shall contain:

(i) a statement indicating those technical features of the invention which are necessary for the definition of the claimed subject matter but which, in combination, are part of the prior art,

(ii) a characterizing portion - preceded by the words "characterized in that," "characterized by," "wherein the improvement comprises," or any other words to the same effect - stating concisely the technical features which, in combination with the features stated under (i), it is desired to protect.

(c) Where the national law of the designated State does not require the manner of claiming provided for in paragraph (b), failure to use that manner of claiming shall have no effect in that State provided the manner of claiming actually used satisfies the national law of that State.



#### 6.4. *Dependent Claims*

(a) Any claim which includes all the features of one or more other claims (claim in dependent form, hereinafter referred to as “dependent claim”) shall do so by a reference, if possible at the beginning, to the other claim or claims and shall then state the additional features claimed. Any dependent claim which refers to more than one other claim (“multiple dependent claim”) shall refer to such claims in the alternative only. Multiple dependent claims shall not serve as a basis for any other multiple dependent claim. Where the national law of the national Office acting as International Searching Authority does not allow multiple dependent claims to be drafted in a manner different from that provided for in the preceding two sentences, failure to use that manner of claiming may result in an indication under Article 17(2)(b) in the international search report. Failure to use the said manner of claiming shall have no effect in a designated State if the manner of claiming actually used satisfies the national law of that State.

(b) Any dependent claim shall be construed as including all the limitations contained in the claim to which it refers or, if the dependent claim is a multiple dependent claim, all the limitations contained in the particular claim in relation to which it is considered.

(c) All dependent claims referring back to a single previous claim, and all dependent claims referring back to several previous claims, shall be grouped together to the extent and in the most practical way possible.

#### 6.5. *Utility Models*

Any designated State in which the grant of a utility model is sought on the basis of an international application may, instead of Rules 6.1 to 6.4, apply in respect of the matters regulated in those Rules the provisions of its national law concerning utility models once the processing of the international application has started in that State, provided that the applicant shall be allowed at least two months from the expiration of the time limit applicable under Article 22 to adapt his application to the requirements of the said provisions of the national law.

#### *PCT Administrative Instruction Section 205.*

##### *Numbering and Identification of Claims Upon Amendment*

(a) Amendments to the claims under Article 19 or Article 34(2)(b) may be made either by cancelling one or more entire claims, by adding one or more new claims or by amending the text of one or more of the claims as filed. All the claims appearing on a replacement sheet shall be numbered in Arabic numerals. Where a claim is cancelled, no renumbering of the other claims shall be required. In all cases where claims are renumbered, they shall be renumbered consecutively.

(b) The applicant shall, in the letter referred to in the second and third sentences of Rule 46.5(a) or in the second and fourth sentences of Rule 66.8(a), indicate the differences between the claims as filed and the claims as amended. He shall, in particular, indicate in the said letter, in connection with each claim appearing in the international application (it being understood that identical indications concerning several claims may be grouped), whether:

- (i) the claim is unchanged;
- (ii) the claim is cancelled;
- (iii) the claim is new;
- (iv) the claim replaces one or more claims as filed;
- (v) the claim is the result of the division of a claim as filed.

filed.

#### *37 CFR 1.436. The claims.*

The requirements as to the content and format of claims are set forth in PCT Art. 6 and PCT Rules 6, 9, 10 and 11 and shall be adhered to. The number of the claims shall be reasonable, considering the nature of the invention claimed.

The claim or claims must “define the matter for which protection is sought.” Claims must be clear and concise. They must be fully supported by the description. PCT Rule 6 contains detailed requirements as to the number and numbering of claims, the extent to which any claim may refer to other parts of the international application, the manner of claiming, and dependent claims. As to the manner of claiming, the claims must, whenever appropriate, be in two distinct parts; namely, the statement of the prior art and the statement of the features for which protection is sought (“the characterizing portion”).

The physical requirements for the claims are the same as those for the description. Note that the claims must commence on a new sheet.

The procedure for rectification of obvious errors is explained in MPEP § 1836. The omission of an entire sheet of the claims cannot be rectified without affecting the international filing date. It is recommended that a request for rectification of obvious errors in the claims be made only if the error is liable to affect the international search; otherwise, the rectification should be made by amending the claims.

The claims can be amended during the international phase under PCT Article 19 on receipt of the international search report, during international preliminary examination if the applicant has filed a Demand, and during the national phase.

Multiple dependent claims are permitted in international applications before the United States Patent and Trademark Office as an International Searching and International Preliminary Examining Authority or as a Designated or Elected Office, if they are in the alternative only and do not serve as a basis for any other multiple dependent claim (PCT Rule 6.4(a), 35 U.S.C. 112). The claims, being an element of the application, should start on a new page (PCT Rule 11.4). Page numbers \*\* must not be placed in the margins (PCT

Rule 11.7(b)). Line numbers should appear in the right half of the left margin (PCT Rule 11.8(b)). Paragraph numbers (e.g., paragraph numbers complying with 37 CFR 1.52(b)(6)) are acceptable provided they are not placed in the margins. See PCT Rule 11.6(e).

The number of claims shall be reasonable, considering the nature of the invention claimed (37 CFR 1.436).

## 1825 The Drawings

### *PCT Article 7.*

#### *The Drawings*

(1) Subject to the provisions of paragraph (2)(ii), drawings shall be required when they are necessary for the understanding of the invention.

(2) Where, without being necessary for the understanding of the invention, the nature of the invention admits of illustration by drawings:

(i) the applicant may include such drawings in the international application when filed.

(ii) any designated Office may require that the applicant file such drawings with it within the prescribed time limit.

### *PCT Rule 7.*

#### *The Drawings*

##### *7.1. Flow Sheets and Diagrams*

Flow sheets and diagrams are considered drawings.

##### *7.2. Time Limit*

The time limit referred to in Article 7(2)(ii) shall be reasonable under the circumstances of the case and shall, in no case, be shorter than two months from the date of the written invitation requiring the filing of drawings or additional drawings under the said provision.

### *PCT Rule 11.*

#### *Physical Requirements of the International Application*

\*\*\*\*\*

##### *11.5. Size of Sheets*

The size of the sheets shall be A4 (29.7 cm x 21 cm). However, any receiving Office may accept international applications on sheets of other sizes provided that the record copy, as transmitted to the International Bureau, and, if the competent International Searching Authority so desires, the search copy, shall be of A4 size.

##### *11.6. Margins*

\*\*\*\*\*

(c) On sheets containing drawings, the surface usable shall not exceed 26.2 cm x 17.0 cm. The sheets shall not contain frames around the usable or used surface. The minimum margins shall be as follows:

- top: 2.5 cm
- left side: 2.5 cm
- right side: 1.5 cm
- bottom: 1.0 cm

\*\*\*\*\*

##### *11.11. Words in Drawings*

(a) The drawings shall not contain text matter, except a single word or words, when absolutely indispensable, such as "water," "steam," "open," "closed," "section on AB," and, in the case of electric circuits and block schematic or flow sheet diagrams, a few short catchwords indispensable for understanding.

(b) Any words used shall be so placed that, if translated, they may be pasted over without interfering with any lines of the drawings.

\*\*\*\*\*

##### *11.13. Special Requirements for Drawings*

(a) Drawings shall be executed in durable, black, sufficiently dense and dark, uniformly thick and well-defined, lines and strokes without colorings.

(b) Cross-sections shall be indicated by oblique hatching which should not impede the clear reading of the reference signs and leading lines.

(c) The scale of the drawings and the distinctness of their graphical execution shall be such that a photographic reproduction with a linear reduction in size to two-thirds would enable all details to be distinguished without difficulty.

(d) When, in exceptional cases, the scale is given on a drawing, it shall be represented graphically.

(e) All numbers, letters and reference lines, appearing on the drawings, shall be simple and clear. Brackets, circles or inverted commas shall not be used in association with numbers and letters.

(f) All lines in the drawings shall, ordinarily, be drawn with the aid of drafting instruments.

(g) Each element of each figure shall be in proper proportion to each of the other elements in the figure, except where the use of a different proportion is indispensable for the clarity of the figure.

(h) The height of the numbers and letters shall not be less than 0.32 cm. For the lettering of drawings, the Latin and, where customary, the Greek alphabets shall be used.

(i) The same sheet of drawings may contain several figures. Where figures on two or more sheets form in effect a single complete figure, the figures on the several sheets shall be so arranged that the complete figure can be assembled without concealing any part of any of the figures appearing on the various sheets.

(j) The different figures shall be arranged on a sheet or sheets without wasting space, preferably in an upright position, clearly separated from one another. Where the figures are not

arranged in an upright position, they shall be presented sideways with the top of the figures at the left side of the sheet.

(k) The different figures shall be numbered in Arabic numerals consecutively and independently of the numbering of the sheets.

(l) Reference signs not mentioned in the description shall not appear in the drawings, and vice versa.

(m) The same features, when denoted by reference signs, shall, throughout the international application, be denoted by the same signs.

(n) If the drawings contain a large number of reference signs, it is strongly recommended to attach a separate sheet listing all reference signs and the features denoted by them.

\*\*\*\*\*

### 37 CFR 1.437. *The drawings.*

(a) Subject to paragraph (b) of this section, when drawings are necessary for the understanding of the invention, or are mentioned in the description, they must be part of an international application as originally filed in the United States Receiving Office in order to maintain the international filing date during the national stage (PCT Art. 7).

(b) Drawings missing from the application upon filing will be accepted if such drawings are received within 30 days of the date of first receipt of the incomplete papers. If the missing drawings are received within the 30-day period, the international filing date shall be the date on which such drawings are received. If such drawings are not timely received, all references to drawings in the international application shall be considered non-existent (PCT Art. 14(2), Administrative Instruction 310).

(c) The physical requirements for drawings are set forth in PCT Rule 11 and shall be adhered to.

The international application must contain drawings when they are necessary for the understanding of the invention. Moreover where, without drawings being actually necessary for the understanding of the invention, its nature admits of illustration by drawings, the applicant may include such drawings and any designated Office may require the applicant to file such drawings during the national phase. Flow sheets and diagrams are considered drawings. "Guidelines for Drawings Under the Patent Cooperation Treaty," published in the *PCT Gazette* (No. 7/1978), may be obtained, in English and French, from the International Bureau.

Drawings must be presented on one or more separate sheets. They may not be included in the description, the claims or the abstract. They may not contain text matter, except a single word or words when absolutely indispensable. Note that if the drawings contain text matter not in English but in a language accepted under PCT Rule 12.1(a) by the International Bureau as a Receiving Office, the international application

will be transmitted to the International Bureau for processing in its capacity as a Receiving Office. See 37 CFR 1.412(c)(6)(ii). If the drawings contain text matter not in a language accepted under PCT Rule 12.1(a) by the International Bureau as a Receiving Office, the application will be denied an international filing date.

All lines in the drawings must, ordinarily, be drawn with the aid of a drafting instrument and must be executed in black, uniformly thick and well-defined lines. PCT Rules 11.10 to 11.13 contain detailed requirements as to further physical requirements of drawings. Drawings newly executed according to national standards may not be required during the national phase if the drawings filed with the international application comply with PCT Rule 11. The examiner may require new drawings where the drawings which were accepted during the international phase did not comply with PCT Rule 11. A file reference may be indicated in the upper left corner on each sheet of the drawings as for the description.

All of the figures constituting the drawings must be grouped together on a sheet or sheets without waste of space, preferably in an upright position and clearly separated from each other. Where the drawings or tables cannot be presented satisfactorily in an upright position, they may be placed sideways, with the tops of the drawings or tables on the left-hand side of the sheet.

The usable surface of sheets (which must be of A4 size) must not exceed 26.2 cm x 17.0 cm. The sheets must not contain frames around the usable surface. The minimum margins which must be observed are: top and left side: 2.5 cm; right side: 1.5 cm; bottom: 1.0 cm.

All sheets of drawings must be numbered in the center of either the top or the bottom of each sheet but not in the margin in numbers larger than those used as reference signs in order to avoid confusion with the latter. For drawings, a separate series of page numbers is to be used. The number of each sheet of the drawings must consist of two Arabic numerals separated by an oblique stroke, the first being the sheet number and the second being the total number of sheets of drawings. For example, "2/5" would be used for the second sheet of drawings where there are five in all.

Different figures on the sheets of drawings must be numbered in Arabic numerals consecutively and inde-

pendently of the numbering of the sheets and, if possible, in the order in which they appear. This numbering should be preceded by the expression "Fig."

The PCT makes no provision for photographs. Nevertheless, they are allowed by the International Bureau where it is impossible to present in a drawing what is to be shown (for instance, crystalline structures). Where, exceptionally, photographs are submitted, they must be on sheets of A4 size, they must be black and white, and they must respect the minimum margins and admit of direct reproduction. Color photographs are not accepted.

The procedure for rectification of obvious errors in the drawings is explained in MPEP § 1836. The omission of an entire sheet of drawings cannot be rectified without affecting the international filing date. Changes other than the rectification of obvious errors are considered amendments.

The drawings can be amended during the international phase only if the applicant files a Demand for international preliminary examination. The drawings can also be amended during the national phase.

If drawings are referred to in an international application and are not found in the search copy file, the examiner should refer the application to a Special Program Examiner in his or her Technology Center. See Administrative Instructions Section 310.

## 1826 The Abstract

### *PCT Rule 8.*

#### *The Abstract*

##### *8.1. Contents and Form of the Abstract*

(a) The abstract shall consist of the following:

(i) a summary of the disclosure as contained in the description, the claims, and any drawings; the summary shall indicate the technical field to which the invention pertains and shall be drafted in a way which allows the clear understanding of the technical problem, the gist of the solution of that problem through the invention, and the principal use or uses of the invention;

(ii) where applicable, the chemical formula which, among all the formulae contained in the international application, best characterizes the invention.

(b) The abstract shall be as concise as the disclosure permits (preferably 50 to 150 words if it is in English or when translated into English).

(c) The abstract shall not contain statements on the alleged merits or value of the claimed invention or on its speculative application.

(d) Each main technical feature mentioned in the abstract and illustrated by a drawing in the international application shall be followed by a reference sign, placed between parentheses.

##### *8.2. Figure*

(a) If the applicant fails to make the indication referred to in Rule 3.3(a)(iii), or if the International Searching Authority finds that a figure or figures other than that figure or those figures suggested by the applicant would, among all the figures of all the drawings, better characterize the invention, it shall, subject to paragraph (b), indicate the figure or figures which should accompany the abstract when the latter is published by the International Bureau. In such case, the abstract shall be accompanied by the figure or figures so indicated by the International Searching Authority. Otherwise, the abstract shall, subject to paragraph (b), be accompanied by the figure or figures suggested by the applicant.

(b) If the International Searching Authority finds that none of the figures of the drawings is useful for the understanding of the abstract, it shall notify the International Bureau accordingly. In such case, the abstract, when published by the International Bureau, shall not be accompanied by any figure of the drawings even where the applicant has made a suggestion under Rule 3.3(a)(iii).

##### *8.3. Guiding Principles in Drafting*

The abstract shall be so drafted that it can efficiently serve as a scanning tool for purposes of searching in the particular art, especially by assisting the scientist, engineer or researcher in formulating an opinion on whether there is a need for consulting the international application itself.

##### *37 CFR 1.438. The abstract.*

(a) Requirements as to the content and form of the abstract are set forth in PCT Rule 8, and shall be adhered to.

(b) Lack of an abstract upon filing of an international application will not affect the granting of a filing date. However, failure to furnish an abstract within one month from the date of the notification by the Receiving Office will result in the international application being declared withdrawn.

The abstract must consist of a summary of the disclosure as contained in the description, the claims and any drawings. Where applicable, it must also contain the most characteristic chemical formula. The abstract must be as concise as the disclosure permits (preferably 50 to 150 words if it is in English or when translated into English). National practice (see MPEP § 608.01(b)) also provides a maximum of 150 words for the abstract. See 37 CFR 1.72(b). The PCT range of 50 - 150 words is not absolute but publication problems could result when the PCT limit is increased beyond the 150 word limit. Maintaining the PCT upper limit is encouraged. As a rule of thumb, it can be said that the volume of the text of the abstract, including one of the figures from the drawings (if

any), should not exceed what can be accommodated on an A4 sheet of typewritten matter, 1 1/2 spaced. The abstract of the international application as filed must begin on a new sheet following the claims (Administrative Instructions Section 207). The other physical requirements must correspond to those for the description. The abstract must be so drafted that it can efficiently serve as a scanning tool for the purposes of searching in the particular art. These and other requirements concerning the abstract are spelled out in detail in PCT Rule 8. Useful guidance can be obtained from the “Guidelines for the Preparation of Abstracts Under the Patent Cooperation Treaty,” published in the *PCT Gazette* (No. 5/1978). Those Guidelines may be obtained, in English and French, from the International Bureau.

The abstract should be primarily related to what is new in the art to which the invention pertains. Phrases should not be used which are implicit, (for instance, “the invention relates to...”), and statements on the alleged merits or value of the invention are not allowed.

Where the receiving Office finds that the abstract is missing, it invites the applicant to furnish it within a time limit fixed in the invitation. The international application is considered withdrawn if no abstract is furnished to the receiving Office within the time limit fixed. Where the receiving Office has not invited the applicant to furnish an abstract, the International Searching Authority establishes one. The same applies where the abstract does not comply with the requirements outlined in the preceding paragraphs. Where the abstract is established by the International Searching Authority, the applicant may submit comments on it within 1 month from the date of mailing of the international search report, (PCT Rule 38.2(b)).

## SUMMARY OF ABSTRACT REQUIREMENTS

Preferably 50-150 words. Should contain:

- (A) Indication of field of invention.
- (B) Clear indication of the technical problem.
- (C) Gist of invention’s solution of the problem.
- (D) Principal use or uses of the invention.
- (E) Reference numbers of the main technical features placed between parentheses.

(F) Where applicable, chemical formula which best characterizes the invention.

Should not contain:

- (A) Superfluous language.
- (B) Legal phraseology such as “said” and “means.”
- (C) Statements of alleged merit or speculative application.
- (D) Prohibited items as defined in PCT Rule 9.

## 1827 Fees [R-2]

A complete list of Patent Cooperation Treaty fee amounts which are to be paid to the United States Patent and Trademark Office, for both the national and international stages, can be found at the beginning of each weekly issue of the *Official Gazette* of the United States Patent and Trademark Office and on the >Office of< PCT Legal \*>Administration< page of the USPTO web site (see MPEP § 1730). Applicants are urged to refer to this list before submitting any fees to the USPTO.

Pursuant to PCT Rules 14.1(c), \*>15.4<, and 16.1(f), the \*>international filing<, transmittal, and search fee payable is the \*>international filing<, transmittal, and search fee in effect on the \*>receipt< date of the international application. See 37 CFR 1.431(c).

## 1828 Priority Claim and Document [R-2]

An applicant who claims the priority of one or more earlier national>, regional< or international applications for the same invention must indicate on the Request, at the time of filing, the country in or for which it was filed, the date of filing, and the application number. See PCT Article 8 and PCT Rule 4.10 for priority claim particulars and PCT Rule 90<sup>bis</sup>.3 for withdrawal of priority claims. Note that under PCT Rule 4.10, an applicant may claim the priority of an application filed in or for a State which is a Member of the World Trade Organization (WTO), even if that State is not party to the Paris Convention for the Protection of Industrial Property (Paris Convention). However, a PCT Contracting State that is not a Member of the WTO would not be obliged to recognize the effects of such a priority claim.

Effective July 1, 1998, applicant may correct or add a priority claim by a notice submitted to the Receiving Office or the International Bureau within 16 months from the priority date, or where the priority date is changed, within 16 months from the priority date so changed, whichever period expires first, provided that a notice correcting or adding a priority claim may in any event be submitted until the expiration of 4 months from the international filing date. PCT Rule 26<sup>bis</sup>.1 and 37 CFR 1.451 and 1.465.

Under the PCT procedure, the applicant may file the certified copy of the earlier filed national application together with the international application in the receiving Office for transmittal with the record copy, or alternatively the certified copy may be submitted by the applicant to the International Bureau or the receiving Office not later than 16 months from the priority date or, if the applicant has requested early processing in any designated Office, not later than the time such processing or examination is requested. The International Bureau will normally furnish copies of the certified copy to the various designated Offices so that the applicant will not normally be required to submit certified copies to each designated Office.

For use of the priority document in a U.S. national application which entered the national stage from an international application after compliance with 35 U.S.C. 371, see MPEP §1893.03(c).

### **1830 International Application Transmittal Letter [R-2]**

A PCT international application transmittal letter, Form PTO-1382, is available free of charge for applicants to use when filing PCT international applications >and related documents< with the United States Receiving Office. The form is intended to simplify the filing of PCT international applications >and related documents< by providing a one-page letter which covers the most common \*\*>submissions< of applicants. Specifically covered are:

\*\*>

- (A) A new international application;
- (B) A response to an invitation from the United States Receiving Office;
- (C) A request for rectification under PCT Rule 91;

- (D) A petition; and
- (E) A sequence listing diskette.<

### **1832 License Request for Foreign Filing Under the PCT**

A license for foreign filing is not required to file an international application in the United States Receiving Office but may be required before the applicant or the U.S. Receiving Office can forward a copy of the international application to a foreign patent office, the International Bureau or other foreign authority (35 U.S.C. 368, 37 CFR 5.1 and 5.11). A foreign filing license to permit transmittal to a foreign office or international authority is not required if the international application does not disclose subject matter in addition to that disclosed in a prior U.S. national application filed more than 6 months prior to the filing of the international application (37 CFR 5.11(a)). In all other instances (direct foreign filings outside the PCT or filings in a foreign receiving Office), the applicant should petition for a license for foreign filing (37 CFR 5.12) and if appropriate, identify any additional subject matter in the international application which was not in the earlier U.S. national application (37 CFR 5.14 (c)). This request and disclosure information may be supplied on the PCT international application transmittal letter, Form PTO-1382.

If no petition or request for a foreign filing license is included in the international application, and it is clear that a license is required because of the designation of foreign countries and the time at which the Record Copy must be transmitted, it is current Office practice to construe the filing of such an international application to include a request for a foreign filing license. If the license can be granted, it will be issued without further correspondence. If no license can be issued, or further information is required, applicant will be contacted. The automatic request for a foreign filing license does not apply to the filing of a foreign application outside the PCT.

### **EFFECT OF SECRECY ORDER**

If a secrecy order is applied to an international application, the application will not be forwarded to the International Bureau as long as the secrecy order remains in effect (PCT Article 27(8) and 35 U.S.C. 368). If the secrecy order remains in effect, the international application will be declared with-

drawn (abandoned) because the Record Copy of the international application was not received in time by the International Bureau (37 CFR 5.3(d), PCT Article 12(3), and PCT Rule 22.3). It is, however, possible to prevent abandonment as to the United States of America if it has been designated, by fulfilling the requirements of 35 U.S.C. 371(c).

## 1834 Correspondence [R-2]

### *PCT Rule 92. Correspondence*

#### *92.1. Need for Letter and for Signature*

(a) Any paper submitted by the applicant in the course of the international procedure provided for in the Treaty and these Regulations, other than the international application itself, shall, if not itself in the form of a letter, be accompanied by a letter identifying the international application to which it relates. The letter shall be signed by the applicant.

(b) If the requirements provided for in paragraph (a) are not complied with, the applicant shall be informed as to the non-compliance and invited to remedy the omission within a time limit fixed in the invitation. The time limit so fixed shall be reasonable in the circumstances; even where the time limit so fixed expires later than the time limit applying to the furnishing of the paper (or even if the latter time limit has already expired), it shall not be less than 10 days and not more than one month from the mailing of the invitation. If the omission is remedied within the time limit fixed in the invitation, the omission shall be disregarded; otherwise, the applicant shall be informed that the paper has been disregarded.

(c) Where non-compliance with the requirements provided for in paragraph (a) has been overlooked and the paper taken into account in the international procedure, the non-compliance shall be disregarded.

#### *92.2. Languages*

(a) Subject to Rules 55.1 and 66.9 and to paragraph (b) of this Rule, any letter or document submitted by the applicant to the International Searching Authority or the International Preliminary Examining Authority shall be in the same language as the international application to which it relates. However, where a translation of the international application has been transmitted under Rule 23.1(b) or furnished under Rule 55.2, the language of such translation shall be used.

(b) Any letter from the applicant to the International Searching Authority or the International Preliminary Examining Authority may be in a language other than that of the international application, provided the said Authority authorizes the use of such language.

(c) *[Deleted]*

(d) Any letter from the applicant to the International Bureau shall be in English or French.

(e) Any letter or notification from the International Bureau to the applicant or to any national Office shall be in English or French.

\*\*\*\*\*

### *PCT Administrative Instruction Section 105. Identification of International Application With Two or More Applicants*

Where any international application indicates two or more applicants, it shall be sufficient, for the purpose of identifying that application, to indicate, in any Form or correspondence relating to such application, the name of the applicant first named in the request. The provisions of the first sentence of this Section do not apply to the demand or to a notice effecting later elections.

## **NOTIFICATION UNDER PCT RULE 92.1(b) OF DEFECTS WITH REGARD TO CORRESPONDENCE**

If the Office finds that papers, other than the international application itself, are not accompanied by a letter identifying the international application to which they relate, or are accompanied by an unsigned letter, or are furnished in the form of an unsigned letter, it notifies the applicant and invites him or her to remedy the omission. The Office disregards the said papers or letter if the omission is not remedied within the time limit fixed in the invitation (PCT Rule 92.1(b)). If the omission has been overlooked and the paper taken into account, the omission is disregarded.

## **CORRESPONDENCE ADDRESS**

Where there is a sole applicant without an agent in an international application, correspondence will be sent to the applicant at his or her indicated address; or, if he or she has appointed one or more agents, to that agent or the first-mentioned of those agents; or, if he or she has not appointed an agent but has indicated a special address for notifications, at that special address.

Where there are two or more applicants who have appointed one or more common agents, correspondence will be addressed to that agent or the first-mentioned of those agents. Where no common agent has been appointed, correspondence will be addressed to the common representative (either the appointed common representative or the applicant who is considered to be the common representative (PCT Rule 90.2) at the indicated address; or, if the common representative has appointed one or more agents, to that agent or the first-mentioned of those agents; or, if the common representative has not appointed an agent but has indi-

cated a special address for notifications, at that address.

### FILING OF CORRESPONDENCE BY MAIL

The “Express Mail” procedure set forth at 37 CFR 1.10 applies to papers filed with the U.S. Patent and Trademark Office (USPTO) in international applications. Accordingly, papers filed with the USPTO in international applications will be accorded by the USPTO the date of deposit with the United States Postal Service as shown on the “date-in” on the “Express Mail” mailing label as the date of filing in the USPTO if the provisions of 37 CFR 1.10 are complied with. See MPEP § 513.

If there is a question regarding the date of deposit, the Express Mail provisions of 37 CFR 1.10(c)-(e) require, in addition to using the “Express Mail Post Office to Addressee” service, an indication of the “Express Mail” mailing label number on each paper or fee. In situations wherein the correspondence includes several papers directed to the same application (for example, Request, description, claims, abstract, drawings, and other papers) the correspondence may be submitted with a cover or transmittal letter, which should itemize the papers. The cover or transmittal letter must have the “Express Mail” mailing label number thereon.

The certificate of mailing by first class mail procedure set forth at 37 CFR 1.8 differs from the 37 CFR 1.10 Express Mail procedure. See 37 CFR 1.8(a)(2)(i)(D) and (E). It is important to understand that the 37 CFR 1.8 certificate of mailing procedure CANNOT be used for filing any papers during the international stage if the date of deposit is desired. If the 37 CFR 1.8 certificate of mailing procedure is used, the paper and/or fee will be accorded the date of receipt in the USPTO unless the receipt date falls on a Saturday, Sunday, or Federal holiday in which case the date of receipt will be the next succeeding day which is not a Saturday, Sunday, or Federal holiday (37 CFR 1.6(a)(1)). Accordingly, the certificate of mailing procedures of 37 CFR 1.8 are not available to have a submission during the international stage considered as timely filed if the submission is not physically received at the USPTO on or before the due date.

### 1834.01 Use of Telegraph, Teleprinter, Facsimile Machine [R-1]

PCT Rule 92.4 provides that a national Office may receive documents by telegraph, teleprinter, or facsimile machine. However, the United States Patent and Trademark Office has not informed the International Bureau that it accepts such submissions other than facsimile transmissions. Accordingly, applicants may not currently file papers in international applications with the United States Patent and Trademark Office via telegraph or teleprinter.

Generally, any paper may be filed by facsimile transmission with certain exceptions which are identified in 37 CFR 1.6(d). It should be noted that a facsimile transmission of a document is not permitted and, if submitted, will not be accorded a date of receipt if the document is:

- (A) Required by statute to be certified;
- (B) A drawing submitted under 37 CFR 1.437;
- (C) An international application for patent; or
- (D) A copy of the international application and the basic national fee necessary to enter the national stage, as specified in 37 CFR 1.495(b).

Facsimile transmission may be used to submit substitute sheets (other than drawings), extensions of time, power of attorney, fee authorizations (other than the basic national fee), confirmation of precautionary designations, Demands, response to written opinions, oaths or declarations, petitions, and translations in international applications.

A Certificate of Transmission may be used as provided in 37 CFR 1.8(a)(1) except in the instances specifically excluded in 37 CFR 1.8(a)(2). Note particularly that the Certificate of Transmission cannot be used for the filing of an international application for patent or correspondence in an international application before the U.S. Receiving Office, the U.S. International Searching Authority, or the U.S. International Preliminary Examining Authority. Guidelines for facsimile transmission are clearly set forth in 37 CFR 1.6(d) and should be read before transmitting by facsimile machine.

A signature on a document received via facsimile in a permitted situation is acceptable as a proper signature. See PCT Rule 92.4(b) and 37 CFR 1.4(d)(1)(ii).



The receipt date of a document transmitted via facsimile is the date in the USPTO on which the transmission is completed, unless the receipt date is a Saturday, Sunday, or Federal holiday in which case the date of receipt will be the next succeeding day which is not a Saturday, Sunday, or Federal holiday (37 CFR 1.6(a)(3)). See 37 CFR 1.6(d). Where a document is illegible or part of the document is not received, the document will be treated as not received to the extent that it is illegible or the transmission failed. See PCT Rule 92.4(c).

## 1834.02 Irregularities in the Mail Service

### *PCT Rule 82.*

#### *Irregularities in the Mail Service*

##### *82.1. Delay or Loss in Mail*

(a) Any interested party may offer evidence that he has mailed the document or letter five days prior to the expiration of the time limit. Except in cases where surface mail normally arrives at its destination within two days of mailing, or where no airmail service is available, such evidence may be offered only if the mailing was by airmail. In any case, evidence may be offered only if the mailing was by mail registered by the postal authorities.

(b) If the mailing, in accordance with paragraph (a), of a document or letter is proven to the satisfaction of the national Office or intergovernmental organization which is the addressee, delay in arrival shall be excused, or, if the document or letter is lost in the mail, substitution for it of a new copy shall be permitted, provided that the interested party proves to the satisfaction of the said Office or organization that the document or letter offered in substitution is identical with the document or letter lost.

(c) In the cases provided for in paragraph (b), evidence of mailing within the prescribed time limit, and, where the document or letter was lost, the substitute document or letter as well as the evidence concerning its identity with the document or letter lost shall be submitted within one month after the date on which the interested party noticed or with due diligence should have noticed the delay or the loss, and in no case later than six months after the expiration of the time limit applicable in the given case.

(d) Any national Office or intergovernmental organization which has notified the International Bureau that it will do so shall, where a delivery service other than the postal authorities is used to mail a document or letter, apply the provisions of paragraphs (a) to (c) as if the delivery service was a postal authority. In such a case, the last sentence of paragraph (a) shall not apply but evidence may be offered only if details of the mailing were recorded by the delivery service at the time of mailing. The notification may contain an indication that it applies only to mailings using specified delivery services or delivery services which satisfy spec-

ified criteria. The International Bureau shall publish the information so notified in the Gazette.

(e) Any national Office or intergovernmental organization may proceed under paragraph (d):

(i) even if, where applicable, the delivery service used was not one of those specified, or did not satisfy the criteria specified, in the relevant notification under paragraph (d), or

(ii) even if that Office or organization has not sent to the International Bureau a notification under paragraph (d).

##### *82.2. Interruption in the Mail Service*

(a) Any interested party may offer evidence that on any of the 10 days preceding the day of expiration of the time limit the postal service was interrupted on account of war, revolution, civil disorder, strike, natural calamity, or other like reason, in the locality where the interested party resides or has his place of business or is staying.

(b) If such circumstances are proven to the satisfaction of the national Office or intergovernmental organization which is the addressee, delay in arrival shall be excused, provided that the interested party proves to the satisfaction of the said Office or organization that he effected the mailing within five days after the mail service was resumed. The provisions of Rule 82.1(c) shall apply *mutatis mutandis*.

## **DELAY OR LOSS IN MAIL**

Delay or loss in the mail shall be excused when it is proven to the satisfaction of the receiving Office that the concerned letter or document was mailed at least five days before the expiration of the time limit. The mailing must have been by registered air mail or, where surface mail would normally arrive at the destination concerned within two days of mailing, by registered surface mail (PCT Rule 82.1(a) to (c)). PCT Rule 82 contains detailed provisions governing the situation where a letter arrives late or gets lost due to irregularities in the mail service, for example, because the mail service was interrupted due to a strike. The provisions operate to excuse failure to meet a time limit for filing a document for up to six months after the expiration of the time limit concerned, provided that the document was mailed at least five days before the expiration of the time limit. In order to take advantage of these provisions, the mailing must have been by registered airmail or, where surface mail would normally arrive at the destination concerned within two days of mailing, by registered surface mail. Evidence is required to satisfy the Office, and a substitute document must be filed promptly—see PCT Rule 82.1(b) and (c) for details.

## INTERRUPTION IN MAIL SERVICE

The provisions of PCT Rule 82.1(c) apply *mutatis mutandis* for interruptions in the mail service caused by war, revolution, civil disorder, strike, natural calamity or other like reasons (PCT Rule 82.2).

Special provisions also apply to mail interruptions caused by war, revolution, civil disorder, strike, natural calamity or other like reasons—see PCT Rule 82.2 for details.

See PCT Rule 80.5 for guidance on periods which expire on a non-working day.

## 1836 Rectification of Obvious Errors [R-2]

*PCT Rule 91.*

*Obvious Errors in Documents*

### 91.1. Rectification

(a) Subject to paragraphs (b) to (g<sup>quater</sup>), obvious errors in the international application or other papers submitted by the applicant may be rectified.

(b) Errors which are due to the fact that something other than what was obviously intended was written in the international application or other paper shall be regarded as obvious errors. The rectification itself shall be obvious in the sense that anyone would immediately realize that nothing else could have been intended than what is offered as rectification.

(c) Omissions of entire elements or sheets of the international application, even if clearly resulting from inattention, at the stage, for example, of copying or assembling sheets, shall not be rectifiable.

(d) Rectification may be made on the request of the applicant. The authority having discovered what appears to be an obvious error may invite the applicant to present a request for rectification as provided in paragraphs (e) to (g<sup>quater</sup>). Rule 26.4 shall apply *mutatis mutandis* to the manner in which rectifications shall be requested.

(e) No rectification shall be made except with the express authorization:

- (i) of the receiving Office if the error is in the request,
- (ii) of the International Searching Authority if the error is in any part of the international application other than the request or in any paper submitted to that Authority,
- (iii) of the International Preliminary Examining Authority if the error is in any part of the international application other than the request or in any paper submitted to that Authority, and
- (iv) of the International Bureau if the error is in any paper, other than the international application or amendments or corrections to that application, submitted to the International Bureau.

(f) Any authority which authorizes or refuses any rectification shall promptly notify the applicant of the authorization or refusal and, in the case of refusal, of the reasons therefor. The

authority which authorizes a rectification shall promptly notify the International Bureau accordingly. Where the authorization of the rectification was refused, the International Bureau shall, upon request made by the applicant prior to the time relevant under paragraph (g<sup>bis</sup>), (g<sup>ter</sup>), or (g<sup>quater</sup>) and subject to the payment of a special fee whose amount shall be fixed in the Administrative Instructions, publish the request for rectification together with the international application. A copy of the request for rectification shall be included in the communication under Article 20 where a copy of the pamphlet is not used for that communication or where the international application is not published by virtue of Article 64(3).

(g) The authorization for rectification referred to in paragraph (e) shall, subject to paragraphs (g<sup>bis</sup>), (g<sup>ter</sup>), and (g<sup>quater</sup>), be effective:

(i) where it is given by the receiving Office or by the International Searching Authority, if its notification to the International Bureau reaches that Bureau before the expiration of 17 months from the priority date;

(ii) where it is given by the International Preliminary Examining Authority, if it is given before the establishment of the international preliminary examination report;

(iii) where it is given by the International Bureau, if it is given before the expiration of 17 months from the priority date.

(g<sup>bis</sup>) If the notification made under paragraph (g)(i) reaches the International Bureau, or if the rectification made under paragraph (g)(iii) is authorized by the International Bureau, after the expiration of 17 months from the priority date but before the technical preparations for international publication have been completed, the authorization shall be effective and the rectification shall be incorporated in the said publication.

(g<sup>ter</sup>) Where the applicant has asked the International Bureau to publish his international application before the expiration of 18 months from the priority date, any notification made under paragraph (g)(i) must reach, and any rectification made under paragraph (g)(iii) must be authorized by, the International Bureau, in order for the authorization to be effective, not later than at the time of the completion of the technical preparations for international publication.

(g<sup>quater</sup>) Where the international application is not published by virtue of Article 64(3), any notification made under paragraph (g)(i) must reach, and any rectification made under paragraph (g)(iii) must be authorized by, the International Bureau, in order for the authorization to be effective, not later than at the time of the communication of the international application under Article 20.

Obvious errors in the international application or other papers submitted by the applicant may generally be rectified under PCT Rule 91, if the rectification is authorized, as required, within the applicable time limit. Any such rectification is free of charge. The omission of entire sheets of the description cannot be rectified, even if resulting from inattention at the stage of copying or assembling sheets.

Applicants often attempt to rely upon the priority application to establish a basis for obvious error. The priority document (application) cannot be used to support obvious error corrections. The rectification is obvious only in the sense that anyone would immediately realize that nothing else could have been intended than what is offered as rectification. \*\*>Examples of obvious errors that are rectifiable include linguistic errors, spelling errors and grammatical errors so long as the meaning of the disclosure does not change upon entry of the rectification. Changes to chemical or mathematical formulas would not generally be rectifiable unless they would be common knowledge to anyone.< A missing chemical formula or missing line of text would not be considered >to be an< obvious error subject to rectification. \*\*

Rectifications must be authorized:

\*\*>

(A) by the Receiving Office if the error is in the request;

(B) by the International Searching Authority if the error is in any part of the international application other than the request or in any paper submitted to that Authority;

(C) by the International Preliminary Examining Authority if the error is in any part of the international application other than the request or in any paper submitted to that Authority and if a demand for Chapter II examination has been filed in the application;

(D) by the International Bureau if the error is in any paper submitted to it other than the international application or amendments or corrections to the application.<

The request for rectification must be addressed to the authority competent to authorize the rectification. It must be filed in time for the rectification to be authorized and for notification of the authorization to reach the International Bureau before the expiration of the applicable time limit, namely:

(A) Where the authorization is given by the Receiving Office or the International Searching Authority its notification must reach the International Bureau before the expiration of 17 months from the priority date (or later, before the technical preparations for international publication have been completed);

(B) Where the authorization is given by the International Preliminary Examining Authority it must be given before the establishment of the international preliminary examination report;

(C) Where the authorization is given by the International Bureau it must be given before the expiration of 17 months from the priority date (or later, >but< before the technical preparations for international publication have been completed)

\*\* The International Searching Authority informs the applicant of the decision by use of Form PCT/ISA/217, while the International Preliminary Examining Authority informs the applicant of the decision >regarding the authorization or refusal to authorize the rectification of obvious errors< by use of Form PCT/IPEA/412.

\*\*

## 1840 The International Searching Authority [R-2]

35 U.S.C. 362. *International Searching Authority and International Preliminary Examining Authority.*

(a) The Patent and Trademark Office may act as an International Searching Authority and International Preliminary Examining Authority with respect to international applications in accordance with the terms and conditions of an agreement which may be concluded with the International Bureau, and may discharge all duties required of such Authorities, including the collection of handling fees and their transmittal to the International Bureau.

(b) The handling fee, preliminary examination fee, and any additional fees due for international preliminary examination shall be paid within such time as may be fixed by the Director.

37 CFR 1.413. *The United States International Searching Authority.*

\*\*>

(a) Pursuant to appointment by the Assembly, the United States Patent and Trademark Office will act as an International Searching Authority for international applications filed in the United States Receiving Office and in other Receiving Offices as may be agreed upon by the Director, in accordance with the agreement between the Patent and Trademark Office and the International Bureau (PCT Art. 16(3)(b)).<

(b) The Patent and Trademark Office, when acting as an International Searching Authority, will be identified by the full title "United States International Searching Authority" or by the abbreviation "ISA/US."

(c) The major functions of the International Searching Authority include:

- (1) Approving or establishing the title and abstract;
- (2) Considering the matter of unity of invention;

\*\*>

(3) Conducting international and international-type searches and preparing international and international-type search reports (PCT Art. 15, 17 and 18, and PCT Rules 25, 33 to 45 and 47), and issuing declarations that no international search report will be established (PCT Article 17(2)(a));

(4) Preparing written opinions of the International Searching Authority in accordance with PCT Rule 43<sup>bis</sup> (when necessary); and

(5) Transmitting the international search report and the written opinion of the International Searching Authority to the applicant and the International Bureau.<

The United States Patent and Trademark Office >(USPTO)< agreed to and was appointed by the PCT Assembly, to act as an International Searching Authority. As such an Authority, \*\*>the primary functions are to establish (1) international search reports and (2) for international applications having an international filing date on or after January 1, 2004, written opinions. See PCT Article 16 and PCT Rule 43<sup>bis</sup><.

Pursuant to an agreement concluded with the International Bureau, the USPTO, as an International Searching Authority, agreed to conduct international searches and prepare international search reports >and written opinions of the International Searching Authority<, for, in addition to the United States of America, Barbados, Brazil, India, Israel, Mexico, New Zealand, the Philippines, Saint Lucia, South Africa, and Trinidad and Tobago. The agreement stipulated the English language and specified that the subject matter to be searched is that which is searched or examined in United States national applications.

#### **TRANSMITTAL OF THE SEARCH COPY TO THE INTERNATIONAL SEARCHING AUTHORITY**

The “search copy” is transmitted by the Receiving Office to the International Searching Authority (PCT Article 12(1)), the details of the transmittal are provided in PCT Rule 23.

#### **THE MAIN PROCEDURAL STEPS IN THE INTERNATIONAL SEARCHING AUTHORITY**

The main procedural steps that any international application goes through in the International Searching Authority are (1) the making of the international search (PCT Article 15), \* (2) the preparing of the international search report (PCT Article 18 and PCT

Rule 43) >and (3) for international applications having an international filing date on or after January 1, 2004, the preparing of a written opinion of the International Searching Authority (PCT Rule 43<sup>bis</sup>)<.

#### **COMPETENT INTERNATIONAL SEARCHING AUTHORITY**

In respect of international applications filed with the U.S. Receiving Office, the United States International Searching Authority, which is the Examining Corps of the \*\*>USPTO<, is competent to carry out the international search (PCT Article 16, PCT Rules 35 and 36, 35 U.S.C. 362 and 37 CFR 1.413).

The European Patent Office \*\*>may also be< competent to carry out the international search (PCT Article 16, PCT Rules 35 and 36) for international applications filed with the U.S. Receiving Office\*\*. See MPEP § 1840.01 >for specific limitations regarding the competency of the EPO as an International Searching Authority for applications filed by U.S. nationals or residents in the USPTO or in the International Bureau (IB) as receiving Office<.

#### **MATTERS TO BE CONSIDERED WHEN CHOOSING AN INTERNATIONAL SEARCHING AUTHORITY**

Choosing The European Patent Office (EPO) as an International Searching Authority could be advantageous to United States applicants who designate countries for European Regional patent protection in PCT International applications for the following reasons:

(A) Claims may be amended according to EPO search results before entering the European \*\*>regional phase<.

(B) The EPO search fee need not be paid upon entering the European \*\*>regional phase<.

(C) The EPO search results may be available for use in a >corresponding< U.S. \* >nonprovisional< application.

(D) The EPO international search may be obtained without the need for a European professional representative.

(E) The \*\*>EPO< search could provide the U.S. applicant with the benefit of a European art search (which may be different from applicant’s own or the USPTO’s search) before it is necessary to enter the \*\*>EPO< or other designated Offices.

Some disadvantages of choosing the European Patent Office to conduct the international search are the following:

(A) The EPO may not be competent to perform the international search if the application was filed by a national or resident of the U.S. and contains one or more claims relating to the fields of biotechnology or business methods. See MPEP § 1840.01.

(B) The EPO will not search any application to the extent that it considers that the international application relates to subject matter set forth in PCT Rule 39.1. See MPEP § 1840.01 and § 1843.02.

(C) Additional mailing time to and from the EPO Searching Authority may shorten the time for applicants to respond to various invitations from the EPO such as for comments on abstracts and payments of additional search fees as well as for PCT Article 19 amendments to the claims after issuance of the international search report and, for international applications filed on or after January 1, 2004, the written opinion established by the International Searching Authority.

(D) There may be more difficulty in solving any procedural problems between the applicant and the EPO than with the USPTO due to physical distance and time differences.

The PCT Applicant's Guide provides helpful information for communications with the European Patent Office.

### **1840.01 The European Patent Office as an International Searching Authority [R-2]**

Since October 1, 1982, the European Patent Office (EPO) has been available as an International Searching Authority for PCT applications filed by U.S. nationals or residents in the U.S. Patent and Trademark Office (USPTO) as receiving Office or in the International Bureau (IB) as receiving Office. The choice of International Searching Authority, either the EPO or the USPTO, must be made by the applicant on filing the international application. The EPO has expressed the following limitations concerning its competency to act as an International Searching Authority. For updates or possible changes to these limitations, applicants should consult the PCT News-

letter which is available in electronic form from the web site of the World Intellectual Property Organization ([www.wipo.int/pct/en/newslett/index.htm](http://www.wipo.int/pct/en/newslett/index.htm)).

## **I. SUBJECT MATTER THAT WILL NOT BE SEARCHED BY THE EPO**

\*\*>

### **A. Field of Biotechnology**

The EPO is not a competent authority within the meaning of PCT Article 16(3)(b), and will not carry out an international search in respect of any international application filed on or after March 1, 2002 and before January 1, 2004 if the application: (A) was filed with the USPTO as receiving Office by a national or resident of the U.S.; or (B) was filed with the IB as receiving Office by a national or resident of the U.S. (provided the application did not also identify as an applicant at its time of filing a national or resident of a European Patent Convention (EPC) Contracting State), where such application contains one or more claims relating to the field of biotechnology as defined by the following units of the International Patent Classification:<

C 12 M	Apparatus for enzymology or microbiology
C 12 N	Micro-organisms or enzymes; compositions thereof
C 12 P	Fermentation or enzyme-using processes to synthesise a desired chemical compound or composition or to separate optical isomers from a racemic mixture
C 12 Q	Measuring or testing processes involving enzymes or micro-organisms; compositions or test papers therefor; processes of preparing such compositions; condition-responsive control in microbiological or enzymological processes
C 07 K	Peptides

- G 01 N 33/50 (including subdivisions) Chemical analysis of biological material, e.g. blood, urine; testing involving biospecific ligand binding methods; immunological testing
- A 61 K 39 Medicinal preparations containing antigens or antibodies
- A 61 K 48 Medicinal preparations containing genetic material which is inserted into cells of the living body to treat genetic diseases; Gene therapy
- A 01 H New plants or processes for obtaining them; plant reproduction by tissue culture techniques

For information, U.S. classes covering the corresponding subject matter are listed below:

- 424 Drug, bio-affecting and body treating compositions
- 435 Chemistry: molecular biology and microbiology
- 436 Chemistry: analytical and immunological testing
- 514 Drug, bio-affecting and body treating compositions
- 530 Chemistry: natural resins or derivatives; peptides or proteins; lignins or reaction products thereof
- 536 Organic compounds—part of the class 532-570 series
- 800 Multicellular living organisms and unmodified parts thereof

930 Peptide or protein sequence

\*\*>

**B. Field of Business Methods**

The EPO is not a competent authority within the meaning of PCT Article 16(3)(b) and will not carry out an international search in respect of any international application filed on or after March 1, 2002 if the application: (A) is filed with the USPTO as receiving Office by a national or resident of the U.S.; or (B) is filed with the IB as receiving Office by a national or resident of the U.S. (provided the application does not also identify as an applicant at its time of filing a national or resident of an EPC Contracting State), where such application contains one or more claims relating to the field of business methods as defined by the following units of the International Patent Classification:<

- G 06 F 17/60 Digital computing or data processing equipment or methods, specially adapted for specific functions: administrative, commercial, managerial, supervisory or forecasting purposes. To the extent that the application falls under above mentioned subgroup but does not relate to business methods the EPO' s competence is not affected.

For information, the U.S. class covering the corresponding subject matter is listed below:

- 705 Data processing: financial, business practice, management, or cost/price determination

The U.S. Receiving Office will forward all international applications to the EPO as ISA if so indicated by the applicant and the EPO will perform a competence check on the search copy. Where the EPO finds that it was indicated as the ISA but the application falls under the limitations indicated above, the EPO will *ex officio* change the ISA from EPO to the USPTO and will inform the applicant, the International Bureau and the USPTO accordingly. The EPO will transfer moneys received as the search fee as well as the search copy to the USPTO.

\*>

**C. < Declaration Under PCT Article 17(2)(a)(i)**

It should be noted that even when the European Patent Office is a competent International Searching Authority (for example, if one or more applicants is a resident or national of an EPC contracting state and the application was filed with the International Bureau as receiving Office), the EPO nonetheless will not search, by virtue of PCT Article 17(2)(a)(i), any international application to the extent that it considers

that the international application relates to subject matter set forth in PCT Rule 39.1. \*\*

**II. FEES FOR SERVICES OF THE ISA/EP**

The international search fee for the European Patent Office must be paid to the \*\*>USPTO< as a Receiving Office \*>within< one month from the time of filing the international application. The search fee for the European Patent Office is announced weekly in the *Official Gazette* in United States dollars. The search fee will change as costs and exchange rates require. If exchange rates fluctuate significantly, the fee may change frequently. Notice of changes will be published in the *Official Gazette* shortly before the effective date of any change.

If the European Patent Office as the International Searching Authority considers that the international application does not comply with the requirement of unity of invention as set forth in PCT Rule 13, the European Patent Office will invite applicants to timely pay directly to it an additional search fee in Euros for each additional invention.

1842 Basic Flow Under the PCT [R-2]

\*>

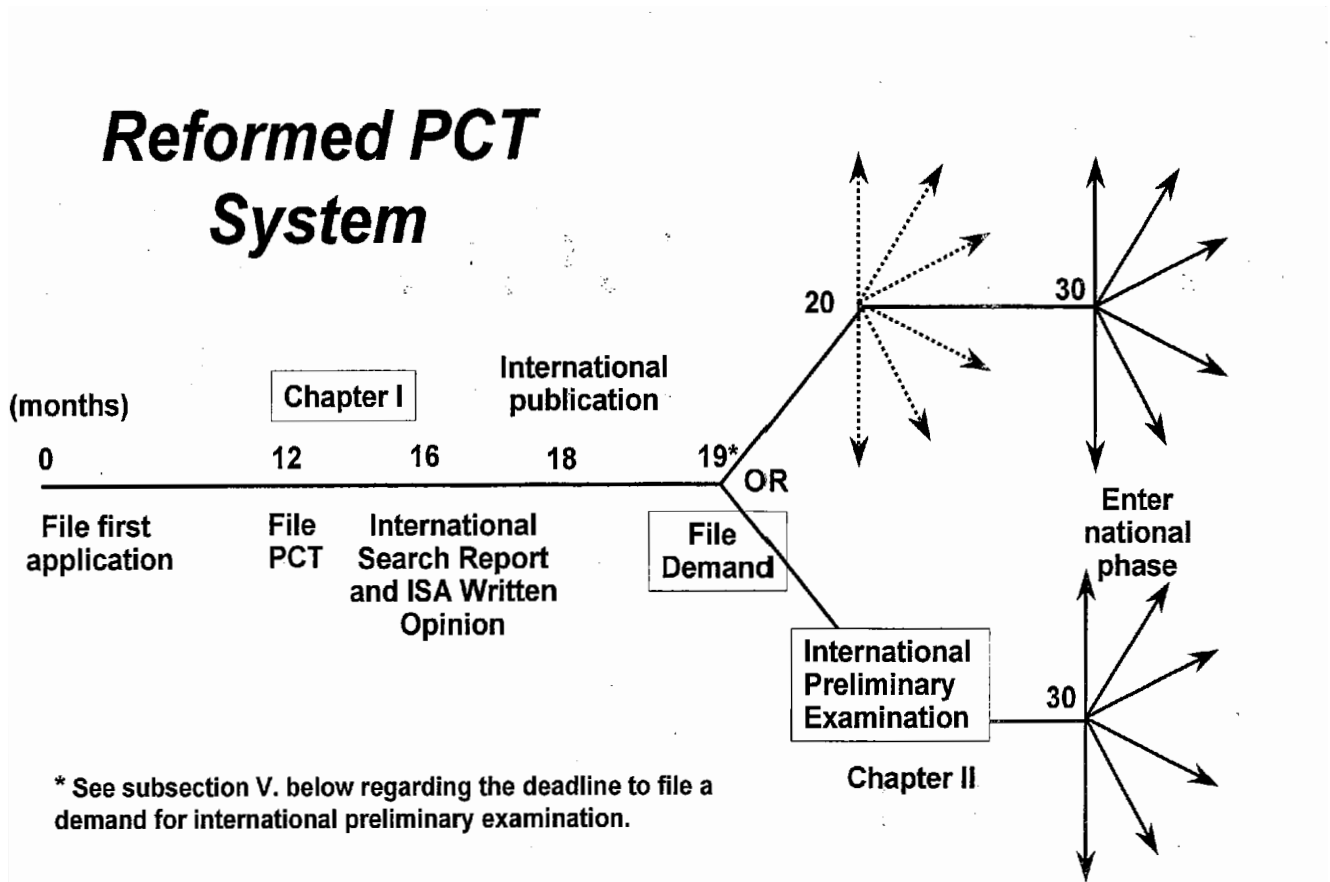

<



## I. MEASURING TIME LIMITS UNDER THE PCT

Time limits under the PCT are measured from the “priority date” of the application. The priority date for the purposes of computing time limits is defined in PCT Article 2(xi). Where an international application does not contain any priority claim under PCT Article 8, the international filing date is considered to be the priority date.

## II. INTERNATIONAL FILING DATE

An international application under the Patent Cooperation Treaty is generally filed within 12 months after the filing of the first application directed to the same subject matter, so that priority may be claimed under PCT Article 8 and Article 4 of the Stockholm Act of the Paris Convention for the Protection of Industrial Property. PCT Article 11 specifies the elements required for an international application to be accorded an international filing date.

## III. ESTABLISHMENT OF THE INTERNATIONAL SEARCH REPORT >AND WRITTEN OPINION OF THE INTERNATIONAL SEARCHING AUTHORITY<

As provided in PCT Rule 42 >and PCT Rule 43<sup>bis</sup><, the time limit for establishing the international search report (or a declaration that no international search report will be established) >and, for international applications having an international filing date on or after January 1, 2004, the written opinion,< is three months from the receipt of the search copy by the International Searching Authority, or nine months from the priority date, whichever time limit expires later.

## IV. INTERNATIONAL PUBLICATION

Under PCT Article 21, the international publication of the international application by the International Bureau shall be effected promptly after the expiration of 18 months from the priority date of that application.

## V. DEADLINE FOR FILING THE DEMAND

>

### A. *International Applications Having a Filing Date On or After January 1, 2004*

International preliminary examination is optional, but if a demand for international preliminary examination is filed in an international application having an international filing date on or after January 1, 2004, it must be filed prior to the expiration of whichever of the following periods expires later: (A) three months from the date of transmittal to the applicant of the international search report and the written opinion; or (B) 22 months from the priority date. Otherwise the demand shall be considered as if it had not been submitted and the International Preliminary Examining Authority shall so declare. See PCT Rule 54. In order to take advantage of a national phase entry time limit of at least 30 months from the priority date in relation to all States designated in the international application, it may be necessary to file a demand before the expiration of 19 months from the priority date. See subsection VI.A., below.

### B. *International Applications Having a Filing Date Before January 1, 2004*<

International Preliminary Examination is optional, and a Demand for International Preliminary Examination may be filed at any time. However, in order to take advantage of a national phase entry time limit of at least 30 months from the priority date in relation to all States designated in the international application, it may be necessary to file a demand before the expiration of 19 months from the priority date. >See subsection VI.A., below.<

## VI. DEADLINE FOR FILING COPY, TRANSLATION, AND FEE IN NATIONAL STAGE OFFICES

A listing of all national and regional offices, and the corresponding time limits for entering the national stage following PCT Chapter I and PCT Chapter II, may be found on WIPO’s web site at: <http://www.wipo.int/pct/en/index.html>.

### A. *National Stage Entry Following PCT Chapter I*

PCT Article 22(1) was amended, effective April 1, 2002, to specify that the national stage requirements are due not later than at the expiration of 30 months from the priority date if no demand has been filed. Prior to April 1, 2002, PCT Article 22(1) specified that these requirements were due not later than at the expiration of 20 months from the priority date. See <http://www.wipo.int/pct/en/index.html> for a list of the Contracting States that have not yet changed their national laws to adopt the 30 month period now set forth in PCT Article 22(1).

### B. *National Stage Entry Following PCT Chapter II*

If the election of a Contracting State has been effected by filing a demand prior to the expiration of the 19th month from the priority date, the provisions of Article 39 apply rather than the provisions of Article 22. The deadline for filing the national stage requirements under PCT Article 39(a) is 30 months from the priority date, but any national law may fix time limits which expire later than the time limit provided in PCT Article 39(a). See PCT Article 39(b) and the list of time limits found on WIPO's web site at <http://www.wipo.int/pct/en/index.html>.

## 1843 The International Search [R-2]

### *PCT Article 17.*

#### *Procedure before the International Searching Authority*

(1) Procedure before the International Searching Authority shall be governed by the provisions of this Treaty, the Regulations, and the agreement which the International Bureau shall conclude, subject to this Treaty and the Regulations, with the said Authority.

(2)(a) If the International Searching Authority considers:

(i) that the international application relates to a subject matter which the International Searching Authority is not required, under the Regulations, to search, and in the particular case decides not to search, or

(ii) that the description, the claims, or the drawings, fail to comply with the prescribed requirements to such an extent that a meaningful search could not be carried out, the said Authority shall so declare and shall notify the applicant and the International Bureau that no international search report will be established.

(b) If any of the situations referred to in subparagraph (a) is found to exist in connection with certain claims only, the international search report shall so indicate in respect of such claims,

whereas, for the other claims, the said report shall be established as provided in Article 18.

(3)(a) If the International Searching Authority considers that the international application does not comply with the requirement of unity of invention as set forth in the Regulations, it shall invite the applicant to pay additional fees. The International Searching Authority shall establish the international search report on those parts of the international application which relate to the invention first mentioned in the claims (main invention) and, provided the required additional fees have been paid within the prescribed time limit, on those parts of the international application which relate to inventions in respect of which the said fees were paid.

(b) The national law of any designated State may provide that, where the national Office of the State finds the invitation, referred to in subparagraph (a), of the International Searching Authority justified and where the applicant has not paid all additional fees, those parts of the international application which consequently have not been searched shall, as far as effects in the State are concerned, be considered withdrawn unless a special fee is paid by the applicant to the national Office of that State.

\*\*>

### *PCT Rule 43<sup>bis</sup>.*

#### *Written Opinion of the International Searching Authority*

#### *43<sup>bis</sup>.1. Written Opinion*

(a) Subject to Rule 69.1(b<sup>bis</sup>), the International Searching Authority shall, at the same time as it establishes the international search report, establish a written opinion as to:

(i) whether the claimed invention appears to be novel, to involve an inventive step (to be non-obvious), and to be industrially applicable;

(ii) whether the international application complies with the requirements of the Treaty and these Regulations in so far as checked by the International Searching Authority.

The written opinion shall also be accompanied by such other observations as these Regulations provide for.

(b) For the purposes of establishing the written opinion, Articles 33(2) to (6), 35(2) and 35(3) and Rules 43.4, 64, 65, 66.1(e), 66.7, 67, 70.2(b) and (d), 70.3, 70.4(ii), 70.5(a), 70.6 to 70.10, 70.12, 70.14 and 70.15(a) shall apply *mutatis mutandis*.

(c) The written opinion shall contain a notification informing the applicant that, if a demand for international preliminary examination is made, the written opinion shall, under Rule 66.1<sup>bis</sup>(a) but subject to Rule 66.1<sup>bis</sup>(b), be considered to be a written opinion of the International Preliminary Examining Authority for the purposes of Rule 66.2(a), in which case the applicant is invited to submit to that Authority, before the expiration of the time limit under Rule 54<sup>bis</sup>.1(a), a written reply together, where appropriate, with amendments.

The international search is a thorough, high quality search of the most relevant resources. Upon completion of the international search an international search

report is established. The report provides information on the relevant prior art to the applicant, the public, the designated Offices, and the International Preliminary Examining Authority.<

PCT Article 15 describes the objective of the international search, i.e., to uncover relevant prior art, and also describes the international-type search. It should be noted generally that an international-type search is performed on all U.S. national applications filed after June 1, 1978.

\*\*>Some major amendments to the PCT Rules became effective January 1, 2004. One of the consequences of these amendments is that for all international applications having an international filing date on or after January 1, 2004, and subject to PCT Rule 69.1(b-bis), the International Searching Authority establishes a written opinion of the International Searching Authority at the same time it establishes either the international search report or the declaration of non-establishment of the international search report under PCT Article 17(2)(a). (For applications having an international filing date prior to January 1, 2004, the International Searching Authority establishes an international search report but does not establish a written opinion.) The written opinion indicates whether the claimed invention appears to be novel, to involve an inventive step (to be non-obvious), and to be industrially applicable. The written opinion also indicates any defects in the form or content of the international application under the PCT Articles or Regulations. In addition, the written opinion includes any observations that the International Searching Authority wishes to make on the clarity of the claims, the description, and the drawings, or on the question of whether the claims are fully supported by the description.<

>

## **1843.01 Prior Art for Chapter I Processing [R-2]**

### *PCT Rule 33.*

#### *Relevant Prior Art for the International Search*

##### *33.1.Relevant Prior Art for the International Search*

(a) For the purposes of Article 15(2), relevant prior art shall consist of everything which has been made available to the public anywhere in the world by means of written disclosure (including drawings and other illustrations) and which is capable of being of assistance in determining that the claimed invention is or is not

new and that it does or does not involve an inventive step (i.e., that it is or is not obvious), provided that the making available to the public occurred prior to the international filing date.

(b) When any written disclosure refers to an oral disclosure, use, exhibition, or other means whereby the contents of the written disclosure were made available to the public, and such making available to the public occurred on a date prior to the international filing date, the international search report shall separately mention that fact and the date on which it occurred if the making available to the public of the written disclosure occurred on a date which is the same as, or later than, the international filing date.

(c) Any published application or any patent whose publication date is the same as, or later than, but whose filing date, or, where applicable, claimed priority date, is earlier than the international filing date of the international application searched, and which would constitute relevant prior art for the purposes of Article 15(2) had it been published prior to the international filing date, shall be specially mentioned in the international search report.

##### *33.2.Fields to Be Covered by the International Search*

(a) The international search shall cover all those technical fields, and shall be carried out on the basis of all those search files, which may contain material pertinent to the invention.

(b) Consequently, not only shall the art in which the invention is classifiable be searched but also analogous arts regardless of where classified.

(c) The question what arts are, in any given case, to be regarded as analogous shall be considered in the light of what appears to be the necessary essential function or use of the invention and not only the specific functions expressly indicated in the international application.

(d) The international search shall embrace all subject matter that is generally recognized as equivalent to the subject matter of the claimed invention for all or certain of its features, even though, in its specifics, the invention as described in the international application is different.

##### *33.3.Orientation of the International Search*

(a) International search shall be made on the basis of the claims, with due regard to the description and the drawings (if any) and with particular emphasis on the inventive concept towards which the claims are directed.

(b) In so far as possible and reasonable, the international search shall cover the entire subject matter to which the claims are directed or to which they might reasonably be expected to be directed after they have been amended.

### *PCT Rule 64.*

#### *Prior Art for International Preliminary Examination*

##### *64.1.Prior Art*

(a) For the purposes of Article 33(2) and (3), everything made available to the public anywhere in the world by means of written disclosure (including drawings and other illustrations)

shall be considered prior art provided that such making available occurred prior to the relevant date.

(b) For the purposes of paragraph (a), the relevant date will be:

(i) subject to item (ii), the international filing date of the international application under international preliminary examination;

(ii) where the international application under international preliminary examination validly claims the priority of an earlier application, the filing date of such earlier application.

#### 64.2. Non-Written Disclosures

In cases where the making available to the public occurred by means of an oral disclosure, use, exhibition or other non-written means (“non-written disclosure”) before the relevant date as defined in Rule 64.1(b) and the date of such non-written disclosure is indicated in a written disclosure which has been made available to the public on a date which is the same as, or later than, the relevant date, the non-written disclosure shall not be considered part of the prior art for the purposes of Article 33(2) and (3). Nevertheless, the international preliminary examination report shall call attention to such non-written disclosure in the manner provided for in Rule 70.9.

#### 64.3. Certain Published Documents

In cases where any application or any patent which would constitute prior art for the purposes of Article 33(2) and (3) had been published prior to the relevant date referred to in Rule 64.1 was published on a date which is the same as, or later than, the relevant date but was filed earlier than the relevant date or claimed the priority of an earlier application which had been filed prior to the relevant date, such published application or patent shall not be considered part of the prior art for the purposes of Article 33(2) and (3). Nevertheless, the international preliminary examination report shall call attention to such application or patent in the manner provided for in Rule 70.10.

The objective of the international search is to discover relevant prior art (PCT Article 15(2)). “Prior art” consists of everything which has been made available to the public anywhere in the world by means of written disclosure (including drawings and other illustrations); it is relevant in respect of the international application if it is capable of being of assistance in determining that the claimed invention is or is not new and that the claimed invention does or does not involve an inventive step (i.e., that it is or is not obvious), and if the making available to the public occurred prior to the international filing date for the purposes of the international search report and prior to the earliest validly claimed priority date for the purposes of the written opinion of the International Searching Authority. For further details, see PCT Rules 33, 43<sup>bis</sup>.1(b) and 64.

A written disclosure, that is, a document, is regarded as made available to the public if, at the relevant date, it was possible for members of the public to gain access to the content of the document and to acquire possession of the content of the document, and there was no bar of confidentiality restricting the use or dissemination of knowledge gained thereby. Where the document only provides the month or the year, but not the specific date, which the document was made available to the public, the content of the document is presumed to have been made available to the public on the last day of that month or that year, respectively, unless evidence is provided to prove otherwise.

Prior art disclosure on the Internet or on an on-line database is considered in the same manner as other forms of written disclosure. Information disclosed on the Internet or an on-line database is considered to be publicly available as of the date the disclosure was publicly posted. Where the examiner obtains an electronic document that establishes the publication date for the Internet disclosure, he/she should make a printout of this document, which must mention both the URL of the relevant Internet disclosure and the date of publication of that relevant Internet disclosure. The examiner must then cite this printout in the international search report as an “L” document and cite the relevant Internet disclosure according to the relevance of its content (“X”, “Y”, “A”) and according to the date as established (“X”, “Y”, “A”, “P,X”, “P,Y”, “P,A”, “E”, etc.). See MPEP § 1844.01 under the heading “DOCUMENTS CONSIDERED TO BE RELEVANT.” Where the examiner is unable to establish the publication date of the relevant Internet disclosure and it is relevant to the inventive step and/or novelty of the claimed invention, he/she should cite it in the international search report as a category “L” document for those claims which it would have affected if it were published in time, giving the date the document was printed out as its publication date.

Examiners are also encouraged to cite prior art that might be of assistance in determining whether other requirements are fulfilled, such as sufficient support of the claims by the description and industrial applicability. The examiner should also note any documents that may be of importance for other reasons, such as documents putting doubt upon the validity of any priority claimed, documents contributing to a better or

more correct understanding of the claimed invention, and documents illustrating the technological background, but the examiner should not spend time in searching for these documents, nor the consideration of such matters unless there is a special reason for doing so in a particular case. Documents which do not qualify as prior art because they post-date the claimed invention may nevertheless be cited to show a universal fact, such as characteristics or properties of a material, or a specific scientific fact, or to show the level of ordinary skill in the art. Furthermore, examiners must recognize that different designated Offices may have different definitions of what is the effective date of prior art. Accordingly, when performing the search, examiners should be mindful to pick out and select for citation, where appropriate, prior art which may be relevant in offices other than the one in which they are situated. However, the examiner need not expand the search beyond the standard search parameters to discover such art. Where the search has been performed and such potentially relevant prior art has been identified, examiners are encouraged to, for example, cite all relevant art published prior to the international filing date even if that art and the international application under consideration have common applicants and/or inventors. As such, if the examiner is basing the international search on a prior search performed in a prior related U.S. national application, it may be necessary for the examiner to review the prior art published within the time period of the one year preceding the filing date of the prior U.S. application for any written disclosures based on the applicant's own work that may have been published within that time period. Any such documents are considered prior art in an international application and are cited on the international search report even though they do not meet the definition of prior art in the prior U.S. national application. A further objective of the international search is to avoid, or at least minimize, additional searching at the national stage.

The international search is made on the basis of the claims, with due regard to the description and the drawings (if any) contained in the international application (PCT Article 15(3)) and should cover the entire subject matter to which the claims are directed or to which they might reasonably be expected to be directed after they have been amended (PCT Rule 33.3(b)).

The relevant date for the purpose of considering prior art for the purposes of establishment of the written opinion of the International Searching Authority is defined in PCT Rule 64.1(b) as the international filing date or, where the international application contains a valid claim for priority, that date of priority.

In establishment of the written opinion, when determining whether there is inventive step, account should be taken of what the applicant acknowledges in his/her description as known. Such admissions should be regarded as correct and used when considering whether the claimed invention lacks novelty and/or inventive step where appropriate.

A nonwritten disclosure such as an oral disclosure, use, exhibition or other means of disclosure is not relevant prior art for the purposes of the international search unless it is substantiated by a written disclosure made available to the public prior to the international filing date and it is the written disclosure which constitutes the prior art. However, if the date on which the written disclosure was made available to the public was on or after the filing date of the international application under consideration, the search report should separately mention that fact and the date on which the written disclosure was available, even though such a written disclosure does not meet the definition of relevant prior art in the international phase, so long as the non-written disclosure was made available to the public on a date prior to the international filing date since such a non-written disclosure may be considered to be prior art under national law in the national phase. See PCT Rules 33.1(b), 64.2 and 70.9.<

#### **DOCUMENTS >AND DATABASES< SEARCHED BY THE INTERNATIONAL SEARCHING AUTHORITY**

The International Searching Authority must endeavor to discover as much of the relevant prior art as its facilities permit (PCT Article 15(4)), and, in any case, must consult the so-called "minimum documentation" (PCT Rule 34).

\*\*>Even though completeness should be the ultimate goal of the international search, this goal may at times be difficult to obtain, because of such factors as text search limitations and the inevitable imperfections of any classification system and its implementation. The examiner therefore consults the appropriate

minimum documentation and the most relevant search resources for the technology, including databases listed in the U.S. Search Guidance index (available through the USPTO Intranet web site), and organizes the search effort and utilizes the search time in such a manner as to reduce to a minimum the possibility of failing to discover existing highly relevant prior art, such as art that fully anticipates any claims.

When conducting the search, it may be necessary to make use of the Internet as a search tool. Where the international application has not yet been published at the time of the search, there exists the danger that search terms used in the search on non-secure Internet search engines or in databases available on the Internet may be observed by third parties. Accordingly, all web sites must be treated as non-secure unless the Office has a commercial arrangement with a service provider in order to maintain confidentiality and a secure connection to that web site. Consequently, extreme caution must be exercised when using the Internet as a search tool where (as in most cases) the international application has not yet been published. Where a relevant database is accessible via the Internet, but an alternative secure connection to the same database is accessible, the secure connection must be used. Where no secure connection to a database on the Internet is available, the search may be conducted on the Internet using generalized search terms representing combinations of features that relate to the claimed invention, which have already been shown to exist in the state of the art.

## 1843.02 < Certain Subject Matter Need Not Be Searched [R-2]

>

*PCT Rule 39.*

*Subject Matter under Article 17(2)(a)(i)*

### 39.1. Definition

No International Searching Authority shall be required to search an international application if, and to the extent to which, its subject matter is any of the following:

- (i) scientific and mathematical theories,
- (ii) plant or animal varieties or essentially biological processes for the production of plants and animals, other than micro-biological processes and the products of such processes,

- (iii) schemes, rules or methods of doing business, performing purely mental acts or playing games,
- (iv) methods for treatment of the human or animal body by surgery or therapy, as well as diagnostic methods,
- (v) mere presentations of information,
- (vi) computer programs to the extent that the International Searching Authority is not equipped to search prior art concerning such programs.

*PCT Rule 66.*

*Procedure Before the International Preliminary Examining Authority*

### 66.1. Basis of the International Preliminary Examination

\*\*\*\*\*

- (e) Claims relating to inventions in respect of which no international search report has been established need not be the subject of international preliminary examination.

*PCT Rule 67.*

*Subject Matter Under Article 34(4)(a)(i)*

### 67.1. Definition

No International Preliminary Examining Authority shall be required to carry out an international preliminary examination on an international application if, and to the extent to which, its subject matter is any of the following:

- (i) scientific and mathematical theories,
- (ii) plant or animal varieties or essentially biological processes for the production of plants and animals, other than micro-biological processes and the products of such processes,
- (iii) schemes, rules, or methods of doing business, performing purely mental acts, or playing games,
- (iv) methods for treatment of the human or animal body by surgery or therapy, as well as diagnostic methods,
- (v) mere presentations of information,
- (vi) computer programs to the extent that the International Preliminary Examining Authority is not equipped to carry out an international preliminary examination concerning such programs.<

The USPTO has declared that it will search and examine, in international applications, all subject matter searched and examined in U.S. national applications. However under PCT \*>Rules< 39, >43<sup>bis</sup>.1(b), 66.1(e) and 67.1,< no International Searching Authority is required to perform an international search >or to establish a written opinion concerning novelty, inventive step and industrial applicability< where the international application relates to any of the following subject matters:

- (A) Scientific and mathematical theories;

(B) Plant or animal varieties or essentially biological processes for the production of plants and animals, other than microbiological processes and the products of such processes;

(C) Schemes, rules or methods of doing business, performing purely mental acts or playing games;

(D) Methods for treatment of the human or animal body by surgery or therapy, as well as diagnostic methods;

(E) Mere presentation of information; and

(F) Computer programs to the extent \*\* the said Authority is not equipped to search prior art \*\*>concerning such programs<.

>See PCT Rule 39. In addition, the examiner is not required to search the international application, to the extent that a meaningful search cannot be carried out, in certain cases where a nucleotide and/or amino acid sequence listing is not furnished in accordance with the prescribed standard or in a computer readable form. See Administrative Instructions Section 513(c). However, the U.S. Patent and Trademark Office has declared that it will search and examine all subject matter searched and examined in U.S. national applications.<

The applicant considering the filing of an international application may be well advised not to file one if the subject matter of the application falls into one of the above mentioned areas. If he or she still does file, the International Searching Authority may declare that it will not establish an international search report. Accordingly, applicant should take into consideration which International Searching Authority (e.g., European Patent Office) he or she selects to conduct the international search. It is to be noted, nevertheless, that the lack of the international search report in such case will not have, in itself, any influence on the validity of the international application and the latter's processing will continue, including its communication to the designated Offices.

>

### **1843.03 < No Search Required if Claims Are Unclear [R-2]**

If the International Searching Authority considers that the description, the claims, or the drawings fail to comply with the prescribed requirements to such an extent that a meaningful search could not be carried

out, it may declare that it will not establish a search report (PCT Article 17(2)(a)(ii)). \*\*>Further, for applications having an international filing date on or after January 1, 2004, if the International Searching Authority considers that the description, claims, or drawings are so unclear, or the claims are so inadequately supported by the description that no meaningful opinion can be formed on the novelty, inventive step (non-obviousness), or industrial applicability of the claimed invention, the Authority shall not go into these issues in its written opinion with regard to the claims so affected (PCT Rules 43<sup>bis</sup>.1(b) and 67). For example, the examiner may determine that a meaningful search cannot be carried out or that no meaningful opinion can be formed in certain cases where a nucleotide and/or amino acid sequence listing is not furnished in accordance with the prescribed standard or in a computer readable form. See Administrative Instructions Section 513(c) and MPEP § 1848. Further, the examiner may determine that a meaningful search cannot be carried out or that no meaningful opinion can be formed for improper multiple dependent claims (see PCT Rule 6.4(a)).<

>

### **1843.04 Procedure for Claims Not Required To Be Searched and for Claims That Are Unclear [R-2]**

The International Searching Authority (ISA) may declare that a meaningful search cannot be carried out with respect to some of the claims only and/or that only certain claims relate to subject matter which the ISA is not required to and has decided not to search. Where only some of the claims will not be searched, the ISA searches the remaining claims of the international application. Any unsearched claims and the reasons why those claims have not been searched are indicated in Box II of the international search report (Form PCT/ISA/210).

If the examiner determines that none of the claims will be searched, the examiner declares that no search report will be established using form PCT/ISA/203. The lack of the international search report will not, in itself, have any influence on the validity of the international application and the latter's processing will continue, including its communication to the designated Offices.

If the international application cites a document that is not published or otherwise not accessible to the ISA and the document appears essential to a correct understanding of the invention to the extent that a meaningful international search would not be possible without knowledge of the content of that document, the ISA may postpone the search and request that the applicant first provide first a copy of the document, if possible to do so within the time limits for the preparation of the international search report of the ISA under the PCT. If no copy of the document is received, the ISA should first attempt to carry out the international search and then, if necessary, indicate that no meaningful search could be carried out in total or that the search needed to be restricted.

For international applications having an international filing date on or after January 1, 2004, and subject to PCT Rule 69.1(b-*bis*), the ISA establishes the written opinion of the International Searching Authority (Form PCT/ISA/237) at the same time it establishes either the international search report (Form PCT/ISA/210) or the declaration of non-establishment of the international search report (Form PCT/ISA/203). However, if the ISA determines that for any or all claims (A) the international application relates to subject matter for which it is not required to establish a written opinion concerning novelty, inventive step and industrial applicability, (B) the description, claims, or drawings, are so unclear, or the claims are so inadequately supported by the description, that no meaningful opinion can be formed on the novelty, inventive step, or industrial applicability, of the claimed invention, or (C) the subject matter of the claims relates to inventions for which no international search report will be established, the ISA indicates, in Box III of the written opinion of the International Searching Authority (Form PCT/ISA/237), that no opinion with regard to novelty, inventive step or industrial applicability will be established with regard to those claims. In most instances it will be sufficient for the examiner to (A) indicate that no international search report has been established for the relevant claims as the reason for not establishing an opinion on novelty, inventive step, and industrial applicability and (B) refer to the international search report or declaration of non-establishment of the international search report for further details.<

&gt;

### **1843.05 Time Limit for Establishing the International Search Report and the Written Opinion of the International Searching Authority [R-2]**

Publication of the international application occurs at 18 months from the earliest priority date or, where there is no priority date, 18 months from the international filing date. The international search report is subject to international publication. The written opinion is not published but is made available to the public after the expiration of 30 months from the priority date. See PCT Rule 44<sup>ter</sup>. The Office goal is to have the search report and, if the application has an international filing date on or after January 1, 2004, the written opinion, mailed in sufficient time to reach the International Bureau by the end of 16 months from the priority date or 9 months from the filing date if no priority claim is made. This is necessary since the technical preparations for publication are completed by 17.5 months from the earliest priority date. In view of the treaty mandated publication and the time needed for technical preparation, the Office sets time periods for completion of the search report and the written opinion which will ensure sufficient time to complete internal processing and review and achieve receipt of the search report and the written opinion at the International Bureau by the 16th month from the priority date. See PCT Rule 42.1 and 43<sup>bis</sup>.1(a).

Thus, as a matter of practice, each Technology Center tends to set its internal time period for completion of the search report and the written opinion to meet the time limits set by the International Application Processing Division. The International Application Processing Division sets its time for completion to ensure adequate time for review, corrections (where necessary) and mailing.

The date of transmittal of the search report becomes critical for applicants since it starts the 2 month period for submission of amendments to the claims under PCT Article 19. See PCT Rule 46.1.

The Patent Cooperation Treaty is extremely date sensitive and for that reason, examiners are encouraged to complete the international search and prepare the search report, and in applications having an inter-



national filing date filed on or after January 1, 2004, the written opinion, promptly after receipt. Monitoring and tracking procedures have been devised to minimize the risk of late search reports and written opinions and/or date of transmission thereof.<

## 1844 The International Search Report [R-2]

*PCT Article 18.*

*The International Search Report*

(1) The international search report shall be established within the prescribed time limit and in the prescribed form.

(2) The international search report shall, as soon as it has been established, be transmitted by the International Searching Authority to the applicant and the International Bureau.

(3) The international search report or the declaration referred to in Article 17(2)(a) shall be translated as provided in the Regulations. The translations shall be prepared by or under the responsibility of the International Bureau.

The results of the international search **\*\*>are<** recorded in the international search report (Form PCT/ISA/210), which>, together with the written opinion of the International Searching Authority (Form PCT/ISA/237) for applications having an international filing date on or after January 1, 2004,< is transmitted with Form PCT/ISA/220**\*\***. The search report will be published by the International Bureau and>, together with the written opinion of the International Searching Authority,< will serve as a basis for examination of the international application by the designated Offices and the International Preliminary **>Examining<** Authority.

**\*\***

The search report >is only for the purpose of identifying prior art and< should not contain any expressions of opinion, reasoning, argument or explanation as to any cited prior art. **\*\*>**However, in applications having an international filing date on or after January 1, 2004, such comments should be included in the written opinion of the International Searching Authority.<

The printed international search report form (Form PCT/ISA/210) to be transmitted to the applicant and to the International Bureau contains two main sheets (“first sheet” and “second sheet”) to be used for all searches. These two main sheets are intended for recording the important features of the search such as the fields searched and for citing documents revealed

by the search. The printed international search report form also contains **>five<** optional continuation sheets for use where necessary. **\*\*>**They are the: “continuation of first sheet (1),” “continuation of first sheet (2),” “continuation of first sheet (3),” “continuation of second sheet” and “patent family annex,” respectively.< The patent family annex sheet is not currently used by the United States International Searching Authority since patent family information is not readily available to the examiner. The “continuation of first sheet (1)” is to be used only >when the international application includes a nucleotide and/or amino acid sequence and indicates the basis on which the international search was carried out, since the relevant listings or related tables may be filed or furnished at different times and in different forms. The “continuation of first sheet (2)” is used where< an indication is made on the first sheet that claims were found unsearchable (item **>2<**) and/or unity of invention is lacking (item **>3<**). The relevant indications must then be made on that continuation sheet. The “continuation of first sheet (**>3<**)” is to contain the text of the abstract where an abstract or an amended abstract has been established by the International Searching Authority (item 5) and an indication to that effect is made on the first sheet. The “continuation of second sheet” is to be used where the space on the second sheet is insufficient for the citation of documents. **\*\*>**The form also includes an< “extra sheet” >which< may be used whenever additional space is required to complete information from the other sheets.

It is to be noted that only the “second sheet”, the “continuation of second sheet” (if any)**\*\*>**, the “continuation of first sheet (2)” (if any), and the “extra sheet” (if any), as well as any separate sheet with information on members of patent families, will be the subject of international publication, as the “first sheet,” “continuation of first sheet (1)” (if any), and the “continuation of first sheet (3)” (if any)< contain only information which will already appear on the front page of the pamphlet >(PCT Rule 48.2(v))<.

**\*\***

## CONTENTS OF THE INTERNATIONAL SEARCH REPORT

The international search report (PCT Rule 43) contains, among other things, the citations of the docu-

ments considered to be relevant (PCT Rule 43.5 and Administrative Instructions Section 503), the classification of the subject matter of the invention (PCT Rule 43.3 and Administrative Instructions Section 504) and an indication of the fields searched (PCT Rule 43.6). Citations of particular relevance must be specially indicated (Administrative Instructions Section 505); citations of certain specific categories of documents are also indicated (Administrative Instructions Section 507); citations which are not relevant to all the claims must be cited in relation to the claim or claims to which they are relevant (Administrative Instructions Section 508); if only certain passages of the cited document are particularly relevant, they must be identified, for example, by indicating the page, the column or the lines, where the passage appears.

### **1844.01 \*\*>Preparing < the International Search Report >(Form PCT/ISA/210)< [R-2]**

#### **>TOTAL NUMBER OF SHEETS**

The first sheet of the international search report indicates the total number of sheets in the report. The correct number is entered, not including sheets that have not been filled-in (blank sheets). The number of sheets only includes the number of sheets from Form PCT/ISA/210.

#### **NUCLEOTIDE AND/OR AMINO ACID SEQUENCE LISTINGS AND RELATED TABLES**

Where the application discloses any nucleotide and/or amino acid sequence, box 1.b of the first sheet is checked and Box No. I (appearing on “continuation of first sheet (1)”) indicates the format (that is, whether in paper copy or computer readable form) and status (that is whether filed with the international application or later, for purposes of search) of the sequence listing, and any related tables.

#### **RESTRICTION OF THE SUBJECT OF THE INTERNATIONAL SEARCH**

The report indicates whether the search was restricted or not for any of the reasons indicated

below. If any such restrictions are applied, the claims in respect of which a search has not been carried out are identified and the reasons for this are indicated. The four categories where such restrictions may arise are:

(A) claims drawn to subject matter not required to be searched by the International Searching Authority (see MPEP § 1843.02);

(B) claims in respect of which a meaningful search cannot be carried out (see MPEP § 1843.03);

(C) multiple dependent claims which do not comply with PCT Rule 6.4(a) (see MPEP § 1843.03);

(D) lack of unity of invention (see MPEP § 1850).

Where claims are not searched for any of the reasons identified in (A)-(C) above, box 2 of the first sheet of the international search report is checked. In addition, Box No. II of the international search report (on “continuation of first sheet (2)”) is completed, giving the details.

Where lack of unity has been found (see MPEP § 1850), box 3 of the first sheet of the international search report is checked. In addition, Box No. III of the international search report (on “continuation of first sheet (2)”) is completed, irrespective of whether an invitation to pay additional search fees has issued. The search report indicates the separate inventions claimed in the application, whether additional search fees were requested and paid, and which claims were searched. It also indicates whether any additional search fees were accompanied by a protest.

#### **TITLE, ABSTRACT, AND FIGURE FOR PUBLICATION**

The international application must contain an abstract and a title. The examiner considers the abstract (together with the title of the invention and the figure of the drawings to be published with the abstract) in relation to the requirements of the Regulations under the PCT. The examiner indicates approval or amendment of the text of the abstract, the title of the invention, and the selection of the figure that is to accompany the abstract in items 4 to 6 of the first sheet of the international search report.

**A. Title***PCT Rule 4.  
The Request (Contents)*

\*\*\*\*\*

**4.3. Title of the Invention**

The title of the invention shall be short (preferably from two to seven words when in English or translated into English) and precise.

\*\*\*\*\*

*PCT Rule 37.  
Missing or Defective Title***37.1. Lack of Title**

If the international application does not contain a title and the receiving Office has notified the International Searching Authority that it has invited the applicant to correct such defect, the International Searching Authority shall proceed with the international search unless and until it receives notification that the said application is considered withdrawn.

**37.2. Establishment of Title**

If the international application does not contain a title and the International Searching Authority has not received a notification from the receiving Office to the effect that the applicant has been invited to furnish a title, or if the said Authority finds that the title does not comply with Rule 4.3, it shall itself establish a title. Such title shall be established in the language in which the international application is to be published or, if a translation into another language was transmitted under Rule 23.1(b) and the International Searching Authority so wishes, in the language of that translation.

The title must be short and precise (preferably from two to seven words in English or when translated into English). Furthermore, the title should clearly and concisely state the technical designation of the invention. In this regard the following should be taken into account:

(A) personal names or trade names or similar terms of non-technical nature which do not serve to identify the invention should not be used;

(B) the abbreviation “etc.,” being vague, should not be used and should be replaced by an indication of what it is intended to cover;

(C) titles such as “Method,” “Apparatus,” “Chemical Compounds” alone or similar vague titles do not clearly state the technical designation of the invention and should not be used.

In general, the examiner is required to draft a new title if the applicant failed to provide a title or if the title is deficient because it does not comply with the requirements of PCT Rule 4.3. The examiner is not required to gain the applicant’s approval of the new title established by the examiner.

**B. Abstract and Figure for Publication***PCT Rule 8.  
The Abstract***8.1. Contents and Form of the Abstract**

(a) The abstract shall consist of the following:

(i) a summary of the disclosure as contained in the description, the claims, and any drawings; the summary shall indicate the technical field to which the invention pertains and shall be drafted in a way which allows the clear understanding of the technical problem, the gist of the solution of that problem through the invention, and the principal use or uses of the invention;

(ii) where applicable, the chemical formula which, among all the formulae contained in the international application, best characterizes the invention.

(b) The abstract shall be as concise as the disclosure permits (preferably 50 to 150 words if it is in English or when translated into English).

(c) The abstract shall not contain statements on the alleged merits or value of the claimed invention or on its speculative application.

(d) Each main technical feature mentioned in the abstract and illustrated by a drawing in the international application shall be followed by a reference sign, placed between parentheses.

**8.2. Figure**

(a) If the applicant fails to make the indication referred to in Rule 3.3(a)(iii), or if the International Searching Authority finds that a figure or figures other than that figure or those figures suggested by the applicant would, among all the figures of all the drawings, better characterize the invention, it shall, subject to paragraph (b), indicate the figure or figures which should accompany the abstract when the latter is published by the International Bureau. In such case, the abstract shall be accompanied by the figure or figures so indicated by the International Searching Authority. Otherwise, the abstract shall, subject to paragraph (b), be accompanied by the figure or figures suggested by the applicant.

(b) If the International Searching Authority finds that none of the figures of the drawings is useful for the understanding of the abstract, it shall notify the International Bureau accordingly. In such case, the abstract, when published by the International Bureau, shall not be accompanied by any figure of the drawings even where the applicant has made a suggestion under Rule 3.3(a)(iii).

*PCT Rule 38.**Missing or Defective Abstract**38.1.Lack of Abstract*

If the international application does not contain an abstract and the receiving Office has notified the International Searching Authority that it has invited the applicant to correct such defect, the International Searching Authority shall proceed with the international search unless and until it receives notification that the said application is considered withdrawn.

*38.2.Establishment of Abstract*

(a) If the international application does not contain an abstract and the International Searching Authority has not received a notification from the receiving Office to the effect that the applicant has been invited to furnish an abstract, or if the said Authority finds that the abstract does not comply with Rule 8, it shall itself establish an abstract. Such abstract shall be established in the language in which the international application is to be published or, if a translation into another language was transmitted under Rule 23.1(b) and the International Searching Authority so wishes, in the language of that translation.

(b) The applicant may, within one month from the date of mailing of the international search report, submit comments on the abstract established by the International Searching Authority. Where that Authority amends the abstract established by it, it shall notify the amendment to the International Bureau.

In general, the examiner will have to establish a new abstract if the applicant did not provide an abstract or if the abstract does not comply with PCT Rule 8. In determining the definitive contents of the abstract, or establishing the text of the abstract anew where it is missing, the examiner should take into consideration the fact that the abstract is merely for use as technical information and, in particular, must not be used for the purpose of interpreting the scope of the protection sought. The abstract constitutes an efficient instrument for the purpose of assisting the scientist, engineer, or researcher in searching in the particular technical field and should in particular make it possible to assess whether there is need for consulting the international application itself. WIPO guidelines for the preparation of abstracts are found in WIPO Standard ST.12/A, which is available from WIPO's web site ([www.wipo.int/scit/en/standards/standards.htm](http://www.wipo.int/scit/en/standards/standards.htm)).

In considering the adequacy of the applicant's abstract and figure, because of practical difficulties experienced by the International Bureau with publica-

tion, examiners should have particular regard to the following:

(A) It is important that the abstract be as concise as the disclosure permits (preferably 50 to 150 words if it is in English or when translated into English). Within this constraint the abstract must provide a summary of the technical information about the disclosure as contained in the description, claims, and drawings. It should be drafted so as to serve as an efficient scanning tool for searching purposes in the art.

(B) Phrases should not be used which can be implied, such as "This disclosure concerns," "The invention defined by this disclosure," and "This invention relates to."

(C) Only one figure should normally be selected unless this would lead to inadequate disclosure. The inclusion of more than two figures should not be considered except in extreme circumstances where necessary information cannot be otherwise conveyed. Where none of the figures is considered useful for the understanding of the invention (even where the applicant has suggested a figure), no figure should be selected.

(D) Abstracts may be incomprehensible if the numerals of the selected figure(s) do not correspond with those in the abstract. Thus, this should be avoided.

(E) An absence of reference numbers on the figures must be accepted as the examiner has no mechanism to initiate their addition.

(F) Each main technical feature mentioned in the abstract and illustrated by a drawing should be followed by a reference sign, placed between parentheses.

If the examiner establishes a new abstract, the applicant can only comment on the new abstract after it has been established in the international search report. The applicant is allowed one month from the date of mailing of the international search report to respond to the examiner's abstract in the report. If the applicant does comment, the examiner takes the applicant's comments into consideration. It is not necessary for the examiner to reply to the applicant's comments even if adverse. If the examiner decides to amend the abstract established in the international search report, the International Bureau and the applicant are notified using Form PCT/ISA/205. See PCT

Rule 38.2(b) and Administrative Instructions Section 515.

When indicating the figure to be published, the applicant's suggestion is found in Box IX of the request Form (PCT/RO/101). Where none of the figures is considered useful for the understanding of the abstract, this is indicated at the appropriate box (item 6 of the first sheet of Form PCT/ISA/210). When no drawings accompany the application, none of the boxes are checked. It is not recommended to select more than one figure; however, if it is necessary to do so then the wording of the form should be changed to reflect the change from single case to plural case. For example, "figure" is changed to "figures", "is" to "are" and No. "to Nos.".

### CLASSIFICATION OF SUBJECT MATTER

The International Searching Authority assigns obligatory International Patent Classification (IPC) symbols in accordance with the rules as set forth in the Guide to the IPC and in the IPC itself (using the edition of the IPC in force at the time), whereby the technical subject of the invention of the application is identified. The International Searching Authority then records the International Patent Classification in Box A of the second sheet of the international search report. The IPC Guide can be accessed via the Patent Examiner's Toolkit under Classification Tools or via WIPO's web site ([www.wipo.int](http://www.wipo.int)).

### RECORDING THE SEARCH

The examiner records the search history in Box B of the second sheet of the international search report. In recording the search history of the international search, the examiner lists the classification identification of the fields searched. Examiners are also encouraged to record the search history in sufficient detail to allow examiners of national stage applications to fully interpret and rely upon the international search. This includes recording the details of any patent and non-patent literature searches as well as searches conducted on the Internet.

Where the international search report is entirely or partly based on a previous search made for an application relating to a similar subject, the previous application number and the relevant search history consulted for this previous search is, where appropriate, identified as having been consulted for the international

application in question, except in those instances where the details of an earlier search cannot be ascertained, or whenever it is impractical to record the full details of the earlier search. In the later case, a summary of the earlier search should be included. Where the previous application has been published, this information is recorded in the international search report.

### DOCUMENTS CONSIDERED TO BE RELEVANT

The completion of Box C of the second sheet of the international search report can be considered as having three components. These are: (A) the citation category; (B) the citation of the document together with identification of the relevant passages where appropriate; and (C) the identification of relevant claim numbers. The citation of multiple documents showing the same inventive elements should be kept to a minimum. Further, when citing a document, the examiner should clearly indicate which portions of the document are most relevant.

#### A. *Citation Category*

Documents which are cited are given a category indication by way of an alphabetic character, details of which are given in Administrative Instructions Sections 505 and 507 and below. The categories for citations are also explained under the "documents considered to be relevant" section of the report. A category should always be indicated for each document cited. Where needed, combinations of different categories are possible.

#### 1. **Particularly Relevant Documents**

Where a document cited in the international search report is particularly relevant, it is indicated by the letters "X" or "Y". Category "X" is applicable where a document is such that when taken alone, a claimed invention cannot be considered novel or where a document is such that when considered in light of common general knowledge, a claimed invention cannot be considered to involve an inventive step. Category "Y" is applicable where a document is such that a claimed invention cannot be considered to involve an inventive step when the document is combined with one or more other documents of the same category,

such combination being obvious to a person skilled in the art.

## 2. Documents Defining the State of the Art and Not Prejudicing Novelty or Inventive Step

Where a document cited in the international search report represents state of the art and is not prejudicial to the novelty or inventive step of the claimed invention, it is indicated by the letter “A”.

## 3. Documents Which Refer to a Non-Written Disclosure

Where a document cited in the international search report refers to a non-written disclosure referred to in PCT Rule 33.1(b), the letter “O” is entered. Examples of such disclosures include conference proceedings. The document category “O” is always accompanied by a symbol indicating the relevance of the document, for example: “O,X”, “O,Y”, or “O,A”.

## 4. Intermediate Documents

Documents published on dates falling between the date of filing of the application being searched and the date of priority claimed, or the earliest priority if there is more than one (see PCT Article 2(xi)(b)), are denoted by the letter “P”. The letter “P” is also given to a document published on the very day of the earliest date of priority of the patent application under consideration. The document category “P” is always accompanied by a symbol indicating the relevance of the document, for example: “P,X”, “P,Y”, or “P,A”.

## 5. Documents Relating to the Theory or Principle Underlying the Invention

Where any document cited in the search report is a document that may be useful for a better understanding of the principle or theory underlying the invention, or is cited to show that the reasoning or the facts underlying the invention are incorrect, it is indicated by the letter “T”.

## 6. Potentially Conflicting Patent Documents

Any patent document bearing a filing or priority date earlier than the filing date of the application searched (not the priority date) but published on or later than that date and the content of which would constitute prior art relevant to novelty (PCT Article

33(2)) is indicated by the letter “E” (see Administrative Instructions Section 507(b) and PCT Rule 33.1(c)).

## 7. Documents Cited in the Application

When the search report cites documents already mentioned in the description of the patent application for which the search is carried out, such documents may be identified on the search report by the wording “cited in the application” under the cited document.

## 8. Documents Cited for Other Reasons

Where in the search report any document is cited for reasons other than those referred to in the foregoing paragraphs (in particular as evidence), for example:

(A) a document which may throw doubt on a priority claim (Article 4(C)(4) of the Paris Convention), or

(B) a document cited to establish the publication date of another citation,

the document is indicated by the letter “L”. Brief reasons for citing the document should be given. Documents of this type need not be indicated as relevant to any particular claims. However, where the evidence that they provide relates only to certain claims (for example the “L” document cited in the search report may invalidate the priority in respect of certain claims and not others), then the citation of the document should refer to those claims.

### B. Relationship Between Documents and Claims

Each citation should include a reference to the claims to which it relates (see Administrative Instructions Section 508). If necessary, various relevant parts of the document cited should each be related to the claims in like manner (with the exception of “L” documents and “A” documents). It is also possible for the same document to represent a different category with respect to different claims. For example:

WO1990/001867 A (WIDEGREN LARS (SE)) 8  
March 1990 (08-03-1990), figures 1 and 2

X 1  
Y 2-5  
A 6-10

The above example means that Figures 1 and 2 of the cited document disclose subject matter which

prejudices the novelty or inventive step of claim 1, which prejudices the inventive step of claims 2-5 when combined with another document cited in the search report, and which represents non-prejudicial state of the art for the subject matter of claims 6-10.

### **C. Citation of the Documents**

Identification of any document should be made according to WIPO Standard ST.14 (see Administrative Instructions Section 503). For “A” citations it is not necessary to indicate the relevant claims unless there is good reason to do so; for example where there is a clear lack of unity *a priori* (see MPEP § 1850) and the citation is relevant only to a particular claim or group of claims or when the claims meet the criteria of novelty, inventive step, and industrial applicability under PCT Article 33(2) to (4) and the “A” category citations represent the most relevant prior art. The box on the second sheet of Form PCT/ISA/210 entitled “Further documents listed are in the continuation of Box C” is checked if a continuation sheet is used to list additional documents that will not fit in the space provided in Box C.

### **FINALIZATION OF THE SEARCH REPORT**

The identification of the International Searching Authority which established the international search report and the date of actual completion, that is, the

date on which the report was drawn up are indicated at the bottom of the second sheet of the international search report. This information is generated automatically by the OACS software when preparing the international search report. The international search report will be accompanied by a transmittal letter (Form PCT/ISA/220) indicating the date the search report was mailed to the applicant. The mailing date is important for the computation of the time limit for filing amendments to the claims under PCT Article 19. See MPEP § 1853.

Pursuant to PCT Rule 43.8, the international search report must indicate the name of the officer of the International Searching Authority responsible for the report, i.e., the “authorized officer.” An “authorized officer” is the person who actually performed the search work and prepared the search report, or another person who was responsible for supervising the search. See Administrative Instructions Section 514. Thus, an examiner need not have signatory authority in order to be named as an authorized officer on the search report. However, the “file copy” of the search report must be signed by an examiner having at least partial signatory authority.

The international search report should be mailed within 3 months of receipt of the search copy or within 9 months from the priority date, whichever is later.

\*\*

PATENT COOPERATION TREATY

**PCT**

INTERNATIONAL SEARCH REPORT

(PCT Article 18 and Rules 43 and 44)

Applicant's or agent's file reference CMC-123-PCT	<b>FOR FURTHER ACTION</b>	see Form PCT/ISA/220 as well as, where applicable, item 5 below.
International application No. PCT/US04/00150	International filing date (day/month/year) 05 January 2004 (05.01.2004)	(Earliest) Priority Date (day/month/year) 06 January 2003 (06.01.2003)
Applicant ACME FASTENER CORPORATION		

This international search report has been prepared by this International Searching Authority and is transmitted to the applicant according to Article 18. A copy is being transmitted to the International Bureau.

This international search report consists of a total of 4 sheets.

It is also accompanied by a copy of each prior art document cited in this report.

1. **Basis of the report**

a. With regard to the **language**, the international search was carried out on the basis of the international application in the language in which it was filed, unless otherwise indicated under this item.

The international search was carried out on the basis of a translation of the international application furnished to this Authority (Rule 23.1(b)).

b.  With regard to any **nucleotide and/or amino acid sequence** disclosed in the international application, see Box No. I.

2.  **Certain claims were found unsearchable** (see Box No. II)

3.  **Unity of invention is lacking** (see Box No. III)

4. With regard to the **title**,

the text is approved as submitted by the applicant.

the text has been established by this Authority to read as follows:

5. With regard to the **abstract**,

the text is approved as submitted by the applicant.

the text has been established, according to Rule 38.2(b), by this Authority as it appears in Box No. IV. The applicant may, within one month from the date of mailing of this international search report, submit comments to this Authority.

6. With regard to the **drawings**,

a. the figure of the **drawings** to be published with the abstract is Figure No. 3

as suggested by the applicant.

as selected by this Authority, because the applicant failed to suggest a figure.

as selected by this Authority, because this figure better characterizes the invention.

b.  none of the figures is to be published with the abstract.

Form PCT/ISA/210 (first sheet) (January 2004)



<b>INTERNATIONAL SEARCH REPORT</b>		International application No. PCT/US04/00150
<b>Box No. II Observations where certain claims were found unsearchable (Continuation of item 2 of first sheet)</b>		
This international search report has not been established in respect of certain claims under Article 17(2)(a) for the following reasons:		
1. <input type="checkbox"/>	Claims Nos.: because they relate to subject matter not required to be searched by this Authority, namely:	
2. <input type="checkbox"/>	Claims Nos.: because they relate to parts of the international application that do not comply with the prescribed requirements to such an extent that no meaningful international search can be carried out, specifically:	
3. <input type="checkbox"/>	Claims Nos.: because they are dependent claims and are not drafted in accordance with the second and third sentences of Rule 6.4(a).	
<b>Box No. III Observations where unity of invention is lacking (Continuation of item 3 of first sheet)</b>		
This International Searching Authority found multiple inventions in this international application, as follows: See Extra Sheet		
1. <input checked="" type="checkbox"/>	As all required additional search fees were timely paid by the applicant, this international search report covers all searchable claims.	
2. <input type="checkbox"/>	As all searchable claims could be searched without effort justifying an additional fee, this Authority did not invite payment of any additional fee.	
3. <input type="checkbox"/>	As only some of the required additional search fees were timely paid by the applicant, this international search report covers only those claims for which fees were paid, specifically claims Nos.:	
4. <input type="checkbox"/>	No required additional search fees were timely paid by the applicant. Consequently, this international search report is restricted to the invention first mentioned in the claims; it is covered by claims Nos.:	
<b>Remark on Protest</b>	<input type="checkbox"/>	The additional search fees were accompanied by the applicant's protest.
	<input checked="" type="checkbox"/>	No protest accompanied the payment of additional search fees.

Form PCT/ISA/210 (continuation of first sheet (2)) (January 2004)

**INTERNATIONAL SEARCH REPORT**

International application No.

PCT/US04/00150

<p><b>A. CLASSIFICATION OF SUBJECT MATTER</b>                  IPC(7) : B25C 5/06                  US CL : 227/8, 121                  According to International Patent Classification (IPC) or to both national classification and IPC</p>																				
<p><b>B. FIELDS SEARCHED</b></p> <p>Minimum documentation searched (classification system followed by classification symbols)                  U.S. : 227/8, 120, 121, 123, 125, 127, 128, 131</p> <p>Documentation searched other than minimum documentation to the extent that such documents are included in the fields searched</p> <p>Electronic data base consulted during the international search (name of data base and, where practicable, search terms used)</p>																				
<p><b>C. DOCUMENTS CONSIDERED TO BE RELEVANT</b></p> <table border="1"> <thead> <tr> <th>Category*</th> <th>Citation of document, with indication, where appropriate, of the relevant passages</th> <th>Relevant to claim No.</th> </tr> </thead> <tbody> <tr> <td>X</td> <td>US 4,573,621 A (NOVAK et al) 08 March 1983 (08.03.1983), col 1, ln 65 - col 2, ln 5</td> <td>1 and 2</td> </tr> <tr> <td>Y</td> <td>figure 3</td> <td>3 and 5 - 15</td> </tr> <tr> <td>A</td> <td></td> <td>4 and 16 -20</td> </tr> <tr> <td>Y</td> <td>US 4,183,453 A (BARRETT et al) 15 January 1980 (15.01.1980), col 6, ln 34 - col 7, ln 7 and figures 5 - 7</td> <td>3 and 5 - 10</td> </tr> <tr> <td>Y</td> <td>US 3,041,614 A (D'HAEM et al) 03 July 1962 (03.07.1962), col 4, ln 76 - col 5, ln 23</td> <td>11 - 15</td> </tr> </tbody> </table>			Category*	Citation of document, with indication, where appropriate, of the relevant passages	Relevant to claim No.	X	US 4,573,621 A (NOVAK et al) 08 March 1983 (08.03.1983), col 1, ln 65 - col 2, ln 5	1 and 2	Y	figure 3	3 and 5 - 15	A		4 and 16 -20	Y	US 4,183,453 A (BARRETT et al) 15 January 1980 (15.01.1980), col 6, ln 34 - col 7, ln 7 and figures 5 - 7	3 and 5 - 10	Y	US 3,041,614 A (D'HAEM et al) 03 July 1962 (03.07.1962), col 4, ln 76 - col 5, ln 23	11 - 15
Category*	Citation of document, with indication, where appropriate, of the relevant passages	Relevant to claim No.																		
X	US 4,573,621 A (NOVAK et al) 08 March 1983 (08.03.1983), col 1, ln 65 - col 2, ln 5	1 and 2																		
Y	figure 3	3 and 5 - 15																		
A		4 and 16 -20																		
Y	US 4,183,453 A (BARRETT et al) 15 January 1980 (15.01.1980), col 6, ln 34 - col 7, ln 7 and figures 5 - 7	3 and 5 - 10																		
Y	US 3,041,614 A (D'HAEM et al) 03 July 1962 (03.07.1962), col 4, ln 76 - col 5, ln 23	11 - 15																		
<p><input type="checkbox"/> Further documents are listed in the continuation of Box C. <input type="checkbox"/> See patent family annex.</p>																				
<p>* Special categories of cited documents:</p> <table border="0"> <tr> <td>"A" document defining the general state of the art which is not considered to be of particular relevance</td> <td>"T" later document published after the international filing date or priority date and not in conflict with the application but cited to understand the principle or theory underlying the invention</td> </tr> <tr> <td>"E" earlier application or patent published on or after the international filing date</td> <td>"X" document of particular relevance; the claimed invention cannot be considered novel or cannot be considered to involve an inventive step when the document is taken alone</td> </tr> <tr> <td>"L" document which may throw doubts on priority claim(s) or which is cited to establish the publication date of another citation or other special reason (as specified)</td> <td>"Y" document of particular relevance; the claimed invention cannot be considered to involve an inventive step when the document is combined with one or more other such documents, such combination being obvious to a person skilled in the art</td> </tr> <tr> <td>"O" document referring to an oral disclosure, use, exhibition or other means</td> <td>"&amp;" document member of the same patent family</td> </tr> <tr> <td>"P" document published prior to the international filing date but later than the priority date claimed</td> <td></td> </tr> </table>			"A" document defining the general state of the art which is not considered to be of particular relevance	"T" later document published after the international filing date or priority date and not in conflict with the application but cited to understand the principle or theory underlying the invention	"E" earlier application or patent published on or after the international filing date	"X" document of particular relevance; the claimed invention cannot be considered novel or cannot be considered to involve an inventive step when the document is taken alone	"L" document which may throw doubts on priority claim(s) or which is cited to establish the publication date of another citation or other special reason (as specified)	"Y" document of particular relevance; the claimed invention cannot be considered to involve an inventive step when the document is combined with one or more other such documents, such combination being obvious to a person skilled in the art	"O" document referring to an oral disclosure, use, exhibition or other means	"&" document member of the same patent family	"P" document published prior to the international filing date but later than the priority date claimed									
"A" document defining the general state of the art which is not considered to be of particular relevance	"T" later document published after the international filing date or priority date and not in conflict with the application but cited to understand the principle or theory underlying the invention																			
"E" earlier application or patent published on or after the international filing date	"X" document of particular relevance; the claimed invention cannot be considered novel or cannot be considered to involve an inventive step when the document is taken alone																			
"L" document which may throw doubts on priority claim(s) or which is cited to establish the publication date of another citation or other special reason (as specified)	"Y" document of particular relevance; the claimed invention cannot be considered to involve an inventive step when the document is combined with one or more other such documents, such combination being obvious to a person skilled in the art																			
"O" document referring to an oral disclosure, use, exhibition or other means	"&" document member of the same patent family																			
"P" document published prior to the international filing date but later than the priority date claimed																				
<p>Date of the actual completion of the international search                  05 March 2004 (05.03.2004)</p>		<p>Date of mailing of the international search report  <b>06 APR 2004</b></p>																		
<p>Name and mailing address of the ISA/US                  Mail Stop PCT, Attn: ISA/US                  Commissioner for Patents                  P.O. Box 1450                  Alexandria, Virginia 22313-1450                  Facsimile No. (703)305-3230</p>		<p>Authorized officer                  Paul A. Bell                  Telephone No. 703-308-3543</p>																		

Form PCT/ISA/210 (second sheet) (January 2004)

## INTERNATIONAL SEARCH REPORT

International application No. PCT/US04/00150
---

This application contains the following inventions or groups of inventions which are not so linked as to form a single general inventive concept under PCT Rule 13.1. In order for all inventions to be searched, the appropriate additional search fees must be paid.

Group I, claim(s) 1 - 2, drawn to an electromagnetic fastener driver with a safety interlock to prevent firing of the tool without the fastener output channel being pressed against a work piece.

Group II, claim(s) 3 and 5, drawn to an electromagnetic fastener driver with means to prevent the feeding of a fastener while the tool is being actuated.

Group III, claim(s) 6 - 10, drawn to an electromagnetic fastener driver with a control means to provide for multiple driving strokes to be delivered to the same fastener with a single actuation of the tool.

Group IV, claim(s) 11 - 15, drawn to an electromagnetic fastener driver with a fastener jam clearance feature.

Group V, claim(s) 4 and 16 - 20, drawn to an electromagnetic fastener driver with means to hold the fastener magazine in a predetermined position.

The inventions listed as Groups I - V do not relate to a single general inventive concept under PCT Rule 13.1 because, under PCT Rule 13.2, they lack the same or corresponding special technical features for the following reasons: The special technical feature of the Group I invention is the safety interlock to prevent firing of the tool without the fastener output channel being pressed against a work piece. The special technical feature of the Group II invention is the means to prevent the feeding of a fastener while the tool is being actuated. The special technical feature of the Group III invention is the control means to provide for multiple driving strokes to be delivered to the same fastener with a single actuation of the tool. The special technical feature of the Group IV invention is the fastener jam clearance feature. The special technical feature of the Group V invention is the means to hold the fastener magazine in a predetermined position. None of these special technical features are common to the other groups, nor do they correspond to a special technical feature in the other groups. Therefore, unity of invention is lacking.

&gt;

## 1845 Written Opinion of the International Searching Authority [R-2]

*PCT Rule 43<sup>bis</sup>.*

*Written Opinion of the International Searching Authority*

### *43<sup>bis</sup>.1. Written Opinion*

(a) Subject to Rule 69.1(b<sup>bis</sup>), the International Searching Authority shall, at the same time as it establishes the international search report, establish a written opinion as to:

(i) whether the claimed invention appears to be novel, to involve an inventive step (to be non-obvious), and to be industrially applicable;

(ii) whether the international application complies with the requirements of the Treaty and these Regulations in so far as checked by the International Searching Authority.

The written opinion shall also be accompanied by such other observations as these Regulations provide for.

(b) For the purposes of establishing the written opinion, Articles 33(2) to (6), 35(2) and 35(3) and Rules 43.4, 64, 65, 66.1(e), 66.7, 67, 70.2(b) and (d), 70.3, 70.4(ii), 70.5(a), 70.6 to 70.10, 70.12, 70.14 and 70.15(a) shall apply *mutatis mutandis*.

(c) The written opinion shall contain a notification informing the applicant that, if a demand for international preliminary examination is made, the written opinion shall, under Rule 66.1<sup>bis</sup>(a) but subject to Rule 66.1<sup>bis</sup>(b), be considered to be a written opinion of the International Preliminary Examining Authority for the purposes of Rule 66.2(a), in which case the applicant is invited to submit to that Authority, before the expiration of the time limit under Rule 54<sup>bis</sup>.1(a), a written reply together, where appropriate, with amendments.

For international applications having an international filing date on or after January 1, 2004, the examiner is required, in most instances, to establish a written opinion on novelty, inventive step, and industrial applicability of the claimed invention at the same time he/she establishes the international search report. The international search report and written opinion together serve to inform the International Preliminary Examining Authority of the documents and arguments necessary to complete the relevant assessments if international preliminary examination is demanded, and to inform the designated Offices of information that may be relevant to examination in the national phase. (The written opinion is transmitted to the designated offices in the form of an international preliminary report on patentability if no international preliminary examination report is established under Chapter II of the PCT). A written opinion of the Inter-

national Searching Authority is not required in the limited instance where a demand for international preliminary examination and required fees (PCT Rule 69.1(a)) have been filed with the United States International Preliminary Examining Authority and the examiner considers all the conditions of PCT Article 34(2)(c)(i) to (iii) to be fulfilled. In this limited instance, a positive international preliminary examination report may be issued. See PCT Rule 69.1(b<sup>bis</sup>)).

The applicant must be notified in the written opinion of the defects found in the application. The examiner is further required to fully state the reasons for his/her opinion (PCT Rule 66.2(b)) and invite a written reply, with amendments where appropriate (PCT Rule 66.2(c)).<

&gt;

## 1845.01 Preparing the Written Opinion of the International Searching Authority (Form PCT/ISA/237) [R-2]

### BOX NO. I. — BASIS OF OPINION

When completing Box I, item 1, of Form PCT/ISA/237, the examiner must indicate whether or not the opinion has been established on the basis of the international application in the language in which it was filed. If a translation was furnished for the purpose of the search, this must be indicated. With respect to Box I, item 2 of Form PCT/ISA/237, if the opinion has been based on a nucleotide and/or amino acid sequence disclosed and necessary to the claimed invention, the examiner must indicate the type of material (e.g., a sequence listing and/or tables related thereto), the format of the material (e.g., in written format and/or in computer readable form) and the time of filing/furnishing (e.g., contained in the international application as filed, filed together with the international application in computer readable form and/or furnished subsequently to this Authority for the purposes of the search). If more than one version or copy of the sequence listing and/or table relating thereto is filed, the examiner must indicate whether the applicant has provided the required statement indicating that the information in the subsequent or additional copies are identical to that in the applica-

tion as filed or does not go beyond the application as filed.

### **BOX NO. II. — PRIORITY**

Box II of Form PCT/ISA/237 is to inform applicant of the status of a request for priority. Where one or more citations of the international search report were published after the earliest priority date, the validity of that earliest priority date requires checking. Where the priority document is one which is in the records of the ISA, it should be obtained from those records. If a copy of the priority document is not available before preparation of the written opinion of the ISA because it has not yet been provided by the applicant, and if that earlier application was not filed with that Authority in its capacity as a national Office or the priority document is not available to that Authority from a digital library in accordance with the Administrative Instructions, the written opinion of the ISA may be established as if the priority had been validly claimed.

If the examiner needs a copy of a foreign priority document, the copy will be supplied on request to the International Bureau (IB) unless the IB has not yet received the priority document, in which case the examiner may invite the applicant to furnish such a copy. See PCT Rule 66.7(a). The examiner may consult with his or her SPRE regarding requesting a copy of the priority document from the IB. If the priority document is not in English, the examiner may invite the applicant to furnish a translation of the priority document within two months of the invitation. See PCT Rule 66.7(b). Box II, item 3, “Additional Observations” may be used to invite applicant to supply a copy of the priority document and/or translation. Preparation of the written opinion by the International Searching Authority should not be delayed to await a response to the invitation. The written opinion of the ISA will ordinarily be established as if the priority claim had been validly claimed even though the copy and/or translation has not been furnished. However, failure to timely furnish a copy of the priority document and/or translation may result in any further written opinion or international preliminary examination report of the International Preliminary Examining Authority being established as if the priority had not been claimed.

If applicant fails to furnish a copy or translation of the earlier application, whose priority has been claimed, check item No. 1 and then check the first box of the subsection if applicant failed to furnish a copy of the earlier application whose priority has been claimed, and check the second box of the subsection if applicant failed to furnish a translation of the earlier application whose priority has been claimed.

When the claim for priority has been found invalid (e.g., the claimed priority date is more than one year prior to the international filing date and the notification under PCT Rule 26<sup>bis</sup>.2(b) has been provided or all claims are directed to inventions which were not described and enabled by the earlier application), check item No. 2 in Box II and indicate why the claim for priority has been found invalid following item No. 3 “Additional observations”.

### **BOX NO. III. — NON-ESTABLISHMENT OF OPINION ON NOVELTY, INVENTIVE STEP AND INDUSTRIAL APPLICABILITY**

Box III of Form PCT/ISA/237 is intended to cover situations where some or all claims of an application are so unclear or inadequately supported by the description that the question of novelty, inventive step (nonobviousness), and industrial applicability cannot be considered, or where the international application or claims thereof relate to subject matter for which it is not required to establish a written opinion concerning novelty, inventive step and industrial applicability, or where no international search report has been established for the claims.

If some or all of the claims of an application relate to subject matter for which it is not required to establish a written opinion concerning novelty, inventive step and industrial applicability, check the appropriate box, indicate which claims relate to that subject matter and specify the reasons.

If some or all of the claims of an application are so unclear that no meaningful opinion could be formed, check the appropriate box, indicate which claims are unclear and specify the reasons.

If some or all of the claims are so inadequately supported by the description that no meaningful opinion could be formed, check the appropriate box.

If no international search report has been established for certain claims, check the appropriate box and indicate the claim numbers.

If the nucleotide and/or amino acid sequence listing does not comply with Annex C of the Administrative Instructions, the examiner must indicate whether the written form and/or the computer readable form is not in compliance and the reason for the non-compliance. Further, if tables related to the sequence listing are included as part of the international application, and these tables fail to comply with the technical requirements of Annex C of the Administrative Instructions, the examiner must indicate this in Box III.

#### **BOX NO. IV. — LACK OF UNITY OF INVENTION**

Box IV of Form PCT/ISA/237 should be used by the examiner to notify applicant that lack of unity has been found.

If, in response to a lack of unity of invention, applicant paid additional fees for additional inventions, the examiner should check the first box under subsection 1.

If the additional fees were paid under protest, the examiner should check the second box under subsection 1.

If applicant neither restricted nor paid additional fees in reply to the lack of unity of invention, the examiner should check the third box under subsection 1.

Subsection 2 of Box IV is to be completed if the examiner determines that unity of invention is lacking but chooses not to invite the applicant to restrict or pay additional fees.

If a lack of unity exists, the examiner would mark the second box under subsection 3. However, since the reasons for the lack of unity have already been set forth on the simultaneously issued international search report, the examiner can simply state that the reason the requirement of unity of invention is not complied with is set forth in the international search report. The first box under subsection 3 would never be marked.

Subsection 4 is used by the examiner to indicate which parts of the application form the basis of the opinion after the lack of unity of invention has been explained.

#### **BOX NO. V. — REASONED STATEMENT WITH REGARD TO NOVELTY, INVENTIVE STEP, AND INDUSTRIAL APPLICABILITY OF CLAIMS**

In Box V of Form PCT/ISA/237, the examiner must list in summary form all claims with regard to the criteria of novelty (N), inventive step (IS), and industrial applicability (IA). For definitions of novelty, inventive step, and industrial applicability see MPEP §§ 1878.01(a)(1), 1878.01(a)(2), and 1878.01(a)(3), respectively.

Box V is the main purpose of the written opinion. All claims without fatal defects are treated on the merits in Box V as to novelty, inventive step (nonobviousness) and industrial applicability.

The treatment of claims in Box V is similar in format to an Office action in a U.S. national patent application except that the words “rejection” and “patentability” are never used in a written opinion. On the international level, all written opinions are non-binding and a patent does not issue; what does issue is an international preliminary examination report (IPER), which is nonbinding on the elected States.

Examiner statements in Box V can be positive or negative. If the claims define over the prior art and meet the test of novelty, inventive step (nonobviousness) and industrial applicability, a statement equivalent to detailed reasons for allowance in a corresponding U.S. national application should be provided, indicating how the claims meet the tests of novelty, inventive step and industrial applicability. Form paragraphs 18.04 and 18.04.01 may be used for this purpose.

##### *¶ 18.04 Meets Novelty and Inventive Step*

Claim [1] the criteria set out in PCT Article 33(2)-(3), because the prior art does not teach or fairly suggest [2].

##### **Examiner Note:**

1. In bracket 1, pluralize “claim” if needed, insert claim no.(s), and insert the verb --meet-- or --meets--, as appropriate.
2. In bracket 2, insert the details of the claimed subject matter that render it unobvious over the prior art.
3. If the claims also meet the industrial applicability criteria set out in PCT Article 33(4), this form paragraph should be followed by form paragraph 18.04.01.
4. If the claims do not meet the industrial applicability criteria set out in PCT Article 33(4), this form paragraph should be followed by form paragraph 18.03.

*¶ 18.04.01 Meets Industrial Applicability*

Claim [1] the criteria set out in PCT Article 33(4), and thus [2] industrial applicability because the subject matter claimed can be made or used in industry.

**Examiner Note:**

1. In bracket 1, pluralize “claim” if needed, insert claim no.(s), and the verb --meet-- or -- meets--, as appropriate.
2. In bracket 2, insert --have-- or --has--, as appropriate.
3. If the claims meet all of the requirements of PCT Article 33(2)-(4), use form paragraph 18.04 before this form paragraph to provide positive statements for novelty and inventive step under PCT Article 33(2)-(3).
4. If the claims have industrial applicability but lack novelty and inventive step, use this form paragraph and additionally use form paragraph 18.01.
5. If the claims have industrial applicability and novelty but lack inventive step, use this form paragraph and additionally use one or more of form paragraphs 18.02, 18.02.01 and 18.02.02, as appropriate.
6. If the claims do not have industrial applicability, use form paragraph 18.03 instead of this form paragraph.

If, on the other hand, it is the opinion of the examiner that some or all claims lack novelty, inventive step, or industrial applicability, specific reasons must be given similar to those used in U.S. national applications. If the claims lack inventive step over a combination of references, the reasons must explain why one of ordinary skill in the art would have been motivated to combine the teachings of the applied references.

Form paragraphs 18.01, 18.02, 18.02.01, 18.02.02, and 18.03 may be used, as appropriate, to explain the negative statements listed in Box V.

*¶ 18.01 Lacks Novelty*

Claim [1] novelty under PCT Article 33(2) as being anticipated by [2].

**Examiner Note:**

1. In bracket 1, pluralize “claim” if needed, insert claim no.(s), and the verb --lack-- or --lacks--, as appropriate.
2. In bracket 2, insert name of prior art relied upon.

*¶ 18.02 Lacks Inventive Step - One Reference*

Claim [1] an inventive step under PCT Article 33(3) as being obvious over [2]. [3]

**Examiner Note:**

1. In bracket 1, pluralize “claim” if needed, insert claim no.(s), and the verb --lack-- or --lacks--, as appropriate.
2. In bracket 2, insert name of prior art relied upon.
3. In bracket 3, add reasoning.

*¶ 18.02.01 Lacks Inventive Step - Two References*

Claim [1] an inventive step under PCT Article 33(3) as being obvious over [2] in view of [3]. [4]

**Examiner Note:**

1. In bracket 1, pluralize “claim” if needed, insert claim no.(s), and the verb --lack-- or --lacks--, as appropriate.
2. In bracket 2, insert name of PRIMARY prior art relied upon.
3. In bracket 3, insert name of SECONDARY prior art relied upon.
4. In bracket 4, add reasoning.

*¶ 18.02.02 Lacks Inventive Step - Additional Reference*

Claim [1] an inventive step under PCT Article 33(3) as being obvious over the prior art as applied in the immediately preceding paragraph and further in view of [2]. [3]

**Examiner Note:**

1. This form paragraph may follow either 18.02 or 18.02.01.
2. In bracket 1, pluralize “claim” if needed, insert claim no.(s), and the verb --lack-- or --lacks--, as appropriate.
3. In bracket 2, insert name of additional prior art relied upon.
4. In bracket 3, add reasoning.

*¶ 18.03 Lacks Industrial Applicability*

Claim [1] industrial applicability as defined by PCT Article 33(4). [2]

**Examiner Note:**

1. In bracket 1, pluralize “claim” if needed, insert claim no.(s), and the verb --lack-- or --lacks--, as appropriate.
2. In bracket 2, add reasoning.

Examiners are encouraged to indicate any amendments which applicant could present which would avoid a negative statement in the international preliminary examination report in the event that applicant chooses to file a demand.

**BOX NO. VI. — CERTAIN DOCUMENTS CITED**

Since all documents cited at the time of establishment of the written opinion will be listed on the simultaneously established search report, there is no need to also list them on the written opinion, and as such this item should be left blank.

**BOX NO. VII. — CERTAIN DEFECTS IN THE INTERNATIONAL APPLICATION**

In Box VII of Form PCT/ISA/237, defects in the form and content of the international application are identified.

Examples of defects that would be listed in Box VII are:

(A) Informalities such as misplaced and/or omitted drawing numerals, misspelled words, grammatical errors, etc.

(B) Improper multiple-dependent claims (PCT Rule 6.4) if not indicated under Box III.

The following form paragraphs are used in Box VII of PCT/ISA/237, "Certain defects in the international application," for noting technical defects.

*¶ 18.08 Drawing Objections - Defects*

The drawings are objected to under PCT Rule 66.2(a)(iii) as containing the following defect(s) in the form or content thereof: [1]

**Examiner Note:**

In bracket 1, insert identification of defects in drawings.

*¶ 18.08.01 Drawing Is Required*

The subject matter of this application admits of illustration by drawing to facilitate understanding of the invention. Applicant is required under PCT Article 7(1) to furnish a drawing.

*¶ 18.09 Description Defective*

The description is objected to as containing the following defect(s) under PCT Rule 66.2(a)(iii) in the form or contents thereof: [1]

**Examiner Note:**

In bracket 1, insert the technical problem, e.g., misspelled word.

*¶ 18.10 Claims Defective*

Claim [1] objected to under PCT Rule 66.2(a)(iii) as containing the following defect(s) in the form or contents thereof: [2]

**Examiner Note:**

1. In bracket 1, pluralize "claim" if needed, insert claim no.(s) and the appropriate verb --is-- or --are--.
2. In bracket 2, identify the technical deficiency.

**BOX NO. VIII. — CERTAIN OBSERVATIONS ON THE INTERNATIONAL APPLICATION**

In Box VIII, the examiner notifies the applicant of observations made as to the clarity of the claims, the description, the drawings, or on the question whether the claims are fully supported by the description.

If the claims, the description, or the drawings are so unclear, or the claims are so inadequately supported by the description, that no meaningful opinion can be formed on the question of novelty, inventive step (nonobviousness) or industrial applicability, the appli-

cant is so informed in Box III. See PCT Article 34(4)(a)(ii). Reasons for the examiner's opinion that the claims, description and drawings, etc., lack clarity must also be provided.

If the above situation is found to exist in certain claims only, the provisions of PCT Article 34(4)(a)(ii) shall apply to those claims only.

If the lack of clarity of the claims, the description, or the drawings is of such a nature that it is possible to form a meaningful opinion on the claimed subject matter, then it is required that the examiner consider the claims and render a written opinion on novelty, inventive step, and industrial applicability in Box V.

Since the claims of an international application are not subject to a rejection on either art or indefiniteness consistent with U.S. practice, observations by the examiner with regard to clarity of the claims, the description and the drawings will be treated in the form of an objection in the written opinion in Box VIII.

The following form paragraphs may be used in Box VIII, "Certain observations on the international application," of Form PCT/ISA/237 for noting objections which are substantive rather than merely technical in nature.

*¶ 18.11 Drawing Objections - Lack Clarity*

The drawings are objected to under PCT Rule 66.2(a)(v) as lacking clarity under PCT Article 7 because: [1]

**Examiner Note:**

In bracket 1, insert reasons why the drawings lack clarity, e.g., inaccurate showing.

*¶ 18.12.01 Claims Objectionable - Inadequate Written Description*

Claim [1] objected to as lacking clarity under PCT Rule 66.2(a)(v) because the claim [2] not fully supported by the description. The application, as originally filed, did not describe: [3]

**Examiner Note:**

1. In bracket 1, pluralize "claim" if needed, insert claim no.(s), and the verb --is-- or --are--, as appropriate.
2. In bracket 2, pluralize "claim" if needed, and insert the verb --is-- or --are--.
3. In bracket 3, identify subject matter not described in the application as filed.

*¶ 18.13.01 Claims Objectionable - Non-Enabling Disclosure*

Claim [1] objected to as lacking clarity under PCT Rule 66.2(a)(v) because the claim [2] not fully supported by the description. The description does not disclose the claimed inven-



tion in a manner sufficiently clear and complete for the claimed invention to be carried out by a person skilled in the art because: [3]

**Examiner Note:**

1. In bracket 1, pluralize “claim” if needed, insert claim no.(s) and the appropriate verb --is-- or --are--.
2. In bracket 2, pluralize “claim” if needed, insert the verb --is-- or --are--.
3. In bracket 3, identify the claimed subject matter that is not enabled and explain why it is not enabled.

¶ 18.14.01 *Claims Objectionable - Lack of Best Mode*

Claim [1] objected to under PCT Rule 66.2(a)(v) because the claim [2] not fully supported by the description. The description fails to set forth the best mode contemplated by the applicant for carrying out the claimed invention as required by PCT Rule 5.1(a)(v) because: [3].

**Examiner Note:**

1. In bracket 1, pluralize “claim” if needed, insert claim no.(s) and the appropriate verb --is-- or --are--.
2. In bracket 2, pluralize “claim” if needed, and insert the appropriate verb --is-- or --are--.
3. In bracket 3, insert the objection and reasons.

¶ 18.15 *Claims Objectionable - Indefiniteness*

Claim [1] objected to under PCT Rule 66.2(a)(v) as lacking clarity under PCT Article 6 because claim [2] indefinite for the following reason(s): [3]

**Examiner Note:**

1. In brackets 1 and 2, pluralize “claim” if needed, insert claim no.(s) and the appropriate verb --is-- or --are--.
2. In bracket 3, insert reasons.

**TIME TO REPLY**

If, in response to the written opinion of the International Searching Authority (Form PCT/ISA/237), applicant wishes to file a demand and amendments and/or arguments, the time period for response is 3 months from the mailing of the international search report and the written opinion or before the expiration of 22 months from the priority date, whichever expires later.

**AUTHORIZED OFFICER**

Pursuant to PCT Rules 43<sup>bis</sup>.1 and 70.14, the written opinion of the International Searching Authority must indicate the name of the officer of the International Searching Authority responsible for the written opinion, i.e., the “authorized officer.” An “authorized officer” is the person who actually performed the search work and prepared the search report and the written opinion, or another person who was responsible for supervising the search and the establishment of the written opinion. See Administrative Instructions Section 514. Thus, an examiner need not have signatory authority in order to be named as an authorized officer on the written opinion. However, the “file copy” of the written opinion must be signed by an examiner having at least partial signatory authority.

PATENT COOPERATION TREATY

From the  
INTERNATIONAL SEARCHING AUTHORITY

To:  
John J. Smith  
220 Jefferson Davis Highway  
Arlington, VA 22202-0234

**PCT**

WRITTEN OPINION OF THE  
INTERNATIONAL SEARCHING AUTHORITY

(PCT Rule 43bis.1)

Applicant's or agent's file reference		Date of mailing (day/month/year) <b>06 APR 2004</b>
CMC-123-PCT		<b>FOR FURTHER ACTION</b> See paragraph 2 below
International application No.	International filing date (day/month/year)	Priority date (day/month/year)
PCT/US04/00150	05 January 2004 (05.01.2004)	06 January 2003 (06.01.2003)
International Patent Classification (IPC) or both national classification and IPC		
IPC(7): B25C 5/06 and US Cl.: 227/8		
Applicant		
ACME FASTENER CORPORATION		

1. This opinion contains indications relating to the following items:

- Box No. I Basis of the opinion
- Box No. II Priority
- Box No. III Non-establishment of opinion with regard to novelty, inventive step and industrial applicability
- Box No. IV Lack of unity of invention
- Box No. V Reasoned statement under Rule 43bis.1(a)(i) with regard to novelty, inventive step or industrial applicability; citations and explanations supporting such statement
- Box No. VI Certain documents cited
- Box No. VII Certain defects in the international application
- Box No. VIII Certain observations on the international application

2. FURTHER ACTION

If a demand for international preliminary examination is made, this opinion will be considered to be a written opinion of the International Preliminary Examining Authority ("IPEA") except that this does not apply where the applicant chooses an Authority other than this one to be the IPEA and the chosen IPEA has notified the International Bureau under Rule 66.1bis(b) that written opinions of this International Searching Authority will not be so considered.

If this opinion is, as provided above, considered to be a written opinion of the IPEA, the applicant is invited to submit to the IPEA a written reply together, where appropriate, with amendments, before the expiration of 3 months from the date of mailing of Form PCT/ISA/220 or before the expiration of 22 months from the priority date, whichever expires later.

For further options, see Form PCT/ISA/220.

3. For further details, see notes to Form PCT/ISA/220.

Name and mailing address of the ISA/ US Mail Stop PCT, Attn: ISA/US Commissioner for Patents P.O. Box 1450 Alexandria, Virginia 22313-1450 Facsimile No. (703)305-3230	Authorized officer Paul A. Bell  Telephone No. 703-308-3543
---	--

Form PCT/ISA/237 (cover sheet) (January 2004)

**WRITTEN OPINION OF THE  
INTERNATIONAL SEARCHING AUTHORITY**

International application No.  
PCT/US04/00150

**Box No. I      Basis of this opinion**

1. With regard to the **language**, this opinion has been established on the basis of the international application in the language in which it was filed, unless otherwise indicated under this item.

This opinion has been established on the basis of a translation from the original language into the following language \_\_\_\_\_, which is the language of a translation furnished for the purposes of international search (under Rules 12.3 and 23.1(b)).

2. With regard to any **nucleotide and/or amino acid sequence** disclosed in the international application and necessary to the claimed invention, this opinion has been established on the basis of:

a. **type of material**

- a sequence listing  
 table(s) related to the sequence listing

b. **format of material**

- in written format  
 in computer readable form

c. **time of filing/furnishing**

- contained in the international application as filed.  
 filed together with the international application in computer readable form.  
 furnished subsequently to this Authority for the purposes of search.

3.  In addition, in the case that more than one version or copy of a sequence listing and/or table relating thereto has been filed or furnished, the required statements that the information in the subsequent or additional copies is identical to that in the application as filed or does not go beyond the application as filed, as appropriate, were furnished.

4. **Additional comments:**

Form PCT/ISA/237 (Box No. I) (January 2004)

WRITTEN OPINION OF THE  
INTERNATIONAL SEARCHING AUTHORITYInternational application No.  
PCT/US04/00150

## Box No. IV Lack of unity of invention

1.  In response to the invitation (Form PCT/ISA/206) to pay additional fees the applicant has:
- paid additional fees
  - paid additional fees under protest
  - not paid additional fees
2.  This Authority found that the requirement of unity of invention is not complied with and chose not to invite the applicant to pay additional fees.
3. This Authority considers that the requirement of unity of invention in accordance with Rule 13.1, 13.2 and 13.3 is
- complied with
  - not complied with for the following reasons:  
See the lack of unity section of the International Search Report (Form PCT/ISA/210)
4. Consequently, this opinion has been established in respect of the following parts of the international application:
- all parts
  - the parts relating to claims Nos. \_\_\_\_\_

Form PCT/ISA/237 (Box No. IV) (January 2004)

**WRITTEN OPINION OF THE  
INTERNATIONAL SEARCHING AUTHORITY**

International application No.  
PCT/US04/00150

**Box No. V Reasoned statement under Rule 43 bis.1(a)(i) with regard to novelty, inventive step or industrial applicability; citations and explanations supporting such statement**

**I. Statement**

Novelty (N)	Claims 3 - 20	YES
	Claims 1 and 2	NO
Inventive Step (IS)	Claims 4 and 16 - 20	YES
	Claims 1 - 3 and 5 - 15	NO
Industrial Applicability (IA)	Claims 1 - 20	YES
	Claims NONE	NO

**2. Citations and explanations**

See the Supplemental Box

Form PCT/ISA/237 (Box No. V) (January 2004)

**WRITTEN OPINION OF THE  
INTERNATIONAL SEARCHING AUTHORITY**

International application No.

PCT/US04/00150

**Box No. VII Certain defects in the international application**

The following defects in the form or contents of the international application have been noted:

The description is objected to as containing the following defect(s) under PCT Rule 66.2(a)(iii) in the form or contents thereof: It is noted that the word "stpaes" at line 15 of page 9 is misspelled .

Form PCT/ISA/237 (Box No. VII) (January 2004)

WRITTEN OPINION OF THE  
INTERNATIONAL SEARCHING AUTHORITY

International application No.  
PCT/US04/00150

Supplemental Box

In case the space in any of the preceding boxes is not sufficient.  
Continuation of:

2. CITATIONS AND EXPLANATIONS

Claims 1 and 2 lack novelty under PCT Article 33(2) as being anticipated by Novak et al. Novak et al. teaches the claimed electromagnetic fastener tool 10 with a housing 12 having a fastener magazine assembly 18 mounted thereon with the magazine assembly having a fastener output channel. The magazine assembly 18 is pivoted between a first position wherein the tool can not be actuated and a second position wherein a fastener may be driven from the tool (note figure 3 and column 1, line 65 through column 2, line 5). The magazine assembly 18 is moved from the first position to the second position by placing the fastener output channel firmly against a work piece. As shown in figure 3 and described at column 4, lines 6 - 49, the magazine assembly 18 and the trigger button 24 are coupled by a safety mechanism 62. This safety mechanism has a sliding rod 64 with the lower end of the rod 64 being attached to the top of channel 48 of the magazine assembly such that rod 64 moves with the magazine assembly. When the magazine assembly 18 is placed on a work piece, it rotates into the second position and pushes rod 64 upward. The upper portion of rod 64 has a spring 74 which includes a cam surface 76, a curved surface 78 and a bottom edge 81. Bottom edge 81 of spring 74 is normally positioned adjacent flange 86 of trigger button 24 and blocks upward movement of the trigger button. Thus, the trigger button may not be depressed (moved upwards) to fire the tool until the bottom edge of spring 74 is moved away from flange 86. This is accomplished by the interaction of curved surface 78 of spring 74 with a corresponding curved surface 82 fixed to the housing 12. When rod 64 moves upward, spring 74 is bent away from trigger button 24 by the interaction of curved surfaces 78 and 82. Thus, placing the fastener output channel of the magazine assembly 18 against a work piece moves bottom edge 81 of spring 74 out of its blocking position adjacent flange 86 of trigger button 24 and permits the tool to be fired.

Claims 3 and 5 lack an inventive step under PCT Article 33(3) as being obvious over Novak et al. in view of Barrett et al. Novak et al. does not teach the claimed mechanical means for blocking the feeding of a fastener from the magazine while the magazine assembly is in the second position (pressed against the work piece). Barrett et al. teaches such a blocking means. Note figures 5 - 7 and column 6, lines 34 - column 7, line 7. The Barrett et al. blocking means is interconnected with the trigger switch 40 such that when the trigger is depressed to fire the tool and drive a fastener from the magazine output channel, a clamp 48 is depressed onto the top of the second fastener in the fastener stick in magazine 42. Forward movement of the second fastener into the magazine output channel is thus prevented as long as trigger switch 40 remains depressed. When the trigger switch is released, clamp 48 moves away from the fastener stick and a fastener can be fed into the magazine output channel. Since the provision of such a blocking means is known as a desirable feature for solenoid actuated fastener driving tools because they are notorious for needing multiple strokes of the driver to properly drive a fastener, it would have been obvious to one of ordinary skill in this art to provide such a blocking means in the Novak et al. solenoid actuated tool. Note the teaching in Barrett et al. from column 2, line 40 through column 5, line 10 regarding the need for multiple driving strokes.

Claims 6 - 10 lack an inventive step under PCT Article 33(3) as being obvious over Novak et al. in view of Barrett et al. Novak et al. does not teach the claimed electronic control means to provide multiple blows from the driver to a single fastener. Barrett et al. discloses a control means which provides for multiple blows by the driver 32 on the fastener for each actuation of the trigger. Barrett et al. teaches at column 1, lines 40 - 49 that it is advantageous to operate solenoid actuated fastener drivers in this manner because such tools may require two or more blows from the driver to properly drive the fastener an adequate depth into the work piece. In view of this known teaching, it would have been obvious to one of ordinary skill in this art to provide the Novak et al. tool with the claimed control means to provide a predetermined plurality of driving strokes to a single fastener.

Claims 11 - 15 lack an inventive step under PCT Article 33(3) as being obvious over Novak et al. in view of D'Haem et al. Novak et al. does not teach the provision of an anti-jam means to clear jammed fasteners from the fastener output channel. The claims call for the fastener output channel to be formed with a removable cover plate to permit clearing the tool in the event of a fastener jam. D'Haem teaches that it is well-known in this art that fastener jams are a problem and that some means is desirable to clear them. D'Haem teaches the use of a removable cover plate to allow clearing the tool as claimed (see column 4, line 76 - column 5, line 23). In view of this teaching, it would have been obvious to one of ordinary skill in this art to provide the claimed anti-jam feature in the Novak et al. tool.

Claims 4 and 16 - 20 meet the criteria set out in PCT Article 33(2) - (3) because the prior art does not teach or fairly suggest the claimed means to hold the fastener magazine in the second position as claimed in claim 4.

Claims 1 - 20 meet the criteria set out in PCT Article 33(4), and thus have industrial applicability because the subject matter claimed can be made or used in industry.

&gt;

**1845.02 Notification of Transmittal of the International Search Report and the Written Opinion of the International Searching Authority, or the Declaration (Form PCT/ISA/220) [R-2]**

The examiner completes the Notification of Transmittal of the International Search Report and the Written Opinion of the International Searching Authority, or Declaration (Form PCT/ISA/220) upon completion of the International Search Report (Form PCT/ISA/210) or the Declaration of Non-Establishment of the International Search Report (Form PCT/ISA/203) and, for applications filed on or after January 1, 2004, completion of the Written Opinion of the International Searching Authority (Form PCT/ISA/237). The Form PCT/ISA/220 serves as a cover letter for the PCT/ISA/210 or PCT/ISA/203 and for the PCT/ISA/237.

When processing an application having an international filing date filed prior to January 1, 2004, the examiner should make sure the Form PCT/ISA/220 being issued is the version of the form dated April 2002 and entitled "Notification of Transmittal of the International Search Report or the Declaration."

**ADDRESS FOR CORRESPONDENCE**

The address for correspondence is taken from the request (Form PCT/ISA/101). When an agent represents the applicant, the address for correspondence is listed in Box No. IV of the PCT request Form. For applicants processing their own applications, the address for correspondence may be listed in Box No. II of the request Form. However, where PALM or the correspondence on file shows any changes in the applicant or address for correspondence effected under PCT Rule 92<sup>bis</sup>, the later address is used.

**APPLICANT**

When there is more than one applicant in respect of the international application, only the first mentioned of these on the request Form is indicated in the international search report. Other applicants, if any, are indicated by the words "et al" following the first applicant's name. The first mentioned applicant is indicated in Box No. II of the request Form, a second applicant is listed in Box No. III; further applicants are listed on the continuation sheet if there are more than two applicants. Company names are written in capital letters; for personal names the family name is given first in capital letters and the given names are in mixed case. This helps to identify the family name.



PATENT COOPERATION TREATY

From the INTERNATIONAL SEARCHING AUTHORITY

PCT

NOTIFICATION OF TRANSMITTAL OF  
THE INTERNATIONAL SEARCH REPORT AND  
THE WRITTEN OPINION OF THE INTERNATIONAL  
SEARCHING AUTHORITY, OR THE DECLARATION

(PCT Rule 44.1)

<p>To:</p> <p>John J. Smith 220 Jefferson Davis Highway Arlington, Virginia 22202-0234</p>	<p>Date of mailing (day/month/year) <b>06 APR 2004</b></p>
<p>Applicant's or agent's file reference CMC-123-PCT</p>	<p><b>FOR FURTHER ACTION</b> See paragraphs 1 and 4 below</p>
<p>International application No. PCT/US04/00150</p>	<p>International filing date (day/month/year) 05 January 2004 (05.01.2004)</p>
<p>Applicant ACME FASTENER CORPORATION</p>	

1.  The applicant is hereby notified that the international search report and the written opinion of the International Searching Authority have been established and are transmitted herewith.

**Filing of amendments and statement under Article 19:**  
The applicant is entitled, if he so wishes, to amend the claims of the international application (see Rule 46):

**When?** The time limit for filing such amendments is normally two months from the date of transmittal of the international search report.

**Where?** Directly to the International Bureau of WIPO, 34 chemin des Colombettes  
1211 Geneva 20, Switzerland, Facsimile No.: +41 22 740 14 35

**For more detailed instructions,** see the notes on the accompanying sheet.

2.  The applicant is hereby notified that no international search report will be established and that the declaration under Article 17(2)(a) to that effect and the written opinion of the International Searching Authority are transmitted herewith.

3.  **With regard to the protest against payment of (an) additional fee(s) under Rule 40.2,** the applicant is notified that:

the protest together with the decision thereon has been transmitted to the International Bureau together with the applicant's request to forward the texts of both the protest and the decision thereon to the designated Offices.

no decision has been made yet on the protest; the applicant will be notified as soon as a decision is made.

4. **Reminders**  
Shortly after the expiration of **18 months** from the priority date, the international application will be published by the International Bureau. If the applicant wishes to avoid or postpone publication, a notice of withdrawal of the international application, or of the priority claim, must reach the International Bureau as provided in Rules 90bis.1 and 90bis.3, respectively, before the completion of the technical preparations for international publication.

The applicant may submit comments on an informal basis on the written opinion of the International Searching Authority to the International Bureau. The International Bureau will send a copy of such comments to all designated Offices unless an international preliminary examination report has been or is to be established. These comments would also be made available to the public but not before the expiration of 30 months from the priority date.

Within **19 months** from the priority date, but only in respect of some designated Offices, a demand for international preliminary examination must be filed if the applicant wishes to postpone the entry into the national phase until **30 months** from the priority date (in some Offices even later); otherwise, the applicant must, within **20 months** from the priority date, perform the prescribed acts for entry into the national phase before those designated Offices.

In respect of other designated Offices, the time limit of **30 months** (or later) will apply even if no demand is filed within 19 months.

See the Annex to Form PCT/IB/301 and, for details about the applicable time limits, Office by Office, see the *PCT Applicant's Guide*, Volume II, National Chapters and the WIPO Internet site.

<p>Name and mailing address of the ISA/ US Mail Stop PCT, Attn: ISA/US Commissioner for Patents P.O. Box 1450 Alexandria, Virginia 22313-1450 Facsimile No. (703) 305-3230</p>	<p>Authorized officer Paul A. Bell Telephone No. 703-308-3543</p>
--	---

Form PCT/ISA/220 (January 2004)

(See notes on accompanying sheet)

### NOTES TO FORM PCT/ISA/220

These Notes are intended to give the basic instructions concerning the filing of amendments under Article 19. The Notes are based on the requirements of the Patent Cooperation Treaty, the Regulations and the Administrative Instructions under that Treaty. In case of discrepancy between these Notes and those requirements, the latter are applicable. For more detailed information, see also the *PCT Applicant's Guide*, a publication of WIPO.

In these Notes, "Article," "Rule" and "Section" refer to the provisions of the PCT, the PCT Regulations and the PCT Administrative Instructions, respectively.

### INSTRUCTIONS CONCERNING AMENDMENTS UNDER ARTICLE 19

The applicant has, after having received the international search report and the written opinion of the International Searching Authority, one opportunity to amend the claims of the international application. It should however be emphasized that, since all parts of the international application (claims, description and drawings) may be amended during the international preliminary examination procedure, there is usually no need to file amendments of the claims under Article 19 except where, e.g. the applicant wants the latter to be published for the purposes of provisional protection or has another reason for amending the claims before international publication. Furthermore, it should be emphasized that provisional protection is available in some States only (see *PCT Applicant's Guide*, Volume I/A, Annexes B1 and B2).

The attention of the applicant is drawn to the fact that amendments to the claims under Article 19 are not allowed where the International Searching Authority has declared, under Article 17(2), that no international search report would be established (see *PCT Applicant's Guide*, Volume I/A, paragraph 296).

#### What parts of the international application may be amended ?

Under Article 19, only the claims may be amended.

During the international phase, the claims may also be amended (or further amended) under Article 34 before the International Preliminary Examining Authority. The description and drawings may only be amended under Article 34 before the International Preliminary Examining Authority.

Upon entry into the national phase, all parts of the international application may be amended under Article 28 or, where applicable, Article 41.

**When ?** Within 2 months from the date of transmittal of the international search report or 16 months from the priority date, whichever time limit expires later. It should be noted, however, that the amendments will be considered as having been received on time if they are received by the International Bureau after the expiration of the applicable time limit but before the completion of the technical preparations for international publication (Rule 46.1).

#### Where not to file the amendments ?

The amendments may only be filed with the International Bureau and not with the receiving Office or the International Searching Authority (Rule 46.2).

Where a demand for international preliminary examination has been/is filed, see below.

**How ?** Either by cancelling one or more entire claims, by adding one or more new claims or by amending the text of one or more of the claims as filed.

A replacement sheet must be submitted for each sheet of the claims which, on account of an amendment or amendments, differs from the sheet originally filed.

All the claims appearing on a replacement sheet must be numbered in Arabic numerals. Where a claim is cancelled, no renumbering of the other claims is required. In all cases where claims are renumbered, they must be renumbered consecutively (Section 205(b)).

**The amendments must be made in the language in which the international application is to be published.**

#### What documents must/may accompany the amendments ?

##### Letter (Section 205(b)):

The amendments must be submitted with a letter.

The letter will not be published with the international application and the amended claims. It should not be confused with the "Statement under Article 19(1)" (see below, under "Statement under Article 19(1)").

**The letter must be in English or French, at the choice of the applicant. However, if the language of the international application is English, the letter must be in English; if the language of the international application is French, the letter must be in French.**

**NOTES TO FORM PCT/ISA/220 (continued)**

The letter must indicate the differences between the claims as filed and the claims as amended. It must, in particular, indicate, in connection with each claim appearing in the international application (it being understood that identical indications concerning several claims may be grouped), whether

- (i) the claim is unchanged;
- (ii) the claim is cancelled;
- (iii) the claim is new;
- (iv) the claim replaces one or more claims as filed;
- (v) the claim is the result of the division of a claim as filed.

**The following examples illustrate the manner in which amendments must be explained in the accompanying letter:**

1. [Where originally there were 48 claims and after amendment of some claims there are 51]:  
"Claims 1 to 29, 31, 32, 34, 35, 37 to 48 replaced by amended claims bearing the same numbers; claims 30, 33 and 36 unchanged; new claims 49 to 51 added."
2. [Where originally there were 15 claims and after amendment of all claims there are 11]:  
"Claims 1 to 15 replaced by amended claims 1 to 11."
3. [Where originally there were 14 claims and the amendments consist in cancelling some claims and in adding new claims]:  
"Claims 1 to 6 and 14 unchanged; claims 7 to 13 cancelled; new claims 15, 16 and 17 added." or  
"Claims 7 to 13 cancelled; new claims 15, 16 and 17 added; all other claims unchanged."
4. [Where various kinds of amendments are made]:  
"Claims 1-10 unchanged; claims 11 to 13, 18 and 19 cancelled; claims 14, 15 and 16 replaced by amended claim 14; claim 17 subdivided into amended claims 15, 16 and 17; new claims 20 and 21 added."

**"Statement under Article 19(1)" (Rule 46.4)**

The amendments may be accompanied by a statement explaining the amendments and indicating any impact that such amendments might have on the description and the drawings (which cannot be amended under Article 19(1)).

The statement will be published with the international application and the amended claims.

**It must be in the language in which the international application is to be published.**

It must be brief, not exceeding 500 words if in English or if translated into English.

It should not be confused with and does not replace the letter indicating the differences between the claims as filed and as amended. It must be filed on a separate sheet and must be identified as such by a heading, preferably by using the words "Statement under Article 19(1)."

It may not contain any disparaging comments on the international search report or the relevance of citations contained in that report. Reference to citations, relevant to a given claim, contained in the international search report may be made only in connection with an amendment of that claim.

**Consequence if a demand for international preliminary examination has already been filed**

If, at the time of filing any amendments and any accompanying statement, under Article 19, a demand for international preliminary examination has already been submitted, the applicant must preferably, at the time of filing the amendments (and any statement) with the International Bureau, also file with the International Preliminary Examining Authority a copy of such amendments (and of any statement) and, where required, a translation of such amendments for the procedure before that Authority (see Rules 55.3(a) and 62.2, first sentence). For further information, see the Notes to the demand form (PCT/IPEA/401).

If a demand for international preliminary examination is made, the written opinion of the International Searching Authority will, except in certain cases where the International Preliminary Examining Authority did not act as International Searching Authority and where it has notified the International Bureau under Rule 66.1*bis*(b), be considered to be a written opinion of the International Preliminary Examining Authority. If a demand is made, the applicant may submit to the International Preliminary Examining Authority a reply to the written opinion together, where appropriate, with amendments before the expiration of 3 months from the date of mailing of Form PCT/ISA/220 or before the expiration of 22 months from the priority date, whichever expires later (Rule 43*bis*.1(c)).

**Consequence with regard to translation of the international application for entry into the national phase**

The applicant's attention is drawn to the fact that, upon entry into the national phase, a translation of the claims as amended under Article 19 may have to be furnished to the designated/elected Offices, instead of, or in addition to, the translation of the claims as filed.

For further details on the requirements of each designated/elected Office, see the *PCT Applicant's Guide*, Volume II.

## 1846 Sections of the Articles, Regulations, and Administrative Instructions Under the PCT Relevant to the International Searching Authority [R-2]

PCT Articles 15 - 20 (Appendix T);  
PCT Rules 33 - 47 (Appendix T); and  
Administrative Instructions Sections 501 - 518  
(Appendix AI).

## 1847 Refund of International Search Fee [R-2]

*37 CFR 1.446. Refund of international application filing and processing fees.*

(a) Money paid for international application fees, where paid by actual mistake or in excess, such as a payment not required by law or treaty and its regulations, may be refunded. A mere change of purpose after the payment of a fee will not entitle a party to a refund of such fee. The Office will not refund amounts of twenty-five dollars or less unless a refund is specifically requested and will not notify the payor of such amounts. If the payor or party requesting a refund does not provide the banking information necessary for making refunds by electronic funds transfer, the Office may use the banking information provided on the payment instrument to make any refund by electronic funds transfer.

(b) Any request for refund under paragraph (a) of this section must be filed within two years from the date the fee was paid. If the Office charges a deposit account by an amount other than an amount specifically indicated in an authorization under § 1.25(b), any request for refund based upon such charge must be filed within two years from the date of the deposit account statement indicating such charge and include a copy of that deposit account statement. The time periods set forth in this paragraph are not extendable.

\*\*>

(c) Refund of the supplemental search fees will be made if such refund is determined to be warranted by the Director or the Director's designee acting under PCT Rule 40.2(c).<

(d) The international and search fees will be refunded if no international filing date is accorded or if the application is withdrawn before transmittal of the record copy to the International Bureau (PCT Rules 15.6 and 16.2). The search fee will be refunded if the application is withdrawn before transmittal of the search copy to the International Searching Authority. The transmittal fee will not be refunded.

(e) The handling fee (§ 1.482(b)) will be refunded (PCT Rule 57.6) only if:

(1) The Demand is withdrawn before the Demand has been sent by the International Preliminary Examining Authority to the International Bureau, or

(2) The Demand is considered not to have been submitted (PCT Rule 54.4(a)).

Although 37 CFR 1.446(a) indicates that a "mere change of purpose after the payment of a fee will not entitle a party to a refund of such fee," 37 CFR 1.446(d) and (e) contain exceptions to this general statement.

According to 37 CFR 1.446(d), the search fee will be refunded if no international filing date is accorded or if the application is withdrawn before the search copy is transmitted to the International Searching Authority. The transmittal fee will not be refunded.

According to 37 CFR 1.446(e), the handling fee will be refunded if the Demand is withdrawn before the Demand has been sent by the International Preliminary Examining Authority to the International Bureau.

Refund of the supplemental search fee will be made if the applicant is successful in a protest (filed pursuant to 37 CFR 1.477) to a holding of lack of unity of invention. The supplemental search fee must be paid and be accompanied by (1) a protest and (2) a request for refund of the supplemental search fee.

Any request for refund of the search fee made after the search copy has been transmitted to the International Searching Authority must be directed to the International Searching Authority and not to the Receiving Office. This is clearly necessary where applicant has chosen the European Patent Office as the International Searching Authority.

## 1848 Sequence Listings and Tables Related to Sequence Listings [R-2]

*PCT Rule 13<sup>ter</sup>.*

*Nucleotide and/or Amino Acid Sequence Listings*

### *13<sup>ter</sup>.1. Sequence Listing for International Authorities*

(a) Where the International Searching Authority finds that the international application contains disclosure of one or more nucleotide and/or amino acid sequences but:

(i) the international application does not contain a sequence listing complying with the standard provided for in the Administrative Instructions, that Authority may invite the applicant to furnish to it, within a time limit fixed in the invitation, a sequence listing complying with that standard;

(ii) the applicant has not already furnished a sequence listing in computer readable form complying with the standard provided for in the Administrative Instructions, that Authority may invite the applicant to furnish to it, within a time limit fixed in the invitation, a sequence listing in such a form complying with that standard.

(b) *[Deleted]*

(c) If the applicant does not comply with an invitation under paragraph (a) within the time limit fixed in the invitation, the International Searching Authority shall not be required to search the international application to the extent that such noncompliance has the result that a meaningful search cannot be carried out.

(d) Where the International Searching Authority finds that the description does not comply with Rule 5.2(b), it shall invite the applicant to file the required correction. Rule 26.4 shall apply *mutatis mutandis* to any correction offered by the applicant. The International Searching Authority shall transmit the correction to the receiving Office and to the International Bureau.

(e) Paragraphs (a) and (c) shall apply *mutatis mutandis* to the procedure before the International Preliminary Examining Authority.

(f) Any sequence listing not contained in the international application as filed shall not, subject to Article 34, form part of the international application.

*PCT Administrative Instruction Section 513.*  
*Sequence Listings*

(a) Where the International Searching Authority receives a correction of a defect under Rule 13<sup>ter</sup>.1(d), it shall:

(i) indelibly mark, in the upper right-hand corner of each replacement sheet, the international application number and the date on which that sheet was received;

(ii) indelibly mark, in the middle of the bottom margin of each replacement sheet, the words "SUBSTITUTE SHEET (RULE 13<sup>ter</sup>.1(d))" or their equivalent in the language of publication of the international application;

(iii) indelibly mark on the letter containing the correction, or accompanying any replacement sheet, the date on which that letter was received;

(iv) keep in its files a copy of the letter containing the correction or, when the correction is contained in a replacement sheet, the replaced sheet, a copy of the letter accompanying the replacement sheet, and a copy of the replacement sheet;

(v) promptly transmit any letter and any replacement sheet to the International Bureau, and a copy thereof to the receiving Office.

(b) Where the international search report is based on a sequence listing that was not contained in the international application as filed but was furnished subsequently to the International Searching Authority, the international search report shall so indicate.

(c) Where a meaningful international search cannot be carried out because a sequence listing is not available to the International Searching Authority in the required form, that Authority shall so state in the international search report.

(d) The International Searching Authority shall indelibly mark, in the upper right-hand corner of the first sheet of any sequence listing in printed form which was not contained in the international application as filed but was furnished subsequently to that Authority, the words "SUBSEQUENTLY FURNISHED SEQUENCE LISTING" or their equivalent in the language of publication of the international application.

(e) The International Searching Authority shall keep in its files:

(i) any sequence listing in printed form which was not contained in the international application as filed but was furnished subsequently to that Authority; and

(ii) any sequence listing in computer readable form.

Where an international application contains disclosure of a nucleotide and/or amino acid sequence, the description must contain a listing of the sequence complying with the standard specified in Annex C of the Administrative Instructions. See MPEP § 1823.02. If the International Searching Authority finds that an international application contains such a disclosure but that the description does not include such a listing or that the listing included does not comply with that standard, the International Searching Authority may invite the applicant to furnish a listing complying with that standard.

If the International Searching Authority finds that a sequence listing is not in a computer readable form provided for in the Administrative Instructions, it may invite the applicant to furnish a listing to it in such a form.

An invitation from the International Searching Authority to furnish a sequence listing complying with the standard specified in the Administrative Instructions, will specify a time limit for complying with the invitation. Any sequence listing furnished by the applicant in response to the invitation must be accompanied by a statement to the effect that the listing does not include matter which goes beyond the disclosure in the international application as filed. If the applicant does not comply within that time limit, the search undertaken by the International Searching Authority may be restricted.

If the applicant wishes to include such a listing in the text of the description itself, appropriate amendments may be made later under PCT Article 34, provided that the applicant files a Demand for international preliminary examination.

The United States Receiving Office has not notified the International Bureau under Administrative Instructions Section 801(b) that it is prepared to accept the filing in computer readable form (CRF) of the sequence listing and/or any *\*>tables<* related to the sequence listing of international applications under Administrative Instructions Section 801(a). However, Administrative Instructions Section 801(c) permits a receiving Office that has not notified the IB

under Administrative Instructions Section 801(b) to decide in a particular case to accept such sequence listing filings. The RO/US will accept applications where the sequence listing and/or table is filed using CD-R or CD-ROM as the electronic medium, and where no paper copy of the sequence listing part is submitted. The application must be filed in accordance with the Guidelines set forth in MPEP § 1823.02, subsection II. A in order to be accepted. There may be a significant cost savings if such a submission is accepted. If accepted under the USPTO's Guidelines, the electronic submission counts as 400 sheets in addition to the actual number of sheets of the Request, description excluding the sequence listing part thereof, claims, abstract and drawings. Four copies of the electronic submission of the sequence listing are required. One copy goes to the IB as part of the Record copy; the second copy becomes part of the Home copy; the third copy becomes part of the Search copy; and the fourth copy goes to the Scientific and Technical Information Center (STIC) as the CRF. Three copies of the electronic submission of any table related to the sequence listing are required. One copy goes to the IB as part of the record copy; the second copy becomes part of the home copy; the third copy becomes part of the search copy. See MPEP § 1823.02.

\*\*

## **1850 Unity of Invention Before the International Searching Authority [R-2]**

>

### *PCT Rule 13. Unity of Invention*

#### *13.1. Requirement*

The international application shall relate to one invention only or to a group of inventions so linked as to form a single general inventive concept ("requirement of unity of invention").

#### *13.2. Circumstances in Which the Requirement of Unity of Invention Is To Be Considered Fulfilled*

Where a group of inventions is claimed in one and the same international application, the requirement of unity of invention referred to in Rule 13.1 shall be fulfilled only when there is a technical relationship among those inventions involving one or more of the same or corresponding special technical features. The expression "special technical features" shall mean those technical features that define a contribution which each of the claimed inventions, considered as a whole, makes over the prior art.

#### *13.3. Determination of Unity of Invention Not Affected Manner of Claiming*

The determination whether a group of inventions is so linked as to form a single general inventive concept shall be made without regard to whether the inventions are claimed in separate claims or as alternatives within a single claim.

#### *13.4. Dependent Claims*

Subject to Rule 13.1, it shall be permitted to include in the same international application a reasonable number of dependent claims, claiming specific forms of the invention claimed in an independent claim, even where the features of any dependent claim could be considered as constituting in themselves an invention.

#### *13.5. Utility Models*

Any designated State in which the grant of a utility model is sought on the basis of an international application may, instead of Rules 13.1 to 13.4, apply in respect of the matters regulated in those Rules the provisions of its national law concerning utility models once the processing of the international application has started in that State, provided that the applicant shall be allowed at least two months from the expiration of the time limit applicable under Article 22 to adapt his application to the requirements of the said provisions of the national law.<

### *PCT Rule 40.*

#### *Lack of Unity of Invention (International Search)*

#### *40.1. Invitation to Pay*

The invitation to pay additional fees provided for in Article 17(3)(a) shall specify the reasons for which the international application is not considered as complying with the requirement of unity of invention and shall indicate the amount to be paid.

#### *40.2. Additional Fees*

(a) The amount of the additional fee due for searching under Article 17(3)(a) shall be determined by the competent International Searching Authority.

(b) The additional fee due for searching under Article 17(3)(a) shall be payable direct to the International Searching Authority.

(c) Any applicant may pay the additional fee under protest, that is, accompanied by a reasoned statement to the effect that the international application complies with the requirement of unity of invention or that the amount of the required additional fee is excessive. Such protest shall be examined by a three-member board or other special instance of the International Searching Authority or any competent higher authority, which, to the extent that it finds the protest justified, shall order the total or partial reimbursement to the applicant of the additional fee. On the request of the applicant, the text of both the protest and the decision thereon shall be notified to the designated Offices together with the international search report. The applicant shall submit any translation thereof with the furnishing of the translation of the international application required under Article 22.

(d) The three-member board, special instance or competent higher authority, referred to in paragraph (c), shall not comprise any person who made the decision which is the subject of the protest.

(e) Where the applicant has, under paragraph (c), paid an additional fee under protest, the International Searching Authority may, after a prior review of the justification for the invitation to pay an additional fee, require that the applicant pay a fee for the examination of the protest (“protest fee”). The protest fee shall be paid within one month from the date of the notification to the applicant of the result of the review. If the protest fee is not so paid, the protest shall be considered withdrawn. The protest fee shall be refunded to the applicant where the three-member board, special instance or higher authority referred to in paragraph (c) finds that the protest was entirely justified.

#### 40.3. Time Limit

The time limit provided for in Article 17(3)(a) shall be fixed, in each case, according to the circumstances of the case, by the International Searching Authority; it shall not be shorter than 15 or 30 days, respectively, depending on whether the applicant’s address is in the same country as or in a different country from that in which the International Searching Authority is located, and it shall not be longer than 45 days, from the date of the invitation.

\*\*

#### 37 CFR 1.475. Unity of invention before the International Searching Authority, the International Preliminary Examining Authority and during the national stage.

(a) An international and a national stage application shall relate to one invention only or to a group of inventions so linked as to form a single general inventive concept (“requirement of unity of invention”). Where a group of inventions is claimed in an application, the requirement of unity of invention shall be fulfilled only when there is a technical relationship among those inventions involving one or more of the same or corresponding special technical features. The expression “special technical features” shall mean those technical features that define a contribution which each of the claimed inventions, considered as a whole, makes over the prior art.

(b) An international or a national stage application containing claims to different categories of invention will be considered to have unity of invention if the claims are drawn only to one of the following combinations of categories:

- (1) A product and a process specially adapted for the manufacture of said product; or
- (2) A product and a process of use of said product; or
- (3) A product, a process specially adapted for the manufacture of the said product, and a use of the said product; or
- (4) A process and an apparatus or means specifically designed for carrying out the said process; or
- (5) A product, a process specially adapted for the manufacture of the said product, and an apparatus or means specifically designed for carrying out the said process.

(c) If an application contains claims to more or less than one of the combinations of categories of invention set forth in paragraph (b) of this section, unity of invention might not be present.

(d) If multiple products, processes of manufacture or uses are claimed, the first invention of the category first mentioned in the claims of the application and the first recited invention of each of the other categories related thereto will be considered as the main invention in the claims, see PCT Article 17(3)(a) and § 1.476(c).

(e) The determination whether a group of inventions is so linked as to form a single general inventive concept shall be made without regard to whether the inventions are claimed in separate claims or as alternatives within a single claim.

\*\*

#### THE REQUIREMENT FOR “UNITY OF INVENTION”

Any international application must relate to one invention only or to a group of inventions so linked as to form a single general inventive concept (PCT Article 3(4)(iii) and 17(3)(a), PCT Rule 3.1, and 37 CFR 1.475). Observance of this requirement is checked by the International Searching Authority and may be relevant in the national (or regional) phase.

The decision in *Caterpillar Tractor Co. v. Commissioner of Patents and Trademarks*, 231 USPQ 590 (E.D. Va. 1986) held that the Patent and Trademark Office interpretation of 37 CFR 1.141(b)(2) as applied to unity of invention determinations in international applications was not in accordance with the Patent Cooperation Treaty and its implementing regulations. In the Caterpillar international application, the USPTO acting as an International Searching Authority, had held lack of unity of invention between a set of claims directed to a process for forming a sprocket and a set of claims drawn to an apparatus (die) for forging a sprocket. The court stated that it was an unreasonable interpretation to say that the expression “specifically designed” as found in former PCT Rule 13.2(ii) means that the process and apparatus have unity of invention if they can only be used with each other, as was set forth in MPEP § 806.05(e).

Therefore, when the Office considers international applications as an International Searching Authority, as an International Preliminary Examining Authority, and during the national stage as a Designated or Elected Office under 35 U.S.C. 371, PCT Rule 13.1 and 13.2 will be followed when considering unity of invention of claims of different categories without regard to the practice in national applications filed under 35 U.S.C. 111. No change was made in restric-

tion practice in United States national applications filed under 35 U.S.C. 111 outside the PCT.

In applying PCT Rule 13.2 to international applications as an International Searching Authority, an International Preliminary Examining Authority and to national stage applications under 35 U.S.C. 371, examiners should consider for unity of invention all the claims to different categories of invention in the application and permit retention in the same application for searching and/or preliminary examination, claims to the categories which meet the requirements of PCT Rule 13.2.

PCT Rule 13.2, as it was modified effective July 1, 1992, no longer specifies the combinations of categories of invention which are considered to have unity of invention. Those categories, which now appear as a part of **\*\*>**Chapter 10 of the International Search and Preliminary Examination Guidelines, may be obtained from WIPO's website ([www.wipo.int/pct/en/texts/gdlines.htm](http://www.wipo.int/pct/en/texts/gdlines.htm)). The categories of invention in former PCT Rule 13.2 have been replaced< with a statement describing the method for determining whether the requirement of unity of invention is satisfied. Unity of invention exists only when there is a technical relationship among the claimed inventions involving one or more special technical features. The term "special technical features" is defined as meaning those technical features that define a contribution which each of the inventions considered as a whole, makes over the prior art. The determination is made based on the contents of the claims as interpreted in light of the description and drawings. **\*\*>**Chapter 10 of the International Search and Preliminary Examination Guidelines< also contains examples concerning unity of invention.

**\*\*>**

## **DETERMINATION OF "UNITY OF INVENTION"**

An international application should relate to only one invention or, if there is more than one invention, the inclusion of those inventions in one international application is only permitted if all inventions are so linked as to form a single general inventive concept (PCT Rule 13.1). With respect to a group of inventions claimed in an international application, unity of invention exists only when there is a technical rela-

tionship among the claimed inventions involving one or more of the same or corresponding special technical features. The expression "special technical features" is defined in PCT Rule 13.2 as meaning those technical features that define a contribution which each of the inventions, considered as a whole, makes over the prior art. The determination is made on the contents of the claims as interpreted in light of the description and drawings (if any).

Whether or not any particular technical feature makes a "contribution" over the prior art, and therefore constitutes a "special technical feature," should be considered with respect to novelty and inventive step. For example, a document discovered in the international search shows that there is a presumption of lack of novelty or inventive step in a main claim, so that there may be no technical relationship left over the prior art among the claimed inventions involving one or more of the same or corresponding special technical features, leaving two or more dependent claims without a single general inventive concept.

Lack of unity of invention may be directly evident "*a priori*," that is, before considering the claims in relation to any prior art, or may only become apparent "*a posteriori*," that is, after taking the prior art into consideration. For example, independent claims to A + X, A + Y, X + Y can be said to lack unity *a priori* as there is no subject matter common to all claims. In the case of independent claims to A + X and A + Y, unity of invention is present *a priori* as A is common to both claims. However, if it can be established that A is known, there is lack of unity *a posteriori*, since A (be it a single feature or a group of features) is not a technical feature that defines a contribution over the prior art.

Although lack of unity of invention should certainly be raised in clear cases, it should neither be raised nor maintained on the basis of a narrow, literal or academic approach. There should be a broad, practical consideration of the degree of interdependence of the alternatives presented, in relation to the state of the art as revealed by the international search or, in accordance with PCT Article 33(6), by any additional document considered to be relevant. If the common matter of the independent claims is well known and the remaining subject matter of each claim differs from that of the others without there being any unifying novel inventive concept common to all, then



clearly there is lack of unity of invention. If, on the other hand, there is a single general inventive concept that appears novel and involves inventive step, then there is unity of invention and an objection of lack of unity does not arise. For determining the action to be taken by the examiner between these two extremes, rigid rules cannot be given and each case should be considered on its merits, the benefit of any doubt being given to the applicant.

From the preceding paragraphs it is clear that the decision with respect to unity of invention rests with the International Searching Authority or the International Preliminary Examining Authority. However, the International Searching Authority or the International Preliminary Examining Authority should not raise objection of lack of unity of invention merely because the inventions claimed are classified in separate classification groups or merely for the purpose of restricting the international search to certain classification groups.<

Unity of invention has to be considered in the first place only in relation to the independent claims in an international application and not the dependent claims. By “dependent” claim is meant a claim which contains all the features of \*->one or more other claims and contains a reference, preferably at the beginning, to the other claim or claims and then states the additional features claimed (PCT Rule 6.4). The examiner should bear in mind that a claim may also contain a reference to another claim even if it is not a dependent claim as defined in PCT Rule 6.4. One example of this is a claim referring to a claim of a different category (for example, “Apparatus for carrying out the process of Claim 1 ...,” or “Process for the manufacture of the product of Claim 1 ...”). Similarly, a claim to one part referring to another cooperating part, for example, “plug for cooperation with the socket of Claim 1 ...”) is not a dependent claim.<

If the independent claims avoid the prior art and satisfy the requirement of unity of invention, no problem of lack of unity arises in respect of any claims that depend on the independent claims. In particular, it does not matter if a dependent claim itself contains a further invention. >For example, suppose claim 1 claims a turbine rotor blade shaped in a specified manner such that it avoids the prior art, while claim 2 is for a “turbine rotor blade as claimed in claim 1” and produced from alloy Z. Then no objection under PCT

Rule 13 arises either because alloy Z was new and its composition was not obvious and thus the alloy itself already contains the essential features of an independent possibly later patentable invention, or because, although alloy Z was not new, its application in respect of turbine rotor blades was not obvious, and thus represents an independent invention in conjunction with turbine rotor blades. As another example, suppose that the main claim defines a process avoiding the prior art for the preparation of a product A starting from a product B and the second claim reads: “Process according to claim 1 characterized by producing B by a reaction using the product C.” In this case, too, no objection arises under PCT Rule 13, whether or not the process for preparation of B from C is novel and inventive, since claim 2 contains all the features of claim 1.< Equally, no problem arises in the case of a genus/species situation where the genus claim avoids the prior art>, provided the genus claim is directed only to alternatives of a similar nature and the species falls entirely within the genus. To determine if a genus claim is directed only to alternatives “of a similar nature,” see subsection “B. Markush Practice” under “ILLUSTRATIONS OF PARTICULAR SITUATIONS” below.< Moreover, no problem arises in the case of a combination/subcombination situation where the subcombination claim avoids the prior art and the combination claim includes all the features of the subcombination.

If, however, an independent claim does not avoid the prior art, then the question whether there is still an inventive link between all the claims dependent on that claim needs to be carefully considered. If there is no link remaining, an objection of lack of unity >a posteriori< (that is, arising only after assessment of the prior art) may be raised. Similar considerations apply in the case of a genus/species or combination/subcombination situation.

This method for determining whether unity of invention exists is intended to be applied even before the commencement of the international search. Where a search of the prior art is made, an initial determination of unity of invention, based on the assumption that the claims avoid the prior art, may be reconsidered on the basis of the results of the search of the prior art.

>Alternative forms of an invention may be claimed either in a plurality of independent claims, or in a sin-

gle claim. In the latter case, the presence of the independent alternatives may not be immediately apparent. In either case, however, the same criteria should be applied in deciding whether there is unity of invention. Accordingly, lack of unity of invention may exist within a single claim. Where the claim contains distinct embodiments that are not linked by a single general inventive concept, the objection as to lack of unity of invention should be raised. PCT Rule 13.3 does not prevent an Authority from objecting to alternatives being contained within a single claim on the basis of considerations such as clarity, the conciseness of claims or the claims fee system applicable in that Authority.

Objection of lack of unity of invention does not normally arise if the combination of a number of individual elements is claimed in a single claim (as opposed to distinct embodiments as discussed in the paragraph immediately above), even if these elements seem unrelated when considered individually.<

#### **\*ILLUSTRATIONS OF PARTICULAR SITUATIONS**

There are three particular situations for which the method for determining unity of invention contained in PCT Rule 13.2 is explained in greater detail:

- (A) Combinations of different categories of claims;
- (B) So-called “Markush practice”; and
- (C) Intermediate and final products.

Principles for the interpretation of the method contained in PCT Rule 13.2, in the context of each of those situations are set out below. It is understood that the principles set out below are, in all instances, interpretations of and not exceptions to the requirements of PCT Rule 13.2.

Examples to assist in understanding the interpretation on the three areas of special concern referred to in the preceding paragraph are set out \*>in Chapter 10 of the International Search and Preliminary Examination Guidelines which can be obtained from WIPO’s web site ([www.wipo.int/pct/en/texts/gdlines.htm](http://www.wipo.int/pct/en/texts/gdlines.htm))<.

\*>

#### **A. < Combinations of Different Categories of Claims**

The method for determining unity of invention under PCT Rule 13 shall be construed as permitting, in particular, the inclusion of any one of the following combinations of claims of different categories in the same international application:

(A) In addition to an independent claim for a given product, an independent claim for a process specially adapted for the manufacture of the said product, and an independent claim for a use of the said product; or

(B) In addition to an independent claim for a given process, an independent claim for an apparatus or means specifically designed for carrying out the said process; or

(C) In addition to an independent claim for a given product, an independent claim for a process specially adapted for the manufacture of the said product and an independent claim for an apparatus or means specifically designed for carrying out the said process \*\*>.

A< process is specially adapted for the manufacture of a product if it inherently results in the product and \* an apparatus or means is specifically designed for carrying out a process if the contribution over the prior art of the apparatus or means corresponds to the contribution the process makes over the prior art.

Thus, a process shall be considered to be specially adapted for the manufacture of a product if the claimed process inherently results in the claimed product with the technical relationship being present between the claimed product and claimed process. The words “specially adapted” are not intended to imply that the product could not also be manufactured by a different process.

Also an apparatus or means shall be considered to be specifically designed for carrying out a claimed process if the contribution over the prior art of the apparatus or means corresponds to the contribution the process makes over the prior art. Consequently, it would not be sufficient that the apparatus or means is merely capable of being used in carrying out the claimed process. However, the expression \*\*>“specifically designed”< does not imply that the apparatus

or means could not be used for carrying out another process, nor that the process could not be carried out using an alternative apparatus or means.

>More extensive combinations than those set forth above should be looked at carefully to ensure that the requirements of both PCT Rule 13 (unity of invention) and PCT Article 6 (conciseness of claims) are satisfied. In particular, while a single set of independent claims according to one of (A), (B), or (C) above is always permissible, it does not require the International Authority to accept a plurality of such sets which could arise by combining the provisions of PCT Rule 13.3 (which provides that the determination of unity of invention be made without regard to whether the inventions are claimed in separate claims or as alternatives within a single claim), with the provisions set out above (thus resulting in a set based on each of a number of independent claims in the same category under PCT Rule 13.3). The proliferation of claims arising from a combined effect of this kind should be accepted only exceptionally. For example, independent claims are permissible for two related articles such as a transmitter and receiver; however, it does not follow that an applicant may include also, in the one international application, four additional independent claims: two for a process for the manufacture of the transmitter and the receiver, respectively, and two for use of the transmitter and receiver, respectively.

A single general inventive concept must link the claims in the various categories and in this connection the wording above should be carefully noted. The link between product and process in (A) is that the process must be “specially adapted for the manufacture of” the product. Similarly, in (B), the apparatus or means claimed must be “specifically designed for” carrying out the process. Likewise, in (C), the process must be “specially adapted for the manufacture of” the product and the apparatus must be “specifically designed for” carrying out the process. In combinations (A) and (C), the emphasis is on, and the essence of the invention should primarily reside in, the product, whereas in combination (B) the emphasis is on, and the invention should primarily reside in, the process. (See Examples in Chapter 10 of the International Search and Preliminary Examination Guidelines which can be obtained from WIPO’s web site ([www.wipo.int/pct/en/texts/gdlines.htm](http://www.wipo.int/pct/en/texts/gdlines.htm)))<

\*>

### **B. < “Markush Practice”**

The situation involving the so-called Markush practice wherein a single claim defines alternatives (chemical or non-chemical) is also governed by PCT Rule 13.2. In this special situation, the requirement of a technical interrelationship and the same or corresponding special technical features as defined in PCT Rule 13.2, shall be considered to be met when the alternatives are of a similar nature.

When the Markush grouping is for alternatives of chemical compounds, they shall be regarded as being of a similar nature where the following criteria are fulfilled:

(A) All alternatives have a common property or activity; and

(B)(1)A common structure is present, i.e., a significant structural element is shared by all of the alternatives; or

\*\*>

(B)(2)< In cases where the common structure cannot be the unifying criteria, all alternatives belong to a recognized class of chemical compounds in the art to which the invention pertains.

In paragraph (B)(1), above, the words “significant structural element is shared by all of the alternatives” refer to cases where the compounds share a common chemical structure which occupies a large portion of their structures, or in case the compounds have in common only a small portion of their structures, the commonly shared structure constitutes a structurally distinctive portion in view of existing prior art>, and the common structure is essential to the common property or activity<. The structural element may be a single component or a combination of individual components linked together.

In paragraph (\*>B<)(2), above, the words “recognized class of chemical compounds” mean that there is an expectation from the knowledge in the art that members of the class will behave in the same way in the context of the claimed invention. In other words, each member could be substituted one for the other, with the expectation that the same intended result would be achieved.

The fact that the alternatives of a Markush grouping can be differently classified \*>should< not, taken

alone, be considered to be justification for a finding of a lack of unity of invention.

When dealing with alternatives, if it can be shown that at least one Markush alternative is not novel over the prior art, the question of unity of invention \*>should< be reconsidered by the examiner. Reconsideration does not necessarily imply that an objection of lack of unity shall be raised. >(See Examples in Chapter 10 of the International Search and Preliminary Examination Guidelines which can be obtained from WIPO's web site ([www.wipo.int/pct/en/texts/gdlines.htm](http://www.wipo.int/pct/en/texts/gdlines.htm))).<

\*>

### C. < *Intermediate and Final Products*

The situation involving intermediate and final products is also governed by PCT Rule 13.2.

The term \*>"intermediate"< is intended to mean intermediate or starting products. Such products have the ability to be used to produce final products through a physical or chemical change in which the intermediate loses its identity.

Unity of invention shall be considered to be present in the context of intermediate and final products where the following two conditions are fulfilled:

(A) The intermediate and final products have the same essential structural element, in that:

(1) The basic chemical structures of the intermediate and the final products are the same, or

(2) The chemical structures of the two products are technically closely interrelated, the intermediate incorporating an essential structural element into the final product; and

(B) The intermediate and final products are technically interrelated, this meaning that the final product is manufactured directly from the intermediate or is separated from it by a small number of intermediates all containing the same essential structural element.

Unity of invention may also be considered to be present between intermediate and final products of which the structures are not known, for example, as between an intermediate having a known structure and a final product the structure of which is not known, or as between an intermediate of unknown structure and a final product of unknown structure. In order to satisfy unity in such cases, there \*>must< be

sufficient evidence to lead one to conclude that the intermediate and final products are technically closely interrelated as, for example, when the intermediate contains the same essential element as the final product or incorporates an essential element into the final product.

It is possible to accept in a single international application different intermediate products used in different processes for the preparation of the final product, provided that they have the same essential structural element.

The intermediate and final products shall not be separated, in the process leading from one to the other, by an intermediate which is not new.

If the same international application claims different intermediates for different structural parts of the final product, unity shall not be regarded as being present between the intermediates.

If the intermediate and final products are families of compounds, each intermediate compound shall correspond to a compound claimed in the family of the final products. However, some of the final products may have no corresponding compound in the family of the intermediate products so that the two families need not be absolutely congruent.

As long as unity of invention can be recognized applying the above interpretations, the fact that, besides the ability to be used to produce final products, the intermediates also exhibit other possible effects or activities shall not affect the decision on unity of invention. >(See Examples in Chapter 10 of the International Search and Preliminary Examination Guidelines which can be obtained from WIPO's web site ([www.wipo.int/pct/en/texts/gdlines.htm](http://www.wipo.int/pct/en/texts/gdlines.htm))).<

\*\*>

### **SEARCH OF ADDITIONAL INVENTIONS WITHOUT PAYMENT OF FEES**

If little or no additional search effort is required, reasons of economy *may* make it advisable for the examiner, while making the search for the main invention, to search at the same time, despite the non-payment of additional fees, one or more additional inventions in the classification units consulted for the main invention. The international search for such additional inventions will then have to be completed in any further classification units which may be rele-

vant, when the additional search fees have been paid. This situation may occur when the lack of unity of invention is found either “*a priori*” or “*a posteriori*.”

When the examiner finds lack of unity of invention, normally, the applicant is invited to pay fees for the search of additional inventions. In exceptional circumstances, however, the examiner may be able to establish both an international search (and for international applications having a filing date on or after January 1, 2004, a written opinion) covering more than one invention with negligible additional work, in particular, when the inventions are conceptually very close. In those cases, the examiner may decide to complete the international search (and where applicable, the written opinion of the International Searching Authority) for the additional invention(s) together with that for the invention first mentioned. For international applications having a filing date on or after January 1, 2004, in considering the amount of work involved, the examiner should take into account the time needed to create the written opinion as well as that needed to perform the search, since even when the additional work with regard to the search is negligible, the opposite may be the case for the written opinion of the International Searching Authority and therefore justify requesting the additional fees. If it is considered that the total additional work does not justify requesting additional fees, all results are included in the international search report without inviting the applicant to pay an additional search fee in respect of the additional inventions searched but stating the finding of lack of unity of invention.

#### **INVITATION TO PAY ADDITIONAL FEES<**

The search fee which the applicant is required to pay is intended to compensate the International Searching Authority for carrying out an international search \*\*>(and for international applications having a filing date on or after January 1, 2004, for preparing a written opinion)<, but only where the international application meets the “requirement of unity of invention”. That means that the international application must relate to only one invention or must relate to a group of inventions which are so linked as to form a single general inventive concept (PCT Articles 3(4)(iii) and 17(3)(a)>.<

If the International Searching Authority finds that the international application does not comply with the

requirement of unity of invention, the applicant will be \*\*>informed of the lack of unity of invention by a communication preceding the issuance of the international search report (and for international applications having a filing date on or after January 1, 2004, a written opinion of the International Searching Authority), which contains an invitation to pay additional search fees. (Form PCT/ISA/206 or USPTO/299 (telephone practice), see below). This invitation specifies the reasons the international application is not considered to comply with the requirement of unity of invention, identifies the separate inventions, and indicates the number of additional search fees and the amount to be paid (PCT Rules 40.1, 40.2(a) and (b)). The International Searching Authority cannot consider the application withdrawn for lack of unity of invention, nor invite the applicant to amend the claims, but informs the applicant that, if the international search report is to be drawn up in respect of those inventions present other than the first mentioned, then the additional fees must be paid within a stipulated period.< Such additional fees are payable directly to the International Searching Authority which is conducting the search, either the United States Patent and Trademark Office or European Patent Office, within the time limit fixed, which must not be shorter than 15 days, if the applicant’s address is in the same country as the International Searching Authority; or 30 days, if applicant’s address is in a country different than the country of the International Searching Authority; and not longer than 45 days from the date of the invitation (PCT Rule 40.3). The search fee amounts for the U.S. and the European Patent Office are found in each weekly edition of the *Official Gazette*.

\*\*>In the invitation to pay additional fees, the International Searching Authority should set out a logically presented, technical reasoning containing the basic considerations behind the finding of lack of unity (PCT Rule 40.1 ).

Since these payments must take place within a period to be set by the International Searching Authority so as to enable the observation of the time limit for establishing the international search report set by PCT Rule 42, the International Searching Authority should endeavor to ensure that international searches be made as early as possible after the receipt of the search copy. The International Searching

Authority finally draws up the international search report (and for international applications having a filing date on or after January 1, 2004, the written opinion of the International Searching Authority) < on those parts of international application which relate to the “main invention,” that is, the invention or the group of inventions so linked as to form a single general inventive concept first mentioned in the claims (PCT Article 17(3)(a)). Moreover, the international search report >(and for international applications having a filing date on or after January 1, 2004, the written opinion of the International Searching Authority) < will be established also on those parts of the international application which relate to any invention (or any group of inventions so linked as to form a single general inventive concept) in respect of which the applicant has paid any additional fee within the prescribed time limits.

\*\*

Where, within the prescribed time limit, the applicant does not pay any additional fees or only pays some of the additional fees indicated, certain parts of the international application will consequently not be searched. The lack of an international search report in respect of such parts of the international application will, in itself, have no influence on the validity of the international application and processing of the international application will continue, both in the international and in the national (regional) phases. The unsearched claims, upon entry into the national stage, will be considered by the examiner and may be the subject of a holding of lack of unity of invention.

\*\*>

#### **PREPARATION OF THE INVITATION TO PAY ADDITIONAL FEES**

Form PCT/ISA/206 is used to invite the applicant to pay additional search fees. In the space provided on form PCT/ISA/206, the examiner should indicate the number of inventions claimed in the international application covering which particular claims and explain why the international application is not considered to comply with the requirements of unity of invention. The examiner should then indicate the total amount of additional fees required for the search of all claimed inventions.

In the box provided at the top of the form, the time limit for response is set according to PCT Rule 40.3, which must not be shorter than 15 days, if the applicant’s address is in the same country as the International Searching Authority; or 30 days, if applicant’s address is in a country different than the country of the International Searching Authority; and not longer than 45 days from the date of the invitation. Extensions of time are not permitted.

Since the space provided on Form PCT/ISA/206 is limited, supplemental attachment sheets, supplied by the examiner, with reference back to the specific section, should be incorporated whenever necessary.<

#### **AUTHORIZED OFFICER**

Form PCT/IPEA/206 must be signed by an examiner with at least partial signatory authority.

#### **>TELEPHONIC UNITY PRACTICE**

Telephone practice may be used to allow applicants to pay additional fees if

(A) Applicant or applicant’s legal representative has a USPTO deposit account,

(B) Applicant or the legal representative orally agrees to charge the additional fees to the account, and

(C) A complete record of the telephone conversation is included with the international search report including:

- (1) Examiner’s name;
- (2) Authorizing attorney’s name;
- (3) Date of conversation;
- (4) Inventions for which additional fees paid;

and

(5) Deposit account number and amount to be charged.

When the telephone practice is used in making lack of unity requirements, it is critical that the examiner orally inform applicant that there is no right to protest the holding of lack of unity of invention for any group of invention(s) for which no additional search fee has been paid.

The examiner must further orally advise applicant that any protest to the holding of lack of unity or the amount of additional fee required must be filed in writing no later than 15 days from the mailing date of the international search report. The examiner should

fill in the information on Form USPTO/299 “Chapter I PCT Telephone Memorandum for Lack of Unity” as a record of the telephonic holding of lack of unity.

If the applicant or the legal representative or agent refuses to either restrict the claims to one invention or authorize payment of additional fees over the telephone, or if applicant does not have a deposit account, the examiner should send a written invitation using the Chapter I form, PCT/ISA/206.

If a written invitation is required, the examiner should, if possible, submit the written invitation to the TC for review and mailing within 7 days from the date the international application is charged to the examiner.

## FORM PARAGRAPHS FOR LACK OF UNITY IN INTERNATIONAL APPLICATIONS

### ¶ 18.05 Heading for Lack of Unity Action (Not Involving Species)

This application contains the following inventions or groups of inventions which are not so linked as to form a single general inventive concept under PCT Rule 13.1. In order for all inventions to be examined, the appropriate additional examination fees must be paid.

#### Examiner Note:

Begin all Lack of Unity actions with this heading.

### ¶ 18.06 Lack of Unity - Three Groups of Claims

Group [1], claim(s) [2], drawn to [3].

Group [4], claim(s) [5], drawn to [6].

Group [7], claim(s) [8], drawn to [9].

#### Examiner Note:

1. In brackets 1, 4 and 7, insert Roman numerals for each Group.
2. In brackets 2, 5 and 8, insert respective claim numbers.
3. In brackets 3, 6 and 9, insert respective names of grouped inventions.

### ¶ 18.06.01 Lack of Unity - Two (or Additional) Groups of Claims

Group [1], claim(s) [2], drawn to [3].

Group [4], claim(s) [5], drawn to [6].

#### Examiner Note:

This form paragraph may be used alone or following form paragraph 18.06.

### ¶ 18.06.02 Lack of Unity - One Additional Group of Claims

Group [1], claim [2], drawn to [3].

#### Examiner Note:

This form paragraph may be used following either form paragraph 18.06 or 18.06.01.

### ¶ 18.07 Lack of Unity - Reasons Why Inventions Lack Unity

The inventions listed as Groups [1] do not relate to a single general inventive concept under PCT Rule 13.1 because, under PCT Rule 13.2, they lack the same or corresponding special technical features for the following reasons: [2]

#### Examiner Note:

1. In bracket 1, insert appropriate Roman numerals for Groups involved.
2. In bracket 2, insert reasoning.

### ¶ 18.16 Lack of Unity - Species - Heading

This application contains claims directed to more than one species of the generic invention. These species are deemed to lack unity of invention because they are not so linked as to form a single general inventive concept under PCT Rule 13.1.

In order for more than one species to be examined, the appropriate additional examination fees must be paid. The species are as follows:

[1]

#### Examiner Note:

In bracket 1, list each species by Fig. No. or embodiment.

### ¶ 18.17 Lack of Unity - Species - Correspondence of the Claims to the Species

The claims are deemed to correspond to the species listed above in the following manner:

[1]

The following claim(s) are generic: [2]

#### Examiner Note:

1. This form paragraph is to be used immediately following 18.16.
2. In bracket 1, for each species, list the claims, e.g., Fig.1 - claims 1, 3 and 6.
3. In bracket 2, identify each generic claim by number or insert the word --NONE--.

### ¶ 18.18 Lack of Unity - Species - Reasons Why Unity Is Lacking

The species listed above do not relate to a single general inventive concept under PCT Rule 13.1 because, under PCT Rule 13.2, the species lack the same or corresponding special technical features for the following reasons: [1]

#### Examiner Note:

1. This form paragraph is to be used immediately following form paragraph 18.17.
2. In bracket 1, insert reasoning.

## PROTEST PROCEDURE

*PCT Administrative Instruction Section 502.  
Transmittal of Protest Against Payment of Additional Fee  
and Decision Thereon Where International Application Is  
Considered To Lack Unity of Invention*

The International Searching Authority shall transmit to the applicant, preferably at the latest together with the international search report, any decision which it has taken under Rule 40.2(c) on the protest of the applicant against payment of an additional fee where the international application is considered to lack unity of invention. At the same time, it shall transmit to the International Bureau a copy of both the protest and the decision thereon, as well as any request by the applicant to forward the texts of both the protest and the decision thereon to the designated Offices.

*37 CFR 1.477. Protest to lack of unity of invention before the International Searching Authority.*

(a) If the applicant disagrees with the holding of lack of unity of invention by the International Searching Authority, additional fees may be paid under protest, accompanied by a request for refund and a statement setting forth reasons for disagreement or why the required additional fees are considered excessive, or both (PCT Rule 40.2(c)).

(b) Protest under paragraph (a) of this section will be examined by the Director or the Director's designee. In the event that the applicant's protest is determined to be justified, the additional fees or a portion thereof will be refunded.

(c) An applicant who desires that a copy of the protest and the decision thereon accompany the international search report when forwarded to the Designated Offices may notify the International Searching Authority to that effect any time prior to the issuance of the international search report. Thereafter, such notification should be directed to the International Bureau (PCT Rule 40.2(c)).

The applicant may protest the allegation of lack of unity of invention or that the number of required additional fees is excessive and request a refund of the additional fee(s) paid. If, and to the extent that, the International Searching Authority finds the protest justified, the fee(s) are refunded (PCT Rule 40.2(c)). (The additional search fees must be paid for any protest to be considered.)

Protest of allegation of lack of unity is in the form of a reasoned statement accompanying payment of the additional fee, explaining why the applicant believes that the requirements of unity of invention are fulfilled and fully taking into account the reasons indicated in the invitation to pay additional fees issued by the International Searching Authority. Any such protest filed with the U.S. International Searching Authority will be decided by a Technology Center Director (MPEP § 1002.02(c) item (2)). To the extent

applicant's protest is found to be justified, total or partial reimbursement of the additional fee will be made. On the request of the applicant, the text of both the protest and the decision thereon is sent to the designated Offices together with the international search report (37 CFR 1.477(c)).

## NOTIFICATION OF DECISION ON PROTEST

Form PCT/ISA/212 is used by the Technology Center (TC) to inform the applicant of the decision regarding applicant's protest on the payment of additional fees concerning unity of invention. The TC checks the appropriate box, i.e., 1 or 2. If box 2 is checked, a clear and concise explanation as to why the protest concerning the unity of invention was found to be unjustified must be given. Since the space is limited, supplemental attachment sheet(s) should be incorporated whenever necessary.

## AUTHORIZED OFFICER

Form PCT/ISA/212 must be signed by a TC Director. See MPEP § 1002.02 (c), item (2).<

## UNITY OF INVENTION - NUCLEOTIDE SEQUENCES

Under 37 CFR 1.475 and 1.499 *et seq.*, when claims do not comply with the requirement of unity of invention, i.e., when the claimed subject matter does not involve "one or more of the same or corresponding special technical features," 37 CFR 1.475(a), an additional fee is required to maintain the claims in the same application. 37 CFR 1.476 (b).

The \*>USPTO< has decided *sua sponte* to partially waive 37 CFR 1.475 and 1.499 *et seq.* to permit applicants to claim up to ten (10) nucleotide sequences that do not have the same or corresponding special technical feature without the payment of an additional fee. The PCT permits inventions that lack unity of invention to be maintained in the same international application for payment of additional fees. Thus, in international applications, for each group for which applicant has paid additional international search and/or preliminary examination fees, the USPTO has determined that up to four (4) such additional sequences per group is a reasonable number for examination. Further, claims directed to the selected sequences will be examined with claims drawn to any sequence combinations which have a common techni-



cal feature with the selected sequences. Nucleotide sequences encoding the same protein are considered to satisfy the unity of invention standard and will continue to be examined together.

See MPEP § 803.04 for examples of nucleotide sequence claims impacted by this partial waiver of 37 CFR 1.475 and 1.499 *et seq.*

>Examples concerning Unity of Invention involving biotechnological inventions may be found in Chapter 10 of the International Search and Preliminary Examination Guidelines which can be obtained from the WIPO's web site ([www.wipo.int/pct/en/texts/gdlines.htm](http://www.wipo.int/pct/en/texts/gdlines.htm)).<

## 1851 Identification of Patent Documents [R-2]

The examiner, in completing the international search report as well as the \*\* written opinion and \*>international preliminary examination< report, is required to cite the references in accordance with the provisions of Administrative Instructions >Sections< 503 and 611 >and WIPO Standard ST.14<. These sections of the Administrative Instructions require reference citations to include, in addition to other information which is apparent from the forms which the examiner fills out, an indication of the two-letter country code of the country or entity issuing or publishing the document and the standard code for identifying the kind of patent document. The discussion which follows is limited to the identification of patent documents (and nonpatent publications) and a listing of the two-letter country codes for countries or other entities which issue or publish industrial property information.

The standard codes for identifying different kinds of patent documents are found in the "WIPO Handbook on Industrial Property Information and Documentation" - WIPO Standard ST.16 which is published by the World Intellectual Property Organization. The listing is extensive. The Special Program Examiners in each Technology Center (TC) have a complete copy of Standard ST.16. It is also accessible on WIPO's web site (<http://www.wipo.int/scit/en/>) under the heading "WIPO Standards and Other Documentation." Provided herein is an abbreviated version representing the countries and codes commonly used by the examiner in preparing search reports.

U.S. patents published before January 2, 2001, are Code A documents generally. Beginning with patents published on January 2, 2001, U.S. patents are Code B documents. Patent Application Publications, first published on March 15, 2001, are Code A documents. Reexamination certificates published before January 2, 2001, are Code B documents. Reexamination certificates published on or after January 2, 2001, are Code C documents. Tables providing a complete list of the kind codes of patents and other documents published by the USPTO are included in MPEP § 901.04(a). All nonpatent literature documents are Code N. Numerical designations are sometimes found on published documents along with the letter code designation. These should be used by the examiner only if such numerical designation is on the document. Numerical codes along with letter codes can be found, for example, on certain published patent documents such as the German Offenlegungsschrift and published international applications. If numerical designations are not provided, the examiner should use only the letter code designation.

The most commonly cited documents are patents and published patent applications. A guideline for the citation of such documents is listed below. The listing is indicated in the order in which the elements should be listed.

In the case of a patent or published patent application:

(A) The Office that issued the document, by the two letter code (WIPO Standard ST.3);

(B) The number of the document as given to it by the Office that issued it (for Japanese patent documents the indication of the year of the reign of the Emperor must precede the serial number of the patent document);

(C) The kind of document, by the appropriate symbols as indicated on the \* document \*\*>under< WIPO Standard ST.16 >or, if not indicated on that document, as provided in that Standard, if possible<;

(D) The name of the patentee or applicant (in capital letters, where appropriate, abbreviated);

(E) The date of publication of the cited patent document \*\*>or, in case of a corrected patent document, the date of issuance of the corrected patent document as referred to under INID code (48) of WIPO Standard ST.9 and, if provided on the document, the

supplementary correction code as referred to under INID code (15);

(F) Where applicable, the pages, columns, lines or paragraph numbers where the relevant passages appear, or the relevant figures of the drawings.

The following examples illustrate the citation of a patent document as indicated above:

\*\*JP 10-105775 A (NCR INTERNATIONAL INC.) 24 April 1998 (24.04.1998) paragraphs 26 to 30.

DE 3744403 A1 (JOSEK, A.) 29 August 1991 (29-08-1991), page 1, abstract.

US 5,635,683 A (MCDERMOTT, R. M. et al.) 03 June 1997 (03/06/1997), column 7, lines 21 to 40.

**STANDARD CODE FOR THE IDENTIFICATION OF DIFFERENT KINDS OF PATENT DOCUMENTS**

The Code, WIPO Standard ST.16, is subdivided into mutually exclusive groups of letters. The groups characterize patent documents, nonpatent literature documents (N), and restricted documents (X). Groups 1-7 comprise letters enabling identification of documents pertaining to different publication levels.

<u>Group 1</u>	Use for documents resulting from a patent application and being identified as the primary or major series (excluding the utility model documents of Group 2 and the special series of patent documents of Group 3, below)
A	First publication level
B	Second publication level
C	Third publication level

<u>Group 2</u>	Use for utility model documents having a numbering series other than the documents of Group 1
U	First publication level

<u>Group 2</u>	Use for utility model documents having a numbering series other than the documents of Group 1
Y	Second publication level
Z	Third publication level

<u>Group 3</u>	Use for special series of patent document
M	Medicament patent documents (e.g., documents previously published by FR)
P	Plant patent documents (e.g., published by US)
S	Design patent documents (e.g., published by US)

<u>Group 4</u>	Use for special types of patent documents or documents derived from/relating to patent applications and not covered by Groups 1 to 3 above, as specified below:
L	Documents, not covered by letter code W, relating to patent documents and containing bibliographic information and only the text of an abstract and/or claim(s) and, where appropriate, a drawing.
R	Separately published search reports
T	Publication, for information or other purposes, of the translation of the whole or part of a patent document already published by another office or organization

<u>Group 4</u>	Use for special types of patent documents or documents derived from/relating to patent applications and not covered by Groups 1 to 3 above>, as specified below<:
W	Documents relating to utility model documents falling in Group 2 and containing bibliographic information and only the text of an abstract and/or claim(s) and, where appropriate, a drawing

<u>Group 5</u>	Use for series of patent documents not covered by Groups 1 to 4, above
E	First publication level
F	Second publication level
G	Third publication level

<u>Group 6</u>	Use for series of patent documents or documents derived from/relating to patent applications not covered by Groups 1 to 5 above, according to the special requirements of each industrial property office
H	
I	

<u>Group 7</u>	Other
N	Non-patent literature documents
X	Documents restricted to the internal use of industrial property offices

*List of Examples of Patent Documents, Previously and Currently Published, or Intended To Be Published, Divided According to Code*

CODE: A	Patent Documents Identified as Primary or Major Series — First Publication Level
EXAMPLES:	
Australia	Standard or petty patent application
Austria	Patent application (Aufgebot)
Belgium	Brevet d'invention/Uitvindingsoctrooi
Belgium	Brevet de perfectionnement/Verbeteringsoctrooi
Belgium	Demande de brevet d'invention/Uitvindingsoctrooiaanvraag
Brazil	Pedido de privilégio (Unexamined patent application for invention)
Bulgaria	Patentna zjavka predostavena za publicna inspektzija (Patent application made available to the public)
Canada	Patent (prior to October 1, 1989, under previous Patent Act)
Canada	Patent application laid open to public inspection under amended Patent Act, as of October 1, 1989)

CODE: A	Patent Documents Identified as Primary or Major Series — First Publication Level	CODE: A	Patent Documents Identified as Primary or Major Series — First Publication Level
China	Patent application published before the examination	France	Certificat d'utilité, première et unique publication
Cuba	Patent application	France	Certificat d'addition à un certificat d'utilité, première et unique publication
Czechoslovakia	Patent application	France	Demande de brevet d'invention, première publication
Czechoslovakia	Inventor's certificate application	France	Demande de certificat d'addition à un brevet d'invention, première publication
Czech Republic	*>Prihláška< Vynálezu (Application for the protection of an invention — patent)	France	Demande de certificat d'utilité, première publication
Denmark	Almindeligt tilgaengeligt patentansøgning	France	Demande de certificat d'addition à un certificat d'utilité, première publication
Egypt	Patent specification	Germany	Offenlegungsschrift
European Patent - Office	Patent application published with search report	Germany (document published by the Patent Office of the former GDR)	Patentschrift (Ausschliessungspatent), patent granted in accordance with paragraph 17.1 of the Patent Law of the former German Democratic Republic of October 27, 1983
European Patent Office	Patent application published without search report	Germany (document published by the Patent Office of the former GDR)	Patentschrift (Wirtschaftspatent), patent granted in accordance with paragraph 17.1 of the Patent Law of the former German Democratic Republic of October 27, 1983
European Patent Office	Separate publication of the search report		
Finland	Julkiseksi tullut patentihakemus-Allmänt tillgänglig patentansökan		
France	Brevet d'invention (old law)		
France	Brevet d'invention première et unique publication		
France	Certificat d'addition à un brevet d'invention, première et unique publication		

CODE: A	Patent Documents Identified as Primary or Major Series — First Publication Level
Greece	Diploma evresitechnias
Greece	Etisi gia Diploma evresitechnias
Greece	Etisi gia Diploma tropopiisis
Hungary	Patent application
India	Patent specification
Ireland	Patent specification
Israel	Bakashah lepatent (Application of patent for invention)
Italy	Domanda di brevetto pubblicata
Japan	Kôkai tokkyo kôhō
Japan	Kôhyo tokkyo kôhō
Luxembourg	Brevet d'invention
Luxembourg	Certificat d'addition à un brevet d'invention
Malawi	Patent application
Mexico	Patent (Granted patent — according to old law)
Mexico	Patent application (according to new law)
Mongolia	Patent
Morocco	Brevet d'invention
Netherlands	Terinzagegelegging
New Zealand	Patent application
Norway	Alment tilgjengelige patentsöknader
OAPI	Brevet d'invention

CODE: A	Patent Documents Identified as Primary or Major Series — First Publication Level
Pakistan	Patent specification
Peru	Patente de invención
Philippines	Patent for invention
Poland	Opis zgłoszeniowy wynalazku
Portugal	Pedido de patente de invenção
Republic of Korea	Konggae t'ukho kongbo
Romania	Descrierea inventiei
Romania	Cerere de brevet de invente
Russian Federation	Zayavka na izobreteniye (Published application for invention)
Slovakia	**>Prihláška Vynálezu< (Published application for invention)
Slovenia	Patent
Slovenia	Patent s *>skrajšanim< trajanjem (Short-term patent)
Soviet Union	Opisanie izobreteniya k patentu
Soviet Union	Opisanie izobreteniya k avtorskomu svidetelstvu
Spain	Patente de invención

CODE: A	Patent Documents Identified as Primary or Major Series — First Publication Level
Spain	Solicitud de patente con informe sobre el estado de la técnica (Patent application published with search report)
Spain	Solicitud de patente sin informe sobre el estado de la técnica (Patent application published without search report)
Sweden	Allmant tillgänglig patentansökan
Switzerland	Auslegeschrift/Fascicule de la demande/Fascicolo della domanda (Patent Application published and pertaining to the technical fields for which search and examination as to novelty are made)
Switzerland	Patentschrift/Fascicule du brevet/Fascicolo del brevetto (Patent published and pertaining to the technical fields for which neither search nor examination as to novelty are made)
Tunisia	Talab Baraat Ekhtiraâ
Turkey	Patent tarifnamesi
United Kingdom	Patent specification (old Law; not printed on documents)
United Kingdom	Patent application (new Law)

CODE: A	Patent Documents Identified as Primary or Major Series — First Publication Level
United States of America	Patent (published before January 2, 2001)
United States of America	Patent application publication (published beginning March 15, 2001)
World Intellectual Property Organization	International application published with or without the international search report
Yugoslavia	Patenta prijava koja se moze razgledati

CODE: B	Patent Documents Identified as Primary or Major Series -Second Publication Level
<b>EXAMPLES:</b>	
Australia	Accepted standard or petty patent
Austria	Patentschrift
Belgium	Brevet d'invention/Uitvindingsoctrooi
Brazil	Patente (granted patent of invention)
Canada	Reissue patent (prior to October 1, 1989, under previous Patent Act)
Cuba	Patente de invención
Czechoslovakia	Popis vynalezu k patentu
Czechoslovakia	Popis vynalezu k autor-skemu osvedceni

CODE: B	Patent Documents Identified as Primary or Major Series -Second Publication Level
Czech Republic	Patentovy spis (patent specification)
Denmark	Fremlaeggelsesskrift (old Law)
Denmark	Patentskrift
Denmark	Patentskrift (amended)
Finland	Kuulutusjulkaisu - Utläggningsskrift
France	Brevet d'invention, deuxième publication de l'invention
France	Certificat d'addition à un brevet d'invention, deuxième publication de l'invention
France	Certificat d'utilité, deuxième publication de l'invention
France	Certificat d'addition à un certificat d'utilité, deuxième publication de l'invention
Germany	Auslegeschrift
Germany (document published by the Patent Office of the former GDR)	Patentschrift (Ausschliessungspatent), patent granted in accordance with paragraph 18.1 of the Patent Law of the former German Democratic Republic of October 27, 1983

CODE: B	Patent Documents Identified as Primary or Major Series -Second Publication Level
Germany (document published by the Patent Office of the former GDR)	Patentschrift (Wirtschaftspatent), patent granted in accordance with paragraph 18.1 of the Patent Law of the former German Democratic Republic of October 27, 1983
Greece	Diploma evresitechnias (Patent of invention)
Greece	Diploma tropopiisis (Patent of addition)
Hungary	Szabadalmi leiras
Indonesia	Patent granted in accordance with article 61 of the Patent Law, Number 6 of 1989 Concerning Patents
Japan	Tokkyo kôhô
Netherlands	Openbaar gemaakte octrooiaanvraag
Norway	Utlegningskrift
Poland	Opis patentowy
Portugal	Patente de invenção (Granted patent of published application)
Republic of Korea	T'ukho kongbo
Spain	Patente de invención con informe sobre el estado de la técnica (Patent specification with search report)

CODE: B	Patent Documents Identified as Primary or Major Series -Second Publication Level
Spain	Patente de invención con examen previo (Patent specification published after examination)
Sweden	Utläggningsskrift
Switzerland	Patentschrift/Fascicule du brevet/Fascicolo del brevetto (Patent published and pertaining to the technical fields for which search and examination as to novelty are made)
United Kingdom	Amended patent specification (old Law)
United Kingdom	Patent specification (new Law)
United States of America	Reexamination certificate (published prior to January 2, 2001)
United States of America	Patent (published on or after January 2, 2001)

CODE: C	Patent Documents Identified as Primary or Major Series - Third Publication Level
EXAMPLES:	
Argentina	Patente de invención (Patent)

CODE: E	Patent Documents Identified as Series Other Than the Documents Coded A, B, C, U, Y, Z, M, P, S, T, W, L or R - First Publication Level
EXAMPLES:	
Canada	Reissue patent (under amended Patent Act, as of October 1, 1989)
France	Certificat d'addition à brevet d'invention (old Law)
Sweden	Patentskrift i ändrad lydelse (Amended patent specification)
United States of America	Reissue patent

CODE: H	Patent Documents Identified in Series According to Special Requirements of Individual Industrial Property Offices
EXAMPLES:	
United States of America	Statutory invention registration



CODE: M	Patent Documents Identified in Series According to Special Requirements of Individual Industrial Property Offices
EXAMPLES:	
France	Brevet spécial de médicament
France	Addition à un brevet spécial de médicament

CODE: P	Plant Patent Documents
EXAMPLES:	
United States of America	Plant patent
United States of America	Plant patent application publication

CODE: S	Design Patent Documents
EXAMPLES:	
Brazil	Pedido de privilégio (unexamined patent application for industrial model)
Russian Federation	Patent na promishlenni obrazets (Design patent)
United States of America	Design patent

CODE: U	Utility Model Documents Having a Numbering Series Other Than the Documents Coded A, B or C— First Publication Level
EXAMPLES:	
Austria	Gebrauchsmusterschrift (published with or without a search report)
Brazil	Pedido de privilégio (unexamined patent application for industrial model)
Bulgaria	Zajavka za polezni modeli predostavena za publichna inspektzija (Utility model application made available to the public)
Czech Republic	Uzity vzor (Utility model)
Denmark	Almindeligt tilgaengeligt brugsmodelansogning
Denmark	Brugsmodelskrift
Finland	Hyödyllisyysmalli-Nyttighetsmodell (Utility model)
Germany	Gebrauchsmuster
Greece	Etisi gia Pistopiitiko Ipodigmatos Chrisimotitas (Utility model application)
Hungary	Hasznalati minta leiras (Utility model specification)

CODE: U	Utility Model Documents Having a Numbering Series Other Than the Documents Coded A, B or C— First Publication Level
Japan	Kôkai jitsuyô shin-an kôhō (Published unexamined utility model application)
Japan	Tôroku jitsuyô shin-an kôhō (Published registered utility model application) (without substantive examination)
Mexico	Utility model
Poland	Opis zgłoszeniowy wzoru użytecznego
Portugal	Pedido de modelo de utilidade (Published application for a utility model)
Republic of Korea	Konggae shilyong shin-an kongbo
Russian Federation	Svidetelstvo na poleznuyu model (Certificate for utility model)
Slovakia	*>Úžitkový< vzor (Utility model)
Spain	Solicitud de modelo de utilidad

CODE: Y	Utility Model Documents Having a Numbering Series Other Than the Documents Coded A, B or C— Second Publication Level
EXAMPLES:	
Brazil	Patente (granted patent of utility model)
Bulgaria	Opisanie na patent za polezen model (Description of a patent for utility model)
Denmark	Brugsmodelskrift
Denmark	Brugsmodelskrift (amended)
Greece	Pistopiitiko Ipodigmatos Chrisimotitas (Utility model)
Japan	Jitsuyô shin-an kôhō (Published examined utility model application)
Poland	Opis ochronny wzoru użytkowego
Portugal	Modelo de utilidade (Granted utility model)
Republic of Korea	Shilyong shin-an kongbo (Utility model specification)
Spain	Modelo de utilidad
**	

**Country Codes**

The two-letter country codes listed below are set forth in WIPO Standard ST.3, which is published in the “WIPO Handbook on Industrial Property Information and Documentation” and is accessible via the internet at the WIPO website ([\\*www.wipo.int/scit/en/standards/standards.htm](http://www.wipo.int/scit/en/standards/standards.htm)). WIPO Standard ST.3 provides, in Annex A, Section 1, a listing of two-letter country codes and/or organizational codes in alphabetic sequence of their short names for the states, other entities and intergovernmental organizations issuing or publishing industrial property documents. Codes for states or organizations that existed on January 1, 1978, but that no longer exist are provided in Annex B, Section 2. Annex B, Section 1 (not reproduced below) lists States for which the Codes have changed.

## Annex A, Section 1

List of States, Other Entities and Intergovernmental Organizations, in Alphabetic Sequence of Their Short Names, and Their Corresponding Codes	
Afghanistan	AF
African Intellectual Property Organization (OAPI)	OA
African Regional Industrial Property Organization (ARIPO)	AP
Albania	AL
Algeria	DZ
Andorra	AD
Angola	AO
Anguilla	AI
Antigua and Barbuda	AG
Argentina	AR
Armenia	AM
Aruba	AW
Australia	AU

Austria	AT
Azerbaijan	AZ
Bahamas	BS
Bahrain	BH
Bangladesh	BD
Barbados	BB
Belarus	BY
Belgium	BE
Belize	BZ
Benelux Trademark Office (BBM) and Benelux Designs Office (BBDM)	BX
Benin	BJ
Bermuda	BM
Bhutan	BT
Bolivia	BO
Bosnia and Herzegovina	BA
Botswana	BW
Bouvet Island	BV
Brazil	BR
Brunei Darussalam	BN
Bulgaria	BG
Burkina Faso	BF
Burundi	BI
Cambodia	KH
Cameroon	CM
Canada	CA
Cape Verde	CV
Cayman Islands	KY
Central African Republic	CF

Chad	TD	>European Community Plant Variety Office (CPVO )	QZ<
Chile	CL	European Community Trade-mark Office (See Office for Harmonization in the Internal Market)	*>EM<
China	CN	European Patent Office (EPO)	EP
Colombia	CO	Falkland Islands (Malvinas)	FK
Comoros	KM	Faroe Islands	FO
Congo	CG	Fiji	FJ
Cook Islands	CK	Finland	FI
Costa Rica	CR	France	FR
Côte d'Ivoire	CI	Gabon	GA
Croatia	HR	Gambia	GM
Cuba	CU	Georgia	GE
Cyprus	CY	Germany	DE
Czech Republic	CZ	Ghana	GH
Democratic People's Republic of Korea	KP	Gibraltar	GI
Democratic Republic of the Congo	CD	Greece	GR
Denmark	DK	Greenland	GL
Djibouti	DJ	Grenada	GD
Dominica	DM	Guatemala	GT
Dominican Republic	DO	Guinea	GN
East Timor	TP	Guinea-Bissau	GW
Ecuador	EC	Gulf Cooperation Council (see Patent Office of the Cooperation Council for the Arab States of the Gulf)	
Egypt	EG	Guyana	GY
El Salvador	SV	Haiti	HT
Equatorial Guinea	GQ	Holy See	VA
Eritrea	ER	Honduras	HN
Estonia	EE		
Ethiopia	ET		
Eurasian Patent Organization (EAPO)	EA		

Hong Kong (See The Hong Kong Special Administrative Region of The People's Republic of China)		Libya	LY
Hungary	HU	Liechtenstein	LI
Iceland	IS	Lithuania	LT
India	IN	Luxembourg	LU
Indonesia	ID	Macau	MO
International Bureau of the World Intellectual Property Organization (WIPO)	IB, WO	Madagascar	MG
Iran (Islamic Republic of)	IR	Malawi	MW
Iraq	IQ	Malaysia	MY
Ireland	IE	Maldives	MV
Israel	IL	Mali	ML
Italy	IT	Malta	MT
Jamaica	JM	Mauritania	MR
Japan	JP	Mauritius	MU
Jordan	JO	Mexico	MX
Kazakhstan	KZ	Monaco	MC
Kenya	KE	Mongolia	MN
Kiribati	KI	Montserrat	MS
Korea (See Democratic People's Republic of Korea; Republic of Korea)		Morocco	MA
Kuwait	KW	Mozambique	MZ
Kyrgyzstan	KG	Myanmar	MM
Laos	LA	Namibia	NA
Latvia	LV	Nauru	NR
Lebanon	LB	Nepal	NP
Lesotho	LS	Netherlands	NL
Liberia	LR	Netherlands Antilles	AN
		New Zealand	NZ
		Nicaragua	NI
		Niger	NE
		Nigeria	NG
		Northern Mariana Islands	MP

Norway	NO	Senegal	SN
Office for Harmonization in the Internal Market (Trade-marks and Designs) (OHIM)	EM	>Serbia and Montenegro	YU<
Oman	OM	Seychelles	SC
Pakistan	PK	Sierra Leone	SL
Palau	PW	Singapore	SG
Panama	PA	Slovakia	SK
Papua New Guinea	PG	Slovenia	SI
Paraguay	PY	Solomon Islands	SB
Patent Office of the Cooperation Council for the Arab States of the Gulf (GCC)	GC	Somalia	SO
Peru	PE	South Africa	ZA
Philippines	PH	South Georgia and the South Sandwich Islands	GS
Poland	PL	Spain	ES
Portugal	PT	Sri Lanka	LK
Qatar	QA	Sudan	SD
Republic of Korea	KR	Suriname	SR
Republic of Moldova	MD	Swaziland	SZ
Romania	RO	Sweden	SE
Russian Federation	RU	Switzerland	CH
Rwanda	RW	Syria	SY
Saint Helena	SH	Taiwan, Province of China	TW
Saint Kitts and Nevis	KN	Tajikistan	TJ
Saint Lucia	LC	Tanzania (see United Republic of Tanzania)	
Saint Vincent and the Grenadines	VC	Thailand	TH
Samoa	WS	The Former Yugoslav Republic of Macedonia	MK
San Marino	SM	The Hong Kong Special Administrative Region of The People's Republic of China	HK
Sao Tome and Principe	ST	>Timor-Leste	TL<
Saudi Arabia	SA		

Togo	TG
Tonga	TO
Trinidad and Tobago	TT
Tunisia	TN
Turkey	TR
Turkmenistan	TM
Turks and Caicos Islands	TC
Tuvalu	TV
Uganda	UG
Ukraine	UA
United Arab Emirates	AE
United Kingdom	GB
United Republic of Tanzania	TZ
United States of America	US
Uruguay	UY
Uzbekistan	UZ
Vanuatu	VU
Vatican City State (See Holy See)	
Venezuela	VE
Viet Nam	VN
Virgin Islands (British)	VG
Western Sahara	EH
World Intellectual Property Organization (WIPO) (International Bureau of)	WO, IB
Yemen	YE
Yugoslavia	YU
Zambia	ZM
Zimbabwe	ZW
Annex B, Section 2	

List of States or Organizations That Existed on January 1, 1978, but That No Longer Exist

Czechoslovakia	CS
Democratic Yemen	SY/YD
German Democratic Republic	DL/DD
International Patent Institute	IB
Soviet Union	SU

**1852 International-Type Search***PCT Rule 41.**Earlier Search Other Than International Search**41.1. Obligation to Use Results; Refund of Fee*

If reference has been made in the request, in the form provided for in Rule 4.11, to an international-type search carried out under the conditions set out in Article 15(5) or to a search other than an international or international-type search, the International Searching Authority shall, to the extent possible, use the results of the said search in establishing the international search report on the international application. The International Searching Authority shall refund the search fee, to the extent and under the conditions provided for in the agreement under Article 16(3)(b) or in a communication addressed to and published in the Gazette by the International Bureau, if the international search report could wholly or partly be based on the results of the said search.

*37 CFR 1.104. Nature of examination.**(a) Examiner's action.*

\*\*\*\*\*

(3) An international-type search will be made in all national applications filed on and after June 1, 1978.

(4) Any national application may also have an international-type search report prepared thereon at the time of the national examination on the merits, upon specific written request therefor and payment of the international-type search report fee set forth in § 1.21(e). The Patent and Trademark Office does not require that a formal report of an international-type search be prepared in order to obtain a search fee refund in a later filed international application.

\*\*\*\*\*

PCT Rule 41 provides that the applicant may request in a later filed international application that the report of the results of the international-type search, i.e., a search similar to an international search, but carried out on a national application (37 CFR 1.104(a)(3) and (a)(4)), be used in establishing an international search report on such international application. An international-type search is conducted on all U.S. national nonprovisional applications filed after June 1, 1978. Upon specific request, at the time of the examination of a U.S. national nonprovisional application and provided that the payment of the appropriate international-type search report fee has been made (37 CFR 1.21(e)) an international-type search report Form PCT/ISA/201 will also be prepared.

**1853 Amendment Under PCT Article 19***PCT Article 19.**Amendment of the Claims before the International Bureau*

(1) The applicant shall, after having received the international search report, be entitled to one opportunity to amend the claims of the international application by filing amendments with the International Bureau within the prescribed time limit. He may, at the same time, file a brief statement, as provided in the Regulations, explaining the amendments and indicating any impact that such amendments might have on the description and the drawings.

(2) The amendments shall not go beyond the disclosure in the international application as filed.

(3) If the national law of any designated State permits amendments to go beyond the said disclosure, failure to comply with paragraph (2) shall have no consequence in that State.

*PCT Rule 46.**Amendment of Claims Before the International Bureau**46.1. Time Limit*

The time limit referred to in Article 19 shall be two months from the date of transmittal of the international search report to the International Bureau and to the applicant by the International Searching Authority or 16 months from the priority date, whichever time limit expires later, provided that any amendment made under Article 19 which is received by the International Bureau after the expiration of the applicable time limit shall be considered to have been received by that Bureau on the last day of that time limit if it reaches it before the technical preparations for international publication have been completed.

*46.2. Where to File*

Amendments made under Article 19 shall be filed directly with the International Bureau.

*46.3. Language of Amendments*

If the international application has been filed in a language other than the language in which it is published, any amendment made under Article 19 shall be in the language of publication.

*46.4. Statement*

(a) The statement referred to in Article 19(1) shall be in the language in which the international application is published and shall not exceed 500 words if in the English language or if translated into that language. The statement shall be identified as such by a heading, preferably by using the words "Statement under Article 19(1)" or their equivalent in the language of the statement.

(b) The statement shall contain no disparaging comments on the international search report or the relevance of citations contained in that report. Reference to citations, relevant to a given claim, contained in the international search report may be made only in connection with an amendment of that claim.



#### 46.5. Form of Amendments

The applicant shall be required to submit a replacement sheet for every sheet of the claims which, on account of an amendment or amendments under Article 19, differs from the sheet originally filed. The letter accompanying the replacement sheets shall draw attention to the differences between the replaced sheets and the replacement sheets. To the extent that any amendment results in the cancellation of an entire sheet, that amendment shall be communicated in a letter.

#### 37 CFR 1.415. The International Bureau.

(a) The International Bureau is the World Intellectual Property Organization located at Geneva, Switzerland. It is the international intergovernmental organization which acts as the coordinating body under the Treaty and the Regulations (PCT Art. 2 (xix) and 35 U.S.C. 351(h)).

(b) The major functions of the International Bureau include:

- (1) Publishing of international applications and the International Gazette;
- (2) Transmitting copies of international applications to Designated Offices;
- (3) Storing and maintaining record copies; and
- (4) Transmitting information to authorities pertinent to the processing of specific international applications.

#### PCT Administrative Instruction Section 205.

##### Numbering and Identification of Claims Upon Amendment

(a) Amendments to the claims under Article 19 or Article 34(2)(b) may be made either by cancelling one or more entire claims, by adding one or more new claims or by amending the text of one or more of the claims as filed. All the claims appearing on a replacement sheet shall be numbered in Arabic numerals. Where a claim is cancelled, no renumbering of the other claims shall be required. In all cases where claims are renumbered, they shall be renumbered consecutively.

(b) The applicant shall, in the letter referred to in the second and third sentences of Rule 46.5(a) or in the second and fourth sentences of Rule 66.8(a), indicate the differences between the claims as filed and the claims as amended. He shall, in particular, indicate in the said letter, in connection with each claim appearing in the international application (it being understood that identical indications concerning several claims may be grouped), whether:

- (i) the claim is unchanged;
- (ii) the claim is cancelled;
- (iii) the claim is new;
- (iv) the claim replaces one or more claims as filed;
- (v) the claim is the result of the division of a claim as filed.

The applicant has one opportunity to amend the claims only of the international application after issuance of the Search Report. The amendments to the claims must be filed directly with the International Bureau, usually within 2 months of the date of mailing of the Search Report. If the amendments to the

claims are timely received by the International Bureau, such amendments will be published as part of the pamphlet directly following the claims as filed. Article 19 offers applicants the opportunity to generally amend the claims before entering the designated Offices. The national laws of some designated Offices may grant provisional protection on the invention from the date of publication of the claims. Therefore, some applicants take advantage of the opportunity under Article 19 to polish the claims anticipating provisional protection. See PCT Rule 46.5.

## 1857 International Publication [R-2]

#### PCT Article 21.

##### International Publication

(1) The International Bureau shall publish international applications.

(2)(a) Subject to the exceptions provided for in subparagraph (b) and in Article 64(3), the international publication of the international application shall be effected promptly after the expiration of 18 months from the priority date of that application.

(b) The applicant may ask the International Bureau to publish his international application any time before the expiration of the time limit referred to in subparagraph (a). The International Bureau shall proceed accordingly, as provided in the Regulations.

(3) The international search report or the declaration referred to in Article 17(2)(a) shall be published as prescribed in the Regulations.

(4) The language and form of the international publication and other details are governed by the Regulations.

(5) There shall be no international publication if the international application is withdrawn or is considered withdrawn before the technical preparations for publication have been completed.

(6) If the international application contains expressions or drawings which, in the opinion of the International Bureau, are contrary to morality or public order, or if, in its opinion, the international application contains disparaging statements as defined in the Regulations, it may omit such expressions drawings, and statements, from its publications, indicating the place and number of words or drawings omitted, and furnishing, upon request, individual copies of the passages omitted.

#### PCT Article 29.

##### Effects of the International Publication

(1) As far as the protection of any rights of the applicant in a designated State is concerned, the effects, in that State, of the international publication of an international application shall, subject to the provisions of paragraphs (2) to (4), be the same as those which the national law of the designated State provides for the compulsory national publication of unexamined national applications as such.

(2) If the language in which the international publication has been effected is different from the language in which publications under the national law are effected in the designated State, the said national law may provide that the effects provided for in paragraph (1) shall be applicable only from such time as:

(i) a translation into the latter language has been published as provided by the national law, or

(ii) a translation into the latter language has been made available to the public, by laying open for public inspection as provided by the national law, or

(iii) a translation into the latter language has been transmitted by the applicant to the actual or prospective unauthorized user of the invention claimed in the international application, or

(iv) both the acts described in (i) and (iii), or both the acts described in (ii) and (iii), have taken place.

(3) The national law of any designated State may provide that, where the international publication has been effected, on the request of the applicant, before the expiration of 18 months from the priority date, the effects provided for in paragraph (1) shall be applicable only from the expiration of 18 months from the priority date.

(4) The national law of any designated State may provide that the effects provided for in paragraph (1) shall be applicable only from the date on which a copy of the international application as published under Article 21 has been received in the national Office of or acting for such State. The said Office shall publish the date of receipt in its gazette as soon as possible.

*PCT Administrative Instruction Section 404.*  
*International Publication Number of International Application*

\*\*>The International Bureau shall assign to each published international application an international publication number which shall be different from the international application number. The international publication number shall be used on the pamphlet and in the Gazette entry. It shall consist of the two-letter code "WO" followed by a four-digit indication of the year of publication, a slant, and a serial number consisting of six digits (e.g., "WO 2004/123456").<

*35 U.S.C. 374. Publication of international application.*

The publication under the treaty defined in section 351(a) of this title, of an international application designating the United States shall be deemed a publication under section 122(b), except as provided in sections 102(e) and 154(d) of this title.

The publication of international applications currently occurs every Thursday. Under PCT Article 20 >and PCT Rules 47.1(a) and 93<sup>bis</sup>.1,< the International Bureau sends copies of published >international< applications to each of the designated Offices >that have requested to receive the published application< on the day of publication. Until October 1, 1995, as a PCT member country, the U.S. Patent and Trademark Office received copies of all published

international applications in printed form for inclusion in the examiner search files. The U.S. Patent and Trademark Office now receives the published international applications on CD-ROM disks and in other electronic formats. For information on obtaining copies of these applications, see MPEP § 901.05(c). \*\*>Published international application information is also available from< the *PCT Gazette*, which can be accessed electronically through The Intellectual Property Digital Library Web site (<http://ipdl.wipo.int/>) of the World Intellectual Property Organization. >In addition, published international applications may be obtained online from the European Patent Office web site (<http://ep.espacenet.com>).<

**PUBLICATION OF SEQUENCE LISTING AND/OR TABLES FILED IN ELECTRONIC FORM**

*PCT Administrative Instruction Section 805.*

*Publication and Communication of International Applications Containing Sequence Listings and/or Tables; Copies; Priority Documents*

(a) Notwithstanding Section 406, an international application containing sequence listings and/or tables may be published under Article 21, in whole or in part, in electronic form as determined by the Director General.

(b) Paragraph (a) shall apply *mutatis mutandis* in relation to:

(i) the communication of an international application under Article 20;

(ii) the furnishing of copies of an international application under Rules 87 and 94.1;

(iii) the furnishing under Rule 17.1, as a priority document, of a copy of an international application containing sequence listings and/or tables filed under Section 801(a);

(iv) the furnishing under Rules 17.2 and 66.7 of copies of a priority document.

As of August 2, 2001, WIPO began to publish sequence listing parts of the description on the Internet where the sequence listing was filed under PCT Administrative Instructions Section 801 as authorized by PCT Administrative Instructions Section 805(a). On September 6, 2002, the PCT Administrative Instructions were further amended to include electronic submissions of tables related to sequence listings. Sequence listing parts of the description and tables may be viewed and downloaded at <http://www.wipo.int/pct/en/sequences/index.htm>. Thus, an international application containing a sequence listing or table filed under Part 8 of the Administrative

Instructions comprises two elements published on the same day:

(A) a paper pamphlet including all parts of the application that were not filed in electronic format under Part 8 of the Administrative Instructions; and

(B) an electronic publication of the sequence listing and/or tables that were filed in electronic format under Part 8 of the Administrative Instructions.

Cross-references between the two elements are included for the sake of clarity. \*\*>The bibliographic page of a published international application filed under Administrative Instructions Section 801 includes the statement: “Published with sequence listing part of description published separately in electronic form and available upon request from the International Bureau.” Conversely, the electronic publication of the sequence listing part of the international application on WIPO’s web site ([www.wipo.int/pct/en/sequences/index.htm](http://www.wipo.int/pct/en/sequences/index.htm)) contains a link to the remainder of the published international application in the electronic *PCT Gazette*.<

### 1857.01 Prior Art Effect of the International Publication [R-2]

*35 U.S.C. 374. Publication of international application.*

The publication under the treaty defined in section 351(a) of this title, of an international application designating the United States shall be deemed a publication under section 122(b), except as provided in sections 102(e) and 154(d) of this title.

*35 U.S.C. 102. Conditions for patentability; novelty and loss of right to patent.*

A person shall be entitled to a patent unless —

\*\*\*\*\*

(e) the invention was described in — (1) an application for patent, published under section 122(b), by another filed in the United States before the invention by the applicant for patent or (2) a patent granted on an application for patent by another filed in the United States before the invention by the applicant for patent, except that an international application filed under the treaty defined in section 351(a) shall have the effects for the purposes of this subsection of an application filed in the United States only if the international application designated the United States and was

published under Article 21(2) of such treaty in the English language; or

\*\*\*\*\*

An international >application< \*\* may be used as prior art as of its international filing date, or an earlier U.S. filing date for which \*\* benefit is properly claimed, under 35 U.S.C. 102(e) if the international application:

(A) was filed on or after November 29, 2000;

(B) designated the United States; and

(C) was published under PCT Article 21(2) in the English language.

If such an international application properly claims benefit >under 35 U.S.C. 119(e), 120, or 365(c)< to an earlier-filed U.S. >national< or international application >designating the U.S.< \*\*, the international application can be applied as prior art under 35 U.S.C. 102(e) as of the earlier filing date, assuming all the conditions of 35 U.S.C. 102(e), 119(e), 120, or 365(c) are met. Note, where the earlier application is >also< an international application, the earlier international application must satisfy the same three conditions (i.e., filed on or after November 29, 2000, designated the U.S. and had been published in English under PCT Article 21(2)) for the earlier international filing date to be a U.S. filing date for prior art purposes under 35 U.S.C. 102(e).

If any of the above conditions have not been satisfied, the publication of the international application and the U.S. application publication of the national stage after compliance with 35 U.S.C. 371 may only be used as prior art as of its publication date under 35 U.S.C. 102(a) or (b). See MPEP § 706.02(a) and § 2136.03. A later filed U.S. application that properly claimed the benefit under 35 U.S.C. 120 or 365(c) of such an international application will have its own U.S. filing date for purposes of 35 U.S.C. 102(e). In addition, international applications, which: (1) were filed prior to November 29, 2000, (2) did not designate the U.S., or (3) were not published in English under PCT Article 21(2) by WIPO, may not be used to reach back (bridge) to an earlier filing date through a \*\* benefit claim for prior art purposes under 35 U.S.C. 102(e).

For more information, see MPEP § 706.02(a) and § 706.02(f)(1).

## 1859 Withdrawal of International Application, \* Designations, or Priority Claims [R-2]

\*\*>

### *PCT Rule 90<sup>bis</sup>. Withdrawals*

#### *90<sup>bis</sup>.1. Withdrawal of the International Application*

(a) The applicant may withdraw the international application at any time prior to the expiration of 30 months from the priority date.

(b) Withdrawal shall be effective on receipt of a notice addressed by the applicant, at his option, to the International Bureau, to the receiving Office or, where Article 39(1) applies, to the International Preliminary Examining Authority.

(c) No international publication of the international application shall be effected if the notice of withdrawal sent by the applicant or transmitted by the receiving Office or the International Preliminary Examining Authority reaches the International Bureau before the technical preparations for international publication have been completed.

#### *90<sup>bis</sup>.2. Withdrawal of Designations*

(a) The applicant may withdraw the designation of any designated State at any time prior to the expiration of 30 months from the priority date. Withdrawal of the designation of a State which has been elected shall entail withdrawal of the corresponding election under Rule 90<sup>bis</sup>.4.

(b) Where a State has been designated for the purpose of obtaining both a national patent and a regional patent, withdrawal of the designation of that State shall be taken to mean withdrawal of only the designation for the purpose of obtaining a national patent, except where otherwise indicated.

(c) Withdrawal of the designations of all designated States shall be treated as withdrawal of the international application under Rule 90<sup>bis</sup>.1.

(d) Withdrawal shall be effective on receipt of a notice addressed by the applicant, at his option, to the International Bureau, to the receiving Office or, where Article 39(1) applies, to the International Preliminary Examining Authority.

(e) No international publication of the designation shall be effected if the notice of withdrawal sent by the applicant or transmitted by the receiving Office or the International Preliminary Examining Authority reaches the International Bureau before the technical preparations for international publication have been completed.

#### *90<sup>bis</sup>.3. Withdrawal of Priority Claims*

(a) The applicant may withdraw a priority claim, made in the international application under Article 8(1), at any time prior to the expiration of 30 months from the priority date.

(b) Where the international application contains more than one priority claim, the applicant may exercise the right provided for in paragraph (a) in respect of one or more or all of the priority claims.

(c) Withdrawal shall be effective on receipt of a notice addressed by the applicant, at his option, to the International Bureau, to the receiving Office or, where Article 39(1) applies, to the International Preliminary Examining Authority.

(d) Where the withdrawal of a priority claim causes a change in the priority date, any time limit which is computed from the original priority date and which has not already expired shall, subject to paragraph (e), be computed from the priority date resulting from that change.

(e) In the case of the time limit referred to in Article 21(2)(a), the International Bureau may nevertheless proceed with the international publication on the basis of the said time limit as computed from the original priority date if the notice of withdrawal sent by the applicant or transmitted by the receiving Office or the International Preliminary Examining Authority reaches the International Bureau after the completion of the technical preparations for international publication.

\*\*\*\*\*

#### *90<sup>bis</sup>.5. Signature*

(a) Any notice of withdrawal referred to in Rules 90<sup>bis</sup>.1 to 90<sup>bis</sup>.4 shall, subject to paragraph (b), be signed by the applicant or, if there are two or more applicants, by all of them. An applicant who is considered to be the common representative under Rule 90.2(b) shall, subject to paragraph (b), not be entitled to sign such a notice on behalf of the other applicants.

(b) Where two or more applicants file an international application which designates a State whose national law requires that national applications be filed by the inventor and where an applicant for that designated State who is an inventor could not be found or reached after diligent effort, a notice of withdrawal referred to in Rules 90<sup>bis</sup>.1 to 90<sup>bis</sup>.4 need not be signed by that applicant ("the applicant concerned") if it is signed by at least one applicant and.

(i) a statement is furnished explaining, to the satisfaction of the receiving Office, the International Bureau, or the International Preliminary Examining Authority, as the case may be, the lack of signature of the applicant concerned, or

(ii) in the case of a notice of withdrawal referred to in Rule 90<sup>bis</sup>.1(b), 90<sup>bis</sup>.2(d), or 90<sup>bis</sup>.3(c), the applicant concerned did not sign the request but the requirements of Rule 4.15(b) were complied with, or

(iii) in the case of a notice of withdrawal referred to in Rule 90<sup>bis</sup>.4(b), the applicant concerned did not sign the demand but the requirements of Rule 53.8(b) were complied with.

*90<sup>bis</sup>.6.Effect of Withdrawal*

(a) Withdrawal under Rule 90<sup>bis</sup> of the international application, any designation, any priority claim, the demand or any election shall have no effect in any designated or elected Office where the processing or examination of the international application has already started under Article 23(2) or Article 40(2).

(b) Where the international application is withdrawn under Rule 90<sup>bis</sup>.1, the international processing of the international application shall be discontinued.

(c) Where the demand or all elections are withdrawn under Rule 90<sup>bis</sup>.4, the processing of the international application by the International Preliminary Examining Authority shall be discontinued.

*90<sup>bis</sup>.7.Faculty Under Article 37(4)(b)*

(a) Any Contracting State whose national law provides for what is described in the second part of Article 37(4)(b) shall notify the International Bureau in writing.

(b) The notification referred to in paragraph (a) shall be promptly published by the International Bureau in the Gazette, and shall have effect in respect of international applications filed more than one month after the date of such publication.

For a discussion of the withdrawal of the demand or of elections (PCT Rule 90<sup>bis</sup>.4), see MPEP § 1880.

Form PCT/IB/372 may be used by the applicant to make a withdrawal under any of PCT Rules 90<sup>bis</sup>.1, 90<sup>bis</sup>.2, 90<sup>bis</sup>.3, and 90<sup>bis</sup>.4. The form is available from WIPO's web site ([www.wipo.int/pct/en/forms/ib/ib372.pdf](http://www.wipo.int/pct/en/forms/ib/ib372.pdf)).

The applicant may withdraw the international application, the designation of any state, or a priority claim by a notice addressed to the International Bureau or to the receiving Office and received before the expiration of 30 months from the priority date. Where Article 39(1) applies, the notice may also be addressed to the International Preliminary Examining Authority. Any such withdrawal is free of charge. A notice of withdrawal must be signed by all the applicants. The provisions for waiver of a power of attorney set forth in PCT Rules 90.4(d) and 90.5(c) do not apply in the case of withdrawals under PCT Rule 90<sup>bis</sup>. An appointed agent or appointed common representative may sign such a notice on behalf of the applicant or applicants who appointed him, but an applicant who is considered to be the common representative may not sign such a notice on behalf of the other applicants. As to the case where an applicant inventor for the United States of America \*\* cannot be found or reached see PCT Rule 90<sup>bis</sup>.5(b).

The applicant may prevent international publication by withdrawing the international application, provided that the notice of withdrawal reaches the International Bureau before the completion of technical preparations for that publication. The notice of withdrawal may state that the withdrawal is to be effective only on the condition that international publication can still be prevented. In such a case the withdrawal is not effective if the condition on which it was made cannot be met that is, if the technical preparations for international publication have already been completed. \*\*

If all designations are withdrawn, the international application will be treated as withdrawn.

\*\*

Where the withdrawal of a priority claim causes a change in the priority date of the international application, any time limit which is computed from the original priority date and which has not yet expired—for example, the time limit before which processing in the national phase cannot start—is computed from the priority date resulting from the change. (It is not possible to extend the time limit concerned if it has already expired when the priority claim is withdrawn.) Thus, international publication may be postponed by withdrawing the priority claim prior to publication. However, if the notice of withdrawal reaches the International Bureau after the completion of the technical preparations for international publication, the International Bureau may proceed with the international publication on the basis of the time limit for international publication as computed from the original priority date.

## **1860 >International Preliminary Examination Procedure for Applications Having an International Filing Date On or After January 1, 2004 [R-2]**

[Note: The regulations under the PCT were changed effective January 1, 2004. A corresponding change was made to Title 37 of the Code of Federal Regulations. See *January 2004 Revision of Patent Cooperation Treaty Application Procedure*, 68 FR 59881 (Oct. 20, 2003), 1276 O.G. 6 (Nov. 11, 2003). All international applications having an international filing date before January 1, 2004,

**will continue to be processed under the procedures in effect on the international filing date. For the international preliminary examination procedure applicable to international applications having an international filing date before January 1 2004, see MPEP § 1860.01 for the information that previously appeared in this section].**

## **EXAMINATION PROCEDURE**

The international preliminary examination is to be carried out in accordance with PCT Article 34 and PCT Rule 66. After the demand is checked for compliance with PCT Rules 53-55, 57 and 58, the first step of the examiner is to study the description, the drawings (if any), the claims of the international application, the documents describing the prior art as cited in the international search report, and the written opinion established by the International Searching Authority.

A further written opinion is usually not mandatory where the written opinion of the International Searching Authority is treated as the first written opinion of the International Preliminary Examining Authority. The United States International Preliminary Examining Authority will treat any written opinion established by the United States International Searching Authority or the European Patent Office International Searching Authority as the first written opinion of the International Preliminary Examining Authority.

Assuming the written opinion of the International Searching Authority is treated as the first written opinion of the International Preliminary Examining Authority, as noted above, no further written opinion need be issued before the international preliminary examination report, even if there are objections outstanding. The examiner takes into consideration any comments or amendments made by the applicant when establishing the international preliminary examination report.

## **FURTHER WRITTEN OPINION SHOULD BE ISSUED**

A further written opinion should be prepared by the examiner if applicant files a response which includes a persuasive argument that the written opinion issued by the International Searching Authority was improper because of a negative opinion with respect to a lack of novelty, inventive step (non-obviousness)

or industrial applicability as described in PCT Article 33(2)-(4); and which results in the examiner considering any of the claims to lack novelty, inventive step (non-obviousness) or industrial applicability as described in PCT Article 33(2)-(4) based on new art not necessitated by any amendment.

Any further written opinion established by the International Preliminary Examining Authority should set forth, as applicable:

(A) Any defects in the international application as described in PCT Article 34(4) concerning subject matter which is not required to be examined or which is unclear or inadequately supported;

(B) Any negative findings with respect to any of the claims because of a lack of novelty, inventive step (non-obviousness) or industrial applicability as described in PCT Article 33(2)-(4);

(C) Any defects in the form or contents of the international application;

(D) Any finding by the examiner that an amendment goes beyond the disclosure in the international application as originally filed;

(E) Any observation which the examiner wishes to make on the clarity of the claims, the description, the drawings or to the question whether the claims are fully supported by the description (PCT Rule 66.2);

(F) Any decision by the examiner not to carry out the international preliminary examination on a claim for which no international search report was issued; or

(G) If the examiner considers that no acceptable nucleotide and/or amino acid sequence listing is available in a form that would allow a meaningful international preliminary examination to be carried out.

The further written opinion is prepared on Form PCT/IPEA/408 to notify applicant of the defects found in the international application. The examiner is further required to fully state the reasons for his/her opinion (PCT Rule 66.2(b)) and invite a written reply, with amendments where appropriate (PCT Rule 66.2(c)), normally setting a 2 month time limit for the reply.

The applicant may reply to the invitation by making amendments or, if applicant disagrees with the opinion of the examiner, by submitting arguments, as the case may be, or both.

The U.S. Rules of Practice pertaining to international preliminary examination of international appli-

cations permit a second written opinion in those cases where sufficient time is available. Normally only one written opinion will be issued. Any reply received after the expiration of the set time limit will not normally be considered in preparing the international preliminary examination report. In situations, however, where the examiner has requested an amendment or where a later amendment places the application in better condition for examination, the amendment may be considered by the examiner.

If the applicant does not reply to any further written opinion established by the International Preliminary Examining Authority within the set time period, the international preliminary examination report will be prepared after expiration of the time limit plus sufficient time to have any reply clear the Mail Center.

### **1860.01 < International Preliminary Examination >Procedure for Applications Having an International Filing Date Before January 1, 2004< [R-2]**

>[Note: For the international preliminary examination procedure applicable to international applications having an international filing date on or after January 1, 2004, see MPEP § 1860.]<

#### **EXAMINATION PROCEDURE**

The International Preliminary Examination is to be carried out in accordance with PCT Article 34 and PCT Rule 66. After the Demand is checked for compliance with PCT Rules 53 - 55, 57 and 58, the first step of the examiner is to study the description, the drawings (if any), and the claims of the international application and the documents describing the prior art as cited in the international search report.

A written opinion must be prepared if the examiner:

(A) Considers that the international application has any of the defects described in PCT Article 34(4) concerning subject matter which is not required to be examined or which is unclear or inadequately supported;

(B) Considers that the report should be negative with respect to any of the claims because of a lack of novelty, inventive step (non-obviousness) or indus-

trial applicability as described in PCT Article 33(2) - (4);

(C) Notices any defects in the form or contents of the international application;

(D) Considers that any amendment goes beyond the disclosure in the international application as originally filed;

(E) Wishes to make an observation on the clarity of the claims, the description, the drawings or to the question whether the claims are fully supported by the description (PCT Rule 66.2);

(F) Decides not to carry out the international preliminary examination on a claim for which no international search report was issued; or

(G) Considers that no acceptable amino acid sequence listing is available in a form that would allow a meaningful international preliminary examination to be carried out.

The written opinion is prepared on form PCT/IPEA/408 to notify applicant of the defects found in the international application. The examiner is further required to fully state the reasons for his/her opinion (PCT Rule 66.2(b)) and invite a written reply, with amendments where appropriate (PCT Rule 66.2(c)), normally setting a 2 month time limit for the reply.

The applicant may reply to the invitation by making amendments or, if applicant disagrees with the opinion of the examiner, by submitting arguments, as the case may be, or both.

The U.S. Rules of Practice pertaining to international preliminary examination of international applications permit a second written opinion in those cases where sufficient time is available. Normally only one written opinion will be issued. Any reply received after the expiration of the set time limit will not normally be considered in preparing the international preliminary examination report. In situations, however, where the examiner has requested an amendment or where a later amendment places the application in better condition for examination, the amendment may be considered by the examiner.

If the applicant does not reply to the written opinion within the set time period, the international preliminary examination report will be prepared after expiration of the time limit plus sufficient time to have any reply clear the Mail Center.

If, after initial examination of the international application, there is no negative statement or com-

ment to be made, then only the international preliminary examination report will issue without a written opinion having been issued.

\*\*

## 1862 Agreement With the International Bureau To Serve as an International Preliminary \*>Examining< Authority [R-2]

*PCT Article 32.*

### *The International Preliminary Examining Authority*

(1) International preliminary examination shall be carried out by the International Preliminary Examining Authority

(2) In the case of demands referred to in Article 31(2)(a), the receiving Office, and, in the case of demands referred to in Article 31(2)(b), the Assembly, shall, in accordance with the applicable agreement between the interested International Preliminary Examining Authority or Authorities and the International Bureau, specify the International Preliminary Examining Authority or Authorities competent for the preliminary examination.

(3) The provisions of Article 16(3) shall apply, *mutatis mutandis*, in respect of the International Preliminary Examining Authorities.

*PCT Article 34.*

### *Procedure before the International Preliminary Examining Authority*

(1) Procedure before the International Preliminary Examining Authority shall be governed by the provisions of this Treaty, the Regulations, and the agreement which the International Bureau shall conclude, subject to this Treaty and the Regulations, with the said Authority.

\*\*\*\*\*

### *37 CFR 1.416. The United States International Preliminary Examining Authority.*

\*\*>

(a) Pursuant to appointment by the Assembly, the United States Patent and Trademark Office will act as an International Preliminary Examining Authority for international applications filed in the United States Receiving Office and in other Receiving Offices as may be agreed upon by the Director, in accordance with agreement between the Patent and Trademark Office and the International Bureau.<

(b) The United States Patent and Trademark Office, when acting as an International Preliminary Examining Authority, will be identified by the full title "United States International Preliminary Examining Authority" or by the abbreviation "IPEA/US."

(c) The major functions of the International Preliminary Examining Authority include:

(1) Receiving and checking for defects in the Demand;

(2) Forwarding Demands in accordance with PCT Rule 59.3;

(3) Collecting the handling fee for the International Bureau and the preliminary examination fee for the United States International Preliminary Examining Authority;

(4) Informing applicant of receipt of the Demand;

(5) Considering the matter of unity of invention;

(6) Providing an international preliminary examination report which is a nonbinding opinion on the questions whether the claimed invention appears to be novel, to involve inventive step (to be nonobvious), and to be industrially applicable; and

(7) Transmitting the international preliminary examination report to applicant and the International Bureau.

An agreement was concluded between the United States Patent and Trademark Office (USPTO) and the International Bureau under which the USPTO agreed to serve as an International Preliminary Examining Authority for those applications filed in the USPTO as a Receiving Office and for those international applications filed in other receiving Offices for which the USPTO has served as an International Searching Authority.

The agreement is provided for in PCT Articles 32(2) & (3) and 34(1), and in PCT Rules 59.1, 63.1, 72.1, and 77.1(a). Authority is given in 35 U.S.C. 361(c), 362(a) & (b) and in 364(a). 37 CFR 1.416(a) and PCT Administrative Instructions Section 103(c) are also relevant.

## 1864 The Demand and Preparation for Filing of Demand [R-2]

*37 CFR 1.480. Demand for international preliminary examination.*

\*\*>

(a) On the filing of a proper Demand in an application for which the United States International Preliminary Examining Authority is competent and for which the fees have been paid, the international application shall be the subject of an international preliminary examination. The preliminary examination fee (§ 1.482(a)(1)) and the handling fee (§ 1.482(b)) shall be due within the applicable time limit set forth in PCT Rule 57.3.

(b) The Demand shall be made on a standardized form (PCT Rule 53). Copies of the printed Demand forms are available from the United States Patent and Trademark Office. Letters requesting printed Demand forms should be marked "Mail Stop PCT."

(c) Withdrawal of a proper Demand prior to the start of the international preliminary examination will entitle applicant to a refund of the preliminary examination fee minus the amount of the transmittal fee set forth in § 1.445(a)(1).

(d) The filing of a Demand shall constitute the election of all Contracting States which are designated and are bound by Chapter II of the Treaty on the international filing date (PCT Rule 53.7).



(e) Any Demand filed after the expiration of the applicable time limit set forth in PCT Rule 54<sup>bis</sup>.1(a) shall be considered as if it had not been submitted (PCT Rule 54<sup>bis</sup>.1(b)).<

Once applicant has **>**filed< an international application under Chapter I **>**of the PCT<, applicant has the right to file a demand for preliminary examination >under Chapter II of the Treaty<. The use of the term “Demand” distinguishes Chapter II from the “Request” under Chapter I. **>**It is not possible to file a demand unless a proper Chapter I “Request” for an international application has been filed. >Chapter I affords applicant the benefit of an international search, which includes an international search report and for international applications having an international filing date on or after January 1, 2004, a written opinion established by the International Searching Authority. The filing of a demand affords applicant examination of the application and allows applicant to file amendments to the description, claims and drawings to correct any defects, respond to any observations, or address negative findings with respect to any of the claims because of a lack of novelty, inventive step (non-obviousness) or industrial applicability as described in PCT Article 33(2)-(4) mentioned in the written opinion (Form PCT/ISA/237) established by the International Searching Authority. Thus, examination enables applicant to attempt to obtain a positive international preliminary examination report, which in some elected Offices is used as a basis for the issuance of a patent.<

The demand should be filed on \* Form PCT/IPEA/401 along with the fee **>**calculation< sheet. For information on obtaining these forms free of charge, see MPEP § 1730.

## 1864.01 Amendments Filed >Under PCT Article 34< **>** [R-2]

>

### *PCT Article 34.*

#### *Procedure Before the International Preliminary Examining Authority*

\*\*\*\*\*

(2)(b)The applicant shall have a right to amend the claims, the description, and the drawings, in the prescribed manner and within the prescribed time limit, before the international prelimi-

nary examination report is established. The amendment shall not go beyond the disclosure in the international application as filed.

\*\*\*\*\*

<

### *PCT Rule 66.*

#### *Procedure Before the International Preliminary Examining Authority*

\*\*\*\*\*

#### *66.8. Form of Amendments*

(a) Subject to paragraph (b), the applicant shall be required to submit a replacement sheet for every sheet of the international application which, on account of an amendment, differs from the sheet previously filed. The letter accompanying the replacement sheets shall draw attention to the differences between the replaced sheets and the replacement sheets and shall preferably also explain the reasons for the amendment.

(b) Where the amendment consists in the deletion of passages or in minor alterations or additions, the replacement sheet referred to in paragraph (a) may be a copy of the relevant sheet of the international application containing the alterations or additions, provided that the clarity and direct reproducibility of that sheet are not adversely affected. To the extent that any amendment results in the cancellation of an entire sheet, that amendment shall be communicated in a letter which shall preferably also explain the reasons for the amendment.

\*\*\*\*\*

#### *37 CFR 1.485. Amendments by applicant during international preliminary examination.*

(a) The applicant may make amendments at the time of filing the Demand. The applicant may also make amendments within the time limit set by the International Preliminary Examining Authority for reply to any notification under § 1.484(b) or to any written opinion. Any such amendments must:

(1) Be made by submitting a replacement sheet in compliance with PCT Rules 10 and 11.1 to 11.13 for every sheet of the application which differs from the sheet it replaces unless an entire sheet is cancelled; and

(2) Include a description of how the replacement sheet differs from the replaced sheet. Amendments that do not comply with PCT Rules 10 and 11.1 to 11.13 may not be entered.

(b) If an amendment cancels an entire sheet of the international application, that amendment shall be communicated in a letter

**>**Under PCT Article 34(2)(b), the applicant has a right to amend the claims, the description, and the drawings in the application before the International Preliminary Examining Authority (IPEA) before the international preliminary examination report is established. The amendment may be filed with the demand (PCT Article 34), within the period for reply to the

written opinion of the International Searching Authority (ISA), or within the period for reply to the written opinion of the IPEA.

See MPEP § 1871 or MPEP § 1871.01, as appropriate, regarding the processing of amendments filed prior to or at the start of international preliminary examination. See MPEP 1878.02 regarding amendments filed in reply to the written opinion of the ISA or IPEA. Amendments under PCT Article 34, like amendments under PCT Article 19 (see MPEP § 1853), may not include new matter and must be accompanied by a description of how the replacement sheet differs from the replaced sheet.<

## 1864.02 Applicant's Right To File a Demand

### *PCT Article 31.*

#### *Demand for International Preliminary Examination*

\*\*\*\*\*

(2)(a) Any applicant who is a resident or national, as defined in the Regulations, of a Contracting State bound by Chapter II, and whose international application has been filed with the receiving Office of or acting for such State, may make a demand for international preliminary examination.

\*\*\*\*\*

### *PCT Rule 54.*

#### *The Applicant Entitled to Make a Demand*

##### *54.1. Residence and Nationality*

(a) Subject to the provisions of paragraph (b), the residence or nationality of the applicant shall, for the purposes of Article 31(2), be determined according to Rule 18.1(a) and (b).

(b) The International Preliminary Examining Authority shall, in the circumstances specified in the Administrative Instructions, request the receiving Office or, where the international application was filed with the International Bureau as receiving Office, the national Office of, or acting for, the Contracting State concerned to decide the question whether the applicant is a resident or national of the Contracting State of which he claims to be a resident or national. The International Preliminary Examining Authority shall inform the applicant of any such request. The applicant shall have an opportunity to submit arguments directly to the Office concerned. The Office concerned shall decide the said question promptly.

##### *54.2. Right to Make a Demand*

The right to make a demand under Article 31(2) shall exist if the applicant making the demand or, if there are two or more applicants, at least one of them is a resident or national of a Contracting State bound by Chapter II and the international applica-

tion has been filed with a receiving Office of or acting for a Contracting State bound by Chapter II.

(i) *[Deleted]*

(ii) *[Deleted]*

##### *54.3 International Applications Filed with the International Bureau as Receiving Office*

Where the international application is filed with the International Bureau as receiving Office under Rule 19.1(a)(iii), the International Bureau shall, for the purposes of Article 31(2)(a), be considered to be acting for the Contracting State of which the applicant is a resident or national.

##### *54.4. Applicant Not Entitled to Make a Demand*

If the applicant does not have the right to make a demand or, in the case of two or more applicants, if none of them has the right to make a demand under Rule 54.2, the demand shall be considered not to have been submitted.

If there is a sole applicant, he or she must be a resident or national of a Contracting State bound by Chapter II of the PCT. If there are two or more applicants, it is sufficient that one of them be a resident or national of a Contracting State bound by Chapter II, regardless of the elected State(s) for which each applicant is indicated. Only applicants for the elected States are required to be indicated in the Demand. The detailed requirements for the various indications required in connection with each applicant (name and address, telephone number, facsimile machine number or teleprinter address, nationality and residence) are the same as those required under PCT Rule 4 in connection with the Request. Note that any inventor who is not also an applicant is not indicated in the Demand.

If the recording of a change in the name or person has been requested under PCT Rule 92<sup>bis</sup>.1 before the Demand was filed, it is the applicant(s) of record at the time when the Demand is filed who must be indicated in the Demand.

## 1864.03 States Which May Be Elected [R-2]

### *PCT Article 31.*

#### *Demand for International Preliminary Examination*

\*\*\*\*\*

(4)(a) The demand shall indicate the Contracting State or States in which the applicant intends to use the results of the international preliminary examination ("elected States"). Additional Contracting States may be elected later. Election may relate only to Contracting States already designated under Article 4.

(b) Applicants referred to in paragraph (2)(a) may elect any Contracting State bound by Chapter II. Applicants referred to in paragraph (2)(b) may elect only such Contracting States bound by Chapter II as have declared that they are prepared to be elected by such applicants.

\*\*\*\*\*

>The filing of a demand on or after January 1, 2004, shall constitute the election of all Contracting States which are designated and are bound by Chapter II of the Treaty on the international filing date (PCT Rule 53.7). For demands filed before January 1, 2004, only those eligible states pursuant to PCT Article 31 indicated as being elected are elected.< Only PCT member states which have ratified or acceded to Chapter II and which were designated in the Request may be elected under Chapter II. The Assembly has taken no action to allow persons who are residents or nationals of a State not party to the PCT or not bound by Chapter II to make a Demand under Article 31(2)(b).

### 1864.04 Agent's Right To Act [R-2]

Any agent entitled to practice before the receiving Office where the international application was filed may represent the applicant before the international authorities (PCT Article 49).

If for any reason, the examiner needs to question the right of an attorney or agent to practice before the International Preliminary Examining Authority >(IPEA)<, the USPTO roster of registered attorneys and agents should be consulted. If the international application was filed with a receiving Office other than the United States, Form PCT/IPEA/410 may be used by the requesting IPEA to ask the receiving Office with which the international application was filed, whether the agent named in the international application has the right to practice before that Office.

The PCT Article and Regulations governing the right to practice are PCT Article 49 and PCT Rule 83.

### 1865 Filing of Demand [R-2]

*PCT Article 31.*

*Demand for International Preliminary Examination*

(1) On the demand of the applicant, his international application shall be the subject of an international preliminary examination as provided in the following provisions and the Regulations.

\*\*\*\*\*

(3) The demand for international preliminary examination shall be made separately from the international application. The demand shall contain the prescribed particulars and shall be in the prescribed language and form.

\*\*\*\*\*

(6)(a)The demand shall be submitted to the competent International Preliminary Examining Authority referred to in Article 32.

\*\*\*\*\*

Applicants should mail the Demand and appropriate fees directly to the International Preliminary Examining Authority >(IPEA)< they desire to prepare the International Preliminary Examination Report. United States applicants who have had the international search prepared by the European Patent Office >(EPO)< may also request the \*\*>EPO< to act as the \*\*>IPEA with some exceptions<. See MPEP § 1865.01.

Demands filed in the European Patent Office should be delivered to the European Patent Office Headquarters at Munich:

Location:

Erhardstr. 27  
D-80331 Munchen  
Germany

Mailing address:

D-80298 Munchen  
Germany

Demands filed in the United States Patent and Trademark Office should be addressed as follows:

Mailing address for delivery by the U.S. Postal Service:

\*\*>Mail Stop PCT  
Commissioner for Patents, Box PCT  
P.O. Box 1450  
Alexandria, VA 22313-1450<.

OR

If hand-carried directly to the USPTO PCT Operations Office:

>Mail Stop PCT<  
Commissioner for Patents\*\*  
2011 South Clark Place  
Crystal Plaza Two, 8th Floor Reception Area (PCT  
Operations)  
Arlington, VA 22202

The "Express Mail" provisions of 37 CFR 1.10 may be used to file a Demand under Chapter II in the USPTO. Applicants are advised that failure to comply with the provisions of 37 CFR 1.10 will result in the paper or fee being accorded the date of receipt and not the date of deposit. See MPEP § 513.

Demand for international preliminary examination may be submitted to the USPTO via facsimile. The Certificate of Mailing or Transmission practice under 37 CFR 1.8 CANNOT be used to file a Demand if the date of deposit is desired. If used, the date of the Demand will be the date of receipt in the USPTO. See MPEP § 513, § 1834, and § 1834.01.

All Demands filed in the USPTO must be in the English language.

PCT Rule 59.3 was amended July 1, 1998 to provide a safeguard in the case of a Demand filed with an International Preliminary Examining Authority which is not competent for the international preliminary examination of a particular international application. The USPTO \*>will< forward such a Demand to the International Bureau and the International Bureau will forward the Demand to a competent International Pre-

liminary Examining Authority pursuant to PCT Rule 59.3(c). The competent International Preliminary Examining Authority will process the Demand based on the date of receipt in the USPTO. See 37 CFR 1.416(c)(2).

### CHOICE OF EXAMINING AUTHORITY

\*\*>For most applications, U.S. residents and nationals may choose to have the international preliminary examination done by the EPO if the EPO served as the International Searching Authority (ISA). However, for certain applications including one or more claims directed to the field of biotechnology, the field of business methods or the field of telecommunication, the EPO will not act as a competent IPEA. See< MPEP § 1865.01.

The IPEA/US will serve as International Preliminary Examining Authority for U.S. residents and nationals if the U.S. or EPO served as ISA and the international application was filed in the U.S. Receiving Office or the International Bureau as receiving Office.

The IPEA/US will also serve as International Preliminary Examining Authority for residents or nationals of Barbados, Brazil, India, Israel, Mexico, New Zealand, the Philippines, Saint Lucia, South Africa, and Trinidad and Tobago if the U.S. was the International Searching Authority.

\*\*>

The demand must be filed directly with the competent International Preliminary Examining Authority or, if two or more Authorities are competent, with the one chosen by the applicant. The full name or two-letter code of that Authority may be indicated by the applicant on the line below:  
 IPEA/ US

**Rec'd PCT/PTO 24 FEB 2004**

**PCT**

**CHAPTER II**

**DEMAND**

under Article 31 of the Patent Cooperation Treaty:  
 The undersigned requests that the international application specified below be the subject of international preliminary examination according to the Patent Cooperation Treaty.

For International Preliminary Examining Authority use only

Identification of IPEA <u>/US</u>		Date of receipt of DEMAND <b>IPEA/US 24 FEB 2004 (24-02-04)</b>	
<b>Box No. I IDENTIFICATION OF THE INTERNATIONAL APPLICATION</b>		Applicant's or agent's file reference CMC-123-PCT	
International application No. PCT/US2004/000150	International filing date (day/month/year) 05 January 2004 (05.01.2004)	(Earliest) Priority date (day/month/year) 06 January 2003 (06.01.2003)	
Title of invention Electro-magnetic Fastener Driver			
<b>Box No. II APPLICANT(S)</b>			
Name and address: (Family name followed by given name; for a legal entity, full official designation. The address must include postal code and name of country.) ACME FASTENER CORPORATION 300 Pratt Street Baltimore, Maryland 20726 United States of America		Telephone No. (410) 876-5432	Applicant's registration No. with the Office
		Facsimile No. (410) 876-5555	
		Teleprinter No.	
State (that is, country) of nationality: US		State (that is, country) of residence: US	
Name and address: (Family name followed by given name; for a legal entity, full official designation. The address must include postal code and name of country.) JONES, Mary 1600 South Eads Street Arlington, Virginia 22202 United States of America			
State (that is, country) of nationality: US		State (that is, country) of residence: US	
Name and address: (Family name followed by given name; for a legal entity, full official designation. The address must include postal code and name of country.)			
State (that is, country) of nationality:		State (that is, country) of residence:	
<input type="checkbox"/> Further applicants are indicated on a continuation sheet.			

Form PCT/IPEA/401 (first sheet) (January 2004)

See Notes to the demand form

Sheet No. 2

International application No.  
PCT/US2004/000150

**Box No. III AGENT OR COMMON REPRESENTATIVE; OR ADDRESS FOR CORRESPONDENCE**

The following person is  agent  common representative  
 and  has been appointed earlier and represents the applicant(s) also for international preliminary examination.  
 is hereby appointed and any earlier appointment of (an) agent(s)/common representative is hereby revoked.  
 is hereby appointed, specifically for the procedure before the International Preliminary Examining Authority, in addition to the agent(s)/common representative appointed earlier.

Name and address: *(Family name followed by given name; for a legal entity, full official designation. The address must include postal code and name of country.)*

SMITH, John J.  
220 Jefferson Davis Highway  
Arlington, Virginia 22202-0234  
United States of America

Telephone No.  
(703) 557 3054

Facsimile No.  
(703) 557 3554

Teleprinter No.

Agent's registration No. with the Office  
77,777

Address for correspondence: Mark this check-box where no agent or common representative is/has been appointed and the space above is used instead to indicate a special address to which correspondence should be sent.

**Box No. IV BASIS FOR INTERNATIONAL PRELIMINARY EXAMINATION**

**Statement concerning amendments:\***

1. The applicant wishes the international preliminary examination to start on the basis of:

- the international application as originally filed
- the description  as originally filed  
 as amended under Article 34
- the claims  as originally filed  
 as amended under Article 19 (together with any accompanying statement)  
 as amended under Article 34
- the drawings  as originally filed  
 as amended under Article 34

- 2.  The applicant wishes any amendment to the claims under Article 19 to be considered as reversed.
- 3.  The applicant wishes the start of the international preliminary examination to be postponed until the expiration of the applicable time limit under Rule 69.1(d).
- 4.  The applicant expressly wishes the international preliminary examination to start earlier than at the expiration of the applicable time limit under Rule 54bis.1(a).

\* Where no check-box is marked, international preliminary examination will start on the basis of the international application as originally filed or, where a copy of amendments to the claims under Article 19 and/or amendments of the international application under Article 34 are received by the International Preliminary Examining Authority before it has begun to draw up a written opinion or the international preliminary examination report, as so amended.

Language for the purposes of international preliminary examination: English

- which is the language in which the international application was filed.
- which is the language of a translation furnished for the purposes of international search.
- which is the language of publication of the international application.
- which is the language of the translation (to be) furnished for the purposes of international preliminary examination.

**Box No. V ELECTION OF STATES**

The filing of this demand constitutes the election of all Contracting States which are designated and are bound by Chapter II of the PCT.

Sheet No. . 3

International application No.  
PCT/US2004/000150

**Box No. VI CHECK LIST**

The demand is accompanied by the following elements, in the language referred to in Box No. IV, for the purposes of international preliminary examination:

- |  |   |       |        |
|--|---|-------|--------|
| 1. translation of international application                              | : | _____ | sheets |
| 2. amendments under Article 34   | : | 2     | sheets |
| 3. copy (or, where required, translation) of amendments under Article 19 | : | _____ | sheets |
| 4. copy (or, where required, translation) of statement under Article 19  | : | _____ | sheets |
| 5. letter  | : | 4     | sheets |
| 6. other ( <i>specify</i> )  | : | _____ | sheets |

For International Preliminary Examining Authority use only  
received not received

- |                          |                          |
|--------------------------|--------------------------|
| <input type="checkbox"/> | <input type="checkbox"/> |
| <input type="checkbox"/> | <input type="checkbox"/> |
| <input type="checkbox"/> | <input type="checkbox"/> |
| <input type="checkbox"/> | <input type="checkbox"/> |
| <input type="checkbox"/> | <input type="checkbox"/> |
| <input type="checkbox"/> | <input type="checkbox"/> |

The demand is also accompanied by the item(s) marked below:

- |  |  |
|--|--|
| 1. <input checked="" type="checkbox"/> fee calculation sheet                             | 5. <input type="checkbox"/> statement explaining lack of signature                         |
| 2. <input type="checkbox"/> original separate power of attorney                          | 6. <input type="checkbox"/> sequence listing in computer readable form                     |
| 3. <input type="checkbox"/> original general power of attorney                           | 7. <input type="checkbox"/> tables in computer readable form related to a sequence listing |
| 4. <input type="checkbox"/> copy of general power of attorney; reference number, if any: | 8. <input type="checkbox"/> other ( <i>specify</i> ):                                      |

**Box No. VII SIGNATURE OF APPLICANT, AGENT OR COMMON REPRESENTATIVE**

*Next to each signature, indicate the name of the person signing and the capacity in which the person signs (if such capacity is not obvious from reading the demand).*

*John J. Smith*  
John J. Smith

For International Preliminary Examining Authority use only

1. Date of actual receipt of DEMAND: <b>Rec'd PCT/PTO 24 FEB 2004</b> (24-02-04)	
2. Adjusted date of receipt of demand due to CORRECTIONS under Rule 60.1(b):	
3. <input type="checkbox"/> The date of receipt of the demand is AFTER the expiration of 19 months from the priority date and item 4 or 5, below, does not apply. <input type="checkbox"/> The applicant has been informed accordingly.	6. <input type="checkbox"/> The date of receipt of the demand is AFTER the expiration of the time limit under Rule 54bis.1(a) and item 7 or 8, below, does not apply.
4. <input type="checkbox"/> The date of receipt of the demand is WITHIN the time limit of 19 months from the priority date as extended by virtue of Rule 80.5.	7. <input type="checkbox"/> The date of receipt of the demand is WITHIN the time limit under Rule 54bis.1(a) as extended by virtue of Rule 80.5.
5. <input type="checkbox"/> Although the date of receipt of the demand is after the expiration of 19 months from the priority date, the delay in arrival is EXCUSED pursuant to Rule 82.	8. <input type="checkbox"/> Although the date of receipt of the demand is after the expiration of the time limit under Rule 54bis.1(a), the delay in arrival is EXCUSED pursuant to Rule 82.

For International Bureau use only

Demand received from IPEA on:

**CHAPTER II**

**PCT**

**FEE CALCULATION SHEET**

**Annex to the Demand**

International application No. <b>PCT/US2004/000150</b>	For International Preliminary Examining Authority use only <b>IPEA/US 24 FEB 2004</b> Date stamp of the IPEA (24-02-04)								
Applicant's or agent's file reference <b>CMC-123-PCT</b>									
Applicant <b>ACME FASTENER CORPORATION</b>									
<p align="center"><b>CALCULATION OF PRESCRIBED FEES</b></p>									
1. Preliminary examination fee .....	600 P								
2. Handling fee ( <i>Applicants from certain States are entitled to a reduction of 75% of the handling fee. Where the applicant is (or all applicants are) so entitled, the amount to be entered at H is 25% of the handling fee.</i> ) .....	162 H								
3. Total of prescribed fees Add the amounts entered at P and H and enter total in the TOTAL box .....	762 <hr/> TOTAL								
<p><b>MODE OF PAYMENT</b></p> <table style="width: 100%; border: none;"> <tr> <td><input checked="" type="checkbox"/> authorization to charge deposit account with the IPEA (see below)</td> <td><input type="checkbox"/> cash</td> </tr> <tr> <td><input type="checkbox"/> cheque</td> <td><input type="checkbox"/> revenue stamps</td> </tr> <tr> <td><input type="checkbox"/> postal money order</td> <td><input type="checkbox"/> coupons</td> </tr> <tr> <td><input type="checkbox"/> bank draft</td> <td><input type="checkbox"/> other (specify):</td> </tr> </table>		<input checked="" type="checkbox"/> authorization to charge deposit account with the IPEA (see below)	<input type="checkbox"/> cash	<input type="checkbox"/> cheque	<input type="checkbox"/> revenue stamps	<input type="checkbox"/> postal money order	<input type="checkbox"/> coupons	<input type="checkbox"/> bank draft	<input type="checkbox"/> other (specify):
<input checked="" type="checkbox"/> authorization to charge deposit account with the IPEA (see below)	<input type="checkbox"/> cash								
<input type="checkbox"/> cheque	<input type="checkbox"/> revenue stamps								
<input type="checkbox"/> postal money order	<input type="checkbox"/> coupons								
<input type="checkbox"/> bank draft	<input type="checkbox"/> other (specify):								
<p><b>AUTHORIZATION TO CHARGE (OR CREDIT) DEPOSIT ACCOUNT</b>  <i>(This mode of payment may not be available at all IPEAs)</i></p> <table style="width: 100%; border: none;"> <tr> <td style="width: 50%; vertical-align: top;"> <input checked="" type="checkbox"/> Authorization to charge the total fees indicated above.   <input checked="" type="checkbox"/> <i>(This check-box may be marked only if the conditions for deposit accounts of the IPEA so permit)</i> Authorization to charge any deficiency or credit any overpayment in the total fees indicated above.                         </td> <td style="width: 50%; vertical-align: top;">                             IPEA/ <u>US</u>                              Deposit Account No.: <u>12-3456</u>                              Date: <u>25 February 2004</u>                              Name: <u>John J. Smith</u>                              Signature: <u>John J. Smith</u> </td> </tr> </table>		<input checked="" type="checkbox"/> Authorization to charge the total fees indicated above.  <input checked="" type="checkbox"/> <i>(This check-box may be marked only if the conditions for deposit accounts of the IPEA so permit)</i> Authorization to charge any deficiency or credit any overpayment in the total fees indicated above.	IPEA/ <u>US</u> Deposit Account No.: <u>12-3456</u> Date: <u>25 February 2004</u> Name: <u>John J. Smith</u> Signature: <u>John J. Smith</u>						
<input checked="" type="checkbox"/> Authorization to charge the total fees indicated above.  <input checked="" type="checkbox"/> <i>(This check-box may be marked only if the conditions for deposit accounts of the IPEA so permit)</i> Authorization to charge any deficiency or credit any overpayment in the total fees indicated above.	IPEA/ <u>US</u> Deposit Account No.: <u>12-3456</u> Date: <u>25 February 2004</u> Name: <u>John J. Smith</u> Signature: <u>John J. Smith</u>								

600.00

162.00

762.00



## 1865.01 The European Patent Office as an International Preliminary Examining Authority [R-2]

\*\*>The European Patent Office (EPO) has expressed the following limitations concerning its competency to act as an International Preliminary Examining Authority (IPEA). For updates or possible changes to these limitations, applicants should consult the PCT Newsletter which is available in electronic form from the web site ([www.wipo.int/pct/en/newslett/index.htm](http://www.wipo.int/pct/en/newslett/index.htm)) of the World Intellectual Property Organization.

### I. FIELD OF BIOTECHNOLOGY

The EPO is not a competent authority within the meaning of PCT Article 16(3)(b) and PCT Article 32(3), and will not carry out international preliminary examination in respect of any international application filed before January 1, 2004, where the corresponding demand was filed with the EPO on or after March 1, 2002, if the application: (A) was filed with the USPTO as receiving Office by a national or resident of the U.S.; or (B) was filed in the International Bureau (IB) as receiving Office by a national or resident of the U.S. (provided the application did not also identify as an applicant at its time of filing a national or resident of a European Patent Convention (EPC) Contracting State); where the application contains one or more claims relating to the field of biotechnology as defined by the following units of the International Patent Classification:<

C 12 M	Apparatus for enzymology or microbiology
C 12 N	Micro-organisms or enzymes; compositions thereof
C 12 P	Fermentation or enzyme-using processes to synthesise a desired chemical compound or composition or to separate optical isomers from a racemic mixture

C 12 Q	Measuring or testing processes involving enzymes or micro-organisms; compositions or test papers therefor; processes of preparing such compositions; condition-responsive control in microbiological or enzymological processes
C 07 K	Peptides
G 01 N 33/50 (including subdivisions)	Chemical analysis of biological material, e.g. blood, urine; testing involving biospecific ligand binding methods; immunological testing
A 61 K 39	Medicinal preparations containing antigens or antibodies
A 61 K 48	Medicinal preparations containing genetic material which is inserted into cells of the living body to treat genetic diseases; Gene therapy
A 01 H	New plants or processes for obtaining them; plant reproduction by tissue culture techniques

For information, U.S. classes covering the corresponding subject matter are listed below:

424	Drug, bio-affecting and body treating compositions
435	Chemistry: molecular biology and microbiology
436	Chemistry: analytical and immunological testing
514	Drug, bio-affecting and body treating compositions
530	Chemistry: natural resins or derivatives; peptides or proteins; lignins or reaction products thereof
536	Organic compounds—part of the class 532-570 series

800 Multicellular living organisms and unmodified parts thereof

930 Peptide or protein sequence

\*\*>

**II. FIELD OF BUSINESS METHODS**

The EPO is not a competent authority within the meaning of PCT Article 16(3)(b) and PCT Article 32(3), and will not carry out international preliminary examination in respect of any international application where the corresponding demand was filed with the EPO on or after March 1, 2002, if the application: (A) is filed with the USPTO as receiving Office by a national or resident of the U.S.; or (B) is filed in the IB as receiving Office by a national or resident of the U.S. (provided the application does not also identify as an applicant at its time of filing a national or resident of an EPC Contracting State); where the application contains one or more claims relating to the field of business methods as defined by the following units of the International Patent Classification:<

G 06 F 17/60 Digital computing or data processing equipment or methods, specially adapted for specific functions: administrative, commercial, managerial, supervisory or forecasting purposes. To the extent that the application falls under above mentioned subgroup but does not relate to business methods the EPO's competence is not affected.

For information, the U.S. class covering the corresponding subject matter is listed below:

705 Data processing: financial, business practice, management, or cost/price determination

\*\*>

**III. FIELD OF TELECOMMUNICATION**

The EPO is not a competent authority within the meaning of PCT Article 16(3)(b) and PCT Article 32(3), and will not carry out international preliminary examination in respect of any international application where the corresponding demand is filed with the EPO on or after March 1, 2002, and before July 1, 2004, where the application: (A) is filed with the USPTO as receiving Office by a national or resident of the U.S.; or (B) is filed in the IB as receiving Office by a national or resident of the U.S. (provided the application does not also identify as an applicant at its time of filing a national or resident of an EPC Contracting State); where the application contains one or more claims relating to the field of telecommunication as defined by the following unit of the International Patent Classification:<

H 04 Electric communication technique with the exception of H04N: Pictorial communication, e.g. television

For information, the U.S. classes covering the corresponding subject matter are listed below:

- 370 Multiplex communications
- 375 Pulse or digital communications
- 379 Telephonic communication
- 380 Cryptography
- 381 Electrical audio signal processing systems and devices
- 455 Telecommunications

Demands for international preliminary examination submitted to a non-competent authority are subject to PCT Rule 59.3. Applicants filing demands with the EPO in applications directed to the above subject matter will receive a notice from the EPO indicating that the demand is being forwarded to the IPEA/US under PCT Rule 59.3(f). Any fees paid by the applicant to

the EPO will be refunded to the applicant. Applicants have one month from the date of receipt of the demand transmitted to the IPEA under PCT Rule 59.3 to pay the handling fee (PCT Rule 57 and 37 CFR 1.482(b)) and the preliminary examination fee (PCT Rule 58 and 37 CFR 1.482(a)). See PCT Rules 57.3 and 58.1(b).

## 1866 Filling in of Headings on Chapter II Forms [R-2]

The examiner will encounter several different forms for use in the Chapter II preliminary examination phase and most of the forms will have the same "header" information to be provided.

The notes below list the common identifying information requested on the top of the first page of most of the forms:

Applicant's mailing address - this is usually the attorney's address taken from the file wrapper.

Applicant's or Agent's File Reference - this is the applicant's or agent's application reference (or docket number) which is composed of either letters or numbers, or both, provided this reference does not exceed twelve characters. This reference may be found in the upper right hand box on the first sheet of the Demand, Form PCT/IPEA/401. See Administrative Instructions Section 109.

International Application Number - this is the \*\* PCT application number as stamped and typed on the international application file wrapper and may also be found on the first page of the Demand, Form PCT/IPEA/401.

International Filing Date - this is the filing date printed on the international application file wrapper and may also be found on the first page of the Demand, Form PCT/IPEA/401.

Applicant (Name) - the first named applicant as set forth on the international application file wrapper and may also be found in box II of the Demand, Form PCT/IPEA/401.

## 1867 Preliminary Examination Fees [R-2]

37 CFR 1.481. *Payment of international preliminary examination fees.*

\*\*>

(a) The handling and preliminary examination fees shall be paid within the time period set in PCT Rule 57.3. The handling fee

or preliminary examination fee payable is the handling fee or preliminary examination fee in effect on the date of payment.<

(1) If the handling and preliminary fees are not paid within the time period set in PCT Rule 57.3, applicant will be notified and given one month within which to pay the deficient fees plus a late payment fee equal to the greater of:

(i) Fifty percent of the amount of the deficient fees, but not exceeding an amount equal to double the handling fee; or

(ii) An amount equal to the handling fee (PCT Rule 58<sup>bis</sup>.2).

(2) The one-month time limit set in this paragraph to pay deficient fees may not be extended.

(b) If the payment needed to cover the handling and preliminary examination fees, pursuant to paragraph (a) of this section, is not timely made in accordance with PCT Rule 58<sup>bis</sup>.1(d), the United States International Preliminary Examination Authority will declare the Demand to be considered as if it had not been submitted.

The preliminary examination fee is for the benefit of the International Preliminary Examining Authority and the amount for the \*>USPTO< doing the preliminary examination is specified in 37 CFR 1.482. The fee is somewhat higher if the international search was performed by an authority other than the USPTO.

The handling fee is a fee for the benefit of the International Bureau and is collected by the International Preliminary Examining Authority. The amount of the handling fee is set out in the PCT schedule of fees which is annexed to the PCT Regulations.

The current amount of both the preliminary examination fee and the handling fee can be found in each weekly issue of the *Official Gazette*. Since supplements to the handling fee were deleted, no additional Chapter II fees are required other than any additional preliminary examination fee where additional inventions are determined to be present. The amount of this fee is also specified in 37 CFR 1.482 and in the weekly issues of the *Official Gazette*. See also PCT Rules 57 and 58.

The time limit for paying the preliminary examination fee and the handling fee is set forth in PCT Rules 57.3 and 58.1(b). >Effective January 1, 2004, for demands filed on or after January 1, 2004, 37 CFR 1.481(a) provides that the preliminary examination fee or handling fee payable is the preliminary examination fee or handling fee in effect on the date of payment. For demands filed before January 1, 2004, former< 37 CFR 1.481(a) provides that the preliminary examination fee or handling fee payable is the preliminary examination fee or handling fee in effect

on the date of receipt of the Demand in the United States International Preliminary Examining Authority. Effective July 1, 1998, PCT Rule 58bis.1(c) was added to consider the preliminary examination fee and handling fee to have been received before the expiration of the time limit set in PCT Rule 57.3 if the fees were submitted prior to the sending of an invitation to pay the fees.

Effective July 1, 1998, PCT Rule 58bis.1(a) was added to permit the International Preliminary Examining Authority to collect a late payment fee set forth in PCT Rule 58bis.2 if the fees for preliminary examination are not paid prior to the sending of the invitation to pay the fees. If the preliminary examination fee and handling fee are not paid within the time set in PCT Rule 57.3, applicants will be notified and given 1 month within which to pay the deficient fees plus a late payment fee equal to the greater of: (1) 50% of the amount of the deficient fees, but not exceeding an amount equal to double the handling fee; or (2) an amount equal to the handling fee. See 37 CFR 1.481(a)(1)(i) and (ii). The 1 month time limit set forth in 37 CFR 1.481(a)(1) to pay deficient fees may not be extended. See 37 CFR 1.481(a)(2).

If the payment needed to cover the preliminary examination fee and handling fee is not timely made in accordance with PCT Rule 58bis.1(d), the United States International Preliminary Examining Authority will declare the Demand to be considered as if it had not been submitted. In this regard, where the Authority sends a notification that the Demand is considered not to have been made and applicant's payment is received on the same date the notification is sent, the fee is considered to be late and the notification remains effective. The fee must antedate the notice in order for the notice not to be effective. See 37 CFR 1.481(b).

## 1868 Correction of Defects in the Demand [R-2]

*PCT Rule 60.*

*Certain Defects in the Demand or Elections*

### *60.1. Defects in the Demand*

\*\*>

(a) Subject to paragraphs (a<sup>bis</sup>) and (a<sup>ter</sup>), if the demand does not comply with the requirements specified in Rules 53.1,

53.2(a)(i) to (iii), 53.2(b), 53.3 to 53.8 and 55.1, the International Preliminary Examining Authority shall invite the applicant to correct the defects within a time limit which shall be reasonable under the circumstances. That time limit shall not be less than one month from the date of the invitation. It may be extended by the International Preliminary Examining Authority at any time before a decision is taken.

(a<sup>bis</sup>) For the purposes of Rule 53.4, if there are two or more applicants, it shall be sufficient that the indications referred to in Rule 4.5(a)(ii) and (iii) be provided in respect of one of them who has the right according to Rule 54.2 to make a demand.

(a<sup>ter</sup>) For the purposes of Rule 53.8, if there are two or more applicants, it shall be sufficient that the demand be signed by one of them.

(b) If the applicant complies with the invitation within the time limit under paragraph (a), the demand shall be considered as if it had been received on the actual filing date, provided that the demand as submitted permitted the international application to be identified; otherwise, the demand shall be considered as if it had been received on the date on which the International Preliminary Examining Authority receives the correction.

(c) If the applicant does not comply with the invitation within the time limit under paragraph (a), the demand shall be considered as if it had not been submitted and the International Preliminary Examining Authority shall so declare.

(d) [Deleted]

(e) If the defect is noticed by the International Bureau, it shall bring the defect to the attention of the International Preliminary Examining Authority, which shall then proceed as provided in paragraphs (a) to (c).<

(f) If the demand does not contain a statement concerning amendments, the International Preliminary Examining Authority shall proceed as provided for in Rules 66.1 and 69.1(a) or (b).

(g) Where the statement concerning amendments contains an indication that amendments under Article 34 are submitted with the demand (Rule 53.9(c)) but no such amendments are, in fact, submitted, the International Preliminary Examining Authority shall invite the applicant to submit the amendments within a time limit fixed in the invitation and shall proceed as provided for in Rule 69.1(e).

\*\*

Defects in the Demand may be corrected. The type of correction determines whether the filing date of the Demand must be changed. The most common defects which result in the mailing of an invitation to correct are found in PCT Rules 53 and 55. If the applicant complies with the invitation, the Demand is considered as if it had been received on the actual filing date, i.e., the original date of receipt. See PCT Rule 60.1(b).

## 1869 Notification to International Bureau of Demand

*PCT Article 31.*

*Demand for International Preliminary Examination*

\*\*\*\*\*

(7) Each elected Office shall be notified of its election.

The International Preliminary Examining Authority, pursuant to PCT Rule 61, promptly notifies the International Bureau and the applicant of the filing of any Demand. The International Bureau in turn notifies each elected Office of their election and also notifies the applicant that such notification has been made.

## 1870 Priority Document and Translation Thereof [R-2]

*PCT Rule 66.*

*Procedure before the International Preliminary Examining Authority*

\*\*\*\*\*

### 66.7. Priority Document

\*\*>

(a) If the International Preliminary Examining Authority needs a copy of the earlier application whose priority is claimed in the international application, the International Bureau shall, on request, promptly furnish such copy. If that copy is not furnished to the International Preliminary Examining Authority because the applicant failed to comply with the requirements of Rule 17.1, and if that earlier application was not filed with that Authority in its capacity as a national Office or the priority document is not available to that Authority from a digital library in accordance with the Administrative Instructions, the international preliminary examination report may be established as if the priority had not been claimed.<

(b) If the application whose priority is claimed in the international application is in a language other than the language or one of the languages of the International Preliminary Examining Authority, that Authority may, where the validity of the priority claim is relevant for the formulation of the opinion referred to in Article 33(1), invite the applicant to furnish a translation in the said language or one of the said languages within two months from the date of the invitation. If the translation is not furnished within that time limit, the international preliminary examination report may be established as if the priority had not been claimed.

\*\*\*\*\*

A copy of the priority document >and/or a translation thereof, if the priority document is not in

English< may be required by the examiner if necessary because of an intervening reference \*\*.

## 1871 >Processing Amendments Filed Under Article 19 and Article 34 Prior to or at the Start of International Preliminary Examination in International Applications Having an International Filing Date On or After January 1, 2004 [R-2]

[Note: The regulations under the PCT were changed effective January 1, 2004. Corresponding changes were made to Title 37 of the Code of Federal Regulations. See *January 2004 Revision of Patent Cooperation Treaty Application Procedure*, 68 FR 59881 (Oct. 20, 2003), 1276 O.G. 6 (Nov. 11, 2003). International applications filed before January 1, 2004, will continue to be processed under the procedures in effect on their international filing date. The discussion of the procedures in effect prior to January 1, 2004, has been moved from this section to newly added MPEP § 1871.01.]

*PCT Rule 62.*

*Copy of the Written Opinion by the International Searching Authority and of Amendments Under Article 19 for the International Preliminary Examining Authority*

### 62.1. Copy of Written Opinion by International Searching Authority and of Amendments Made Before the Demand Is Filed

Upon receipt of a demand, or a copy thereof, from the International Preliminary Examining Authority, the International Bureau shall promptly transmit to that Authority.

(i) a copy of the written opinion established under Rule 43<sup>bis</sup>.1, unless the national Office or intergovernmental organization that acted as International Searching Authority is also acting as International Preliminary Examining Authority; and

(ii) a copy of any amendment under Article 19, and any statement referred to in that Article, unless that Authority has indicated that it has already received such a copy.

### 62.2. Amendments Made After the Demand Is Filed

If, at the time of filing any amendments under Article 19, a demand has already been submitted, the applicant shall preferably, at the same time as he files the amendments with the International Bureau, also file with the International Preliminary Examining Authority a copy of such amendments and any statement referred to in that Article. In any case, the International Bureau shall promptly transmit a copy of such amendments and statement to that Authority

*PCT Rule 62<sup>bis</sup>.**Translation for the International Preliminary Examining Authority of the Written Opinion of the International Searching Authority**62<sup>bis</sup>.1. Translation and Observations*

(a) Upon request of the International Preliminary Examining Authority, the written opinion established under Rule 43<sup>bis</sup>.1 shall, when not in English or in a language accepted by that Authority, be translated into English by or under the responsibility of the International Bureau.

(b) The International Bureau shall transmit a copy of the translation to the International Preliminary Examining Authority within two months from the date of receipt of the request for translation, and shall at the same time transmit a copy to the applicant.

(c) The applicant may make written observations as to the correctness of the translation and shall send a copy of the observations to the International Preliminary Examining Authority and to the International Bureau.

The documents making up the international application may include amendments of the claims filed by the applicant under PCT Article 19. Article 19 amendments are exclusively amendments to the claims and these amendments can only be made after the search report has been established. Article 19 amendments will be transmitted to the International Preliminary Examining Authority (IPEA) by the International Bureau. The International Bureau marks, in the upper right-hand corner of each replacement sheet submitted under PCT Article 19, the international application number, the date on which that sheet was received under PCT Article 19 and, in the middle of the bottom margin, the words "AMENDED SHEET (ARTICLE 19)." If a demand for international preliminary examination has already been submitted, the applicant should preferably, at the time he/she files the Article 19 amendments, also file a copy of the amendments with the IPEA.

The IPEA starts the international preliminary examination when it is in possession of the demand; the required fees; if the applicant is required to furnish a translation under PCT Rule 55.2, that translation; either the international search report or a notice of the declaration by the International Searching Authority under PCT Article 17(2)(a) that no international search report will be established; and the written opinion established under PCT Rule 43<sup>bis</sup>.1, provided that the IPEA shall not start the international preliminary examination before the expiration of the later of three

months from the transmittal of the international search report and written opinion or of the declaration that no international search report will be established; or the expiration of 22 months from the priority date unless the applicant expressly requests an earlier start, with the exception of the following situations:

(A) If the competent IPEA is part of the same national Office or intergovernmental organization as the competent International Searching Authority, the international preliminary examination may, if the IPEA so wishes, start at the same time as the international search, provided that the examination is not to be postponed according to the statement concerning PCT Article 19 amendments (PCT Rule 53.9(b));

(B) Where the statement concerning amendments contains an indication that amendments under PCT Article 19 are to be taken into account (PCT Rule 53.9(a)(i)), the IPEA does not start the international preliminary examination before it has received a copy of the amendments concerned. These will be transmitted to the IPEA by the International Bureau. The applicant should preferably, at the time he/she files the demand, also file a copy of the amendments with the IPEA;

(C) Where the statement concerning amendments contains an indication that the start of the international preliminary examination is to be postponed (PCT Rule 53.9(b)), the IPEA does not start the international preliminary examination before:

(1) it has received a copy of any amendments made under PCT Article 19;

(2) it has received a notice from the applicant that he/she does not wish to make amendments under PCT Article 19; or

(3) the later of three months from the transmittal of the international search report and written opinion or of the declaration that no international search report will be established; or the expiration of 22 months from the priority date;

whichever occurs first;

(D) Where the statement concerning amendments contains an indication that amendments under PCT Article 34 are submitted with the demand (PCT Rule 53.9(c)) but no such amendments are, in fact, submitted, the IPEA does not start the international preliminary examination before it has received the amendments or before the time limit fixed in the invi-

tation referred to in PCT Rule 60.1(g) has expired, whichever occurs first.

The applicant has the right to amend the claims, the description, and the drawings, in the prescribed manner and before the start of international preliminary examination. The amendment must not go beyond the disclosure in the international application as filed. These amendments are referred to as PCT Article 34(2)(b) amendments. It should be noted that PCT Article 19 amendments are strictly amendments to the claims made during the Chapter I search phase while PCT Article 34(2)(b) amendments to the description, claims, and drawings are made during the Chapter II examination phase.

When amendments to the description, claims, or drawings are made under PCT Rule 66.8, they may be accompanied by an explanation. These amendments may have been submitted to avoid possible objections as to lack of novelty or lack of inventive step in view of the citations listed in the international search report and the observations on novelty, inventive step, and industrial applicability set forth in the written opinion established by the International Searching Authority; to meet any objections noted by the International Searching Authority under PCT Article 17(2)(a)(ii) (i.e., that all or at least some claims do not permit a meaningful search) or under PCT Rule 13 (i.e., that there is a lack of unity of invention); or to meet objections that may be raised for some other reason, e.g., to remedy some obscurity which the applicant himself/herself has noted in the original documents.

The amendments are made by the applicant of his/her own volition. This means that the applicant is not restricted to amendments necessary to remedy a defect in his/her international application. It does not, however, mean that the applicant should be regarded as free to amend in any way he/she chooses. Any amendment must not add subject matter which goes beyond the disclosure of the international application as originally filed. Furthermore, it should not itself cause the international application as amended to be objectionable under the PCT, e.g., the amendment should not introduce obscurity.

As a matter of policy and to ensure consistency in handling amendments filed under PCT Articles 19 and 34 of the PCT, the following guidelines for processing these amendments have been established:

(A) Any argument or amendment which complies with 37 CFR 1.485(a) will be considered;

(B) Amendments filed after the demand:

(1) will be considered if filed before the later of: three months from the transmittal of either the international search report or a notice of the declaration by the International Searching Authority under PCT Article 17(2)(a) that no international search report will be established, and the written opinion established under PCT Rule 43<sup>bis</sup>.1; or the expiration of 22 months from the priority date, unless the applicant expressly requests an earlier start to international preliminary examination,

(2) will be considered if filed before the application is docketed to the examiner,

(3) may be considered if filed after docketing. The examiner has discretion to consider such amendments if the examiner determines that the amendment places the application in better condition for examination or the examiner determines that the amendment should otherwise be entered;

(C) Amendments and/or arguments filed after expiration of the period for response to the written opinion:

(1) will be considered if the amendment was requested by the examiner,

(2) need not be taken into account for the purposes of a further written opinion or the international preliminary examination report if they are received after the examiner has begun to draw up that opinion or report. The applicant may file an amendment to the description, the claims and the drawings in the prescribed manner, even if this is outside the time period set for reply in PCT Rule 66.2(d). Since the examiner may begin to draw up the final report once the time period set for reply in PCT Rule 66.2(d) expires, amendments filed after the expiration of the time period set in for reply in PCT Rule 66.2(d) may or may not be considered. There may be situations where it is advisable, to the extent possible, to take such amendments or arguments into account, for example, where the international preliminary examination report has not yet been completed and it is readily apparent to the examiner that consideration of the late-filed response would result in the issuance of a favorable report.

It is expected, due to the relatively short time period for completion of preliminary examination,

that the Chapter II application will be taken up promptly after docketing to the examiner for preparation of either a further written opinion, if necessary, or the final report.

Amendments timely filed but misdirected or otherwise late reaching the examiner will be considered as in the case of regular domestic applications and may require a supplemental written opinion and/or final report.

Clearly, these guidelines offer the examiner flexibility. The examiner should be guided by the overriding principle that the international preliminary examination report (Form PCT/IPEA/409) should be established with as few written opinions as possible and resolution of as many issues as possible consistent with the goal of a timely and quality report.

See also Administrative Instructions Section 602 regarding processing of amendments by the IPEA.

**1871.01 < Processing Amendments Filed Under Article 19 and Article 34 Prior to or at the Start of International Preliminary Examination >in International Applications Having an International Filing Date Before January 1, 2004< [R-2]**

>[Note: If the international filing date is on or after January 1, 2004, the amendments are processed as indicated in MPEP § 1871 rather than as indicated in this section.]

*Former<*

*PCT Rule 62.*

*Copy of Amendments Under Article 19 for the International Preliminary Examining Authority*

*62.1. Amendments Made Before the Demand Is Filed*

Upon receipt of a demand, or a copy thereof, from the International Preliminary Examining Authority, the International Bureau shall promptly transmit a copy of any amendments under Article 19, and any statement referred to in that Article, to that Authority, unless that Authority has indicated that it has already received such a copy.

*62.2. Amendments Made After the Demand Is Filed*

If, at the time of filing any amendments under Article 19, a demand has already been submitted, the applicant shall preferably,

at the same time as he files the amendments with the International Bureau, also file with the International Preliminary Examining Authority a copy of such amendments and any statement referred to in that Article. In any case, the International Bureau shall promptly transmit a copy of such amendments and statement to that Authority.

The documents making up the international application may include amendments of the claims filed by the applicant under PCT Article 19. PCT Article 19 amendments are exclusively amendments to the claims and these amendments can only be made after the search report has been established. PCT Article 19 amendments will be transmitted to the International Preliminary Examining Authority by the International Bureau. If a Demand for international preliminary examination has already been submitted, the applicant should preferably, at the time he files the PCT Article 19 amendments, also file a copy of the amendments with the International Preliminary Examining Authority. In the event that the time limit for filing amendments under PCT Article 19, as provided in PCT Rule 46.1, has not expired and the Demand includes a statement that the start of the international preliminary examination is to be postponed under PCT Rule 53.9(b), the international preliminary examination should not start before the examiner receives a copy of any amendments made under PCT Article 19 or a notice from the applicant that he does not wish to make amendments under PCT Article 19, or before the expiration of 20 months from the priority date, whichever occurs first.

The applicant has the right to amend the claims, the description, and the drawings, in the prescribed manner and before the start of international preliminary examination. The amendment must not go beyond the disclosure in the international application as filed. These amendments are referred to as PCT Article 34(2)(b) amendments. It should be noted that PCT Article 19 amendments are strictly amendments to the claims made during the Chapter I search phase while PCT Article 34(2)(b) amendments to the description, claims, and drawings are made during the Chapter II examination phase.

When amendments to the description, claims, or drawings are made under PCT Rule 66.8, they may be accompanied by an explanation. These amendments may have been submitted to avoid possible objections as to lack of novelty or lack of inventive step in view



of the citations listed in the international search report; to meet any objections noted by the International Searching Authority under PCT Article 17(2)(a)(ii) (i.e., that all or at least some claims do not permit a meaningful search) or under PCT Rule 13 (i.e., that there is a lack of unity of invention); or to meet objections that may be raised for some other reason, e.g., to remedy some obscurity which the applicant himself/herself has noted in the original documents.

The amendments are made by the applicant of his/her own volition. This means that the applicant is not restricted to amendments necessary to remedy a defect in his/her international application. It does not, however, mean that the applicant should be regarded as free to amend in any way he/she chooses. Any amendment must not add subject matter which goes beyond the disclosure of the international application as originally filed. Furthermore, it should not itself cause the international application as amended to be objectionable under the PCT, e.g., the amendment should not introduce obscurity.

As a matter of policy and to ensure consistency in handling amendments filed under PCT Articles 19 and 34 of the PCT, the following guidelines for processing these amendments have been established:

(A) Any amendment which complies with 37 CFR 1.485(a) will be considered;

(B) Amendments filed after the Demand

(1) will be considered if filed before the application is docketed to the examiner,

(2) may be considered if filed after docketing. The examiner has discretion to consider such amendments if the examiner determines that the amendment places the application in better condition for examination or the examiner determines that the amendment should otherwise be entered;

(C) Amendments filed after expiration of the period for response to the written opinion

(1) will be considered if the amendment was requested by the examiner,

(2) may be considered if the examiner determines that the amendment places the application in better condition for examination or the examiner determines that the amendment should otherwise be entered.

It is expected, due to the relatively short time period for completion of preliminary examination, that the Chapter II application will be taken up for preparation of the written opinion promptly after docketing to the examiner and taken up for preparation of the final report promptly after the time expires for response to the written opinion (i.e., after allowing for mail processing). The examiner is not obliged to consider amendments or arguments which are filed after he/she has taken up the case for preparation of the written opinion or the final report.

Amendments timely filed but misdirected or are otherwise late reaching the examiner will be considered as in the case of regular domestic applications and may require a supplemental written opinion and/or final report.

Clearly, these guidelines offer the examiner flexibility. The examiner should be guided by the overriding principle that the final report (the PCT/IPEA/409) should be established with as few written opinions as possible and resolution of as many issues as possible consistent with the goal of a timely and quality report.

See also Administrative Instructions Section 602 regarding processing of amendments by the International Preliminary Examining Authority.

## **1872 Transmittal of Demand to the Examining Corps**

*PCT Administrative Instruction Section 605.*

*File to be used for International Preliminary Examination*

Where the International Preliminary Examining Authority is part of the same national Office or intergovernmental organization as the International Searching Authority, the same file shall serve the purposes of international search and international preliminary examination.

When the PCT International Application Processing Division has finished processing of the papers and fees filed with a complete Demand, a copy of the Demand and other papers are forwarded to the appropriate Technology Center for examination. The documents will be placed in the Search Copy file wrapper before forwarding to the examiner.

\*\*

## 1874 Determination if International Preliminary Examination Is Required and Possible [R-2]

*PCT Article 34.*

*Procedure Before the International Preliminary Examining Authority*

\*\*\*\*\*

(4)(a) If the International Preliminary Examining Authority considers

(i) that the international application relates to a subject matter on which the International Preliminary Examining Authority is not required, under the Regulations, to carry out an international preliminary examination, and an international preliminary examination, and in the particular case decides not to carry out such examination, or

(ii) that the description, the claims, or the drawings, are so unclear, or the claims are so inadequately supported by the description, that no meaningful opinion can be formed on the novelty, inventive step (non-obviousness), or industrial applicability, of the claimed invention, the said authority shall not go into the questions referred to in Article 33(1) and shall inform the applicant of this opinion and the reasons therefor.

(b) If any of the situations referred to in subparagraph (a) is found to exist in, or in connection with, certain claims only, the provisions of that subparagraph shall apply only to the said claims.

There are instances where international preliminary examination is not required because of the nature of the subject matter claimed and also because the claims are so indefinite that no examination is possible. Such instances should seldom occur, especially since most problems of this nature would have already been discovered and indicated at the time of the international search.

If it is found that certain claims of an international application relate to subject matter for which no international preliminary examination is required, \*\*>check the appropriate box on a Form PCT/IPEA/408 in an application having an international filing date before January 1, 2004, or on a Form PCT/IPEA/408 or a Form PCT/IPEA/409, as appropriate, in an application having an international filing date on or after January 1, 2004 (see MPEP § 1860)<. It should be noted that subject matter which is normally examined under U.S. national procedure should also be examined as an International Preliminary Examining Authority.

The examiner should check the appropriate box if it is found that the description, claims or drawings are

so unclear, or the claims are so inadequately supported by the description that no opinion could be formed as to the novelty, inventive step (nonobviousness) and industrial applicability of the claimed invention.

Subject matter not searched under Chapter I will not be the subject of a preliminary examination under Chapter II. This is so even if claims which were not searched under Chapter I are modified to be acceptable for examination.

## 1875 Unity of Invention Before the International Preliminary Examining Authority [R-2]

*PCT Article 34.*

*Procedure before the International Preliminary Examining Authority*

\*\*\*\*\*

(3)(a) If the International Preliminary Examining Authority considers that the international application does not comply with the requirement of unity of invention as set forth in the Regulations, it may invite the applicant, at his option, to restrict the claims so as to comply with the requirement or to pay additional fees.

\*\*\*\*\*

(c) If the applicant does not comply with the invitation referred to in subparagraph (a) within the prescribed time limit, the International Preliminary Examining Authority shall establish an international preliminary examination report on those parts of the international application which relate to what appears to be the main invention and shall indicate the relevant facts in the said report. The national law of any elected State may provide that, where its national Office finds the invitation of the International Preliminary Examining Authority justified, those parts of the international application which do not relate to the main invention shall, as far as effects in that State are concerned, be considered withdrawn unless a special fee is paid by the applicant to that Office.

\*\*\*\*\*

*37 CFR 1.488. Determination of unity of invention before the International Preliminary Examining Authority.*

(a) Before establishing any written opinion or the international preliminary examination report, the International Preliminary Examining Authority will determine whether the international application complies with the requirement of unity of invention as set forth in § 1.475.

(b) If the International Preliminary Examining Authority considers that the international application does not comply with the requirement of unity of invention, it may:

(1) Issue a written opinion and/or an international preliminary examination report, in respect of the entire international application and indicate that unity of invention is lacking and specify the reasons therefor without extending an invitation to restrict or pay additional fees. No international preliminary examination will be conducted on inventions not previously searched by an International Searching Authority.

(2) Invite the applicant to restrict the claims or pay additional fees, pointing out the categories of invention found, within a set time limit which will not be extended. No international preliminary examination will be conducted on inventions not previously searched by an International Searching Authority, or

(3) If applicant fails to restrict the claims or pay additional fees within the time limit set for reply, the International Preliminary Examining Authority will issue a written opinion and/or establish an international preliminary examination report on the main invention and shall indicate the relevant facts in the said report. In case of any doubt as to which invention is the main invention, the invention first mentioned in the claims and previously searched by an International Searching Authority shall be considered the main invention.

(c) Lack of unity of invention may be directly evident before considering the claims in relation to any prior art, or after taking the prior art into consideration, as where a document discovered during the search shows the invention claimed in a generic or linking claim lacks novelty or is clearly obvious, leaving two or more claims joined thereby without a common inventive concept. In such a case the International Preliminary Examining Authority may raise the objection of lack of unity of invention.

The examiner will usually begin the preliminary examination by checking the international application for unity of invention. The international preliminary examination will only be directed to inventions which have been searched by the International Searching Authority. All claims directed to inventions which have not been searched by the International Searching Authority will not be considered by the International Preliminary Examining Authority. If the examiner in the International Preliminary Examining Authority finds lack of unity of invention in the claims to be examined, an invitation is normally prepared and sent to the applicant requesting the payment of additional fees or the restriction of the claims on Form PCT/IPEA/405. Such an invitation will include the identification of what the examiner considers to be the “main invention” which will be examined if no additional fees are paid or restriction is made by the applicant.

The procedure before the International Preliminary Examining Authority regarding lack of unity of invention is governed by PCT Article 34(3)(a) through (c), PCT Rule 68 (see also PCT Rule 70.13), and 37 CFR 1.475 and 1.488. It should be noted that

in most instances lack of unity of invention will have been noted and reported upon by the International Searching Authority which will have drawn up an international search report >(and for international applications having a filing date on or after January 1, 2004, a written opinion)< based on those parts of the international application relating to the invention, or unified linked group of inventions, first mentioned in the claims (“main invention”) >, unless the applicant has paid additional fees<. If the applicant has paid additional search fees, additional inventions would also have been searched. No international preliminary examination will be conducted on inventions not previously searched by an International Searching Authority (37 CFR 1.488(b)(2)).

\*\*

If the examiner determines that unity of invention is lacking, there are two options:

(A) The examiner may conduct an international preliminary examination covering all the claimed and previously searched inventions and indicate that unity of invention is lacking and specify the reasons therefor without extending an invitation to restrict or pay additional fees (PCT Rule 68.1), or

(B) The examiner may invite the applicant to restrict the claims, so as to comply with the requirement, or pay additional fees, pointing out the categories of invention found >using Form PCT/IPEA/405 or USPTO/499 (telephone practice). See MPEP § 1875.01<. The invitation to restrict or pay additional fees shall state the reasons for which the international application is considered as not complying with the requirement of unity of invention. (PCT Rule 68.2). Inventions not previously searched will not be considered or included in the invitation.

The written opinion, if any, and the international preliminary examination report must be established on all inventions for which examination fees have been paid.

If the applicant fails to reply to the invitation to restrict the claims or pay additional examination fees due to lack of unity of invention >(by not paying the additional fees or by not restricting the claims either sufficiently or at all)<, the written opinion>, if any,< and international preliminary examination report must be established on the claims directed to what appears to be the main invention (PCT Article 34(3)(c)). The

main invention, in case of doubt, is the first claimed invention for which an international search report has been issued by the International Searching Authority. The main invention, as viewed by the examiner, must be set forth on Form PCT/IPEA/405.

>If the applicant timely complies with the invitation to pay additional fees even under protest, or to restrict the claims, the examiner carries out international preliminary examination on those claimed inventions for which additional fees have been paid or to which the claims have been restricted. It should be noted that the national law of any elected State may provide that, where its national Office finds the invitation of the International Preliminary Examining Authority justified, those parts of the international application which do not relate to the main invention shall, as far as effects in that State are concerned, be considered withdrawn unless a special fee is paid by the applicant to that Office (PCT Article 34(3)(c)).< Whether or not the question of unity of invention has been raised by the International Searching Authority, it may be considered by the examiner when serving as an authorized officer of the International Preliminary Examining Authority. In the examiner's consideration, all documents cited by the International Searching Authority should be taken into account and any additional relevant documents considered. However, there are cases of lack of unity of invention, where, compared with the procedure of inviting the applicant to restrict the international application or pay additional fees (PCT Rule 68.2), little or no additional effort is involved in establishing the written opinion>, if any,< and the international preliminary examination report for the entire international application. Then reasons of economy may make it advisable for the examiner to use the option referred to in PCT Rule 68.1 by choosing not to invite the applicant to restrict the claims or to pay additional fees.

Unity of invention is defined by 37 CFR 1.475 which describes the circumstances in which the requirement of unity of invention is considered fulfilled.

### **1875.01 Preparation of Invitation Concerning Unity [R-2]**

The "Invitation to restrict or pay additional fees" Form PCT/IPEA/405 is used to invite the applicant, at his/her option, to restrict the claims to comply with

the requirements of unity of invention or to pay additional examination fees. In addition, the examiner must explain the reasons why the international application is not considered to comply with the requirement of unity of invention. The examiner must also specify, on Form PCT/IPEA/405, at least one group or groups of claims which, if elected, would comply with the requirement for unity of invention.

#### **INVITATION >TO RESTRICT OR PAY ADDITIONAL FEES<**

In the space provided on form PCT/IPEA/405, the examiner should identify the disclosed inventions by claim numerals and indicate which disclosed inventions are so linked as to form a single general inventive concept, thereby complying with the requirement of unity of invention. For example, claims to different categories of invention such as a product, claims to a process specifically adapted for the manufacture of the product and a claim for a use of the product would be considered related inventions which comply with the unity of invention requirement, whereas a claim to an apparatus for making the product in the same application would be considered a second invention for which additional fees would be required. The reasons for holding that unity of invention is lacking must be specified. See 37 CFR 1.475 and \*\*>Chapter 10 of the International Search and Preliminary Examination Guidelines which can be obtained from WIPO's web site ([www.wipo.int/pct/en/texts/gdlines.htm](http://www.wipo.int/pct/en/texts/gdlines.htm))<.

Also, the examiner should specify the main invention and claims directed thereto which will be examined if the applicant fails to restrict or pay additional fees. The main invention, in case of doubt, is the first claimed invention or related invention before the International Preliminary Examining Authority for which a search fee has been paid and an international search report has been prepared.

The examiner should indicate the total amount of additional fees required for examination of all claimed inventions.

In the box provided at the top of the form, the time limit for response is set according to PCT Rule 68.2, normally a 1 month time limit >(not shorter than one month but not longer than two months)<. Extensions of time are not permitted.

Since the space provided on Form PCT/IPEA/405 is limited, supplemental attachment sheets, supplied by the examiner, with reference back to the specific section, should be incorporated whenever necessary.

### AUTHORIZED OFFICER

Form PCT/IPEA/405 must be signed by an examiner with at least partial signatory authority.

### TELEPHONIC RESTRICTION PRACTICE

Telephone practice may be used \*\* to allow applicants to elect an invention to be examined or to pay additional fees \*\* if:

(A) \*\* >Applicant or applicant's legal representative has a USPTO< deposit account,

(B) Applicant or the legal representative or agent orally agrees to charge the additional fees to the account, and

(C) A complete record of the telephone conversation is included with the written opinion>, if any, or the international preliminary examination report,< including:

- (1) Examiner's name;
- (2) Authorizing attorney's name;
- (3) Date of conversation;
- (4) Invention elected and/or inventions for which additional fees paid; and
- (5) Deposit account number and amount to be charged.

\*\*

When the telephone practice is used in making lack of unity requirements, it is critical that the examiner orally inform applicant that there is no right to protest the holding of lack of unity of invention for any group of invention(s) for which no additional examination fee has been paid.

The examiner must further orally advise applicant that any protest to the holding of lack of unity or the amount of additional fee required must be filed in writing no later than one month from the mailing date of the written opinion or the international preliminary examination report if the lack of unity holding is first mailed with the IPER because there was no written opinion. The examiner should fill in the information on Form USPTO/499 "Chapter II PCT Telephone Memorandum for Lack of Unity" as a record of the telephonic holding of lack of unity.

>If applicant refuses to either restrict the claims to one invention or authorize payment of additional fees, or if applicant does not have a deposit account, Form PCT/IPEA/405 should be prepared and mailed to applicant.

If a written invitation is required, the examiner should, if possible, submit that written invitation to the TC for review and mailing within 7 days from the date the international application is charged to the examiner.

See MPEP § 1850 for form paragraphs for lack of unity in international applications.<

\*\*

### 1875.02 Reply to Invitation Concerning Lack of Unity of Invention [R-2]

*PCT Administrative Instruction Section 603.*

*Transmittal of Protest Against Payment of Additional Fee and Decision Thereon Where International Application is Considered to Lack Unity of Invention*

The International Preliminary Examining Authority shall transmit to the applicant, at the latest together with the international preliminary examination report, any decision which it has taken under Rule 68.3(c) on the protest of the applicant against payment of the additional fee where the international application is considered to lack unity of invention. At the same time, it shall transmit to the International Bureau a copy of both the protest and the decision thereon, as well as any request by the applicant to forward the texts of both the protest and the decision thereon to the elected Offices.

*37 CFR 1.489. Protest to lack of unity of invention before the International Preliminary Examining Authority.*

(a) If the applicant disagrees with the holding of lack of unity of invention by the International Preliminary Examining Authority, additional fees may be paid under protest, accompanied by a request for refund and a statement setting forth reasons for disagreement or why the required additional fees are considered excessive, or both.

\*\*

(b) >Protest under paragraph (a) of this section will be examined by the Director or the Director's designee. In the event that the applicant's protest is determined to be justified, the additional fees or a portion thereof will be refunded.<

(c) An applicant who desires that a copy of the protest and the decision thereon accompany the international preliminary examination report when forwarded to the Elected Offices, may notify the International Preliminary Examining Authority to that effect any time prior to the issuance of the international preliminary examination report. Thereafter, such notification should be directed to the International Bureau.

Applicant may reply by paying some or all additional fees or by restricting the claims to one invention. If applicant makes no reply within the set time limit, the international preliminary examination will proceed on the basis of the main invention only.

If applicant has paid an additional fee or fees, a protest to the holding of lack of unity of invention may be filed with the International Preliminary Examining Authority.

#### **NOTIFICATION OF DECISION ON PROTEST**

Form PCT/IPEA/420 is used by the Technology Center (TC) to inform the applicant of the decision regarding applicant's protest on the payment of additional fees concerning unity of invention.

#### **NOTIFICATION**

The TC checks the appropriate box, i.e., 1 or 2. If box 2 is checked, a clear and concise explanation as to why the protest concerning the unity of invention was found to be unjustified must be given.

Since the space is limited, supplemental attachment sheet(s) should be incorporated whenever necessary.

#### **AUTHORIZED OFFICER**

Form PCT/IPEA/420 must be signed by a TC Director. See MPEP § 1002.02(\*>c<), >item (2)<.

### **1876 Notation of Errors and Informalities by the Examiner [R-2]**

*PCT Administrative Instruction Section 607.  
Rectifications of Obvious Errors Under Rule 91.1*

Where the International Preliminary Examining Authority authorizes a rectification of an obvious error under Rule 91.1, Rule 70.16 and Section 602(a) and (b) shall apply *mutatis mutandis*, provided that, where a sheet is marked as indicated in Section 602, the words "RECTIFIED SHEET (RULE 91)" shall be used.

Although the examiner is not responsible for discovering errors in the international application, if any errors come to the attention of the examiner, they \*>may< be noted and called to the applicant's attention. The examiner may invite applicant to rectify obvious errors using Form PCT/IPEA/411. Errors that are not obvious may be called to applicant's attention in \*>Box< VII of PCT/IPEA/408.

#### **AUTHORIZED OFFICER**

Form PCT/IPEA/408 and \*>Form PCT/IPEA/411< must be signed by an examiner having at least partial signatory authority.

### **1876.01 Request for Rectification and Notification of Action Thereon [R-2]**

#### **NOTIFICATION OF DECISION CONCERNING REQUEST FOR RECTIFICATION**

The rectification of obvious errors is governed by PCT Rules 91.1 and 66.5.

#### **NOTIFICATION**

If the applicant requests correction of any obvious errors in the international application or in any paper submitted to the International Preliminary Examining Authority, other than in the request, any acceptable correction should be authorized by using Form PCT/IPEA/412.

The procedure governing the rectification of obvious errors is set forth in PCT rules 91.1(d) and 26.4\*. Rectification may be made on the request of the applicant. Any rectification offered to the international preliminary examining authority may be stated in a letter addressed to the international preliminary examining authority if the rectification is of such a nature that it can be transferred from the letter to the international application without adversely affecting the clarity and direct reproducibility of the sheet on to which the rectification is to be transferred; otherwise, the applicant is required to submit a replacement sheet embodying the rectification and the letter accompanying the replacement sheet must draw attention to the differences between the replaced sheet and the replacement sheet.

The examiner after fully considering applicant's Request for Rectification of an obvious error, will notify applicant of the action taken on Form PCT/IPEA/412. Since the space provided is limited, supplemental sheet(s) should be incorporated whenever necessary.

#### **AUTHORIZED OFFICER**

Form PCT/IPEA/412 must be signed by an examiner having at least partial signatory authority.

## 1877 Nucleotide and/or Amino Acid Sequence Listings During the International Preliminary Examination

If the International Preliminary Examining Authority finds that the international application contains disclosure of one or more nucleotide and/or amino acid sequences but (A) the international application does not contain a sequence listing complying with the standard provided for in the Administrative Instructions, or (B) applicant has not furnished a sequence listing in computer readable form complying with the standard provided for in the Administrative Instructions, the International Preliminary Examining Authority may request the applicant to furnish such sequence listing or listing in computer readable form in accordance with the Administrative Instructions. PCT Rule 13<sup>ter</sup>.1(e).

## 1878 >Preparation of the Written Opinion of the International Preliminary Examining Authority in International Applications Having an International Filing Date On or After January 1, 2004 [R-2]

[Note: The regulations under the PCT were changed effective January 1, 2004. Corresponding changes were made to Title 37 of the Code of Federal Regulations. See *January 2004 Revision of Patent Cooperation Treaty Application Procedure*, 68 FR 59881 (Oct. 20, 2003), 1276 O.G. 6 (Nov. 11, 2003). The discussion of the procedures in effect for international applications filed prior to January 1, 2004, has been moved from this section to newly added MPEP § 1878.01.]

### *PCT Article 34.*

#### *Procedure Before the International Preliminary Examining Authority*

\*\*\*\*\*

(2)(c) The applicant shall receive at least one written opinion from the International Preliminary Examining Authority unless such Authority considers that all of the following conditions are fulfilled:

(i) the invention satisfies the criteria set forth in Article 33(1),

(ii) the international application complies with the requirements of this Treaty and the Regulations in so far as checked by that Authority,

(iii) no observations are intended to be made under Article 35(2), last sentence.

\*\*\*\*\*

#### *37 CFR 1.484. Conduct of international preliminary examination.*

(a) An international preliminary examination will be conducted to formulate a non-binding opinion as to whether the claimed invention has novelty, involves an inventive step (is non-obvious) and is industrially applicable.

(b) International preliminary examination will begin in accordance with PCT Rule 69.1.

(c) No international preliminary examination will be conducted on inventions not previously searched by an International Searching Authority.

(d) The International Preliminary Examining Authority will establish a written opinion if any defect exists or if the claimed invention lacks novelty, inventive step or industrial applicability and will set a non-extendable time limit in the written opinion for the applicant to reply.

(e) The written opinion established by the International Searching Authority under PCT Rule 43bis.1 shall be considered to be a written opinion of the United States International Preliminary Examining Authority for the purposes of paragraph (d) of this section.

(f) The International Preliminary Examining Authority may establish further written opinions under paragraph (d) of this section.

(g) If no written opinion under paragraph (d) of this section is necessary, or if no further written opinion under paragraph (f) of this section is to be established, or after any written opinion and the reply thereto or the expiration of the time limit for reply to such written opinion, an international preliminary examination report will be established by the International Preliminary Examining Authority. One copy will be submitted to the International Bureau and one copy will be submitted to the applicant.

(h) An applicant will be permitted a personal or telephone interview with the examiner, which may be requested after the filing of a Demand, and must be conducted during the period between the establishment of the written opinion and the establishment of the international preliminary examination report. Additional interviews may be conducted where the examiner determines that such additional interviews may be helpful to advancing the international preliminary examination procedure. A summary of any such personal or telephone interview must be filed by the applicant or, if not filed by applicant be made of record in the file by the examiner.

(i) If the application whose priority is claimed in the international application is in a language other than English, the United States International Preliminary Examining Authority may, where the validity of the priority claim is relevant for the formulation of the opinion referred to in Article 33(1), invite the applicant to furnish an English translation of the priority document within two months from the date of the invitation. If the

translation is not furnished within that time limit, the international preliminary report may be established as if the priority had not been claimed.

*PCT Rule 66.*

*Procedure Before the International Preliminary Examining Authority*

\*\*\*\*\*

*66.1<sup>bis</sup> Written Opinion of the International Searching Authority*

\*\*\*\*\*

(a) Subject to paragraph (b), the written opinion established by the International Searching Authority under Rule 43<sup>bis</sup>.1 shall be considered to be a written opinion of the International Preliminary Examining Authority for the purposes of Rule 66.2(a).

\*\*\*\*\*

*66.4 Additional Opportunity for Submitting Amendments or Argument*

(a) If the International Preliminary Examining Authority wishes to issue one or more additional written opinions, it may do so, and Rules 66.2 and 66.3 shall apply.

\*\*\*\*\*

In applications having an international filing date on or after January 1, 2004, a written opinion must be prepared by the International Searching Authority at the same time the international search report is prepared. The United States International Preliminary Examining Authority (IPEA) will consider the written opinion of the International Searching Authority to be the first written opinion of the IPEA and as such in most instances no further written opinion need be issued by the U.S. examiner handling the international preliminary examination before establishment of the international preliminary examination report, even if there are objections outstanding. The examiner is to take into consideration any comments or amendments made by the applicant when he/she establishes the international preliminary examination report. However, a further written opinion must be prepared if applicant files a response which includes a persuasive argument that the written opinion issued by the International Searching Authority was improper because of a negative opinion with respect to a lack of novelty, inventive step (non-obviousness) or industrial applicability as described in PCT Article 33(2)-(4); and which results in the examiner considering any of the

claims to lack novelty, inventive step (non-obviousness) or industrial applicability as described in PCT Article 33(2)-(4) based on new art not necessitated by any amendment. Such a further written opinion should be established on the Written Opinion of the International Preliminary Examining Authority (Form PCT/IPEA/408).

**BOX NO. I. — BASIS OF OPINION**

Box I of the Form PCT/IPEA/408 should be filled out in accordance with the instructions for Box I of Form PCT/ISA/237 provided in MPEP § 1845.01.

Additionally, for the purpose of completing Box I, item 2, of Form PCT/IPEA/408, substitute and/or rectified sheets of the specification and drawings filed during Chapter I proceedings are considered to be originally filed/furnished pages and should be listed as originally filed/furnished pages. Only those amendments or rectifications to the specification and drawings filed on the date of demand or after the filing of a demand should be listed as pages “received by this Authority on\_\_\_\_\_.” Substitute and/or rectified sheets of claims filed during the Chapter I proceedings are also considered to be originally filed/furnished pages and should be listed as originally filed/furnished pages. However, amended sheets of claims filed under PCT Article 19 in response to the international search report are to be indicated as pages as amended (together with any statement) under PCT Article 19. The International Bureau (IB) marks, in the upper right-hand corner of each replacement sheet submitted under PCT Article 19, the international application number, the date on which that sheet was received under PCT Article 19 and, in the middle of the bottom margin, the words “AMENDED SHEET (ARTICLE 19).” See Administrative Instructions Section 417. Only those pages of claims filed on the date of demand or after the filing of a demand should be listed as pages “received by this Authority on\_\_\_\_\_.”

The examiner must also indicate, in Box I, item 3, if any of the amendments filed resulted in the cancellation of any pages of the description, any of the claims or drawings, or any pages of the sequence listing and/or any tables related to the sequence listing. If the examiner considers any of the amendments to go beyond the original disclosure, the examiner must point this out in Box I, item 4 and explain the reasons for this determination in the Supplemental Box.



**BOX NO. II. — PRIORITY**

Where the priority document is provided by the applicant in compliance with PCT Rule 17.1 after the preparation of the search report and the written opinion of the ISA, any written opinion of the IPEA and/or the international preliminary examination report should reconsider the validity of the priority claim. Where the priority document is a foreign document and it is not already in the file, the IPEA may request a copy of the document from the IB and, if necessary, a translation from the applicant. In the meantime, if the outcome of the examination requires the issuing of an opinion, that opinion should be issued without waiting to obtain the priority document and/or the translation. An appropriate comment should be made under the heading “Additional observations, if necessary” in Box II of the written opinion. If such a copy of the priority document and/or the translation is not available because of non-compliance by the applicant with PCT Rule 17.1 and/or PCT Rule 66.7 (b) within the relevant time period, and if the priority document is not available to that Authority from a digital library in accordance with the Administrative Instructions, any written opinion of the IPEA and/or the IPER may be established as if the priority had not been claimed where there is a pertinent intervening reference. This is indicated by checking the appropriate boxes in item 1 of Box No. II in the opinion or report.

**BOX NO. III. — NON-ESTABLISHMENT OF OPINION ON NOVELTY, INVENTIVE STEP AND INDUSTRIAL APPLICABILITY**

Box III of Form PCT/IPEA/408 is intended to cover situations where some or all claims of an application are so unclear or inadequately supported by the description that the question of novelty, inventive step (nonobviousness), and industrial applicability cannot be considered, or where the international application or claims thereof relate to subject matter which does not require international preliminary examination, or where no international search report has been established for the claims.

Box III of Form PCT/IPEA/408 should be filled out in accordance with the instructions for Box III of Form PCT/ISA/237 provided in MPEP § 1845.01.

**BOX NO. IV. — LACK OF UNITY OF INVENTION**

Box IV of Form PCT/IPEA/408 should be used by the examiner to notify applicant that lack of unity of invention has been found.

If in reply to an invitation to restrict, applicant restricted the claims to a particular group, check the first box under subsection 1. If applicant paid additional fees for examination of additional inventions, check the second box under subsection 1. If the additional fees were paid under protest, check the third box under subsection 1. If applicant neither restricted nor paid additional fees in reply to the objection of lack of unity of invention, check the fourth box under subsection 1.

Subsection 2 of Box IV is to be completed if the examiner determines that unity of invention is lacking but chooses not to invite the applicant to restrict or pay additional fees.

Subsection 3 of Box IV is to be completed to indicate which claims were the subject of international preliminary examination. If all claims are to be examined, check the first box under subsection 3. If only some of the claims were the subject of international preliminary examination, check the second box under subsection 3 and identify the claim numbers.

**BOX NO. V. — REASONED STATEMENT WITH REGARD TO NOVELTY, INVENTIVE STEP, AND INDUSTRIAL APPLICABILITY OF CLAIMS**

In Box V, the examiner must list in summary form all claims with regard to the criteria of novelty (N), inventive step (IS), and industrial applicability (IA), and should be filled out in accordance with the instructions for Box V of Form PCT/ISA/237 provided in MPEP § 1845.01.

In applications where the examiner has determined that an additional written opinion is required, the application should be searched by the examiner at least to the point of bringing the previous search up to date. Prior art discovered in a search and applied in a reasoned statement in Box V must be made of record in Box V. Prior art already cited on the international

search report need not again be cited on the written opinion or international preliminary examination report. The subsequently discovered prior art is to be cited in compliance with PCT Rule 43.5 and Administrative Instructions Section 503 using the same citation format used on the international search report. Two copies of each newly cited reference should be included in the PCT Chapter II file when it is sent to PCT Operations for the mailing of the form PCT/IPEA/408. One of the copies of the newly cited reference will be sent to the applicant and one copy will be retained in the Chapter II file.

#### **BOX NO. VI. — CERTAIN DOCUMENTS CITED**

Box VI provides a convenient manner of listing two different types of newly discovered documents which were not applied in Box V:

(A) Published documents - by the application number or patent number as well as the publication date, filing date and priority date; and

(B) Nonwritten disclosure - by the kind of disclosure, date of the disclosure and the date of the written disclosure referring to the nonwritten disclosure.

As with the newly cited art in Box V, the subsequently discovered prior art is to be cited in compliance with PCT Rule 43.5 and Administrative Instructions Section 503 using the same citation format used on the international search report. Two copies of each newly cited reference should be included in the PCT Chapter II file when it is sent to PCT Operations for the mailing of the Form PCT/IPEA/408. One of the copies of the newly cited reference will be sent to the applicant and one copy will be retained in the Chapter II file.

#### **BOX VII. — CERTAIN DEFECTS IN THE INTERNATIONAL APPLICATION**

In Box VII, defects in the form and content of the international application are identified. Box VII should be filled out in accordance with the instructions for Box No. VII of Form PCT/ISA/237 provided in MPEP § 1845.01.

#### **BOX NO. VIII. — CERTAIN OBSERVATIONS ON THE INTERNATIONAL APPLICATION**

In Box VIII, the examiner notifies the applicant of observations made as to the clarity of the claims, the description, the drawings, or on the question whether the claims are fully supported by the description. Box VIII should be filled out in accordance with the instructions for Box VIII of Form PCT/ISA/237 provided in MPEP § 1845.01.

#### **TIME TO REPLY**

An invitation by the International Preliminary Examining Authority (IPEA) to applicant to reply to the examiner's written opinion will normally set a 2-month time limit for reply.

However, PCT Rule 69.2 sets forth time limits for the IPEA to establish the international preliminary examination report (IPER). Accordingly, in applications filed on or after January 1, 2004, a 1-month time limit should be set by the examiner in situations when a 2-month time limit would risk delaying the date of establishment of the IPER beyond:

(A) 28 months from the priority date; or

(B) 6 months from the time provided under PCT Rule 69.1 for the start of international preliminary examination; or

(C) 6 months from the date of receipt by the IPEA of the translation furnished under PCT Rule 55.2.

As a general rule, a 1-month time limit for reply to the written opinion should be set by the examiner if the written opinion (Form PCT/IPEA/408) has not been completed by the examiner within 24 months following the application's "priority date" as defined in PCT Article 2.

The United States rules pertaining to international preliminary examination of international applications do not provide for any extension of time to reply to a written opinion. See 37 CFR 1.484 (d)-(f) and MPEP § 1878.02.

#### **AUTHORIZED OFFICER**

Every written opinion must be signed by an examiner having at least partial signatory authority.

## 1878.01 < Preparation of the Written Opinion >in International Applications Having an International Filing Date Before January 1, 2004< [R-2]

>[Note: In international applications filed on or after January 1, 2004, the first written opinion is usually prepared by the International Searching Authority (see MPEP §§ 1845-1845.01), and a further written opinion may be prepared by the International Preliminary Examining Authority (see MPEP § 1878.)<

### *PCT Article 34.*

#### *Procedure Before the International Preliminary Examining Authority*

\*\*\*\*\*

(2)(c) The applicant shall receive at least one written opinion from the International Preliminary Examining Authority unless such Authority considers that all of the following conditions are fulfilled:

- (i) the invention satisfies the criteria set forth in Article 33(1),
- (ii) the international application complies with the requirements of this Treaty and the Regulations in so far as checked by that Authority,
- (iii) no observations are intended to be made under Article 35(2), last sentence.

\*\*\*\*\*

>Former<

#### *37 CFR 1.484. Conduct of international preliminary examination.*

(a) An international preliminary examination will be conducted to formulate a non-binding opinion as to whether the claimed invention has novelty, involves an inventive step (is non-obvious) and is industrially applicable.

(b) International preliminary examination will begin promptly upon receipt of a proper Demand in an application for which the United States International Preliminary Examining Authority is competent, for which the fees for international preliminary examination (§ 1.482) have been paid, and which requests examination based on the application as filed or as amended by an amendment which has been received by the United States International Preliminary Examining Authority. Where a Demand requests examination based on a PCT Article 19 amendment which has not been received, examination may begin at 20 months without receipt of the PCT Article 19 amendment. Where a Demand requests examination based on a PCT Article 34 amendment which has not been received, applicant will be noti-

fied and given a time period within which to submit the amendment.

- (1) Examination will begin after the earliest of:
  - (i) Receipt of the amendment;
  - (ii) Receipt of applicant's statement that no amendment will be made; or
  - (iii) Expiration of the time period set in the notification.
- (2) No international preliminary examination report will be established prior to issuance of an international search report.
- (c) No international preliminary examination will be conducted on inventions not previously searched by an International Searching Authority.

(d) The International Preliminary Examining Authority will establish a written opinion if any defect exists or if the claimed invention lacks novelty, inventive step or industrial applicability and will set a non-extendable time limit in the written opinion for the applicant to reply.

(e) If no written opinion under paragraph (d) of this section is necessary, or after any written opinion and the reply thereto or the expiration of the time limit for reply to such written opinion, an international preliminary examination report will be established by the International Preliminary Examining Authority. One copy will be submitted to the International Bureau and one copy will be submitted to the applicant.

(f) An applicant will be permitted a personal or telephone interview with the examiner, which must be conducted during the non-extendable time limit for reply by the applicant to a written opinion. Additional interviews may be conducted where the examiner determines that such additional interviews may be helpful to advancing the international preliminary examination procedure. A summary of any such personal or telephone interview must be filed by the applicant as a part of the reply to the written opinion or, if applicant files no reply, be made of record in the file by the examiner.

(g) If the application whose priority is claimed in the international application is in a language other than English, the United States International Preliminary Examining Authority may, where the validity of the priority claim is relevant for the formulation of the opinion referred to in Article 33(1), invite the applicant to furnish an English translation of the priority document within two months from the date of the invitation. If the translation is not furnished within that time limit, the international preliminary examination report may be established as if the priority had not been claimed.

A written opinion must be prepared if the examiner:

- (A) Considers that the international application has any of the defects described in PCT Article 34(4);
- (B) Considers that the report should be negative with respect to any of the claims because of a lack of novelty, inventive step (non-obviousness) or industrial applicability;
- (C) Notices any defects in the form or contents of the international application under the PCT;

(D) Considers that any amendment goes beyond the disclosure in the international application as originally filed;

(E) Wishes to make an observation on the clarity of the claims, the description, the drawings or to question whether the claims are fully supported by the description;

(F) Decides not to carry out the international preliminary examination on a claim for which no international search report was issued; or

(G) Considers that no acceptable amino acid sequence listing is available in a form that would allow a meaningful international preliminary examination to be carried out.

The applicant must be notified on Form PCT/IPEA/408 of the defects found in the application. The examiner is further required to fully state the reasons for his/her opinion (PCT Rule 66.2(b)) and invite a written reply, with amendments where appropriate (PCT Rule 66.2(c)), setting a time limit for the reply of normally 2 months.

The examiner should insert the words "first" or "second", as the case may be, in the space provided on page 1 of the written opinion.

## ITEM I. BASIS OF OPINION

Applicant has two opportunities to amend the international application prior to international preliminary examination. Under PCT Article 19, the applicant is entitled to one opportunity to amend the claims of the international application by filing amendments with the International Bureau within 2 months of the mailing of the international search report. See PCT Rule 46.1. Applicant is also permitted to make amendments before the International Preliminary Examining Authority under PCT Article 34(2)(b) and PCT Rule 66.1. Any amendment, however, that does not accompany the filing of the Demand but is filed later may not be considered unless it reaches the examiner before he/she takes up the application for examination.

>When completing Box I, item 1, of Form PCT/IPEA/408, the examiner must indicate whether or not the opinion has been established on the basis of the international application in the language in which it was filed. If a translation was furnished for the purpose of the search, this must be indicated.< For the purpose of completing Box I, Item 1, \*\* substitute

and/or rectified sheets of the specification and drawings filed during Chapter I proceedings are considered to be originally filed pages/sheets and should be listed as originally filed pages/sheets. Only those amendments or rectifications to the specification and drawings filed on the date of Demand or after the filing of a Demand should be listed as later filed pages/sheets. Substitute and/or rectified sheets of claims filed during the Chapter I proceedings are also considered to be originally filed pages/sheets and should be listed as originally filed pages/sheets. However, amended sheets of claims filed under Article 19 in response to the international search report are to be indicated as pages/sheets as amended under Article 19. Only those amendments, or rectifications to the claims filed on the date of Demand or after the filing of a Demand should be listed as later filed pages/sheets. \*\*>The examiner must also indicate, in Box I, item 3, if any of the amendments filed resulted in the cancellation of any pages of the description, any of the claims or drawings, or any pages of the sequence listing and/or any tables related to the sequence listing. If the examiner considers any of the amendments to go beyond the original disclosure, the examiner must point this out in Box I, item 4 and explain the reasons for this determination in the Supplemental Box.<

## ITEM II. PRIORITY

Item II of Form PCT/IPEA/408 is to inform applicant of non-establishment of a request for priority.

If applicant fails to furnish a copy or translation of the earlier application, whose priority has been claimed, within the time limit set by the examiner pursuant to PCT Rule 66.7, check box No. 1 and then check the first box of the subsection if applicant failed to furnish a copy of the earlier application whose priority has been claimed, and check the second box in the subsection if applicant failed to furnish a translation of the earlier application whose priority has been claimed.

When the claim for priority has been found invalid (e.g., the claimed priority date is more than one year prior to the international filing date and the notification under PCT Rule 4.10(d) has been provided or all claims are directed to inventions which were not described and enabled by the earlier application), check box No. 2 of Item II and indicate why the claim for priority has been found invalid following No. 3

“Additional observations”. The examiner is reminded that when some claims in an international application are directed to an invention which was disclosed in the earlier application, the priority claim is valid provided that a copy and/or translation of the earlier application have/has been filed and the filing date of the earlier application is one year or less from the filing date of the international application.

### **ITEM III. NON-ESTABLISHMENT OF OPINION ON NOVELTY, INVENTIVE STEP AND INDUSTRIAL APPLICABILITY**

Item III of Form PCT/IPEA/408 is intended to cover situations where some or all claims of an application are so unclear or inadequately supported by the description that the question of novelty, inventive step (nonobviousness), and industrial applicability cannot be considered, or where the international application or claims thereof relate to subject matter which does not require international preliminary examination, or where no international search report has been established for the claims.

If some or all of the claims of an application relate to subject matter which does not require international preliminary examination, check the appropriate box, indicate which claims relate to that subject matter and specify the reasons.

If some or all of the claims of an application are so unclear that no meaningful opinion could be formed, check the appropriate box, indicate which claims are unclear and specify the reasons.

If some or all of the claims are so inadequately supported by the description that no meaningful opinion could be formed, check the appropriate box.

If no international search report has been established for certain claims, check the appropriate box and indicate the claim numbers.

### **ITEM IV. LACK OF UNITY OF INVENTION**

Item IV of Form PCT/IPEA/408 should be used by the examiner to notify applicant that lack of unity of invention has been found.

If in reply to an invitation to restrict, applicant restricted the claims to a particular group, check the first box under subsection 1.

If applicant paid additional fees for examination of additional invention, check the second box under subsection 1.

If the additional fees were paid under protest, check the third box under subsection 1.

If applicant neither restricted nor paid additional fees in reply to the objection of lack of unity of invention, check the fourth box under subsection 1.

Subsection 2 of Item IV is to be completed if the examiner determines that unity of invention is lacking but chooses not to invite the applicant to restrict or pay additional fees.

Subsection 3 of Item IV is to be completed to indicate which claims were the subject of international preliminary examination.

If all claims are to be examined, check the first box under subsection 3.

If only some of the claims were the subject of international preliminary examination, check the second box under subsection 3 and identify the claim numbers.

### **ITEM V. REASONED STATEMENT WITH REGARD TO NOVELTY, INVENTIVE STEP, AND INDUSTRIAL APPLICABILITY OF CLAIMS**

In Item V, the examiner must list in summary form all claims with regard to the criteria of novelty (N), inventive step (IS), and industrial applicability (IA).

Item V is the main purpose of the Written Opinion. All claims without fatal defects are treated on the merits in Item V as to novelty, inventive step (nonobviousness) and industrial applicability.

The treatment of claims in Item V is similar in format to an Office action in a U.S. national patent application except that the words “rejection” and “patentability” are never used in a written opinion. On the international level, all written opinions are non-binding and a patent does not issue; what does issue is an international preliminary examination report (IPER), which is nonbinding on the Elected States.

Examiner statements in Item V can be positive or negative. If the claims define over the prior art and meet the test of novelty, inventive step (nonobviousness) and industrial applicability, a statement equivalent to detailed reasons for allowance in a corresponding U.S. national application should be provided, indicating how the claims meet the tests of novelty, inventive step and industrial applicability.

Form paragraphs 18.04 and 18.04.01 may be used for this purpose.

*¶ 18.04 Meets Novelty and Inventive Step*

Claim [1] the criteria set out in PCT Article 33(2)-(3), because the prior art does not teach or fairly suggest [2].

**Examiner Note:**

1. In bracket 1, pluralize “claim” if needed, insert claim no.(s), and insert the verb --meet-- or --meets--, as appropriate.
2. In bracket 2, insert the details of the claimed subject matter that render it unobvious over the prior art.
3. If the claims also meet the industrial applicability criteria set out in PCT Article 33(4), this form paragraph should be followed by form paragraph 18.04.01.
4. If the claims do not meet the industrial applicability criteria set out in PCT Article 33(4), this form paragraph should be followed by form paragraph 18.03.

*¶ 18.04.01 Meets Industrial Applicability*

Claim [1] the criteria set out in PCT Article 33(4), and thus [2] industrial applicability because the subject matter claimed can be made or used in industry.

**Examiner Note:**

1. In bracket 1, pluralize “claim” if needed, insert claim no.(s), and the verb --meet-- or -- meets--, as appropriate.
2. In bracket 2, insert --have-- or --has--, as appropriate.
3. If the claims meet all of the requirements of PCT Article 33(2)-(4), use form paragraph 18.04 before this form paragraph to provide positive statements for novelty and inventive step under PCT Article 33(2)-(3).
4. If the claims have industrial applicability but lack novelty and inventive step, use this form paragraph and additionally use form paragraph 18.01.
5. If the claims have industrial applicability and novelty but lack inventive step, use this form paragraph and additionally use one or more of form paragraphs 18.02, 18.02.01 and 18.02.02, as appropriate.
6. If the claims do not have industrial applicability, use form paragraph 18.03 instead of this form paragraph.

If, on the other hand it is the opinion of the examiner that some or all claims lack novelty, inventive step, or industrial applicability, specific reasons must be given similar to those used in U.S. national applications. If the claims lack inventive step over a combination of references, the reasons must explain why one of ordinary skill in the art would have been motivated to combine the teachings of the applied references.

Form paragraphs 18.01, 18.02, 18.02.01, 18.02.02, and 18.03 may be used, as appropriate, to explain the negative statements listed in Item V.

*¶ 18.01 Lacks Novelty*

Claim [1] novelty under PCT Article 33(2) as being anticipated by [2].

**Examiner Note:**

1. In bracket 1, pluralize ‘claim’ if needed, insert claim no.(s), and the verb --lack-- or --lacks--, as appropriate.
2. In bracket 2, insert name of prior art relied upon.

*¶ 18.02 Lacks Inventive Step - One Reference*

Claim [1] an inventive step under PCT Article 33(3) as being obvious over [2]. [3]

**Examiner Note:**

1. In bracket 1, pluralize ‘claim’ if needed, insert claim no.(s), and the verb --lack-- or --lacks--, as appropriate.
2. In bracket 2, insert name of prior art relied upon.
3. In bracket 3, add reasoning.

*¶ 18.02.01 Lacks Inventive Step - Two References*

Claim [1] an inventive step under PCT Article 33(3) as being obvious over [2] in view of [3]. [4]

**Examiner Note:**

1. In bracket 1, pluralize ‘claim’ if needed, insert claim no.(s), and the verb --lack-- or --lacks--, as appropriate.
2. In bracket 2, insert name of PRIMARY prior art relied upon.
3. In bracket 3, insert name of SECONDARY prior art relied upon.
4. In bracket 4, add reasoning.

*¶ 18.02.02 Lacks Inventive Step - Additional Reference*

Claim [1] an inventive step under PCT Article 33(3) as being obvious over the prior art as applied in the immediately preceding paragraph and further in view of [2]. [3]

**Examiner Note:**

1. This form paragraph may follow either 18.02 or 18.02.01.
2. In bracket 1, pluralize ‘claim’ if needed, insert claim no.(s), and the verb --lack-- or --lacks--, as appropriate.
3. In bracket 2, insert name of additional prior art relied upon.
4. In bracket 3, add reasoning.

*¶ 18.03 Lacks Industrial Applicability*

Claim [1] industrial applicability as defined by PCT Article 33(4). [2]

**Examiner Note:**

1. In bracket 1, pluralize ‘claim’ if needed, insert claim no.(s), and the verb --lack-- or --lacks--, as appropriate.
2. In bracket 2, add reasoning.

Examiners are encouraged to indicate any amendments which applicant could present which would avoid a negative statement in the international preliminary examination report.

All international applications where an examination has been demanded should be searched by the examiner at least to the point of bringing the previous search up to date. Prior art discovered in a search and applied in an Item V statement must be made of record in Item V. Prior art already cited on the international search report need not again be cited on the written opinion or international preliminary examination report. The subsequently discovered prior art is to be cited in compliance with PCT Rule 43.5 and Administrative Instructions Section 503 using the same citation format used on the international search report. Two copies of each newly cited reference should be included in the PCT Chapter II file when it is sent to PCT Operations for the mailing of the form PCT/IPEA/408. One of the copies of the newly cited reference will be sent to the applicant and one copy will be retained in the Chapter II file.

#### ITEM VI. CERTAIN DOCUMENTS CITED

Item VI provides a convenient manner of listing two different types of documents:

(A) Published documents - by the application number or patent number as well as the publication date, filing date and priority date; and

(B) Nonwritten disclosure - by the kind of disclosure, date of the disclosure and the date of the written disclosure referring to the nonwritten disclosure.

#### ITEM VII. CERTAIN DEFECTS IN THE INTERNATIONAL APPLICATION

In Item VII, defects in the form and content of the international application are identified.

Examples of defects that would be listed in Item VII are:

(A) Informalities such as misplaced and/or omitted drawing numerals, misspelled words, grammatical errors, etc.

(B) \*\* Improper multiple-dependent claims (PCT Rule 6.4) if not indicated under Item III.

The following form paragraphs are used in Box VII of PCT/IPEA/408 or PCT/IPEA/409 "Certain defects in the international application" for noting technical defects.

#### ¶ 18.08 Drawing Objections - Defects

The drawings are objected to under PCT Rule 66.2(a)(iii) as containing the following defect(s) in the form or content thereof: [1]

#### Examiner Note:

In bracket 1, insert identification of defects in drawings.

#### ¶ 18.08.01 Drawing Is Required

The subject matter of this application admits of illustration by drawing to facilitate understanding of the invention. Applicant is required under PCT Article 7(1) to furnish a drawing.

#### ¶ 18.09 Description Defective

The description is objected to as containing the following defect(s) under PCT Rule 66.2(a)(iii) in the form or contents thereof: [1]

#### Examiner Note:

In bracket 1, insert the technical problem, e.g., misspelled word.

#### ¶ 18.10 Claims Defective

Claim [1] objected to under PCT Rule 66.2(a)(iii) as containing the following defect(s) in the form or contents thereof: [2]

#### Examiner Note:

1. In bracket 1, pluralize 'claim' if needed, insert claim no.(s) and the appropriate verb --is-- or --are--.
2. In bracket 2, identify the technical deficiency.

#### ITEM VIII. CERTAIN OBSERVATIONS ON THE INTERNATIONAL APPLICATION

In Item VIII, the examiner notifies the applicant of observations made as to the clarity of the claims, the description, the drawings, or on the question whether the claims are fully supported by the description.

If the claims, the description, or the drawings are so unclear, or the claims are so inadequately supported by the description, that no meaningful opinion can be formed on the question of novelty, inventive step (nonobviousness) or industrial applicability, the applicant is so informed in Item III (PCT Article 34(4)(a)(ii)). Reasons for the examiner's opinion that the claims, description and drawings, etc., lack clarity must also be provided.

If the above situation is found to exist in certain claims only, the provisions of PCT Article 34(4)(ii) shall apply to those claims only.

If the lack of clarity of the claims, the description, or the drawings is of such a nature that it is possible to form a meaningful opinion on the claimed subject matter, then it is required that the examiner consider the claims and render a written opinion on novelty,

inventive step, and industrial applicability in Item V of Form PCT/IPEA/408.

Since the claims of an international application are not subject to a rejection on either art or indefiniteness consistent with U.S. practice, observations by the examiner with regard to clarity of the claims, the description and the drawings will be treated in the form of an objection in the written opinion in Item VIII.

The following form paragraphs are used in Box VIII “Certain observations on the international application” of PCT/IPEA/408 and PCT/IPEA/409 for noting objections which are substantive rather than merely technical in nature.

*¶ 18.11 Drawing Objections - Lack Clarity*

The drawings are objected to under PCT Rule 66.2(a)(v) as lacking clarity under PCT Article 7 because: [1]

**Examiner Note:**

In bracket 1, insert reasons why the drawings lack clarity, e.g., inaccurate showing.

*¶ 18.12.01 Claims Objectionable - Inadequate Written Description*

Claim [1] objected to as lacking clarity under PCT Rule 66.2(a)(v) because the claim [2] not fully supported by the description. The application, as originally filed, did not describe: [3]

**Examiner Note:**

1. In bracket 1, pluralize “claim” if needed, insert claim no.(s), and the verb --is-- or --are--, as appropriate.
2. In bracket 2, pluralize “claim” if needed, and insert the verb -is- or --are--.
3. In bracket 3, identify subject matter not described in the application as filed.

*¶ 18.13.01 Claims Objectionable - Non-Enabling Disclosure*

Claim [1] objected to as lacking clarity under PCT Rule 66.2(a)(v) because the claim [2] not fully supported by the description. The description does not disclose the claimed invention in a manner sufficiently clear and complete for the claimed invention to be carried out by a person skilled in the art because: [3]

**Examiner Note:**

1. In bracket 1, pluralize “claim” if needed, insert claim no.(s) and the appropriate verb --is-- or --are--.
2. In bracket 2, pluralize “claim” if needed, insert the verb --is-- or --are--.
3. In bracket 3, identify the claimed subject matter that is not enabled and explain why it is not enabled.

*¶ 18.14.01 Claims Objectionable - Lack of Best Mode*

Claim [1] objected to under PCT Rule 66.2(a)(v) because the claim [2] not fully supported by the description. The description fails to set forth the best mode contemplated by the applicant for carrying out the claimed invention as required by PCT Rule 5.1(a)(v) because: [3].

**Examiner Note:**

1. In bracket 1, pluralize “claim” if needed, insert claim no.(s) and the appropriate verb --is-- or --are--.
2. In bracket 2, pluralize “claim” if needed, and insert the appropriate verb --is-- or --are--.
3. In bracket 3, insert the objection and reasons.

*¶ 18.15 Claims Objectionable - Indefiniteness*

Claim [1] objected to under PCT Rule 66.2(a)(v) as lacking clarity under PCT Article 6 because claim [2] indefinite for the following reason(s): [3]

**Examiner Note:**

1. In brackets 1 and 2, pluralize “claim” if needed, insert claim no.(s) and the appropriate verb --is-- or --are--.
2. In bracket 3, insert reasons.

**TIME TO REPLY**

An invitation by the International Preliminary Examining Authority (IPEA) to applicant to reply to the examiner’s written opinion will normally set a 2-month time limit for reply.

However, PCT Rule 69.2 sets forth time limits for the IPEA to establish the international preliminary examination report (IPER). Accordingly, a 1-month time limit should be set by the examiner in situations when a 2-month time limit would risk delaying the date of establishment of the IPER beyond:

- (A) 28 months from the priority date; or
- (B) 8 months from the date of payment of the handling fee referred to in PCT Rule 57.1 and the preliminary examination fee referred to in PCT Rule 58.1(a); or
- (C) 8 months from the date of receipt by the IPEA of the translation furnished under PCT Rule 55.2.

As a general rule, a 1-month time limit for reply to the written opinion should be set by the examiner if the written opinion (Form PCT/IPEA/408) has not been completed by the examiner within 24 months following the application’s “priority date” as defined in PCT Article 2.



The United States rules pertaining to international preliminary examination of international applications do not provide for any extension of time to reply to a first written opinion. See 37 CFR 1.484(d) and MPEP § 1878.02.

### AUTHORIZED OFFICER

Every written opinion must be signed by an examiner having at least partial signatory authority.

The first document prepared by the examiner in most international applications during the international preliminary examination proceedings will be the written opinion. Normally only in those international applications where all the formal matters are proper and the claims are directed to inventions which have novelty, inventive step and industrial applicability will an international preliminary examination report be established without a written opinion having been issued first.

### 1878.01(a) Prior Art \*\*>for Purposes of the Written Opinion and the International Preliminary Examination Report< [R-2]

*PCT Article 33.*

*The International Preliminary Examination*

\*\*\*\*\*

(6) The international preliminary examination shall take into consideration all the documents cited in the international search report. It may take into consideration any additional documents considered to be relevant in the particular case.

*PCT Rule 64.*

*Prior Art for International Preliminary Examination*

#### 64.1. Prior Art

(a) For the purposes of Article 33(2) and (3), everything made available to the public anywhere in the world by means of written disclosure (including drawings and other illustrations) shall be considered prior art provided that such making available occurred prior to the relevant date.

(b) For the purposes of paragraph (a), the relevant date will be:

(i) subject to item (ii), the international filing date of the international application under international preliminary examination;

(ii) where the international application under international preliminary examination validly claims the priority of an earlier application, the filing date of such earlier application.

#### 64.2. Non-Written Disclosures

In cases where the making available to the public occurred by means of an oral disclosure, use, exhibition or other non-written means ("non-written disclosure") before the relevant date as defined in Rule 64.1(b) and the date of such non-written disclosure is indicated in a written disclosure which has been made available to the public on a date which is the same as, or later than, the relevant date, the non-written disclosure shall not be considered part of the prior art for the purposes of Article 33(2) and (3). Nevertheless, the international preliminary examination report shall call attention to such non-written disclosure in the manner provided for in Rule 70.9.

#### 64.3. Certain Published Documents

In cases where any application or any patent which would constitute prior art for the purposes of Article 33(2) and (3) had it been published prior to the relevant date referred to in Rule 64.1 was published on a date which is the same as, or later than, the relevant date but was filed earlier than the relevant date or claimed the priority of an earlier application which had been filed prior to the relevant date, such published application or patent shall not be considered part of the prior art for the purposes of Article 33(2) and (3). Nevertheless, the international preliminary examination report shall call attention to such application or patent in the manner provided for in Rule 70.10.

>The above provisions apply *mutatis mutandis* to the written opinion of the International Searching Authority. See PCT Rule 43<sup>bis</sup>.1(b).<

The relevant date for the purpose of considering prior art is defined in PCT Rule 64.1(b) as the international filing date or, where the international application contains a valid claim for priority, that date of priority.

>When a potentially relevant document has been published between a claimed priority date of the application and its international filing date, the examiner is required to consider whether the claimed priority date is valid for the purposes of determining the "relevant date" of the claims in the international application. Note that if there is time left for the applicant to perfect, correct or add a priority claim but there is insufficient time for the examiner to make a proper determination as to whether the priority claim is valid, due to the need to issue a timely written opinion by the International Searching Authority, the "relevant date" for the purposes of the written opinion will be based on the claimed priority date. See Chapter 11 of the International Search and Preliminary Examination Guidelines, which may be obtained from WIPO's website ([www.wipo.int/pct/en/texts/gdlines.htm](http://www.wipo.int/pct/en/texts/gdlines.htm)).< In cases where any application or any

patent which would constitute prior art for the purpose of international preliminary examination as to novelty and inventive step (nonobviousness) was published on or after the relevant date of the international application under consideration but was filed earlier than the relevant date or claimed the priority of an earlier application which was filed prior to the relevant date, the published application or patent is not to be considered part of the prior art for the purpose of international preliminary examination as to novelty and inventive step. Nevertheless, these documents are to be listed on Form PCT/IPEA/409 under the heading "CERTAIN PUBLISHED DOCUMENTS".

In determining whether there is inventive step, account should be taken of what the applicant acknowledges in his/her description as known. Such acknowledged prior art should be regarded as correct and used during preliminary examination where appropriate.

For oral or nonwritten disclosure, see PCT Rules 64.2 and 70.9.

### **1878.01(a)(1) Novelty \*\*>for Purposes of the Written Opinion and the International Preliminary Examination Report< [R-2]**

Novelty is defined in PCT Article 33(2).

#### *PCT Article 33.*

##### *The International Preliminary Examination*

\*\*\*\*\*

(2) For the purposes of the international preliminary examination, a claimed invention shall be considered novel if it is not anticipated by the prior art as defined in the Regulations.

\*\*\*\*\*

>The above provisions apply *mutatis mutandis* to the written opinion of the International Searching Authority. See PCT Rule 43<sup>bis</sup>.1(b).<

### **1878.01(a)(2) Inventive Step \*\*>for Purposes of the Written Opinion and the International Preliminary Examination Report< [R-2]**

Inventive step is defined in PCT Article 33(3).

#### *PCT Article 33.*

##### *The International Preliminary Examination*

\*\*\*\*\*

(3) For purposes of the international preliminary examination, a claimed invention shall be considered to involve an inventive step if, having regard to the prior art as defined in the Regulations, it is not, at the prescribed relevant date, obvious to a person skilled in the art.

\*\*\*\*\*

#### *PCT Rule 65.*

##### *Inventive Step or Non-Obviousness*

#### *65.1.Approach to Prior Art*

For the purposes of Article 33(3), the international preliminary examination shall take into consideration the relation of any particular claim to the prior art as a whole. It shall take into consideration the claim's relation not only to individual documents or parts thereof taken separately but also its relation to combinations of such documents or parts of documents, where such combinations are obvious to a person skilled in the art.

#### *65.2.Relevant Date*

For the purposes of Article 33(3), the relevant date for the consideration of inventive step (non-obviousness) is the date prescribed in Rule 64.1.

>The above provisions apply *mutatis mutandis* to the written opinion of the International Searching Authority. See PCT Rule 43<sup>bis</sup>.1(b).<

### **1878.01(a)(3) Industrial Applicability \*\*>for Purposes of the Written Opinion and the International Preliminary Examination Report< [R-2]**

Industrial applicability is defined in PCT Article 33(4).

#### *PCT Article 33.*

##### *The International Preliminary Examination*

\*\*\*\*\*

(4) For the purposes of the international preliminary examination, a claimed invention shall be considered industrially applicable if, according to its nature, it can be made or used (in the technological sense) in any kind of industry. "Industry" shall be understood in its broadest sense, as in the Paris Convention for the Protection of Industrial Property.

\*\*\*\*\*

>The above provisions apply *mutatis mutandis* to the written opinion of the International Searching Authority. See PCT Rule 43<sup>bis</sup>.1(b).<

## 1878.02 Reply to the Written Opinion >of the ISA or IPEA< [R-2]

### *PCT Article 34.*

#### *Procedure Before the International Preliminary Examining Authority*

\*\*\*\*\*

\*\*>

(2)(d)< The applicant may respond to the written opinion.

\*\*\*\*\*

### *PCT Rule 66.*

#### *Procedure before the International Preliminary Examining Authority*

\*\*\*\*\*

#### *66.3. Formal Response to the International Preliminary Examining Authority*

(a) The applicant may respond to the invitation referred to in Rule 66.2(c) of the International Preliminary Examining Authority by making amendments or - if he disagrees with the opinion of that Authority - by submitting arguments, as the case may be, or do both.

(b) Any response shall be submitted directly to the International Preliminary Examining Authority.

\*\*\*\*\*

#### *66.5. Amendment*

Any change, other than the rectification of obvious errors, in the claims, the description, or the drawings, including cancellation of claims, omission of passages in the description, or omission of certain drawings, shall be considered an amendment.

#### *66.6. Informal Communications with the Applicant*

The International Preliminary Examining Authority may, at any time, communicate informally, over the telephone, in writing, or through personal interviews, with the applicant. The said Authority shall, at its discretion, decide whether it wishes to grant more than one personal interview if so requested by the applicant, or whether it wishes to reply to any informal written communication from the applicant.

\*\*\*\*\*

#### *66.8. Form of Amendments*

(a) Subject to paragraph (b), the applicant shall be required to submit a replacement sheet for every sheet of the international application which, on account of an amendment, differs from the

sheet previously filed. The letter accompanying the replacement sheets shall draw attention to the differences between the replaced sheets and the replacement sheets and shall preferably also explain the reasons for the amendment.

(b) Where the amendment consists in the deletion of passages or in minor alterations or additions, the replacement sheet referred to in paragraph (a) may be a copy of the relevant sheet of the international application containing the alterations or additions, provided that the clarity and direct reproducibility of that sheet are not adversely affected. To the extent that any amendment results in the cancellation of an entire sheet, that amendment shall be communicated in a letter which shall preferably also explain the reasons for the amendment.

#### *66.9. Language of Amendments*

(a) Subject to paragraphs (b) and (c), if the international application has been filed in a language other than the language in which it is published, any amendment, as well as any letter referred to in Rule 66.8, shall be submitted in the language of publication.

(b) If the international preliminary examination is carried out, pursuant to rule 55.2, on the basis of a translation of the international application, any amendment, as well as any letter referred to in paragraph (a), shall be submitted in the language of that translation.

(c) Subject to Rule 55.3, if an amendment or letter is not submitted in a language as required under paragraph (a) or (b), the International Preliminary Examining Authority shall, if practicable, having regard to the time limit for establishing the international preliminary examination report, invite the applicant to furnish the amendment or letter in the required language within a time limit which shall be reasonable under the circumstances.

(d) If the applicant fails to comply, within the time limit under paragraph (c), with the invitation to furnish an amendment in the required language, the amendment shall not be taken into account for the purposes of the international preliminary examination. If the applicant fails to comply, within the time limit under paragraph (c), with the invitation to furnish a letter referred to in paragraph (a) in the required language, the amendment concerned need not be taken into account for the purposes of the international preliminary examination.

#### *37 CFR 1.485. Amendments by applicant during international preliminary examination.*

(a) The applicant may make amendments at the time of filing the Demand. The applicant may also make amendments within the time limit set by the International Preliminary Examining Authority for reply to any notification under § 1.484(b) or to any written opinion. Any such amendments must:

(1) Be made by submitting a replacement sheet in compliance with PCT Rules 10 and 11.1 to 11.13 for every sheet of the application which differs from the sheet it replaces unless an entire sheet is cancelled; and

(2) Include a description of how the replacement sheet differs from the replaced sheet. Amendments that do not comply with PCT Rules 10 and 11.1 to 11.13 may not be entered

(b) If an amendment cancels an entire sheet of the international application, that amendment shall be communicated in a letter.

All amendments in reply to a written opinion must be received within the time limit set for reply in order to be assured of consideration in the international preliminary examination report. Amendments filed at or before expiration of the period for reply will be considered. Since the examiner will begin to draw up the final report rather promptly after the time period expires, amendments filed after expiration of the reply period may not be considered. >However, as indicated in MPEP § 1871, there may be situations where it is advisable, to the extent possible, to take such amendments or arguments into account, for example, where the international preliminary examination report has not yet been completed and it is readily apparent to the examiner that consideration of the late-filed response would result in the issuance of a favorable report.< In view of the short time period for completion of preliminary examination, applicants are strongly encouraged to file any amendments promptly. 37 CFR 1.484(d) does not allow for extensions of time to reply to a written opinion. The policy of not allowing extensions of time is to ensure that the USPTO can meet its treaty deadline for transmission of the final report.

Any change, other than the rectification of obvious errors in the claims, the description, or the drawings, including the cancellation of claims, omission of passages in the description or omission of certain drawings will be considered an amendment (PCT Rule 66.5). The Patent and Trademark Office when acting as the International Preliminary Examining Authority will not accept any non-English applications or amendments.

Any amendments to the claims, the description, and the drawings in reply to a written opinion must (1) be made by submitting a replacement sheet for every sheet of the application which differs from the sheet it replaces unless an entire sheet is cancelled and (2) include a description of how the replacement sheet differs from the replaced sheet in accordance with PCT Rule 66.8.

In the particular case where the amendment cancels claims, passages in the description or certain drawings resulting in the cancellation of an entire sheet, the

amendment must be submitted in the form of a letter cancelling the sheet (PCT Rule 66.8(a)).

Replacement sheets must be in typed form.

Any paper submitted by the applicant, if not in the form of a letter, must be accompanied by a letter signed by the applicant or agent (PCT Rule 92.1). The letter must draw attention to the differences between the replaced sheet and the replacement sheet.

The examiner should make sure that amendments filed in accordance with the PCT, which are necessary to correct any deficiencies notified to the applicant, do not go beyond the disclosure of the international application as filed, thus violating PCT Article 34(2)(b). In other words, no amendment should contain matter that cannot be substantiated by the application as originally filed. In a situation where new matter is introduced by amendment in reply to a written opinion, the international preliminary examination report will be established as if the amendment had not been made, and the report should so indicate. It shall also indicate the reasons why the amendment goes beyond the disclosure (PCT Rule 70.2(c)).

## INTERVIEWS

The examiner or applicant may, >after the filing of a demand and< during the time limit for reply to the written opinion, request a telephone or personal interview. Only one interview is a matter of right, whether by telephone or in person. Additional interviews may be authorized by the examiner in a particular international application where such additional interview may be helpful to advance the international preliminary examination procedure.

All interviews of substance must be made of record by using PCT/IPEA/428 Notice on Informal Communication with the Applicant.

When an interview is arranged, whether by telephone or in writing, and whether by the examiner or by the applicant, the matters for discussion should be stated.

The records of interviews or telephone conversations should indicate, where appropriate, whether a reply is due from the applicant or agent or whether the examiner wishes to issue an additional written opinion or establish the international preliminary examination report.

If the applicant desires to reply to the written opinion, such reply must be filed within the time limit set

for reply in order to assure consideration. No extensions to the time limit will be considered or granted. If no timely reply is received from the applicant, the international preliminary examination report will be established by the examiner, treating each claim substantially as it was treated in the written opinion. Replies to the written opinion which are not filed within the time limit set but which reach the examiner before the examiner takes up the application for preparation of the final report may be considered. Thus, only timely replies can be assured of consideration.

The applicant may reply to the invitation referred to in Rule 66.2(c) by making amendments or, if the applicant disagrees with the opinion of the authority, by submitting arguments, as the case may be, or both (PCT Rule 66.3).

If applicant does not reply to the written opinion, the international preliminary examination report will be prepared in time for forwarding to the International Division in finished form by 27 months from the priority date.

## **1879 Preparation of the International Preliminary Examination Report [R-2]**

### *PCT Article 35.*

#### *The International Preliminary Examination Report*

(1) The international preliminary examination report shall be established within the prescribed time limit and in the prescribed form.

(2) The international preliminary examination report shall not contain any statement on the question whether the claimed invention is or seems to be patentable or unpatentable according to any national law. It shall state, subject to the provisions of paragraph (3), in relation to each claim, whether the claim appears to satisfy the criteria of novelty, inventive step (non-obviousness), and industrial applicability, as defined for the purposes of the international preliminary examination in Article 33(1) to (4). The statement shall be accompanied by the citation of the documents believed to support the stated conclusion with such explanations as the circumstances of the case may require. The statement shall also be accompanied by such other observation as the Regulations provide for.

(3)(a) If, at the time of establishing the international preliminary examination report, the International Preliminary Examining Authority considers that any of the situations referred to in Article 34(4)(a) exists, that report shall state this opinion and the reasons therefor. It shall not contain any statement as provided in paragraph (2).

(b) If a situation under Article 34(4)(b) is found to exist, the international preliminary examination report shall, in relation

to the claims in question, contain the statement as provided in subparagraph (a), whereas, in relation to the other claims, it shall contain the statement as provided in paragraph (2).

### *PCT Administrative Instruction Section 604.*

#### *Guidelines for Explanations Contained in the International Preliminary Examination Report*

(a) Explanations under Rule 70.8 shall clearly point out to which of the three criteria of novelty, inventive step (non-obviousness) and industrial applicability referred to in Article 35(2), taken separately, any cited document is applicable and shall clearly describe, with reference to the cited documents, the reasons supporting the conclusion that any of the said criteria is or is not satisfied.

(b) Explanations under Article 35(2) shall be concise and preferably in the form of short sentences.

\*\*

The international preliminary examination report is established on Form PCT/IPEA/409.

The international preliminary examination report must be established within:

>For applications having an international filing date on or after January 1, 2004:

- (A) 28 months from the priority date; or
- (B) 6 months from the time provided under PCT Rule 69.1 for the start of international preliminary examination; or
- (C) 6 months from the date of receipt by the IPEA of the translation furnished under PCT Rule 55.2 whichever expires last, as provided in PCT Rule 69.2.

For applications having an international filing date before January 1, 2004:<

- (A) 28 months from the priority date; or
- (B) 8 months from the date of payment of the fees referred to in PCT Rules 57.1 and 58.1(a); or
- (C) 8 months from the date of receipt by the International Preliminary Examining Authority of the translation furnished under PCT Rule 55.2, whichever expires last, as provided in PCT Rule 69.2.

To meet the 28-month date for establishing the report, Office practice is to complete internal processing by 27 months from the priority date in order to provide adequate time for reviewing, final processing and mailing. Thus, under normal circumstances, the applicant receives the report, at the latest, 2 months before national processing at the elected Offices may start. This ensures that he/she has time to consider whether, and in which elected Offices, he/she wants to

enter the national stage and to take the necessary action.

The international preliminary examination report contains, among other things, a statement (in the form of simple “yes” or “no”), in relation to each claim which has been examined, on whether the claim appears to satisfy the criteria of novelty, inventive step (non-obviousness) and industrial applicability. The statement is, where appropriate, accompanied by the citation of relevant documents together with concise explanations pointing out the criteria to which the cited documents are applicable and giving reasons for the International Preliminary Examining Authority’s conclusions. Where applicable, the report also includes remarks relating to the question of unity of invention.

The international preliminary examination report identifies the basis on which it is established, that is, whether, and if so, which amendments have been taken into account. Replacement sheets containing amendments under PCT Article 19 and/or Article 34 which have been taken into account are attached as “annexes” to the international preliminary examination report. Amendments under PCT Article 19 which have been considered as reversed by an amendment under PCT Article 34 \*\* are not annexed to the report; neither are the letters which accompany replacement sheets.

>Superseded amendments are not normally included. However, if a first replacement sheet is acceptable and a second replacement sheet for the same numbered sheet contains subject matter that goes beyond the original disclosure of the application as filed, the second replacement sheet supersedes the first replacement sheet, but both the first and second replacement sheets shall be attached to the international preliminary examination report. In this case, the superseded replacement sheets are to be marked as provided in Administrative Instructions Section 602.< The international preliminary examination report may not express a view on the patentability of the invention. PCT Article 35(2) expressly states that “the international preliminary examination report shall not contain any statement on the question whether the claimed invention is or seems to be patentable or unpatentable according to any national law.”

## CLASSIFICATION OF SUBJECT MATTER

The classification of the subject matter shall be either (1) that given by the International Searching Authority under PCT Rule 43.3, if the examiner agrees with such classification, or (2) shall be that which the examiner considers to be correct, if the examiner does not agree with that classification. Both the International Patent Classification (IPC) and the U.S. classification should be given. This classification is placed on the first sheet of the report.

### \* >BOX NO.< I. BASIS OF REPORT

>When completing Box I, item 1, of Form PCT/IPEA/409, the examiner must indicate whether or not the report has been established on the basis of the international application in the language in which it was filed. If a translation was furnished for the purpose of the search, the publication or the examination, this must be indicated.< The international preliminary examination report will be established on the basis of any amendments, rectifications, priority and/or unity of invention holdings and shall answer the questions concerning novelty, inventive step, and industrial applicability for each of the claims under examination.

In completing Form PCT/IPEA/409, the examiner should first indicate any amendments and/or rectifications of obvious errors taken into account in establishing the international preliminary examination report. The amendments and/or rectifications should be indicated by references to the dates on which the amendments and/or rectifications were filed.

For the purpose of completing Box I, item 1, substitute and/or rectified sheets of the specification and drawings filed during Chapter I proceedings are considered to be originally filed pages/sheets and should be listed as originally filed pages/sheets. Only those amendments or rectifications to the specification and drawings filed on the date of Demand or after the filing of a Demand should be listed as later filed pages/sheets.

Substitute and/or rectified sheets of claims filed during the Chapter I proceedings are also considered to be originally filed claims and should be listed as originally filed claims. However, amended sheets of claims filed under Article 19 in response to the international search report are to be indicated as claims as amended under Article 19. Applicant’s submission of

a timely amendment to the claims alleged to be under Article 19 is accepted under Article 34 (not Article 19) unless the International Bureau has indicated the amendments were accepted under Article 19. Only those amendments, or rectifications to the claims filed on the date of Demand or after the filing of a Demand should be listed as later filed claims. \*\*

Amendments and/or rectifications filed but not taken into account in the establishment of the report (e.g., an amendment not taken into account because the amendment went beyond the disclosure of the international application as filed or a rectification that is not considered to be merely a correction of an obvious error) are then indicated separately. The replacement sheets (but not replacement sheets superseded by later replacement sheets) or letters cancelling sheets under PCT Rule 66.8(a) are included as an annex to the report.

>With respect to Box I, item 3, the examiner must indicate whether any amendments have resulted in the cancellation of pages of the description, claims, drawings, sequence listings or any tables related to sequence listings.

With respect to Box 1, item 4, the examiner must indicate whether any amendments to the description, claims, drawings, sequence listings or any tables related to sequence listing that are annexed to the report, have been treated as if they had not been made because they go beyond the disclosure as filed.<

The final report package when sent to the International Application Processing Division for mailing must include copies of all amendments and rectifications entered and any cover letters to those amendments.

**\* >BOX NO.< II. PRIORITY**

\*>Box 2< II of Form PCT/IPEA/409 is to inform applicant of non-establishment of a request for priority. If the report is established as if the priority claim contained in the Request of the international application had not been made, it shall so indicate. This will occur in the event that the applicant has failed to comply with the invitation to furnish either

- (A) a copy of the earlier application whose priority is claimed, or
- (B) a translation of the earlier application, or
- (C) where the priority claim is found invalid, e.g., the claimed priority date is more than one year prior

to the international filing date (PCT Rule 17) or all claims are directed to inventions which were not described and enabled by the earlier application (PCT Rule 64.1), or

- (D) where the priority claim has been withdrawn.

**\* >BOX NO.< III. NON-ESTABLISHMENT OF OPINION WITH REGARD TO NOVELTY, INVENTIVE STEP OR INDUSTRIAL APPLICABILITY**

Indications that a report has not been established on the questions of novelty, inventive step or industrial applicability, either as to some claims or as to all claims, are given in Item III on the Report. The examiner must specify that the report has not been established because:

(A) the application relates to subject matter which does not require international preliminary examination;

(B) the description, claims or drawings are so unclear that no meaningful opinion could be formed;

(C) the claims are so inadequately supported by the description that no meaningful opinion could be formed.

Where the report has not been established in relation to certain claims only, the claims affected must be specified.

>If the nucleotide and/or amino acid sequence listing, and/or tables related thereto, do not comply with the standard in Annex C of the Administrative Instructions, the examiner must indicate the reason for non-compliance.<

**\* >BOX NO.< IV. LACK OF UNITY OF INVENTION**

If the applicant has paid additional fees or has restricted the claims in response to an invitation to do so or if the applicant has failed to respond to the invitation to pay additional fees or restrict the claims, the international preliminary examination report shall so indicate. The examiner should indicate whether:

- (A) the claims have been restricted;
- (B) additional fees have been paid without protest;
- (C) additional fees have been paid by the applicant under protest;

(D) the applicant has neither restricted the claims nor paid additional fees;

(E) the examiner was of the opinion that the international application did not comply with the requirement of unity of invention but decided not to issue an invitation to restrict the claims or pay additional fees.

In addition, if the examiner is examining less than all the claims, the examiner must indicate which parts of the international application were, and which parts were not, the subject of international preliminary examination.

In the case where additional fees were paid under protest, the text of the protest, together with the decision thereon, must be annexed to the report by International Application Processing Division IPEA personnel if the applicant has so requested.

Where an indication has been given under item (E) above, the examiner must also specify the reasons for which the international application was not considered as complying with the requirement of unity of invention.

**\* >BOX NO.< V. REASONED STATEMENT UNDER ARTICLE 35(2) WITH REGARD TO NOVELTY, INVENTIVE STEP, AND INDUSTRIAL APPLICABILITY; AND CITATIONS AND EXPLANATIONS SUPPORTING SUCH STATEMENT**

The examiner must indicate whether each claim appears to satisfy the criteria of novelty, inventive step (nonobviousness), and industrial applicability. The determination or statement should be made on each of the three criteria taken separately. The determination as to any criteria should be negative if the criteria as to the particular claim is not satisfied. The examiner should always cite documents believed to support any negative determination as to novelty and inventive step. Any negative holding as to lack of industrial applicability must be fully explained. See the >furthur< discussion \*>in< MPEP § \*\*>1845.01 relating to Box No. V of Form PCT/ISA/237<. The citation of documents should be in accordance with Administrative Instructions Sections 503 and 611. The procedure is the same as the procedure for search report citations. Explanations should clearly indicate, with reference to the cited documents, the reasons supporting the conclusions that any of the said criteria is or is not satisfied, unless the statement is positive

and the reason for citing any document is easy to understand when consulting the document. If only certain passages of the cited documents are relevant, the examiner should identify them, for example, by indicating the page, column, or the lines where such passages appear. Preferably, a reasoned statement should be provided in all instances.

**\* >BOX NO.< VI. CERTAIN DOCUMENTS CITED**

If the examiner has discovered, or the international search report has cited, a relevant document which refers to a nonwritten disclosure, and the document was only published on or after the relevant date of the international application, the examiner must indicate on the international preliminary examination report:

(A) the date on which the document was made available to the public;

(B) the date on which the non-written public disclosure occurred.

The examiner should also identify any published application or patent and should provide for each such published application or patent the following indications:

(A) its date of publication;

(B) its filing date, and its claimed priority date (if any).

The Report may also indicate that, in the opinion of the International Preliminary Examining Authority, the priority date of the document cited has not been validly claimed (PCT Rule 70.10).

Guidelines explaining to the examiner the manner of indicating certain special categories of documents as well as the manner of indicating the claims to which the documents cited in such report are relevant are set forth in Administrative Instructions Sections 507(c), (d), and (e) and 508.

**\* >BOX NO.< VII. CERTAIN DEFECTS IN THE INTERNATIONAL APPLICATION**

If, in the opinion of the examiner, defects existing in the form or contents of the international application have not been suitably solved at the prescribed time limit for establishing the international preliminary examination report, the examiner may include this opinion in the report, and if included, must also



indicate the reasons therefor. See the >further< discussion \*in< MPEP § \*\*>1845.01 relating to Box No. VII of Form PCT/ISA/237.

#### **\*\* >BOX NO. VIII.< CERTAIN OBSERVATIONS ON THE INTERNATIONAL APPLICATION**

If, in the opinion of the examiner, the clarity of claims, the description, and the drawings, or the question as to whether the claims are fully supported by the description have not been suitably solved at the prescribed time limit for establishing the international preliminary examination report, the examiner may include this opinion in the report, and if included, must also indicate the reasons therefor. See the >further< discussion \*in< MPEP § \*\*>1845.01 relating to Box No. VIII of Form PCT/ISA/237.

#### **FINALIZATION OF THE INTERNATIONAL PRELIMINARY EXAMINATION REPORT**

The date on which the report was completed and the name and mailing address of the International Pre-

liminary Examining Authority are indicated on the cover sheet (Form PCT/IPEA/416) of the international preliminary examination report. This information is generated automatically by the OACS software when preparing the report. In addition, the date on which the demand for international preliminary examination was submitted and the name of the authorized officer responsible for the report must be indicated. Pursuant to Administrative Instructions Section 612, an “authorized officer” is the person who actually performed the examination work and prepared the international preliminary examination report or another person who was responsible for supervising the examination. Thus, an examiner need not have signatory authority in order to be named as an authorized officer on the examination report. However, the “file copy” of the international preliminary examination report must be signed by a primary examiner.

\*\*

PATENT COOPERATION TREATY

From the  
INTERNATIONAL PRELIMINARY EXAMINING AUTHORITY

**PCT**

NOTIFICATION OF TRANSMITTAL OF  
INTERNATIONAL PRELIMINARY  
REPORT ON PATENTABILITY  
(Chapter II of the Patent Cooperation Treaty)

(PCT Rule 71.1)

To:

John J. Smith  
220 Jefferson Davis Highway  
Arlington, Virginia 22202-0234

Date of mailing  
(day/month/year) **04 MAY 2004**

Applicant's or agent's file reference  
CMC-123-PCT

**IMPORTANT NOTIFICATION**

International application No.  
PCT/US04/00150

International filing date (day/month/year)  
05 January 2004 (05.01.2004)

Priority date (day/month/year)  
06 January 2003 (06.01.2003)

Applicant  
ACME FASTENER CORPORATION

1. The applicant is hereby notified that this International Preliminary Examining Authority transmits herewith the international preliminary report on patentability and its annexes, if any, established on the international application.
2. A copy of the report and its annexes, if any, is being transmitted to the International Bureau for communication to all the elected Offices.
3. Where required by any of the elected Offices, the International Bureau will prepare an English translation of the report (but not of any annexes) and will transmit such translation to those Offices.
4. **REMINDER**  
The applicant must enter the national phase before each elected Office by performing certain acts (filing translations and paying national fees) within 30 months from the priority date (or later in some Offices) (Article 39(1)) (see also the reminder sent by the International Bureau with Form PCT/IB/301).  
Where a translation of the international application must be furnished to an elected Office, that translation must contain a translation of any annexes to the international preliminary report on patentability. It is the applicant's responsibility to prepare and furnish such translation directly to each elected Office concerned.  
For further details on the applicable time limits and requirements of the elected Offices, see Volume II of the *PCT Applicant's Guide*.  
The applicant's attention is drawn to Article 33(5), which provides that the criteria of novelty, inventive step and industrial applicability described in Article 33(2) to (4) merely serve the purposes of international preliminary examination and that "any Contracting State may apply additional or different criteria for the purposes of deciding whether, in that State, the claimed invention is patentable or not" (see also Article 27(5)). Such additional criteria may relate, for example, to exemptions from patentability, requirements for enabling disclosure, clarity and support for the claims.

Name and mailing address of the IPEA/ US  
Mail Stop PCT, Attn: IPEA/US  
Commissioner for Patents  
P. O. Box 1450  
Alexandria, Virginia 22313-1450  
Facsimile No. (703)305-3230

Authorized officer **Paul A. Bell**  
Paul A. Bell  
Telephone No. 703-308-3543

Form PCT/IPEA/416 (January 2004)

PATENT COOPERATION TREATY

PCT

INTERNATIONAL PRELIMINARY REPORT ON PATENTABILITY  
(Chapter II of the Patent Cooperation Treaty)

(PCT Article 36 and Rule 70)

Applicant's or agent's file reference CMC-123-PCT	<b>FOR FURTHER ACTION</b>	See Form PCT/IPEA/416
International application No. PCT/US04/00150	International filing date (day/month/year) 05 January 2004 (05.01.2004)	Priority date (day/month/year) 06 January 2003 (06.01.2003)
International Patent Classification (IPC) or national classification and IPC  IPC(7): B25C 5/06 and US Cl.: 227/8		
Applicant ACME FASTENER CORPORATION		

1. This report is the international preliminary examination report, established by this International Preliminary Examining Authority under Article 35 and transmitted to the applicant according to Article 36.

2. This REPORT consists of a total of 6 sheets, including this cover sheet.

3. This report is also accompanied by ANNEXES, comprising:

a.  (sent to the applicant and to the International Bureau) a total of 2 sheets, as follows:

sheets of the description, claims and/or drawings which have been amended and are the basis of this report and/or sheets containing rectifications authorized by this Authority (see Rule 70.16 and Section 607 of the Administrative Instructions).

sheets which supersede earlier sheets, but which this Authority considers contain an amendment that goes beyond the disclosure in the international application as filed, as indicated in item 4 of Box No. I and the Supplemental Box.

b.  (sent to the International Bureau only) a total of \_\_\_\_\_, containing a sequence listing and/or tables related thereto, in computer readable form only, as indicated in the Supplemental Box Relating to Sequence Listing (see Section 802 of the Administrative Instructions).

4. This report contains indications relating to the following items:

Box No. I Basis of the report

Box No. II Priority

Box No. III Non-establishment of opinion with regard to novelty, inventive step and industrial applicability

Box No. IV Lack of unity of invention

Box No. V Reasoned statement under Article 35(2) with regard to novelty, inventive step or industrial applicability; citations and explanations supporting such statement

Box No. VI Certain documents cited

Box No. VII Certain defects in the international application

Box No. VIII Certain observations on the international application

Date of submission of the demand	Date of completion of this report  21 April 2004 (21.04.2004)
Name and mailing address of the IPEA/ US Mail Stop PCT, Attn: IPEA/US Commissioner for Patents P.O. Box 1450 Alexandria, Virginia 22313-1450 Facsimile No. (703)305-3230	Authorized officer  <i>Paul A. Bell</i> Paul A. Bell Telephone No. 703-308-3543

Form PCT/IPEA/409 (cover sheet) (January 2004)

INTERNATIONAL PRELIMINARY REPORT ON PATENTABILITY

International application No.  
PCT/US04/00150

Box No. I Basis of the report

1. With regard to the **language**, this report is based on the international application in the language in which it was filed, unless otherwise indicated under this item.

- This report is based on translations from the original language into the following language \_\_\_\_\_, which is the language of a translation furnished for the purposes of:
  - international search (under Rules 12.3 and 23.1(b))
  - publication of the international application (under Rule 12.4)
  - international preliminary examination (under Rules 55.2 and/or 55.3)

2. With regard to the **elements** of the international application, this report is based on *(replacement sheets which have been furnished to the receiving Office in response to an invitation under Article 14 are referred to in this report as "originally filed" and are not annexed to this report)*:

- the international application as originally filed/furnished
- the description:
  - pages 1 - 10 \_\_\_\_\_ as originally filed/furnished
  - pages\* \_\_\_\_\_ received by this Authority on \_\_\_\_\_
  - pages\* \_\_\_\_\_ received by this Authority on \_\_\_\_\_
- the claims:
  - pages \_\_\_\_\_ as originally filed/furnished
  - pages\* \_\_\_\_\_ as amended (together with any statement) under Article 19
  - pages\* 11 and 12 \_\_\_\_\_ received by this Authority on 24 February 2004 (25.02.2004)
  - pages\* \_\_\_\_\_ received by this Authority on \_\_\_\_\_
- the drawings:
  - pages 1/2 - 2/2 \_\_\_\_\_ as originally filed/furnished
  - pages\* \_\_\_\_\_ received by this Authority on \_\_\_\_\_
  - pages\* \_\_\_\_\_ received by this Authority on \_\_\_\_\_
- a sequence listing and/or any related table(s) - see Supplemental Box Relating to Sequence Listing.

3.  The amendments have resulted in the cancellation of:

- the description, pages \_\_\_\_\_
- the claims, Nos. 4 \_\_\_\_\_
- the drawings, sheets/figs \_\_\_\_\_
- the sequence listing (*specify*): \_\_\_\_\_
- any table(s) related to sequence listing (*specify*): \_\_\_\_\_

4.  This report has been established as if (some of) the amendments annexed to this report and listed below had not been made, since they have been considered to go beyond the disclosure as filed, as indicated in the Supplemental Box (Rule 70.2(c)).

- the description, pages \_\_\_\_\_
- the claims, Nos. \_\_\_\_\_
- the drawings, sheets/figs \_\_\_\_\_
- the sequence listing (*specify*): \_\_\_\_\_
- any table(s) related to sequence listing (*specify*): \_\_\_\_\_

\* If item 4 applies, some or all of those sheets may be marked "superseded."

## INTERNATIONAL PRELIMINARY REPORT ON PATENTABILITY

International application No.

PCT/US04/00150

## Box No. IV Lack of unity of invention

1.  In response to the invitation to restrict or pay additional fees the applicant has:
- restricted the claims.
- paid additional fees.
- paid additional fees under protest.
- neither restricted nor paid additional fees.
2.  This Authority found that the requirement of unity of invention is not complied with and chose, according to Rule 68.1, not to invite the applicant to restrict or pay additional fees.
3. This Authority considers that the requirement of unity of invention in accordance with Rules 13.1, 13.2 and 13.3 is:
- complied with.
- not complied with for the following reasons:
- This application contains the following inventions or groups of inventions which are not so linked as to form a single general inventive concept under PCT Rule 13.1. In order for all inventions to be examined, the appropriate additional examination fees must be paid.
- Group I, claim(s) 1 - 3, 5 and 16 - 20 drawn to an electromagnetic fastener driver with means to hold the fastener magazine in a predetermined position.
- Group II, claim(s) 6 - 10, drawn to an electromagnetic fastener driver with a control means to provide for multiple driving strokes to be delivered to the same fastener with a single actuation of the tool.
- Group III, claim(s) 11 - 15, drawn to an electromagnetic fastener driver with a fastener jam clearance feature.
- The inventions listed as Groups I - III do not relate to a single general inventive concept under PCT Rule 13.1 because, under PCT Rule 13.2, they lack the same or corresponding special technical features for the following reasons: The special technical feature of the Group I invention is the claimed means to hold the fastener magazine in a predetermined position. The special technical feature of the Group II invention is the claimed control means to provide for multiple driving strokes to be delivered to the same fastener with a single actuation of the tool. The special technical feature of the Group III invention is the claimed fastener jam clearance feature. None of these special technical features are common to the other groups, nor do they correspond to a special technical feature in the other groups. Therefore, unity of invention is lacking.
4. Consequently, this report has been established in respect of the following parts of the international application:
- all parts.
- the parts relating to claims Nos. \_\_\_\_\_

Form PCT/IPEA/409 (Box No. IV) (January 2004)

**INTERNATIONAL PRELIMINARY REPORT ON PATENTABILITY**

International application No.

PCT/US04/00150

**Box No. V Reasoned statement under Article 35(2) with regard to novelty, inventive step or industrial applicability; citations and explanations supporting such statement**

1. Statement

Novelty (N)	Claims	<u>1 - 3 and 5 - 20</u>	YES
	Claims	<u>NONE</u>	NO
Inventive step (IS)	Claims	<u>1 - 3, 5 and 16 - 20</u>	YES
	Claims	<u>6 - 15</u>	NO
Industrial applicability (IA)	Claims	<u>1 - 3 and 5 - 20</u>	YES
	Claims	<u>NONE</u>	NO

2. Citations and explanations (Rule 70.7)

Please see Supplemental Box

## INTERNATIONAL PRELIMINARY REPORT ON PATENTABILITY

International application No.

PCT/US04/00150

**Box No. VII Certain defects in the international application**

The following defects in the form or contents of the international application have been noted:

The description is objected to as containing the following defect(s) under PCT Rule 66.2(a)(iii) in the form or contents thereof:  
It is noted that the word "stpaes" at line 15 of page 9 is misspelled.

Form PCT/IPEA/409 (Box No. VII) (January 2004)

## INTERNATIONAL PRELIMINARY REPORT ON PATENTABILITY

International application No.  
PCT/US04/00150

## Supplemental Box

In case the space in any of the preceding boxes is not sufficient.  
Continuation of:

## 2. Citations and Explanations

Claims 6 - 10 lack an inventive step under PCT Article 33(3) as being obvious over Novak et al. in view of Barrett et al. Novak et al. teaches an electromagnetic fastener tool 10 with a housing 12 having a fastener magazine assembly 18 mounted thereon with the magazine assembly having a fastener output channel. The magazine assembly 18 is pivoted between a first position wherein the tool can not be actuated and a second position wherein a fastener may be driven from the tool (note figure 3 and column 1, line 65 through column 2, line 5). The magazine assembly 18 is moved from the first position to the second position by placing the fastener output channel firmly against a work piece. As shown in figure 3 and described at column 4, lines 6 - 49, the magazine assembly 18 and the trigger button 24 are coupled by a safety mechanism 62. This safety mechanism has a sliding rod 64 with the lower end of the rod 64 being attached to the top of channel 48 of the magazine assembly such that rod 64 moves with the magazine assembly. When magazine assembly 18 is placed on a work piece, it rotates into the second position and pushes rod 64 upward. The upper portion of rod 64 has a spring 74 which includes a cam surface 76, a curved surface 78 and a bottom edge 81. Bottom edge 81 of spring 74 is normally positioned adjacent flange 86 of trigger button 24 and blocks upward movement of the trigger button. Thus, the trigger button may not be depressed (moved upward) to fire the tool until the bottom edge 81 of spring 74 is moved away from flange 86. This is accomplished by the interaction of curved surface 78 of spring 74 with a corresponding curved surface 82 fixed to the housing 12. When rod 64 moves upward, spring 74 is bent away from trigger button 24 by the interaction of curved surfaces 78 and 82. Thus, placing the fastener output channel of the magazine assembly 18 against a work piece moves bottom surface 81 of spring 74 out of its blocking position adjacent flange 86 of trigger button 24 and permits the tool to be fired. Novak et al. does not teach the claimed electronic control means to provide multiple blows from the driver to a single fastener. Barrett et al. discloses a control means which provides for multiple blows by the driver 32 on the fastener for each actuation of the trigger. Barrett et al. teaches at column 1, lines 40 - 49 that it is advantageous to operate solenoid actuated fastener drivers in this manner because these tools may require two or more blows from the driver to properly drive the fastener an adequate depth into the work piece. In view of this known teaching, it would have been obvious to one of ordinary skill in this art to provide the Novak et al. tool with the claimed control means to provide a predetermined plurality of driving strokes to a single fastener.

Claims 11 - 15 lack an inventive step under PCT Article 33(3) as being obvious over Novak et al. in view of D'Haem et al. Novak et al. does not teach the provision of an anti-jam means to clear jammed fasteners from the fastener output channel. The claims call for the fastener output channel to be formed with a removable cover plate to permit clearing the tool in the event of a fastener jam. D'Haem et al. teaches the use of a removable cover plate to allow clearing the tool as claimed (see column 4, line 76 - column 5, line 23). In view of this teaching, it would have been obvious to one of ordinary skill in this art to provide the claimed anti-jam feature in the Novak et al. tool.

Claims 1 - 3, 5, and 16 - 20 meet the criteria set out in PCT Article 33(2) - (3), because the prior art does not teach or fairly suggest the means to hold the fastener magazine in the second position as claimed.

Claims 1 - 3 and 5 - 20 meet the criteria set out in PCT Article 33(4), and thus have industrial applicability because the subject matter claimed can be made or used in industry.



## 1879.01 > Time Limit for Preparing Report in International Applications Having an International Filing Date On or After January 1, 2004 [R-2]

[Note: The regulations under the PCT were changed effective January 1, 2004 and corresponding changes were made to Title 37 of the Code of Federal Regulations. See *January 2004 Revision of Patent Cooperation Treaty Application Procedure*, 68 FR 59881 (Oct. 20, 2003), 1276 O.G. 6 (Nov. 11, 2003). The discussion of the procedures in effect for applications filed prior to January 1, 2004 has been moved from this section to newly added MPEP § 1879.01(a).]

### *PCT Rule 69.*

#### *Start of and Time Limit for International Preliminary Examination*

##### *69.1. Start of International Preliminary Examination*

(a) Subject to paragraphs (b) to (e), the International Preliminary Examining Authority shall start the international preliminary examination when it is in possession of all of the following:

- (i) the demand;
- (ii) the amount due (in full) for the handling fee and the preliminary examination fee, including where applicable, the late payment fee under Rule 58<sup>bis</sup>.2; and
- (iii) either the international search report and the written opinion established under Rule 43<sup>bis</sup>.1 or a notice of the declaration by the International Searching Authority under Article 17(2)(a) that no international search report will be established;

provided that the International Preliminary Examining Authority shall not start the international preliminary examination before the expiration of the applicable time limit under Rule 54<sup>bis</sup>.1(a) unless the applicant expressly requests an earlier start.

(b) If the national Office or intergovernmental organization that acts as International Searching Authority also acts as International Preliminary Examining Authority, the international preliminary examination may, if that national Office or intergovernmental organization so wishes and subject to paragraphs (d) and (e), start at the same time as the international search.

(b<sup>bis</sup>) Where, in accordance with paragraph (b), the national Office or intergovernmental organization that acts as both International Searching Authority and International Preliminary Examining Authority wishes to start the international preliminary examination at the same time as the international search and considers that all of the conditions referred to in Article 34(2)(c)(i) to (iii) are fulfilled, that national Office or intergovernmental organi-

zation need not, in its capacity as International Searching Authority, establish a written opinion under Rule 43<sup>bis</sup>.1

(c) Where the statement concerning amendments contains an indication that amendments under Article 19 are to be taken into account (Rule 53.9(a)(i)), the International Preliminary Examining Authority shall not start the international preliminary examination before it has received a copy of the amendments concerned.

(d) Where the statement concerning amendments contains an indication that the start of the international preliminary examination is to be postponed (Rule 53.9(b)), the International Preliminary Examining Authority shall not start the international preliminary examination before whichever of the following occurs first:

- (i) it has received a copy of any amendments made under Article 19;
- (ii) it has received a notice from the applicant that he does not wish to make amendments under Article 19; or
- (iii) the expiration of the applicable time limit under Rule 54<sup>bis</sup>.1(a).

(e) Where the statement concerning amendments contains an indication that amendments under Article 34 are submitted with the demand (Rule 53.9(c)) but no such amendments are, in fact, submitted, the International Preliminary Examining Authority shall not start the international preliminary examination before it has received the amendments or before the time limit fixed in the invitation referred to in Rule 60.1(g) has expired, whichever occurs first.

##### *69.2. Time Limit for International Preliminary Examination*

The time limit for establishing the international preliminary examination report shall be whichever of the following periods expires last:

- (i) 28 months from the priority date; or
- (ii) six months from the time provided under Rule 69.1 for the start of the international preliminary examination; or
- (iii) six months from the date of receipt by the International Preliminary Examining Authority of the translation furnished under Rule 55.2.

PCT Rule 69.2 was amended as reproduced above for applications having an international filing date on or after January 1, 2004. The time limit for preparing the international preliminary examination report is 28 months from the priority date, or 6 months from the time provided under PCT Rule 69.1 for the start of the international preliminary examination, or 6 months from the date of receipt by the International Preliminary Examining Authority of the translation furnished under PCT Rule 55.2, whichever expires first. This time limit is 27 months internally to ensure sufficient time to process, review and mail the report in sufficient time to reach the International Bureau by 28 months from the earliest priority date.

### 1879.01(a) < Time Limit for Preparing Report >in International Application Having an International Filing Date Before January 1, 2004< [R-2]

>[Note: For international applications filed on or after January 1, 2004, see MPEP § 1879.01.]

Former<

*PCT Rule 69.*

*Start of and Time Limit for International Preliminary Examination*

>(as amended July 1, 1998)<

#### 69.1.Start of International Preliminary Examination

(a) Subject to paragraphs (b) to (e), the International Preliminary Examining Authority shall start the international preliminary examination when it is in possession both of the demand and of either the international search report or a notice of the declaration by the International Searching Authority under Article 17(2)(a) that no international search report will be established.

(b) If the competent International Preliminary Examining Authority is part of the same national Office or intergovernmental organization as the competent International Searching Authority, the international preliminary examination may, if the International Preliminary Examining Authority so wishes and subject to paragraph (d), start at the same time as the international search.

(c) Where the statement concerning amendments contains an indication that amendments under Article 19 are to be taken into account (Rule 53.9(a)(i)), the International Preliminary Examining Authority shall not start the international preliminary examination before it has received a copy of the amendments concerned

(d) Where the statement concerning amendments contains an indication that the start of the international preliminary examination is to be postponed (Rule 53.9(b)), the International Preliminary Examining Authority shall not start the international preliminary examination before

(i) it has received a copy of any amendments made under Article 19,

(ii) it has received a notice from the applicant that he does not wish to make amendments under Article 19, or

(iii) the expiration of 20 months from the priority date, whichever occurs first.

(e) Where the statement concerning amendments contains an indication that amendments under Article 34 are submitted with the demand (Rule 53.9(c)) but no such amendments are, in fact, submitted, the International Preliminary Examining Authority shall not start the international preliminary examination before it has received the amendments or before the time limit fixed in the invitation referred to in Rule 60.1(g) has expired, whichever occurs first.

#### 69.2.Time Limit for International Preliminary Examination

The time limit for establishing the international preliminary examination report shall be:

(i) 28 months from the priority date, or

(ii) eight months from the date of payment of the fees referred to in Rules 57.1 and 58.1(a), or

(iii) eight months from the date of receipt by the International Preliminary Examining Authority of the translation furnished under Rule 55.2, whichever expires last.

\*\*>For international applications having an international filing date before January 1, 2004, the period for preparing the IPER is set forth in former PCT Rule 69.2 (as amended July 1, 1998)<. The time limit for preparing the international preliminary examination report is 28 months from the priority date, or 8 months from the date of payment of the fees referred to in PCT Rules 57.1 and 58.1(a), or 8 months from the date of receipt by the International Preliminary Examining Authority of the translation furnished under PCT Rule 55.2, whichever expires first. This time limit is 27 months internally to ensure sufficient time to process, review and mail the report in sufficient time to reach the International Bureau by 28 months from the earliest priority date.

### 1879.02 Transmittal of the International Preliminary Examination Report

*PCT Article 36.*

*Transmittal, Translation, and Communication of the International Preliminary Examination Report*

(1) The international preliminary examination report, together with the prescribed annexes, shall be transmitted to the applicant and to the International Bureau.

\*\*\*\*\*

*PCT Rule 71.*

*Transmittal of the International Preliminary Examination Report*

#### 71.1.Recipients

The International Preliminary Examining Authority shall, on the same day, transmit one copy of the international preliminary examination report and its annexes, if any, to the International Bureau, and one copy to the applicant.

#### 71.2.Copies of Cited Documents

(a) The request under Article 36(4) may be presented any time during seven years from the international filing date of the international application to which the report relates.

(b) The International Preliminary Examining Authority may require that the party (applicant or elected Office) presenting the request pay to it the cost of preparing and mailing the copies. The level of the cost of preparing copies shall be provided for in the agreements referred to in Article 32(2) between the International Preliminary Examining Authorities and the International Bureau.

(c) *[Deleted]*

(d) Any International Preliminary Examining Authority may perform the obligations referred to in paragraphs (a) and (b) through another agency responsible to it.

The international preliminary examination report is transmitted to the International Bureau using a transmittal Form PCT/IPEA/416. Every effort is made to ensure that the transmittal is effected in sufficient time to reach the International Bureau before the expiration of the time limit set in PCT Rule 69.2.

### AUTHORIZED OFFICER

Form PCT/IPEA/416 must be signed by a primary examiner.

### 1879.03 Translations [R-2]

\*\*

#### *PCT Article 36.*

#### *Transmittal, Translation, and Communication of the International Preliminary Examination Report*

\*\*\*\*\*

(2)(a) The international preliminary examination report and its annexes shall be translated into the prescribed languages.

(b) Any translation of the said report shall be prepared by or under the responsibility of the International Bureau, whereas any translation of the said annexes shall be prepared by the applicant.

\*\*\*\*\*

>

#### *PCT Rule 70.*

#### *International Preliminary Report on Patentability by the International Preliminary Examining Authority (International Preliminary Examination Report)*

\*\*\*\*\*

#### *70.17 Languages of the Report and the Annexes*

The report and any annex shall be in the language in which the international application to which they relate is published, or, if the international preliminary examination is carried out, pursuant to Rule 55.2, on the basis of a translation of the international application, in the language of that translation.<

#### *PCT Rule 72.*

\*\*>*Translation of the International Preliminary Examination Report and of the Written Opinion of the International Searching Authority*<

#### *72.1. Languages*

(a) Any elected State may require that the international preliminary examination report, established in any language other than the official language, or one of the official languages, of its national Office, be translated into English.

(b) Any such requirement shall be notified to the International Bureau, which shall promptly publish it in the Gazette.

#### *72.2. Copy of Translation for the Applicant*

The International Bureau shall transmit a copy of the translation referred to in Rule 72.1(a) of the international preliminary examination report to the applicant at the same time as it communicates such translation to the interested elected Office or Offices.

\*\*>

#### *72.2<sup>bis</sup>. Translation of the Written Opinion of the International Searching Authority Established Under Rule 43<sup>bis</sup>.1*

In the case referred to in Rule 73.2(b)(ii), the written opinion established by the International Searching Authority under Rule 43<sup>bis</sup>.1 shall, upon request of the elected Office concerned, be translated into English by or under the responsibility of the International Bureau. The International Bureau shall transmit a copy of the translation to the elected Office concerned within two months from the date of receipt of the request for translation, and shall at the same time transmit a copy to the applicant.

#### *72.3. Observations on the Translation*

The applicant may make written observations as to the correctness of the translation of the international preliminary examination report or of the written opinion established by the International Searching Authority under Rule 43<sup>bis</sup>.1 and shall send a copy of the observations to each of the interested elected Offices and to the International Bureau.<

The >written opinion established by the International Searching Authority and the< international preliminary examination report and any annexes are established in Chinese, English, French, German, Japanese, Russian or Spanish, if the international application was filed in one of those languages or translated into one of those languages. See PCT Rules 48.3(b), 55.2 and 70.17. Each elected State may require that >the written opinion and/or< the report, if it is not in (one of) the official language(s) of its national Office, be translated into English. See PCT Rule 72.1(a). In that case, the translation of the body of the >written opinion and/or< report is prepared by >the< International Bureau, which transmits copies to the applicant

and to each interested elected Office. If any elected Office requires a translation of annexes to the report, the preparation and furnishing of that translation is the responsibility of the applicant. See PCT Article 36(2)(b).

The U.S. requires the final report and the annexes thereto to be in English. Translation of the annexes for national stage purposes is required pursuant to 35 U.S.C. 371(c)(5) and 37 CFR 1.495(e). Failure to timely provide such translation results in cancellation of the annexes.

## 1879.04 Confidential Nature of the Report [R-2]

### *PCT Article 38.*

#### *Confidential Nature of the International Preliminary Examination*

(1) Neither the International Bureau nor the International Preliminary Examining Authority shall, unless requested or authorized by the applicant, allow access within the meaning, and with the proviso, of Article 30(4) to the file of the international preliminary examination by any person or authority at any time, except by the elected Offices once the international preliminary examination report has been established.

(2) Subject to the provisions of paragraph (1) and Articles 36(1) and (3) and 37(3)(b), neither the International Bureau nor the International Preliminary Examining Authority shall, unless requested or authorized by the applicant, give information on the issuance or non-issuance of an international preliminary examination report and on the withdrawal or non-withdrawal of the demand or of any election.

>

### *PCT Rule 44<sup>ter</sup>.*

#### *Confidential Nature of Written Opinion, Report, Translation and Observations*

(a) The International Bureau and the International Searching Authority shall not, unless requested or authorized by the applicant, allow access by any person or authority before the expiration of 30 months from the priority date:

(i) to the written opinion established under Rule 43<sup>bis</sup>.1, to any translation thereof prepared under Rule 44<sup>bis</sup>.3(d) or to any written observations on such translation sent by the applicant under Rule 44<sup>bis</sup>.4;

(ii) if a report is issued under Rule 44<sup>bis</sup>.1, to that report, to any translation of it prepared under Rule 44<sup>bis</sup>.3(b) or to any written observations on that translation sent by the applicant under Rule 44<sup>bis</sup>.4.

(b) For the purposes of paragraph (a), the term “access” covers any means by which third parties may acquire cognizance, including individual communication and general publication.<

### *37 CFR 1.11. Files open to the public.*

(a) The specification, drawings, and all papers relating to the file of an abandoned published application, except if a redacted copy of the application was used for the patent application publication, a patent, or a statutory invention registration are open to inspection by the public, and copies may be obtained upon the payment of the fee set forth in § 1.19(b)(2). See § 2.27 for trademark files.

\*\*\*\*\*

### *37 CFR 1.14. Patent applications preserved in confidence.*

\*\*\*\*\*

\*\*>

(g) *International applications.* (1) Copies of international application files for international applications which designate the U.S. and which have been published in accordance with PCT Article 21(2), or copies of a document in such application files, will be furnished in accordance with PCT Articles 30 and 38 and PCT Rules 94.2 and 94.3, upon written request including a showing that the publication of the application has occurred and that the U.S. was designated, and upon payment of the appropriate fee (see § 1.19(b)), if:

(i) With respect to the Home Copy (the copy of the international application kept by the Office in its capacity as the Receiving Office, see PCT Article 12(1)), the international application was filed with the U.S. Receiving Office;

(ii) With respect to the Search Copy (the copy of an international application kept by the Office in its capacity as the International Searching Authority, see PCT Article 12(1)), the U.S. acted as the International Searching Authority, except for the written opinion of the International Searching Authority which shall not be available until the expiration of thirty months from the priority date; or

(iii) With respect to the Examination Copy (the copy of an international application kept by the Office in its capacity as the International Preliminary Examining Authority), the United States acted as the International Preliminary Examining Authority, an International Preliminary Examination Report has issued, and the United States was elected.

(2) A copy of an English language translation of a publication of an international application which has been filed in the United States Patent and Trademark Office pursuant to 35 U.S.C. 154(d)(4) will be furnished upon written request including a showing that the publication of the application in accordance with PCT Article 21(2) has occurred and that the U.S. was designated, and upon payment of the appropriate fee (§ 1.19(b)(4)).

(3) Access to international application files for international applications which designate the U.S. and which have been published in accordance with PCT Article 21(2), or copies of a document in such application files, will be permitted in accordance with PCT Articles 30 and 38 and PCT Rules 44<sup>ter</sup>.1, 94.2

and 94.3, upon written request including a showing that the publication of the application has occurred and that the U.S. was designated.

(4) In accordance with PCT Article 30, copies of an international application-as-filed under paragraph (a) of this section will not be provided prior to the international publication of the application pursuant to PCT Article 21(2).

(5) Access to international application files under paragraphs (a)(1)(i) through (a)(1)(vi) and (g)(3) of this section will not be permitted with respect to the Examination Copy in accordance with PCT Article 38.

(h) *Access or copies in other circumstances.* The Office, either *sua sponte* or on petition, may also provide access or copies of all or part of an application if necessary to carry out an Act of Congress or if warranted by other special circumstances. Any petition by a member of the public seeking access to, or copies of, all or part of any pending or abandoned application preserved in confidence pursuant to paragraph (a) of this section, or any related papers, must include:

(1) The fee set forth in § 1.17(h); and

(2) A showing that access to the application is necessary to carry out an Act of Congress or that special circumstances exist which warrant petitioner being granted access to all or part of the application.

For a discussion of the availability of copies of documents from international application files and/or access to international application files, see MPEP § 110.<

## 1880 Withdrawal of Demand or Election [R-2]

### *PCT Article 37.*

#### *Withdrawal of Demand or Election*

(1) The applicant may withdraw any or all elections.

(2) If the election of all elected States is withdrawn, the demand shall be considered withdrawn.

(3)(a) Any withdrawal shall be notified to the International Bureau.

(b) The elected Office concerned and the International Preliminary Examining Authority concerned shall be notified accordingly by the International Bureau.

(4)(a) Subject to the provisions of subparagraph (b), withdrawal of the demand or of the election of a Contracting State shall, unless the national law of that State provides otherwise, be considered to be withdrawal of the international application as far as that State is concerned.

(b) Withdrawal of the demand or of the election shall not be considered to be withdrawal of the international application if such withdrawal is effected prior to the expiration of the applicable time limit under Article 22; however, any Contracting State may provide in its national law that the aforesaid shall apply only if its national Office has received, within the said time limit, a

copy of the international application, together with a translation (as prescribed), and the national fee.

### *PCT Rule 90<sup>bis</sup>. Withdrawals*

\*\*\*\*\*

#### *90<sup>bis</sup>.4. Withdrawal of the Demand, or of Elections*

(a) The applicant may withdraw the demand or any or all elections at any time prior to the expiration of 30 months from the priority date.

(b) Withdrawal shall be effective upon receipt of a notice addressed by the applicant to the International Bureau.

(c) If the notice of withdrawal is submitted by the applicant to the International Preliminary Examining Authority, that Authority shall mark the date of receipt on the notice and transmit it promptly to the International Bureau. The notice shall be considered to have been submitted to the International Bureau on the date marked.

\*\*\*\*\*

### *PCT Administrative Instruction Section 606. Cancellation of Elections*

\*\*>

(a) The International Preliminary Examining Authority shall cancel *ex officio*:

(i) the election of any State which is not a designated State;

(ii) the election of any State not bound by Chapter II of the Treaty.

(b) The International Preliminary Examining Authority shall enclose that election within square brackets, shall draw a line between the square brackets while still leaving the election legible and shall enter, in the margin, the words "CANCELLED EX OFFICIO BY IPEA" or their equivalent in the language of the demand, and shall notify the applicant accordingly.

Any withdrawal of the demand or any election must be sent to the International Bureau or to the International Preliminary Examining Authority<. Withdrawal, if timely, is effective upon receipt by the International Bureau >or the International Preliminary Examining Authority. Pursuant to PCT Rule 90<sup>bis</sup>.5, the withdrawal must be signed by all of the applicants, except as provided in PCT Rule 90<sup>bis</sup>.5(b) in the case where an applicant/inventor for the United States could not be found or reached after diligent effort and the withdrawal is signed by at least one applicant. Pursuant to PCT Rules 90.4(e) and 90.5(d), the requirement for a separate power of attorney or a copy of the general power of attorney shall not be waived in cases of withdrawal.<

**1881 Receipt of Notice of Election and Preliminary Examination Report by the United States Patent and Trademark Office [R-2]**

*PCT Rule 61.*

*Notification of the Demand and Elections*

\*\*\*\*\*

*61.2. Notification to the Elected Offices*

(a) The notification provided for in Article 31(7) shall be effected by the International Bureau.

\*\*>

(b) The notification shall indicate the number and filing date of the international application, the name of the applicant, the filing date of the application whose priority is claimed (where priority is claimed) and the date of receipt by the International Preliminary Examining Authority of the demand.<

(c) The notification shall be sent to the elected Office together with the communication provided for in Article 20. Elections effected after such communication shall be notified promptly after they have been made.

\*\*>

(d) Where the applicant makes an express request to an elected Office under Article 40(2) prior to the international publication of the international application, the International Bureau shall, upon request of the applicant or the elected Office, promptly effect the communication provided for in Article 20 to that Office.<

*61.3. Information for the Applicant*

The International Bureau shall inform the applicant in writing of the notification referred to in Rule 61.2 and of the elected Offices notified under Article 31(7).

\*\*\*\*\*

All notices of election are received by the >Office of< PCT \*\*>Operations< from the International Bureau. The >Office of< PCT \*\*>Operations< prepares the appropriate records of the election and places the paper in storage with the communicated copy of the international application until the national stage is entered. >The international preliminary examination report received by the USPTO will also be included in the national stage file. The international preliminary examination report is communicated to the elected Offices by the International Bureau.<

\*\*

**1893 National Stage (U.S. National Application Filed Under 35 U.S.C. 371) [R-2]**

*37 CFR 1.9. Definitions.*

(a)(1) A national application as used in this chapter means a U.S. application for patent which was either filed in the Office under 35 U.S.C. 111, or which entered the national stage from an international application after compliance with 35 U.S.C. 371.

(2) A provisional application as used in this chapter means a U.S. national application for patent filed in the Office under 35 U.S.C. 111(b).

(3) A nonprovisional application as used in this chapter means a U.S. national application for patent which was either filed in the Office under 35 U.S.C. 111(a), or which entered the national stage from an international application after compliance with 35 U.S.C. 371.

\*\*\*\*\*

Thus, there are three types of U.S. national applications: a national stage application under the PCT (an application which entered the national stage in the U.S. from an international application after compliance with 35 U.S.C. 371), a regular domestic national application filed under 35 U.S.C. 111(a), and a provisional application filed under 35 U.S.C. 111(b).

An applicant who uses the Patent Cooperation Treaty gains the benefit of:<

(A) a delay in the time when papers must be submitted to the national offices;

(B) an international search (to judge the level of the relevant prior art) >and, for international applications filed on or after January 1, 2004, a written opinion on the question of whether the claimed invention appears to be novel, to involve an inventive step (to be non-obvious), and to be industrially applicable< before having to expend resources for filing fees, translations and other costs;

(C) a delay in the expenditure of fees;

(D) additional time for research;

(E) additional time to evaluate financial, marketing, commercial and other considerations>; and

(F) the option of obtaining international preliminary examination<.

The time delay is, however, the benefit most often recognized as primary. Ultimately, applicant might choose to submit the national stage application. The national stage is unique compared to a domestic national application in that

(A) it is submitted later (i.e., normally 30 months or more from a claimed priority date as compared to 12 months for a domestic application claiming priority).

(B) the status of the prior art is generally known before the national stage begins and this is not necessarily so in a domestic national application.

(C) if the filing of an international application is to be taken into account in determining the patentability or validity of any application for patent or granted patent, then special provisions apply. See MPEP § 1895.01, subsection (E) and MPEP § 1896.

### IDENTIFICATION OF THE NATIONAL STAGE APPLICATION

Once an international application enters the U.S. national phase (“national stage application”) has been accorded a U.S. application number (the two digit series code followed by a six digit serial number), that number should be used whenever papers or other communications are directed to the USPTO regarding the national stage application. See 37 CFR 1.5 (a). The national stage application is tracked through the Patent Application Locating and Monitoring (PALM) system by the eight digit U.S. application number. Therefore, processing is expedited if the U.S. application number is indicated. The international application number, international filing date, and the national stage entry date under 35 U.S.C. 371 (if such has been accorded) should also be included, as such would also be helpful for identification purposes and can be used to cross-check a possibly erroneous U.S. application number.

### 1893.01 Commencement and Entry [R-1]

\*\*

#### 35 U.S.C. 371. National stage: Commencement.

(a) Receipt from the International Bureau of copies of international applications with any amendments to the claims, international search reports, and international preliminary examination reports including any annexes thereto may be required in the case of international applications designating or electing the United States.

(b) Subject to subsection (f) of this section, the national stage shall commence with the expiration of the applicable time limit under article 22 (1) or (2), or under article 39 (1)(a) of the treaty.

(c) The applicant shall file in the Patent and Trademark Office —

(1) the national fee provided in section 41(a) of this title;

(2) a copy of the international application, unless not required under subsection (a) of this section or already communicated by the International Bureau, and a translation into the English language of the international application, if it was filed in another language;

(3) amendments, if any, to the claims in the international application, made under article 19 of the treaty, unless such amendments have been communicated to the Patent and Trademark Office by the International Bureau, and a translation into the English language if such amendments were made in another language;

(4) an oath or declaration of the inventor (or other person authorized under chapter 11 of this title) complying with the requirements of section 115 of this title and with regulations prescribed for oaths or declarations of applicants;

(5) a translation into the English language of any annexes to the international preliminary examination report, if such annexes were made in another language.

(d) The requirement with respect to the national fee referred to in subsection (c)(1), the translation referred to in subsection (c)(2), and the oath or declaration referred to in subsection (c)(4) of this section shall be complied with by the date of the commencement of the national stage or by such later time as may be fixed by the Director. The copy of the international application referred to in subsection (c)(2) shall be submitted by the date of the commencement of the national stage. Failure to comply with these requirements shall be regarded as abandonment of the application by the parties thereof, unless it be shown to the satisfaction of the Director that such failure to comply was unavoidable. The payment of a surcharge may be required as a condition of accepting the national fee referred to in subsection (c)(1) or the oath or declaration referred to in subsection (c)(4) of this section if these requirements are not met by the date of the commencement of the national stage. The requirements of subsection (c)(3) of this section shall be complied with by the date of the commencement of the national stage, and failure to do so shall be regarded as a cancellation of the amendments to the claims in the international application made under article 19 of the treaty. The requirement of subsection (c)(5) shall be complied with at such time as may be fixed by the Director and failure to do so shall be regarded as cancellation of the amendments made under article 34 (2)(b) of the treaty.

(e) After an international application has entered the national stage, no patent may be granted or refused thereon before the expiration of the applicable time limit under article 28 or article 41 of the treaty, except with the express consent of the applicant. The applicant may present amendments to the specification, claims, and drawings of the application after the national stage has commenced.

(f) At the express request of the applicant, the national stage of processing may be commenced at any time at which the application is in order for such purpose and the applicable requirements of subsection (c) of this section have been complied with.

*37 CFR 1.491. National stage commencement and entry.*

(a) Subject to 35 U.S.C. 371(f), the national stage shall commence with the expiration of the applicable time limit under PCT Article 22(1) or (2), or under PCT Article 39(1)(a).

(b) An international application enters the national stage when the applicant has filed the documents and fees required by 35 U.S.C. 371(c) within the period set in \*\* § 1.495.

Subject to 35 U.S.C. 371(f), commencement of the national stage occurs upon expiration of the applicable time limit, as stated in 35 U.S.C. 371(b) and 37 CFR 1.491(a).

Entry into the national stage occurs upon completion of certain acts, as stated in 37 CFR 1.491(b).

### 1893.01(a) Entry via the U.S. Designated or Elected Office [R-2]

#### *PCT Article 2. Definitions*

\*\*\*\*\*

(xiii)“designated Office” means the national Office of or acting for the State designated by the applicant under Chapter I of this Treaty;

(xiv)“elected Office” means the national Office of or acting for the State elected by the applicant under Chapter II of this Treaty;

\*\*\*\*\*

#### *37 CFR 1.414. The United States Patent and Trademark Office as a Designated Office or Elected Office.*

(a) The United States Patent and Trademark Office will act as a Designated Office or Elected Office for international applications in which the United States of America has been designated or elected as a State in which patent protection is desired.

(b) The United States Patent and Trademark Office, when acting as a Designated Office or Elected Office during international processing will be identified by the full title “United States Designated Office” or by the abbreviation “DO/US” or by the full title “United States Elected Office” or by the abbreviation “EO/US.”

(c) The major functions of the United States Designated Office or Elected Office in respect to international applications in which the United States of America has been designated or elected, include:

(1) Receiving various notifications throughout the international stage and

(2) Accepting for national stage examination international applications which satisfy the requirements of 35 U.S.C. 371.

An international application designating the U.S. will enter the national stage via the U.S. Designated Office unless a Demand electing the U.S. is filed

under PCT Article 31 whereupon entry will be via the U.S. Elected Office. The procedure for entry is as prescribed in 37 CFR 1.495.

#### *37 CFR 1.495. Entering the national stage in the United States of America.*

(a) The applicant in an international application must fulfill the requirements of 35 U.S.C. 371 within the time periods set forth in paragraphs (b) and (c) of this section in order to prevent the abandonment of the international application as to the United States of America. The thirty-month time period set forth in paragraphs (b), (c), (d), (e) and (h) of this section may not be extended. International applications for which those requirements are timely fulfilled will enter the national stage and obtain an examination as to the patentability of the invention in the United States of America.

(b) To avoid abandonment of the application, the applicant shall furnish to the United States Patent and Trademark Office not later than the expiration of thirty months from the priority date:

(1) A copy of the international application, unless it has been previously communicated by the International Bureau or unless it was originally filed in the United States Patent and Trademark Office; and

(2) The basic national fee (see § 1.492(a)).

\*\*>

(c) If applicant complies with paragraph (b) of this section before expiration of thirty months from the priority date but omits either a translation of the international application, as filed, into the English language, if the international application was originally filed in another language and if any English language translation of the publication of the international application previously submitted under 35 U.S.C. 154(d) (§ 1.417) is not also a translation of the international application as filed (35 U.S.C. 371(c)(2)), or the oath or declaration of the inventor (35 U.S.C. 371(c)(4) and § 1.497), if a declaration of inventorship in compliance with § 1.497 has not been previously submitted in the international application under PCT Rule 4.17(iv) within the time limits provided for in PCT Rule 26<sup>ter</sup>.1, applicant will be so notified and given a period of time within which to file the translation and/or oath or declaration in order to prevent abandonment of the application. The payment of the processing fee set forth in § 1.492(f) is required for acceptance of an English translation later than the expiration of thirty months after the priority date. The payment of the surcharge set forth in § 1.492(e) is required for acceptance of the oath or declaration of the inventor later than the expiration of thirty months after the priority date. A “Sequence Listing” need not be translated if the “Sequence Listing” complies with PCT Rule 12.1(d) and the description complies with PCT Rule 5.2(b).<

(d) A copy of any amendments to the claims made under PCT Article 19, and a translation of those amendments into English, if they were made in another language, must be furnished not later than the expiration of thirty months from the priority date. Amendments under PCT Article 19 which are not received by the expiration of thirty months from the priority date will be considered to be canceled.

(e) A translation into English of any annexes to an international preliminary examination report (if applicable), if the



annexes were made in another language, must be furnished not later than the expiration of thirty months from the priority date. Translations of the annexes which are not received by the expiration of thirty months from the priority date may be submitted within any period set pursuant to paragraph (c) of this section accompanied by the processing fee set forth in § 1.492(f). Annexes for which translations are not timely received will be considered canceled.

(f) Verification of the translation of the international application or any other document pertaining to an international application may be required where it is considered necessary, if the international application or other document was filed in a language other than English.

\*\*>

(g) The documents and fees submitted under paragraphs (b) and (c) of this section must be clearly identified as a submission to enter the national stage under 35 U.S.C. 371. Otherwise, the submission will be considered as being made under 35 U.S.C. 111(a).<

(h) An international application becomes abandoned as to the United States thirty months from the priority date if the requirements of paragraph (b) of this section have not been complied with within thirty months from the priority date. If the requirements of paragraph (b) of this section are complied with within thirty months from the priority date but either of any required translation of the international application as filed or the oath or declaration are not timely filed, an international application will become abandoned as to the United States upon expiration of the time period set pursuant to paragraph (c) of this section.

### **1893.01(a)(1) Submissions Required by 30 Months from the Priority Date [R-2]**

To begin entry into the national stage, applicant is required to comply with 37 CFR 1.495(b) within 30 months from the priority date. Thus, applicant must pay the basic national fee on or before 30 months from the priority date and be sure that a copy of the international application has been received by the U.S. Designated or Elected Office prior to expiration of 30 months from the priority date. \*\*>Where the international application was filed with the United States Receiving Office as the competent receiving Office, the copy of the international application referred to in 37 CFR 1.495(b) is not required.< Payment of the basic national fee will indicate applicant's intention to enter the national stage and will provide a U.S. correspondence address in most instances.

Facsimile transmission is not acceptable for submission of the basic national fee and/or the copy of the international application. See 37 CFR 1.6(d).

Likewise, the certificate of mailing procedures of 37 CFR 1.8 do not apply to the filing of the copy of the international application and payment of the basic national fee. See 37 CFR 1.8(a)(2)(i)(F).

Applicants cannot pay the basic national fee with a surcharge after the 30 month deadline. Failure to pay the basic national fee within 30 months from the priority date will result in abandonment of the application. The time for payment of the basic fee is not extendable.

Similarly, the copy of the international application \* required \* >under 37 CFR 1.495(b) must< be provided within 30 months from the priority date >to avoid abandonment<. A copy of the international application is provided to the U.S. Designated or Elected Office by the International Bureau (the copy is ordinarily received shortly after publication at about 18 months from the priority date). The International Bureau also mails a confirmation (Form \*>PCT/IB/308)< to applicant upon which applicant can rely that the copy has been provided. >This confirmation constitutes conclusive evidence of transmission of the international application.< See PCT Rule 47.1(c). The copy >of the international application< is placed in a file to await applicant's submission of the basic national fee and other national stage requirements.

If the basic national fee has been paid >and the copy of the international application (if required) has been received< by expiration of 30 months from the priority date>,< but the required oath >or< declaration or translation has not been filed within 30 months from the priority date, \*\* the Office will send applicant a \*>Notification of Missing Requirements (Form PCT/DO/EO/905) identifying any deficiency< and provide a period of time to \*>correct< the deficiency as set forth in 37 CFR 1.495(c). The time period usually set is 2 months from the date of the notification by the Office or 32 months from the priority date, whichever is later. This period may be extended for up to 5 additional months pursuant to the provisions of 37 CFR 1.136(a). \*\*>Failure to timely file the proper reply to the notification will result in abandonment of the national stage application.

For further information regarding the oath or declaration required under 35 U.S.C. 371(c)(4) and 37 CFR 1.497 for entry into the U.S. national phase, see MPEP § 1893.01(e).

For further information regarding the translation required under 35 U.S.C. 371(c)(2) and 37 CFR 1.495(c), see MPEP § 1893.01(d).<

### **1893.01(a)(2) Article 19 Amendment (Filed With the International Bureau) [R-2]**

The >claims of an< international application may be amended under >PCT< Article 19 after issuance of the search report. >The description and drawings may not be amended under PCT Article 19.< The amendment is forwarded to the U.S. Designated Office by the International Bureau for inclusion in the U.S. national stage application. Article 19 amendments which were made in English will be entered by substituting each page of amendment for the corresponding English language page of claims of the international application. If the Article 19 amendments were made in a language other than English, applicant must provide an English translation for the U.S. national stage application. The >Article 19 amendment(s) and the< English translation of the amendment(s) must be \*>received by the Office< by 30 months from the priority date, \*>unless applicant has requested early processing of the national stage application under 35 U.S.C. 371(f), in which case the amendment(s) under PCT Article 19 and the English translation of the amendment(s) must be filed by the time applicant has submitted the basic national fee, an oath or declaration in compliance with 37 CFR 1.497(a)-(b), and any required translation of the international application if such time is earlier than 30 months from the priority date. Otherwise,< the amendment(s) will be considered to be canceled, 35 U.S.C. 371(d). \*\* If such >canceled< amendments are desired, they \*>must< be offered under 37 CFR 1.121 as a preliminary amendment or a responsive amendment under 37 CFR 1.111.

Applicants entering the national stage in the U.S. are encouraged to submit an amendment in accordance with 37 CFR 1.121 rather than an English translation of an Article 19 amendment. Sometimes when an Article 19 amendment is translated into English, it cannot be entered. That is, each page of an Article 19 amendment must be entered by substituting a page of amendment for the corresponding page of claims of the international application. After translation of a

page, the translated page may no longer correspond to a page of the claims of the international application such that the amendment is capable of entry by substituting the page of English translation (of the amendment) for the corresponding page of claims of the international application without leaving an inconsistency. Where applicant chooses to submit an English translation of the Article 19 amendment, applicant should check to be sure that the English translation can be entered by substituting the pages of translation for corresponding pages of the claims of the international application without leaving an inconsistency. If entry of the page of translation causes inconsistencies in the claims of the international application the translation will not be entered. For example, if the translation of the originally filed application has a page which begins with claim 1 and ends with a first part of claim 2 with the remainder of claim 2 on the next page then translation of the Article 19 amendment to only claim 1 must include a substitute page or pages beginning with the changes to claim 1 and ending with the last of the exact same first part of claim 2. This enables the original translated first page of claims to be replaced by the translation of the amendment without changing the subsequent unamended page(s). Alternatively, applicant may submit a preliminary amendment in accordance with 37 CFR 1.121.

### **1893.01(a)(3) Article 34 Amendments (Filed with the International Preliminary Examining Authority) [R-2]**

\*\*>Amendments to the international application that were properly made under PCT Article 34 during the international preliminary examination phase (i.e., Chapter II) will be annexed by the International Preliminary Examining Authority to the international preliminary examination report (IPER) and communicated to the elected Offices. See PCT Article 36, PCT Rule 70.16, and MPEP § 1893.03(e). If these annexes are in English, they will normally be entered into the U.S. national stage application by the Office absent a clear instruction by the applicant that the annexes are not to be entered. However, if entry of the replacement sheets will result in an obvious inconsistency in the description, claims or drawings of the international application, then the annexes will not be

entered. If the annexes are in a foreign language, a proper translation of the annexes must be furnished to the Office not later than the expiration of 30 months from the priority date, unless a period has been set pursuant to 37 CFR 1.495(c) to furnish an oath or declaration or English translation of the international application, in which case the translations of the annexes, accompanied by the processing fee set forth in 37 CFR 1.492(f), may be submitted within the period set pursuant to 37 CFR 1.495(c). See 37 CFR 1.495(e). Annexes for which translations are not timely received will be considered canceled. Amendments made under PCT Article 34 to the international application after commencement and entry into the U.S. national phase (see MPEP § 1893.01) will not be considered in a U.S. national stage application. However, applicants may still amend the U.S. national stage application by way of a preliminary amendment submitted in accordance with 37 CFR 1.115 and 37 CFR 1.121.

Where an English translation of the annexes is provided, the translation must be such that the translation of the originally filed application can be changed by replacing the originally filed application page(s) (of translation) with substitute page(s) of translation of the annex. \*\*>Thus<, applicant should check to be sure that the English translation can be entered by substituting the pages of translation for corresponding pages of the claims of the international application without leaving an inconsistency. If entry of the page of translation causes inconsistencies in the specification or claims of the international application the translation will not be entered. >Non-entry of the annexes will be indicated on the “NOTICE OF ACCEPTANCE OF APPLICATION UNDER 35 U.S.C. 371 AND 37 CFR 1.495” (Form PCT/DO/EO/903).< For example, if the translation of the originally filed application has a page which begins with claim 1 and ends with a first part of claim 2 with the remainder of claim 2 on the next page then translation of the annex to only claim 1 must include a substitute page or pages beginning with the changes to claim 1 and ending with the last of the exact same first part of claim 2. This enables the original translated first page of claims to be replaced by the translation of the annex without changing the subsequent unamended page(s). Alternatively applicant may submit a preliminary amendment in accordance with 37 CFR 1.121.

>The fact that an amendment made to the international application during the international phase was entered in the national stage application does not necessarily mean that the amendment is proper. Specifically, amendments are not permitted to introduce “new matter” into the application. See PCT Article 34(2)(b). Where it is determined that such amendments introduce new matter into the application, then the examiner should proceed as in the case of regular U.S. national applications filed under 35 U.S.C. 111(a) by requiring removal of the new matter and making any necessary rejections to the claims. See MPEP § 608.04 and § 2163.06.<

### 1893.01(c) Fees [R-2]

Because the national stage fees are subject to change, applicants and examiners should always consult the *Official Gazette* for the current fee listing.

Fees under 37 CFR 1.16 relate to national applications under 35 U.S.C. 111(a), and not to international applications entering the national stage under 35 U.S.C. 371. National stage fees are specifically provided for in 37 CFR 1.492. >However, an authorization to charge fees under 37 CFR 1.16 in an international application entering the national stage under 35 U.S.C. 371 will be treated as an authorization to charge fees under 37 CFR 1.492. See 37 CFR 1.25(b). Accordingly, applications< will not be held abandoned if an authorization to charge fees under 37 CFR 1.16 has been provided instead of an authorization to charge fees under 37 CFR 1.492.

\*\* >A preliminary amendment accompanying the initial national stage submission under 35 U.S.C. 371 that cancels claims and/or eliminates multiple dependent claims will be effective to reduce the number of claims to be considered in calculating extra claim fees required under 37 CFR 1.492(b)-(c) and/or eliminate the multiple dependent claim fee required under 37 CFR 1.492(d). A subsequently filed amendment canceling claims and/or eliminating multiple dependent claims will not entitle applicant to a refund of fees previously paid. See MPEP § 607 and § 608.<

### 1893.01(d) Translation [R-2]

Applicants entering the national stage in the U.S. are required to file \*>an English< translation of the international application \*if the international application was filed in another language \*>and was not pub-

lished under PCT Article 21(2) in English. 35 U.S.C. 371(c)(2) and 37 CFR 1.495(c). A “Sequence Listing” need not be translated if the “Sequence Listing” complies with PCT Rule 12.1(d) and the description complies with PCT Rule 5.2(b). See 37 CFR 1.495(c). The translation must be a translation of the international application as filed or with any changes which have been properly accepted under PCT Rule 26 or any rectifications which have been properly accepted under PCT Rule 91. A translation of less than all of the international application (e.g., a translation that fails to include a translation of text contained in the drawings or a translation that includes a translation of claims amended under PCT Article 19 or 34 but does not include a translation of the original claims) is unacceptable. In addition, a translation that includes modifications other than changes that have been properly accepted under PCT Rule 26 or 91 (e.g., a translation that includes headings that were not present in the international application as originally filed) is unacceptable. A translation of words contained in the drawings must be furnished either in the form of new drawings or in the form of a copy of the original drawings with the translation pasted on the original text matter. See PCT Rule 49.5(d).

Amendments, even those considered to be minor or to not include new matter, may not be incorporated into the translation. If an amendment to the international application as filed is desired for the national stage, it may be submitted in accordance with 37 CFR 1.121. An amendment filed under 37 CFR 1.121 should be submitted within 1 month after completion of the 35 U.S.C. 371(c) requirements and entry into the national stage. See 37 CFR 1.496(a). If applicant has timely paid the basic national fee and submitted the copy of the international application but the translation is missing or is defective, a Notification of Missing Requirements (PCT/DO/EO/905) will be sent to applicant setting a period to correct any missing or defective requirements. The time period is 32 months from the priority date or 2 months from the date of the notice, whichever expires later. The time period may be extended for up to five additional months as provided in 37 CFR 1.136(a). A processing fee is required for accepting a translation after 30 months from the priority date. See 37 CFR 1.492(f).

Pursuant to PCT Rule 48.3(c), if the international application is published in a language other than

English, the publication shall include an English translation of the title of the invention, the abstract, and any text matter pertaining to the figure or figures accompanying the abstract. The translations shall be prepared under the responsibility of the International Bureau.

A translation of the international application as filed and identified as provided in 37 CFR 1.417 submitted for the purpose of obtaining provisional rights pursuant to 35 U.S.C. 154(d)(4) can be relied on to fulfill the translation requirement under 35 U.S.C. 371(c)(2) in a national stage application. See 37 CFR 1.495(g).

### 1893.01(e) Oath/Declaration [R-2]

*37 CFR 1.497. Oath or declaration under 35 U.S.C. 371(c)(4).*

(a) When an applicant of an international application desires to enter the national stage under 35 U.S.C. 371 pursuant to § 1.495, and a declaration in compliance with this section has not been previously submitted in the international application under PCT Rule 4.17(iv) within the time limits provided for in PCT Rule 26<sup>ter</sup>.1, he or she must file an oath or declaration that:

- (1) Is executed in accordance with either §§ 1.66 or 1.68;
- (2) Identifies the specification to which it is directed;
- (3) Identifies each inventor and the country of citizenship of each inventor; and
- (4) States that the person making the oath or declaration believes the named inventor or inventors to be the original and first inventor or inventors of the subject matter which is claimed and for which a patent is sought.

(b)(1) The oath or declaration must be made by all of the actual inventors except as provided for in §§ 1.42, 1.43 or 1.47.

(2) If the person making the oath or declaration or any supplemental oath or declaration is not the inventor (§§ 1.42, 1.43, or §1.47), the oath or declaration shall state the relationship of the person to the inventor, and, upon information and belief, the facts which the inventor would have been required to state. If the person signing the oath or declaration is the legal representative of a deceased inventor, the oath or declaration shall also state that the person is a legal representative and the citizenship, residence and mailing address of the legal representative.

(c) Subject to paragraph (f) of this section, if the oath or declaration meets the requirements of paragraphs (a) and (b) of this section, the oath or declaration will be accepted as complying with 35 U.S.C. 371(c)(4) and § 1.495(c). However, if the oath or declaration does not also meet the requirements of § 1.63, a supplemental oath or declaration in compliance with § 1.63 or an application data sheet will be required in accordance with § 1.67.

(d) If the oath or declaration filed pursuant to 35 U.S.C. 371(c)(4) and this section names an inventive entity different from the inventive entity set forth in the international application, or if a change to the inventive entity has been effected under PCT Rule 92bis subsequent to the execution of any oath or declaration

which was filed in the application under PCT Rule 4.17(iv) or this section and the inventive entity thus changed is different from the inventive entity identified in any such oath or declaration, applicant must submit:

(1) A statement from each person being added as an inventor and from each person being deleted as an inventor that any error in inventorship in the international application occurred without deceptive intention on his or her part;

(2) The processing fee set forth in § 1.17(i); and

(3) If an assignment has been executed by any of the original named inventors, the written consent of the assignee (see § 3.73(b) of this chapter); and

(4) Any new oath or declaration required by paragraph (f) of this section.

(e) The Office may require such other information as may be deemed appropriate under the particular circumstances surrounding the correction of inventorship.

(f) A new oath or declaration in accordance with this section must be filed to satisfy 35 U.S.C. 371(c)(4) if the declaration was filed under PCT Rule 4.17(iv), and:

(1) There was a change in the international filing date pursuant to PCT Rule 20.2 after the declaration was executed; or

(2) A change in the inventive entity was effected under PCT Rule 92bis after the declaration was executed and no declaration which sets forth and is executed by the inventive entity as so changed has been filed in the application.

(g) If a priority claim has been corrected or added pursuant to PCT Rule 26<sup>bis</sup> during the international stage after the declaration of inventorship was executed in the international application under PCT Rule 4.17(iv), applicant will be required to submit either a new oath or declaration or an application data sheet as set forth in § 1.76 correctly identifying the application upon which priority is claimed.

Applicants entering the national stage in the U.S. are required to file an oath or declaration of the inventor in accordance with 37 CFR 1.497(a) and (b). If the basic national fee and copy of the international application has been received by the expiration of 30 months from the priority date, but the required oath or declaration has not been filed, the Office will send applicant a Notification of Missing Requirements (Form PCT/DO/EO/905) setting a time period to correct any missing or defective requirements and to submit the surcharge fee required under 37 CFR 1.492(e) unless previously paid. The time period is 32 months from the priority date or 2 months from the date of the notice, whichever expires later. The time period may be extended for up to five additional months as provided in 37 CFR 1.136(a). Failure to timely file the required oath or declaration will result in abandonment of the application.

An oath or declaration satisfying the requirements of 37 CFR 1.497(a)-(b) will be sufficient for the pur-

poses of entering the U.S. national phase. However, if the oath or declaration fails to also comply with the additional requirements for oaths and declarations set forth in 37 CFR 1.63, applicants will need to submit a supplemental oath or declaration, or an application data sheet where permitted under 37 CFR 1.63(c), to correct the deficiency. See 37 CFR 1.497(c).

In general, the requirement for an oath or declaration in compliance with 37 CFR 1.497(a)-(b) will have been previously satisfied if a declaration in compliance with PCT Rule 4.17 (iv) and executed by all the inventors was submitted within the time limits provided in PCT Rule 26<sup>ter</sup>.1 in the international phase. However, if the inventorship was changed in the international application under PCT Rule 92<sup>bis</sup> such that the inventorship identified in the PCT Rule 4.17(iv) declaration no longer corresponds to that of the international application (see 37 CFR 1.41(a)(4)), then a new oath or declaration in accordance with 37 CFR 1.497(a)-(b) will be required to enter the national stage. See 37 CFR 1.497(f)(2). Similarly, a new oath or declaration in compliance with 37 CFR 1.497(a)-(b) is required where the PCT Rule 4.17(iv) declaration was executed prior to a change in the international filing date pursuant to PCT Rule 20.2. See 37 CFR 1.497(f)(1). In addition, where a priority claim has been corrected or added pursuant to PCT Rule 26<sup>bis</sup> after execution of the PCT Rule 4.17(iv) declaration, then a supplemental oath or declaration, or an application data sheet, identifying the correct priority claim will be required. See 37 CFR 1.497(g).

## CORRECTION OF INVENTORSHIP

The inventorship of an international application entering the national stage under 35 U.S.C. 371 is that inventorship set forth in the international application, which includes any changes effected under PCT Rule 92<sup>bis</sup>. See 37 CFR 1.41(a)(4). Accordingly, an oath or declaration that names an inventive entity different than that set forth in the international application will not be accepted for purposes of entering the U.S. national phase unless the requirements under 37 CFR 1.497(d) are satisfied. These requirements include: (A) a statement from each person being added as an inventor and from each person being deleted as an inventor that any error in inventorship in the international application occurred without deceptive inten-

tion on his or her part; (B) the processing fee set forth in 37 CFR 1.17(i); and (C) the written consent of the assignee if an assignment has been executed by any of the original named inventors (see 37 CFR 3.73(b)).<

If an inventor refuses to execute the oath or declaration or \*\*>cannot be found or reached after diligent effort<, applicant must file an oath or declaration and a petition in accordance with 37 CFR 1.47. >See 37 CFR 1.497(b) and MPEP § 409.03.< Similarly, where an inventor is deceased or legally incapacitated, an oath or declaration in accordance with the provisions of 37 CFR 1.42 or 1.43 must be provided. \*\*>See 37 CFR 1.497(b) and MPEP § 409.01 and § 409.02.

Where there has been no change of inventorship but the name of an inventor indicated in the international application is different from the corresponding name indicated in an oath or declaration submitted under 37 CFR 1.497, for example, on account of marriage, then a petition under 37 CFR 1.182 will be required to accept the oath or declaration with the changed name. See MPEP § 605.04(c).<

### 1893.02 Abandonment [R-1]

If the requirements of 35 U.S.C. 371(c) are not complied with by the time period set in \*\* 37 CFR 1.495(b) and (c), \*\* the application is considered to be abandoned, see \*\* 37 CFR 1.495(h).

Examiners and applicants should be aware that sometimes papers filed for the national stage are deficient and abandonment results. For example, if the fee submitted does not include at least the amount of the basic national fee that is due, the application becomes abandoned.

Applicant may file a petition to revive an abandoned application in accordance with the provisions of 37 CFR 1.137. See MPEP § 711.03(c).

### 1893.03 Prosecution of U.S. National Stage Applications Before the Examiner [R-2]

*37 CFR 1.496. Examination of international applications in the national stage.*

(a) International applications which have complied with the requirements of 35 U.S.C. 371(c) will be taken up for action based on the date on which such requirements were met. However, unless an express request for early processing has been filed under 35 U.S.C. 371(f), no action may be taken prior to one month after entry into the national stage.

(b) A national stage application filed under 35 U.S.C. 371 may have paid therein the basic national fee as set forth in § 1.492(a)(4) if it contains, or is amended to contain, at the time of entry into the national stage, only claims which have been indicated in an international preliminary examination report prepared by the United States Patent and Trademark Office as satisfying the criteria of PCT Article 33(1)-(4) as to novelty, inventive step and industrial applicability. Such national stage applications in which the basic national fee as set forth in § 1.492(a)(4) has been paid may be amended subsequent to the date of entry into the national stage only to the extent necessary to eliminate objections as to form or to cancel rejected claims. Such national stage applications in which the basic national fee as set forth in § 1.492(a)(4) has been paid will be taken up out of order.

An international application which enters the national stage will be forwarded to the appropriate Technology Center (TC) for examination in turn based on the 35 U.S.C. 371(c) date of the application. As set forth in 37 CFR 1.496(b), if an application includes only claims which have been indicated in an IPER prepared by the USPTO to satisfy the criteria of PCT Article 33(1)-(4), the application qualifies for the reduced basic national fee set forth in 37 CFR 1.492(a)(4). Applications in which the reduced basic national fee has been paid will be taken up out of order by the examiner. See MPEP § 708 for a discussion of the order of examination of applications by examiners.

Once the national stage application has been taken up by the examiner, prosecution proceeds in the same manner as for a domestic application with the exceptions that:

(A) the international filing date is the date to keep in mind when searching the prior art; and

(B) unity of invention proceeds as under 37 CFR 1.475.

>In addition, the International Publication Number and the Publication Date MUST be in the national stage application if the application is allowed. The International Publication Number and the Publication date can be found in the WIPO Publication block on the DO/US Worksheet. If the Publication Number and the Publication date are not found on the worksheet or if the worksheet is missing, the information may be taken either from the International Publication or the *PCT Gazette* page. The examiner should ensure that the International Publication Number and the Publication date are in one of these three locations before the application is sent to Office of Patent Publication.<

### 1893.03(a) How To Identify That an Application Is a U.S. National Stage Application [R-2]

Applicant's initially deposited application must be clearly identified as a submission to enter the national stage under 35 U.S.C. 371. See 37 CFR 1.495(g). Otherwise, unless the submission is clearly identified as a submission pursuant to 35 U.S.C. 154(d)(4) for the purpose of obtaining provisional rights, the application will be treated as an application filed under 35 U.S.C. 111(a). See 37 CFR 1.417.

That is, if applicant wishes the application to be filed under 35 U.S.C. 111(a), applicant's originally filed application papers need indicate simply that the papers are for a new U.S. patent application. If, however, applicant is submitting papers for entry into the national stage of a PCT application, or to establish an effective date for provisional rights resulting from the filing of a PCT application under 35 U.S.C. 154(d), applicant must so state. Examination of the original application papers occurs in either the Office of Initial Patent Examination or in the National Stage Processing Division of the Office of PCT Operations where it is determined whether applicant has asked that the papers be treated as a submission to enter the national stage under 35 U.S.C. 371. If the application is accepted for entry into the national stage, the National Stage Processing Division will mail Form PCT/DO/EO/903 indicating acceptance of the application as a national stage submission under 35 U.S.C. 371 and will stamp the face of the file with an indication that the application is "filed under 35 U.S.C. 371." Accordingly, the key indicators which reflect that an application is an application which entered the national stage from an international application after compliance with 35 U.S.C. 371 are:

(A) The file face indication of "filed under 35 U.S.C. 371";

(B) PALM will indicate that the application is a national stage application (e.g., under "Continuity Data");

(C) The Form PCT/DO/EO/903 indicating acceptance of the application as a national stage application which has met the requirements of 35 U.S.C. 371; and

\*>

(D) Applicant's statement (or the equivalent) in the originally filed application papers that the application is a submission to enter the national stage under 35 U.S.C. 371. Applicants who use transmittal Form PCT/DO/EO/1390 will, in the absence of conflicting instructions, satisfy the requirement for such a statement since the form includes an indication that the application is a national stage submission under 35 U.S.C. 371.

Initially, the examiner should inspect the face of the file wrapper (if not an IFW) and/or PALM for an indication that it was submitted under 35 U.S.C. 371 and should also check the application papers for the presence of Form PCT/DO/EO/903. If neither of these indications are present the application may, in the absence of evidence to the contrary (there is an indication in the originally filed application papers that processing as a national stage is desired), be treated as a filing under 35 U.S.C. 111(a). Thus, if both indications are present, the application should be treated as a submission under 35 U.S.C. 371. If the application is not an IFW and the face of the file wrapper does not indicate "filed under 35 U.S.C. 371," but a properly completed Form PCT/DO/EO/903 is in the file, the examiner should complete the face of the file by adding "filed under 35 U.S.C. 371" in the upper left margin thereof. The examiner should initial and date this change. If the file wrapper does not include a properly completed Form PCT/DO/EO/903 but the face of the file indicates "filed under 35 U.S.C. 371," the application should be returned to the National Stage Processing Division of the Office of PCT Operations for certification that the application has been accepted for the national stage.

In accordance with the notice at 1077 O.G. 13 (14 April 1987), if the applicant files a U.S. national application and clearly identifies in the accompanying oath or declaration the specification to which it is directed by referring to a particular international application by PCT Application Number and International Filing Date and that he or she is executing the declaration as, and seeking a U.S. Patent as, the inventor of the invention described in the identified international application, then the application will be accepted as submitted under 35 U.S.C. 371. Merely claiming priority of an international (PCT)

application in an oath or declaration will not serve to indicate a \*>submission< under 35 U.S.C. 371. Also, if there are any conflicting instructions as to whether the filing is under 35 U.S.C. 111(a) or 35 U.S.C. 371, the application will be accepted as filed under 35 U.S.C. 111(a). \*\*>A conflicting instruction will be present, for example, where applicant includes in the initial submission under 35 U.S.C. 371, a “Utility

Patent Application Transmittal” (Form PTO/SB/05) or includes a benefit claim under 35 U.S.C. 120 to the international application. Applications that have been processed under 35 U.S.C. 371 and later found by the examiner to contain conflicting instructions should be forwarded to the Office of PCT Legal Administration for resolution.<



\*\*&gt;



## UNITED STATES PATENT AND TRADEMARK OFFICE

UNITED STATES DEPARTMENT OF COMMERCE  
 United States Patent and Trademark Office  
 Address: COMMISSIONER FOR PATENTS  
 P.O. Box 1450  
 Alexandria, Virginia 22313-1450  
 www.uspto.gov

U.S. APPLICATION NUMBER NO.	FIRST NAMED APPLICANT	ATTY. DOCKET NO.
10/611,687	John Smith	00000

INTERNATIONAL APPLICATION NO.

PCT/BR02/33313

I.A. FILING DATE

PRIORITY DATE

01/01/2003

12/28/2002

John Smith  
 212 Main Street  
 Anytown, PA 12345

CONFIRMATION NO. 1271

371 ACCEPTANCE LETTER



\*OC00000009879118\*

Date Mailed: 02/19/2004

**NOTICE OF ACCEPTANCE OF APPLICATION UNDER 35 U.S.C 371 AND 37 CFR 1.495**

The applicant is hereby advised that the United States Patent and Trademark Office in its capacity as a Designated / Elected Office (37 CFR 1.495), has determined that the above identified international application has met the requirements of 35 U.S.C. 371, and is ACCEPTED for national patentability examination in the United States Patent and Trademark Office.

The United States Application Number assigned to the application is shown above and the relevant dates are:

11/01/200311/01/2003

DATE OF RECEIPT OF 35 U.S.C. 371(c)(1), (c)(2)  
 and (c)(4) REQUIREMENTS

DATE OF COMPLETION OF ALL 35 U.S.C. 371  
 REQUIREMENTS

A Filing Receipt (PTO-103X) will be issued for the present application in due course. **THE DATE APPEARING ON THE FILING RECEIPT AS THE " FILING DATE" IS THE DATE ON WHICH THE LAST OF THE 35 U.S.C. 371 (c)(1), (c)(2) and (c)(4) REQUIREMENTS HAS BEEN RECEIVED IN THE OFFICE. THIS DATE IS SHOWN ABOVE.** The filing date of the above identified application is the international filing date of the international application (Article 11(3) and 35 U.S.C. 363). Once the Filing Receipt has been received, send all correspondence to the Group Art Unit designated thereon.

The following items have been received:

- Indication of Small Entity Status
- Copy of the International Application filed on 11/01/2003
- English Translation of the IA filed on 11/01/2003
- Copy of the International Search Report filed on 11/01/2003
- Copy of IPE Report filed on 11/01/2003
- Copy of Annexes to the IPE filed on 11/01/2003
- Copy of Article 19 Amendments filed on 11/01/2003
- Preliminary Amendments filed on 11/01/2003
- Information Disclosure Statements filed on 11/01/2003
- Biochemical Sequence Diskette filed on 11/01/2003
- Oath or Declaration filed on 11/01/2003
- Biochemical Sequence Listing filed on 11/01/2003
- Small Entity Statement filed on 11/01/2003
- Request for Immediate Examination filed on 11/01/2003
- Copy of references cited in ISR filed on 11/01/2003

- U.S. Basic National Fees filed on 11/01/2003
- Substitute Specification filed on 11/01/2003
- Assignment filed on 11/01/2003
- Priority Documents filed on 11/01/2003
- Power of Attorney filed on 11/01/2003

The following defects have been observed:

- The translations of Annexes are canceled since the translations were not submitted prior to 30 months from the priority date.

---

Applicant is reminded that any communications to the United States Patent and Trademark Office must be mailed to the address given in the heading and include the U.S. application no. shown above (37 CFR 1.5)

---

TAMALA D HOLLAND  
Telephone: (703) 305-5483

PART 1 - ATTORNEY/APPLICANT COPY

FORM PCT/DO/EO/903 (371 Acceptance Notice)

<

### 1893.03(b) The Filing Date of a U.S. National Stage Application [R-2]

An international application designating the U.S. has two stages (international and national) with the filing date being the same in both stages. Often the date of entry into the national stage is confused with the filing date. It should be borne in mind that the filing date of the international stage application is also the filing date for the national stage application. Specifically, 35 U.S.C. 363 provides that

An international application designating the United States shall have the effect, from its international filing date under Article 11 of the treaty, of a national application for patent regularly filed in the Patent and Trademark Office except as otherwise provided in section 102(e) of this title.

Similarly, PCT Article 11(3) provides that

...an international filing date shall have the effect of a regular national application in each designated State as of the international filing date, which date shall be considered to be the actual filing date in each designated State.

37 CFR 1.496(a), first sentence, reads “International applications which have complied with the requirements of 35 U.S.C. 371(c) will be taken up for action based on the date on which such requirements were met.” Thus, when the file wrapper label or PALM bib-data sheet \*and filing receipt are printed, the information is read from the PALM data base and the information printed in the filing date box is the date of receipt of 35 U.S.C. 371(c)(1), (c)(2) and (c)(4) requirements rather than the actual international filing date.

\*The NOTIFICATION OF ACCEPTANCE OF APPLICATION UNDER 35 U.S.C. 371 AND 37 CFR 1.495 (Form PCT/DO/EO/903), a copy of which is reproduced in MPEP § 1893.03(a), indicates the date of receipt of the 35 U.S.C. 371(c)(1), (c)(2), and (c)(4) requirements, and it also indicates the date of completion of all 35 U.S.C. 371 requirements, which is further explained below.

The “Application Filing Date” field formerly displayed in \*\*PAIR\*\* was changed to “Filing or 371(c) Date” to clearly indicate that for international applications that enter the national stage under 35 U.S.C. 371, the information displayed in this field

is the date of receipt of the 35 U.S.C. 371(c)(1), (c)(2) and (c)(4) requirements. Applicants are quite often confused as to the true filing date and will ask for corrected filing receipts thinking that the information thereon is wrong. This explanation should offer some clarity. For most legal purposes, the filing date is the PCT international filing date. Exceptions to this general rule include the following:

(A) Availability as a prior art reference under former 35 U.S.C. 102(e) (prior to the amendment by the American Inventors Protection Act of 1999 (AIPA) (Pub. L. 106-113, 113 Stat. 1501 (1999))). If a U.S. patent issued from an international application filed prior to November 29, 2000, the international application was not considered to have been filed in the United States for prior art purposes under 35 U.S.C. 102(e) and PCT Article 64(4)(a) until the date the application fulfilled the requirements of 35 U.S.C. 371(c) (1), (2), and (4).

(B) Availability as a prior art reference under 35 U.S.C. 102(e) as amended by the AIPA, and further amended by the Intellectual Property and High Technology Technical Amendments Act of 2002 (Pub. L. 107-273, 116 Stat. 1758 (2002)). If an international application was filed on or after November 29, 2000, but did not designate the U.S. or was not published in English under PCT Article 21(2), the international filing date is not treated as a U.S. filing date for prior art purposes under 35 U.S.C. 102(e). See MPEP § 706.02(a) and § 2136.03.

(C) Patent term adjustment under 35 U.S.C. 154(b)(1)(B) and 37 CFR 1.702(b) when the USPTO has failed to issue a patent within three years of the “actual filing date” of an application. In this situation, the “actual filing date” is the date the national stage commenced under 35 U.S.C. 371(b) or (f). See MPEP § 2730.

>The “Date of Completion of all 35 U.S.C. 371 Requirements” included on the NOTIFICATION OF ACCEPTANCE OF APPLICATION UNDER 35 U.S.C. 371 AND 37 CFR 1.495 (Form PCT/DO/EO/903) is relevant for purposes of patent term adjustment under 35 U.S.C. 154(b)(1)(A)(i)(II) and 37 CFR 1.702(a)(1) when the USPTO has failed to mail at least one of a notification under 35 U.S.C. 132 or a notice of allowance under 35 U.S.C. 151 not later than fourteen months after the date on which the

requirements under 35 U.S.C. 371 were fulfilled. This date is the latest of:

(A) the date of submission of the basic national fee;

(B) the date of submission or communication of the copy of the international application;

(C) the date of submission of the translation of the international application if the international application is not in the English language;

(D) the date of submission of an oath or declaration of the inventor in compliance with 35 U.S.C. 371 (c)(4) (see 37 CFR 1.497(c) for an explanation of when an oath or declaration will be accepted as complying with 35 U.S.C. 371(c)(4));

(E) the earlier of 30 months from the priority date or the date of request for early processing under 35 U.S.C. 371(f) if requested prior to 30 months from the priority date (Form PCT/DO/EO/903 will indicate the date early processing was requested);

(F) if a request for early processing has not been requested prior to 30 months from the priority date, the date of submission of any translation of the annexes to the international preliminary examination report if the annexes are filed within the time period set in a Notice of Missing Requirements (Form PCT/DO/EO/905) requiring either a translation of the international application or an oath or declaration; and

(G) the date of submission of any surcharge for submitting the oath or declaration later than 30 months from the priority date.<

### **1893.03(c) The Priority Date, Priority Claim, and Priority Papers for a U.S. National Stage Application [R-2]**

A U.S. national stage application **\*\*>**may be entitled to: (A) a right of priority under 35 U.S.C. 119(a) and 365(b) based on a prior foreign application or international application designating at least one country other than the United States; and (B) the benefit of an earlier filed U.S. national application or international application designating the United States pursuant to 35 U.S.C. 119(e) or 35 U.S.C. 120 and 365(c).

### **RIGHT OF< PRIORITY \* UNDER 35 U.S.C. 119(a) and 365(b)**

**\*\*>**Pursuant to 35 U.S.C. 365(b)< a U.S. national stage application **\*\*>**shall be entitled to a right of priority based on a prior foreign application or international application designating at least one country other than the United States in accordance with the conditions and requirements of< 35 U.S.C. 119(a) and **\*\*>**the treaty and the PCT regulations. See in particular PCT Article 8 and PCT Rules 4.10 and 26<sup>bis</sup>. To obtain priority in the U.S. national stage application to such applications, the priority must have been timely claimed in the international stage of the international application. See 37 CFR 1.55(a)(1)(ii). If priority< was properly claimed in the international stage of the international application, the claim for priority is acknowledged and the national stage application file is checked to see if the file contains a copy of the certified copy of the priority document submitted to the International Bureau.

If the **\*\*** priority claim in the national stage application is to an application, the priority of which was not claimed in the international stage of the international application, the claim for priority must be denied for failing to meet the requirements of the Patent Cooperation Treaty, specifically PCT Rule 4.10.

For a comparison with 35 U.S.C. 119(a)-(d) priority claims in a national application filed under 35 U.S.C. 111(a), see MPEP § 1895.01.

### **THE CERTIFIED COPY**

The requirement in PCT Rule 17 for a certified copy of the foreign priority application is normally fulfilled by applicant providing a certified copy to the receiving Office or to the International Bureau within 16 months from the priority date. Subsequently, the International Bureau forwards a photocopy of the certified priority document when it forwards a copy of the international application (shortly after publication at 18 months from the priority date) to each Designated Office. The copy from the International Bureau is placed in the U.S. national stage file. The International Bureau stamps the face of the photocopy of the certified priority document with an indication that the certified priority document was received at the International Bureau. The stamped copy of the priority document sent to the U.S. Patent and Trademark

Office from the International Bureau is acceptable to establish that applicant has filed a certified copy of the priority document. The examiner should acknowledge in the next Office action that the certified copy of the foreign priority document has been filed. Note

the example of an acceptable priority document with the stamp (box) in the upper right hand section indicating receipt by the International Bureau (WIPO) on 30 November 1992 and the stamped term "PRIORITY DOCUMENT."

REPUBLIQUE FRANÇAISE

INSTITUT NATIONAL DE LA PROPRIÉTÉ INDUSTRIELLE

PRIORITY DOCUMENT

REC'D 3 0 NOV 1992

WIPO PCT

# BREVETS D'INVENTION

## CERTIFICATS D'UTILITÉ CERTIFICATS D'ADDITION

### Copie officielle

Le Directeur général de l'Institut national de la propriété industrielle certifie que le document ci-annexé est la copie certifiée conforme, d'une demande de titre de propriété industrielle déposée à l'Institut.

Fait à Paris le       - 7 SEP. 1992      

*Pour le Directeur général de l'Institut  
national de la propriété industrielle*

*Le Chef de Division*

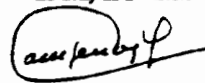

*Yves CAMPENON*



26bis, rue de Léninegrad 75800 PARIS Cédex 08  
Tél. (1) 42 94 52 52 Télex 290 368 INPI PAR Télécopie (1) 42 93 59 30  
Établissement public national créé par la loi n° 51-444 du 19 avril 1951

BA 267/141190

If applicant has not forwarded a certified copy of the priority application in time for the International Bureau to forward it to the U.S. Designated Office with the copy of the international application, then applicant will have to provide a certified copy of the priority document during the national stage to fulfill the requirement of 37 CFR 1.55(a)(2).

**\*>BENEFIT< CLAIM UNDER 35 U.S.C. 119(e), OR 120 AND 365(c)**

A national stage application may include a \*>benefit< claim under 35 U.S.C. 119(e), or 120 and 365(c) to a prior U.S. national application or under 35 U.S.C. 120 and 365(c) to a prior international application designating the U.S. The conditions for according benefit under 35 U.S.C. 120 are as described in MPEP § 201.07, § 201.08, and § 201.11 and are similar regardless of whether the U.S. national application is a national stage application submitted under 35 U.S.C. 371 or a national application filed under 35 U.S.C. 111(a).

The conditions for according benefit under 35 U.S.C. 119(e) are also similar for national stage applications and applications filed under 35 U.S.C. 111(a), and the conditions are described in MPEP § 201.11.

In order for a national stage application (of international application “X”) to obtain benefit under 35 U.S.C. 119(e) of a prior U.S. provisional application, the national stage application must comply with the requirements set forth in 37 CFR 1.78(a)(4) through 37 CFR 1.78(a)(6). Public Law 106-113 amended 35 U.S.C. 119(e) to eliminate the copendency requirement for a nonprovisional application claiming benefit of a provisional application. 35 U.S.C. 119(e)(2) as amended became effective on November 29, 1999 and applies to provisional applications filed on or after June 8, 1995. 37 CFR 1.78(a)(4) requires that the prior provisional application must be entitled to a filing date as set forth in 37 CFR 1.53(c), and the basic filing fee set forth in 37 CFR 1.16(k) must be paid on the provisional application within the time period set forth in 37 CFR 1.53(g). Additionally, the provisional application must name as an inventor at least one inventor named in the later filed international application “X” and disclose the named inventor’s invention claimed in at least one claim of the national stage application in the

manner provided by the first paragraph of 35 U.S.C. 112. The national stage application must contain a reference to the provisional application (either in an application data sheet (37 CFR 1.76) or in the first sentence of the specification), identifying it as a provisional application, and including the provisional application number (series code and serial number). The required reference to the earlier provisional application must be submitted within the time period provided by 37 CFR 1.78(a)(5)(ii). This time period is not extendable. >However, if the entire delay, between the date the claim was due under 37 CFR 1.78(a)(5)(ii) and the date the claim was filed, was unintentional, a petition under 37 CFR 1.78(a)(6) may be filed to accept the delayed claim.< If the provisional application was filed in a language other than English, the provisional application or the national stage application must contain an English-language translation of the non-English language provisional application and a statement that the translation is accurate. If the translation and statement that the translation is accurate were not previously filed in the provisional application or in the later-filed national stage application, applicant will be notified and given a period of time within which to file an English-language translation and a statement that the translation is accurate. Failure to timely reply to such a notice will result in abandonment of the national stage application. See 37 CFR 1.78(a)(5)(iv).

In order for a national stage application (of international application “X”) to obtain benefit under 35 U.S.C. 120 and 365(c) of a prior filed copending nonprovisional application or prior filed copending international application designating the United States of America, the national stage application must comply with the requirements set forth in 37 CFR 1.78(a)(1) through 37 CFR 1.78(a)(3). The prior nonprovisional application or international application must name as an inventor at least one inventor named in the later filed international application “X” and disclose the named inventor’s invention claimed in at least one claim of the national stage application in the manner provided by the first paragraph of 35 U.S.C. 112. The national stage application must contain a reference to the prior nonprovisional or international application (either in an application data sheet (37 CFR 1.76) or in the first sentence of the specification), identifying it by application number (series

code and serial number) or international application number and international filing date and indicating the relationship of the applications. The required reference to the earlier filed application must be submitted within the later of four months from the date on which the national stage commenced under 35 U.S.C. 371(b) or (f) or sixteen months from the filing date of the prior-filed application. This time period is not extendable and failure to timely submit the required reference to the earlier application will be considered a waiver of any benefit under 35 U.S.C. 120, 121, or 365(c) to such prior-filed application. See 37 CFR 1.78(a)(2)(ii). However, if the entire delay, between the date the claim was due under 37 CFR 1.78(a)(2)(ii) and the date the claim was filed, was unintentional, a petition under 37 CFR 1.78(a)(3) may be filed to accept the delayed claim.

A prior filed nonprovisional application is copending with the national stage application if the prior U.S. national application was pending on the international filing date of the national stage application.

A prior international application designating the United States of America is copending with the national stage application if the prior international application was not abandoned or withdrawn on the international filing date of international application "X."

Note: a national stage application submitted under 35 U.S.C. 371 may not claim benefit of the filing date of the international application of which it is the national stage since its filing date is the date of filing of that international application. See also MPEP § 1893.03(b). Stated differently, since the international application is not an earlier application (it has the same filing date as the national stage), a benefit claim >under 35 U.S.C. 120< in the national stage to the international application is inappropriate >and may result in the submission being treated as an application filed under 35 U.S.C. 111(a). See MPEP § 1893.03(a)<. Accordingly, it is not necessary for the applicant to amend the first sentence of the specification to reference the international application number that was used to identify the application during international processing of the application by the international authorities prior to commencement of the national stage.

For a comparison with 35 U.S.C. 120 benefit claims in a national application filed under 35 U.S.C. 111(a), see MPEP § 1895.

### **1893.03(d) Unity of Invention [R-2]**

*37 CFR 1.499. Unity of invention during the national stage*

If the examiner finds that a national stage application lacks unity of invention under § 1.475, the examiner may in an Office action require the applicant in the response to that action to elect the invention to which the claims shall be restricted. Such requirement may be made before any action on the merits but may be made at any time before the final action at the discretion of the examiner. Review of any such requirement is provided under §§ 1.143 and 1.144.

PCT Rule 13 was amended effective July 1, 1992. 37 CFR 1.475 was amended effective May 1, 1993 to correspond to PCT Rule 13.

Examiners are reminded that unity of invention (not restriction) practice is applicable in international applications (both Chapter I and II) and in national stage applications submitted under 35 U.S.C. 371. Restriction practice continues to apply to U.S. national applications filed under 35 U.S.C. 111(a), even if the application filed under 35 U.S.C. 111(a) claims >benefit under 35 U.S.C. 120 and 365(c)< to an earlier international application >designating the United States< or to an earlier U.S. national stage application submitted under 35 U.S.C. 371.

When making a lack of unity of invention requirement, the examiner must (1) list the different groups of claims and (2) explain why each group lacks unity with each other group (i.e., why there is no single general inventive concept) specifically describing the unique special technical feature in each group.

The principles of unity of invention are used to determine the types of claimed subject matter and the combinations of claims to different categories of invention that are permitted to be included in a single international or national stage patent application. >See MPEP § 1850 for a detailed discussion of Unity of Invention.< The basic principle is that an application should relate to only one invention or, if there is more than one invention, that applicant would have a right to include in a single application only those inventions which are so linked as to form a single general inventive concept.

A group of inventions is considered linked to form a single general inventive concept where there is a technical relationship among the inventions that



involves at least one common or corresponding special technical feature. The expression special technical features is defined as meaning those technical features that define the contribution which each claimed invention, considered as a whole, makes over the prior art. For example, a corresponding technical feature is exemplified by a key defined by certain claimed structural characteristics which correspond to the claimed features of a lock to be used with the claimed key. Note also >the< examples \*\* contained in \*\*>Chapter 10 of the International Search and Preliminary Examination Guidelines which can be obtained from WIPO's web site ([www.wipo.int/pct/en/texts/gdlines.htm](http://www.wipo.int/pct/en/texts/gdlines.htm))<.

A process is “specially adapted” for the manufacture of a product if the claimed process inherently produces the claimed product with the technical relationship being present between the claimed process and the claimed product. The expression “specially adapted” does not imply that the product could not also be manufactured by a different process.

An apparatus or means is specifically designed for carrying out the process when the apparatus or means is suitable for carrying out the process with the technical relationship being present between the claimed apparatus or means and the claimed process. The expression specifically designed does not imply that the apparatus or means could not be used for carrying out another process, nor does it imply that the process could not be carried out using an alternative apparatus or means.

Note: the determination regarding unity of invention is made without regard to whether a group of inventions is claimed in separate claims or as alternatives within a single claim. The basic criteria for unity of invention are the same, regardless of the manner in which applicant chooses to draft a claim or claims.

>

## FORM PARAGRAPHS FOR LACK OF UNITY IN NATIONAL STAGE APPLICATIONS

### ¶ 18.19 National Stage Restriction in 35 U.S.C. 371 Applications

Restriction is required under 35 U.S.C. 121 and 372.

This application contains the following inventions or groups of inventions which are not so linked as to form a single general inventive concept under PCT Rule 13.1.

In accordance with 37 CFR 1.499, applicant is required, in reply to this action, to elect a single invention to which the claims must be restricted.

#### Examiner Note:

1. This form paragraph is to be used when making a restriction requirement in an application filed under the provisions of 35 U.S.C. 371.
2. This form paragraph is to be followed by form paragraphs 18.06 through 18.06.02, as appropriate, and by form paragraph 18.07.

### ¶ 18.20 National Stage Election of Species in 35 U.S.C. 371 Applications

This application contains claims directed to more than one species of the generic invention. These species are deemed to lack unity of invention because they are not so linked as to form a single general inventive concept under PCT Rule 13.1.

The species are as follows:

[1]

Applicant is required, in reply to this action, to elect a single species to which the claims shall be restricted if no generic claim is finally held to be allowable. The reply must also identify the claims readable on the elected species, including any claims subsequently added. An argument that a claim is allowable or that all claims are generic is considered non-responsive unless accompanied by an election.

Upon the allowance of a generic claim, applicant will be entitled to consideration of claims to additional species which are written in dependent form or otherwise include all the limitations of an allowed generic claim as provided by 37 CFR 1.141. If claims are added after the election, applicant must indicate which are readable upon the elected species. MPEP § 809.02(a).

#### Examiner Note:

1. This form paragraph is to be used when making an election of species requirement in an application filed under the provisions of 35 U.S.C. 371.
2. In bracket 1, list each species by Fig. No. or embodiment.
3. This form paragraph is to be followed by form paragraphs 18.17 and 18.18.

### ¶ 18.21 National Stage Election by Original Presentation in 35 U.S.C. 371 Applications

Newly submitted claim [1] directed to an invention that lacks unity with the invention originally claimed for the following reasons: [2]

Since applicant has received an action on the merits for the originally presented invention, this invention has been constructively elected by original presentation for prosecution on the merits. Accordingly, claim [3] withdrawn from consideration as being directed to a non-elected invention. See 37 CFR 1.142(b) and MPEP § 821.03.

<

### **1893.03(e) Papers Received from the International Bureau and Placed in a U.S. National Stage Application File [R-2]**

The national stage application includes papers forwarded by the International Bureau and papers from applicant. Some of the papers from the International Bureau are identified in this section with a brief note as to their importance to the national stage application. The examiner should review each such paper and the important aspect indicated.

#### **THE PAMPHLET**

The Pamphlet includes

(A) a cover page with the applicant/inventor data, the application data (\*>application< number, filing date, etc.) and the Abstract (and, if appropriate, a figure of drawing),

(B) the description, claims and drawing parts of the international application, and

(C) the search report (Form PCT/ISA/210).

The cover page is important as a source of the correct application data, most importantly the filing date and priority date accorded to the international application. If the pamphlet is published in English, \*\*>the< Office will use the description, claims, abstract and drawings as published in the pamphlet for the U.S. national stage \*>application< under 35 U.S.C. 371. The description, claims and drawing parts of the international application reflect the application subject matter on the international filing date and are important for comparison with any amendments to check for new matter. The search report reflects the International Searching Authority's opinion regarding the prior art.

When the international application is published as the pamphlet, the abstract is reproduced on the cover page of the publication, even though it appears on a separate sheet of the international application in accordance with PCT Rule 11.4(a). Thus the requirement of 37 CFR 1.52(b) that the abstract "commence on a separate >physical< sheet >or electronic page<" does not apply to the copy of the application (pamphlet) communicated to the designated Offices by the International Bureau under PCT Article 20. Accordingly, it is improper for the examiner of the U.S.

national stage application to require the applicant to provide an abstract commencing on a separate sheet if the abstract does not appear on a separate sheet in the pamphlet. Unless the abstract is properly amended under the U.S. rules during national stage processing, the abstract that appears on the cover page of the pamphlet will be the abstract published by the USPTO under 35 U.S.C. 122(b) and in any U.S. patent issuing from the application.

>In addition, the Office will normally use the title of the invention indicated on the cover page of the publication as the title of the national stage application that will appear on the filing receipt. The cover page will include an English translation of the title if the international application was published in a foreign language. See PCT Rule 48.3(c). Applicants desiring to have the filing receipt reflect a title that is different than the English language title appearing on the cover page must submit either a preliminary amendment amending the title or an application data sheet (37 CFR 1.76) with the desired title. Filing receipts are mailed shortly after the mailing of the NOTIFICATION OF ACCEPTANCE OF APPLICATION UNDER 35 U.S.C. 371 AND 37 CFR 1.495 (Form PCT/DO/EO/903).<

#### **THE INTERNATIONAL PRELIMINARY EXAMINATION REPORT \*\*>AND THE INTERNATIONAL PRELIMINARY REPORT ON PATENTABILITY (CHAPTER I AND II)**

When an international preliminary examination is performed by an International Preliminary Examining Authority (IPEA), an international preliminary examination report (IPER) is prepared on Form PCT/IPEA/409 by the IPEA and sent to the elected Offices. This report reflects the IPEA's non-binding opinion regarding novelty, inventive step and industrial applicability. For international applications filed on or after January 1, 2004, the IPER bears the title "International Preliminary Report on Patentability (Chapter II of the Patent Cooperation Treaty)".

If the applicant did not timely file a demand for international preliminary examination with the IPEA, and the international application has a filing date on or after January 1, 2004, then an "International Preliminary Report on Patentability (Chapter I of the Patent Cooperation Treaty)" reflecting the International Searching Authority's (ISA's) non-binding

opinion regarding novelty, inventive step and industrial applicability is sent to the designated Offices.

The examiner may adopt any portion or all of the report on patentability of the IPEA or ISA upon consideration in the national stage so long as it is consistent with U.S. practice. The first Office action on the merits should indicate the report on patentability of the IPEA or ISA has been considered by the examiner. The indication may be a mere acknowledgement.

The IPER may include annexes, i.e., amendments to the international application that were made during the international phase. See MPEP § 1893.01(a)(3). These annexes will be placed in the U.S. national stage application file. Consequently, if the international application has been extensively amended during the international stage, there may be a number of different copies of the description, claims and drawings present in the national stage application file. The IPER may be consulted in Box No. I “Basis of the report” to determine what pages the report was based upon. Using the IPER as a roadmap of what happened during Chapter II examination will help determine which version should be examined.

Original sheets, substitute sheets, and rectified sheets included as part of the application examined under Chapter II are listed in the IPER as pages “originally filed/furnished.” Replacement sheets showing amendments made under PCT Article 19 or 34 and considered during Chapter II are also listed. See MPEP § 1879. If the IPER was established in a language other than English, the International Bureau will translate the IPER into English. However, the International Bureau will not translate the annexes to the IPER into English. Unless proper and timely translations are furnished by the applicant, foreign language annexes will be considered canceled. See MPEP § 1893.01(a)(3). All replacement sheets in the international application are marked with the international application number and the date of receipt in the upper right-hand corner. Replacement sheets that contain changes in format only and are accepted by the receiving Office are marked as “SUBSTITUTE SHEET” at the bottom of the page. Replacement sheets that contain a rectification of an obvious error and are accepted by either the ISA or the IPEA are marked as “RECTIFIED SHEET” at the bottom of the

page. Additionally, replacement sheets to the claims submitted to the International Bureau as Article 19 Amendments will be marked as “AMENDED SHEET (Article 19)” at the bottom of the page. Furthermore, replacement sheets to the description, claims and drawings submitted to the IPEA as Article 34 Amendments will be marked as “AMENDED SHEET” at the bottom of the page. The IPER will indicate in “Box No. I Basis of the Report” that replacement sheets submitted under either PCT Article 19 or 34 have been considered and will indicate the date they were received and the replacement sheets will be annexed to the IPER. The NOTIFICATION OF ACCEPTANCE OF APPLICATION UNDER 35 U.S.C. 371 AND 37 CFR 1.495 (Form PCT/DO/EO/903) should also be consulted, as it will indicate if the annexes or their translation have not been entered. A sample copy of the form has been reproduced at the end of MPEP § 1893.03(a). Additionally, if the annexes have been entered, the National Stage Processing Division of the Office of PCT Operations will write in pencil on any original sheet(s) or translations thereof that were replaced, “Replaced by Article 34 Amendment” and on the amended sheet(s) or translations thereof,” Article 34.”<

## THE PRIORITY DOCUMENT

See the discussion in MPEP § 1893.03(c).

## NOTIFICATION OF WITHDRAWAL

If the national stage application papers include an indication that the international application or US designation has been withdrawn, then the application should be brought to the attention of the Office of PCT Legal Administration to determine whether the withdrawal occurred prior to completion of the requirements under 35 U.S.C. 371(c). If the withdrawal occurred prior to completion of the requirements under 35 U.S.C. 371(c), then entry into the U.S. national stage is prohibited. See 35 U.S.C. 366. The indication of withdrawal may appear on a Notification of Withdrawal (PCT/IB/307 or PCT/RO/136), a Notification that International Application Considered to Be Withdrawn (Form PCT/RO/117), or other notification.

### **1893.03(f) Drawings and PCT Rule 11 [R-2]**

The drawings for the national stage application must comply with PCT Rule 11. The copy of the drawings provided by the International Bureau has already been checked and should be in compliance with PCT Rule 11. Accordingly, the drawing provided by the International Bureau >(see MPEP § 1893.03(e)< should be acceptable. The USPTO may not impose requirements beyond those imposed by the Patent Cooperation Treaty (e.g., PCT Rule 11). However, the examiner does \* have the authority to require new \*\* drawings if the drawings were published without meeting all requirements under the PCT for drawings. \*\*

### **1893.03(g) Information Disclosure Statement in a National Stage Application [R-2]**

An extensive discussion of Information Disclosure Statement practice is to be found in MPEP § 609. Although not specifically stated therein, the duty to disclose information material to patentability as defined in 37 CFR 1.56 is placed on individuals associated with the filing and prosecution of a national stage application in the same manner as for a domestic national application. The \*\*>averment< with respect to the duty under 37 CFR 1.56 >required under 37 CFR 1.63(b)(3) in an oath or declaration is applicable to oaths and declarations filed in U.S. national stage applications. See 37 CFR 1.497(c)<.

When an international application is filed under the Patent Cooperation Treaty (PCT), prior art documents may be cited by the examiner in the international search report and/or the international preliminary examination report. It is desirable for the U.S. examiner to consider the documents cited in the international application when examining the U.S. national stage application or when examining an application filed under 35 U.S.C. 111(a) which claims the benefit of the international application under 35 U.S.C. 365(a) or (c).

As a result of an agreement among the European Patent Office (EPO), Japan Patent Office (JPO), and the United States Patent and Trademark Office (USPTO), copies of documents cited in the international search report issued by any one of these Inter-

national Searching Authority Offices generally are being sent to the other Offices when designated in the international application. Accordingly, in many national stage applications where the international search was conducted by the EPO, JPO, or USPTO, copies of the documents cited in the international search report are made available to the examiner in the national stage application.

When all the requirements for a national stage application have been completed, applicant is notified (Form PCT/DO/EO/903) of the acceptance of the application under 35 U.S.C. 371, including an itemized list of the items received. The itemized list includes an indication of whether a copy of the international search report and copies of the references cited therein are present in the national stage file. The examiner will consider the documents cited in the international search report, without any further action by applicant under 37 CFR 1.97 and 1.98, when both the international search report and copies of the documents are indicated to be present in the national stage file. The examiner will note the consideration in the first Office action. There is no requirement that the examiners list the documents on a PTO-892 form. See form paragraphs 6.53, 6.54, and 6.55 (reproduced in MPEP § 609). Otherwise, applicant must follow the procedure set forth in 37 CFR 1.97 and 1.98 in order to ensure that the examiner considers the documents cited in the international search report.

This practice applies only to documents cited in the international search report relative to a national stage application filed under 35 U.S.C. 371. It does not apply to documents cited in an international preliminary examination report that are not cited in the search report. It does not apply to applications filed under 35 U.S.C. 111(a) claiming the benefit of an international application filing date.

### **1895 A Continuation>, Divisional,< or Continuation-in-Part Application of a PCT Application Designating the United States [R-2]**

It is possible to file a U.S. national application under 35 U.S.C. 111(a) during the pendency (prior to the abandonment) of an international application which designates the United States without completing the requirements for entering the national stage

under 35 U.S.C. 371(c). The ability to take such action is based on provisions of the United States patent law. 35 U.S.C. 363 provides that “[a]n international application designating the United States shall have the effect, from its international filing date under article 11 of the treaty, of a national application for patent regularly filed in the Patent and Trademark Office....” 35 U.S.C. 371(d) indicates that failure to timely comply with the requirements of 35 U.S.C. 371(c) “shall be regarded as abandonment... by the parties thereof....” It is therefore clear that an international application which designates the United States has the effect of a pending U.S. application from the international application filing date until its abandonment as to the United States. The first sentence of 35 U.S.C. 365(c) specifically provides that “[i]n accordance with the conditions and requirements of section 120 of this title,... a national application shall be entitled to the benefit of the filing date of a prior international application designating the United States.” The condition of 35 U.S.C. 120 relating to the time of filing requires the later application to be filed before the patenting or abandonment of or termination of proceedings on the first application. The filing of continuations \*\* of an international (PCT) application designating the U.S. was used primarily in instances where there was difficulty in obtaining a signed oath or declaration by the expiration of the time for entry into the national stage. Because these continuation \*\* applications historically resulted from a need to bypass the requirements of 35 U.S.C. 371, they became known as “bypass” applications. Since applicants are now notified of missing or defective oaths or declarations and/or translations, and are given a time period to respond which is extendable under 37 CFR 1.136(a), the use of this practice >with respect to continuation applications< has diminished.

\*\*>Continuation-in-part applications are generally filed in instances where applicants seek to add matter to the disclosure which is not supported by the disclosure of the international application as originally filed, as new matter may not be added to a U.S. national stage application. See 37 CFR 1.121(f).<

## 1895.01 Handling of and Considerations in the Handling of \*\* Continuations>, Divisions,< and Continuations-In-Part of \* PCT \*>Applications< [R-2]

\*\*

Rather than \*\*>submitting< national stage application >papers under 35 U.S.C. 371<, a continuing application (i.e., continuation, C-I-P, or division) under 35 U.S.C. 111(a) of the international >(PCT)< application may be filed. Pursuant to 35 U.S.C. 365(c), a regular national application filed under 35 U.S.C. 111(a) and 37 CFR 1.53(b) (not under 37 CFR 1.53(d) or former 37 CFR 1.60 or 1.62) may claim benefit of the filing date of an international application which designates the United States.

A typical time line involving a continuing application filed during the pendency of an international application is illustrated as follows:

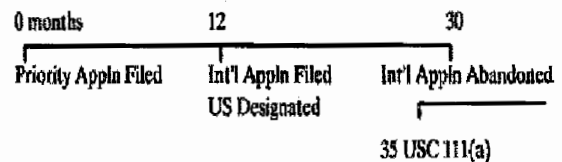

\*\*>To obtain benefit under 35 U.S.C. 120 and 365(c) of a prior international application designating the U.S., the continuing application must:

(A) include a specific reference to the prior international application (either in the application data sheet (37 CFR 1.76) or in the first sentence of the specification),

(B) be copending with the prior international application, and

(C) have at least one inventor in common with the prior international application.

With regard to (A), the specific reference to the international application required under 35 U.S.C. 120 and 365(c) must either be contained in the first sentence of the specification or included in an application data sheet. 37 CFR 1.78(a)(2)(iii). The specific reference must identify the parent international application by international application number and inter-

national filing date and indicate the relationship of the applications (i.e., continuation, continuation-in-part, or division). See 37 CFR 1.78(a)(2)(i) and MPEP § 201.11. An example of an appropriate first sentence of the specification is, for example, “This is a continuation of International Application PCT/EP2004/000000, with an international filing date of January 5, 2004, now abandoned.” The required reference must be submitted within the time period provided by 37 CFR 1.78(a)(5)(ii). This time period is not extendable. A certified copy of the international application (and an English translation) of the international application may be required by the examiner to perfect the claim for benefit under 35 U.S.C. 120 and 365(c) if the international application did not originate in the United States and such is necessary, for example, where an intervening reference is found and applied in a rejection of one or more claims. If the international application was published by the International Bureau pursuant to PCT Article 21, then a certified copy would not normally be necessary.

If benefit under 35 U.S.C. 119(e), 120 and 365(c) is also being claimed to an earlier filed national application (or international application designating the U.S.) via an intermediate international application designating the U.S., the examiner must examine the intermediate international application to see if it contains a proper reference to the earlier application. The reference will usually be included on the cover page of the published international application and/or may appear in the first sentence of the description of the published application. A lack of a proper reference in the published international application does not necessarily mean that a proper reference is not contained in the second international application. Accordingly, the examiner may need to inspect the Home Copy of the international application (if the USPTO was the receiving Office) to determine whether the requirements under 37 CFR 1.78(a) have been satisfied. For example, the Home Copy file may contain a proper reference in a separate paper or a decision granting a petition to accept a late benefit claim may be present in the application file. See MPEP § 201.11(a).

With regard to (B), a U.S. national application is considered copending with a prior international application designating the U.S. if the international application was pending on the filing date of the U.S. national application. Generally, except in cases where

the international application has been withdrawn (either generally or as to the United States), an international application becomes abandoned as to the United States upon expiration of 30 months from the priority date (i.e., the priority date claimed in the international application or, if no priority is claimed, the international filing date) unless a proper submission under 35 U.S.C. 371 to enter the U.S. national phase is filed prior to the expiration of this 30-month period. See MPEP § 1893.01(a)(1) and § 1893.02. However, if the international application is one where the 20-month period from the priority date expired before April 1, 2002, then it was necessary to file a demand electing the United States prior to the expiration of 19 months from the priority date in order to extend the international phase to 30 months from the priority date. If such a demand was not timely filed, then under former 37 CFR 1.494, such an international application became abandoned at the expiration of 20 months from the priority date unless a proper submission under 35 U.S.C. 371 to enter the U.S. national phase was made prior to the expiration of 20 months from the priority date. Accordingly, if the international application is not subject to the filing of a demand in order to delay entry into the U.S. national phase to 30 months from the priority date, then a national application filed prior to the expiration of this 30 month period will be copending with the international application unless the international application was withdrawn, either generally or as to the United States, prior to the filing of the national application. To determine whether the application was withdrawn, the examiner must either review the Home Copy of the international application file (if the USPTO was the receiving Office), or require applicant to certify that the international application was not withdrawn or considered to be withdrawn, either generally or as to the United States, prior to the filing date of the national application claiming benefit under 35 U.S.C. 120 and 365(c) to such international application. If the national application claiming benefit to the international application was filed after the expiration of this 30-month period, then there will be no copendency in the absence of a timely and proper submission to enter the U.S. national phase under 35 U.S.C. 371. The existence of a national stage application may be checked through PALM and the records of the national stage application should be consulted to ver-

ify copendency. Additionally, if the 20-month period from the priority date of the international application expired before April 1, 2002 and the national application claiming benefit under 35 U.S.C. 120 and 365(c) was filed later than 20 months from the priority date of the international application, the applicant may be required to submit proof of the filing of a demand electing the United States within 19 months from the priority date. This proof may be in the form of a copy of the “Notification of Receipt of Demand by Competent International Preliminary Examining Authority” (Form PCT/IPEA/402) showing the demand was received prior to the expiration of 19 months from the priority date, and a copy of the “Notification Concerning Elected Offices Notified of Their Election” (Form PCT/IB/332) showing the election of the United States. If the parent international application was not copending (i.e., abandoned or withdrawn), benefit under 35 U.S.C. 120 is not possible.

With regard to (C), inventors will normally be identified on the cover page of the published international application. In addition, such information is indicated in the *PCT Gazette*, which is available in electronic form from WIPO’s web site ([www.wipo.int/pct/en/index.html](http://www.wipo.int/pct/en/index.html)).

#### **PRIORITY CLAIMS UNDER 35 U.S.C. 119(a)-(d)**

A claim for foreign priority under 35 U.S.C. 119 (a)-(d) must be made in the continuing application in order to obtain the benefit of the filing date of the prior filed foreign application. This is true regardless of whether such a claim was made in the parent international application. A foreign priority claim is proper in the continuing application if the foreign application was filed within 12 months prior to the filing of the continuing application or within 12 months prior to the international filing date of the parent international application. In addition, the required claim must be made within the time period set forth in 37 CFR 1.55 (a)(1). This time period is not extendable. See MPEP § 201.14. A certified copy of any foreign priority document must be provided by the applicant unless the parent international application has entered the national stage under 35 U.S.C. 371 and the national stage application contains a photocopy of the priority document from the International Bureau. See MPEP § 1893.03(c). In such case, the applicant, in the con-

tinuing application, may state that the priority document is contained in the national stage application.

For a discussion of U.S. national applications filed under 35 U.S.C. 111(a) having foreign priority claims under 35 U.S.C. 119(a)-(d) and 365(a) to a prior international application designating at least one country other than the United States, see MPEP § 201.13(b).<

#### **1896 The Differences Between a National Application Filed Under 35 U.S.C. 111(a) and a National Stage Application Submitted Under 35 U.S.C. 371 [R-2]**

The following section describes the differences between a U.S. national application filed under 35 U.S.C. 111(a), including those claiming benefit of a PCT application under 35 U.S.C. 120 (a **continuation**), **division**,< or a **continuation-in-part** of a PCT application), and a U.S. **national stage application** (submitted under 35 U.S.C. 371).

*Chart of Some Common Differences*

	National Applications (filed under 35 U.S.C. 111(a))	National Stage Applications (submitted under 35 U.S.C. 371)
Filing Date	Deposit date in USPTO of specification, claim and any necessary drawing	International filing date of PCT application
Date application was “filed in the United States” for prior art purposes under 35 U.S.C. 102(e)	See MPEP § 706.02(f)(1)	See MPEP §§ 706.02(f)(1), 1857.01, and 1895.01

	National Applications (filed under 35 U.S.C. 111(a))	National Stage Applications (submitted under 35 U.S.C. 371)
35 U.S.C. 119(a)-(d) Priority Requirement	Claim & certified copy provided by applicant	Copy of certified copy provided by WIPO, claim by applicant
Unity of Invention	U.S. restriction practice	Unity of invention practice under 37 CFR 1.499
Filing Fees	37 CFR 1.16	37 CFR 1.492
Reference to Application in Declaration	Attached application, U.S. Application No., etc.	Same as in a 35 U.S.C. 111(a) filing or may refer to the international application
Copendency with International Application	Applicant provides proof	Not an issue

The differences between a national application filed under 35 U.S.C. 111(a) and a national application submitted under 35 U.S.C. 371 are often subtle, but the differences are important.

## I. FILING DATE

The filing date of a 35 U.S.C. 111(a) application is the date when the USPTO receives a specification >as prescribed by 35 U.S.C. 112 containing a description and at least one< claim, and any >required< drawings. See 37 CFR 1.53(b).

The filing date of a PCT international application is the date applicant satisfies Article 11 requirements, i.e., includes a >description, a claim, names at least one applicant who is a resident or national of a PCT Contracting State, filed in the prescribed language, and designates at least one Contracting State. See

MPEP § 1810. By virtue of 35 U.S.C. 363, the U.S. filing date of an international application that designates the United States is, for most legal purposes, the international filing date. See MPEP § 1893.03(b).<

## II. EFFECTIVE DATE AS A REFERENCE

A reference under 35 U.S.C. 102(e) must be a U.S. patent, a U.S. application publication (35 U.S.C. 122(b)), or a WIPO publication of an international application under PCT Article 21(2).

### *References That Did Not Result From, Nor Claimed Benefit of, an International Application*

The 35 U.S.C. 102(e) date of a reference that did not result from, nor claimed the benefit of, an international application is its earliest effective U.S. filing date, taking into consideration any proper priority or benefit claims to prior U.S. applications under 35 U.S.C. 119(e) or 120 if the prior application(s) properly support(s) the subject matter used to make the rejection. See MPEP § 706.02(a).

### *References That Resulted From, or Claimed Benefit of, an International Application*

If a reference resulted from, or claimed the benefit of, an international application, the following must be determined:

(A) If the international application meets the following three conditions:

- (1) an international filing date on or after November 29, 2000;
- (2) designated the United States; and
- (3) published under PCT Article 21(2) in English,

the international filing date is a U.S. filing date for prior art purposes under 35 U.S.C. 102(e). If such an international application properly claims benefit to an earlier-filed U.S. or international application, or priority to an earlier-filed U.S. provisional application, apply the reference under 35 U.S.C. 102(e) as of the earlier filing date, assuming all the conditions of 35 U.S.C. 102(e), 119(e), 120, or 365(c) are met. Note, where the earlier application is an international application, the earlier international application must satisfy the same three conditions (i.e., filed on or after November 29, 2000, designated the U.S., and had been published in English under PCT Article 21(2))



for the earlier international filing date to be a U.S. filing date for prior art purposes under 35 U.S.C. 102(e).

(B) If the international application was filed on or after November 29, 2000, but did **not** designate the United States or was **not** published in English under PCT Article 21(2), do **not** treat the international filing date as a U.S. filing date for prior art purposes under 35 U.S.C. 102(e). In this situation, do **not** apply under 35 U.S.C. 102(e) the reference as of its international filing date, its date of completion of the 35 U.S.C. 371(c)(1), (2) and (4) requirements, or any earlier filing date to which such an international application claims benefit or priority. The reference may be applied under 35 U.S.C. 102(a) or (b) as of its publication date, or 35 U.S.C. 102(e) as of any later U.S. filing date of an application that properly claimed the benefit of the international application (if applicable).

(C) If the international application has an international filing date prior to November 29, 2000, apply the reference under the provisions of 35 U.S.C. 102 and 374, prior to the AIPA amendments:

(1) For U.S. patents, apply the reference under 35 U.S.C. 102(e) as of the earlier of the date of completion of the requirements of 35 U.S.C. 371(c)(1), (2) and (4) or the filing date of the later-filed U.S. application that claimed the benefit of the international application;

(2) For U.S. application publications and WIPO publications directly resulting from international applications under PCT Article 21(2), never apply these references under 35 U.S.C. 102(e). These references may be applied as of their publication dates under 35 U.S.C. 102(a) or (b);

(3) For U.S. application publications of applications that claim the benefit under 35 U.S.C. 120 or 365(c) of an international application filed prior to November 29, 2000, apply the reference under 35 U.S.C. 102(e) as of the actual filing date of the later-filed U.S. application that claimed the benefit of the international application.

Examiners should be aware that although a publication of, or a U.S. patent issued from, an international application may not have a 35 U.S.C. 102(e) date at all, or may have a 35 U.S.C. 102(e) date that is after the effective filing date of the application being examined (so it is not “prior art”, the corresponding WIPO

publication of an international application may have an earlier 35 U.S.C. 102(a) or (b) date.

### III. 35 U.S.C. 119(a)-(d) AND 365(b) < PRIORITY REQUIREMENTS

The certified copy of the foreign priority application must be provided to the Office by applicant in a U.S. national application filed under 35 U.S.C. 111(a). Where applicant filed an international application claiming priority to an earlier filed national application, the certified copy of the priority application may be provided to the International Bureau by applicant during the international stage. The International Bureau (WIPO) then sends a copy of the certified copy of the priority application to each designated office for inclusion in the national stage application. A U.S. national stage application filed under 35 U.S.C. 371 will have a photocopy of the priority document with the first page stamped by the International Bureau to indicate that it is a priority document received by WIPO and the date of such receipt. Such a photocopy is acceptable in a U.S. national stage application to establish that applicant has filed a certified copy of the priority document. If the photocopy is missing from the national stage application file, either the document has been misplaced or it was not provided due to a defect in priority during the international stage. If the priority claim was not in accordance with PCT Rule 4.10 or the priority document was not provided in accordance with PCT Rule 17, the photocopy of the priority document will not have been provided by the International Bureau. If a copy of the foreign priority document is not in the national stage application file but applicant asserts that a certified copy of the priority document was timely furnished under PCT Rule 17 in the international phase, then the examiner should consult with a Special Program Examiner in his or her Technology Center.

### IV. UNITY OF INVENTION

U.S. national applications filed under 35 U.S.C. 111(a) are subject to restriction practice in accordance with 37 CFR 1.141-1.146. See MPEP § 803. U.S. national stage applications (which entered the national stage from international applications after compliance with 35 U.S.C. 371) are subject to unity of invention

practice in accordance with 37 CFR 1.475 and 1.499 (effective May 1, 1993).

**V. FILING FEES**

U.S. national applications filed under 35 U.S.C. 111(a) are subject to the national application filing fees set forth at 37 CFR 1.16. Submissions to enter the U.S. national stage under 35 U.S.C. 371 are subject to the national stage fees prescribed at 37 CFR 1.492.

**VI. REFERENCE TO APPLICATION IN DECLARATION**

Applicant's oath or declaration is required to identify the specification to which it is directed (37 CFR

1.63(b)(1)). The specification may be identified in a U.S. national application filed under 35 U.S.C. 111(a) by reference to an attached specification or by reference to the application number and filing date of a specification previously filed in the Office. MPEP § 601.01(a) gives the minimum requirements for identification of the specification. Submissions to enter the U.S. national stage under 35 U.S.C. 371 may identify the specification (in the oath or declaration) in the same manner as applications filed under 35 U.S.C. 111(a) or may identify the specification by reference to the application number and filing date of the international application.



MANUAL OF PATENT EXAMINING PROCEDURE

# Chapter 1900 Protest

## 1901 Protest Under 37 CFR 1.291

- 1901.01 Who Can Protest
- 1901.02 Information Which Can Be Relied on in Protest
- 1901.03 How Protest Is Submitted
- 1901.04 When Should the Protest Be Submitted
- 1901.05 Initial Office Handling and Acknowledgment of Protest
- 1901.06 Examiner Treatment of Protest
- 1901.07 Protestor Participation
- 1901.07(a) Filing of Multiple Papers Relating to Same Issues

## 1906 Supervisory Review of an Examiner's Decision Adverse to Protestor

## 1907 Unauthorized Participation by Protestor

## 1920 Citation of Prior Art Under 37 CFR 1.501(a)

## 1901 Protest Under 37 CFR 1.291

*37 CFR 1.291. Protests by the public against pending applications.*

(a) Protests by a member of the public against pending applications will be referred to the examiner having charge of the subject matter involved. A protest specifically identifying the application to which the protest is directed will be entered in the application file if:

(1) The protest is submitted prior to the date the application was published or the mailing of a notice of allowance under § 1.311, whichever occurs first; and

(2) The protest is either served upon the applicant in accordance with § 1.248, or filed with the Office in duplicate in the event service is not possible.

(b) Protests raising fraud or other inequitable conduct issues will be entered in the application file, generally without comment on those issues. Protests which do not adequately identify a pending patent application will be returned to the protestor and will not be further considered by the Office. A protest submitted in accordance with the second sentence of paragraph (a) of this section will be considered by the Office if the application is still pending when the protest and application file are brought before the examiner and it includes:

(1) A listing of the patents, publications, or other information relied upon;

(2) A concise explanation of the relevance of each listed item;

(3) A copy of each listed patent or publication or other item of information in written form or at least the pertinent portions thereof; and

(4) An English language translation of all the necessary and pertinent parts of any non-English language patent, publication, or other item of information in written form relied upon.

(c) A member of the public filing a protest in an application under paragraph (a) of this section will not receive any communications from the Office relating to the protest, other than the return

of a self-addressed postcard which the member of the public may include with the protest in order to receive an acknowledgment by the Office that the protest has been received. In the absence of a request by the Office, an applicant has no duty to, and need not, reply to a protest. The limited involvement of the member of the public filing a protest pursuant to paragraph (a) of this section ends with the filing of the protest, and no further submission on behalf of the protestor will be considered, except for additional prior art, or unless such submission raises new issues which could not have been earlier presented.

*37 CFR 1.248. Service of papers; manner of service; proof of service; proof of service in cases other than interferences.*

(a) Service of papers must be on the attorney or agent of the party if there be such or on the party if there is no attorney or agent, and may be made in any of the following ways:

(1) By delivering a copy of the paper to the person served;

(2) By leaving a copy at the usual place of business of the person served with someone in his employment;

(3) When the person served has no usual place of business, by leaving a copy at the person's residence, with some person of suitable age and discretion who resides there;

(4) Transmission by first class mail. When service is by mail the date of mailing will be regarded as the date of service;

(5) Whenever it shall be satisfactorily shown to the Commissioner that none of the above modes of obtaining or serving the paper is practicable, service may be by notice published in the *Official Gazette*.

(b) Papers filed in the Patent and Trademark Office which are required to be served shall contain proof of service. Proof of service may appear on or be affixed to papers filed. Proof of service shall include the date and manner of service. In the case of personal service, proof of service shall also include the name of any person served, certified by the person who made service. Proof of service may be made by:

(1) An acknowledgement of service by or on behalf of the person served or

(2) A statement signed by the attorney or agent containing the information required by this section.

(c) See § 1.646 for service of papers in interferences.

The degree of participation allowed a protestor is solely within the discretion of the Commissioner of Patents and Trademarks.

37 CFR 1.291(a) gives recognition to the value of written protests in bringing information to the attention of the Office and in avoiding the issuance of invalid patents. All protests must be submitted prior to the publication of the application or the mailing of a notice of allowance, whichever occurs first, because no protest or other form of preissuance opposition to the grant of a patent may be initiated after publication of the application without the applicant's express

written consent as specified by 35 U.S.C. 122(c). 37 CFR 1.291(a) provides that public protests against pending applications will be referred to the examiner having charge of the subject matter involved and will be entered in the application file if the protest is submitted prior to the date the application was published or the mailing of a notice of allowance under 37 CFR 1.311, whichever occurs first, and the protest is either served upon the applicant or filed in duplicate in the event service is not possible. Paragraph (b) of 37 CFR 1.291 assures members of the public that a protest will be fully considered by the Office if the protest is submitted in accordance with 37 CFR 1.291(a), the application is still pending when the protest and application file are brought before the examiner, and the protest includes:

(A) a listing of the patents, publications, or other information relied on;

(B) a concise explanation of the relevance of each listed item;

(C) a copy of each listed patent, publication, or other item of information in written form, or at least the pertinent portions thereof; and

(D) an English language translation of all necessary and pertinent parts of any non-English language document relied on.

A party obtaining knowledge of an application pending in the Office may file a protest against the application and may therein call attention to any facts within protestor's knowledge which, in protestor's opinion, would make the grant of a patent thereon improper.

A protestor does not, however, by the mere filing of a protest, obtain the "right" to argue the protest before the Office. Active participation by a protestor "ends with the filing of the protest, and no further submission on behalf of the protestor will be considered, except for additional prior art, or unless such submission raises new issues which could not have been earlier presented." 37 CFR 1.291(c). The USPTO will acknowledge the receipt of a protest in an original or a reissue application file only if a self-addressed postcard is included with the protest (see MPEP § 1901.05). The question of whether or not a patent will issue is a matter between the applicant and the Office acting on behalf of the public.

### **1901.01 Who Can Protest**

Any member of the public, including private persons, corporate entities, and government agencies, may file a protest under 37 CFR 1.291. A protest may be filed by an attorney or other representative on behalf of an unnamed principal since 37 CFR 1.291 does not require that the principal be identified.

### **1901.02 Information Which Can Be Relied on in Protest**

Any information which, in the protestor's opinion, would make the grant of a patent improper can be relied on in a protest under 37 CFR 1.291(a). While prior art documents, such as patents and publications, are most often the types of information relied on in protests, 37 CFR 1.291(a) is not limited to prior art documents. Protests may be based on any facts or information adverse to patentability. The content and substance of the protest are more important than whether prior art documents, or some other form of evidence adverse to patentability, are being relied on. The Office recognizes that when evidence other than prior art documents is relied on, problems may arise as to authentication and the probative value to assign to such evidence. However, the fact that such problems may arise, and have to be resolved, does not preclude the Office from considering such evidence, nor does it mean that such evidence cannot be relied on in a protest under 37 CFR 1.291. Information in a protest should be set forth in the manner required by 37 CFR 1.291(b).

The following are examples of the kinds of information, in addition to prior art documents, which can be relied on in a protest under 37 CFR 1.291(a):

(A) Information demonstrating that the invention was publicly "known or used by others in this country... before the invention thereof by the applicant for patent" and is therefore barred under 35 U.S.C. 102(a) and/or 103.

(B) Information that the invention was "in public use or on sale in this country, more than 1 year prior to the date of the application for patent in the United States" (35 U.S.C. 102(b)).

(C) Information that the applicant "has abandoned the invention" (35 U.S.C. 102(c)) or "did not himself invent the subject matter sought to be patented" (35 U.S.C. 102(f)).

(D) Information relating to inventorship under 35 U.S.C. 102(g).

(E) Information relating to sufficiency of disclosure or failure to disclose best mode, under 35 U.S.C. 112.

(F) Any other information demonstrating that the application lacks compliance with the statutory requirements for patentability.

(G) Information indicating “fraud” or “violation of the duty of disclosure” under 37 CFR 1.56 may be the subject of a protest under 37 CFR 1.291(a). Protests raising fraud or other inequitable conduct issues will be entered in the application file, generally without comment on those issues. 37 CFR 1.291(b).

Different forms of evidence may accompany, or be submitted as a part of, a protest under 37 CFR 1.291(a). Conventional prior art documents such as patents and publications are the most common form of evidence. However, other forms of evidence can likewise be submitted. Some representative examples of other forms of evidence are litigation-related materials such as complaints, answers, depositions, answers to interrogatories, exhibits, transcripts of hearings or trials, court orders and opinions, stipulations of the parties, etc. Where only a portion of the litigation-related materials is relevant to the protest, protestors are encouraged to submit only the relevant portion(s).

In a protest based on an alleged public use or sale by, or on behalf of, the applicant or applicant’s assignee, evidence of such public use or sale may be submitted along with affidavits or declarations identifying the source(s) of the evidence and explaining its relevance and meaning. Such evidence might include documents containing offers for sale by applicant or applicant’s assignee, orders, invoices, receipts, delivery schedules, etc. The Office will make a decision as to whether or not public use or sale has been established based on the evidence the Office has available. If applicant denies the authenticity of the documents and/or evidence, or if the alleged public use and/or sale is by a party other than applicant or applicant’s assignee, protestor may find it desirable or necessary to proceed via 37 CFR 1.292 (public use proceedings) rather than by a protest under 37 CFR 1.291.

While the forms in which evidence and/or information may be submitted with, or as a part of, a protest under 37 CFR 1.291(a) are not limited, protestors

must recognize that such submissions may encounter problems such as establishing authenticity and/or the probative value to apply to the evidence. Obviously, the Office will have to evaluate each item of evidence and/or information submitted with a view as to both its authenticity and what weight to give thereto.

Information which is subject to a court-imposed protective or secrecy order may be submitted with, or as a part of, a protest under 37 CFR 1.291(a). Trade secret information which was obtained by a protestor through agreements with others can likewise be submitted. Such information, if submitted, will be treated in accordance with the guidelines set forth in MPEP § 724 and will be made public if a reasonable examiner would consider the information important in deciding whether to allow the application to issue as a patent.

### **1901.03 How Protest Is Submitted**

A protest under 37 CFR 1.291(a) must be submitted in writing, must specifically identify the application to which the protest is directed by application number or serial number and filing date, and must include a listing of all patents, publications, or other information relied on; a concise explanation of the relevance of each listed item; an English language translation of all relevant parts of any non-English language document; and be accompanied by a copy of each patent, publication, or other document relied on. Protestors are encouraged to use form PTO-1449 “Information Disclosure Statement” (or an equivalent form) when preparing a protest under 37 CFR 1.291, especially the listing enumerated under 37 CFR 1.291(b)(1). See MPEP § 609. In addition, the protest and any accompanying papers must either (1) reflect that a copy of the same has been served upon the applicant or upon the applicant’s attorney or agent of record; or (2) be filed with the Office in duplicate in the event service is not possible.

It is important that any protest against a pending application specifically identify the application to which the protest is directed with the identification being as complete as possible. If possible, the following information should be placed on the protest:

- (A) Name of Applicant(s).
- (B) Application number (mandatory).
- (C) Filing date of application.
- (D) Title of invention.

(E) Group art unit number (if known).

(F) Name of examiner to whom the application is assigned (if known).

(G) Current status and location of application (if known).

(H) The word “ATTENTION:” followed by the area of the Office to which the protest is directed as set forth below.

In addition to the above information, the protest itself should be clearly identified as a “PROTEST UNDER 37 CFR 1.291(a).” If the protest includes exhibits or other attachments, these should also contain identifying information thereon in order to prevent them from becoming inadvertently separated and lost.

Any protest can be submitted by mail to the Assistant Commissioner for Patents, Washington, D.C. 20231, and should be directed to the attention of the Director of the particular Technology Center in which the application is pending. If the protestor is unable to specifically identify the application to which the protest is directed, but, nevertheless, believes such an application to be pending, the protest should be directed to the attention of the Office of Petitions, along with as much identifying data for the application as possible. Protests which do not adequately identify a pending patent application will be returned to the protestor and will not be further considered by the Office.

Where a protest is directed to a reissue application for a patent which is involved in litigation, the outside envelope and the top right-hand portion of the protest should be marked with the words “REISSUE LITIGATION.” The notations preferably should be written in a bright color with a felt point marker. Any “REISSUE LITIGATION” protest mailed to the Office should be so marked and mailed to BOX DAC. However, in view of the urgent nature of most “REISSUE LITIGATION” protests, protestor may wish to hand-carry the protest to the appropriate area in order to ensure prompt receipt and to avoid any unnecessary delays.

### **INITIAL PROTEST SUBMISSION MUST BE COMPLETE**

A protest must be complete and contain a copy of every document relied on by protestor, whether the document is a prior art document, court litigation

material, affidavit, or declaration, etc., because a protestor will *not* be given an opportunity to supplement or complete any protest which is incomplete. Active participation by protestor ends with the filing of the initial protest, as provided in 37 CFR 1.291(c), and no further submission on behalf of protestor will be acknowledged or considered, except for additional prior art, or unless such submission clearly raises new issues which could not have been earlier presented. Protests which will not be entered in the application file include those further submissions in violation of 37 CFR 1.291(c) by which protestor merely seeks to participate in the examination process. For example, mere arguments relating to an Office action or an applicant’s reply would not qualify as a new protest. Likewise, additional comments seeking to bring in further or even new data or information with respect to an issue previously raised by protestor would not qualify as a new protest. The Office will not add these arguments or comments to the original protest and will not enter them in the application file.

Even new protests which also argue Office actions or replies or any matter beyond the new issue should not be accepted. Improper protests will be returned by the Technology Center (TC) Director. While improper protests will be returned, a new protest by an earlier protestor will be proper and can be entered if it is clearly limited to new issues which could not have been earlier presented, and thereby constitutes a new protest.

As indicated in 37 CFR 1.291(b)(3), a protest must be accompanied by a copy of each prior art document relied on in order to ensure consideration by the examiner, although a protest without copies of prior art documents will not necessarily be ignored. While a protest without copies of documents will not necessarily be ignored, the submission of such documents with the protest will obviously expedite and ensure consideration of the documents, which consideration might not otherwise occur. Further, some documents which are available to protestor may not be otherwise available to the Office.

Every effort should be made by a protestor to serve a copy of the protest upon the attorney or agent of record or upon the applicant if no attorney or agent is of record. Of course, the copy served upon applicant or upon applicant’s attorney or agent should be a complete copy including a copy of each prior art or other

document relied on in the same manner as required by 37 CFR 1.291(a) for the Office copy. The protest filed in the Office should reflect, by an appropriate “Certificate of Service,” that service has been made as provided in 37 CFR 1.291(a). Only in those instances where service is not possible should the protest be filed in duplicate in order that the Office can attempt service.

#### **1901.04 When Should the Protest Be Submitted**

A protest under 37 CFR 1.291(a) must be submitted prior to the date the application was published or the mailing of a notice of allowance under 37 CFR 1.311, whichever occurs first, and the application must be pending when the protest and application file are brought before the examiner in order to be ensured of consideration. As a practical matter, any protest should be submitted as soon as possible after the protestor becomes aware of the existence of the application to which the protest is to be directed. By submitting a protest early in the examination process, i.e., before the Office acts on the application if possible, the protestor ensures that the protest will receive maximum consideration and will be of the most benefit to the Office in its examination of the application. A protest submitted after the mailing of the notice of allowance will not knowingly be ignored if the protest includes prior art documents which clearly anticipate or clearly render obvious one or more claims. However, the likelihood of consideration of a protest decreases as the patent date approaches.

A protest filed after final rejection and complying with 37 CFR 1.291(a) will be considered if the application is still pending when the protest and application are provided to the examiner. However, prosecution will not ordinarily be reopened after final rejection if the prior art cited in the protest is merely cumulative of the prior art cited in the final rejection. If a protest is not submitted within the time period set forth in 37 CFR 1.291(a)(1) it will be acknowledged as set forth in MPEP § 1901.05 only if a self-addressed postcard is included with the protest, and referred to the examiner having charge of the subject matter involved for handling as set forth in MPEP § 1901.06.

A protest with regard to a reissue application should be filed within the 2-month period following

announcement of the filing of the reissue application in the *Official Gazette*. If, for some reason, the protest of the reissue application cannot be filed within the 2-month period provided by MPEP § 1441, the protest can be submitted at a later time, but the protestor must be aware that reissue applications are “special” and a later filed protest may be received after action by the examiner. Any request by a protestor in a reissue application for an extension of the 2-month period following the announcement in the *Official Gazette* will be considered only if filed in the form of a petition under 37 CFR 1.182 and accompanied by the petition fee set forth in 37 CFR 1.17(h). The petition under 37 CFR 1.182 and the petition fee must be filed prior to the expiration of the 2-month period provided by MPEP § 1441. The petition must explain why the additional time is necessary and the nature of the protest intended. A copy of such petition must be served upon applicant in accordance with 37 CFR 1.248. The petition should be directed to the appropriate Technology Center (TC) which will forward the petition to the Office of Petitions for decision. Any such petition will be critically reviewed as to demonstrated need before being granted since the delay of examination of a reissue application of another party is being requested. Accordingly, the requests should be made only where necessary, for the minimum period required, and with a justification establishing the necessity for the extension.

If the protest is a “REISSUE LITIGATION” protest, it is particularly important that it be filed early if protestor wishes it considered at the time the Office first acts on the application. Protestors should be aware that the Office will entertain petitions under 37 CFR 1.182, when accompanied by the petition fee set forth in 37 CFR 1.17(h), to waive the 2-month delay period of MPEP § 1441 in appropriate circumstances. Accordingly, protestors to reissue applications cannot automatically assume that the full 2-month delay period of MPEP § 1441 will always be available.

If a protest is filed in a reissue application related to a patent involved in a pending interference proceeding, the reissue application should be referred to the Office of the Deputy Commissioner for Patent Examination Policy before the protest is considered and the application is acted on by the TC. See also MPEP § 1441 as to the filing of a protest in a reissue application.



## **1901.05 Initial Office Handling and Acknowledgment of Protest**

### **PROTESTS REFERRED TO EXAMINER**

Protests filed against pending applications will be referred to the examiner having charge of the application involved. 37 CFR 1.291(a). A protest specifically identifying the application to which it is directed will be entered in the application file, if (1) the protest is submitted prior to the publication of the application or the mailing of a notice of allowance under 37 CFR 1.311, whichever occurs first, (see MPEP § 1901.04) and (2) a copy has been served on applicant in accordance with 37 CFR 1.248, or a duplicate copy is filed with the Office in the event service is not possible. 37 CFR 1.291(a).

A protest where the application is specifically identified, which is submitted in conformance with 37 CFR 1.291(a) and (b), will be considered by the Office.

### **PROTEST DOES NOT INDICATE SERVICE**

If the protest filed in the Office does not, however, indicate service on applicant or applicant's attorney or agent, and is not filed in duplicate, then the Office will undertake to determine whether or not service has been made by contacting applicant or applicant's attorney or agent by telephone or in writing to ascertain if service has been made. If service has not been made and no duplicate has been filed, then the Office may request protestor to file such a duplicate before the protest is referred to the examiner. Alternatively, if the protest involves only a few pages, the Office may, in its sole discretion, elect to reproduce the protest rather than delay referring it to the examiner. If duplicate protest papers are mailed to applicant or applicant's attorney or agent by the Office, the application file should reflect that fact, either by a letter transmitting the protest or, if no transmittal letter is used, simply by an appropriate notation in the "Contents" section of the application file wrapper.

### **ACKNOWLEDGMENT OF PROTEST**

A protestor in an original or reissue application will not receive any communications from the Office relat-

ing to the protest, or to the application, other than the return of a self-addressed postcard which protestor may include with the protest in order to receive an acknowledgment that the protest has been received by the Office. 37 CFR 1.291(c). The Office will acknowledge a protest by return of the self-addressed postcard prior to the protest's entry into the application file or return to the protestor, as appropriate.

### **APPLICATIONS AND STATUS THEREOF MAINTAINED IN CONFIDENCE**

The postcard acknowledging receipt of a protest in other than a reissue application will not and must not indicate whether such application in fact exists or the status of any such application. Office employees must exercise care to ensure that matters relating to applications are *not* discussed with protestor or communicated in writing to protestor. Original applications are, of course, required by 35 U.S.C. 122 to be kept in confidence unless published pursuant to 35 U.S.C. 122(b). Thus, unless a protestor has been granted access to an original application, the protestor is not entitled to obtain from the Office any information concerning the same, including the mere fact that such an application exists. Petitions for access to patent applications with the exception of applications involved in or related to a proceeding before the Board of Patent Appeals or Interferences are decided by the Office of Petitions pursuant to delegation contained in MPEP § 1002.02(b). Reissue applications filed on, or after, March 1, 1977 are pursuant to 37 CFR 1.11(b) "open to inspection by the general public." After an application is published pursuant to 35 U.S.C. 122(b), a copy of the file wrapper of the published application may be requested by filing a written request under 37 CFR 1.14(c)(2) including the fee as set forth in 37 CFR 1.19(b)(2).

The Office will communicate with the applicant regarding any protest entered in an application file and may require the applicant to supply information pursuant to 37 CFR 1.291(c), including replies to specific questions raised by the protest, in order for the Office to decide any issues raised thereby. Under 37 CFR 1.291(c), the examiner can require the applicant to reply to the protest and answer specific questions raised by the protest.

## 1901.06 Examiner Treatment of Protest

Office practice as defined in 37 CFR 1.291(a) gives recognition to the value of the written protests in avoiding the issuance of invalid patents. However, the fact that one or more protests has been filed in an application, whether the application is an original application or a reissue application, does not relieve the examiner from conducting a *normal* examination on the merits, including the required search. Evidence submitted in a protest will be considered on the same basis as other *ex parte* evidence. *In re Reuter*, 651 F.2d 751, 758, 210 USPQ 249, 255 (CCPA 1981).

### INITIAL REVIEW

An examiner initially receiving a protest will immediately review the same for the following:

(A) To ensure that either the protest or the application file wrapper indicates that a copy of the protest has been served on applicant or applicant's attorney or agent. If a copy is not indicated as having been served on applicant or applicant's attorney and is not filed in duplicate, then the examiner should undertake to determine whether or not service has been made by contacting applicant or applicant's attorney or agent, but *not* protestor. If it has, this should be noted on the protest or on the application file. If service has not been made, the protest and application file should be brought to the attention of the TC Director for appropriate action. See MPEP § 1901.05.

(B) A protest raising issues of "fraud," "inequitable conduct," or "violation of duty of disclosure" will be entered in the application file, generally without comments on those issues.

If a protest is filed in a reissue application and the reissue application is related to a patent involved in a pending interference proceeding, such application should be referred to the Office of Patent Legal Administration before considering the protest and acting on the applications.

### PERIOD FOR COMMENTS BY APPLICANT

If the primary examiner's initial review reveals that the protest is ready for consideration during the examination, the examiner may nevertheless consider it desirable, or necessary, to obtain applicant's comments on the protest before further action. In such sit-

uations, the examiner will offer applicant an opportunity to file comments within a set period, usually 1 month, unless circumstances warrant a longer period.

Form Paragraph 19.01 can be used to offer applicant an opportunity to file comments on the protest.

#### ¶ 19.01 Period for Comments on Protest by Applicant

A protest against issuance of a patent based upon this application has been filed under 37 CFR 1.291(a) on [1], and a copy [2]. Any comments or reply applicant desires to file before consideration of the protest must be filed by [3].

#### Examiner Note:

1. Applicant is normally given one month to submit any comments, unless circumstances in the case would warrant a longer period.
2. A copy of this Office action is NOT sent to the protestor. See 37 CFR 1.291(c).
3. In bracket 2, insert either-- has been served on applicant-- or -- is attached hereto--.

Where necessary or desirable to decide questions raised by the protest, under 37 CFR 1.291(c) the primary examiner can require the applicant to reply to the protest and answer specific questions raised by the protest. The primary examiner cannot require a reply to questions relating to "fraud," "inequitable conduct," or "violation of the duty of disclosure" since those issues are generally not commented on by the Office. Any questions directed to applicant by the primary examiner must be limited to seeking answers reasonably necessary in order for the primary examiner to decide questions raised by the protest and which are before the primary examiner for decision. The primary examiner is not permitted, under 37 CFR 1.291(c), to seek answers to questions which are not before the primary examiner for decision. The primary examiner must use care in requiring information from applicant pursuant to 37 CFR 1.291(c) to ensure that the required information is necessary to the decision to be made.

Form Paragraph 19.02 can be used to require additional information from applicant regarding issues raised by the protest.

#### ¶ 19.02 Requirement for Information

The protest under 37 CFR 1.291 filed on [1] has been considered. In order to reach a full and proper consideration of the issues raised therein, it is necessary to obtain additional information from applicant regarding these issues. In particular [2]. The failure to reply to this requirement for information within ONE MONTH or THIRTY DAYS, whichever is longer, of the mailing date of

this requirement will result in abandonment of the application. This time period may be extended under the provisions of 37 CFR 1.136.

**Examiner Note:**

While the examiner normally should not need further information from applicant, this form paragraph may be used to request specific additional information from the applicant.

**PROTESTOR NOT PERMITTED TO COMPLETE INCOMPLETE PROTEST**

A protestor may not complete an incomplete protest, nor further participate in, or inquire as to the status of, any Office proceedings relating to the initial protest. 37 CFR 1.291. The examiner must not, therefore, communicate with protestor in any way and will not consider a later submission by protestor, except for additional prior art, or unless such submission raises new issues which could not have been earlier raised and constitutes in effect a new protest (see MPEP § 1901.07). Improper protests will be returned by the TC Director.

**TREATMENT OF TIMELY SUBMITTED PROTEST**

If the protest has been timely submitted, i.e., before the publication of the application or the mailing of a notice of allowance under 37 CFR 1.311, whichever occurs first, and the application is still pending when the protest and application file are brought before the examiner, the examiner must consider each of the prior art or other documents submitted in conformance with 37 CFR 1.291(b). At least those prior art documents which the examiner relies on in rejecting claims will be made of record by means of form PTO-892, unless the protestor has listed such prior art or other documents on form PTO-1449 (or an acceptable substitute as provided by MPEP § 609), in which case the examiner will place the examiner's initials adjacent to the citations in the boxes provided on the form PTO-1449 (see MPEP § 609). Where the prior art or other documents have not been cited on a PTO-892, or listed and initialed on a PTO-1449, the examiner will place a notation in the protest paper adjacent to the reference to the documents. The notation should include the examiner's initials and the term "checked." The examiner will also indicate in the next

Office action that all documents submitted have been considered.

It is not intended that the examiner be overly technical in construing 37 CFR 1.291(b) and refuse consideration of a protest because it does not include all of the contents enumerated by 37 CFR 1.291(b). The examiner should consider the protest to the extent it is helpful even though one or more of the listed items is omitted.

Where prior art or other documents are considered by the examiner, even though not submitted in full conformance with 37 CFR 1.291(b), the examiner *must*, for all those documents considered but not listed on the form PTO-892, (1) mark "checked" and place the examiner's initials beside each citation, or (2) where all the documents cited on a given page have been considered, mark "All checked" and place the examiner's initials in the left-hand margin beside the citations. See MPEP § 609. Where prior art or other documents are listed by the protestor on form PTO-1449, even though not submitted in full conformance with 37 CFR 1.291(b), the examiner *must*, for all those documents considered, place the examiner's initials adjacent to the citations in the boxes provided on the form PTO-1449. Where the prior art or other documents are listed by the protestor on form PTO-1449, but are not submitted in full compliance with 37 CFR 1.291(b), the examiner *must*, for all those documents not considered, draw a line through the citation on the form PTO-1449. See MPEP § 609. If a protest entered in an application file complies with 37 CFR 1.291(b), the examiner is required to fully consider *all* the issues, except for any issues of "fraud," "inequitable conduct," or "duty of disclosure" raised by the protestor, and clearly state the examiner's position thereon in detail.

**PROTEST FILED AFTER ALLOWANCE OR THE PUBLICATION OF THE APPLICATION**

If the protest is submitted after the publication of the application or the mailing of a notice of allowance under 37 CFR 1.311, whichever occurs first, it should not be entered in the application file. The applicant should be notified that the protest is untimely and that it is not being entered in the application file. The handling of the protest will vary depending on the particular situation as follows.

**A. Service of Copy Included**

Where the protest includes an indication of service of copy on the applicant, the original protest should be discarded.

**B. Service of Copy Not Included**

Where the protest does not include an indication of service, the duplicate copy of the protest (if present) should be discarded and the original protest papers should be sent to the applicant along with the notification of nonentry.

**COPIES OF DOCUMENTS NOT SUBMITTED**

If the protest is not accompanied by a copy of each prior art or other document relied on as required by 37 CFR 1.291(b), the examiner will consider the documents submitted. The protestor cannot be assured that the examiner will consider the missing document(s). However, if the examiner does so, the examiner will either cite the document on form PTO-892 or place a notation in the protest paper adjacent to the reference to the document which will include the examiner's initials and the term "checked." If the examiner considered a document not submitted, the next Office action will so indicate.

**CONSIDERATION OF PROTESTOR'S ARGUMENTS**

In view of the value of written protests, the examiner must give careful consideration to the points and arguments made on behalf of the protestor. Any Office action by the examiner treating the merits of a timely submitted protest complying with 37 CFR 1.291(b) must specifically consider and make evident by detailed reasoning the examiner's position as to the major arguments and points raised by the protestor. While it is not necessary for the examiner to respond to each and every minute argument or point, the major arguments and points must be specifically covered. The examiner will not, under any circumstances, treat or discuss those arguments or points directed to "fraud," "inequitable conduct," or "violation of duty of disclosure."

**RESULTS OF CONSIDERATION REPORTED TO TECHNOLOGY CENTER (TC) DIRECTOR**

After the examiner has considered the protest, the examiner will report the results of such consideration to the TC Director.

**1901.07 Protestor Participation**

In accordance with the limited protestor participation in protests, 37 CFR 1.291(c) was amended effective July 1, 1982, and further amended on December 1, 1997, to provide that:

"limited involvement of the member of the public filing a protest . . . ends with the filing of the protest, and no further submission on behalf of the protestor will be considered, except for additional prior art, or unless such submission raises new issues which could not have been earlier presented."

37 CFR 1.291(c) was amended effective December 1, 1997, by removing the blanket limitation of one protest per protestor, and now provides for a second or subsequent submission in the form of additional prior art. However, mere argument that is later submitted by an initial protestor would not be entered and would be returned unless it is shown that the argument relates to a new issue that could not have been earlier raised. Prior art submitted by a previous protestor prior to the publication of the application or the mailing of the notice of allowance under 37 CFR 1.311, whichever occurs first, will be made of record without a showing that it relates to a new issue. However, it should be noted that entry of later submitted prior art in the file record does not assure its consideration by the examiner if submitted late in the examination process. See MPEP § 1901 and § 1901.04. Accordingly, initial protests should be as complete as possible when first filed. The mere filing of a protest does not grant access to protestor or relieve the Office of its obligations under 35 U.S.C. 122 to maintain applications "in confidence." Nor does the mere filing of a protest automatically mean that protestor will have any "right" to participate to any particular degree. 37 CFR 1.291(c) does not permit protestor, or any other member of the public, to contact or receive information from the Office as to the disposition or status of the protest, or the application to which it is directed, or to participate in any Office proceedings relating to the protest. The Office does not serve cop-

ies of Office actions or other documents mailed by the Office on protestors, and does not require applicants to serve copies of papers filed with the Office on protestors. Furthermore, a protestor is not permitted to participate in interviews, appeal a decision by the examiner adverse to the protestor to the Board of Patent Appeals and Interferences, or participate in an appeal by applicant. The disposition of the protest will, once it has been filed under paragraph (c), be an *ex parte* matter between the Office and the applicant. Where protestor has access to an application, for example, a reissue application which is open to the public and may be inspected under 37 CFR 1.11, the proceedings may thereby be monitored.

Under 37 CFR 1.291(c), applicant may be required by the Office to reply to a protest. Any reply thereto would be *ex parte* and would not be served on the protestor. The *ex parte* nature of the requirements for information under paragraph (c) differs from past practice under which information could be required, or requested, from applicant and one or more protestors.

### **1901.07(a) Filing of Multiple Papers Relating to Same Issues**

Under 37 CFR 1.291(c), protestor participation ends with the filing of the initial protest, and protestor will not be allowed to complete any protest that is incomplete. No further submission on behalf of protestor will be considered, except for additional prior art, or unless such submission clearly raises new issues which could not have been earlier presented. Protests which will not be entered in the application file include those further submissions in violation of 37 CFR 1.291(c) by which protestor seeks to participate in the examination process. For example, mere arguments relating to an Office action or an applicant's reply would not qualify as a new issue. Likewise, additional comments seeking to bring in further or even new data or information with respect to an issue previously raised by protestor would not qualify as a new issue. Even new protests which also argue

Office actions or replies or any matter beyond the new issue should not be accepted. Improper protests will be refused consideration and returned by the Technology Center (TC) Director. While improper protests will be returned, a new protest by an earlier protestor will be proper and can be entered if it is clearly limited to new issues which could not have been earlier presented.

### **1906 Supervisory Review of an Examiner's Decision Adverse to Protestor**

As pointed out in MPEP § 1901.07, a protestor cannot appeal to the Board of Patent Appeals and Interferences from an adverse decision of the examiner. Further, a decision by examiner adverse to a protestor is final, and under the restricted protestor participation permitted under 37 CFR 1.291(c) is not petitionable to the Commissioner.

### **1907 Unauthorized Participation by Protestor**

Office personnel must exercise care to ensure that substantive matters relating to the application are not discussed *ex parte* with protestor or communicated in writing *ex parte* to protestor. The examiner must not communicate in any manner with protestor. See 37 CFR 1.291(c).

### **1920 Citation of Prior Art Under 37 CFR 1.501(a)**

37 CFR 1.501(a) permits any person at any time during the period of enforceability of a patent to cite to the Office, in writing, prior art consisting of patent and printed publications which that person states to be pertinent and applicable to the patent and believes to have a bearing on the patentability of any claim(s) of the patent. See MPEP § 2202 - § 2208.



# Chapter 2000 Duty of Disclosure

- 2000.01 Introduction
- 2001 Duty of Disclosure, Candor, and Good Faith**
- 2001.01 Who Has Duty To Disclose
- 2001.03 To Whom Duty of Disclosure Is Owed
- 2001.04 Information Under 37 CFR 1.56(a)
- 2001.05 Materiality Under 37 CFR 1.56(b)
- 2001.06 Sources of Information
- 2001.06(a) Prior Art Cited in Related Foreign Applications
- 2001.06(b) Information Relating to or From Copending United States Patent Applications
- 2001.06(c) Information From Related Litigation
- 2001.06(d) Information Relating to Claims Copied From a Patent
- 2002 Disclosure — By Whom and How Made**
- 2002.01 By Whom Made
- 2002.02 Must be in Writing
- 2003 Disclosure — When Made**
- 2003.01 Disclosure After Patent Is Granted
- 2004 Aids to Compliance With Duty of Disclosure**
- 2005 Comparison to Requirement for Information**
- 2010 Office Handling of Duty of Disclosure/Inequitable Conduct Issues**
- 2012 Reissue Applications Involving Issues of Fraud, Inequitable Conduct, and/or Violation of Duty of Disclosure**
- 2012.01 Collateral Estoppel
- 2013 Protests Involving Issues of Fraud, Inequitable Conduct, and/or Violation of Duty of Disclosure**
- 2014 Duty of Disclosure in Reexamination Proceedings**
- 2016 Fraud, Inequitable Conduct, or Violation of Duty of Disclosure Affects All Claims**
- 2022.05 Determination of “Error Without Any Deceptive Intention”

## 2000.01 Introduction [R-2]

This Chapter deals with the duties owed toward the U.S. Patent and Trademark Office by the inventor and every other individual who is substantively involved in the preparation or prosecution of the application and who is associated with the inventor or the inventor’s assignee. These duties, of candor and good faith and disclosure, have been codified in 37 CFR 1.56, as promulgated pursuant to carrying out the duties of the \*>Director< under Sections 2, 3, 131, and 132 of Title 35 of the United States Code.

## 2001 Duty of Disclosure, Candor, and Good Faith

37 CFR 1.56. *Duty to disclose information material to patentability.*

(a) A patent by its very nature is affected with a public interest. The public interest is best served, and the most effective

patent examination occurs when, at the time an application is being examined, the Office is aware of and evaluates the teachings of all information material to patentability. Each individual associated with the filing and prosecution of a patent application has a duty of candor and good faith in dealing with the Office, which includes a duty to disclose to the Office all information known to that individual to be material to patentability as defined in this section. The duty to disclose information exists with respect to each pending claim until the claim is cancelled or withdrawn from consideration, or the application becomes abandoned. Information material to the patentability of a claim that is cancelled or withdrawn from consideration need not be submitted if the information is not material to the patentability of any claim remaining under consideration in the application. There is no duty to submit information which is not material to the patentability of any existing claim. The duty to disclose all information known to be material to patentability is deemed to be satisfied if all information known to be material to patentability of any claim issued in a patent was cited by the Office or submitted to the Office in the manner prescribed by §§ 1.97(b)-(d) and 1.98. However, no patent will be granted on an application in connection with which fraud on the Office was practiced or attempted or the duty of disclosure was violated through bad faith or intentional misconduct. The Office encourages applicants to carefully examine:

(1) Prior art cited in search reports of a foreign patent office in a counterpart application, and

(2) The closest information over which individuals associated with the filing or prosecution of a patent application believe any pending claim patentably defines, to make sure that any material information contained therein is disclosed to the Office.

(b) Under this section, information is material to patentability when it is not cumulative to information already of record or being made of record in the application, and

(1) It establishes, by itself or in combination with other information, a *prima facie* case of unpatentability of a claim; or

(2) It refutes, or is inconsistent with, a position the applicant takes in:

(i) Opposing an argument of unpatentability relied on by the Office, or

(ii) Asserting an argument of patentability.

A *prima facie* case of unpatentability is established when the information compels a conclusion that a claim is unpatentable under the preponderance of evidence, burden-of-proof standard, giving each term in the claim its broadest reasonable construction consistent with the specification, and before any consideration is given to evidence which may be submitted in an attempt to establish a contrary conclusion of patentability.

(c) Individuals associated with the filing or prosecution of a patent application within the meaning of this section are:

(1) Each inventor named in the application;

(2) Each attorney or agent who prepares or prosecutes the application; and

(3) Every other person who is substantively involved in the preparation or prosecution of the application and who is associated with the inventor, with the assignee or with anyone to whom there is an obligation to assign the application.

(d) Individuals other than the attorney, agent or inventor may comply with this section by disclosing information to the attorney, agent, or inventor.

(e) In any continuation-in-part application, the duty under this section includes the duty to disclose to the Office all information known to the person to be material to patentability, as defined in paragraph (b) of this section, which became available between the filing date of the prior application and the national or PCT international filing date of the continuation-in-part application.

37 CFR 1.56 defines the duty to disclose information to the Office.

### 2001.01 Who Has Duty To Disclose

*37 CFR 1.56. Duty to disclose information material to patentability.*

\*\*\*\*\*

(c) Individuals associated with the filing or prosecution of a patent application within the meaning of this section are:

- (1) Each inventor named in the application;
- (2) Each attorney or agent who prepares or prosecutes the application; and

(3) Every other person who is substantively involved in the preparation or prosecution of the application and who is associated with the inventor, with the assignee or with anyone to whom there is an obligation to assign the application.

\*\*\*\*\*

Individuals having a duty of disclosure are limited to those who are “substantively involved in the preparation or prosecution of the application.” This is intended to make clear that the duty does not extend to typists, clerks, and similar personnel who assist with an application.

The word “with” appears before “the assignee” and “anyone to whom there is an obligation to assign” to make clear that the duty applies only to individuals, not to organizations. For instance, the duty of disclosure would not apply to a corporation or institution as such. However, it would apply to individuals within the corporation or institution who were substantively involved in the preparation or prosecution of the application, and actions by such individuals may affect the rights of the corporation or institution.

### 2001.03 To Whom Duty of Disclosure Is Owed [R-2]

37 CFR 1.56(a) states that the “duty of candor and good faith” is owed “in dealing with the Office” and that all associated with the filing and prosecution of a

patent application have a “duty to disclose to the Office” material information. This duty “in dealing with” and “to” the Office extends, of course, to all dealings which such individuals have with the Office, and is not limited to representations to or dealings with the examiner. For example, the duty would extend to proceedings before the Board of Patent Appeals and Interferences and the Office of the \* Commissioner for Patents.

### 2001.04 Information Under 37 CFR 1.56(a) [R-2]

*37 CFR 1.56. Duty to disclose information material to patentability.*

(a) A patent by its very nature is affected with a public interest. The public interest is best served, and the most effective patent examination occurs when, at the time an application is being examined, the Office is aware of and evaluates the teachings of all information material to patentability. Each individual associated with the filing and prosecution of a patent application has a duty of candor and good faith in dealing with the Office, which includes a duty to disclose to the Office all information known to that individual to be material to patentability as defined in this section. The duty to disclose information exists with respect to each pending claim until the claim is cancelled or withdrawn from consideration, or the application becomes abandoned. Information material to the patentability of a claim that is cancelled or withdrawn from consideration need not be submitted if the information is not material to the patentability of any claim remaining under consideration in the application. There is no duty to submit information which is not material to the patentability of any existing claim. The duty to disclose all information known to be material to patentability is deemed to be satisfied if all information known to be material to patentability of any claim issued in a patent was cited by the Office or submitted to the Office in the manner prescribed by §§ 1.97(b)-(d) and 1.98. However, no patent will be granted on an application in connection with which fraud on the Office was practiced or attempted or the duty of disclosure was violated through bad faith or intentional misconduct. The Office encourages applicants to carefully examine:

(1) Prior art cited in search reports of a foreign patent office in a counterpart application, and

(2) The closest information over which individuals associated with the filing or prosecution of a patent application believe any pending claim patentably defines, to make sure that any material information contained therein is disclosed to the Office.

\*\*\*\*\*

The language of 37 CFR 1.56 (and 37 CFR 1.555) has been modified effective March 16, 1992 to emphasize that there is a duty of candor and good faith which is broader than the duty to disclose material information. 37 CFR 1.56 further states that “no

patent will be granted on an application in connection with which fraud on the Office was practiced or attempted or the duty of disclosure was violated through bad faith or intentional misconduct.”

The Office strives to issue valid patents. The Office has both an obligation not to unjustly issue patents and an obligation not to unjustly deny patents. Innovation and technological advancement are best served when an inventor is issued a patent with the scope of protection that is deserved. The rules as adopted serve to remind individuals associated with the preparation and prosecution of patent applications of their duty of candor and good faith in their dealings with the Office, and will aid the Office in receiving, in a timely manner, the information it needs to carry out effective and efficient examination of patent applications.

The amendment to 37 CFR 1.56 was proposed to address criticism concerning a perceived lack of certainty in the materiality standard. The rule as promulgated will provide greater clarity and hopefully minimize the burden of litigation on the question of inequitable conduct before the Office, while providing the Office with the information necessary for effective and efficient examination of patent applications. 37 CFR 1.56 has been amended to present a clearer and more objective definition of what information the Office considers material to patentability. The rules do not define fraud or inequitable conduct which have elements both of materiality and of intent.

The definition of materiality in 37 CFR 1.56 does not impose substantial new burdens on applicants, but is intended to provide the Office with the information it needs to make a proper and independent determination on patentability. It is the patent examiner who should make the determination after considering all the facts involved in the particular case.

37 CFR 1.56 states that each individual associated with the filing and prosecution of a patent application has a duty to disclose all information known to that individual to be material to patentability as defined in the section. Thus, the duty applies to contemporaneously or presently known information. The fact that information was known years ago does not mean that it was recognized that the information is material to the present application.

The term “information” as used in 37 CFR 1.56 means all of the kinds of information required to be disclosed and includes any information which is

“material to patentability.” Materiality is defined in 37 CFR 1.56(b) and discussed herein at MPEP § 2001.05. In addition to prior art such as patents and publications, 37 CFR 1.56 includes, for example, information on >enablement,< possible prior public uses, sales, offers to sell, derived knowledge, prior invention by another, inventorship conflicts, and the like. >“Materiality is not limited to prior art but embraces *any* information that a reasonable examiner would be substantially likely to consider important in deciding whether to allow an application to issue as a patent.” *Bristol-Myers Squibb Co. v. Rhone-Poulenc Rorer, Inc.*, 326 F.3d 1226, 1234, 66 USPQ2d 1481, 1486 (Fed. Cir. 2003) (emphasis in original) (finding article which was not prior art to be material to enablement issue).<

The term “information” is intended to be all encompassing, similar to the scope of the term as discussed with respect to 37 CFR 1.291(a) (see MPEP § 1901.02). 37 CFR 1.56(a) also states: “The Office encourages applicants to carefully examine: (1) prior art cited in search reports of a foreign patent office in a counterpart application, and (2) the closest information over which individuals associated with the filing or prosecution of a patent application believe any pending claim patentably defines, to make sure that any material information contained therein is disclosed to the Office.” The sentence does not create any new duty for applicants, but is placed in the text of the rule as helpful guidance to individuals who file and prosecute patent applications.

It should be noted that the rules are *not* intended to require information *favorable* to patentability such as, for example, evidence of commercial success of the invention. Similarly, the rules are not intended to require, for example, disclosure of information concerning the level of skill in the art for purposes of determining obviousness.

37 CFR 1.56(a) states that the duty to disclose information exists until the application becomes abandoned. The duty to disclose information, however, does not end when an application becomes allowed but extends until a patent is granted on that application. The rules provide for information being considered after a notice of allowance is mailed and before the issue fee is paid (37 CFR 1.97(d)) (see MPEP § 609, paragraph B(3)). The rules also provide for an application to be withdrawn from issue



(A) because one or more claims are unpatentable (37 CFR 1.313(c)(1));

(B) for express abandonment so that information may be considered in a continuing application before a patent issues (37 CFR 1.313(c)(3)); or

(C) for consideration of a request for continued examination (RCE) under 37 CFR 1.114 (37 CFR 1.313(a) and (c)(2)). Note that RCE practice does not apply to utility or plant applications filed before June 8, 1995 or to design applications. See MPEP § 706.07(h).

See MPEP § 1308 for additional information pertaining to withdrawal of an application from issue.

In a continuation-in-part application, individuals covered by 37 CFR 1.56 have a duty to disclose to the Office all information known to be material to patentability which became available between the filing date of the prior application and the national or PCT international filing date of the continuation-in-part application. See 37 CFR 1.56(e).

37 CFR 1.56 provides that the duty of disclosure can be met by submitting information to the Office in the manner prescribed by 37 CFR 1.97 and 1.98. See MPEP § 609. Applicants are provided certainty as to when information will be considered, and applicants will be informed when information is not considered. Note, however, that the Office may order or conduct reexamination proceedings based on prior art that was *cited/considered* in any prior related Office proceeding. See MPEP § 2242 and MPEP § 2258.01.

The Office does not believe that courts should, or will, find violations of the duty of disclosure because of unintentional noncompliance with 37 CFR 1.97 and 1.98. If the noncompliance is intentional, however, the applicant will have assumed the risk that the failure to submit the information in a manner that will result in its being considered by the examiner may be held to be a violation.

The Office does not anticipate any significant change in the quantity of information cited to the Office. Presumably, applicants will continue to submit information for consideration by the Office in applications rather than making and relying on their own determinations of materiality. An incentive remains to submit the information to the Office because it will result in a strengthened patent and will avoid later questions of materiality and intent to deceive. In addition, the new rules will actually facili-

tate the filing of information since the burden of submitting information to the Office has been reduced by eliminating, in most cases, the requirement for a concise statement of the relevance of each item of information listed in an information disclosure statement. It should also be noted that 37 CFR 1.97(h) states that the filing of an information disclosure statement shall not be considered to be an admission that the information cited in the statement is, or is considered to be, material to patentability as defined in 37 CFR 1.56.

## 2001.05 Materiality Under 37 CFR 1.56(b)

37 CFR 1.56. *Duty to disclose information material to patent ability.*

\*\*\*\*\*

(b) Under this section, information is material to patentability when it is not cumulative to information already of record or being made of record in the application, and

(1) It establishes, by itself or in combination with other information, a *prima facie* case of unpatentability of a claim; or

(2) It refutes, or is inconsistent with, a position the applicant takes in:

(i) Opposing an argument of unpatentability relied on by the Office, or

(ii) Asserting an argument of patentability.

A *prima facie* case of unpatentability is established when the information compels a conclusion that a claim is unpatentable under the preponderance of evidence, burden-of-proof standard, giving each term in the claim its broadest reasonable construction consistent with the specification, and before any consideration is given to evidence which may be submitted in an attempt to establish a contrary conclusion of patentability.

\*\*\*\*\*

Under the rule, information is not material unless it comes within the definition of 37 CFR 1.56(b)(1) or (2). If information is not material, there is no duty to disclose the information to the Office. Thus, it is theoretically possible for applicants to draft claims and a specification to avoid a *prima facie* case of obviousness over a reference and then to be able to withhold the reference from the examiner. The Office believes that most applicants will wish to submit the information, however, even though they may not be required to do so, to strengthen the patent and avoid the risks of an incorrect judgment on their part on materiality or that it may be held that there was an intent to deceive the Office.

## 2001.06 Sources of Information [R-2]

All individuals covered by 37 CFR 1.56 (reproduced in MPEP § 2001.01) have a duty to disclose to the U.S. Patent and Trademark Office all material information they are *aware* of regardless of the source of or how they become aware of the information. >See *Brasseler, U.S.A. I, L.P. v. Stryker Sales Corp.*, 267 F.3d 1370, 1383, 60 USPQ2d 1482, 1490 (Fed. Cir. 2001) (“Once an attorney, or an applicant has notice that information exists that appears material and questionable, that person cannot ignore that notice in an effort to avoid his or her duty to disclose.”).< Materiality controls whether information must be disclosed to the Office, not the circumstances under which or the source from which the information is obtained. If material, the information must be disclosed to the Office. The duty to disclose material information extends to information such individuals are aware of prior to or at the time of filing the application or become aware of during the prosecution thereof.

Such individuals may be or become aware of material information from various sources such as, for example, co-workers, trade shows, communications from or with competitors, potential infringers, or other third parties, related foreign applications (see MPEP § 2001.06(a)), prior or copending United States patent applications (see MPEP § 2001.06(b)), related litigation (see MPEP § 2001.06(c)) and preliminary examination searches.

### 2001.06(a) Prior Art Cited in Related Foreign Applications [R-2]

Applicants and other individuals, as set forth in 37 CFR 1.56, have a duty to bring to the attention of the Office any material prior art or other information cited or brought to their attention in any related foreign application. The inference that such prior art or other information is material is especially strong \*\* where it has been used in rejecting the same or similar claims in the foreign application >or where it has been identified in some manner as particularly relevant<. See *Gemveto Jewelry Co. v. Lambert Bros., Inc.*, 542 F. Supp. 933, 216 USPQ 976 (S.D. N.Y. 1982) wherein a patent was held invalid or unenforceable because patentee’s foreign counsel did not disclose to patentee’s United States counsel or to the Office prior

art cited by the Dutch Patent Office in connection with the patentee’s corresponding Dutch application. The court stated, 542 F. Supp. at 943, 216 USPQ at 985:

Foreign patent attorneys representing applicants for U.S. patents through local correspondent firms surely must be held to the same standards of conduct which apply to their American counterparts; a double standard of accountability would allow foreign attorneys and their clients to escape responsibility for fraud or inequitable conduct merely by withholding from the local correspondent information unfavorable to patentability and claiming ignorance of United States disclosure requirements.

### 2001.06(b) Information Relating to or From Copending United States Patent Applications [R-2]

The individuals covered by 37 CFR 1.56 have a duty to bring to the attention of the examiner, or other Office official involved with the examination of a particular application, information within their knowledge as to other copending United States applications which are “material to patentability” of the application in question. As set forth by the court in *Armour & Co. v. Swift & Co.*, 466 F.2d 767, 779, 175 USPQ 70, 79 (7th Cir. 1972):

[W]e think that it is unfair to the busy examiner, no matter how diligent and well informed he may be, to assume that he retains details of every pending file in his mind when he is reviewing a particular application . . . [T]he applicant has the burden of presenting the examiner with a complete and accurate record to support the allowance of letters patent.

See also MPEP § 2004, paragraph 9.

Accordingly, the individuals covered by 37 CFR 1.56 cannot assume that the examiner of a particular application is necessarily aware of other applications which are “material to patentability” of the application in question, but must instead bring such other applications to the attention of the examiner. >See *Dayco Prod., Inc. v. Total Containment, Inc.*, 329 F.3d 1358, 1365-69, 66 USPQ2d 1801, 1806-08 (Fed. Cir. 2003).< For example, if a particular inventor has different applications pending in which similar subject matter but patentably indistinct claims are present that fact must be disclosed to the examiner of each of the involved applications. Similarly, the prior art references from one application must be made of record

in another subsequent application if such prior art references are “material to patentability” of the subsequent application.>See *Dayco Prod.*, 329 F.3d at 1369, 66 USPQ2d at 1808.<

\*\*>If< the application under examination is identified as a continuation>, divisional,< or continuation-in-part of an earlier application, the examiner will consider the prior art cited in the earlier application.>See MPEP § 609.< The examiner must indicate in the first Office action whether the prior art in a related earlier application has been reviewed. Accordingly, no separate citation of the same prior art need be made in the later application.

### **2001.06(c) Information From Related Litigation [R-2]**

Where the subject matter for which a patent is being sought is or has been involved in litigation, the existence of such litigation and any other material information arising therefrom must be brought to the attention of the U.S. Patent and Trademark Office. Examples of such material information include evidence of possible prior public use or sales, questions of inventorship, prior art, allegations of “fraud,” “inequitable conduct,” and “violation of duty of disclosure.” Another example of such material information is any assertion that is made during litigation which is contradictory to assertions made to the examiner. *Environ Prods., Inc. v. Total Containment, Inc.*, 43 USPQ2d 1288, 1291 (E.D. Pa. 1997). Such information might arise during litigation in, for example, pleadings, admissions, discovery including interrogatories, depositions, and other documents and testimony.

Where a patent for which reissue is being sought is, or has been, involved in litigation which raised a question material to examination of the reissue application, such as the validity of the patent, or any allegation of “fraud,” “inequitable conduct,” or “violation of duty of disclosure,” the existence of such litigation must be brought to the attention of the Office by the applicant at the time of, or shortly after, filing the application, either in the reissue oath or declaration, or in a separate paper, preferably accompanying the application, as filed. Litigation begun after filing of the reissue application should be promptly brought to the attention of the Office. The details and documents

from the litigation, insofar as they are “material to patentability” of the reissue application as defined in 37 CFR 1.56, should accompany the application as filed, or be submitted as promptly thereafter as possible. See *Critikon, Inc. v. Becton Dickinson Vascular Access, Inc.*, 120 F.3d 1253, 1258, 1259, 43 USPQ2d 1666, 1670-71 (Fed. Cir. 1997) (patent held unenforceable due to inequitable conduct based on patentee's failure to disclose a relevant reference and for failing to disclose ongoing litigation).

For example, the defenses raised against validity of the patent, or charges of “fraud” or “inequitable conduct” in the litigation, would normally be “material to the examination” of the reissue application. It would, in most situations, be appropriate to bring such defenses to the attention of the Office by filing in the reissue application a copy of the court papers raising such defenses. At a minimum, the applicant should call the attention of the Office to the litigation, the existence and the nature of any allegations relating to validity and/or “fraud,” or “inequitable conduct” relating to the original patent, and the nature of litigation materials relating to these issues. Enough information should be submitted to clearly inform the Office of the nature of these issues so that the Office can intelligently evaluate the need for asking for further materials in the litigation. See MPEP § 1442.04.

>If litigation papers of a live litigation relating to a pending reissue application are filed with the Office, the litigation papers along with the reissue application file should be forwarded to the Solicitor's Office for processing. If the litigation is not live, the litigation papers are processed by the Technology Center assigned the reissue application.<

### **2001.06(d) Information Relating to Claims Copied From a Patent [R-2]**

Where claims are copied or substantially copied from a patent, 37 CFR 1.607(c) requires applicant shall, at the time he or she presents the claim(s), identify the patent and the numbers of the patent claims. \*\*Clearly, the information required by 37 CFR 1.607(c) as to the source of copied claims is material information under 37 CFR 1.56 and failure to inform the USPTO of such information may violate the duty of disclosure.

## 2002 Disclosure — By Whom and How Made

37 CFR 1.56. *Duty to disclose information material to patentability.*

\*\*\*\*\*

(d) Individuals other than the attorney, agent or inventor may comply with this section by disclosing information to the attorney, agent, or inventor.

\*\*\*\*\*

### 2002.01 By Whom Made

37 CFR 1.56(d) makes clear that information may be disclosed to the Office through an attorney or agent of record or through a *pro se* inventor, and that other individuals may satisfy their duty of disclosure to the Office by disclosing information to such an attorney, agent, or inventor who then is responsible for disclosing the same to the Office. Information that is not material need not be passed along to the Office.

### 2002.02 Must be in Writing

37 CFR 1.2. *Business to be transacted in writing.*

All business with the Patent and Trademark Office should be transacted in writing. The personal attendance of applicants or their attorneys or agents at the Patent and Trademark Office is unnecessary. The action of the Patent and Trademark Office will be based exclusively on the written record in the Office. No attention will be paid to any alleged oral promise, stipulation, or understanding in relation to which there is disagreement or doubt.

37 CFR 1.4. *Nature of correspondence and signature requirements.*

\*\*\*\*\*

(b) Since each file must be complete in itself, a separate copy of every paper to be filed in a patent or trademark application, patent file, trademark registration file, or other proceeding must be furnished for each file to which the paper pertains, even though the contents of the papers filed in two or more files may be identical. The filing of duplicate copies of correspondence in the file of an application, patent, trademark registration file, or other proceeding should be avoided, except in situations in which the Office requires the filing of duplicate copies. The Office may dispose of duplicate copies of correspondence in the file of an application, patent, trademark registration file, or other proceeding.

\*\*\*\*\*

A disclosure under 37 CFR 1.56 must be in writing as prescribed by 37 CFR 1.2, and a copy of any such disclosure must be filed in each application or other

proceeding to which the disclosure pertains (37 CFR 1.4(b)).

## 2003 Disclosure — When Made

In reissue applications, applicants are encouraged to file information disclosure statements at the time of filing or within 2 months of filing, since reissue applications are taken up “special” (see MPEP § 1442 and § 1442.03). However, in a reissue where waiver of the normal 2 month delay period of 37 CFR 1.176 is being requested (see MPEP § 1441), the statement should be filed at the time of filing the application, or as soon thereafter as possible.

The presumption of validity is generally strong when prior art was before and considered by the Office and weak when it was not. See *Bolkcom v. Carborundum Co.*, 523 F.2d 492, 498, 186 USPQ 466, 471 (6th Cir. 1975).

### 2003.01 Disclosure After Patent Is Granted [R-2]

>

#### I. < BY CITATIONS OF PRIOR ART UNDER 37 CFR 1.501

Where a patentee or any member of the public (including private persons, corporate entities, and government agencies) has prior >art< patents or printed publications which the patentee or member of the public desires to have made of record in the patent file, patentee or such member of the public may file a citation of such prior art with the U.S. Patent and Trademark Office pursuant to >35 U.S.C. 301 and< 37 CFR 1.501. Such citations and papers will be entered without comment by the Office. The Office >generally< does not \*\* consider the citation and papers but merely places them of record in the patent file. Information which may be filed under 37 CFR 1.501 is limited to prior art patents and printed publications. Any citations which include items other than patents and printed publications will not be entered in the patent file. See MPEP § 2202 through § 2208.

>

#### II. < BY REEXAMINATION

Where any person, including patentee, has prior art patents and/or printed publications which said person

desires to have the U.S. Patent and Trademark Office consider after a patent has issued, such person may file a request for *>ex parte<* reexamination of the patent (see 37 CFR 1.510 and MPEP § 2209 through § 2220). *>*For a request for *inter partes* reexamination, see 37 CFR 1.913 and MPEP § 2609 through § 2620.*<*

## 2004 Aids to Compliance With Duty of Disclosure [R-2]

While it is not appropriate to attempt to set forth procedures by which attorneys, agents, and other individuals may ensure compliance with the duty of disclosure, the items listed below are offered as examples of possible procedures which could help avoid problems with the duty of disclosure. Though compliance with these procedures may not be required, they are presented as helpful suggestions for avoiding duty of disclosure problems.

1. Many attorneys, both corporate and private, are using letters and questionnaires for applicants and others involved with the filing and prosecution of the application and checklists for themselves and applicants to ensure compliance with the duty of disclosure. The letter generally explains the duty of disclosure and what it means to the inventor and assignee. The questionnaire asks the inventor and assignee questions about

- the origin of the invention and its point of departure from what was previously known and in the prior art,

- possible public uses and sales,

- prior publication, knowledge, patents, foreign patents, etc.

The checklist is used by the attorney to ensure that the applicant has been informed of the duty of disclosure and that the attorney has inquired of and cited material prior art.

The use of these types of aids would appear to be most helpful, though not required, in identifying prior art and may well help the attorney and the client avoid or more easily explain a potentially embarrassing and harmful “fraud” allegation.

2. It is desirable to ask questions about inventorship. Who is the proper inventor? Are there disputes or possible disputes about inventorship? If there are

questions, call them to the attention of the U.S. Patent and Trademark Office.

3. It is desirable to ask questions of the inventor about the disclosure of the best mode. Make sure that the best mode is described. See MPEP § 2165 - § 2165.04.

4. It is desirable for an attorney or agent to make certain that the inventor, especially a foreign inventor, recognizes his or her responsibilities in signing the oath or declaration. See 37 CFR 1.69(a).

*37 CFR 1.69. Foreign language oaths and declarations.*

(a) Whenever an individual making an oath or declaration cannot understand English, the oath or declaration must be in a language that such individual can understand and shall state that such individual understands the content of any documents to which the oath or declaration relates.

\*\*\*\*\*

Note MPEP § 602.06 for a more detailed discussion.

5. It is desirable for an attorney or agent to carefully evaluate and explain to the applicant and others involved the scope of the claims, particularly the broadest claims. Ask specific questions about possible prior art which might be material in reference to the broadest claim or claims. There is some tendency to mistakenly evaluate prior art in the light of the gist of what is regarded as the invention or narrower interpretations of the claims, rather than measuring the art against the broadest claim with all of its reasonable interpretations. It is desirable to pick out the broadest claim or claims and measure the materiality of prior art against a reasonably broad interpretation of these claims.

6. It may be useful to evaluate the materiality of prior art or other information from the viewpoint of whether it is the closest prior art or other information. This will tend to put the prior art or other information in better perspective. See *Semiconductor Energy Laboratory Co. v. Samsung Electronics Co.*, 204 F.3d 1368, 1374, 54 USPQ2d 1001, 1005 (Fed. Cir. 2000) (“A withheld reference may be highly material when it discloses a more complete combination of relevant features, even if those features are before the patent examiner in other references.” (citations omitted)). However, 37 CFR 1.56 may still require the submission of prior art or other information which is not as close as that of record.

7. Care should be taken to see that prior art or other information cited in a specification or in an information disclosure statement is properly described and that the information is not incorrectly or incompletely characterized. It is particularly important for an attorney or agent to review, before filing, an application which was prepared by someone else, e.g., a foreign application. It is also important that an attorney or agent make sure that foreign clients, including foreign applicants, attorneys, and agents understand the requirements of the duty of disclosure, and that the U.S. attorney or agent review any information disclosure statements or citations to ensure that compliance with 37 CFR 1.56 is present. See *Semiconductor Energy Laboratory Co. v. Samsung Electronics Co.*, 204 F.3d 1368, 54 USPQ2d 1001 (Fed. Cir. 2000). During prosecution patentee submitted an untranslated 29-page Japanese reference as well as a concise explanation of its relevance and an existing one-page partial English translation, both of which were directed to less material portions of the reference. The untranslated portions of the Japanese reference “contained a more complete combination of the elements claimed [in the patent] than anything else before the PTO.” 204 F.3d at 1374, 54 USPQ2d at 1005. The patentee, whose native language was Japanese, was held to have understood the materiality of the reference. “The duty of candor does not require that the applicant translate every foreign reference, but only that the applicant refrain from submitting partial translations and concise explanations that it knows will misdirect the examiner’s attention from the reference’s relevant teaching.” 204 F.3d at 1378, 54 USPQ2d at 1008. See also *Gemveto Jewelry Co. v. Lambert Bros., Inc.*, 542 F. Supp. 933, 216 USPQ 976 (S.D.N.Y. 1982) wherein a patent was held invalid or unenforceable because patentee’s foreign counsel did not disclose to patentee’s United States counsel or to the Office prior art cited by the Dutch Patent Office in connection with the patentee’s corresponding Dutch application. The court stated, 542 F. Supp. at 943, 216 USPQ at 985:

Foreign patent attorneys representing applicants for U.S. patents through local correspondent firms surely must be held to the same standards of conduct which apply to their American counterparts; a double standard of accountability would allow foreign attorneys and their clients to escape responsibility for fraud or inequitable conduct merely by withholding from the local correspondent

information unfavorable to patentability and claiming ignorance of United States disclosure requirements.

8. Care should be taken to see that inaccurate statements or inaccurate experiments are not introduced into the specification, either inadvertently or intentionally. For example, stating that an experiment “was run” or “was conducted” when in fact the experiment was not run or conducted is a misrepresentation of the facts. No results should be represented as actual results unless they have actually been achieved. Paper >or prophetic< examples should not be described using the past tense. \*>*Hoffman-La Roche, Inc. v. Promega Corp.*, 323 F.3d 1354, 1367, 66 USPQ2d 1385, 1394 (Fed. Cir. 2003); see also< MPEP § 608.01(p) and § 707.07(l). Also, misrepresentations can occur when experiments which were run or conducted are inaccurately reported in the specification, e.g., an experiment is changed by leaving out one or more ingredients. See *Steierman v. Connelly*, 192 USPQ 433 (Bd. Pat. Int. 1975); 192 USPQ 446 (Bd. Pat. Int. 1976).

9. Do not rely on the examiner of a particular application to be aware of other applications belonging to the same applicant or assignee. It is desirable to call such applications to the attention of the examiner even if there is only a question that they might be “material to patentability” of the application the examiner is considering. >See *Dayco Prod., Inc. v. Total Containment, Inc.*, 329 F.3d 1358, 1365-69, 66 USPQ2d 1801, 1806-08 (Fed. Cir. 2003) (contrary decision of another examiner reviewing substantially similar claims is ‘material’; copending application may be ‘material’ even though it cannot result in a shorter patent term, when it could affect the rights of the patentee to assign the issued patents).< It is desirable to be particularly careful that prior art or other information in one application is cited to the examiner in other applications to which it would be material. Do not assume that an examiner will necessarily remember, when examining a particular application, other applications which the examiner is examining, or has examined. \*\*>A “lapse on the part of the examiner does not excuse the applicant.”< *KangaROOS U.S.A., Inc. v. Caldor, Inc.*, 778 F.2d 1571, 1576, 228 USPQ 32, 35 (Fed. Cir. 1985)\*\*>; see also MPEP § 2001.06(b).<

10. When in doubt, it is desirable and safest to submit information. Even though the attorney, agent, or

applicant doesn't consider it necessarily material, someone else may see it differently and embarrassing questions can be avoided. The court in *U.S. Industries v. Norton Co.*, 210 USPQ 94, 107 (N.D. N.Y. 1980) stated "In short, the question of relevancy in close cases, should be left to the examiner and not the applicant." See also *LaBounty Mfg., Inc. v. U.S. Int'l Trade Comm'n*, 958 F.2d 1066, 22 USPQ2d 1025 (Fed. Cir. 1992).

11. It may be desirable to submit information about prior uses and sales even if it appears that they may have been experimental, not involve the specifically claimed invention, or not encompass a completed invention. See *Hycor Corp. v. The Schlueter Co.*, 740 F.2d 1529, 1534-37, 222 USPQ 553, 557-559 (Fed. Cir. 1984). See also *LaBounty Mfg., Inc. v. U.S. Int'l Trade Comm'n*, 958 F.2d 1066, 22 USPQ2d 1025 (Fed. Cir. 1992).

12. Submit information promptly. An applicant, attorney, or agent who is aware of prior art or other information and its significance should submit same early in prosecution, e.g., before the first action by the examiner, and not wait until after allowance. Potentially material information discovered late in the prosecution should be immediately submitted. That the issue fee has been paid is no reason or excuse for failing to submit information. See *Elmwood Liquid Products, Inc. v. Singleton Packing Corp.*, 328 F. Supp. 974, 170 USPQ 398 (M.D. Fla. 1971).

13. It is desirable to avoid the submission of long lists of documents if it can be avoided. Eliminate clearly irrelevant and marginally pertinent cumulative information. If a long list is submitted, highlight those documents which have been specifically brought to applicant's attention and/or are known to be of most significance. See *Penn Yan Boats, Inc. v. Sea Lark Boats, Inc.*, 359 F. Supp. 948, 175 USPQ 260 (S.D. Fla. 1972), *aff'd*, 479 F.2d 1338, 178 USPQ 577 (5th Cir. 1973), *cert. denied*, 414 U.S. 874 (1974). But cf. *Molins PLC v. Textron Inc.*, 48 F.3d 1172, 33 USPQ2d 1823 (Fed. Cir. 1995).

14. Watch out for continuation-in-part applications where intervening material information or documents may exist; particularly watch out for foreign patents and publications related to the parent application and dated more than 1 year before the filing date of the CIP. These and other intervening documents may be material information. See *In re Ruscetta*, 255 F.2d

687, 690-91, 118 USPQ 101, 104 (CCPA 1958); *In re van \*>Langenhoven<*, 458 F.2d 132, 173 USPQ 426 (CCPA 1972); *Chromalloy American Corp. v. Alloy Surfaces Co.*, 339 F. Supp. 859, 173 USPQ 295 (D. Del. 1972).

15. Watch out for information that might be deemed to be prior art under 35 U.S.C. 102(f) and (g).

Prior art under 35 U.S.C. 102(f) may be available under 35 U.S.C. 103. See *OddzOn Products, Inc. v. Just Toys, Inc.*, 122 F.3d 1396, 1401, 43 USPQ2d 1641, 1644 (Fed. Cir. 1997)(35 U.S.C. "102(f) is a prior art provision for purposes of § 103"); *Dale Electronics v. R.C.L. Electronics*, 488 F.2d 382, 386, 180 USPQ 225, 227 (1st. Cir. 1973); and *Ex parte Andresen*, 212 USPQ 100, 102 (Bd. App. 1981).

Note also that evidence of prior invention under 35 U.S.C. 102(g) may be available under 35 U.S.C. 103, such as in *In re Bass*, 474 F.2d 1276, 177 USPQ 178 (CCPA 1973).

Note 35 U.S.C. 103(c) disqualifies 35 U.S.C. 102(f)/103 or 102(g)/103 prior art which was, at the time the second invention was made, owned by or subject to an obligation of assignment to, the person who owned the first invention. Further note that 35 U.S.C. 103(c) disqualifies 35 U.S.C. 102(e)/103 prior art for applications filed on or after November 29, 1999. See MPEP § 706.02(1) - § 706.02(1)(2).

16. Watch out for information picked up by the inventors and others at conventions, plant visits, in-house reviews, etc. See, for example, *Dale Electronics v. R.C.L. Electronics*, 488 F.2d 382, 386-87, 180 USPQ 225, 228 (1st Cir. 1973).

17. Make sure that all of the individuals who are subject to the duty of disclosure, such as spelled out in 37 CFR 1.56, are informed of and fulfill their duty.

18. Finally, if information was specifically considered and discarded as not material, this fact might be recorded in an attorney's file or applicant's file, including the reason for discarding it. If judgment might have been bad or something might have been overlooked inadvertently, a note made at the time of evaluation might be an invaluable aid in explaining that the mistake was honest and excusable. Though such records are not required, they could be helpful in recalling and explaining actions in the event of a question of "fraud" or "inequitable conduct" raised at a later time.

## 2005 Comparison to Requirement for Information [R-2]

Under 37 CFR 1.56, each individual associated with the filing and prosecution of a patent application has a duty to disclose on his or her own initiative information material to patentability under 37 CFR 1.56. By contrast, under 37 CFR 1.105, an examiner or other Office employee is authorized to require, from parties identified in 37 CFR 1.56, information reasonably necessary to examine or treat a matter in an application. The provisions of 37 CFR 1.105 are detailed in MPEP § 704 *et seq.* The criteria for requiring information under 37 CFR 1.56, i.e., materiality to the patentability of claimed subject matter, is substantially higher than the criteria for requiring information under 37 CFR 1.105, i.e., reasonable necessity to the examination of the application. >See, e.g., *Star Fruits S.N.C. v. United States*, 280 F.Supp.2d 512, 515-61 (E.D. Va 2003) (“Beyond that which a patent applicant is duty-bound to disclose pursuant to 37 CFR 1.56, an examiner may require the production of ‘such information as may be reasonably necessary to properly examine or treat the matter.’”).< Thus, information required by the examiner pursuant to 37 CFR 1.105 would not necessarily be considered material to patentability in itself, but would be necessary to obtain a complete record from which a determination of patentability will be made.

## 2010 Office Handling of Duty of Disclosure/Inequitable Conduct Issues [R-2]

Determination of inequitable conduct issues requires an evaluation of the intent of the party involved. While some court decisions have held that intent may be inferred in some circumstances, consideration of the good faith of the party, or lack thereof, is often required. In several court decisions, a high level of proof of intent to mislead the Office was required in order to prove inequitable conduct under 37 CFR 1.56. See *In re Harito*, 847 F.2d 801, 6 USPQ2d 1930 (Fed. Cir. 1988) and *FMC Corp. v. Manitowoc Co.*, 835 F.2d 1411, 5 USPQ2d 1112 (Fed. Cir. 1987). The Office is not the best forum in which to determine whether there was an “intent to mislead”; such intent is best determined when the trier of facts can observe demeanor of witnesses subjected

to cross-examination. A court, with subpoena power, is presently the best forum to consider duty of disclosure issues under the present evidentiary standard for finding an “intent to mislead.” The court proceeding involves two participating adverse parties. This is not the case in the Office, since even “protesting” parties are not permitted to participate under the rules. Also, it is the courts and not the Office that are in the best position to fashion an equitable remedy to fit the precise facts in those cases where inequitable conduct is established. Furthermore, inequitable conduct is not set by statute as a criteria for patentability but rather is a judicial application of the doctrine of unclean hands which is appropriate to be handled by the courts rather than by an administrative body. Because of the lack of tools in the Office to deal with this issue and because of its sensitive nature and potential impact on a patent, Office determinations generally will not deter subsequent litigation of the same issue in the courts on appeal or in separate litigation. Office determinations would significantly add to the expense and time involved in obtaining a patent with little or no benefit to the patent owner or any other parties with an interest.

Accordingly, the Office does not investigate and reject original or reissue applications under 37 CFR 1.56. Likewise, the Office will not comment upon duty of disclosure issues which are brought to the attention of the Office in original or reissue applications except to note in the application, in appropriate circumstances, that such issues are no longer considered by the Office during its examination of patent applications. Examination of lack of deceptive intent in reissue applications will continue but without any investigation of inequitable conduct issues. Applicant’s statement of lack of deceptive intent normally will be accepted as dispositive except in special circumstances such as an admission or judicial determination of fraud or inequitable conduct. >See notice published in the *Official Gazette* at 1095 O.G. 16 (October 11, 1988).< See >also< MPEP § 2022.05.

>Issues of fraud and/or inequitable conduct in an interference proceeding before the Board of Patent Appeals and Interferences (Board) will be considered by the Board if they are raised by way of preliminary motion for judgment under 37 CFR 1.633(a). The motion must be filed during the period set for filing preliminary motions (37 CFR 1.636(a)), or good



cause (37 CFR 1.655(b)) must be shown as to why the issues of fraud and/or inequitable conduct were not timely raised during the preliminary motion period. Issues of fraud and/or inequitable conduct will not be considered in any interference in which the times for taking testimony or the times for filing briefs for final hearing have already been set, unless 'good cause' is shown under 37 CFR 1.655(b). An example of good cause would be where fraud or inequitable conduct is first discovered during taking of testimony. See notice published in the *Official Gazette* at 1133 O.G. 21 (December 10, 1991).<

## 2012 Reissue Applications Involving Issues of Fraud, Inequitable Conduct, and/or Violation of Duty of Disclosure [R-2]

Questions of "fraud," "inequitable conduct," or violation of "duty of disclosure" or "candor and good faith" can arise in reissue applications.

### REQUIREMENT FOR "ERROR WITHOUT ANY DECEPTIVE INTENTION"

Both 35 U.S.C. 251 and 37 CFR 1.175 promulgated pursuant thereto require that the error must have arisen "without any deceptive intention." *In re Heany*, 1911 C.D. 138, 180 (1911), unequivocally states:

Where such a condition [fraudulent or deceptive intention] is shown to exist the right to reissue the patent is forfeited.

Similarly, the court in *In re Clark*, 522 F.2d 623, 627, 187 USPQ 209, 213 (CCPA 1975) indicated:

Reissue is not available to rescue a patentee who had presented claims limited to avoid particular prior art and then had failed to disclose that prior art . . . after that failure to disclose has resulted in invalidating of the claims.

It is clear that "fraud" cannot be purged through the reissue process. See conclusions of Law 89 and 91 in *Intermountain Research and Eng'g Co. v. Hercules Inc.*, 171 USPQ 577, 631-32 (C.D. Cal. 1971).

Clearly, where several patents or applications stem from an original application which contained fraudulent claims ultimately allowed, the doctrine of unclean hands bars allowance or enforcement of any of the claims of any of the applications or patents. See *Keystone Driller Co. v. General Excavator Co.*, 290 U.S.

240, 245, 19 USPQ 228, 230 (1933); *East Chicago Machine Tool Corp. v. Stone Container Corp.*, 181 USPQ 744, 748 (N.D. Ill.), *modified*, 185 USPQ 210 (N.D. Ill. 1974). See also *Chromalloy American Corp. v. Alloy Surfaces Co.*, 339 F. Supp. 859, 173 USPQ 295 (D.Del. 1972) and *Strong v. General Electric Co.*, 305 F. Supp. 1084, 162 USPQ 141 (N.D. Ga. 1969), *aff'd*, 434 F.2d 1042, 168 USPQ 8 (5th Cir. 1970), *cert. denied*, 403 U.S. 906 (1971) where fraud or inequitable conduct affecting only certain claims or only one of related patents was held to affect the other claims or patent. Clearly, "fraud" practiced or attempted in an application which issues as a patent is "fraud" practiced or attempted in connection with any subsequent application to reissue that patent. The reissue application and the patent are inseparable as far as questions of "fraud," "inequitable conduct," or "violation of the duty of disclosure" are concerned. See *In re Heany, supra*; and *Norton v. Curtiss*, 433 F.2d 779, 792, 167 USPQ 532, 543 (CCPA 1970), wherein the court stated:

We take this to indicate that any conduct which will prevent the enforcement of a patent after the patent issues should, if discovered earlier, prevent the issuance of the patent.

Clearly, if a reissue patent would not be enforceable after its issue because of "fraud," "inequitable conduct" or "violation of the duty of disclosure" during the prosecution of the patent sought to be reissued, the reissue patent application should not issue. \*>Where no investigation is needed to establish< such circumstances, an appropriate remedy would be to reject the claims in the application in accordance with 35 U.S.C. 251. See MPEP § 1448.

The examiner is **not to make any investigation** as to the lack of deceptive intent requirement in reissue applications. Applicant's statement (in the oath or declaration) of lack of deceptive intent will be accepted as dispositive except in special circumstances such as **an admission or judicial determination** of fraud, inequitable conduct or violation of the duty of disclosure, where no investigation need be made and the fact of the admission or judicial determination exists *per se*. Also, any admission of fraud, inequitable conduct or violation of the duty of disclosure must be explicit, unequivocal, and not subject to other interpretation. Where a rejection is made based upon such an admission (see MPEP § 1448) and applicant

responds with any reasonable interpretation of the facts that would not lead to a conclusion of fraud, inequitable conduct or violation of the duty of disclosure, the rejection should be withdrawn. Alternatively, if applicant shows that the admission noted by the examiner was not in fact an admission, the rejection should also be withdrawn.

### 2012.01 Collateral Estoppel [R-2]

The Supreme Court in *Blonder-Tongue Labs., Inc. v. Univ. of Ill. Found.*, 402 U.S. 313, 169 USPQ 513 (1971) set forth the rule that once a patent has been declared invalid via judicial inquiry, a collateral estoppel barrier is created against further litigation involving the patent, unless the patentee-plaintiff can demonstrate “that he did not have” a full and fair chance to litigate the validity of his patent in “the earlier case.” See also *Ex parte Varga*, 189 USPQ 209 (Bd. App. 1973). As stated in *Kaiser Industries Corp. v. Jones & Laughlin Steel Corp.*, 515 F.2d 964, 987, 185 USPQ 343, 362 (3rd Cir. 1975):

In fashioning the rule of *Blonder-Tongue*, Justice White for a unanimous Court made it clear that a determination of patent invalidity, after a thorough and equitable judicial inquiry, creates a collateral estoppel barrier to further litigation to enforce that patent.

Under 35 U.S.C. 251, the \*>Director< can reissue a patent only if there is “error without any deceptive intention.” The \*>Director< is without authority to reissue a patent when “deceptive intention” was present during prosecution of the parent application. See *In re Clark*, 522 F.2d 62, 187 USPQ 209 (CCPA 1975) and *In re Heany*, 1911 C.D. 138, 180 (1911). Thus, the collateral estoppel barrier applies where reissue is sought of a patent which has been held invalid or unenforceable for “fraud” or “violation of duty of disclosure” in procuring of said patent. It was held in *In re Kahn*, 202 USPQ 772, 773 (Comm’r Pat. 1979):

Therefore, since the Kahn patent was held invalid, *inter alia*, for “failure to disclose material facts of which \* \* \* [Kahn] was aware” this application may be stricken under 37 CFR 1.56 via the doctrine of collateral estoppel as set forth in *Blonder-Tongue*, *supra*.

\*\*\*\*\*

The Patent and Trademark Office . . . has found no clear justification for not adhering to the doctrine of collateral estoppel under *Blonder-Tongue* in this case.

Applicant has had his day in court. He appears to have had a full and fair chance to litigate the validity of his patent.

See MPEP § 2259 for collateral estoppel in reexamination proceedings.

### 2013 Protests Involving Issues of Fraud, Inequitable Conduct, and/or Violation of Duty of Disclosure [R-2]

37 CFR 1.291 permits protests by the public against pending applications.

Submissions under 37 CFR 1.291 are not limited to prior art documents such as patents and publications, but are intended to include any information, which in the protestor’s opinion, would make or have made the grant of the patent improper (see MPEP § 1901.02). This includes, of course, information indicating the presence of “fraud” or “inequitable conduct” or “violation of the duty of disclosure,” which will be entered in the application file, generally without comment >other than to state that such information will not be considered (see MPEP § 2010).< See MPEP § 1901.06.

Protests should be in conformance with 37 CFR 1.291(a) and (b), and include a statement of the alleged facts involved, the point or points to be reviewed, and the action requested. Any briefs or memoranda in support of the petition, and any affidavits, declarations, depositions, exhibits, or other material in support of the alleged facts, should accompany the protest.

### 2014 Duty of Disclosure in Reexamination Proceedings [R-2]

As provided in 37 CFR 1.555, the duty of disclosure in >both *ex parte* and *inter partes*< reexamination proceedings applies to the patent owner. That duty is a continuing obligation on the part of the patent owner throughout the proceedings. However, issues of “fraud,” “inequitable conduct,” or “violation of duty of disclosure” are not considered in reexamination. See MPEP § 2280 >for *ex parte* reexamination proceedings and MPEP § 2684 for *inter partes* reexamination proceedings<. If questions of “fraud” or “inequitable conduct” or “violation of the duty of disclosure” are discovered during reexamination proceedings, the existence of such questions will be noted by the examiner in an Office action

without further comment. See MPEP § 2258 >for *ex parte* reexamination proceedings and MPEP § 2658 for *inter partes* reexamination proceedings<.

For the patent owner's duty to disclose prior or concurrent proceedings in which the patent is or was involved, see MPEP § 2282 >(for *ex parte* reexamination), § 2686 (for *inter partes* reexamination),< and § 2001.06(c).

## 2016 Fraud, Inequitable Conduct, or Violation of Duty of Disclosure Affects All Claims

A finding of “fraud,” “inequitable conduct,” or violation of duty of disclosure with respect to any claim in an application or patent, renders all the claims thereof unpatentable or invalid. See *Chromalloy American Corp. v. Alloy Surfaces Co.*, 339 F. Supp. 859, 173 USPQ 295 (D.Del. 1972) and *Strong v. General Electric Co.*, 305 F. Supp. 1084, 162 USPQ 141 (N.D. Ga. 1969), *aff'd*, 434 F.2d 1042, 168 USPQ 8 (5th Cir. 1970), *cert. denied*, 403 U.S. 906 (1971). In *J. P. Stevens & Co. v. Lex Tex Ltd.*, 747 F.2d 1553, 1561, 223 USPQ 1089, 1093-94 (Fed. Cir. 1984), the court stated:

Once a court concludes that inequitable conduct occurred, all the claims — not just the particular claims in which the inequitable conduct is directly connected — are unenforceable. See *generally*, cases collected in 4 Chisum, PATENTS, paragraph 19.03[6] at 19-85 n. 10 (1984). Inequitable conduct “goes to the patent right as a whole, independently of particular claims.” *In re Clark* 522 F.2d 623, 626, 187 USPQ 209, 212 (CCPA).

The court noted in footnote 8 of *Stevens*:

In *In re Multiple Litigation Involving Frost Patent*, 540 F.2d 601, 611, 191 USPQ 241, 249 (3rd. Cir. 1976),

some claims were upheld despite nondisclosure with respect to others. The case is not precedent in this court.

As stated in *Gemveto Jewelry Co. v. Lambert Bros., Inc.*, 542 F. Supp. 933, 943, 216 USPQ 976, 984 (S. D. N. Y. 1984) (quoting Patent Law Perspectives, 1977 Developments, § G.1 [1]-189):

The gravamen of the fraud defense is that the patentee has failed to discharge his duty of dealing with the examiner in a manner free from the taint of “fraud or other inequitable conduct.” If such conduct is established in connection with the prosecution of a patent, the fact that the lack of candor did not directly affect *all* the claims in the patent has never been the governing principle. It is the inequitable conduct that generates the unenforceability of the patent and we cannot think of cases where a patentee partially escaped the consequences of his wrongful acts by arguing that he only committed acts of omission or commission with respect to a limited number of claims. It is an all or nothing proposition. [Emphasis in original.]

## 2022.05 Determination of “Error Without Any Deceptive Intention” [R-2]

If the application is a reissue application, the action by the examiner may extend to a determination as to whether at least one “error” required by 35 U.S.C. 251 has been alleged, i.e., identified. Further, the examiner should determine whether applicant has *averred* in the reissue oath or declaration, as required by 37 CFR 1.175(a)(2), (b)(1), and (b)(2), that all “errors” arose “without any deceptive intention.” However, the examiner should not normally comment or question as to whether \*\* the averred statement as to lack of deceptive intention appears correct or true. See MPEP § 1414.



# Chapter 2100 Patentability

- 2105 Patentable Subject Matter — Living Subject Matter**
- 2106 Patentable Subject Matter — Computer-Related Inventions**
  - 2106.01 Computer Programming and 35 U.S.C. 112, First Paragraph
  - 2106.02 Disclosure in Computer Programming Cases
- 2107 General Principles Governing Utility Rejections**
  - 2107.01 Procedural Considerations Related to Rejections for Lack of Utility
  - 2107.02 Special Considerations for Asserted Therapeutic or Pharmacological Utilities
- 2111 Claim Interpretation; Broadest Reasonable Interpretation**
  - 2111.01 Plain Meaning
  - 2111.02 Effect of Preamble
  - 2111.03 Transitional Phrases
- 2112 Requirements of Rejection Based on Inherency; Burden of Proof**
  - 2112.01 Composition, Product, and Apparatus Claims
  - 2112.02 Process Claims
- 2113 Product-by-Process Claims**
- 2114 Apparatus and Article Claims — Functional Language**
- 2115 Material or Article Worked Upon by Apparatus**
- 2116 Material Manipulated in Process**
  - 2116.01 Novel, Unobvious Starting Material or End Product
- 2121 Prior Art; General Level of Operability Required to Make a Prima Facie Case**
  - 2121.01 Use of Prior Art in Rejections Where Operability Is in Question
  - 2121.02 Compounds and Compositions — What Constitutes Enabling Prior Art
  - 2121.03 Plant Genetics — What Constitutes Enabling Prior Art
  - 2121.04 Apparatus and Articles — What Constitutes Enabling Prior Art
- 2122 Discussion of Utility in the Prior Art**
- 2123 Rejection Over Prior Art’s Broad Disclosure Instead of Preferred Embodiments**
- 2124 Exception to the Rule That the Critical Reference Date Must Precede the Filing Date**
- 2125 Drawings as Prior Art**
- 2126 Availability of a Document as a “Patent” for Purposes of Rejection Under 35 U.S.C. 102(a), (b), and (d)**
  - 2126.01 Date of Availability of a Patent As a Reference
  - 2126.02 Scope of Reference’s Disclosure Which Can Be Used to Reject Claims When the Reference Is a “Patent” but Not a “Publication”
- 2127 Domestic and Foreign Patent Applications as Prior Art**
- 2128 “Printed Publications” as Prior Art**
  - 2128.01 Level of Public Accessibility Required
  - 2128.02 Date Publication Is Available as a Reference
- 2129 Admissions as Prior Art**
- 2131 Anticipation — Application of 35 U.S.C. 102(a), (b), and (e)**
  - 2131.01 Multiple Reference 35 U.S.C. 102 Rejections
  - 2131.02 Genus-Species Situations
  - 2131.03 Anticipation of Ranges
  - 2131.04 Secondary Considerations
  - 2131.05 Nonanalogous Art
- 2132 35 U.S.C. 102(a)**
  - 2132.01 Publications as 35 U.S.C. 102(a) Prior Art
- 2133 35 U.S.C. 102(b)**
  - 2133.01 Rejections of Continuation-In-Part (CIP) Applications
    - 2133.02 Rejections Based on Publications and Patents
    - 2133.03 Rejections Based on “Public Use” or “On Sale”
      - 2133.03(a) “Public Use”
      - 2133.03(b) “On Sale”
      - 2133.03(c) The “Invention”
      - 2133.03(d) “In This Country”
      - 2133.03(e) Permitted Activity; Experimental Use
        - 2133.03(e)(1) Commercial Exploitation
        - 2133.03(e)(2) Intent
        - 2133.03(e)(3) “Completeness” of the Invention
        - 2133.03(e)(4) Factors Indicative of an Experimental Purpose
        - 2133.03(e)(5) Experimentation and Degree of Supervision and Control
        - 2133.03(e)(6) Permitted Experimental Activity and Testing
        - 2133.03(e)(7) Activity of an Independent Third Party Inventor
- 2134 35 U.S.C. 102(c)**
- 2135 35 U.S.C. 102(d)**
  - 2135.01 The Four Requirements of 35 U.S.C. 102(d)
- 2136 35 U.S.C. 102(e)**
  - 2136.01 Status of U.S. Patent as a Reference Before and After Issuance
  - 2136.02 Content of the Prior Art Available Against the Claims
  - 2136.03 Critical Reference Date

MANUAL OF PATENT EXAMINING PROCEDURE

- 2136.04 Different Inventive Entity; Meaning of “by Another”
- 2136.05 Overcoming a Rejection Under 35 U.S.C. 102(e)
- 2137 35 U.S.C. 102(f)**
- 2137.01 Inventorship
- 2137.02 Applicability of 35 U.S.C. 103(c)
- 2138 35 U.S.C. 102(g)**
- 2138.01 Interference Practice
- 2138.02 “The Invention Was Made in This Country”
- 2138.03 “By Another Who Has Not Abandoned, Suppressed, or Concealed It”
- 2138.04 “Conception”
- 2138.05 “Reduction to Practice”
- 2138.06 “Reasonable Diligence”
- 2141 35 U.S.C. 103; The Graham Factual Inquiries**
- 2141.01 Scope and Content of the Prior Art
- 2141.01(a) Analogous and Nonanalogous Art
- 2141.02 Differences Between Prior Art and Claimed Invention
- 2141.03 Level of Ordinary Skill in the Art
- 2142 Legal Concept of Prima Facie Obviousness**
- 2143 Basic Requirements of a Prima Facie Case of Obviousness**
- 2143.01 Suggestion or Motivation to Modify the References
- 2143.02 Reasonable Expectation of Success Is Required
- 2143.03 All Claim Limitations Must Be Taught or Suggested
- 2144 Sources of Rationale Supporting a Rejection Under 35 U.S.C. 103**
- 2144.01 Implicit Disclosure
- 2144.02 Reliance on Scientific Theory
- 2144.03 Reliance on Common Knowledge in the Art or “Well Known” Prior Art
- 2144.04 Legal Precedent as Source of Supporting Rationale
- 2144.05 Obviousness of Ranges
- 2144.06 Art Recognized Equivalence for the Same Purpose
- 2144.07 Art Recognized Suitability for an Intended Purpose
- 2144.08 Obviousness of Species When Prior Art Teaches Genus
- 2144.09 Close Structural Similarity Between Chemical Compounds (Homologs, Analogues, Isomers)
- 2145 Consideration of Applicant’s Rebuttal Arguments**
- 2146 35 U.S.C. 103(c)**
- 2161 Three Separate Requirements for Specification Under 35 U.S.C. 112, First Paragraph**
- 2162 Policy Underlying 35 U.S.C. 112, First Paragraph**
- 2163 The Written Description Requirement**
- 2163.01 Support for the Claimed Subject Matter in Disclosure
- 2163.02 Standard for Determining Compliance With the Written Description Requirement
- 2163.03 Typical Circumstances Where Adequate Written Description Issue Arises
- 2163.04 Burden on the Examiner With Regard to the Written Description Requirement
- 2163.05 Changes to the Scope of Claims
- 2163.06 Relationship of Written Description Requirement to New Matter
- 2163.07 Amendments to Application Which Are Supported in the Original Description
- 2163.07(a) Inherent Function, Theory, or Advantage
- 2163.07(b) Incorporation by Reference
- 2164 The Enablement Requirement**
- 2164.01 Test of Enablement
- 2164.01(a) Undue Experimentation Factors
- 2164.01(b) How to Make the Claimed Invention
- 2164.01(c) How to Use the Claimed Invention
- 2164.02 Working Example
- 2164.03 Relationship of Predictability of the Art and the Enablement Requirement
- 2164.04 Burden on the Examiner Under the Enablement Requirement
- 2164.05 Determination of Enablement Based on Evidence As a Whole
- 2164.05(a) Specification Must Be Enabling as of the Filing Date
- 2164.05(b) Specification Must Be Enabling to Persons Skilled in the Art
- 2164.06 Quantity of Experimentation
- 2164.06(a) Examples of Enablement Issues-Missing Information
- 2164.06(b) Examples of Enablement Issues — Chemical Cases
- 2164.07 Relationship of Enablement Requirement to Utility Requirement of 35 U.S.C. 101
- 2164.08 Enablement Commensurate in Scope With the Claims
- 2164.08(a) Single Means Claim
- 2164.08(b) Inoperative Subject Matter
- 2164.08(c) Critical Feature Not Claimed
- 2165 The Best Mode Requirement**
- 2165.01 Considerations Relevant to Best Mode
- 2165.02 Best Mode Requirement Compared to Enablement Requirement
- 2165.03 Requirements for Rejection for Lack of Best Mode

- 2165.04 Examples of Evidence of Concealment
- 2171 Two Separate Requirements for Claims Under 35 U.S.C. 112, Second Paragraph**
- 2172 Subject Matter Which Applicants Regard as Their Invention**
- 2172.01 Unclaimed Essential Matter
- 2173 Claims Must Particularly Point Out and Distinctly Claim the Invention**
- 2173.01 Claim Terminology
- 2173.02 Clarity and Precision
- 2173.03 Inconsistency Between Claim and Specification Disclosure or Prior Art
- 2173.04 Breadth Is Not Indefiniteness
- 2173.05 Specific Topics Related to Issues Under 35 U.S.C. 112, Second Paragraph
- 2173.05(a) New Terminology
- 2173.05(b) Relative Terminology
- 2173.05(c) Numerical Ranges and Amounts Limitations
- 2173.05(d) Exemplary Claim Language (“for example,” “such as”)
- 2173.05(e) Lack of Antecedent Basis
- 2173.05(f) Reference to Limitations in Another Claim
- 2173.05(g) Functional Limitations
- 2173.05(h) Alternative Limitations
- 2173.05(i) Negative Limitations
- 2173.05(j) Old Combination
- 2173.05(k) Aggregation
- 2173.05(m) Prolix
- 2173.05(n) Multiplicity
- 2173.05(o) Double Inclusion
- 2173.05(p) Claim Directed to Product-By-Process or Product and Process
- 2173.05(q) “Use” Claims
- 2173.05(r) Omnibus Claim
- 2173.05(s) Reference to Figures or Tables
- 2173.05(t) Chemical Formula
- 2173.05(u) Trademarks or Trade Names in a Claim
- 2173.05(v) Mere Function of Machine
- 2173.06 Prior Art Rejection of Claim Rejected as Indefinite
- 2174 Relationship Between the Requirements of the First and Second Paragraphs of 35 U.S.C. 112**
- 2181 Identifying a 35 U.S.C. 112, Sixth Paragraph Limitation**
- 2182 Scope of the Search and Identification of the Prior Art**
- 2183 Making a Prima Facie Case of Equivalence**
- 2184 Determining Whether an Applicant Has Met the Burden of Proving Nonequivalence After a Prima Facie Case Is Made**
- 2185 Related Issues Under 35 U.S.C. 112, First or Second Paragraphs**

- 2186 Relationship to the Doctrine of Equivalents**
- 2190 Prosecution Laches**

## **2105 Patentable Subject Matter — Living Subject Matter [R-1]**

The decision of the Supreme Court in *Diamond v. Chakrabarty*, 447 U.S. 303, 206 USPQ 193 (1980), held that microorganisms produced by genetic engineering are not excluded from patent protection by 35 U.S.C. 101. It is clear from the Supreme Court decision and opinion that the question of whether or not an invention embraces living matter is irrelevant to the issue of patentability. The test set down by the Court for patentable subject matter in this area is whether the living matter is the result of human intervention.

In view of this decision, the Office has issued these guidelines as to how 35 U.S.C. 101 will be interpreted.

The Supreme Court made the following points in the *Chakrabarty* opinion:

1. “Guided by these canons of construction, this Court has read the term ‘manufacture’ in § 101 in accordance with its dictionary definition to mean ‘the production of articles for use from raw materials prepared by giving to these materials new forms, qualities, properties, or combinations whether by hand labor or by machinery.’”
2. “In choosing such expansive terms as ‘manufacture’ and ‘composition of matter,’ modified by the comprehensive ‘any,’ Congress plainly contemplated that the patent laws would be given wide scope.”
3. “The Act embodied Jefferson’s philosophy that ‘ingenuity should receive a liberal encouragement.’ 5 Writings of Thomas Jefferson, at 75-76. See *Graham v. John Deere Co.*, 383 U.S. 1, 7-10 (1966). Subsequent patent statutes in 1836, 1870, and 1874 employed this same broad language. In 1952, when the patent laws were recodified, Congress replaced the word ‘art’ with ‘process,’ but otherwise left Jefferson’s language intact. The Committee Reports accompanying the 1952 act inform us that Congress intended statutory subject matter to ‘include any thing under the sun that is made by man.’ S. Rep. No. 1979, 82d Cong., 2d Sess., 5 (1952).”
4. “This is not to suggest that § 101 has no limits or that it embraces every discovery. The laws of nature, physical phenomena, and abstract ideas have been held not patentable.”
5. “Thus, a new mineral discovered in the earth or a new plant found in the wild is not patentable subject matter. Likewise, Einstein could not patent his celebrated law

that  $E=mc^2$ ; nor could Newton have patented the law of gravity.”

6. “His claim is not to a hitherto unknown natural phenomenon, but to a nonnaturally occurring manufacture or composition of matter — a product of human ingenuity ‘having a distinctive name, character [and] use.’”

7. “Congress thus recognized that the relevant distinction was not between living and inanimate things, but between products of nature, whether living or not, and human-made inventions. Here, respondent’s microorganism is the result of human ingenuity and research.”

8. After reference to *Funk Seed Co. & Kalo Co.*, 333 U.S.127 (1948), “Here, by contrast, the patentee has produced a new bacterium with markedly different characteristics from any found in nature and one having the potential for significant utility. His discovery is not nature’s handiwork, but his own; accordingly it is patentable subject matter under § 101.”

A review of the Court statements above as well as the whole *Chakrabarty* opinion reveals:

(A) That the Court did not limit its decision to genetically engineered living organisms;

(B) The Court enunciated a very broad interpretation of “manufacture” and “composition of matter” in 35 U.S.C. 101 (Note esp. quotes 1, 2, and 3 above);

(C) The Court set forth several tests for weighing whether patentable subject matter under 35 U.S.C. 101 is present, stating (in quote 7 above) that:

The relevant distinction was not between living and inanimate things but between products of nature, whether living or not, and human-made inventions.

The tests set forth by the Court are (note especially the italicized portions):

(A) “The laws of nature, physical phenomena and abstract ideas” are not patentable subject matter.

(B) A “nonnaturally occurring manufacture or composition of matter — a product of human ingenuity — having a distinctive name, character, [and] use” is patentable subject matter.

(C) “[A] new mineral discovered in the earth or a new plant found in the wild is not patentable subject matter. Likewise, Einstein could not patent his celebrated  $E=mc^2$ ; nor could Newton have patented the law of gravity. Such discoveries are ‘manifestations of... nature, free to all men and reserved exclusively to none.’”

(D) “[T]he production of articles for use from raw materials prepared by giving to these materials *new*

*forms, qualities, properties, or combinations whether by hand labor or by machinery*” [emphasis added] is a “manufacture” under 35 U.S.C. 101.

In analyzing the history of the Plant Patent Act of 1930, the Court stated: “In enacting the Plant Patent Act, Congress addressed both of these concerns [the concern that plants, even those artificially bred, were products of nature for purposes of the patent law and the concern that plants were thought not amenable to the written description]. It explained at length its belief that the work of the plant breeder ‘in aid of nature’ was patentable invention. S. Rep. No. 315, 71st Cong., 2d Sess., 6-8 (1930); H.R. Rep. No. 1129, 71st Cong., 2d Sess., 7-9 (1930).”

The Office will decide the questions as to patentable subject matter under 35 U.S.C. 101 on a case-by-case basis following the tests set forth in *Chakrabarty*, e.g., that “a nonnaturally occurring manufacture or composition of matter” is patentable, etc. It is inappropriate to try to attempt to set forth here in advance the exact parameters to be followed.

The standard of patentability has not and will not be lowered. The requirements of 35 U.S.C. 102 and 103 still apply. The tests outlined above simply mean that a rational basis will be present for any 35 U.S.C. 101 determination. In addition, the requirements of 35 U.S.C. 112 must also be met. In this regard, see MPEP § 608.01(p).

\*\*>In another case addressing< the scope of 35 U.S.C. 101, the \*\*>Supreme Court< held that patentable subject matter under 35 U.S.C. 101 includes \*\*>newly developed plant breeds<, even though plant protection is also available under the Plant Patent Act (35 U.S.C. 161 - 164) and the Plant Variety Protection Act (7 U.S.C. 2321 *et. seq.*). \*\*> *J.E.M. Ag Supply, Inc. v. Pioneer Hi-Bred Int’ l, Inc.*, 534 U.S. 124, 143-46, 122 S.Ct. 593, 605-06, 60 USPQ2d 1865, 1874 (2001) (The scope of coverage of 35 U.S.C.101 is not limited by the Plant Patent Act or the Plant Variety Protection Act; each statute can be regarded as effective because of its different requirements and protections).< See also *Ex parte Hibberd*, 227 USPQ 443 (Bd. Pat. App. & Inter. 1985), wherein the Board held that plant subject matter may be the proper subject of a patent under 35 U.S.C. 101 even though such subject matter may be protected under the Plant Patent Act or the Plant Variety Protection Act. Following the reasoning in *Chakrabarty*, the Board of Patent

Appeals and Interferences has also determined that animals are patentable subject matter under 35 U.S.C. 101. In *Ex parte Allen*, 2 USPQ2d 1425 (Bd. Pat. App. & Inter. 1987), the Board decided that a polyploid Pacific coast oyster could have been the proper subject of a patent under 35 U.S.C. 101 if all the criteria for patentability were satisfied. Shortly after the *Allen* decision, the Commissioner of Patents and Trademarks issued a notice (Animals - Patentability, 1077 O.G. 24, April 21, 1987) that the Patent and Trademark Office would now consider nonnaturally occurring, nonhuman multicellular living organisms, including animals, to be patentable subject matter within the scope of 35 U.S.C. 101.

If the broadest reasonable interpretation of the claimed invention as a whole encompasses a human being, then a rejection under 35 U.S.C. 101 must be made indicating that the claimed invention is directed to nonstatutory subject matter. Furthermore, the claimed invention must be examined with regard to all issues pertinent to patentability, and any applicable rejections under 35 U.S.C. 102, 103, or 112 must also be made.

## **2106 Patentable Subject Matter — Computer-Related Inventions [R-2]**

### **I. INTRODUCTION**

These Examination Guidelines for Computer-Related Inventions (“Guidelines”) are to assist Office personnel in the examination of applications drawn to computer-related inventions. “Computer-related inventions” include inventions implemented in a computer and inventions employing computer-readable media. The Guidelines are based on the Office’s current understanding of the law and are believed to be fully consistent with binding precedent of the Supreme Court, the Federal Circuit and the Federal Circuit’s predecessor courts.

These Guidelines do not constitute substantive rule-making and hence do not have the force and effect of law. These Guidelines have been designed to assist Office personnel in analyzing claimed subject matter for compliance with substantive law. Rejections will be based upon the substantive law and it is these rejections which are appealable. Consequently, any failure by Office personnel to follow the Guidelines is neither appealable nor petitionable.

The Guidelines alter the procedures Office personnel will follow when examining applications drawn to computer-related inventions and are equally applicable to claimed inventions implemented in either hardware or software. The Guidelines also clarify the Office’s position on certain patentability standards related to this field of technology. Office personnel are to rely on these Guidelines in the event of any inconsistent treatment of issues between these Guidelines and any earlier provided guidance from the Office.

Office personnel should no longer rely on the Freeman-Walter-Abele test to determine whether a claimed invention is directed to statutory subject matter. *State Street Bank & Trust Co. v. Signature Financial Group Inc.*, 149 F. 3d 1368, 1374, 47 USPQ2d 1596, 1601-02 (Fed. Cir. 1998) (“After *Diehr* and *Chakrabarty*, the Freeman-Walter-Abele test has little, if any, applicability to determining the presence of statutory subject matter.”).

Office personnel have had difficulty in properly treating claims directed to methods of doing business. Claims should not be categorized as methods of doing business. Instead, such claims should be treated like any other process claims, pursuant to these Guidelines when relevant. See, e.g., *State Street*, 149 F.3d at 1374-75, 47 USPQ2d at 1602 (Fed. Cir. 1998); *In re Toma*, 575 F.2d 872, 877-78, 197 USPQ 852, 857 (CCPA 1978); *In re Musgrave*, 431 F.2d 882, 893, 167 USPQ 280, 289-90 (CCPA 1970). See also *In re Schrader*, 22 F.3d 290, 297-98, 30 USPQ2d 1455, 1461-62 (Fed. Cir. 1994) (Newman, J., dissenting); *Paine, Webber, Jackson & Curtis, Inc. v. Merrill Lynch, Pierce, Fenner & Smith, Inc.*, 564 F. Supp. 1358, 1368-69, 218 USPQ 212, 220 (D. Del. 1983).

The appendix which appears at the end of this section includes a flow chart of the process Office personnel will follow in conducting examinations for computer-related inventions.

### **II. DETERMINE WHAT APPLICANT HAS INVENTED AND IS SEEKING TO PATENT**

It is essential that patent applicants obtain a prompt yet complete examination of their applications. Under the principles of compact prosecution, each claim should be reviewed for compliance with every statutory requirement for patentability in the initial review of the application, even if one or more claims are



found to be deficient with respect to some statutory requirement. Thus, Office personnel should state all reasons and bases for rejecting claims in the first Office action. Deficiencies should be explained clearly, particularly when they serve as a basis for a rejection. Whenever practicable, Office personnel should indicate how rejections may be overcome and how problems may be resolved. A failure to follow this approach can lead to unnecessary delays in the prosecution of the application.

Prior to focusing on specific statutory requirements, Office personnel must begin examination by determining what, precisely, the applicant has invented and is seeking to patent, and how the claims relate to and define that invention. (As the courts have repeatedly reminded the Office: “The goal is to answer the question ‘What did applicants invent?’ ” *In re Abele*, 684 F.2d 902, 907, 214 USPQ 682, 687. Accord, e.g., *Arrhythmia Research Tech. v. Corazonix Corp.*, 958 F.2d 1053, 1059, 22 USPQ2d 1033, 1038 (Fed. Cir. 1992).) Consequently, Office personnel will no longer begin examination by determining if a claim recites a “mathematical algorithm.” Rather they will review the complete specification, including the detailed description of the invention, any specific embodiments that have been disclosed, the claims and any specific, substantial, and credible utilities that have been asserted for the invention.

#### **A. Identify and Understand Any Practical Application Asserted for the Invention**

The claimed invention as a whole must accomplish a practical application. That is, it must produce a “useful, concrete and tangible result.” *State Street*, 149 F.3d at 1373, 47 USPQ2d at 1601-02. The purpose of this requirement is to limit patent protection to inventions that possess a certain level of “real world” value, as opposed to subject matter that represents nothing more than an idea or concept, or is simply a starting point for future investigation or research (*Brenner v. Manson*, 383 U.S. 519, 528-36, 148 USPQ 689, 693-96); *In re Ziegler*, 992, F.2d 1197, 1200-03, 26 USPQ2d 1600, 1603-06 (Fed. Cir. 1993)). Accordingly, a complete disclosure should contain some indication of the practical application for the claimed invention, i.e., why the applicant believes the claimed invention is useful.

Apart from the utility requirement of 35 U.S.C. 101, usefulness under the patent eligibility standard requires significant functionality to be present to satisfy the useful result aspect of the practical application requirement. See *Arrhythmia*, 958 F.2d at 1057, 22 USPQ2d at 1036. Merely claiming nonfunctional descriptive material stored in a computer-readable medium does not make the invention eligible for patenting. For example, a claim directed to a word processing file stored on a disk may satisfy the utility requirement of 35 U.S.C. 101 since the information stored may have some “real world” value. However, the mere fact that the claim may satisfy the utility requirement of 35 U.S.C. 101 does not mean that a useful result is achieved under the practical application requirement. The claimed invention as a whole must produce a “useful, concrete and tangible” result to have a practical application.

Although the courts have yet to define the terms useful, concrete, and tangible in the context of the practical application requirement for purposes of these guidelines, the following examples illustrate claimed inventions that have a practical application because they produce useful, concrete, and tangible result:

- Claims drawn to a long-distance telephone billing process containing mathematical algorithms were held to be directed to patentable subject matter because “the claimed process applies the Boolean principle to produce a useful, concrete, tangible result without pre-empting other uses of the mathematical principle.” *AT&T Corp. v. Excel Communications, Inc.*, 172 F.3d 1352, 1358, 50 USPQ2d 1447, 1452 (Fed. Cir. 1999);

- “[T]ransformation of data, representing discrete dollar amounts, by a machine through a series of mathematical calculations into a final share price, constitutes a practical application of a mathematical algorithm, formula, or calculation, because it produces ‘a useful, concrete and tangible result’ -- a final share price momentarily fixed for recording and reporting purposes and even accepted and relied upon by regulatory authorities and in subsequent trades.” *State Street*, 149 F.3d at 1373, 47 USPQ2d at 1601; and

- Claims drawn to a rasterizer for converting discrete waveform data samples into anti-aliased pixel illumination intensity data to be displayed on a

display means were held to be directed to patentable subject matter since the claims defined “a specific machine to produce a useful, concrete, and tangible result.” *In re Alappat*, 33 F.3d 1526, 1544, 31 USPQ2d 1545, 1557 (Fed. Cir. 1994).

A process that consists solely of the manipulation of an abstract idea is not concrete or tangible. See *In re Warmerdam*, 33 F.3d 1354, 1360, 31 USPQ2d 1754, 1759 (Fed. Cir. 1994). See also *Schrader*, 22 F.3d at 295, 30 USPQ2d at 1459. Office personnel have the burden to establish a *prima facie* case that the claimed invention as a whole is directed to solely an abstract idea or to manipulation of abstract ideas or does not produce a useful result. Only when the claim is devoid of any limitation to a practical application in the technological arts should it be rejected under 35 U.S.C. 101. Compare *Musgrave*, 431 F.2d at 893, 167 USPQ at 289; *In re Foster*, 438 F.2d 1011, 1013, 169 USPQ 99, 101 (CCPA 1971). Further, when such a rejection is made, Office personnel must expressly state how the language of the claims has been interpreted to support the rejection.

The applicant is in the best position to explain why an invention is believed useful. Office personnel should therefore focus their efforts on pointing out statements made in the specification that identify all practical applications for the invention. Office personnel should rely on such statements throughout the examination when assessing the invention for compliance with all statutory criteria. An applicant may assert more than one practical application, but only one is necessary to satisfy the utility requirement. Office personnel should review the entire disclosure to determine the features necessary to accomplish at least one asserted practical application.

### ***B. Review the Detailed Disclosure and Specific Embodiments of the Invention To Determine What the Applicant Has Invented***

The written description will provide the clearest explanation of the applicant’s invention, by exemplifying the invention, explaining how it relates to the prior art and explaining the relative significance of various features of the invention. Accordingly, Office personnel should begin their evaluation of a computer-related invention as follows:

- determine what the programmed computer does when it performs the processes dictated by the software (i.e., the functionality of the programmed computer) (*Arrhythmia*, 958 F.2d at 1057, 22 USPQ at 1036, “It is of course true that a modern digital computer manipulates data, usually in binary form, by performing mathematical operations, such as addition, subtraction, multiplication, division, or bit shifting, on the data. But this is only how the computer does what it does. Of importance is the significance of the data and their manipulation in the real world, i.e., what the computer is doing.”);

- determine how the computer is to be configured to provide that functionality (i.e., what elements constitute the programmed computer and how those elements are configured and interrelated to provide the specified functionality); and

- if applicable, determine the relationship of the programmed computer to other subject matter outside the computer that constitutes the invention (e.g., machines, devices, materials, or process steps other than those that are part of or performed by the programmed computer). (Many computer-related inventions do not consist solely of a computer. Thus, Office personnel should identify those claimed elements of the computer-related invention that are not part of the programmed computer, and determine how those elements relate to the programmed computer. Office personnel should look for specific information that explains the role of the programmed computer in the overall process or machine and how the programmed computer is to be integrated with the other elements of the apparatus or used in the process.)

Patent applicants can assist the Office by preparing applications that clearly set forth these aspects of a computer-related invention.

### ***C. Review the Claims***

The claims define the property rights provided by a patent, and thus require careful scrutiny. The goal of claim analysis is to identify the boundaries of the protection sought by the applicant and to understand how the claims relate to and define what the applicant has indicated is the invention. Office personnel must first determine the scope of a claim by thoroughly analyzing the language of the claim before determining if the claim complies with each statutory requirement for patentability. See *In re Hiniker Co.*, 150 F.3d

1362, 1369, 47 USPQ2d 1523, 1529 (Fed. Cir. 1998) (“[T]he name of the game is the claim.”).

Office personnel should begin claim analysis by identifying and evaluating each claim limitation. For processes, the claim limitations will define steps or acts to be performed. For products, the claim limitations will define discrete physical structures or materials. Product claims are claims that are directed to either machines, manufactures or compositions of matter. The discrete physical structures or materials may be comprised of hardware or a combination of hardware and software.

Office personnel are to correlate each claim limitation to all portions of the disclosure that describe the claim limitation. This is to be done in all cases, i.e., whether or not the claimed invention is defined using means or step plus function language. The correlation step will ensure that Office personnel correctly interpret each claim limitation.

The subject matter of a properly construed claim is defined by the terms that limit its scope. It is this subject matter that must be examined. As a general matter, the grammar and intended meaning of terms used in a claim will dictate whether the language limits the claim scope. Language that suggests or makes optional but does not require steps to be performed or does not limit a claim to a particular structure does not limit the scope of a claim or claim limitation. The following are examples of language that may raise a question as to the limiting effect of the language in a claim:

- (A) statements of intended use or field of use,
- (B) “adapted to” or “adapted for” clauses,
- (C) “wherein” clauses, or
- (D) “whereby” clauses.

This list of examples is not intended to be exhaustive.

Office personnel must rely on the applicant’s disclosure to properly determine the meaning of \*\* the claims. *Markman v. Westview Instruments*, 52 F.3d 967, 980, 34 USPQ2d 1321, 1330 (Fed. Cir.) (*en banc*), *aff’d*, U.S. , 116 S. Ct. 1384 (1996). \*\*>Claim terms are presumed to have the ordinary and customary meanings attributed to them by those of ordinary skill in the art. *Sunracer Roots Enter. Co. v. SRAM Corp.*, 336 F.3d 1298, 1302, 67 USPQ2d 1438, 1441 (Fed. Cir. 2003); *Brookhill-Wilk I, LLC v. Intuitive Surgical, Inc.*, 334 F.3d 1294, 1298, 67

USPQ2d 1132, 1136 (Fed. Cir. 2003)(“In the absence of an express intent to impart a novel meaning to the claim terms, the words are presumed to take on the ordinary and customary meanings attributed to them by those of ordinary skill in the art.”) However, an applicant is entitled to be his or her own lexicographer and may rebut the presumption that claim terms are to be given their ordinary and customary meaning by clearly setting forth a definition of the term that is different from its ordinary and customary meaning. *See In re Paulsen*, 30 F.3d 1475, 1480, 31 USPQ2d 1671, 1674 (Fed. Cir. 1994).< Where an explicit definition is provided by the applicant for a term, that definition will control interpretation of the term as it is used in the claim. *Toro Co. v. White Consolidated Industries Inc.*, 199 F.3d 1295, 1301, 53 USPQ2d 1065, 1069 (Fed. Cir. 1999) (meaning of words used in a claim is not construed in a “lexicographic vacuum, but in the context of the specification and drawings.”). \*\* Any special meaning assigned to a term “must be sufficiently clear in the specification that any departure from common usage would be so understood by a person of experience in the field of the invention.” *Multi-form Desiccants Inc. v. Medzam Ltd.*, 133 F.3d 1473, 1477, 45 USPQ2d 1429, 1432 (Fed. Cir. 1998). \*\*>See also MPEP § 2111.01.<

If the applicant asserts that a term has a meaning that conflicts with the term’s art-accepted meaning, Office personnel should encourage the applicant to amend the claim to better reflect what applicant intends to claim as the invention. If the application becomes a patent, it becomes prior art against subsequent applications. Therefore, it is important for later search purposes to have the patentee employ commonly accepted terminology, particularly for searching text-searchable databases.

Office personnel must always remember to use the perspective of one of ordinary skill in the art. Claims and disclosures are not to be evaluated in a vacuum. If elements of an invention are well known in the art, the applicant does not have to provide a disclosure that describes those elements. In such a case the elements will be construed as encompassing any and every art-recognized hardware or combination of hardware and software technique for implementing the defined requisite functionalities.

Office personnel are to give claims their broadest reasonable interpretation in light of the supporting

disclosure. *In re Morris*, 127 F.3d 1048, 1054-55, 44 USPQ2d 1023, 1027-28 (Fed. Cir. 1997). Limitations appearing in the specification but not recited in the claim are not read into the claim. >*E-Pass Techs., Inc. v. 3Com Corp.*, 343 F.3d 1364, 1369, 67 USPQ2d 1947, 1950 (Fed. Cir. 2003) (claims must be interpreted “in view of the specification” without importing limitations from the specification into the claims unnecessarily).< *In re Prater*, 415 F.2d 1393, 1404-05, 162 USPQ 541, 550-551 (CCPA 1969). See also *In re Zletz*, 893 F.2d 319, 321-22, 13 USPQ2d 1320, 1322 (Fed. Cir. 1989) (“During patent examination the pending claims must be interpreted as broadly as their terms reasonably allow.... The reason is simply that during patent prosecution when claims can be amended, ambiguities should be recognized, scope and breadth of language explored, and clarification imposed.... An essential purpose of patent examination is to fashion claims that are precise, clear, correct, and unambiguous. Only in this way can uncertainties of claim scope be removed, as much as possible, during the administrative process.”).

Where means plus function language is used to define the characteristics of a machine or manufacture invention, claim limitations must be interpreted to read on only the structures or materials disclosed in the specification and “equivalents thereof.” (Two *en banc* decisions of the Federal Circuit have made clear that the Office is to interpret means plus function language according to 35 U.S.C. 112, sixth paragraph. In the first, *In re Donaldson*, 16 F.3d 1189, 1193, 29 USPQ2d 1845, 1848 (Fed. Cir. 1994), the court held:

The plain and unambiguous meaning of paragraph six is that one construing means-plus-function language in a claim must look to the specification and interpret that language in light of the corresponding structure, material, or acts described therein, and equivalents thereof, to the extent that the specification provides such disclosure. Paragraph six does not state or even suggest that the PTO is exempt from this mandate, and there is no legislative history indicating that Congress intended that the PTO should be. Thus, this court must accept the plain and precise language of paragraph six.

Consistent with *Donaldson*, in the second decision, *In re Alappat*, 33 F.3d 1526, 1540, 31 USPQ2d 1545, 1554 (Fed. Cir. 1994) (in banc), the Federal Circuit held:

Given *Alappat*'s disclosure, it was error for the Board majority to interpret each of the means clauses in claim 15 so broadly as to “read on any and every means for performing the function” recited, as it said it was doing, and then to conclude that claim 15 is nothing more than a process claim wherein each means clause represents a step in that process. Contrary to suggestions by the Commissioner, this court's precedents do not support the Board's view that the particular apparatus claims at issue in this case may be viewed as nothing more than process claims.

Disclosure may be express, implicit or inherent. Thus, at the outset, Office personnel must attempt to correlate claimed means to elements set forth in the written description. The written description includes the original specification and the drawings. Office personnel are to give the claimed means plus function limitations their broadest reasonable interpretation consistent with all corresponding structures or materials described in the specification and their equivalents including the manner in which the claimed functions are performed. See *Kemco Sales, Inc. v. Control Papers Company, Inc.*, 208 F.3d 1352, 54 USPQ2d 1308 (Fed. Cir. 2000). Further guidance in interpreting the scope of equivalents is provided in MPEP § 2181 through § 2186.

While it is appropriate to use the specification to determine what applicant intends a term to mean, a positive limitation from the specification cannot be read into a claim that does not impose that limitation. A broad interpretation of a claim by Office personnel will reduce the possibility that the claim, when issued, will be interpreted more broadly than is justified or intended. An applicant can always amend a claim during prosecution to better reflect the intended scope of the claim.

Finally, when evaluating the scope of a claim, every limitation in the claim must be considered. Office personnel may not dissect a claimed invention into discrete elements and then evaluate the elements in isolation. Instead, the claim as a whole must be considered. See, e.g., *Diamond v. Diehr*, 450 U.S. at 188-89, 209 USPQ at 9 (“In determining the eligibility of respondents' claimed process for patent protection under 101, their claims must be considered as a whole. It is inappropriate to dissect the claims into old and new elements and then to ignore the presence of the old elements in the analysis. This is particularly true in a process claim because a new combination of steps in a process may be patentable even though all

the constituents of the combination were well known and in common use before the combination was made.”).

### III. CONDUCT A THOROUGH SEARCH OF THE PRIOR ART

Prior to classifying the claimed invention under 35 U.S.C. 101, Office personnel are expected to conduct a thorough search of the prior art. Generally, a thorough search involves reviewing both U.S. and foreign patents and nonpatent literature. In many cases, the result of such a search will contribute to Office personnel’s understanding of the invention. Both claimed and unclaimed aspects of the invention described in the specification should be searched if there is a reasonable expectation that the unclaimed aspects may be later claimed. A search must take into account any structure or material described in the specification and its equivalents which correspond to the claimed means plus function limitation, in accordance with 35 U.S.C. 112, sixth paragraph and MPEP § 2181 through § 2186.

### IV. DETERMINE WHETHER THE CLAIMED INVENTION COMPLIES WITH 35 U.S.C. 101

#### A. Consider the Breadth of 35 U.S.C. 101 Under Controlling Law

As the Supreme Court has held, Congress chose the expansive language of 35 U.S.C. 101 so as to include “anything under the sun that is made by man.” *Diamond v. Chakrabarty*, 447 U.S. 303, 308-09, 206 USPQ 193, 197 (1980). Accordingly, section 101 of title 35, United States Code, provides:

Whoever invents or discovers any new and useful process, machine, manufacture, or composition of matter, or any new and useful improvement thereof, may obtain a patent therefor, subject to the conditions and requirements of this title.

In *Chakrabarty*, 447 U.S. at 308-309, 206 USPQ at 197, the court stated:

In choosing such expansive terms as “manufacture” and “composition of matter,” modified by the comprehensive “any,” Congress plainly contemplated that the patent laws would be given wide scope. The relevant legislative history also supports a broad construction. The Patent Act of 1793, authored by Thomas Jefferson, defined statutory

subject matter as “any new and useful art, machine, manufacture, or composition of matter, or any new or useful improvement [thereof].” Act of Feb. 21, 1793, ch. 11, § 1, 1 Stat. 318. The Act embodied Jefferson’s philosophy that “ingenuity should receive a liberal encouragement.” V Writings of Thomas Jefferson, at 75-76. See *Graham v. John Deere Co.*, 383 U.S. 1, 7-10 (148 USPQ 459, 462-464) (1966). Subsequent patent statutes in 1836, 1870, and 1874 employed this same broad language. In 1952, when the patent laws were recodified, Congress replaced the word “art” with “process,” but otherwise left Jefferson’s language intact. The Committee Reports accompanying the 1952 Act inform us that Congress intended statutory subject matter to “include anything under the sun that is made by man.” S. Rep. No. 1979, 82d Cong., 2d Sess., 5 (1952); H.R. Rep. No. 1923, 82d Cong., 2d Sess., 6 (1952). [Footnote omitted]

This perspective has been embraced by the Federal Circuit:

The plain and unambiguous meaning of section 101 is that any new and useful process, machine, manufacture, or composition of matter, or any new and useful improvement thereof, may be patented if it meets the requirements for patentability set forth in Title 35, such as those found in sections 102, 103, and 112. The use of the expansive term “any” in section 101 represents Congress’s intent not to place any restrictions on the subject matter for which a patent may be obtained beyond those specifically recited in section 101 and the other parts of Title 35. . . . Thus, it is improper to read into section 101 limitations as to the subject matter that may be patented where the legislative history does not indicate that Congress clearly intended such limitations.

*Alappat*, 33 F.3d at 1542, 31 USPQ2d at 1556.

As cast, 35 U.S.C. 101 defines four categories of inventions that Congress deemed to be the appropriate subject matter of a patent; namely, processes, machines, manufactures and compositions of matter. The latter three categories define “things” while the first category defines “actions” (i.e., inventions that consist of a series of steps or acts to be performed). See 35 U.S.C. 100(b) (“The term ‘process’ means process, art, or method, and includes a new use of a known process, machine, manufacture, composition of matter, process, machine, manufacture, composition of matter, or material.”).

Federal courts have held that 35 U.S.C. 101 does have certain limits. First, the phrase “anything under the sun that is made by man” is limited by the text of 35 U.S.C. 101, meaning that one may only patent something that is a machine, manufacture, composition of matter or a process. See, e.g., *Alappat*, 33 F.3d at 1542, 31 USPQ2d at 1556; *Warmerdam*, 33 F.3d at

1358, 31 USPQ2d at 1757 (Fed. Cir. 1994). Second, 35 U.S.C. 101 requires that the subject matter sought to be patented be a “useful” invention. Accordingly, a complete definition of the scope of 35 U.S.C. 101, reflecting Congressional intent, is that any new and useful process, machine, manufacture or composition of matter under the sun that is made by man is the proper subject matter of a patent.

The subject matter courts have found to be outside the four statutory categories of invention is limited to abstract ideas, laws of nature and natural phenomena. While this is easily stated, determining whether an applicant is seeking to patent an abstract idea, a law of nature or a natural phenomenon has proven to be challenging. These three exclusions recognize that subject matter that is not a practical application or use of an idea, a law of nature or a natural phenomenon is not patentable. See, e.g., *Rubber-Tip Pencil Co. v. Howard*, 87 U.S. (20 Wall.) 498, 507 (1874) (“idea of itself is not patentable, but a new device by which it may be made practically useful is”); *Mackay Radio & Telegraph Co. v. Radio Corp. of America*, 306 U.S. 86, 94, 40 USPQ 199, 202 (1939) (“While a scientific truth, or the mathematical expression of it, is not patentable invention, a novel and useful structure created with the aid of knowledge of scientific truth may be.”); *Warmerdam*, 33 F.3d at 1360, 31 USPQ2d at 1759 (“steps of ‘locating’ a medial axis, and ‘creating’ a bubble hierarchy . . . describe nothing more than the manipulation of basic mathematical constructs, the paradigmatic ‘abstract idea’”).

Courts have expressed a concern over “preemption” of ideas, laws of nature or natural phenomena. The concern over preemption was expressed as early as 1852. See *Le Roy v. Tatham*, 55 U.S. 156, 175 (1852) (“A principle, in the abstract, is a fundamental truth; an original cause; a motive; these cannot be patented, as no one can claim in either of them an exclusive right.”); *Funk Brothers Seed Co. v. Kalo Inoculant Co.*, 333 U.S. 127, 132, 76 USPQ 280, 282 (1948) (combination of six species of bacteria held to be nonstatutory subject matter). The concern over preemption serves to bolster and justify the prohibition against the patenting of such subject matter. In fact, such concerns are only relevant to claiming a scientific truth or principle. Thus, a claim to an “abstract idea” is nonstatutory because it does not represent a

practical application of the idea, not because it would preempt the idea.

### ***B. Classify the Claimed Invention as to Its Proper Statutory Category***

To properly determine whether a claimed invention complies with the statutory invention requirements of 35 U.S.C. 101, Office personnel should classify each claim into one or more statutory or nonstatutory categories. If the claim falls into a nonstatutory category, that should not preclude complete examination of the application for satisfaction of all other conditions of patentability. This classification is only an initial finding at this point in the examination process that will be again assessed after the examination for compliance with 35 U.S.C. 102, 103, and 112 is completed and before issuance of any Office action on the merits.

If the invention as set forth in the written description is statutory, but the claims define subject matter that is not, the deficiency can be corrected by an appropriate amendment of the claims. In such a case, Office personnel should reject the claims drawn to nonstatutory subject matter under 35 U.S.C. 101, but identify the features of the invention that would render the claimed subject matter statutory if recited in the claim.

#### **1. Nonstatutory Subject Matter**

Claims to computer-related inventions that are clearly nonstatutory fall into the same general categories as nonstatutory claims in other arts, namely natural phenomena such as magnetism, and abstract ideas or laws of nature which constitute “descriptive material.” Abstract ideas, *Warmerdam*, 33 F.3d at 1360, 31 USPQ2d at 1759, or the mere manipulation of abstract ideas, *Schrader*, 22 F.3d at 292-93, 30 USPQ2d at 1457-58, are not patentable. Descriptive material can be characterized as either “functional descriptive material” or “nonfunctional descriptive material.” In this context, “functional descriptive material” consists of data structures and computer programs which impart functionality when employed as a computer component. (The definition of “data structure” is “a physical or logical relationship among data elements, designed to support specific data manipulation functions.” The New IEEE Standard Dictionary of Electrical and Electronics Terms 308

(5th ed. 1993).) “Nonfunctional descriptive material” includes but is not limited to music, literary works and a compilation or mere arrangement of data.

Both types of “descriptive material” are nonstatutory when claimed as descriptive material *per se*. *Warmerdam*, 33 F.3d at 1360, 31 USPQ2d at 1759. When functional descriptive material is recorded on some computer-readable medium it becomes structurally and functionally interrelated to the medium and will be statutory in most cases since use of technology permits the function of the descriptive material to be realized. Compare *In re Lowry*, 32 F.3d 1579, 1583-84, 32 USPQ2d 1031, 1035 (Fed. Cir. 1994) (claim to data structure stored on a computer readable medium that increases computer efficiency held statutory) and *Warmerdam*, 33 F.3d at 1360-61, 31 USPQ2d at 1759 (claim to computer having a specific data structure stored in memory held statutory product-by-process claim) with *Warmerdam*, 33 F.3d at 1361, 31 USPQ2d at 1760 (claim to a data structure *per se* held nonstatutory). When nonfunctional descriptive material is recorded on some computer-readable medium, it is not statutory since no requisite functionality is present to satisfy the practical application requirement. Merely claiming nonfunctional descriptive material stored in a computer-readable medium does not make it statutory. Such a result would exalt form over substance. *In re Sarkar*, 588 F.2d 1330, 1333, 200 USPQ 132, 137 (CCPA 1978) (“[E]ach invention must be evaluated as claimed; yet semantogenic considerations preclude a determination based solely on words appearing in the claims. In the final analysis under 101, the claimed invention, as a whole, must be evaluated for what it is.”) (quoted with approval in *Abele*, 684 F.2d at 907, 214 USPQ at 687). See also *In re Johnson*, 589 F.2d 1070, 1077, 200 USPQ 199, 206 (CCPA 1978) (“form of the claim is often an exercise in drafting”). Thus, nonstatutory music is not a computer component and it does not become statutory by merely recording it on a compact disk. Protection for this type of work is provided under the copyright law.

Claims to processes that do nothing more than solve mathematical problems or manipulate abstract ideas or concepts are more complex to analyze and are addressed below.

If the “acts” of a claimed process manipulate only numbers, abstract concepts or ideas, or signals representing any of the foregoing, the acts are not being applied to appropriate subject matter. *Schrader*, 22 F.3d at 294-95, 30 USPQ2d at 1458-59. Thus, a process consisting solely of mathematical operations, i.e., converting one set of numbers into another set of numbers, does not manipulate appropriate subject matter and thus cannot constitute a statutory process.

In practical terms, claims define nonstatutory processes if they:

- consist solely of mathematical operations without some claimed practical application (i.e., executing a “mathematical algorithm”); or
- simply manipulate abstract ideas, e.g., a bid (*Schrader*, 22 F.3d at 293-94, 30 USPQ2d at 1458-59) or a bubble hierarchy (*Warmerdam*, 33 F.3d at 1360, 31 USPQ2d at 1759), without some claimed practical application.

Cf. *Alappat*, 33 F.3d at 1543 n.19, 31 USPQ2d at 1556 n.19 in which the Federal Circuit recognized the confusion:

The Supreme Court has not been clear . . . as to whether such subject matter is excluded from the scope of 101 because it represents laws of nature, natural phenomena, or abstract ideas. See *Diehr*, 450 U.S. at 186 (viewed mathematical algorithm as a law of nature); *Gottschalk v. Benson*, 409 U.S. 63, 71-72 (1972) (treated mathematical algorithm as an “idea”). The Supreme Court also has not been clear as to exactly what kind of mathematical subject matter may not be patented. The Supreme Court has used, among others, the terms “mathematical algorithm,” “mathematical formula,” and “mathematical equation” to describe types of mathematical subject matter not entitled to patent protection standing alone. The Supreme Court has not set forth, however, any consistent or clear explanation of what it intended by such terms or how these terms are related, if at all.

Certain mathematical algorithms have been held to be nonstatutory because they represent a mathematical definition of a law of nature or a natural phenomenon. For example, a mathematical algorithm representing the formula  $E = mc^2$  is a “law of nature” — it defines a “fundamental scientific truth” (i.e., the relationship between energy and mass). To comprehend how the law of nature relates to any object, one invariably has to perform certain steps (e.g., multiplying a number representing the mass of an object by

the square of a number representing the speed of light). In such a case, a claimed process which consists solely of the steps that one must follow to solve the mathematical representation of  $E = mc^2$  is indistinguishable from the law of nature and would “pre-empt” the law of nature. A patent cannot be granted on such a process.

**(a) Functional Descriptive Material: “Data Structures” Representing Descriptive Material *Per Se* or Computer Programs Representing Computer Listings *Per Se***

Data structures not claimed as embodied in computer-readable media are descriptive material *per se* and are not statutory because they are not capable of causing functional change in the computer. See, e.g., *Warmerdam*, 33 F.3d at 1361, 31 USPQ2d at 1760 (claim to a data structure *per se* held nonstatutory). Such claimed data structures do not define any structural and functional interrelationships between the data structure and other claimed aspects of the invention which permit the data structure’s functionality to be realized. In contrast, a claimed computer-readable medium encoded with a data structure defines structural and functional interrelationships between the data structure and the computer software and hardware components which permit the data structure’s functionality to be realized, and is thus statutory.

Similarly, computer programs claimed as computer listings *per se*, i.e., the descriptions or expressions of the programs, are not physical “things.” They are neither computer components nor statutory processes, as they are not “acts” being performed. Such claimed computer programs do not define any structural and functional interrelationships between the computer program and other claimed elements of a computer which permit the computer program’s functionality to be realized. In contrast, a claimed computer-readable medium encoded with a computer program is a computer element which defines structural and functional interrelationships between the computer program and the rest of the computer which permit the computer program’s functionality to be realized, and is thus statutory. Accordingly, it is important to distinguish claims that define descriptive material *per se* from claims that define statutory inventions.

Computer programs are often recited as part of a claim. Office personnel should determine whether the computer program is being claimed as part of an otherwise statutory manufacture or machine. In such a case, the claim remains statutory irrespective of the fact that a computer program is included in the claim. The same result occurs when a computer program is used in a computerized process where the computer executes the instructions set forth in the computer program. Only when the claimed invention taken as a whole is directed to a mere program listing, i.e., to only its description or expression, is it descriptive material *per se* and hence nonstatutory.

Since a computer program is merely a set of instructions capable of being executed by a computer, the computer program itself is not a process and Office personnel should treat a claim for a computer program, without the computer-readable medium needed to realize the computer program’s functionality, as nonstatutory functional descriptive material. When a computer program is claimed in a process where the computer is executing the computer program’s instructions, Office personnel should treat the claim as a process claim. See paragraph IV.B.2(b), below. When a computer program is recited in conjunction with a physical structure, such as a computer memory, Office personnel should treat the claim as a product claim. See paragraph IV.B.2(a), below.

**(b) Nonfunctional Descriptive Material**

Descriptive material that cannot exhibit any functional interrelationship with the way in which computing processes are performed does not constitute a statutory process, machine, manufacture or composition of matter and should be rejected under 35 U.S.C. 101. Thus, Office personnel should consider the claimed invention as a whole to determine whether the necessary functional interrelationship is provided.

Where certain types of descriptive material, such as music, literature, art, photographs and mere arrangements or compilations of facts or data, are merely stored so as to be read or outputted by a computer without creating any functional interrelationship, either as part of the stored data or as part of the computing processes performed by the computer, then such descriptive material alone does not impart functionality either to the data as so structured, or to the computer. Such “descriptive material” is not a



process, machine, manufacture or composition of matter. (Data consists of facts, which become information when they are seen in context and convey meaning to people. Computers process data without any understanding of what that data represents. Computer Dictionary 210 (Microsoft Press, 2d ed. 1994).)

The policy that precludes the patenting of nonfunctional descriptive material would be easily frustrated if the same descriptive material could be patented when claimed as an article of manufacture. For example, music is commonly sold to consumers in the format of a compact disc. In such cases, the known compact disc acts as nothing more than a carrier for nonfunctional descriptive material. The purely nonfunctional descriptive material cannot alone provide the practical application for the manufacture.

Office personnel should be prudent in applying the foregoing guidance. Nonfunctional descriptive material may be claimed in combination with other functional descriptive multi-media material on a computer-readable medium to provide the necessary functional and structural interrelationship to satisfy the requirements of 35 U.S.C. 101. The presence of the claimed nonfunctional descriptive material is not necessarily determinative of nonstatutory subject matter. For example, a computer that recognizes a particular grouping of musical notes read from memory and upon recognizing that particular sequence, causes another defined series of notes to be played, defines a functional interrelationship among that data and the computing processes performed when utilizing that data, and as such is statutory because it implements a statutory process.

### (c) Natural Phenomena Such as Electricity and Magnetism

Claims that recite nothing but the physical characteristics of a form of energy, such as a frequency, voltage, or the strength of a magnetic field, define energy or magnetism, *per se*, and as such are nonstatutory natural phenomena. *O'Reilly v. Morse*, 56 U.S. (15 How.) 62, 112-14 (1853). However, a signal claim directed to a practical application of electromagnetic energy is statutory regardless of its transitory nature. See *O'Reilly*, 56 U.S. at 114-19; *In re Breslow*, 616 F.2d 516, 519-21, 205 USPQ 221, 225-26 (CCPA 1980).

## 2. Statutory Subject Matter

For the purposes of a 35 U.S.C. 101 analysis, it is of little relevance whether the claim is directed to a machine or a process. The legal principles are the same. *AT&T Corp. v. Excel Communications, Inc.*, 172 F.3d 1352, 1357, 50 USPQ2d 1447, 1451 (Fed. Cir. 1999).

### (a) Statutory Product Claims

Products may be either machines, manufactures, or compositions of matter.

A *machine* is “a concrete thing, consisting of parts or of certain devices and combinations of devices.” *Burr v. Duryee*, 68 U.S. (1 Wall.) 531, 570 (1863).

A *manufacture* is “the production of articles for use from raw or prepared materials by giving to these materials new forms, qualities, properties or combinations, whether by hand labor or by machinery.” *Chakrabarty*, 447 U.S. at 308, 206 USPQ at 196-97 (quoting *American Fruit Growers, Inc. v. Brogdex Co.*, 283 U.S. 1, 11 (1931)).

A *composition of matter* is “a composition of two or more substances [or] . . . a[] composite article, whether [it] be the result[] of chemical union, or of mechanical mixture, or whether . . . [it] be [a] gas[], fluid[], powder[], or solid[].” *Id.* at 308, 206 USPQ at 197 (quoting *Shell Development Co. v. Watson*, 149 F. Supp. 279, 280, 113 USPQ 265, 266 (D.D.C. 1957), *aff'd per curiam*, 252 F.2d 861, 116 USPQ 428 (D.C. Cir. 1958)).

If a claim defines a useful machine or manufacture by identifying the physical structure of the machine or manufacture in terms of its hardware or hardware and software combination, it defines a statutory product. See, e.g., *Lowry*, 32 F.3d at 1583, 32 USPQ2d at 1034-35; *Warmerdam*, 33 F.3d at 1361-62, 31 USPQ2d at 1760.

Office personnel must treat each claim as a whole. The mere fact that a hardware element is recited in a claim does not necessarily limit the claim to a specific machine or manufacture. Cf. *In re Iwahashi*, 888 F.2d 1370, 1374-75, 12 USPQ2d 1908, 1911-12 (Fed. Cir. 1989), cited with approval in *Alappat*, 33 F.3d at 1544 n.24, 31 USPQ2d at 1558 n.24.

A claim limited to a machine or manufacture, which has a practical application in the technological arts, is statutory. In most cases, a claim to a specific machine or manufacture will have a practical application in the technological arts. See *Alappat*, 33 F.3d at 1544, 31 USPQ2d at 1557 (“the claimed invention as a whole is directed to a combination of interrelated elements which combine to form a machine for converting discrete waveform data samples into anti-aliased pixel illumination intensity data to be displayed on a display means. This is not a disembodied mathematical concept which may be characterized as an ‘abstract idea,’ but rather a specific machine to produce a useful, concrete, and tangible result.”); and *State Street*, 149 F.3d at 1373, 47 USPQ2d at 1601 (“the transformation of data, representing discrete dollar amounts, by a machine through a series of mathematical calculations into a final share price, constitutes a practical application of a mathematical algorithm, formula, or calculation, because it produces ‘a useful, concrete and tangible result’ – a final share price momentarily fixed for recording and reporting purposes and even accepted and relied upon by regulatory authorities and in subsequent trades.”). Also see *AT&T*, 172 F.3d at 1358, 50 USPQ2d at 1452 (Claims drawn to a long-distance telephone billing process containing mathematical algorithms were held patentable subject matter because the process used the algorithm to produce a useful, concrete, tangible result without preempting other uses of the mathematical principle.).

### (b) Statutory Process Claims

A claim that requires one or more acts to be performed defines a process. However, not all processes are statutory under 35 U.S.C. 101. *Schrader*, 22 F.3d at 296, 30 USPQ2d at 1460. To be statutory, a claimed computer-related process must either: (A) result in a physical transformation outside the computer for which a practical application in the technological arts is either disclosed in the specification or would have been known to a skilled artisan (discussed in i) below), or (B) be limited to a practical application within the technological arts (discussed in ii) below). See *Diamond v. Diehr*, 450 U.S. at 183-84, 209 USPQ at 6 (quoting *Cochrane v. Deener*, 94 U.S. 780, 787-88 (1877)) (“A [statutory] process is a mode of treatment of certain materials to produce a given result. It

is an act, or a series of acts, performed upon the subject-matter to be transformed and reduced to a different state or thing.... The process requires that certain things should be done with certain substances, and in a certain order; but the tools to be used in doing this may be of secondary consequence.”). See also *Alappat*, 33 F.3d at 1543, 31 USPQ2d at 1556-57 (quoting *Diamond v. Diehr*, 450 U.S. at 192, 209 USPQ at 10). See also *id.* at 1569, 31 USPQ2d at 1578-79 (Newman, J., concurring) (“unpatentability of the principle does not defeat patentability of its practical applications”) (citing *O’Reilly v. Morse*, 56 U.S. (15 How.) at 114-19). If a physical transformation occurs outside the computer, a disclosure that permits a skilled artisan to practice the claimed invention, i.e., to put it to a practical use, is sufficient. On the other hand, it is necessary for the claimed invention taken as a whole to produce a practical application if there is only a transformation of signals or data inside a computer or if a process merely manipulates concepts or converts one set of numbers into another.

A claimed process is clearly statutory if it results in a physical transformation outside the computer, i.e., falls into one or both of the following specific categories (“safe harbors”).

#### i) Safe Harbors

##### - Independent Physical Acts (Post-Computer Process Activity)

A process is statutory if it requires physical acts to be performed outside the computer independent of and following the steps to be performed by a programmed computer, where those acts involve the manipulation of tangible physical objects and result in the object having a different physical attribute or structure. *Diamond v. Diehr*, 450 U.S. at 187, 209 USPQ at 8. Thus, if a process claim includes one or more post-computer process steps that result in a physical transformation outside the computer (beyond merely conveying the direct result of the computer operation), the claim is clearly statutory.

Examples of this type of statutory process include the following:

- A method of curing rubber in a mold which relies upon updating process parameters, using a computer processor to determine a time period for curing the rubber, using the computer processor to

determine when the time period has been reached in the curing process and then opening the mold at that stage.

- A method of controlling a mechanical robot which relies upon storing data in a computer that represents various types of mechanical movements of the robot, using a computer processor to calculate positioning of the robot in relation to given tasks to be performed by the robot, and controlling the robot's movement and position based on the calculated position.

Examples of claimed processes that do not achieve a practical application include:

- step of "updating alarm limits" found to constitute changing the number value of a variable to represent the result of the calculation (*Parker v. Flook*, 437 U.S. 584, 585, 198 USPQ 193, 195 (1978));

- final step of "equating" the process outputs to the values of the last set of process inputs found to constitute storing the result of calculations (*In re Gelnovatch*, 595 F.2d 32, 41 n.7, 201 USPQ 136, 145 n.7 (CCPA 1979); and

- step of "transmitting electrical signals representing" the result of calculations (*In re De Castelet*, 562 F.2d 1236, 1244, 195 USPQ 439, 446 (CCPA 1977) ("That the computer is instructed to transmit electrical signals, representing the results of its calculations, does not constitute the type of 'post solution activity' found in *Flook*, [437 U.S. 584, 198 USPQ 193 (1978)], and does not transform the claim into one for a process merely using an algorithm. The final transmitting step constitutes nothing more than reading out the result of the calculations.")); and

-step of displaying a calculation as a gray code scale (*In re Abele*, 684 F.2d 902, 908, 214 USPQ 682, 687 (CCPA 1982)).

**- Manipulation of Data Representing Physical Objects or Activities (Pre-Computer Process Activity)**

Another statutory process is one that requires the measurements of physical objects or activities to be transformed outside of the computer into computer data (*In re Gelnovatch*, 595 F.2d 32, 41 n.7, 201 USPQ 136, 145 n.7 (CCPA 1979) (data-gathering

step did not measure physical phenomenon); *Arrhythmia*, 958 F.2d at 1056, 22 USPQ2d at 1036), where the data comprises signals corresponding to physical objects or activities external to the computer system, and where the process causes a physical transformation of the signals which are intangible representations of the physical objects or activities. *Schrader*, 22 F.3d at 294, 30 USPQ2d at 1459 citing with approval *Arrhythmia*, 958 F.2d at 1058-59, 22 USPQ2d at 1037-38; *Abele*, 684 F.2d at 909, 214 USPQ at 688; *In re Taner*, 681 F.2d 787, 790, 214 USPQ 678, 681 (CCPA 1982).

Examples of this type of claimed statutory process include the following:

- A method of using a computer processor to analyze electrical signals and data representative of human cardiac activity by converting the signals to time segments, applying the time segments in reverse order to a high pass filter means, using the computer processor to determine the amplitude of the high pass filter's output, and using the computer processor to compare the value to a predetermined value. In this example the data is an intangible representation of physical activity, i.e., human cardiac activity. The transformation occurs when heart activity is measured and an electrical signal is produced. This process has real world value in predicting vulnerability to ventricular tachycardia immediately after a heart attack.

- A method of using a computer processor to receive data representing Computerized Axial Tomography ("CAT") scan images of a patient, performing a calculation to determine the difference between a local value at a data point and an average value of the data in a region surrounding the point, and displaying the difference as a gray scale for each point in the image, and displaying the resulting image. In this example the data is an intangible representation of a physical object, i.e., portions of the anatomy of a patient. The transformation occurs when the condition of the human body is measured with X-rays and the X-rays are converted into electrical digital signals that represent the condition of the human body. The real world value of the invention lies in creating a new CAT scan image of body tissue without the presence of bones.

- A method of using a computer processor to conduct seismic exploration, by imparting spherical seismic energy waves into the earth from a seismic source, generating a plurality of reflected signals in response to the seismic energy waves at a set of receiver positions in an array, and summing the reflection signals to produce a signal simulating the reflection response of the earth to the seismic energy. In this example, the electrical signals processed by the computer represent reflected seismic energy. The transformation occurs by converting the spherical seismic energy waves into electrical signals which provide a geophysical representation of formations below the earth's surface. Geophysical exploration of formations below the surface of the earth has real world value.

Examples of claimed processes that independently limit the claimed invention to safe harbor include:

- a method of conducting seismic exploration which requires generating and manipulating signals from seismic energy waves before "summing" the values represented by the signals (*Taner*, 681 F.2d at 788, 214 USPQ at 679); and
- a method of displaying X-ray attenuation data as a signed gray scale signal in a "field" using a particular algorithm, where the antecedent steps require generating the data using a particular machine (e.g., a computer tomography scanner). *Abele*, 684 F.2d at 908, 214 USPQ at 687 ("The specification indicates that such attenuation data is available only when an X-ray beam is produced by a CAT scanner, passed through an object, and detected upon its exit. Only after these steps have been completed is the algorithm performed, and the resultant modified data displayed in the required format.").

Examples of claimed processes that do not limit the claimed invention to pre-computing safe harbor include:

- "perturbing" the values of a set of process inputs, where the subject matter "perturbed" was a number and the act of "perturbing" consists of substituting the numerical values of variables (*Gelnovatch*, 595 F.2d at 41 n.7, 201 USPQ at 145 n.7 ("Appellants' claimed step of perturbing the values of a set of process inputs (step 3), in addi-

tion to being a mathematical operation, appears to be a data-gathering step of the type we have held insufficient to change a nonstatutory method of calculation into a statutory process.... In this instance, the perturbed process inputs are not even measured values of physical phenomena, but are instead derived by numerically changing the values in the previous set of process inputs.")); and

- selecting a set of arbitrary measurement point values (*Sarkar*, 588 F.2d at 1331, 200 USPQ at 135).

If a claim does not clearly fall into one or both of the safe harbors, the claim may still be statutory if it is limited to a practical application in the technological arts.

## ii) **Computer-Related Processes Limited to a Practical Application in the Technological Arts**

There is always some form of physical transformation within a computer because a computer acts on signals and transforms them during its operation and changes the state of its components during the execution of a process. Even though such a physical transformation occurs within a computer, such activity is not determinative of whether the process is statutory because such transformation alone does not distinguish a statutory computer process from a nonstatutory computer process. What is determinative is not how the computer performs the process, but what the computer does to achieve a practical application. See *Arrhythmia*, 958 F.2d at 1057, 22 USPQ2d at 1036.

A process that merely manipulates an abstract idea or performs a purely mathematical algorithm is nonstatutory despite the fact that it might inherently have some usefulness. In *Sarkar*, 588 F.2d at 1335, 200 USPQ at 139, the court explained why this approach must be followed:

No mathematical equation can be used, as a practical matter, without establishing and substituting values for the variables expressed therein. Substitution of values dictated by the formula has thus been viewed as a form of mathematical step. If the steps of gathering and substituting values were alone sufficient, every mathematical equation, formula, or algorithm having any practical use would be per se subject to patenting as a "process" under 101. Consideration of whether the substitution of specific values is enough to convert the disembodied ideas present in the formula into an embodiment of those ideas, or into

an application of the formula, is foreclosed by the current state of the law.

For such subject matter to be statutory, the claimed process must be limited to a practical application of the abstract idea or mathematical algorithm in the technological arts. See *Alappat*, 33 F.3d at 1543, 31 USPQ2d at 1556-57 (quoting *Diamond v. Diehr*, 450 U.S. at 192, 209 USPQ at 10). See also *Alappat* 33 F.3d at 1569, 31 USPQ2d at 1578-79 (Newman, J., concurring) (“unpatentability of the principle does not defeat patentability of its practical applications”) (citing *O’Reilly v. Morse*, 56 U.S. (15 How.) at 114-19). A claim is limited to a practical application when the method, as claimed, produces a concrete, tangible and useful result; i.e., the method recites a step or act of producing something that is concrete, tangible and useful. See *AT&T*, 172 F.3d at 1358, 50 USPQ2d at 1452. Likewise, a machine claim is statutory when the machine, as claimed, produces a concrete, tangible and useful result (as in *State Street*, 149 F.3d at 1373, 47 USPQ2d at 1601) and/or when a specific machine is being claimed (as in *Alappat*, 33 F.3d at 1544, 31 USPQ2d at 1557 (in banc)). For example, a computer process that simply calculates a mathematical algorithm that models noise is nonstatutory. However, a claimed process for digitally filtering noise employing the mathematical algorithm is statutory.

Examples of this type of claimed statutory process include the following:

- A computerized method of optimally controlling transfer, storage and retrieval of data between cache and hard disk storage devices such that the most frequently used data is readily available.
- A method of controlling parallel processors to accomplish multi-tasking of several computing tasks to maximize computing efficiency. See, e.g., *In re Bernhart*, 417 F.2d 1395, 1400, 163 USPQ 611,616 (CCPA 1969).
- A method of making a word processor by storing an executable word processing application program in a general purpose digital computer’s memory, and executing the stored program to impart word processing functionality to the general purpose digital computer by changing the state of the computer’s arithmetic logic unit when pro-

gram instructions of the word processing program are executed.

- A digital filtering process for removing noise from a digital signal comprising the steps of calculating a mathematical algorithm to produce a correction signal and subtracting the correction signal from the digital signal to remove the noise.

## V. EVALUATE APPLICATION FOR COMPLIANCE WITH 35 U.S.C. 112

Office personnel should begin their evaluation of an application’s compliance with 35 U.S.C. 112 by considering the requirements of 35 U.S.C. 112, second paragraph. The second paragraph contains two separate and distinct requirements: (A) that the claim(s) set forth the subject matter applicants regard as the invention, and (B) that the claim(s) particularly point out and distinctly claim the invention. An application will be deficient under 35 U.S.C. 112, second paragraph when (A) evidence including admissions, other than in the application as filed, shows applicant has stated that he or she regards the invention to be different from what is claimed, or when (B) the scope of the claims is unclear.

After evaluation of the application for compliance with 35 U.S.C. 112, second paragraph, Office personnel should then evaluate the application for compliance with the requirements of 35 U.S.C. 112, first paragraph. The first paragraph contains three separate and distinct requirements:

- (A) adequate written description,
- (B) enablement, and
- (C) best mode.

An application will be deficient under 35 U.S.C. 112, first paragraph when the written description is not adequate to identify what the applicant has invented, or when the disclosure does not enable one skilled in the art to make and use the invention as claimed without undue experimentation. Deficiencies related to disclosure of the best mode for carrying out the claimed invention are not usually encountered during examination of an application because evidence to support such a deficiency is seldom in the record. *Fonar Corp. v. General Electric Co.*, 107 F.3d 1543, 1548-49, 41 USPQ2d 1801, 1804 (Fed. Cir. 1997).

If deficiencies are discovered with respect to 35 U.S.C. 112, Office personnel must be careful to apply the appropriate paragraph of 35 U.S.C. 112.

**A. Determine Whether the Claimed Invention Complies with 35 U.S.C. 112, Second Paragraph Requirements**

**1. Claims Setting Forth the Subject Matter Applicant Regards as Invention**

Applicant's specification must conclude with claim(s) that set forth the subject matter which the applicant regards as the invention. The invention set forth in the claims is presumed to be that which applicant regards as the invention, unless applicant considers the invention to be something different from what has been claimed as shown by evidence, including admissions, outside the application as filed. An applicant may change what he or she regards as the invention during the prosecution of the application.

**2. Claims Particularly Pointing Out and Distinctly Claiming the Invention**

Office personnel shall determine whether the claims set out and circumscribe the invention with a reasonable degree of precision and particularity. In this regard, the definiteness of the language must be analyzed, not in a vacuum, but always in light of the teachings of the disclosure as it would be interpreted by one of ordinary skill in the art. Applicant's claims, interpreted in light of the disclosure, must reasonably apprise a person of ordinary skill in the art of the invention. However, the applicant need not explicitly recite in the claims every feature of the invention. For example, if an applicant indicates that the invention is a particular computer, the claims do not have to recite every element or feature of the computer. In fact, it is preferable for claims to be drafted in a form that emphasizes what the applicant has invented (i.e., what is new rather than old). *In re Dossel*, 115 F.3d 942, 946, 42 USPQ2d 1881, 1884 (Fed. Cir. 1997).

A means plus function limitation is distinctly claimed if the description makes it clear that the means corresponds to well-defined structure of a computer or computer component implemented in either hardware or software and its associated hardware platform. *Atmel Corp. v. Information Storage Devices Inc.*, 198 F.3d 1374, 1380, 53 USPQ2d 1225, 1229

(*Fed. Cir. 1999*); *B. Braun Medical, Inc. v. Abbott Labs.*, 124 F.3d 1419, 1424, 43 USPQ2d 1896, 1899 (Fed. Cir. 1997). Such means may be defined as:

- a programmed computer with a particular functionality implemented in hardware or hardware and software;
- a logic circuit or other component of a programmed computer that performs a series of specifically identified operations dictated by a computer program; or
- a computer memory encoded with executable instructions representing a computer program that can cause a computer to function in a particular fashion.

The scope of a "means" limitation is defined as the corresponding structure or material (e.g., a specific logic circuit) set forth in the written description and equivalents. See MPEP § 2181 through § 2186. Thus, a claim using means plus function limitations without corresponding disclosure of specific structures or materials that are not well-known fails to particularly point out and distinctly claim the invention. *Dossel*, 115 F.3d at 946-47, 42 USPQ2d at 1884-85. For example, if the applicant discloses only the functions to be performed and provides no express, implied or inherent disclosure of hardware or a combination of hardware and software that performs the functions, the application has not disclosed any "structure" which corresponds to the claimed means. Office personnel should reject such claims under 35 U.S.C. 112, second paragraph. *B. Braun Medical*, 124 F.3d at 1424, 43 USPQ2d at 1899. The rejection shifts the burden to the applicant to describe at least one specific structure or material that corresponds to the claimed means in question, and to identify the precise location or locations in the specification where a description of at least one embodiment of that claimed means can be found. In contrast, if the corresponding structure is disclosed to be a memory or logic circuit that has been configured in some manner to perform that function (e.g., using a defined computer program), the application has disclosed "structure" which corresponds to the claimed means.

When a claim or part of a claim is defined in computer program code, whether in source or object code format, a person of skill in the art must be able to ascertain the metes and bounds of the claimed

invention. In certain circumstances, as where self-documenting programming code is employed, use of programming language in a claim would be permissible because such program source code presents “sufficiently high-level language and descriptive identifiers” to make it universally understood to others in the art without the programmer having to insert any comments. See *Computer Dictionary* 353 (Microsoft Press, 2ed. 1994) for a definition of “self-documenting code.” Applicants should be encouraged to functionally define the steps the computer will perform rather than simply reciting source or object code instructions.

## ***B. Determine Whether the Claimed Invention Complies with 35 U.S.C. 112, First Paragraph Requirements***

### **1. Adequate Written Description**

The satisfaction of the enablement requirement does not satisfy the written description requirement. See *In re Barker*, 559 F.2d 588, 591, 194 USPQ 470, 472 (CCPA 1977) (a specification may be sufficient to enable one skilled in the art to make and use the invention, but still fail to comply with the written description requirement). See also *In re DiLeone*, 436 F.2d 1404, 1405, 168 USPQ 592, 593 (CCPA 1971). For the written description requirement, an applicant’s specification must reasonably convey to those skilled in the art that the applicant was in possession of the claimed invention as of the date of invention. *Regents of the University of California v. Eli Lilly & Co.*, 119 F.3d 1559, 1568, 43 USPQ2d 1398, 1405 (Fed. Cir. 1997); *Hyatt v. Boone*, 146 F.3d 1348, 1354, 47 USPQ2d 1128, 1132 (Fed. Cir. 1998). The claimed invention subject matter need not be described literally, i.e., using the same terms, in order for the disclosure to satisfy the description requirement. Software aspects of inventions may be described functionally. See *Robotic Vision Sys. v. View Eng’g, Inc.*, 112 F.3d 1163, 1166, 42 USPQ2d 1619, 1622-23 (Fed. Cir. 1997); *Fonar Corp. v. General Electric Co.*, 107 F.3d 1543, 1549, 41 USPQ2d 1801, 1805 (Fed. Cir. 1997); *In re Hayes Microcomputer Prods., Inc.*, 982 F.2d 1527, 1537-38, 25 USPQ2d 1241, 1248-49 (Fed. Cir. 1992). >See MPEP § 2163 for further guidance with respect to the evaluation of a

patent application for compliance with the written description requirement.<

### **2. Enabling Disclosure**

An applicant’s specification must enable a person skilled in the art to make and use the claimed invention without undue experimentation. The fact that experimentation is complex, however, will not make it undue if a person of skill in the art typically engages in such complex experimentation. For a computer-related invention, the disclosure must enable a skilled artisan to configure the computer to possess the requisite functionality, and, where applicable, interrelate the computer with other elements to yield the claimed invention, without the exercise of undue experimentation. The specification should disclose how to configure a computer to possess the requisite functionality or how to integrate the programmed computer with other elements of the invention, unless a skilled artisan would know how to do so without such disclosure. See, e.g., *Dossel*, 115 F.3d at 946-47, 42 USPQ2d at 1884-85; *Northern Telecom v. Datapoint Corp.*, 908 F.2d 931, 941-43, 15 USPQ2d 1321, 1328-30 (Fed. Cir.1990) (judgment of invalidity reversed for clear error where expert testimony on both sides showed that a programmer of reasonable skill could write a satisfactory program with ordinary effort based on the disclosure); *DeGeorge v. Bernier*, 768 F.2d 1318, 1324, 226 USPQ 758, 762-63 (Fed. Cir. 1985) (superseded by statute with respect to issues not relevant here) (invention was adequately disclosed for purposes of enablement even though all of the circuitry of a word processor was not disclosed, since the undisclosed circuitry was deemed inconsequential because it did not pertain to the claimed circuit); *In re Phillips*, 608 F.2d 879, 882-83, 203 USPQ 971, 975 (CCPA 1979) (computerized method of generating printed architectural specifications dependent on use of glossary of predefined standard phrases and error-checking feature enabled by overall disclosure generally defining errors); *In re Donohue*, 550 F.2d 1269, 1271, 193 USPQ 136, 137 (CCPA 1977) (“Employment of block diagrams and descriptions of their functions is not fatal under 35 U.S.C. 112, first paragraph, providing the represented structure is conventional and can be determined without undue experimentation.”); *In re Knowlton*, 481 F.2d 1357, 1366-68, 178 USPQ 486, 493-94 (CCPA 1973) (examiner’s

contention that a software invention needed a detailed description of all the circuitry in the complete hardware system reversed).

For many computer-related inventions, it is not unusual for the claimed invention to involve more than one field of technology. For such inventions, the disclosure must satisfy the enablement standard for each aspect of the invention. See *In re Naquin*, 398 F.2d 863, 866, 158 USPQ 317, 319 CCPA 1968) (“When an invention, in its different aspects, involves distinct arts, that specification is adequate which enables the adepts of each art, those who have the best chance of being enabled, to carry out the aspect proper to their specialty.”); *Ex parte Zechnall*, 194 USPQ 461, 461 (Bd. App. 1973) (“appellants’ disclosure must be held sufficient if it would enable a person skilled in the electronic computer art, in cooperation with a person skilled in the fuel injection art, to make and use appellants’ invention”). As such, the disclosure must teach a person skilled in each art how to make and use the relevant aspect of the invention without undue experimentation. For example, to enable a claim to a programmed computer that determines and displays the three-dimensional structure of a chemical compound, the disclosure must

- enable a person skilled in the art of molecular modeling to understand and practice the underlying molecular modeling processes; and
- enable a person skilled in the art of computer programming to create a program that directs a computer to create and display the image representing the three-dimensional structure of the compound.

In other words, the disclosure corresponding to each aspect of the invention must be enabling to a person skilled in each respective art.

In many instances, an applicant will describe a programmed computer by outlining the significant elements of the programmed computer using a functional block diagram. Office personnel should review the specification to ensure that along with the functional block diagram the disclosure provides information that adequately describes each “element” in hardware or hardware and its associated software and how such elements are interrelated. See *In re Scarbrough*, 500 F.2d 560, 565, 182 USPQ 298, 301-02 (CCPA 1974) (“It is not enough that a person skilled in the art, by carrying on investigations along the line indicated in

the instant application, and by a great amount of work eventually might find out how to make and use the instant invention. The statute requires the application itself to inform, not to direct others to find out for themselves (citation omitted).”); *Knowlton*, 481 F.2d at 1367, 178 USPQ at 493 (disclosure must constitute more than a “sketchy explanation of flow diagrams or a bare group of program listings together with a reference to a proprietary computer on which they might be run”). See also *In re Gunn*, 537 F.2d 1123, 1127-28, 190 USPQ 402, 405 (CCPA 1976); *In re Brands-tadter*, 484 F.2d 1395, 1406-07, 179 USPQ 286, 294 (CCPA 1973); and *In re Ghiron*, 442 F.2d 985, 991, 169 USPQ 723, 727-28 (CCPA 1971).

## VI. DETERMINE WHETHER THE CLAIMED INVENTION COMPLIES WITH 35 U.S.C. 102 AND 103

As is the case for inventions in any field of technology, assessment of a claimed computer-related invention for compliance with 35 U.S.C. 102 and 103 begins with a comparison of the claimed subject matter to what is known in the prior art. If no differences are found between the claimed invention and the prior art, the claimed invention lacks novelty and is to be rejected by Office personnel under 35 U.S.C. 102. Once distinctions are identified between the claimed invention and the prior art, those distinctions must be assessed and resolved in light of the knowledge possessed by a person of ordinary skill in the art. Against this backdrop, one must determine whether the invention would have been obvious at the time the invention was made. If not, the claimed invention satisfies 35 U.S.C. 103. Factors and considerations dictated by law governing 35 U.S.C. 103 apply without modification to computer-related inventions. Moreover, merely using a computer to automate a known process does not by itself impart nonobviousness to the invention. See *Dann v. Johnston*, 425 U.S. 219, 227-30, 189 USPQ 257, 261 (1976); *In re Venner*, 262 F.2d 91, 95, 120 USPQ 193, 194 (CCPA 1958).

If the difference between the prior art and the claimed invention is limited to descriptive material stored on or employed by a machine, Office personnel must determine whether the descriptive material is functional descriptive material or nonfunctional descriptive material, as described *supra* in paragraphs IV.B.1(a) and IV. B.1(b). Functional descriptive mate-



rial is a limitation in the claim and must be considered and addressed in assessing patentability under 35 U.S.C. 103. Thus, a rejection of the claim as a whole under 35 U.S.C. 103 is inappropriate unless the functional descriptive material would have been suggested by the prior art. *In re Dembiczak*, 175 F.3d 994, 1000, 50 USPQ2d 1614, 1618 (Fed. Cir. 1999). Nonfunctional descriptive material cannot render nonobvious an invention that would have otherwise been obvious. >*In re Ngai*, \_\_\_ F.3d \_\_\_, 2004 WL 1068957 (Fed. Cir. May 13, 2004).< Cf. *In re Gulack*, 703 F.2d 1381, 1385, 217 USPQ 401, 404 (Fed. Cir. 1983) (when descriptive material is not functionally related to the substrate, the descriptive material will not distinguish the invention from the prior art in terms of patentability).

Common situations involving nonfunctional descriptive material are:

- a computer-readable storage medium that differs from the prior art solely with respect to nonfunctional descriptive material, such as music or a literary work, encoded on the medium,
- a computer that differs from the prior art solely with respect to nonfunctional descriptive material that cannot alter how the machine functions (i.e.,

the descriptive material does not reconfigure the computer), or

- a process that differs from the prior art only with respect to nonfunctional descriptive material that cannot alter how the process steps are to be performed to achieve the utility of the invention.

Thus, if the prior art suggests storing a song on a disk, merely choosing a particular song to store on the disk would be presumed to be well within the level of ordinary skill in the art at the time the invention was made. The difference between the prior art and the claimed invention is simply a rearrangement of nonfunctional descriptive material.

## **VII. CLEARLY COMMUNICATE FINDINGS, CONCLUSIONS AND THEIR BASES**

Once Office personnel have concluded the above analyses of the claimed invention under all the statutory provisions, including 35 U.S.C. 101, 112, 102 and 103, they should review all the proposed rejections and their bases to confirm their correctness. Only then should any rejection be imposed in an Office action. The Office action should clearly communicate the findings, conclusions and reasons which support them.

**Appendix to Examination Guidelines for Computer-Related Inventions****Computer-Related Inventions****II. Determine What Applicant Has Invented and Is Seeking to Patent**

- A. Identify and Understand Any Practical Application Asserted for the Invention
- B. Review the Detailed Disclosure and Specific Embodiments of the Invention to Determine What Applicant Has Invented
- C. Review the Claims

**III. Conduct a Thorough Search of the Prior Art****IV. Determine Whether the Claimed Invention Complies with 35 U.S.C. 101****V. Evaluate Application for Compliance with 35 U.S.C. 112**

- A. Determine Whether the Claimed Invention Complies with 35 U.S.C. 112, Second Paragraph
  - 1. Claims Setting Forth the Subject Matter Applicant Regards as Invention
  - 2. Claims Particularly Pointing Out and Distinctly Claiming the Invention
- B. Determine Whether the Claimed Invention Complies with 35 U.S.C. 112, First Paragraph
  - 1. Adequate Written Description
  - 2. Enabling Disclosure

**VI. Determine Whether the Claimed Invention Complies with 35 U.S.C. 102 and 103****VII. Clearly Communicate Findings, Conclusions and Their Bases**

A-1

## 2106.01 Computer Programming and 35 U.S.C. 112, First Paragraph

The requirements for sufficient disclosure of inventions involving computer programming is the same as for all inventions sought to be patented. Namely, there must be an adequate written description, the original disclosure should be sufficiently enabling to allow one to make and use the invention as claimed, and there must be presentation of a best mode for carrying out the invention.

The following guidelines, while applicable to a wide range of arts, are intended to provide a guide for analyzing 35 U.S.C. 112, first paragraph, issues in applications involving computer programs, software, firmware, or block diagram cases wherein one or more of the “block diagram” elements are at least partially comprised of a computer software component. It should be recognized that sufficiency of disclosure issues in computer cases necessarily will require an inquiry into both the sufficiency of the disclosed hardware as well as the disclosed software due to the interrelationship and interdependence of computer hardware and software.

### WRITTEN DESCRIPTION

The function of the description requirement is to ensure that the inventor had possession of, as of the filing date of the application relied on, the specific subject matter later claimed by him or her; how the specification accomplishes this is not material. *In re Herschler*, 591 F.2d 693, 700-01, 200 USPQ 711, 717 (CCPA 1979) and further reiterated in *In re Kaslow*, 707 F.2d 1366, 707 F.2d 1366, 217 USPQ 1089 (Fed. Cir. 1983). See also MPEP § 2163 - § 2163.04.

### BEST MODE

The purpose of the best mode requirement is to “restrain inventors from applying for patents while at the same time concealing from the public the preferred embodiments of their inventions which they have in fact conceived,” *In re Gay*, 309 F.2d 769, 772, 135 USPQ 311, 315 (CCPA 1962); “only evidence of concealment + (accidental or intentional) is to be considered [in judging the adequacy of a best mode disclosure]. That evidence, in order to result in affirmance of a best mode rejection, must tend to show that the quality of an applicant’s best mode dis-

closure is so poor as to effectively result in concealment.” *In re Sherwood*, 613 F.2d 809, 816-817, 204 USPQ 537, 544 (CCPA 1980). Also, see *White Consol. Indus. v. Vega Servo-Control Inc.*, 214 USPQ 796, 824 (S.D. Mich. 1982), *aff’d on related grounds*, 713 F.2d 788, 218 USPQ 961 (Fed. Cir. 1983). See also MPEP § 2165 - § 2165.04.

There are two factual inquiries to be made in determining whether a specification satisfies the best mode requirement. First, there must be a subjective determination as to whether at the time the application was filed, the inventor knew of a best mode of practicing the invention. Second, if the inventor had a best mode of practicing the invention, there must be an objective determination as to whether the best mode was disclosed in sufficient detail to allow one skilled in the art to practice it. *Fonar Corp. v. General Electric Co.*, 107 F.3d 1543, 41 USPQ2d 1801, 1804 (Fed. Cir. 1997); *Chemcast Corp. v. Arco Industries*, 913 F.2d 923, 927-28, 16 USPQ2d 1033, 1036 (Fed. Cir. 1990). “As a general rule, where software constitutes part of a best mode of carrying out an invention, description of such a best mode is satisfied by a disclosure of the functions of the software. This is because, normally, writing code for such software is within the skill of the art, not requiring undue experimentation, once its functions have been disclosed. . . . [F]low charts or source code listings are not a requirement for adequately disclosing the functions of software.” *Fonar Corp.*, 107 F.3d at 1549, 41 USPQ2d at 1805 (citations omitted).

### ENABLEMENT

When basing a rejection on the failure of the applicant’s disclosure to meet the enablement provisions of the first paragraph of 35 U.S.C. 112, the examiner must establish on the record that he or she has a reasonable basis for questioning the adequacy of the disclosure to enable a person of ordinary skill in the art to make and use the claimed invention without resorting to *undue experimentation*. See *In re Brown*, 477 F.2d 946, 177 USPQ 691 (CCPA 1973); *In re Ghiron*, 442 F.2d 985, 169 USPQ 723 (CCPA 1971). Once the examiner has advanced a reasonable basis for questioning the adequacy of the disclosure, it becomes incumbent on the applicant to rebut that challenge and factually demonstrate that his or her application disclosure is in fact sufficient. See *In re Doyle*, 482 F.2d

1385, 1392, 179 USPQ 227, 232 (CCPA 1973); *In re Scarbrough*, 500 F.2d 560, 566, 182 USPQ 298, 302 (CCPA 1974); *In re Ghiron*, *supra*. See also MPEP § 2106, paragraph V.B.2 and § 2164 - § 2164.08(c).

### 2106.02 Disclosure in Computer Programming Cases [R-1]

To establish a reasonable basis for questioning the adequacy of a disclosure, the examiner must present a factual analysis of a disclosure to show that a person skilled in the art would not be able to make and use the claimed invention without resorting to undue experimentation.

In computer applications, it is not unusual for the claimed invention to involve two areas of prior art or more than one technology, e.g., an appropriately programmed computer and an area of application of said computer. *White Consol. Indus.*, 214 USPQ at 821. In regard to the “skilled in the art” standard, in cases involving both the art of computer programming, and another technology, the examiner must recognize that the knowledge of persons skilled in both technologies is the appropriate criteria for determining sufficiency. See *In re Naquin*, 398 F.2d 863, 158 USPQ 317 (CCPA 1968); *In re Brown*, 477 F.2d 946, 177 USPQ 691 (CCPA 1973); and *White Consol. Indus. v. Vega Servo-Control, Inc.*, 214 USPQ 796, 822 (S.D.Mich. 1982), *aff’d on related grounds*, 713 F.2d 788, 218 USPQ 961 (Fed. Cir. 1983).

In a typical computer application, system components are often represented in a “block diagram” format, i.e., a group of hollow rectangles representing the elements of the system, functionally labeled, and interconnected by lines. Such block diagram computer cases may be categorized into (A) systems which include but are more comprehensive than a computer and (B) systems wherein the block elements are totally within the confines of a computer.

#### BLOCK ELEMENTS MORE COMPREHENSIVE THAN A COMPUTER

The first category of such block diagram cases involves systems which include a computer as well as other system hardware and/or software components. In order to meet his or her burden of establishing a reasonable basis for questioning the adequacy of such disclosure, the examiner should initiate a factual analysis of the system by focusing on each of the individ-

ual block element components. More specifically, such an inquiry should focus on the diverse functions attributed to each block element as well as the teachings in the specification as to how such a component could be implemented. If based on such an analysis, the examiner can reasonably contend that more than routine experimentation would be required by one of ordinary skill in the art to implement such a component or components, that component or components should specifically be challenged by the examiner as part of a 35 U.S.C. 112, first paragraph rejection. Additionally, the examiner should determine whether certain of the hardware or software components depicted as block elements are themselves complex assemblages which have widely differing characteristics and which must be precisely coordinated with other complex assemblages. Under such circumstances, a reasonable basis may exist for challenging such a functional block diagram form of disclosure. See *In re Ghiron*, 442 F.2d 985, 169 USPQ 723 (CCPA 1971) and *In re Brown*, *supra*. Moreover, even if the applicant has cited prior art patents or publications to demonstrate that particular block diagram hardware or software components are old, it should not always be considered as self-evident how such components are to be interconnected to function in a disclosed complex manner. See *In re Scarbrough*, 500 F.2d 560, 566, 182 USPQ 298, 301 (CCPA 1974) and *In re Forman*, 463 F.2d 1125, 1129, 175 USPQ 12, 16 (CCPA 1972). Furthermore, in complex systems including a digital computer, a microprocessor, or a complex control unit as one of many block diagram elements, timing between various system elements may be of the essence and without a timing chart relating the timed sequences for each element, an unreasonable amount of work may be required to come up with the detailed relationships an applicant alleges that he or she has solved. See *In re Scarbrough*, 500 F.2d at 566, 182 USPQ at 302.

For example, in a block diagram disclosure of a complex claimed system which includes a microprocessor and other system components controlled by the microprocessor, a mere reference to a prior art, commercially available microprocessor, without any description of the precise operations to be performed by the microprocessor, fails to disclose how such a microprocessor would be properly programmed to either perform any required calculations

or to coordinate the other system components in the proper timed sequence to perform the functions disclosed and claimed. If, in such a system, a particular program is disclosed, such a program should be carefully reviewed to ensure that its scope is commensurate with the scope of the functions attributed to such a program in the claims. See *In re Brown*, 477 F.2d at 951, 177 USPQ at 695. If the disclosure fails to disclose any program and if more than routine experimentation would be required of one skilled in the art to generate such a program, the examiner clearly would have a reasonable basis for challenging the sufficiency of such a disclosure. The amount of experimentation that is considered routine will vary depending on the facts and circumstances of individual cases. No exact numerical standard has been fixed by the courts, but the “amount of required experimentation must, however, be reasonable.” *White Consol. Indus.*, 713 F.2d at 791, 218 USPQ at 963. One court apparently found that the amount of experimentation involved was reasonable where a skilled programmer was able to write a general computer program, implementing an embodiment form, within 4 hours. *Hirschfield v. Banner*, 462 F. Supp. 135, 142, 200 USPQ 276, 279 (D.D.C. 1978), *aff’d*, 615 F.2d 1368 (D.C. Cir. 1986), *cert. denied*, 450 U.S. 994 (1981). On the other hand, another court found that, where the required period of experimentation for skilled programmers to develop a particular program would run to 1 to 2 man years, this would be “a clearly unreasonable requirement” (*White Consol. Indus.*, 713 F.2d at 791, 218 USPQ at 963).

## BLOCK ELEMENTS WITHIN A COMPUTER

The second category of block diagram cases occurs most frequently in pure data processing applications where the combination of block elements is totally within the confines of a computer, there being no interfacing with external apparatus other than normal input/output devices. In some instances, it has been found that particular kinds of block diagram disclosures were sufficient to meet the enabling requirement of 35 U.S.C. 112, first paragraph. See *In re Knowlton*, 481 F.2d 1357, 178 USPQ 486 (CCPA 1973), *In re Comstock*, 481 F.2d 905, 178 USPQ 616 (CCPA 1973). Most significantly, however, in both the *Comstock* and *Knowlton* cases, the decisions turned on the appellants’ disclosure of (A) a reference to and reli-

ance on an identified prior art computer system and (B) an operative computer program for the referenced prior art computer system. Moreover, in *Knowlton* the disclosure was presented in such a detailed fashion that the individual program’s steps were specifically interrelated with the operative structural elements in the referenced prior art computer system. The court in *Knowlton* indicated that the disclosure did not merely consist of a sketchy explanation of flow diagrams or a bare group of program listings together with a reference to a proprietary computer in which they might be run. The disclosure was characterized as going into considerable detail in explaining the interrelationships between the disclosed hardware and software elements. Under such circumstances, the Court considered the disclosure to be concise as well as full, clear, and exact to a sufficient degree to satisfy the literal language of 35 U.S.C. 112, first paragraph. It must be emphasized that because of the significance of the program listing and the reference to and reliance on an identified prior art computer system, absent either of these items, a block element disclosure within the confines of a computer should be scrutinized in precisely the same manner as the first category of block diagram cases discussed above.

Regardless of whether a disclosure involves block elements more comprehensive than a computer or block elements totally within the confines of a computer, the examiner, when analyzing method claims, must recognize that the specification must be adequate to teach how to practice the claimed method. If such practice requires a particular apparatus, it is axiomatic that the application must therefore provide a sufficient disclosure of that apparatus if such is not already available. See *In re Ghiron*, 442 F.2d 985, 991, 169 USPQ 723, 727 (CCPA 1971) and *In re Gunn*, 537 F.2d 1123, 1128, 190 USPQ 402, 406 (CCPA 1976). When the examiner questions the adequacy of computer system or computer programming disclosures, the examiner’s reasons for finding the specification to be nonenabling should be supported by the record as a whole. In this regard, it is also essential for the examiner to reasonably challenge evidence submitted by the applicant. For example, in *In re Naquin*, *supra*, affiant’s statement unchallenged by the examiner, that the average computer programmer was familiar with the subroutine necessary for performing the claimed process, was held to be

a statement of fact which rendered the examiner's rejection baseless. In other words, unless the examiner presents a reasonable basis for challenging the disclosure in view of the record as a whole, a 35 U.S.C. 112, first paragraph rejection in a computer system or computer programming application will not be sustained on appeal. See *In re Naquin, supra*, and *In re Morehouse*, 545 F.2d 162, 165-66, 192 USPQ 29, 32 (CCPA 1976).

While no specific universally applicable rule exists for recognizing an insufficiently disclosed application involving computer programs, an examining guideline to generally follow is to challenge the sufficiency of such disclosures which fail to include either the computer program itself or a reasonably detailed flowchart which delineates the sequence of operations the program must perform. In programming applications software disclosure only includes a flowchart, as the complexity of functions and the generality of the individual components of the flowchart increase, the basis for challenging the sufficiency of such a flowchart becomes more reasonable because the likelihood of more than routine experimentation being required to generate a working program from such a flowchart also increases.

As stated earlier, once an examiner has advanced a reasonable basis or presented evidence to question the adequacy of a computer system or computer programming disclosure, the applicant must show that his or her specification would enable one of ordinary skill in the art to make and use the claimed invention without resorting to undue experimentation. In most cases, efforts to meet this burden involve submitting affidavits, referencing prior art patents or technical publications, arguments of counsel, or combinations of these approaches.

#### **AFFIDAVIT PRACTICE (37 CFR 1.132)**

In computer cases, affidavits must be critically analyzed. Affidavit practice usually initially involves analyzing the skill level and/or qualifications of the affiant, which should be of the routineer in the art. When an affiant's skill level is higher than that required by the routineer for a particular application, an examiner may challenge the affidavit since it would not be made by a routineer in the art, and therefore would not be probative as to the amount of experimentation required by a routineer in the art to

implement the invention. An affiant having a skill level or qualifications above that of the routineer in the art would require less experimentation to implement the claimed invention than that for the routineer. Similarly, an affiant having a skill level or qualifications below that of the routineer in the art would require more experimentation to implement the claimed invention than that for the routineer in the art. In either situation, the standard of the routineer in the art would not have been met.

In computer systems or programming cases, the problems with a given affidavit, which relate to the sufficiency of disclosure issue, generally involve affiants submitting few facts to support their conclusions or opinions. Some affidavits may go so far as to present conclusions on the ultimate legal question of sufficiency. *In re Brandstadter*, 484 F.2d 1395, 179 USPQ 286 (CCPA 1973), illustrates the extent of the inquiry into the factual basis underlying an affiant's conclusions or opinions. In *Brandstadter*, the invention concerned a stored program controller (computer) programmed to control the storing, retrieving, and forwarding of messages in a communications system. The disclosure consisted of broadly defined block diagrams of the structure of the invention and no flowcharts or program listings of the programs of the controller. The Court quoted extensively from the Examiner's Office Actions and Examiner's Answer in its opinion where it was apparent that the Examiner consistently argued that the disclosure was merely a broad system diagram in the form of labelled block diagrams along with statements of a myriad of desired results. Various affidavits were presented in which the affiants stated that all or some of the system circuit elements in the block diagrams were either well-known in the art or "could be constructed" by the skilled design engineer, that the controller was "capable of being programmed" to perform the stated functions or results desired, and that the routineer in the art "could design or construct or was able to program" the system. The Court did consider the affiants' statements as being some evidence on the ultimate legal question of enablement but concluded that the statements failed in their purpose since they recited conclusions or opinions with few facts to support or buttress these conclusions. With reference to the lack of a disclosed computer program or even a flowchart of the program to control the message switching

system, the record contained no evidence as to the number of programmers needed, the number of man-hours and the level of skill of the programmers to produce the program required to practice the invention.

It should be noted also that it is not opinion evidence directed to the ultimate legal question of enablement, but rather factual evidence directed to the amount of time and effort and level of knowledge required for the practice of the invention from the disclosure alone which can be expected to rebut a *prima facie* case of nonenablement. See *Hirschfield*, 462 F. Supp. at 143, 200 USPQ at 281. It has also been held that where an inventor described the problem to be solved to an affiant, thus enabling the affiant to generate a computer program to solve the problem, such an affidavit failed to demonstrate that the application alone would have taught a person of ordinary skill in the art how to make and use the claimed invention. See *In re Brown*, 477 F.2d at 951, 177 USPQ at 695. The Court indicated that it was not factually established that the applicant did not convey to the affiant vital and additional information in their several meetings in addition to that set out in the application. Also of significance for an affidavit to be relevant to the determination of enablement is that it must be probative of the level of skill of the routinier in the art as of the time the applicant filed his application. See *In re Gunn*, 537 F.2d at 1128, 190 USPQ at 406. In this case, each of the affiants stated what was known at the time he executed the affidavit, and not what was known at the time the applicant filed his application.

## REFERENCING PRIOR ART DOCUMENTS

Earlier, it had been discussed that citing in the specification the commercial availability of an identified prior art computer system is very pertinent to the issue of enablement. But in some cases, this approach may not be sufficient to meet the applicant's burden. Merely citing in an affidavit extracts from technical publications in order to satisfy the enablement requirement is not sufficient if it is not made clear that a person skilled in the art would know which, or what parts, of the cited circuits could be used to construct the claimed device or how they could be interconnected to act in combination to produce the required results. See *In re Forman*, 463 F.2d at 1129,

175 USPQ at 16. This analysis would appear to be less critical where the circuits comprising applicant's system are essentially standard components comprising an identified prior art computer system and a standard device attached thereto.

Prior art patents are often relied on by applicants to show the state of the art for purposes of enablement. However, these patents must have an issue date earlier than the effective filing date of the application under consideration. See *In re Budnick*, 537 F.2d 535, 538, 190 USPQ 422, 424 (CCPA 1976). An analogous point was made in *In re Gunn*, *supra*, where the court indicated that patents issued after the filing date of the applicant's application are not evidence of subject matter known to any person skilled in the art since their subject matter may have been known only to the patentees and the Patent and Trademark Office.

Merely citing prior art patents to demonstrate that the challenged components are old may not be sufficient proof since, even if each of the enumerated devices or labelled blocks in a block diagram disclosure were old, *per se*, this would not make it self-evident how each would be interconnected to function in a disclosed complex combination manner. Therefore, the specification in effect must set forth the integration of the prior art; otherwise, it is likely that undue experimentation, or more than routine experimentation would be required to implement the claimed invention. See *In re Scarbrough*, 560 F.2d at 565, 182 USPQ at 301. The court also noted that any cited patents which are used by the applicant to demonstrate that particular box diagram hardware or software components are old must be analyzed as to whether such patents are germane to the instant invention and as to whether such patents provide better detail of disclosure as to such components than an applicant's own disclosure. Also any patent or publication cited to provide evidence that a particular programming technique is well-known in the programming art does not demonstrate that one of ordinary skill in the art could make and use correspondingly disclosed programming techniques unless both programming techniques are of approximately the same degree of complexity. See *In re Knowlton*, 500 F.2d 566, 572, 183 USPQ 33, 37 (CCPA 1974).

## ARGUMENTS OF COUNSEL

Arguments of counsel may be effective in establishing that an examiner has not properly met his or her burden or has otherwise erred in his or her position. In these situations, an examiner may have failed to set forth any basis for questioning the adequacy of the disclosure or may not have considered the whole specification, including the drawings and the written description. However, it must be emphasized that arguments of counsel alone cannot take the place of evidence in the record once an examiner has advanced a reasonable basis for questioning the disclosure. See *In re Budnick*, 537 F.2d at 538, 190 USPQ at 424; *In re Schulze*, 346 F.2d 600, 145 USPQ 716 (CCPA 1965); *In re Cole*, 326 F.2d 769, 140 USPQ 230 (CCPA 1964). For example, in a case where the record consisted substantially of arguments and opinions of applicant's attorney, the court indicated that factual affidavits could have provided important evidence on the issue of enablement. See *In re Knowlton*, 500 F.2d at 572, 183 USPQ at 37; *In re Wiseman*, 596 F.2d 1019, 201 USPQ 658 (CCPA 1979).

## 2107 Guidelines for Examination of Applications for Compliance with the Utility Requirement

### I. INTRODUCTION

The following Guidelines establish the policies and procedures to be followed by Office personnel in the evaluation of any patent application for compliance with the utility requirements of 35 U.S.C. 101 and 112. These Guidelines have been promulgated to assist Office personnel in their review of applications for compliance with the utility requirement. The Guidelines do not alter the substantive requirements of 35 U.S.C. 101 and 112, nor are they designed to obviate the examiner's review of applications for compliance with all other statutory requirements for patentability. The Guidelines do not constitute substantive rulemaking and hence do not have the force and effect of law. Rejections will be based upon the substantive law, and it is these rejections which are appealable. Consequently, any perceived failure by Office personnel to follow these Guidelines is neither appealable nor petitionable.

## II. EXAMINATION GUIDELINES FOR THE UTILITY REQUIREMENT

Office personnel are to adhere to the following procedures when reviewing patent applications for compliance with the "useful invention" ("utility") requirement of 35 U.S.C. 101 and 112, first paragraph.

(A) Read the claims and the supporting written description.

(1) Determine what the applicant has claimed, noting any specific embodiments of the invention.

(2) Ensure that the claims define statutory subject matter (i.e., a process, machine, manufacture, composition of matter, or improvement thereof).

(3) If at any time during the examination, it becomes readily apparent that the claimed invention has a well-established utility, do not impose a rejection based on lack of utility. An invention has a well-established utility if (i) a person of ordinary skill in the art would immediately appreciate why the invention is useful based on the characteristics of the invention (e.g., properties or applications of a product or process), and (ii) the utility is specific, substantial, and credible.

(B) Review the claims and the supporting written description to determine if the applicant has asserted for the claimed invention any specific and substantial utility that is credible:

(1) If the applicant has asserted that the claimed invention is useful for any particular practical purpose (i.e., it has a "specific and substantial utility") and the assertion would be considered credible by a person of ordinary skill in the art, do not impose a rejection based on lack of utility.

(i) A claimed invention must have a specific and substantial utility. This requirement excludes "throw-away," "insubstantial," or "nonspecific" utilities, such as the use of a complex invention as landfill, as a way of satisfying the utility requirement of 35 U.S.C. 101.

(ii) Credibility is assessed from the perspective of one of ordinary skill in the art in view of the disclosure and any other evidence of record (e.g., test data, affidavits or declarations from experts in the art, patents or printed publications) that is probative of the applicant's assertions. An applicant need only provide one credible assertion of specific and substantial



utility for each claimed invention to satisfy the utility requirement.

(2) If no assertion of specific and substantial utility for the claimed invention made by the applicant is credible, and the claimed invention does not have a readily apparent well-established utility, reject the claim(s) under 35 U.S.C. 101 on the grounds that the invention as claimed lacks utility. Also reject the claims under 35 U.S.C. 112, first paragraph, on the basis that the disclosure fails to teach how to use the invention as claimed. The 35 U.S.C. 112, first paragraph, rejection imposed in conjunction with a 35 U.S.C. 101 rejection should incorporate by reference the grounds of the corresponding 35 U.S.C. 101 rejection.

(3) If the applicant has not asserted any specific and substantial utility for the claimed invention and it does not have a readily apparent well-established utility, impose a rejection under 35 U.S.C. 101, emphasizing that the applicant has not disclosed a specific and substantial utility for the invention. Also impose a separate rejection under 35 U.S.C. 112, first paragraph, on the basis that the applicant has not disclosed how to use the invention due to the lack of a specific and substantial utility. The 35 U.S.C. 101 and 112 rejections shift the burden of coming forward with evidence to the applicant to:

(i) Explicitly identify a specific and substantial utility for the claimed invention; and

(ii) Provide evidence that one of ordinary skill in the art would have recognized that the identified specific and substantial utility was well-established at the time of filing. The examiner should review any subsequently submitted evidence of utility using the criteria outlined above. The examiner should also ensure that there is an adequate nexus between the evidence and the properties of the now claimed subject matter as disclosed in the application as filed. That is, the applicant has the burden to establish a probative relation between the submitted evidence and the originally disclosed properties of the claimed invention.

(C) Any rejection based on lack of utility should include a detailed explanation why the claimed invention has no specific and substantial credible utility. Whenever possible, the examiner should provide

documentary evidence regardless of publication date (e.g., scientific or technical journals, excerpts from treatises or books, or U.S. or foreign patents) to support the factual basis for the *prima facie* showing of no specific and substantial credible utility. If documentary evidence is not available, the examiner should specifically explain the scientific basis for his or her factual conclusions.

(1) Where the asserted utility is not specific or substantial, a *prima facie* showing must establish that it is more likely than not that a person of ordinary skill in the art would not consider that any utility asserted by the applicant would be specific and substantial. The *prima facie* showing must contain the following elements:

(i) An explanation that clearly sets forth the reasoning used in concluding that the asserted utility for the claimed invention is not both specific and substantial nor well-established;

(ii) Support for factual findings relied upon in reaching this conclusion; and

(iii) An evaluation of all relevant evidence of record, including utilities taught in the closest prior art.

(2) Where the asserted specific and substantial utility is not credible, a *prima facie* showing of no specific and substantial credible utility must establish that it is more likely than not that a person skilled in the art would not consider credible any specific and substantial utility asserted by the applicant for the claimed invention. The *prima facie* showing must contain the following elements:

(i) An explanation that clearly sets forth the reasoning used in concluding that the asserted specific and substantial utility is not credible;

(ii) Support for factual findings relied upon in reaching this conclusion; and

(iii) An evaluation of all relevant evidence of record, including utilities taught in the closest prior art.

(3) Where no specific and substantial utility is disclosed or is well-established, a *prima facie* showing of no specific and substantial utility need only establish that applicant has not asserted a utility and that, on the record before the examiner, there is no known well-established utility.

(D) A rejection based on lack of utility should not be maintained if an asserted utility for the claimed invention would be considered specific, substantial, and credible by a person of ordinary skill in the art in view of all evidence of record.

Office personnel are reminded that they must treat as true a statement of fact made by an applicant in relation to an asserted utility, unless countervailing evidence can be provided that shows that one of ordinary skill in the art would have a legitimate basis to doubt the credibility of such a statement. Similarly, Office personnel must accept an opinion from a qualified expert that is based upon relevant facts whose accuracy is not being questioned; it is improper to disregard the opinion solely because of a disagreement over the significance or meaning of the facts offered.

Once a *prima facie* showing of no specific and substantial credible utility has been properly established, the applicant bears the burden of rebutting it. The applicant can do this by amending the claims, by providing reasoning or arguments, or by providing evidence in the form of a declaration under 37 CFR 1.132 or a patent or a printed publication that rebuts the basis or logic of the *prima facie* showing. If the applicant responds to the *prima facie* rejection, the Office personnel should review the original disclosure, any evidence relied upon in establishing the *prima facie* showing, any claim amendments, and any new reasoning or evidence provided by the applicant in support of an asserted specific and substantial credible utility. It is essential for Office personnel to recognize, fully consider and respond to each substantive element of any response to a rejection based on lack of utility. Only where the totality of the record continues to show that the asserted utility is not specific, substantial, and credible should a rejection based on lack of utility be maintained.

If the applicant satisfactorily rebuts a *prima facie* rejection based on lack of utility under 35 U.S.C. 101, withdraw the 35 U.S.C. 101 rejection and the corresponding rejection imposed under 35 U.S.C. 112, first paragraph.

## 2107.01 General Principles Governing Utility Rejections [R-1]

### *35 U.S.C. 101. Inventions patentable*

Whoever invents or discovers any new and useful process, machine, manufacture, or composition of matter, or any new and

useful improvement thereof may obtain a patent therefor, subject to the conditions and requirements of this title.

See MPEP § 2107 for guidelines for the examination of applications for compliance with the utility requirement of 35 U.S.C. 101.

The Office must examine each application to ensure compliance with the “useful invention” or utility requirement of 35 U.S.C. 101. In discharging this obligation, however, Office personnel must keep in mind several general principles that control application of the utility requirement. As interpreted by the Federal courts, 35 U.S.C. 101 has two purposes. First, 35 U.S.C. 101 defines which categories of inventions are eligible for patent protection. An invention that is not a machine, an article of manufacture, a composition or a process cannot be patented. See *Diamond v. Chakrabarty*, 447 U.S. 303, 206 USPQ 193 (1980); *Diamond v. Diehr*, 450 U.S. 175, 209 USPQ 1 (1981). Second, 35 U.S.C. 101 serves to ensure that patents are granted on only those inventions that are “useful.” This second purpose has a Constitutional footing — Article I, Section 8 of the Constitution authorizes Congress to provide exclusive rights to inventors to promote the “useful arts.” See *Carl Zeiss Stiftung v. Renishaw PLC*, 945 F.2d 1173, 20 USPQ2d 1094 (Fed. Cir. 1991). Thus, to satisfy the requirements of 35 U.S.C. 101, an applicant must claim an invention that is statutory subject matter and must show that the claimed invention is “useful” for some purpose either explicitly or implicitly. Application of this latter element of 35 U.S.C. 101 is the focus of these guidelines.

Deficiencies under the “useful invention” requirement of 35 U.S.C. 101 will arise in one of two forms. The first is where it is not apparent why the invention is “useful.” This can occur when an applicant fails to identify any specific and substantial utility for the invention or fails to disclose enough information about the invention to make its usefulness immediately apparent to those familiar with the technological field of the invention. *Brenner v. Manson*, 383 U.S. 519, 148 USPQ 689 (1966); *In re Ziegler*, 992 F.2d 1197, 26 USPQ2d 1600 (Fed. Cir. 1993). The second type of deficiency arises in the rare instance where an assertion of specific and substantial utility for the invention made by an applicant is not credible.

## I. SPECIFIC AND SUBSTANTIAL REQUIREMENTS

To satisfy 35 U.S.C. 101, an invention must be “useful.” Courts have recognized that the term “useful” used with reference to the utility requirement can be a difficult term to define. *Brenner v. Manson*, 383 U.S. 519, 529, 148 USPQ 689, 693 (1966) (simple everyday word like “useful” can be “pregnant with ambiguity when applied to the facts of life.”). Where an applicant has set forth a specific and substantial utility, courts have been reluctant to uphold a rejection under 35 U.S.C. 101 solely on the basis that the applicant’s opinion as to the nature of the specific and substantial utility was inaccurate. For example, in *Nelson v. Bowler*, 626 F.2d 853, 206 USPQ 881 (CCPA 1980), the court reversed a finding by the Office that the applicant had not set forth a “practical” utility under 35 U.S.C. 101. In this case the applicant asserted that the composition was “useful” in a particular pharmaceutical application and provided evidence to support that assertion. Courts have used the labels “practical utility,” “substantial utility,” or “specific utility” to refer to this aspect of the “useful invention” requirement of 35 U.S.C. 101. The Court of Customs and Patent Appeals has stated:

Practical utility is a shorthand way of attributing “real-world” value to claimed subject matter. In other words, one skilled in the art can use a claimed discovery in a manner which provides some immediate benefit to the public.

*Nelson v. Bowler*, 626 F.2d 853, 856, 206 USPQ 881, 883 (CCPA 1980).

Practical considerations require the Office to rely on the inventor’s understanding of his or her invention in determining whether and in what regard an invention is believed to be “useful.” Because of this, Office personnel should focus on and be receptive to assertions made by the applicant that an invention is “useful” for a particular reason.

### *Specific Utility*

A “specific utility” is *specific* to the subject matter claimed. This contrasts with a *general* utility that would be applicable to the broad class of the invention. Office personnel should distinguish between situations where an applicant has disclosed a specific

use for or application of the invention and situations where the applicant merely indicates that the invention may prove useful without identifying with specificity why it is considered useful. For example, indicating that a compound may be useful in treating unspecified disorders, or that the compound has “useful biological” properties, would not be sufficient to define a specific utility for the compound. Similarly, a claim to a polynucleotide whose use is disclosed simply as a “gene probe” or “chromosome marker” would not be considered to be *specific* in the absence of a disclosure of a specific DNA target. A general statement of diagnostic utility, such as diagnosing an unspecified disease, would ordinarily be insufficient absent a disclosure of what condition can be diagnosed. Contrast the situation where an applicant discloses a specific biological activity and reasonably correlates that activity to a disease condition. Assertions falling within the latter category are sufficient to identify a specific utility for the invention. Assertions that fall in the former category are insufficient to define a specific utility for the invention, especially if the assertion takes the form of a general statement that makes it clear that a “useful” invention may arise from what has been disclosed by the applicant. *Knapp v. Anderson*, 477 F.2d 588, 177 USPQ 688 (CCPA 1973).

### *Substantial Utility*

A “substantial utility” defines a “real world” use. Utilities that require or constitute carrying out further research to identify or reasonably confirm a “real world” context of use are not substantial utilities. For example, both a therapeutic method of treating a known or newly discovered disease and an assay method for identifying compounds that themselves have a “substantial utility” define a “real world” context of use. An assay that measures the presence of a material which has a stated correlation to a predisposition to the onset of a particular disease condition would also define a “real world” context of use in identifying potential candidates for preventive measures or further monitoring. On the other hand, the following are examples of situations that require or constitute carrying out further research to identify or reasonably confirm a “real world” context of use and, therefore, do not define “substantial utilities”:

(A) Basic research such as studying the properties of the claimed product itself or the mechanisms in which the material is involved;

(B) A method of treating an *unspecified* disease or condition;

(C) A method of assaying for or identifying a material that itself has no specific and/or substantial utility;

(D) A method of making a material that itself has no specific, substantial, and credible utility; and

(E) A claim to an intermediate product for use in making a final product that has no specific, substantial and credible utility.

Office personnel must be careful not to interpret the phrase “immediate benefit to the public” or similar formulations in other cases to mean that products or services based on the claimed invention must be “currently available” to the public in order to satisfy the utility requirement. See, e.g., *Brenner v. Manson*, 383 U.S. 519, 534-35, 148 USPQ 689, 695 (1966). Rather, any reasonable use that an applicant has identified for the invention that can be viewed as providing a public benefit should be accepted as sufficient, at least with regard to defining a “substantial” utility.

### **Research Tools**

Some confusion can result when one attempts to label certain types of inventions as not being capable of having a specific and substantial utility based on the setting in which the invention is to be used. One example is inventions to be used in a research or laboratory setting. Many research tools such as gas chromatographs, screening assays, and nucleotide sequencing techniques have a clear, specific and unquestionable utility (e.g., they are useful in analyzing compounds). An assessment that focuses on whether an invention is useful only in a research setting thus does not address whether the invention is in fact “useful” in a patent sense. Instead, Office personnel must distinguish between inventions that have a specifically identified substantial utility and inventions whose asserted utility requires further research to identify or reasonably confirm. Labels such as “research tool,” “intermediate” or “for research purposes” are not helpful in determining if an applicant has identified a specific and substantial utility for the invention.

## **II. WHOLLY INOPERATIVE INVENTIONS; “INCREDIBLE” UTILITY**

An invention that is “inoperative” (i.e., it does not operate to produce the results claimed by the patent applicant) is not a “useful” invention in the meaning of the patent law. See, e.g., *Newman v. Quigg*, 877 F.2d 1575, 1581, 11 USPQ2d 1340, 1345 (Fed. Cir. 1989); *In re Harwood*, 390 F.2d 985, 989, 156 USPQ 673, 676 (CCPA 1968) (“An inoperative invention, of course, does not satisfy the requirement of 35 U.S.C. 101 that an invention be useful.”). However, as the Federal Circuit has stated, “[t]o violate [35 U.S.C.] 101 the claimed device must be totally incapable of achieving a useful result.” *Brooktree Corp. v. Advanced Micro Devices, Inc.*, 977 F.2d 1555, 1571, 24 USPQ2d 1401, 1412 (Fed. Cir. 1992) (emphasis added). See also *E.I. du Pont De Nemours and Co. v. Berkley and Co.*, 620 F.2d 1247, 1260 n.17, 205 USPQ 1, 10 n.17 (8th Cir. 1980) (“A small degree of utility is sufficient . . . The claimed invention must only be capable of performing some beneficial function . . . An invention does not lack utility merely because the particular embodiment disclosed in the patent lacks perfection or performs crudely . . . A commercially successful product is not required . . . Nor is it essential that the invention accomplish all its intended functions . . . or operate under all conditions . . . partial success being sufficient to demonstrate patentable utility . . . In short, the defense of non-utility cannot be sustained without proof of total incapacity.”) If an invention is only partially successful in achieving a useful result, a rejection of the claimed invention as a whole based on a lack of utility is not appropriate. See *In re Brana*, 51 F.3d 1560, 34 USPQ2d 1436 (Fed. Cir. 1995); *In re Gardner*, 475 F.2d 1389, 177 USPQ 396 (CCPA), *reh’g denied*, 480 F.2d 879 (CCPA 1973); *In re Marzocchi*, 439 F.2d 220, 169 USPQ 367 (CCPA 1971).

Situations where an invention is found to be “inoperative” and therefore lacking in utility are rare, and rejections maintained solely on this ground by a Federal court even rarer. In many of these cases, the utility asserted by the applicant was thought to be “incredible in the light of the knowledge of the art, or factually misleading” when initially considered by the Office. *In re Citron*, 325 F.2d 248, 253, 139 USPQ 516, 520 (CCPA 1963). Other cases suggest that on initial evaluation, the Office considered the asserted

utility to be inconsistent with known scientific principles or “speculative at best” as to whether attributes of the invention necessary to impart the asserted utility were actually present in the invention. *In re Sichert*, 566 F.2d 1154, 196 USPQ 209 (CCPA 1977). However cast, the underlying finding by the court in these cases was that, based on the factual record of the case, it was clear that the invention could not and did not work as the inventor claimed it did. Indeed, the use of many labels to describe a single problem (e.g., a false assertion regarding utility) has led to some of the confusion that exists today with regard to a rejection based on the “utility” requirement. Examples of such cases include: an invention asserted to change the taste of food using a magnetic field (*Fregeau v. Mossinghoff*, 776 F.2d 1034, 227 USPQ 848 (Fed. Cir. 1985)), a perpetual motion machine (*Newman v. Quigg*, 877 F.2d 1575, 11 USPQ2d 1340 (Fed. Cir. 1989)), a flying machine operating on “flapping or flutter function” (*In re Houghton*, 433 F.2d 820, 167 USPQ 687 (CCPA 1970)), a “cold fusion” process for producing energy (*In re Swartz*, 232 F.3d 862, 56 USPQ2d 1703, (Fed. Cir. 2000)), a method for increasing the energy output of fossil fuels upon combustion through exposure to a magnetic field (*In re Ruskin*, 354 F.2d 395, 148 USPQ 221 (CCPA 1966)), uncharacterized compositions for curing a wide array of cancers (*In re Citron*, 325 F.2d 248, 139 USPQ 516 (CCPA 1963)), a method of controlling the aging process (*In re Eltgroth*, 419 F.2d 918, 164 USPQ 221 (CCPA 1970)), and a method of restoring hair growth (*In re Ferens*, 417 F.2d 1072, 163 USPQ 609 (CCPA 1969)). >These examples are fact specific and should not be applied as a *per se* rule.< Thus, in view of the rare nature of such cases, Office personnel should not label an asserted utility “incredible,” “speculative” or otherwise unless it is clear that a rejection based on “lack of utility” is proper.

### III. THERAPEUTIC OR PHARMACOLOGICAL UTILITY

Inventions asserted to have utility in the treatment of human or animal disorders are subject to the same legal requirements for utility as inventions in any other field of technology. *In re Chilowsky*, 229 F.2d 457, 461-2, 108 USPQ 321, 325 (CCPA 1956) (“There appears to be no basis in the statutes or decisions for requiring any more conclusive evidence of

operativeness in one type of case than another. The character and amount of evidence needed may vary, depending on whether the alleged operation described in the application appears to accord with or to contravene established scientific principles or to depend upon principles alleged but not generally recognized, but the degree of certainty as to the ultimate fact of operativeness or inoperativeness should be the same in all cases”); *In re Gazave*, 379 F.2d 973, 978, 154 USPQ 92, 96 (CCPA 1967) (“Thus, in the usual case where the mode of operation alleged can be readily understood and conforms to the known laws of physics and chemistry, operativeness is not questioned, and no further evidence is required.”). As such, pharmacological or therapeutic inventions that provide any “immediate benefit to the public” satisfy 35 U.S.C. 101. The utility being asserted in *Nelson* related to a compound with pharmacological utility. *Nelson v. Bowler*, 626 F.2d 853, 856, 206 USPQ 881, 883 (CCPA 1980). Office personnel should rely on *Nelson* and other cases as providing general guidance when evaluating the utility of an invention that is based on any therapeutic, prophylactic, or pharmacological activities of that invention.

Courts have repeatedly found that the mere identification of a pharmacological activity of a compound that is relevant to an asserted pharmacological use provides an “immediate benefit to the public” and thus satisfies the utility requirement. As the Court of Customs and Patent Appeals held in *Nelson v. Bowler*:

Knowledge of the pharmacological activity of any compound is obviously beneficial to the public. It is inherently faster and easier to combat illnesses and alleviate symptoms when the medical profession is armed with an arsenal of chemicals having known pharmacological activities. Since it is crucial to provide researchers with an incentive to disclose pharmacological activities in as many compounds as possible, we conclude that adequate proof of any such activity constitutes a showing of practical utility.

*Nelson v. Bowler*, 626 F.2d 853, 856, 206 USPQ 881, 883 (CCPA 1980).

In *Nelson v. Bowler*, the court addressed the practical utility requirement in the context of an interference proceeding. Bowler challenged the patentability of the invention claimed by Nelson on the basis that Nelson had failed to sufficiently and persuasively disclose in his application a practical utility for the invention. Nelson had developed and claimed a class

of synthetic prostaglandins modeled on naturally occurring prostaglandins. Naturally occurring prostaglandins are bioactive compounds that, at the time of Nelson's application, had a recognized value in pharmacology (e.g., the stimulation of uterine smooth muscle which resulted in labor induction or abortion, the ability to raise or lower blood pressure, etc.). To support the utility he identified in his disclosure, Nelson included in his application the results of tests demonstrating the bioactivity of his new substituted prostaglandins relative to the bioactivity of naturally occurring prostaglandins. The court concluded that Nelson had satisfied the practical utility requirement in identifying the synthetic prostaglandins as pharmacologically active compounds. In reaching this conclusion, the court considered and rejected arguments advanced by Bowler that attacked the evidentiary basis for Nelson's assertions that the compounds were pharmacologically active.

In *In re Jolles*, 628 F.2d 1322, 206 USPQ 885 (CCPA 1980), an inventor claimed protection for pharmaceutical compositions for treating leukemia. The active ingredient in the compositions was a structural analog to a known anticancer agent. The applicant provided evidence showing that the claimed analogs had the same general pharmaceutical activity as the known anticancer agents. The court reversed the Board's finding that the asserted pharmaceutical utility was "incredible," pointing to the evidence that showed the relevant pharmacological activity.

In *Cross v. Iizuka*, 753 F.2d 1040, 224 USPQ 739 (Fed. Cir. 1985), the Federal Circuit affirmed a finding by the Board of Patent Appeals and Interferences that a pharmacological utility had been disclosed in the application of one party to an interference proceeding. The invention that was the subject of the interference count was a chemical compound used for treating blood disorders. Cross had challenged the evidence in Iizuka's specification that supported the claimed utility. However, the Federal Circuit relied extensively on *Nelson v. Bowler* in finding that Iizuka's application had sufficiently disclosed a pharmacological utility for the compounds. It distinguished the case from cases where only a generalized "nebulous" expression, such as "biological properties," had been disclosed in a specification. Such statements, the court held, "convey little explicit indication regarding the utility of a compound." *Cross*,

753 F.2d at 1048, 224 USPQ at 745 (citing *In re Kirk*, 376 F.2d 936, 941, 153 USPQ 48, 52 (CCPA 1967)).

Similarly, courts have found utility for therapeutic inventions despite the fact that an applicant is at a very early stage in the development of a pharmaceutical product or therapeutic regimen based on a claimed pharmacological or bioactive compound or composition. The Federal Circuit, in *Cross v. Iizuka*, 753 F.2d 1040, 1051, 224 USPQ 739, 747-48 (Fed. Cir. 1985), commented on the significance of data from *in vitro* testing that showed pharmacological activity:

We perceive no insurmountable difficulty, under appropriate circumstances, in finding that the first link in the screening chain, *in vitro* testing, may establish a practical utility for the compound in question. Successful *in vitro* testing will marshal resources and direct the expenditure of effort to further *in vivo* testing of the most potent compounds, thereby providing an immediate benefit to the public, analogous to the benefit provided by the showing of an *in vivo* utility.

The Federal Circuit has reiterated that therapeutic utility sufficient under the patent laws is not to be confused with the requirements of the FDA with regard to safety and efficacy of drugs to marketed in the United States.

FDA approval, however, is not a prerequisite for finding a compound useful within the meaning of the patent laws. *Scott [v. Finney]*, 34 F.3d 1058, 1063, 32 USPQ2d 1115, 1120 [(Fed.Cir. 1994)]. Usefulness in patent law, and in particular in the context of pharmaceutical inventions, necessarily includes the expectation of further research and development. The stage at which an invention in this field becomes useful is well before it is ready to be administered to humans. Were we to require Phase II testing in order to prove utility, the associated costs would prevent many companies from obtaining patent protection on promising new inventions, thereby eliminating an incentive to pursue, through research and development, potential cures in many crucial areas such as the treatment of cancer.

*In re Brana*, 51 F.3d 1560, 34 USPQ2d 1436 (Fed. Cir. 1995). Accordingly, Office personnel should not construe 35 U.S.C. 101, under the logic of "practical" utility or otherwise, to require that an applicant demonstrate that a therapeutic agent based on a claimed invention is a safe or fully effective drug for humans. See, e.g., *In re Sichert*, 566 F.2d 1154, 196 USPQ 209 (CCPA 1977); *In re Hartop*, 311 F.2d 249, 135 USPQ 419 (CCPA 1962); *In re Anthony*, 414 F.2d 1383,

162 USPQ 594 (CCPA 1969); *In re Watson*, 517 F.2d 465, 186 USPQ 11 (CCPA 1975).

These general principles are equally applicable to situations where an applicant has claimed a process for treating a human or animal disorder. In such cases, the asserted utility is usually clear — the invention is asserted to be useful in treating the particular disorder. If the asserted utility is credible, there is no basis to challenge such a claim on the basis that it lacks utility under 35 U.S.C. 101.

See MPEP § 2107.03 for special considerations for asserted therapeutic or pharmacological utilities.

#### **IV. RELATIONSHIP BETWEEN 35 U.S.C. 112, FIRST PARAGRAPH, AND 35 U.S.C. 101**

A deficiency under 35 U.S.C. 101 also creates a deficiency under 35 U.S.C. 112, first paragraph. See *In re Brana*, 51 F.3d 1560, 34 USPQ2d 1436 (Fed. Cir. 1995); *In re Jolles*, 628 F.2d 1322, 1326 n.10, 206 USPQ 885, 889 n.11 (CCPA 1980); *In re Fouche*, 439 F.2d 1237, 1243, 169 USPQ 429, 434 (CCPA 1971) (“If such compositions are in fact useless, appellant’s specification cannot have taught how to use them.”). Courts have also cast the 35 U.S.C. 101/35 U.S.C. 112 relationship such that 35 U.S.C. 112 presupposes compliance with 35 U.S.C. 101. See *In re Ziegler*, 992 F.2d 1197, 1200-1201, 26 USPQ2d 1600, 1603 (Fed. Cir. 1993) (“The how to use prong of section 112 incorporates as a matter of law the requirement of 35 U.S.C. 101 that the specification disclose as a matter of fact a practical utility for the invention. ... If the application fails as a matter of fact to satisfy 35 U.S.C. § 101, then the application also fails as a matter of law to enable one of ordinary skill in the art to use the invention under 35 U.S.C. § 112.”); *In re Kirk*, 376 F.2d 936, 942, 153 USPQ 48, 53 (CCPA 1967) (“Necessarily, compliance with § 112 requires a description of how to use presently useful inventions, otherwise an applicant would anomalously be required to teach how to use a useless invention.”). For example, the Federal Circuit noted, “[o]bviously, if a claimed invention does not have utility, the specification cannot enable one to use it.” *In re Brana*, 51 F.3d 1560, 34 USPQ2d 1436 (Fed. Cir. 1995). As such, a rejection properly imposed under 35 U.S.C. 101 should be accompanied with a rejection under 35 U.S.C. 112, first paragraph. It is equally clear that a rejection based on “lack of utility,” whether grounded

upon 35 U.S.C. 101 or 35 U.S.C. 112, first paragraph, rests on the same basis (i.e., the asserted utility is not credible). To avoid confusion, any rejection that is imposed on the basis of 35 U.S.C. 101 should be accompanied by a rejection based on 35 U.S.C. 112, first paragraph. The 35 U.S.C. 112, first paragraph, rejection should be set out as a separate rejection that incorporates by reference the factual basis and conclusions set forth in the 35 U.S.C. 101 rejection. The 35 U.S.C. 112, first paragraph, rejection should indicate that because the invention as claimed does not have utility, a person skilled in the art would not be able to use the invention as claimed, and as such, the claim is defective under 35 U.S.C. 112, first paragraph. A 35 U.S.C. 112, first paragraph, rejection should not be imposed or maintained unless an appropriate basis exists for imposing a rejection under 35 U.S.C. 101. In other words, Office personnel should not impose a 35 U.S.C. 112, first paragraph, rejection grounded on a “lack of utility” basis unless a 35 U.S.C. 101 rejection is proper. In particular, the factual showing needed to impose a rejection under 35 U.S.C. 101 must be provided if a rejection under 35 U.S.C. 112, first paragraph, is to be imposed on “lack of utility” grounds.

It is important to recognize that 35 U.S.C. 112, first paragraph, addresses matters other than those related to the question of whether or not an invention lacks utility. These matters include whether the claims are fully supported by the disclosure (*In re Vaeck*, 947 F.2d 488, 495, 20 USPQ2d 1438, 1444 (Fed. Cir. 1991)), whether the applicant has provided an enabling disclosure of the claimed subject matter (*In re Wright*, 999 F.2d 1557, 1561-1562, 27 USPQ2d 1510, 1513 (Fed. Cir. 1993)), whether the applicant has provided an adequate written description of the invention and whether the applicant has disclosed the best mode of practicing the claimed invention (*Chemcast Corp. v. Arco Indus. Corp.*, 913 F.2d 923, 927-928, 16 USPQ2d 1033, 1036-1037 (Fed. Cir. 1990)). See also *Transco Products Inc. v. Performance Contracting Inc.*, 38 F.3d 551, 32 USPQ2d 1077 (Fed. Cir. 1994); *Glaxo Inc. v. Novopharm Ltd.* 52 F.3d 1043, 34 USPQ2d 1565 (Fed. Cir. 1995). The fact that an applicant has disclosed a specific utility for an invention and provided a credible basis supporting that specific utility does not provide a basis for concluding that the claims comply with all the requirements of

35 U.S.C. 112, first paragraph. For example, if an applicant has claimed a process of treating a certain disease condition with a certain compound and provided a credible basis for asserting that the compound is useful in that regard, but to actually practice the invention as claimed a person skilled in the relevant art would have to engage in an undue amount of experimentation, the claim may be defective under 35 U.S.C. 112, but not 35 U.S.C. 101. To avoid confusion during examination, any rejection under 35 U.S.C. 112, first paragraph, based on grounds other than “lack of utility” should be imposed separately from any rejection imposed due to “lack of utility” under 35 U.S.C. 101 and 35 U.S.C. 112, first paragraph.

## **2107.02 Procedural Considerations Related to Rejections for Lack of Utility [R-1]**

### **I. THE CLAIMED INVENTION IS THE FOCUS OF THE UTILITY REQUIREMENT**

The claimed invention is the focus of the assessment of whether an applicant has satisfied the utility requirement. Each claim (i.e., each “invention”), therefore, must be evaluated on its own merits for compliance with all statutory requirements. Generally speaking, however, a dependent claim will define an invention that has utility if the claim from which it depends has defined an invention having utility. An exception to this general rule is where the utility specified for the invention defined in a dependent claim differs from that indicated for the invention defined in the independent claim from which the dependent claim depends. Where an applicant has established utility for a species that falls within an identified genus of compounds, and presents a generic claim covering the genus, as a general matter, that claim should be treated as being sufficient under 35 U.S.C. 101. Only where it can be established that other species clearly encompassed by the claim do not have utility should a rejection be imposed on the generic claim. In such cases, the applicant should be encouraged to amend the generic claim so as to exclude the species that lack utility.

It is common and sensible for an applicant to identify several specific utilities for an invention, particularly where the invention is a product (e.g., a machine,

an article of manufacture or a composition of matter). However, regardless of the category of invention that is claimed (e.g., product or process), an applicant need only make one credible assertion of specific utility for the claimed invention to satisfy 35 U.S.C. 101 and 35 U.S.C. 112; additional statements of utility, even if not “credible,” do not render the claimed invention lacking in utility. See, e.g., *Raytheon v. Roper*, 724 F.2d 951, 958, 220 USPQ 592, 598 (Fed. Cir. 1983), *cert. denied*, 469 U.S. 835 (1984) (“When a properly claimed invention meets at least one stated objective, utility under 35 U.S.C. 101 is clearly shown.”); *In re Gottlieb*, 328 F.2d 1016, 1019, 140 USPQ 665, 668 (CCPA 1964) (“Having found that the antibiotic is useful for some purpose, it becomes unnecessary to decide whether it is in fact useful for the other purposes ‘indicated’ in the specification as possibly useful.”); *In re Malachowski*, 530 F.2d 1402, 189 USPQ 432 (CCPA 1976); *Hoffman v. Klaus*, 9 USPQ2d 1657 (Bd. Pat. App. & Inter. 1988). Thus, if applicant makes one credible assertion of utility, utility for the claimed invention as a whole is established.

Statements made by the applicant in the specification or incident to prosecution of the application before the Office cannot, standing alone, be the basis for a lack of utility rejection under 35 U.S.C. 101 or 35 U.S.C. 112. *Tol-O-Matic, Inc. v. Proma Produkt-Und Mktg. Gesellschaft m.b.h.*, 945 F.2d 1546, 1553, 20 USPQ2d 1332, 1338 (Fed. Cir. 1991) (It is not required that a particular characteristic set forth in the prosecution history be achieved in order to satisfy 35 U.S.C. 101.). An applicant may include statements in the specification whose technical accuracy cannot be easily confirmed if those statements are not necessary to support the patentability of an invention with regard to any statutory basis. Thus, the Office should not require an applicant to strike nonessential statements relating to utility from a patent disclosure, regardless of the technical accuracy of the statement or assertion it presents. Office personnel should also be especially careful not to read into a claim unclaimed results, limitations or embodiments of an invention. See *Carl Zeiss Stiftung v. Renishaw PLC*, 945 F.2d 1173, 20 USPQ2d 1094 (Fed. Cir. 1991); *In re Krimmel*, 292 F.2d 948, 130 USPQ 215 (CCPA 1961). Doing so can inappropriately change the relationship of an asserted utility to the claimed invention



and raise issues not relevant to examination of that claim.

## **II. IS THERE AN ASSERTED OR WELL-ESTABLISHED UTILITY FOR THE CLAIMED INVENTION?**

Upon initial examination, the examiner should review the specification to determine if there are any statements asserting that the claimed invention is useful for any particular purpose. A complete disclosure should include a statement which identifies a specific and substantial utility for the invention.

### ***A. An Asserted Utility Must Be Specific and Substantial***

A statement of specific and substantial utility should fully and clearly explain why the applicant believes the invention is useful. Such statements will usually explain the purpose of or how the invention may be used (e.g., a compound is believed to be useful in the treatment of a particular disorder). Regardless of the form of statement of utility, it must enable one ordinarily skilled in the art to understand why the applicant believes the claimed invention is useful.

Except where an invention has a well-established utility, the failure of an applicant to specifically identify why an invention is believed to be useful renders the claimed invention deficient under 35 U.S.C. 101 and 35 U.S.C. 112, first paragraph. In such cases, the applicant has failed to identify a “specific and substantial utility” for the claimed invention. For example, a statement that a composition has an unspecified “biological activity” or that does not explain why a composition with that activity is believed to be useful fails to set forth a “specific and substantial utility.” *Brenner v. Manson*, 383 US 519, 148 USPQ 689 (1966) (general assertion of similarities to known compounds known to be useful without sufficient corresponding explanation why claimed compounds are believed to be similarly useful insufficient under 35 U.S.C. 101); *In re Ziegler*, 992 F.2d 1197, 1201, 26 USPQ2d 1600, 1604 (Fed. Cir. 1993) (disclosure that composition is “plastic-like” and can form “films” not sufficient to identify specific and substantial utility for invention); *In re Kirk*, 376 F.2d 936, 153 USPQ 48 (CCPA 1967) (indication that compound is “biologically active” or has “biological properties” insufficient standing alone). See also *In re Joly*, 376

F.2d 906, 153 USPQ 45 (CCPA 1967); *Kawai v. Metlesics*, 480 F.2d 880, 890, 178 USPQ 158, 165 (CCPA 1973) (contrasting description of invention as sedative which did suggest specific utility to general suggestion of “pharmacological effects on the central nervous system” which did not). In contrast, a disclosure that identifies a particular biological activity of a compound and explains how that activity can be utilized in a particular therapeutic application of the compound does contain an assertion of specific and substantial utility for the invention.

Situations where an applicant either fails to indicate why an invention is considered useful, or where the applicant inaccurately describes the utility should rarely arise. One reason for this is that applicants are required to disclose the best mode known to them of practicing the invention at the time they file their application. An applicant who omits a description of the specific and substantial utility of the invention, or who incompletely describes that utility, may encounter problems with respect to the best mode requirement of 35 U.S.C. 112, first paragraph.

### ***B. No Statement of Utility for the Claimed Invention in the Specification Does Not Per Se Negate Utility***

Occasionally, an applicant will not explicitly state in the specification or otherwise assert a specific and substantial utility for the claimed invention. If no statements can be found asserting a specific and substantial utility for the claimed invention in the specification, Office personnel should determine if the claimed invention has a well-established utility. An invention has a well-established utility if (i) a person of ordinary skill in the art would immediately appreciate why the invention is useful based on the characteristics of the invention (e.g., properties or applications of a product or process), and (ii) the utility is specific, substantial, and credible. If an invention has a well-established utility, rejections under 35 U.S.C. 101 and 35 U.S.C. 112, first paragraph, based on lack of utility should not be imposed. *In re Folkers*, 344 F.2d 970, 145 USPQ 390 (CCPA 1965). For example, if an application teaches the cloning and characterization of the nucleotide sequence of a well-known protein such as insulin, and those skilled in the art at the time of filing knew that insulin had a well-established use, it would be improper to reject the claimed invention as

lacking utility solely because of the omitted statement of specific and substantial utility.

If a person of ordinary skill would not immediately recognize a specific and substantial utility for the claimed invention (i.e., why it would be useful) based on the characteristics of the invention or statements made by the applicant, the examiner should reject the application under 35 U.S.C. 101 and under 35 U.S.C. 112, first paragraph, as failing to identify a specific and substantial utility for the claimed invention. The rejection should clearly indicate that the basis of the rejection is that the application fails to identify a specific and substantial utility for the invention. The rejection should also specify that the applicant must reply by indicating why the invention is believed useful and where support for any subsequently asserted utility can be found in the specification as filed. See MPEP § 2701.

If the applicant subsequently indicates why the invention is useful, Office personnel should review that assertion according to the standards articulated below for review of the credibility of an asserted utility.

### III. EVALUATING THE CREDIBILITY OF AN ASSERTED UTILITY

#### A. *An Asserted Utility Creates a Presumption of Utility*

In most cases, an applicant's assertion of utility creates a presumption of utility that will be sufficient to satisfy the utility requirement of 35 U.S.C. 101. See, e.g., *In re Jolles*, 628 F.2d 1322, 206 USPQ 885 (CCPA 1980); *In re Irons*, 340 F.2d 974, 144 USPQ 351 (CCPA 1965); *In re Langer*, 503 F.2d 1380, 183 USPQ 288 (CCPA 1974); *In re Sichert*, 566 F.2d 1154, 1159, 196 USPQ 209, 212-13 (CCPA 1977). As the Court of Customs and Patent Appeals stated in *In re Langer*:

As a matter of Patent Office practice, a specification which contains a disclosure of utility which corresponds in scope to the subject matter sought to be patented must be taken as sufficient to satisfy the utility requirement of § 101 for the entire claimed subject matter unless there is a reason for one skilled in the art to question the objective truth of the statement of utility or its scope.

*In re Langer*, 503 F.2d at 1391, 183 USPQ at 297 (emphasis in original). The “Langer” test for utility

has been used by both the Federal Circuit and the Court of Customs and Patent Appeals in evaluation of rejections under 35 U.S.C. 112, first paragraph, where the rejection is based on a deficiency under 35 U.S.C. 101. In *In re Brana*, 51 F.3d 1560, 34 USPQ2d 1436 (Fed. Cir. 1995), the Federal Circuit explicitly adopted the Court of Customs and Patent Appeals' formulation of the “Langer” standard for 35 U.S.C. 112, first paragraph rejections, as it was expressed in a slightly reworded format in *In re Marzocchi*, 439 F.2d 220, 223, 169 USPQ 367, 369 (CCPA 1971), namely:

[A] specification disclosure which contains a teaching of the manner and process of making and using the invention in terms which correspond in scope to those used in describing and defining the subject matter sought to be patented must be taken as in compliance with the enabling requirement of the first paragraph of § 112 unless there is reason to doubt the objective truth of the statements contained therein which must be relied on for enabling support. (emphasis added).

Thus, *Langer* and subsequent cases direct the Office to presume that a statement of utility made by an applicant is true. See *In re Langer*, 503 F.2d at 1391, 183 USPQ at 297; *In re Malachowski*, 530 F.2d 1402, 1404, 189 USPQ 432, 435 (CCPA 1976); *In re Brana*, 51 F.3d 1560, 34 USPQ2d 1436 (Fed. Cir. 1995). For obvious reasons of efficiency and in deference to an applicant's understanding of his or her invention, when a statement of utility is evaluated, Office personnel should not begin by questioning the truth of the statement of utility. Instead, any inquiry must start by asking if there is any reason to question the truth of the statement of utility. This can be done by simply evaluating the logic of the statements made, taking into consideration any evidence cited by the applicant. If the asserted utility is credible (i.e., believable based on the record or the nature of the invention), a rejection based on “lack of utility” is not appropriate. Clearly, Office personnel should not begin an evaluation of utility by assuming that an asserted utility is likely to be false, based on the technical field of the invention or for other general reasons.

Compliance with 35 U.S.C. 101 is a question of fact. *Raytheon v. Roper*, 724 F.2d 951, 956, 220 USPQ 592, 596 (Fed. Cir. 1983) *cert. denied*, 469 U.S. 835 (1984). Thus, to overcome the presumption of truth that an assertion of utility by the applicant

enjoys, Office personnel must establish that it is more likely than not that one of ordinary skill in the art would doubt (i.e., “question”) the truth of the statement of utility. The evidentiary standard to be used throughout *ex parte* examination in setting forth a rejection is a preponderance of the totality of the evidence under consideration. *In re Oetiker*, 977 F.2d 1443, 1445, 24 USPQ2d 1443, 1444 (Fed. Cir. 1992) (“After evidence or argument is submitted by the applicant in response, patentability is determined on the totality of the record, by a preponderance of evidence with due consideration to persuasiveness of argument.”); *In re Corkill*, 771 F.2d 1496, 1500, 226 USPQ 1005, 1008 (Fed. Cir. 1985). A preponderance of the evidence exists when it suggests that it is more likely than not that the assertion in question is true. *Herman v. Huddleston*, 459 U.S. 375, 390 (1983). To do this, Office personnel must provide evidence sufficient to show that the statement of asserted utility would be considered “false” by a person of ordinary skill in the art. Of course, a person of ordinary skill must have the benefit of both facts and reasoning in order to assess the truth of a statement. This means that if the applicant has presented facts that support the reasoning used in asserting a utility, Office personnel must present countervailing facts and reasoning sufficient to establish that a person of ordinary skill would not believe the applicant’s assertion of utility. *In re Brana*, 51 F.3d 1560, 34 USPQ2d 1436 (Fed. Cir. 1995). The initial evidentiary standard used during evaluation of this question is a preponderance of the evidence (i.e., the totality of facts and reasoning suggest that it is more likely than not that the statement of the applicant is false).

#### **B. When Is an Asserted Utility Not Credible?**

Where an applicant has specifically asserted that an invention has a particular utility, that assertion cannot simply be dismissed by Office personnel as being “wrong,” even when there may be reason to believe that the assertion is not entirely accurate. Rather, Office personnel must determine if the assertion of utility is credible (i.e., whether the assertion of utility is believable to a person of ordinary skill in the art based on the totality of evidence and reasoning provided). An assertion is credible unless (A) the logic underlying the assertion is seriously flawed, or (B) the facts upon which the assertion is based are inconsis-

tent with the logic underlying the assertion. Credibility as used in this context refers to the reliability of the statement based on the logic and facts that are offered by the applicant to support the assertion of utility.

One situation where an assertion of utility would not be considered credible is where a person of ordinary skill would consider the assertion to be “incredible in view of contemporary knowledge” and where nothing offered by the applicant would counter what contemporary knowledge might otherwise suggest. Office personnel should be careful, however, not to label certain types of inventions as “incredible” or “speculative” as such labels do not provide the correct focus for the evaluation of an assertion of utility. “Incredible utility” is a conclusion, not a starting point for analysis under 35 U.S.C. 101. A conclusion that an asserted utility is incredible can be reached only after the Office has evaluated both the assertion of the applicant regarding utility and any evidentiary basis of that assertion. The Office should be particularly careful not to start with a presumption that an asserted utility is, *per se*, “incredible” and then proceed to base a rejection under 35 U.S.C. 101 on that presumption.

Rejections under 35 U.S.C. 101 have been rarely sustained by federal courts. Generally speaking, in these rare cases, the 35 U.S.C. 101 rejection was sustained either because the applicant failed to disclose any utility for the invention or asserted a utility that could only be true if it violated a scientific principle, such as the second law of thermodynamics, or a law of nature, or was wholly inconsistent with contemporary knowledge in the art. *In re Gazave*, 379 F.2d 973, 978, 154 USPQ 92, 96 (CCPA 1967). Special care therefore should be taken when assessing the credibility of an asserted therapeutic utility for a claimed invention. In such cases, a previous lack of success in treating a disease or condition, or the absence of a proven animal model for testing the effectiveness of drugs for treating a disorder in humans, should not, standing alone, serve as a basis for challenging the asserted utility under 35 U.S.C. 101.

#### **IV. INITIAL BURDEN IS ON THE OFFICE TO ESTABLISH A *PRIMA FACIE* CASE AND PROVIDE EVIDENTIARY SUPPORT THEREOF**

To properly reject a claimed invention under 35 U.S.C. 101, the Office must (A) make a *prima*

*facie* showing that the claimed invention lacks utility, and (B) provide a sufficient evidentiary basis for factual assumptions relied upon in establishing the *prima facie* showing. *In re Gaubert*, 524 F.2d 1222, 1224, 187 USPQ 664, 666 (CCPA 1975) (“Accordingly, the PTO must do more than merely question operability - it must set forth factual reasons which would lead one skilled in the art to question the objective truth of the statement of operability.”). If the Office cannot develop a proper *prima facie* case and provide evidentiary support for a rejection under 35 U.S.C. 101, a rejection on this ground should not be imposed. See, e.g., *In re Oetiker*, 977 F.2d 1443, 1445, 24 USPQ2d 1443, 1444 (Fed. Cir. 1992) (“[T]he examiner bears the initial burden, on review of the prior art or on any other ground, of presenting a *prima facie* case of unpatentability. If that burden is met, the burden of coming forward with evidence or argument shifts to the applicant.... If examination at the initial stage does not produce a *prima facie* case of unpatentability, then without more the applicant is entitled to grant of the patent.”). See also *Fregeau v. Mossinghoff*, 776 F.2d 1034, 227 USPQ 848 (Fed. Cir. 1985) (applying *prima facie* case law to 35 U.S.C. 101); *In re Piasecki*, 745 F.2d 1468, 223 USPQ 785 (Fed. Cir. 1984).

The *prima facie* showing must be set forth in a well-reasoned statement. Any rejection based on lack of utility should include a detailed explanation why the claimed invention has no specific and substantial credible utility. Whenever possible, the examiner should provide documentary evidence regardless of publication date (e.g., scientific or technical journals, excerpts from treatises or books, or U.S. or foreign patents) to support the factual basis for the *prima facie* showing of no specific and substantial credible utility. If documentary evidence is not available, the examiner should specifically explain the scientific basis for his or her factual conclusions.

Where the asserted utility is not specific or substantial, a *prima facie* showing must establish that it is more likely than not that a person of ordinary skill in the art would not consider that any utility asserted by the applicant would be specific and substantial. The *prima facie* showing must contain the following elements:

(A) An explanation that clearly sets forth the reasoning used in concluding that the asserted utility for

the claimed invention is neither both specific and substantial nor well-established;

(B) Support for factual findings relied upon in reaching this conclusion; and

(C) An evaluation of all relevant evidence of record, including utilities taught in the closest prior art.

Where the asserted specific and substantial utility is not credible, a *prima facie* showing of no specific and substantial credible utility must establish that it is more likely than not that a person skilled in the art would not consider credible any specific and substantial utility asserted by the applicant for the claimed invention. The *prima facie* showing must contain the following elements:

(A) An explanation that clearly sets forth the reasoning used in concluding that the asserted specific and substantial utility is not credible;

(B) Support for factual findings relied upon in reaching this conclusion; and

(C) An evaluation of all relevant evidence of record, including utilities taught in the closest prior art.

Where no specific and substantial utility is disclosed or is well-established, a *prima facie* showing of no specific and substantial utility need only establish that applicant has not asserted a utility and that, on the record before the examiner, there is no known well-established utility.

It is imperative that Office personnel use specificity in setting forth and initial rejection under 35 U.S.C. 101 and support any factual conclusions made in the *prima facie* showing.

By using specificity, the applicant will be able to identify the assumptions made by the Office in setting forth the rejection and will be able to address those assumptions properly.

## V. EVIDENTIARY REQUESTS BY AN EXAMINER TO SUPPORT AN ASSERTED UTILITY

In appropriate situations the Office may require an applicant to substantiate an asserted utility for a claimed invention. See *In re Pottier*, 376 F.2d 328, 330, 153 USPQ 407, 408 (CCPA 1967) (“When the operativeness of any process would be deemed unlikely by one of ordinary skill in the art, it is not

improper for the examiner to call for evidence of operativeness.”). See also *In re Jolles*, 628 F.2d 1322, 1327, 206 USPQ 885, 890 (CCPA 1980); *In re Citron*, 325 F.2d 248, 139 USPQ 516 (CCPA 1963); *In re Novak*, 306 F.2d 924, 928, 134 USPQ 335, 337 (CCPA 1962). In *In re Citron*, the court held that when an “alleged utility appears to be incredible in the light of the knowledge of the art, or factually misleading, applicant must establish the asserted utility by acceptable proof.” 325 F.2d at 253, 139 USPQ at 520. The court approved of the board’s decision which affirmed the rejection under 35 U.S.C. 101 “in view of the art knowledge of the lack of a cure for cancer and the absence of any clinical data to substantiate the allegation.” 325 F.2d at 252, 139 USPQ at 519 (emphasis in original). The court thus established a higher burden on the applicant where the statement of use is incredible or misleading. In such a case, the examiner should challenge the use and require sufficient evidence of operativeness. The purpose of this authority is to enable an applicant to cure an otherwise defective factual basis for the operability of an invention. Because this is a curative authority (e.g., evidence is requested to enable an applicant to support an assertion that is inconsistent with the facts of record in the application), Office personnel should indicate not only why the factual record is defective in relation to the assertions of the applicant, but also, where appropriate, what type of evidentiary showing can be provided by the applicant to remedy the problem.

Requests for additional evidence should be imposed rarely, and only if necessary to support the scientific credibility of the asserted utility (e.g., if the asserted utility is not consistent with the evidence of record and current scientific knowledge). As the Federal Circuit recently noted, “[o]nly after the PTO provides evidence showing that one of ordinary skill in the art would reasonably doubt the asserted utility does the burden shift to the applicant to provide rebuttal evidence sufficient to convince such a person of the invention’s asserted utility.” *In re Brana*, 51 F.3d 1560, 34 USPQ2d 1436 (Fed. Cir. 1995) (citing *In re Bundy*, 642 F.2d 430, 433, 209 USPQ 48, 51 (CCPA 1981)). In *Brana*, the court pointed out that the purpose of treating cancer with chemical compounds does not suggest, *per se*, an incredible utility. Where the prior art disclosed “structurally similar com-

pounds to those claimed by applicants which have been proven *in vivo* to be effective as chemotherapeutic agents against various tumor models . . . , one skilled in the art would be without basis to reasonably doubt applicants’ asserted utility on its face.” 51 F.3d at 1566, 34 USPQ2d at 1441. As courts have stated, “it is clearly improper for the examiner to make a demand for further test data, which as evidence would be essentially redundant and would seem to serve for nothing except perhaps to unduly burden the applicant.” *In re Isaacs*, 347 F.2d 887, 890, 146 USPQ 193, 196 (CCPA 1965).

## VI. CONSIDERATION OF A REPLY TO A *PRIMA FACIE* REJECTION FOR LACK OF UTILITY

If a rejection under 35 U.S.C. 101 has been properly imposed, along with a corresponding rejection under 35 U.S.C. 112, first paragraph, the burden shifts to the applicant to rebut the *prima facie* showing. *In re Oetiker*, 977 F.2d 1443, 1445, 24 USPQ2d 1443, 1444 (Fed. Cir. 1992) (“The examiner bears the initial burden, on review of the prior art or on any other ground, of presenting a *prima facie* case of unpatentability. If that burden is met, the burden of coming forward with evidence or argument shifts to the applicant. . . . After evidence or argument is submitted by the applicant in response, patentability is determined on the totality of the record, by a preponderance of evidence with due consideration to persuasiveness of argument.”). An applicant can do this using any combination of the following: amendments to the claims, arguments or reasoning, or new evidence submitted in an affidavit or declaration under 37 CFR 1.132, or in a printed publication. New evidence provided by an applicant must be relevant to the issues raised in the rejection. For example, declarations in which conclusions are set forth without establishing a nexus between those conclusions and the supporting evidence, or which merely express opinions, may be of limited probative value with regard to rebutting a *prima facie* case. *In re Grunwell*, 609 F.2d 486, 203 USPQ 1055 (CCPA 1979); *In re Buchner*, 929 F.2d 660, 18 USPQ2d 1331 (Fed. Cir. 1991). See MPEP § 716.01(a) through § 716.01(c).

If the applicant responds to the *prima facie* rejection, Office personnel should review the original disclosure, any evidence relied upon in establishing the *prima facie* showing, any claim amendments, and any new reasoning or evidence provided by the applicant in support of an asserted specific and substantial credible utility. It is essential for Office personnel to recognize, fully consider and respond to each substantive element of any response to a rejection based on lack of utility. Only where the totality of the record continues to show that the asserted utility is not specific, substantial, and credible should a rejection based on lack of utility be maintained. If the record as a whole would make it more likely than not that the asserted utility for the claimed invention would be considered credible by a person of ordinary skill in the art, the Office cannot maintain the rejection. *In re Rinehart*, 531 F.2d 1048, 1052, 189 USPQ 143, 147 (CCPA 1976).

## VII. EVALUATION OF EVIDENCE RELATED TO UTILITY

There is no predetermined amount or character of evidence that must be provided by an applicant to support an asserted utility, therapeutic or otherwise. Rather, the character and amount of evidence needed to support an asserted utility will vary depending on what is claimed (*Ex parte Ferguson*, 117 USPQ 229 (Bd. App. 1957)), and whether the asserted utility appears to contravene established scientific principles and beliefs. *In re Gazave*, 379 F.2d 973, 978, 154 USPQ 92, 96 (CCPA 1967); *In re Chilowsky*, 229 F.2d 457, 462, 108 USPQ 321, 325 (CCPA 1956). Furthermore, the applicant does not have to provide evidence sufficient to establish that an asserted utility is true “beyond a reasonable doubt.” *In re Irons*, 340 F.2d 974, 978, 144 USPQ 351, 354 (CCPA 1965). Nor must an applicant provide evidence such that it establishes an asserted utility as a matter of statistical certainty. *Nelson v. Bowler*, 626 F.2d 853, 856-57, 206 USPQ 881, 883-84 (CCPA 1980) (reversing the Board and rejecting Bowler’s arguments that the evidence of utility was statistically insignificant. The court pointed out that a rigorous correlation is not necessary when the test is reasonably predictive of the response). See also *Rey-Bellet v. Englehardt*, 493 F.2d 1380, 181 USPQ 453 (CCPA 1974) (data from animal

testing is relevant to asserted human therapeutic utility if there is a “satisfactory correlation between the effect on the animal and that ultimately observed in human beings”). Instead, evidence will be sufficient if, considered as a whole, it leads a person of ordinary skill in the art to conclude that the asserted utility is more likely than not true.

### 2107.03 Special Considerations for Asserted Therapeutic or Pharmacological Utilities

The Federal courts have consistently reversed rejections by the Office asserting a lack of utility for inventions claiming a pharmacological or therapeutic utility where an applicant has provided evidence that reasonably supports such a utility. In view of this, Office personnel should be particularly careful in their review of evidence provided in support of an asserted therapeutic or pharmacological utility.

#### I. A REASONABLE CORRELATION BETWEEN THE EVIDENCE AND THE ASSERTED UTILITY IS SUFFICIENT

As a general matter, evidence of pharmacological or other biological activity of a compound will be relevant to an asserted therapeutic use if there is a reasonable correlation between the activity in question and the asserted utility. *Cross v. Iizuka*, 753 F.2d 1040, 224 USPQ 739 (Fed. Cir. 1985); *In re Jolles*, 628 F.2d 1322, 206 USPQ 885 (CCPA 1980); *Nelson v. Bowler*, 626 F.2d 853, 206 USPQ 881 (CCPA 1980). An applicant can establish this reasonable correlation by relying on statistically relevant data documenting the activity of a compound or composition, arguments or reasoning, documentary evidence (e.g., articles in scientific journals), or any combination thereof. The applicant does not have to prove that a correlation exists between a particular activity and an asserted therapeutic use of a compound as a matter of statistical certainty, nor does he or she have to provide actual evidence of success in treating humans where such a utility is asserted. Instead, as the courts have repeatedly held, all that is required is a reasonable correlation between the activity and the asserted use. *Nelson v. Bowler*, 626 F.2d 853, 857, 206 USPQ 881, 884 (CCPA 1980).

## II. STRUCTURAL SIMILARITY TO COMPOUNDS WITH ESTABLISHED UTILITY

Courts have routinely found evidence of structural similarity to a compound known to have a particular therapeutic or pharmacological utility as being supportive of an assertion of therapeutic utility for a new compound. In *In re Jolles*, 628 F.2d 1322, 206 USPQ 885 (CCPA 1980), the claimed compounds were found to have utility based on a finding of a close structural relationship to daunorubicin and doxorubicin and shared pharmacological activity with those compounds, both of which were known to be useful in cancer chemotherapy. The evidence of close structural similarity with the known compounds was presented in conjunction with evidence demonstrating substantial activity of the claimed compounds in animals customarily employed for screening anti-cancer agents. Such evidence should be given appropriate weight in determining whether one skilled in the art would find the asserted utility credible. Office personnel should evaluate not only the existence of the structural relationship, but also the reasoning used by the applicant or a declarant to explain why that structural similarity is believed to be relevant to the applicant's assertion of utility.

## III. DATA FROM *IN VITRO* OR ANIMAL TESTING IS GENERALLY SUFFICIENT TO SUPPORT THERAPEUTIC UTILITY

If reasonably correlated to the particular therapeutic or pharmacological utility, data generated using *in vitro* assays, or from testing in an animal model or a combination thereof almost invariably will be sufficient to establish therapeutic or pharmacological utility for a compound, composition or process. A cursory review of cases involving therapeutic inventions where 35 U.S.C. 101 was the dispositive issue illustrates the fact that the Federal courts are not particularly receptive to rejections under 35 U.S.C. 101 based on inoperability. Most striking is the fact that in those cases where an applicant supplied a reasonable evidentiary showing supporting an asserted therapeutic utility, almost uniformly the 35 U.S.C. 101-based rejection was reversed. See, e.g., *In re Brana*, 51 F.3d 1560, 34 USPQ 1436 (Fed. Cir. 1995); *Cross v. Iizuka*, 753 F.2d 1040, 224 USPQ 739 (Fed. Cir. 1985); *In re Jolles*, 628 F.2d 1322, 206 USPQ 885 (CCPA 1980); *Nelson v. Bowler*, 626 F.2d 853, 856, 206 USPQ 881,

883 (CCPA 1980); *In re Malachowski*, 530 F.2d 1402, 189 USPQ 432 (CCPA 1976); *In re Gaubert*, 530 F.2d 1402, 189 USPQ 432 (CCPA 1975); *In re Gazave*, 379 F.2d 973, 154 USPQ 92 (CCPA 1967); *In re Hartop*, 311 F.2d 249, 135 USPQ 419 (CCPA 1962); *In re Krimmel*, 292 F.2d 948, 130 USPQ 215 (CCPA 1961). Only in those cases where the applicant was unable to come forward with any relevant evidence to rebut a finding by the Office that the claimed invention was inoperative was a 35 U.S.C. 101 rejection affirmed by the court. *In re Citron*, 325 F.2d 248, 253, 139 USPQ 516, 520 (CCPA 1963) (therapeutic utility for an uncharacterized biological extract not supported or scientifically credible); *In re Buting*, 418 F.2d 540, 543, 163 USPQ 689, 690 (CCPA 1969) (record did not establish a credible basis for the assertion that the single class of compounds in question would be useful in treating disparate types of cancers); *In re Novak*, 306 F.2d 924, 134 USPQ 335 (CCPA 1962) (claimed compounds did not have capacity to effect physiological activity upon which utility claim based). Contrast, however, *In re Buting* to *In re Gardner*, 475 F.2d 1389, 177 USPQ 396 (CCPA 1973), *reh'g denied*, 480 F.2d 879 (CCPA 1973), in which the court held that utility for a genus was found to be supported through a showing of utility for one species. In no case has a Federal court required an applicant to support an asserted utility with data from human clinical trials.

If an applicant provides data, whether from *in vitro* assays or animal tests or both, to support an asserted utility, and an explanation of why that data supports the asserted utility, the Office will determine if the data and the explanation would be viewed by one skilled in the art as being reasonably predictive of the asserted utility. See, e.g., *Ex parte Maas*, 9 USPQ2d 1746 (Bd. Pat. App. & Inter. 1987); *Ex parte Balzarini*, 21 USPQ2d 1892 (Bd. Pat. App. & Inter. 1991). Office personnel must be careful to evaluate all factors that might influence the conclusions of a person of ordinary skill in the art as to this question, including the test parameters, choice of animal, relationship of the activity to the particular disorder to be treated, characteristics of the compound or composition, relative significance of the data provided and, most importantly, the explanation offered by the applicant as to why the information provided is believed to support the asserted utility. If the data

supplied is consistent with the asserted utility, the Office cannot maintain a rejection under 35 U.S.C. 101.

Evidence does not have to be in the form of data from an art-recognized animal model for the particular disease or disease condition to which the asserted utility relates. Data from any test that the applicant reasonably correlates to the asserted utility should be evaluated substantively. Thus, an applicant may provide data generated using a particular animal model with an appropriate explanation as to why that data supports the asserted utility. The absence of a certification that the test in question is an industry-accepted model is not dispositive of whether data from an animal model is in fact relevant to the asserted utility. Thus, if one skilled in the art would accept the animal tests as being reasonably predictive of utility in humans, evidence from those tests should be considered sufficient to support the credibility of the asserted utility. *In re Hartop*, 311 F.2d 249, 135 USPQ 419 (CCPA 1962); *In re Krimmel*, 292 F.2d 948, 953, 130 USPQ 215, 219 (CCPA 1961); *Ex parte Krepelka*, 231 USPQ 746 (Bd. Pat. App. & Inter. 1986). Office personnel should be careful not to find evidence unpersuasive simply because no animal model for the human disease condition had been established prior to the filing of the application. See *In re Chilowsky*, 229 F.2d 457, 461, 108 USPQ 321, 325 (CCPA 1956) (“The mere fact that something has not previously been done clearly is not, in itself, a sufficient basis for rejecting all applications purporting to disclose how to do it.”); *In re Wooddy*, 331 F.2d 636, 639, 141 USPQ 518, 520 (CCPA 1964) (“It appears that no one on earth is certain as of the present whether the process claimed will operate in the manner claimed. Yet absolute certainty is not required by the law. The mere fact that something has not previously been done clearly is not, in itself, a sufficient basis for rejecting all applications purporting to disclose how to do it.”).

#### IV. HUMAN CLINICAL DATA

Office personnel should not impose on applicants the unnecessary burden of providing evidence from human clinical trials. There is no decisional law that requires an applicant to provide data from human clinical trials to establish utility for an invention related to treatment of human disorders (see *In re*

*Isaacs*, 347 F.2d 889, 146 USPQ 193 (CCPA 1963); *In re Langer*, 503 F.2d 1380, 183 USPQ 288 (CCPA 1974)), even with respect to situations where no art-recognized animal models existed for the human disease encompassed by the claims. *Ex parte Balzarini*, 21 USPQ2d 1892 (Bd. Pat. App. & Inter. 1991) (human clinical data is not required to demonstrate the utility of the claimed invention, even though those skilled in the art might not accept other evidence to establish the efficacy of the claimed therapeutic compositions and the operativeness of the claimed methods of treating humans). Before a drug can enter human clinical trials, the sponsor, often the applicant, must provide a convincing rationale to those especially skilled in the art (e.g., the Food and Drug Administration) that the investigation may be successful. Such a rationale would provide a basis for the sponsor’s expectation that the investigation may be successful. In order to determine a protocol for phase I testing, the first phase of clinical investigation, some credible rationale of how the drug might be effective or could be effective would be necessary. Thus, as a general rule, if an applicant has initiated human clinical trials for a therapeutic product or process, Office personnel should presume that the applicant has established that the subject matter of that trial is reasonably predictive of having the asserted therapeutic utility.

#### V. SAFETY AND EFFICACY CONSIDERATIONS

The Office must confine its review of patent applications to the statutory requirements of the patent law. Other agencies of the government have been assigned the responsibility of ensuring conformance to standards established by statute for the advertisement, use, sale or distribution of drugs. The FDA pursues a two-prong test to provide approval for testing. Under that test, a sponsor must show that the investigation does not pose an unreasonable and significant risk of illness or injury and that there is an acceptable rationale for the study. As a review matter, there must be a rationale for believing that the compound could be effective. If the use reviewed by the FDA is not set forth in the specification, FDA review may not satisfy 35 U.S.C. 101. However, if the reviewed use is one set forth in the specification, Office personnel must be extremely hesitant to challenge utility. In such a



situation, experts at the FDA have assessed the rationale for the drug or research study upon which an asserted utility is based and found it satisfactory. Thus, in challenging utility, Office personnel must be able to carry their burden that there is no sound rationale for the asserted utility even though experts designated by Congress to decide the issue have come to an opposite conclusion. “FDA approval, however, is not a prerequisite for finding a compound useful within the meaning of the patent laws.” *In re Brana*, 51 F.3d 1560, 34 USPQ2d 1436 (Fed. Cir. 1995) (citing *Scott v. Finney*, 34 F.3d 1058, 1063, 32 USPQ2d 1115, 1120 (Fed. Cir. 1994)).

Thus, while an applicant may on occasion need to provide evidence to show that an invention will work as claimed, it is improper for Office personnel to request evidence of safety in the treatment of humans, or regarding the degree of effectiveness. See *In re Sichert*, 566 F.2d 1154, 196 USPQ 209 (CCPA 1977); *In re Hartop*, 311 F.2d 249, 135 USPQ 419 (CCPA 1962); *In re Anthony*, 414 F.2d 1383, 162 USPQ 594 (CCPA 1969); *In re Watson*, 517 F.2d 465, 186 USPQ 11 (CCPA 1975); *In re Krimmel*, 292 F.2d 948, 130 USPQ 215 (CCPA 1961); *Ex parte Jovanovics*, 211 USPQ 907 (Bd. Pat. App. & Inter. 1981).

## VI. TREATMENT OF SPECIFIC DISEASE CONDITIONS

Claims directed to a method of treating or curing a disease for which there have been no previously successful treatments or cures warrant careful review for compliance with 35 U.S.C. 101. The credibility of an asserted utility for treating a human disorder may be more difficult to establish where current scientific understanding suggests that such a task would be impossible. Such a determination has always required a good understanding of the state of the art as of the time that the invention was made. For example, prior to the 1980’s, there were a number of cases where an asserted use in treating cancer in humans was viewed as “incredible.” *In re Jolles*, 628 F.2d 1322, 206 USPQ 885 (CCPA 1980); *In re Buting*, 418 F.2d 540, 163 USPQ 689 (CCPA 1969); *Ex parte Stevens*, 16 USPQ2d 1379 (Bd. Pat. App. & Inter. 1990); *Ex parte Busse*, 1 USPQ2d 1908 (Bd. Pat. App. & Inter. 1986); *Ex parte Krepelka*, 231 USPQ 746 (Bd. Pat. App. & Inter. 1986); *Ex parte Jovanovics*, 211 USPQ 907 (Bd. Pat. App. & Inter. 1981). The fact that there

is no known cure for a disease, however, cannot serve as the basis for a conclusion that such an invention lacks utility. Rather, Office personnel must determine if the asserted utility for the invention is credible based on the information disclosed in the application. Only those claims for which an asserted utility is not credible should be rejected. In such cases, the Office should carefully review what is being claimed by the applicant. An assertion that the claimed invention is useful in treating a symptom of an incurable disease may be considered credible by a person of ordinary skill in the art on the basis of a fairly modest amount of evidence or support. In contrast, an assertion that the claimed invention will be useful in “curing” the disease may require a significantly greater amount of evidentiary support to be considered credible by a person of ordinary skill in the art. *In re Sichert*, 566 F.2d 1154, 196 USPQ 209 (CCPA 1977); *In re Jolles*, 628 F.2d 1322, 206 USPQ 885 (CCPA 1980). See also *Ex parte Ferguson*, 117 USPQ 229 (Bd. Pat. App. & Inter. 1957).

In these cases, it is important to note that the Food and Drug Administration has promulgated regulations that enable a party to conduct clinical trials for drugs used to treat life threatening and severely-debilitating illnesses, even where no alternative therapy exists. See 21 CFR 312.80-88 (1994). Implicit in these regulations is the recognition that experts qualified to evaluate the effectiveness of therapeutics can and often do find a sufficient basis to conduct clinical trials of drugs for incurable or previously untreatable illnesses. Thus, affidavit evidence from experts in the art indicating that there is a reasonable expectation of success, supported by sound reasoning, usually should be sufficient to establish that such a utility is credible.

### 2111 Claim Interpretation; Broadest Reasonable Interpretation [R-1]

#### CLAIMS MUST BE GIVEN THEIR BROADEST REASONABLE INTERPRETATION

During patent examination, the pending claims must be “given \*>their< broadest reasonable interpretation consistent with the specification.” >*In re Hyatt*, 211 F.3d 1367, 1372, 54 USPQ2d 1664, 1667 (Fed. Cir. 2000).< Applicant always has the opportunity to amend the claims during prosecution, and broad interpretation by the examiner reduces the possibility that

the claim, once issued, will be interpreted more broadly than is justified. *In re Prater*, 415 F.2d 1393, 1404-05, 162 USPQ 541, 550-51 (CCPA 1969) (Claim 9 was directed to a process of analyzing data generated by mass spectrographic analysis of a gas. The process comprised selecting the data to be analyzed by subjecting the data to a mathematical manipulation. The examiner made rejections under 35 U.S.C. 101 and 102. In the 35 U.S.C. 102 rejection, the examiner explained that the claim was anticipated by a mental process augmented by pencil and paper markings. The court agreed that the claim was not limited to using a machine to carry out the process since the claim did not explicitly set forth the machine. The court explained that “reading a claim in light of the specification, to thereby interpret limitations explicitly recited in the claim, is a quite different thing from ‘reading limitations of the specification into a claim,’ to thereby narrow the scope of the claim by implicitly adding disclosed limitations which have no express basis in the claim.” The court found that applicant was advocating the latter, i.e., the impermissible importation of subject matter from the specification into the claim.). See also *In re Morris*, 127 F.3d 1048, 1054-55, 44 USPQ2d 1023, 1027-28 (Fed. Cir. 1997) (The court held that the PTO is not required, in the course of prosecution, to interpret claims in applications in the same manner as a court would interpret claims in an infringement suit. Rather, the “PTO applies to verbiage of the proposed claims the broadest reasonable meaning of the words in their ordinary usage as they would be understood by one of ordinary skill in the art, taking into account whatever enlightenment by way of definitions or otherwise that may be afforded by the written description contained in applicant’s specification.”).

The broadest reasonable interpretation of the claims must also be consistent with the interpretation that those skilled in the art would reach. *In re Cortright*, 165 F.3d 1353, 1359, 49 USPQ2d 1464, 1468 (Fed. Cir. 1999) (The Board’s construction of the claim limitation “restore hair growth” as requiring the hair to be returned to its original state was held to be an \*\*>incorrect< interpretation of the limitation. The court held that, consistent with applicant’s disclosure and the disclosure of three patents from analogous arts using the same phrase to require only some increase in hair growth, one of ordinary skill would construe

“restore hair growth” to mean that the claimed method increases the amount of hair grown on the scalp, but does not necessarily produce a full head of hair.).

### 2111.01 Plain Meaning [R-2]

>

#### I. <THE WORDS OF A CLAIM MUST BE GIVEN THEIR “PLAIN MEANING” UNLESS THEY ARE DEFINED IN THE SPECIFICATION

While the claims of issued patents are interpreted in light of the specification, prosecution history, prior art and other claims, this is not the mode of claim interpretation to be applied during examination. During examination, the claims must be interpreted as broadly as their terms reasonably allow. >*In re American Academy of Science Tech Center*, \_\_\_ F.3d \_\_\_, 2004 WL 1067528 (Fed. Cir. May 13, 2004)(The USPTO uses a different standard for construing claims than that used by district courts; during examination the USPTO must give claims their broadest reasonable interpretation.)< This means that the words of the claim must be given their plain meaning unless applicant has provided a clear definition in the specification. *In re Zletz*, 893 F.2d 319, 321, 13 USPQ2d 1320, 1322 (Fed. Cir. 1989) (discussed below)\*\*>; *Chef America, Inc. v. Lamb-Weston, Inc.*, 358 F.3d 1371, 1372, 69 USPQ2d 1857 (Fed. Cir. 2004) (Ordinary, simple English words whose meaning is clear and unquestionable, absent any indication that their use in a particular context changes their meaning, are construed to mean exactly what they say. Thus, “heating the resulting batter-coated dough to a temperature in the range of about 400°F to 850°F” required heating the dough, rather than the air inside an oven, to the specified temperature.)< One must bear in mind that, especially in nonchemical cases, the words in a claim are generally not limited in their meaning by what is shown or disclosed in the specification. >See, e.g., *Liebel-Flarsheim Co. v. Medrad Inc.*, 358 F.3d 898, 906, 69 USPQ2d 1801, 1807 (Fed. Cir. 2004)(discussing recent cases wherein the court expressly rejected the contention that if a patent describes only a single embodiment, the claims of the patent must be construed as being limited to that embodiment.)< It is only when the specification

provides definitions for terms appearing in the claims that the specification can be used in interpreting claim language. *In re Vogel*, 422 F.2d 438, 441, 164 USPQ 619, 622 (CCPA 1970). >See also *Superguide Corp. v. DirecTV Enterprises, Inc.*, 358 F.3d 870, 875, 69 USPQ2d 1865, 1868 (Fed. Cir. 2004) (“Though understanding the claim language may be aided by explanations contained in the written description, it is important not to import into a claim limitations that are not part of the claim. For example, a particular embodiment appearing in the written description may not be read into a claim when the claim language is broader than the embodiment.”); *E-Pass Techs., Inc. v. 3Com Corp.*, 343 F.3d 1364, 1369, 67 USPQ2d 1947, 1950 (Fed. Cir. 2003) (“Interpretation of descriptive statements in a patent’s written description is a difficult task, as an inherent tension exists as to whether a statement is a clear lexicographic definition or a description of a preferred embodiment. The problem is to interpret claims ‘in view of the specification’ without unnecessarily importing limitations from the specification into the claims.”); *Altiris Inc. v. Symantec Corp.*, 318 F.3d 1363, 1371, 65 USPQ2d 1865, 1869-70 (Fed. Cir. 2003) (Although the specification discussed only a single embodiment, the court held that it was improper to read a specific order of steps into method claims where, as a matter of logic or grammar, the language of the method claims did not impose a specific order on the performance of the method steps, and the specification did not directly or implicitly require a particular order). See also paragraph III., below.< There is one exception, and that is when an element is claimed using language falling under the scope of 35 U.S.C. 112, 6th paragraph (often broadly referred to as means or step plus function language). In that case, the specification must be consulted to determine the structure, material, or acts corresponding to the function recited in the claim. *In re Donaldson*, 16 F.3d 1189, 29 USPQ2d 1845 (Fed. Cir. 1994) (see MPEP § 2181- § 2186).

In *In re Zletz, supra*, the examiner and the Board had interpreted claims reading “normally solid polypropylene” and “normally solid polypropylene having a crystalline polypropylene content” as being limited to “normally solid linear high homopolymers of propylene which have a crystalline polypropylene content.” The court ruled that limitations, not present in the claims, were improperly imported from the

specification. See also *In re Marosi*, 710 F.2d 799, 218 USPQ 289 (Fed. Cir. 1983) (“Claims are not to be read in a vacuum, and limitations therein are to be interpreted in light of the specification in giving them their ‘broadest reasonable interpretation’.” 710 F.2d at 802, 218 USPQ at 292 (quoting *In re Okuzawa*, 537 F.2d 545, 548, 190 USPQ 464, 466 (CCPA 1976)) (emphasis in original). The court looked to the specification to construe “essentially free of alkali metal” as including unavoidable levels of impurities but no more.). Compare *In re Weiss*, 989 F.2d 1202, 26 USPQ2d 1885 (Fed. Cir. 1993) (unpublished decision - cannot be cited as precedent) (The claim related to an athletic shoe with cleats that “break away at a preselected level of force” and thus prevent injury to the wearer. The examiner rejected the claims over prior art teaching athletic shoes with cleats not intended to break off and rationalized that the cleats would break away given a high enough force. The court reversed the rejection stating that when interpreting a claim term which is ambiguous, such as “a preselected level of force”, we must look to the specification for the meaning ascribed to that term by the inventor.” The specification had defined “preselected level of force” as that level of force at which the breaking away will prevent injury to the wearer during athletic exertion. It should be noted that the limitation was part of a means plus function element.)

>

## II. <“PLAIN MEANING” REFERS TO THE >ORDINARY AND CUSTOMARY< MEANING GIVEN TO THE TERM BY THOSE OF ORDINARY SKILL IN THE ART

\*\*>Claim terms are presumed to have the ordinary and customary meanings attributed to them by those of ordinary skill in the art. *Sunrace Roots Enter. Co. v. SRAM Corp.*, 336 F.3d 1298, 1302, 67 USPQ2d 1438, 1441 (Fed. Cir. 2003); *Brookhill-Wilk I, LLC v. Intuitive Surgical, Inc.*, 334 F.3d 1294, 1298 67 USPQ2d 1132, 1136 (Fed. Cir. 2003)(“In the absence of an express intent to impart a novel meaning to the claim terms, the words are presumed to take on the ordinary and customary meanings attributed to them by those of ordinary skill in the art.”). It is the use of the words in the context of the written description and customarily by those skilled in the relevant art that accurately

reflects both the “ordinary” and the “customary” meaning of the terms in the claims. *Ferguson Beauregard/Logic Controls v. Mega Systems*, 350 F.3d 1327, 1338, 69 USPQ2d 1001, 1009 (Fed. Cir. 2003) (Dictionary definitions were used to determine the ordinary and customary meaning of the words “normal” and “predetermine” to those skilled in the art. In construing claim terms, the general meanings gleaned from reference sources, such as dictionaries, must always be compared against the use of the terms in context, and the intrinsic record must always be consulted to identify which of the different possible dictionary meanings is most consistent with the use of the words by the inventor.); *ACTV, Inc. v. The Walt Disney Company*, 346 F.3d 1082, 1092, 68 USPQ2d 1516, 1524 (Fed. Cir. 2003) (Since there was no definition given for the term “URL” in the specification, the term should be given its broadest reasonable interpretation and take on the ordinary and customary meaning attributed to it by those of ordinary skill in the art; thus, the term “URL” was held to encompass both relative and absolute URLs.); and *E-Pass Technologies, Inc. v. 3Com Corporation*, 343 F.3d 1364, 1368, 67 USPQ2d 1947, 1949 (Fed. Cir. 2003) (Where no explicit definition for the term “electronic multi-function card” was given in the specification, this term should be given its ordinary meaning and broadest reasonable interpretation; the term should not be limited to the industry standard definition of credit card where there is no suggestion that this definition applies to the electronic multi-function card as claimed, and should not be limited to preferred embodiments in the specification.).

The ordinary and customary meaning of a term may be evidenced by a variety of sources, *Brookhill-Wilk I, LLC v. Intuitive Surgical, Inc.*, 334 F.3d 1294, 1298, 67 USPQ2d 1132, 1136 (Fed. Cir. 2003), including: the claims themselves, *Process Control Corp. v. HydReclaim Corp.*, 190 F.3d 1350, 1357, 52 USPQ2d 1029, 1033 (Fed. Cir. 1999); dictionaries and treatises, *Tex. Digital Sys., Inc. v. Telegenix, Inc.*, 308 F.3d 1193, 1202, 64 USPQ2d 1812, 1818 (Fed. Cir. 2002); and the written description, the drawings, and the prosecution history, see, e.g., *DeMarini Sports, Inc. v. Worth, Inc.*, 239 F.3d 1314, 1324, 57 USPQ2d 1889, 1894 (Fed. Cir. 2001). If extrinsic reference sources, such as dictionaries, evidence more than one definition for the term, the intrinsic record must be con-

sulted to identify which of the different possible definitions is most consistent with applicant’s use of the terms. *Brookhill-Wilk I*, 334 F. 3d at 1300, 67 USPQ2d at 1137; see also *Renishaw PLC v. Marposs Societa’ per Azioni*, 158 F.3d 1243, 1250, 48 USPQ2d 1117, 1122 (Fed. Cir. 1998) (“Where there are several common meanings for a claim term, the patent disclosure serves to point away from the improper meanings and toward the proper meanings.”). If more than one extrinsic definition is consistent with the use of the words in the intrinsic record, the claim terms may be construed to encompass all consistent meanings. *Tex. Digital*, 308 F.3d at 1203, 64 USPQ2d at 1819. See also *Rexnord Corp. v. Laitram Corp.*, 274 F.3d 1336, 1342, 60 USPQ2d 1851, 1854 (Fed. Cir. 2001)(explaining the court’s analytical process for determining the meaning of disputed claim terms); *Toro Co. v. White Consol. Indus., Inc.*, 199 F.3d 1295, 1299, 53 USPQ2d 1065, 1067 (Fed. Cir. 1999)(“[W]ords in patent claims are given their ordinary meaning in the usage of the field of the invention, unless the text of the patent makes clear that a word was used with a special meaning.”). \*->Compare *MSM Investments Co. v. Carolwood Corp.*, 259 F.3d 1335, 1339-40, 59 USPQ2d 1856, 1859-60 (Fed. Cir. 2001) (Claims directed to a method of feeding an animal a beneficial amount of methylsulfonylmethane (MSM) to enhance the animal’s diet were held anticipated by prior oral administration of MSM to human patients to relieve pain. Although the ordinary meaning of “feeding” is limited to provision of food or nourishment, the broad definition of “food” in the written description warranted finding that the claimed method encompasses the use of MSM for both nutritional and pharmacological purposes.); and *Rapoport v. Dement*, 254 F.3d 1053, 1059-60, 59 USPQ2d 1215, 1219-20 (Fed. Cir. 2001) (Both intrinsic evidence and the plain meaning of the term “method for treatment of sleep apneas” supported construction of the term as being limited to treatment of the underlying sleep apnea disorder itself, and not encompassing treatment of anxiety and other secondary symptoms related to sleep apnea.).

Furthermore, the specification must be reviewed to determine “whether the presumption of ordinary and customary meaning is rebutted.” *Tex. Digital*, 308 F.3d at 1204. “The presumption will be overcome where the patentee, acting as his own lexicographer,

has set forth a definition for the term different from its ordinary and customary meaning or where the patentee has disavowed or disclaimed scope of coverage, by using words or expressions of manifest exclusion or restriction, representing a clear disavowal of claim scope.” *International Rectifier Corp. v. IXYS Corp.*, 361 F.3d 1363, 1368, 70 USPQ2d 1209, 1214 (Fed. Cir. 2004). See also paragraph III., below.

### III. <APPLICANT MAY BE OWN LEXICOGRAPHER

\*\*>An applicant is entitled to be his or her own lexicographer and may rebut the presumption that claim terms are to be given their ordinary and customary meaning by clearly setting forth a definition of the term that is different from its ordinary and customary meaning(s). See *In re Paulsen*, 30 F.3d 1475, 1480, 31 USPQ2d 1671, 1674 (Fed. Cir. 1994) (inventor may define specific terms used to describe invention, but must do so “with reasonable clarity, deliberateness, and precision” and, if done, must “set out his uncommon definition in some manner within the patent disclosure’ so as to give one of ordinary skill in the art notice of the change” in meaning) (quoting *Intellicall, Inc. v. Phonometrics, Inc.*, 952 F.2d 1384, 1387-88, 21 USPQ2d 1383, 1386 (Fed. Cir. 1992)). Where an explicit definition is provided by the applicant for a term, that definition will control interpretation of the term as it is used in the claim. *Toro Co. v. White Consolidated Industries Inc.*, 199 F.3d 1295, 1301, 53 USPQ2d 1065, 1069 (Fed. Cir. 1999) (meaning of words used in a claim is not construed in a “lexicographic vacuum, but in the context of the specification and drawings”). Any< special meaning assigned to a term “must be sufficiently clear in the specification that any departure from common usage would be so understood by a person of experience in the field of the invention.” *Multiform Desiccants Inc. v. Medzam Ltd.*, 133 F.3d 1473, 1477, 45 USPQ2d 1429, 1432 (Fed. Cir. 1998). See also *Process Control Corp. v. HydReclaim Corp.*, 190 F.3d 1350, 1357, 52 USPQ2d 1029, 1033 (Fed. Cir. 1999) and MPEP § 2173.05(a).

### 2111.02 Effect of Preamble [R-2]

The determination of whether a preamble limits a claim is made on a case-by-case basis in light of the facts in each case; there is no litmus test defining when a preamble limits the scope of a claim. *Catalina*

*Mktg. Int’l v. Coolsavings.com, Inc.*, 289 F.3d 801, 808, 62 USPQ2d 1781, 1785 (Fed. Cir. 2002). See *id.* at 808-10, 62 USPQ2d at 1784-86 for a discussion of guideposts that have emerged from various decisions exploring the preamble’s effect on claim scope, as well as a hypothetical example illustrating these principles.

“[A] claim preamble has the import that the claim as a whole suggests for it.” *Bell Communications Research, Inc. v. Vitalink Communications Corp.*, 55 F.3d 615, 620, 34 USPQ2d 1816, 1820 (Fed. Cir. 1995). “If the claim preamble, when read in the context of the entire claim, recites limitations of the claim, or, if the claim preamble is ‘necessary to give life, meaning, and vitality’ to the claim, then the claim preamble should be construed as if in the balance of the claim.” *Pitney Bowes, Inc. v. Hewlett-Packard Co.*, 182 F.3d 1298, 1305, 51 USPQ2d 1161, 1165-66 (Fed. Cir. 1999). See also >*Jansen v. Rexall Sundown, Inc.*, 342 F.3d 1329, 1333, 68 USPQ2d 1154, 1158 (Fed. Cir. 2003)(In considering the effect of the preamble in a claim directed to a method of treating or preventing pernicious anemia in humans by administering a certain vitamin preparation to “a human in need thereof,” the court held that the claims’ recitation of a patient or a human “in need” gives life and meaning to the preamble’s statement of purpose.)< *Kropa v. Robie*, 187 F.2d 150, 152, 88 USPQ 478, 481 (CCPA 1951) (A preamble reciting “An abrasive article” was deemed essential to point out the invention defined by claims to an article comprising abrasive grains and a hardened binder and the process of making it. The court stated “it is only by that phrase that it can be known that the subject matter defined by the claims is comprised as an abrasive article. Every union of substances capable *inter alia* of use as abrasive grains and a binder is not an ‘abrasive article.’” Therefore, the preamble served to further define the structure of the article produced.)

### PREAMBLE STATEMENTS LIMITING STRUCTURE

Any terminology in the preamble that limits the structure of the claimed invention must be treated as a claim limitation. See, e.g., *Corning Glass Works v. Sumitomo Elec. U.S.A., Inc.*, 868 F.2d 1251, 1257, 9 USPQ2d 1962, 1966 (Fed. Cir. 1989) (The determination of whether preamble recitations are structural

limitations can be resolved only on review of the entirety of the application “to gain an understanding of what the inventors actually invented and intended to encompass by the claim.”); *Pac-Tec Inc. v. Amerace Corp.*, 903 F.2d 796, 801, 14 USPQ2d 1871, 1876 (Fed. Cir. 1990) (determining that preamble language that constitutes a structural limitation is actually part of the claimed invention). See also *In re Stencel*, 828 F.2d 751, 4 USPQ2d 1071 (Fed. Cir. 1987). (The claim at issue was directed to a driver for setting a joint of a threaded collar, however the body of the claim did not directly include the structure of the collar as part of the claimed article. The examiner did not consider the preamble, which did set forth the structure of the collar, as limiting the claim. The court found that the collar structure could not be ignored. While the claim was not directly limited to the collar, the collar structure recited in the preamble did limit the structure of the driver. “[T]he framework - the teachings of the prior art - against which patentability is measured is not all drivers broadly, but drivers suitable for use in combination with this collar, for the claims are so limited.” *Id.* at 1073, 828 F.2d at 754.)

#### **PREAMBLE STATEMENTS RECITING PURPOSE OR INTENDED USE**

The claim preamble must be read in the context of the entire claim. The determination of whether preamble recitations are structural limitations or mere statements of purpose or use “can be resolved only on review of the entirety of the [record] to gain an understanding of what the inventors actually invented and intended to encompass by the claim.” *Corning Glass Works*, 868 F.2d at 1257, 9 USPQ2d at 1966. If the body of a claim fully and intrinsically sets forth all of the limitations of the claimed invention, and the preamble merely states, for example, the purpose or intended use of the invention, rather than any distinct definition of any of the claimed invention’s limitations, then the preamble is not considered a limitation and is of no significance to claim construction. *Pitney Bowes, Inc. v. Hewlett-Packard Co.*, 182 F.3d 1298, 1305, 51 USPQ2d 1161, 1165 (Fed. Cir. 1999). See also *Rowe v. Dror*, 112 F.3d 473, 478, 42 USPQ2d 1550, 1553 (Fed. Cir. 1997) (“where a patentee defines a structurally complete invention in the claim body and uses the preamble only to state a purpose or intended use for the invention, the preamble is not a

claim limitation”); *Kropa v. Robie*, 187 F.2d at 152, 88 USPQ2d at 480-81 (preamble is not a limitation where claim is directed to a product and the preamble merely recites a property inherent in an old product defined by the remainder of the claim); *STX LLC v. Brine*, 211 F.3d 588, 591, 54 USPQ2d 1347, 1350 (Fed. Cir. 2000) (holding that the preamble phrase “which provides improved playing and handling characteristics” in a claim drawn to a head for a lacrosse stick was not a claim limitation). Compare *Jansen v. Rexall Sundown, Inc.*, 342 F.3d 1329, 1333-34, 68 USPQ2d 1154, 1158 (Fed. Cir. 2003) (In a claim directed to a method of treating or preventing pernicious anemia in humans by administering a certain vitamin preparation to “a human in need thereof,” the court held that the preamble is not merely a statement of effect that may or may not be desired or appreciated, but rather is a statement of the intentional purpose for which the method must be performed. Thus the claim is properly interpreted to mean that the vitamin preparation must be administered to a human with a recognized need to treat or prevent pernicious anemia.); *In re Cruciferous Sprout Litig.*, 301 F.3d 1343, 1346-48, 64 USPQ2d 1202, 1204-05 (Fed. Cir. 2002) (A claim at issue was directed to a method of preparing a food rich in glucosinolates wherein cruciferous sprouts are harvested prior to the 2-leaf stage. The court held that the preamble phrase “rich in glucosinolates” helps define the claimed invention, as evidenced by the specification and prosecution history, and thus is a limitation of the claim (although the claim was anticipated by prior art that produced sprouts inherently “rich in glucosinolates”).)

During examination, statements in the preamble reciting the purpose or intended use of the claimed invention must be evaluated to determine whether the recited purpose or intended use results in a structural difference (or, in the case of process claims, manipulative difference) between the claimed invention and the prior art. If so, the recitation serves to limit the claim. See, e.g., *In re Otto*, 312 F.2d 937, 938, 136 USPQ 458, 459 (CCPA 1963) (The claims were directed to a core member for hair curlers and a process of making a core member for hair curlers. Court held that the intended use of hair curling was of no significance to the structure and process of making.); *In re Sinex*, 309 F.2d 488, 492, 135 USPQ 302, 305 (CCPA 1962) (statement of intended use in an

apparatus claim did not distinguish over the prior art apparatus). If a prior art structure is capable of performing the intended use as recited in the preamble, then it meets the claim. See, e.g., *In re Schreiber*, 128 F.3d 1473, 1477, 44 USPQ2d 1429, 1431 (Fed. Cir. 1997) (anticipation rejection affirmed based on Board's factual finding that the reference dispenser (a spout disclosed as useful for purposes such as dispensing oil from an oil can) would be capable of dispensing popcorn in the manner set forth in appellant's claim 1 (a dispensing top for dispensing popcorn in a specified manner)) and cases cited therein. See also MPEP § 2112 - § 2112.02.

### 2111.03 Transitional Phrases [R-2]

The transitional phrases “comprising”, “consisting essentially of” and “consisting of” define the scope of a claim with respect to what unrecited additional components or steps, if any, are excluded from the scope of the claim.

The transitional term “comprising”, which is synonymous with “including,” “containing,” or “characterized by,” is inclusive or open-ended and does not exclude additional, unrecited elements or method steps. See, e.g., *>Invitrogen Corp. v. Biocrest Mfg., L.P.*, 327 F.3d 1364, 1368, 66 USPQ2d 1631, 1634 (Fed. Cir. 2003) (“The transition ‘comprising’ in a method claim indicates that the claim is open-ended and allows for additional steps.”); *< Genentech, Inc. v. Chiron Corp.*, 112 F.3d 495, 501, 42 USPQ2d 1608, 1613 (Fed. Cir. 1997) (“Comprising” is a term of art used in claim language which means that the named elements are essential, but other elements may be added and still form a construct within the scope of the claim.); *Moleculon Research Corp. v. CBS, Inc.*, 793 F.2d 1261, 229 USPQ 805 (Fed. Cir. 1986); *In re Baxter*, 656 F.2d 679, 686, 210 USPQ 795, 803 (CCPA 1981); *Ex parte Davis*, 80 USPQ 448, 450 (Bd. App. 1948) (“comprising” leaves “the claim open for the inclusion of unspecified ingredients even in major amounts”).

The transitional phrase “consisting of” excludes any element, step, or ingredient not specified in the claim. *In re Gray*, 53 F.2d 520, 11 USPQ 255 (CCPA 1931); *Ex parte Davis*, 80 USPQ 448, 450 (Bd. App. 1948) (“consisting of” defined as “closing the claim to the inclusion of materials other than those recited except for impurities ordinarily associated there-

with.”). *>But see Norian Corp. v. Stryker Corp.*, 363 F.3d 1321, 1331-32, 70 USPQ2d 1508, 1516 (Fed. Cir. 2004) (holding that a bone repair kit “consisting of” claimed chemicals was infringed by a bone repair kit including a spatula in addition to the claimed chemicals because the presence of the spatula was unrelated to the claimed invention).*< A claim which depends from a claim which “consists of” the recited elements or steps cannot add an element or step. When the phrase “consists of” appears in a clause of the body of a claim, rather than immediately following the preamble, it limits only the element set forth in that clause; other elements are not excluded from the claim as a whole. Mannesmann Demag Corp. v. Engineered Metal Products Co.*, 793 F.2d 1279, 230 USPQ 45 (Fed. Cir. 1986).

The transitional phrase “consisting essentially of” limits the scope of a claim to the specified materials or steps “and those that do not materially affect the basic and novel characteristic(s)” of the claimed invention. *In re Herz*, 537 F.2d 549, 551-52, 190 USPQ 461, 463 (CCPA 1976) (emphasis in original) (Prior art hydraulic fluid required a dispersant which appellants argued was excluded from claims limited to a functional fluid “consisting essentially of” certain components. In finding the claims did not exclude the prior art dispersant, the court noted that appellants’ specification indicated the claimed composition can contain any well-known additive such as a dispersant, and there was no evidence that the presence of a dispersant would materially affect the basic and novel characteristic of the claimed invention. The prior art composition had the same basic and novel characteristic (increased oxidation resistance) as well as additional enhanced detergent and dispersant characteristics.). “A ‘consisting essentially of’ claim occupies a middle ground between closed claims that are written in a ‘consisting of’ format and fully open claims that are drafted in a ‘comprising’ format.” *PPG Industries v. Guardian Industries*, 156 F.3d 1351, 1354, 48 USPQ2d 1351, 1353-54 (Fed. Cir. 1998). See also *Atlas Powder v. E.I. duPont de Nemours & Co.*, 750 F.2d 1569, 224 USPQ 409 (Fed. Cir. 1984); *In re Janakirama-Rao*, 317 F.2d 951, 137 USPQ 893 (CCPA 1963); *Water Technologies Corp. vs. Calco, Ltd.*, 850 F.2d 660, 7 USPQ2d 1097 (Fed. Cir. 1988). For the purposes of searching for and applying prior art under 35 U.S.C. 102 and 103,

absent a clear indication in the specification or claims of what the basic and novel characteristics actually are, “consisting essentially of” will be construed as equivalent to “comprising.” See, e.g., *PPG*, 156 F.3d at 1355, 48 USPQ2d at 1355 (“PPG could have defined the scope of the phrase ‘consisting essentially of’ for purposes of its patent by making clear in its specification what it regarded as constituting a material change in the basic and novel characteristics of the invention.”). See also *AK Steel Corp. v. Sollac*, 344 F.3d 1234, 1240-41, 68 USPQ2d 1280, 1283-84 (Fed. Cir. 2003) (Applicant’s statement in the specification that “silicon contents in the coating metal should not exceed about 0.5% by weight” along with a discussion of the deleterious effects of silicon provided basis to conclude that silicon in excess of 0.5% by weight would materially alter the basic and novel properties of the invention. Thus, “consisting essentially of” as recited in the preamble was interpreted to permit no more than 0.5% by weight of silicon in the aluminum coating.); *In re Janakirama-Rao*, 317 F.2d 951, 954, 137 USPQ 893, 895-96 (CCPA 1963). If an applicant contends that additional steps or materials in the prior art are excluded by the recitation of “consisting essentially of,” applicant has the burden of showing that the introduction of additional steps or components would materially change the characteristics of applicant’s invention. *In re De Lajarte*, 337 F.2d 870, 143 USPQ 256 (CCPA 1964). See also *Ex parte Hoffman*, 12 USPQ2d 1061, 1063-64 (Bd. Pat. App. & Inter. 1989) (“Although ‘consisting essentially of’ is typically used and defined in the context of compositions of matter, we find nothing intrinsically wrong with the use of such language as a modifier of method steps. . . [rendering] the claim open only for the inclusion of steps which do not materially affect the basic and novel characteristics of the claimed method. To determine the steps included versus excluded the claim must be read in light of the specification. . . . [I]t is an applicant’s burden to establish that a step practiced in a prior art method is excluded from his claims by ‘consisting essentially of’ language.”).

#### OTHER TRANSITIONAL PHRASES

Transitional phrases such as “having” must be interpreted in light of the specification to determine

whether open or closed claim language is intended. See, e.g., *Lampi Corp. v. American Power Products Inc.*, 228 F.3d 1365, 1376, 56 USPQ2d 1445, 1453 (Fed. Cir. 2000) (The term “having” was interpreted as open terminology, allowing the inclusion of other components in addition to those recited); *Crystal Semiconductor Corp. v. TriTech Microelectronics Int’l Inc.*, 246 F.3d 1336, 1348, 57 USPQ2d 1953, 1959 (Fed. Cir. 2001) (term “having” in transitional phrase “does not create a presumption that the body of the claim is open”); *Regents of the Univ. of Cal. v. Eli Lilly & Co.*, 119 F.3d 1559, 1573, 43 USPQ2d 1398, 1410 (Fed. Cir. 1997) (In the context of a cDNA having a sequence coding for human PI, the term “having” still permitted inclusion of other moieties.). The transitional phrase “composed of” has been interpreted in the same manner as either “consisting of” or “consisting essentially of,” depending on the facts of the particular case. See *AFG Industries, Inc. v. Cardinal IG Company*, 239 F.3d 1239, 1245, 57 USPQ2d 1776, 1780-81 (Fed. Cir. 2001) (based on specification and other evidence, “composed of” interpreted in same manner as “consisting essentially of”); *In re Bertsch*, 132 F.2d 1014, 1019-20, 56 USPQ 379, 384 (CCPA 1942) (“Composed of” interpreted in same manner as “consisting of”; however, court further remarked that “the words ‘composed of’ may under certain circumstances be given, in patent law, a broader meaning than ‘consisting of.’”).

#### 2112 Requirements of Rejection Based on Inherency; Burden of Proof [R-2]

The express, implicit, and inherent disclosures of a prior art reference may be relied upon in the rejection of claims under 35 U.S.C. 102 or 103. “The inherent teaching of a prior art reference, a question of fact, arises both in the context of anticipation and obviousness.” *In re Napier*, 55 F.3d 610, 613, 34 USPQ2d 1782, 1784 (Fed. Cir. 1995) (affirmed a 35 U.S.C. 103 rejection based in part on inherent disclosure in one of the references). See also *In re Grasselli*, 713 F.2d 731, 739, 218 USPQ 769, 775 (Fed. Cir. 1983).



&gt;

### **I. <SOMETHING WHICH IS OLD DOES NOT BECOME PATENTABLE UPON THE DISCOVERY OF A NEW PROPERTY**

\*> “[T]he discovery of a previously unappreciated property of a prior art composition, or of a scientific explanation for the prior art’s functioning, does not render the old composition patentably new to the discoverer.” *Atlas Powder Co. v. Ireco Inc.*, 190 F.3d 1342, 1347, 51 USPQ2d 1943, 1947 (Fed. Cir. 1999). Thus the < claiming of a new use, new function or unknown property which is inherently present in the prior art does not necessarily make the claim patentable. *In re Best*, 562 F.2d 1252, 1254, 195 USPQ 430, 433 (CCPA 1977). See also MPEP § 2112.01 with regard to inherency and product-by-process claims and MPEP § 2141.02 with regard to inherency and rejections under 35 U.S.C. 103.

&gt;

### **II. INHERENT FEATURE NEED NOT BE RECOGNIZED AT THE TIME OF THE INVENTION**

There is no requirement that a person of ordinary skill in the art would have recognized the inherent disclosure *at the time of invention*, but only that the subject matter is in fact inherent in the prior art reference. *Schering Corp. v. Geneva Pharm. Inc.*, 339 F.3d 1373, 1377, 67 USPQ2d 1664, 1668 (Fed. Cir. 2003) (rejecting the contention that inherent anticipation requires recognition by a person of ordinary skill in the art before the critical date and allowing expert testimony with respect to post-critical date clinical trials to show inherency); see also *Toro Co. v. Deere & Co.*, 355 F.3d 1313, 1320, 69 USPQ2d 1584, 1590 (Fed. Cir. 2004) (“[T]he fact that a characteristic is a necessary feature or result of a prior-art embodiment (that is itself sufficiently described and enabled) is enough for inherent anticipation, even if that fact was unknown at the time of the prior invention.”); *Abbott Labs v. Geneva Pharms., Inc.*, 182 F.3d 1315, 1319, 51 USPQ2d 1307, 1310 (Fed. Cir. 1999) (“If a product that is offered for sale inherently possesses each of the limitations of the claims, then the invention is on sale, whether or not the parties to the transaction recognize that the product possesses the claimed characteristics.”); *Atlas Powder Co. v. Ireco, Inc.*, 190 F.3d 1342,

1348-49 (Fed. Cir. 1999) (“Because ‘sufficient aeration’ was inherent in the prior art, it is irrelevant that the prior art did not recognize the key aspect of [the] invention.... An inherent structure, composition, or function is not necessarily known.”).

### **III. <A REJECTION UNDER 35 U.S.C. 102/103 CAN BE MADE WHEN THE PRIOR ART PRODUCT SEEMS TO BE IDENTICAL EXCEPT THAT THE PRIOR ART IS SILLENT AS TO AN INHERENT CHARACTERISTIC**

Where applicant claims a composition in terms of a function, property or characteristic and the composition of the prior art is the same as that of the claim but the function is not explicitly disclosed by the reference, the examiner may make a rejection under both 35 U.S.C. 102 and 103, expressed as a 102/103 rejection. “There is nothing inconsistent in concurrent rejections for obviousness under 35 U.S.C. 103 and for anticipation under 35 U.S.C. 102.” *In re Best*, 562 F.2d 1252, 1255 n.4, 195 USPQ 430, 433 n.4 (CCPA 1977). This same rationale should also apply to product, apparatus, and process claims claimed in terms of function, property or characteristic. Therefore, a 35 U.S.C. 102/103 rejection is appropriate for these types of claims as well as for composition claims.

&gt;

### **IV. <EXAMINER MUST PROVIDE RATIONALE OR EVIDENCE TENDING TO SHOW INHERENCY**

The fact that a certain result or characteristic may occur or be present in the prior art is not sufficient to establish the inherency of that result or characteristic. *In re Rijckaert*, 9 F.3d 1531, 1534, 28 USPQ2d 1955, 1957 (Fed. Cir. 1993) (reversed rejection because inherency was based on what would result due to optimization of conditions, not what was necessarily present in the prior art); *In re Oelrich*, 666 F.2d 578, 581-82, 212 USPQ 323, 326 (CCPA 1981). “To establish inherency, the extrinsic evidence ‘must make clear that the missing descriptive matter is necessarily present in the thing described in the reference, and that it would be so recognized by persons of ordinary skill. Inherency, however, may not be established by probabilities or possibilities. The mere fact that a

certain thing may result from a given set of circumstances is not sufficient.’ ” *In re Robertson*, 169 F.3d 743, 745, 49 USPQ2d 1949, 1950-51 (Fed. Cir. 1999) (citations omitted) (The claims were drawn to a disposable diaper having three fastening elements. The reference disclosed two fastening elements that could perform the same function as the three fastening elements in the claims. The court construed the claims to require three separate elements and held that the reference did not disclose a separate third fastening element, either expressly or inherently.).

“In relying upon the theory of inherency, the examiner must provide a basis in fact and/or technical reasoning to reasonably support the determination that the allegedly inherent characteristic necessarily flows from the teachings of the applied prior art.” *Ex parte Levy*, 17 USPQ2d 1461, 1464 (Bd. Pat. App. & Inter. 1990) (emphasis in original) (Applicant’s invention was directed to a biaxially oriented, flexible dilation catheter balloon (a tube which expands upon inflation) used, for example, in clearing the blood vessels of heart patients). The examiner applied a U.S. patent to Schjeldahl which disclosed injection molding a tubular preform and then injecting air into the preform to expand it against a mold (blow molding). The reference did not directly state that the end product balloon was biaxially oriented. It did disclose that the balloon was “formed from a thin flexible inelastic, high tensile strength, biaxially oriented synthetic plastic material.” *Id.* at 1462 (emphasis in original). The examiner argued that Schjeldahl’s balloon was inherently biaxially oriented. The Board reversed on the basis that the examiner did not provide objective evidence or cogent technical reasoning to support the conclusion of inherency.).

In *In re Schreiber*, 128 F.3d 1473, 44 USPQ2d 1429 (Fed. Cir. 1997), the court affirmed a finding that a prior patent to a conical spout used primarily to dispense oil from an oil can inherently performed the functions recited in applicant’s claim to a conical container top for dispensing popped popcorn. The examiner had asserted inherency based on the structural similarity between the patented spout and applicant’s disclosed top, i.e., both structures had the same general shape. The court stated:

[N]othing in Schreiber’s [applicant’s] claim suggests that Schreiber’s container is of a ‘different shape’ than Harz’s [patent]. In fact, [ ] an embodiment according to Harz

(Fig. 5) and the embodiment depicted in Fig. 1 of Schreiber’s application have the same general shape. For that reason, the examiner was justified in concluding that the opening of a conically shaped top as disclosed by Harz is inherently of a size sufficient to ‘allow [ ] several kernels of popped popcorn to pass through at the same time’ and that the taper of Harz’s conically shaped top is inherently of such a shape ‘as to by itself jam up the popped popcorn before the end of the cone and permit the dispensing of only a few kernels at a shake of a package when the top is mounted to the container.’ The examiner therefore correctly found that Harz established a *prima facie* case of anticipation.

*In re Schreiber*, 128 F.3d at 1478, 44 USPQ2d at 1432.

>

**V. <ONCE A REFERENCE TEACHING PRODUCT APPEARING TO BE SUBSTANTIALLY IDENTICAL IS MADE THE BASIS OF A REJECTION, AND THE EXAMINER PRESENTS EVIDENCE OR REASONING TENDING TO SHOW INHERENCY, THE BURDEN SHIFTS TO THE APPLICANT TO SHOW AN UNOBVIOUS DIFFERENCE**

“[T]he PTO can require an applicant to prove that the prior art products do not necessarily or inherently possess the characteristics of his [or her] claimed product. Whether the rejection is based on ‘inherency’ under 35 U.S.C. 102, on ‘*prima facie* obviousness’ under 35 U.S.C. 103, jointly or alternatively, the burden of proof is the same...[footnote omitted].” The burden of proof is similar to that required with respect to product-by-process claims. *In re Fitzgerald*, 619 F.2d 67, 70, 205 USPQ 594, 596 (CCPA 1980) (quoting *In re Best*, 562 F.2d 1252, 1255, 195 USPQ 430, 433-34 (CCPA 1977)).

In *In re Fitzgerald*, the claims were directed to a self-locking screw-threaded fastener comprising a metallic threaded fastener having patches of crystallizable thermoplastic bonded thereto. The claim further specified that the thermoplastic had a reduced degree of crystallization shrinkage. The specification disclosed that the locking fastener was made by heating the metal fastener to melt a thermoplastic blank which is pressed against the metal. After the thermoplastic adheres to the metal fastener, the end product is cooled by quenching in water. The examiner made a rejection based on a U.S. patent to Barnes. Barnes

taught a self-locking fastener in which the patch of thermoplastic was made by depositing thermoplastic powder on a metallic fastener which was then heated. The end product was cooled in ambient air, by cooling air or by contacting the fastener with a water trough. The court first noted that the two fasteners were identical or only slightly different from each other. “Both fasteners possess the same utility, employ the same crystallizable polymer (nylon 11), and have an adherent plastic patch formed by melting and then cooling the polymer.” *Id.* at 596 n.1, 619 F.2d at 70 n.1. The court then noted that the Board had found that Barnes’ cooling rate could reasonably be expected to result in a polymer possessing the claimed crystallization shrinkage rate. Applicants had not rebutted this finding with evidence that the shrinkage rate was indeed different. They had only argued that the crystallization shrinkage rate was dependent on the cool down rate and that the cool down rate of Barnes was much slower than theirs. Because a difference in the cool down rate does not necessarily result in a difference in shrinkage, objective evidence was required to rebut the 35 U.S.C. 102/103 *prima facie* case.

In *In re Schreiber*, 128 F.3d 1473, 1478, 44 USPQ2d 1429, 1432 (Fed.Cir.1997), the court held that applicant’s declaration failed to overcome a *prima facie* case of anticipation because the declaration did not specify the dimensions of either the dispensing top that was tested or the popcorn that was used. Applicant’s declaration merely asserted that a conical dispensing top built according to a figure in the prior art patent was too small to jam and dispense popcorn and thus could not inherently perform the functions recited in applicant’s claims. The court pointed out the disclosure of the prior art patent was not limited to use as an oil can dispenser, but rather was broader than the precise configuration shown in the patent’s figure. The court also noted that the Board of Patent Appeals and Interferences found as a factual matter that a scaled-up version of the top disclosed in the patent would be capable of performing the functions recited in applicant’s claim.

See MPEP § 2113 for more information on the analogous burden of proof applied to product-by-process claims.

## 2112.01 Composition, Product, and Apparatus Claims [R-2]

>

### I. <PRODUCT AND APPARATUS CLAIMS — WHEN THE STRUCTURE RECITED IN THE REFERENCE IS SUBSTANTIALLY IDENTICAL TO THAT OF THE CLAIMS, CLAIMED PROPERTIES OR FUNCTIONS ARE PRESUMED TO BE INHERENT

Where the claimed and prior art products are identical or substantially identical in structure or composition, or are produced by identical or substantially identical processes, a *prima facie* case of either anticipation or obviousness has been established. *In re Best*, 562 F.2d 1252, 1255, 195 USPQ 430, 433 (CCPA 1977). “When the PTO shows a sound basis for believing that the products of the applicant and the prior art are the same, the applicant has the burden of showing that they are not.” *In re Spada*, 911 F.2d 705, 709, 15 USPQ2d 1655, 1658 (Fed. Cir. 1990). Therefore, the *prima facie* case can be rebutted by evidence showing that the prior art products do not necessarily possess the characteristics of the claimed product. *In re Best*, 562 F.2d at 1255, 195 USPQ at 433. See also *Titanium Metals Corp. v. Banner*, 778 F.2d 775, 227 USPQ 773 (Fed. Cir. 1985) (Claims were directed to a titanium alloy containing 0.2-0.4% Mo and 0.6-0.9% Ni having corrosion resistance. A Russian article disclosed a titanium alloy containing 0.25% Mo and 0.75% Ni but was silent as to corrosion resistance. The Federal Circuit held that the claim was anticipated because the percentages of Mo and Ni were squarely within the claimed ranges. The court went on to say that it was immaterial what properties the alloys had or who discovered the properties because the composition is the same and thus must necessarily exhibit the properties.).

See also *In re Ludtke*, 441 F.2d 660, 169 USPQ 563 (CCPA 1971) (Claim 1 was directed to a parachute canopy having concentric circumferential panels radially separated from each other by radially extending tie lines. The panels were separated “such that the critical velocity of each successively larger panel will be less than the critical velocity of the previous panel, whereby said parachute will sequentially open and

thus gradually decelerate.” The court found that the claim was anticipated by Menget. Menget taught a parachute having three circumferential panels separated by tie lines. The court upheld the rejection finding that applicant had failed to show that Menget did not possess the functional characteristics of the claims.); *Northam Warren Corp. v. D. F. Newfield Co.*, 7 F. Supp. 773, 22 USPQ 313 (E.D.N.Y. 1934) (A patent to a pencil for cleaning fingernails was held invalid because a pencil of the same structure for writing was found in the prior art.).

&gt;

## II. <COMPOSITION CLAIMS — IF THE COMPOSITION IS PHYSICALLY THE SAME, IT MUST HAVE THE SAME PROPERTIES

“Products of identical chemical composition can not have mutually exclusive properties.” A chemical composition and its properties are inseparable. Therefore, if the prior art teaches the identical chemical structure, the properties applicant discloses and/or claims are necessarily present. *In re Spada*, 911 F.2d 705, 709, 15 USPQ2d 1655, 1658 (Fed. Cir. 1990) (Applicant argued that the claimed composition was a pressure sensitive adhesive containing a tacky polymer while the product of the reference was hard and abrasion resistant. “The Board correctly found that the virtual identity of monomers and procedures sufficed to support a *prima facie* case of unpatentability of Spada’s polymer latexes for lack of novelty.”).

&gt;

## III. PRODUCT CLAIMS – NONFUNCTIONAL PRINTED MATTER DOES NOT DISTINGUISH CLAIMED PRODUCT FROM OTHERWISE IDENTICAL PRIOR ART PRODUCT

Where the only difference between a prior art product and a claimed product is printed matter that is not functionally related to the product, the content of the printed matter will not distinguish the claimed product from the prior art. *In re Ngai*, \_\_\_ F.3d \_\_\_, 2004 WL 1068957 (Fed. Cir. May 13, 2004) (Claim at issue was a kit requiring instructions and a buffer agent. The Federal Circuit held that the claim was anticipated by a prior art reference that taught a kit that included instructions and a buffer agent, even though

the content of the instructions differed.). See also *In re Gulack*, 703 F.2d 1381, 1385-86, 217 USPQ 401, 404 (Fed. Cir. 1983) (“Where the printed matter is not functionally related to the substrate, the printed matter will not distinguish the invention from the prior art in terms of patentability....[T]he critical question is whether there exists any new and unobvious functional relationship between the printed matter and the substrate.”).<

## 2112.02 Process Claims

### PROCESS CLAIMS — PRIOR ART DEVICE ANTICIPATES A CLAIMED PROCESS IF THE DEVICE CARRIES OUT THE PROCESS DURING NORMAL OPERATION

Under the principles of inherency, if a prior art device, in its normal and usual operation, would necessarily perform the method claimed, then the method claimed will be considered to be anticipated by the prior art device. When the prior art device is the same as a device described in the specification for carrying out the claimed method, it can be assumed the device will inherently perform the claimed process. *In re King*, 801 F.2d 1324, 231 USPQ 136 (Fed. Cir. 1986) (The claims were directed to a method of enhancing color effects produced by ambient light through a process of absorption and reflection of the light off a coated substrate. A prior art reference to *Donley* disclosed a glass substrate coated with silver and metal oxide 200-800 angstroms thick. While *Donley* disclosed using the coated substrate to produce architectural colors, the absorption and reflection mechanisms of the claimed process were not disclosed. However, *King*’s specification disclosed using a coated substrate of *Donley*’s structure for use in his process. The Federal Circuit upheld the Board’s finding that “*Donley* inherently performs the function disclosed in the method claims on appeal when that device is used in ‘normal and usual operation’ ” and found that a *prima facie* case of anticipation was made out. *Id.* at 138, 801 F.2d at 1326. It was up to applicant to prove that *Donley*’s structure would not perform the claimed method when placed in ambient light.). See also *In re Best*, 562 F.2d 1252, 1255, 195 USPQ 430, 433 (CCPA 1977) (Applicant claimed a process for preparing a hydrolytically-stable zeolitic aluminosilicate which included a step of “cooling the steam zeolite ...

at a rate sufficiently rapid that the cooled zeolite exhibits a X-ray diffraction pattern ....” All the process limitations were expressly disclosed by a U.S. patent to Hansford except the cooling step. The court stated that any sample of Hansford’s zeolite would necessarily be cooled to facilitate subsequent handling. Therefore, a *prima facie* case under 35 U.S.C. 102/103 was made. Applicant had failed to introduce any evidence comparing X-ray diffraction patterns showing a difference in cooling rate between the claimed process and that of Hansford or any data showing that the process of Hansford would result in a product with a different X-ray diffraction. Either type of evidence would have rebutted the *prima facie* case under 35 U.S.C. 102. A further analysis would be necessary to determine if the process was unobvious under 35 U.S.C. 103.); *Ex parte Novitski*, 26 USPQ2d 1389 (Bd. Pat. App. & Inter. 1993) (The Board rejected a claim directed to a method for protecting a plant from plant pathogenic nematodes by inoculating the plant with a nematode inhibiting strain of *P. cepacia*. A U.S. patent to *Dart* disclosed inoculation using *P. cepacia* type Wisconsin 526 bacteria for protecting the plant from fungal disease. *Dart* was silent as to nematode inhibition but the Board concluded that nematode inhibition was an inherent property of the bacteria. The Board noted that applicant had stated in the specification that Wisconsin 526 possesses an 18% nematode inhibition rating.).

### **PROCESS OF USE CLAIMS — NEW AND UN-OBVIOUS USES OF OLD STRUCTURES AND COMPOSITIONS MAY BE PATENTABLE**

The discovery of a new use for an old structure based on unknown properties of the structure might be patentable to the discoverer as a process of using. *In re Hack*, 245 F.2d 246, 248, 114 USPQ 161, 163 (CCPA 1957). However, when the claim recites using an old composition or structure and the “use” is directed to a result or property of that composition or structure, then the claim is anticipated. *In re May*, 574 F.2d 1082, 1090, 197 USPQ 601, 607 (CCPA 1978) (Claims 1 and 6, directed to a method of effecting nonaddictive analgesia (pain reduction) in animals, were found to be anticipated by the applied prior art which disclosed the same compounds for effecting analgesia but which was silent as to addiction. The court upheld the rejection and stated that the

applicants had merely found a new property of the compound and such a discovery did not constitute a new use. The court went on to reverse the rejection of claims 2-5 and 7-10 which recited a process of using a new compound. The court relied on evidence showing that the nonaddictive property of the new compound was unexpected.). See also *In re Tomlinson*, 363 F.2d 928, 150 USPQ 623 (CCPA 1966) (The claim was directed to a process of inhibiting light degradation of polypropylene by mixing it with one of a genus of compounds, including nickel dithiocarbamate. A reference taught mixing polypropylene with nickel dithiocarbamate to lower heat degradation. The court held that the claims read on the obvious process of mixing polypropylene with the nickel dithiocarbamate and that the preamble of the claim was merely directed to the result of mixing the two materials. “While the references do not show a specific recognition of that result, its discovery by appellants is tantamount only to finding a property in the old composition.” 363 F.2d at 934, 150 USPQ at 628 (emphasis in original).).

### **2113 Product-by-Process Claims [R-1]**

#### **PRODUCT-BY-PROCESS CLAIMS ARE NOT LIMITED TO THE MANIPULATIONS OF THE RECITED STEPS, ONLY THE STRUCTURE IMPLIED BY THE STEPS**

“[E]ven though product-by-process claims are limited by and defined by the process, determination of patentability is based on the product itself. The patentability of a product does not depend on its method of production. If the product in the product-by-process claim is the same as or obvious from a product of the prior art, the claim is unpatentable even though the prior product was made by a different process.” *In re Thorpe*, 777 F.2d 695, 698, 227 USPQ 964, 966 (Fed. Cir. 1985) (citations omitted) (Claim was directed to a novolac color developer. The process of making the developer was allowed. The difference between the inventive process and the prior art was the addition of metal oxide and carboxylic acid as separate ingredients instead of adding the more expensive pre-reacted metal carboxylate. The product-by-process claim was rejected because the end product, in both the prior art and the allowed process, ends up containing metal carboxylate. The fact that the metal carboxylate is not

directly added, but is instead produced in-situ does not change the end product.).

>The structure implied by the process steps should be considered when assessing the patentability of product-by-process claims over the prior art, especially where the product can only be defined by the process steps by which the product is made, or where the manufacturing process steps would be expected to impart distinctive structural characteristics to the final product. See, e.g., *In re Garnero*, 412 F.2d 276, 279, 162 USPQ 221, 223 (CCPA 1979) (holding “interbonded by interfusion” to limit structure of the claimed composite and noting that terms such as “welded,” “intermixed,” “ground in place,” “press fitted,” and “etched” are capable of construction as structural limitations.)<

#### **ONCE A PRODUCT APPEARING TO BE SUBSTANTIALLY IDENTICAL IS FOUND AND A 35 U.S.C. 102/103 REJECTION MADE, THE BURDEN SHIFTS TO THE APPLICANT TO SHOW AN UNOBTAINABLE DIFFERENCE**

“The Patent Office bears a lesser burden of proof in making out a case of *prima facie* obviousness for product-by-process claims because of their peculiar nature” than when a product is claimed in the conventional fashion. *In re Fessmann*, 489 F.2d 742, 744, 180 USPQ 324, 326 (CCPA 1974). Once the examiner provides a rationale tending to show that the claimed product appears to be the same or similar to that of the prior art, although produced by a different process, the burden shifts to applicant to come forward with evidence establishing an unobvious difference between the claimed product and the prior art product. *In re Marosi*, 710 F.2d 798, 802, 218 USPQ 289, 292 (Fed. Cir. 1983) (The claims were directed to a zeolite manufactured by mixing together various inorganic materials in solution and heating the resultant gel to form a crystalline metal silicate essentially free of alkali metal. The prior art described a process of making a zeolite which, after ion exchange to remove alkali metal, appeared to be “essentially free of alkali metal.” The court upheld the rejection because the applicant had not come forward with any evidence that the prior art was not “essentially free of alkali

metal” and therefore a different and unobvious product.).

*Ex parte Gray*, 10 USPQ2d 1922 (Bd. Pat. App. & Inter. 1989) (The prior art disclosed human nerve growth factor (b-NGF) isolated from human placental tissue. The claim was directed to b-NGF produced through genetic engineering techniques. The factor produced seemed to be substantially the same whether isolated from tissue or produced through genetic engineering. While the applicant questioned the purity of the prior art factor, no concrete evidence of an unobvious difference was presented. The Board stated that the dispositive issue is whether the claimed factor exhibits any unexpected properties compared with the factor disclosed by the prior art. The Board further stated that the applicant should have made some comparison between the two factors to establish unexpected properties since the materials appeared to be identical or only slightly different.).

#### **THE USE OF 35 U.S.C. 102/103 REJECTIONS FOR PRODUCT-BY-PROCESS CLAIMS HAS BEEN APPROVED BY THE COURTS**

“[T]he lack of physical description in a product-by-process claim makes determination of the patentability of the claim more difficult, since in spite of the fact that the claim may recite only process limitations, it is the patentability of the product claimed and not of the recited process steps which must be established. We are therefore of the opinion that when the prior art discloses a product which reasonably appears to be either identical with or only slightly different than a product claimed in a product-by-process claim, a rejection based alternatively on either section 102 or section 103 of the statute is eminently fair and acceptable. As a practical matter, the Patent Office is not equipped to manufacture products by the myriad of processes put before it and then obtain prior art products and make physical comparisons therewith.” *In re Brown*, 459 F.2d 531, 535, 173 USPQ 685, 688 (CCPA 1972).

#### **2114 Apparatus and Article Claims — Functional Language [R-1]**

For a discussion of case law which provides guidance in interpreting the functional portion of means-plus-function limitations see MPEP § 2181 - § 2186.

### APPARATUS CLAIMS MUST BE STRUCTURALLY DISTINGUISHABLE FROM THE PRIOR ART

>While features of an apparatus may be recited either structurally or functionally, claims< directed to >an< apparatus must be distinguished from the prior art in terms of structure rather than function. >*In re Schreiber*, 128 F.3d 1473, 1477-78, 44 USPQ2d 1429, 1431-32 (Fed. Cir. 1997) (The absence of a disclosure in a prior art reference relating to function did not defeat the Board’s finding of anticipation of claimed apparatus because the limitations at issue were found to be inherent in the prior art reference); see also *In re Swinehart*, 439 F.2d 210, 212-13, 169 USPQ 226, 228-29 (CCPA 1971);< *In re Danly*, 263 F.2d 844, 847, 120 USPQ 528, 531 (CCPA 1959). “[A]pparatus claims cover what a device *is*, not what a device *does*.” *Hewlett-Packard Co. v. Bausch & Lomb Inc.*, 909 F.2d 1464, 1469, 15 USPQ2d 1525, 1528 (Fed. Cir. 1990) (emphasis in original).

### MANNER OF OPERATING THE DEVICE DOES NOT DIFFERENTIATE APPARATUS CLAIM FROM THE PRIOR ART

A claim containing a “recitation with respect to the manner in which a claimed apparatus is intended to be employed does not differentiate the claimed apparatus from a prior art apparatus” if the prior art apparatus teaches all the structural limitations of the claim. *Ex parte Masham*, 2 USPQ2d 1647 (Bd. Pat. App. & Inter. 1987) (The preamble of claim 1 recited that the apparatus was “for mixing flowing developer material” and the body of the claim recited “means for mixing ..., said mixing means being stationary and completely submerged in the developer material”. The claim was rejected over a reference which taught all the structural limitations of the claim for the intended use of mixing flowing developer. However, the mixer was only partially submerged in the developer material. The Board held that the amount of submersion is immaterial to the structure of the mixer and thus the claim was properly rejected.).

### A PRIOR ART DEVICE CAN PERFORM ALL THE FUNCTIONS OF THE APPARATUS CLAIM AND STILL NOT ANTICIPATE THE CLAIM

Even if the prior art device performs all the functions recited in the claim, the prior art cannot anticipate the claim if there is any structural difference. It should be noted, however, that means plus function limitations are met by structures which are equivalent to the corresponding structures recited in the specification. *In re Ruskin*, 347 F.2d 843, 146 USPQ 211 (CCPA 1965) as implicitly modified by *In re Donaldson*, 16 F.3d 1189, 29 USPQ2d 1845 (Fed. Cir. 1994). See also *In re Robertson*, 169 F.3d 743, 745, 49 USPQ2d 1949, 1951 (Fed. Cir. 1999) (The claims were drawn to a disposable diaper having three fastening elements. The reference disclosed two fastening elements that could perform the same function as the three fastening elements in the claims. The court construed the claims to require three separate elements and held that the reference did not disclose a separate third fastening element, either expressly or inherently.).

### 2115 Material or Article Worked Upon by Apparatus [R-2]

#### MATERIAL OR ARTICLE WORKED UPON DOES NOT LIMIT APPARATUS CLAIMS

“Expressions relating the apparatus to contents thereof during an intended operation are of no significance in determining patentability of the apparatus claim.” *Ex parte Thibault*, 164 USPQ 666, 667 (Bd. App. 1969). Furthermore, “[i]nclusion of material or article worked upon by a structure being claimed does not impart patentability to the claims.” *In re Young*, 75 F.2d \*996<, 25 USPQ 69 (CCPA 1935) (as restated in *In re Otto*, 312 F.2d 937, 136 USPQ 458, 459 (CCPA 1963)).

In *In re Young*, a claim to a machine for making concrete beams included a limitation to the concrete reinforced members made by the machine as well as the structural elements of the machine itself. The court held that the inclusion of the article formed within the body of the claim did not, without more, make the claim patentable.

In *In re Casey*, 370 F.2d 576, 152 USPQ 235 (CCPA 1967), an apparatus claim recited “[a] taping machine comprising a supporting structure, a brush

attached to said supporting structure, said brush being formed with projecting bristles which terminate in free ends to collectively define a surface to which adhesive tape will detachably adhere, and means for providing relative motion between said brush and said supporting structure while said adhesive tape is adhered to said surface.” An obviousness rejection was made over a reference to Kienzle which taught a machine for perforating sheets. The court upheld the rejection stating that “the references in claim 1 to adhesive tape handling do not expressly or impliedly require any particular structure in addition to that of Kienzle.” The perforating device had the structure of the taping device as claimed, the difference was in the use of the device, and “the manner or method in which such machine is to be utilized is not germane to the issue of patentability of the machine itself.”

Note that this line of cases is limited to claims directed to machinery which works upon an article or material in its intended use. It does not apply to product claims or kit claims (i.e., claims directed to a plurality of articles grouped together as a kit).

## 2116 Material Manipulated in Process

The materials on which a process is carried out must be accorded weight in determining the patentability of a process. *Ex parte Leonard*, 187 USPQ 122 (Bd. App. 1974).

### 2116.01 Novel, Unobvious Starting Material or End Product [R-2]

All the limitations of a claim must be considered when weighing the differences between the claimed invention and the prior art in determining the obviousness of a process or method claim. See MPEP § 2143.03.

*In re Ochiai*, 71 F.3d 1565, 37 USPQ2d 1127 (Fed. Cir. 1995) and *In re Brouwer*, 77 F.3d 422, 37 USPQ2d 1663 (Fed. Cir. 1996) addressed the issue of whether an otherwise conventional process could be patented if it were limited to making or using a nonobvious product. In both cases, the Federal Circuit held that the use of *per se* rules is improper in applying the test for obviousness under 35 U.S.C. 103. Rather, 35 U.S.C. 103 requires a highly fact-dependent analysis involving taking the claimed subject matter as a whole and comparing it to the prior art.

>“A process yielding a novel and nonobvious product may nonetheless be obvious; conversely, a process yielding a well-known product may yet be nonobvious.” *TorPharm, Inc. v. Ranbaxy Pharmaceuticals, Inc.*, 336 F.3d 1322, 1327, 67 USPQ2d 1511, 1514 (Fed. Cir. 2003).< To support a rejection under 35 U.S.C. 103, the collective teachings of the prior art must have suggested to one of ordinary skill in the art that, at the time the invention was made, applicant’s claimed invention would have been obvious. In applying this test to the claims on appeal in *Ochiai* and *Brouwer*, the court held that there simply was no suggestion or motivation in the prior art to make or use novel, nonobvious products in the claimed processes. Consequently, the court overturned the rejections based upon 35 U.S.C. 103.

Interpreting the claimed invention as a whole requires consideration of all claim limitations. Thus, proper claim construction requires treating language in a process claim which recites the making or using of a nonobvious product as a material limitation. Motivation to make or use the nonobvious product must be present in the prior art for a 35 U.S.C. 103 rejection to be sustained. The decision in *Ochiai* specifically dispelled any distinction between processes of making a product and methods of using a product with regard to the effect of any product limitations in either type of claim.

As noted in *Brouwer*, 77 F.3d at 425, 37 USPQ2d at 1666, the inquiry as to whether a claimed invention would have been obvious is “highly fact-specific by design”. Accordingly, obviousness must be assessed on a case-by-case basis. The following decisions are illustrative of the lack of *per se* rules in applying the test for obviousness under 35 U.S.C. 103 and of the fact-intensive comparison of claimed processes with the prior art: *In re Durden*, 763 F.2d 1406, 226 USPQ 359 (Fed. Cir. 1985) (The examiner rejected a claim directed to a process in which patentable starting materials were reacted to form patentable end products. The prior art showed the same chemical reaction mechanism applied to other chemicals. The court held that the process claim was obvious over the prior art.); *In re Albertson*, 332 F.2d 379, 141 USPQ 730 (CCPA 1964) (Process of chemically reducing one novel, nonobvious material to obtain another novel, nonobvious material was claimed. The process was held obvious because the reduction reaction was old.); *In*



*re Kanter*, 399 F.2d 249, 158 USPQ 331 (CCPA 1968) (Process of siliconizing a patentable base material to obtain a patentable product was claimed. Rejection based on prior art teaching the siliconizing process as applied to a different base material was upheld.); Cf. *In re Pleuddemann*, 910 F.2d 823, 15 USPQ2d 1738 (Fed. Cir. 1990) (Methods of bonding polymer and filler using a novel silane coupling agent held patentable even though methods of bonding using other silane coupling agents were well known because the process could not be conducted without the new agent); *In re Kuehl*, 475 F.2d 658, 177 USPQ 250 (CCPA 1973) (Process of cracking hydrocarbons using novel zeolite catalyst found to be patentable even though catalytic cracking process was old. “The test under 103 is whether in view of the prior art the invention as a whole would have been obvious at the time it was made, and the prior art here does not include the zeolite, ZK-22. The obviousness of the process of cracking hydrocarbons with ZK-22 as a catalyst must be determined without reference to knowledge of ZK-22 and its properties.” 475 F.2d at 664-665, 177 USPQ at 255.); and *In re Mancy*, 499 F.2d 1289, 182 USPQ 303 (CCPA 1974) (Claim to a process for the production of a known antibiotic by cultivating a novel, unobvious microorganism was found to be patentable.).

## 2121 Prior Art; General Level of Operability Required to Make a *Prima Facie* Case

### PRIOR ART IS PRESUMED TO BE OPERABLE/ENABLING

When the reference relied on expressly anticipates or makes obvious all of the elements of the claimed invention, the reference is presumed to be operable. Once such a reference is found, the burden is on applicant to provide facts rebutting the presumption of operability. *In re Sasse*, 629 F.2d 675, 207 USPQ 107 (CCPA 1980). See also MPEP § 716.07.

### WHAT CONSTITUTES AN “ENABLING DISCLOSURE” DOES NOT DEPEND ON THE TYPE OF PRIOR ART THE DISCLOSURE IS CONTAINED IN

The level of disclosure required within a reference to make it an “enabling disclosure” is the same no

matter what type of prior art is at issue. It does not matter whether the prior art reference is a U.S. patent, foreign patent, a printed publication or other. There is no basis in the statute (35 U.S.C. 102 or 103) for discriminating either in favor of or against prior art references on the basis of nationality. *In re Moreton*, 288 F.2d 708, 129 USPQ 227 (CCPA 1961).

## 2121.01 Use of Prior Art in Rejections Where Operability Is in Question [R-2]

“In determining that quantum of prior art disclosure which is necessary to declare an applicant’s invention ‘not novel’ or ‘anticipated’ within section 102, the stated test is whether a reference contains an ‘enabling disclosure’... .” *In re Hoeksema*, 399 F.2d 269, 158 USPQ 596 (CCPA 1968). \*->The disclosure in an assertedly anticipating reference must provide an enabling disclosure of the desired subject matter; mere naming or description of the subject matter is insufficient, if it cannot be produced without undue experimentation. *Elan Pharm., Inc. v. Mayo Foundation for Medical and Education Research*, 346 F.3d 1051, 1054, 68 USPQ2d 1373, 1376 (Fed. Cir. 2003) (At issue was whether a prior art reference enabled one of ordinary skill in the art to produce Elan’s claimed transgenic mouse without undue experimentation. Without a disclosure enabling one skilled in the art to produce a transgenic mouse without undue experimentation, the reference would not be applicable as prior art.).< A reference contains an “enabling disclosure” if the public was in possession of the claimed invention before the date of invention. “Such possession is effected if one of ordinary skill in the art could have combined the publication’s description of the invention with his [or her] own knowledge to make the claimed invention.” *In re Donohue*, 766 F.2d 531, 226 USPQ 619 (Fed. Cir. 1985).

### I. 35 U.S.C. 102 REJECTIONS AND ADDITION OF EVIDENCE SHOWING REFERENCE IS OPERABLE

It is possible to make a 35 U.S.C. 102 rejection even if the reference does not itself teach one of ordinary skill how to practice the invention, i.e., how to make or use the article disclosed. If the reference teaches every claimed element of the article, second-

ary evidence, such as other patents or publications, can be cited to show public possession of the method of making and/or using. *In re Donohue*, 766 F.2d at 533, 226 USPQ at 621. See MPEP § 2131.01 for more information on 35 U.S.C. 102 rejections using secondary references to show that the primary reference contains an “enabling disclosure.”

## II. 35 U.S.C. 103 REJECTIONS AND USE OF INOPERATIVE PRIOR ART

“Even if a reference discloses an inoperative device, it is prior art for all that it teaches.” *Beckman Instruments v. LKB Produkter AB*, 892 F.2d 1547, 1551, 13 USPQ2d 1301, 1304 (Fed. Cir. 1989). Therefore, “a non-enabling reference may qualify as prior art for the purpose of determining obviousness under 35 U.S.C. 103.” *Symbol Techs. Inc. v. Opticon Inc.*, 935 F.2d 1569, 1578, 19 USPQ2d 1241, 1247 (Fed. Cir. 1991).

### 2121.02 Compounds and Compositions — What Constitutes Enabling Prior Art

#### ONE OF ORDINARY SKILL IN THE ART MUST BE ABLE TO MAKE OR SYNTHESIZE

Where a process for making the compound is not developed until after the date of invention, the mere naming of a compound in a reference, without more, cannot constitute a description of the compound. *In re Hoeksema*, 399 F.2d 269, 158 USPQ 596 (CCPA 1968). Note, however, that a reference is presumed operable until applicant provides facts rebutting the presumption of operability. *In re Sasse*, 629 F.2d 675, 207 USPQ 107 (CCPA 1980). Therefore, applicant must provide evidence showing that a process for making was not known at the time of the invention. See the following paragraph for the evidentiary standard to be applied.

#### A REFERENCE DOES NOT CONTAIN AN “ENABLING DISCLOSURE” IF ATTEMPTS AT MAKING THE COMPOUND OR COMPOSITION WERE UNSUCCESSFUL BEFORE THE DATE OF INVENTION

When a prior art reference merely discloses the structure of the claimed compound, evidence showing

that attempts to prepare that compound were unsuccessful before the date of invention will be adequate to show inoperability. *In re Wiggins*, 488 F.2d 538, 179 USPQ 421 (CCPA 1971). However, the fact that an author of a publication did not attempt to make the compound disclosed, without more, will not overcome a rejection based on that publication. *In re Donohue*, 766 F.2d 531, 226 USPQ 619 (Fed. Cir. 1985) (In this case, the examiner had made a rejection under 35 U.S.C. 102(b) over a publication, which disclosed the claimed compound, in combination with two patents teaching a general process of making the particular class of compounds. The applicant submitted an affidavit stating that the authors of the publication had not actually synthesized the compound. The court held that the fact that the publication’s author did not synthesize the disclosed compound was immaterial to the question of reference operability. The patents were evidence that synthesis methods were well known. The court distinguished *Wiggins*, in which a very similar rejection was reversed. In *Wiggins*, attempts to make the compounds using the prior art methods were all unsuccessful.). Compare *In re Hoeksema*, 399 F.2d 269, 158 USPQ 596 (CCPA 1968) (A claim to a compound was rejected over a patent to *De Boer* which disclosed compounds similar in structure to those claimed (obvious homologs) and a process of making these compounds. Applicant responded with an affidavit by an expert named Wiley which stated that there was no indication in the *De Boer* patent that the process disclosed in *De Boer* could be used to produce the claimed compound and that he did not believe that the process disclosed in *De Boer* could be adapted to the production of the claimed compound. The court held that the facts stated in this affidavit were legally sufficient to overcome the rejection and that applicant need not show that all known processes are incapable of producing the claimed compound for this showing would be practically impossible.).

### 2121.03 Plant Genetics — What Constitutes Enabling Prior Art

#### THOSE OF ORDINARY SKILL MUST BE ABLE TO GROW AND CULTIVATE THE PLANT

When the claims are drawn to plants, the reference, combined with knowledge in the prior art, must

enable one of ordinary skill in the art to reproduce the plant. *In re LeGrice*, 301 F.2d 929, 133 USPQ 365 (CCPA 1962) (National Rose Society Annual of England and various other catalogues showed color pictures of the claimed roses and disclosed that applicant had raised the roses. The publications were published more than 1 year before applicant's filing date. The court held that the publications did not place the rose in the public domain. Information on the grafting process required to reproduce the rose was not included in the publications and such information was necessary for those of ordinary skill in the art (plant breeders) to reproduce the rose.). Compare *Ex parte Thomson*, 24 USPQ2d 1618 (Bd. Pat. App. & Inter. 1992) (Seeds were commercially available more than 1 year prior to applicant's filing date. One of ordinary skill in the art could grow the claimed cotton cultivar from the commercially available seeds. Thus, the publications describing the cotton cultivar had "enabled disclosures." The Board distinguished *In re LeGrice* by finding that the catalogue picture of the rose of *In re LeGrice* was the only evidence in that case. There was no evidence of commercial availability in enabling form since the asexually reproduced rose could not be reproduced from seed. Therefore, the public would not have possession of the rose by its picture alone, but the public would have possession of the cotton cultivar based on the publications and the availability of the seeds.).

### **2121.04 Apparatus and Articles — What Constitutes Enabling Prior Art**

#### **PICTURES MAY CONSTITUTE AN "ENABLING DISCLOSURE"**

Pictures and drawings may be sufficiently enabling to put the public in the possession of the article pictured. Therefore, such an enabling picture may be used to reject claims to the article. However, the picture must show all the claimed structural features and how they are put together. *Jockmus v. Leviton*, 28 F.2d 812 (2d Cir. 1928). See also MPEP § 2125 for a discussion of drawings as prior art.

### **2122 Discussion of Utility in the Prior Art**

#### **UTILITY NEED NOT BE DISCLOSED IN REFERENCE**

In order to constitute anticipatory prior art, a reference must identically disclose the claimed compound, but no utility need be disclosed by the reference. *In re Schoenwald*, 964 F.2d 1122, 22 USPQ2d 1671 (Fed. Cir. 1992) (The application claimed compounds used in ophthalmic compositions to treat dry eye syndrome. The examiner found a printed publication which disclosed the claimed compound but did not disclose a use for the compound. The court found that the claim was anticipated since the compound and a process of making it was taught by the reference. The court explained that "no utility need be disclosed for a reference to be anticipatory of a claim to an old compound." 964 F.2d at 1124, 22 USPQ2d at 1673. It is enough that the claimed compound is taught by the reference.).

### **2123 Rejection Over Prior Art's Broad Disclosure Instead of Preferred Embodiments**

#### **PATENTS ARE RELEVANT AS PRIOR ART FOR ALL THEY CONTAIN**

"The use of patents as references is not limited to what the patentees describe as their own inventions or to the problems with which they are concerned. They are part of the literature of the art, relevant for all they contain." *In re Heck*, 699 F.2d 1331, 1332-33, 216 USPQ 1038, 1039 (Fed. Cir. 1983) (quoting *In re Lemelson*, 397 F.2d 1006, 1009, 158 USPQ 275, 277 (CCPA 1968)).

A reference may be relied upon for all that it would have reasonably suggested to one having ordinary skill in the art, including nonpreferred embodiments. *Merck & Co. v. Biocraft Laboratories*, 874 F.2d 804, 10 USPQ2d 1843 (Fed. Cir.), cert. denied, 493 U.S. 975 (1989). See also *Celeritas Technologies Ltd. v. Rockwell International Corp.*, 150 F.3d 1354, 1361, 47 USPQ2d 1516, 1522-23 (Fed. Cir. 1998) (The court held that the prior art anticipated the claims even though it taught away from the claimed invention. "The fact that a modem with a single carrier data

signal is shown to be less than optimal does not vitiate the fact that it is disclosed.”).

### **NONPREFERRED EMBODIMENTS CONSTITUTE PRIOR ART**

Disclosed examples and preferred embodiments do not constitute a teaching away from a broader disclosure or nonpreferred embodiments. *In re Susi*, 440 F.2d 442, 169 USPQ 423 (CCPA 1971). “A known or obvious composition does not become patentable simply because it has been described as somewhat inferior to some other product for the same use.” *In re Gurley*, 27 F.3d 551, 554, 31 USPQ2d 1130, 1132 (Fed. Cir. 1994) (The invention was directed to an epoxy impregnated fiber-reinforced printed circuit material. The applied prior art reference taught a printed circuit material similar to that of the claims but impregnated with polyester-imide resin instead of epoxy. The reference, however, disclosed that epoxy was known for this use, but that epoxy impregnated circuit boards have “relatively acceptable dimensional stability” and “some degree of flexibility,” but are inferior to circuit boards impregnated with polyester-imide resins. The court upheld the rejection concluding that applicant’s argument that the reference teaches away from using epoxy was insufficient to overcome the rejection since “Gurley asserted no discovery beyond what was known in the art.” 27 F.3d at 554, 31 USPQ2d at 1132.).

### **2124 Exception to the Rule That the Critical Reference Date Must Precede the Filing Date**

#### **IN SOME CIRCUMSTANCES A FACTUAL REFERENCE NEED NOT ANTEDATE THE FILING DATE**

In certain circumstances, references cited to show a universal fact need not be available as prior art before applicant’s filing date. *In re Wilson*, 311 F.2d 266, 135 USPQ 442 (CCPA 1962). Such facts include the characteristics and properties of a material or a scientific truism. Some specific examples in which later publications showing factual evidence can be cited include situations where the facts shown in the reference are evidence “that, as of an application’s filing date, undue experimentation would have been required, *In re Corneil*, 347 F.2d 563, 568, 145 USPQ

702, 705 (CCPA 1965), or that a parameter absent from the claims was or was not critical, *In re Rainer*, 305 F.2d 505, 507 n.3, 134 USPQ 343, 345 n.3 (CCPA 1962), or that a statement in the specification was inaccurate, *In re Marzocchi*, 439 F.2d 220, 223 n.4, 169 USPQ 367, 370 n.4 (CCPA 1971), or that the invention was inoperative or lacked utility, *In re Langer*, 503 F.2d 1380, 1391, 183 USPQ 288, 297 (CCPA 1974), or that a claim was indefinite, *In re Glass*, 492 F.2d 1228, 1232 n.6, 181 USPQ 31, 34 n.6 (CCPA 1974), or that characteristics of prior art products were known, *In re Wilson*, 311 F.2d 266, 135 USPQ 442 (CCPA 1962).” *In re Koller*, 613 F.2d 819, 823 n.5, 204 USPQ 702, 706 n.5 (CCPA 1980) (quoting *In re Hogan*, 559 F.2d 595, 605 n.17, 194 USPQ 527, 537 n.17 (CCPA 1977) (emphasis in original)). However, it is impermissible to use a later factual reference to determine whether the application is enabled or described as required under 35 U.S.C. 112, first paragraph. *In re Koller*, 613 F.2d 819, 823 n. 5, 204 USPQ 702, 706 n.5 (CCPA 1980). References which do not qualify as prior art because they post-date the claimed invention may be relied upon to show the level of ordinary skill in the art at or around the time the invention was made. *Ex parte Erlich*, 22 USPQ 1463 (Bd. Pat. App. & Inter. 1992).

### **2125 Drawings as Prior Art**

#### **DRAWINGS CAN BE USED AS PRIOR ART**

Drawings and pictures can anticipate claims if they clearly show the structure which is claimed. *In re Mraz*, 455 F.2d 1069, 173 USPQ 25 (CCPA 1972). However, the picture must show all the claimed structural features and how they are put together. *Jockmus v. Leviton*, 28 F.2d 812 (2d Cir. 1928). The origin of the drawing is immaterial. For instance, drawings in a design patent can anticipate or make obvious the claimed invention as can drawings in utility patents. When the reference is a utility patent, it does not matter that the feature shown is unintended or unexplained in the specification. The drawings must be evaluated for what they reasonably disclose and suggest to one of ordinary skill in the art. *In re Aslanian*, 590 F.2d 911, 200 USPQ 500 (CCPA 1979). See MPEP § 2121.04 for more information on prior art drawings as “enabled disclosures.”

### **PROPORTIONS OF FEATURES IN A DRAWING ARE NOT EVIDENCE OF ACTUAL PROPORTIONS WHEN DRAWINGS ARE NOT TO SCALE**

When the reference does not disclose that the drawings are to scale and is silent as to dimensions, arguments based on measurement of the drawing features are of little value. See *Hockerson-Halberstadt, Inc. v. Avia Group Int'l*, 222 F.3d 951, 956, 55 USPQ2d 1487, 1491 (Fed. Cir. 2000) (The disclosure gave no indication that the drawings were drawn to scale. “[I]t is well established that patent drawings do not define the precise proportions of the elements and may not be relied on to show particular sizes if the specification is completely silent on the issue.”). However, the description of the article pictured can be relied on, in combination with the drawings, for what they would reasonably teach one of ordinary skill in the art. *In re Wright*, 569 F.2d 1124, 193 USPQ 332 (CCPA 1977) (“We disagree with the Solicitor’s conclusion, reached by a comparison of the relative dimensions of appellant’s and *Bauer*’s drawing figures, that *Bauer* ‘clearly points to the use of a chime length of roughly 1/2 to 1 inch for a whiskey barrel.’ This ignores the fact that *Bauer* does not disclose that his drawings are to scale. ... However, we agree with the Solicitor that *Bauer*’s teaching that whiskey losses are influenced by the distance the liquor needs to ‘traverse the pores of the wood’ (albeit in reference to the thickness of the barrelhead)” would have suggested the desirability of an increased chime length to one of ordinary skill in the art bent on further reducing whiskey losses.” 569 F.2d at 1127, 193 USPQ at 335-36.)

### **2126 Availability of a Document as a “Patent” for Purposes of Rejection Under 35 U.S.C. 102(a), (b), and (d)**

#### **THE NAME “PATENT” ALONE DOES NOT MAKE A DOCUMENT AVAILABLE AS A PRIOR ART PATENT UNDER 35 U.S.C. 102(a) OR (b)**

What a foreign country designates to be a patent may not be a patent for purposes of rejection under 35 U.S.C. 102(a) and (b); it is the substance of the rights conferred and the way information within the “patent” is controlled that is determinative. *In re*

*Ekenstam*, 256 F.2d 321, 118 USPQ 349 (CCPA 1958). See the next paragraph for further explanation with respect to when a document can be applied in a rejection as a “patent.” See MPEP § 2135.01 for a further discussion of the use of “patents” in 35 U.S.C. 102(d) rejections.

#### **A SECRET PATENT IS NOT AVAILABLE AS A REFERENCE UNDER 35 U.S.C. 102(a) or (b) UNTIL IT IS AVAILABLE TO THE PUBLIC BUT IT MAY BE AVAILABLE UNDER 35 U.S.C. 102(d) AS OF GRANT DATE**

Secret patents are defined as patents which are insufficiently accessible to the public to constitute “printed publications.” Decisions on the issue of what is sufficiently accessible to be a “printed publication” are located in MPEP § 2128 - § 2128.01.

Even if a patent grants an exclusionary right (is enforceable), it is not available as prior art under 35 U.S.C. 102(a) or (b) if it is secret or private. *In re Carlson*, 983 F.2d 1032, 1037, 25 USPQ2d 1207, 1211 (Fed. Cir. 1992). The document must be at least minimally available to the public to constitute prior art. The patent is sufficiently available to the public for the purposes of 35 U.S.C. 102(a) or (b) if it is laid open for public inspection or disseminated in printed form. See, e.g., *In re Carlson*, 938 F.2d at 1037, 25 USPQ2d at 1211 (“We recognize that *Geschmacksmuster* on display for public view in remote cities in a far-away land may create a burden of discovery for one without the time, desire, or resources to journey there in person or by agent to observe that which was registered under German law. Such a burden, however, is by law imposed upon the hypothetical person of ordinary skill in the art who is charged with knowledge of all contents of the relevant prior art.”). The date that the patent is made available to the public is the date it is available as a 35 U.S.C. 102(a) or (b) reference. *In re Ekenstam*, 256 F.2d 321, 118 USPQ 349 (CCPA 1958). But a period of secrecy after granting the patent has been held to have no effect in connection with 35 U.S.C. 102(d). These patents are usable in rejections under 35 U.S.C. 102(d) as of the date patent rights are granted. *In re Kathawala*, 9 F.3d 942, 28 USPQ2d 1789 (Fed. Cir. 1993). See MPEP § 2135 - § 2135.01 for more information on 35 U.S.C. 102(d).

## 2126.01 Date of Availability of a Patent as a Reference [R-2]

### DATE FOREIGN PATENT IS EFFECTIVE AS A REFERENCE IS USUALLY THE DATE PATENT RIGHTS ARE FORMALLY AWARDED TO ITS APPLICANT

The date the patent is available as a reference is generally the date that the patent becomes enforceable. This date is the date the sovereign formally bestows patent rights to the applicant. *In re Monks*, 588 F.2d 308, 200 USPQ 129 (CCPA 1978). There is an exception to this rule when the patent is secret as of the date the rights are awarded. *In re Ekenstam*, 256 F.2d 321, 118 USPQ 349 (CCPA 1958).

Note that MPEP § 901.05 summarizes in tabular form dates of patenting for many foreign patents. *Chisum*, Patents § 3.06[4] n.2 gives a good summary of decisions which specify reference availability dates for specific classes of foreign patents. A copy of *Chisum* is kept in the law library of the Solicitor's Office and in the Lutrelle F. Parker, Sr., Memorial Law Library located in \*>Crystal Plaza 3/4-3D62<.

## 2126.02 Scope of Reference's Disclosure Which Can Be Used to Reject Claims When the Reference Is a "Patent" but Not a "Publication"

### OFTEN UNCLAIMED DETAILS FOUND IN THE PATENT SPECIFICATION CAN BE RELIED ON EVEN IF PATENT IS SECRET

When the patented document is used as a patent and not as a publication, the examiner is not restricted to the information conveyed by the patent claims but may use any information provided in the specification which relates to the subject matter of the patented claims when making a rejection under 35 U.S.C. 102(a), (b) or (d). *Ex parte Ovist*, 152 USPQ 709, 710 (Bd. App. 1963) (The claim of an Italian patent was generic and thus embraced the species disclosed in the examples, the Board added that the entire specification was germane to the claimed invention and upheld the examiner's 35 U.S.C. 102(b) rejection.); *In re Kathawala*, 9 F.3d 942, 28 USPQ2d 1785 (Fed. Cir. 1993) (The claims at issue were rejected under 35 U.S.C. 102(d) by applicant's own parent applica-

tions in Greece and Spain. The applicant argued that the "invention ... patented in Spain was not the same 'invention' claimed in the U.S. application because the Spanish patent claimed processes for making [compounds for inhibition of cholesterol biosynthesis] and claims 1 and 2 were directed to the compounds themselves." 9 F.3d at 944, 28 USPQ2d at 1786. The Federal Circuit held that "when an applicant files a foreign application fully disclosing his invention and having the potential to claim his invention in a number of ways, the reference in section 102(d) to 'invention ... patented' necessarily includes all disclosed aspects of the invention." 9 F.3d at 945-46, 28 USPQ2d at 1789.)

*In re Fuge*, 272 F.2d 954, 957, 124 USPQ 105, 107 (CCPA 1959), does not conflict with the above decisions. This decision simply states "that, at the least, the scope of the patent embraces everything included in the [claim]." (emphasis added).

Note that the courts have interpreted the phrase "invention ... patented" in 102(a), (b), and (d) the same way and have cited decisions without regard to which of these subsections of 35 U.S.C. 102 was at issue in the particular case at hand. Therefore, it does not seem to matter to which subsection of 102 the cases are directed; the court decisions are interchangeable as to this issue.

## 2127 Domestic and Foreign Patent Applications as Prior Art [R-2]

### I. ABANDONED APPLICATIONS, INCLUDING PROVISIONAL APPLICATIONS

#### *Abandoned Applications Disclosed to the Public Can Be Used as Prior Art*

"An abandoned patent application may become evidence of prior art only when it has been appropriately disclosed, as, for example, when the abandoned patent [application] is reference[d] in the disclosure of another patent, in a publication, or by voluntary disclosure under [former Defensive Publication rule] 37 CFR 1.139." *Lee Pharmaceutical v. Kreps*, 577 F.2d 610, 613, 198 USPQ 601, 605 (9th Cir. 1978). An abandoned patent application becomes available as prior art only as of the date the public gains access to it. See \*\*>37 CFR 1.14(a)(1)(ii) and (iv)<. However, the subject matter of an abandoned

application, including both provisional and nonprovisional applications, referred to in a prior art U.S. patent may be relied on in a 35 U.S.C. 102(e) rejection based on that patent if the disclosure of the abandoned application is actually included or incorporated by reference in the patent. Compare *In re Lund*, 376 F.2d 982, 991, 153 USPQ 625, 633 (CCPA 1967) (The court reversed a rejection over a patent which was a continuation-in-part of an abandoned application. Applicant's filing date preceded the issue date of the patent reference. The abandoned application contained subject matter which was essential to the rejection but which was not carried over into the continuation-in-part. The court held that the subject matter of the abandoned application was not available to the public as of either the parent's or the child's filing dates and thus could not be relied on in the 102(e) rejection.). See also MPEP § 901.02. See MPEP § 2136.02 and § 2136.03 for the 35 U.S.C. 102(e) date of a U.S. patent claiming priority under 35 U.S.C. 119 or 120.

## II. APPLICATIONS WHICH HAVE ISSUED INTO U.S. PATENTS

### *A 35 U.S.C. 102(e) Rejection Cannot Rely on Matter Which Was Canceled from the Application and Thus Did Not Get Published in the Issued Patent*

Canceled matter in the application file of a U.S. patent cannot be relied upon in a rejection under 35 U.S.C. 102(e). *Ex Parte Stalego*, 154 USPQ 52, 53 (Bd. App. 1966). The canceled matter only becomes available as prior art as of the date the application issues into a patent since this is the date the application file becomes available to the public. *In re Lund*, 376 F.2d 982, 153 USPQ 625 (CCPA 1967). For more information on available prior art for use in 35 U.S.C. 102(e) rejections see MPEP § 2136.02.

## III. FOREIGN APPLICATIONS OPEN FOR PUBLIC INSPECTION (LAID OPEN APPLICATIONS)

### *Laid Open Applications May Constitute "Published" Documents*

When the specification is not issued in printed form but is announced in an official journal and anyone can

inspect or obtain copies, it is sufficiently accessible to the public to constitute a "publication" within the meaning of 35 U.S.C. 102(a) and (b). See *In re Wyer*, 655 F.2d 221, 210 USPQ 790 (CCPA 1981).

Older cases have held that laid open patent applications are not "published" and cannot constitute prior art. *Ex parte Haller*, 103 USPQ 332 (Bd. App. 1953). However, whether or not a document is "published" for the purposes of 35 U.S.C. 102 and 103 depends on how accessible the document is to the public. As technology has made reproduction of documents easier, the accessibility of the laid open applications has increased. Items provided in easily reproducible form have thus become "printed publications" as the phrase is used in 35 U.S.C. 102. *In re Wyer*, 655 F.2d 221, 226, 210 USPQ 790, 794 (CCPA 1981) (Laid open Australian patent application held to be a "printed publication" even though only the abstract was published because it was laid open for public inspection, microfilmed, "diaz copies" were distributed to five suboffices having suitable reproduction equipment and the diazo copies were available for sale.). The contents of a foreign patent application should not be relied upon as prior art until the date of publication (i.e., the insertion into the laid open application) can be confirmed by an examiner's review of a copy of the document. See MPEP § 901.05.

## IV. PENDING U.S. APPLICATIONS

As specified in 37 CFR 1.14(a), all pending U.S. applications are preserved in confidence except for published applications, reissue applications, and applications in which a request to open the complete application to inspection by the public has been granted by the Office (37 CFR 1.11(b)). However, if an application that has not been published has an assignee or inventor in common with the application being examined, a rejection will be proper in some circumstances. For instance, when the claims between the two applications are not independent or distinct, a provisional double patenting rejection is made. See MPEP § 804. If the copending applications differ by at least one inventor and at least one of the applications would have been obvious in view of the other, a provisional rejection over 35 U.S.C. 102(e) or 103 is made when appropriate. See MPEP § 706.02(f)(2), § 706.02(k), § 706.02(l)(1), and § 706.02(l)(3).

See MPEP § 706.02(a), § 804 and § 2136 *et seq.* for information pertaining to rejections relying on U.S. application publications.

## 2128 “Printed Publications” as Prior Art

### A REFERENCE IS A “PRINTED PUBLICATION” IF IT IS ACCESSIBLE TO THE PUBLIC

A reference is proven to be a “printed publication” “upon a satisfactory showing that such document has been disseminated or otherwise made available to the extent that persons interested and ordinarily skilled in the subject matter or art, exercising reasonable diligence, can locate it.” *In re Wyer*, 655 F.2d 221, 210 USPQ 790 (CCPA 1981) (quoting *I.C.E. Corp. v. Armco Steel Corp.*, 250 F. Supp. 738, 743, 148 USPQ 537, 540 (SDNY 1966)) (“We agree that ‘printed publication’ should be approached as a unitary concept. The traditional dichotomy between ‘printed’ and ‘publication’ is no longer valid. Given the state of technology in document duplication, data storage, and data retrieval systems, the ‘probability of dissemination’ of an item very often has little to do with whether or not it is ‘printed’ in the sense of that word when it was introduced into the patent statutes in 1836. In any event, interpretation of the words ‘printed’ and ‘publication’ to mean ‘probability of dissemination’ and ‘public accessibility’ respectively, now seems to render their use in the phrase ‘printed publication’ somewhat redundant.”) *In re Wyer*, 655 F.2d at 226, 210 USPQ at 794.

See also *Carella v. Starlight Archery*, 804 F.2d 135, 231 USPQ 644 (Fed. Cir. 1986) (Starlight Archery argued that Carella’s patent claims to an archery sight were anticipated under 35 U.S.C. 102(a) by an advertisement in a Wisconsin Bow Hunter Association (WBHA) magazine and a WBHA mailer prepared prior to Carella’s filing date. However, there was no evidence as to when the mailer was received by any of the addressees. Plus, the magazine had not been mailed until 10 days after Carella’s filing date. The court held that since there was no proof that either the advertisement or mailer was accessible to any mem-

ber of the public before the filing date there could be no rejection under 35 U.S.C. 102(a).).

### ELECTRONIC PUBLICATIONS AS PRIOR ART

#### *Status as a “Printed Publication”*

An electronic publication, including an on-line database or Internet publication, is considered to be a “printed publication” within the meaning of 35 U.S.C. 102(a) and (b) provided the publication was accessible to persons concerned with the art to which the document relates. See *In re Wyer*, 655 F.2d 221, 227, 210 USPQ 790, 795 (CCPA 1981) (“Accordingly, whether information is printed, handwritten, or on microfilm or a magnetic disc or tape, etc., the one who wishes to characterize the information, in whatever form it may be, as a ‘printed publication’ \* \* \* should produce sufficient proof of its dissemination or that it has otherwise been available and accessible to persons concerned with the art to which the document relates and thus most likely to avail themselves of its contents.’ ” (citations omitted).). See also *Amazon.com v. Barnesandnoble.com*, 73 F. Supp. 2d 1228, 53 USPQ2d 1115, 1119 (W.D. Wash. 1999) (Pages from a website were relied on by defendants as an anticipatory reference (to no avail), however status of the reference as prior art was not challenged.); *In re Epstein*, 32 F.3d 1559, 31 USPQ2d 1817 (Fed. Cir. 1994) (Database printouts of abstracts which were not themselves prior art publications were properly relied as providing evidence that the software products referenced therein were “first installed” or “released” more than one year prior to applicant’s filing date.).

The Office policy requiring recordation of the field of search and search results (see MPEP § 719.05) weighs in favor of finding that Internet and on-line database references cited by the examiner are “accessible to persons concerned with the art to which the document relates and thus most likely to avail themselves of its contents.” *Wyer*, 655 F.2d at 221, 210 USPQ at 790. Office copies of an electronic document must be retained if the same document may not be available for retrieval in the future. This is especially important for sources such as the Internet and online databases.



***Date of Availability***

Prior art disclosures on the Internet or on an on-line database are considered to be publicly available as of the date the item was publicly posted. If the publication does not include a publication date (or retrieval date), it cannot be relied upon as prior art under 35 U.S.C. 102(a) or (b), although it may be relied upon to provide evidence regarding the state of the art. Examiners may ask the Scientific and Technical Information Center to find the earliest date of publication. See MPEP § 901.06(a), paragraph IV. G.

***Extent of Teachings Relied Upon***

An electronic publication, like any publication, may be relied upon for all that it would have reasonably suggested to one having ordinary skill in the art. See MPEP § 2121.01 and § 2123. Note, however, that if an electronic document which is the abstract of a patent or printed publication is relied upon in a rejection under 35 U.S.C. 102 or 103, only the text of the abstract (and not the underlying document) may be relied upon to support the rejection. In situations where the electronic version and the published paper version of the same or a corresponding patent or printed publication differ appreciably, each may need to be cited and relied upon as independent references based on what they disclose.

***Internet Usage Policy***

See MPEP § 904.02(c) for the portions of the Internet Usage Policy pertaining to Internet searching and documenting search strategies. See MPEP § 707.05 for the proper citation of electronic documents.

**EXAMINER NEED NOT PROVE ANYONE ACTUALLY LOOKED AT THE DOCUMENT**

One need not prove someone actually looked at a publication when that publication is accessible to the public through a library or patent office. See *In re Wyer*, 655 F.2d 221, 210 USPQ 790 (CCPA 1981); *In re Hall*, 781 F.2d 897, 228 USPQ 453 (Fed. Cir. 1986).

**2128.01 Level of Public Accessibility Required [R-2]**

&gt;

**I. <A THESIS PLACED IN A UNIVERSITY LIBRARY MAY BE PRIOR ART IF SUFFICIENTLY ACCESSIBLE TO THE PUBLIC**

A doctoral thesis indexed and shelved in a library is sufficiently accessible to the public to constitute prior art as a “printed publication.” *In re Hall*, 781 F.2d 897, 228 USPQ 453 (Fed. Cir. 1986). Even if access to the library is restricted, a reference will constitute a “printed publication” as long as a presumption is raised that the portion of the public concerned with the art would know of the invention. *In re Bayer*, 568 F.2d 1357, 196 USPQ 670 (CCPA 1978).

In *In re Hall*, general library cataloging and shelving practices showed that a doctoral thesis deposited in university library would have been indexed, cataloged and shelved and thus available to the public before the critical date. Compare *In re Cronyn*, 890 F.2d 1158, 13 USPQ2d 1070 (Fed. Cir. 1989) wherein doctoral theses were shelved and indexed by index cards filed alphabetically by student name and kept in a shoe box in the chemistry library. The index cards only listed the student name and title of the thesis. Two of three judges held that the students’ theses were not accessible to the public. The court reasoned that the theses had not been either cataloged or indexed in a meaningful way since thesis could only be found if the researcher’s name was known, but the name bears no relationship to the subject of the thesis. One judge, however, held that the fact that the theses were shelved in the library was enough to make them sufficiently accessible to the public. The nature of the index was not determinative. This judge relied on prior Board decisions (*Gulliksen v. Halberg*, 75 USPQ 252, 257 (Bd. App. 1937) and *Ex parte Hershberger*, 96 USPQ 54, 56 (Bd. App. 1952)), which held that shelving a single copy in a public library makes the work a “printed publication.” It should be noted that these Board decisions have not been expressly overruled but have been criticized in other decisions. See *In re Tenney*, 254 F.2d 619, 117 USPQ 348 (CCPA 1958) (concurring opinion by *J.Rich*) (A document, of which there is but one copy, whether it be

handwritten, typewritten or on microfilm, may be technically accessible to anyone who can find it. Such a document is not “printed” in the sense that a printing press has been used to reproduce the document. If only technical accessibility were required “logic would require the inclusion within the term [printed] of all unprinted public documents for they are all ‘accessible.’ While some tribunals have gone quite far in that direction, as in the ‘college thesis cases’ I feel they have done so unjustifiably and on the wrong theory. Knowledge is not in the possession of *the public* where there has been no dissemination, as distinguished from technical accessibility...” The real significance of the word “printed” is grounded in the “probability of wide circulation.” See also *Deep Welding, Inc. v. Sciaky Bros.*, 417 F.2d 1227, 163 USPQ 144 (7th Cir. 1969) (calling the holding of *Ex parte Hershberger* “extreme”). Compare *In re Bayer*, 568 F.2d 1357, 196 USPQ 670 (CCPA 1978) (A reference will constitute a “printed publication” as long as a presumption is raised that the portion of the public concerned with the art would know of the invention even if accessibility is restricted to only this part of the public. But accessibility to applicant’s thesis was restricted to only three members of a graduate committee. There can be no presumption that those concerned with the art would have known of the invention in this case.).

&gt;

## II. <ORALLY PRESENTED PAPER CAN CONSTITUTE A “PRINTED PUBLICATION” IF WRITTEN COPIES ARE AVAILABLE WITHOUT RESTRICTION

A paper which is orally presented in a forum open to all interested persons constitutes a “printed publication” if written copies are disseminated without restriction. *Massachusetts Institute of Technology v. AB Fortia*, 774 F.2d 1104, 1109, 227 USPQ 428, 432 (Fed. Cir. 1985) (Paper orally presented to between 50 and 500 persons at a scientific meeting open to all persons interested in the subject matter, with written copies distributed without restriction to all who requested, is a printed publication. Six persons requested and obtained copies.).

&gt;

## III. <INTERNAL DOCUMENTS INTENDED TO BE CONFIDENTIAL ARE NOT “PRINTED PUBLICATIONS”

Documents and items only distributed internally within an organization which are intended to remain confidential are not “printed publications” no matter how many copies are distributed. >There must be an existing policy of confidentiality or agreement to remain confidential within the organization. Mere intent to remain confidential is insufficient.< *In re George*, 2 USPQ2d 1880 (Bd. Pat. App. & Inter. 1987) (Research reports disseminated in-house to only those persons who understood the policy of confidentiality regarding such reports are not printed publications even though the policy was not specifically stated in writing.); *Garret Corp. v. United States*, 422 F.2d 874, 878, 164 USPQ 521, 524 (Ct. Cl. 1970) (“While distribution to government agencies and personnel alone may not constitute publication ... distribution to commercial companies without restriction on use clearly does.”); *Northern Telecom Inc. v. Datapoint Corp.*, 908 F.2d 931, 15 USPQ2d 1321 (Fed. Cir. 1990) (Four reports on the AESOP-B military computer system which were not under security classification were distributed to about fifty organizations involved in the AESOP-B project. One document contained the legend “Reproduction or further dissemination is not authorized.” The other documents were of the class that would contain this legend. The documents were housed in Mitre Corporation’s library. Access to this library was restricted to those involved in the AESOP-B project. The court held that public access was insufficient to make the documents “printed publications.”).

## 2128.02 Date Publication Is Available as a Reference

### DATE OF ACCESSIBILITY CAN BE SHOWN THROUGH EVIDENCE OF ROUTINE BUSINESS PRACTICES

Evidence showing routine business practices can be used to establish the date on which a publication became accessible to the public. Specific evidence showing when the specific document actually became available is not always necessary. *Constant v.*

*Advanced Micro-Devices, Inc.*, 848 F.2d 1560, 7 USPQ2d 1057 (Fed. Cir.), *cert. denied*, 988 U.S. 892 (1988) (Court held that evidence submitted by Intel regarding undated specification sheets showing how the company usually treated such specification sheets was enough to show that the sheets were accessible by the public before the critical date.); *In re Hall*, 781 F.2d 897, 228 USPQ 453 (Fed. Cir. 1986) (Librarian's affidavit establishing normal time frame and practice for indexing, cataloging and shelving doctoral theses established that the thesis in question would have been accessible by the public before the critical date.).

#### **A JOURNAL ARTICLE OR OTHER PUBLICATION BECOMES AVAILABLE AS PRIOR ART ON DATE OF IT IS RECEIVED BY A MEMBER OF THE PUBLIC**

A publication disseminated by mail is not prior art until it is received by at least one member of the public. Thus, a magazine or technical journal is effective as of its date of publication (date when first person receives it) not the date it was mailed or sent to the publisher. *In re Schlittler*, 234 F.2d 882, 110 USPQ 304 (CCPA 1956).

### **2129 Admissions as Prior Art [R-2]**

>

#### **I. <ADMISSIONS BY APPLICANT CONSTITUTE PRIOR ART**

\*\*>A statement by an applicant during prosecution identifying the work of another as “prior art” is an admission that that work is available as prior art against the claims, regardless of whether the admitted prior art would otherwise qualify as prior art under the statutory categories of 35 U.S.C. 102. *Riverwood Int'l Corp. v. R.A. Jones & Co.*, 324 F.3d 1346, 1354, 66 USPQ2d 1331, 1337 (Fed Cir. 2003). However, even if labeled as “prior art,” the work of the same inventive entity may not be considered prior art against the claims unless it falls under one of the statutory categories. *Id.*; see also *Reading & Bates Construction Co. v. Baker Energy Resources Corp.*, 748 F.2d 645, 650, 223 USPQ 1168, 1172 (Fed. Cir. 1984) (“[W]here the inventor continues to improve upon his own work product, his foundational work product

should not, without a statutory basis, be treated as prior art solely because he admits knowledge of his own work. It is common sense that an inventor, regardless of an admission, has knowledge of his own work.”).

Consequently, the examiner must determine whether the subject matter identified as “prior art” is applicant's own work, or the work of another. In the absence of another credible explanation, examiners should treat such subject matter as the work of another.

#### **II. DISCUSSION OF PRIOR ART IN SPECIFICATION**

Where the specification identifies work done by another as “prior art,” the subject matter so identified is treated as admitted prior art. *In re Nomiya*, 509 F.2d 566, 571, 184 USPQ 607, 611 (CCPA 1975) (holding applicant's labeling of two figures in the application drawings as “prior art” to be an admission that what was pictured was prior art relative to applicant's improvement).

#### **III. JEPSON CLAIMS**

Drafting a claim in *Jepson* format (i.e., the format described in 37 CFR 1.75(e); see MPEP § 608.01(m)) is taken as an implied admission that the subject matter of the preamble is the prior art work of another. *In re Fout*, 675 F.2d 297, 301, 213 USPQ 532, 534 (CCPA 1982) (holding preamble of *Jepson*-type claim to be admitted prior art where applicant's specification credited another as the inventor of the subject matter of the preamble). However, this implication may be overcome where applicant gives another credible reason for drafting the claim in *Jepson* format. *In re Ehrreich*, 590 F.2d 902, 909-910, 200 USPQ 504, 510 (CCPA 1979) (holding preamble not to be admitted prior art where applicant explained that the *Jepson* format was used to avoid a double patenting rejection in a co-pending application and the examiner cited no art showing the subject matter of the preamble). Moreover, where the preamble of a *Jepson* claim describes applicant's own work, such may not be used against the claims. *Reading & Bates Construction Co. v. Baker Energy Resources Corp.*, 748 F.2d 645, 650, 223 USPQ 1168, 1172 (Fed. Cir. 1984); *Ehrreich*, 590 F.2d at 909-910, 200 USPQ at 510.

#### IV. INFORMATION DISCLOSURE STATEMENT (IDS)

Mere listing of a reference in an information disclosure statement is not taken as an admission that the reference is prior art against the claims. *Riverwood Int'l Corp. v. R.A. Jones & Co.*, 324 F.3d 1346, 1354-55, 66 USPQ2d 1331, 1337-38 (Fed. Cir. 2003) (listing of applicant's own prior patent in an IDS does not make it available as prior art absent a statutory basis); *see also* 37 CFR 1.97(h) ("The filing of an information disclosure statement shall not be construed to be an admission that the information cited in the statement is, or is considered to be, material to patentability as defined in § 1.56(b).")<

#### 2131 Anticipation — Application of 35 U.S.C. 102(a), (b), and (e) [R-1]

35 U.S.C. 102. *Conditions for patentability; novelty and loss of right to patent.*

A person shall be entitled to a patent unless -

(a) the invention was known or used by others in this country, or patented or described in a printed publication in this or a foreign country, before the invention thereof by the applicant for a patent, or

(b) the invention was patented or described in a printed publication in this or a foreign country or in public use or on sale in this country, more than one year prior to the date of application for patent in the United States, or

(c) he has abandoned the invention, or

(d) the invention was first patented or caused to be patented, or was the subject of an inventor's certificate, by the applicant or his legal representatives or assigns in a foreign country prior to the date of the application for patent in this country on an application for patent or inventor's certificate filed more than twelve months before the filing of the application in the United States, or

\*\*>

(e) the invention was described in — (1) an application for patent, published under section 122(b), by another filed in the United States before the invention by the applicant for patent or (2) a patent granted on an application for patent by another filed in the United States before the invention by the applicant for patent, except that an international application filed under the treaty defined in section 351(a) shall have the effects for the purposes of this subsection of an application filed in the United States only if the international application designated the United States and was published under Article 21(2) of such treaty in the English language; or<

(f) he did not himself invent the subject matter sought to be patented, or

(g) during the course of an interference conducted under section 135 or section 291, another inventor involved therein establishes, to the extent permitted in section 104, that before such person's invention thereof the invention was made by such other

inventor and not abandoned, suppressed, or concealed, or (2) before such person's invention thereof, the invention was made in this country by another inventor who had not abandoned, suppressed, or concealed it. In determining priority of invention under this subsection, there shall be considered not only the respective dates of conception and reduction to practice of the invention, but also the reasonable diligence of one who was first to conceive and last to reduce to practice, from a time prior to conception by the other.

#### TO ANTICIPATE A CLAIM, THE REFERENCE MUST TEACH EVERY ELEMENT OF THE CLAIM

"A claim is anticipated only if each and every element as set forth in the claim is found, either expressly or inherently described, in a single prior art reference." *Verdegaal Bros. v. Union Oil Co. of California*, 814 F.2d 628, 631, 2 USPQ2d 1051, 1053 (Fed. Cir. 1987). >"When a claim covers several structures or compositions, either generically or as alternatives, the claim is deemed anticipated if any of the structures or compositions within the scope of the claim is known in the prior art." *Brown v. 3M*, 265 F.3d 1349, 1351, 60 USPQ2d 1375, 1376 (Fed. Cir. 2001) (claim to a system for setting a computer clock to an offset time to address the Year 2000 (Y2K) problem, applicable to records with year date data in "at least one of two-digit, three-digit, or four-digit" representations, was held anticipated by a system that offsets year dates in only two-digit formats). *See also* MPEP § 2131.02.< "The identical invention must be shown in as complete detail as is contained in the ... claim." *Richardson v. Suzuki Motor Co.*, 868 F.2d 1226, 1236, 9 USPQ2d 1913, 1920 (Fed. Cir. 1989). The elements must be arranged as required by the claim, but this is not an *ipsisimilis verbis* test, i.e., identity of terminology is not required. *In re Bond*, 910 F.2d 831, 15 USPQ2d 1566 (Fed. Cir. 1990). Note that, in some circumstances, it is permissible to use multiple references in a 35 U.S.C. 102 rejection. *See* MPEP § 2131.01.

#### 2131.01 Multiple Reference 35 U.S.C. 102 Rejections

Normally, only one reference should be used in making a rejection under 35 U.S.C. 102. However, a 35 U.S.C. 102 rejection over multiple references has been held to be proper when the extra references are cited to:

(A) Prove the primary reference contains an “enabled disclosure;”

(B) Explain the meaning of a term used in the primary reference; or

(C) Show that a characteristic not disclosed in the reference is inherent.

See paragraphs I-III below for more explanation of each circumstance.

## **I. TO PROVE REFERENCE CONTAINS AN “ENABLED DISCLOSURE”**

### ***Extra References and Extrinsic Evidence Can Be Used To Show the Primary Reference Contains an “Enabled Disclosure”***

When the claimed composition or machine is disclosed identically by the reference, an additional reference may be relied on to show that the primary reference has an “enabled disclosure.” *In re Samour*, 571 F.2d 559, 197 USPQ 1 (CCPA 1978) and *In re Donohue*, 766 F.2d 531, 226 USPQ 619 (Fed. Cir. 1985) (Compound claims were rejected under 35 U.S.C. 102(b) over a publication in view of two patents. The publication disclosed the claimed compound structure while the patents taught methods of making compounds of that general class. The applicant argued that there was no motivation to combine the references because no utility was previously known for the compound and that the 35 U.S.C. 102 rejection over multiple references was improper. The court held that the publication taught all the elements of the claim and thus motivation to combine was not required. The patents were only submitted as evidence of what was in the public's possession before applicant's invention.).

## **II. TO EXPLAIN THE MEANING OF A TERM USED IN THE PRIMARY REFERENCE**

### ***Extra References or Other Evidence Can Be Used to Show Meaning of a Term Used in the Primary Reference***

Extrinsic evidence may be used to explain but not expand the meaning of terms and phrases used in the reference relied upon as anticipatory of the claimed subject matter. *In re Baxter Travenol Labs.*, 952 F.2d 388, 21 USPQ2d 1281 (Fed. Cir. 1991) (Baxter Trave-

nol Labs. invention was directed to a blood bag system incorporating a bag containing DEHP, an additive to the plastic which improved the bag's red blood cell storage capability. The examiner rejected the claims over a technical progress report by Becker which taught the same blood bag system but did not expressly disclose the presence of DEHP. The report, however, did disclose using commercial blood bags. It also disclosed the blood bag system as “very similar to [Baxter] Travenol's commercial two bag blood container.” Extrinsic evidence (depositions, declarations and Baxter Travenol's own admissions) showed that commercial blood bags, at the time Becker's report was written, contained DEHP. Therefore, one of ordinary skill in the art would have known that “commercial blood bags” meant bags containing DEHP. The claims were thus held to be anticipated.).

## **III. TO SHOW THAT A CHARACTERISTIC NOT DISCLOSED IN THE REFERENCE IS INHERENT**

### ***Extra Reference or Evidence Can Be Used To Show an Inherent Characteristic of the Thing Taught by the Primary Reference***

“To serve as an anticipation when the reference is silent about the asserted inherent characteristic, such gap in the reference may be filled with recourse to extrinsic evidence. Such evidence must make clear that the missing descriptive matter is necessarily present in the thing described in the reference, and that it would be so recognized by persons of ordinary skill.” *Continental Can Co. USA v. Monsanto Co.*, 948 F.2d 1264, 1268, 20 USPQ2d 1746, 1749 (Fed. Cir. 1991) (The court went on to explain that “this modest flexibility in the rule that ‘anticipation’ requires that every element of the claims appear in a single reference accommodates situations in which the common knowledge of technologists is not recorded in the reference; that is, where technological facts are known to those in the field of the invention, albeit not known to judges.” 948 F.2d at 1268, 20 USPQ at 1749-50.). Note that as long as there is evidence of record establishing inherency, failure of those skilled in the art to contemporaneously recognize an inherent property, function or ingredient of a prior art reference does not preclude a finding of anticipation. *Atlas Powder Co. v. IRECO, Inc.*,

190 F.3d 1342, 1349, 51 USPQ2d 1943, 1948 (Fed. Cir. 1999) (Two prior art references disclosed blasting compositions containing water-in-oil emulsions with identical ingredients to those claimed, in overlapping ranges with the claimed composition. The only element of the claims arguably not present in the prior art compositions was “sufficient aeration . . . entrapped to enhance sensitivity to a substantial degree.” The Federal Circuit found that the emulsions described in both references would inevitably and inherently have “sufficient aeration” to sensitize the compound in the claimed ranges based on the evidence of record (including test data and expert testimony). This finding of inherency was not defeated by the fact that one of the references taught away from air entrapment or purposeful aeration.). See also *In re King*, 801 F.2d 1324, 1327, 231 USPQ 136, 139 (Fed. Cir. 1986); *Titanium Metals Corp. v. Banner*, 778 F.2d 775, 782, 227 USPQ 773, 778 (Fed. Cir. 1985). See MPEP § 2112 - § 2112.02 for case law on inherency. Also note that the critical date of extrinsic evidence showing a universal fact need not antedate the filing date. See MPEP § 2124.

## 2131.02 Genus-Species Situations

### A SPECIES WILL ANTICIPATE A CLAIM TO A GENUS

“A generic claim cannot be allowed to an applicant if the prior art discloses a species falling within the claimed genus.” The species in that case will anticipate the genus. *In re Slayter*, 276 F.2d 408, 411, 125 USPQ 345, 347 (CCPA 1960); *In re Gosteli*, 872 F.2d 1008, 10 USPQ2d 1614 (Fed. Cir. 1989) (Gosteli claimed a genus of 21 specific chemical species of bicyclic thia-aza compounds in Markush claims. The prior art reference applied against the claims disclosed two of the chemical species. The parties agreed that the prior art species would anticipate the claims unless applicant was entitled to his foreign priority date.).

### A REFERENCE THAT CLEARLY NAMES THE CLAIMED SPECIES ANTICIPATES THE CLAIM NO MATTER HOW MANY OTHER SPECIES ARE NAMED

A genus does not always anticipate a claim to a species within the genus. However, when the species is

clearly named, the species claim is anticipated no matter how many other species are additionally named. *Ex parte A*, 17 USPQ2d 1716 (Bd. Pat. App. & Inter. 1990) (The claimed compound was named in a reference which also disclosed 45 other compounds. The Board held that the comprehensiveness of the listing did not negate the fact that the compound claimed was specifically taught. The Board compared the facts to the situation in which the compound was found in the *Merck Index*, saying that “the tenth edition of the *Merck Index* lists ten thousand compounds. In our view, each and every one of those compounds is ‘described’ as that term is used in 35 U.S.C. § 102(a), in that publication.”). *Id.* at 1718. See also *In re Sivaramakrishnan*, 673 F.2d 1383, 213 USPQ 441 (CCPA 1982) (The claims were directed to polycarbonate containing cadmium laurate as an additive. The court upheld the Board’s finding that a reference specifically naming cadmium laurate as an additive amongst a list of many suitable salts in polycarbonate resin anticipated the claims. The applicant had argued that cadmium laurate was only disclosed as representative of the salts and was expected to have the same properties as the other salts listed while, as shown in the application, cadmium laurate had unexpected properties. The court held that it did not matter that the salt was not disclosed as being preferred, the reference still anticipated the claims and because the claim was anticipated, the unexpected properties were immaterial.).

### A GENERIC CHEMICAL FORMULA WILL ANTICIPATE A CLAIMED SPECIES COVERED BY THE FORMULA WHEN THE SPECIES CAN BE “AT ONCE ENVISAGED” FROM THE FORMULA

When the compound is not specifically named, but instead it is necessary to select portions of teachings within a reference and combine them, e.g., select various substituents from a list of alternatives given for placement at specific sites on a generic chemical formula to arrive at a specific composition, anticipation can only be found if the classes of substituents are sufficiently limited or well delineated. *Ex parte A*, 17 USPQ2d 1716 (Bd. Pat. App. & Inter. 1990). If one of ordinary skill in the art is able to “at once envisage” the specific compound within the generic chemical formula, the compound is anticipated. One

of ordinary skill in the art must be able to draw the structural formula or write the name of each of the compounds included in the generic formula before any of the compounds can be “at once envisaged.” One may look to the preferred embodiments to determine which compounds can be anticipated. *In re Petering*, 301 F.2d 676, 133 USPQ 275 (CCPA 1962).

In *In re Petering*, the prior art disclosed a generic chemical formula “wherein X, Y, Z, P, and R’ represent either hydrogen or alkyl radicals, R a side chain containing an OH group.” The court held that this formula, without more, could not anticipate a claim to 7-methyl-9-[d, l’-ribityl]-isoalloxazine because the generic formula encompassed a vast number and perhaps even an infinite number of compounds. However, the reference also disclosed preferred substituents for X, Y, Z, R, and R’ as follows: where X, P, and R’ are hydrogen, where Y and Z may be hydrogen or methyl, and where R is one of eight specific isoalloxazines. The court determined that this more limited generic class consisted of about 20 compounds. The limited number of compounds covered by the preferred formula in combination with the fact that the number of substituents was low at each site, the ring positions were limited, and there was a large unchanging structural nucleus, resulted in a finding that the reference sufficiently described “each of the various permutations here involved as fully as if he had drawn each structural formula or had written each name.” The claimed compound was 1 of these 20 compounds. Therefore, the reference “described” the claimed compound and the reference anticipated the claims.

In *In re Schauman*, 572 F.2d 312, 197 USPQ 5 (CCPA 1978), claims to a specific compound were anticipated because the prior art taught a generic formula embracing a limited number of compounds closely related to each other in structure and the properties possessed by the compound class of the prior art was that disclosed for the claimed compound. The broad generic formula seemed to describe an infinite number of compounds but claim 1 was limited to a structure with only one variable substituent R. This substituent was limited to low alkyl radicals. One of ordinary skill in the art would at once envisage the subject matter within claim 1 of the reference.)

Compare *In re Meyer*, 599 F.2d 1026, 202 USPQ 175 (CCPA 1979) (A reference disclosing “alkaline chlorine or bromine solution” embraces a large number of species and cannot be said to anticipate claims to “alkali metal hypochlorite.”); *Akzo N.V. v. International Trade Comm’n*, 808 F.2d 1471, 1 USPQ2d 1241 (Fed. Cir. 1986) (Claims to a process for making aramid fibers using a 98% solution of sulfuric acid were not anticipated by a reference which disclosed using sulfuric acid solution but which did not disclose using a 98% concentrated sulfuric acid solution.). See MPEP § 2144.08 for a discussion of obviousness in genus-species situations.

### 2131.03 Anticipation of Ranges [R-2]

>

#### I. <A SPECIFIC EXAMPLE IN THE PRIOR ART WHICH IS WITHIN A CLAIMED RANGE ANTICIPATES THE RANGE

“[W]hen, as by a recitation of ranges or otherwise, a claim covers several compositions, the claim is ‘anticipated’ if *one* of them is in the prior art.” *Titanium Metals Corp. v. Banner*, 778 F.2d 775, 227 USPQ 773 (Fed. Cir. 1985) (citing *In re Petering*, 301 F.2d 676, 682, 133 USPQ 275, 280 (CCPA 1962)) (emphasis in original) (Claims to titanium (Ti) alloy with 0.6-0.9% nickel (Ni) and 0.2-0.4% molybdenum (Mo) were held anticipated by a graph in a Russian article on Ti-Mo-Ni alloys because the graph contained an actual data point corresponding to a Ti alloy containing 0.25% Mo and 0.75% Ni and this composition was within the claimed range of compositions.).

>

#### II. <PRIOR ART WHICH TEACHES A RANGE WITHIN, OVERLAPPING, OR TOUCHING THE CLAIMED RANGE ANTICIPATES IF THE PRIOR ART RANGE DISCLOSES THE CLAIMED RANGE WITH “SUFFICIENT SPECIFICITY”

When the prior art discloses a range which touches, overlaps or is within the claimed range, but no specific examples falling within the claimed range are disclosed, a case by case determination must be made as to anticipation. In order to anticipate the claims, the claimed subject matter must be disclosed in the reference with “sufficient specificity to consti-

tute an anticipation under the statute.” What constitutes a “sufficient specificity” is fact dependent. If the claims are directed to a narrow range, the reference teaches a broad range, and there is evidence of unexpected results within the claimed narrow range, depending on the other facts of the case, it may be reasonable to conclude that the narrow range is not disclosed with “sufficient specificity” to constitute an anticipation of the claims. The unexpected results may also render the claims unobvious. The question of “sufficient specificity” is similar to that of “clearly envisaging” a species from a generic teaching. See MPEP § 2131.02. A 35 U.S.C. 102/103 combination rejection is permitted if it is unclear if the reference teaches the range with “sufficient specificity.” The examiner must, in this case, provide reasons for anticipation as well as a motivational statement regarding obviousness. *Ex parte Lee*, 31 USPQ2d 1105 (Bd. Pat. App. & Inter. 1993) (expanded Board). For a discussion of the obviousness of ranges see MPEP § 2144.05.

>

### III. PRIOR ART WHICH TEACHES A VALUE OR RANGE THAT IS VERY CLOSE TO, BUT DOES NOT OVERLAP OR TOUCH, THE CLAIMED RANGE DOES NOT ANTICIPATE THE CLAIMED RANGE

“[A]nticipation under § 102 can be found only when the reference discloses exactly what is claimed and that where there are differences between the reference disclosure and the claim, the rejection must be based on § 103 which takes differences into account.” *Titanium Metals Corp. v. Banner*, 778 F.2d 775, 227 USPQ 773 (Fed. Cir. 1985) (Claims to titanium (Ti) alloy with 0.8% nickel (Ni) and 0.3% molybdenum (Mo) were not anticipated by, although they were held obvious over, a graph in a Russian article on Ti-Mo-Ni alloys in which the graph contained an actual data point corresponding to a Ti alloy containing 0.25% Mo and 0.75% Ni.).<

#### 2131.04 Secondary Considerations

Evidence of secondary considerations, such as unexpected results or commercial success, is irrelevant to 35 U.S.C. 102 rejections and thus cannot overcome a rejection so based. *In re Wiggins*, 488 F.2d 538, 543, 179 USPQ 421, 425 (CCPA 1973).

#### 2131.05 Nonanalogous Art [R-2]

“Arguments that the alleged anticipatory prior art is ‘nonanalogous art’ or ‘teaches away from the invention’ or is not recognized as solving the problem solved by the claimed invention, [are] not ‘germane’ to a rejection under section 102.” *Twin Disc, Inc. v. United States*, 231 USPQ 417, 424 (Cl. Ct. 1986) (quoting *In re Self*, 671 F.2d 1344, 213 USPQ 1, 7 (CCPA 1982)). >See also *State Contracting & Eng’g Corp. v. Condotte America, Inc.*, 346 F.3d 1057, 1068, 68 USPQ2d 1481, 1488 (Fed. Cir. 2003) (The question of whether a reference is analogous art is not relevant to whether that reference anticipates. A reference may be directed to an entirely different problem than the one addressed by the inventor, or may be from an entirely different field of endeavor than that of the claimed invention, yet the reference is still anticipatory if it explicitly or inherently discloses every limitation recited in the claims.).<

A reference is no less anticipatory if, after disclosing the invention, the reference then disparages it. The question whether a reference “teaches away” from the invention is inapplicable to an anticipation analysis. *Celeritas Technologies Ltd. v. Rockwell International Corp.*, 150 F.3d 1354, 1361, 47 USPQ2d 1516, 1522-23 (Fed. Cir. 1998) (The prior art was held to anticipate the claims even though it taught away from the claimed invention. “The fact that a modem with a single carrier data signal is shown to be less than optimal does not vitiate the fact that it is disclosed.”). See also *Atlas Powder Co. v. IRECO, Inc.*, 190 F.3d 1342, 1349, 51 USPQ2d 1943, 1948 (Fed. Cir. 1999) (Claimed composition was anticipated by prior art reference that inherently met claim limitation of “sufficient aeration” even though reference taught away from air entrapment or purposeful aeration.).

#### 2132 35 U.S.C. 102(a)

*35 U.S.C. 102. Conditions for patentability; novelty and loss of right to patent.*

A person shall be entitled to a patent unless -

(a) the invention was known or used by others in this country, or patented or described in a printed publication in this or a foreign country, before the invention thereof by the applicant for a patent.

\*\*\*\*\*



**I. “KNOWN OR USED”****“Known or Used” Means Publicly Known or Used**

“The statutory language ‘known or used by others in this country’ (35 U.S.C. § 102(a)), means knowledge or use which is accessible to the public.” *Carella v. Starlight Archery*, 804 F.2d 135, 231 USPQ 644 (Fed. Cir. 1986). The knowledge or use is accessible to the public if there has been no deliberate attempt to keep it secret. *W. L. Gore & Assoc. v. Garlock, Inc.*, 721 F.2d 1540, 220 USPQ 303 (Fed. Cir. 1983).

See MPEP § 2128 - § 2128.02 for case law concerning public accessibility of publications.

**Another’s Sale of a Product Made by a Secret Process Can Be a 35 U.S.C. 102(a) Public Use if the Process Can Be Determined by Examining the Product**

“The nonsecret use of a claimed process in the usual course of producing articles for commercial purposes is a public use.” But a secret use of the process coupled with the sale of the product does not result in a public use of the process unless the public could learn the claimed process by examining the product. Therefore, secret use of a process by another, even if the product is commercially sold, cannot result in a rejection under 35 U.S.C. 102(a) if an examination of the product would not reveal the process. *Id.*

**II. “IN THIS COUNTRY”****Only Knowledge or Use in the U.S. Can Be Used in a 35 U.S.C. 102(a) Rejection**

The knowledge or use relied on in a 35 U.S.C. 102(a) rejection must be knowledge or use “in this country.” Prior knowledge or use which is not present in the United States, even if widespread in a foreign country, cannot be the basis of a rejection under 35 U.S.C. 102(a). *In re Ekenstam*, 256 F.2d 321, 118 USPQ 349 (CCPA 1958). Note that the changes made to 35 U.S.C. 104 by NAFTA (Public Law 103-182) and Uruguay Round Agreements Act (Public Law 103-465) do not modify the meaning of “in this country” as used in 35 U.S.C. 102(a) and thus “in this country” still means in the United States for purposes of 35 U.S.C. 102(a) rejections.

**III. “BY OTHERS”****“Others” Means Any Combination of Authors or Inventors Different Than the Inventive Entity**

The term “others” in 35 U.S.C. 102(a) refers to any entity which is different from the inventive entity. The entity need only differ by one person to be “by others.” This holds true for all types of references eligible as prior art under 35 U.S.C. 102(a) including publications as well as public knowledge and use. Any other interpretation of 35 U.S.C. 102(a) “would negate the one year [grace] period afforded under § 102(b).” *In re Katz*, 687 F.2d 450, 215 USPQ 14 (CCPA 1982).

**IV. “PATENTED IN THIS OR A FOREIGN COUNTRY”**

See MPEP § 2126 for information on the use of secret patents as prior art.

**2132.01 Publications as 35 U.S.C. 102(a) Prior Art****35 U.S.C. 102(a) PRIMA FACIE CASE IS ESTABLISHED IF REFERENCE PUBLICATION IS “BY OTHERS”**

A *prima facie* case is made out under 35 U.S.C. 102(a) if, within 1 year of the filing date, the invention, or an obvious variant thereof, is described in a “printed publication” whose authorship differs in any way from the inventive entity unless it is stated within the publication itself that the publication is describing the applicant’s work. *In re Katz*, 687 F.2d 450, 215 USPQ 14 (CCPA 1982). See MPEP § 2128 for case law on what constitutes a “printed publication.” Note that when the reference is a U.S. patent published within the year prior to the application filing date, a 35 U.S.C. 102(e) rejection should be made. See MPEP § 2136 - § 2136.05 for case law dealing with 102(e).

**APPLICANT CAN REBUT PRIMA FACIE CASE BY SHOWING REFERENCE’S DISCLOSURE WAS DERIVED FROM APPLICANT’S OWN WORK**

Applicant’s disclosure of his or her own work within the year before the application filing date cannot be used against him or her under 35 U.S.C.

102(a). *In re Katz*, 687 F.2d 450, 215 USPQ 14 (CCPA 1982) (discussed below). Therefore, where the applicant is one of the co-authors of a publication cited against his or her application, the publication may be removed as a reference by the filing of affidavits made out by the other authors establishing that the relevant portions of the publication originated with, or were obtained from, applicant. Such affidavits are called disclaiming affidavits. *Ex parte Hirschler*, 110 USPQ 384 (Bd. App. 1952). The rejection can also be overcome by submission of a specific declaration by the applicant establishing that the article is describing applicant's own work. *In re Katz*, 687 F.2d 450, 215 USPQ 14 (CCPA 1982). However, if there is evidence that the co-author has refused to disclaim inventorship and believes himself or herself to be an inventor, applicant's affidavit will not be enough to establish that applicant is the sole inventor and the rejection will stand. *Ex parte Kroger*, 219 USPQ 370 (Bd. Pat. App. & Int. 1982) (discussed below). It is also possible to overcome the rejection by adding the coauthors as inventors to the application if the requirements of 35 U.S.C. 116, third paragraph are met. *In re Searles*, 422 F.2d 431, 164 USPQ 623 (CCPA 1970).

In *In re Katz*, 687 F.2d 450, 215 USPQ 14 (CCPA 1982), Katz stated in a declaration that the coauthors of the publication, Chiorazzi and Eshhar, "were students working under the direction and supervision of the inventor, Dr. David H. Katz." The court held that this declaration, in combination with the fact that the publication was a research paper, was enough to establish Katz as the sole inventor and that the work described in the publication was his own. In research papers, students involved only with assay and testing are normally listed as coauthors but are not considered co-inventors.

In *Ex parte Kroger*, 219 USPQ 370 (Bd. Pat. App. & Inter. 1982), Kroger, Knaster and others were listed as authors on an article on photovoltaic power generation. The article was used to reject the claims of an application listing Kroger and Rod as inventors. Kroger and Rod submitted affidavits declaring themselves to be the inventors. The affidavits also stated that Knaster merely carried out assignments and

worked under the supervision and direction of Kroger. The Board stated that if this were the only evidence in the case, it would be established, under *In re Katz*, that Kroger and Rod were the only inventors. However, in this case, there was evidence that Knaster had refused to sign an affidavit disclaiming inventorship and Knaster had introduced evidence into the case in the form of a letter to the PTO in which he alleged that he was a co-inventor. The Board held that the evidence had not been fully developed enough to overcome the rejection. Note that the rejection had been made under 35 U.S.C. 102(f) but the Board treated the issue the same as if it had arisen under 35 U.S.C. 102(a). See also case law dealing with overcoming 102(e) rejections as presented in MPEP § 2136.05. Many of the issues are the same.

### **A 37 CFR 1.131 AFFIDAVIT CAN BE USED TO OVERCOME A 35 U.S.C. 102(a) REJECTION**

When the reference is not a statutory bar under 35 U.S.C. 102(b), (c), or (d), applicant can overcome the rejection by swearing back of the reference through the submission of an affidavit under 37 CFR 1.131. *In re Foster*, 343 F.2d 980, 145 USPQ 166 (CCPA 1965). If the reference is disclosing applicant's own work as derived from him or her, applicant may submit either a 37 CFR 1.131 affidavit to ante-date the reference or a 37 CFR 1.132 affidavit to show derivation of the reference subject matter from applicant and invention by applicant. *In re Facius*, 408 F.2d 1396, 161 USPQ 294 (CCPA 1969). See MPEP § 715 for more information on when an affidavit under 37 CFR 1.131 can be used to overcome a reference and what evidence is required.

### **2133 35 U.S.C. 102(b)**

*35 U.S.C. 102. Conditions for patentability; novelty and loss of right to patent.*

A person shall be entitled to a patent unless -

\*\*\*\*\*

(b) the invention was patented or described in a printed publication in this or a foreign country or in public use or on sale in this country, more than one year prior to the date of application for patent in the United States.

\*\*\*\*\*

### **THE 1-YEAR GRACE PERIOD IS EXTENDED TO THE NEXT WORKING DAY IF IT WOULD OTHERWISE END ON A HOLIDAY OR WEEK-END**

Publications, patents, public uses and sales must occur “more than one year prior to the date of application for patent in the United States” in order to bar a patent under 35 U.S.C. 102(b). However, applicant’s own activity will not bar a patent if the 1-year grace period expires on a Saturday, Sunday, or Federal holiday and the application’s U.S. filing date is the next succeeding business day. *Ex parte Olah*, 131 USPQ 41 (Bd. App. 1960). Despite changes to 37 CFR 1.6(a)(2) and 1.10 which require the PTO to accord a filing date to an application as of the date of deposit as “Express Mail” with the U.S. Postal Service in accordance with 37 CFR 1.10 (e.g., a Saturday filing date), the rule changes do not affect applicant’s concurrent right to defer the filing of an application until the next business day when the last day for “taking any action” falls on a Saturday, Sunday, or a Federal holiday (e.g., the last day of the 1-year grace period falls on a Saturday).

### **THE 1-YEAR TIME BAR IS MEASURED FROM THE U.S. FILING DATE**

If one discloses his or her own work more than 1 year before the filing of the patent application, that person is barred from obtaining a patent. *In re Katz*, 687 F.2d 450, 454, 215 USPQ 14, 17 (CCPA 1982). The 1-year time bar is measured from the U.S. filing date. Thus, applicant will be barred from obtaining a patent if the public came into possession of the invention on a date before the 1-year grace period ending with the U.S. filing date. It does not matter how the public came into possession of the invention. Public possession could occur by a public use, public sale, a publication, a patent or any combination of these. In addition, the prior art need not be identical to the claimed invention but will bar patentability if it is an obvious variant thereof. *In re Foster*, 343 F.2d 980, 145 USPQ 166 (CCPA 1966). See MPEP § 706.02 regarding the effective U.S. filing date of an application.

### **2133.01 Rejections of Continuation-In-Part (CIP) Applications**

When applicant files a continuation-in-part whose claims are not supported by the parent application, the effective filing date is the filing date of the child CIP. Any prior art disclosing the invention or an obvious variant thereof having a critical reference date more than 1 year prior to the filing date of the child will bar the issuance of a patent under 35 U.S.C. 102(b). *Paperless Accounting v. Bay Area Rapid Transit System*, 804 F.2d 659, 665, 231 USPQ 649, 653 (Fed. Cir. 1986).

### **2133.02 Rejections Based on Publications and Patents**

#### **APPLICANT’S OWN WORK WHICH WAS AVAILABLE TO THE PUBLIC BEFORE THE GRACE PERIOD MAY BE USED IN A 35 U.S.C. 102(b) REJECTION**

“Any invention described in a printed publication more than one year prior to the date of a patent application is prior art under Section 102(b), even if the printed publication was authored by the patent applicant.” *De Graffenried v. United States*, 16 USPQ2d 1321, 1330 n.7 (Cl. Ct. 1990). “Once an inventor has decided to lift the veil of secrecy from his [or her] work, he [or she] must choose between the protection of a federal patent, or the dedication of his [or her] idea to the public at large.” *Bonito Boats, Inc. v. Thunder Craft Boats, Inc.*, 489 U.S. 141, 148, 9 USPQ2d 1847, 1851 (1989).

#### **A 35 U.S.C. 102(b) REJECTION CREATES A STATUTORY BAR TO PATENTABILITY OF THE REJECTED CLAIMS**

A rejection under 35 U.S.C. 102(b) cannot be overcome by affidavits and declarations under 37 CFR 1.131 (Rule 131 Declarations), foreign priority dates, or evidence that applicant himself invented the subject matter. Outside the 1-year grace period, applicant is barred from obtaining a patent containing any anticipated or obvious claims. *In re Foster*, 343 F.2d 980, 984, 145 USPQ 166, 170 (CCPA 1965).

### 2133.03 Rejections Based on “Public Use” or “On Sale” [R-1]

35 U.S.C. 102(b) “contains several distinct bars to patentability, each of which relates to activity or disclosure more than one year prior to the date of the application. Two of these - the ‘public use’ and the ‘on sale’ objections - are sometimes considered together although it is quite clear that either may apply when the other does not.” *Dart Indus. v. E.I. du Pont de Nemours & Co.*, 489 F.2d 1359, 1365, 179 USPQ 392, 396 (7th Cir. 1973). There may be a public use of an invention absent any sales activity. Likewise, there may be a nonpublic, e.g., “secret,” sale or offer to sell an invention which nevertheless constitutes a statutory bar. *Hobbs v. United States*, 451 F.2d 849, 859-60, 171 USPQ 713, 720 (5th Cir. 1971).

In similar fashion, not all “public use” and “on sale” activities will necessarily occasion the identical result. Although both activities affect how an inventor may use an invention prior to the filing of a patent application, “non-commercial” 35 U.S.C. 102(b) activity may not be viewed the same as similar “commercial” activity. See MPEP § 2133.03(a) and § 2133.03(e)(1). Likewise, “public use” activity by an applicant may not be considered in the same light as similar “public use” activity by one other than an applicant. See MPEP § 2133.03(a) and § 2133.03(e)(7). Additionally, the concepts of “completion” and “experimental use” have differing significance in “commercial” and “non-commercial” environments. See MPEP § 2133.03(c) and § 2133.03(e) - § 2133.03(e)(6).

It should be noted that 35 U.S.C. 102(b) may create a bar to patentability either alone, if the device in public use or placed on sale anticipates a later claimed invention, or in conjunction with 35 U.S.C. 103, if the claimed invention would have been obvious from the device in conjunction with the prior art. *LaBounty Mfg. v. United States Int’l Trade Comm’n*, 958 F.2d 1066, 1071, 22 USPQ2d 1025, 1028 (Fed. Cir. 1992).

#### POLICY CONSIDERATIONS

(A) “One policy underlying the [on-sale] bar is to obtain widespread disclosure of new inventions to the public via patents as soon as possible.” *RCA Corp. v. Data Gen. Corp.*, 887 F.2d 1056, 1062, 12 USPQ2d 1449, 1454 (Fed. Cir. 1989).

(B) \* >Another policy underlying the< public use and on-sale bars \*\* >is< to prevent the inventor from commercially exploiting the exclusivity of his [or her] invention substantially beyond the statutorily authorized period. *RCA Corp. v. Data Gen. Corp.*, 887 F.2d 1056, 1062, 12 USPQ2d 1449, 1454 (Fed. Cir. 1989). See MPEP § 2133.03(e)(1).

(C) Another underlying policy for the public use and on-sale bars is to discourage “the removal of inventions from the public domain which the public justifiably comes to believe are freely available.” *Manville Sales Corp. v. Paramount Sys., Inc.*, 917 F.2d 544, 549, 16 USPQ2d 1587, 1591 (Fed. Cir. 1990).

### 2133.03(a) “Public Use”

#### ONE USE IN THE PUBLIC DOMAIN BY ONE PERSON MAY BAR A PATENT

“[T]o constitute the public use of an invention it is not necessary that more than one of the patent articles should be publicly used. The use of a great number may tend to strengthen the proof, but one well defined case of such use is just as effectual to annul the patent as many.” Likewise, it is not necessary that more than one person use the invention. *Egbert v. Lippmann*, 104 U.S. 333, 336 (1881).

#### PUBLIC KNOWLEDGE IS NOT NECESSARILY PUBLIC USE UNDER 35 U.S.C. 102(b)

Mere knowledge of the invention by the public does not warrant rejection under 35 U.S.C. 102(b). 35 U.S.C. 102(b) bars public use or sale, not public knowledge. *TP Labs., Inc., v. Professional Positioners, Inc.*, 724 F.2d 965, 970, 220 USPQ 577, 581 (Fed. Cir. 1984).

Note, however, that public knowledge may provide grounds for rejection under 35 U.S.C. 102(a). See MPEP § 2132.

#### A. Commercial Versus Noncommercial Use and the Impact of Secrecy

##### 1. “Public Use” and “Non-secret Use” Are Not Necessarily Synonymous

“Public” is not necessarily synonymous with “non-secret.” The fact “that non-secret uses of the device were made [by the inventor or someone connected

with the inventor] prior to the critical date is not itself dispositive of the issue of whether activity barring a patent under 35 U.S.C. 102(b) occurred. The fact that the device was not hidden from view may make the use not secret, but nonsecret use is not *ipso facto* ‘public use’ activity. Nor, it must be added, is all secret use *ipso facto* not ‘public use’ within the meaning of the statute,” if the inventor is making commercial use of the invention under circumstances which preserve its secrecy. *TP Labs., Inc. v. Professional Positioners, Inc.*, 724 F.2d 965, 972, 220 USPQ 577, 583 (Fed. Cir. 1983) (citations omitted).

## 2. Even If the Invention Is Hidden, Inventor Who Puts Machine or Article Embodying the Invention in Public View Is Barred from Obtaining a Patent as the Invention Is in Public Use

When the inventor or someone connected to the inventor puts the invention on display or sells it, there is a “public use” within the meaning of 35 U.S.C. 102(b) even though by its very nature an invention is completely hidden from view as part of a larger machine or article, if the invention is otherwise used in its natural and intended way and the larger machine or article is accessible to the public. *In re Blaisdell*, 242 F.2d 779, 783, 113 USPQ 289, 292 (CCPA 1957); *Hall v. Macneale*, 107 U.S. 90, 96-97 (1882); *Ex parte Kuklo*, 25 USPQ2d 1387, 1390 (Bd. Pat. App. & Inter. 1992) (Display of equipment including the structural features of the claimed invention to visitors of laboratory is public use even though public did not see inner workings of device. The person to whom the invention is publicly disclosed need not understand the significance and technical complexities of the invention.).

## 3. There Is No Public Use If Inventor Restricted Use to Locations Where There Was a Reasonable Expectation of Privacy and the Use Was for His or Her Own Enjoyment

An inventor’s private use of the invention, for his or her own enjoyment is not a public use. *Moleculon Research Corp. v. CBS, Inc.*, 793 F.2d 1261, 1265, 229 USPQ 805, 809 (Fed. Cir. 1986) (Inventor showed inventive puzzle to close friends while in his dorm room and later the president of the company at

which he was working saw the puzzle on the inventor’s desk and they discussed it. Court held that the inventor retained control and thus these actions did not result in a “public use.”).

## B. Use by Third Parties Deriving the Invention from Applicant

### An Invention Is in Public Use If the Inventor Allows Another To Use the Invention Without Restriction or Obligation of Secrecy

“Public use” of a claimed invention under 35 U.S.C. 102(b) occurs when the inventor allows another person to use the invention without limitation, restriction or obligation of secrecy to the inventor.” *In re Smith*, 714 F.2d 1127, 1134, 218 USPQ 976, 983 (Fed. Cir. 1983). The presence or absence of a confidentiality agreement is not itself determinative of the public use issue, but is one factor to be considered along with the time, place, and circumstances of the use which show the amount of control the inventor retained over the invention. *Moleculon Research Corp. v. CBS, Inc.*, 793 F.2d 1261, 1265, 229 USPQ 805, 809 (Fed. Cir. 1986). See *Ex parte C*, 27 USPQ2d 1492, 1499 (Bd. Pat. App. & Inter. 1992) (Inventor sold inventive soybean seeds to growers who contracted and were paid to plant the seeds to increase stock for later sale. The commercial nature of the use of the seed coupled with the “on-sale” aspects of the contract and apparent lack of confidentiality requirements rose to the level of a “public use” bar.); *Egbert v. Lippmann*, 104 U.S. 333, 336 (1881) (Public use found where inventor allowed another to use inventive corset insert, though hidden from view during use, because he did not impose an obligation of secrecy or restrictions on its use.).

## C. Use by Independent Third Parties

### Use by an Independent Third Party Is Public Use If It Sufficiently “Informs” the Public of the Invention or a Competitor Could Reasonably Ascertain the Invention

Any “nonsecret” use of an invention by someone unconnected to the inventor, such as someone who has independently made the invention, in the ordinary course of a business for trade or profit may be a “public use,” *Bird Provision Co. v. Owens Country Sausage, Inc.*, 568 F.2d 369, 374-76, 197 USPQ

134, 138-40 (5th Cir. 1978). Additionally, even a “secret” use by another inventor of a machine or process to make a product is “public” if the details of the machine or process are ascertainable by inspection or analysis of the product that is sold or publicly displayed. *Gillman v. Stern*, 114 F.2d 28, 46 USPQ 430 (2d Cir. 1940); *Dunlop Holdings, Ltd. v. Ram Golf Corp.*, 524 F.2d 33, 36-7, 188 USPQ 481, 483-484 (7th Cir. 1975). If the details of an inventive process are not ascertainable from the product sold or displayed and the third party has kept the invention as a trade secret then that use is not a public use and will not bar a patent issuing to someone unconnected to the user. *W.L. Gore & Assocs. v. Garlock, Inc.*, 721 F.2d 1540, 1550, 220 USPQ 303, 310 (Fed. Cir. 1983). However, a device qualifies as prior art if it places the claimed features in the public's possession before the critical date even if other unclaimed aspects of the device were not publicly available. *Lockwood v. American Airlines, Inc.*, 41 USPQ2d 1961, 1964-65 (Fed. Cir. 1997) (Computer reservation system was prior art even though “essential algorithms of the SABRE software were proprietary and confidential and...those aspects of the system that were readily apparent to the public would not have been sufficient to enable one skilled in the art to duplicate the [unclaimed aspects of the] system.”). The extent that the public becomes “informed” of an invention involved in public use activity by one other than an applicant depends upon the factual circumstances surrounding the activity and how these comport with the policies underlying the on sale and public use bars. *Manville Sales Corp. v. Paramount Sys., Inc.*, 917 F.2d 544, 549, 16 USPQ2d 1587, 1591 (Fed. Cir. 1990) (quoting *King Instrument Corp. v. Otari Corp.*, 767 F.2d 833, 860, 226 USPQ 402, 406 (Fed. Cir. 1985)). By way of example, in an allegedly “secret” use by a third party other than an applicant, if a large number of employees of such a party, who are not under a promise of secrecy, are permitted unimpeded access to an invention, with affirmative steps by the party to educate other employees as to the nature of the invention, the public is “informed.” *Chemithon Corp. v. Proctor & Gamble Co.*, 287 F. Supp. 291, 308, 159 USPQ 139, 154 (D.Md. 1968), *aff’d.*, 427 F.2d 893, 165 USPQ 678 (4th Cir. 1970).

Even if public use activity by one other than an applicant is not sufficiently “informing,” there may be

adequate grounds upon which to base a rejection under 35 U.S.C. 102(f) and 35 U.S.C. 102(g). See *Dunlop Holdings Ltd. v. Ram Golf Corp.*, 524 F.2d 33, 188 USPQ 481 (7th Cir. 1975). See MPEP § 2137 and § 2138.

### 2133.03(b) “On Sale” [R-2]

An impermissible sale has occurred if there was a definite sale, or offer to sell, more than 1 year before the effective filing date of the U.S. application and the subject matter of the sale, or offer to sell, fully anticipated the claimed invention or would have rendered the claimed invention obvious by its addition to the prior art. *Ferag AG v. Quipp, Inc.*, 45 F.3d 1562, 1565, 33 USPQ2d 1512, 1514 (Fed. Cir. 1995). The on-sale bar of 35 U.S.C. 102(b) is triggered if the invention is both (1) the subject of a commercial offer for sale not primarily for experimental purposes and (2) ready for patenting. *Pfaff v. Wells Elecs., Inc.*, 525 U.S. 55, 67, 48 USPQ2d 1641, 1646-47 (1998). Traditional contract law principles are applied when determining whether a commercial offer for sale has occurred. See *Linear Tech. Corp. v. Micrel, Inc.*, 275 F.3d 1040, 1048, 61 USPQ2d 1225, 1229 (Fed. Cir. 2001), *petition for cert. filed*, 71 USLW 3093 (Jul. 03, 2002) (No. 02-39); *Group One, Ltd. v. Hallmark Cards, Inc.*, 254 F.3d 1041, 1047, 59 USPQ2d 1121, 1126 (Fed. Cir. 2001) (“As a general proposition, we will look to the Uniform Commercial Code (‘UCC’) to define whether ... a communication or series of communications rises to the level of a commercial offer for sale.”).

#### I. THE MEANING OF “SALE”

A sale is a contract between parties wherein the seller agrees “to give and to pass rights of property” in return for the buyer’s payment or promise “to pay the seller for the things bought or sold.” *In re Caveney*, 761 F.2d 671, 676, 226 USPQ 1, 4 (Fed. Cir. 1985). A contract for the sale of goods requires a concrete offer and acceptance of that offer. See, e.g., *Linear Tech.*, 275 F.3d at 1052-54, 61 USPQ2d at 1233-34 (Court held there was no sale within the meaning of 35 U.S.C. 102(b) where prospective purchaser submitted an order for goods at issue, but received an order acknowledgement reading “will advise-not booked.” Prospective purchaser would understand that order was not accepted.).

**A. Conditional Sale May Bar a Patent**

An invention may be deemed to be “on sale” even though the sale was conditional. The fact that the sale is conditioned on buyer satisfaction does not, without more, prove that the sale was for an experimental purpose. *Strong v. General Elec. Co.*, 434 F.2d 1042, 1046, 168 USPQ 8, 12 (5th Cir. 1970).

**B. Nonprofit Sale May Bar a Patent**

A “sale” need not be for profit to bar a patent. If the sale was for the commercial exploitation of the invention, it is “on sale” within the meaning of 35 U.S.C. 102(b). *In re Dybel*, 524 F.2d 1393, 1401, 187 USPQ 593, 599 (CCPA 1975) (“Although selling the devices for a profit would have demonstrated the purpose of commercial exploitation, the fact that appellant realized no profit from the sales does not demonstrate the contrary.”).

**C. A Single Sale or Offer To Sell May Bar a Patent**

Even a single sale or offer to sell the invention may bar patentability under 35 U.S.C. 102(b). *Consolidated Fruit-Jar Co. v. Wright*, 94 U.S. 92, 94 (1876); *Atlantic Thermoplastics Co. v. Faytex Corp.*, 970 F.2d 834, 836-37, 23 USPQ2d 1481, 1483 (Fed. Cir. 1992).

**D. A Sale of Rights Is Not a Sale of the Invention and Will Not in Itself Bar a Patent**

\*\*>”[A]n assignment or sale of the rights in the invention and potential patent rights is not a sale of ‘the invention’ within the meaning of section 102(b).” *Moleculon Research Corp. v. CBS, Inc.*, 793 F.2d 1261, 1267, 229 USPQ 805, 809 (Fed. Cir. 1986); see also *In re Kollar*, 286 F.3d 1326, 1330 n.3, 1330-1331, 62 USPQ2d 1425, 1428 n.3, 1428-1429 (Fed. Cir. 2002) (distinguishing licenses which trigger the on-sale bar (e.g., a standard computer software license wherein the product is just as immediately transferred to the licensee as if it were sold), from licenses that merely grant rights to an invention which do not *per se* trigger the on-sale bar (e.g., exclusive rights to market the invention or potential patent rights)); *Group One, Ltd. v. Hallmark Cards, Inc.*, 254 F.3d 1041, 1049 n. 2, 59 USPQ2d 1121, 1129 n. 2 (Fed. Cir. 2001).<

**E. Buyer Must Be Uncontrolled by the Seller or Offerer**

A sale or offer for sale must take place between separate entities. *In re Caveney*, 761 F.2d 671, 676, 226 USPQ 1, 4 (Fed. Cir. 1985). “Where the parties to the alleged sale are related, whether there is a statutory bar depends on whether the seller so controls the purchaser that the invention remains out of the public’s hands. *Ferag AG v. Quipp, Inc.*, 45 F.3d 1562, 1566, 33 USPQ2d 1512, 1515 (Fed. Cir. 1995) (Where the seller is a parent company of the buyer company, but the President of the buyer company had “essentially unfettered” management authority over the operations of the buyer company, the sale was a statutory bar.).

**II. OFFERS FOR SALE**

“Only an offer which rises to the level of a commercial offer for sale, one which the other party could make into a binding contract by simple acceptance (assuming consideration), constitutes an offer for sale under §102(b).” *Group One, Ltd. v. Hallmark Cards, Inc.*, 254 F.3d 1041,1048, 59 USPQ2d 1121, 1126 (Fed. Cir. 2001).

**A. Rejected or Unreceived Offer for Sale Is Enough To Bar a Patent**

Since the statute creates a bar when an invention is placed “on sale,” a mere offer to sell is sufficient commercial activity to bar a patent. *In re Theis*, 610 F.2d 786, 791, 204 USPQ 188, 192 (CCPA 1979). Even a rejected offer may create an on sale bar. *UMC Elecs. v. United States*, 816 F.2d 647, 653, 2 USPQ2d 1465, 1469 (Fed. Cir. 1987). In fact, the offer need not even be actually received by a prospective purchaser. *Wende v. Horine*, 225 F. 501 (7th Cir. 1915).

**B. Delivery of the Offered Item Is Not Required**

“It is not necessary that a sale be consummated for the bar to operate.” *Buildex v. Kason Indus., Inc.*, 849 F.2d 1461, 1463-64, 7 USPQ2d 1325, 1327-28 (Fed. Cir. 1988) (citations omitted). See also *Weatherchem Corp. v. J.L. Clark Inc.*, 163 F.3d 1326, 1333, 49 USPQ2d 1001, 1006-07 (Fed. Cir. 1998) (A signed purchase agreement prior to the critical date constituted a commercial offer; it was immaterial that there

was no delivery of later patented caps and no exchange of money until after critical date.).

**C. Seller Need Not Have the Goods “On Hand” when the Offer for Sale Is Made**

Goods need not be “on hand” and transferred at the time of the sale or offer. The date of the offer for sale is the effective date of the “on sale” activity. *J. A. La Porte, Inc. v. Norfolk Dredging Co.*, 787 F.2d 1577, 1582, 229 USPQ 435, 438 (Fed. Cir. 1986). However, the invention must be complete and “ready for patenting” (see MPEP § 2133.03(c)) before the critical date. *Pfaff v. Wells Elecs., Inc.*, 525 U.S. 55, 67, 119 S.Ct. 304, 311-12, 48 USPQ2d 1641, 1647 (1998). See also *Micro Chemical, Inc. v. Great Plains Chemical Co.*, 103 F.3d 1538, 1545, 41 USPQ2d 1238, 1243 (Fed. Cir. 1997) (The on-sale bar was not triggered by an offer to sell because the inventor “was not close to completion of the invention at the time of the alleged offer and had not demonstrated a high likelihood that the invention would work for its intended purpose upon completion.”); *Shatterproof Glass Corp. v. Libbey-Owens Ford Co.*, 758 F.2d 613, 225 USPQ 634 (Fed. Cir. 1985) (Where there was no evidence that the samples shown to the potential customers were made by the new process and apparatus, the offer to sell did not rise to the level of an on sale bar.). Compare *Barmag Barmer Maschinenfabrik AG v. Murata Mach., Ltd.*, 731 F.2d 831, 221 USPQ 561 (Fed. Cir. 1984) (Where a “make shift” model of the inventive product was shown to the potential purchasers in conjunction with the offer to sell, the offer was enough to bar a patent under 35 U.S.C. 102(b).).

**III. SALE BY INVENTOR, ASSIGNEE OR OTHERS ASSOCIATED WITH THE INVENTOR IN THE COURSE OF BUSINESS**

**A. Sale Activity Need Not Be Public**

Unlike questions of public use, there is no requirement that “on sale” activity be “public.” “Public” as used in 35 U.S.C. 102(b) modifies “use” only. “Public” does not modify “sale.” *Hobbs v. United States*, 451 F.2d 849, 171 USPQ 713, 720 (5th Cir. 1971).

**B. Inventor’s Consent to the Sale Is Not a Prerequisite To Finding an On Sale Bar**

If the invention was placed on sale by a third party who obtained the invention from the inventor, a patent is barred even if the inventor did not consent to the sale or have knowledge that the invention was embodied in the sold article. *Electric Storage Battery Co. v. Shimadzu*, 307 U.S. 5, 41 USPQ 155 (1938); *In re Blaisdell*, 242 F.2d 779, 783, 113 USPQ 289, 292 (CCPA 1957); *CTS Corp. v. Electro Materials Corp. of America*, 469 F. Supp. 801, 819, 202 USPQ 22, 38 (S.D.N.Y. 1979).

**C. Objective Evidence of Sale or Offer To Sell Is Needed**

In determining if a sale or offer to sell the claimed invention has occurred, a key question to ask is whether, under the totality of the circumstances, the inventor sold or offered for sale a product that embodies the invention claimed in the application. Objective evidence such as a description of the inventive product in the contract of sale or in another communication with the purchaser controls over an uncommunicated intent by the seller to deliver the inventive product under the contract for sale. *Ferag AG v. Quipp, Inc.*, 45 F.3d 1562, 1567, 33 USPQ2d 1512, 1516 (Fed. Cir. 1995) (On sale bar found where initial negotiations and agreement containing contract for sale neither clearly specified nor precluded use of the inventive design, but an order confirmation prior to the critical date did specify use of inventive design.). The purchaser need not have actual knowledge of the invention for it to be on sale. The determination of whether “the offered product is in fact the claimed invention may be established by any relevant evidence, such as memoranda, drawings, correspondence, and testimony of witnesses.” *RCA Corp. v. Data Gen. Corp.*, 887 F.2d 1056, 1060, 12 USPQ2d 1449, 1452 (Fed. Cir. 1989). However, “what the purchaser reasonably believes the inventor to be offering is relevant to whether, on balance, the offer objectively may be said to be of the patented invention.” *Envirotech Corp. v. Westech Eng’g, Inc.*, 904 F.2d 1571, 1576, 15 USPQ2d 1230, 1234 (Fed. Cir. 1990) (Where a proposal to supply a general contractor with a product did not mention a new design but, rather, referenced a prior art design, the uncommunicated intent of the supplier to supply the new design if



awarded the contract did not constitute an “on sale” bar to a patent on the new design, even though the supplier’s bid reflected the lower cost of the new design.).

#### IV. SALES BY INDEPENDENT THIRD PARTIES

##### A. *Sales or Offers for Sale by Independent Third Parties Will Bar a Patent*

Sale or offer for sale of the invention by an independent third party more than 1 year before the filing date of applicant’s patent will bar applicant from obtaining a patent. “An exception to this rule exists where a patented method is kept secret and remains secret after a sale of the unpatented product of the method. Such a sale prior to the critical date is a bar if engaged in by the patentee or patent applicant, but not if engaged in by another.” *In re Caveney*, 761 F.2d 671, 675-76, 226 USPQ 1, 3-4 (Fed. Cir. 1985).

##### B. *Nonprior Art Publications Can Be Used as Evidence of Sale Before the Critical Date*

Abstracts identifying a product’s vendor containing information useful to potential buyers such as whom to contact, price terms, documentation, warranties, training and maintenance along with the date of product release or installation before the inventor’s critical date may provide sufficient evidence of prior sale by a third party to support a rejection based on 35 U.S.C. 102(b) or 103. *In re Epstein*, 32 F.3d 1559, 31 USPQ2d 1817 (Fed. Cir. 1994) (Examiner’s rejection was based on nonprior art published abstracts which disclosed software products meeting the claims. The abstracts specified software release dates and dates of first installation which were more than 1 year before applicant’s filing date.).

#### 2133.03(c) The “Invention” [R-2]

35 U.S.C. 102. *Conditions for patentability; novelty and loss of right to patent.*

A person shall be entitled to a patent unless -

\*\*\*\*\*

(b) the invention was...in public use or on sale in this country, more than one year prior to the date of the application for patent in the United States

\*\*\*\*\*

(Emphasis added).

#### I. LEVEL OF COMPLETENESS REQUIRED

The level of completion required likely will differ in cases of “public use” which are not intertwined with a sale. *UMC Elecs. Co. v. United States*, 816 F.2d 647, 652 n.6, 2 USPQ2d 1465, 1468 n.6 (Fed. Cir. 1987). The court decisions do not address the level required in pure “public use” cases but it is unlikely that the invention can be publicly used without a working embodiment. The case law presented below is directed to “on sale” situations.

##### *The Invention Must Be “Ready for Patenting” at the Time of the Sale*

In *Pfaff v. Wells Elecs., Inc.*, 525 U.S. 55, 66-68, 119 S.Ct. 304, 311-12, 48 USPQ2d 1641, 1647 (1998), the Supreme Court enunciated a two-prong test for determining whether an invention was “on sale” within the meaning of 35 U.S.C. 102(b) even if it has not yet been reduced to practice. “[T]he on-sale bar applies when two conditions are satisfied before the critical date [more than one year before the effective filing date of the U.S. application]. First, the product must be the subject of a commercial offer for sale.... Second, the invention must be ready for patenting.” *Id.* at 67, 119 S.Ct. at 311-12, 48 USPQ2d at 1646-47. “Ready for patenting,” the second prong of the *Pfaff* test, “may be satisfied in at least two ways: by proof of reduction to practice before the critical date; or by proof that prior to the critical date the inventor had prepared drawings or other descriptions of the invention that were sufficiently specific to enable a person skilled in the art to practice the invention.” *Id.* at 67, 199 S.Ct. at 311-12, 48 USPQ2d at 1647 (The patent was held invalid because the invention for a computer chip socket was “ready for patenting” when it was offered for sale more than one year prior to the application filing date. Even though the invention had not yet been reduced to practice, the manufacturer was able to produce the claimed computer chip sockets using the inventor’s detailed drawings and specifications, and those sockets contained all elements of invention claimed in the patent.). See also *Weatherchem Corp. v. J.L. Clark Inc.*, 163 F.3d 1326, 1333, 49 USPQ2d 1001, 1006-07 (Fed. Cir. 1998) (The invention was held “ready for patenting” since the detailed drawings of plastic dispensing caps

offered for sale “contained each limitation of the claims and were sufficiently specific to enable person skilled in art to practice the invention”).

If the invention was actually reduced to practice before being sold or offered for sale more than 1 year before filing of the application, a patent will be barred. *Vanmoor v. Wal-Mart Stores, Inc.*, 201 F.3d 1363, 1366-67, 53 USPQ2d 1377, 1379 (Fed. Cir. 2000) (“Here the pre-critical date sales were of completed cartridges made to specifications that remained unchanged to the present day, showing that any invention embodied in the accused cartridges was reduced to practice before the critical date. The *Pfaff* ready for patenting condition is also satisfied because the specification drawings, available prior to the critical date, were actually used to produce the accused cartridges.”); *In re Hamilton*, 882 F.2d 1576, 1580, 11 USPQ2d 1890, 1893 (Fed. Cir. 1989). “If a product that is offered for sale inherently possesses each of the limitations of the claims, then the invention is on sale, whether or not the parties to the transaction recognize that the product possesses the claimed characteristics.” *Abbott Laboratories v. Geneva Pharmaceuticals, Inc.*, 182 F.3d 1315, 1319, 51 USPQ2d 1307, 1310 (Fed. Cir. 1999) (Claim for a particular anhydrous crystalline form of a pharmaceutical compound was held invalid under the on-sale bar of 35 U.S.C. 102(b), even though the parties to the U.S. sales of the foreign manufactured compound did not know the identity of the particular crystalline form.); *STX LLC v. Brine Inc.*, 211 F.3d 588, 591, 54 USPQ2d 1347, 1350 (Fed. Cir. 2000) (Claim for a lacrosse stick was held invalid under the on-sale bar despite the argument that it was not known at the time of sale whether the sticks possessed the recited “improved playing and handling characteristics.” “Subjective qualities inherent in a product, such as ‘improved playing and handling’, cannot serve as an escape hatch to circumvent an on-sale bar.”). Actual reduction to practice in the context of an on-sale bar issue usually requires testing under actual working conditions in such a way as to demonstrate the practical utility of an invention for its intended purpose beyond the probability of failure, unless by virtue of the very simplicity of an invention its practical operativeness is clear. *Field v. Knowles*, 183 F.2d 593, 601, 86 USPQ 373, 379 (CCPA 1950); *Steinberg v. Seitz*, 517 F.2d 1359, 1363, 186 USPQ 209, 212 (CCPA 1975).

The invention need not be ready for satisfactory commercial marketing for sale to bar a patent. *Atlantic Thermoplastics Co. v. Faytex Corp.*, 970 F.2d 834, 836-37, 23 USPQ2d 1481, 1483 (Fed. Cir. 1992).

## II. INVENTOR HAS SUBMITTED A 37 CFR 1.131 AFFIDAVIT OR DECLARATION

Affidavits or declarations submitted under 37 CFR 1.131 to swear behind a reference may constitute, among other things, an admission that an invention was “complete” more than 1 year before the filing of an application. See *In re Foster*, 343 F.2d 980, 987-88, 145 USPQ 166, 173 (CCPA 1965); *Dart Indus. v. E.I. duPont de Nemours & Co.*, 489 F.2d 1359, 1365, 179 USPQ 392, 396 (7th Cir. 1973). Also see MPEP § 715.10.

## III. SALE OF A PROCESS

A claimed process, which is a series of acts or steps, is not sold in the same sense as is a claimed product, device, or apparatus, which is a tangible item. “‘Know-how’ describing what the process consists of and how the process should be carried out may be sold in the sense that the buyer acquires knowledge of the process and obtains the freedom to carry it out pursuant to the terms of the transaction. However, such a transaction is not a ‘sale’ of the invention within the meaning of §102(b) because the process has not been carried out or performed as a result of the transaction.” *In re Kollar*, 286 F.3d 1326, 1332, 62 USPQ2d 1425, 1429 (Fed. Cir. 2002). However, sale of a product made by the claimed process by the patentee or a licensee would constitute a sale of the process within the meaning of 35 U.S.C. 102(b). See *id.* at 1333, 62 USPQ2d at 1429; *D.L. Auld Co. v. Chroma Graphics Corp.*, 714 F.2d 1144, 1147-48, 219 USPQ 13, 15-16 (Fed. Cir. 1983) (Even though the sale of a product made by a claimed method before the critical date did not reveal anything about the method to the public, the sale resulted in a “forfeiture” of any right to a patent to that method); *W.L. Gore & Assocs., Inc. v. Garlock, Inc.*, 721 F.2d 1540, 1550, 220 USPQ 303, 310 (Fed. Cir. 1983). The application of 35 U.S.C. 102(b) would also be triggered by actually performing the claimed process itself for consideration. See *Scaltech, Inc. v. Retec/Tetra, L.L.C.*, 269 F.3d 1321, 1328, 60 USPQ2d 1687, 1691 (Fed. Cir. 2001) (Patent was held invalid under 35 U.S.C.

102(b) based on patentee's offer to perform the claimed process for treating oil refinery waste more than one year before filing the patent application). >Moreover, the sale of a device embodying a claimed process may trigger the on-sale bar. *Minton v. National Ass'n. of Securities Dealers, Inc.*, 336 F.3d 1373, 1378, 67 USPQ2d 1614, 1618 (Fed. Cir. 2003) (finding a fully operational computer program implementing and thus embodying the claimed method to trigger the on-sale bar).<

### 2133.03(d) "In This Country"

For purposes of judging the applicability of the 35 U.S.C. 102(b) bars, public use or on sale activity must take place in the United States. The "on sale" bar does not generally apply where both manufacture and delivery occur in a foreign country. *Gandy v. Main Belting Co.*, 143 U.S. 587, 593 (1892). However, "on sale" status can be found if substantial activity prefatory to a "sale" occurs in the United States. *Robbins Co. v. Lawrence Mfg. Co.*, 482 F.2d 426, 433, 178 USPQ 577, 583 (9th Cir. 1973). An offer for sale, made or originating in this country, may be sufficient prefatory activity to bring the offer within the terms of the statute, even though sale and delivery take place in a foreign country. The same rationale applies to an offer by a foreign manufacturer which is communicated to a prospective purchaser in the United States prior to the critical date. *CTS Corp. v. Piher Int'l Corp.*, 593 F.2d 777, 201 USPQ 649 (7th Cir. 1979).

### 2133.03(e) Permitted Activity; Experimental Use [R-2]

The question posed by the experimental use doctrine is "whether the primary purpose of the inventor at the time of the sale, as determined from an objective evaluation of the facts surrounding the transaction, was to conduct experimentation." *Allen Eng'g Corp. v. Bartell Indus., Inc.*, 299 F.3d 1336, 1354, 63 USPQ2d 1769, 1780 (Fed. Cir. 2002), quoting *EZ Dock v. Schafer Sys., Inc.*, 276 F.3d 1347, 1356-57, 61 USPQ2d 1289, 1295-96 (Fed. Cir. 2002) (Linn, J., concurring). Experimentation must be the primary purpose and any commercial exploitation must be incidental. >Moreover, the experimental activity must

have a nexus with the claimed invention. In other words, testing must be performed to "perfect claimed features, or ... features inherent to the claimed invention." *SmithKline Beecham Corp. v. Apotex Corp.*, \_\_\_ F.3d \_\_\_, 2004 WL 868425 (Fed. Cir. April 24, 2004) (holding that clinical trials to gain FDA approval were not "experimental use" because the claimed invention was a chemical compound that was reduced to practice when synthesized; the FDA trials had no relationship to the claimed invention because the testing was directed to the compound's unclaimed intended use).<

If the use or sale was experimental, there is no bar under 35 U.S.C. 102(b). "A use or sale is experimental for purposes of section 102(b) if it represents a *bona fide* effort to perfect the invention or to ascertain whether it will answer its intended purpose....If any commercial exploitation does occur, it must be merely incidental to the primary purpose of the experimentation to perfect the invention." *LaBounty Mfg. v. United States Int'l Trade Comm'n*, 958 F.2d 1066, 1071, 22 USPQ2d 1025, 1028 (Fed. Cir. 1992) (quoting *Pennwalt Corp. v. Akzona Inc.*, 740 F.2d 1573, 1581, 222 USPQ 833, 838 (Fed. Cir. 1984)). "The experimental use exception...does not include market testing where the inventor is attempting to gauge consumer demand for his claimed invention. The purpose of such activities is commercial exploitation and not experimentation." *In re Smith*, 714 F.2d 1127, 1134, 218 USPQ 976, 983 (Fed. Cir. 1983).

### 2133.03(e)(1) Commercial Exploitation [R-1]

\*\*

>One< policy of the on sale and public use bars is the prevention of inventors from exploiting their inventions commercially more than 1 year prior to the filing of a patent application. Therefore, if applicant's precritical date activity is\*\*>a sale or offer for sale that is< an attempt at market penetration, a patent is barred. Thus, even if there is *bona fide* experimental activity, an inventor may not commercially exploit an invention more than 1 year prior to the filing date of an application. *In re Theis*, 610 F.2d 786, 793, 204 USPQ 188, 194 (CCPA 1979).

### THE COMMERCIAL ACTIVITY MUST LEGITIMATELY ADVANCE DEVELOPMENT OF THE INVENTION TOWARDS COMPLETION

As the degree of commercial exploitation surrounding 35 U.S.C. 102(b) activity increases, the burden on an applicant to establish clear and convincing evidence of experimental activity with respect to a public use becomes more difficult. Where the examiner has found a *prima facie* case of a sale or an offer to sell, this burden will rarely be met unless clear and convincing necessity for the experimentation is established by the applicant. This does not mean, of course, that there are no circumstances which would permit alleged experimental activity in an atmosphere of commercial exploitation. In certain circumstances, even a sale may be necessary to legitimately advance the experimental development of an invention if the primary purpose of the sale is experimental. *In re Theis*, 610 F.2d 786, 793, 204 USPQ 188, 194 (CCPA 1979); *Robbins Co. v. Lawrence Mfg. Co.*, 482 F.2d 426, 433, 178 USPQ 577, 582 (9th Cir. 1973). However, careful scrutiny by the examiner of the objective factual circumstances surrounding such a sale is essential. See *Ushakoff v. United States*, 327 F.2d 669, 140 USPQ 341 (Ct.Cl. 1964); *Cloud v. Standard Packaging Corp.*, 376 F.2d 384, 153 USPQ 317 (7th Cir. 1967).

### SIGNIFICANT FACTORS INDICATIVE OF "COMMERCIAL EXPLOITATION"

As discussed in MPEP § 2133.03, a policy consideration in questions of 35 U.S.C. 102(b) activity is premature "commercial exploitation" of a "completed" or "ready for patenting" invention (see MPEP § 2133.03(c)). The extent of commercial activity which constitutes 35 U.S.C. 102(b) "on sale" status depends upon the circumstances of the activity, the basic indicator being the subjective intent of the inventor as manifested through objective evidence. The following activities should be used by the examiner as indicia of this subjective intent:

(A) Preparation of various contemporaneous "commercial" documents, e.g., orders, invoices, receipts, delivery schedules, etc.;

(B) Preparation of price lists (*Akron Brass Co. v. Elkhart Brass Mfg. Co.*, 353 F.2d 704, 709, 147 USPQ 301, 305 (7th Cir. 1965) and distribution of price quo-

tations (*Amphenol Corp. v. General Time Corp.*, 158 USPQ 113, 117 (7th Cir. 1968));

(C) Display of samples to prospective customers (*Cataphote Corp. v. DeSoto Chemical Coatings, Inc.*, 356 F.2d 24, 27, 148 USPQ 527, 529 (9th Cir. 1966) *mod. on other grounds*, 358 F.2d 732, 149 USPQ 159 (9th Cir.), *cert. denied*, 385 U.S. 832 (1966); *Chicopee Mfg. Corp. v. Columbus Fiber Mills Co.*, 165 F.Supp. 307, 323-325, 118 USPQ 53, 65-67 (M.D.Ga. 1958));

(D) Demonstration of models or prototypes (*General Elec. Co. v. United States*, 206 USPQ 260, 266-67 (Ct. Cl. 1979); *Red Cross Mfg. v. Toro Sales Co.*, 525 F.2d 1135, 1140, 188 USPQ 241, 244-45 (7th Cir. 1975); *Philco Corp. v. Admiral Corp.*, 199 F. Supp. 797, 815-16, 131 USPQ 413, 429-30 (D.Del. 1961)), especially at trade conventions (*InterRoyal Corp. v. Simmons Co.*, 204 USPQ 562, 563-65 (S.D. N.Y. 1979)), and even though no orders are actually obtained (*Monogram Mfg. v. F. & H. Mfg.*, 144 F.2d 412, 62 USPQ 409, 412 (9th Cir. 1944));

(E) Use of an invention where an admission fee is charged (*In re Josserand*, 188 F.2d 486, 491, 89 USPQ 371, 376 (CCPA 1951); *Greenewalt v. Stanley*, 54 F.2d 195, 12 USPQ 122 (3d Cir. 1931)); and

(F) Advertising in publicity releases, brochures, and various periodicals (*In re Theis*, 610 F.2d 786, 792 n.6, 204 USPQ 188, 193 n. 6 (CCPA 1979); *InterRoyal Corp. v. Simmons Co.*, 204 USPQ 562, 564-66 (S.D.N.Y.1979); *Akron Brass, Inc. v. Elkhart Brass Mfg., Inc.*, 353 F.2d 704, 709, 147 USPQ 301, 305 (7th Cir.1965); *Tucker Aluminum Prods. v. Grossman*, 312 F.2d 393, 394, 136 USPQ 244, 245 (9th Cir. 1963)).

\*\*

>See MPEP § 2133.03(e)(4) for factors indicative of an experimental purpose.<

### 2133.03(e)(2) Intent

"When sales are made in an ordinary commercial environment and the goods are placed outside the inventor's control, an inventor's secretly held subjective intent to 'experiment,' even if true, is unavailing without objective evidence to support the contention. Under such circumstances, the customer at a minimum must be made aware of the experimentation." *LaBounty Mfg., Inc. v. United States Int'l Trade Comm'n*, 958 F.2d 1066, 1072, 22 USPQ2d 1025,

1029 (Fed. Cir. 1992) (quoting *Harrington Mfg. Co. v. Powell Mfg. Co.*, 815 F.2d 1478, 1480 n.3, 2 USPQ2d 1364, 1366 n.3 (Fed. Cir. 1986); *Paragon Podiatry Laboratory, Inc. v. KLM Labs., Inc.*, 984 F.2d 1182, 25 USPQ2d 1561 (Fed. Cir. 1993) (Paragon sold the inventive units to the trade as completed devices without any disclosure to either doctors or patients of their involvement in alleged testing. Evidence of the inventor's secretly held belief that the units were not durable and may not be satisfactory for consumers was not sufficient, alone, to avoid a statutory bar.).

### 2133.03(e)(3) “Completeness” of the Invention [R-2]

#### EXPERIMENTAL USE ENDS WHEN THE INVENTION IS ACTUALLY REDUCED TO PRACTICE

Experimental use “means perfecting or completing an invention to the point of determining that it will work for its intended purpose.” Therefore, experimental use “ends with an actual reduction to practice.” *RCA Corp. v. Data Gen. Corp.*, 887 F.2d 1056, 1061, 12 USPQ2d 1449, 1453 (Fed. Cir. 1989). If the examiner concludes from the evidence of record that an applicant was satisfied that an invention was in fact “complete,” awaiting approval by the applicant from an organization such as Underwriters' Laboratories will not normally overcome this conclusion. *Inter-Royal Corp. v. Simmons Co.*, 204 USPQ 562, 566 (S.D.N.Y. 1979); *Skil Corp. v. Rockwell Manufacturing Co.*, 358 F. Supp. 1257, 1261, 178 USPQ 562, 565 (N.D.Ill. 1973), *aff'd. in part, rev'd in part sub nom. Skil Corp. v. Lucerne Products Inc.*, 503 F.2d 745, 183 USPQ 396, 399 (7th Cir. 1974), *cert. denied*, 420 U.S. 974, 185 USPQ 65 (1975). >See also *SmithKline Beecham Corp. v. Apotex Corp.*, \_\_\_ F.3d \_\_\_, 2004 WL 868425 (Fed. Cir. April 24, 2004) (holding that because a claim to a chemical compound was reduced to practice when it was made, subsequent testing for FDA approval was not “experimental use”).< See MPEP § 2133.03(c) for more information of what constitutes a “complete” invention.

The fact that alleged experimental activity does not lead to specific modifications or refinements of an invention is evidence, although not conclusive evidence, that such activity is not within the realm per-

mitted by the statute. This is especially the case where the evidence of record clearly demonstrates to the examiner that an invention was considered “complete” by an inventor at the time of the activity. Nevertheless, any modifications or refinements which did result from such experimental activity must at least be a feature of the claimed invention to be of any probative value. *In re Theis*, 610 F.2d 786, 793, 204 USPQ 188, 194 (CCPA 1979).

#### DISPOSAL OF PROTOTYPES

Where a prototype of an invention has been disposed of by an inventor before the critical date, inquiry by the examiner should focus upon the intent of the inventor and the reasonableness of the disposal under all circumstances. The fact that an otherwise reasonable disposal of a prototype involves incidental income is not necessarily fatal. *In re Dybel*, 524 F.2d 1393, 1399, n.5, 187 USPQ 593, 597 n.5 (CCPA 1975). However, if a prototype is considered “complete” by an inventor and all experimentation on the underlying invention has ceased, unrestricted disposal of the prototype constitutes a bar under 35 U.S.C. 102(b). *In re Blaisdell*, 242 F.2d 779, 113 USPQ 289 (CCPA 1957); *contra, Watson v. Allen*, 254 F.2d 342, 117 USPQ 68 (D.C. Cir. 1958).

### 2133.03(e)(4) Factors Indicative of an Experimental Purpose [R-1]

\*\*>The courts have considered a number of factors in determining whether a claimed invention was the subject of a commercial offer for sale primarily for purposes of experimentation. “These factors include: (1) the necessity for public testing, (2) the amount of control over the experiment retained by the inventor, (3) the nature of the invention, (4) the length of the test period, (5) whether payment was made, (6) whether there was a secrecy obligation, (7) whether records of the experiment were kept, (8) who conducted the experiment, ... (9) the degree of commercial exploitation during testing[,] ... (10) whether the invention reasonably requires evaluation under actual conditions of use, (11) whether testing was systematically performed, (12) whether the inventor continually monitored the invention during testing, and (13) the nature of contacts made with potential customers.” *Allen Eng'g Corp. v. Bartell Indus., Inc.*, 299 F.3d 1336, 1353, 63 USPQ2d 1769, 1780 (Fed. Cir. 2002)

quoting *EZ Dock v. Schafer Sys., Inc.*, 276 F.3d 1347, 1357, 61 USPQ2d 1289, 1296 (Fed. Cir. 2002) (Linn, J., concurring).

Once alleged experimental activity is advanced by an applicant to explain a *prima facie* case under 35 U.S.C. 102(b), the examiner must determine whether the scope and length of the activity were reasonable in terms of the experimental purpose intended by the applicant and the nature of the subject matter involved. No one of, or particular combination of, factors \*\* is necessarily determinative of this purpose.

>See MPEP § 2133.03(e)(1) for factors indicative of commercial exploitation.<

### **2133.03(e)(5) Experimentation and Degree of Supervision and Control [R-1]**

#### **THE INVENTOR MUST MAINTAIN SUFFICIENT CONTROL OVER THE INVENTION DURING TESTING BY THIRD PARTIES**

\*\*>A< significant determinative factor in questions of experimental purpose is the extent of supervision and control maintained by an inventor over an invention during an alleged period of experimentation. Once a period of experimental activity has ended and supervision and control has been relinquished by an inventor without any restraints on subsequent use of an invention, an unrestricted subsequent use of the invention is a 35 U.S.C. 102(b) bar. *In re Blaisdell*, 242 F.2d 779, 784, 113 USPQ 289, 293 (CCPA 1957).

### **2133.03(e)(6) Permitted Experimental Activity and Testing [R-2]**

#### **DEVELOPMENTAL TESTING IS PERMITTED**

Testing of an invention in the normal context of its technological development is generally within the realm of permitted experimental activity. Likewise, experimentation to determine utility, as that term is applied in 35 U.S.C. 101, may also constitute permissible activity. See *General Motors Corp. v. Bendix Aviation Corp.*, 123 F. Supp. 506, 521, 102 USPQ 58, 69 (N.D.Ind. 1954). For example, where an invention

relates to a chemical composition with no known utility, i.e., a patent application for the composition could not be filed (35 U.S.C. 101; 35 U.S.C. 112, first paragraph), continued testing to find utility would likely be permissible under 35 U.S.C. 102(b), absent a sale of the composition or other evidence of commercial exploitation. >But see, *SmithKline Beecham Corp. v. Apotex Corp.*, \_\_\_ F.3d \_\_\_, 2004 WL 868425 (Fed. Cir. April 24, 2004) (testing to gain FDA approval was not experimental use where the claim was directed to a chemical compound without regard to the compound's end-use).<

#### **MARKET TESTING IS NOT PERMITTED**

Experimentation to determine product acceptance, i.e., market testing, is typical of a trader's and not an inventor's experiment and is thus not within the area of permitted experimental activity. *Smith & Davis Mfg. Co. v. Mellon*, 58 F. 705, 707 (8th Cir. 1893) Likewise, testing of an invention for the benefit of appeasing a customer, or to conduct "minor 'tune up' procedures not requiring an inventor's skills, but rather the skills of a competent technician," are also not within the exception. *In re Theis*, 610 F.2d 786, 793, 204 USPQ 188, 193-94 (CCPA 1979).

#### **EXPERIMENTAL ACTIVITY IN THE CONTEXT OF DESIGN APPLICATIONS**

The public use of an ornamental design which is directed toward generating consumer interest in the aesthetics of the design is not an experimental use. *In re Mann*, 861 F.2d 1581, 8 USPQ2d 2030 (Fed. Cir. 1988) (display of a wrought iron table at a trade show held to be public use). However, "experimentation directed to functional features of a product also containing an ornamental design may negate what otherwise would be considered a public use within the meaning of section 102(b)." *Tone Brothers, Inc. v. Sysco Corp.*, 28 F.3d 1192, 1196, 31 USPQ2d 1321, 1326 (Fed. Cir. 1994) (A study wherein students evaluated the effect of the functional features of a spice container design may be considered an experimental use.).

## 2133.03(e)(7) Activity of an Independent Third Party Inventor

### EXPERIMENTAL USE EXCEPTION IS PERSONAL TO AN APPLICANT

The statutory bars of 35 U.S.C. 102(b) are applicable even though public use or on sale activity is by a party other than an applicant. Where an applicant presents evidence of experimental activity by such other party, the evidence will not overcome the *prima facie* case under 35 U.S.C. 102(b) based upon the activity of such party unless the activity was under the supervision and control of the applicant. *Magnetics v. Arnold Eng'g Co.*, 438 F.2d 72, 74, 168 USPQ 392, 394 (7th Cir. 1971), *Bourne v. Jones*, 114 F.Supp. 413, 419, 98 USPQ 206, 210 (S.D. Fla. 1951), *aff'd.*, 207 F.2d 173, 98 USPQ 205 (5th Cir. 1953), *cert. denied*, 346 U.S. 897, 99 USPQ 490 (1953); *contra*, *Watson v. Allen*, 254 F.2d 342, 117 USPQ 68 (D.C.Cir. 1957). In other words, the experimental use activity exception is personal to an applicant.

### 2134 35 U.S.C. 102(c) [R-1]

35 U.S.C. 102. Conditions for patentability; novelty and loss of right to patent.

A person shall be entitled to a patent unless -

\*\*\*\*\*

(c) he has abandoned the invention.

\*\*\*\*\*

### UNDER 35 U.S.C. 102(c), AN ABANDONMENT MUST BE INTENTIONAL

“Actual abandonment under 35 U.S.C. 102(c) requires that the inventor intend to abandon the invention, and intent can be implied from the inventor’s conduct with respect to the invention. *In re Gibbs*, 437 F.2d 486, 168 USPQ 578 (CCPA 1971). Such intent to abandon the invention will not be imputed, and every reasonable doubt should be resolved in favor of the inventor.” *Ex parte Dunne*, 20 USPQ2d 1479 (Bd. Pat. App. & Inter. 1991).

### DELAY IN MAKING FIRST APPLICATION

Abandonment under 35 U.S.C. 102(c) requires a deliberate, though not necessarily express, surrender

of any rights to a patent. To abandon the invention the inventor must intend a dedication to the public. Such dedication may be either express or implied, by actions or inactions of the inventor. Delay alone is not sufficient to infer the requisite intent to abandon. *Moore v. United States*, 194 USPQ 423, 428 (Ct. Cl. 1977) (The drafting and retention in his own files of two patent applications by inventor indicates an intent to retain his invention; delay in filing the applications was not sufficient to establish abandonment); but see *Davis Harvester Co., Inc. v. Long Mfg. Co.*, 252 F. Supp. 989, 1009-10, 149 USPQ 420, 435-436 (E.D. N.C. 1966) (Where the inventor does nothing over a period of time to develop or patent his invention, ridicules the attempts of another to develop that invention and begins to show active interest in promoting and developing his invention only after successful marketing by another of a device embodying that invention, the inventor has abandoned his invention under 35 U.S.C. 102(c).).

### DELAY IN REAPPLYING FOR PATENT AFTER ABANDONMENT OF PREVIOUS PATENT APPLICATION

Where there is no evidence of expressed intent or conduct by inventor to abandon his invention, delay in reapplying for patent after abandonment of a previous application does not constitute abandonment under 35 U.S.C. 102(c). *Petersen v. Fee Int'l, Ltd.*, 381 F. Supp. 1071, 182 USPQ 264 (W.D. Okla. 1974).

### DISCLOSURE WITHOUT CLAIMING IN A PRIOR ISSUED PATENT

Any inference of abandonment (i.e., intent to dedicate to the public) of subject matter disclosed but not claimed in a previously issued patent is rebuttable by an application filed at any time before a statutory bar arises. Accordingly, a rejection of a claim of a patent application under 35 U.S.C. 102(c) predicated solely on the issuance of a patent which discloses the subject matter of the claim in the application without claiming it would be improper, regardless of whether there is copendency between the application at issue and the application which issued as the patent. *In re Gibbs*, 437 F.2d 486, 168 USPQ 578 (CCPA 1971).

## ONLY WHEN THERE IS A PRIORITY CONTEST CAN A LAPSE OF TIME BAR A PATENT

The mere lapse of time will not bar a patent. The only exception is when there is a priority contest under 35 U.S.C. 102(g) and applicant abandons, suppresses or conceals the invention. *Panduit Corp. v. Dennison Mfg. Co.*, 774 F.2d 1082, 1101, 227 USPQ 337, 350 (Fed. Cir. 1985). Abandonment, suppression and concealment are treated by the courts under 35 U.S.C. 102(g). See MPEP § 2138.03 for more information on this issue.

### 2135 35 U.S.C. 102(d)

35 U.S.C. 102. *Conditions for patentability; novelty and loss of right to patent.*

A person shall be entitled to a patent unless -

\*\*\*\*\*

(d) the invention was first patented or caused to be patented, or was the subject of an inventor's certificate, by the applicant or his legal representatives or assigns in a foreign country prior to the date of the application for patent in this country on an application for patent or inventor's certificate filed more than twelve months before the filing of the application in the United States.

\*\*\*\*\*

### GENERAL REQUIREMENTS OF 35 U.S.C. 102(d)

35 U.S.C. 102(d) establishes four conditions which, if all are present, establish a bar against the granting of a patent in this country:

(A) The foreign application must be filed more than 12 months before the effective U.S. filing date (See MPEP § 706.02 regarding effective U.S. filing date of an application);

(B) The foreign application must have been filed by the same applicant as in the United States or by his or her legal representatives or assigns.

(C) The foreign patent or inventor's certificate must be actually granted (e.g., by sealing of the papers in Great Britain) before the U.S. filing date. It need not be published.

(D) The same invention must be involved.

If such a foreign patent or inventor's certificate is discovered by the examiner, the rejection is made under 35 U.S.C. 102(d) on the ground of statutory bar.

See MPEP § 2135.01 for further clarification of each of the four requirements of 35 U.S.C. 102(d).

### 2135.01 The Four Requirements of 35 U.S.C. 102(d)

#### I. FOREIGN APPLICATION MUST BE FILED MORE THAN 12 MONTHS BEFORE THE EFFECTIVE U.S. FILING DATE

##### A. *An Anniversary Date Ending on a Weekend or Holiday Results in an Extension to the Next Business Day*

The U.S. application is filed in time to prevent a 35 U.S.C. 102(d) bar from arising if it is filed on the 1 year anniversary date of the filing date of the foreign application. If this day is a Saturday, Sunday or Federal holiday, the year would be extended to the following business day. See *Ex parte Olah*, 131 USPQ 41 (Bd. App. 1960.) Despite changes to 37 CFR 1.6(a)(2) and 1.10, which require the PTO to accord a filing date to an application as of the date of deposit as "Express Mail" with the U.S. Postal Service in accordance with 37 CFR 1.10 (e.g., a Saturday filing date), the rule changes do not affect applicant's concurrent right to defer the filing of an application until the next business day when the last day for "taking any action" falls on a Saturday, Sunday, or a Federal holiday (e.g., the last day of the 1-year grace period falls on a Saturday).

##### B. *A Continuation-in-Part Breaks the Chain of Priority as to Foreign as Well as U.S. Parents*

In the case where applicant files a foreign application, later files a U.S. application claiming priority based on the foreign application, and then files a continuation-in-part (CIP) application whose claims are not entitled to the filing date of the U.S. parent, the effective filing date is the filing date of the CIP and applicant cannot obtain the benefit of either the U.S. parent or foreign application filing dates. *In re Van Langenhoven*, 458 F.2d 132, 137, 173 USPQ 426, 429 (CCPA 1972). If the foreign application issues into a patent before the filing date of the CIP, it may be used in a 35 U.S.C. 102(d)/103 rejection if the subject matter added to the CIP does not render the claims nonobvious over the foreign patent. *Ex parte Appeal No. 242-47*, 196 USPQ 828 (Bd. App. 1976) (Foreign



patent can be combined with other prior art to bar a U.S. patent in an obviousness rejection based on 35 U.S.C. 102(d)/103).

## II. FOREIGN APPLICATION MUST HAVE BEEN FILED BY SAME APPLICANT, HIS OR HER LEGAL REPRESENTATIVE OR ASSIGNS

Note that where the U.S. application was made by two or more inventors, it is permissible for these inventors to claim priority from separate applications, each to one of the inventors or a subcombination of inventors. For instance, a U.S. application naming inventors A and B may be entitled to priority from one application to A and one to B filed in a foreign country.

## III. THE FOREIGN PATENT OR INVENTOR'S CERTIFICATE WAS ACTUALLY GRANTED BEFORE THE U.S. FILING DATE

### A. To Be "Patented" an Exclusionary Right Must Be Awarded to the Applicant

"Patented" means "a formal bestowal of patent rights from the sovereign to the applicant." *In re Monks*, 588 F.2d 308, 310, 200 USPQ 129, 131 (CCPA 1978); *American Infra-Red Radiant Co. v. Lambert Indus.*, 360 F.2d 977, 149 USPQ 722 (8th Cir.), cert. denied, 385 U.S. 920 (1966) (German Gebrauchsmuster petty patent was held to be a patent usable in a 35 U.S.C. 102(d) rejection. Gebrauchsmuster are not examined and only grant a 6-year patent term. However, except as to duration, the exclusionary patent right granted is as extensive as in the U.S.).

### B. A Published Application Is Not a "Patent"

An application must issue into a patent before it can be applied in a 35 U.S.C. 102(d) rejection. *Ex parte Fujishiro*, 199 USPQ 36 (Bd. App. 1977) ("Patenting," within the meaning of 35 U.S.C. 102(d), does not occur upon laying open of a Japanese utility model application (kokai or kohyo)); *Ex parte Links*, 184 USPQ 429 (Bd. App. 1974) (German applications, which have not yet been published for opposition, are published in the form of printed documents called Offenlegungsschriften 18 months after filing. These applications are unexamined or in the process of being examined at the time of publication. The

Board held that an Offenlegungsschrift is not a patent under 35 U.S.C. 102(d) even though some provisional rights are granted. The Board explained that the provisional rights are minimal and do not come into force if the application is withdrawn or refused.).

### C. An Allowed Application Can Be a "Patent" for Purposes of 35 U.S.C. 102(d) as of the Date Published for Opposition Even Though It Has Not Yet Been Granted as a Patent

An examined application which has been allowed by the examiner and published to allow the public to oppose the grant of a patent has been held to be a "patent" for purposes of rejection under 35 U.S.C. 102(d) as of the date of publication for opposition if substantial provisional enforcement rights arise. *Ex parte Beik*, 161 USPQ 795 (Bd. App. 1968) (This case dealt with examined German applications. After a determination that an application is allowable, the application is published in the form of a printed document called an Auslegeschrift. The publication begins a period of opposition were the public can present evidence showing unpatentability. Provisional patent rights are granted which are substantially the same as those available once the opposition period is over and the patent is granted. The Board found that an Auslegeschrift provides the legal effect of a patent for purposes of rejection under 35 U.S.C. 102(d).).

### D. Grant Occurs When Patent Becomes Enforceable

The critical date of a foreign patent as a reference under 35 U.S.C. 102(d) is the date the patent becomes enforceable (issued, sealed or granted). *In re Monks*, 588 F.2d 308, 310, 200 USPQ 129, 131 (CCPA 1978) (British reference became available as prior art on date the patent was "sealed" because as of this date applicant had the right to exclude others from making, using or selling the claimed invention.).

### E. 35 U.S.C. 102(d) Applies as of Grant Date Even If There Is a Period of Secrecy After Patent Grant

A period of secrecy after granting the patent, as in Belgium and Spain, has been held to have no effect in connection with 35 U.S.C. 102(d). These patents are usable in rejections under 35 U.S.C. 102(d) as of the date patent rights are granted. *In re Kathawala*, 9 F.3d

942, 28 USPQ2d 1789 (Fed. Cir. 1993) (An invention is “patented” for purposes of 35 U.S.C. 102(d) when the patentee’s rights under the patent become fixed. The fact that applicant’s Spanish application was not published until after the U.S. filing date is immaterial since the Spanish patent was granted before U.S. filing.); *Gramme Elec. Co. v. Arnoux and Hochhausen Elec. Co.*, 17 F. 838, 1883 C.D. 418 (S.D.N.Y. 1883) (Rejection made under a predecessor of 35 U.S.C. 102(d) based on an Austrian patent granted an exclusionary right for 1 year but was kept secret, at the option of the patentee, for that period. The court held that the Austrian patent grant date was the relevant date under the statute for purposes of 35 U.S.C. 102(d) but that the patent could not have been used to in a rejection under 35 U.S.C. 102(a) or (b).); *In re Talbott*, 443 F.2d 1397, 170 USPQ 281 (CCPA 1971) (Applicant cannot avoid a 35 U.S.C. 102(d) rejection by exercising an option to keep the subject matter of a German Gebrauchsmuster (petty patent) in secrecy until time of U.S. filing.).

#### IV. THE SAME INVENTION MUST BE INVOLVED

##### *“Same Invention” Means That the Application Claims Could Have Been Presented in the Foreign Patent*

Under 35 U.S.C. 102(d), the “invention... patented” in the foreign country must be the same as the invention sought to be patented in the U.S. When the foreign patent contains the same claims as the U.S. application, there is no question that “the invention was first patented... in a foreign country.” *In re Kathawala*, 9 F.3d 942, 945, 28 USPQ2d 1785, 1787 (Fed. Cir. 1993). However, the claims need not be identical or even within the same statutory class. If applicant is granted a foreign patent which fully discloses the invention and which gives applicant a number of different claiming options in the U.S., the reference in 35 U.S.C. 102(d) to “‘invention... patented’ necessarily includes all the disclosed aspects of the invention. Thus, the section 102(d) bar applies regardless whether the foreign patent contains claims to less than all aspects of the invention.” 9 F.3d at 946, 28 USPQ2d at 1788. In essence, a 35 U.S.C. 102(d) rejection applies if applicant’s foreign application supports the subject matter of the U.S. claims. *In re*

*Kathawala*, 9 F.3d 942, 28 USPQ2d 1785 (Fed. Cir. 1993) (Applicant was granted a Spanish patent claiming a method of making a composition. The patent disclosed compounds, methods of use and processes of making the compounds. After the Spanish patent was granted, the applicant filed a U.S. application with claims directed to the compound but not the process of making it. The Federal Circuit held that it did not matter that the claims in the U.S. application were directed to the composition instead of the process because the foreign specification would have supported claims to the composition. It was immaterial that the formulations were unpatentable pharmaceutical compositions in Spain.).

#### 2136 35 U.S.C. 102(e) [R-1]

\*\*>Revised 35 U.S.C. 102(e), as amended by the American Inventors Protection Act of 1999 (AIPA) (Pub. L. 106-113, 113 Stat. 1501 (1999)), and as further amended by the Intellectual Property and High Technology Technical Amendments Act of 2002 (Pub. L. 107-273, 116 Stat. 1758 (2002)), applies in the examination of all applications, whenever filed, and the reexamination of, or other proceedings to contest, all patents. Thus, the filing date of the application being examined is no longer relevant in determining what version of 35 U.S.C. 102(e) to apply in determining the patentability of that application, or the patent resulting from that application. The revised statutory provisions supercede all previous versions of 35 U.S.C. 102(e) and 374, with only one exception, which is when the potential reference is based on an international application filed prior to November 29, 2000 (discussed further below). The provisions amending 35 U.S.C. 102(e) and 374 in Pub. L. 107-273 are completely retroactive to the effective date of the relevant provisions in the AIPA (November 29, 2000). Revised 35 U.S.C. 102(e) allows the use of certain international application publications and U.S. patent application publications, and certain U.S. patents as prior art under 35 U.S.C. 102(e) as of their respective U.S. filing dates, including certain international filing dates. The prior art date of a reference under 35 U.S.C. 102(e) may be the international filing date if the international filing date was on or after November 29, 2000, the international application designated the United States, and the international application was published by the World Intellectual

Property Organization (WIPO) under the Patent Cooperation Treaty (PCT) Article 21(2) in the English language. See MPEP § 706.02(f)(1) for examination guidelines on the application of 35 U.S.C. 102(e).<

*35 U.S.C. 102. Conditions for patentability; novelty and loss of right to patent.*

A person shall be entitled to a patent unless-

\*\*\*\*\*

\*\*>

(e) the invention was described in — (1) an application for patent, published under section 122(b), by another filed in the United States before the invention by the applicant for patent or (2) a patent granted on an application for patent by another filed in the United States before the invention by the applicant for patent, except that an international application filed under the treaty defined in section 351(a) shall have the effects for the purposes of this subsection of an application filed in the United States only if the international application designated the United States and was published under Article 21(2) of such treaty in the English language.<

\*\*\*\*\*

\*\*>As mentioned above, references based on international applications that were filed prior to November 29, 2000 are subject to the former (pre-AIPA) version of 35 U.S.C. 102(e) as set forth below.<

*Former 35 U.S.C. 102. Conditions for patentability; novelty and loss of right to patent.*

A person shall be entitled to a patent unless-

\*\*\*\*\*

(e) the invention was described in a patent granted on an application for patent by another filed in the United States before the invention thereof by the applicant for patent, or on an international application by another who has fulfilled the requirements of paragraphs (1), (2), and (4) of section 371(c) of this title before the invention thereof by the applicant for patent.

\*\*\*\*\*

**\*\*>STATUTORY INVENTION REGISTRATIONS (SIRs) ARE ELIGIBLE AS PRIOR ART UNDER 35 U.S.C. 102(e)**

In accordance with 35 U.S.C. 157(c), a published SIR will be treated the same as a U.S. patent for all defensive purposes, usable as a reference as of its filing date in the same manner as a U.S. patent. A SIR is prior art under all applicable sections of 35 U.S.C. 102 including 35 U.S.C. 102(e). See MPEP § 1111.<

## **DEFENSIVE PUBLICATIONS ARE NOT PRIOR ART AS OF THEIR FILING DATE**

The Defensive Publication Program, available between April 1968 and May 1985, provided for the voluntary publication of the abstract of the technical disclosure of a pending application under certain conditions. A defensive publication is not a patent or an application publication under 35 U.S.C. 122(b); it is a publication. Therefore, it is prior art only as of its publication date. *Ex parte Osmond*, 191 USPQ 334 (Bd. App. 1973). See MPEP § 711.06(a) for more information on Defensive Publications.

## **2136.01 Status of U.S. Application as a Reference [R-2]**

**WHEN THERE IS NO COMMON ASSIGNEE OR INVENTOR, A U.S. APPLICATION MUST ISSUE AS A PATENT OR BE PUBLISHED AS A SIR OR AS AN APPLICATION PUBLICATION BEFORE IT IS AVAILABLE AS PRIOR ART UNDER 35 U.S.C. 102(e)**

In addition to U.S. patents and SIRs, certain U.S. application publications and certain international application publications are also available as prior art under 35 U.S.C. 102(e) as of their effective U.S. filing dates (which will include certain international filing dates). See MPEP § 706.02(a).

**WHEN THERE IS A COMMON ASSIGNEE OR INVENTOR, A PROVISIONAL 35 U.S.C. 102(e) REJECTION OVER AN EARLIER FILED UNPUBLISHED APPLICATION CAN BE MADE**

Based on the assumption that an application will ripen into a U.S. patent (or into an application publication), it is permissible to provisionally reject a later application over an earlier filed, and unpublished, application under 35 U.S.C. 102(e) when \*>there< is a common assignee or inventor. *In re Irish*, 433 F.2d 1342, 167 USPQ 764 (CCPA 1970). In addition, a provisional 35 U.S.C. 102(e) rejection may be made if the earlier filed copending U.S. application has been published as redacted (37 CFR 1.217) and the subject matter relied upon in the rejection is not supported in the redacted publication of the patent application. Such a provisional rejection “serves to put applicant on notice at the earliest possible time of the possible

prior art relationship between copending applications” and gives applicant the fullest opportunity to overcome the rejection by amendment or submission of evidence. In addition, since both applications are pending and usually have the same assignee, more options are available to applicant for overcoming the provisional rejection than if the other application were already issued. *Ex parte Bartfeld*, 16 USPQ2d 1714 (Bd. Pat. App. & Int. 1990) *aff’d on other grounds*, 925 F.2d 1450, 17 USPQ2d 1885 (Fed. Cir. 1991). Note that provisional rejections over 35 U.S.C. 102(e) are only authorized when there is a common inventor or assignee, otherwise the copending application prior to publication must remain confidential. MPEP § 706.02(f)(2) and § 706.02(k) discuss the procedures to be used in provisional rejections over 35 U.S.C. 102(e) and 102(e)/103.

For applications filed on or after November 29, 1999, a provisional rejection under 35 U.S.C. 102(e)/103 is not proper if the application contains evidence that the application and the prior art reference were owned by the same person, or subject to an obligation of assignment to the same person, at the time the invention was made. The changes to 35 U.S.C. 102(e) in the Intellectual Property and High Technology Technical Amendments Act of 2002 (Pub. L. 107-273, 116 Stat. 1758 (2002)) did not affect 35 U.S.C. 103(c) as amended on November 29, 1999. See MPEP § 706.02(l)(1) through § 706.02(l)(3) for information relating to rejections under 35 U.S.C. 102(e)/103 and evidence of common ownership.

## **2136.02 Content of the Prior Art Available Against the Claims [R-1]**

### **A 35 U.S.C. 102(e) REJECTION MAY RELY ON ANY PART OF THE PATENT OR APPLICATION PUBLICATION DISCLOSURE**

Under 35 U.S.C. 102(e), the entire disclosure of a U.S. patent, **\*\*>a U.S. patent< application publication \*\*>**, or an international application publication< having an earlier >effective U.S.< filing date >(which will include certain international filing dates)< can be relied on to reject the claims. *Sun Studs, Inc. v. ATA Equip. Leasing, Inc.*, 872 F.2d 978, 983, 10 USPQ2d 1338, 1342 (Fed. Cir. 1989). >See MPEP § 706.02(a).<

### **\* REFERENCE MUST ITSELF CONTAIN THE SUBJECT MATTER RELIED ON IN THE REJECTION**

When a U.S. patent, **\*\*>a U.S. patent< application publication \*\*>**, or an international application publication< is used to reject claims under 35 U.S.C. 102(e), the disclosure relied on in the rejection must be present in the issued patent or application publication. It is the >earliest effective U.S.< filing date >(which will include certain international filing dates)< of the U.S. patent or application publication being relied on as the critical reference date and subject matter not included in the patent or application publication itself can only be used when that subject matter becomes public. Portions of the patent application which were canceled are not part of the patent or application publication and thus cannot be relied on in a 35 U.S.C. 102(e) rejection over the issued patent or application publication. *Ex parte Stalego*, 154 USPQ 52 (Bd. App. 1966). Likewise, subject matter which is disclosed in a parent application, but not included in the child continuation-in-part (CIP) cannot be relied on in a 35 U.S.C. 102(e) rejection over the issued or published CIP. *In re Lund*, 376 F.2d 982, 153 USPQ 625 (CCPA 1967) (The examiner made a 35 U.S.C. 102(e) rejection over an issued U.S. patent which was a continuation-in-part (CIP). The parent application of the U.S. patent reference contained an example II which was not carried over to the CIP. The court held that the subject matter embodied in the canceled example II could not be relied on as of either parent or child filing date. Thus, the use of example II subject matter to reject the claims under 35 U.S.C. 102(e) was improper.).

### **THE SUPREME COURT HAS AUTHORIZED 35 U.S.C. 103 REJECTIONS BASED ON 35 U.S.C. 102(e)**

U.S. patents may be used as of their filing dates to show that the claimed subject matter is anticipated or obvious. Obviousness can be shown by combining other prior art with the U.S. patent reference in a 35 U.S.C. 103 rejection. *Hazeltine Research v. Brenner*, 382 U.S. 252, 147 USPQ 429 (1965). Similarly, **\*\*>certain< U.S. application publications and certain international application publications may also be used as of their >earliest effective U.S.<filing dates >(which will include certain international filing**

dates) < to show that the claimed subject matter would have been anticipated or obvious.

For applications filed on or after November 29, 1999, if the applicant provides evidence that the application and prior art reference were owned by the same person, or subject to an obligation of assignment to the same person, at the time the invention was made, any rejections under 35 U.S.C. 102(e)/103 based upon such a commonly owned reference should not be made or maintained. See MPEP § 706.02(l)(1) - § 706.02(l)(3) for additional information on rejections under 35 U.S.C. 102(e)/103 and evidence of common ownership.

### 2136.03 Critical Reference Date [R-2]

#### I. FOREIGN PRIORITY DATE

##### *Reference's Foreign Priority Date Under 35 U.S.C. 119(a)-(d) and (f) Cannot Be Used as the 35 U.S.C. 102(e) Reference Date*

35 U.S.C. 102(e) is explicitly limited to certain references “filed in the United States before the invention thereof by the applicant” (emphasis added). Foreign applications’ filing dates that are claimed (via 35 U.S.C. 119(a) – (d), (f) or 365(a)) in applications, which have been published as U.S. or WIPO application publications or patented in the U.S., may not be used as 35 U.S.C. 102(e) dates for prior art purposes. This includes international filing dates claimed as foreign priority dates under 35 U.S.C. 365(a). Therefore, the foreign priority date of the reference under 35 U.S.C. 119(a)-(d) (f), and 365(a) cannot be used to antedate the application filing date. In contrast, applicant may be able to overcome the 35 U.S.C. 102(e) rejection by proving he or she is entitled to his or her own 35 U.S.C. 119 priority date which is earlier than the reference’s U.S. filing date. *In re Hilmer*, 359 F.2d 859, 149 USPQ 480 (CCPA 1966) (*Hilmer I*) (Applicant filed an application with a right of priority to a German application. The examiner rejected the claims over a U.S. patent to Habicht based on its Swiss priority date. The U.S. filing date of Habicht was later than the application’s German priority date. The court held that the reference’s Swiss priority date could not be relied on in a 35 U.S.C. 102(e) rejection. Because the U.S. filing date of Habicht was later than the earliest effective filing date (German priority date) of the application, the rejection was reversed.). See MPEP

§ 201.15 for information on procedures to be followed in considering applicant's right of priority.

Note that certain international application (PCT) filings are considered to be “filings in the United States” for purposes of applying an application publication as prior art. See MPEP § 706.02(a).

#### II. INTERNATIONAL (PCT) APPLICATIONS; INTERNATIONAL APPLICATION PUBLICATIONS

If the potential reference resulted from, or claimed the benefit of, an international application, the following must be determined:

(A) If the international application meets the following three conditions:

- (1) an international filing date on or after November 29, 2000;
- (2) designated the United States; and
- (3) published under PCT Article 21(2) in English,

the international filing date is a U.S. filing date for prior art purposes under 35 U.S.C. 102(e). If such an international application properly claims benefit to an earlier-filed U.S. or international application, or priority to an earlier-filed U.S. provisional application, apply the reference under 35 U.S.C. 102(e) as of the earlier filing date, assuming all the conditions of 35 U.S.C. 102(e) and 35 U.S.C. 119(e), 120, or 365(c) are met. >In addition, the subject matter relied upon in the rejection must be disclosed in the earlier-filed application in compliance with 35 U.S.C. 112, first paragraph, in order to give that subject matter the benefit of the earlier filing date under 35 U.S.C. 102(e). < Note, where the earlier application is an international application, the earlier international application must satisfy the same three conditions (i.e., filed on or after November 29, 2000, designated the U.S., and had been published in English under PCT Article 21(2)) for the earlier international filing date to be a U.S. filing date for prior art purposes under 35 U.S.C. 102(e).

(B) If the international application was filed on or after November 29, 2000, but did **not** designate the United States or was **not** published in English under PCT Article 21(2), do **not** treat the international filing date as a U.S. filing date. In this situation, do **not** apply the reference as of its international filing date, its date of completion of the 35 U.S.C. 371(c)(1), (2) and (4) requirements, or any earlier filing date to

which such an international application claims benefit or priority. The reference may be applied under 35 U.S.C. 102(a) or (b) as of its publication date, or 35 U.S.C. 102(e) as of any later U.S. filing date of an application that properly claimed the benefit of the international application (if applicable).

(C) If the international application has an international filing date prior to November 29, 2000, apply the reference under the provisions of 35 U.S.C. 102 and 374, prior to the AIPA amendments:

(1) For U.S. patents, apply the reference under 35 U.S.C. 102(e) as of the earlier of the date of completion of the requirements of 35 U.S.C. 371(c)(1), (2) and (4) or the filing date of the later-filed U.S. application that claimed the benefit of the international application;

(2) For U.S. application publications and WIPO publications directly resulting from international applications under PCT Article 21(2), never apply these references under 35 U.S.C. 102(e). These references may be applied as of their publication dates under 35 U.S.C. 102(a) or (b);

(3) For U.S. application publications of applications that claim the benefit under 35 U.S.C. 120 or 365(c) of an international application filed prior to November 29, 2000, apply the reference under 35 U.S.C. 102(e) as of the actual filing date of the later-filed U.S. application that claimed the benefit of the international application.

Examiners should be aware that although a publication of, or a U.S. patent issued from, an international application may not have a 35 U.S.C. 102(e) date at all, or may have a 35 U.S.C. 102(e) date that is after the effective filing date of the application being examined (so it is not “prior art”), the corresponding WIPO publication of an international application may have an earlier 35 U.S.C. 102(a) or (b) date.

### III. PRIORITY FROM PROVISIONAL APPLICATION UNDER 35 U.S.C. 119(e)

The 35 U.S.C. 102(e) critical reference date of a U.S. patent or U.S. application publications and certain international application publications entitled to the benefit of the filing date of a provisional application under 35 U.S.C. 119(e) is the filing date of the provisional application with certain exceptions >if the provisional application(s) properly supports the subject matter relied upon to make the rejection in com-

pliance with 35 U.S.C. 112, first paragraph<. See MPEP § 706.02(f)(1), examples 5 to 9. Note that international applications which (1) were filed prior to November 29, 2000, or (2) did not designate the U.S., or (3) were not published in English under PCT Article 21(2) by WIPO, may not be used to reach back (bridge) to an earlier filing date through a priority or benefit claim for prior art purposes under 35 U.S.C. 102(e).

### IV. PARENT’S FILING DATE WHEN REFERENCE IS A CONTINUATION-IN-PART OF THE PARENT

#### *Filing Date of U.S. Parent Application Can Only Be Used as the 35 U.S.C. 102(e) Date If It Supports the Claims of the Issued Child*

In order to carry back the 35 U.S.C. 102(e) critical date of the U.S. patent reference to the filing date of a parent application, the >U.S. patent reference< must \* have a right of priority to the earlier date under 35 U.S.C. 120 or 365(c) and >the parent application must< support the invention claimed as required by 35 U.S.C. 112, first paragraph. “For if a patent could not theoretically have issued the day the application was filed, it is not entitled to be used against another as ‘secret prior art’ ” under 35 U.S.C. 102(e). *In re Wertheim*, 646 F.2d 527, 537, 209 USPQ 554, 564 (CCPA 1981) (The examiner made a 35 U.S.C. 103 rejection over a U.S. patent to Pfluger. The Pfluger patent (Pfluger IV) was the child of a string of abandoned parent applications (Pfluger I, the first application, Pfluger II and III, both CIPs). Pfluger IV was a continuation of Pfluger III. The court characterized the contents of the applications as follows: Pfluger I - subject matter A, II-AB, III-ABC, IV-ABC. ABC anticipated the claims of the examined application, but the filing date of III was later than the application filing date. So the examiner reached back to “A” in Pfluger I and combined this disclosure with another reference to establish obviousness. The court held that the examiner impermissibly carried over “A” and should have instead determined which of the parent applications contained the subject matter which made Pfluger patentable. Only if B and C were not claimed, or at least not critical to the patentability of Pfluger IV, could the filing date of Pfluger I be used. The court reversed the rejection based on a determination

that Pfluger IV was only entitled to the Pfluger III filing date. The added new matter (C) was critical to the claims of the issued patent.). Note that *In re Wertheim* modified the holding of *In re Lund*, 376 F.2d 982, 153 USPQ 625 (CCPA 1967) as to “carrying back” the subject matter to the parent applications.

See also *Ex parte Gilderdale*, 1990 Pat. App. LEXIS 25 (Bd. Pat. App. & Inter. Appeal no. 89-0352) (The examiner made a 35 U.S.C. 102(e) rejection over a U.S. patent to Hernandez. Hernandez was a continuation of a continuation-in-part. Both the parent and grandparent had been abandoned. The parent listed a different inventive entity but supported the subject matter of the child’s claims. The parent was filed on the same day as the examined application and thus no 35 U.S.C. 102(e) rejection could be made based on the parent’s filing date. The Board reversed the rejection, explaining that the Hernandez patent was entitled to the filing date of its parent, as the parent supported the patent claims and 35 U.S.C. 120 was satisfied. Under 35 U.S.C. 120, an application can claim the benefit of an earlier filing date even if not all inventors are the same. However, Hernandez was not entitled to the grandparent filing date because the parent and child applications contained new matter as compared to the grandparent.).

Compare *Ex parte Ebata*, 19 USPQ2d 1952 (Bd. Pat. App. & Inter. 1991) (The claims were directed to a method of administering a salt of lysocellin to animals. A 35 U.S.C. 102(e) rejection was made over Martin. Martin was a continuation of an application which was in turn a continuation-in-part of an abandoned application. The grandparent application disclosed administering a manganese complex of lysocellin to animals. The Board found that “the new matter relates to additional forms of lysocellin which are useful in Martin’s process, i.e., species or embodiments other than the manganese complex. This is far different from adding limitations which are required or necessary for patentability.” Unlike the situation in *In re Wertheim*, Martin’s invention was patentable as presented in the grandparent application.).

See also MPEP § 706.02(f)(1), examples 2 and 5 to 9.

## V. DATE OF CONCEPTION OR REDUCTION TO PRACTICE

### *35 U.S.C. 102(e) Reference Date Is the Filing Date Not Date of Inventor’s Conception or Reduction to Practice*

If a reference available under 35 U.S.C. 102(e) discloses, but does not claim the subject matter of the claims being examined or an obvious variant, the reference is not prior art under 35 U.S.C. 102(g). Furthermore, the reference does not qualify as “prior art” under 35 U.S.C. 102\*\* as of a date earlier than its filing date based upon any prior inventive activity that is disclosed in the U.S. patent or U.S. patent application >in the absence of evidence that the subject matter was actually reduced to practice in this country on an earlier date<. See MPEP § 2138. When the cases are not in interference, the effective date of the reference as prior art is its filing date in the United States (which will include certain international filing dates), as stated in 35 U.S.C. 102(e). See MPEP § 706.02(a). The date that the prior art subject matter was conceived or reduced to practice is of no importance when 35 U.S.C. 102(g) is not at issue. *Sun Studs, Inc. v. ATA Equip. Leasing, Inc.*, 872 F.2d 978, 983, 10 USPQ2d 1338, 1342 (Fed. Cir. 1989) (The defendant sought to invalidate patents issued to Mason and Sohn assigned to Sun Studs. The earliest of these patents issued in June 1973. A U.S. patent to Mouat was found which issued in March 1976 and which disclosed the invention of Mason and Sohn. While the patent to Mouat issued after the Mason and Sohn patents, it was filed 7 months earlier than the earliest of the Mason and Sohn patents. Sun Studs submitted affidavits showing conception in 1969 and diligence to the constructive reduction to practice and therefore antedated the patent to Mouat. The defendant sought to show that Mouat conceived the invention in 1966. The court held that conception of the subject matter of the reference only becomes an issue when the claims of the conflicting patents cover inventions which are the same or obvious over one another. When 35 U.S.C. 102(e) applies but not 35 U.S.C. 102(g), the filing date of the prior art patent is the earliest date that can be used to reject or invalidate claims.).

### 2136.04 Different Inventive Entity; Meaning of “By Another” [R-1]

#### IF THERE IS ANY DIFFERENCE IN THE INVENTIVE ENTITY, THE REFERENCE IS “BY ANOTHER”

“Another” means other than applicants, *In re Land*, 368 F.2d 866, 151 USPQ 621 (CCPA 1966), in other words, a different inventive entity. The inventive entity is different if not all inventors are the same. The fact that the application and reference have one or more inventors in common is immaterial. *Ex parte DesOrmeaux*, 25 USPQ2d 2040 (Bd. Pat. App. & Inter. 1992) (The examiner made a 35 U.S.C. 102(e) rejection based on an issued U.S. patent to three inventors. The rejected application was a continuation-in-part of the issued parent with an extra inventor. The Board found that the patent was “by another” and thus could be used in a 35 U.S.C. 102(e)/103 rejection of the application.).

#### A DIFFERENT INVENTIVE ENTITY IS *PRIMA FACIE* EVIDENCE THAT THE REFERENCE IS “BY ANOTHER”

As stated by the House and Senate reports on the bills enacting section 35 U.S.C. 102(e) as part of the 1952 Patent Act, this subsection of 102 codifies the Milburn rule of *Milburn v. Davis-Bournonville*, 270 U.S. 390 (1926). The Milburn rule authorized the use of a U.S. patent containing a disclosure of the invention as a reference against a later filed application as of the U.S. patent filing date. The existence of an earlier filed U.S. application containing the subject matter claimed in the application being examined indicates that applicant was not the first inventor. Therefore, a U.S. patent, \*\* a U.S. patent application publication or international application publication, by a different inventive entity, whether or not the application shares some inventors in common with the patent, is *prima facie* evidence that the invention was made “by another” as set forth in \*>35 U.S.C.< 102(e). *In re Mathews*, 408 F.2d 1393, 161 USPQ 276 (CCPA 1969); *In re Facius*, 408 F.2d 1396, 161 USPQ 294 (CCPA 1969); *Ex parte DesOrmeaux*, 25 USPQ2d 2040 (Bd. Pat. App. & Inter. 1992). See MPEP >§ 706.02(b) and < § 2136.05 for discussion of

methods of overcoming >35 U.S.C.< 102(e) rejections.

### 2136.05 Overcoming a Rejection Under 35 U.S.C. 102(e) [R-1]

#### A 35 U.S.C. 102(e) REJECTION CAN BE OVERCOME BY ANTEDATING THE FILING DATE OR SHOWING THAT DISCLOSURE RELIED ON IS APPLICANT’S OWN WORK

When a prior U.S. patent, \*\* U.S. patent application publication>,< or international application publication\* is not a statutory bar, a 35 U.S.C. 102(e) rejection can be overcome by antedating the filing date (see MPEP § 2136.03 regarding critical reference date of 35 U.S.C. 102(e) prior art) of the reference by submitting an affidavit or declaration under 37 CFR 1.131 or by submitting an affidavit or declaration under 37 CFR 1.132 establishing that the relevant disclosure is applicant’s own work. *In re Mathews*, 408 F.2d 1393, 161 USPQ 276 (CCPA 1969). The filing date can also be antedated by applicant’s earlier foreign priority application or provisional application if 35 U.S.C. 119 is met and the foreign application or provisional application “supports” (conforms to 35 U.S.C. 112, first paragraph, requirements) all the claims of the U.S. application. *In re Gosteli*, 872 F.2d 1008, 10 USPQ2d 1614 (Fed. Cir. 1989). But a prior application which was not copending with the application at issue cannot be used to antedate a reference. *In re Costello*, 717 F.2d 1346, 219 USPQ 389 (Fed. Cir. 1983). A terminal disclaimer also does not overcome a 35 U.S.C. 102(e) rejection. See, e.g., *In re Bartfeld*, 925 F.2d 1415, 17 USPQ2d 1885 (Fed. Cir. 1991).

See MPEP § 706.02(b) for a list of methods which can be used to overcome rejections based on 35 U.S.C. 102(e) rejections. For information on the required contents of a 37 CFR 1.131 affidavit or declaration and the situations in which such affidavits and declarations are permitted see MPEP § 715. An affidavit or declaration is not appropriate if the reference describes applicant’s own work. In this case, applicant must submit an affidavit or declaration under 37 CFR 1.132. See the next paragraph for more information concerning the requirements of 37 CFR 1.132 affidavits and declarations.



**A 35 U.S.C. 102(e) REJECTION CAN BE OVERCOME BY SHOWING THE REFERENCE IS DESCRIBING APPLICANT'S OWN WORK**

“The fact that an application has named a different inventive entity than a patent does not necessarily make that patent prior art.” *Applied Materials Inc. v. Gemini Research Corp.*, 835 F.2d 279, 15 USPQ2d 1816 (Fed. Cir. 1988). The issue turns on what the evidence of record shows as to who invented the subject matter. *In re Whittle*, 454 F.2d 1193, 1195, 172 USPQ 535, 537 (CCPA 1972). In fact, even if applicant's work was publicly disclosed prior to his or her application, applicant's own work may not be used against him or her unless there is a time bar under 35 U.S.C. 102(b). *In re DeBaun*, 687 F.2d 459, 214 USPQ 933 (CCPA 1982) (citing *In re Katz*, 687 F.2d 450, 215 USPQ 14 (CCPA 1982)). Therefore, when the unclaimed subject matter of a reference is applicant's own invention, applicant may overcome a *prima facie* case based on the patent, \*\* U.S. patent application publication>,< or international application publication, by showing that the disclosure is a description of applicant's own previous work. Such a showing can be made by proving that the patentee, or \*\* the inventor(s) of the U.S. patent application publication or the international application publication, was associated with applicant (e.g. worked for the same company) and learned of applicant's invention from applicant. *In re Mathews*, 408 F.2d 1393, 161 USPQ 276 (CCPA 1969). In the situation where one application is first filed by inventor X and then a later application is filed by X & Y, it must be proven that the joint invention was made first, was thereafter described in the sole applicant's patent, or \*\* was thereafter described in the sole applicant's U.S. patent application publication or international application publication, and then the joint application was filed. *In re Land*, 368 F.2d 866, 151 USPQ 621 (CCPA 1966).

In *In re Land*, separate U.S. patents to Rogers and to Land were used to reject a joint application to Rogers and Land under 35 U.S.C. 102(e)/103. The inventors worked for the same company (Polaroid) and in the same laboratory. All the patents flowed from the same research. In addition, the patent applications were prepared by the same attorneys, were interrelated and contained cross-references to each other. The court affirmed the rejection because (1) the

inventive entities of the patents (one to Rogers and one to Land) were different from the inventive entity of the joint application (Rogers and Land) and (2) Land and Rogers brought their knowledge of their individual work with them when they made the joint invention. There was no indication that the portions of the references relied on disclosed anything they did jointly. Neither was there any showing that what they did jointly was done before the filing of the reference patent applications.

See also *In re Carreira*, 532 F.2d 1356, 189 USPQ 461 (CCPA 1976) (The examiner rejected claims to a joint application to Carreira, Kyrakakis, Solodar, and Labana under 35 U.S.C. 102(e) and 103 in view of a U.S. patent issued to Tulagin and Carreira or a patent issued to Clark. The applicants submitted declarations under 37 CFR 1.132 by Tulagin and Clark in which each declarant stated he was “not the inventor of the use of compounds having a hydroxyl group in a position ortho to an azo linkage.” The court held that these statements were vague and inconclusive because the declarants did not disclose the use of this generic compound but rather species of this generic compound in their patents and it was the species which met the claims. The declaration that each did not invent the use of the generic compound does not establish that Tulagin and Clark did not invent the use of the species.)

MPEP § 715.01(a), § 715.01(c), and § 716.10 set forth more information pertaining to the contents and uses of affidavits and declarations under 37 CFR 1.132 for antedating references. See MPEP § 706.02(l)(1) for information pertaining to rejections under 35 U.S.C. 102(e)/103 and the applicability of 35 U.S.C. 103(c).

**APPLICANT NEED NOT SHOW DILIGENCE OR REDUCTION TO PRACTICE WHEN THE SUBJECT MATTER DISCLOSED IN THE REFERENCE IS APPLICANT'S OWN WORK**

When the reference reflects applicant's own work, applicant need not prove diligence or reduction to practice to establish that he or she invented the subject matter disclosed in the reference. A showing that the reference disclosure arose from applicant's work coupled with a showing of conception by the applicant before the filing date of the reference will overcome the 35 U.S.C. 102(e) rejection. The showing can be

made by submission of an affidavit by the inventor under 37 CFR 1.132. The other patentees need not submit an affidavit disclaiming inventorship, but, if submitted, a disclaimer by all other patentees should be considered by the examiner. *In re DeBaun*, 687 F.2d 459, 214 USPQ 933 (CCPA 1982) (Declaration submitted by DeBaun stated that he was the inventor of subject matter disclosed in the U.S. patent reference of DeBaun and Noll. Exhibits were attached to the declaration showing conception and included drawings DeBaun had prepared and given to counsel for purposes of preparing the application which issued as the reference patent. The court held that, even though the evidence was not sufficient to antedate the prior art patent under 37 CFR 1.131, diligence and/or reduction to practice was not required to show DeBaun invented the subject matter. Declarant's statement that he conceived the invention first was enough to overcome the 35 U.S.C. 102(e) rejection.).

**CLAIMING OF INDIVIDUAL ELEMENTS OR SUBCOMBINATIONS IN A COMBINATION CLAIM OF THE REFERENCE DOES NOT ITSELF ESTABLISH THAT THE PATENTEE INVENTED THOSE ELEMENTS**

The existence of combination claims in a reference is not evidence that the patentee invented the individual elements or subcombinations included if the elements and subcombinations are not separately claimed apart from the combination. *In re DeBaun*, 687 F.2d 459, 214 USPQ 933 (CCPA 1982) (citing *In re Facius*, 408 F.2d 1396, 1406, 161 USPQ 294, 301 (CCPA 1969)).

See also *In re Mathews*, 408 F.2d 1393, 161 USPQ 276 (CCPA 1969) (On September 15, 1961, Dewey filed an application disclosing and claiming a time delay protective device for an electric circuit. In disclosing the invention, Dewey completely described, but did not claim, a "gating means 19" invented by Mathews which was usable in the protective device. Dewey and Mathews were coworkers at General Electric Company, the assignee. Mathews filed his application on March 7, 1963, before the Dewey patent issued but almost 18 months after its filing. The Mathews application disclosed that "one illustration of a circuit embodying the present invention is shown in copending patent application S.N. 138,476-Dewey." The examiner used Dewey to reject all the

Mathews claims under 35 U.S.C. 102(e). In response, Mathews submitted an affidavit by Dewey under 37 CFR 1.132. In the affidavit, Dewey stated that he did not invent the gating means 19 but had learned of the gating means through Mathews and that GE attorneys had advised that the gating means be disclosed in Dewey's application to comply with 35 U.S.C. 112, first paragraph. The examiner argued that the only way to overcome a 35 U.S.C. 102(e) rejection was by submitting an affidavit or declaration under 37 CFR 1.131 to antedate the filing date of the reference. The court reversed the rejection, holding that the totality of the evidence on record showed that Dewey derived his knowledge from Mathews who is "the original, first and sole inventor.").

**2137 35 U.S.C. 102(f)**

*35 U.S.C. 102. Conditions for patentability; novelty and loss of right to patent.*

A person shall be entitled to a patent unless -

\*\*\*\*\*

(f) he did not himself invent the subject matter sought to be patented.

\*\*\*\*\*

Where it can be shown that an applicant "derived" an invention from another, a rejection under 35 U.S.C. 102(f) is proper. *Ex parte Kusko*, 215 USPQ 972, 974 (Bd. App. 1981) ("most, if not all, determinations under section 102(f) involve the question of whether one party derived an invention from another").

While derivation will bar the issuance of a patent to the deriver, a disclosure by the deriver, absent a bar under 35 U.S.C. 102(b), will not bar the issuance of a patent to the party from which the subject matter was derived. *In re Costello*, 717 F.2d 1346, 1349, 219 USPQ 389, 390-91 (Fed. Cir. 1983) ("[a] prior art reference that is not a statutory bar may be overcome by two generally recognized methods": an affidavit under 37 CFR 1.131, or an affidavit under 37 CFR 1.132 "showing that the relevant disclosure is a description of the applicant's own work"); *In re Facius*, 408 F.2d 1396, 1407, 161 USPQ 294, 302 (CCPA 1969) (subject matter incorporated into a patent that was brought to the attention of the patentee by applicant, and hence derived by the patentee from the applicant, is available for use against applicant

unless applicant had actually invented the subject matter placed in the patent).

Where there is a published article identifying the authorship (MPEP § 715.01(c)) or a patent identifying the inventorship (MPEP § 715.01(a)) that discloses subject matter being claimed in an application undergoing examination, the designation of authorship or inventorship does not raise a presumption of inventorship with respect to the subject matter disclosed in the article or with respect to the subject matter disclosed but not claimed in the patent so as to justify a rejection under 35 U.S.C. 102(f). However, it is incumbent upon the inventors named in the application, in reply to an inquiry regarding the appropriate inventorship under subsection (f), or to rebut a rejection under 35 U.S.C. 102(a) or (e), to provide a satisfactory showing by way of affidavit under 37 CFR 1.132 that the inventorship of the application is correct in that the reference discloses subject matter invented by the applicant rather than derived from the author or patentee notwithstanding the authorship of the article or the inventorship of the patent. *In re Katz*, 687 F.2d 450, 455, 215 USPQ 14, 18 (CCPA 1982) (inquiry is appropriate to clarify any ambiguity created by an article regarding inventorship, and it is then incumbent upon the applicant to provide “a satisfactory showing that would lead to a reasonable conclusion that [applicant] is the...inventor” of the subject matter disclosed in the article and claimed in the application).

#### **DERIVATION REQUIRES COMPLETE CONCEPTION BY ANOTHER AND COMMUNICATION TO THE ALLEGED DERIVER**

“The mere fact that a claim recites the use of various components, each of which can be argumentatively assumed to be old, does not provide a proper basis for a rejection under 35 U.S.C. 102(f).” *Ex parte Billottet*, 192 USPQ 413, 415 (Bd. App. 1976). Derivation requires complete conception by another and communication of that conception by any means to the party charged with derivation prior to any date on which it can be shown that the one charged with derivation possessed knowledge of the invention. *Kilbey v. Thiele*, 199 USPQ 290, 294 (Bd. Pat. Inter. 1978).

See also *Price v. Symsek*, 988 F.2d 1187, 1190, 26 USPQ2d 1031, 1033 (Fed. Cir. 1993); *Hedgewick v. Akers*, 497 F.2d 905, 908, 182 USPQ 167, 169 (CCPA

1974). “Communication of a complete conception must be sufficient to enable one of ordinary skill in the art to construct and successfully operate the invention.” *Hedgewick*, 497 F.2d at 908, 182 USPQ at 169. See also *Gambro Lundia AB v. Baxter Healthcare Corp.*, 110 F.3d 1573, 1577, 42 USPQ2d 1378, 1383 (Fed. Cir. 1997) (Issue in proving derivation is “whether the communication enabled one of ordinary skill in the art to make the patented invention.”).

#### **PARTY ALLEGING DERIVATION DOES NOT HAVE TO PROVE AN ACTUAL REDUCTION TO PRACTICE, DERIVATION OF PUBLIC KNOWLEDGE, OR DERIVATION IN THIS COUNTRY**

The party alleging derivation “need not prove an actual reduction to practice in order to show derivation.” *Scott v. Brandenburger*, 216 USPQ 326, 327 (Bd. App. 1982). Furthermore, the application of subsection (f) is not limited to public knowledge derived from another, and “the site of derivation need not be in this country to bar a deriver from patenting the subject matter.” *Ex parte Andresen*, 212 USPQ 100, 102 (Bd. App. 1981).

#### **DERIVATION DISTINGUISHED FROM PRIORITY OF INVENTION**

Although derivation and priority of invention both focus on inventorship, derivation addresses originality (i.e., who invented the subject matter), whereas priority focuses on which party first invented the subject matter. *Price v. Symsek*, 988 F.2d 1187, 1190, 26 USPQ2d 1031, 1033 (Fed. Cir. 1993).

#### **35 U.S.C. 102(f) MAY APPLY WHERE 35 U.S.C. 102(a) AND 35 U.S.C. 102(e) ARE NOT AVAILABLE STATUTORY GROUNDS FOR REJECTION**

35 U.S.C. 102(f) does not require an inquiry into the relative dates of a reference and the application, and therefore may be applicable where subsections (a) and (e) are not available for references having an effective date subsequent to the effective date of the application being examined. However for a reference having a date later than the date of the application some evidence may exist that the subject matter of the reference was derived from the applicant in view of the relative dates. *Ex parte Kusko*, 215 USPQ 972,

974 (Bd. App. 1981) (The relative dates of the events are important in determining derivation; a publication dated more than a year after applicant's filing date that merely lists as literary coauthors individuals other than applicant is not the strong evidence needed to rebut a declaration by the applicant that he is the sole inventor.).

## 2137.01 Inventorship [R-2]

The requirement that the applicant for a patent be the inventor is a characteristic of U.S. patent law not generally shared by other countries. Consequently, foreign applicants may misunderstand U.S. law regarding naming of the actual inventors causing an error in the inventorship of a U.S. application that may claim priority to a previous foreign application under 35 U.S.C. 119. A request under 37 CFR 1.48(a) is required to correct any error in naming the inventors in the U.S. application as filed. MPEP § 201.03. Foreign applicants may need to be reminded of the requirement for identity of inventorship between a U.S. application and a 35 U.S.C. 119 priority application. MPEP § 201.13.

If a determination is made that the inventive entity named in a U.S. application is not correct, such as when a request under 37 CFR 1.48(a) is not granted or is not entered for technical reasons, but the admission therein regarding the error in inventorship is uncontroverted, a rejection under 35 U.S.C. 102(f) should be made.

>

### I. <EXECUTORS OF OATH OR DECLARATION UNDER 37 CFR 1.63 ARE PRESUMED TO BE THE INVENTORS

The party or parties executing an oath or declaration under 37 CFR 1.63 are presumed to be the inventors. *Driscoll v. Cebalo*, 5 USPQ2d 1477, 1481 (Bd. Pat. Inter. 1982); *In re DeBaun*, 687 F.2d 459, 463, 214 USPQ 933, 936 (CCPA 1982) (The inventor of an element, *per se*, and the inventor of that element as used in a combination may differ. "The existence of combination claims does not evidence inventorship by the patentee of the individual elements or subcombinations thereof if the latter are not separately claimed apart from the combination." (quoting *In re Facius*, 408 F.2d 1396, 1406, 161 USPQ 294, 301 (CCPA 1969) (emphasis in original)); *Brader v. Schaeffer*,

193 USPQ 627, 631 (Bd. Pat. Inter. 1976) (in regard to an inventorship correction: "[a]s between inventors their word is normally taken as to who are the actual inventors" when there is no disagreement).

>

### II. <AN INVENTOR MUST CONTRIBUTE TO THE CONCEPTION OF THE INVENTION

The definition for inventorship can be simply stated: "The threshold question in determining inventorship is who conceived the invention. Unless a person contributes to the conception of the invention, he is not an inventor. ... Insofar as defining an inventor is concerned, reduction to practice, *per se*, is irrelevant [except for simultaneous conception and reduction to practice, *Fiers v. Revel*, 984 F.2d 1164, 1168, 25 USPQ2d 1601, 1604-05 (Fed. Cir. 1993)]. One must contribute to the conception to be an inventor." *In re Hardee*, 223 USPQ 1122, 1123 (Comm'r Pat. 1984). See also >*Board of Education ex rel. Board of Trustees of Florida State Univ. v. American Bioscience Inc.*, 333 F.3d 1330, 1340, 67 USPQ2d 1252, 1259 (Fed. Cir. 2003) ("Invention requires conception." With regard to the inventorship of chemical compounds, an inventor must have a conception of the specific compounds being claimed. "[G]eneral knowledge regarding the anticipated biological properties of groups of complex chemical compounds is insufficient to confer inventorship status with respect to specifically claimed compounds."); < *Ex parte Smernoff*, 215 USPQ 545, 547 (Bd. App. 1982) ("one who suggests an idea of a result to be accomplished, rather than the means of accomplishing it, is not an coinventor"). See MPEP § 2138.04 - § 2138.05 for a discussion of what evidence is required to establish conception or reduction to practice.

>

### III. <AS LONG AS THE INVENTOR MAINTAINS INTELLECTUAL DOMINATION OVER MAKING THE INVENTION, IDEAS, SUGGESTIONS, AND MATERIALS MAY BE ADOPTED FROM OTHERS

"In arriving at ... conception [the inventor] may consider and adopt ideas and materials derived from many sources ... [such as] a suggestion from an employee, or hired consultant ... so long as he main-

tains intellectual domination of the work of making the invention down to the successful testing, selecting or rejecting as he goes...even if such suggestion [or material] proves to be the key that unlocks his problem.” *Morse v. Porter*, 155 USPQ 280, 283 (Bd. Pat. Inter. 1965). See also *New England Braiding Co. v. A.W. Chesterton Co.*, 970 F.2d 878, 883, 23 USPQ2d 1622, 1626 (Fed. Cir. 1992) (Adoption of the ideas and materials from another can become a derivation.).

&gt;

#### IV. <THE INVENTOR IS NOT REQUIRED TO REDUCE THE INVENTION TO PRACTICE

Difficulties arise in separating members of a team effort, where each member of the team has contributed something, into those members that actually contributed to the conception of the invention, such as the physical structure or operative steps, from those members that merely acted under the direction and supervision of the conceivers. *Fritsch v. Lin*, 21 USPQ2d 1737, 1739 (Bd. Pat. App. & Inter. 1991) (The inventor “took no part in developing the procedures...for expressing the EPO gene in mammalian host cells and isolating the resulting EPO product.” However, “it is not essential for the inventor to be personally involved in carrying out process steps...where implementation of those steps does not require the exercise of inventive skill.”); *In re DeBaun*, 687 F.2d 459, 463, 214 USPQ 933, 936 (CCPA 1982) (“there is no requirement that the inventor be the one to reduce the invention to practice so long as the reduction to practice was done on his behalf”).

See also *Mattor v. Coolegem*, 530 F.2d 1391, 1395, 189 USPQ 201, 204 (CCPA 1976) (one following oral instructions is viewed as merely a technician); *Tucker v. Naito*, 188 USPQ 260, 263 (Bd. Pat. Inter. 1975) (inventors need not “personally construct and test their invention”); *Davis v. Carrier*, 81 F.2d 250, 252, 28 USPQ 227, 229 (CCPA 1936) (noninventor’s work was merely that of a skilled mechanic carrying out the details of a plan devised by another).

&gt;

#### V. <REQUIREMENTS FOR JOINT INVENTORSHIP

The inventive entity for a particular application is based on some contribution to at least one of the

claims made by each of the named inventors. “Inventors may apply for a patent jointly even though (1) they did not physically work together or at the same time, (2) each did not make the same type or amount of contribution, or (3) each did not make a contribution to the subject matter of every claim of the patent.” 35 U.S.C. 116. “[T]he statute neither states nor implies that two inventors can be ‘joint inventors’ if they have had no contact whatsoever and are completely unaware of each other’s work.” What is required is some “quantum of collaboration or connection.” In other words, “[f]or persons to be joint inventors under Section 116, there must be some element of joint behavior, such as collaboration or working under common direction, one inventor seeing a relevant report and building upon it or hearing another’s suggestion at a meeting.” *Kimberly-Clark Corp. v. Procter & Gamble Distrib. Co.*, 973 F.2d 911, 916-17, 23 USPQ2d 1921, 1925-26 (Fed. Cir. 1992); *Moler v. Purdy*, 131 USPQ 276, 279 (Bd. Pat. Inter. 1960) (“it is not necessary that the inventive concept come to both [joint inventors] at the same time”).

Each joint inventor must generally contribute to the conception of the invention. A coinventor need not make a contribution to every claim of a patent. A contribution to one claim is enough. “The contributor of any disclosed means of a means-plus-function claim element is a joint inventor as to that claim, unless one asserting sole inventorship can show that the contribution of that means was simply a reduction to practice of the sole inventor’s broader concept.” *Ethicon Inc. v. United States Surgical Corp.*, 135 F.3d 1456, 1460-63, 45 USPQ2d 1545, 1548-1551 (Fed. Cir. 1998) (The electronics technician who contributed to one of the two alternative structures in the specification to define “the means for detaining” in a claim limitation was held to be a joint inventor.).

&gt;

#### VI. <INVENTORSHIP IS GENERALLY “TO ANOTHER” WHERE THERE ARE DIFFERENT INVENTIVE ENTITIES WITH AT LEAST ONE INVENTOR IN COMMON

“[A] joint application or patent and a sole application or patent by one of the joint inventors are [by] different legal entities and accordingly, the issuance of the earlier filed application as a patent becomes a

reference for everything it discloses” (*Ex parte Utschig*, 156 USPQ 156, 157 (Bd. App. 1966)) except where:

(A) the claimed invention in a later filed application is entitled to the benefit of an earlier filed application under 35 U.S.C. 120 (an overlap of inventors rather than an identical inventive entity is permissible). In this situation, a rejection under 35 U.S.C. 102(e) is precluded. See *Applied Materials Inc. v. Gemini Research Corp.*, 835 F.2d 279, 281, 15 USPQ2d 1816, 1818 (Fed. Cir. 1988) (“The fact that an application has named a different inventive entity than a patent does not necessarily make that patent prior art.”); and

(B) the subject matter developed by another person and the claimed subject matter were, at the time the invention was made, owned by the same person or subject to an obligation of assignment to the same person. In this situation, a rejection under 35 U.S.C. 102(f)/103 or 102(g)/103, or 102(e)/103 for applications filed on or after November 29, 1999, is precluded by 35 U.S.C. 103(c). See MPEP § 706.02(1) and § 706.02(1)(1).

For case law relating to inventorship by “another” involving different inventive entities with at least one inventor in common see *Ex parte DesOrmeaux*, 25 USPQ2d 2040 (Bd. Pat. App. & Inter. 1992) (the presence of a common inventor in a reference patent and a pending application does not preclude the determination that the reference inventive entity is to “another” within the meaning of 35 U.S.C. 102(e)) and the discussion of prior art available under 35 U.S.C. 102(e) in MPEP § 2136.04.

### 2137.02 Applicability of 35 U.S.C. 103(c)

35 U.S.C. 103(c) states that subsection (f) of 35 U.S.C. 102 will not preclude patentability where subject matter developed by another person, that would otherwise qualify under 35 U.S.C. 102(f), and the claimed invention of an application under examination were owned by the same person or subject to an obligation of assignment to the same person at the time the invention was made. See MPEP § 706.02(1) and § 2146.

### 2138 35 U.S.C. 102(g)

*35 U.S.C. 102. Conditions for patentability; novelty and loss of right to patent.*

A person shall be entitled to a patent unless -

\*\*\*\*\*

(g)(1) during the course of an interference conducted under section 135 or section 291, another inventor involved therein establishes, to the extent permitted in section 104, that before such person’s invention thereof the invention was made by such other inventor and not abandoned, suppressed, or concealed, or (2) before such person’s invention thereof, the invention was made in this country by another inventor who had not abandoned, suppressed, or concealed it. In determining priority of invention under this subsection, there shall be considered not only the respective dates of conception and reduction to practice of the invention, but also the reasonable diligence of one who was first to conceive and last to reduce to practice, from a time prior to conception by the other.

35 U.S.C. 102(g) issues such as conception, reduction to practice and diligence, while more commonly applied to interference matters, also arise in other contexts.

35 U.S.C. 102(g) may form the basis for an *ex parte* rejection if: (1) the subject matter at issue has been actually reduced to practice by another before the applicant’s invention; and (2) there has been no abandonment, suppression or concealment. See, e.g., *Amgen, Inc. v. Chugai Pharmaceutical Co.*, 927 F.2d 1200, 1205, 18 USPQ2d 1016, 1020 (Fed. Cir. 1991); *New Idea Farm Equipment Corp. v. Sperry Corp.*, 916 F.2d 1561, 1566, 16 USPQ2d 1424, 1428 (Fed. Cir. 1990); *E.I. DuPont de Nemours & Co. v. Phillips Petroleum Co.*, 849 F.2d 1430, 1434, 7 USPQ2d 1129, 1132 (Fed. Cir. 1988); *Kimberly-Clark v. Johnson & Johnson*, 745 F.2d 1437, 1444-46, 223 USPQ 603, 606-08 (Fed. Cir. 1984). To qualify as prior art under 35 U.S.C. 102(g), however, there must be evidence that the subject matter was actually reduced to practice, in that conception alone is not sufficient. See *Kimberly-Clark*, 745 F.2d at 1445, 223 USPQ at 607. While the filing of an application for patent is a constructive reduction to practice, the filing of an application does not in itself provide the evidence necessary to show an actual reduction to practice of any of the subject matter disclosed in the application as is necessary to provide the basis for an *ex parte* rejection under 35 U.S.C. 102(g). Thus, absent evidence showing an actual reduction to practice (which is generally not available during *ex parte* examination), the disclo-

sure of a United States patent application publication or patent falls under 35 U.S.C. 102(e) and not under 35 U.S.C. 102(g). *Cf. In re Zletz*, 893 F.2d 319, 323, 13 USPQ2d 1320, 1323 (Fed. Cir. 1990) (the disclosure in a reference United States patent does not fall under 35 U.S.C. 102(g) but under 35 U.S.C. 102(e)).

In addition, subject matter qualifying as prior art only under 35 U.S.C. 102(g) may also be the basis for an *ex parte* rejection under 35 U.S.C. 103. See *In re Bass*, 474 F.2d 1276, 1283, 177 USPQ 178, 183 (CCPA 1973) (in an unsuccessful attempt to utilize a 37 CFR 1.131 affidavit relating to a combination application, applicants admitted that the subcombination screen of a copending application which issued as a patent was earlier conceived than the combination). 35 U.S.C. 103(c), however, states that subsection (g) of 35 U.S.C. 102 will not preclude patentability where subject matter developed by another person, that would otherwise qualify under 35 U.S.C. 102(g), and the claimed invention of an application under examination were owned by the same person or subject to an obligation of assignment to the same person at the time the invention was made. See MPEP § 706.02(1) and § 2146.

For additional examples of 35 U.S.C. 102(g) issues such as conception, reduction to practice and diligence outside the context of interference matters, see *In re Costello*, 717 F.2d 1346, 219 USPQ 389 (Fed. Cir. 1983) (discussing the concepts of conception and constructive reduction to practice in the context of a declaration under 37 CFR 1.131), and *Kawai v. Metlesics*, 480 F.2d 880, 178 USPQ 158 (CCPA 1973) (holding constructive reduction to practice for priority under 35 U.S.C. 119 requires meeting the requirements of 35 U.S.C. 101 and 35 U.S.C. 112).

## 2138.01 Interference Practice

### 35 U.S.C. 102(g) IS THE BASIS OF INTERFERENCE PRACTICE

Subsection (g) of 35 U.S.C. 102 is the basis of interference practice for determining priority of invention between two parties. See *Bigham v. Godtfredsen*, 857 F.2d 1415, 1416, 8 USPQ2d 1266, 1267 (Fed. Cir. 1988), 35 U.S.C. 135, 37 CFR 1.601+ and MPEP chapter 2300. An interference is an *inter partes* proceeding directed at determining the first to invent as among the parties to the proceeding, involving two

or more pending applications naming different inventors or one or more pending applications and one or more unexpired patents naming different inventors (37 CFR 1.601(i)). The United States is unusual in having a first to invent rather than a first to file system. *Paulik v. Rizkalla*, 760 F.2d 1270, 1272, 226 USPQ 224, 225 (Fed. Cir. 1985) (reviews the legislative history of the subsection in a concurring opinion by Judge Rich). The first of many to reduce an invention to practice around the same time will be the sole party to obtain a patent, *Radio Corp. of America v. Radio Eng'g Labs., Inc.*, 293 U.S. 1, 2, 21 USPQ 353, 353-4 (1934), unless another was the first to conceive and couple a later-in-time reduction to practice with diligence from a time just prior to when the second conceiver entered the field to the first conceiver's reduction to practice. *Hull v. Davenport*, 90 F.2d 103, 105, 33 USPQ 506, 508 (CCPA 1937). See the priority time charts below illustrating this point. Upon conclusion of an interference, subject matter claimed by the losing party that was the basis of the interference is rejected under 35 U.S.C. 102(g), unless the acts showing prior invention were not in this country.

It is noted that 35 U.S.C. 101 requires that whoever invents or discovers is the party who may obtain a patent for the particular invention or discovery. 35 U.S.C. 111 (applicant) or 35 U.S.C. 116 (applicants) set forth the requirement that the actual inventor(s) be the party who applies for a patent or that a patent be applied for on behalf of the inventor. Where it can be shown that an applicant has "derived" an invention from another, a rejection under 35 U.S.C. 102(f) is proper. *Ex parte Kusko*, 215 USPQ 972, 974 (Bd. App. 1981) ("most, if not all, determinations under Section 102(f) involve the question of whether one party derived an invention from another"); *Price v. Symsek*, 988 F.2d 1187, 1190, 26 USPQ2d 1031, 1033 (Fed. Cir. 1993) (Although derivation and priority of invention both focus on inventorship, derivation addresses originality, i.e., who invented the subject matter, whereas priority focuses on which party invented the subject matter first.).

### PRIORITY TIME CHARTS

The following priority time charts illustrate the award of invention priority in several situations. The time charts apply to interference proceedings and are also applicable to declarations or affidavits filed under

37 CFR 1.131 to antedate references which are available as prior art under 35 U.S.C. 102(a) or 102(e). Note, however, in the context of 37 CFR 1.131, an applicant does not have to show that the invention was not abandoned, suppressed, or concealed from the time of an actual reduction to practice to a constructive reduction to practice because the length of time taken to file a patent application after an actual reduction to practice is generally of no consequence except in an interference proceeding. *Paulik v. Rizkalla*, 760 F.2d 1270, 226 USPQ 224 (Fed. Cir. 1985). See the discussion of abandonment, suppression, and concealment in MPEP § 2138.03.

For purposes of analysis under 37 CFR 1.131, the conception and reduction to practice of the reference to be antedated are both considered to be on the effective filing date of domestic patent or foreign patent or the date of printed publication.

In the charts, C = conception, R = reduction to practice (either actual or constructive), Ra = actual reduction to practice, Rc = constructive reduction to practice, and T<sub>D</sub> = commencement of diligence.

**Example 1**

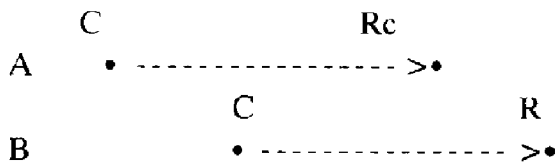

A is awarded priority in an interference, or antedates B as a reference in the context of a declaration or affidavit filed under 37 CFR 1.131, because A conceived the invention before B and constructively reduced the invention to practice before B reduced the invention to practice. The same result would be reached if the conception date was the same for both inventors A and B.

**Example 2**

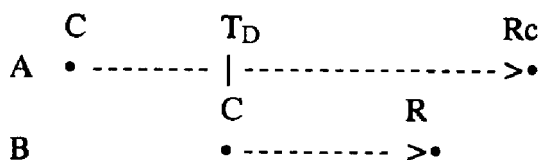

A is awarded priority in an interference, or antedates B as a reference in the context of a declaration or affidavit filed under 37 CFR 1.131, if A can show reasonable diligence from T<sub>D</sub> (a point just prior to B's conception) until Rc because A conceived the invention before B, and diligently constructively reduced the invention to practice even though this was after B reduced the invention to practice.

**Example 3**

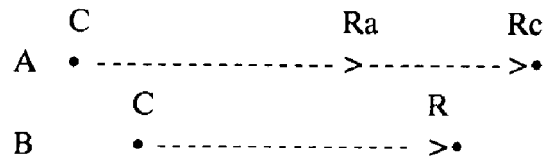

A is awarded priority in an interference in the absence of abandonment, suppression, or concealment from Ra to Rc, because A conceived the invention before B, actually reduced the invention to practice before B reduced the invention to practice, and did not abandon, suppress, or conceal the invention after actually reducing the invention to practice and before constructively reducing the invention to practice.

A antedates B as a reference in the context of a declaration or affidavit filed under 37 CFR 1.131 because A conceived the invention before B and actually reduced the invention to practice before B reduced the invention to practice.

**Example 4**

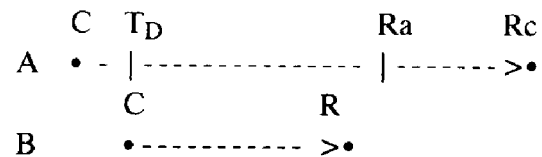

A is awarded priority in an interference if A can show reasonable diligence from T<sub>D</sub> (a point just prior to B's conception) until Ra in the absence of abandonment, suppression, or concealment from Ra to Rc, because A conceived the invention before B, diligently actually reduced the invention to practice (after B reduced the invention to practice), and did not abandon, suppress, or conceal the



invention after actually reducing the invention to practice and before constructively reducing the invention to practice.

A antedates B as a reference in the context of a declaration or affidavit filed under 37 CFR 1.131 because A conceived the invention before B, and diligently actually reduced the invention to practice, even though this was after B reduced the invention to practice.

### **37 CFR 1.131 DOES NOT APPLY IN INTERFERENCE PROCEEDINGS**

Interference practice operates to the exclusion of *ex parte* practice under 37 CFR 1.131 which permits an applicant to show an actual date of invention prior to the effective date of a patent or literature reference applied under 35 U.S.C. 102(a) or (e), as long as the patent is not a domestic patent claiming the same patentable invention. *Ex parte Standish*, 10 USPQ2d 1454, 1457 (Bd. Pat. App. & Inter. 1988) (An application claim to the “same patentable invention” claimed in a domestic patent requires interference rather than an affidavit under 37 CFR 1.131 to antedate the patent. The term “same patentable invention” encompasses a claim that is either anticipated by or obvious in view of the subject matter recited in the patent claim.). Subject matter which is available as prior art only under 35 U.S.C. 102(g) is by definition made before the applicant made his invention and is therefore not open to further inquiry under 37 CFR 1.131.

### **LOST COUNTS IN AN INTERFERENCE ARE NOT, *PER SE*, STATUTORY PRIOR ART**

Loss of an interference count alone does not make its subject matter statutory prior art to losing party; however, lost count subject matter that is available as prior art under 35 U.S.C. 102 may be used alone or in combination with other references under 35 U.S.C. 103. But see *In re Deckler*, 977 F.2d 1449, 24 USPQ2d 1448 (Fed. Cir. 1992) (Under the principles of *res judicata* and *collateral estoppel*, Deckler was not entitled to claims that were patentably indistinguishable from the claim lost in interference even though the subject matter of the lost count was not available for use in an obviousness rejection under 35 U.S.C. 103.).

### **2138.02 “The Invention Was Made in This Country”**

An invention is made when there is a conception and a reduction to practice. *Dunn v. Ragin*, 50 USPQ 472, 474 (Bd. Pat. Inter. 1941). Prior art under 35 U.S.C. 102(g) is limited to an invention that is made. *In re Katz*, 687 F.2d 450, 454, 215 USPQ 14, 17 (CCPA 1982) (the publication of an article, alone, is not deemed a constructive reduction to practice, and therefore its disclosure does not prove that any invention within the meaning of 35 U.S.C. 102(g) has ever been made).

Subject matter under 35 U.S.C. 102(g) is available only if made in this country. 35 U.S.C. 104. *Kondo v. Martel*, 220 USPQ 47 (Bd. Pat. Inter. 1983) (acts of conception, reduction to practice and diligence must be demonstrated in this country). Compare *Colbert v. Lofdahl*, 21 USPQ2d 1068, 1071 (Bd. Pat. App. & Inter. 1991) (“[i]f the invention is reduced to practice in a foreign country and knowledge of the invention was brought into this country and disclosed to others, the inventor can derive no benefit from the work done abroad and such knowledge is merely evidence of conception of the invention”).

In accordance with 35 U.S.C. 102(g)(1), a party involved in an interference proceeding under 35 U.S.C. 135 or 291 may establish a date of invention under 35 U.S.C. 104. 35 U.S.C. 104, as amended by GATT (Public Law 103-465, 108 Stat. 4809 (1994)) and NAFTA (Public Law 103-182, 107 Stat. 2057 (1993)), provides that an applicant can establish a date of invention in a NAFTA member country on or after December 8, 1993 or in WTO member country other than a NAFTA member country on or after January 1, 1996. Accordingly, an interference count may be won or lost on the basis of establishment of invention by one of the parties in a NAFTA or WTO member country, thereby rendering the subject matter of that count unpatentable to the other party under the principles of *res judicata* and *collateral estoppel*, even though such subject matter is not available as statutory prior art under 35 U.S.C. 102(g). See MPEP § 2138.01 regarding lost interference counts which are not statutory prior art.

### 2138.03 “By Another Who Has Not Abandoned, Suppressed, or Concealed It”

35 U.S.C. 102(g) generally makes available as prior art within the meaning of 35 U.S.C. 103, the prior invention of another who has not abandoned, suppressed or concealed it. *In re Bass*, 474 F.2d 1276, 177 USPQ 178 (CCPA 1973); *In re Suska*, 589 F.2d 527, 200 USPQ 497 (CCPA 1979) (The result of applying the suppression and concealment doctrine is that the inventor who did not conceal (but was the *de facto* last inventor) is treated legally as the first to invent, while the *de facto* first inventor who suppressed or concealed is treated as a later inventor. The *de facto* first inventor, by his suppression and concealment, lost the right to rely on his actual date of invention not only for priority purposes, but also for purposes of avoiding the invention of the counts as prior art.).

“The courts have consistently held that an invention, though completed, is deemed abandoned, suppressed, or concealed if, within a reasonable time after completion, no steps are taken to make the invention publicly known. Thus failure to file a patent application; to describe the invention in a publicly disseminated document; or to use the invention publicly, have been held to constitute abandonment, suppression, or concealment.” *Correge v. Murphy*, 705 F.2d 1326, 1330, 217 USPQ 753, 756 (Fed. Cir. 1983) (quoting *International Glass Co. v. United States*, 408 F.2d 395, 403, 159 USPQ 434, 441 (Ct. Cl. 1968)). In *Correge*, an invention was actually reduced to practice, 7 months later there was a public disclosure of the invention, and 8 months thereafter a patent application was filed. The court held filing a patent application within 1 year of a public disclosure is not an unreasonable delay, therefore reasonable diligence must only be shown between the date of the actual reduction to practice and the public disclosure to avoid the inference of abandonment.

#### DURING AN INTERFERENCE PROCEEDING, AN INFERENCE OF SUPPRESSION OR CONCEALMENT MAY ARISE FROM DELAY IN FILING PATENT APPLICATION

Once an invention is actually reduced to practice an inventor need not rush to file a patent application.

*Shindelar v. Holdeman*, 628 F.2d 1337, 1341, 207 USPQ 112, 116 (CCPA 1980). The length of time taken to file a patent application after an actual reduction to practice is generally of no consequence except in an interference proceeding. *Paulik v. Rizkalla*, 760 F.2d 1270, 1271, 226 USPQ 225, 226 (Fed. Cir. 1985) (suppression or concealment may be deliberate or may arise due to an inference from a “too long” delay in filing a patent application). *Peeler v. Miller*, 535 F.2d 647, 656, 190 USPQ 117,124 (CCPA 1976) (“mere delay, without more, is not sufficient to establish suppression or concealment.” “What we are deciding here is that Monsanto’s delay is not ‘merely delay’ and that Monsanto’s justification for the delay is inadequate to overcome the inference of suppression created by the excessive delay.” The word “mere” does not imply a total absence of a limit on the duration of delay. Whether any delay is “mere” is decided only on a case-by-case basis.).

Where a junior party in an interference relies upon an actual reduction to practice to demonstrate first inventorship, and where the hiatus in time between the date for the junior party’s asserted reduction to practice and the filing of its application is unreasonably long, the hiatus may give rise to an inference that the junior party in fact suppressed or concealed the invention and the junior party will not be allowed to rely upon the earlier actual reduction to practice. *Young v. Dworkin*, 489 F.2d 1277, 1280 n.3, 180 USPQ 388, 391 n.3 (CCPA 1974) (suppression and concealment issues are to be addressed on a case-by-case basis).

#### SUPPRESSION OR CONCEALMENT NEED NOT BE ATTRIBUTED TO INVENTOR

Suppression or concealment need not be attributed to the inventor. *Peeler v. Miller*, 535 F.2d 647, 653-54, 190 USPQ 117, 122 (CCPA 1976) (“four year delay from the time an inventor ... completes his work ... and the time his assignee-employer files a patent application is, *prima facie*, unreasonably long in an interference with a party who filed first”); *Shindelar v. Holdeman*, 628 F.2d 1337, 1341-42, 207 USPQ 112, 116-17 (CCPA 1980) (A patent attorney’s workload will not preclude a holding of an unreasonable delay—a total of 3 months was identified as possible of excuse in regard to the filing of an application.).

## INFERENCE OF SUPPRESSION OR CONCEALMENT IS REBUTTABLE

Notwithstanding a finding of suppression or concealment, a constructive reduction to practice such as renewed activity just prior to other party's entry into field coupled with the diligent filing of an application would still cause the junior party to prevail. *Lutzker v. Plet*, 843 F.2d 1364, 1367-69, 6 USPQ2d 1370, 1371-72 (Fed. Cir. 1988) (activities directed towards commercialization not sufficient to rebut inference); *Holmwood v. Cherpeck*, 2 USPQ2d 1942, 1945 (Bd. Pat. App. & Inter. 1986) (the inference of suppression or concealment may be rebutted by showing activity directed to perfecting the invention, preparing the application, or preparing other compounds within the scope of the generic invention); *Engelhardt v. Judd*, 369 F.2d 408, 411, 151 USPQ 732, 735 (CCPA 1966) ("We recognize that an inventor of a new series of compounds should not be forced to file applications piecemeal on each new member as it is synthesized, identified and tested for utility. A reasonable amount of time should be allowed for completion of the research project on the whole series of new compounds, and a further reasonable time period should then be allowed for drafting and filing the patent application(s) thereon."); *Bogoslowsky v. Huse*, 142 F.2d 75, 77, 61 USPQ 349, 351 (CCPA 1944) (The doctrine of suppression and concealment is not applicable to conception without an actual reduction to practice.).

## ABANDONMENT

A finding of suppression or concealment may not amount to a finding of abandonment wherein a right to a patent is lost. *Steierman v. Connelly*, 197 USPQ 288, 289 (Comm'r Pat. 1976); *Correge v. Murphy*, 705 F.2d 1326, 1329, 217 USPQ 753, 755 (Fed. Cir. 1983) (an invention cannot be abandoned until it is first reduced to practice).

### 2138.04 "Conception" [R-1]

Conception has been defined as "the complete performance of the mental part of the inventive act" and it is "the formation in the mind of the inventor of a definite and permanent idea of the complete and oper-

ative invention as it is thereafter to be applied in practice...." *Townsend v. Smith*, 36 F.2d 292, 295, 4 USPQ 269, 271 (CCPA 1930). "[C]onception is established when the invention is made sufficiently clear to enable one skilled in the art to reduce it to practice without the exercise of extensive experimentation or the exercise of inventive skill." *Hiatt v. Ziegler*, 179 USPQ 757, 763 (Bd. Pat. Inter. 1973). Conception has also been defined as a disclosure of an invention which enables one skilled in the art to reduce the invention to a practical form without "exercise of the inventive faculty." *Gunter v. Stream*, 573 F.2d 77, 197 USPQ 482 (CCPA 1978). See also *Coleman v. Dines*, 754 F.2d 353, 224 USPQ 857 (Fed. Cir. 1985) (It is settled that in establishing conception a party must show possession of every feature recited in the count, and that every limitation of the count must have been known to the inventor at the time of the alleged conception. Conception must be proved by corroborating evidence.); *Hybritech Inc. v. Monoclonal Antibodies Inc.*, 802 F. 2d 1367, 1376, 231 USPQ 81, 87 (Fed. Cir. 1986) (Conception is the "formation in the mind of the inventor, of a definite and permanent idea of the complete and operative invention, as it is hereafter to be applied in practice."); *Hitzeman v. Rutter*, 243 F.3d 1345, 58 USPQ2d 1161 (Fed. Cir. 2001) (Inventor's "hope" that a genetically altered yeast would produce antigen particles having the particle size and sedimentation rates recited in the claims did not establish conception, since the inventor did not show that he had a "definite and permanent understanding" as to whether or how, or a reasonable expectation that, the yeast would produce the recited antigen particles.).

## CONCEPTION MUST BE DONE IN THE MIND OF THE INVENTOR

The inventor must form a definite and permanent idea of the complete and operable invention to establish conception. *Bosies v. Benedict*, 27 F.3d 539, 543, 30 USPQ2d 1862, 1865 (Fed. Cir. 1994) (Testimony by a noninventor as to the meaning of a variable of a generic compound described in an inventor's notebook was insufficient as a matter of law to establish the meaning of the variable because the testimony was not probative of what the inventors conceived.).

**AS LONG AS THE INVENTOR MAINTAINS INTELLECTUAL DOMINATION OVER MAKING THE INVENTION, IDEAS, SUGGESTIONS, AND MATERIALS MAY BE ADOPTED FROM OTHERS**

An inventor may consider and adopt ideas, suggestions and materials derived from many sources: a suggestion from an employee, a hired consultant or a friend even if the adopted material proves to be the key that unlocks the problem so long as the inventor “maintains intellectual domination of the work of making the invention down to the successful testing, selecting or rejecting....” *Morse v. Porter*, 155 USPQ 280, 283 (Bd. Pat. Inter. 1965); *Stahelin v. Secher*, 24 USPQ2d 1513, 1522 (Bd. Pat. App. & Inter. 1992) (“evidence of conception naming only one of the actual inventive entity inures to the benefit of and serves as evidence of conception by the complete inventive entity”).

**CONCEPTION REQUIRES CONTEMPORANEOUS RECOGNITION AND APPRECIATION OF THE INVENTION**

There must be a contemporaneous recognition and appreciation of the invention for there to be conception. *Silvestri v. Grant*, 496 F.2d 593, 596, 181 USPQ 706, 708 (CCPA 1974) (“an accidental and unappreciated duplication of an invention does not defeat the patent right of one who, though later in time was the first to recognize that which constitutes the inventive subject matter”); *Langer v. Kaufman*, 465 F.2d 915, 918, 175 USPQ 172, 174 (CCPA 1972) (new form of catalyst was not recognized when it was first produced; conception cannot be established *nunc pro tunc*). However, an inventor does not need to know that the invention will work for there to be complete conception. *Burroughs Wellcome Co. v. Barr Labs., Inc.*, 40 F.3d 1223, 1228, 32 USPQ2d 1915, 1919 (Fed. Cir. 1994) (Draft patent application disclosing treatment of AIDS with AZT reciting dosages, forms, and routes of administration was sufficient to collaborate conception whether or not the inventors believed the inventions would work based on initial screening tests.) >Furthermore, the inventor does not need to appreciate the patentability of the invention. *Dow Chem. Co. v. Astro-Valcour, Inc.*, 267 F.3d 1334, 1341, 60 USPQ2d 1519, 1523 (Fed. Cir. 2001).

The first to conceive of a species is not necessarily the first to conceive of the generic invention. *In re Jolley*, 308 F.3d 1317, 1323 n.2, 64 USPQ2d 1901, 1905 n.2 (Fed. Cir. 2002). Further, while conception of a species within a genus may constitute conception of the genus, conception of one species and the genus may not constitute conception of another species in the genus. *Oka v. Youssefye*, 849 F.2d 581, 7 USPQ2d 1169 (Fed. Cir. 1988) (conception of a chemical requires both the idea of the structure of the chemical and possession of an operative method of making it). See also *Amgen v. Chugai Pharmaceutical Co.*, 927 F.2d 1200, 1206, 18 USPQ2d 1016, 1021 (Fed. Cir. 1991) (in the isolation of a gene, defining a gene by its principal biological property is not sufficient for conception absent an ability to envision the detailed constitution as well as a method for obtaining it); *Fiers v. Revel*, 984 F.2d 1164, 1170, 25 USPQ2d 1601, 1605 (Fed. Cir. 1993) (“[b]efore reduction to practice, conception only of a process for making a substance, without conception of a structural or equivalent definition of that substance, can at most constitute a conception of the substance claimed as a process” but cannot constitute conception of the substance; as “conception is not enablement,” conception of a purified DNA sequence coding for a specific protein by function and a method for its isolation that could be carried out by one of ordinary skill in the art is not conception of that material).

On rare occasions conception and reduction to practice occur simultaneously. *Alpert v. Slatin*, 305 F.2d 891, 894, 134 USPQ 296, 299 (CCPA 1962). “[I]n some unpredictable areas of chemistry and biology, there is no conception until the invention has been reduced to practice.” *MacMillan v. Moffett*, 432 F.2d 1237, 1234-40, 167 USPQ 550, 552-553 (CCPA 1970). See also *Hitzeman v. Rutter*, 243 F.3d 1345, 58 USPQ2d 1161 (Fed. Cir. 2001) (conception simultaneous with reduction to practice where appellant lacked reasonable certainty that yeast’s performance of certain intracellular processes would result in the claimed antigen particles); *Dunn v. Ragin*, 50 USPQ 472, 475 (Bd. Pat. Inter. 1941) (a new variety of asexually reproduced plant is conceived and reduced to practice when it is grown and recognized as a new variety). Under these circumstances, conception is not complete if subsequent experimentation reveals factual uncertainty which “so

undermines the specificity of the inventor's idea that it is not yet a definite and permanent reflection of the complete invention as it will be used in practice." *Burroughs Wellcome Co. v. Barr Labs., Inc.*, 40 F.3d 1223, 1229, 32 USPQ2d 1915, 1920 (Fed. Cir. 1994).

### **A PREVIOUSLY ABANDONED APPLICATION WHICH WAS NOT COPENDING WITH A SUBSEQUENT APPLICATION IS EVIDENCE ONLY OF CONCEPTION**

An abandoned application with which no subsequent application was copending serves to abandon benefit of the application's filing as a constructive reduction to practice and the abandoned application is evidence only of conception. *In re Costello*, 717 F.2d 1346, 1350, 219 USPQ 389, 392 (Fed. Cir. 1983).

### **2138.05 "Reduction to Practice"**

Reduction to practice may be an actual reduction or a constructive reduction to practice which occurs when a patent application on the claimed invention is filed. The filing of a patent application serves as conception and constructive reduction to practice of the subject matter described in the application. Thus the inventor need not provide evidence of either conception or actual reduction to practice when relying on the content of the patent application. *Hyatt v. Boone*, 146 F.3d 1348, 1352, 47 USPQ2d 1128, 1130 (Fed. Cir. 1998). A reduction to practice can be done by another on behalf of the inventor. *De Solms v. Schoenwald*, 15 USPQ2d 1507, 1510 (Bd. Pat. App. & Inter. 1990). "While the filing of the original application theoretically constituted a constructive reduction to practice at the time, the subsequent abandonment of that application also resulted in an abandonment of the benefit of that filing as a constructive reduction to practice. The filing of the original application is, however, evidence of conception of the invention." *In re Costello*, 717 F.2d 1346, 1350, 219 USPQ 389, 392 (Fed. Cir. 1983).

### **CONSTRUCTIVE REDUCTION TO PRACTICE REQUIRES COMPLIANCE WITH 35 U.S.C. 112, FIRST PARAGRAPH**

When a party to an interference seeks the benefit of an earlier-filed U.S. patent application, the earlier application must meet the requirements of 35 U.S.C.

120 and 35 U.S.C. 112, first paragraph for the subject matter of the count. The earlier application must meet the enablement requirement and must contain a written description of the subject matter of the interference count. *Hyatt v. Boone*, 146 F.3d 1348, 1352, 47 USPQ2d 1128, 1130 (Fed. Cir. 1998). Proof of a constructive reduction to practice requires sufficient disclosure under the "how to use" and "how to make" requirements of 35 U.S.C. 112, first paragraph. *Kawai v. Metlesics*, 480 F.2d 880, 886, 178 USPQ 158, 163 (CCPA 1973) (A constructive reduction to practice is not proven unless the specification discloses a practical utility where one would not be obvious. Prior art which disclosed an anticonvulsant compound which differed from the claimed compound only in the absence of a -CH<sub>2</sub>- group connecting two functional groups was not sufficient to establish utility of the claimed compound because the compounds were not so closely related that they could be presumed to have the same utility.). The purpose of the written description requirement is "to ensure that the inventor had possession, as of the filing date of the application relied on, of the specific subject matter later claimed by him." *In re Edwards*, 568 F.2d 1349, 1351-52, 196 USPQ 465, 467 (CCPA 1978). The written description must include all of the limitations of the interference count, or the applicant must show that any absent text is necessarily comprehended in the description provided and would have been so understood at the time the patent application was filed. Furthermore, the written description must be sufficient, when the entire specification is considered, such that the "necessary and only reasonable construction" that would be given it by a person skilled in the art is one that clearly supports each positive limitation in the count. *Hyatt v. Boone*, 146 F.3d at 1354-55, 47 USPQ2d at 1130-1132 (Fed. Cir. 1998) (The claim could be read as describing subject matter other than that of the count and thus did not establish that the applicant was in possession of the invention of the count.). See also *Bigham v. Godfredsen*, 857 F.2d 1415, 1417, 8 USPQ2d 1266, 1268 (Fed. Cir. 1988) ("[t]he generic term halogen comprehends a limited number of species, and ordinarily constitutes a sufficient written description of the common halogen species," except where the halogen species are patentably distinct).

## REQUIREMENTS TO ESTABLISH ACTUAL REDUCTION TO PRACTICE

“In an interference proceeding, a party seeking to establish an actual reduction to practice must satisfy a two-prong test: (1) the party constructed an embodiment or performed a process that met every element of the interference count, and (2) the embodiment or process operated for its intended purpose.” *Eaton v. Evans*, 204 F.3d 1094, 1097, 53 USPQ2d 1696, 1698 (Fed. Cir. 2000).

The same evidence sufficient for a constructive reduction to practice may be insufficient to establish an actual reduction to practice, which requires a showing of the invention in a physical or tangible form that shows every element of the count. *Wetmore v. Quick*, 536 F.2d 937, 942, 190 USPQ 223, 227 (CCPA 1976). For an actual reduction to practice, the invention must have been sufficiently tested to demonstrate that it will work for its intended purpose, but it need not be in a commercially satisfactory stage of development. If a device is so simple, and its purpose and efficacy so obvious, construction alone is sufficient to demonstrate workability. *King Instrument Corp. v. Otari Corp.*, 767 F.2d 853, 860, 226 USPQ 402, 407 (Fed. Cir. 1985).

For additional cases pertaining to the requirements necessary to establish actual reduction to practice see *DSL Dynamic Sciences, Ltd. v. Union Switch & Signal, Inc.*, 928 F.2d 1122, 1126, 18 USPQ2d 1152, 1155 (Fed. Cir. 1991) (“events occurring after an alleged actual reduction to practice can call into question whether reduction to practice has in fact occurred”); *Corona v. Dovan*, 273 U.S. 692, 1928 C.D. 252 (1928) (“A process is reduced to practice when it is successfully performed. A machine is reduced to practice when it is assembled, adjusted and used. A manufacture [i.e., article of manufacture] is reduced to practice when it is completely manufactured. A composition of matter is reduced to practice when it is completely composed.” 1928 C.D. at 262-263 (emphasis added).); *Fitzgerald v. Arbib*, 268 F.2d 763, 765-66, 122 USPQ 530, 531-32 (CCPA 1959) (“the reduction to practice of a three-dimensional design invention requires the production of an article embodying that design” in “other than a mere drawing”).

## TESTING REQUIRED TO ESTABLISH AN ACTUAL REDUCTION TO PRACTICE

“The nature of testing which is required to establish a reduction to practice depends on the particular facts of each case, especially the nature of the invention.” *Gellert v. Wanberg*, 495 F.2d 779, 783, 181 USPQ 648, 652 (CCPA 1974) (“an invention may be tested sufficiently ... where less than all of the conditions of actual use are duplicated by the tests”); *Wells v. Fremont*, 177 USPQ 22, 24-5 (Bd. Pat. Inter. 1972) (“even where tests are conducted under ‘bench’ or laboratory conditions, those conditions must ‘fully duplicate each and every condition of actual use’ or if they do not, then the evidence must establish a relationship between the subject matter, the test condition and the intended functional setting of the invention,” but it is not required that all the conditions of all actual uses be duplicated, such as rain, snow, mud, dust and submersion in water).

## REDUCTION TO PRACTICE REQUIRES RECOGNITION AND APPRECIATION OF THE INVENTION

The invention must be recognized and appreciated for a reduction to practice to occur. “The rule that conception and reduction to practice cannot be established nunc pro tunc simply requires that in order for an experiment to constitute an actual reduction to practice, there must have been contemporaneous appreciation of the invention at issue by the inventor.... Subsequent testing or later recognition may not be used to show that a party had contemporaneous appreciation of the invention. However, evidence of subsequent testing may be admitted for the purpose of showing that an embodiment was produced and that it met the limitations of the count.” *Cooper v. Goldfarb*, 154 F.3d 1321, 1331, 47 USPQ2d 1896, 1904 (Fed. Cir. 1998) (citations omitted). *Meitzner v. Corte*, 537 F.2d 524, 528, 190 USPQ 407, 410 (CCPA 1976) (there can be no conception or reduction to practice of a new form or of a process using such a new form of an otherwise old composition where there has been no recognition or appreciation of the existence of the new form); *Estee Lauder, Inc. v. L'Oreal S.A.*, 129 F.3d 588, 593, 44 USPQ2d 1610, 1615 (Fed. Cir. 1997) (“[W]hen testing is necessary to establish utility, there must be recognition and appreciation that the tests were successful for reduction to practice to

occur.” A showing that testing was completed before the critical date, and that testing ultimately proved successful, was held insufficient to establish a reduction to practice before the critical date, since the success of the testing was not appreciated or recognized until after the critical date.); *Parker v. Frilette*, 462 F.2d 544, 547, 174 USPQ 321, 324 (CCPA 1972) (“[an] inventor need not understand precisely why his invention works in order to achieve an actual reduction to practice”).

### **RECOGNITION OF THE INVENTION BY ANOTHER MAY INURE TO THE BENEFIT OF THE INVENTOR**

“Inurement involves a claim by an inventor that, as a matter of law, the acts of another person should accrue to the benefit of the inventor.” *Cooper v. Goldfarb*, 154 F.3d 1321, 1331, 47 USPQ2d 1896, 1904 (Fed. Cir. 1998). Before a non-inventor’s recognition of the utility of the invention can inure to the benefit of the inventor, the following three-prong test must be met: (1) the inventor must have conceived of the invention, (2) the inventor must have had an expectation that the embodiment tested would work for the intended purpose of the invention, and (3) the inventor must have submitted the embodiment for testing for the intended purpose of the invention. *Genentech Inc. v. Chiron Corp.*, 220 F.3d 1345, 1354, 55 USPQ2d 1636, 1643 (Fed. Cir. 2000). In *Genentech*, a non-inventor hired by the inventors to test yeast samples for the presence of the fusion protein encoded by the DNA construct of the invention recognized the growth-enhancing property of the fusion protein, but did not communicate this recognition to the inventors. The court found that because the inventors did not submit the samples for testing growth-promoting activity, the intended purpose of the invention, the third prong was not satisfied and the uncommunicated recognition of the activity of the fusion protein by the non-inventor did not inure to their benefit. See also *Cooper v. Goldfarb*, 240 F.3d 1378, 1385, 57 USPQ2d 1990, 1995 (Fed. Cir. 2001) (Cooper sent to Goldfarb samples of a material for use in vascular grafts. At the time the samples were sent, Cooper was unaware of the importance of the fibril length of the material. Cooper did not at any time later convey to, or request from, Goldfarb any information regarding fibril length. Therefore, Goldfarb’s determi-

nation of the fibril lengths of the material could not inure to Cooper’s benefit.).

### **IN AN INTERFERENCE PROCEEDING, ALL LIMITATIONS OF A COUNT MUST BE REDUCED TO PRACTICE**

The device reduced to practice must include every limitation of the count. *Fredkin v. Irasek*, 397 F.2d 342, 158 USPQ 280, 285 (CCPA 1968); every limitation in a count is material and must be proved to establish an actual reduction to practice. *Meitzner v. Corte*, 537 F.2d 524, 528, 190 USPQ 407, 410. See also *Hull v. Bonis*, 214 USPQ 731, 734 (Bd. Pat. Inter. 1982) (no doctrine of equivalents—remedy is a preliminary motion to amend the count to conform to the proofs).

### **CLAIMED INVENTION IS NOT ACTUALLY REDUCED TO PRACTICE UNLESS THERE IS A KNOWN UTILITY**

Utility for the invention must be known at the time of the reduction to practice. *Wiesner v. Weigert*, 666 F.2d 582, 588, 212 USPQ 721, 726 (CCPA 1981) (except for plant and design inventions); *Azar v. Burns*, 188 USPQ 601, 604 (Bd. Pat. Inter. 1975) (a composition and a method cannot be actually reduced to practice unless the composition and the product produced by the method have a practical utility); *Ciric v. Flanigen*, 511 F.2d 1182, 1185, 185 USPQ 103, 105-6 (CCPA 1975) (“when a count does not recite any particular utility, evidence establishing a substantial utility for any purpose is sufficient to prove a reduction to practice”; “the demonstrated similarity of ion exchange and adsorptive properties between the newly discovered zeolites and known crystalline zeolites ... have established utility for the zeolites of the count”); *Engelhardt v. Judd*, 369 F.2d 408, 411, 151 USPQ 732, 735 (CCPA 1966) (When considering an actual reduction to practice as a bar to patentability for claims to compounds, it is sufficient to successfully demonstrate utility of the compounds in animals for somewhat different pharmaceutical purposes than those asserted in the specification for humans.); *Rey-Bellet v. Engelhardt*, 993 F.2d 1380, 1384, 181 USPQ 453, 455 (CCPA 1974) (Two categories of tests on laboratory animals have been considered adequate to show utility and reduction to practice: first, tests carried out to prove utility in

humans where there is a satisfactory correlation between humans and animals, and second, tests carried out to prove utility for treating animals.).

### **A PROBABLE UTILITY MAY NOT BE SUFFICIENT TO ESTABLISH UTILITY**

A probable utility does not establish a practical utility, which is established by actual testing or where the utility can be “foretold with certainty.” *Bindra v. Kelly*, 206 USPQ 570, 575 (Bd. Pat. Inter. 1979) (Reduction to practice was not established for an intermediate useful in the preparation of a second intermediate with a known utility in the preparation of a pharmaceutical. The record established there was a high degree of probability of a successful preparation because one skilled in the art may have been motivated, in the sense of 35 U.S.C. 103, to prepare the second intermediate from the first intermediate. However, a strong probability of utility is not sufficient to establish practical utility.); *Wu v. Jucker*, 167 USPQ 467, 472 (Bd. Pat. Inter. 1968) (screening test where there was an indication of possible utility is insufficient to establish practical utility). But see *Nelson v. Bowler*, 628 F.2d 853, 858, 206 USPQ 881, 885 (CCPA 1980) (Relevant evidence is judged as a whole for its persuasiveness in linking observed properties to suggested uses. Reasonable correlation between the two is sufficient for an actual reduction to practice.).

### **2138.06 “Reasonable Diligence” [R-1]**

The diligence of 35 U.S.C. 102(g) relates to reasonable “attorney-diligence” and “engineering-diligence” (*Keizer v. Bradley*, 270 F.2d 396, 397, 123 USPQ 215, 216 (CCPA 1959)), which does not require that “an inventor or his attorney ... drop all other work and concentrate on the particular invention involved....” *Emery v. Ronden*, 188 USPQ 264, 268 (Bd. Pat. Inter. 1974).

### **CRITICAL PERIOD FOR ESTABLISHING DILIGENCE BETWEEN ONE WHO WAS FIRST TO CONCEIVE BUT LATER TO REDUCE TO PRACTICE THE INVENTION**

The critical period for diligence for a first conceiver but second reducer begins not at the time of conception of the first conceiver but just prior to the entry in the field of the party who was first to reduce to practice and continues until the first conceiver reduces to

practice. *Hull v. Davenport*, 90 F.2d 103, 105, 33 USPQ 506, 508 (CCPA 1937) (“lack of diligence from the time of conception to the time immediately preceding the conception date of the second conceiver is not regarded as of importance except as it may have a bearing upon his subsequent acts”). What serves as the entry date into the field of a first reducer is dependent upon what is being relied on by the first reducer, e.g., conception plus reasonable diligence to reduction to practice (*Fritsch v. Lin*, 21 USPQ2d 1731, 1734 (Bd. Pat. App. & Inter. 1991), *Emery v. Ronden*, 188 USPQ 264, 268 (Bd. Pat. Inter. 1974)); an actual reduction to practice or a constructive reduction to practice by the filing of either a U.S. application (*Rebstock v. Flouret*, 191 USPQ 342, 345 (Bd. Pat. Inter. 1975)) or reliance upon priority under 35 U.S.C. 119 of a foreign application (*Justus v. Appenzeller*, 177 USPQ 332, 339 (Bd. Pat. Inter. 1971) (chain of priorities under 35 U.S.C. 119 and 120, priority under 35 U.S.C. 119 denied for failure to supply certified copy of the foreign application during pendency of the application filed within the twelfth month)).

### **THE ENTIRE PERIOD DURING WHICH DILIGENCE IS REQUIRED MUST BE ACCOUNTED FOR BY EITHER AFFIRMATIVE ACTS OR ACCEPTABLE EXCUSES**

An applicant must account for the entire period during which diligence is required. *Gould v. Schawlow*, 363 F.2d 908, 919, 150 USPQ 634, 643 (CCPA 1966) (Merely stating that there were no weeks or months that the invention was not worked on is not enough.); *In re Harry*, 333 F.2d 920, 923, 142 USPQ 164, 166 (CCPA 1964) (statement that the subject matter “was diligently reduced to practice” is not a showing but a mere pleading). A 2-day period lacking activity has been held to be fatal. *In re Mulder*, 716 F.2d 1542, 1545, 219 USPQ 189, 193 (Fed. Cir. 1983) (37 CFR 1.131 issue); *Fitzgerald v. Arbib*, 268 F.2d 763, 766, 122 USPQ 530, 532 (CCPA 1959) (Less than 1 month of inactivity during critical period. Efforts to exploit an invention commercially do not constitute diligence in reducing it to practice. An actual reduction to practice in the case of a design for a three-dimensional article requires that it should be embodied in some structure other than a mere drawing.); *Kendall v. Searles*, 173 F.2d 986, 993, 81 USPQ 363, 369 (CCPA



1949) (Diligence requires that applicants must be specific as to dates and facts.).

The period during which diligence is required must be accounted for by either affirmative acts or acceptable excuses. *Rebstock v. Flouret*, 191 USPQ 342, 345 (Bd. Pat. Inter. 1975); *Rieser v. Williams*, 225 F.2d 419, 423, 118 USPQ 96, 100 (CCPA 1958) (Being last to reduce to practice, party cannot prevail unless he has shown that he was first to conceive and that he exercised reasonable diligence during the critical period from just prior to opponent's entry into the field); *Griffith v. Kanamaru*, 816 F.2d 624, 2 USPQ2d 1361 (Fed. Cir. 1987) (Court generally reviewed cases on excuses for inactivity including vacation extended by ill health and daily job demands, and held lack of university funding and personnel are not acceptable excuses.); *Litchfield v. Eigen*, 535 F.2d 72, 190 USPQ 113 (CCPA 1976) (budgetary limits and availability of animals for testing not sufficiently described); *Morway v. Bondi*, 203 F.2d 741, 749, 97 USPQ 318, 323 (CCPA 1953) (voluntarily laying aside inventive concept in pursuit of other projects is generally not an acceptable excuse although there may be circumstances creating exceptions); *Anderson v. Crowther*, 152 USPQ 504, 512 (Bd. Pat. Inter. 1965) (preparation of routine periodic reports covering all accomplishments of the laboratory insufficient to show diligence); *Wu v. Jucker*, 167 USPQ 467, 472-73 (Bd. Pat. Inter. 1968) (applicant improperly allowed test data sheets to accumulate to a sufficient amount to justify interfering with equipment then in use on another project); *Tucker v. Natta*, 171 USPQ 494, 498 (Bd. Pat. Inter. 1971) (“[a]ctivity directed toward the reduction to practice of a genus does not establish, *prima facie*, diligence toward the reduction to practice of a species embraced by said genus”); *Justus v. Appenzeller*, 177 USPQ 332, 340-1 (Bd. Pat. Inter. 1971) (Although it is possible that patentee could have reduced the invention to practice in a shorter time by relying on stock items rather than by designing a particular piece of hardware, patentee exercised reasonable diligence to secure the required hardware to actually reduce the invention to practice. “[I]n deciding the question of diligence it is immaterial that the inventor may not have taken the expeditious course....”).

### **WORK RELIED UPON TO SHOW REASONABLE DILIGENCE MUST BE DIRECTLY RELATED TO THE REDUCTION TO PRACTICE**

The work relied upon to show reasonable diligence must be directly related to the reduction to practice of the invention in issue. *Naber v. Cricchi*, 567 F.2d 382, 384, 196 USPQ 294, 296 (CCPA 1977), *cert. denied*, 439 U.S. 826 (1978). >See also *Scott v. Koyama*, 281 F.3d 1243, 1248-49, 61 USPQ2d 1856, 1859 (Fed. Cir. 2002) (Activities directed at building a plant to practice the claimed process of producing tetrafluoroethane on a large scale constituted efforts toward actual reduction to practice, and thus were evidence of diligence. The court distinguished cases where diligence was not found because inventors either discontinued development or failed to complete the invention while pursuing financing or other commercial activity.); *In re Jolley*, 308 F.3d 1317, 1326-27, 64 USPQ2d 1901, 1908-09 (Fed. Cir. 2002) (diligence found based on research and procurement activities related to the subject matter of the interference count).< “[U]nder some circumstances an inventor should also be able to rely on work on closely related inventions as support for diligence toward the reduction to practice on an invention in issue.” *Ginos v. Nedelec*, 220 USPQ 831, 836 (Bd. Pat. Inter. 1983) (work on other closely related compounds that were considered to be part of the same invention and which were included as part of a grandparent application). “The work relied upon must be directed to attaining a reduction to practice of the subject matter of the counts. It is not sufficient that the activity relied on concerns related subject matter.” *Gunn v. Bosch*, 181 USPQ 758, 761 (Bd. Pat. Inter. 1973) (An actual reduction to practice of the invention at issue which occurred when the inventor was working on a different invention “was fortuitous, and not the result of a continuous intent or effort to reduce to practice the invention here in issue. Such fortuitousness is inconsistent with the exercise of diligence toward reduction to practice of that invention.” 181 USPQ at 761. Furthermore, evidence drawn towards work on improvement of samples or specimens generally already in use at the time of conception that are but one element of the oscillator circuit of the count does not show diligence towards the construction and testing of the overall combination.); *Broos v. Barton*, 142 F.2d 690, 691, 61 USPQ 447, 448 (CCPA 1944)

(preparation of application in U.S. for foreign filing constitutes diligence); *De Solms v. Schoenwald*, 15 USPQ2d 1507 (Bd. Pat. App. & Inter. 1990) (principles of diligence must be given to inventor's circumstances including skill and time; requirement of corroboration applies only to testimony of inventor); *Huelster v. Reiter*, 168 F.2d 542, 78 USPQ 82 (CCPA 1948) (if inventor was not able to make an actual reduction to practice of the invention, he must also show why he was not able to constructively reduce the invention to practice by the filing of an application).

### **DILIGENCE REQUIRED IN PREPARING AND FILING PATENT APPLICATION**

The diligence of attorney in preparing and filing patent application inures to the benefit of the inventor. Conception was established at least as early as the date a draft of a patent application was finished by a patent attorney on behalf of the inventor. Conception is less a matter of signature than it is one of disclosure. Attorney does not prepare a patent application on behalf of particular named persons, but on behalf of the true inventive entity. Six days to execute and file application is acceptable. *Haskell v. Coleburne*, 671 F.2d 1362, 213 USPQ 192, 195 (CCPA 1982). See also *Bey v. Kollonitsch*, 866 F.2d 1024, 231 USPQ 967 (Fed. Cir. 1986) (Reasonable diligence is all that is required of the attorney. Reasonable diligence is established if attorney worked reasonably hard on the application during the continuous critical period. If the attorney has a reasonable backlog of unrelated cases which he takes up in chronological order and carries out expeditiously, that is sufficient. Work on a related case(s) that contributed substantially to the ultimate preparation of an application can be credited as diligence.).

### **END OF DILIGENCE PERIOD IS MARKED BY EITHER ACTUAL OR CONSTRUCTIVE REDUCTION TO PRACTICE**

“[I]t is of no moment that the end of that period [for diligence] is fixed by a constructive, rather than an actual, reduction to practice.” *Justus v. Appenzeller*, 177 USPQ 332, 340-41 (Bd. Pat. Inter. 1971).

## **2141 35 U.S.C. 103; the Graham Factual Inquiries**

*35 U.S.C. 103. Conditions for patentability; non-obvious subject matter.*

(a) A patent may not be obtained though the invention is not identically disclosed or described as set forth in section 102 of this title, if the differences between the subject matter sought to be patented and the prior art are such that the subject matter as a whole would have been obvious at the time the invention was made to a person having ordinary skill in the art to which said subject matter pertains. Patentability shall not be negated by the manner in which the invention was made.

(b)(1) Notwithstanding subsection (a), and upon timely election by the applicant for patent to proceed under this subsection, a biotechnological process using or resulting in a composition of matter that is novel under section 102 and nonobvious under subsection (a) of this section shall be considered nonobvious if-

(A) claims to the process and the composition of matter are contained in either the same application for patent or in separate applications having the same effective filing date; and

(B) the composition of matter, and the process at the time it was invented, were owned by the same person or subject to an obligation of assignment to the same person.

(2) A patent issued on a process under paragraph (1)-

(A) shall also contain the claims to the composition of matter used in or made by that process, or

(B) shall, if such composition of matter is claimed in another patent, be set to expire on the same date as such other patent, notwithstanding section 154.

(3) For purposes of paragraph (1), the term “biotechnological process” means-

(A) a process of genetically altering or otherwise inducing a single- or multi-celled organism to-

(i) express an exogenous nucleotide sequence,

(ii) inhibit, eliminate, augment, or alter expression of an endogenous nucleotide sequence, or

(iii) express a specific physiological characteristic not naturally associated with said organism;

(B) cell fusion procedures yielding a cell line that expresses a specific protein, such as a monoclonal antibody; and

(C) a method of using a product produced by a process defined by subparagraph (A) or (B), or a combination of subparagraphs (A) and (B).

(c) Subject matter developed by another person, which qualifies as prior art only under one or more of subsections (e), (f), and (g) of section 102 of this title, shall not preclude patentability under this section where the subject matter and the claimed invention were, at the time the invention was made, owned by the same person or subject to an obligation of assignment to the same person.

## STANDARD OF PATENTABILITY TO BE APPLIED IN OBVIOUSNESS REJECTIONS

Patent examiners carry the responsibility of making sure that the standard of patentability enunciated by the Supreme Court and by the Congress is applied in each and every case. The Supreme Court in *Graham v. John Deere*, 383 U.S. 1, 148 USPQ 459 (1966), stated:

Under § 103, the scope and content of the prior art are to be determined; differences between the prior art and the claims at issue are to be ascertained; and the level of ordinary skill in the pertinent art resolved. Against this background, the obviousness or nonobviousness of the subject matter is determined. Such secondary considerations as commercial success, long felt but unsolved needs, failure of others, etc., might be utilized to give light to the circumstances surrounding the origin of the subject matter sought to be patented. As indicia of obviousness or nonobviousness, these inquires may have relevancy. . .

This is not to say, however, that there will not be difficulties in applying the nonobviousness test. What is obvious is not a question upon which there is likely to be uniformity of thought in every given factual context. The difficulties, however, are comparable to those encountered daily by the courts in such frames of reference as negligence and scienter, and should be amenable to a case-by-case development. We believe that strict observance of the requirements laid down here will result in that uniformity and definitiveness which Congress called for in the 1952 Act.

Office policy is to follow *Graham v. John Deere Co.* in the consideration and determination of obviousness under 35 U.S.C. 103. As quoted above, the four factual inquires enunciated therein as a background for determining obviousness are as follows:

- (A) Determining the scope and contents of the prior art;
- (B) Ascertaining the differences between the prior art and the claims in issue;
- (C) Resolving the level of ordinary skill in the pertinent art; and
- (D) Evaluating evidence of secondary considerations.

The Supreme Court reaffirmed and relied upon the *Graham* three pronged test in its consideration and determination of obviousness in the fact situations presented in *Sakraida v. Ag Pro, Inc.*, 425 U.S. 273, 189 USPQ 449, *reh'g denied*, 426 U.S. 955 (1976)

and *Anderson's-Black Rock, Inc. v. Pavement Salvage Co.*, 396 U.S. 57, 163 USPQ 673 (1969). In each case, the Court discussed whether the claimed combinations produced a “new or different function” and a “synergistic result,” but it clearly decided whether the claimed inventions were nonobviousness on the basis of the three-way test in *Graham*. Nowhere in its decisions in these cases does the Court state that the “new or different function” and “synergistic result” tests supersede a finding of nonobvious or obviousness under the *Graham* test.

Accordingly, examiners should apply the test for patentability under 35 U.S.C. 103 set forth in *Graham*. See below for a detailed discussion of each of the *Graham* factual inquiries. It should be noted that the Supreme Court's application of the *Graham* test to the fact circumstances in *Ag Pro* was somewhat stringent, as it was in *Black Rock*. Note *Republic Industries, Inc. v. Schlage Lock Co.*, 592 F.2d 963, 200 USPQ 769 (7th Cir. 1979). The Court of Appeals for the Federal Circuit stated in *Stratoflex, Inc. v. Aeroquip Corp.*, 713 F.2d 1530, 1540, 218 USPQ 871, 880 (Fed. Cir. 1983) that

A requirement for “synergism” or a “synergistic effect” is nowhere found in the statute, 35 U.S.C. When present, for example in a chemical case, synergism may point toward nonobviousness, but its absence has no place in evaluating the evidence on obviousness. The more objective findings suggested in *Graham*, supra, are drawn from the language of the statute and are fully adequate guides for evaluating the evidence relating to compliance with 35 U.S.C. § 103. *Bowser Inc. v. United States*, 388 F. 2d 346, 156 USPQ 406 (Ct. Cl. 1967).

## BASIC CONSIDERATIONS WHICH APPLY TO OBVIOUSNESS REJECTIONS

When applying 35 U.S.C. 103, the following tenets of patent law must be adhered to:

- (A) The claimed invention must be considered as a whole;
- (B) The references must be considered as a whole and must suggest the desirability and thus the obviousness of making the combination;
- (C) The references must be viewed without the benefit of impermissible hindsight vision afforded by the claimed invention; and
- (D) Reasonable expectation of success is the standard with which obviousness is determined.

*Hodosh v. Block Drug Co., Inc.*, 786 F.2d 1136, 1143 n.5, 229 USPQ 182, 187 n.5 (Fed. Cir. 1986).

## **OBJECTIVE EVIDENCE MUST BE CONSIDERED**

Objective evidence or secondary considerations such as unexpected results, commercial success, long-felt need, failure of others, copying by others, licensing, and skepticism of experts are relevant to the issue of obviousness and must be considered in every case in which they are present. When evidence of any of these secondary considerations is submitted, the examiner must evaluate the evidence. The weight to be accorded to the evidence depends on the individual factual circumstances of each case. *Stratoflex, Inc. v. Aeroquip Corp.*, 713 F.2d 1530, 218 USPQ 871 (Fed. Cir. 1983); *Hybritech, Inc. v. Monoclonal Antibodies, Inc.*, 802 F.2d 1367, 231 USPQ 81 (Fed. Cir. 1986), *cert. denied*, 480 U.S. 947 (1987). The ultimate determination on patentability is made on the entire record. *In re Oetiker*, 977 F.2d 1443, 1446, 24 USPQ2d 1443, 1445 (Fed. Cir. 1992).

See MPEP § 716- § 716.06 for a discussion of objective evidence and its role in the final legal determination of whether a claimed invention would have been obvious under 35 U.S.C. 103.

## **2141.01 Scope and Content of the Prior Art**

### **I. PRIOR ART AVAILABLE UNDER 35 U.S.C. 102 IS AVAILABLE UNDER 35 U.S.C. 103**

“Before answering *Graham’s* ‘content’ inquiry, it must be known whether a patent or publication is in the prior art under 35 U.S.C. § 102.” *Panduit Corp. v. Dennison Mfg. Co.*, 810 F.2d 1561, 1568, 1 USPQ2d 1593, 1597 (Fed. Cir.), *cert. denied*, 481 U.S. 1052 (1987). Subject matter that is prior art under 35 U.S.C. 102 can be used to support a rejection under section 103. *Ex parte Andresen*, 212 USPQ 100, 102 (Bd. Pat. App. & Inter. 1981) (“it appears to us that the commentator [of 35 U.S.C.A.] and the [congressional] committee viewed section 103 as including all of the various bars to a patent as set forth in section 102.”).

A 35 U.S.C. 103 rejection is based on 35 U.S.C. 102(a), 102(b), 102(e), etc. depending on the type of prior art reference used and its publication or issue

date. For instance, an obviousness rejection over a U.S. patent which was issued more than 1 year before the filing date of the application is said to be a statutory bar just as if it anticipated the claims under 35 U.S.C. 102(b). Analogously, an obviousness rejection based on a publication which would be applied under 102(a) if it anticipated the claims can be overcome by swearing behind the publication date of the reference by filing an affidavit or declaration under 37 CFR 1.131.

For an overview of what constitutes prior art under 35 U.S.C. 102, see MPEP § 901 - § 901.06(d) and § 2121 - § 2129.

### **II. SUBSTANTIVE CONTENT OF THE PRIOR ART**

See MPEP § 2121 - § 2129 for case law relating to the substantive content of the prior art (e.g., availability of inoperative devices, extent to which prior art must be enabling, broad disclosure rather than preferred embodiments, admissions, etc.).

### **III. CONTENT OF THE PRIOR ART IS DETERMINED AT THE TIME THE INVENTION WAS MADE TO AVOID HINDSIGHT**

The requirement “at the time the invention was made” is to avoid impermissible hindsight. See MPEP § 2145, paragraph X.A. for a discussion of rebutting applicants’ arguments that a rejection is based on hindsight.

“It is difficult but necessary that the decisionmaker forget what he or she has been taught . . . about the claimed invention and cast the mind back to the time the invention was made (often as here many years), to occupy the mind of one skilled in the art who is presented only with the references, and who is normally guided by the then-accepted wisdom in the art.” *W.L. Gore & Associates, Inc. v. Garlock, Inc.*, 721 F.2d 1540, 220 USPQ 303, 313 (Fed. Cir. 1983), *cert. denied*, 469 U.S. 851 (1984).

### **IV. 35 U.S.C. 103(c) — EVIDENCE REQUIRED TO SHOW CONDITIONS OF 35 U.S.C. 103 APPLY**

An applicant who wants to avail himself or herself of the benefits of 35 U.S.C. 103(c) has the burden of establishing that subject matter which qualifies as prior art under subsection (e), (f) or (g) of section

102 and the claimed invention were, at the time the invention was made, owned by the same person or subject to an obligation of assignment to the same person. *Ex parte Yoshino*, 227 USPQ 52 (Bd. Pat. App. & Inter. 1985). Note that for applications filed prior to November 29, 1999, 35 U.S.C. 103(c) is limited on its face to subject matter developed by another person which qualifies as prior art only under subsection (f) or (g) of section 102. See MPEP § 706.02(l)(1). See also *In re Bartfeld*, 925 F.2d 1450, 1453-54, 17 USPQ2d 1885, 1888 (Fed. Cir. 1991) (Applicant attempted to overcome a 35 U.S.C. 102(e)/103 rejection with a terminal disclaimer by alleging that the public policy intent of 35 U.S.C. 103(c) was to prohibit the use of “secret” prior art in obviousness determinations. The court rejected this argument, holding “We may not disregard the unambiguous exclusion of § 102(e) from the statute’s purview.”).

See MPEP § 706.02(l)(2) for the requirements which must be met to establish common ownership.

### **2141.01(a) Analogous and Nonanalogous Art [R-2]**

#### **TO RELY ON A REFERENCE UNDER 35 U.S.C. 103, IT MUST BE ANALOGOUS PRIOR ART**

The examiner must determine what is “analogous prior art” for the purpose of analyzing the obviousness of the subject matter at issue. “In order to rely on a reference as a basis for rejection of an applicant’s invention, the reference must either be in the field of applicant’s endeavor or, if not, then be reasonably pertinent to the particular problem with which the inventor was concerned.” *In re Oetiker*, 977 F.2d 1443, 1446, 24 USPQ2d 1443, 1445 (Fed. Cir. 1992). See also *In re Deminski*, 796 F.2d 436, 230 USPQ 313 (Fed. Cir. 1986); *In re Clay*, 966 F.2d 656, 659, 23 USPQ2d 1058, 1060-61 (Fed. Cir. 1992) (“A reference is reasonably pertinent if, even though it may be in a different field from that of the inventor’s endeavor, it is one which, because of the matter with which it deals, logically would have commended itself to an inventor’s attention in considering his problem.”); \* *Wang Laboratories Inc. v. Toshiba Corp.*, 993 F.2d 858, 26 USPQ2d 1767 (Fed. Cir. 1993)>; and *State Contracting & Eng’g Corp. v. Condotte America, Inc.*, 346 F.3d 1057, 1069, 68 USPQ2d

1481, 1490 (Fed. Cir. 2003) (where the general scope of a reference is outside the pertinent field of endeavor, the reference may be considered analogous art if subject matter disclosed therein is relevant to the particular problem with which the inventor is involved)<.

#### **PTO CLASSIFICATION IS SOME EVIDENCE OF ANALOGY, BUT SIMILARITIES AND DIFFERENCES IN STRUCTURE AND FUNCTION CARRY MORE WEIGHT**

While Patent Office classification of references and the cross-references in the official search notes >of the class definitions< are some evidence of “nonanalogy” or “analogy” respectively, the court has found “the similarities and differences in structure and function of the inventions to carry far greater weight.” *In re Ellis*, 476 F.2d 1370, 1372, 177 USPQ 526, 527 (CCPA 1973) (The structural similarities and functional overlap between the structural gratings shown by one reference and the shoe scrapers of the type shown by another reference were readily apparent, and therefore the arts to which the reference patents belonged were reasonably pertinent to the art with which appellant’s invention dealt (pedestrian floor gratings).); *In re Clay*, 966 F.2d 656, 23 USPQ2d 1058 (Fed. Cir. 1992) (Claims were directed to a process for storing a refined liquid hydrocarbon product in a storage tank having a dead volume between the tank bottom and its outlet port wherein a gelled solution filled the tank’s dead volume to prevent loss of stored product while preventing contamination. One of the references relied upon disclosed a process for reducing the permeability of natural underground hydrocarbon bearing formations using a gel similar to that of applicant to improve oil production. The court disagreed with the PTO’s argument that the reference and claimed inventions were part of the same endeavor, “maximizing withdrawal of petroleum stored in petroleum reserves,” and found that the inventions involved different fields of endeavor since the reference taught the use of the gel in a different structure for a different purpose under different temperature and pressure conditions, and since the application related to storage of liquid hydrocarbons rather than extraction of crude petroleum. The court also found the reference was not reasonably pertinent to the problem with which the inventor was concerned

because a person having ordinary skill in the art would not reasonably have expected to solve the problem of dead volume in tanks for refined petroleum by considering a reference dealing with plugging underground formation anomalies.).

### ANALOGY IN THE CHEMICAL ARTS

See, for example, *Ex parte Bland*, 3 USPQ2d 1103 (Bd. Pat. App. & Inter. 1986) (Claims were drawn to a particulate composition useful as a preservative for an animal foodstuff (or a method of inhibiting fungus growth in an animal foodstuff therewith) comprising verxite having absorbed thereon propionic acid. All references were concerned with absorbing biologically active materials on carriers, and therefore the teachings in each of the various references would have been pertinent to the problems in the other references and the invention at hand.); *Stratoflex, Inc. v. Aeroquip Corp.*, 713 F.2d 1530, 218 USPQ 871 (Fed. Cir. 1983) (Problem confronting inventor was preventing electrostatic buildup in PTFE tubing caused by hydrocarbon fuel flow while precluding leakage of fuel. Two prior art references relied upon were in the rubber hose art, both referencing the problem of electrostatic buildup caused by fuel flow. The court found that because PTFE and rubber are used by the same hose manufacturers and experience the same and similar problems, a solution found for a problem experienced with either PTFE or rubber hosing would be looked to when facing a problem with the other.); *In re Mlot-Fijalkowski*, 676 F.2d 666, 213 USPQ 713 (CCPA 1982) (Problem faced by appellant was enhancement and immobilization of dye penetrant indications. References which taught the use of dyes and finely divided developer materials to produce colored images preferably in, but not limited to, the duplicating paper art were properly relied upon because the court found that appellant's problem was one of dye chemistry, and a search for its solution would include the dye arts in general.).

### ANALOGY IN THE MECHANICAL ARTS

See, for example, *In re Oetiker*, 977 F.2d 1443, 24 USPQ2d 1443 (Fed. Cir. 1992) (Applicant claimed an improvement in a hose clamp which differed from the prior art in the presence of a preassembly "hook" which maintained the preassembly condition of the clamp and disengaged automatically when the clamp

was tightened. The Board relied upon a reference which disclosed a hook and eye fastener for use in garments, reasoning that all hooking problems are analogous. The court held the reference was not within the field of applicant's endeavor, and was not reasonably pertinent to the particular problem with which the inventor was concerned because it had not been shown that a person of ordinary skill, seeking to solve a problem of fastening a hose clamp, would reasonably be expected or motivated to look to fasteners for garments. The Commissioner further argued in the brief on appeal that a disengageable catch is a common everyday mechanical concept, however the court held that the Commissioner did not explain why a "catch" of unstated structure is such a concept, and why it would have made the claimed invention obvious.). Compare *Stevenson v. International Trade Comm.*, 612 F.2d 546, 550, 204 USPQ 276, 280 (CCPA 1979) ("In a simple mechanical invention a broad spectrum of prior art must be explored and it is reasonable to permit inquiry into other areas where one of ordinary skill in the art would be aware that similar problems exist.").

Also see *In re Deminski*, 796 F.2d 436, 230 USPQ 313 (Fed. Cir. 1986) (Applicant's claims related to double-acting high pressure gas transmission line compressors in which the valves could be removed easily for replacement. The Board relied upon references which taught either a double-acting piston pump or a double-acting piston compressor. The court agreed that since the cited pumps and compressors have essentially the same function and structure, the field of endeavor includes both types of double-action piston devices for moving fluids.); *Pentec, Inc. v. Graphic Controls Corp.*, 776 F.2d 309, 227 USPQ 766 (Fed. Cir. 1985) (Claims at issue were directed to an instrument marker pen body, the improvement comprising a pen arm holding means having an integrally molded hinged member for folding over against the pen body. Although the patent owners argued the hinge and fastener art was nonanalogous, the court held that the problem confronting the inventor was the need for a simple holding means to enable frequent, secure attachment and easy removal of a marker pen to and from a pen arm, and one skilled in the pen art trying to solve that problem would have looked to the fastener and hinge art.); and *Ex parte Goodyear Tire & Rubber Co.*, 230 USPQ 357 (Bd. Pat. App. & Inter.

1985) (A reference in the clutch art was held reasonably pertinent to the friction problem faced by applicant, whose claims were directed to a braking material, because brakes and clutches utilize interfacing materials to accomplish their respective purposes.).

### **ANALOGY IN THE ELECTRICAL ARTS**

See, for example, *Wang Laboratories, Inc. v. Toshiba Corp.*, 993 F.2d 858, 26 USPQ2d 1767 (Fed. Cir. 1993) (Patent claims were directed to single in-line memory modules (SIMMs) for installation on a printed circuit motherboard for use in personal computers. Reference to a SIMM for an industrial controller was not necessarily in the same field of endeavor as the claimed subject matter merely because it related to memories. Reference was found to be in a different field of endeavor because it involved memory circuits in which modules of varying sizes may be added or replaced, whereas the claimed invention involved compact modular memories. Furthermore, since memory modules of the claims at issue were intended for personal computers and used dynamic random-access-memories, whereas reference SIMM was developed for use in large industrial machine controllers and only taught the use of static random-access-memories or read-only-memories, the finding that the reference was nonanalogous was supported by substantial evidence.); *Medtronic, Inc. v. Cardiac Pacemakers*, 721 F.2d 1563, 220 USPQ 97 (Fed. Cir. 1983) (Patent claims were drawn to a cardiac pacemaker which comprised, among other components, a runaway inhibitor means for preventing a pacemaker malfunction from causing pulses to be applied at too high a frequency rate. Two references disclosed circuits used in high power, high frequency devices which inhibited the runaway of pulses from a pulse source. The court held that one of ordinary skill in the pacemaker designer art faced with a rate-limiting problem would look to the solutions of others faced with rate limiting problems, and therefore the references were in an analogous art.).

### **EXAMPLES OF ANALOGY IN THE DESIGN ARTS**

See MPEP § 1504.03 for a discussion of the relevant case law setting forth the general requirements for analogous art in design applications.

For examples of analogy in the design arts, see *In re Rosen*, 673 F.2d 388, 213 USPQ 347 (CCPA 1982) (The design at issue was a coffee table of contemporary styling. The court held designs of contemporary furniture other than coffee tables, such as the desk and circular glass table top designs of the references relied upon, would reasonably fall within the scope of the knowledge of the designer of ordinary skill.); *Ex parte Pappas*, 23 USPQ2d 1636 (Bd. Pat. App. & Inter. 1992) (At issue was an ornamental design for a feed bunk with an inclined corner configuration. Examiner relied upon references to a bunk lacking the inclined corners claimed by appellant and the *Architectural Precast Concrete Drafting Handbook*. The Board found the *Architectural Precast Concrete Drafting Handbook* was analogous art, noting that a bunk may be a wood or concrete trough, and that both references relied upon “disclose structures in which at least one upstanding leg is generally perpendicular to a base portion to define a corner configuration between the leg and base portion.”); *In re Butera*, 1 F.3d 1252, 28 USPQ2d 1399 (Fed. Cir. 1993) (unpublished - not citable as precedent) (The claimed invention, a spherical design for a combined insect repellent and air freshener, was rejected by the Board as obvious over a single reference to a design for a metal ball anode. The court reversed, holding the reference design to be nonanalogous art. “A prior design is of the type claimed if it has the same general use as that claimed in the design patent application . . . . One designing a combined insect repellent and air freshener would therefore not have reason to know of or look to a design for a metal ball anode.” 28 USPQ2d at 1400.).

### **2141.02 Differences Between Prior Art and Claimed Invention**

Ascertaining the differences between the prior art and the claims at issue requires interpreting the claim language, and considering both the invention and the prior art references as a whole. See MPEP § 2111 - § 2116.01 for case law pertaining to claim interpretation.

### **THE CLAIMED INVENTION AS A WHOLE MUST BE CONSIDERED**

In determining the differences between the prior art and the claims, the question under 35 U.S.C. 103 is

not whether the differences themselves would have been obvious, but whether the claimed invention as a whole would have been obvious. *Stratoflex, Inc. v. Aeroquip Corp.*, 713 F.2d 1530, 218 USPQ 871 (Fed. Cir. 1983); *Schenck v. Nortron Corp.*, 713 F.2d 782, 218 USPQ 698 (Fed. Cir. 1983) (Claims were directed to a vibratory testing machine (a hard-bearing wheel balancer) comprising a holding structure, a base structure, and a supporting means which form “a single integral and gaplessly continuous piece.” *Nortron* argued the invention is just making integral what had been made in four bolted pieces, improperly limiting the focus to a structural difference from the prior art and failing to consider the invention as a whole. The prior art perceived a need for mechanisms to dampen resonance, whereas the inventor eliminated the need for dampening via the one-piece gapless support structure. “Because that insight was contrary to the understandings and expectations of the art, the structure effectuating it would not have been obvious to those skilled in the art.” 713 F.2d at 785, 218 USPQ at 700 (citations omitted).).

See also *In re Hirao*, 535 F.2d 67, 190 USPQ 15 (CCPA 1976) (Claims were directed to a three step process for preparing sweetened foods and drinks. The first two steps were directed to a process of producing high purity maltose (the sweetener), and the third was directed to adding the maltose to foods and drinks. The parties agreed that the first two steps were unobvious but formed a known product and the third step was obvious. The Solicitor argued the preamble was directed to a process for preparing foods and drinks sweetened mildly and thus the specific method of making the high purity maltose (the first two steps in the claimed process) should not be given weight, analogizing with product-by-process claims. The court held “due to the admitted unobviousness of the first two steps of the claimed combination of steps, the subject matter as a whole would not have been obvious to one of ordinary skill in the art at the time the invention was made.” 535 F.2d at 69, 190 USPQ at 17 (emphasis in original). The preamble only recited the purpose of the process and did not limit the body of the claim. Therefore, the claimed process was a three step process, not the product formed by two steps of the process or the third step of using that product.).

### **DISTILLING THE INVENTION DOWN TO A “GIST” OR “THRUST” OF AN INVENTION DISREGARDS “AS A WHOLE” REQUIREMENT**

Distilling an invention down to the “gist” or “thrust” of an invention disregards the requirement of analyzing the subject matter “as a whole.” *W.L. Gore & Associates, Inc. v. Garlock, Inc.*, 721 F.2d 1540, 220 USPQ 303 (Fed. Cir. 1983), *cert. denied*, 469 U.S. 851 (1984) (restricting consideration of the claims to a 10% per second rate of stretching of unsintered PTFE and disregarding other limitations resulted in treating claims as though they read differently than allowed); *Bausch & Lomb v. Barnes-Hind/Hydrocurve, Inc.*, 796 F.2d 443, 447-49, 230 USPQ 416, 419-20 (Fed. Cir. 1986), *cert. denied*, 484 U.S. 823 (1987) (District court focused on the “concept of forming ridgeless depressions having smooth rounded edges using a laser beam to vaporize the material,” but “disregarded express limitations that the product be an ophthalmic lens formed of a transparent cross-linked polymer and that the laser marks be surrounded by a smooth surface of unsublimated polymer.”). See also *Jones v. Hardy*, 727 F.2d 1524, 1530, 220 USPQ 1021, 1026 (Fed. Cir. 1984) (“treating the advantage as the invention disregards statutory requirement that the invention be viewed ‘as a whole’ ”); *Panduit Corp. v. Dennison Mfg. Co.*, 810 F.2d 1561, 1 USPQ2d 1593 (Fed. Cir.), *cert. denied*, 481 U.S. 1052 (1987) (district court improperly distilled claims down to a one word solution to a problem).

### **DISCOVERING SOURCE/CAUSE OF A PROBLEM IS PART OF “AS A WHOLE” INQUIRY**

“[A] patentable invention may lie in the discovery of the source of a problem even though the remedy may be obvious once the source of the problem is identified. This is part of the ‘subject matter as a whole’ which should always be considered in determining the obviousness of an invention under 35 U.S.C. § 103.” *In re Spinnoble*, 405 F.2d 578, 585, 160 USPQ 237, 243 (CCPA 1969). However, “discovery of the cause of a problem . . . does not always result in a patentable invention. . . . [A] different situation exists where the solution is obvious from prior art which contains the same solution for a similar problem.” *In re Wiseman*, 596 F.2d 1019, 1022, 201 USPQ 658, 661 (CCPA 1979) (emphasis in original).



In *In re Spinnoble*, the claim was directed to a plural compartment mixing vial wherein a center seal plug was placed between two compartments for temporarily isolating a liquid-containing compartment from a solids-containing compartment. The claim differed from the prior art in the selection of butyl rubber with a silicone coating as the plug material instead of natural rubber. The prior art recognized that leakage from the liquid to the solids compartment was a problem, and considered the problem to be a result of moisture passing around the center plug because of microscopic fissures inherently present in molded or blown glass. The court found the inventor discovered the cause of moisture transmission was through the center plug, and there was no teaching in the prior art which would suggest the necessity of selecting applicant's plug material which was more impervious to liquids than the natural rubber plug of the prior art.

In *In re Wiseman*, 596 F.2d at 1022, 201 USPQ at 661, claims directed to grooved carbon disc brakes wherein the grooves were provided to vent steam or vapor during a braking action to minimize fading of the brakes were rejected as obvious over a reference showing carbon disc brakes without grooves in combination with a reference showing grooves in noncarbon disc brakes for the purpose of cooling the faces of the braking members and eliminating dust, thereby reducing fading of the brakes. The court affirmed the rejection, holding that even if applicants discovered the cause of a problem, the solution would have been obvious from the prior art which contained the same solution (inserting grooves in disc brakes) for a similar problem.

#### **APPLICANTS ALLEGING DISCOVERY OF A SOURCE OF A PROBLEM MUST PROVIDE SUBSTANTIATING EVIDENCE**

Applicants who allege they discovered the source of a problem must provide evidence substantiating the allegation, either by way of affidavits or declarations, or by way of a clear and persuasive assertion in the specification. *In re Wiseman*, 596 F.2d 1019, 201 USPQ 658 (CCPA 1979) (unsubstantiated statement of counsel was insufficient to show appellants discovered source of the problem); *In re Kaslow*, 707 F.2d 1366, 217 USPQ 1089 (Fed. Cir. 1983) (Claims were directed to a method for redeeming merchandising coupons which contain a UPC "5-by-5" bar code

wherein, among other steps, the memory at each supermarket would identify coupons by manufacturer and transmit the data to a central computer to provide an audit thereby eliminating the need for clearinghouses and preventing retailer fraud. In challenging the propriety of an obviousness rejection, appellant argued he discovered the source of a problem (retailer fraud and manual clearinghouse operations) and its solution. The court found appellant's specification did not support the argument that he discovered the source of the problem with respect to retailer fraud, and that the claimed invention failed to solve the problem of manual clearinghouse operations.).

#### **DISCLOSED INHERENT PROPERTIES ARE PART OF "AS A WHOLE" INQUIRY**

"In determining whether the invention as a whole would have been obvious under 35 U.S.C. 103, we must first delineate the invention as a whole. In delineating the invention as a whole, we look not only to the subject matter which is literally recited in the claim in question... but also to those properties of the subject matter which are inherent in the subject matter *and* are disclosed in the specification. . . Just as we look to a chemical and its properties when we examine the obviousness of a composition of matter claim, it is this invention *as a whole*, and not some part of it, which must be obvious under 35 U.S.C. 103." *In re Antonie*, 559 F.2d 618, 620, 195 USPQ 6,8 (CCPA 1977) (emphasis in original) (citations omitted) (The claimed wastewater treatment device had a tank volume to contractor area of 0.12 gal./sq. ft. The court found the invention as a whole was the ratio of 0.12 and its inherent property that the claimed devices maximized treatment capacity regardless of other variables in the devices. The prior art did not recognize that treatment capacity was a function of the tank volume to contractor ratio, and therefore the parameter optimized was not recognized in the art to be a result-effective variable.). See also *In re Papesch*, 315 F.2d 381, 391, 137 USPQ 43, 51 (CCPA 1963) ("From the standpoint of patent law, a compound and all its properties are inseparable.").

Obviousness cannot be predicated on what is not known at the time an invention is made, even if the inherency of a certain feature is later established. *In re Rijckaert*, 9 F.2d 1531, 28 USPQ2d 1955 (Fed. Cir.

1993). See MPEP § 2112 for the requirements of rejections based on inherency.

### **PRIOR ART MUST BE CONSIDERED IN ITS ENTIRETY, INCLUDING DISCLOSURES THAT TEACH AWAY FROM THE CLAIMS**

A prior art reference must be considered in its entirety, i.e., as a whole, including portions that would lead away from the claimed invention. *W.L. Gore & Associates, Inc. v. Garlock, Inc.*, 721 F.2d 1540, 220 USPQ 303 (Fed. Cir. 1983), *cert. denied*, 469 U.S. 851 (1984) (Claims were directed to a process of producing a porous article by expanding shaped, unsintered, highly crystalline poly(tetrafluoroethylene) (PTFE) by stretching said PTFE at a 10% per second rate to more than five times the original length. The prior art teachings with regard to unsintered PTFE indicated the material does not respond to conventional plastics processing, and the material should be stretched slowly. A reference teaching rapid stretching of conventional plastic polypropylene with reduced crystallinity combined with a reference teaching stretching unsintered PTFE would not suggest rapid stretching of highly crystalline PTFE, in light of the disclosures in the art that teach away from the invention, i.e., that the conventional polypropylene should have reduced crystallinity before stretching, and that PTFE should be stretched slowly.)

### **2141.03 Level of Ordinary Skill in the Art [R-2]**

#### **FACTORS TO CONSIDER IN DETERMINING LEVEL OF ORDINARY SKILL**

“Factors that may be considered in determining level of ordinary skill in the art include (1) the educational level of the inventor; (2) type of problems encountered in the art; (3) prior art solutions to those problems; (4) rapidity with which innovations are made; (5) sophistication of the technology; and (6) educational level of active workers in the field.” *Environmental Designs, Ltd. v. Union Oil Co.*, 713 F.2d 693, 696, 218 USPQ 865, 868 (Fed. Cir. 1983), *cert. denied*, 464 U.S. 1043 (1984).

The “hypothetical ‘person having ordinary skill in the art’ to which the claimed subject matter pertains

would, of necessity have the capability of understanding the scientific and engineering principles applicable to the pertinent art.” *Ex parte Hiyamizu*, 10 USPQ2d 1393, 1394 (Bd. Pat. App. & Inter. 1988) (The Board disagreed with the examiner’s definition of one of ordinary skill in the art (a doctorate level engineer or scientist working at least 40 hours per week in semiconductor research or development), finding that the hypothetical person is not definable by way of credentials, and that the evidence in the application did not support the conclusion that such a person would require a doctorate or equivalent knowledge in science or engineering.)

References which do not qualify as prior art because they postdate the claimed invention may be relied upon to show the level of ordinary skill in the art at or around the time the invention was made. *Ex parte Erlich*, 22 USPQ 1463 (Bd. Pat. App. & Inter. 1992). >Moreover, documents not available as prior art because the documents were not widely disseminated may be used to demonstrate the level of ordinary skill in the art. For example, the document may be relevant to establishing “a motivation to combine which is implicit in the knowledge of one of ordinary skill in the art.” *National Steel Car Ltd. v. Canadian Pacific Railway Ltd.*, 357 F.3d 1319, 1338, 69 USPQ2d 1641, 1656 (Fed. Cir. 2004)(holding that a drawing made by an engineer that was not prior art may nonetheless “be used to demonstrate a motivation to combine implicit in the knowledge of one of ordinary skill in the art”).<

#### **SPECIFYING A PARTICULAR LEVEL OF SKILL IS NOT NECESSARY WHERE THE PRIOR ART ITSELF REFLECTS AN APPROPRIATE LEVEL**

If the only facts of record pertaining to the level of skill in the art are found within the prior art of record, the court has held that an invention may be held to have been obvious without a specific finding of a particular level of skill where the prior art itself reflects an appropriate level. *Chore-Time Equipment, Inc. v. Cumberland Corp.*, 713 F.2d 774, 218 USPQ 673 (Fed. Cir. 1983). See also *Okajima v. Bourdeau*, 261 F.3d 1350, 1355, 59 USPQ2d 1795, 1797 (Fed. Cir. 2001).

### ASCERTAINING LEVEL OF ORDINARY SKILL IS NECESSARY TO MAINTAIN OBJECTIVITY

“The importance of resolving the level of ordinary skill in the art lies in the necessity of maintaining objectivity in the obviousness inquiry.” *Ryko Mfg. Co. v. Nu-Star, Inc.*, 950 F.2d 714, 718, 21 USPQ2d 1053, 1057 (Fed. Cir. 1991). The examiner must ascertain what would have been obvious to one of ordinary skill in the art at the time the invention was made, and not to the inventor, a judge, a layman, those skilled in remote arts, or to geniuses in the art at hand. *Environmental Designs, Ltd. v. Union Oil Co.*, 713 F.2d 693, 218 USPQ 865 (Fed. Cir. 1983), *cert. denied*, 464 U.S. 1043 (1984).

### 2142 Legal Concept of *Prima Facie* Obviousness

The legal concept of *prima facie* obviousness is a procedural tool of examination which applies broadly to all arts. It allocates who has the burden of going forward with production of evidence in each step of the examination process. See *In re Rinehart*, 531 F.2d 1048, 189 USPQ 143 (CCPA 1976); *In re Linter*, 458 F.2d 1013, 173 USPQ 560 (CCPA 1972); *In re Saunders*, 444 F.2d 599, 170 USPQ 213 (CCPA 1971); *In re Tiffin*, 443 F.2d 394, 170 USPQ 88 (CCPA 1971), *amended*, 448 F.2d 791, 171 USPQ 294 (CCPA 1971); *In re Warner*, 379 F.2d 1011, 154 USPQ 173 (CCPA 1967), *cert. denied*, 389 U.S. 1057 (1968). The examiner bears the initial burden of factually supporting any *prima facie* conclusion of obviousness. If the examiner does not produce a *prima facie* case, the applicant is under no obligation to submit evidence of nonobviousness. If, however, the examiner does produce a *prima facie* case, the burden of coming forward with evidence or arguments shifts to the applicant who may submit additional evidence of nonobviousness, such as comparative test data showing that the claimed invention possesses improved properties not expected by the prior art. The initial evaluation of *prima facie* obviousness thus relieves both the examiner and applicant from evaluating evidence beyond the prior art and the evidence in the specification as filed until the art has been shown to suggest the claimed invention.

To reach a proper determination under 35 U.S.C. 103, the examiner must step backward in time and

into the shoes worn by the hypothetical “person of ordinary skill in the art” when the invention was unknown and just before it was made. In view of all factual information, the examiner must then make a determination whether the claimed invention “as a whole” would have been obvious at that time to that person. Knowledge of applicant’s disclosure must be put aside in reaching this determination, yet kept in mind in order to determine the “differences,” conduct the search and evaluate the “subject matter as a whole” of the invention. The tendency to resort to “hindsight” based upon applicant’s disclosure is often difficult to avoid due to the very nature of the examination process. However, impermissible hindsight must be avoided and the legal conclusion must be reached on the basis of the facts gleaned from the prior art.

### ESTABLISHING A *PRIMA FACIE* CASE OF OBVIOUSNESS

To establish a *prima facie* case of obviousness, three basic criteria must be met. First, there must be some suggestion or motivation, either in the references themselves or in the knowledge generally available to one of ordinary skill in the art, to modify the reference or to combine reference teachings. Second, there must be a reasonable expectation of success. Finally, the prior art reference (or references when combined) must teach or suggest all the claim limitations. The teaching or suggestion to make the claimed combination and the reasonable expectation of success must both be found in the prior art, and not based on applicant’s disclosure. *In re Vaeck*, 947 F.2d 488, 20 USPQ2d 1438 (Fed. Cir. 1991). See MPEP § 2143 - § 2143.03 for decisions pertinent to each of these criteria.

The initial burden is on the examiner to provide some suggestion of the desirability of doing what the inventor has done. “To support the conclusion that the claimed invention is directed to obvious subject matter, either the references must expressly or impliedly suggest the claimed invention or the examiner must present a convincing line of reasoning as to why the artisan would have found the claimed invention to have been obvious in light of the teachings of the references.” *Ex parte Clapp*, 227 USPQ 972, 973 (Bd. Pat. App. & Inter. 1985). See MPEP § 2144 -

§ 2144.09 for examples of reasoning supporting obviousness rejections.

When the motivation to combine the teachings of the references is not immediately apparent, it is the duty of the examiner to explain why the combination of the teachings is proper. *Ex parte Skinner*, 2 USPQ2d 1788 (Bd. Pat. App. & Inter. 1986). A statement of a rejection that includes a large number of rejections must explain with reasonable specificity at least one rejection, otherwise the examiner procedurally fails to establish a *prima facie* case of obviousness. *Ex parte Blanc*, 13 USPQ2d 1383 (Bd. Pat. App. & Inter. 1989) (Rejection based on nine references which included at least 40 prior art rejections without explaining any one rejection with reasonable specificity was reversed as procedurally failing to establish a *prima facie* case of obviousness.).

If the examiner determines there is factual support for rejecting the claimed invention under 35 U.S.C. 103, the examiner must then consider any evidence supporting the patentability of the claimed invention, such as any evidence in the specification or any other evidence submitted by the applicant. The ultimate determination of patentability is based on the entire record, by a preponderance of evidence, with due consideration to the persuasiveness of any arguments and any secondary evidence. *In re Oetiker*, 977 F.2d 1443, 24 USPQ2d 1443 (Fed. Cir. 1992). The legal standard of “a preponderance of evidence” requires the evidence to be more convincing than the evidence which is offered in opposition to it. With regard to rejections under 35 U.S.C. 103, the examiner must provide evidence which as a whole shows that the legal determination sought to be proved (i.e., the reference teachings establish a *prima facie* case of obviousness) is more probable than not.

When an applicant submits evidence, whether in the specification as originally filed or in reply to a rejection, the examiner must reconsider the patentability of the claimed invention. The decision on patentability must be made based upon consideration of all the evidence, including the evidence submitted by the examiner and the evidence submitted by the applicant. A decision to make or maintain a rejection in the face of all the evidence must show that it was based on the totality of the evidence. Facts established by rebuttal evidence must be evaluated along with the facts on which the conclusion of obviousness was

reached, not against the conclusion itself. *In re Eli Lilly & Co.*, 902 F.2d 943, 14 USPQ2d 1741 (Fed. Cir. 1990).

See *In re Piasecki*, 745 F.2d 1468, 223 USPQ 785 (Fed. Cir. 1984) for a discussion of the proper roles of the examiner’s *prima facie* case and applicant’s rebuttal evidence in the final determination of obviousness. See MPEP § 706.02(j) for a discussion of the proper contents of a rejection under 35 U.S.C. 103.

### **2143 Basic Requirements of a *Prima Facie* Case of Obviousness**

To establish a *prima facie* case of obviousness, three basic criteria must be met. First, there must be some suggestion or motivation, either in the references themselves or in the knowledge generally available to one of ordinary skill in the art, to modify the reference or to combine reference teachings. Second, there must be a reasonable expectation of success. Finally, the prior art reference (or references when combined) must teach or suggest all the claim limitations.

The teaching or suggestion to make the claimed combination and the reasonable expectation of success must both be found in the prior art, not in applicant’s disclosure. *In re Vaeck*, 947 F.2d 488, 20 USPQ2d 1438 (Fed. Cir. 1991).

### **2143.01 Suggestion or Motivation To Modify the References [R-2]**

#### **THE PRIOR ART MUST SUGGEST THE DESIRABILITY OF THE CLAIMED INVENTION**

“There are three possible sources for a motivation to combine references: the nature of the problem to be solved, the teachings of the prior art, and the knowledge of persons of ordinary skill in the art.” *In re Rouffet*, 149 F.3d 1350, 1357, 47 USPQ2d 1453, 1457-58 (Fed. Cir. 1998) (The combination of the references taught every element of the claimed invention, however without a motivation to combine, a rejection based on a *prima facie* case of obvious was held improper.). The level of skill in the art cannot be relied upon to provide the suggestion to combine references. *Al-Site Corp. v. VSI Int’l Inc.*, 174 F.3d 1308, 50 USPQ2d 1161 (Fed. Cir. 1999).

“In determining the propriety of the Patent Office case for obviousness in the first instance, it is necessary to ascertain whether or not the reference teachings would appear to be sufficient for one of ordinary skill in the relevant art having the reference before him to make the proposed substitution, combination, or other modification.” *In re Linter*, 458 F.2d 1013, 1016, 173 USPQ 560, 562 (CCPA 1972).

Obviousness can only be established by combining or modifying the teachings of the prior art to produce the claimed invention where there is some teaching, suggestion, or motivation to do so found either explicitly or implicitly in the references themselves or in the knowledge generally available to one of ordinary skill in the art. “The test for an implicit showing is what the combined teachings, knowledge of one of ordinary skill in the art, and the nature of the problem to be solved as a whole would have suggested to those of ordinary skill in the art.” *In re Kotzab*, 217 F.3d 1365, 1370, 55 USPQ2d 1313, 1317 (Fed. Cir. 2000). See also *In re Lee*, 277 F.3d 1338, 1342-44, 61 USPQ2d 1430, 1433-34 (Fed. Cir. 2002) (discussing the importance of relying on objective evidence and making specific factual findings with respect to the motivation to combine references); *In re Fine*, 837 F.2d 1071, 5 USPQ2d 1596 (Fed. Cir. 1988); *In re Jones*, 958 F.2d 347, 21 USPQ2d 1941 (Fed. Cir. 1992).

>In *Ruiz v. A.B. Chance Co.*, 357 F.3d 1270, 69 USPQ2d 1686 (Fed. Cir. 2004), the patent claimed underpinning a slumping building foundation using a screw anchor attached to the foundation by a metal bracket. One prior art reference taught a screw anchor with a concrete bracket, and a second prior art reference disclosed a pier anchor with a metal bracket. The court found motivation to combine the references to arrive at the claimed invention in the “nature of the problem to be solved” because each reference was directed “to precisely the same problem of underpinning slumping foundations.” *Id.* at 1276, 69 USPQ2d at 1690. The court also *rejected* the notion that “an express written motivation to combine must appear in prior art references....” *Id.* at 1276, 69 USPQ2d at 1690.<

In *In re Kotzab*, the claims were drawn to an injection molding method using a single temperature sensor to control a plurality of flow control valves. The primary reference disclosed a multizone device having multiple sensors, each of which controlled an

associated flow control valve, and also taught that one *system* may be used to control a number of valves. The court found that there was insufficient evidence to show that one *system* was the same as one *sensor*. While the control of multiple valves by a single sensor rather than by multiple sensors was a “technologically simple concept,” there was no finding “as to the specific understanding or principle within the knowledge of the skilled artisan” that would have provided the motivation to use a single sensor as the system to control more than one valve. 217 F.3d at 1371, 55 USPQ2d at 1318.

In *In re Fine*, the claims were directed to a system for detecting and measuring minute quantities on nitrogen compounds comprising a gas chromatograph, a converter which converts nitrogen compounds into nitric oxide by combustion, and a nitric oxide detector. The primary reference disclosed a system for monitoring sulfur compounds comprising a chromatograph, combustion means, and a detector, and the secondary reference taught nitric oxide detectors. The examiner and Board asserted that it would have been within the skill of the art to substitute one type of detector for another in the system of the primary reference, however the court found there was no support or explanation of this conclusion and reversed.

In *In re Jones*, the claimed invention was the 2-(2 $\phi$ -aminoethoxy) ethanol salt of dicamba, a compound with herbicidal activity. The primary reference disclosed *inter alia* the substituted ammonium salts of dicamba as herbicides, however the reference did not specifically teach the claimed salt. Secondary references teaching the amine portion of the salt were directed to shampoo additives and a byproduct of the production of morpholine. The court found there was no suggestion to combine these references to arrive at the claimed invention.

#### **WHERE THE TEACHINGS OF THE PRIOR ART CONFLICT, THE EXAMINER MUST WEIGH THE SUGGESTIVE POWER OF EACH REFERENCE**

The test for obviousness is what the combined teachings of the references would have suggested to one of ordinary skill in the art, and all teachings in the prior art must be considered to the extent that they are in analogous arts. Where the teachings of two or more

prior art references conflict, the examiner must weigh the power of each reference to suggest solutions to one of ordinary skill in the art, considering the degree to which one reference might accurately discredit another. *In re Young*, 927 F.2d 588, 18 USPQ2d 1089 (Fed. Cir. 1991) (Prior art patent to Carlisle disclosed controlling and minimizing bubble oscillation for chemical explosives used in marine seismic exploration by spacing seismic sources close enough to allow the bubbles to intersect before reaching their maximum radius so the secondary pressure pulse was reduced. An article published several years later by Knudsen opined that the Carlisle technique does not yield appreciable improvement in bubble oscillation suppression. However, the article did not test the Carlisle technique under comparable conditions because Knudsen did not use Carlisle's spacing or seismic source. Furthermore, where the Knudsen model most closely approximated the patent technique there was a 30% reduction of the secondary pressure pulse. On these facts, the court found that the Knudsen article would not have deterred one of ordinary skill in the art from using the Carlisle patent teachings.).

**FACT THAT REFERENCES CAN BE COMBINED OR MODIFIED IS NOT SUFFICIENT TO ESTABLISH *PRIMA FACIE* OBVIOUSNESS**

The mere fact that references can be combined or modified does not render the resultant combination obvious unless the prior art also suggests the desirability of the combination. *In re Mills*, 916 F.2d 680, 16 USPQ2d 1430 (Fed. Cir. 1990) (Claims were directed to an apparatus for producing an aerated cementitious composition by drawing air into the cementitious composition by driving the output pump at a capacity greater than the feed rate. The prior art reference taught that the feed means can be run at a variable speed, however the court found that this does not require that the output pump be run at the claimed speed so that air is drawn into the mixing chamber and is entrained in the ingredients during operation. Although a prior art device "may be capable of being modified to run the way the apparatus is claimed, there must be a suggestion or motivation in the reference to do so." 916 F.2d at 682, 16 USPQ2d at 1432.). See also *In re Fritch*, 972 F.2d 1260, 23 USPQ2d 1780 (Fed. Cir. 1992) (flexible landscape edging device which is conformable to a ground surface of

varying slope not suggested by combination of prior art references).

**FACT THAT THE CLAIMED INVENTION IS WITHIN THE CAPABILITIES OF ONE OF ORDINARY SKILL IN THE ART IS NOT SUFFICIENT BY ITSELF TO ESTABLISH *PRIMA FACIE* OBVIOUSNESS**

A statement that modifications of the prior art to meet the claimed invention would have been " 'well within the ordinary skill of the art at the time the claimed invention was made' " because the references relied upon teach that all aspects of the claimed invention were individually known in the art is not sufficient to establish a *prima facie* case of obviousness without some objective reason to combine the teachings of the references. *Ex parte Levengood*, 28 USPQ2d 1300 (Bd. Pat. App. & Inter. 1993). See also *In re Kotzab*, 217 F.3d 1365, 1371, 55 USPQ2d 1313, 1318 (Fed. Cir. 2000) (Court reversed obviousness rejection involving technologically simple concept because there was no finding as to the principle or specific understanding within the knowledge of a skilled artisan that would have motivated the skilled artisan to make the claimed invention); *Al-Site Corp. v. VSI Int'l Inc.*, 174 F.3d 1308, 50 USPQ2d 1161 (Fed. Cir. 1999) (The level of skill in the art cannot be relied upon to provide the suggestion to combine references.).

**THE PROPOSED MODIFICATION CANNOT RENDER THE PRIOR ART UNSATISFACTORY FOR ITS INTENDED PURPOSE**

If proposed modification would render the prior art invention being modified unsatisfactory for its intended purpose, then there is no suggestion or motivation to make the proposed modification. *In re Gordon*, 733 F.2d 900, 221 USPQ 1125 (Fed. Cir. 1984) (Claimed device was a blood filter assembly for use during medical procedures wherein both the inlet and outlet for the blood were located at the bottom end of the filter assembly, and wherein a gas vent was present at the top of the filter assembly. The prior art reference taught a liquid strainer for removing dirt and water from gasoline and other light oils wherein the inlet and outlet were at the top of the device, and wherein a pet-cock (stopcock) was located at the bottom of the device for periodically removing the

collected dirt and water. The reference further taught that the separation is assisted by gravity. The Board concluded the claims were *prima facie* obvious, reasoning that it would have been obvious to turn the reference device upside down. The court reversed, finding that if the prior art device was turned upside down it would be inoperable for its intended purpose because the gasoline to be filtered would be trapped at the top, the water and heavier oils sought to be separated would flow out of the outlet instead of the purified gasoline, and the screen would become clogged.).

“Although statements limiting the function or capability of a prior art device require fair consideration, simplicity of the prior art is rarely a characteristic that weighs against obviousness of a more complicated device with added function.” *In re Dance*, 160 F.3d 1339, 1344, 48 USPQ2d 1635, 1638 (Fed. Cir. 1998) (Court held that claimed catheter for removing obstruction in blood vessels would have been obvious in view of a first reference which taught all of the claimed elements except for a “means for recovering fluid and debris” in combination with a second reference describing a catheter including that means. The court agreed that the first reference, which stressed simplicity of structure and taught emulsification of the debris, did not teach away from the addition of a channel for the recovery of the debris.).

#### **THE PROPOSED MODIFICATION CANNOT CHANGE THE PRINCIPLE OF OPERATION OF A REFERENCE**

If the proposed modification or combination of the prior art would change the principle of operation of the prior art invention being modified, then the teachings of the references are not sufficient to render the claims *prima facie* obvious. *In re Ratti*, 270 F.2d 810, 123 USPQ 349 (CCPA 1959) (Claims were directed to an oil seal comprising a bore engaging portion with outwardly biased resilient spring fingers inserted in a resilient sealing member. The primary reference relied upon in a rejection based on a combination of references disclosed an oil seal wherein the bore engaging portion was reinforced by a cylindrical sheet metal casing. Patentee taught the device required rigidity for operation, whereas the claimed invention required resiliency. The court reversed the rejection holding

the “suggested combination of references would require a substantial reconstruction and redesign of the elements shown in [the primary reference] as well as a change in the basic principle under which the [primary reference] construction was designed to operate.” 270 F.2d at 813, 123 USPQ at 352.).

#### **2143.02 Reasonable Expectation of Success Is Required**

##### **OBVIOUSNESS REQUIRES ONLY A REASONABLE EXPECTATION OF SUCCESS**

The prior art can be modified or combined to reject claims as *prima facie* obvious as long as there is a reasonable expectation of success. *In re Merck & Co., Inc.*, 800 F.2d 1091, 231 USPQ 375 (Fed. Cir. 1986) (Claims directed to a method of treating depression with amitriptyline (or nontoxic salts thereof) were rejected as *prima facie* obvious over prior art disclosures that amitriptyline is a compound known to possess psychotropic properties and that imipramine is a structurally similar psychotropic compound known to possess antidepressive properties, in view of prior art suggesting the aforementioned compounds would be expected to have similar activity because the structural difference between the compounds involves a known bioisosteric replacement and because a research paper comparing the pharmacological properties of these two compounds suggested clinical testing of amitriptyline as an antidepressant. The court sustained the rejection, finding that the teachings of the prior art provide a sufficient basis for a reasonable expectation of success.); *Ex parte Blanc*, 13 USPQ2d 1383 (Bd. Pat. App. & Inter. 1989) (Claims were directed to a process of sterilizing a polyolefinic composition with high-energy radiation in the presence of a phenolic polyester antioxidant to inhibit discoloration or degradation of the polyolefin. Appellant argued that it is unpredictable whether a particular antioxidant will solve the problem of discoloration or degradation. However, the Board found that because the prior art taught that appellant’s preferred antioxidant is very efficient and provides better results compared with other prior art antioxidants, there would have been a reasonable expectation of success.).

**AT LEAST SOME DEGREE OF PREDICTABILITY IS REQUIRED; APPLICANTS MAY PRESENT EVIDENCE SHOWING THERE WAS NO REASONABLE EXPECTATION OF SUCCESS**

Obviousness does not require absolute predictability, however, at least some degree of predictability is required. Evidence showing there was no reasonable expectation of success may support a conclusion of nonobviousness. *In re Rinehart*, 531 F.2d 1048, 189 USPQ 143 (CCPA 1976) (Claims directed to a method for the commercial scale production of polyesters in the presence of a solvent at superatmospheric pressure were rejected as obvious over a reference which taught the claimed method at atmospheric pressure in view of a reference which taught the claimed process except for the presence of a solvent. The court reversed, finding there was no reasonable expectation that a process combining the prior art steps could be successfully scaled up in view of unchallenged evidence showing that the prior art processes individually could not be commercially scaled up successfully.). See also *Amgen, Inc. v. Chugai Pharmaceutical Co.*, 927 F.2d 1200, 1207-08, 18 USPQ2d 1016, 1022-23 (Fed. Cir.), *cert. denied*, 502 U.S. 856 (1991) (In the context of a biotechnology case, testimony supported the conclusion that the references did not show that there was a reasonable expectation of success.); *In re O'Farrell*, 853 F.2d 894, 903, 7 USPQ2d 1673, 1681 (Fed. Cir. 1988) (The court held the claimed method would have been obvious over the prior art relied upon because one reference contained a detailed enabling methodology, a suggestion to modify the prior art to produce the claimed invention, and evidence suggesting the modification would be successful.).

**PREDICTABILITY IS DETERMINED AT THE TIME THE INVENTION WAS MADE**

Whether an art is predictable or whether the proposed modification or combination of the prior art has a reasonable expectation of success is determined at the time the invention was made. *Ex parte Erlich*, 3 USPQ2d 1011 (Bd. Pat. App. & Inter. 1986) (Although an earlier case reversed a rejection because of unpredictability in the field of monoclonal antibodies,

the court found “in this case at the time this invention was made, one of ordinary skill in the art would have been motivated to produce monoclonal antibodies specific for human fibroblast interferon using the method of [the prior art] with a reasonable expectation of success.” 3 USPQ2d at 1016 (emphasis in original).).

**2143.03 All Claim Limitations Must Be Taught or Suggested**

To establish *prima facie* obviousness of a claimed invention, all the claim limitations must be taught or suggested by the prior art. *In re Royka*, 490 F.2d 981, 180 USPQ 580 (CCPA 1974). “All words in a claim must be considered in judging the patentability of that claim against the prior art.” *In re Wilson*, 424 F.2d 1382, 1385, 165 USPQ 494, 496 (CCPA 1970). If an independent claim is nonobvious under 35 U.S.C. 103, then any claim depending therefrom is nonobvious. *In re Fine*, 837 F.2d 1071, 5 USPQ2d 1596 (Fed. Cir. 1988).

**INDEFINITE LIMITATIONS MUST BE CONSIDERED**

A claim limitation which is considered indefinite cannot be disregarded. If a claim is subject to more than one interpretation, at least one of which would render the claim unpatentable over the prior art, the examiner should reject the claim as indefinite under 35 U.S.C. 112, second paragraph (see MPEP § 706.03(d)) and should reject the claim over the prior art based on the interpretation of the claim that renders the prior art applicable. *Ex parte Ionescu*, 222 USPQ 537 (Bd. Pat. App. & Inter. 1984) (Claims on appeal were rejected on indefiniteness grounds only; the rejection was reversed and the case remanded to the examiner for consideration of pertinent prior art.). Compare *In re Wilson*, 424 F.2d 1382, 165 USPQ 494 (CCPA 1970) (if no reasonably definite meaning can be ascribed to certain claim language, the claim is indefinite, not obvious) and *In re Steele*, 305 F.2d 859, 134 USPQ 292 (CCPA 1962) (it is improper to rely on speculative assumptions regarding the meaning of a claim and then base a rejection under 35 U.S.C. 103 on these assumptions).



### LIMITATIONS WHICH DO NOT FIND SUPPORT IN THE ORIGINAL SPECIFICATION MUST BE CONSIDERED

When evaluating claims for obviousness under 35 U.S.C. 103, all the limitations of the claims must be considered and given weight, including limitations which do not find support in the specification as originally filed (i.e., new matter). *Ex parte Grasselli*, 231 USPQ 393 (Bd. App. 1983) *aff'd mem.* 738 F.2d 453 (Fed. Cir. 1984) (Claim to a catalyst expressly excluded the presence of sulfur, halogen, uranium, and a combination of vanadium and phosphorous. Although the negative limitations excluding these elements did not appear in the specification as filed, it was error to disregard these limitations when determining whether the claimed invention would have been obvious in view of the prior art.).

### 2144 Sources of Rationale Supporting a Rejection Under 35 U.S.C. 103

#### RATIONALE MAY BE IN A REFERENCE, OR REASONED FROM COMMON KNOWLEDGE IN THE ART, SCIENTIFIC PRINCIPLES, ART-RECOGNIZED EQUIVALENTS, OR LEGAL PRECEDENT

The rationale to modify or combine the prior art does not have to be expressly stated in the prior art; the rationale may be expressly or impliedly contained in the prior art or it may be reasoned from knowledge generally available to one of ordinary skill in the art, established scientific principles, or legal precedent established by prior case law. *In re Fine*, 837 F.2d 1071, 5 USPQ2d 1596 (Fed. Cir. 1988); *In re Jones*, 958 F.2d 347, 21 USPQ2d 1941 (Fed. Cir. 1992). See also *In re Kotzab*, 217 F.3d 1365, 1370, 55 USPQ2d 1313, 1317 (Fed. Cir. 2000) (setting forth test for implicit teachings); *In re Eli Lilly & Co.*, 902 F.2d 943, 14 USPQ2d 1741 (Fed. Cir. 1990) (discussion of reliance on legal precedent); *In re Nilssen*, 851 F.2d 1401, 1403, 7 USPQ2d 1500, 1502 (Fed. Cir. 1988) (references do not have to explicitly suggest combining teachings); *Ex parte Clapp*, 227 USPQ 972 (Bd. Pat. App. & Inter. 1985) (examiner must present convincing line of reasoning supporting rejection); and *Ex parte Levengood*, 28 USPQ2d 1300 (Bd. Pat. App. & Inter. 1993) (reliance on logic and sound scientific reasoning).

### THE EXPECTATION OF SOME ADVANTAGE IS THE STRONGEST RATIONALE FOR COMBINING REFERENCES

The strongest rationale for combining references is a recognition, expressly or impliedly in the prior art or drawn from a convincing line of reasoning based on established scientific principles or legal precedent, that some advantage or expected beneficial result would have been produced by their combination. *In re Sernaker*, 702 F.2d 989, 994-95, 217 USPQ 1, 5-6 (Fed. Cir. 1983).

#### LEGAL PRECEDENT CAN PROVIDE THE RATIONALE SUPPORTING OBVIOUSNESS ONLY IF THE FACTS IN THE CASE ARE SUFFICIENTLY SIMILAR TO THOSE IN THE APPLICATION

The examiner must apply the law consistently to each application after considering all the relevant facts. If the facts in a prior legal decision are sufficiently similar to those in an application under examination, the examiner may use the rationale used by the court. If the applicant has demonstrated the criticality of a specific limitation, it would not be appropriate to rely solely on case law as the rationale to support an obviousness rejection. “The value of the exceedingly large body of precedent wherein our predecessor courts and this court have applied the law of obviousness to particular facts, is that there has been built a wide spectrum of illustrations and accompanying reasoning, that have been melded into a fairly consistent application of law to a great variety of facts.” *In re Eli Lilly & Co.*, 902 F.2d 943, 14 USPQ2d 1741 (Fed. Cir. 1990).

#### RATIONALE DIFFERENT FROM APPLICANT’S IS PERMISSIBLE

The reason or motivation to modify the reference may often suggest what the inventor has done, but for a different purpose or to solve a different problem. It is not necessary that the prior art suggest the combination to achieve the same advantage or result discovered by applicant. *In re Linter*, 458 F.2d 1013, 173 USPQ 560 (CCPA 1972) (discussed below); *In re Dillon*, 919 F.2d 688, 16 USPQ2d 1897 (Fed. Cir. 1990), *cert. denied*, 500 U.S. 904 (1991) (discussed below). Although *Ex parte Levengood*, 28 USPQ2d

1300, 1302 (Bd. Pat. App. & Inter. 1993) states that obviousness cannot be established by combining references “without also providing evidence of the motivating force which would impel one skilled in the art to do what the patent applicant has done” (emphasis added), reading the quotation in context it is clear that while there must be motivation to make the claimed invention, there is no requirement that the prior art provide the same reason as the applicant to make the claimed invention.

In *In re Linter* the claimed invention was a laundry composition consisting essentially of a dispersant, cationic fabric softener, sugar, sequestering phosphate, and brightener in specified proportions. The claims were rejected over the combination of a primary reference which taught all the claim limitations except for the presence of sugar, and secondary references which taught the addition of sugar as a filler or weighting agent in compositions containing cationic fabric softeners. Appellant argued that in the claimed invention, the sugar is responsible for the compatibility of the cationic softener with the other detergent components. The court sustained the rejection, stating “The fact that appellant uses sugar for a different purpose does not alter the conclusion that its use in a prior art composition would be [sic, would have been] *prima facie* obvious from the purpose disclosed in the references.” 173 USPQ at 562.

In *In re Dillon*, applicant claimed a composition comprising a hydrocarbon fuel and a sufficient amount of a tetra-orthoester of a specified formula to reduce the particulate emissions from the combustion of the fuel. The claims were rejected as obvious over a reference which taught hydrocarbon fuel compositions containing tri-orthoesters for dewatering fuels, in combination with a reference teaching the equivalence of tri-orthoesters and tetra-orthoesters as water scavengers in hydraulic (nonhydrocarbon) fluids. The Board affirmed the rejection finding “there was a ‘reasonable expectation’ that the tri- and tetra-orthoester fuel compositions would have similar properties based on ‘close structural and chemical similarity’ between the tri- and tetra-orthoesters and the fact that both the prior art and Dillon use these compounds ‘as fuel additives’.” 919 F.2d at 692, 16 USPQ2d at 1900. The court held “it is not necessary in order to establish a *prima facie* case of obviousness . . . that there be a suggestion or expectation from *the prior art* that the

claimed [invention] will have the same or a similar utility as *one newly discovered by applicant*,” and concluded that here a *prima facie* case was established because “[t]he art provided the motivation to make the claimed compositions in the expectation that they would have similar properties.” 919 F.2d at 693, 16 USPQ2d at 1901 (emphasis in original).

See MPEP § 2145, paragraph II for case law pertaining to the presence of additional advantages or latent properties not recognized in the prior art.

### 2144.01 Implicit Disclosure

“[I]n considering the disclosure of a reference, it is proper to take into account not only specific teachings of the reference but also the inferences which one skilled in the art would reasonably be expected to draw therefrom.” *In re Preda*, 401 F.2d 825, 826, 159 USPQ 342, 344 (CCPA 1968) (A process for catalytically producing carbon disulfide by reacting sulfur vapor and methane in the presence of charcoal at a temperature of “about 750-830°C” was found to be met by a reference which expressly taught the same process at 700°C because the reference recognized the possibility of using temperatures greater than 750°C. The reference disclosed that catalytic processes for converting methane with sulfur vapors into carbon disulfide at temperatures greater than 750°C (albeit without charcoal) was known, and that 700°C was “much lower than had previously proved feasible.”); *In re Lamberti*, 545 F.2d 747, 750, 192 USPQ 278, 280 (CCPA 1976) (Reference disclosure of a compound where the R-S-R $\phi$  portion has “at least one methylene group attached to the sulfur atom” implies that the other R group attached to the sulfur atom can be other than methylene and therefore suggests asymmetric dialkyl moieties.).

### 2144.02 Reliance on Scientific Theory

The rationale to support a rejection under 35 U.S.C. 103 may rely on logic and sound scientific principle. *In re Soli*, 317 F.2d 941, 137 USPQ 797 (CCPA 1963). However, when an examiner relies on a scientific theory, evidentiary support for the existence and meaning of that theory must be provided. *In re Grose*, 592 F.2d 1161, 201 USPQ 57 (CCPA 1979) (Court held that different crystal forms of zeolites would not have been structurally obvious one from the other because there was no chemical theory supporting such

a conclusion. The known chemical relationship between structurally similar compounds (homologs, analogs, isomers) did not support a finding of *prima facie* obviousness of claimed zeolite over the prior art because a zeolite is not a compound but a mixture of compounds related to each other by a particular crystal structure.). Although the theoretical mechanism of an invention may be explained by logic and sound scientific reasoning, this fact does not support an obviousness determination unless logic and scientific reasoning would have led one of ordinary skill in the art to make the claimed invention. *Ex parte Levengood*, 28 USPQ2d 1300 (Bd. Pat. App. & Inter. 1993).

### **2144.03 Reliance on Common Knowledge in the Art or “Well Known” Prior Art [R-1]**

\*\*>In limited circumstances, it is appropriate for an examiner to take official notice of facts not in the record or to rely on “common knowledge” in making a rejection, however such rejections should be judiciously applied.

#### **PROCEDURE FOR RELYING ON COMMON KNOWLEDGE OR TAKING OFFICIAL NOTICE**

The standard of review applied to findings of fact is the “substantial evidence” standard under the Administrative Procedure Act (APA). See *In re Gartside*, 203 F.3d 1305, 1315, 53 USPQ2d 1769, 1775 (Fed. Cir. 2000). See also MPEP § 1216.01. In light of recent Federal Circuit decisions as discussed below and the substantial evidence standard of review now applied to USPTO Board decisions, the following guidance is provided in order to assist the examiners in determining when it is appropriate to take official notice of facts without supporting documentary evidence or to rely on common knowledge in the art in making a rejection, and if such official notice is taken, what evidence is necessary to support the examiner’s conclusion of common knowledge in the art.

#### **A. Determine When It Is Appropriate To Take Official Notice Without Documentary Evidence To Support The Examiner’s Conclusion**

Official notice without documentary evidence to support an examiner’s conclusion is permissible only

in some circumstances. While “official notice” may be relied on, these circumstances should be rare when an application is under final rejection or action under 37 CFR 1.113. Official notice unsupported by documentary evidence should only be taken by the examiner where the facts asserted to be well-known, or to be common knowledge in the art are capable of instant and unquestionable demonstration as being well-known. As noted by the court in *In re Ahlert*, 424 F.2d 1088, 1091, 165 USPQ 418, 420 (CCPA 1970), the notice of facts beyond the record which may be taken by the examiner must be “capable of such instant and unquestionable demonstration as to defy dispute” (citing *In re Knapp Monarch Co.*, 296 F.2d 230, 132 USPQ 6 (CCPA 1961)). In *Ahlert*, the court held that the Board properly took judicial notice that “it is old to adjust intensity of a flame in accordance with the heat requirement.” See also *In re Fox*, 471 F.2d 1405, 1407, 176 USPQ 340, 341 (CCPA 1973) (the court took “judicial notice of the fact that tape recorders commonly erase tape automatically when new ‘audio information’ is recorded on a tape which already has a recording on it”). In appropriate circumstances, it might not be unreasonable to take official notice of the fact that it is desirable to make something faster, cheaper, better, or stronger without the specific support of documentary evidence. Furthermore, it might not be unreasonable for the examiner in a first Office action to take official notice of facts by asserting that certain limitations in a dependent claim are old and well known expedients in the art without the support of documentary evidence provided the facts so noticed are of notorious character and serve only to “fill in the gaps” which might exist in the evidentiary showing made by the examiner to support a particular ground of rejection. *In re Zurko*, 258 F.3d 1379, 1385, 59 USPQ2d 1693, 1697 (Fed. Cir. 2001); *Ahlert*, 424 F.2d at 1092, 165 USPQ at 421.

It would not be appropriate for the examiner to take official notice of facts without citing a prior art reference where the facts asserted to be well known are not capable of instant and unquestionable demonstration as being well-known. For example, assertions of technical facts in the areas of esoteric technology or specific knowledge of the prior art must always be supported by citation to some reference work recognized as standard in the pertinent art. *In re Ahlert*, 424 F.2d at 1091, 165 USPQ at 420-21. See also *In re*

*Grose*, 592 F.2d 1161, 1167-68, 201 USPQ 57, 63 (CCPA 1979) (“[W]hen the PTO seeks to rely upon a chemical theory, in establishing a prima facie case of obviousness, it must provide evidentiary support for the existence and meaning of that theory.”); *In re Eynde*, 480 F.2d 1364, 1370, 178 USPQ 470, 474 (CCPA 1973) (“[W]e reject the notion that judicial or administrative notice may be taken of the state of the art. The facts constituting the state of the art are normally subject to the possibility of rational disagreement among reasonable men and are not amenable to the taking of such notice.”).

It is never appropriate to rely solely on “common knowledge” in the art without evidentiary support in the record, as the principal evidence upon which a rejection was based. *Zurko*, 258 F.3d at 1385, 59 USPQ2d at 1697 (“[T]he Board cannot simply reach conclusions based on its own understanding or experience—or on its assessment of what would be basic knowledge or common sense. Rather, the Board must point to some concrete evidence in the record in support of these findings.”). While the court explained that, “as an administrative tribunal the Board clearly has expertise in the subject matter over which it exercises jurisdiction,” it made clear that such “expertise may provide sufficient support for conclusions [only] as to peripheral issues.” *Id.* at 1385-86, 59 USPQ2d at 1697. As the court held in *Zurko*, an assessment of basic knowledge and common sense that is not based on any evidence in the record lacks substantial evidence support. *Id.* at 1385, 59 USPQ2d at 1697. See also *In re Lee*, 277 F.3d 1338, 1344-45, 61 USPQ2d 1430, 1434-35 (Fed. Cir. 2002) (In reversing the Board’s decision, the court stated “ ‘common knowledge and common sense’ on which the Board relied in rejecting Lee’s application are not the specialized knowledge and expertise contemplated by the Administrative Procedure Act. Conclusory statements such as those here provided do not fulfill the agency’s obligation....The board cannot rely on conclusory statements when dealing with particular combinations of prior art and specific claims, but must set forth the rationale on which it relies.”).

***B. If Official Notice Is Taken of a Fact, Unsupported by Documentary Evidence, the Technical Line Of Reasoning Underlying a Decision To Take Such Notice Must Be Clear and Unmistakable***

Ordinarily, there must be some form of evidence in the record to support an assertion of common knowledge. See *Lee*, 277 F.3d at 1344-45, 61 USPQ2d at 1434-35 (Fed. Cir. 2002); *Zurko*, 258 F.3d at 1386, 59 USPQ2d at 1697 (holding that general conclusions concerning what is “basic knowledge” or “common sense” to one of ordinary skill in the art without specific factual findings and some concrete evidence in the record to support these findings will not support an obviousness rejection). In certain older cases, official notice has been taken of a fact that is asserted to be “common knowledge” without specific reliance on documentary evidence where the fact noticed was readily verifiable, such as when other references of record supported the noticed fact, or where there was nothing of record to contradict it. See *In re Soli*, 317 F.2d 941, 945-46, 137 USPQ 797, 800 (CCPA 1963) (accepting the examiner’s assertion that the use of “a control is standard procedure throughout the entire field of bacteriology” because it was readily verifiable and disclosed in references of record not cited by the Office); *In re Chevenard*, 139 F.2d 711, 713, 60 USPQ 239, 241 (CCPA 1943) (accepting the examiner’s finding that a brief heating at a higher temperature was the equivalent of a longer heating at a lower temperature where there was nothing in the record to indicate the contrary and where the applicant never demanded that the examiner produce evidence to support his statement). If such notice is taken, the basis for such reasoning must be set forth explicitly. The examiner must provide specific factual findings predicated on sound technical and scientific reasoning to support his or her conclusion of common knowledge. See *Soli*, 317 F.2d at 946, 37 USPQ at 801; *Chevenard*, 139 F.2d at 713, 60 USPQ at 241. The applicant should be presented with the explicit basis on which the examiner regards the matter as subject to official notice and be allowed to challenge the assertion in the next reply after the Office action in which the common knowledge statement was made.

**C. *If Applicant Challenges a Factual Assertion as Not Properly Officially Noticed or not Properly Based Upon Common Knowledge, the Examiner Must Support the Finding With Adequate Evidence***

To adequately traverse such a finding, an applicant must specifically point out the supposed errors in the examiner's action, which would include stating why the noticed fact is not considered to be common knowledge or well-known in the art. See 37 CFR 1.111(b). See also *Chevenard*, 139 F.2d at 713, 60 USPQ at 241 (“[I]n the absence of any demand by appellant for the examiner to produce authority for his statement, we will not consider this contention.”). A general allegation that the claims define a patentable invention without any reference to the examiner's assertion of official notice would be inadequate. If applicant adequately traverses the examiner's assertion of official notice, the examiner must provide documentary evidence in the next Office action if the rejection is to be maintained. See 37 CFR 1.104(c)(2). See also *Zurko*, 258 F.3d at 1386, 59 USPQ2d at 1697 (“[T]he Board [or examiner] must point to some concrete evidence in the record in support of these findings” to satisfy the substantial evidence test). If the examiner is relying on personal knowledge to support the finding of what is known in the art, the examiner must provide an affidavit or declaration setting forth specific factual statements and explanation to support the finding. See 37 CFR 1.104(d)(2).

If applicant does not traverse the examiner's assertion of official notice or applicant's traverse is not adequate, the examiner should clearly indicate in the next Office action that the common knowledge or well-known in the art statement is taken to be admitted prior art because applicant either failed to traverse the examiner's assertion of official notice or that the traverse was inadequate. If the traverse was inadequate, the examiner should include an explanation as to why it was inadequate.

**D. *Determine Whether the Next Office Action Should Be Made Final***

If the examiner adds a reference in the next Office action after applicant's rebuttal, and the newly added reference is added only as directly corresponding evidence to support the prior common knowledge finding, and it does not result in a new issue or constitute a

new ground of rejection, the Office action may be made final. If no amendments are made to the claims, the examiner must not rely on any other teachings in the reference if the rejection is made final. If the newly cited reference is added for reasons other than to support the prior common knowledge statement and a new ground of rejection is introduced by the examiner that is not necessitated by applicant's amendment of the claims, the rejection may not be made final. See MPEP § 706.07(a).

**E. *Summary***

Any rejection based on assertions that a fact is well-known or is common knowledge in the art without documentary evidence to support the examiner's conclusion should be judiciously applied. Furthermore, as noted by the court in *Ahlert*, any facts so noticed should be of notorious character and serve only to “fill in the gaps” in an insubstantial manner which might exist in the evidentiary showing made by the examiner to support a particular ground for rejection. It is never appropriate to rely solely on common knowledge in the art without evidentiary support in the record as the principal evidence upon which a rejection was based. See *Zurko*, 258 F.3d at 1386, 59 USPQ2d at 1697; *Ahlert*, 424 F.2d at 1092, 165 USPQ 421.<

**2144.04 Legal Precedent as Source of Supporting Rationale [R-1]**

As discussed in MPEP § 2144, if the facts in a prior legal decision are sufficiently similar to those in an application under examination, the examiner may use the rationale used by the court. Examples directed to various common practices which the court has held normally require only ordinary skill in the art and hence are considered routine expedients are discussed below. If the applicant has demonstrated the criticality of a specific limitation, it would not be appropriate to rely solely on case law as the rationale to support an obviousness rejection.

**I. AESTHETIC DESIGN CHANGES**

*In re Seid*, 161 F.2d 229, 73 USPQ 431 (CCPA 1947) (Claim was directed to an advertising display device comprising a bottle and a hollow member in the shape of a human figure from the waist up which

was adapted to fit over and cover the neck of the bottle, wherein the hollow member and the bottle together give the impression of a human body. Appellant argued that certain limitations in the upper part of the body, including the arrangement of the arms, were not taught by the prior art. The court found that matters relating to ornamentation only which have no mechanical function cannot be relied upon to patentably distinguish the claimed invention from the prior art.). But see *In re Dembiczak*, 175 F.3d 994, 50 USPQ2d 1614 (Fed. Cir. 1999) (The claims of a utility application, drawn to a generally round, orange plastic trash bag with a jack-o-lantern face, were rejected under 35 U.S.C. 103. However, the court reversed the rejection for lack of motivation to combine conventional trash bags with a reference showing a jack-o-lantern face on an orange paper bag stuffed with newspapers.); *Ex parte Hilton*, 148 USPQ 356 (Bd. App. 1965) (Claims were directed to fried potato chips with a specified moisture and fat content, whereas the prior art was directed to french fries having a higher moisture content. While recognizing that in some cases the particular shape of a product is of no patentable significance, the Board held in this case the shape (chips) is important because it results in a product which is distinct from the reference product (french fries)).

## II. ELIMINATION OF A STEP OR AN ELEMENT AND ITS FUNCTION

### A. *Omission of an Element and Its Function Is Obvious If the Function of the Element Is Not Desired*

*Ex parte Wu*, 10 USPQ 2031 (Bd. Pat. App. & Inter. 1989) (Claims at issue were directed to a method for inhibiting corrosion on metal surfaces using a composition consisting of epoxy resin, petroleum sulfonate, and hydrocarbon diluent. The claims were rejected over a primary reference which disclosed an anticorrosion composition of epoxy resin, hydrocarbon diluent, and polybasic acid salts wherein said salts were taught to be beneficial when employed in a freshwater environment, in view of secondary references which clearly suggested the addition of petroleum sulfonate to corrosion inhibiting compositions. The Board affirmed the rejection, holding that it would have been obvious to omit the polybasic acid salts of the primary

reference where the function attributed to such salt is not desired or required, such as in compositions for providing corrosion resistance in environments which do not encounter fresh water.). See also *In re Larson*, 340 F.2d 965, 144 USPQ 347 (CCPA 1965) (Omission of additional framework and axle which served to increase the cargo carrying capacity of prior art mobile fluid carrying unit would have been obvious if this feature was not desired.); and *In re Kuhle*, 526 F.2d 553, 188 USPQ 7 (CCPA 1975) (deleting a prior art switch member and thereby eliminating its function was an obvious expedient).

### B. *Omission of an Element with Retention of the Element's Function Is an Indicia of Unobviousness*

Note that the omission of an element and retention of its function is an indicia of unobviousness. *In re Edge*, 359 F.2d 896, 149 USPQ 556 (CCPA 1966) (Claims at issue were directed to a printed sheet having a thin layer of erasable metal bonded directly to the sheet wherein said thin layer obscured the original print until removal by erasure. The prior art disclosed a similar printed sheet which further comprised an intermediate transparent and erasure-proof protecting layer which prevented erasure of the printing when the top layer was erased. The claims were found unobvious over the prior art because the although the transparent layer of the prior art was eliminated, the function of the transparent layer was retained since appellant's metal layer could be erased without erasing the printed indicia.).

## III. AUTOMATING A MANUAL ACTIVITY

*In re Venner*, 262 F.2d 91, 95, 120 USPQ 193, 194 (CCPA 1958) (Appellant argued that claims to a permanent mold casting apparatus for molding trunk pistons were allowable over the prior art because the claimed invention combined "old permanent-mold structures together with a timer and solenoid which automatically actuates the known pressure valve system to release the inner core after a predetermined time has elapsed." The court held that broadly providing an automatic or mechanical means to replace a manual activity which accomplished the same result is not sufficient to distinguish over the prior art.).

#### IV. CHANGES IN SIZE, SHAPE, OR SEQUENCE OF ADDING INGREDIENTS

##### A. Changes in Size/Proportion

*In re Rose*, 220 F.2d 459, 105 USPQ 237 (CCPA 1955) (Claims directed to a lumber package “of appreciable size and weight requiring handling by a lift truck” where held unpatentable over prior art lumber packages which could be lifted by hand because limitations relating to the size of the package were not sufficient to patentably distinguish over the prior art.); *In re Rinehart*, 531 F.2d 1048, 189 USPQ 143 (CCPA 1976) (“mere scaling up of a prior art process capable of being scaled up, if such were the case, would not establish patentability in a claim to an old process so scaled.” 531 F.2d at 1053, 189 USPQ at 148.).

In *Gardner v. TEC Systems, Inc.*, 725 F.2d 1338, 220 USPQ 777 (Fed. Cir. 1984), *cert. denied*, 469 U.S. 830, 225 USPQ 232 (1984), the Federal Circuit held that, where the only difference between the prior art and the claims was a recitation of relative dimensions of the claimed device and a device having the claimed relative dimensions would not perform differently than the prior art device, the claimed device was not patentably distinct from the prior art device.

##### B. Changes in Shape

*In re Dailey*, 357 F.2d 669, 149 USPQ 47 (CCPA 1966) (The court held that the configuration of the claimed disposable plastic nursing container was a matter of choice which a person of ordinary skill in the art would have found obvious absent persuasive evidence that the particular configuration of the claimed container was significant.).

##### C. Changes in Sequence of Adding Ingredients

*Ex parte Rubin*, 128 USPQ 440 (Bd. App. 1959) (Prior art reference disclosing a process of making a laminated sheet wherein a base sheet is first coated with a metallic film and thereafter impregnated with a thermosetting material was held to render *prima facie* obvious claims directed to a process of making a laminated sheet by reversing the order of the prior art process steps.). See also *In re Burhans*, 154 F.2d 690, 69 USPQ 330 (CCPA 1946) (selection of any order of performing process steps is *prima facie* obvious in the absence of new or unexpected results); *In re Gibson*, 39 F.2d 975, 5 USPQ 230 (CCPA 1930) (Selection of

any order of mixing ingredients is *prima facie* obvious.).

#### V. MAKING PORTABLE, INTEGRAL, SEPARABLE, ADJUSTABLE, OR CONTINUOUS

##### A. Making Portable

*In re Lindberg*, 194 F.2d 732, 93 USPQ 23 (CCPA 1952) (Fact that a claimed device is portable or movable is not sufficient by itself to patentably distinguish over an otherwise old device unless there are new or unexpected results.).

##### B. Making Integral

*In re Larson*, 340 F.2d 965, 968, 144 USPQ 347, 349 (CCPA 1965) (A claim to a fluid transporting vehicle was rejected as obvious over a prior art reference which differed from the prior art in claiming a brake drum integral with a clamping means, whereas the brake disc and clamp of the prior art comprise several parts rigidly secured together as a single unit. The court affirmed the rejection holding, among other reasons, “that the use of a one piece construction instead of the structure disclosed in [the prior art] would be merely a matter of obvious engineering choice.”); but see *Schenck v. Nortron Corp.*, 713 F.2d 782, 218 USPQ 698 (Fed. Cir. 1983) (Claims were directed to a vibratory testing machine (a hard-bearing wheel balancer) comprising a holding structure, a base structure, and a supporting means which form “a single integral and gaplessly continuous piece.” Nortron argued that the invention is just making integral what had been made in four bolted pieces. The court found this argument unpersuasive and held that the claims were patentable because the prior art perceived a need for mechanisms to dampen resonance, whereas the inventor eliminated the need for dampening via the one-piece gapless support structure, showing insight that was contrary to the understandings and expectations of the art.).

##### C. Making Separable

*In re Dulberg*, 289 F.2d 522, 523, 129 USPQ 348, 349 (CCPA 1961) (The claimed structure, a lipstick holder with a removable cap, was fully met by the prior art except that in the prior art the cap is “press fitted” and therefore not manually removable. The court held that “if it were considered desirable for any

reason to obtain access to the end of [the prior art's] holder to which the cap is applied, it would be obvious to make the cap removable for that purpose.”).

#### **D. Making Adjustable**

*In re Stevens*, 212 F.2d 197, 101 USPQ 284 (CCPA 1954) (Claims were directed to a handle for a fishing rod wherein the handle has a longitudinally adjustable finger hook, and the hand grip of the handle connects with the body portion by means of a universal joint. The court held that adjustability, where needed, is not a patentable advance, and because there was an art-recognized need for adjustment in a fishing rod, the substitution of a universal joint for the single pivot of the prior art would have been obvious.).

#### **E. Making Continuous**

*In re Dilnot*, 319 F.2d 188, 138 USPQ 248 (CCPA 1963) (Claim directed to a method of producing a cementitious structure wherein a stable air foam is introduced into a slurry of cementitious material differed from the prior art only in requiring the addition of the foam to be continuous. The court held the claimed continuous operation would have been obvious in light of the batch process of the prior art.).

### **VI. REVERSAL, DUPLICATION, OR REARRANGEMENT OF PARTS**

#### **A. Reversal of Parts**

*In re Gazda*, 219 F.2d 449, 104 USPQ 400 (CCPA 1955) (Prior art disclosed a clock fixed to the stationary steering wheel column of an automobile while the gear for winding the clock moves with steering wheel; mere reversal of such movement, so the clock moves with wheel, was held to be an obvious expedient.).

#### **B. Duplication of Parts**

*In re Harza*, 274 F.2d 669, 124 USPQ 378 (CCPA 1960) (Claims at issue were directed to a water-tight masonry structure wherein a water seal of flexible material fills the joints which form between adjacent pours of concrete. The claimed water seal has a “web” which lies \*\* in the joint, and a plurality of “ribs” \*\* >projecting outwardly from each side of the web into one of the adjacent concrete slabs. <The prior art disclosed a flexible water stop for preventing passage of water between masses of concrete in the shape of a

plus sign (+). Although the reference did not disclose a plurality of ribs, the court held that mere duplication of parts has no patentable significance unless a new and unexpected result is produced.).

#### **C. Rearrangement of Parts**

*In re Japikse*, 181 F.2d 1019, 86 USPQ 70 (CCPA 1950) (Claims to a hydraulic power press which read on the prior art except with regard to the position of the starting switch were held unpatentable because shifting the position of the starting switch would not have modified the operation of the device.); *In re Kuhle*, 526 F.2d 553, 188 USPQ 7 (CCPA 1975) (the particular placement of a contact in a conductivity measuring device was held to be an obvious matter of design choice). However, “The mere fact that a worker in the art could rearrange the parts of the reference device to meet the terms of the claims on appeal is not by itself sufficient to support a finding of obviousness. The prior art must provide a motivation or reason for the worker in the art, without the benefit of appellant’s specification, to make the necessary changes in the reference device.” *Ex parte Chicago Rawhide Mfg. Co.*, 223 USPQ 351, 353 (Bd. Pat. App. & Inter. 1984).

### **VII. PURIFYING AN OLD PRODUCT**

Pure materials are novel *vis-à-vis* less pure or impure materials because there is a difference between pure and impure materials. Therefore, the issue is whether claims to a pure material are unobvious over the prior art. *In re Bergstrom*, 427 F.2d 1394, 166 USPQ 256 (CCPA 1970). Purer forms of known products may be patentable, but the mere purity of a product, by itself, does not render the product unobvious. *Ex parte Gray*, 10 USPQ2d 1922 (Bd. Pat. App. & Inter. 1989).

Factors to be considered in determining whether a purified form of an old product is obvious over the prior art include whether the claimed chemical compound or composition has the same utility as closely related materials in the prior art, and whether the prior art suggests the particular form or structure of the claimed material or suitable methods of obtaining that form or structure. *In re Cofer*, 354 F.2d 664, 148 USPQ 268 (CCPA 1966) (Claims to the free-flowing crystalline form of a compound were held unobvious over references disclosing the viscous



liquid form of the same compound because the prior art of record did not suggest the claimed compound in crystalline form or how to obtain such crystals.).

See also *Ex parte Stern*, 13 USPQ2d 1379 (Bd. Pat. App. & Inter. 1987) (Claims to interleukin 2 (a protein with a molecular weight of over 12,000) purified to homogeneity were held unpatentable over references which recognized the desirability of purifying interleukin 2 to homogeneity in a view of a reference which taught a method of purifying proteins having molecular weights in excess of 12,000 to homogeneity wherein the prior art method was similar to the method disclosed by appellant for purifying interleukin 2.).

Compare *Ex parte Gray*, 10 USPQ2d 1922 (Bd. Pat. App. & Inter. 1989) (Claims were directed to human nerve growth factor b-NGF free from other proteins of human origin, and the specification disclosed making the claimed factor through the use of recombinant DNA technology. The claims were rejected as *prima facie* obvious in view of two references disclosing b-NGF isolated from human placental tissue. The Board applied case law pertinent to product-by-process claims, reasoning that the prior art factor appeared to differ from the claimed factor only in the method of obtaining the factor. The Board held that the burden of persuasion was on appellant to show that the claimed product exhibited unexpected properties compared with that of the prior art. The Board further noted that “no objective evidence has been provided establishing that no method was known to those skilled in this field whereby the claimed material might have been synthesized.” 10 USPQ2d at 1926.).

## 2144.05 Obviousness of Ranges [R-1]

See MPEP § 2131.03 for case law pertaining to rejections based on the anticipation of ranges under 35 U.S.C. 102 and 35 U.S.C. 102/103.

### I. OVERLAP OF RANGES

In the case where the claimed ranges “overlap or lie inside ranges disclosed by the prior art” a *prima facie* case of obviousness exists. *In re Wertheim*, 541 F.2d 257, 191 USPQ 90 (CCPA 1976); *In re Woodruff*, 919 F.2d 1575, 16 USPQ2d 1934 (Fed. Cir. 1990) (The prior art taught carbon monoxide concentrations of “about 1-5%” while the claim was limited to “more

than 5%.” The court held that “about 1-5%” allowed for concentrations slightly above 5% thus the ranges overlapped.); *In re Geisler*, 116 F.3d 1465, 1469-71, 43 USPQ2d 1362, 1365-66 (Fed. Cir. 1997) (Claim reciting thickness of a protective layer as falling within a range of “50 to 100 Angstroms” considered *prima facie* obvious in view of prior art reference teaching that “for suitable protection, the thickness of the protective layer should be not less than about 10 nm [i.e., 100 Angstroms].” The court stated that “by stating that ‘suitable protection’ is provided if the protective layer is ‘about’ 100 Angstroms thick, [the prior art reference] directly teaches the use of a thickness within [applicant’s] claimed range.”). Similarly, a *prima facie* case of obviousness exists where the claimed ranges and prior art ranges do not overlap but are close enough that one skilled in the art would have expected them to have the same properties. *Titanium Metals Corp. of America v. Banner*, 778 F.2d 775, 227 USPQ 773 (Fed. Cir. 1985) (Court held as proper a rejection of a claim directed to an alloy of “having 0.8% nickel, 0.3% molybdenum, up to 0.1% iron, balance titanium” as obvious over a reference disclosing alloys of 0.75% nickel, 0.25% molybdenum, balance titanium and 0.94% nickel, 0.31% molybdenum, balance titanium.).

> “[A] prior art reference that discloses a range encompassing a somewhat narrower claimed range is sufficient to establish a *prima facie* case of obviousness.” *In re Peterson*, 315 F.3d 1325, 1330, 65 USPQ2d 1379, 1382-83 (Fed. Cir. 2003). However, if the reference’s disclosed range is so broad as to encompass a very large number of possible distinct compositions, this might present a situation analogous to the obviousness of a species when the prior art broadly discloses a genus. *Id.* See also *In re Baird*, 16 F.3d 380, 29 USPQ2d 1550 (Fed. Cir. 1994); *In re Jones*, 958 F.2d 347, 21 USPQ2d 1941 (Fed. Cir. 1992); MPEP § 2144.08.<

### II. OPTIMIZATION OF RANGES

#### A. Optimization Within Prior Art Conditions or Through Routine Experimentation

Generally, differences in concentration or temperature will not support the patentability of subject matter encompassed by the prior art unless there is evidence indicating such concentration or temperature

is critical. “[W]here the general conditions of a claim are disclosed in the prior art, it is not inventive to discover the optimum or workable ranges by routine experimentation.” *In re Aller*, 220 F.2d 454, 456, 105 USPQ 233, 235 (CCPA 1955) (Claimed process which was performed at a temperature between 40°C and 80°C and an acid concentration between 25% and 70% was held to be *prima facie* obvious over a reference process which differed from the claims only in that the reference process was performed at a temperature of 100°C and an acid concentration of 10%.); >see also *Peterson*, 315 F.3d at 1330, 65 USPQ2d at 1382 (“The normal desire of scientists or artisans to improve upon what is already generally known provides the motivation to determine where in a disclosed set of percentage ranges is the optimum combination of percentages.”); < \*\* *In re Hoeschele*, 406 F.2d 1403, 160 USPQ 809 (CCPA 1969) (Claimed elastomeric polyurethanes which fell within the broad scope of the references were held to be unpatentable thereover because, among other reasons, there was no evidence of the criticality of the claimed ranges of molecular weight or molar proportions.). For more recent cases applying this principle, see *Merck & Co. Inc. v. Biocraft Laboratories Inc.*, 874 F.2d 804, 10 USPQ2d 1843 (Fed. Cir.), *cert. denied*, 493 U.S. 975 (1989); *In re Kulling*, 897 F.2d 1147, 14 USPQ2d 1056 (Fed. Cir. 1990); and *In re Geisler*, 116 F.3d 1465, 43 USPQ2d 1362 (Fed. Cir. 1997).

### ***B. Only Result-Effective Variables Can Be Optimized***

A particular parameter must first be recognized as a result-effective variable, i.e., a variable which achieves a recognized result, before the determination of the optimum or workable ranges of said variable might be characterized as routine experimentation. *In re Antonie*, 559 F.2d 618, 195 USPQ 6 (CCPA 1977) (The claimed wastewater treatment device had a tank volume to contractor area of 0.12 gal./sq. ft. The prior art did not recognize that treatment capacity is a function of the tank volume to contractor ratio, and therefore the parameter optimized was not recognized in the art to be a result-effective variable.). See also *In re Boesch*, 617 F.2d 272, 205 USPQ 215 (CCPA 1980) (prior art suggested proportional balancing to achieve desired results in the formation of an alloy).

### **III. REBUTTAL OF *PRIMA FACIE* CASE OF OBVIOUSNESS**

Applicants can rebut a *prima facie* case of obviousness based on overlapping ranges by showing the criticality of the claimed range. “The law is replete with cases in which the difference between the claimed invention and the prior art is some range or other variable within the claims. . . . In such a situation, the applicant must show that the particular range is critical, generally by showing that the claimed range achieves unexpected results relative to the prior art range.” *In re Woodruff*, 919 F.2d 1575, 16 USPQ2d 1934 (Fed. Cir. 1990). See MPEP § 716.02 - § 716.02(g) for a discussion of criticality and unexpected results.

A *prima facie* case of obviousness may also be rebutted by showing that the art, in any material respect, teaches away from the claimed invention. *In re Geisler*, 116 F.3d 1465, 1471, 43 USPQ2d 1362, 1366 (Fed. Cir. 1997) (Applicant argued that the prior art taught away from use of a protective layer for a reflective article having a thickness within the claimed range of “50 to 100 Angstroms.” Specifically, a patent to Zehender, which was relied upon to reject applicant’s claim, included a statement that the thickness of the protective layer “should be not less than about [100 Angstroms].” The court held that the patent did not teach away from the claimed invention. “Zehender suggests that there are benefits to be derived from keeping the protective layer as thin as possible, consistent with achieving adequate protection. A thinner coating reduces light absorption and minimizes manufacturing time and expense. Thus, while Zehender expresses a preference for a thicker protective layer of 200-300 Angstroms, at the same time it provides the motivation for one of ordinary skill in the art to focus on thickness levels at the bottom of Zehender’s ‘suitable’ range- about 100 Angstroms- and to explore thickness levels below that range. The statement in Zehender that ‘[i]n general, the thickness of the protective layer should be not less than about [100 Angstroms]’ falls far short of the kind of teaching that would discourage one of skill in the art from fabricating a protective layer of 100 Angstroms or less. [W]e are therefore ‘not convinced that there was a sufficient teaching away in the art to overcome [the] strong case of obviousness’ made out by

Zehender.”). See MPEP § 2145, paragraph X.D., for a discussion of “teaching away” references.

### **2144.06 Art Recognized Equivalence for the Same Purpose**

#### **COMBINING EQUIVALENTS KNOWN FOR THE SAME PURPOSE**

“It is *prima facie* obvious to combine two compositions each of which is taught by the prior art to be useful for the same purpose, in order to form a third composition to be used for the very same purpose.... [T]he idea of combining them flows logically from their having been individually taught in the prior art.” *In re Kerkhoven*, 626 F.2d 846, 850, 205 USPQ 1069, 1072 (CCPA 1980) (citations omitted) (Claims to a process of preparing a spray-dried detergent by mixing together two conventional spray-dried detergents were held to be *prima facie* obvious.). See also *In re Crockett*, 279 F.2d 274, 126 USPQ 186 (CCPA 1960) (Claims directed to a method and material for treating cast iron using a mixture comprising calcium carbide and magnesium oxide were held unpatentable over prior art disclosures that the aforementioned components individually promote the formation of a nodular structure in cast iron.); and *Ex parte Quadranti*, 25 USPQ2d 1071 (Bd. Pat. App. & Inter. 1992) (mixture of two known herbicides held *prima facie* obvious). But see *In re Geiger*, 815 F.2d 686, 2 USPQ2d 1276 (Fed. Cir. 1987) (“Based upon the prior art and the fact that each of the three components of the composition used in the claimed method is conventionally employed in the art for treating cooling water systems, the board held that it would have been *prima facie* obvious, within the meaning of 35 U.S.C. 103, to employ these components in combination for their known functions and to optimize the amount of each additive.... Appellant argues... hindsight reconstruction or at best,... ‘obvious to try’.... We agree with appellant.”).

#### **SUBSTITUTING EQUIVALENTS KNOWN FOR THE SAME PURPOSE**

In order to rely on equivalence as a rationale supporting an obviousness rejection, the equivalency must be recognized in the prior art, and cannot be based on applicant’s disclosure or the mere fact that the components at issue are functional or mechanical

equivalents. *In re Ruff*, 256 F.2d 590, 118 USPQ 340 (CCPA 1958) (The mere fact that components are claimed as members of a Markush group cannot be relied upon to establish the equivalency of these components. However, an applicant’s expressed recognition of an art-recognized or obvious equivalent may be used to refute an argument that such equivalency does not exist.); *In re Scott*, 323 F.2d 1016, 139 USPQ 297 (CCPA 1963) (Claims were drawn to a hollow fiberglass shaft for archery and a process for the production thereof where the shaft differed from the prior art in the use of a paper tube as the core of the shaft as compared with the light wood or hardened foamed resin core of the prior art. The Board found the claimed invention would have been obvious, reasoning that the prior art foam core is the functional and mechanical equivalent of the claimed paper core. The court reversed, holding that components which are functionally or mechanically equivalent are not necessarily obvious in view of one another, and in this case, the use of a light wood or hardened foam resin core does not fairly suggest the use of a paper core.); *Smith v. Hayashi*, 209 USPQ 754 (Bd. of Pat. Inter. 1980) (The mere fact that phthalocyanine and selenium function as equivalent photoconductors in the claimed environment was not sufficient to establish that one would have been obvious over the other. However, there was evidence that both phthalocyanine and selenium were known photoconductors in the art of electrophotography. “This, in our view, presents strong evidence of obviousness in substituting one for the other in an electrophotographic environment as a photoconductor.” 209 USPQ at 759.).

An express suggestion to substitute one equivalent component or process for another is not necessary to render such substitution obvious. *In re Fout*, 675 F.2d 297, 213 USPQ 532 (CCPA 1982).

### **2144.07 Art Recognized Suitability for an Intended Purpose**

The selection of a known material based on its suitability for its intended use supported a *prima facie* obviousness determination in *Sinclair & Carroll Co. v. Interchemical Corp.*, 325 U.S. 327, 65 USPQ 297 (1945) (Claims to a printing ink comprising a solvent having the vapor pressure characteristics of butyl carbitol so that the ink would not dry at room temperature but would dry quickly upon heating were

held invalid over a reference teaching a printing ink made with a different solvent that was nonvolatile at room temperature but highly volatile when heated in view of an article which taught the desired boiling point and vapor pressure characteristics of a solvent for printing inks and a catalog teaching the boiling point and vapor pressure characteristics of butyl carb-itol. “Reading a list and selecting a known compound to meet known requirements is no more ingenious than selecting the last piece to put in the last opening in a jig-saw puzzle.” 325 U.S. at 335, 65 USPQ at 301.).

See also *In re Leshin*, 227 F.2d 197, 125 USPQ 416 (CCPA 1960) (selection of a known plastic to make a container of a type made of plastics prior to the invention was held to be obvious); *Ryco, Inc. v. Ag-Bag Corp.*, 857 F.2d 1418, 8 USPQ2d 1323 (Fed. Cir. 1988) (Claimed agricultural bagging machine, which differed from a prior art machine only in that the brake means were hydraulically operated rather than mechanically operated, was held to be obvious over the prior art machine in view of references which disclosed hydraulic brakes for performing the same function, albeit in a different environment.).

## **2144.08 Obviousness of Species When Prior Art Teaches Genus**

### **I. GUIDELINES FOR THE EXAMINATION OF CLAIMS DIRECTED TO SPECIES OF CHEMICAL COMPOSITIONS BASED UPON A SINGLE PRIOR ART REFERENCE**

These “Genus-Species Guidelines” are to assist Office personnel in the examination of applications which contain claims to species or a subgenus of chemical compositions for compliance with 35 U.S.C. 103 based upon a single prior art reference which discloses a genus encompassing the claimed species or subgenus but does not expressly disclose the particular claimed species or subgenus. Office personnel should attempt to find additional prior art to show that the differences between the prior art primary reference and the claimed invention as a whole would have been obvious. Where such additional prior art is not found, Office personnel should follow these guidelines to determine whether a single reference 35 U.S.C. 103 rejection would be appropriate.

The guidelines are based on the Office’s current understanding of the law and are believed to be fully consistent with binding precedent of the Supreme Court, the Federal Circuit, and the Federal Circuit’s predecessor courts.

The analysis of the guidelines begins at the point during examination after a single prior art reference is found disclosing a genus encompassing the claimed species or subgenus. Before reaching this point, Office personnel should follow appropriate antecedent examination procedures. Accordingly, Office personnel should first analyze the claims as a whole in light of and consistent with the written description, considering all claim limitations. When evaluating the scope of a claim, every limitation in the claim must be considered. See, e.g., *In re Ochiai*, 71 F.3d 1565, 1572, 37 USPQ2d 1127, 1133 (Fed. Cir. 1995). However, the claimed invention may not be dissected into discrete elements to be analyzed in isolation, but must be considered as a whole. See, e.g., *W.L. Gore & Assoc., Inc. v. Garlock, Inc.*, 721 F.2d 1540, 1548, 220 USPQ 303, 309 (Fed. Cir. 1983); *Jones v. Hardy*, 727 F.2d 1524, 1530, 220 USPQ 1021, 1026 (Fed. Cir. 1983) (“treating the advantage as the invention disregards the statutory requirement that the invention be viewed ‘as a whole’”). Next, Office personnel should conduct a thorough search of the prior art and identify all relevant references. Both claimed and unclaimed aspects of the invention should be searched if there is a reasonable expectation that the unclaimed aspects may be later claimed. If the most relevant prior art consists of a single prior art reference disclosing a genus encompassing the claimed species or subgenus, Office personnel should follow the guidelines set forth herein.

These guidelines do not constitute substantive rule-making and hence do not have the force and effect of law. Rather, they are to assist Office personnel in analyzing claimed subject matter for compliance with substantive law. Thus, rejections must be based upon the substantive law, and it is these rejections which are appealable, not any failure by Office personnel to follow these guidelines.

Office personnel are to rely on these guidelines in the event of any inconsistent treatment of issues between these guidelines and any earlier provided guidance from the Office.

## II. DETERMINE WHETHER THE CLAIMED SPECIES OR SUBGENUS WOULD HAVE BEEN OBVIOUS TO ONE OF ORDINARY SKILL IN THE PERTINENT ART AT THE TIME THE INVENTION WAS MADE

The patentability of a claim to a specific compound or subgenus embraced by a prior art genus should be analyzed no differently than any other claim for purposes of 35 U.S.C. 103. “The section 103 requirement of unobviousness is no different in chemical cases than with respect to other categories of patentable inventions.” *In re Papesch*, 315 F.2d 381, 385, 137 USPQ 43, 47 (CCPA 1963). A determination of patentability under 35 U.S.C. 103 should be made upon the facts of the particular case in view of the totality of the circumstances. See, e.g., *In re Dillon*, 919 F.2d 688, 692-93, 16 USPQ2d 1897, 1901 (Fed. Cir. 1990) (*in banc*). Use of *per se* rules by Office personnel is improper for determining whether claimed subject matter would have been obvious under 35 U.S.C. 103. See, e.g., *In re Brouwer*, 77 F.3d 422, 425, 37 USPQ2d 1663, 1666 (Fed. Cir. 1996); *In re Ochiai*, 71 F.3d 1565, 1572, 37 USPQ2d 1127, 1133 (Fed. Cir. 1995); *In re Baird*, 16 F.3d 380, 382, 29 USPQ2d 1550, 1552 (Fed. Cir. 1994). The fact that a claimed species or subgenus is encompassed by a prior art genus is not sufficient by itself to establish a *prima facie* case of obviousness. *In re Baird*, 16 F.3d 380, 382, 29 USPQ2d 1550, 1552 (Fed. Cir. 1994) (“The fact that a claimed compound may be encompassed by a disclosed generic formula does not by itself render that compound obvious.”); *In re Jones*, 958 F.2d 347, 350, 21 USPQ2d 1941, 1943 (Fed. Cir. 1992) (Federal Circuit has “decline[d] to extract from *Merck [ & Co. v. Biocraft Laboratories Inc.*, 874 F.2d 804, 10 USPQ2d 1843 (Fed. Cir. 1989)] the rule that... regardless of how broad, a disclosure of a chemical genus renders obvious any species that happens to fall within it.”). See also *In re Deuel*, 51 F.3d 1552, 1559, 34 USPQ2d 1210, 1215 (Fed. Cir. 1995).

A proper obviousness analysis involves a three-step process. First, Office personnel should establish a *prima facie* case of unpatentability considering the factors set out by the Supreme Court in *Graham v. John Deere*. See, e.g., *In re Bell*, 991 F.2d 781, 783, 26 USPQ2d 1529, 1531 (Fed. Cir. 1993) (“The PTO bears the burden of establishing a case of *prima facie* obviousness.”); *In re Rijckaert*, 9 F.3d 1531, 1532,

28 USPQ2d 1955, 1956 (Fed. Cir. 1993); *In re Oetiker*, 977 F.2d 1443, 1445, 24 USPQ2d 1443, 1444 (Fed. Cir. 1992). *Graham v. John Deere Co.*, 383 U.S. 1, 17-18 (1966), requires that to make out a case of obviousness, one must:

(A) determine the scope and contents of the prior art;

(B) ascertain the differences between the prior art and the claims in issue;

(C) determine the level of skill in the pertinent art; and

(D) evaluate any evidence of secondary considerations. If a *prima facie* case is established, the burden shifts to applicant to come forward with rebuttal evidence or argument to overcome the *prima facie* case.

If a *prima facie* case is established, the burden shifts to applicant to come forward with rebuttal evidence or argument to overcome the *prima facie* case. See, e.g., *Bell*, 991 F.2d at 783-84, 26 USPQ2d at 1531; *Rijckaert*, 9 F.3d at 1532, 28 USPQ2d at 1956; *Oetiker*, 977 F.2d at 1445, 24 USPQ2d at 1444. Finally, Office personnel should evaluate the totality of the facts and all of the evidence to determine whether they still support a conclusion that the claimed invention would have been obvious to one of ordinary skill in the art at the time the invention was made. *Id.*

### A. Establishing a *Prima Facie* Case of Obviousness

To establish a *prima facie* case of obviousness in a genus-species chemical composition situation, as in any other 35 U.S.C. 103 case, it is essential that Office personnel find some motivation or suggestion to make the claimed invention in light of the prior art teachings. See, e.g., *In re Brouwer*, 77 F.3d 422, 425, 37 USPQ2d 1663, 1666 (Fed. Cir. 1996) (“[T]he mere possibility that one of the esters or the active methylene group-containing compounds... could be modified or replaced such that its use would lead to the specific sulfoalkylated resin recited in claim 8 does not make the process recited in claim 8 obvious ‘unless the prior art suggested the desirability of [such a] modification’ or replacement.”) (quoting *In re Gordon*, 733 F.2d 900, 902, 221 USPQ 1125, 1127 (Fed. Cir. 1984)); *In re Vaeck*, 947 F.2d 488, 493, 20 USPQ2d 1438, 1442 (Fed. Cir. 1991) (“[A] proper analysis under § 103 requires, *inter alia*, con-

sideration of... whether the prior art would have suggested to those of ordinary skill in the art that they should make the claimed composition or device, or carry out the claimed process.”). In order to find such motivation or suggestion there should be a reasonable likelihood that the claimed invention would have the properties disclosed by the prior art teachings. The prior art disclosure may be express, implicit, or inherent. Regardless of the type of disclosure, the prior art must provide some motivation to one of ordinary skill in the art to make the claimed invention in order to support a conclusion of obviousness. See, e.g., *Vaeck*, 947 F.2d at 493, 20 USPQ2d at 1442 (A proper obviousness analysis requires consideration of “whether the prior art would also have revealed that in so making or carrying out [the claimed invention], those of ordinary skill would have a reasonable expectation of success.”); *In re Dow Chemical Co.*, 837 F.2d 469, 473, 5 USPQ2d 1529, 1531 (Fed. Cir. 1988) (“The consistent criterion for determination of obviousness is whether the prior art would have suggested to one of ordinary skill in the art that this process should be carried out and would have a reasonable likelihood of success, viewed in the light of the prior art.”); *Hodosh v. Block Drug Co.*, 786 F.2d 1136, 1143 n.5, 229 USPQ 182, 187 n.5 (Fed. Cir. 1986). These disclosed findings should be made with a complete understanding of the first three “Graham factors.” When evidence of secondary considerations such as unexpected results is initially before the Office, for example in the specification, that evidence should be considered in deciding whether there is a *prima facie* case of obviousness. The determination as to whether a *prima facie* case exists should be made on the full record before the Office at the time of the determination. Thus, Office personnel should:

- (A) determine the “scope and content of the prior art”;
- (B) ascertain the “differences between the prior art and the claims at issue”; and
- (C) determine “the level of ordinary skill in the pertinent art.”

*Graham v. John Deere*, 383 U.S. 1, 17, 148 USPQ 459, 467 (1966). *Accord*, e.g., *In re Paulsen*, 30 F.3d 1475, 1482, 31 USPQ2d 1671, 1676 (Fed. Cir. 1994).

## 1. Determine the Scope and Content of the Prior Art

As an initial matter, Office personnel should determine the scope and content of the relevant prior art. Each reference must qualify as prior art under 35 U.S.C. 102 (e.g., *Panduit Corp. v. Dennison Mfg. Co.*, 810 F.2d 1561, 1568, 1 USPQ2d 1593, 1597 (Fed. Cir. 1987) (“Before answering *Graham’s* ‘content’ inquiry, it must be known whether a patent or publication is in the prior art under 35 U.S.C. § 102.”)) and should be in the field of applicant’s endeavor, or be reasonably pertinent to the particular problem with which the inventor was concerned. *In re Oetiker*, 977 F.2d 1443, 1447, 24 USPQ2d 1443, 1445 (Fed. Cir. 1992). *Accord*, e.g., *In re Clay*, 966 F.2d 656, 658-59, 23 USPQ2d 1058, 1060 (Fed. Cir. 1992).

In the case of a prior art reference disclosing a genus, Office personnel should make findings as to:

- (A) the structure of the disclosed prior art genus and that of any expressly described species or subgenus within the genus;
- (B) any physical or chemical properties and utilities disclosed for the genus, as well as any suggested limitations on the usefulness of the genus, and any problems alleged to be addressed by the genus;
- (C) the predictability of the technology; and
- (D) the number of species encompassed by the genus taking into consideration all of the variables possible.

## 2. Ascertain the Differences Between the Closest Disclosed Prior Art Species or Subgenus of Record and the Claimed Species or Subgenus

Once the structure of the disclosed prior art genus and that of any expressly described species or subgenus within the genus are identified, Office personnel should compare it to the claimed species or subgenus to determine the differences. Through this comparison, the closest disclosed species or subgenus in the prior art reference should be identified and compared to that claimed. Office personnel should make explicit findings on the similarities and differences between the closest disclosed prior art species or subgenus of record and the claimed species or subgenus including findings relating to similarity of structure, chemical properties and utilities. In *Stratoflex, Inc. v. Aeroquip*

*Corp.*, 713 F.2d 1530, 1537, 218 USPQ 871, 877 (Fed. Cir. 1983), the Court noted that “the question under 35 U.S.C. § 103 is not whether the differences [between the claimed invention and the prior art] would have been obvious” but “whether the claimed invention *as a whole* would have been obvious.” (emphasis in original).

### 3. Determine the Level of Skill in the Art

Office personnel should evaluate the prior art from the standpoint of the hypothetical person having ordinary skill in the art at the time the claimed invention was made. See, *Ryko Mfg. Co. v. Nu-Star Inc.*, 950 F.2d 714, 718, 21 USPQ2d 1053, 1057 (Fed. Cir. 1991) (“The importance of resolving the level of ordinary skill in the art lies in the necessity of maintaining objectivity in the obviousness inquiry.”); *Uniroyal Inc. v. Rudkin-Wiley Corp.*, 837 F.2d 1044, 1050, 5 USPQ2d 1434, 1438 (Fed. Cir. 1988) (evidence must be viewed from position of ordinary skill, not of an expert). In most cases, the only facts of record pertaining to the level of skill in the art will be found within the prior art reference. However, any additional evidence presented by applicant should be evaluated.

### 4. Determine Whether One of Ordinary Skill in the Art Would Have Been Motivated To Select the Claimed Species or Subgenus

In light of the findings made relating to the three *Graham* factors, Office personnel should determine whether one of ordinary skill in the relevant art would have been motivated to make the claimed invention as a whole, i.e., to select the claimed species or subgenus from the disclosed prior art genus. See, e.g., *Ochiai*, 71 F.3d at 1569-70, 37 USPQ2d at 1131; *Deuel*, 51 F.3d at 1557, 34 USPQ2d at 1214 (“[A] *prima facie* case of unpatentability requires that the teachings of the prior art suggest *the claimed compounds* to a person of ordinary skill in the art.” (emphasis in original)); *Jones*, 958 F.2d at 351, 21 USPQ2d at 1943-44 (Fed. Cir. 1992); *Dillon*, 919 F.2d at 692, 16 USPQ2d at 1901; *In re Lulu*, 747 F.2d 703, 705, 223 USPQ 1257, 1258 (Fed. Cir. 1984) (“The prior art must provide one of ordinary skill in the art the motivation to make the proposed molecular modifications needed to arrive at the claimed compound.”). See also *In re Kemps*, 97 F.3d 1427, 1430, 40 USPQ2d 1309,

1311 (Fed. Cir. 1996) (discussing motivation to combine). To address this key issue, Office personnel should consider all relevant prior art teachings, focusing on the following, where present.

#### (a) Consider the Size of the Genus

Consider the size of the prior art genus, bearing in mind that size alone cannot support an obviousness rejection. See, e.g., *Baird*, 16 F.3d at 383, 29 USPQ2d at 1552 (observing that “it is not the mere number of compounds in this limited class which is significant here but, rather, the total circumstances involved”). There is no absolute correlation between the size of the prior art genus and a conclusion of obviousness. *Id.* Thus, the mere fact that a prior art genus contains a small number of members does not create a *per se* rule of obviousness. Some motivation to select the claimed species or subgenus must be taught by the prior art. See, e.g., *Deuel*, 51 F.3d at 1558-59, 34 USPQ2d at 1215 (“No particular one of these DNAs can be obvious unless there is something in the prior art to lead to the particular DNA and indicate that it should be prepared.”); *Baird*, 16 F.3d at 382-83, 29 USPQ2d at 1552; *Bell*, 991 F.2d at 784, 26 USPQ2d at 1531 (“Absent anything in the cited prior art suggesting which of the  $10^{36}$  possible sequences suggested by Rinderknecht corresponds to the IGF gene, the PTO has not met its burden of establishing that the prior art would have suggested the claimed sequences.”). However, a genus may be so small that, when considered in light of the totality of the circumstances, it would anticipate the claimed species or subgenus. For example, it has been held that a prior art genus containing only 20 compounds and a limited number of variations in the generic chemical formula inherently anticipated a claimed species within the genus because “one skilled in [the] art would... envisage *each member*” of the genus. *In re Petering*, 301 F.2d 676, 681, 133 USPQ 275, 280 (CCPA 1962) (emphasis in original). More specifically, the court in *Petering* stated:

A simple calculation will show that, excluding isomerism within certain of the R groups, the limited class we find in Karrer contains only 20 compounds. However, we wish to point out that it is not the mere number of compounds in this limited class which is significant here but, rather, the total circumstances involved, including such factors as the limited number of variations for R, only two alternatives for Y and Z, no alternatives for the other ring

positions, and a large unchanging parent structural nucleus. With these circumstances in mind, it is our opinion that Karrer has described to those with ordinary skill in this art each of the various permutations here involved as fully as if he had drawn each structural formula or had written each name.

*Id.* (emphasis in original). *Accord In re Schaumann*, 572 F.2d 312, 316, 197 USPQ 5, 9 (CCPA 1978) (prior art genus encompassing claimed species which disclosed preference for lower alkyl secondary amines and properties possessed by the claimed compound constituted description of claimed compound for purposes of 35 U.S.C. 102(b)). *C.f.*, *In re Ruschig*, 343 F.2d 965, 974, 145 USPQ 274, 282 (CCPA 1965) (Rejection of claimed compound in light of prior art genus based on *Petering* is not appropriate where the prior art does not disclose a small recognizable class of compounds with common properties.).

#### (b) Consider the Express Teachings

If the prior art reference expressly teaches a particular reason to select the claimed species or subgenus, Office personnel should point out the express disclosure which would have motivated one of ordinary skill in the art to select the claimed invention. An express teaching may be based on a statement in the prior art reference such as an art recognized equivalence. For example, see *Merck & Co. v. Biocraft Labs.*, 874 F.2d 804, 807, 10 USPQ2d 1843, 1846 (Fed. Cir. 1989) (holding claims directed to diuretic compositions comprising a specific mixture of amiloride and hydrochlorothiazide were obvious over a prior art reference expressly teaching that amiloride was a pyrazinoylguanidine which could be coadministered with potassium excreting diuretic agents, including hydrochlorothiazide which was a named example, to produce a diuretic with desirable sodium and potassium eliminating properties). See also, *In re Kemps*, 97 F.3d 1427, 1430, 40 USPQ2d 1309, 1312 (Fed. Cir. 1996) (holding there is sufficient motivation to combine teachings of prior art to achieve claimed invention where one reference specifically refers to the other).

#### (c) Consider the Teachings of Structural Similarity

Consider any teachings of a “typical,” “preferred,” or “optimum” species or subgenus within the dis-

closed genus. If such a species or subgenus is structurally similar to that claimed, its disclosure may motivate one of ordinary skill in the art to choose the claimed species or subgenus from the genus, based on the reasonable expectation that structurally similar species usually have similar properties. See, e.g., *Dillon*, 919 F.2d at 693, 696, 16 USPQ2d at 1901, 1904. See also *Deuel*, 51 F.3d at 1558, 34 USPQ2d at 1214 (“Structural relationships may provide the requisite motivation or suggestion to modify known compounds to obtain new compounds. For example, a prior art compound may suggest its homologs because homologs often have similar properties and therefore chemists of ordinary skill would ordinarily contemplate making them to try to obtain compounds with improved properties.”). The utility of such properties will normally provide some motivation to make the claimed species or subgenus. *Id.*

In making an obviousness determination, Office personnel should consider the number of variables which must be selected or modified, and the nature and significance of the differences between the prior art and the claimed invention. See, e.g., *In re Jones*, 958 F.2d 347, 350, 21 USPQ2d 1941, 1943 (Fed. Cir. 1992) (reversing obviousness rejection of novel dicamba salt with acyclic structure over broad prior art genus encompassing claimed salt, where disclosed examples of genus were dissimilar in structure, lacking an ether linkage or being cyclic); *In re Susi*, 440 F.2d 442, 445, 169 USPQ 423, 425 (CCPA 1971) (the difference from the particularly preferred subgenus of the prior art was a hydroxyl group, a difference conceded by applicant “to be of little importance”). In the area of biotechnology, an exemplified species may differ from a claimed species by a conservative substitution (“the replacement in a protein of one amino acid by another, chemically similar, amino acid... [which] is generally expected to lead to either no change or only a small change in the properties of the protein.” *Dictionary of Biochemistry and Molecular Biology* 97 (John Wiley & Sons, 2d ed. 1989)). The effect of a conservative substitution on protein function depends on the nature of the substitution and its location in the chain. Although at some locations a conservative substitution may be benign, in some proteins only one amino acid is allowed at a given position. For example, the gain or loss of even one methyl group can destabilize the structure if close packing is



required in the interior of domains. James Darnell *et al.*, *Molecular Cell Biology* 51 (2d ed. 1990).

The closer the physical and chemical similarities between the claimed species or subgenus and any exemplary species or subgenus disclosed in the prior art, the greater the expectation that the claimed subject matter will function in an equivalent manner to the genus. See, e.g., *Dillon*, 919 F.2d at 696, 16 USPQ2d at 1904 (and cases cited therein). *Cf. Baird*, 16 F.3d at 382-83, 29 USPQ2d at 1552 (disclosure of dissimilar species can provide teaching away).

Similarly, consider any teaching or suggestion in the reference of a preferred species or subgenus that is significantly different in structure from the claimed species or subgenus. Such a teaching may weigh against selecting the claimed species or subgenus and thus against a determination of obviousness. *Baird*, 16 F.3d at 382-83, 29 USPQ2d at 1552 (reversing obviousness rejection of species in view of large size of genus and disclosed “optimum” species which differed greatly from and were more complex than the claimed species); *Jones*, 958 F.2d at 350, 21 USPQ2d at 1943 (reversing obviousness rejection of novel dicamba salt with acyclic structure over broad prior art genus encompassing claimed salt, where disclosed examples of genus were dissimilar in structure, lacking an ether linkage or being cyclic). For example, teachings of preferred species of a complex nature within a disclosed genus may motivate an artisan of ordinary skill to make similar complex species and thus teach away from making simple species within the genus. *Baird*, 16 F.3d at 382, 29 USPQ2d at 1552. See also *Jones*, 958 F.2d at 350, 21 USPQ2d at 1943 (disclosed salts of genus held not sufficiently similar in structure to render claimed species *prima facie* obvious).

Concepts used to analyze the structural similarity of chemical compounds in other types of chemical cases are equally useful in analyzing genus-species cases. For example, a claimed tetra-orthoester fuel composition was held to be obvious in light of a prior art tri-orthoester fuel composition based on their structural and chemical similarity and similar use as fuel additives. *Dillon*, 919 F.2d at 692-93, 16 USPQ2d at 1900-02. Likewise, claims to amitriptyline used as an antidepressant were held obvious in light of the structural similarity to imipramine, a known antidepressant prior art compound, where both compounds were tri-

cyclic dibenzo compounds and differed structurally only in the replacement of the unsaturated carbon atom in the center ring of amitriptyline with a nitrogen atom in imipramine. *In re Merck & Co.*, 800 F.2d 1091, 1096-97, 231 USPQ 375, 378-79 (Fed. Cir. 1986). Other structural similarities have been found to support a *prima facie* case of obviousness. See, e.g., *In re May*, 574 F.2d 1082, 1093-95, 197 USPQ 601, 610-11 (CCPA 1978) (stereoisomers); *In re Wilder*, 563 F.2d 457, 460, 195 USPQ 426, 429 (CCPA 1977) (adjacent homologs and structural isomers); *In re Hoch*, 428 F.2d 1341, 1344, 166 USPQ 406, 409 (CCPA 1970) (acid and ethyl ester); *In re Druey*, 319 F.2d 237, 240, 138 USPQ 39, 41 (CCPA 1963) (omission of methyl group from pyrazole ring). Generally, some teaching of a structural similarity will be necessary to suggest selection of the claimed species or subgenus. *Id.*

#### (d) Consider the Teachings of Similar Properties or Uses

Consider the properties and utilities of the structurally similar prior art species or subgenus. It is the properties and utilities that provide real world motivation for a person of ordinary skill to make species structurally similar to those in the prior art. *Dillon*, 919 F.2d at 697, 16 USPQ2d at 1905; *In re Stemmiski*, 444 F.2d 581, 586, 170 USPQ 343, 348 (CCPA 1971). Conversely, lack of any known useful properties weighs against a finding of motivation to make or select a species or subgenus. *In re Albrecht*, 514 F.2d 1389, 1392, 1395-96, 185 USPQ 585, 587, 590 (CCPA 1975) (The prior art compound so irritated the skin that it could not be regarded as useful for the disclosed anesthetic purpose, and therefore a person skilled in the art would not have been motivated to make related compounds.); *Stemmiski*, 444 F.2d at 586, 170 USPQ at 348 (close structural similarity alone is not sufficient to create a *prima facie* case of obviousness when the reference compounds lack utility, and thus there is no motivation to make related compounds.). However, the prior art need not disclose a newly discovered property in order for there to be a *prima facie* case of obviousness. *Dillon*, 919 F.2d at 697, 16 USPQ2d at 1904-05 (and cases cited therein). If the claimed invention and the structurally similar prior art species share any useful property, that will generally be sufficient to motivate an artisan of

ordinary skill to make the claimed species, *e.g.*, *id.* For example, based on a finding that a tri-orthoester and a tetra-orthoester behave similarly in certain chemical reactions, it has been held that one of ordinary skill in the relevant art would have been motivated to select either structure. 919 F.2d at 692, 16 USPQ2d at 1900-01. In fact, similar properties may normally be presumed when compounds are very close in structure. *Dillon*, 919 F.2d at 693, 696, 16 USPQ2d at 1901, 1904. See also *In re Grabiak*, 769 F.2d 729, 731, 226 USPQ 870, 871 (Fed. Cir. 1985) (“When chemical compounds have ‘very close’ structural similarities and similar utilities, without more a *prima facie* case may be made.”). Thus, evidence of similar properties or evidence of any useful properties disclosed in the prior art that would be expected to be shared by the claimed invention weighs in favor of a conclusion that the claimed invention would have been obvious. *Dillon*, 919 F.2d at 697-98, 16 USPQ2d at 1905; *In re Wilder*, 563 F.2d 457, 461, 195 USPQ 426, 430 (CCPA 1977); *In re Linter*, 458 F.2d 1013, 1016, 173 USPQ 560, 562 (CCPA 1972).

**(e) Consider the Predictability of the Technology**

Consider the predictability of the technology. See, *e.g.*, *Dillon*, 919 F.2d at 692-97, 16 USPQ2d at 1901-05; *In re Grabiak*, 769 F.2d 729, 732-33, 226 USPQ 870, 872 (Fed. Cir. 1985). If the technology is unpredictable, it is less likely that structurally similar species will render a claimed species obvious because it may not be reasonable to infer that they would share similar properties. See, *e.g.*, *In re May*, 574 F.2d 1082, 1094, 197 USPQ 601, 611 (CCPA 1978) (*prima facie* obviousness of claimed analgesic compound based on structurally similar prior art isomer was rebutted with evidence demonstrating that analgesia and addiction properties could not be reliably predicted on the basis of chemical structure); *In re Schechter*, 205 F.2d 185, 191, 98 USPQ 144, 150 (CCPA 1953) (unpredictability in the insecticide field, with homologs, isomers and analogs of known effective insecticides having proven ineffective as insecticides, was considered as a factor weighing against a conclusion of obviousness of the claimed compounds). However, obviousness does not require absolute predictability, only a reasonable expectation of success, *i.e.*, a reasonable expectation of obtaining similar properties. See, *e.g.*, *In re*

*O’Farrell*, 853 F.2d 894, 903, 7 USPQ2d 1673, 1681 (Fed. Cir. 1988).

**(f) Consider Any Other Teaching To Support the Selection of the Species or Subgenus**

The categories of relevant teachings enumerated above are those most frequently encountered in a genus-species case, but they are not exclusive. Office personnel should consider the totality of the evidence in each case. In unusual cases, there may be other relevant teachings sufficient to support the selection of the species or subgenus and, therefore, a conclusion of obviousness.

**5. Make Express Fact-Findings and Determine Whether They Support a *Prima Facie* Case of Obviousness**

Based on the evidence as a whole (*In re Bell*, 991 F.2d 781,784, 26 USPQ2d 1529, 1531 (Fed. Cir. 1993); *In re Kulling*, 897 F.2d 1147, 1149, 14 USPQ2d 1056, 1057 (Fed. Cir. 1990)), Office personnel should make express fact-findings relating to the *Graham* factors, focusing primarily on the prior art teachings discussed above. The fact-findings should specifically articulate what teachings or suggestions in the prior art would have motivated one of ordinary skill in the art to select the claimed species or subgenus. *Kulling*, 897 F.2d at 1149, 14 USPQ2d at 1058; *Panduit Corp. v. Dennison Mfg. Co.*, 810 F.2d 1561, 1579 n.42, 1 USPQ2d 1593, 1606 n.42 (Fed. Cir. 1987). Thereafter, it should be determined whether these findings, considered as a whole, support a *prima facie* case that the claimed invention would have been obvious to one of ordinary skill in the relevant art at the time the invention was made.

**B. Determining Whether Rebuttal Evidence Is Sufficient To Overcome the *Prima Facie* Case of Obviousness**

If a *prima facie* case of obviousness is established, the burden shifts to the applicant to come forward with arguments and/or evidence to rebut the *prima facie* case. See, *e.g.*, *Dillon*, 919 F.2d at 692, 16 USPQ2d at 1901. Rebuttal evidence and arguments can be presented in the specification, *In re Soni*, 54 F.3d 746, 750, 34 USPQ2d 1684, 1687 (Fed. Cir. 1995), by counsel, *In re Chu*, 66 F.3d 292, 299, 36

USPQ2d 1089, 1094-95 (Fed. Cir. 1995), or by way of an affidavit or declaration under 37 CFR 1.132, e.g., *Soni*, 54 F.3d at 750, 34 USPQ2d at 1687; *In re Piasecki*, 745 F.2d 1468, 1474, 223 USPQ 785, 789-90 (Fed. Cir. 1984). However, arguments of counsel cannot take the place of factually supported objective evidence. See, e.g., *In re Huang*, 100 F.3d 135, 139-40, 40 USPQ2d 1685, 1689 (Fed. Cir. 1996); *In re De Blauwe*, 736 F.2d 699, 705, 222 USPQ 191, 196 (Fed. Cir. 1984).

Office personnel should consider all rebuttal arguments and evidence presented by applicants. See, e.g., *In re Soni*, 54 F.3d 746, 750, 34 USPQ2d 1684, 1687 (Fed. Cir. 1995) (error not to consider evidence presented in the specification). *C.f.*, *In re Alton*, 76 F.3d 1168, 37 USPQ2d 1578 (Fed. Cir. 1996) (error not to consider factual evidence submitted to counter a 35 U.S.C. 112 rejection); *In re Beattie*, 974 F.2d 1309, 1313, 24 USPQ2d 1040, 1042-43 (Fed. Cir. 1992) (Office personnel should consider declarations from those skilled in the art praising the claimed invention and opining that the art teaches away from the invention.); *Piasecki*, 745 F.2d at 1472, 223 USPQ at 788 (“[Rebuttal evidence] may relate to any of the *Graham* factors including the so-called secondary considerations.”). Rebuttal evidence may include evidence of “secondary considerations,” such as “commercial success, long felt but unsolved needs, [and] failure of others.” *Graham v. John Deere Co.*, 383 U.S. at 17, 148 USPQ at 467. See also, e.g., *In re Piasecki*, 745 F.2d 1468, 1473, 223 USPQ 785, 788 (Fed. Cir. 1984) (commercial success). Rebuttal evidence may also include evidence that the claimed invention yields unexpectedly improved properties or properties not present in the prior art. Rebuttal evidence may consist of a showing that the claimed compound possesses unexpected properties. *Dillon*, 919 F.2d at 692-93, 16 USPQ2d at 1901. A showing of unexpected results must be based on evidence, not argument or speculation. *In re Mayne*, 104 F.3d 1339, 1343-44, 41 USPQ2d 1451, 1455-56 (Fed. Cir. 1997) (conclusory statements that claimed compound possesses unusually low immune response or unexpected biological activity that is unsupported by comparative data held insufficient to overcome *prima facie* case of obviousness). Rebuttal evidence may include evidence that the claimed invention was copied by others. See, e.g., *In re GPAC*, 57 F.3d 1573, 1580,

35 USPQ2d 1116, 1121 (Fed. Cir. 1995); *Hybritech Inc. v. Monoclonal Antibodies*, 802 F.2d 1367, 1380, 231 USPQ 81, 90 (Fed. Cir. 1986). It may also include evidence of the state of the art, the level of skill in the art, and the beliefs of those skilled in the art. See, e.g., *In re Oelrich*, 579 F.2d 86, 91-92, 198 USPQ 210, 214 (CCPA 1978) (Expert opinions regarding the level of skill in the art were probative of the Nonobviousness of the claimed invention.); *Piasecki*, 745 F.2d at 1471, 1473-74, 223 USPQ at 790 (Evidence of nontechnological nature is pertinent to the conclusion of obviousness. The declarations of those skilled in the art regarding the need for the invention and its reception by the art were improperly discounted by the Board.); *Beattie*, 974 F.2d at 1313, 24 USPQ2d at 1042-43 (Seven declarations provided by music teachers opining that the art teaches away from the claimed invention must be considered, but were not probative because they did not contain facts and did not deal with the specific prior art that was the subject of the rejection.). For example, rebuttal evidence may include a showing that the prior art fails to disclose or render obvious a method for making the compound, which would preclude a conclusion of obviousness of the compound. A conclusion of obviousness requires that the reference(s) relied upon be enabling in that it put the public in possession of the claimed invention. The court in *In re Hoeksema*, 399 F.2d 269, 274, 158 USPQ 596, 601 (CCPA 1968), stated:

Thus, upon careful reconsideration it is our view that if the prior art of record fails to disclose or render obvious a method for making a claimed compound, at the time the invention was made, it may not be legally concluded that the compound itself is in the possession of the public. [footnote omitted.] In this context, we say that the absence of a known or obvious process for making the claimed compounds overcomes a presumption that the compounds are obvious, based on close relationships between their structures and those of prior art compounds.

The *Hoeksema* court further noted that once a *prima facie* case of obviousness is made by the PTO through citation of references, the burden is on the applicant to produce contrary evidence establishing that the reference being relied on would not enable a skilled artisan to produce the different compounds claimed. *Id.* at 274-75, 158 USPQ at 601. See also *Ashland Oil, Inc. v. Delta Resins & Refractories, Inc.*, 776 F.2d 281, 295, 297, 227 USPQ 657, 666, 667 (Fed. Cir. 1985) (citing *Hoeksema* for the proposition

above); *In re Grose*, 592 F.2d 1161, 1168, 201 USPQ 57, 63-64 (CCPA 1979) (“One of the assumptions underlying a prima facie obviousness rejection based upon a structural relationship between compounds, such as adjacent homologs, is that a method disclosed for producing one would provide those skilled in the art with a method for producing the other... Failure of the prior art to disclose or render obvious a method for making any composition of matter, whether a compound or a mixture of compounds like a zeolite, precludes a conclusion that the composition would have been obvious.”).

Consideration of rebuttal evidence and arguments requires Office personnel to weigh the proffered evidence and arguments. Office personnel should avoid giving evidence no weight, except in rare circumstances. *Id.* See also *In re Alton*, 76 F.3d 1168, 1174-75, 37 USPQ2d 1578, 1582-83 (Fed. Cir. 1996). However, to be entitled to substantial weight, the applicant should establish a nexus between the rebuttal evidence and the claimed invention, i.e., objective evidence of nonobviousness must be attributable to the claimed invention. The Federal Circuit has acknowledged that applicant bears the burden of establishing nexus, stating:

In the *ex parte* process of examining a patent application, however, the PTO lacks the means or resources to gather evidence which supports or refutes the applicant’s assertion that the sales constitute commercial success. *C.f. Ex parte Remark*, 15 USPQ2d 1498, 1503 ([BPAI] 1990) (evidentiary routine of shifting burdens in civil proceedings inappropriate in *ex parte* prosecution proceedings because examiner has no available means for adducing evidence). Consequently, the PTO must rely upon the applicant to provide hard evidence of commercial success.

*In re Huang*, 100 F.3d 135, 139-40, 40 USPQ2d 1685, 1689 (Fed. Cir. 1996). See also *GPAC*, 57 F.3d at 1580, 35 USPQ2d at 1121; *In re Paulsen*, 30 F.3d 1475, 1482, 31 USPQ2d 1671, 1676 (Fed. Cir. 1994) (Evidence of commercial success of articles not covered by the claims subject to the 35 U.S.C. 103 rejection was not probative of nonobviousness.). Additionally, the evidence must be reasonably commensurate in scope with the claimed invention. See, e.g., *In re Kulling*, 897 F.2d 1147, 1149, 14 USPQ2d 1056, 1058 (Fed. Cir. 1990); *In re Grasselli*, 713 F.2d 731, 743, 218 USPQ 769, 777 (Fed. Cir. 1983). *In re Soni*, 54 F.3d 746, 34 USPQ2d 1684 (Fed. Cir. 1995) does not change this analysis. In *Soni*, the Court

declined to consider the Office’s argument that the evidence of nonobviousness was not commensurate in scope with the claim because it had not been raised by the examiner (54 F.3d at 751, 34 USPQ2d at 1688).

When considering whether proffered evidence is commensurate in scope with the claimed invention, Office personnel should not require the applicant to show unexpected results over the entire range of properties possessed by a chemical compound or composition. See, e.g., *In re Chupp*, 816 F.2d 643, 646, 2 USPQ2d 1437, 1439 (Fed. Cir. 1987). Evidence that the compound or composition possesses superior and unexpected properties in one of a spectrum of common properties can be sufficient to rebut a *prima facie* case of obviousness. *Id.*

For example, a showing of unexpected results for a single member of a claimed subgenus, or a narrow portion of a claimed range would be sufficient to rebut a *prima facie* case of obviousness if a skilled artisan “could ascertain a trend in the exemplified data that would allow him to reasonably extend the probative value thereof.” *In re Clemens*, 622 F.2d 1029, 1036, 206 USPQ 289, 296 (CCPA 1980) (Evidence of the unobviousness of a broad range can be proven by a narrower range when one skilled in the art could ascertain a trend that would allow him to reasonably extend the probative value thereof.). But see, *Grasselli*, 713 F.2d at 743, 218 USPQ at 778 (evidence of superior properties for sodium containing composition insufficient to establish the non-obviousness of broad claims for a catalyst with “an alkali metal” where it was well known in the catalyst art that different alkali metals were not interchangeable and applicant had shown unexpected results only for sodium containing materials); *In re Greenfield*, 571 F.2d 1185, 1189, 197 USPQ 227, 230 (CCPA 1978) (evidence of superior properties in one species insufficient to establish the nonobviousness of a subgenus containing hundreds of compounds); *In re Lindner*, 457 F.2d 506, 508, 173 USPQ 356, 358 (CCPA 1972) (one test not sufficient where there was no adequate basis for concluding the other claimed compounds would behave the same way). However, an exemplary showing may be sufficient to establish a reasonable correlation between the showing and the entire scope of the claim, when viewed by a skilled artisan. See, e.g., *Chupp*, 816 F.2d at 646, 2 USPQ2d at 1439; *Clemens*, 622 F.2d at 1036, 206 USPQ at 296. On the

other hand, evidence of an unexpected property may not be sufficient regardless of the scope of the showing. Usually, a showing of unexpected results is sufficient to overcome a *prima facie* case of obviousness. See, e.g., *In re Albrecht*, 514 F.2d 1389, 1396, 185 USPQ 585, 590 (CCPA 1975). However, where the claims are not limited to a particular use, and where the prior art provides other motivation to select a particular species or subgenus, a showing of a new use may not be sufficient to confer patentability. See *Dillon*, 919 F.2d at 692, 16 USPQ2d at 1900-01. Accordingly, each case should be evaluated individually based on the totality of the circumstances.

Office personnel should not evaluate rebuttal evidence for its “knockdown” value against the *prima facie* case, *Piasecki*, 745 F.2d at 1473, 223 USPQ at 788, or summarily dismiss it as not compelling or insufficient. If the evidence is deemed insufficient to rebut the *prima facie* case of obviousness, Office personnel should specifically set forth the facts and reasoning that justify this conclusion.

### III. RECONSIDER ALL EVIDENCE AND CLEARLY COMMUNICATE FINDINGS AND CONCLUSIONS

A determination under 35 U.S.C. 103 should rest on all the evidence and should not be influenced by

any earlier conclusion. See, e.g., *Piasecki*, 745 F.2d at 1472-73, 223 USPQ at 788; *In re Eli Lilly & Co.*, 902 F.2d 943, 945, 14 USPQ2d 1741, 1743 (Fed. Cir. 1990). Thus, once the applicant has presented rebuttal evidence, Office personnel should reconsider any initial obviousness determination in view of the entire record. See, e.g., *Piasecki*, 745 F.2d at 1472, 223 USPQ at 788; *Eli Lilly*, 902 F.2d at 945, 14 USPQ2d at 1743. All the proposed rejections and their bases should be reviewed to confirm their correctness. Only then should any rejection be imposed in an Office action. The Office action should clearly communicate the Office’s findings and conclusions, articulating how the conclusions are supported by the findings.

Where applicable, the findings should clearly articulate which portions of the reference support any rejection. Explicit findings on motivation or suggestion to select the claimed invention should also be articulated in order to support a 35 U.S.C. 103 ground of rejection. *Dillon*, 919 F.2d at 693, 16 USPQ2d at 1901; *In re Mills*, 916 F.2d 680, 683, 16 USPQ2d 1430, 1433 (Fed. Cir. 1990). Conclusory statements of similarity or motivation, without any articulated rationale or evidentiary support, do not constitute sufficient factual findings.

I. If the closest prior art is a single reference disclosing a genus, determine whether the claimed species or subgenus would have been obvious to one of ordinary skill in the pertinent art at the time the invention was made by performing the following analysis...

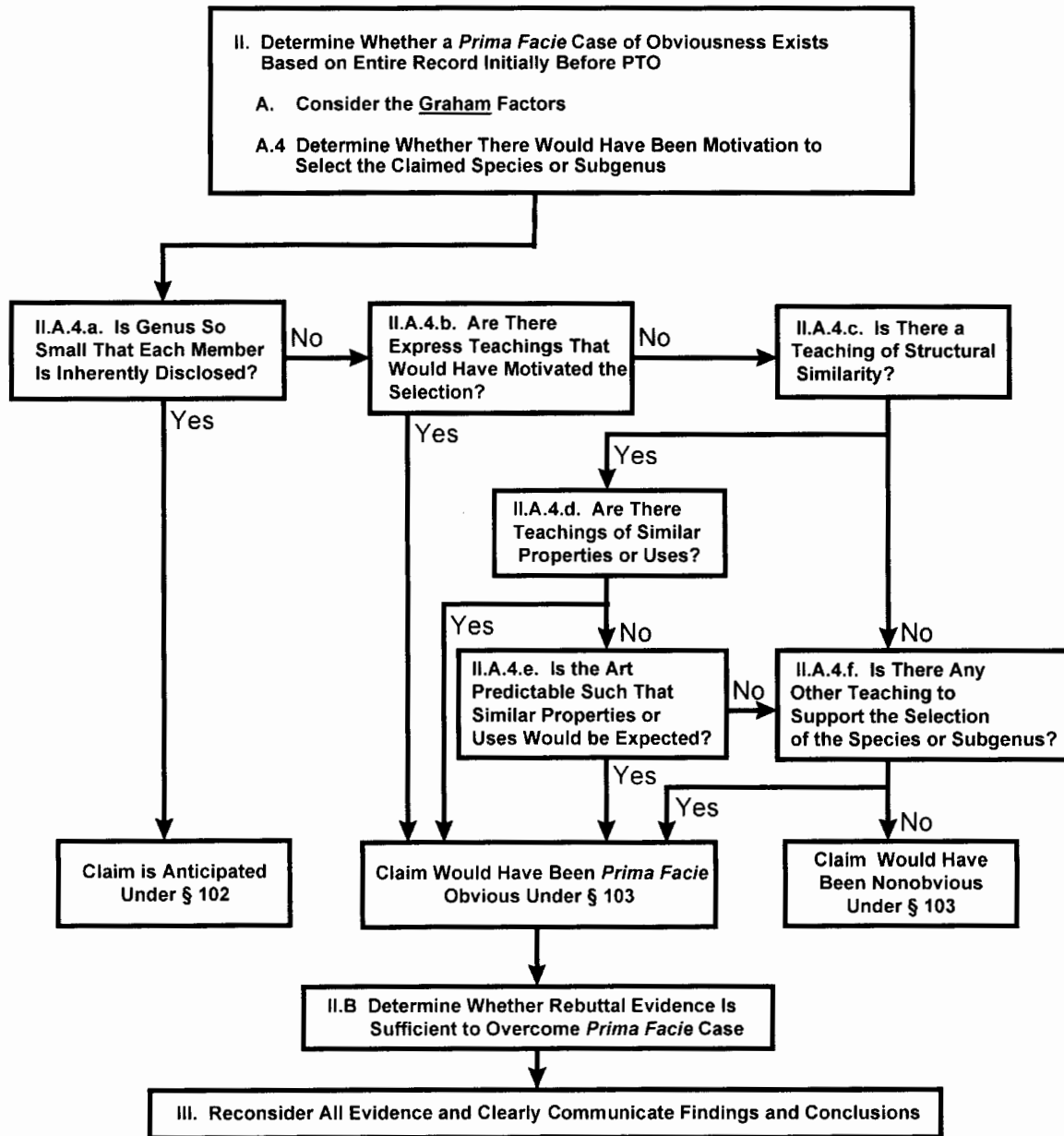

## 2144.09 Close Structural Similarity Between Chemical Compounds (Homologs, Analogues, Isomers)

### REJECTION BASED ON CLOSE STRUCTURAL SIMILARITY IS FOUNDED ON THE EXPECTATION THAT COMPOUNDS SIMILAR IN STRUCTURE WILL HAVE SIMILAR PROPERTIES

A *prima facie* case of obviousness may be made when chemical compounds have very close structural similarities and similar utilities. “An obviousness rejection based on similarity in chemical structure and function entails the motivation of one skilled in the art to make a claimed compound, in the expectation that compounds similar in structure will have similar properties.” *In re Payne*, 606 F.2d 303, 313, 203 USPQ 245, 254 (CCPA 1979). See *In re Papesch*, 315 F.2d 381, 137 USPQ 43 (CCPA 1963) (discussed in more detail below) and *In re Dillon*, 919 F.2d 688, 16 USPQ2d 1897 (Fed. Cir. 1991) (discussed below and in MPEP § 2144) for an extensive review of the case law pertaining to obviousness based on close structural similarity of chemical compounds. See also MPEP § 2144.08, paragraph II.A.4.(c).

### HOMOLOGY AND ISOMERISM ARE FACTS WHICH MUST BE CONSIDERED WITH ALL OTHER RELEVANT FACTS IN DETERMINING OBVIOUSNESS

Compounds which are position isomers (compounds having the same radicals in physically different positions on the same nucleus) or homologs (compounds differing regularly by the successive addition of the same chemical group, e.g., by  $-CH_2-$  groups) are generally of sufficiently close structural similarity that there is a presumed expectation that such compounds possess similar properties. *In re Wilder*, 563 F.2d 457, 195 USPQ 426 (CCPA 1977). See also *In re May*, 574 F.2d 1082, 197 USPQ 601 (CCPA 1978) (stereoisomers *prima facie* obvious).

Isomers having the same empirical formula but different structures are not necessarily considered equivalent by chemists skilled in the art and therefore are not necessarily suggestive of each other. *Ex parte Mowry*, 91 USPQ 219 (Bd. App. 1950) (claimed

cyclohexylstyrene not *prima facie* obvious over prior art isohexylstyrene). Similarly, homologs which are far removed from adjacent homologs may not be expected to have similar properties. *In re Mills*, 281 F.2d 218, 126 USPQ 513 (CCPA 1960) (prior art disclosure of  $C_8$  to  $C_{12}$  alkyl sulfates was not sufficient to render *prima facie* obvious claimed  $C_1$  alkyl sulfate).

Homology and isomerism involve close structural similarity which must be considered with all other relevant facts in determining the issue of obviousness. *In re Mills*, 281 F.2d 218, 126 USPQ 513 (CCPA 1960); *In re Wiechert*, 370 F.2d 927, 152 USPQ 247 (CCPA 1967). Homology should not be automatically equated with *prima facie* obviousness because the claimed invention and the prior art must each be viewed “as a whole.” *In re Langer*, 465 F.2d 896, 175 USPQ 169 (CCPA 1972) (Claims to a polymerization process using a sterically hindered amine were held unobvious over a similar prior art process because the prior art disclosed a large number of unhindered amines and only one sterically hindered amine (which differed from a claimed amine by 3 carbon atoms), and therefore the reference as a whole did not apprise the ordinary artisan of the significance of hindered amines as a class.).

### PRESENCE OF A TRUE HOMOLOGOUS OR ISOMERIC RELATIONSHIP IS NOT CONTROLLING

Prior art structures do not have to be true homologs or isomers to render structurally similar compounds *prima facie* obvious. *In re Payne*, 606 F.2d 303, 203 USPQ 245 (CCPA 1979) (Claimed and prior art compounds were both directed to heterocyclic carbamoyloximino compounds having pesticidal activity. The only structural difference between the claimed and prior art compounds was that the ring structures of the claimed compounds had two carbon atoms between two sulfur atoms whereas the prior art ring structures had either one or three carbon atoms between two sulfur atoms. The court held that although the prior art compounds were not true homologs or isomers of the claimed compounds, the similarity between the chemical structures and properties is sufficiently close that one of ordinary skill in the art would have been motivated to make the claimed compounds in searching for new pesticides.).

See also *In re Mayne*, 104 F.3d 1339, 41 USPQ2d 1451 (Fed. Cir. 1997) (claimed protein was held to be obvious in light of structural similarities to the prior art, including known structural similarity of Ile and Lev); *In re Merck & Co., Inc.*, 800 F.2d 1091, 231 USPQ 375 (Fed. Cir. 1986) (claimed and prior art compounds used in a method of treating depression would have been expected to have similar activity because the structural difference between the compounds involved a known bioisosteric replacement) (see MPEP § 2144.08, paragraph II.A.4(c) for a more detailed discussion of the facts in the *Mayne* and *Merck* cases); *In re Dillon*, 919 F.2d 688, 16 USPQ2d 1897 (Fed. Cir. 1991) (The tri-orthoester fuel compositions of the prior art and the claimed tetra-orthoester fuel compositions would have been expected to have similar properties based on close structural and chemical similarity between the orthoesters and the fact that both the prior art and applicant used the orthoesters as fuel additives.) (See MPEP § 2144 for a more detailed discussion of the facts in the *Dillon* case.).

Compare *In re Grabiak*, 769 F.2d 729, 226 USPQ 871 (Fed. Cir. 1985) (substitution of a thioester group for an ester group in an herbicidal safener compound was not suggested by the prior art); *In re Bell*, 991 F.2d 781, 26 USPQ2d 1529 (Fed. Cir. 1993) (The established relationship between a nucleic acid and the protein it encodes in the genetic code does not render a gene *prima facie* obvious over its corresponding protein in the same way that closely related structures in chemistry may create a *prima facie* case because there are a vast number of nucleotide sequences that might encode for a specific protein as a result of degeneracy in the genetic code (i.e., the fact that most amino acids are specified by more than one nucleotide sequence or codon).); *In re Deuel*, 51 F.3d 1552, 1558-59, 34 USPQ2d 1210, 1215 (Fed. Cir. 1995) (“A prior art disclosure of the amino acid sequence of a protein does not necessarily render particular DNA molecules encoding the protein obvious because the redundancy of the genetic code permits one to hypothesize an enormous number of DNA sequences coding for the protein.” The existence of a general method of gene cloning in the prior art is not sufficient, without more, to render obvious a particular cDNA molecule.).

#### **PRESENCE OR ABSENCE OF PRIOR ART SUGGESTION OF METHOD OF MAKING A CLAIMED COMPOUND MAY BE RELEVANT IN DETERMINING *PRIMA FACIE* OBVIOUSNESS**

“[T]he presence—or absence—of a suitably operative, obvious process for making a composition of matter may have an ultimate bearing on whether that composition is obvious—or nonobvious—under 35 U.S.C. 103.” *In re Maloney*, 411 F.2d 1321, 1323, 162 USPQ 98, 100 (CCPA 1969).

“[I]f the prior art of record fails to disclose or render obvious a method for making a claimed compound, at the time the invention was made, it may not be legally concluded that the compound itself is in the possession of the public. In this context, we say that the absence of a known or obvious process for making the claimed compounds overcomes a presumption that the compounds are obvious, based on the close relationships between their structures and those of prior art compounds.” *In re Hoeksema*, 399 F.2d 269, 274-75, 158 USPQ 597, 601 (CCPA 1968).

See *In re Payne*, 606 F.2d 303, 203 USPQ 245 (CCPA 1979) for a general discussion of circumstances under which the prior art suggests methods for making novel compounds which are of close structural similarity to compounds known in the prior art. In the biotechnology arts, the existence of a general method of gene cloning in the prior art is not sufficient, without more, to render obvious a particular cDNA molecule. *In re Deuel*, 51 F.3d 1552, 1558, 34 USPQ2d 1210, 1215 (Fed. Cir. 1995) (“[T]he existence of a general method of isolating cDNA or DNA molecules is essentially irrelevant to the question whether the specific molecules themselves would have been obvious, in the absence of other prior art that suggests the claimed DNAs.”); *In re Bell*, 991 F.2d 781, 785, 26 USPQ2d 1529, 1532 (Fed. Cir. 1993). However, it may be proper to apply “methodology in rejecting product claims under 35 U.S.C. 103, depending on the particular facts of the case, the manner and context in which methodology applies, and the overall logic of the rejection.” *Ex parte Goldgaber*, 41 USPQ2d 1172, 1176 (Bd. Pat. App. & Inter. 1996).



**PRESUMPTION OF OBVIOUSNESS BASED ON STRUCTURAL SIMILARITY IS OVERCOME WHERE THERE IS NO REASONABLE EXPECTATION OF SIMILAR PROPERTIES**

The presumption of obviousness based on a reference disclosing structurally similar compounds may be overcome where there is evidence showing there is no reasonable expectation of similar properties in structurally similar compounds. *In re May*, 574 F.2d 1082, 197 USPQ 601 (CCPA 1978) (appellant produced sufficient evidence to establish a substantial degree of unpredictability in the pertinent art area, and thereby rebutted the presumption that structurally similar compounds have similar properties); *In re Schechter*, 205 F.2d 185, 98 USPQ 144 (CCPA 1953). See also *Ex parte Blattner*, 2 USPQ2d 2047 (Bd. Pat. App. & Inter. 1987) (Claims directed to compounds containing a 7-membered ring were rejected as *prima facie* obvious over a reference which taught 5- and 6-membered ring homologs of the claimed compounds. The Board reversed the rejection because the prior art taught that the compounds containing a 5-membered ring possessed the opposite utility of the compounds containing the 6-membered ring, undermining the examiner's asserted *prima facie* case arising from an expectation of similar results in the claimed compounds which contain a 7-membered ring.).

**IF PRIOR ART COMPOUNDS HAVE NO UTILITY, OR UTILITY ONLY AS INTERMEDIATES, CLAIMED STRUCTURALLY SIMILAR COMPOUNDS MAY NOT BE *PRIMA FACIE* OBVIOUS OVER THE PRIOR ART**

If the prior art does not teach any specific or significant utility for the disclosed compounds, then the prior art is not sufficient to render structurally similar claims *prima facie* obvious because there is no motivation for one of ordinary skill in the art to make the reference compounds, much less any structurally related compounds. *In re Stemniski*, 444 F.2d 581, 170 USPQ 343 (CCPA 1971).

Where structurally similar "prior art compounds 'cannot be regarded as useful' for the sole use disclosed [by the reference],... a person having ordinary skill in the art would lack the 'necessary impetus' to make the claimed compounds." *In re Albrecht*, 514 F.2d 1389, 1396, 185 USPQ 585, 590 (CCPA 1975) (prior art reference studied the local anesthetic activ-

ity of various compounds, and taught that compounds structurally similar to those claimed were irritating to human skin and therefore "cannot be regarded as useful anesthetics." 514 F.2d at 1393, 185 USPQ at 587).

Similarly, if the prior art merely discloses compounds as intermediates in the production of a final product, one of ordinary skill in the art would not have been motivated to stop the reference synthesis and investigate the intermediate compounds with an expectation of arriving at claimed compounds which have different uses. *In re Lulu*, 747 F.2d 703, 223 USPQ 1257 (Fed. Cir. 1984).

***PRIMA FACIE* CASE REBUTTABLE BY EVIDENCE OF SUPERIOR OR UNEXPECTED RESULTS**

A *prima facie* case of obviousness based on structural similarity is rebuttable by proof that the claimed compounds possess unexpectedly advantageous or superior properties. *In re Papesch*, 315 F.2d 381, 137 USPQ 43 (CCPA 1963) (Affidavit evidence which showed that claimed triethylated compounds possessed anti-inflammatory activity whereas prior art trimethylated compounds did not was sufficient to overcome obviousness rejection based on the homologous relationship between the prior art and claimed compounds.); *In re Wiechert*, 370 F.2d 927, 152 USPQ 247 (CCPA 1967) (a 7-fold improvement of activity over the prior art held sufficient to rebut *prima facie* obviousness based on close structural similarity).

However, a claimed compound may be obvious because it was suggested by, or structurally similar to, a prior art compound even though a particular benefit of the claimed compound asserted by patentee is not expressly disclosed in the prior art. It is the differences in fact in their respective properties which are determinative of nonobviousness. If the prior art compound does in fact possess a particular benefit, even though the benefit is not recognized in the prior art, applicant's recognition of the benefit is not in itself sufficient to distinguish the claimed compound from the prior art. *In re Dillon*, 919 F.2d 688, 16 USPQ2d 1897 (Fed. Cir. 1991).

See MPEP § 716.02 - § 716.02(g) for a discussion of evidence alleging unexpectedly advantageous or superior results.

## 2145 Consideration of Applicant's Rebuttal Arguments [R-2]

### I. ARGUMENT DOES NOT REPLACE EVIDENCE WHERE EVIDENCE IS NECESSARY

Attorney argument is not evidence unless it is an admission, in which case, an examiner may use the admission in making a rejection. See MPEP § 2129 and § 2144.03 for a discussion of admissions as prior art.

The arguments of counsel cannot take the place of evidence in the record. *In re Schulze*, 346 F.2d 600, 602, 145 USPQ 716, 718 (CCPA 1965); *In re Geisler*, 116 F.3d 1465, 43 USPQ2d 1362 (Fed. Cir. 1997) (“An assertion of what seems to follow from common experience is just attorney argument and not the kind of factual evidence that is required to rebut a *prima facie* case of obviousness.”). See MPEP § 716.01(c) for examples of attorney statements which are not evidence and which must be supported by an appropriate affidavit or declaration.

### II. ARGUING ADDITIONAL ADVANTAGES OR LATENT PROPERTIES

#### *Prima Facie Obviousness Is Not Rebutted by Merely Recognizing Additional Advantages or Latent Properties Present in the Prior Art*

Mere recognition of latent properties in the prior art does not render nonobvious an otherwise known invention. *In re Wiseman*, 596 F.2d 1019, 201 USPQ 658 (CCPA 1979) (Claims were directed to grooved carbon disc brakes wherein the grooves were provided to vent steam or vapor during a braking action. A prior art reference taught noncarbon disc brakes which were grooved for the purpose of cooling the faces of the braking members and eliminating dust. The court held the prior art references when combined would overcome the problems of dust and overheating solved by the prior art and would inherently overcome the steam or vapor cause of the problem relied upon for patentability by applicants. Granting a patent on the discovery of an unknown but inherent function (here venting steam or vapor) “would remove from the public that which is in the public domain by virtue of its inclusion in, or obviousness from, the prior art.” 596 F.2d at 1022, 201 USPQ at 661.); *In re Baxter*

*Travenol Labs.*, 952 F.2d 388, 21 USPQ2d 1281 (Fed. Cir. 1991) (Appellant argued that the presence of DEHP as the plasticizer in a blood collection bag unexpectedly suppressed hemolysis and therefore rebutted any *prima facie* showing of obviousness, however the closest prior art utilizing a DEHP plasticized blood collection bag inherently achieved same result, although this fact was unknown in the prior art.).

“The fact that appellant has recognized another advantage which would flow naturally from following the suggestion of the prior art cannot be the basis for patentability when the differences would otherwise be obvious.” *Ex parte Obiaya*, 227 USPQ 58, 60 (Bd. Pat. App. & Inter. 1985) (The prior art taught combustion fluid analyzers which used labyrinth heaters to maintain the samples at a uniform temperature. Although appellant showed an unexpectedly shorter response time was obtained when a labyrinth heater was employed, the Board held this advantage would flow naturally from following the suggestion of the prior art.). See also *Lantech Inc. v. Kaufman Co. of Ohio Inc.*, 878 F.2d 1446, 12 USPQ2d 1076, 1077 (Fed. Cir. 1989), *cert. denied*, 493 U.S. 1058 (1990) (unpublished — not citable as precedent) (“The recitation of an additional advantage associated with doing what the prior art suggests does not lend patentability to an otherwise unpatentable invention.”).

*In re Lintner*, 458 F.2d 1013, 173 USPQ 560 (CCPA 1972) and *In re Dillon*, 919 F.2d 688, 16 USPQ2d 1897 (Fed. Cir. 1990) discussed in MPEP § 2144 are also pertinent to this issue.

See MPEP § 716.02 - § 716.02(g) for a discussion of declaratory evidence alleging unexpected results.

### III. ARGUING THAT PRIOR ART DEVICES ARE NOT PHYSICALLY COMBINABLE

“The test for obviousness is not whether the features of a secondary reference may be bodily incorporated into the structure of the primary reference.... Rather, the test is what the combined teachings of those references would have suggested to those of ordinary skill in the art.” *In re Keller*, 642 F.2d 413, 425, 208 USPQ 871, 881 (CCPA 1981). See also *In re Sneed*, 710 F.2d 1544, 1550, 218 USPQ 385, 389 (Fed. Cir. 1983) (“[I]t is not necessary that the inventions of the references be physically combinable to render obvious the invention under review.”); and *In*

*re Nievelt*, 482 F.2d 965, 179 USPQ 224, 226 (CCPA 1973) (“Combining the teachings of references does not involve an ability to combine their specific structures.”).

However, the claimed combination cannot change the principle of operation of the primary reference or render the reference inoperable for its intended purpose. See MPEP § 2143.01.

#### IV. ARGUING AGAINST REFERENCES INDIVIDUALLY

One cannot show nonobviousness by attacking references individually where the rejections are based on combinations of references. *In re Keller*, 642 F.2d 413, 208 USPQ 871 (CCPA 1981); *In re Merck & Co., Inc.*, 800 F.2d 1091, 231 USPQ 375 (Fed. Cir. 1986).

#### V. ARGUING ABOUT THE NUMBER OF REFERENCES COMBINED

Reliance on a large number of references in a rejection does not, without more, weigh against the obviousness of the claimed invention. *In re Gorman*, 933 F.2d 982, 18 USPQ2d 1885 (Fed. Cir. 1991) (Court affirmed a rejection of a detailed claim to a candy sucker shaped like a thumb on a stick based on thirteen prior art references.).

#### VI. ARGUING LIMITATIONS WHICH ARE NOT CLAIMED

Although the claims are interpreted in light of the specification, limitations from the specification are not read into the claims. *In re Van Geuns*, 988 F.2d 1181, 26 USPQ2d 1057 (Fed. Cir. 1993) (Claims to a superconducting magnet which generates a “uniform magnetic field” were not limited to the degree of magnetic field uniformity required for Nuclear Magnetic Resonance (NMR) imaging. Although the specification disclosed that the claimed magnet may be used in an NMR apparatus, the claims were not so limited.); *Constant v. Advanced Micro-Devices, Inc.*, 848 F.2d 1560, 1571-72, 7 USPQ2d 1057, 1064-1065 (Fed. Cir.), *cert. denied*, 488 U.S. 892 (1988) (Various limitations on which appellant relied were not stated in the claims; the specification did not provide evidence indicating these limitations must be read into the claims to give meaning to the disputed terms.); *Ex parte McCullough*, 7 USPQ2d 1889, 1891 (Bd. Pat. App. & Inter. 1987) (Claimed electrode was rejected

as obvious despite assertions that electrode functions differently than would be expected when used in non-aqueous battery since “although the demonstrated results may be germane to the patentability of a battery containing appellant’s electrode, they are not germane to the patentability of the invention claimed on appeal.”).

See MPEP § 2111 - § 2116.01, for additional case law relevant to claim interpretation.

#### VII. ARGUING ECONOMIC INFEASIBILITY

The fact that a combination would not be made by businessmen for economic reasons does not mean that a person of ordinary skill in the art would not make the combination because of some technological incompatibility. *In re Farrenkopf*, 713 F.2d 714, 219 USPQ 1 (Fed. Cir. 1983) (Prior art reference taught that addition of inhibitors to radioimmunoassay is the most convenient, but costliest solution to stability problem. The court held that the additional expense associated with the addition of inhibitors would not discourage one of ordinary skill in the art from seeking the convenience expected therefrom.).

#### VIII. ARGUING ABOUT THE AGE OF REFERENCES

“The mere age of the references is not persuasive of the unobviousness of the combination of their teachings, absent evidence that, notwithstanding knowledge of the references, the art tried and failed to solve the problem.” *In re Wright*, 569 F.2d 1124, 1127, 193 USPQ 332, 335 (CCPA 1977) (100 year old patent was properly relied upon in a rejection based on a combination of references.). See also *Ex parte Meyer*, 6 USPQ2d 1966 (Bd. Pat. App. & Inter. 1988) (length of time between the issuance of prior art patents relied upon (1920 and 1976) was not persuasive of unobviousness).

#### IX. ARGUING THAT PRIOR ART IS NONANALOGOUS

A prior art reference is analogous if the reference is in the field of applicant’s endeavor or, if not, the reference is reasonably pertinent to the particular problem with which the inventor was concerned. *In re Oetiker*, 977 F.2d 1443, 1446, 24 USPQ2d 1443, 1445 (Fed. Cir. 1992).

See MPEP § 2141.01(a) for case law pertaining to analogous art.

## X. ARGUING IMPROPER RATIONALES FOR COMBINING REFERENCES

### A. *Impermissible Hindsight*

Applicants may argue that the examiner's conclusion of obviousness is based on improper hindsight reasoning. However, "[a]ny judgement on obviousness is in a sense necessarily a reconstruction based on hindsight reasoning, but so long as it takes into account only knowledge which was within the level of ordinary skill in the art at the time the claimed invention was made and does not include knowledge gleaned only from applicant's disclosure, such a reconstruction is proper." *In re McLaughlin* 443 F.2d 1392, 1395, 170 USPQ 209, 212 (CCPA 1971). >Applicants may also argue that the combination of two or more references is "hindsight" because "express" motivation to combine the references is lacking. However, there is no requirement that an "express, written motivation to combine must appear in prior art references before a finding of obviousness." See *Ruiz v. A.B. Chance Co.*, 357 F.3d 1270, 1276, 69 USPQ2d 1686, 1690 (Fed. Cir. 2004). For example, motivation to combine prior art references may exist in the nature of the problem to be solved (*Ruiz* at 1276, 69 USPQ2d at 1690) or the knowledge of one of ordinary skill in the art (*National Steel Car v. Canadian Pacific Railway Ltd.*, 357 F.3d 1319, 1338, 69 USPQ2d 1641, 1656 (Fed. Cir. 2004)). See MPEP § 2143.01 for a discussion of proper motivation to combine references.<

### B. *Obvious To Try Rationale*

An applicant may argue the examiner is applying an improper "obvious to try" rationale in support of an obviousness rejection.

"The admonition that 'obvious to try' is not the standard under § 103 has been directed mainly at two kinds of error. In some cases, what would have been 'obvious to try' would have been to vary all parameters or try each of numerous possible choices until one possibly arrived at a successful result, where the prior art gave either no indication of which parameters were critical or no direction as to which of many pos-

sible choices is likely to be successful.... In others, what was 'obvious to try' was to explore a new technology or general approach that seemed to be a promising field of experimentation, where the prior art gave only general guidance as to the particular form of the claimed invention or how to achieve it." *In re O'Farrell*, 853 F.2d 894, 903, 7 USPQ2d 1673, 1681 (Fed. Cir. 1988) (citations omitted) (The court held the claimed method would have been obvious over the prior art relied upon because one reference contained a detailed enabling methodology, a suggestion to modify the prior art to produce the claimed invention, and evidence suggesting the modification would be successful.). See the cases cited in *O'Farrell* for examples of decisions where the court discussed an improper "obvious to try" approach. See also *In re Eli Lilly & Co.*, 902 F.2d 943, 14 USPQ2d 1741 (Fed. Cir. 1990) and *In re Ball Corp.*, 925 F.2d 1480, 18 USPQ2d 1491 (Fed. Cir. 1991) (unpublished) for examples of cases where appellants argued that an improper "obvious to try" standard was applied, but the court found that there was proper motivation to modify the references.

### C. *Lack of Suggestion To Combine References*

As discussed in MPEP § 2143.01, there must be some suggestion or motivation, either in the references themselves or in the knowledge generally available to one of ordinary skill in the art, to modify or combine reference teachings. The Federal Circuit has produced a number of decisions overturning obviousness rejections due to a lack of suggestion in the prior art of the desirability of combining references, as discussed in the aforementioned section.

### D. *References Teach Away from the Invention or Render Prior Art Unsatisfactory for Intended Purpose*

In addition to the material below, see MPEP § 2141.02 (prior art must be considered in its entirety, including disclosures that teach away from the claims) and MPEP § 2143.01 (proposed modification cannot render the prior art unsatisfactory for its intended purpose or change the principle of operation of a reference).

### 1. The Nature of the Teaching Is Highly Relevant

A prior art reference that “teaches away” from the claimed invention is a significant factor to be considered in determining obviousness; however, “the nature of the teaching is highly relevant and must be weighed in substance. A known or obvious composition does not become patentable simply because it has been described as somewhat inferior to some other product for the same use.” *In re Gurley*, 27 F.3d 551, 554, 31 USPQ2d 1130, 1132 (Fed. Cir. 1994) (Claims were directed to an epoxy resin based printed circuit material. A prior art reference disclosed a polyester-imide resin based printed circuit material, and taught that although epoxy resin based materials have acceptable stability and some degree of flexibility, they are inferior to polyester-imide resin based materials. The court held the claims would have been obvious over the prior art because the reference taught epoxy resin based material was useful for applicant’s purpose, applicant did not distinguish the claimed epoxy from the prior art epoxy, and applicant asserted no discovery beyond what was known to the art.).

### 2. References Cannot Be Combined Where Reference Teaches Away from Their Combination

It is improper to combine references where the references teach away from their combination. *In re Grasselli*, 713 F.2d 731, 743, 218 USPQ 769, 779 (Fed. Cir. 1983) (The claimed catalyst which contained both iron and an alkali metal was not suggested by the combination of a reference which taught the interchangeability of antimony and alkali metal with the same beneficial result, combined with a reference expressly excluding antimony from, and adding iron to, a catalyst.).

### 3. Proceeding Contrary to Accepted Wisdom Is Evidence of Nonobviousness

The totality of the prior art must be considered, and proceeding contrary to accepted wisdom in the art is evidence of nonobviousness. *In re Hedges*, 783 F.2d

1038, 228 USPQ 685 (Fed. Cir. 1986) (Applicant’s claimed process for sulfonating diphenyl sulfone at a temperature above 127°C was contrary to accepted wisdom because the prior art as a whole suggested using lower temperatures for optimum results as evidenced by charring, decomposition, or reduced yields at higher temperatures.).

Furthermore, “[k]nown disadvantages in old devices which would naturally discourage search for new inventions may be taken into account in determining obviousness.” *United States v. Adams*, 383 U.S. 39, 52, 148 USPQ 479, 484 (1966).

## XI. FORM PARAGRAPHS

See MPEP § 707.07(f) for form paragraphs 7.37 through 7.38 which may be used where applicant’s arguments are not persuasive or are moot.

### 2146 35 U.S.C. 103(c)

*35 U.S.C. 103. Conditions of patentability; non-obvious subject matter.*

\*\*\*\*\*

(c) Subject matter developed by another person, which qualifies as prior art only under one or more subsections (e), (f), and (g) of section 102 of this title, shall not preclude patentability under this section where the subject matter and the claimed invention were, at the time the invention was made, owned by the same person or subject to an obligation of assignment to the same person.

Effective November 29, 1999, 35 U.S.C. 103(c) provides that subject matter developed by another which qualifies as “prior art” only under one or more of subsections 35 U.S.C. 102(e), (f) and (g) is not to be considered when determining whether an invention sought to be patented is obvious under 35 U.S.C. 103, provided the subject matter and the claimed invention were commonly owned at the time the invention was made. 35 U.S.C. 103(c) applies only to subject matter which qualifies as prior art under 35 U.S.C. 103; it does not affect subject matter which qualifies as prior art under 35 U.S.C. 102, i.e., anticipatory prior art. See MPEP § 706.02(1) - § 706.02(1)(3).

## 2161 Three Separate Requirements for Specification Under 35 U.S.C. 112, First Paragraph

### THE SPECIFICATION MUST INCLUDE A WRITTEN DESCRIPTION OF THE INVENTION, ENABLEMENT, AND BEST MODE OF CARRYING OUT THE CLAIMED INVENTION

The first paragraph of 35 U.S.C. 112 provides:

The specification shall contain a written description of the invention, and of the manner and process of making and using it, in such full, clear, concise, and exact terms as to enable any person skilled in the art to which it pertains, or with which it is most nearly connected, to make and use the same, and shall set forth the best mode contemplated by the inventor of carrying out his invention. [emphasis added].

This section of the statute requires that the specification include the following:

- (A) A written description of the invention;
- (B) The manner and process of making and using the invention (the enablement requirement); and
- (C) The best mode contemplated by the inventor of carrying out his invention.

### THE THREE REQUIREMENTS ARE SEPARATE AND DISTINCT FROM EACH OTHER

The written description requirement is separate and distinct from the enablement requirement. *In re Barker*, 559 F.2d 588, 194 USPQ 470 (CCPA 1977), cert. denied, 434 U.S. 1064 (1978); *Vas-Cath, Inc. v. Mahurkar*, 935 F.2d 1555, 1562, 19 USPQ2d 1111, 1115 (Fed. Cir. 1991) (While acknowledging that some of its cases concerning the written description requirement and the enablement requirement are confusing, the Federal Circuit reaffirmed that under 35 U.S.C. 112, first paragraph, the written description requirement is separate and distinct from the enablement requirement and gave an example thereof.). An invention may be described without the disclosure being enabling (e.g., a chemical compound for which there is no disclosed or apparent method of making), and a disclosure could be enabling without describing the invention (e.g., a specification describing a method of making and using a paint composition made of functionally defined ingredients within broad ranges would be enabling for formulations falling

within the description but would not describe any specific formulation). See *In re Armbruster*, 512 F.2d 676, 677, 185 USPQ 152, 153 (CCPA 1975) (“[A] specification which ‘describes’ does not necessarily also ‘enable’ one skilled in the art to make or use the claimed invention.”). Best mode is a separate and distinct requirement from the enablement requirement. *In re Newton*, 414 F.2d 1400, 163 USPQ 34 (CCPA 1969).

## 2162 Policy Underlying 35 U.S.C. 112, First Paragraph

To obtain a valid patent, a patent application must be filed that contains a full and clear disclosure of the invention in the manner prescribed by 35 U.S.C. 112, first paragraph. The requirement for an adequate disclosure ensures that the public receives something in return for the exclusionary rights that are granted to the inventor by a patent. The grant of a patent helps to foster and enhance the development and disclosure of new ideas and the advancement of scientific knowledge. Upon the grant of a patent in the U.S., information contained in the patent becomes a part of the information available to the public for further research and development, subject only to the patentee’s right to exclude others during the life of the patent.

In exchange for the patent rights granted, 35 U.S.C. 112, first paragraph, sets forth the minimum requirements for the quality and quantity of information that must be contained in the patent to justify the grant. As discussed in more detail below, the patentee must disclose in the patent sufficient information to put the public in possession of the invention and to enable those skilled in the art to make and use the invention. The applicant must not conceal from the public the best way of practicing the invention that was known to the patentee at the time of filing the patent application. Failure to fully comply with the disclosure requirements could result in the denial of a patent, or in a holding of invalidity of an issued patent.

## 2163 Guidelines for the Examination of Patent Applications Under the 35 U.S.C. 112, para. 1, “Written Description” Requirement [R-2]

The following Guidelines establish the policies and procedures to be followed by Office personnel in the

evaluation of any patent application for compliance with the written description requirement of 35 U.S.C. 112. These Guidelines are based on the Office's current understanding of the law and are believed to be fully consistent with binding precedent of the U.S. Supreme Court, as well as the U.S. Court of Appeals for the Federal Circuit and its predecessor courts.

The Guidelines do not constitute substantive rule-making and hence do not have the force and effect of law. They are designed to assist Office personnel in analyzing claimed subject matter for compliance with substantive law. Rejections will be based upon the substantive law, and it is these rejections which are appealable. Consequently, any perceived failure by Office personnel to follow these Guidelines is neither appealable nor petitionable.

These Guidelines are intended to form part of the normal examination process. Thus, where Office personnel establish a prima facie case of lack of written description for a claim, a thorough review of the prior art and examination on the merits for compliance with the other statutory requirements, including those of 35 U.S.C. 101, 102, 103, and 112, is to be conducted prior to completing an Office action which includes a rejection for lack of written description.

## I. GENERAL PRINCIPLES GOVERNING COMPLIANCE WITH THE "WRITTEN DESCRIPTION" REQUIREMENT FOR APPLICATIONS

The first paragraph of 35 U.S.C. 112 requires that the "specification shall contain a written description of the invention \* \* \*." This requirement is separate and distinct from the enablement requirement. See, e.g., *Vas-Cath, Inc. v. Mahurkar*, 935 F.2d 1555, 1560, 19 USPQ2d 1111, 1114 (Fed. Cir. 1991). >See also *Univ. of Rochester v. G.D. Searle & Co.*, 358 F.3d 916, 920-23, 69 USPQ2d 1886, 1890-93 (Fed. Cir. 2004) (discussing history and purpose of the written description requirement); *In re Curtis*, 354 F.3d 1347, 1357, 69 USPQ2d 1274, 1282 (Fed. Cir. 2004) ("conclusive evidence of a claim's enablement is not equally conclusive of that claim's satisfactory written description").< The written description requirement has several policy objectives. "[T]he 'essential goal' of the description of the invention requirement is to clearly convey the information that an applicant has invented the subject matter which is claimed." *In re*

*Barker*, 559 F.2d 588, 592 n.4, 194 USPQ 470, 473 n.4 (CCPA 1977). Another objective is to put the public in possession of what the applicant claims as the invention. See *Regents of the University of California v. Eli Lilly*, 119 F.3d 1559, 1566, 43 USPQ2d 1398, 1404 (Fed. Cir. 1997), *cert. denied*, 523 U.S. 1089 (1998). The written description requirement of the Patent Act promotes the progress of the useful arts by ensuring that patentees adequately describe their inventions in their patent specifications in exchange for the right to exclude others from practicing the invention for the duration of the patent's term.

To satisfy the written description requirement, a patent specification must describe the claimed invention in sufficient detail that one skilled in the art can reasonably conclude that the inventor had possession of the claimed invention. See, e.g., >*Moba, B.V. v. Diamond Automation, Inc.*, 325 F.3d 1306, 1319, 66 USPQ2d 1429, 1438 (Fed. Cir. 2003);< *Vas-Cath, Inc. v. Mahurkar*, 935 F.2d at 1563, 19 USPQ2d at 1116. However, a showing of possession alone does not cure the lack of a written description. *Enzo Biochem, Inc. v. Gen-Probe, Inc.*, \*\*>323 F.3d 956, 969-70,< 63 USPQ2d 1609, 1617 (Fed. Cir. 2002). Much of the written description case law addresses whether the specification as originally filed supports claims not originally in the application. The issue raised in the cases is most often phrased as whether the original application provides "adequate support" for the claims at issue or whether the material added to the specification incorporates "new matter" in violation of 35 U.S.C. 132. The "written description" question similarly arises in the interference context, where the issue is whether the specification of one party to the interference can support the newly added claims corresponding to the count at issue, i.e., whether that party can "make the claim" corresponding to the interference count. See, e.g., *Martin v. Mayer*, 823 F.2d 500, 503, 3 USPQ2d 1333, 1335 (Fed. Cir. 1987). In addition, early opinions suggest the Patent and Trademark Office was unwilling to find written descriptive support when the only description was found in the claims; however, this viewpoint was rejected. See *In re Koller*, 613 F.2d 819, 204 USPQ 702 (CCPA 1980) (original claims constitute their own description); accord *In re Gardner*, 475 F.2d 1389, 177 USPQ 396 (CCPA 1973); accord *In re Wertheim*, 541 F.2d 257, 191 USPQ 90 (CCPA 1976). It is

now well accepted that a satisfactory description may be in the claims or any other portion of the originally filed specification. These early opinions did not address the quality or specificity of particularity that was required in the description, i.e., how much description is enough.

An applicant shows possession of the claimed invention by describing the claimed invention with all of its limitations using such descriptive means as words, structures, figures, diagrams, and formulas that fully set forth the claimed invention. *Lockwood v. American Airlines, Inc.*, 107 F.3d 1565, 1572, 41 USPQ2d 1961, 1966 (Fed. Cir. 1997). Possession may be shown in a variety of ways including description of an actual reduction to practice, or by showing that the invention was “ready for patenting” such as by the disclosure of drawings or structural chemical formulas that show that the invention was complete, or by describing distinguishing identifying characteristics sufficient to show that the applicant was in possession of the claimed invention. See, e.g., *Pfaff v. Wells Elecs., Inc.*, 525 U.S. 55, 68, 119 S.Ct. 304, 312, 48 USPQ2d 1641, 1647 (1998); *Eli Lilly*, 119 F.3d at 1568, 43 USPQ2d at 1406; *Amgen, Inc. v. Chugai Pharmaceutical*, 927 F.2d 1200, 1206, 18 USPQ2d 1016, 1021 (Fed. Cir. 1991) (one must define a compound by “whatever characteristics sufficiently distinguish it”). “Compliance with the written description requirement is essentially a fact-based inquiry that will ‘necessarily vary depending on the nature of the invention claimed.’” *Enzo Biochem*, \*\*>323 F.3d at 963<, 63 USPQ2d at 1613. An application specification may show actual reduction to practice by describing testing of the claimed invention or, in the case of biological materials, by specifically describing a deposit made in accordance with 37 CFR 1.801 *et seq.* See *Enzo Biochem*, \*\*>323 F.3d at 965<, 63 USPQ2d at 1614 (“reference in the specification to a deposit may also satisfy the written description requirement with respect to a claimed material”); see also Deposit of Biological Materials for Patent Purposes, Final Rule, 54 FR 34,864 (August 22, 1989) (“The requirement for a specific identification is consistent with the description requirement of the first paragraph of 35 U.S.C. 112, and to provide an antecedent basis for the biological material which either has been or will be deposited before the patent is granted.” *Id.* at 34,876. “The description must be sufficient to permit verifica-

tion that the deposited biological material is in fact that disclosed. Once the patent issues, the description must be sufficient to aid in the resolution of questions of infringement.” *Id.* at 34,880.). Such a deposit is not a substitute for a written description of the claimed invention. The written description of the deposited material needs to be as complete as possible because the examination for patentability proceeds solely on the basis of the written description. See, e.g., *In re Lundak*, 773 F.2d 1216, 227 USPQ 90 (Fed. Cir. 1985). See also 54 FR at 34,880 (“As a general rule, the more information that is provided about a particular deposited biological material, the better the examiner will be able to compare the identity and characteristics of the deposited biological material with the prior art.”).

A question as to whether a specification provides an adequate written description may arise in the context of an original claim which is not described sufficiently (see, e.g., *Enzo Biochem*, \*\*>323 F.3d at 968<, 63 USPQ2d at 1616 (Fed. Cir. 2002); *Eli Lilly*, 119 F.3d 1559, 43 USPQ2d 1398), a new or amended claim wherein a claim limitation has been added or removed, or a claim to entitlement of an earlier priority date or effective filing date under 35 U.S.C. 119, 120, or 365(c). Most typically, the issue will arise in the context of determining whether new or amended claims are supported by the description of the invention in the application as filed (see, e.g., *In re Wright*, 866 F.2d 422, 9 USPQ2d 1649 (Fed. Cir. 1989)), whether a claimed invention is entitled to the benefit of an earlier priority date or effective filing date under 35 U.S.C. 119, 120, or 365(c) (see, e.g., *New Railhead Mfg. L.L.C. v. Vermeer Mfg. Co.*, 298 F.3d 1290, 63 USPQ2d 1843 (Fed. Cir. 2002); *Tronzo v. Biomet, Inc.*, 156 F.3d 1154, 47 USPQ2d 1829 (Fed. Cir. 1998); *Fiers v. Revel*, 984 F.2d 1164, 25 USPQ2d 1601 (Fed. Cir. 1993); *In re Ziegler*, 992 F.2d 1197, 1200, 26 USPQ2d 1600, 1603 (Fed. Cir. 1993)), or whether a specification provides support for a claim corresponding to a count in an interference (see, e.g., *Fields v. Conover*, 443 F.2d 1386, 170 USPQ 276 (CCPA 1971)). Compliance with the written description requirement is a question of fact which must be resolved on a case-by-case basis. *Vas-Cath, Inc. v. Mahurkar*, 935 F.2d at 1563, 19 USPQ2d at 1116 (Fed. Cir. 1991).



### A. *Original Claims*

There is a strong presumption that an adequate written description of the claimed invention is present when the application is filed. *In re Wertheim*, 541 F.2d 257, 263, 191 USPQ 90, 97 (CCPA 1976) (“we are of the opinion that the PTO has the initial burden of presenting evidence or reasons why persons skilled in the art would not recognize in the disclosure a description of the invention defined by the claims”). However, as discussed in paragraph I, *supra*, the issue of a lack of adequate written description may arise even for an original claim when an aspect of the claimed invention has not been described with sufficient particularity such that one skilled in the art would recognize that the applicant had possession of the claimed invention. The claimed invention as a whole may not be adequately described if the claims require an essential or critical feature which is not adequately described in the specification and which is not conventional in the art or known to one of ordinary skill in the art. For example, consider the claim “A gene comprising SEQ ID NO:1.” A determination of what the claim as a whole covers may result in a conclusion that specific structures such as a promoter, a coding region, or other elements are included. Although all genes encompassed by this claim share the characteristic of comprising SEQ ID NO:1, there may be insufficient description of those specific structures (e.g., promoters, enhancers, coding regions, and other regulatory elements) which are also included.

The claimed invention as a whole may not be adequately described where an invention is described solely in terms of a method of its making coupled with its function and there is no described or art-recognized correlation or relationship between the structure of the invention and its function. A biomolecule sequence described only by a functional characteristic, without any known or disclosed correlation between that function and the structure of the sequence, normally is not a sufficient identifying characteristic for written description purposes, even when accompanied by a method of obtaining the claimed sequence. For example, even though a genetic code table would correlate a known amino acid sequence with a genus of coding nucleic acids, the same table cannot predict the native, naturally occurring nucleic acid sequence of a naturally occurring mRNA or its corresponding cDNA. Cf. *In re Bell*,

991 F.2d 781, 26 USPQ2d 1529 (Fed. Cir. 1993), and *In re Deuel*, 51 F.3d 1552, 34 USPQ2d 1210 (Fed. Cir. 1995) (holding that a process could not render the product of that process obvious under 35 U.S.C. 103). The Federal Circuit has pointed out that under United States law, a description that does not render a claimed invention obvious cannot sufficiently describe the invention for the purposes of the written description requirement of 35 U.S.C. 112. *Eli Lilly*, 119 F.3d at 1567, 43 USPQ2d at 1405. Compare *Fonar Corp. v. General Electric Co.*, 107 F.3d 1543, 1549, 41 USPQ2d 1801, 1805 (Fed. Cir. 1997) (“As a general rule, where software constitutes part of a best mode of carrying out an invention, description of such a best mode is satisfied by a disclosure of the functions of the software. This is because, normally, writing code for such software is within the skill of the art, not requiring undue experimentation, once its functions have been disclosed. \* \* \* Thus, flow charts or source code listings are not a requirement for adequately disclosing the functions of software.”).

A lack of adequate written description issue also arises if the knowledge and level of skill in the art would not permit one skilled in the art to immediately envisage the product claimed from the disclosed process. See, e.g., *Fujikawa v. Wattanasin*, 93 F.3d 1559, 1571, 39 USPQ2d 1895, 1905 (Fed. Cir. 1996) (a “laundry list” disclosure of every possible moiety does not constitute a written description of every species in a genus because it would not “reasonably lead” those skilled in the art to any particular species); *In re Ruschig*, 379 F.2d 990, 995, 154 USPQ 118, 123 (CCPA 1967) (“If n-propylamine had been used in making the compound instead of n-butylamine, the compound of claim 13 would have resulted. Appellants submit to us, as they did to the board, an imaginary specific example patterned on specific example 6 by which the above butyl compound is made so that we can see what a simple change would have resulted in a specific supporting disclosure being present in the present specification. The trouble is that there is no such disclosure, easy though it is to imagine it.”) (emphasis in original); *Purdue Pharma L.P. v. Faulding Inc.*, 230 F.3d 1320, 1328, 56 USPQ2d 1481, 1487 (Fed. Cir. 2000) (“the specification does not clearly disclose to the skilled artisan that the inventors ... considered the ratio... to be part of their invention .... There is therefore no force to Purdue’s argument that

the written description requirement was satisfied because the disclosure revealed a broad invention from which the [later-filed] claims carved out a patentable portion”).

### **B. New or Amended Claims**

The proscription against the introduction of new matter in a patent application (35 U.S.C. 132 and 251) serves to prevent an applicant from adding information that goes beyond the subject matter originally filed. See *In re Rasmussen*, 650 F.2d 1212, 1214, 211 USPQ 323, 326 (CCPA 1981). See MPEP § 2163.06 through § 2163.07 for a more detailed discussion of the written description requirement and its relationship to new matter. The claims as filed in the original specification are part of the disclosure and, therefore, if an application as originally filed contains a claim disclosing material not found in the remainder of the specification, the applicant may amend the specification to include the claimed subject matter. *In re Benno*, 768 F.2d 1340, 226 USPQ 683 (Fed. Cir. 1985). Thus, the written description requirement prevents an applicant from claiming subject matter that was not adequately described in the specification as filed. New or amended claims which introduce elements or limitations which are not supported by the as-filed disclosure violate the written description requirement. See, e.g., *In re Lukach*, 442 F.2d 967, 169 USPQ 795 (CCPA 1971) (subgenus range was not supported by generic disclosure and specific example within the subgenus range); *In re Smith*, 458 F.2d 1389, 1395, 173 USPQ 679, 683 (CCPA 1972) (a subgenus is not necessarily described by a genus encompassing it and a species upon which it reads).

While there is no *in haec verba* requirement, newly added claim limitations must be supported in the specification through express, implicit, or inherent disclosure. An amendment to correct an obvious error does not constitute new matter where one skilled in the art would not only recognize the existence of the error in the specification, but also recognize the appropriate correction. *In re Oda*, 443 F.2d 1200, 170 USPQ 268 (CCPA 1971). With respect to the correction of sequencing errors in applications disclosing nucleic acid and/or amino acid sequences, it is well known that sequencing errors are a common problem in molecular biology. See, e.g.,

Peter Richterich, Estimation of Errors in ‘Raw’ DNA Sequences: A Validation Study, 8 *Genome Research* 251-59 (1998). If an application as filed includes sequence information and references a deposit of the sequenced material made in accordance with the requirements of 37 CFR 1.801 *et seq.*, amendment may be permissible. Deposits made after the application filing date cannot be relied upon to support additions to or correction of information in the application as filed. Corrections of minor errors in the sequence may be possible based on the argument that one of skill in the art would have resequenced the deposited material and would have immediately recognized the minor error. Deposits made after the filing date can only be relied upon to provide support for the correction of sequence information if applicant submits a statement in compliance with 37 CFR 1.804 stating that the biological material which is deposited is a biological material specifically defined in the application as filed.

Under certain circumstances, omission of a limitation can raise an issue regarding whether the inventor had possession of a broader, more generic invention. See, e.g., *PIN/NIP, Inc. v. Platte Chem. Co.*, 304 F.3d 1235, 1248, 64 USPQ2d 1344, 1353 (Fed. Cir. 2002) (Claim for a method of inhibiting sprout growth on tubers by treating them with spaced, sequential application of two chemicals was held invalid for lack of adequate written description where the specification indicated that invention was a method of applying a “composition,” or mixture, of the two chemicals.); *Gentry Gallery, Inc. v. Berkline Corp.*, 134 F.3d 1473, 45 USPQ2d 1498 (Fed. Cir. 1998) (claims to a sectional sofa comprising, inter alia, a console and a control means were held invalid for failing to satisfy the written description requirement where the claims were broadened by removing the location of the control means); *Johnson Worldwide Associates v. Zebco Corp.*, 175 F.3d 985, 993, 50 USPQ2d 1607, 1613 (Fed. Cir. 1999) (In *Gentry Gallery*, the “court’s determination that the patent disclosure did not support a broad meaning for the disputed claim terms was premised on clear statements in the written description that described the location of a claim element—the ‘control means’ --as ‘the only possible location’ and that variations were ‘outside the stated purpose of the invention.’ *Gentry Gallery*, 134 F.3d at 1479, 45 USPQ2d at 1503. *Gentry Gallery*, then, considers the

situation where the patent's disclosure makes crystal clear that a particular (i.e., narrow) understanding of a claim term is an 'essential element of [the inventor's] invention.'"); *Tronzo v. Biomet*, 156 F.3d at 1158-59, 47 USPQ2d at 1833 (Fed. Cir. 1998) (claims to generic cup shape were not entitled to filing date of parent application which disclosed "conical cup" in view of the disclosure of the parent application stating the advantages and importance of the conical shape.). A claim that omits an element which applicant describes as an essential or critical feature of the invention originally disclosed does not comply with the written description requirement. See *Gentry Gallery*, 134 F.3d at 1480, 45 USPQ2d at 1503; *In re Sus*, 306 F.2d 494, 504, 134 USPQ 301, 309 (CCPA 1962) ("[O]ne skilled in this art would not be taught by the written description of the invention in the specification that any 'aryl or substituted aryl radical' would be suitable for the purposes of the invention but rather that only certain aryl radicals and certain specifically substituted aryl radicals [i.e., aryl azides] would be suitable for such purposes.") (emphasis in original). A claim which omits matter disclosed to be essential to the invention as described in the specification or in other statements of record may also be subject to rejection under 35 U.S.C. 112, para. 1, as not enabling, or under 35 U.S.C. 112, para. 2. See *In re Mayhew*, 527 F.2d 1229, 188 USPQ 356 (CCPA 1976); *In re Venezia*, 530 F.2d 956, 189 USPQ 149 (CCPA 1976); and *In re Collier*, 397 F.2d 1003, 158 USPQ 266 (CCPA 1968). See also MPEP § 2172.01.

The fundamental factual inquiry is whether the specification conveys with reasonable clarity to those skilled in the art that, as of the filing date sought, applicant was in possession of the invention as now claimed. See, e.g., *Vas-Cath, Inc.*, 935 F.2d at 1563-64, 19 USPQ2d at 1117.

## II. METHODOLOGY FOR DETERMINING ADEQUACY OF WRITTEN DESCRIPTION

### A. *Read and Analyze the Specification for Compliance with 35 U.S.C. 112, para. 1*

Office personnel should adhere to the following procedures when reviewing patent applications for compliance with the written description requirement of 35 U.S.C. 112, para. 1. The examiner has the initial

burden, after a thorough reading and evaluation of the content of the application, of presenting evidence or reasons why a person skilled in the art would not recognize that the written description of the invention provides support for the claims. There is a strong presumption that an adequate written description of the claimed invention is present in the specification as filed, *Wertheim*, 541 F.2d at 262, 191 USPQ at 96; however, with respect to newly added or amended claims, applicant should show support in the original disclosure for the new or amended claims. See MPEP § 714.02 and § 2163.06 ("Applicant should \* \* \* specifically point out the support for any amendments made to the disclosure."); and MPEP § 2163.04 ("If applicant amends the claims and points out where and/or how the originally filed disclosure supports the amendment(s), and the examiner finds that the disclosure does not reasonably convey that the inventor had possession of the subject matter of the amendment at the time of the filing of the application, the examiner has the initial burden of presenting evidence or reasoning to explain why persons skilled in the art would not recognize in the disclosure a description of the invention defined by the claims."). Consequently, rejection of an original claim for lack of written description should be rare. The inquiry into whether the description requirement is met is a question of fact that must be determined on a case-by-case basis. See *In re Smith*, 458 F.2d 1389, 1395, 173 USPQ 679, 683 (CCPA 1972) ("Precisely how close [to the claimed invention] the description must come to comply with Sec. 112 must be left to case-by-case development."); *In re Wertheim*, 541 F.2d at 262, 191 USPQ at 96 (inquiry is primarily factual and depends on the nature of the invention and the amount of knowledge imparted to those skilled in the art by the disclosure).

### 1. For Each Claim, Determine What the Claim as a Whole Covers

Claim construction is an essential part of the examination process. Each claim must be separately analyzed and given its broadest reasonable interpretation in light of and consistent with the written description. See, e.g., *In re Morris*, 127 F.3d 1048, 1053-54, 44 USPQ2d 1023, 1027 (Fed. Cir. 1997). The entire claim must be considered, including the preamble language and the transitional phrase. "Preamble language" is that language in a claim appearing before

the transitional phase, e.g., before “comprising,” “consisting essentially of,” or “consisting of.” The transitional term “comprising” (and other comparable terms, e.g., “containing,” and “including”) is “open-ended” -it covers the expressly recited subject matter, alone or in combination with unrecited subject matter. See, e.g., *Genentech, Inc. v. Chiron Corp.*, 112 F.3d 495, 501, 42 USPQ2d 1608, 1613 (Fed. Cir. 1997) (“‘Comprising’ is a term of art used in claim language which means that the named elements are essential, but other elements may be added and still form a construct within the scope of the claim.”); *Ex parte Davis*, 80 USPQ 448, 450 (Bd. App. 1948) (“comprising” leaves the “claim open for the inclusion of unspecified ingredients even in major amounts”). See also MPEP § 2111.03. “By using the term ‘consisting essentially of,’ the drafter signals that the invention necessarily includes the listed ingredients and is open to unlisted ingredients that do not materially affect the basic and novel properties of the invention. A ‘consisting essentially of’ claim occupies a middle ground between closed claims that are written in a ‘consisting of’ format and fully open claims that are drafted in a ‘comprising’ format.” *PPG Industries v. Guardian Industries*, 156 F.3d 1351, 1354, 48 USPQ2d 1351, 1353-54 (Fed. Cir. 1998). For the purposes of searching for and applying prior art under 35 U.S.C. 102 and 103, absent a clear indication in the specification or claims of what the basic and novel characteristics actually are, “consisting essentially of” will be construed as equivalent to “comprising.” See, e.g., *PPG*, 156 F.3d at 1355, 48 USPQ2d at 1355 (“PPG could have defined the scope of the phrase ‘consisting essentially of’ for purposes of its patent by making clear in its specification what it regarded as constituting a material change in the basic and novel characteristics of the invention.”). See also *AK Steel Corp. v. Sollac*, 344 F.3d 1234, 1239-1240, 68 USPQ2d 1280, 1283-84 (Fed. Cir. 2003); *In re Janakirama-Rao*, 317 F.2d 951, 954, 137 USPQ 893, 895-96 (CCPA 1963). If an applicant contends that additional steps or materials in the prior art are excluded by the recitation of “consisting essentially of,” applicant has the burden of showing that the introduction of additional steps or components would materially change the characteristics of applicant’s invention. *In re De Lajarte*, 337 F.2d 870, 143 USPQ 256 (CCPA 1964). See also MPEP § 2111.03. The claim as a

whole, including all limitations found in the preamble (see *Pac-Tec Inc. v. Amerace Corp.*, 903 F.2d 796, 801, 14 USPQ2d 1871, 1876 (Fed. Cir. 1990) (determining that preamble language that constitutes a structural limitation is actually part of the claimed invention)), the transitional phrase, and the body of the claim, must be sufficiently supported to satisfy the written description requirement. An applicant shows possession of the claimed invention by describing the claimed invention with all of its limitations. *Lockwood*, 107 F.3d at 1572, 41 USPQ2d at 1966.

The examiner should evaluate each claim to determine if sufficient structures, acts, or functions are recited to make clear the scope and meaning of the claim, including the weight to be given the preamble. See, e.g., *Bell Communications Research, Inc. v. Vitalink Communications Corp.*, 55 F.3d 615, 620, 34 USPQ2d 1816, 1820 (Fed. Cir. 1995) (“[A] claim preamble has the import that the claim as a whole suggests for it.”); *Corning Glass Works v. Sumitomo Elec. U.S.A., Inc.*, 868 F.2d 1251, 1257, 9 USPQ2d 1962, 1966 (Fed. Cir. 1989) (The determination of whether preamble recitations are structural limitations can be resolved only on review of the entirety of the application “to gain an understanding of what the inventors actually invented and intended to encompass by the claim.”). The absence of definitions or details for well-established terms or procedures should not be the basis of a rejection under 35 U.S.C. 112, para. 1, for lack of adequate written description. Limitations may not, however, be imported into the claims from the specification.

## 2. Review the Entire Application to Understand How Applicant Provides Support for the Claimed Invention Including Each Element and/or Step

Prior to determining whether the disclosure satisfies the written description requirement for the claimed subject matter, the examiner should review the claims and the entire specification, including the specific embodiments, figures, and sequence listings, to understand how applicant provides support for the various features of the claimed invention. An element may be critical where those of skill in the art would require it to determine that applicant was in possession of the invention. Compare *Rasmussen*, 650 F.2d at 1215, 211 USPQ at 327 (“one skilled in the art who

read Rasmussen's specification would understand that it is unimportant how the layers are adhered, so long as they are adhered") (emphasis in original), with *Amgen, Inc. v. Chugai Pharmaceutical Co., Ltd.*, 927 F.2d 1200, 1206, 18 USPQ2d 1016, 1021 (Fed. Cir. 1991) ("it is well established in our law that conception of a chemical compound requires that the inventor be able to define it so as to distinguish it from other materials, and to describe how to obtain it"). The analysis of whether the specification complies with the written description requirement calls for the examiner to compare the scope of the claim with the scope of the description to determine whether applicant has demonstrated possession of the claimed invention. Such a review is conducted from the standpoint of one of skill in the art at the time the application was filed (see, e.g., *Wang Labs. v. Toshiba Corp.*, 993 F.2d 858, 865, 26 USPQ2d 1767, 1774 (Fed. Cir. 1993)) and should include a determination of the field of the invention and the level of skill and knowledge in the art. Generally, there is an inverse correlation between the level of skill and knowledge in the art and the specificity of disclosure necessary to satisfy the written description requirement. Information which is well known in the art need not be described in detail in the specification. See, e.g., *Hybritech, Inc. v. Monoclonal Antibodies, Inc.*, 802 F.2d 1367, 1379-80, 231 USPQ 81, 90 (Fed. Cir. 1986).

### **3. Determine Whether There is Sufficient Written Description to Inform a Skilled Artisan That Applicant was in Possession of the Claimed Invention as a Whole at the Time the Application Was Filed**

#### **(a) Original claims**

Possession may be shown in many ways. For example, possession may be shown by describing an actual reduction to practice of the claimed invention. Possession may also be shown by a clear depiction of the invention in detailed drawings or in structural chemical formulas which permit a person skilled in the art to clearly recognize that applicant had possession of the claimed invention. An adequate written description of the invention may be shown by any description of sufficient, relevant, identifying characteristics so long as a person skilled in the art would recognize that the inventor had possession of the claimed invention.

See, e.g., *Purdue Pharma L.P. v. Faulding Inc.*, 230 F.3d 1320, 1323, 56 USPQ2d 1481, 1483 (Fed. Cir. 2000) (the written description "inquiry is a factual one and must be assessed on a case-by-case basis"); see also *Pfaff v. Wells Electronics, Inc.*, 55 U.S. at 66, 119 S.Ct. at 311, 48 USPQ2d at 1646 ("The word 'invention' must refer to a concept that is complete, rather than merely one that is 'substantially complete.' It is true that reduction to practice ordinarily provides the best evidence that an invention is complete. But just because reduction to practice is sufficient evidence of completion, it does not follow that proof of reduction to practice is necessary in every case. Indeed, both the facts of the Telephone Cases and the facts of this case demonstrate that one can prove that an invention is complete and ready for patenting before it has actually been reduced to practice.").

A specification may describe an actual reduction to practice by showing that the inventor constructed an embodiment or performed a process that met all the limitations of the claim and determined that the invention would work for its intended purpose. *Cooper v. Goldfarb*, 154 F.3d 1321, 1327, 47 USPQ2d 1896, 1901 (Fed. Cir. 1998). See also *UMC Elecs. Co. v. United States*, 816 F.2d 647, 652, 2 USPQ2d 1465, 1468 (Fed. Cir. 1987) ("[T]here cannot be a reduction to practice of the invention \* \* \* without a physical embodiment which includes all limitations of the claim."); *Estee Lauder Inc. v. L'Oreal, S.A.*, 129 F.3d 588, 593, 44 USPQ2d 1610, 1614 (Fed. Cir. 1997) ("[A] reduction to practice does not occur until the inventor has determined that the invention will work for its intended purpose."); *Mahurkar v. C.R. Bard, Inc.*, 79 F.3d 1572, 1578, 38 USPQ2d 1288, 1291 (Fed. Cir. 1996) (determining that the invention will work for its intended purpose may require testing depending on the character of the invention and the problem it solves). Description of an actual reduction to practice of a biological material may be shown by specifically describing a deposit made in accordance with the requirements of 37 CFR 1.801 *et seq.* See especially 37 CFR 1.804 and 1.809. See also paragraph I., *supra*.

An applicant may show possession of an invention by disclosure of drawings or structural chemical formulas that are sufficiently detailed to show that applicant was in possession of the claimed invention as a whole. See, e.g., *Vas-Cath*, 935 F.2d at 1565,

19 USPQ2d at 1118 (“drawings alone may provide a ‘written description’ of an invention as required by Sec. 112\”); *In re Wolfensperger*, 302 F.2d 950, 133 USPQ 537 (CCPA 1962) (the drawings of applicant’s specification provided sufficient written descriptive support for the claim limitation at issue); *Autogiro Co. of America v. United States*, 384 F.2d 391, 398, 155 USPQ 697, 703 (Ct. Cl. 1967) (“In those instances where a visual representation can flesh out words, drawings may be used in the same manner and with the same limitations as the specification.”); *Eli Lilly*, 119 F.3d at 1568, 43 USPQ2d at 1406 (“In claims involving chemical materials, generic formulae usually indicate with specificity what the generic claims encompass. One skilled in the art can distinguish such a formula from others and can identify many of the species that the claims encompass. Accordingly, such a formula is normally an adequate description of the claimed genus.”). The description need only describe in detail that which is new or not conventional. See *Hybritech v. Monoclonal Antibodies*, 802 F.2d at 1384, 231 USPQ at 94; *Fonar Corp. v. General Electric Co.*, 107 F.3d at 1549, 41 USPQ2d at 1805 (source code description not required). This is equally true whether the claimed invention is directed to a product or a process.

An applicant may also show that an invention is complete by disclosure of sufficiently detailed, relevant identifying characteristics which provide evidence that applicant was in possession of the claimed invention, i.e., complete or partial structure, other physical and/or chemical properties, functional characteristics when coupled with a known or disclosed correlation between function and structure, or some combination of such characteristics. >*Enzo Biochem*, 323 F.3d at 964, 63 USPQ2d at 1613.< For example, the presence of a restriction enzyme map of a gene may be relevant to a statement that the gene has been isolated. One skilled in the art may be able to determine whether the gene disclosed is the same as or different from a gene isolated by another by comparing the restriction enzyme maps. In contrast, evidence that the gene could be digested with a nuclease would not normally represent a relevant characteristic since any gene would be digested with a nuclease. Similarly, isolation of an mRNA and its expression to produce the protein of interest is strong evidence of possession of an mRNA for the protein.

For some biomolecules, examples of identifying characteristics include a sequence, structure, binding affinity, binding specificity, molecular weight, and length. Although structural formulas provide a convenient method of demonstrating possession of specific molecules, other identifying characteristics or combinations of characteristics may demonstrate the requisite possession. For example, >disclosure of an antigen fully characterized by its structure, formula, chemical name, physical properties, or deposit in a public depository provides an adequate written description of an antibody claimed by its binding affinity to that antigen. *Noelle v. Lederman*, 355 F.3d 1343, 1349, 69 USPQ2d 1508, 1514 (Fed. Cir. 2004) (holding there is a lack of written descriptive support for an antibody defined by its binding affinity to an antigen that itself was not adequately described). Additionally,< unique cleavage by particular enzymes, isoelectric points of fragments, detailed restriction enzyme maps, a comparison of enzymatic activities, or antibody cross-reactivity may be sufficient to show possession of the claimed invention to one of skill in the art. See *Lockwood*, 107 F.3d at 1572, 41 USPQ2d at 1966 (“written description” requirement may be satisfied by using “such descriptive means as words, structures, figures, diagrams, formulas, etc., that fully set forth the claimed invention”). A definition by function alone “does not suffice” to sufficiently describe a coding sequence “because it is only an indication of what the gene does, rather than what it is.” *Eli Lilly*, 119 F.3d at 1568, 43 USPQ2d at 1406. See also *Fiers*, 984 F.2d at 1169-71, 25 USPQ2d at 1605-06 (discussing *Amgen Inc. v. Chugai Pharmaceutical Co.*, 927 F.2d 1200, 18 USPQ2d 1016 (Fed. Cir. 1991)). >An adequate written description of a chemical invention also requires a precise definition, such as by structure, formula, chemical name, or physical properties, and not merely a wish or plan for obtaining the chemical invention claimed. See, e.g., *Univ. of Rochester v. G.D. Searle & Co.*, 358 F.3d 916, 927, 69 USPQ2d 1886, 1894-95 (Fed. Cir. 2004) (The patent at issue claimed a method of selectively inhibiting PGHS-2 activity by administering a non-steroidal compound that selectively inhibits activity of the PGHS-2 gene product, however the patent did not disclose any compounds that can be used in the claimed methods. While there was a description of assays for screening

compounds to identify those that inhibit the expression or activity of the PGHS-2 gene product, there was no disclosure of which peptides, polynucleotides, and small organic molecules selectively inhibit PGHS-2. The court held that “[w]ithout such disclosure, the claimed methods cannot be said to have been described.”<

If a claim limitation invokes 35 U.S.C. 112, para. 6, it must be interpreted to cover the corresponding structure, materials, or acts in the specification and “equivalents thereof.” See 35 U.S.C. 112, para. 6. See also *B. Braun Medical, Inc. v. Abbott Lab.*, 124 F.3d 1419, 1424, 43 USPQ2d 1896, 1899 (Fed. Cir. 1997). In considering whether there is 35 U.S.C. 112, para. 1, support for a means- (or step) plus-function claim limitation, the examiner must consider not only the original disclosure contained in the summary and detailed description of the invention portions of the specification, but also the original claims, abstract, and drawings. A means- (or step-) plus-function claim limitation is adequately described under 35 U.S.C. 112, para. 1, if: (1) The written description adequately links or associates adequately described particular structure, material, or acts to the function recited in a means- (or step-) plus-function claim limitation; or (2) it is clear based on the facts of the application that one skilled in the art would have known what structure, material, or acts perform the function recited in a means- (or step-) plus-function limitation. Note also: A rejection under 35 U.S.C. 112, para. 2, “cannot stand where there is adequate description in the specification to satisfy 35 U.S.C. 112, first paragraph, regarding means-plus-function recitations that are not, per se, challenged for being unclear.” *In re Noll*, 545 F.2d 141, 149, 191 USPQ 721, 727 (CCPA 1976). See Supplemental Examination Guidelines for Determining the Applicability of 35 U.S.C. 112, para. 6, 65 Fed. Reg. 38510, June 21, 2000. See also MPEP § 2181.

What is conventional or well known to one of ordinary skill in the art need not be disclosed in detail. See *Hybritech Inc. v. Monoclonal Antibodies, Inc.*, 802 F.2d at 1384, 231 USPQ at 94. If a skilled artisan would have understood the inventor to be in possession of the claimed invention at the time of filing, even if every nuance of the claims is not explicitly described in the specification, then the adequate description requirement is met. See, e.g., *Vas-Cath*,

935 F.2d at 1563, 19 USPQ2d at 1116; *Martin v. Johnson*, 454 F.2d 746, 751, 172 USPQ 391, 395 (CCPA 1972) (stating “the description need not be in *ipsis verbis* [i.e., “in the same words”] to be sufficient”).

A claim which is limited to a single disclosed embodiment or species is analyzed as a claim drawn to a single embodiment or species, whereas a claim which encompasses two or more embodiments or species within the scope of the claim is analyzed as a claim drawn to a genus. See also MPEP § 806.04(e).

**i) For Each Claim Drawn to a Single Embodiment Or Species:**

(A) Determine whether the application describes an actual reduction to practice of the claimed invention.

(B) If the application does not describe an actual reduction to practice, determine whether the invention is complete as evidenced by a reduction to drawings or structural chemical formulas that are sufficiently detailed to show that applicant was in possession of the claimed invention as a whole.

(C) If the application does not describe an actual reduction to practice or reduction to drawings or structural chemical formula as discussed above, determine whether the invention has been set forth in terms of distinguishing identifying characteristics as evidenced by other descriptions of the invention that are sufficiently detailed to show that applicant was in possession of the claimed invention.

(1) Determine whether the application as filed describes the complete structure (or acts of a process) of the claimed invention as a whole. The complete structure of a species or embodiment typically satisfies the requirement that the description be set forth “in such full, clear, concise, and exact terms” to show possession of the claimed invention. 35 U.S.C. 112, para. 1. Cf. *Fields v. Conover*, 443 F.2d 1386, 1392, 170 USPQ 276, 280 (CCPA 1971) (finding a lack of written description because the specification lacked the “full, clear, concise, and exact written description” which is necessary to support the claimed invention). If a complete structure is disclosed, the written description requirement is satisfied for that species or embodiment, and a rejection under 35 U.S.C. 112,

para. 1, for lack of written description must not be made.

(2) If the application as filed does not disclose the complete structure (or acts of a process) of the claimed invention as a whole, determine whether the specification discloses other relevant identifying characteristics sufficient to describe the claimed invention in such full, clear, concise, and exact terms that a skilled artisan would recognize applicant was in possession of the claimed invention. For example, if the art has established a strong correlation between structure and function, one skilled in the art would be able to predict with a reasonable degree of confidence the structure of the claimed invention from a recitation of its function. Thus, the written description requirement may be satisfied through disclosure of function and minimal structure when there is a well-established correlation between structure and function. In contrast, without such a correlation, the capability to recognize or understand the structure from the mere recitation of function and minimal structure is highly unlikely. In this latter case, disclosure of function alone is little more than a wish for possession; it does not satisfy the written description requirement. See *Eli Lilly*, 119 F.3d at 1568, 43 USPQ2d at 1406 (written description requirement not satisfied by merely providing “a result that one might achieve if one made that invention”); *In re Wilder*, 736 F.2d 1516, 1521, 222 USPQ 369, 372-73 (Fed. Cir. 1984) (affirming a rejection for lack of written description because the specification does “little more than outline goals appellants hope the claimed invention achieves and the problems the invention will hopefully ameliorate”). Compare *Fonar*, 107 F.3d at 1549, 41 USPQ2d at 1805 (disclosure of software function adequate in that art).

Whether the specification shows that applicant was in possession of the claimed invention is not a single, simple determination, but rather is a factual determination reached by considering a number of factors. Factors to be considered in determining whether there is sufficient evidence of possession include the level of skill and knowledge in the art, partial structure, physical and/or chemical properties, functional characteristics alone or coupled with a known or disclosed correlation between structure and function, and the method of making the claimed invention. Disclosure of any combination of such identifying characteristics

that distinguish the claimed invention from other materials and would lead one of skill in the art to the conclusion that the applicant was in possession of the claimed species is sufficient. See *Eli Lilly*, 119 F.3d at 1568, 43 USPQ2d at 1406. Patents and printed publications in the art should be relied upon to determine whether an art is mature and what the level of knowledge and skill is in the art. In most technologies which are mature, and wherein the knowledge and level of skill in the art is high, a written description question should not be raised for original claims even if the specification discloses only a method of making the invention and the function of the invention. See, e.g., *In re Hayes Microcomputer Products, Inc. Patent Litigation*, 982 F.2d 1527, 1534-35, 25 USPQ2d 1241, 1246 (Fed. Cir. 1992) (“One skilled in the art would know how to program a microprocessor to perform the necessary steps described in the specification. Thus, an inventor is not required to describe every detail of his invention. An applicant’s disclosure obligation varies according to the art to which the invention pertains. Disclosing a microprocessor capable of performing certain functions is sufficient to satisfy the requirement of section 112, first paragraph, when one skilled in the relevant art would understand what is intended and know how to carry it out.”). In contrast, for inventions in emerging and unpredictable technologies, or for inventions characterized by factors not reasonably predictable which are known to one of ordinary skill in the art, more evidence is required to show possession. For example, disclosure of only a method of making the invention and the function may not be sufficient to support a product claim other than a product-by-process claim. See, e.g., *Fiers v. Revel*, 984 F.2d at 1169, 25 USPQ2d at 1605; *Amgen*, 927 F.2d at 1206, 18 USPQ2d at 1021. Where the process has actually been used to produce the product, the written description requirement for a product-by-process claim is clearly satisfied; however, the requirement may not be satisfied where it is not clear that the acts set forth in the specification can be performed, or that the product is produced by that process. Furthermore, disclosure of a partial structure without additional characterization of the product may not be sufficient to evidence possession of the claimed invention. See, e.g., *Amgen*, 927 F.2d at 1206, 18 USPQ2d at 1021 (“A gene is a chemical compound, albeit a complex one, and it is well established



in our law that conception of a chemical compound requires that the inventor be able to define it so as to distinguish it from other materials, and to describe how to obtain it. Conception does not occur unless one has a mental picture of the structure of the chemical, or is able to define it by its method of preparation, its physical or chemical properties, or whatever characteristics sufficiently distinguish it. It is not sufficient to define it solely by its principal biological property, e.g., encoding human erythropoietin, because an alleged conception having no more specificity than that is simply a wish to know the identity of any material with that biological property. We hold that when an inventor is unable to envision the detailed constitution of a gene so as to distinguish it from other materials, as well as a method for obtaining it, conception has not been achieved until reduction to practice has occurred, i.e., until after the gene has been isolated.”) (citations omitted). In such instances the alleged conception fails not merely because the field is unpredictable or because of the general uncertainty surrounding experimental sciences, but because the conception is incomplete due to factual uncertainty that undermines the specificity of the inventor’s idea of the invention. *Burroughs Wellcome Co. v. Barr Laboratories Inc.*, 40 F.3d 1223, 1229, 32 USPQ2d 1915, 1920 (Fed. Cir. 1994). Reduction to practice in effect provides the only evidence to corroborate conception (and therefore possession) of the invention. *Id.*

Any claim to a species that does not meet the test described under at least one of (a), (b), or (c) must be rejected as lacking adequate written description under 35 U.S.C. 112, para. 1.

**ii) For each claim drawn to a genus:**

The written description requirement for a claimed genus may be satisfied through sufficient description of a representative number of species by actual reduction to practice (see i)(A), above), reduction to drawings (see i)(B), above), or by disclosure of relevant, identifying characteristics, i.e., structure or other physical and/or chemical properties, by functional characteristics coupled with a known or disclosed correlation between function and structure, or by a combination of such identifying characteristics, sufficient to show the applicant was in possession of the claimed genus (see i)(C), above). See *Eli Lilly*, 119 F.3d at 1568, 43 USPQ2d at 1406.

A “representative number of species” means that the species which are adequately described are representative of the entire genus. Thus, when there is substantial variation within the genus, one must describe a sufficient variety of species to reflect the variation within the genus. >The disclosure of only one species encompassed within a genus adequately describes a claim directed to that genus only if the disclosure “indicates that the patentee has invented species sufficient to constitute the gen[us].” See *Enzo Biochem*, 323 F.3d at 966, 63 USPQ2d at 1615; *Noelle v. Lederman*, 355 F.3d 1343, 1350, 69 USPQ2d 1508, 1514 (Fed. Cir. 2004) (Fed. Cir. 2004)(“[A] patentee of a biotechnological invention cannot necessarily claim a genus after only describing a limited number of species because there may be unpredictability in the results obtained from species other than those specifically enumerated.”). “A patentee will not be deemed to have invented species sufficient to constitute the genus by virtue of having disclosed a single species when ... the evidence indicates ordinary artisans could not predict the operability in the invention of any species other than the one disclosed.” *In re Curtis*, 354 F.3d 1347, 1358, 69 USPQ2d 1274, 1282 (Fed. Cir. 2004)(Claims directed to PTFE dental floss with a friction-enhancing coating were not supported by a disclosure of a microcrystalline wax coating where there was no evidence in the disclosure or anywhere else in the record showing applicant conveyed that any other coating was suitable for a PTFE dental floss.)< On the other hand, there may be situations where one species adequately supports a genus. See, e.g., *Rasmussen*, 650 F.2d at 1214, 211 USPQ at 326-27 (disclosure of a single method of adheringly applying one layer to another was sufficient to support a generic claim to “adheringly applying” because one skilled in the art reading the specification would understand that it is unimportant how the layers are adhered, so long as they are adhered); *In re Herschler*, 591 F.2d 693, 697, 200 USPQ 711, 714 (CCPA 1979) (disclosure of corticosteroid in DMSO sufficient to support claims drawn to a method of using a mixture of a “physiologically active steroid” and DMSO because “use of known chemical compounds in a manner auxiliary to the invention must have a corresponding written description only so specific as to lead one having ordinary skill in the art to that class of compounds. Occasionally, a functional recitation of

those known compounds in the specification may be sufficient as that description.”); *In re Smythe*, 480 F.2d 1376, 1383, 178 USPQ 279, 285 (CCPA 1973) (the phrase “air or other gas which is inert to the liquid” was sufficient to support a claim to “inert fluid media” because the description of the properties and functions of the air or other gas segmentizing medium would suggest to a person skilled in the art that appellant’s invention includes the use of “inert fluid” broadly.). However, in *Tronzo v. Biomet*, 156 F.3d at 1159, 47 USPQ2d at 1833 (Fed. Cir. 1998), the disclosure of a species in the parent application did not suffice to provide written description support for the genus in the child application. What constitutes a “representative number” is an inverse function of the skill and knowledge in the art. Satisfactory disclosure of a “representative number” depends on whether one of skill in the art would recognize that the applicant was in possession of the necessary common attributes or features of the elements possessed by the members of the genus in view of the species disclosed. For inventions in an unpredictable art, adequate written description of a genus which embraces widely variant species cannot be achieved by disclosing only one species within the genus. See, e.g., *Eli Lilly*. Description of a representative number of species does not require the description to be of such specificity that it would provide individual support for each species that the genus embraces. For example, in the molecular biology arts, if an applicant disclosed an amino acid sequence, it would be unnecessary to provide an explicit disclosure of nucleic acid sequences that encoded the amino acid sequence. Since the genetic code is widely known, a disclosure of an amino acid sequence would provide sufficient information such that one would accept that an applicant was in possession of the full genus of nucleic acids encoding a given amino acid sequence, but not necessarily any particular species. Cf. *In re Bell*, 991 F.2d 781, 785, 26 USPQ2d 1529, 1532 (Fed. Cir. 1993) and *In re Baird*, 16 F.3d 380, 382, 29 USPQ2d 1550, 1552 (Fed. Cir. 1994). If a representative number of adequately described species are not disclosed for a genus, the claim to that genus must be rejected as lacking adequate written description under 35 U.S.C. 112, para. 1.

**(b) New Claims, Amended Claims, or Claims Asserting Entitlement to the Benefit of an Earlier Priority Date or Filing Date under 35 U.S.C. 119, 120, or 365(c)**

The examiner has the initial burden of presenting evidence or reasoning to explain why persons skilled in the art would not recognize in the original disclosure a description of the invention defined by the claims. See *Wertheim*, 541 F.2d at 263, 191 USPQ at 97 (“[T]he PTO has the initial burden of presenting evidence or reasons why persons skilled in the art would not recognize in the disclosure a description of the invention defined by the claims.”). However, when filing an amendment an applicant should show support in the original disclosure for new or amended claims. See MPEP § 714.02 and § 2163.06 (“Applicant should \* \* \* specifically point out the support for any amendments made to the disclosure.”).

To comply with the written description requirement of 35 U.S.C. 112, para. 1, or to be entitled to an earlier priority date or filing date under 35 U.S.C. 119, 120, or 365(c), each claim limitation must be expressly, implicitly, or inherently supported in the originally filed disclosure. When an explicit limitation in a claim “is not present in the written description whose benefit is sought it must be shown that a person of ordinary skill would have understood, at the time the patent application was filed, that the description requires that limitation.” *Hyatt v. Boone*, 146 F.3d 1348, 1353, 47 USPQ2d 1128, 1131 (Fed. Cir. 1998). See also *In re Wright*, 866 F.2d 422, 425, 9 USPQ2d 1649, 1651 (Fed. Cir. 1989) (Original specification for method of forming images using photosensitive microcapsules which describes removal of microcapsules from surface and warns that capsules not be disturbed prior to formation of image, unequivocally teaches absence of permanently fixed microcapsules and supports amended language of claims requiring that microcapsules be “not permanently fixed” to underlying surface, and therefore meets description requirement of 35 U.S.C. 112.); *In re Robins*, 429 F.2d 452, 456-57, 166 USPQ 552, 555 (CCPA 1970) (“[W]here no explicit description of a generic invention is to be found in the specification[,] ... mention of representative compounds may provide an implicit description upon which to base generic claim language.”); *In re Smith*, 458 F.2d 1389, 1395, 173 USPQ 679, 683 (CCPA 1972) (a subgenus is not necessarily implicitly

described by a genus encompassing it and a species upon which it reads); *In re Robertson*, 169 F.3d 743, 745, 49 USPQ2d 1949, 1950-51 (Fed. Cir. 1999) (“To establish inherency, the extrinsic evidence ‘must make clear that the missing descriptive matter is necessarily present in the thing described in the reference, and that it would be so recognized by persons of ordinary skill. Inherency, however, may not be established by probabilities or possibilities. The mere fact that a certain thing may result from a given set of circumstances is not sufficient.’”) (citations omitted). Furthermore, each claim must include all elements which applicant has described as essential. See, e.g., *Johnson Worldwide Associates Inc. v. Zebco Corp.*, 175 F.3d at 993, 50 USPQ2d at 1613; *Gentry Gallery, Inc. v. Berkline Corp.*, 134 F.3d at 1479, 45 USPQ2d at 1503; *Tronzo v. Biomet*, 156 F.3d at 1159, 47 USPQ2d at 1833.

If the originally filed disclosure does not provide support for each claim limitation, or if an element which applicant describes as essential or critical is not claimed, a new or amended claim must be rejected under 35 U.S.C. 112, para. 1, as lacking adequate written description, or in the case of a claim for priority under 35 U.S.C. 119, 120, or 365(c), the claim for priority must be denied.

### **III. COMPLETE PATENTABILITY DETERMINATION UNDER ALL STATUTORY REQUIREMENTS AND CLEARLY COMMUNICATE FINDINGS, CONCLUSIONS, AND THEIR BASES**

The above only describes how to determine whether the written description requirement of 35 U.S.C. 112, para. 1, is satisfied. Regardless of the outcome of that determination, Office personnel must complete the patentability determination under all the relevant statutory provisions of title 35 of the U.S. Code.

Once Office personnel have concluded analysis of the claimed invention under all the statutory provisions, including 35 U.S.C. 101, 112, 102, and 103, they should review all the proposed rejections and their bases to confirm their correctness. Only then should any rejection be imposed in an Office action. The Office action should clearly communicate the findings, conclusions, and reasons which support

them. When possible, the Office action should offer helpful suggestions on how to overcome rejections.

#### **A. For Each Claim Lacking Written Description Support, Reject the Claim Under 35 U.S.C. 112, para. 1, for Lack of Adequate Written Description**

A description as filed is presumed to be adequate, unless or until sufficient evidence or reasoning to the contrary has been presented by the examiner to rebut the presumption. See, e.g., *In re Marzocchi*, 439 F.2d 220, 224, 169 USPQ 367, 370 (CCPA 1971). The examiner, therefore, must have a reasonable basis to challenge the adequacy of the written description. The examiner has the initial burden of presenting by a preponderance of evidence why a person skilled in the art would not recognize in an applicant’s disclosure a description of the invention defined by the claims. *Wertheim*, 541 F.2d at 263, 191 USPQ at 97. In rejecting a claim, the examiner must set forth express findings of fact regarding the above analysis which support the lack of written description conclusion. These findings should:

- (A) Identify the claim limitation at issue; and
- (B) Establish a *prima facie* case by providing reasons why a person skilled in the art at the time the application was filed would not have recognized that the inventor was in possession of the invention as claimed in view of the disclosure of the application as filed. A general allegation of “unpredictability in the art” is not a sufficient reason to support a rejection for lack of adequate written description.

When appropriate, suggest amendments to the claims which can be supported by the application’s written description, being mindful of the prohibition against the addition of new matter in the claims or description. See *Rasmussen*, 650 F.2d at 1214, 211 USPQ at 326.

#### **B. Upon Reply by Applicant, Again Determine the Patentability of the Claimed Invention, Including Whether the Written Description Requirement Is Satisfied by Reperforming the Analysis Described Above in View of the Whole Record**

Upon reply by applicant, before repeating any rejection under 35 U.S.C. 112, para. 1, for lack of

written description, review the basis for the rejection in view of the record as a whole, including amendments, arguments, and any evidence submitted by applicant. If the whole record now demonstrates that the written description requirement is satisfied, do not repeat the rejection in the next Office action. If the record still does not demonstrate that the written description is adequate to support the claim(s), repeat the rejection under 35 U.S.C. 112, para. 1, fully respond to applicant's rebuttal arguments, and properly treat any further showings submitted by applicant in the reply. When a rejection is maintained, any affidavits relevant to the 112, para. 1, written description requirement, must be thoroughly analyzed and discussed in the next Office action. See *In re Alton*, 76 F.3d 1168, 1176, 37 USPQ2d 1578, 1584 (Fed. Cir. 1996).

### **2163.01 Support for the Claimed Subject Matter in Disclosure**

A written description requirement issue generally involves the question of whether the subject matter of a claim is supported by [conforms to] the disclosure of an application as filed. If the examiner concludes that the claimed subject matter is not supported [described] in an application as filed, this would result in a rejection of the claim on the ground of a lack of written description under 35 U.S.C. 112, first paragraph or denial of the benefit of the filing date of a previously filed application. The claim should not be rejected or objected to on the ground of new matter. As framed by the court in *In re Rasmussen*, 650 F.2d 1212, 211 USPQ 323 (CCPA 1981), the concept of new matter is properly employed as a basis for objection to amendments to the abstract, specification or drawings attempting to add new disclosure to that originally presented. While the test or analysis of description requirement and new matter issues is the same, the examining procedure and statutory basis for addressing these issues differ. See MPEP § 2163.06.

### **2163.02 Standard for Determining Compliance With the Written Description Requirement**

The courts have described the essential question to be addressed in a description requirement issue in a variety of ways. An objective standard for determin-

ing compliance with the written description requirement is, "does the description clearly allow persons of ordinary skill in the art to recognize that he or she invented what is claimed." *In re Gosteli*, 872 F.2d 1008, 1012, 10 USPQ2d 1614, 1618 (Fed. Cir. 1989). Under *Vas-Cath, Inc. v. Mahurkar*, 935 F.2d 1555, 1563-64, 19 USPQ2d 1111, 1117 (Fed. Cir. 1991), to satisfy the written description requirement, an applicant must convey with reasonable clarity to those skilled in the art that, as of the filing date sought, he or she was in possession of the invention, and that the invention, in that context, is whatever is now claimed. The test for sufficiency of support in a parent application is whether the disclosure of the application relied upon "reasonably conveys to the artisan that the inventor had possession at that time of the later claimed subject matter." *Ralston Purina Co. v. Far-Mar-Co., Inc.*, 772 F.2d 1570, 1575, 227 USPQ 177, 179 (Fed. Cir. 1985) (quoting *In re Kaslow*, 707 F.2d 1366, 1375, 217 USPQ 1089, 1096 (Fed. Cir. 1983)).

Whenever the issue arises, the fundamental factual inquiry is whether the specification conveys with reasonable clarity to those skilled in the art that, as of the filing date sought, applicant was in possession of the invention as now claimed. See, e.g., *Vas-Cath, Inc. v. Mahurkar*, 935 F.2d 1555, 1563-64, 19 USPQ2d 1111, 1117 (Fed. Cir. 1991). An applicant shows possession of the claimed invention by describing the claimed invention with all of its limitations using such descriptive means as words, structures, figures, diagrams, and formulas that fully set forth the claimed invention. *Lockwood v. American Airlines, Inc.*, 107 F.3d 1565, 1572, 41 USPQ2d 1961, 1966 (Fed. Cir. 1997). Possession may be shown in a variety of ways including description of an actual reduction to practice, or by showing that the invention was "ready for patenting" such as by the disclosure of drawings or structural chemical formulas that show that the invention was complete, or by describing distinguishing identifying characteristics sufficient to show that the applicant was in possession of the claimed invention. See, e.g., *Pfaff v. Wells Elecs., Inc.*, 525 U.S. 55, 68, 119 S.Ct. 304, 312, 48 USPQ2d 1641, 1647 (1998); *Regents of the University of California v. Eli Lilly*, 119 F.3d 1559, 1568, 43 USPQ2d 1398, 1406 (Fed. Cir. 1997); *Amgen, Inc. v. Chugai Pharmaceutical*, 927 F.2d 1200, 1206, 18 USPQ2d 1016, 1021

(Fed. Cir. 1991) (one must define a compound by “whatever characteristics sufficiently distinguish it”).

The subject matter of the claim need not be described literally (i.e., using the same terms or *in haec verba*) in order for the disclosure to satisfy the description requirement. If a claim is amended to include subject matter, limitations, or terminology not present in the application as filed, involving a departure from, addition to, or deletion from the disclosure of the application as filed, the examiner should conclude that the claimed subject matter is not described in that application. This conclusion will result in the rejection of the claims affected under 35 U.S.C. 112, first paragraph - description requirement, or denial of the benefit of the filing date of a previously filed application, as appropriate.

See MPEP § 2163 for examination guidelines pertaining to the written description requirement.

### **2163.03 Typical Circumstances Where Adequate Written Description Issue Arises**

A description requirement issue can arise in a number of different circumstances where it must be determined whether the subject matter of a claim is supported in an application as filed. See MPEP § 2163 for examination guidelines pertaining to the written description requirement. While a question as to whether a specification provides an adequate written description may arise in the context of an original claim which is not described sufficiently (see, e.g., *Regents of the University of California v. Eli Lilly*, 119 F.3d 1559, 43 USPQ2d 1398 (Fed. Cir. 1997)), there is a strong presumption that an adequate written description of the claimed invention is present in the specification as filed. *In re Wertheim*, 541 F.2d 257, 262, 191 USPQ 90, 96 (CCPA 1976). Consequently, rejection of an original claim for lack of written description should be rare. Most typically, the issue will arise in the following circumstances:

#### **I. AMENDMENT AFFECTING A CLAIM**

An amendment to the claims or the addition of a new claim must be supported by the description of the invention in the application as filed. *In re Wright*, 866 F.2d 422, 9 USPQ2d 1649 (Fed. Cir. 1989). An

amendment to the specification (e.g., a change in the definition of a term used both in the specification and claim) may indirectly affect a claim even though no actual amendment is made to the claim.

#### **II. RELIANCE ON FILING DATE OF PARENT APPLICATION UNDER 35 U.S.C. 120**

Under 35 U.S.C. 120, the claims in a U.S. application are entitled to the benefit of the filing date of an earlier filed U.S. application if the subject matter of the claim is disclosed in the manner provided by 35 U.S.C. 112, first paragraph in the earlier filed application. See, e.g., *Tronzo v. Biomet, Inc.*, 156 F.3d 1154, 47 USPQ2d 1829 (Fed. Cir. 1998); *In re Scheiber*, 587 F.2d 59, 199 USPQ 782 (CCPA 1978).

#### **III. RELIANCE ON PRIORITY UNDER 35 U.S.C. 119**

Under 35 U.S.C. 119 (a) or (e), the claims in a U.S. application are entitled to the benefit of a foreign priority date or the filing date of a provisional application if the corresponding foreign application or provisional application supports the claims in the manner required by 35 U.S.C. 112, first paragraph. *In re Ziegler*, 992 F.2d 1197, 1200, 26 USPQ2d 1600, 1603 (Fed. Cir. 1993); *Kawai v. Metlesics*, 480 F.2d 880, 178 USPQ 158 (CCPA 1973); *In re Gosteli*, 872 F.2d 1008, 10 USPQ2d 1614 (Fed. Cir. 1989).

#### **IV. SUPPORT FOR A CLAIM CORRESPONDING TO A COUNT IN AN INTERFERENCE**

In an interference proceeding, the claim corresponding to a count must be supported by the specification in the manner provided by 35 U.S.C. 112, first paragraph. *Fields v. Conover*, 443 F.2d 1386, 170 USPQ 276 (CCPA 1971) (A broad generic disclosure to a class of compounds was not a sufficient written description of a specific compound within the class.). Furthermore, when a party to an interference seeks the benefit of an earlier-filed U.S. patent application, the earlier application must meet the requirements of 35 U.S.C. 112, first paragraph for the subject matter of the count. *Hyatt v. Boone*, 146 F.3d 1348, 1352, 47 USPQ2d 1128, 1130 (Fed. Cir. 1998).

### 2163.04 Burden on the Examiner with Regard to the Written Description Requirement

The inquiry into whether the description requirement is met must be determined on a case-by-case basis and is a question of fact. *In re Wertheim*, 541 F.2d 257, 262, 191 USPQ 90, 96 (CCPA 1976). A description as filed is presumed to be adequate, unless or until sufficient evidence or reasoning to the contrary has been presented by the examiner to rebut the presumption. See, e.g., *In re Marzocchi*, 439 F.2d 220, 224, 169 USPQ 367, 370 (CCPA 1971). The examiner, therefore, must have a reasonable basis to challenge the adequacy of the written description. The examiner has the initial burden of presenting by a preponderance of evidence why a person skilled in the art would not recognize in an applicant's disclosure a description of the invention defined by the claims. *Wertheim*, 541 F.2d at 263, 191 USPQ at 97.

#### I. STATEMENT OF REJECTION REQUIREMENTS

In rejecting a claim, the examiner must set forth express findings of fact which support the lack of written description conclusion (see MPEP § 2163 for examination guidelines pertaining to the written description requirement). These findings should:

(A) Identify the claim limitation at issue; and

(B) Establish a *prima facie* case by providing reasons why a person skilled in the art at the time the application was filed would not have recognized that the inventor was in possession of the invention as claimed in view of the disclosure of the application as filed. A general allegation of "unpredictability in the art" is not a sufficient reason to support a rejection for lack of adequate written description. A simple statement such as "Applicant has not pointed out where the new (or amended) claim is supported, nor does there appear to be a written description of the claim limitation '\_\_\_\_' in the application as filed." may be sufficient where the claim is a new or amended claim, the support for the limitation is not apparent, and applicant has not pointed out where the limitation is supported.

When appropriate, suggest amendments to the claims which can be supported by the application's written description, being mindful of the prohibition against the addition of new matter in the claims or description. See *Rasmussen*, 650 F.2d at 1214, 211 USPQ at 326.

#### II. RESPONSE TO APPLICANT'S REPLY

Upon reply by applicant, before repeating any rejection under 35 U.S.C. 112, para. 1, for lack of written description, review the basis for the rejection in view of the record as a whole, including amendments, arguments, and any evidence submitted by applicant. If the whole record now demonstrates that the written description requirement is satisfied, do not repeat the rejection in the next Office action. If the record still does not demonstrate that the written description is adequate to support the claim(s), repeat the rejection under 35 U.S.C. 112, para. 1, fully respond to applicant's rebuttal arguments, and properly treat any further showings submitted by applicant in the reply. When a rejection is maintained, any affidavits relevant to the 35 U.S.C. 112, para. 1, written description requirement, must be thoroughly analyzed and discussed in the next Office action. See *In re Alton*, 76 F.3d 1168, 1176, 37 USPQ2d 1578, 1584 (Fed. Cir. 1996).

### 2163.05 Changes to the Scope of Claims [R-2]

The failure to meet the written description requirement of 35 U.S.C. 112, first paragraph, commonly arises when the claims are changed after filing to either broaden or narrow the breadth of the claim limitations, or to alter a numerical range limitation or to use claim language which is not synonymous with the terminology used in the original disclosure. To comply with the written description requirement of 35 U.S.C. 112, para. 1, or to be entitled to an earlier priority date or filing date under 35 U.S.C. 119, 120, or 365(c), each claim limitation must be expressly, implicitly, or inherently supported in the originally filed disclosure. See MPEP § 2163 for examination guidelines pertaining to the written description requirement.

## I. BROADENING CLAIM

### *Omission of a Limitation*

Under certain circumstances, omission of a limitation can raise an issue regarding whether the inventor had possession of a broader, more generic invention. See, e.g., *Gentry Gallery, Inc. v. Berkline Corp.*, 134 F.3d 1473, 45 USPQ2d 1498 (Fed. Cir. 1998) (claims to a sectional sofa comprising, *inter alia*, a console and a control means were held invalid for failing to satisfy the written description requirement where the claims were broadened by removing the location of the control means.); *Johnson Worldwide Associates v. Zebco Corp.*, 175 F.3d 985, 993, 50 USPQ2d 1607, 1613 (Fed. Cir. 1999) (In *Gentry Gallery*, the “court’s determination that the patent disclosure did not support a broad meaning for the disputed claim terms was premised on clear statements in the written description that described the location of a claim element--the ‘control means’--as ‘the only possible location’ and that variations were ‘outside the stated purpose of the invention.’” *Gentry Gallery*, 134 F.3d at 1479, 45 USPQ2d at 1503. *Gentry Gallery*, then, considers the situation where the patent’s disclosure makes crystal clear that a particular (i.e., narrow) understanding of a claim term is an ‘essential element of [the inventor’s] invention.’ ”); *Tronzo v. Biomet*, 156 F.3d at 1158-59, 47 USPQ2d at 1833 (Fed. Cir. 1998) (claims to generic cup shape were not entitled to filing date of parent application which disclosed “conical cup” in view of the disclosure of the parent application stating the advantages and importance of the conical shape.); *In re Wilder*, 736 F.2d 1516, 222 USPQ 369 (Fed. Cir. 1984) (reissue claim omitting “in synchronism” limitation with respect to scanning means and indexing means was not supported by the original patent’s disclosure in such a way as to indicate possession, as of the original filing date, of that generic invention.).

A claim that omits an element which applicant describes as an essential or critical feature of the invention originally disclosed does not comply with the written description requirement. See *Gentry Gallery*, 134 F.3d at 1480, 45 USPQ2d at 1503; *In re Sus*, 306 F.2d 494, 504, 134 USPQ 301, 309 (CCPA 1962) (“[O]ne skilled in this art would not be taught by the written description of the invention in the specification that any ‘aryl or substituted aryl radical’ would

be suitable for the purposes of the invention but rather that only certain aryl radicals and certain specifically substituted aryl radicals [i.e., aryl azides] would be suitable for such purposes.”) (emphasis in original). Compare *In re Peters*, 723 F.2d 891, 221 USPQ 952 (Fed. Cir. 1983) (In a reissue application, a claim to a display device was broadened by removing the limitations directed to the specific tapered shape of the tips without violating the written description requirement. The shape limitation was considered to be unnecessary since the specification, as filed, did not describe the tapered shape as essential or critical to the operation or patentability of the claim.). A claim which omits matter disclosed to be essential to the invention as described in the specification or in other statements of record may also be subject to rejection under 35 U.S.C. 112, para. 1, as not enabling, or under 35 U.S.C. 112, para. 2. See *In re Mayhew*, 527 F.2d 1229, 188 USPQ 356 (CCPA 1976); *In re Venezia*, 530 F.2d 956, 189 USPQ 149 (CCPA 1976); and *In re Collier*, 397 F.2d 1003, 158 USPQ 266 (CCPA 1968). See also MPEP § 2172.01.

### *Addition of Generic Claim*

The written description requirement for a claimed genus may be satisfied through sufficient description of a representative number of species. A “representative number of species” means that the species which are adequately described are representative of the entire genus. Thus, when there is substantial variation within the genus, one must describe a sufficient variety of species to reflect the variation within the genus. >The disclosure of only one species encompassed within a genus adequately describes a claim directed to that genus only if the disclosure “indicates that the patentee has invented species sufficient to constitute the gen[us].” See *Enzo Biochem*, 323 F.3d at 966, 63 USPQ2d at 1615. “A patentee will not be deemed to have invented species sufficient to constitute the genus by virtue of having disclosed a single species when ... the evidence indicates ordinary artisans could not predict the operability in the invention of any species other than the one disclosed.” *In re Curtis*, 354 F.3d 1347, 1358, 69 USPQ2d 1274, 1282 (Fed. Cir. 2004) (Claims directed to PTFE dental floss with a friction-enhancing coating were not supported by a disclosure of a microcrystalline wax coating where there was no evidence in the disclosure or

anywhere else in the record showing applicant conveyed that any other coating was suitable for a PTFE dental floss.)< On the other hand, there may be situations where one species adequately supports a genus. See, e.g., *In re Rasmussen*, 650 F.2d 1212, 1214, 211 USPQ 323, 326-27 (CCPA 1981) (disclosure of a single method of adheringly applying one layer to another was sufficient to support a generic claim to “adheringly applying” because one skilled in the art reading the specification would understand that it is unimportant how the layers are adhered, so long as they are adhered); *In re Herschler*, 591 F.2d 693, 697, 200 USPQ 711, 714 (CCPA 1979) (disclosure of corticosteroid in DMSO sufficient to support claims drawn to a method of using a mixture of a “physiologically active steroid” and DMSO because “use of known chemical compounds in a manner auxiliary to the invention must have a corresponding written description only so specific as to lead one having ordinary skill in the art to that class of compounds. Occasionally, a functional recitation of those known compounds in the specification may be sufficient as that description.”); *In re Smythe*, 480 F.2d 1376, 1383, 178 USPQ 279, 285 (CCPA 1973) (the phrase “air or other gas which is inert to the liquid” was sufficient to support a claim to “inert fluid media” because the description of the properties and functions of the air or other gas segmentizing medium would suggest to a person skilled in the art that appellant’s invention includes the use of “inert fluid” broadly.). However, in *Tronzo v. Biomet*, 156 F.3d 1154, 1159, 47 USPQ2d 1829, 1833 (Fed. Cir. 1998), the disclosure of a species in the parent application did not suffice to provide written description support for the genus in the child application. Similarly, see *In re Gosteli*, 872 F.2d 1008, 10 USPQ2d 1614 (Fed. Cir. 1989) (generic and subgeneric claims in the U.S. application were not entitled to the benefit of foreign priority where the foreign application disclosed only two of the species encompassed by the broad generic claim and the subgeneric Markush claim that encompassed 21 compounds).

## II. NARROWING OR SUBGENERIC CLAIM

The introduction of claim changes which involve narrowing the claims by introducing elements or limitations which are not supported by the as-filed disclosure is a violation of the written description

requirement of 35 U.S.C. 112, first paragraph. See, e.g., *Fujikawa v. Wattanasin*, 93 F.3d 1559, 1571, 39 USPQ2d 1895, 1905 (Fed. Cir. 1996) (a “laundry list” disclosure of every possible moiety does not constitute a written description of every species in a genus because it would not “reasonably lead” those skilled in the art to any particular species); *In re Ruschig*, 379 F.2d 990, 995, 154 USPQ 118, 123 (CCPA 1967) (“If n-propylamine had been used in making the compound instead of n-butylamine, the compound of claim 13 would have resulted. Appellants submit to us, as they did to the board, an imaginary specific example patterned on specific example 6 by which the above butyl compound is made so that we can see what a simple change would have resulted in a specific supporting disclosure being present in the present specification. The trouble is that there is no such disclosure, easy though it is to imagine it.”) (emphasis in original). In *Ex parte Ohshiro*, 14 USPQ2d 1750 (Bd. Pat. App. & Inter. 1989), the Board affirmed the rejection under 35 U.S.C. 112, first paragraph, of claims to an internal combustion engine which recited “at least one of said piston and said cylinder (head) having a recessed channel.” The Board held that the application which disclosed a cylinder head with a recessed channel and a piston without a recessed channel did not specifically disclose the “species” of a channeled piston.

While these and other cases find that recitation of an undisclosed species may violate the description requirement, a change involving subgeneric terminology may or may not be acceptable. Applicant was not entitled to the benefit of a parent filing date when the claim was directed to a subgenus (a specified range of molecular weight ratios) where the parent application contained a generic disclosure and a specific example that fell within the recited range because the court held that subgenus range was not described in the parent application. *In re Lukach*, 442 F.2d 967, 169 USPQ 795 (CCPA 1971). On the other hand, in *Ex parte Sorenson*, 3 USPQ2d 1462 (Bd. Pat. App. & Inter. 1987), the subgeneric language of “aliphatic carboxylic acid” and “aryl carboxylic acid” did not violate the written description requirement because species falling within each subgenus were disclosed as well as the generic carboxylic acid. See also *In re Smith*, 458 F.2d 1389, 1395, 173 USPQ 679, 683 (CCPA 1972) (“Whatever may be the viability of an



inductive-deductive approach to arriving at a claimed subgenus, it cannot be said that such a subgenus is necessarily described by a genus encompassing it and a species upon which it reads.” (emphasis added)). Each case must be decided on its own facts in terms of what is reasonably communicated to those skilled in the art. *In re Wilder*, 736 F.2d 1516, 1520, 222 USPQ 369, 372 (Fed. Cir. 1984).

### III. RANGE LIMITATIONS

With respect to changing numerical range limitations, the analysis must take into account which ranges one skilled in the art would consider inherently supported by the discussion in the original disclosure. In the decision in *In re Wertheim*, 541 F.2d 257, 191 USPQ 90 (CCPA 1976), the ranges described in the original specification included a range of “25%-60%” and specific examples of “36%” and “50%.” A corresponding new claim limitation to “at least 35%” did not meet the description requirement because the phrase “at least” had no upper limit and caused the claim to read literally on embodiments outside the “25% to 60%” range, however a limitation to “between 35% and 60%” did meet the description requirement.

See also *Purdue Pharma L.P. v. Faulding Inc.*, 230 F.3d 1320, 1328, 56 USPQ2d 1481, 1487 (Fed. Cir. 2000) (“[T]he specification does not clearly disclose to the skilled artisan that the inventors... considered the... ratio to be part of their invention.... There is therefore no force to Purdue’s argument that the written description requirement was satisfied because the disclosure revealed a broad invention from which the [later-filed] claims carved out a patentable portion”). Compare *Union Oil of Cal. v. Atlantic Richfield Co.*, 208 F.3d 989, 997, 54 USPQ2d 1227, 1232-33 (Fed. Cir. 2000) (Description in terms of ranges of chemical properties which work in combination with ranges of other chemical properties to produce an automotive gasoline that reduces emissions was found to provide an adequate written description even though the exact chemical components of each combination were not disclosed and the specification did not disclose any distinct embodiments corresponding to any claim at issue. “[T]he Patent Act and this court’s case law require only sufficient description to show one of skill in the . . . art that the inventor possessed the claimed invention at the time of filing.”).

## 2163.06 Relationship of Written Description Requirement to New Matter

Lack of written description is an issue that generally arises with respect to the subject matter of a claim. If an applicant amends or attempts to amend the abstract, specification or drawings of an application, an issue of new matter will arise if the content of the amendment is not described in the application as filed. Stated another way, information contained in any one of the specification, claims or drawings of the application as filed may be added to any other part of the application without introducing new matter.

There are two statutory provisions that prohibit the introduction of new matter: 35 U.S.C. 132 - No amendment shall introduce new matter into the disclosure of the invention; and, similarly providing for a reissue application, 35 U.S.C. 251 - No new matter shall be introduced into the application for reissue.

### I. TREATMENT OF NEW MATTER

If new subject matter is added to the disclosure, whether it be in the abstract, the specification, or the drawings, the examiner should object to the introduction of new matter under 35 U.S.C. 132 or 251 as appropriate, and require applicant to cancel the new matter. If new matter is added to the claims, the examiner should reject the claims under 35 U.S.C. 112, first paragraph - written description requirement. *In re Rasmussen*, 650 F.2d 1212, 211 USPQ 323 (CCPA 1981). The examiner should still consider the subject matter added to the claim in making rejections based on prior art since the new matter rejection may be overcome by applicant.

In an instance in which the claims have not been amended, *per se*, but the specification has been amended to add new matter, a rejection of the claims under 35 U.S.C. 112, first paragraph should be made whenever any of the claim limitations are affected by the added material.

When an amendment is filed in reply to an objection or rejection based on 35 U.S.C. 112, first paragraph, a study of the entire application is often necessary to determine whether or not “new matter” is involved. Applicant should therefore specifically point out the support for any amendments made to the disclosure.

## II. REVIEW OF NEW MATTER OBJECTIONS AND/OR REJECTIONS

A rejection of claims is reviewable by the Board of Patent Appeals and Interferences, whereas an objection and requirement to delete new matter is subject to supervisory review by petition under 37 CFR 1.181. If both the claims and specification contain new matter either directly or indirectly, and there has been both a rejection and objection by the examiner, the issue becomes appealable and should not be decided by petition.

## III. CLAIMED SUBJECT MATTER NOT DISCLOSED IN REMAINDER OF SPECIFICATION

The claims as filed in the original specification are part of the disclosure and therefore, if an application as originally filed contains a claim disclosing material not disclosed in the remainder of the specification, the applicant may amend the specification to include the claimed subject matter. *In re Benno*, 768 F.2d 1340, 226 USPQ 683 (Fed. Cir. 1985). Form Paragraph 7.44 may be used where originally claimed subject matter lacks proper antecedent basis in the specification. See MPEP § 608.01(o).

### 2163.07 Amendments to Application Which Are Supported in the Original Description [R-1]

Amendments to an application which are supported in the original description are NOT new matter.

#### I. REPHRASING

Mere rephrasing of a passage does not constitute new matter. Accordingly, a rewording of a passage where the same meaning remains intact is permissible. *In re Anderson*, 471 F.2d 1237, 176 USPQ 331 (CCPA 1973). The mere inclusion of dictionary or art recognized definitions known at the time of filing an application would not be considered new matter. If there are multiple definitions for a term and a definition is added to the application, it must be clear from the application as filed that applicant intended a particular definition, in order to avoid an issue of new matter and/or lack of written description.

See, e.g., *Schering Corp. v. Amgen, Inc.*, 222 F.3d 1347, 1352-53, 55 USPQ2d 1650, 1654 (Fed. Cir. 2000). In *Schering*, the original disclosure drawn to recombinant DNA molecules utilized the term “leukocyte interferon.” Shortly after the filing date, a scientific committee abolished the term in favor of “IFN-(a),” since the latter term more specifically identified a particular polypeptide and since the committee found that leukocytes also produced other types of interferon. The court held that the subsequent amendment to the specification and claims substituting the term “IFN-(a)” for “leukocyte interferon” merely renamed the invention and did not constitute new matter. The claims were limited to cover only the interferon subtype coded for by the inventor’s original deposits.

#### II. OBVIOUS ERRORS

An amendment to correct an obvious error does not constitute new matter where one skilled in the art would not only recognize the existence of error in the specification, but also the appropriate correction. *In re Oda*, 443 F.2d 1200, 170 USPQ 268 (CCPA 1971).

Where a \* foreign priority document under 35 U.S.C. 119 is of record in the >U.S.< application file, applicant may not rely on the disclosure of that document to support correction of an error in the pending >U.S.< application. *Ex parte Bondiou*, 132 USPQ 356 (Bd. App. 1961). This prohibition applies regardless of the language of the foreign priority documents because a claim for priority is simply a claim for the benefit of an earlier filing date for subject matter that is common to two or more applications, and does not serve to incorporate the content of the priority document in the application in which the claim for priority is made. This prohibition does not apply \*\* where the \*>U.S.< application explicitly incorporates \*\*>the foreign priority< document by reference.

>Where a U.S. application as originally filed was in a non-English language and an English translation thereof was subsequently submitted pursuant to 37 CFR 1.52(d), if there is an error in the English translation, applicant may rely on the disclosure of the originally filed non-English language U.S. application to support correction of an error in the English translation document.<

### **2163.07(a) Inherent Function, Theory, or Advantage**

By disclosing in a patent application a device that inherently performs a function or has a property, operates according to a theory or has an advantage, a patent application necessarily discloses that function, theory or advantage, even though it says nothing explicit concerning it. The application may later be amended to recite the function, theory or advantage without introducing prohibited new matter. *In re Reynolds*, 443 F.2d 384, 170 USPQ 94 (CCPA 1971); *In re Smythe*, 480 F. 2d 1376, 178 USPQ 279 (CCPA 1973). “To establish inherency, the extrinsic evidence ‘must make clear that the missing descriptive matter is necessarily present in the thing described in the reference, and that it would be so recognized by persons of ordinary skill. Inherency, however, may not be established by probabilities or possibilities. The mere fact that a certain thing may result from a given set of circumstances is not sufficient.’” *In re Robertson*, 169 F.3d 743, 745, 49 USPQ2d 1949, 1950-51 (Fed. Cir. 1999) (citations omitted).

### **2163.07(b) Incorporation by Reference [R-1]**

Instead of repeating some information contained in another document, an application may attempt to incorporate the content of another document or part thereof by reference to the document in the text of the specification. The information incorporated is as much a part of the application as filed as if the text was repeated in the application, and should be treated as part of the text of the application as filed. Replacing the identified material incorporated by reference with the actual text is not new matter. See MPEP § 608.01(p) for Office policy regarding incorporation by reference. >See MPEP § 2181 for the impact of incorporation by reference on the determination of whether applicant has complied with the requirements of 35 U.S.C. 112, second paragraph when 35 U.S.C. 112, sixth paragraph is invoked.<

### **2164 The Enablement Requirement [R-2]**

The enablement requirement refers to the requirement of 35 U.S.C. 112, first paragraph that the speci-

fication describe how to make and how to use the invention. The invention that one skilled in the art must be enabled to make and use is that defined by the claim(s) of the particular application or patent.

The purpose of the requirement that the specification describe the invention in such terms that one skilled in the art can make and use the claimed invention is to ensure that the invention is communicated to the interested public in a meaningful way. The information contained in the disclosure of an application must be sufficient to inform those skilled in the relevant art how to both make and use the claimed invention. >However, to comply with 35 U.S.C. 112, first paragraph, it is not necessary to “enable one of ordinary skill in the art to make and use a perfected, commercially viable embodiment absent a claim limitation to that effect.” *CFMT, Inc. v. Yieldup Int’l Corp.*, 349 F.3d 1333, 1338, 68 USPQ2d 1940, 1944 (Fed. Cir. 2003) (an invention directed to a general system to improve the cleaning process for semiconductor wafers was enabled by a disclosure showing improvements in the overall system).< Detailed procedures for making and using the invention may not be necessary if the description of the invention itself is sufficient to permit those skilled in the art to make and use the invention. A patent claim is invalid if it is not supported by an enabling disclosure.

The enablement requirement of 35 U.S.C. 112, first paragraph, is separate and distinct from the description requirement. *Vas-Cath, Inc. v. Mahurkar*, 935 F.2d 1555, 1563, 19 USPQ2d 1111, 1116-17 (Fed. Cir. 1991) (“the purpose of the ‘written description’ requirement is broader than to merely explain how to ‘make and use’ ”). See also MPEP § 2161. Therefore, the fact that an additional limitation to a claim may lack descriptive support in the disclosure as originally filed does not necessarily mean that the limitation is also not enabled. In other words, the statement of a new limitation in and of itself may enable one skilled in the art to make and use the claim containing that limitation even though that limitation may not be described in the original disclosure. Consequently, such limitations must be analyzed for both enablement and description using their separate and distinct criteria.

Furthermore, when the subject matter is not in the specification portion of the application as filed but is

in the claims, the limitation in and of itself may enable one skilled in the art to make and use the claim containing the limitation. When claimed subject matter is only presented in the claims and not in the specification portion of the application, the specification should be objected to for lacking the requisite support for the claimed subject matter using Form Paragraph 7.44. See MPEP § 2163.06. This is an objection to the specification only and enablement issues should be treated separately.

### 2164.01 Test of Enablement

Any analysis of whether a particular claim is supported by the disclosure in an application requires a determination of whether that disclosure, when filed, contained sufficient information regarding the subject matter of the claims as to enable one skilled in the pertinent art to make and use the claimed invention. The standard for determining whether the specification meets the enablement requirement was cast in the Supreme Court decision of *Mineral Separation v. Hyde*, 242 U.S. 261, 270 (1916) which postured the question: is the experimentation needed to practice the invention undue or unreasonable? That standard is still the one to be applied. *In re Wands*, 858 F.2d 731, 737, 8 USPQ2d 1400, 1404 (Fed. Cir. 1988). Accordingly, even though the statute does not use the term “undue experimentation,” it has been interpreted to require that the claimed invention be enabled so that any person skilled in the art can make and use the invention without undue experimentation. *In re Wands*, 858 F.2d at 737, 8 USPQ2d at 1404 (Fed. Cir. 1988). See also *United States v. Telectronics, Inc.*, 857 F.2d 778, 785, 8 USPQ2d 1217, 1223 (Fed. Cir. 1988) (“The test of enablement is whether one reasonably skilled in the art could make or use the invention from the disclosures in the patent coupled with information known in the art without undue experimentation.”). A patent need not teach, and preferably omits, what is well known in the art. *In re Buchner*, 929 F.2d 660, 661, 18 USPQ2d 1331, 1332 (Fed. Cir. 1991); *Hybritech, Inc. v. Monoclonal Antibodies, Inc.*, 802 F.2d 1367, 1384, 231 USPQ 81, 94 (Fed. Cir. 1986), cert. denied, 480 U.S. 947 (1987); and *Lindemann Maschinenfabrik GMBH v. American Hoist & Derrick Co.*, 730 F.2d 1452, 1463, 221 USPQ 481, 489 (Fed. Cir. 1984). Determining enablement is a question of law based on underlying factual findings.

*In re Vaeck*, 947 F.2d 488, 495, 20 USPQ2d 1438, 1444 (Fed. Cir. 1991); *Atlas Powder Co. v. E.I. du Pont de Nemours & Co.*, 750 F.2d 1569, 1576, 224 USPQ 409, 413 (Fed. Cir. 1984).

### UNDUE EXPERIMENTATION

The fact that experimentation may be complex does not necessarily make it undue, if the art typically engages in such experimentation. *In re Certain Limited-Charge Cell Culture Microcarriers*, 221 USPQ 1165, 1174 (Int’l Trade Comm’n 1983), aff’d. sub nom., *Massachusetts Institute of Technology v. A.B. Fortia*, 774 F.2d 1104, 227 USPQ 428 (Fed. Cir. 1985). See also *In re Wands*, 858 F.2d at 737, 8 USPQ2d at 1404. The test of enablement is not whether any experimentation is necessary, but whether, if experimentation is necessary, it is undue. *In re Angstadt*, 537 F.2d 498, 504, 190 USPQ 214, 219 (CCPA 1976).

### 2164.01(a) Undue Experimentation Factors

There are many factors to be considered when determining whether there is sufficient evidence to support a determination that a disclosure does not satisfy the enablement requirement and whether any necessary experimentation is “undue.” These factors include, but are not limited to:

- (A) The breadth of the claims;
- (B) The nature of the invention;
- (C) The state of the prior art;
- (D) The level of one of ordinary skill;
- (E) The level of predictability in the art;
- (F) The amount of direction provided by the inventor;
- (G) The existence of working examples; and
- (H) The quantity of experimentation needed to make or use the invention based on the content of the disclosure.

*In re Wands*, 858 F.2d 731, 737, 8 USPQ2d 1400, 1404 (Fed. Cir. 1988) (reversing the PTO’s determination that claims directed to methods for detection of hepatitis B surface antigens did not satisfy the enablement requirement). In *Wands*, the court noted that there was no disagreement as to the facts, but merely a disagreement as to the interpretation of the data and the conclusion to be made from the facts. *In re Wands*, 858 F.2d at 736-40, 8 USPQ2d at 1403-07. The Court

held that the specification was enabling with respect to the claims at issue and found that “there was considerable direction and guidance” in the specification; there was “a high level of skill in the art at the time the application was filed;” and “all of the methods needed to practice the invention were well known.” 858 F.2d at 740, 8 USPQ2d at 1406. After considering all the factors related to the enablement issue, the court concluded that “it would not require undue experimentation to obtain antibodies needed to practice the claimed invention.” *Id.*, 8 USPQ2d at 1407.

It is improper to conclude that a disclosure is not enabling based on an analysis of only one of the above factors while ignoring one or more of the others. The examiner’s analysis must consider all the evidence related to each of these factors, and any conclusion of nonenablement must be based on the evidence as a whole. 858 F.2d at 737, 740, 8 USPQ2d at 1404, 1407.

A conclusion of lack of enablement means that, based on the evidence regarding each of the above factors, the specification, at the time the application was filed, would not have taught one skilled in the art how to make and/or use the full scope of the claimed invention without undue experimentation. *In re Wright*, 999 F.2d 1557, 1562, 27 USPQ2d 1510, 1513 (Fed. Cir. 1993).

The determination that “undue experimentation” would have been needed to make and use the claimed invention is not a single, simple factual determination. Rather, it is a conclusion reached by weighing all the above noted factual considerations. *In re Wands*, 858 F.2d at 737, 8 USPQ2d at 1404. These factual considerations are discussed more fully in MPEP § 2164.08 (scope or breadth of the claims), § 2164.05(a) (nature of the invention and state of the prior art), § 2164.05(b) (level of one of ordinary skill), § 2164.03 (level of predictability in the art and amount of direction provided by the inventor), § 2164.02 (the existence of working examples) and § 2164.06 (quantity of experimentation needed to make or use the invention based on the content of the disclosure).

### **2164.01(b) How to Make the Claimed Invention**

As long as the specification discloses at least one method for making and using the claimed invention

that bears a reasonable correlation to the entire scope of the claim, then the enablement requirement of 35 U.S.C. 112 is satisfied. *In re Fisher*, 427 F.2d 833, 839, 166 USPQ 18, 24 (CCPA 1970). Failure to disclose other methods by which the claimed invention may be made does not render a claim invalid under 35 U.S.C. 112. *Spectra-Physics, Inc. v. Coherent, Inc.*, 827 F.2d 1524, 1533, 3 USPQ2d 1737, 1743 (Fed. Cir.), *cert. denied*, 484 U.S. 954 (1987).

Naturally, for unstable and transitory chemical intermediates, the “how to make” requirement does not require that the applicant teach how to make the claimed product in stable, permanent or isolatable form. *In re Breslow*, 616 F.2d 516, 521, 205 USPQ 221, 226 (CCPA 1980).

A key issue that can arise when determining whether the specification is enabling is whether the starting materials or apparatus necessary to make the invention are available. In the biotechnical area, this is often true when the product or process requires a particular strain of microorganism and when the microorganism is available only after extensive screening.

The Court in *In re Ghiron*, 442 F.2d 985, 991, 169 USPQ 723, 727 (CCPA 1971), made clear that if the practice of a method requires a particular apparatus, the application must provide a sufficient disclosure of the apparatus if the apparatus is not readily available. The same can be said if certain chemicals are required to make a compound or practice a chemical process. *In re Howarth*, 654 F.2d 103, 105, 210 USPQ 689, 691 (CCPA 1981).

### **2164.01(c) How to Use the Claimed Invention**

If a statement of utility in the specification contains within it a connotation of how to use, and/or the art recognizes that standard modes of administration are known and contemplated, 35 U.S.C. 112 is satisfied. *In re Johnson*, 282 F.2d 370, 373, 127 USPQ 216, 219 (CCPA 1960); *In re Hitchings*, 342 F.2d 80, 87, 144 USPQ 637, 643 (CCPA 1965). See also *In re Brana*, 51 F.2d 1560, 1566, 34 USPQ2d 1437, 1441 (Fed. Cir. 1993).

For example, it is not necessary to specify the dosage or method of use if it is known to one skilled in the art that such information could be obtained without undue experimentation. If one skilled in the art,

based on knowledge of compounds having similar physiological or biological activity, would be able to discern an appropriate dosage or method of use without undue experimentation, this would be sufficient to satisfy 35 U.S.C. 112, first paragraph. The applicant need not demonstrate that the invention is completely safe. See also MPEP § 2107.01 and § 2107.03.

When a compound or composition claim is limited by a particular use, enablement of that claim should be evaluated based on that limitation. See *In re Vaeck*, 947 F.2d 488, 495, 20 USPQ2d 1438, 1444 (Fed. Cir. 1991) (claiming a chimeric gene capable of being expressed in any cyanobacterium and thus defining the claimed gene by its use).

In contrast, when a compound or composition claim is not limited by a recited use, any enabled use that would reasonably correlate with the entire scope of that claim is sufficient to preclude a rejection for nonenablement based on how to use. If multiple uses for claimed compounds or compositions are disclosed in the application, then an enablement rejection must include an explanation, sufficiently supported by the evidence, why the specification fails to enable each disclosed use. In other words, if any use is enabled when multiple uses are disclosed, the application is enabling for the claimed invention.

### 2164.02 Working Example

Compliance with the enablement requirement of 35 U.S.C. 112, first paragraph, does not turn on whether an example is disclosed. An example may be “working” or “prophetic.” A working example is based on work actually performed. A prophetic example describes an embodiment of the invention based on predicted results rather than work actually conducted or results actually achieved.

An applicant need not have actually reduced the invention to practice prior to filing. In *Gould v. Quigg*, 822 F.2d 1074, 1078, 3 USPQ 2d 1302, 1304 (Fed. Cir. 1987), as of Gould's filing date, no person had built a light amplifier or measured a population inversion in a gas discharge. The Court held that “The mere fact that something has not previously been done clearly is not, in itself, a sufficient basis for rejecting all applications purporting to disclose how to do it.” 822 F.2d at 1078, 3 USPQ2d at 1304 (quoting *In re Chilowsky*, 229 F.2d 457, 461, 108 USPQ 321, 325 (CCPA 1956)).

The specification need not contain an example if the invention is otherwise disclosed in such manner that one skilled in the art will be able to practice it without an undue amount of experimentation. *In re Borkowski*, 422 F.2d 904, 908, 164 USPQ 642, 645 (CCPA 1970).

Lack of a working example, however, is a factor to be considered, especially in a case involving an unpredictable and undeveloped art. But because only an enabling disclosure is required, applicant need not describe all actual embodiments.

### NONE OR ONE WORKING EXAMPLE

When considering the factors relating to a determination of non-enablement, if all the other factors point toward enablement, then the absence of working examples will not by itself render the invention non-enabled. In other words, lack of working examples or lack of evidence that the claimed invention works as described should never be the sole reason for rejecting the claimed invention on the grounds of lack of enablement. A single working example in the specification for a claimed invention is enough to preclude a rejection which states that nothing is enabled since at least that embodiment would be enabled. However, a rejection stating that enablement is limited to a particular scope may be appropriate.

The presence of only one working example should never be the sole reason for rejecting claims as being broader than the enabling disclosure, even though it is a factor to be considered along with all the other factors. To make a valid rejection, one must evaluate all the facts and evidence and state why one would not expect to be able to extrapolate that one example across the entire scope of the claims.

### CORRELATION: *IN VITRO/IN VIVO*

The issue of “correlation” is related to the issue of the presence or absence of working examples. “Correlation” as used herein refers to the relationship between *in vitro* or *in vivo* animal model assays and a disclosed or a claimed method of use. An *in vitro* or *in vivo* animal model example in the specification, in effect, constitutes a “working example” if that example “correlates” with a disclosed or claimed method invention. If there is no correlation, then the examples do not constitute “working examples.” In this regard, the issue of “correlation” is also dependent on

the state of the prior art. In other words, if the art is such that a particular model is recognized as correlating to a specific condition, then it should be accepted as correlating unless the examiner has evidence that the model does not correlate. Even with such evidence, the examiner must weigh the evidence for and against correlation and decide whether one skilled in the art would accept the model as reasonably correlating to the condition. *In re Brana*, 51 F.3d 1560, 1566, 34 USPQ2d 1436, 1441 (Fed. Cir. 1995) (reversing the PTO decision based on finding that *in vitro* data did not support *in vivo* applications).

Since the initial burden is on the examiner to give reasons for the lack of enablement, the examiner must also give reasons for a conclusion of lack of correlation for an *in vitro* or *in vivo* animal model example. A rigorous or an invariable exact correlation is not required, as stated in *Cross v. Iizuka*, 753 F.2d 1040, 1050, 224 USPQ 739, 747 (Fed. Cir. 1985):

[B]ased upon the relevant evidence as a whole, there is a reasonable correlation between the disclosed *in vitro* utility and an *in vivo* activity, and therefore a rigorous correlation is not necessary where the disclosure of pharmacological activity is reasonable based upon the probative evidence. (Citations omitted.)

## WORKING EXAMPLES AND A CLAIMED GENUS

For a claimed genus, representative examples together with a statement applicable to the genus as a whole will ordinarily be sufficient if one skilled in the art (in view of level of skill, state of the art and the information in the specification) would expect the claimed genus could be used in that manner without undue experimentation. Proof of enablement will be required for other members of the claimed genus only where adequate reasons are advanced by the examiner to establish that a person skilled in the art could not use the genus as a whole without undue experimentation.

### 2164.03 Relationship of Predictability of the Art and the Enablement Requirement [R-2]

The amount of guidance or direction needed to enable the invention is inversely related to the amount of knowledge in the state of the art as well as the predictability in the art. *In re Fisher*, 427 F.2d 833, 839,

166 USPQ 18, 24 (CCPA 1970). The “amount of guidance or direction” refers to that information in the application, as originally filed, that teaches exactly how to make or use the invention. The more that is known in the prior art about the nature of the invention, how to make, and how to use the invention, and the more predictable the art is, the less information needs to be explicitly stated in the specification. In contrast, if little is known in the prior art about the nature of the invention and the art is unpredictable, the specification would need more detail as to how to make and use the invention in order to be enabling. >See, e.g., *Chiron Corp. v. Genentech Inc.*, 363 F.3d 1247, 1254, 70 USPQ2d 1321, 1326 (Fed. Cir. 2004) (“Nascent technology, however, must be enabled with a ‘specific and useful teaching.’ The law requires an enabling disclosure for nascent technology because a person of ordinary skill in the art has little or no knowledge independent from the patentee’s instruction. Thus, the public’s end of the bargain struck by the patent system is a full enabling disclosure of the claimed technology.” (citations omitted)).<

The “predictability or lack thereof” in the art refers to the ability of one skilled in the art to extrapolate the disclosed or known results to the claimed invention. If one skilled in the art can readily anticipate the effect of a change within the subject matter to which the claimed invention pertains, then there is predictability in the art. On the other hand, if one skilled in the art cannot readily anticipate the effect of a change within the subject matter to which that claimed invention pertains, then there is lack of predictability in the art. Accordingly, what is known in the art provides evidence as to the question of predictability. In particular, the court in *In re Marzocchi*, 439 F.2d 220, 223-24, 169 USPQ 367, 369-70 (CCPA 1971), stated:

[I]n the field of chemistry generally, there may be times when the well-known unpredictability of chemical reactions will alone be enough to create a reasonable doubt as to the accuracy of a particular broad statement put forward as enabling support for a claim. This will especially be the case where the statement is, on its face, contrary to generally accepted scientific principles. Most often, additional factors, such as the teachings in pertinent references, will be available to substantiate any doubts that the asserted scope of objective enablement is in fact commensurate with the scope of protection sought and to support any demands based thereon for proof. [Footnote omitted.]

The scope of the required enablement varies inversely with the degree of predictability involved, but even in unpredictable arts, a disclosure of every operable species is not required. A single embodiment may provide broad enablement in cases involving predictable factors, such as mechanical or electrical elements. *In re Vickers*, 141 F.2d 522, 526-27, 61 USPQ 122, 127 (CCPA 1944); *In re Cook*, 439 F.2d 730, 734, 169 USPQ 298, 301 (CCPA 1971). However, in applications directed to inventions in arts where the results are unpredictable, the disclosure of a single species usually does not provide an adequate basis to support generic claims. *In re Soll*, 97 F.2d 623, 624, 38 USPQ 189, 191 (CCPA 1938). In cases involving unpredictable factors, such as most chemical reactions and physiological activity, more may be required. *In re Fisher*, 427 F.2d 833, 839, 166 USPQ 18, 24 (CCPA 1970) (contrasting mechanical and electrical elements with chemical reactions and physiological activity). See also *In re Wright*, 999 F.2d 1557, 1562, 27 USPQ2d 1510, 1513 (Fed. Cir. 1993); *In re Vaeck*, 947 F.2d 488, 496, 20 USPQ2d 1438, 1445 (Fed. Cir. 1991). This is because it is not obvious from the disclosure of one species, what other species will work.

#### **2164.04 Burden on the Examiner Under \*>the< Enablement Requirement [R-1]**

Before any analysis of enablement can occur, it is necessary for the examiner to construe the claims. For terms that are not well-known in the art, or for terms that could have more than one meaning, it is necessary that the examiner select the definition that he/she intends to use when examining the application, based on his/her understanding of what applicant intends it to mean, and explicitly set forth the meaning of the term and the scope of the claim when writing an Office action. See *Genentech v. Wellcome Foundation*, 29 F.3d 1555, 1563-64, 31 USPQ2d 1161, 1167-68 (Fed. Cir. 1994).

In order to make a rejection, the examiner has the initial burden to establish a reasonable basis to question the enablement provided for the claimed invention. *In re Wright*, 999 F.2d 1557, 1562, 27 USPQ2d 1510, 1513 (Fed. Cir. 1993) (examiner must provide a reasonable explanation as to why the scope of protection provided by a claim is not adequately enabled by the disclosure). A specification disclosure which con-

tains a teaching of the manner and process of making and using an invention in terms which correspond in scope to those used in describing and defining the subject matter sought to be patented must be taken as being in compliance with the enablement requirement of 35 U.S.C. 112, first paragraph, unless there is a reason to doubt the objective truth of the statements contained therein which must be relied on for enabling support. Assuming that sufficient reason for such doubt exists, a rejection for failure to teach how to make and/or use will be proper on that basis. *In re Marzocchi*, 439 F.2d 220, 224, 169 USPQ 367, 370 (CCPA 1971). As stated by the court, "it is incumbent upon the Patent Office, whenever a rejection on this basis is made, to explain *why* it doubts the truth or accuracy of any statement in a supporting disclosure and to back up assertions of its own with acceptable evidence or reasoning which is inconsistent with the contested statement. Otherwise, there would be no need for the applicant to go to the trouble and expense of supporting his presumptively accurate disclosure." 439 F.2d at 224, 169 USPQ at 370.

According to *In re Bowen*, 492 F.2d 859, 862-63, 181 USPQ 48, 51 (CCPA 1974), the minimal requirement is for the examiner to give reasons for the uncertainty of the enablement. This standard is applicable even when there is no evidence in the record of operability without undue experimentation beyond the disclosed embodiments. See also *In re Brana*, 51 F.3d 1560, 1566, 34 USPQ2d 1436, 1441 (Fed. Cir. 1995) (citing *In re Bundy*, 642 F.2d 430, 433, 209 USPQ 48, 51 (CCPA 1981)) (discussed in MPEP § 2164.07 regarding the relationship of the enablement requirement to the utility requirement of 35 U.S.C. 101).

While the analysis and conclusion of a lack of enablement are based on the factors discussed in MPEP § 2164.01(a) and the evidence as a whole, it is not necessary to discuss each factor in the written enablement rejection. The language should focus on those factors, reasons, and evidence that lead the examiner to conclude that the specification fails to teach how to make and use the claimed invention without undue experimentation, or that the scope of any enablement provided to one skilled in the art is not commensurate with the scope of protection sought by the claims. This can be done by making specific findings of fact, supported by the evidence, and then drawing conclusions based on these findings of fact.



For example, doubt may arise about enablement because information is missing about one or more essential parts or relationships between parts which one skilled in the art could not develop without undue experimentation. In such a case, the examiner should specifically identify what information is missing and why one skilled in the art could not supply the information without undue experimentation. See MPEP § 2164.06(a). References should be supplied if possible to support a *prima facie* case of lack of enablement, but are not always required. *In re Marzocchi*, 439 F.2d 220, 224, 169 USPQ 367, 370 (CCPA 1971). However, specific technical reasons are always required.

In accordance with the principles of compact prosecution, if an enablement rejection is appropriate, the first Office action on the merits should present the best case with all the relevant reasons, issues, and evidence so that all such rejections can be withdrawn if applicant provides appropriate convincing arguments and/or evidence in rebuttal. Providing the best case in the first Office action will also allow the second Office action to be made final should applicant fail to provide appropriate convincing arguments and/or evidence. Citing new references and/or expanding arguments in a second Office action could prevent that Office action from being made final. The principles of compact prosecution also dictate that if an enablement rejection is appropriate and the examiner recognizes limitations that would render the claims enabled, the examiner should note such limitations to applicant as early in the prosecution as possible.

In other words, the examiner should always look for enabled, allowable subject matter and communicate to applicant what that subject matter is at the earliest point possible in the prosecution of the application.

### **2164.05 Determination of Enablement Based on Evidence as a Whole**

Once the examiner has weighed all the evidence and established a reasonable basis to question the enablement provided for the claimed invention, the burden falls on applicant to present persuasive arguments, supported by suitable proofs where necessary, that one skilled in the art would be able to make and use the claimed invention using the application as a guide. *In re Brandstadter*, 484 F.2d 1395, 1406-07,

179 USPQ 286, 294 (CCPA 1973). The evidence provided by applicant need not be conclusive but merely convincing to one skilled in the art.

Applicant may submit factual affidavits under 37 CFR 1.132 or cite references to show what one skilled in the art knew at the time of filing the application. A declaration or affidavit is, itself, evidence that must be considered. The weight to give a declaration or affidavit will depend upon the amount of factual evidence the declaration or affidavit contains to support the conclusion of enablement. *In re Buchner*, 929 F.2d 660, 661, 18 USPQ2d 1331, 1332 (Fed. Cir. 1991) (“expert’s opinion on the ultimate legal conclusion must be supported by something more than a conclusory statement”); *cf. In re Alton*, 76 F.3d 1168, 1174, 37 USPQ2d 1578, 1583 (Fed. Cir. 1996) (declarations relating to the written description requirement should have been considered).

Applicant should be encouraged to provide any evidence to demonstrate that the disclosure enables the claimed invention. In chemical and biotechnical applications, evidence actually submitted to the FDA to obtain approval for clinical trials may be submitted. However, considerations made by the FDA for approving clinical trials are different from those made by the PTO in determining whether a claim is enabled. See *Scott v. Finney*, 34 F.3d 1058, 1063, 32 USPQ2d 1115, 1120 (Fed. Cir. 1994) (“Testing for full safety and effectiveness of a prosthetic device is more properly left to the [FDA].”). Once that evidence is submitted, it must be weighed with all other evidence according to the standards set forth above so as to reach a determination as to whether the disclosure enables the claimed invention.

To overcome a *prima facie* case of lack of enablement, applicant must demonstrate by argument and/or evidence that the disclosure, as filed, would have enabled the claimed invention for one skilled in the art at the time of filing. This does not preclude applicant from providing a declaration after the filing date which demonstrates that the claimed invention works. However, the examiner should carefully compare the steps, materials, and conditions used in the experiments of the declaration with those disclosed in the application to make sure that they are commensurate in scope; i.e., that the experiments used the guidance in the specification as filed and what was well known to one of skill in the art. Such a showing also must be

commensurate with the scope of the claimed invention, i.e., must bear a reasonable correlation to the scope of the claimed invention.

The examiner must then weigh all the evidence before him or her, including the specification and any new evidence supplied by applicant with the evidence and/or sound scientific reasoning previously presented in the rejection and decide whether the claimed invention is enabled. The examiner should **never** make the determination based on personal opinion. The determination should always be based on the weight of all the evidence.

### **2164.05(a) Specification Must Be Enabling as of the Filing Date [R-2]**

Whether the specification would have been enabling as of the filing date involves consideration of the nature of the invention, the state of the prior art, and the level of skill in the art. The initial inquiry is into the nature of the invention, i.e., the subject matter to which the claimed invention pertains. The nature of the invention becomes the backdrop to determine the state of the art and the level of skill possessed by one skilled in the art.

The state of the prior art is what one skilled in the art would have known, at the time the application was filed, about the subject matter to which the claimed invention pertains. The relative skill of those in the art refers to the skill of those in the art in relation to the subject matter to which the claimed invention pertains at the time the application was filed. See MPEP § 2164.05(b).

The state of the prior art provides evidence for the degree of predictability in the art and is related to the amount of direction or guidance needed in the specification as filed to meet the enablement requirement. The state of the prior art is also related to the need for working examples in the specification.

The state of the art for a given technology is not static in time. It is entirely possible that a disclosure filed on January 2, 1990, would not have been enabled. However, if the same disclosure had been filed on January 2, 1996, it might have enabled the claims. Therefore, the state of the prior art must be evaluated for each application based on its filing date.

35 U.S.C. 112 requires the specification to be enabling only to a person “skilled in the art to which it pertains, or with which it is most nearly connected.”

In general, the pertinent art should be defined in terms of the problem to be solved rather than in terms of the technology area, industry, trade, etc. for which the invention is used.

The specification need not disclose what is well-known to those skilled in the art and preferably omits that which is well-known to those skilled and already available to the public. *In re Buchner*, 929 F.2d 660, 661, 18 USPQ2d 1331, 1332 (Fed. Cir. 1991); *Hybritech, Inc. v. Monoclonal Antibodies, Inc.*, 802 F.2d 1367, 1384, 231 USPQ 81, 94 (Fed. Cir. 1986), *cert. denied*, 480 U.S. 947 (1987); and *Lindemann Maschinenfabrik GMBH v. American Hoist & Derrick Co.*, 730 F.2d 1452, 1463, 221 USPQ 481, 489 (Fed. Cir. 1984).

The state of the art existing at the filing date of the application is used to determine whether a particular disclosure is enabling as of the filing date. >*Chiron Corp. v. Genentech Inc.*, 363 F.3d 1247, 1254, 70 USPQ2d 1321, 1325-26 (Fed. Cir. 2004) (“a patent document cannot enable technology that arises after the date of application”).< Publications dated after the filing date providing information publicly first disclosed after the filing date generally cannot be used to show what was known at the time of filing. *In re Gunn*, 537 F.2d 1123, 1128, 190 USPQ 402,405-06 (CCPA 1976); *In re Budnick*, 537 F.2d 535, 538, 190 USPQ 422, 424 (CCPA 1976) (In general, if an applicant seeks to use a patent to prove the state of the art for the purpose of the enablement requirement, the patent must have an issue date earlier than the effective filing date of the application.). While a later dated publication cannot supplement an insufficient disclosure in a prior dated application to make it enabling, applicant can offer the testimony of an expert based on the publication as evidence of the level of skill in the art at the time the application was filed. *Gould v. Quigg*, 822 F.2d 1074, 1077, 3 USPQ2d 1302, 1304 (Fed. Cir. 1987).

In general, the examiner should not use post-filing date references to demonstrate that the patent is non-enabling. Exceptions to this rule could occur if a later-dated reference provides evidence of what one skilled in the art would have known on or before the effective filing date of the patent application. *In re Hogan*, 559 F.2d 595, 605, 194 USPQ 527, 537 (CCPA 1977). If individuals of skill in the art state that a particular invention is not possible years after the filing date,

that would be evidence that the disclosed invention was not possible at the time of filing and should be considered. In *In re Wright*, 999 F.2d 1557, 1562, 27 USPQ2d 1510, 1513-14 (Fed. Cir. 1993) an article published 5 years after the filing date of the application adequately supported the examiner's position that the physiological activity of certain viruses was sufficiently unpredictable so that a person skilled in the art would not have believed that the success with one virus and one animal could be extrapolated successfully to all viruses with all living organisms. Claims not directed to the specific virus and the specific animal were held nonenabled.

### **2164.05(b) Specification Must Be Enabling to Persons Skilled in the Art**

The relative skill of those in the art refers to the skill of those in the art in relation to the subject matter to which the claimed invention pertains at the time the application was filed. Where different arts are involved in the invention, the specification is enabling if it enables persons skilled in each art to carry out the aspect of the invention applicable to their specialty. *In re Naquin*, 398 F.2d 863, 866, 158 USPQ 317, 319 (CCPA 1968).

When an invention, in its different aspects, involves distinct arts, the specification is enabling if it enables those skilled in each art, to carry out the aspect proper to their specialty. "If two distinct technologies are relevant to an invention, then the disclosure will be adequate if a person of ordinary skill in each of the two technologies could practice the invention from the disclosures." *Technicon Instruments Corp. v. Alpkem Corp.*, 664 F. Supp. 1558, 1578, 2 USPQ2d 1729, 1742 (D. Ore. 1986), aff'd in part, vacated in part, rev'd in part, 837 F. 2d 1097 (Fed. Cir. 1987) (unpublished opinion), appeal after remand, 866 F. 2d 417, 9 USPQ 2d 1540 (Fed. Cir. 1989). In *Ex parte Zech-nall*, 194 USPQ 461 (Bd. App. 1973), the Board stated "appellants' disclosure must be held sufficient if it would enable a person skilled in the electronic computer art, in cooperation with a person skilled in the fuel injection art, to make and use appellants' invention." 194 USPQ at 461.

### **2164.06 Quantity of Experimentation**

The quantity of experimentation needed to be performed by one skilled in the art is only one factor

involved in determining whether "undue experimentation" is required to make and use the invention. "[A]n extended period of experimentation may not be undue if the skilled artisan is given sufficient direction or guidance." *In re Colianni*, 561 F.2d 220, 224, 195 USPQ 150, 153 (CCPA 1977). "The test is not merely quantitative, since a considerable amount of experimentation is permissible, if it is merely routine, or if the specification in question provides a reasonable amount of guidance with respect to the direction in which the experimentation should proceed." *In re Wands*, 858 F.2d 731, 737, 8 USPQ2d 1400, 1404 (Fed. Cir. 1988) (citing *In re Angstadt*, 537 F.2d 489, 502-04, 190 USPQ 214, 217-19 (CCPA 1976)). Time and expense are merely factors in this consideration and are not the controlling factors. *United States v. Telectronics Inc.*, 857 F.2d 778, 785, 8 USPQ2d 1217, 1223 (Fed. Cir. 1988), cert. denied, 490 U.S. 1046 (1989).

In the chemical arts, the guidance and ease in carrying out an assay to achieve the claimed objectives may be an issue to be considered in determining the quantity of experimentation needed. For example, if a very difficult and time consuming assay is needed to identify a compound within the scope of a claim, then this great quantity of experimentation should be considered in the overall analysis. Time and difficulty of experiments are not determinative if they are merely routine. Quantity of examples is only one factor that must be considered before reaching the final conclusion that undue experimentation would be required. *In re Wands*, 858 F.2d at 737, 8 USPQ2d at 1404.

#### **I. EXAMPLE OF REASONABLE EXPERIMENTATION**

In *United States v. Telectronics, Inc.*, 857 F.2d 778, 8 USPQ2d 1217 (Fed. Cir. 1988), cert. denied, 490 U.S. 1046 (1989), the court reversed the findings of the district court for lack of clear and convincing proof that undue experimentation was needed. The court ruled that since one embodiment (stainless steel electrodes) and the method to determine dose/response was set forth in the specification, the specification was enabling. The question of time and expense of such studies, approximately \$50,000 and 6-12 months standing alone, failed to show undue experimentation.

## II. EXAMPLE OF UNREASONABLE EXPERIMENTATION

In *In re Ghiron*, 442 F.2d 985, 991-92, 169 USPQ 723, 727-28 (CCPA 1971), functional “block diagrams” were insufficient to enable a person skilled in the art to practice the claimed invention with only a reasonable degree of experimentation because the claimed invention required a “modification to prior art overlap computers,” and because “many of the components which appellants illustrate as rectangles in their drawing necessarily are themselves complex assemblages . . . . It is common knowledge that many months or years elapse from the announcement of a new computer by a manufacturer before the first prototype is available. This does not bespeak of a routine operation but of extensive experimentation and development work . . . .”

### 2164.06(a) Examples of \*>Enablement< Issues-Missing Information [R-1]

It is common that doubt arises about enablement because information is missing about one or more essential parts or relationships between parts which one skilled in the art could not develop without undue experimentation. In such a case, the examiner should specifically identify what information is missing and why the missing information is needed to provide enablement.

## I. ELECTRICAL AND MECHANICAL DEVICES OR PROCESSES

For example, a disclosure of an electrical circuit apparatus, depicted in the drawings by block diagrams with functional labels, was held to be nonenabling in *In re Gunn*, 537 F.2d 1123, 1129, 190 USPQ 402, 406 (CCPA 1976). There was no indication in the specification as to whether the parts represented by boxes were “off the shelf” or must be specifically constructed or modified for applicant’s system. Also there were no details in the specification of how the parts should be interconnected, timed and controlled so as to obtain the specific operations desired by the applicant. In *In re Donohue*, 550 F.2d 1269, 193 USPQ 136 (CCPA 1977), the lack of enablement was caused by lack of information in the specification about a single block labelled “LOGIC” in the drawings. See also

*Union Pacific Resources Co. v. Chesapeake Energy Corp.*, 236 F.3d 684, 57 USPQ2d 1293 (Fed. Cir. 2001) (Claims directed to a method of determining the location of a horizontal borehole in the earth failed to comply with enablement requirement of 35 U.S.C. 112 because certain computer programming details used to perform claimed method were not disclosed in the specification, and the record showed that a person of skill in art would not understand how to “compare” or “rescale” data as recited in the claims in order to perform the claimed method.).

*In re Ghiron*, 442 F.2d 985, 169 USPQ 723 (CCPA 1971), involved a method of facilitating transfers from one subset of program instructions to another which required modification of prior art “overlap mode” computers. The Board rejected the claims on the basis, *inter alia*, that the disclosure was insufficient to satisfy the requirements of 35 U.S.C. 112, first paragraph and was affirmed. The Board focused on the fact that the drawings were “block diagrams, i.e., a group of rectangles representing the elements of the system, functionally labelled and interconnected by lines.” 442 F.2d at 991, 169 USPQ at 727. The specification did not particularly identify each of the elements represented by the blocks or the relationship therebetween, nor did it specify particular apparatus intended to carry out each function. The Board further questioned whether the selection and assembly of the required components could be carried out routinely by persons of ordinary skill in the art.

An adequate disclosure of a device may require details of how complex components are constructed and perform the desired function. The claim before the court in *In re Scarbrough*, 500 F.2d 560, 182 USPQ 298 (CCPA 1974) was directed to a system which comprised several component parts (e.g., computer, timing and control mechanism, A/D converter, etc.) only by generic name and overall ultimate function. The court concluded that there was not an enabling disclosure because the specification did not describe how “complex elements known to perform broadly recited functions in different systems would be adaptable for use in Appellant’s particular system with only a reasonable amount of experimentation” and that “an unreasonable amount of work would be required to arrive at the detailed relationships appellant says that he has solved.” 500 F.2d at 566, 182 USPQ at 302.

## II. MICROORGANISMS

Patent applications involving living biological products, such as microorganisms, as critical elements in the process of making the invention, present a unique question with regard to availability. The issue was raised in a case involving claims drawn to a fermentative method of producing two novel antibiotics using a specific microorganism and claims to the novel antibiotics so produced. *In re Argoudelis*, 434 F.2d 1390, 168 USPQ 99 (CCPA 1970). As stated by the court, “a unique aspect of using microorganisms as starting materials is that a sufficient description of how to obtain the microorganism from nature cannot be given.” 434 F.2d at 1392, 168 USPQ at 102. It was determined by the court that availability of the biological product via a public depository provided an acceptable means of meeting the written description and the enablement requirements of 35 U.S.C. 112, first paragraph.

To satisfy the enablement requirement a deposit must be made “prior to issue” but need not be made prior to filing the application. *In re Lundak*, 773 F.2d 1216, 1223, 227 USPQ 90, 95 (Fed. Cir. 1985).

The availability requirement of enablement must also be considered in light of the scope or breadth of the claim limitations. The Board of Appeals considered this issue in an application which claimed a fermentative method using microorganisms belonging to a species. Applicants had identified three novel individual strains of microorganisms that were related in such a way as to establish a new species of microorganism, a species being a broader classification than a strain. The three specific strains had been appropriately deposited. The issue focused on whether the specification enabled one skilled in the art to make any member of the species other than the three strains which had been deposited. The Board concluded that the verbal description of the species was inadequate to allow a skilled artisan to make any and all members of the claimed species. *Ex parte Jackson*, 217 USPQ 804, 806 (Bd. App. 1982).

See MPEP § 2402 - § 2411.03 for a detailed discussion of the deposit rules. See MPEP § 2411.01 for rejections under 35 U.S.C. 112 based on deposit issues.

## III. DRUG CASES

See MPEP § 2107 - § 2107.03 for a discussion of the utility requirement under 35 U.S.C. 112, first paragraph, in drug cases.

### 2164.06(b) Examples of Enablement Issues — Chemical Cases

The following summaries should not be relied on to support a case of lack of enablement without carefully reading the case.

#### SEVERAL DECISIONS RULING THAT THE DISCLOSURE WAS NONENABLING

(A) In *Enzo Biochem, Inc. v. Calgene, Inc.*, 188 F.3d 1362, 52 USPQ2d 1129 (Fed. Cir. 1999), the court held that claims in two patents directed to genetic antisense technology (which aims to control gene expression in a particular organism), were invalid because the breadth of enablement was not commensurate in scope with the claims. Both specifications disclosed applying antisense technology in regulating three genes in *E. coli*. Despite the limited disclosures, the specifications asserted that the “[t]he practices of this invention are generally applicable with respect to any organism containing genetic material which is capable of being expressed ... such as bacteria, yeast, and other cellular organisms.” The claims of the patents encompassed application of antisense methodology in a broad range of organisms. Ultimately, the court relied on the fact that (1) the amount of direction presented and the number of working examples provided in the specification were very narrow compared to the wide breadth of the claims at issue, (2) antisense gene technology was highly unpredictable, and (3) the amount of experimentation required to adapt the practice of creating antisense DNA from *E. coli* to other types of cells was quite high, especially in light of the record, which included notable examples of the inventor’s own failures to control the expression of other genes in *E. coli* and other types of cells. Thus, the teachings set forth in the specification provided no more than a “plan” or “invitation” for those of skill in the art to experiment using the technology in other types of cells.

(B) In *In re Wright*, 999 F.2d 1557, 27 USPQ2d 1510 (Fed. Cir. 1993), the 1983 application disclosed a vaccine against the RNA tumor virus known as Prague Avian Sarcoma Virus, a member of the Rous Associated Virus family. Using functional language, Wright claimed a vaccine “comprising an immunologically effective amount” of a viral expression product. *Id.*, at 1559, 27 USPQ2d at 1511. Rejected claims covered all RNA viruses as well as avian RNA viruses. The examiner provided a teaching that in 1988, a vaccine for another retrovirus (i.e., AIDS) remained an intractable problem. This evidence, along with evidence that the RNA viruses were a diverse and complicated genus, convinced the Federal Circuit that the invention was not enabled for either all retroviruses or even for avian retroviruses.

(C) In *In re Goodman*, 11 F.3d 1046, 29 USPQ2d 2010 (Fed. Cir. 1993), a 1985 application functionally claimed a method of producing protein in plant cells by expressing a foreign gene. The court stated: “[n]aturally, the specification must teach those of skill in the art ‘how to make and use the invention as broadly as it is claimed.’ ” *Id.* at 1050, 29 USPQ2d at 2013. Although protein expression in dicotyledonous plant cells was enabled, the claims covered any plant cell. The examiner provided evidence that even as late as 1987, use of the claimed method in monocot plant cells was not enabled. *Id.* at 1051, 29 USPQ2d at 2014.

(D) In *In re Vaeck*, 947 F.2d 488, 495, 20 USPQ2d 1438, 1444 (Fed. Cir. 1991), the court found that several claims were not supported by an enabling disclosure “[t]aking into account the relatively incomplete understanding of the biology of cyanobacteria as of appellants’ filing date, as well as the limited disclosure by appellants of the particular cyanobacterial genera operative in the claimed invention...” The claims at issue were not limited to any particular genus or species of cyanobacteria and the specification mentioned nine genera and the working examples employed one species of cyanobacteria.

(E) In *In re Colianni*, 561 F.2d 220, 222-23, 195 USPQ 150, 152 (CCPA 1977), the court affirmed a rejection under 35 U.S.C. 112, first paragraph, because the specification, which was directed to a method of mending a fractured bone by applying “sufficient” ultrasonic energy to the bone, did not

define a “sufficient” dosage or teach one of ordinary skill how to select the appropriate intensity, frequency, or duration of the ultrasonic energy.

### SEVERAL DECISIONS RULING THAT THE DISCLOSURE WAS ENABLING

(A) In *PPG Ind. v. Guardian Ind.*, 75 F.3d 1558, 1564, 37 USPQ2d 1618, 1623 (Fed. Cir. 1996), the court ruled that even though there was a software error in calculating the ultraviolet transmittance data for examples in the specification making it appear that the production of a cerium oxide-free glass that satisfied the transmittance limitation would be difficult, the specification indicated that such glass could be made. The specification was found to indicate how to minimize the cerium content while maintaining low ultraviolet transmittance.

(B) In *In re Wands*, 858 F.2d 731, 8 USPQ2d 1400 (Fed. Cir. 1988), the court reversed the rejection for lack of enablement under 35 U.S.C. 112, first paragraph, concluding that undue experimentation would not be required to practice the invention. The nature of monoclonal antibody technology is such that experiments first involve the entire attempt to make monoclonal hybridomas to determine which ones secrete antibody with the desired characteristics. The court found that the specification provided considerable direction and guidance on how to practice the claimed invention and presented working examples, that all of the methods needed to practice the invention were well known, and that there was a high level of skill in the art at the time the application was filed. Furthermore, the applicant carried out the entire procedure for making a monoclonal antibody against HBsAg three times and each time was successful in producing at least one antibody which fell within the scope of the claims.

(C) In *In re Bundy*, 642 F.2d 430, 434, 209 USPQ 48, 51-52 (CCPA 1981), the court ruled that appellant’s disclosure was sufficient to enable one skilled in the art to use the claimed analogs of naturally occurring prostaglandins even though the specification lacked any examples of specific dosages, because the specification taught that the novel prostaglandins had certain pharmacological properties and possessed activity similar to known E-type prostaglandins.

## **2164.07 Relationship of Enablement Requirement to Utility Requirement of 35 U.S.C. 101**

The requirement of 35 U.S.C. 112, first paragraph as to how to use the invention is different from the utility requirement of 35 U.S.C. 101. The requirement of 35 U.S.C. 101 is that some specific, substantial, and credible use be set forth for the invention. On the other hand, 35 U.S.C. 112, first paragraph requires an indication of how the use (required by 35 U.S.C. 101) can be carried out, i.e., how the invention can be used.

If an applicant has disclosed a specific and substantial utility for an invention and provided a credible basis supporting that utility, that fact alone does not provide a basis for concluding that the claims comply with all the requirements of 35 U.S.C. 112, first paragraph. For example, if an applicant has claimed a process of treating a certain disease condition with a certain compound and provided a credible basis for asserting that the compound is useful in that regard, but to actually practice the invention as claimed a person skilled in the relevant art would have to engage in an undue amount of experimentation, the claim may be defective under 35 U.S.C. 112, but not 35 U.S.C. 101. To avoid confusion during examination, any rejection under 35 U.S.C. 112, first paragraph, based on grounds other than “lack of utility” should be imposed separately from any rejection imposed due to “lack of utility” under 35 U.S.C. 101 and 35 U.S.C. 112, first paragraph.

### **I. WHEN UTILITY REQUIREMENT IS NOT SATISFIED**

#### **A. *Not Useful or Operative***

If a claim fails to meet the utility requirement of 35 U.S.C. 101 because it is shown to be nonuseful or inoperative, then it necessarily fails to meet the how-to-use aspect of the enablement requirement of 35 U.S.C. 112, first paragraph. As noted in *In re Fouche*, 439 F.2d 1237, 169 USPQ 429 (CCPA 1971), if “compositions are in fact useless, appellant’s specification cannot have taught how to use them.” 439 F.2d at 1243, 169 USPQ at 434. The examiner should make both rejections (i.e., a rejection under 35 U.S.C. 112, first paragraph and a rejection under 35 U.S.C.

101) where the subject matter of a claim has been shown to be nonuseful or inoperative.

The 35 U.S.C. 112, first paragraph, rejection should indicate that because the invention as claimed does not have utility, a person skilled in the art would not be able to use the invention as claimed, and as such, the claim is defective under 35 U.S.C. 112, first paragraph. A 35 U.S.C. 112, first paragraph, rejection should not be imposed or maintained unless an appropriate basis exists for imposing a rejection under 35 U.S.C. 101. In other words, Office personnel should not impose a 35 U.S.C. 112, first paragraph, rejection grounded on a “lack of utility” basis unless a 35 U.S.C. 101 rejection is proper. In particular, the factual showing needed to impose a rejection under 35 U.S.C. 101 must be provided if a 35 U.S.C. 112, first paragraph, rejection is to be imposed on “lack of utility” grounds. See MPEP § 2107 - § 2107.03 for a more detailed discussion of the utility requirements of 35 U.S.C. 101 and 112, first paragraph.

#### **B. *Burden on the Examiner***

When the examiner concludes that an application is describing an invention that is nonuseful, inoperative, or contradicts known scientific principles, the burden is on the examiner to provide a reasonable basis to support this conclusion. Rejections based on 35 U.S.C. 112, first paragraph and 35 U.S.C. 101 should be made.

#### **Examiner Has Initial Burden To Show That One of Ordinary Skill in the Art Would Reasonably Doubt the Asserted Utility**

The examiner has the initial burden of challenging an asserted utility. Only after the examiner has provided evidence showing that one of ordinary skill in the art would reasonably doubt the asserted utility does the burden shift to the applicant to provide rebuttal evidence sufficient to convince one of ordinary skill in the art of the invention’s asserted utility. *In re Swartz*, 232 F.3d 862, 863, 56 USPQ2d 1703, 1704 (Fed. Cir. 2000); *In re Brana*, 51 F.3d 1560, 1566, 34 USPQ2d 1436, 1441 (Fed. Cir. 1995) (citing *In re Bundy*, 642 F.2d 430, 433, 209 USPQ 48, 51 (CCPA 1981)).

### C. *Rebuttal by Applicant*

If a rejection under 35 U.S.C. 101 has been properly imposed, along with a corresponding rejection under 35 U.S.C. 112, first paragraph, the burden shifts to the applicant to rebut the *prima facie* showing. *In re Oetiker*, 977 F.2d 1443, 1445, 24 USPQ2d 1443, 1444 (Fed. Cir. 1992). There is no predetermined amount or character of evidence that must be provided by an applicant to support an asserted utility. Rather, the character and amount of evidence needed to support an asserted utility will vary depending on what is claimed (*Ex parte Ferguson*, 117 USPQ 229, 231 (Bd. App. 1957)), and whether the asserted utility appears to contravene established scientific principles and beliefs. *In re Gazave*, 379 F.2d 973, 978, 154 USPQ 92, 96 (CCPA 1967); *In re Chilowsky*, 229 F.2d 457, 462, 108 USPQ 321, 325 (CCPA 1956). Furthermore, the applicant does not have to provide evidence sufficient to establish that an asserted utility is true “beyond a reasonable doubt.” *In re Irons*, 340 F.2d 974, 978, 144 USPQ 351, 354 (CCPA 1965). Instead, evidence will be sufficient if, considered as a whole, it leads a person of ordinary skill in the art to conclude that the asserted utility is more likely than not true. See MPEP § 2107.02 for a more detailed discussion of consideration of a reply to a *prima facie* rejection for lack of utility and evaluation of evidence related to utility.

## II. WHEN UTILITY REQUIREMENT IS SATISFIED

In some instances, the use will be provided, but the skilled artisan will not know how to effect that use. In such a case, no rejection will be made under 35 U.S.C. 101, but a rejection will be made under 35 U.S.C. 112, first paragraph. As pointed out in *Mowry v. Whitney*, 81 U.S. (14 Wall.) 620 (1871), an invention may in fact have great utility, i.e., may be “a highly useful invention,” but the specification may still fail to “enable any person skilled in the art or science” to use the invention. 81 U.S. (14 Wall.) at 644.

### 2164.08 Enablement Commensurate in Scope With the Claims [R-2]

All questions of enablement are evaluated against the claimed subject matter. The focus of the examination inquiry is whether everything within the scope of

the claim is enabled. Accordingly, the first analytical step requires that the examiner determine exactly what subject matter is encompassed by the claims. >See, e.g., *AK Steel Corp. v. Sollac*, 344 F.3d 1234, 1244, 68 USPQ2d 1280, 1287 (Fed. Cir. 2003)(When a range is claimed, there must be reasonable enablement of the scope of the range. Here, the claims at issue encompassed amounts of silicon as high as 10% by weight, however the specification included statements clearly and strongly warning that a silicon content above 0.5% by weight in an aluminum coating causes coating problems. Such statements indicate that higher amounts will not work in the claimed invention.)< The examiner should determine what each claim recites and what the subject matter is when the claim is considered as a whole, not when its parts are analyzed individually. No claim should be overlooked. With respect to dependent claims, 35 U.S.C. 112, fourth paragraph, should be followed. This paragraph states that “a claim in a dependent form shall be construed to incorporate by reference all the limitations of the claim to which it refers” and requires the dependent claim to further limit the subject matter claimed.

The Federal Circuit has repeatedly held that “the specification must teach those skilled in the art how to make and use the full scope of the claimed invention without ‘undue experimentation’.” *In re Wright*, 999 F.2d 1557, 1561, 27 USPQ2d 1510, 1513 (Fed. Cir. 1993). Nevertheless, not everything necessary to practice the invention need be disclosed. In fact, what is well-known is best omitted. *In re Buchner*, 929 F.2d 660, 661, 18 USPQ2d 1331, 1332 (Fed. Cir. 1991). All that is necessary is that one skilled in the art be able to practice the claimed invention, given the level of knowledge and skill in the art. Further the scope of enablement must only bear a “reasonable correlation” to the scope of the claims. See, e.g., *In re Fisher*, 427 F.2d 833, 839, 166 USPQ 18, 24 (CCPA 1970).

As concerns the breadth of a claim relevant to enablement, the only relevant concern should be whether the scope of enablement provided to one skilled in the art by the disclosure is commensurate with the scope of protection sought by the claims. >*AK Steel Corp. v. Sollac*, 344 F.3d 1234, 1244, 68 USPQ2d 1280, 1287 (Fed. Cir. 2003);< *In re Moore*, 439 F.2d 1232, 1236, 169 USPQ 236, 239 (CCPA 1971). See also *Plant Genetic Sys., N.V. v. DeKalb*



*Genetics Corp.*, 315 F.3d 1335, 1339, 65 USPQ2d 1452, 1455 (Fed. Cir. 2003) (alleged “pioneer status” of invention irrelevant to enablement determination).

The determination of the propriety of a rejection based upon the scope of a claim relative to the scope of the enablement involves two stages of inquiry. The first is to determine how broad the claim is with respect to the disclosure. The entire claim must be considered. The second inquiry is to determine if one skilled in the art is enabled to make and use the entire scope of the claimed invention without undue experimentation.

How a teaching is set forth, by specific example or broad terminology, is not important. *In re Marzocchi*, 439 F.2d 220, 223-24 169 USPQ 367, 370 (CCPA 1971). A rejection of a claim under 35 U.S.C. 112 as broader than the enabling disclosure is a first paragraph enablement rejection and not a second paragraph definiteness rejection. Claims are not rejected as broader than the enabling disclosure under 35 U.S.C. 112 for noninclusion of limitations dealing with factors which must be presumed to be within the level of ordinary skill in the art; the claims need not recite such factors where one of ordinary skill in the art to whom the specification and claims are directed would consider them obvious. *In re Skrivan*, 427 F.2d 801, 806, 166 USPQ 85, 88 (CCPA 1970). One does not look to the claims but to the specification to find out how to practice the claimed invention. *W.L. Gore & Assoc., Inc. v. Garlock, Inc.*, 721 F.2d 1540, 1558, 220 USPQ 303, 316-17 (Fed. Cir. 1983); *In re Johnson*, 558 F.2d 1008, 1017, 194 USPQ 187, 195 (CCPA 1977). In *In re Goffe*, 542 F.2d 564, 567, 191 USPQ 429, 431 (CCPA 1976), the court stated:

[T]o provide effective incentives, claims must adequately protect inventors. To demand that the first to disclose shall limit his claims to what he has found will work or to materials which meet the guidelines specified for “preferred” materials in a process such as the one herein involved would not serve the constitutional purpose of promoting progress in the useful arts.

When analyzing the enabled scope of a claim, the teachings of the specification must not be ignored because claims are to be given their broadest reasonable interpretation that is consistent with the specification. “That claims are interpreted in light of the specification does not mean that everything in the specification must be read into the claims.” *Raytheon*

*Co. v. Roper Corp.*, 724 F.2d 951, 957, 220 USPQ 592, 597 (Fed. Cir. 1983), *cert. denied*, 469 U.S. 835 (1984).

The record must be clear so that the public will have notice as to the patentee’s scope of protection when the patent issues. If a reasonable interpretation of the claim is broader than the description in the specification, it is necessary for the examiner to make sure the full scope of the claim is enabled. Limitations and examples in the specification do not generally limit what is covered by the claims.

The breadth of the claims was a factor considered in *Amgen v. Chugai Pharmaceutical Co.*, 927 F.2d 1200, 18 USPQ2d 1016 (Fed. Cir.), *cert. denied*, 502 U.S. 856 (1991). In the *Amgen* case, the patent claims were directed to a purified DNA sequence encoding polypeptides which are analogs of erythropoietin (EPO). The Court stated that:

Amgen has not enabled preparation of DNA sequences sufficient to support its all-encompassing claims. . . . [D]espite extensive statements in the specification concerning all the analogs of the EPO gene that can be made, there is little enabling disclosure of particular analogs and how to make them. Details for preparing only a few EPO analog genes are disclosed. . . . This disclosure might well justify a generic claim encompassing these and similar analogs, but it represents inadequate support for Amgen’s desire to claim all EPO gene analogs. There may be many other genetic sequences that code for EPO-type products. Amgen has told how to make and use only a few of them and is therefore not entitled to claim all of them.

927 F.2d at 1213-14, 18 USPQ2d at 1027. However, when claims are directed to any purified and isolated DNA sequence encoding a specifically named protein where the protein has a specifically identified sequence, a rejection of the claims as broader than the enabling disclosure is generally not appropriate because one skilled in the art could readily determine any one of the claimed embodiments.

See also *In re Wright*, 999 F.2d 1557, 1562, 27 USPQ2d 1510, 1513 (Fed. Cir. 1993) (The evidence did not show that a skilled artisan would have been able to carry out the steps required to practice the full scope of claims which encompass “any and all live, non-pathogenic vaccines, and processes for making such vaccines, which elicit immunoprotective activity in any animal toward any RNA virus.” (original emphasis)); *In re Goodman*, 11 F.3d 1046,

1052, 29 USPQ2d 2010, 2015 (Fed. Cir. 1993) (The specification did not enable the broad scope of the claims for producing mammalian peptides in plant cells because the specification contained only an example of producing gamma-interferon in a dicot species, and there was evidence that extensive experimentation would have been required for encoding mammalian peptide into a monocot plant at the time of filing); *In re Fisher*, 427 F.2d 833, 839, 166 USPQ 18, 24 (CCPA 1970) (Where applicant claimed a composition suitable for the treatment of arthritis having a potency of “at least” a particular value, the court held that the claim was not commensurate in scope with the enabling disclosure because the disclosure was not enabling for compositions having a slightly higher potency. Simply because applicant was the first to achieve a composition beyond a particular threshold potency did not justify or support a claim that would dominate every composition that exceeded that threshold value.); *In re Vaeck*, 947 F.2d 488, 495, 20 USPQ2d 1438, 1444 (Fed. Cir. 1991) (Given the relatively incomplete understanding in the biotechnological field involved, and the lack of a reasonable correlation between the narrow disclosure in the specification and the broad scope of protection sought in the claims, a rejection under 35 U.S.C. 112, first paragraph for lack of enablement was appropriate.).

If a rejection is made based on the view that the enablement is not commensurate in scope with the claim, the examiner should identify the subject matter that is considered to be enabled.

### **2164.08(a) Single Means Claim**

A single means claim, i.e., where a means recitation does not appear in combination with another recited element of means, is subject to an undue breadth rejection under 35 U.S.C. 112, first paragraph. *In re Hyatt*, 708 F.2d 712, 714-715, 218 USPQ 195, 197 (Fed. Cir. 1983) (A single means claim which covered every conceivable means for achieving the stated purpose was held nonenabling for the scope of the claim because the specification disclosed at most only those means known to the inventor.). When claims depend on a recited property, a fact situation comparable to *Hyatt* is possible, where the claim covers every conceivable structure (means) for achieving the stated property (result) while the specification discloses at most only those known to the inventor.

### **2164.08(b) Inoperative Subject Matter**

The presence of inoperative embodiments within the scope of a claim does not necessarily render a claim nonenabled. The standard is whether a skilled person could determine which embodiments that were conceived, but not yet made, would be inoperative or operative with expenditure of no more effort than is normally required in the art. *Atlas Powder Co. v. E.I. du Pont de Nemours & Co.*, 750 F.2d 1569, 1577, 224 USPQ 409, 414 (Fed. Cir. 1984) (prophetic examples do not make the disclosure nonenabling).

Although, typically, inoperative embodiments are excluded by language in a claim (e.g., preamble), the scope of the claim may still not be enabled where undue experimentation is involved in determining those embodiments that are operable. A disclosure of a large number of operable embodiments and the identification of a single inoperative embodiment did not render a claim broader than the enabled scope because undue experimentation was not involved in determining those embodiments that were operable. *In re Angstadt*, 537 F.2d 498, 502-503, 190 USPQ 214, 218 (CCPA 1976). However, claims reading on significant numbers of inoperative embodiments would render claims nonenabled when the specification does not clearly identify the operative embodiments and undue experimentation is involved in determining those that are operative. *Atlas Powder Co. v. E.I. duPont de Nemours & Co.*, 750 F.2d 1569, 1577, 224 USPQ 409, 414 (Fed. Cir. 1984); *In re Cook*, 439 F.2d 730, 735, 169 USPQ 298, 302 (CCPA 1971).

### **2164.08(c) Critical Feature Not Claimed**

A feature which is taught as critical in a specification and is not recited in the claims should result in a rejection of such claim under the enablement provision section of 35 U.S.C. 112. See *In re Mayhew*, 527 F.2d 1229, 1233, 188 USPQ 356, 358 (CCPA 1976). In determining whether an unclaimed feature is critical, the entire disclosure must be considered. Features which are merely preferred are not to be considered critical. *In re Goffe*, 542 F.2d 564, 567, 191 USPQ 429, 431 (CCPA 1976).

Limiting an applicant to the preferred materials in the absence of limiting prior art would not serve the constitutional purpose of promoting the progress in

the useful arts. Therefore, an enablement rejection based on the grounds that a disclosed critical limitation is missing from a claim should be made only when the language of the specification makes it clear that the limitation is critical for the invention to function as intended. Broad language in the disclosure, including the abstract, omitting an allegedly critical feature, tends to rebut the argument of criticality.

## 2165 The Best Mode Requirement

A third requirement of the first paragraph of 35 U.S.C. 112 is that:

The specification . . . shall set forth the best mode contemplated by the inventor of carrying out his invention.

“The best mode requirement creates a statutory bargained-for-exchange by which a patentee obtains the right to exclude others from practicing the claimed invention for a certain time period, and the public receives knowledge of the preferred embodiments for practicing the claimed invention.” *Eli Lilly & Co. v. Barr Laboratories Inc.*, 251 F.3d 955, 963, 58 USPQ2d 1865, 1874 (Fed. Cir. 2001).

The best mode requirement is a safeguard against the desire on the part of some people to obtain patent protection without making a full disclosure as required by the statute. The requirement does not permit inventors to disclose only what they know to be their second-best embodiment, while retaining the best for themselves. *In re Nelson*, 280 F.2d 172, 126 USPQ 242 (CCPA 1960).

Determining compliance with the best mode requirement requires a two-prong inquiry. First, it must be determined whether, at the time the application was filed, the inventor possessed a best mode for practicing the invention. This is a subjective inquiry which focuses on the inventor’s state of mind at the time of filing. Second, if the inventor did possess a best mode, it must be determined whether the written description disclosed the best mode such that a person skilled in the art could practice it. This is an objective inquiry, focusing on the scope of the claimed invention and the level of skill in the art. *Eli Lilly & Co. v. Barr Laboratories Inc.*, 251 F.3d 955, 963, 58 USPQ2d 1865, 1874 (Fed. Cir. 2001).

The failure to disclose a better method will not invalidate a patent if the inventor, at the time of filing the application, did not know of the better method OR

did not appreciate that it was the best method. All applicants are required to disclose for the claimed subject matter the best mode contemplated by the inventor even though applicant may not have been the discoverer of that mode. *Benger Labs. Ltd. v. R.K. Laros Co.*, 209 F. Supp. 639, 135 USPQ 11 (E.D. Pa. 1962).

## ACTIVE CONCEALMENT OR GROSSLY INEQUITABLE CONDUCT IS NOT REQUIRED TO ESTABLISH FAILURE TO DISCLOSE THE BEST MODE

Failure to disclose the best mode need not rise to the level of active concealment or grossly inequitable conduct in order to support a rejection or invalidate a patent. Where an inventor knows of a specific material that will make possible the successful reproduction of the effects claimed by the patent, but does not disclose it, speaking instead in terms of broad categories, the best mode requirement has not been satisfied. *Union Carbide Corp. v. Borg-Warner*, 550 F.2d 555, 193 USPQ 1 (6th Cir. 1977).

If the failure to set forth the best mode in a patent disclosure is the result of inequitable conduct (e.g., where the patent specification omitted crucial ingredients and disclosed a fictitious and inoperable slurry as Example 1), not only is that patent in danger of being held unenforceable, but other patents dealing with the same technology that are sought to be enforced in the same cause of action are subject to being held unenforceable. *Consolidated Aluminum Corp. v. Foseco Inc.*, 910 F.2d 804, 15 USPQ2d 1481 (Fed. Cir. 1990).

## 2165.01 Considerations Relevant to Best Mode [R-2]

### I. DETERMINE WHAT IS THE INVENTION

Determine what the invention is — the invention is defined in the claims. The specification need not set forth details not relating to the essence of the invention. *In re Bosy*, 360 F.2d 972, 149 USPQ 789 (CCPA 1966). See also *Northern Telecom Ltd. v. Samsung Electronics Co.*, 215 F.3d 1281, 55 USPQ2d 1065 (Fed. Cir. 2000) (Unclaimed matter that is unrelated to the operation of the claimed invention does not trigger the best mode requirement); *Eli Lilly & Co. v. Barr Laboratories Inc.*, 251 F.3d 955, 966, 58 USPQ2d 1865, 1877 (Fed. Cir. 2001) (“[P]atentee’s

failure to disclose an unclaimed preferred mode for accomplishing a routine detail does not violate the best mode requirement because one skilled in the art is aware of alternative means for accomplishing the routine detail that would still produce the best mode of the claimed invention.”).

## II. SPECIFIC EXAMPLE IS NOT REQUIRED

There is no statutory requirement for the disclosure of a specific example — a patent specification is not intended nor required to be a production specification. *In re Gay*, 309 F.2d 768, 135 USPQ 311 (CCPA 1962).

The absence of a specific working example is not necessarily evidence that the best mode has not been disclosed, nor is the presence of one evidence that it has. Best mode may be represented by a preferred range of conditions or group of reactants. *In re Honn*, 364 F.2d 454, 150 USPQ 652 (CCPA 1966).

## III. DESIGNATION AS BEST MODE IS NOT REQUIRED

There is no requirement in the statute that applicants point out which of their embodiments they consider to be their best; that the disclosure includes the best mode contemplated by applicants is enough to satisfy the statute. *Ernsthausen v. Nakayama*, 1 USPQ2d 1539 (Bd. Pat. App. & Inter. 1985).

## IV. UPDATING BEST MODE IS NOT REQUIRED

There is no requirement to update in the context of a foreign priority application under 35 U.S.C. 119, *Standard Oil Co. v. Montedison, S.p.A.*, 494 F.Supp. 370, 206 USPQ 676 (D.Del. 1980) (better catalyst developed between Italian priority and U.S. filing dates), and continuing applications claiming the benefit of an earlier filing date under 35 U.S.C. 120, *Transco Products, Inc. v. Performance Contracting Inc.*, 38 F.3d 551, 32 USPQ2d 1077 (Fed. Cir. 1994) (continuation under former 37 CFR 1.60); *Sylgab Steel and Wire Corp. v. Imoco-Gateway Corp.*, 357 F.Supp. 657, 178 USPQ 22 (N.D. Ill. 1973) (continuation); *Johns-Manville Corp. v. Guardian Industries Corp.*, 586 F.Supp. 1034, 221 USPQ 319 (E.D. Mich. 1983) (continuation and CIP). In the last cited case, the court stated that applicant would have been obliged to disclose an updated refinement if it were

essential to the successful practice of the invention and it related to amendments to the CIP that were not present in the parent application. In *Carter-Wallace, Inc. v. Riverton Labs., Inc.*, 433 F.2d 1034, 167 USPQ 656 (2d Cir. 1970), the court assumed, but did not decide, that an applicant must update the best mode when filing a CIP application.

## V. DEFECT IN BEST MODE CANNOT BE CURED BY NEW MATTER

If the best mode contemplated by the inventor at the time of filing the application is not disclosed, such a defect cannot be cured by submitting an amendment seeking to put into the specification something required to be there when the patent application was originally filed. *In re Hay*, 534 F.2d 917, 189 USPQ 790 (CCPA 1976).

Any proposed amendment of this type (adding a specific mode of practicing the invention not described in the application as filed) should be treated as new matter. New matter under 35 U.S.C. 132 and 251 should be objected to and coupled with a requirement to cancel the new matter.

## 2165.02 Best Mode Requirement Compared to Enablement Requirement

The best mode requirement is a separate and distinct requirement from the enablement requirement of the first paragraph of 35 U.S.C. 112. *In re Newton*, 414 F.2d 1400, 163 USPQ 34 (CCPA 1969).

The best mode provision of 35 U.S.C. 112 is not directed to a situation where the application fails to set forth any mode — such failure is equivalent to nonenablement. *In re Glass*, 492 F.2d 1228, 181 USPQ 31 (CCPA 1974).

The enablement requirement looks to placing the subject matter of the claims generally in the possession of the public. If, however, the applicant develops specific instrumentalities or techniques which are recognized by the applicant at the time of filing as the best way of carrying out the invention, then the best mode requirement imposes an obligation to disclose that information to the public as well. *Spectra-Physics, Inc. v. Coherent, Inc.*, 827 F.2d 1524, 3 USPQ 2d 1737 (Fed. Cir.), *cert. denied*, 484 U.S. 954 (1987).

### 2165.03 Requirements for Rejection for Lack of Best Mode [R-1]

#### ASSUME BEST MODE IS DISCLOSED UNLESS THERE IS EVIDENCE TO THE CONTRARY

The examiner should assume that the best mode is disclosed in the application, unless evidence is presented that is inconsistent with that assumption. It is extremely rare that a best mode rejection properly would be made in *ex parte* prosecution. The information that is necessary to form the basis for a rejection based on the failure to set forth the best mode is rarely accessible to the examiner, but is generally uncovered during discovery procedures in interference, litigation, or other *inter partes* proceedings.

#### EXAMINER MUST DETERMINE WHETHER THE INVENTOR KNEW THAT ONE MODE WAS BETTER THAN ANOTHER, AND IF SO, WHETHER THE DISCLOSURE IS ADEQUATE TO ENABLE ONE OF ORDINARY SKILL IN THE ART TO PRACTICE THE BEST MODE

According to the approach used by the court in *Chemcast Corp. v. Arco Industries*, 913 F.2d 923, 16 USPQ2d 1033 (Fed. Cir. 1990), a proper best mode analysis has two components:

(A) >Determine whether, at the time the application was filed, the inventor knew of a mode of practicing the claimed invention that the inventor considered to be better than any other.<

The first component is a subjective inquiry because it focuses on the inventor's state of mind at the time the application was filed. Unless the examiner has evidence that the inventors had information in their possession

(1) at the time the application was filed

(2) that a mode was considered to be better than any others by the inventors,

there is no reason to address the second component and there is no proper basis for a best mode rejection. If the facts satisfy the first component, then, and only then, is the following second component analyzed:

(B) Compare what was known in (A) with what was disclosed - is the disclosure adequate to enable one skilled in the art to practice the best mode?

Assessing the adequacy of the disclosure in this regard is largely an objective inquiry that depends on the level of skill in the art. Is the information contained in the specification disclosure sufficient to enable a person skilled in the relevant art to make and use the best mode?

A best mode rejection is proper only when the first inquiry can be answered in the affirmative, and the second inquiry answered in the negative with reasons to support the conclusion that the specification is non-enabling with respect to the best mode.

### 2165.04 Examples of Evidence of Concealment

In determining the adequacy of a best mode disclosure, only evidence of concealment (accidental or intentional) is to be considered. That evidence must tend to show that the quality of an applicant's best mode disclosure is so poor as to effectively result in concealment.

#### I. EXAMPLES — BEST MODE REQUIREMENT SATISFIED

In one case, even though the inventor had more information in his possession concerning the contemplated best mode than was disclosed (a known computer program) the specification was held to delineate the best mode in a manner sufficient to require only the application of routine skill to produce a workable digital computer program. *In re Sherwood*, 613 F.2d 809, 204 USPQ 537 (CCPA 1980).

In another case, the claimed subject matter was a time controlled thermostat, but the application did not disclose the specific Quartzmatic motor which was used in a commercial embodiment. The Court concluded that failure to disclose the commercial motor did not amount to concealment since similar clock motors were widely available and widely advertised. There was no evidence that the specific Quartzmatic motor was superior except possibly in price. *Honeywell v. Diamond*, 208 USPQ 452 (D.D.C. 1980).

There was held to be no violation of the best mode requirement even though the inventor did not disclose the only mode of calculating the stretch rate for plastic rods that he used because that mode would have been employed by those of ordinary skill in the art at the time the application was filed. *W.L. Gore &*

*Assoc., Inc. v. Garlock Inc.*, 721 F.2d 1540, 220 USPQ 303 (Fed. Cir. 1983).

There was no best mode violation where there was no evidence that the monoclonal antibodies used by the inventors differed from those obtainable according to the processes described in the specification. It was not disputed that the inventors obtained the antibodies used in the invention by following the procedures in the specification, that these were the inventors' preferred procedures, and that the data reported in the specification was for the antibody that the inventors had actually used. *Scripps Clinic and Research Foundation v. Genentech, Inc.*, 927 F.2d 1565, 18 USPQ 2d 1001 (Fed. Cir. 1991).

Where an organism was created by the insertion of genetic material into a cell obtained from generally available sources, all that was required to satisfy the best mode requirement was an adequate description of the means for carrying out the invention, not deposit of the cells. As to the observation that no scientist could ever duplicate exactly the cell used by applicants, the court observed that the issue is whether the disclosure is adequate, not that an exact duplication is necessary. *Amgen, Inc. v. Chugai Pharmaceutical Co.*, 927 F.2d 1200, 18 USPQ 2d 1016 (Fed. Cir. 1991).

There was held to be no violation of the best mode requirement where the Solicitor argued that concealment could be inferred from the disclosure in a specification that each analog is "surprisingly and unexpectedly more useful than one of the corresponding prostaglandins . . . for at least one of the pharmacological purposes." It was argued that appellant must have had test results to substantiate this statement and this data should have been disclosed. The court concluded that no withholding could be inferred from general statements of increased selectivity and narrower spectrum of potency for these novel analogs, conclusions which could be drawn from the elementary pharmacological testing of the analogs. *In re Bundy*, 642 F.2d 430, 435, 209 USPQ 48, 52 (CCPA 1981).

## II. EXAMPLES — BEST MODE REQUIREMENT NOT SATISFIED

The best mode requirement was held to be violated where inventors of a laser failed to disclose details of their preferred TiCuSil brazing method which were not contained in the prior art and were contrary to cri-

teria for the use of TiCuSil as contained in the literature. *Spectra-Physics, Inc. v. Coherent, Inc.*, 827 F.2d 1524, 3 USPQ 2d 1737 (Fed. Cir. 1987).

The best mode requirement was violated because an inventor failed to disclose whether to use a specific surface treatment that he knew was necessary to the satisfactory performance of his invention, even though how to perform the treatment itself was known in the art. The argument that the best mode requirement may be met solely by reference to what was known in the prior art was rejected as incorrect. *Dana Corp. v. IPC Ltd. Partnership*, 860 F.2d 415, 8 USPQ2d 1692 (Fed. Cir. 1988).

### 2171 Two Separate Requirements for Claims Under 35 U.S.C. 112, Second Paragraph

The second paragraph of 35 U.S.C. 112 is directed to requirements for the claims:

The specification shall conclude with one or more claims particularly pointing out and distinctly claiming the subject matter which the applicant regards as his invention.

There are two separate requirements set forth in this paragraph:

(A) the claims must set forth the subject matter that applicants regard as their invention; and

(B) the claims must particularly point out and distinctly define the metes and bounds of the subject matter that will be protected by the patent grant.

The first requirement is a subjective one because it is dependent on what the applicants for a patent regard as their invention. The second requirement is an objective one because it is not dependent on the views of applicant or any particular individual, but is evaluated in the context of whether the claim is definite — i.e., whether the scope of the claim is clear to a hypothetical person possessing the ordinary level of skill in the pertinent art.

Although an essential purpose of the examination process is to determine whether or not the claims define an invention that is both novel and nonobvious over the prior art, another essential purpose of patent examination is to determine whether or not the claims are precise, clear, correct, and unambiguous. The uncertainties of claim scope should be removed, as much as possible, during the examination process.

The inquiry during examination is patentability of the invention as applicant regards it. If the claims do not particularly point out and distinctly claim that which applicants regard as their invention, the appropriate action by the examiner is to reject the claims under 35 U.S.C. 112, second paragraph. *In re Zletz*, 893 F.2d 319, 13 USPQ2d 1320 (Fed. Cir. 1989). If a rejection is based on 35 U.S.C. 112, second paragraph, the examiner should further explain whether the rejection is based on indefiniteness or on the failure to claim what applicants regard as their invention. *Ex parte Ionescu*, 222 USPQ 537, 539 (Bd. App. 1984).

## 2172 Subject Matter Which Applicants Regard as Their Invention

### I. FOCUS FOR EXAMINATION

A rejection based on the failure to satisfy this requirement is appropriate only where applicant has stated, somewhere other than in the application as filed, that the invention is something different from what is defined by the claims. In other words, the invention set forth in the claims must be presumed, in the absence of evidence to the contrary, to be that which applicants regard as their invention. *In re Moore*, 439 F.2d 1232, 169 USPQ 236 (CCPA 1971).

### II. EVIDENCE TO THE CONTRARY

Evidence that shows that a claim does not correspond in scope with that which applicant regards as applicant's invention may be found, for example, in contentions or admissions contained in briefs or remarks filed by applicant, *Solomon v. Kimberly-Clark Corp.*, 216 F.3d 1372, 55 USPQ2d 1279 (Fed. Cir. 2000); *In re Prater*, 415 F.2d 1393, 162 USPQ 541 (CCPA 1969), or in affidavits filed under 37 CFR 1.132, *In re Cormany*, 476 F.2d 998, 177 USPQ 450 (CCPA 1973). The content of applicant's specification is not used as evidence that the scope of the claims is inconsistent with the subject matter which applicants regard as their invention. As noted in *In re Ehrreich*, 590 F.2d 902, 200 USPQ 504 (CCPA 1979), agreement, or lack thereof, between the claims and the specification is properly considered only with respect to 35 U.S.C. 112, first paragraph; it is irrelevant to compliance with the second paragraph of that section.

### III. SHIFT IN CLAIMS PERMITTED

The second paragraph of 35 U.S.C. 112 does not prohibit applicants from changing what they regard as their invention during the pendency of the application. *In re Saunders*, 444 F.2d 599, 170 USPQ 213 (CCPA 1971) (Applicant was permitted to claim and submit comparative evidence with respect to claimed subject matter which originally was only the preferred embodiment within much broader claims (directed to a method).). The fact that claims in a continuation application were directed to originally disclosed subject matter which applicants had not regarded as part of their invention when the parent application was filed was held not to prevent the continuation application from receiving benefits of the filing date of the parent application under 35 U.S.C. 120. *In re Brower*, 433 F.2d 813, 167 USPQ 684 (CCPA 1970).

#### 2172.01 Unclaimed Essential Matter [R-1]

A claim which omits matter disclosed to be essential to the invention as described in the specification or in other statements of record may be rejected under 35 U.S.C. 112, first paragraph, as not enabling. *In re Mayhew*, 527 F.2d 1229, 188 USPQ 356 (CCPA 1976). See also MPEP § 2164.08(c). Such essential matter may include missing elements, steps or necessary structural cooperative relationships of elements described by the applicant(s) as necessary to practice the invention.

In addition, a claim which fails to interrelate essential elements of the invention as defined by applicant(s) in the specification may be rejected under 35 U.S.C. 112, second paragraph, for failure to point out and distinctly claim the invention. See *In re Venezia*, 530 F.2d 956, 189 USPQ 149 (CCPA 1976); *In re Collier*, 397 F.2d 1003, 158 USPQ 266 (CCPA 1968). >But see *Ex parte Nolden*, 149 USPQ 378, 380 (Bd. Pat. App. 1965) (“[I]t is not essential to a patentable combination that there be interdependency between the elements of the claimed device or that all the elements operate concurrently toward the desired result”); *Ex parte Huber*, 148 USPQ 447, 448-49 (Bd. Pat. App. 1965) (A claim does not necessarily fail to comply with 35 U.S.C. 112, second paragraph where the various elements do not function simultaneously,

are not directly functionally related, do not directly intercooperate, and/or serve independent purposes.)<

## 2173 Claims Must Particularly Point Out and Distinctly Claim the Invention

The primary purpose of this requirement of definiteness of claim language is to ensure that the scope of the claims is clear so the public is informed of the boundaries of what constitutes infringement of the patent. A secondary purpose is to provide a clear measure of what applicants regard as the invention so that it can be determined whether the claimed invention meets all the criteria for patentability and whether the specification meets the criteria of 35 U.S.C. 112, first paragraph with respect to the claimed invention.

### 2173.01 Claim Terminology [R-2]

A fundamental principle contained in 35 U.S.C. 112, second paragraph is that applicants are their own lexicographers. They can define in the claims what they regard as their invention essentially in whatever terms they choose so long as **\*\*>**any special meaning assigned to a term is clearly set forth in the specification. See MPEP § 2111.01.< Applicant may use functional language, alternative expressions, negative limitations, or any style of expression or format of claim which makes clear the boundaries of the subject matter for which protection is sought. As noted by the court in *In re Swinehart*, 439 F.2d 210, 160 USPQ 226 (CCPA 1971), a claim may not be rejected solely because of the type of language used to define the subject matter for which patent protection is sought.

### 2173.02 Clarity and Precision [R-1]

The examiner's focus during examination of claims for compliance with the requirement for definiteness of 35 U.S.C. 112, second paragraph, is whether the claim meets the threshold requirements of clarity and precision, not whether more suitable language or modes of expression are available. When the examiner is satisfied that patentable subject matter is disclosed, and it is apparent to the examiner that the claims are directed to such patentable subject matter, he or she should allow claims which define the patentable subject matter with a reasonable degree of particularity and distinctness. Some latitude in the manner

of expression and the aptness of terms should be permitted even though the claim language is not as precise as the examiner might desire. Examiners are encouraged to suggest claim language to applicants to improve the clarity or precision of the language used, but should not reject claims or insist on their own preferences if other modes of expression selected by applicants satisfy the statutory requirement.

The essential inquiry pertaining to this requirement is whether the claims set out and circumscribe a particular subject matter with a reasonable degree of clarity and particularity. Definiteness of claim language must be analyzed, not in a vacuum, but in light of:

- (A) The content of the particular application disclosure;
- (B) The teachings of the prior art; and
- (C) The claim interpretation that would be given by one possessing the ordinary level of skill in the pertinent art at the time the invention was made.

In reviewing a claim for compliance with 35 U.S.C. 112, second paragraph, the examiner must consider the claim as a whole to determine whether the claim apprises one of ordinary skill in the art of its scope and, therefore, serves the notice function required by 35 U.S.C. 112, second paragraph, >by providing clear warning to others as to what constitutes infringement of the patent<. See, e.g., *Solomon v. Kimberly-Clark Corp.*, 216 F.3d 1372, 1379, 55 USPQ2d 1279, 1283 (Fed. Cir. 2000). See also *In re Larsen*, No. 01-1092 (Fed. Cir. May 9, 2001) (unpublished) (The preamble of the *Larsen* claim recited only a hanger and a loop but the body of the claim positively recited a linear member. The court observed that the totality of all the limitations of the claim and their interaction with each other must be considered to ascertain the inventor's contribution to the art. Upon review of the claim in its entirety, the court concluded that the claim at issue apprises one of ordinary skill in the art of its scope and, therefore, serves the notice function required by 35 U.S.C. 112 paragraph 2.).

>If the language of the claim is such that a person of ordinary skill in the art could not interpret the metes and bounds of the claim so as to understand how to avoid infringement, a rejection of the claim under 35 U.S.C. 112, second paragraph, would be appropriate. See *Morton Int'l, Inc. v. Cardinal Chem. Co.*, 5 F.3d 1464, 1470, 28 USPQ2d 1190, 1195 (Fed.



Cir. 1993). However, if the language used by applicant satisfies the statutory requirements of 35 U.S.C. 112, second paragraph, but the examiner merely wants the applicant to improve the clarity or precision of the language used, the claim must not be rejected under 35 U.S.C. 112, second paragraph, rather, the examiner should suggest improved language to the applicant.

For example, a claim recites “a suitable liquid such as the filtrate of the contaminated liquid to be filtered and solids of a filtering agent such as perlite, cellulose powder, etc.” The mere use of the phrase “such as” in the claim does not by itself render the claim indefinite. Office policy is not to employ *per se* rules to make technical rejections. Examples of claim language which have been held to be indefinite set forth in MPEP § 2173.05(d) are fact specific and should not be applied as *per se* rules. The test for definiteness under 35 U.S.C. 112, second paragraph, is whether “those skilled in the art would understand what is claimed when the claim is read in light of the specification.” *Orthokinetics, Inc. v. Safety Travel Chairs, Inc.*, 806 F.2d 1565, 1576, 1 USPQ2d 1081, 1088 (Fed. Cir. 1986). If one skilled in the art is able to ascertain in the example above, the meaning of the terms “suitable liquid” and “solids of a filtering agent” in light of the specification, 35 U.S.C. 112, second paragraph, is satisfied. If upon review of the claim as a whole in light of the specification, the examiner determines that a rejection under 35 U.S.C. 112, second paragraph, is not appropriate in the above-noted example, but is of the opinion that the clarity and the precision of the language can be improved by the deletion of the phrase “such as” in the claim, the examiner may make such a suggestion to the applicant. If applicant does not accept the examiner’s suggestion, the examiner should not pursue the issue.

If upon review of a claim in its entirety, the examiner concludes that a rejection under 35 U.S.C. 112, second paragraph, is appropriate, such a rejection should be made and an analysis as to why the phrase(s) used in the claim is “vague and indefinite” should be included in the Office action. If applicants traverse the rejection, with or without the submission of an amendment, and the examiner considers applicant’s arguments to be persuasive, the examiner should indicate in the next Office communication that

the previous rejection under 35 U.S.C. 112, second paragraph, has been withdrawn and provide an explanation as to what prompted the change in the examiner’s position (e.g., examiners may make specific reference to portions of applicant’s remarks that were considered to be the basis as to why the previous rejection was withdrawn).

By providing an explanation as to the action taken, the examiner will enhance the clarity of the prosecution history record. As noted by the Supreme Court in *Festo Corp. v. Shoketsu Kinzoku Kogyo Kabushiki Co.*, 535 U.S. 722, 122 S.Ct. 1831, 1838, 62 USPQ2d 1705, 1710 (2002), a clear and complete prosecution file record is important in that “[p]rosecution history estoppel requires that the claims of a patent be interpreted in light of the proceedings in the PTO during the application process.” In *Festo*, the court held that “a narrowing amendment made to satisfy any requirement of the Patent Act may give rise to an estoppel.” With respect to amendments made to comply with the requirements of 35 U.S.C. 112, the court stated that “[i]f a § 112 amendment is truly cosmetic, then it would not narrow the patent’s scope or raise an estoppel. On the other hand, if a § 112 amendment is necessary and narrows the patent’s scope—even if only for the purpose of better description—estoppel may apply.” *Id.*, at 1840, 62 USPQ2d at 1712. The court further stated that “when the court is unable to determine the purpose underlying a narrowing amendment—and hence a rationale for limiting the estoppel to the surrender of particular equivalents—the court should presume that the patentee surrendered all subject matter between the broader and the narrower language...the patentee should bear the burden of showing that the amendment does not surrender the particular equivalent in question.” *Id.*, at 1842, 62 USPQ2d at 1713. Thus, whenever possible, the examiner should make the record clear by providing explicit reasoning for making or withdrawing any rejection related to 35 U.S.C. 112, second paragraph.<

### **2173.03 Inconsistency Between Claim \*>and< Specification Disclosure or Prior Art [R-1]**

Although the terms of a claim may appear to be definite, inconsistency with the specification disclosure or prior art teachings may make an otherwise definite claim take on an unreasonable degree of

uncertainty. *In re Cohn*, 438 F.2d 989, 169 USPQ 95 (CCPA 1971); *In re Hammack*, 427 F.2d 1378, 166 USPQ 204 (CCPA 1970). In *Cohn*, the claim was directed to a process of treating a surface with a corroding solution until the metallic appearance is supplanted by an “opaque” appearance. Noting that no claim may be read apart from and independent of the supporting disclosure on which it is based, the court found that the description, definitions and examples set forth in the specification relating to the appearance of the surface after treatment were inherently inconsistent and rendered the claim indefinite.

#### **2173.04 Breadth Is Not Indefiniteness**

Breadth of a claim is not to be equated with indefiniteness. *In re Miller*, 441 F.2d 689, 169 USPQ 597 (CCPA 1971). If the scope of the subject matter embraced by the claims is clear, and if applicants have not otherwise indicated that they intend the invention to be of a scope different from that defined in the claims, then the claims comply with 35 U.S.C. 112, second paragraph.

Undue breadth of the claim may be addressed under different statutory provisions, depending on the reasons for concluding that the claim is too broad. If the claim is too broad because it does not set forth that which applicants regard as their invention as evidenced by statements outside of the application as filed, a rejection under 35 U.S.C. 112, second paragraph, would be appropriate. If the claim is too broad because it is not supported by the original description or by an enabling disclosure, a rejection under 35 U.S.C. 112, first paragraph, would be appropriate. If the claim is too broad because it reads on the prior art, a rejection under either 35 U.S.C. 102 or 103 would be appropriate.

#### **2173.05 Specific Topics Related to Issues Under 35 U.S.C. 112, Second Paragraph [R-1]**

The following sections are devoted to a discussion of specific topics where issues under 35 U.S.C. 112, second paragraph, have been addressed. These sections are not intended to be an exhaustive list of the issues that can arise under 35 U.S.C. 112, second paragraph, but are intended to provide guidance in areas that have been addressed with some frequency

in recent examination practice. The court and Board decisions cited are representative. As with all appellate decisions, the results are largely dictated by the facts in each case. The use of the same language in a different context may justify a different result.

>See MPEP § 2181 for guidance in determining whether an applicant has complied with the requirements of 35 U.S.C. 112, second paragraph, when 35 U.S.C. 112, sixth paragraph, is invoked.<

#### **2173.05(a) New Terminology [R-2]**

>

##### **I. <THE MEANING OF EVERY TERM SHOULD BE APPARENT**

The meaning of every term used in a claim should be apparent from the prior art or from the specification and drawings at the time the application is filed. Applicants need not confine themselves to the terminology used in the prior art, but are required to make clear and precise the terms that are used to define the invention whereby the metes and bounds of the claimed invention can be ascertained. During patent examination, the pending claims must be given the broadest reasonable interpretation consistent with the specification. *In re Morris*, 127 F.3d 1048, 1054, 44 USPQ2d 1023, 1027 (Fed. Cir. 1997); *In re Prater*, 415 F.2d 1393, 162 USPQ 541 (CCPA 1969). See also MPEP § 2111 - § 2111.01. When the specification states the meaning that a term in the claim is intended to have, the claim is examined using that meaning, in order to achieve a complete exploration of the applicant’s invention and its relation to the prior art. *In re Zletz*, 893 F.2d 319, 13 USPQ2d 1320 (Fed. Cir. 1989).

>

##### **II. <THE REQUIREMENT FOR CLARITY AND PRECISION MUST BE BALANCED WITH THE LIMITATIONS OF THE LANGUAGE**

Courts have recognized that it is not only permissible, but often desirable, to use new terms that are frequently more precise in describing and defining the new invention. *In re Fisher*, 427 F.2d 833, 166 USPQ 18 (CCPA 1970). Although it is difficult to compare the claimed invention with the prior art when new

terms are used that do not appear in the prior art, this does not make the new terms indefinite.

New terms are often used when a new technology is in its infancy or is rapidly evolving. The requirements for clarity and precision must be balanced with the limitations of the language and the science. If the claims, read in light of the specification, reasonably apprise those skilled in the art both of the utilization and scope of the invention, and if the language is as precise as the subject matter permits, the statute (35 U.S.C. 112, second paragraph) demands no more. *Shatterproof Glass Corp. v. Libbey Owens Ford Co.*, 758 F.2d 613, 225 USPQ 634 (Fed. Cir. 1985) (interpretation of “freely supporting” in method claims directed to treatment of a glass sheet); *Hybritech, Inc. v. Monoclonal Antibodies, Inc.*, 802 F.2d 1367, 231 USPQ 81 (Fed. Cir. 1986) (interpretation of a limitation specifying a numerical value for antibody affinity where the method of calculation was known in the art at the time of filing to be imprecise). This does not mean that the examiner must accept the best effort of applicant. If the proposed language is not considered as precise as the subject matter permits, the examiner should provide reasons to support the conclusion of indefiniteness and is encouraged to suggest alternatives that are free from objection.

>

### III. <TERMS USED CONTRARY TO THEIR ORDINARY MEANING MUST BE CLEARLY REDEFINED IN THE WRITTEN DESCRIPTION

Consistent with the well-established axiom in patent law that a patentee or applicant is free to be his or her own lexicographer, a patentee or applicant may use terms in a manner contrary to or inconsistent with one or more of their ordinary meanings if the written description clearly redefines the terms. See, e.g., *Process Control Corp. v. HydReclaim Corp.*, 190 F.3d 1350, 1357, 52 USPQ2d 1029, 1033 (Fed. Cir. 1999) (“While we have held many times that a patentee can act as his own lexicographer to specifically define terms of a claim contrary to their ordinary meaning,” in such a situation the written description must clearly redefine a claim term “so as to put a reasonable competitor or one reasonably skilled in the art on notice that the patentee intended to so redefine that claim term.”); *Hormone Research Foundation Inc. v.*

*Genentech Inc.*, 904 F.2d 1558, 15 USPQ2d 1039 (Fed. Cir. 1990). Accordingly, when there is more than one definition for a term, it is incumbent upon applicant to make clear which definition is being relied upon to claim the invention. Until the meaning of a term or phrase used in a claim is clear, a rejection under 35 U.S.C. 112, second paragraph is appropriate. >In applying the prior art, the claims should be construed to encompass all definitions that are consistent with applicant’s use of the term. See *Tex. Digital Sys., Inc. v. Telegenix, Inc.*, 308 F.3d 1193, 1202, 64 USPQ2d 1812, 1818 (Fed. Cir. 2002).< It is appropriate to compare the meaning of terms given in technical dictionaries in order to ascertain the accepted meaning of a term in the art. *In re Barr*, 444 F.2d 588, 170 USPQ 330 (CCPA 1971).

### 2173.05(b) Relative Terminology

The fact that claim language, including terms of degree, may not be precise, does not automatically render the claim indefinite under 35 U.S.C. 112, second paragraph. *Seattle Box Co., v. Industrial Crating & Packing, Inc.*, 731 F.2d 818, 221 USPQ 568 (Fed. Cir. 1984). Acceptability of the claim language depends on whether one of ordinary skill in the art would understand what is claimed, in light of the specification.

### WHEN A TERM OF DEGREE IS PRESENT, DETERMINE WHETHER A STANDARD IS DISCLOSED OR WHETHER ONE OF ORDINARY SKILL IN THE ART WOULD BE APPRISED OF THE SCOPE OF THE CLAIM

When a term of degree is presented in a claim, first a determination is to be made as to whether the specification provides some standard for measuring that degree. If it does not, a determination is made as to whether one of ordinary skill in the art, in view of the prior art and the status of the art, would be nevertheless reasonably apprised of the scope of the invention. Even if the specification uses the same term of degree as in the claim, a rejection may be proper if the scope of the term is not understood when read in light of the specification. While, as a general proposition, broadening modifiers are standard tools in claim drafting in order to avoid reliance on the doctrine of equivalents in infringement actions, when the scope of the claim is unclear a rejection under 35 U.S.C. 112, second

paragraph, is proper. See *In re Wiggins*, 488 F. 2d 538, 541, 179 USPQ 421, 423 (CCPA 1973).

When relative terms are used in claims wherein the improvement over the prior art rests entirely upon size or weight of an element in a combination of elements, the adequacy of the disclosure of a standard is of greater criticality.

#### REFERENCE TO AN OBJECT THAT IS VARIABLE MAY RENDER A CLAIM INDEFINITE

A claim may be rendered indefinite by reference to an object that is variable. For example, the Board has held that a limitation in a claim to a bicycle that recited “said front and rear wheels so spaced as to give a wheelbase that is between 58 percent and 75 percent of the height of the rider that the bicycle was designed for” was indefinite because the relationship of parts was not based on any known standard for sizing a bicycle to a rider, but on a rider of unspecified build. *Ex parte Brummer*, 12 USPQ2d 1653 (Bd. Pat. App. & Inter. 1989). On the other hand, a claim limitation specifying that a certain part of a pediatric wheelchair be “so dimensioned as to be insertable through the space between the doorframe of an automobile and one of the seats” was held to be definite. *Orthokinetics, Inc. v. Safety Travel Chairs, Inc.*, 806 F.2d 1565, 1 USPQ2d 1081 (Fed. Cir. 1986). The court stated that the phrase “so dimensioned” is as accurate as the subject matter permits, noting that the patent law does not require that all possible lengths corresponding to the spaces in hundreds of different automobiles be listed in the patent, let alone that they be listed in the claims.

##### A. “About”

The term “about” used to define the area of the lower end of a mold as between 25 to about 45% of the mold entrance was held to be clear, but flexible. *Ex parte Eastwood*, 163 USPQ 316 (Bd. App. 1968). Similarly, in *W.L. Gore & Associates, Inc. v. Garlock, Inc.*, 721 F.2d 1540, 220 USPQ 303 (Fed. Cir. 1983), the court held that a limitation defining the stretch rate of a plastic as “exceeding about 10% per second” is definite because infringement could clearly be assessed through the use of a stopwatch. However, the court held that claims reciting “at least about” were invalid for indefiniteness where there was close prior art and there was nothing in the specification, prose-

cution history, or the prior art to provide any indication as to what range of specific activity is covered by the term “about.” *Amgen, Inc. v. Chugai Pharmaceutical Co.*, 927 F.2d 1200, 18 USPQ2d 1016 (Fed. Cir. 1991).

##### B. “Essentially”

The phrase “a silicon dioxide source that is essentially free of alkali metal” was held to be definite because the specification contained guidelines and examples that were considered sufficient to enable a person of ordinary skill in the art to draw a line between unavoidable impurities in starting materials and essential ingredients. *In re Marosi*, 710 F.2d 799, 218 USPQ 289 (CCPA 1983). The court further observed that it would be impractical to require applicants to specify a particular number as a cutoff between their invention and the prior art.

##### C. “Similar”

The term “similar” in the preamble of a claim that was directed to a nozzle “for high-pressure cleaning units or similar apparatus” was held to be indefinite since it was not clear what applicant intended to cover by the recitation “similar” apparatus. *Ex parte Kristensen*, 10 USPQ2d 1701 (Bd. Pat. App. & Inter. 1989).

A claim in a design patent application which read: “The ornamental design for a feed bunk or similar structure as shown and described.” was held to be indefinite because it was unclear from the specification what applicant intended to cover by the recitation of “similar structure.” *Ex parte Pappas*, 23 USPQ2d 1636 (Bd. Pat. App. & Inter. 1992).

##### D. “Substantially”

The term “substantially” is often used in conjunction with another term to describe a particular characteristic of the claimed invention. It is a broad term. *In re Nehrenberg*, 280 F.2d 161, 126 USPQ 383 (CCPA 1960). The court held that the limitation “to substantially increase the efficiency of the compound as a copper extractant” was definite in view of the general guidelines contained in the specification. *In re Mattison*, 509 F.2d 563, 184 USPQ 484 (CCPA 1975). The court held that the limitation “which produces substantially equal E and H plane illumination patterns” was definite because one of ordinary skill in the art

would know what was meant by “substantially equal.” *Andrew Corp. v. Gabriel Electronics*, 847 F.2d 819, 6 USPQ2d 2010 (Fed. Cir. 1988).

### **E. “Type”**

The addition of the word “type” to an otherwise definite expression (e.g., Friedel-Crafts catalyst) extends the scope of the expression so as to render it indefinite. *Ex parte Copenhaver*, 109 USPQ 118 (Bd. App. 1955). Likewise, the phrase “ZSM-5-type aluminosilicate zeolites” was held to be indefinite because it was unclear what “type” was intended to convey. The interpretation was made more difficult by the fact that the zeolites defined in the dependent claims were not within the genus of the type of zeolites defined in the independent claim. *Ex parte Attig*, 7 USPQ2d 1092 (Bd. Pat. App. & Inter. 1986).

### **F. Other Terms**

The phrases “relatively shallow,” “of the order of,” “the order of about 5mm,” and “substantial portion” were held to be indefinite because the specification lacked some standard for measuring the degree intended and, therefore, properly rejected as indefinite under 35 U.S.C. 112, second paragraph. *Ex parte Oetiker*, 23 USPQ2d 1641 (Bd. Pat. App. & Inter. 1992).

The term “or like material” in the context of the limitation “coke, brick, or like material” was held to render the claim indefinite since it was not clear how the materials other than coke or brick had to resemble the two specified materials to satisfy the limitations of the claim. *Ex parte Caldwell*, 1906 C.D. 58 (Comm’r Pat. 1906).

The terms “comparable” and “superior” were held to be indefinite in the context of a limitation relating the characteristics of the claimed material to other materials - “properties that are superior to those obtained with comparable” prior art materials. *Ex parte Anderson*, 21 USPQ2d 1241 (Bd. Pat. App. & Inter. 1991). It was not clear from the specification which properties had to be compared and how comparable the properties would have to be to determine infringement issues. Further, there was no guidance as to the meaning of the term “superior.”

## **2173.05(c) Numerical Ranges and Amounts Limitations**

Generally, the recitation of specific numerical ranges in a claim does not raise an issue of whether a claim is definite.

### **I. NARROW AND BROADER RANGES IN THE SAME CLAIM**

Use of a narrow numerical range that falls within a broader range in the same claim may render the claim indefinite when the boundaries of the claim are not discernible. Description of examples and preferences is properly set forth in the specification rather than in a single claim. A narrower range or preferred embodiment may also be set forth in another independent claim or in a dependent claim. If stated in a single claim, examples and preferences lead to confusion over the intended scope of the claim. In those instances where it is not clear whether the claimed narrower range is a limitation, a rejection under 35 U.S.C. 112, second paragraph should be made. The Examiner should analyze whether the metes and bounds of the claim are clearly set forth. Examples of claim language which have been held to be indefinite are (A) “a temperature of between 45 and 78 degrees Celsius, preferably between 50 and 60 degrees Celsius”; and (B) “a predetermined quantity, for example, the maximum capacity.”

While a single claim that includes both a broad and a narrower range may be indefinite, it is not improper under 35 U.S.C. 112, second paragraph, to present a dependent claim that sets forth a narrower range for an element than the range set forth in the claim from which it depends. For example, if claim 1 reads “A circuit ... wherein the resistance is 70-150 ohms.” and claim 2 reads “The circuit of claim 1 wherein the resistance is 70-100 ohms.”, then claim 2 should not be rejected as indefinite.

### **II. OPEN-ENDED NUMERICAL RANGES**

Open-ended numerical ranges should be carefully analyzed for definiteness. For example, when an independent claim recites a composition comprising “at least 20% sodium” and a dependent claim sets forth specific amounts of nonsodium ingredients which add up to 100%, apparently to the exclusion of sodium, an ambiguity is created with regard to the “at least”

limitation (unless the percentages of the nonsodium ingredients are based on the weight of the nonsodium ingredients). On the other hand, the court held that a composition claimed to have a theoretical content greater than 100% (i.e., 20-80% of A, 20-80% of B and 1-25% of C) was not indefinite simply because the claims may be read in theory to include compositions that are impossible in fact to formulate. It was observed that subject matter which cannot exist in fact can neither anticipate nor infringe a claim. *In re Kroekel*, 504 F.2d 1143, 183 USPQ 610 (CCPA 1974).

In a claim directed to a chemical reaction process, a limitation required that the amount of one ingredient in the reaction mixture should “be maintained at less than 7 mole percent” based on the amount of another ingredient. The examiner argued that the claim was indefinite because the limitation sets only a maximum amount and is inclusive of substantially no ingredient resulting in termination of any reaction. The court did not agree because the claim was clearly directed to a reaction process which did not warrant distorting the overall meaning of the claim to preclude performing the claimed process. *In re Kirsch*, 498 F.2d 1389, 182 USPQ 286 (CCPA 1974).

Some terms have been determined to have the following meanings in the factual situations of the reported cases: the term “up to” includes zero as a lower limit, *In re Mochel*, 470 F.2d 638, 176 USPQ 194 (CCPA 1974); and “a moisture content of not more than 70% by weight” reads on dry material, *Ex parte Khusid*, 174 USPQ 59 (Bd. App. 1971).

### III. “EFFECTIVE AMOUNT”

The common phrase “an effective amount” may or may not be indefinite. The proper test is whether or not one skilled in the art could determine specific values for the amount based on the disclosure. See *In re Mattison*, 509 F.2d 563, 184 USPQ 484 (CCPA 1975). The phrase “an effective amount . . . for growth stimulation” was held to be definite where the amount was not critical and those skilled in the art would be able to determine from the written disclosure, including the examples, what an effective amount is. *In re Halleck*, 422 F.2d 911, 164 USPQ 647 (CCPA 1970). The phrase “an effective amount” has been held to be indefinite when the claim fails to state the function which is to be achieved and more than one effect can

be implied from the specification or the relevant art. *In re Fredericksen* 213 F.2d 547, 102 USPQ 35 (CCPA 1954). The more recent cases have tended to accept a limitation such as “an effective amount” as being definite when read in light of the supporting disclosure and in the absence of any prior art which would give rise to uncertainty about the scope of the claim. In *Ex parte Skuballa*, 12 USPQ2d 1570 (Bd. Pat. App. & Inter. 1989), the Board held that a pharmaceutical composition claim which recited an “effective amount of a compound of claim 1” without stating the function to be achieved was definite, particularly when read in light of the supporting disclosure which provided guidelines as to the intended utilities and how the uses could be effected.

### 2173.05(d) Exemplary Claim Language (“for example,” “such as”) [R-1]

Description of examples or preferences is properly set forth in the specification rather than the claims. If stated in the claims, examples and preferences >may< lead to confusion over the intended scope of a claim. In those instances where it is not clear whether the claimed narrower range is a limitation, a rejection under 35 U.S.C. 112, second paragraph should be made. The examiner should analyze whether the metes and bounds of the claim are clearly set forth. Examples of claim language which have been held to be indefinite because the intended scope of the claim was unclear are:

- (A) “R is halogen, for example, chlorine”;
- (B) “material such as rock wool or asbestos” *Ex parte Hall*, 83 USPQ 38 (Bd. App. 1949);
- (C) “lighter hydrocarbons, such, for example, as the vapors or gas produced” *Ex parte Hasche*, 86 USPQ 481 (Bd. App. 1949); and
- (D) “normal operating conditions such as while in the container of a proportioner” *Ex parte Steigerwald*, 131 USPQ 74 (Bd. App. 1961).

>The above examples of claim language which have been held to be indefinite are fact specific and should not be applied as *per se* rules. See MPEP § 2173.02 for guidance regarding when it is appropriate to make a rejection under 35 U.S.C. 112, second paragraph.<

**2173.05(e) Lack of Antecedent Basis [R-1]**

A claim is indefinite when it contains words or phrases whose meaning is unclear. The lack of clarity could arise where a claim refers to “said lever” or “the lever,” where the claim contains no earlier recitation or limitation of a lever and where it would be unclear as to what element the limitation was making reference. Similarly, if two different levers are recited earlier in the claim, the recitation of “said lever” in the same or subsequent claim would be unclear where it is uncertain which of the two levers was intended. A claim which refers to “said aluminum lever,” but recites only “a lever” earlier in the claim, is indefinite because it is uncertain as to the lever to which reference is made. Obviously, however, the failure to provide explicit antecedent basis for terms does not always render a claim indefinite. If the scope of a claim would be reasonably ascertainable by those skilled in the art, then the claim is not indefinite. *Ex parte Porter*, 25 USPQ2d 1144, 1145 (Bd. Pat. App. & Inter. 1992) (“controlled stream of fluid” provided reasonable antecedent basis for “the controlled fluid”). Inherent components of elements recited have antecedent basis in the recitation of the components themselves. For example, the limitation “the outer surface of said sphere” would not require an antecedent recitation that the sphere has an outer surface. >See *Bose Corp. v. JBL, Inc.*, 274 F.3d 1354, 1359, 61 USPQ2d 1216, 1218-19 (Fed. Cir 2001) (holding that recitation of “an ellipse” provided antecedent basis for “an ellipse having a major diameter” because “[t]here can be no dispute that mathematically an inherent characteristic of an ellipse is a major diameter”).<

**EXAMINER SHOULD SUGGEST CORRECTIONS TO ANTECEDENT PROBLEMS**

Antecedent problems in the claims are typically drafting oversights that are easily corrected once they are brought to the attention of applicant. The examiner’s task of making sure the claim language complies with the requirements of the statute should be carried out in a positive and constructive way, so that minor problems can be identified and easily corrected, and so that the major effort is expended on more substantive issues. However, even though indefiniteness in claim language is of semantic origin, it is

not rendered unobjectionable simply because it could have been corrected. *In re Hammack*, 427 F.2d 1384 n.5, 166 USPQ 209 n.5 (CCPA 1970).

**A CLAIM TERM WHICH HAS NO ANTECEDENT BASIS IN THE DISCLOSURE IS NOT NECESSARILY INDEFINITE**

The mere fact that a term or phrase used in the claim has no antecedent basis in the specification disclosure does not mean, necessarily, that the term or phrase is indefinite. There is no requirement that the words in the claim must match those used in the specification disclosure. Applicants are given a great deal of latitude in how they choose to define their invention so long as the terms and phrases used define the invention with a reasonable degree of clarity and precision.

**A CLAIM IS NOT *PER SE* INDEFINITE IF THE BODY OF THE CLAIM RECITES ADDITIONAL ELEMENTS WHICH DO NOT APPEAR IN THE PREAMBLE**

The mere fact that the body of a claim recites additional elements which do not appear in the claim’s preamble does not render the claim indefinite under 35 U.S.C. 112, second paragraph. See *In re Larsen*, No. 01-1092 (Fed. Cir. May 9, 2001) (unpublished) (The preamble of the *Larsen* claim recited only a hanger and a loop but the body of the claim positively recited a linear member. The examiner rejected the claim under 35 U.S.C. 112, second paragraph, because the omission from the claim’s preamble of a critical element (i.e., a linear member) renders that claim indefinite. The court reversed the examiner’s rejection and stated that the totality of all the limitations of the claim and their interaction with each other must be considered to ascertain the inventor’s contribution to the art. Upon review of the claim in its entirety, the court concluded that the claim at issue apprises one of ordinary skill in the art of its scope and, therefore, serves the notice function required by 35 U.S.C. 112, paragraph 2.).

**2173.05(f) Reference to Limitations in Another Claim**

A claim which makes reference to a preceding claim to define a limitation is an acceptable claim

construction which should not necessarily be rejected as improper or confusing under 35 U.S.C. 112, second paragraph. For example, claims which read: “The product produced by the method of claim 1.” or “A method of producing ethanol comprising contacting amylose with the culture of claim 1 under the following conditions .....” are not indefinite under 35 U.S.C. 112, second paragraph, merely because of the reference to another claim. See also *Ex parte Porter*, 25 USPQ2d 1144 (Bd. Pat. App. & Inter. 1992) where reference to “the nozzle of claim 7” in a method claim was held to comply with 35 U.S.C. 112, second paragraph. However, where the format of making reference to limitations recited in another claim results in confusion, then a rejection would be proper under 35 U.S.C. 112, second paragraph.

### 2173.05(g) Functional Limitations

A functional limitation is an attempt to define something by what it does, rather than by what it is (e.g., as evidenced by its specific structure or specific ingredients). There is nothing inherently wrong with defining some part of an invention in functional terms. Functional language does not, in and of itself, render a claim improper. *In re Swinehart*, 439 F.2d 210, 169 USPQ 226 (CCPA 1971).

A functional limitation must be evaluated and considered, just like any other limitation of the claim, for what it fairly conveys to a person of ordinary skill in the pertinent art in the context in which it is used. A functional limitation is often used in association with an element, ingredient, or step of a process to define a particular capability or purpose that is served by the recited element, ingredient or step. Whether or not the functional limitation complies with 35 U.S.C. 112, second paragraph, is a different issue from whether the limitation is properly supported under 35 U.S.C. 112, first paragraph, or is distinguished over the prior art. A few examples are set forth below to illustrate situations where the issue of whether a functional limitation complies with 35 U.S.C. 112, second paragraph, was considered.

It was held that the limitation used to define a radical on a chemical compound as “incapable of forming a dye with said oxidizing developing agent” although functional, was perfectly acceptable because it set definite boundaries on the patent protection sought. *In re Barr*, 444 F.2d 588, 170 USPQ 33 (CCPA 1971).

In a claim that was directed to a kit of component parts capable of being assembled, the Court held that limitations such as “members adapted to be positioned” and “portions . . . being resiliently dilatible whereby said housing may be slidably positioned” serve to precisely define present structural attributes of interrelated component parts of the claimed assembly. *In re Venezia*, 530 F.2d 956, 189 USPQ 149 (CCPA 1976).

### 2173.05(h) Alternative Limitations

#### I. MARKUSH GROUPS

Alternative expressions are permitted if they present no uncertainty or ambiguity with respect to the question of scope or clarity of the claims. One acceptable form of alternative expression, which is commonly referred to as a Markush group, recites members as being “selected from the group consisting of A, B and C.” See *Ex parte Markush*, 1925 C.D. 126 (Comm’r Pat. 1925).

*Ex parte Markush* sanctions claiming a genus expressed as a group consisting of certain specified materials. Inventions in metallurgy, refractories, ceramics, pharmacy, pharmacology and biology are most frequently claimed under the Markush formula but purely mechanical features or process steps may also be claimed by using the Markush style of claiming. See *Ex parte Head*, 214 USPQ 551 (Bd. App. 1981); *In re Gaubert*, 524 F.2d 1222, 187 USPQ 664 (CCPA 1975); and *In re Harnisch*, 631 F.2d 716, 206 USPQ 300 (CCPA 1980). It is improper to use the term “comprising” instead of “consisting of.” *Ex parte Dotter*, 12 USPQ 382 (Bd. App. 1931).

The use of Markush claims of diminishing scope should not, in itself, be considered a sufficient basis for objection to or rejection of claims. However, if such a practice renders the claims indefinite or if it results in undue multiplicity, an appropriate rejection should be made.

Similarly, the double inclusion of an element by members of a Markush group is not, in itself, sufficient basis for objection to or rejection of claims. Rather, the facts in each case must be evaluated to determine whether or not the multiple inclusion of one or more elements in a claim renders that claim indefinite. The mere fact that a compound may be embraced by more than one member of a Markush



group recited in the claim does not necessarily render the scope of the claim unclear. For example, the Markush group, “selected from the group consisting of amino, halogen, nitro, chloro and alkyl” should be acceptable even though “halogen” is generic to “chloro.”

The materials set forth in the Markush group ordinarily must belong to a recognized physical or chemical class or to an art-recognized class. However, when the Markush group occurs in a claim reciting a process or a combination (not a single compound), it is sufficient if the members of the group are disclosed in the specification to possess at least one property in common which is mainly responsible for their function in the claimed relationship, and it is clear from their very nature or from the prior art that all of them possess this property. While in the past the test for Markush-type claims was applied as liberally as possible, present practice which holds that claims reciting Markush groups are not generic claims (MPEP § 803) may subject the groups to a more stringent test for propriety of the recited members. Where a Markush expression is applied only to a portion of a chemical compound, the propriety of the grouping is determined by a consideration of the compound as a whole, and does not depend on there being a community of properties in the members of the Markush expression.

When materials recited in a claim are so related as to constitute a proper Markush group, they may be recited in the conventional manner, or alternatively. For example, if “wherein R is a material selected from the group consisting of A, B, C and D” is a proper limitation, then “wherein R is A, B, C or D” shall also be considered proper.

### ***Subgenus Claim***

Genus, subgenus, and Markush-type claims, if properly supported by the disclosure, are all acceptable ways for applicants to claim their inventions. They provide different ways to present claims of different scope. Examiners should therefore not reject Markush-type claims merely because there are genus claims that encompass the Markush-type claims.

See also MPEP § 608.01(p) and § 715.03.

See MPEP § 803.02 for restriction practice re Markush-type claims.

## **II. “OR” TERMINOLOGY**

Alternative expressions using “or” are acceptable, such as “wherein R is A, B, C, or D.” The following phrases were each held to be acceptable and not in violation of 35 U.S.C. 112, second paragraph in *In re Gaubert*, 524 F.2d 1222, 187 USPQ 664 (CCPA 1975): “made entirely or in part of”; “at least one piece”; and “iron, steel or any other magnetic material.”

## **III. “OPTIONALLY”**

An alternative format which requires some analysis before concluding whether or not the language is indefinite involves the use of the term “optionally.” In *Ex parte Cordova*, 10 USPQ2d 1949 (Bd. Pat. App. & Inter. 1989) the language “containing A, B, and optionally C” was considered acceptable alternative language because there was no ambiguity as to which alternatives are covered by the claim. A similar holding was reached with regard to the term “optionally” in *Ex parte Wu*, 10 USPQ2d 2031 (Bd. Pat. App. & Inter. 1989). In the instance where the list of potential alternatives can vary and ambiguity arises, then it is proper to make a rejection under 35 U.S.C. 112, second paragraph, and explain why there is confusion.

## **2173.05(i) Negative Limitations**

The current view of the courts is that there is nothing inherently ambiguous or uncertain about a negative limitation. So long as the boundaries of the patent protection sought are set forth definitely, albeit negatively, the claim complies with the requirements of 35 U.S.C. 112, second paragraph. Some older cases were critical of negative limitations because they tended to define the invention in terms of what it was not, rather than pointing out the invention. Thus, the court observed that the limitation “R is an alkenyl radical other than 2-butenyl and 2,4-pentadienyl” was a negative limitation that rendered the claim indefinite because it was an attempt to claim the invention by excluding what the inventors did not invent rather than distinctly and particularly pointing out what they did invent. *In re Schechter*, 205 F.2d 185, 98 USPQ 144 (CCPA 1953).

A claim which recited the limitation “said homopolymer being free from the proteins, soaps, resins, and sugars present in natural Hevea rubber” in

order to exclude the characteristics of the prior art product, was considered definite because each recited limitation was definite. *In re Wakefield*, 422 F.2d 897, 899, 904, 164 USPQ 636, 638, 641 (CCPA 1970). In addition, the court found that the negative limitation “incapable of forming a dye with said oxidized developing agent” was definite because the boundaries of the patent protection sought were clear. *In re Barr*, 444 F.2d 588, 170 USPQ 330 (CCPA 1971).

Any negative limitation or exclusionary proviso must have basis in the original disclosure. If alternative elements are positively recited in the specification, they may be explicitly excluded in the claims. See *In re Johnson*, 558 F.2d 1008, 1019, 194 USPQ 187, 196 (CCPA 1977) (“[the] specification, having described the whole, necessarily described the part remaining.”). See also *Ex parte Grasselli*, 231 USPQ 393 (Bd. App. 1983), *aff’d mem.*, 738 F.2d 453 (Fed. Cir. 1984). The mere absence of a positive recitation is not basis for an exclusion. Any claim containing a negative limitation which does not have basis in the original disclosure should be rejected under 35 U.S.C. 112, first paragraph, as failing to comply with the written description requirement. Note that a lack of literal basis in the specification for a negative limitation may not be sufficient to establish a *prima facie* case for lack of descriptive support. *Ex parte Parks*, 30 USPQ2d 1234, 1236 (Bd. Pat. App. & Inter. 1993). See MPEP § 2163 - § 2163.07(b) for a discussion of the written description requirement of 35 U.S.C. 112, first paragraph.

### 2173.05(j) Old Combination

#### A CLAIM SHOULD NOT BE REJECTED ON THE GROUND OF OLD COMBINATION

With the passage of the 1952 Patent Act, the courts and the Board have taken the view that a rejection based on the principle of old combination is NO LONGER VALID. Claims should be considered proper so long as they comply with the provisions of 35 U.S.C. 112, second paragraph.

A rejection on the basis of old combination was based on the principle applied in *Lincoln Engineering Co. v. Stewart-Warner Corp.*, 303 U.S. 545, 37 USPQ 1 (1938). The principle was that an inventor who made an improvement or contribution to but one element of a generally old combination, should not be

able to obtain a patent on the entire combination including the new and improved element. A rejection required the citation of a single reference which broadly disclosed a combination of the claimed elements functionally cooperating in substantially the same manner to produce substantially the same results as that of the claimed combination. The case of *In re Hall*, 208 F.2d 370, 100 USPQ 46 (CCPA 1953) illustrates an application of this principle.

The court pointed out in *In re Bernhardt*, 417 F.2d 1395, 163 USPQ 611 (CCPA 1969) that the statutory language (particularly point out and distinctly claim) is the only proper basis for an old combination rejection, and in applying the rejection, that language determines what an applicant has a right and obligation to do. A majority opinion of the Board of Appeals held that Congress removed the underlying rationale of *Lincoln Engineering* in the 1952 Patent Act, and thereby effectively legislated that decision out of existence. *Ex parte Barber*, 187 USPQ 244 (Bd. App. 1974). Finally, the Court of Appeals for the Federal Circuit, in *Radio Steel and Mfg. Co. v. MTD Products, Inc.*, 731 F.2d 840, 221 USPQ 657 (Fed. Cir. 1984), followed the *Bernhardt* case, and ruled that a claim was not invalid under *Lincoln Engineering* because the claim complied with the requirements of 35 U.S.C. 112, second paragraph. Accordingly, a claim should not be rejected on the ground of old combination.

### 2173.05(k) Aggregation [R-1]

\*\*>A claim should not be rejected on the ground of “aggregation.” *In re Gustafson*, 331 F.2d 905, 141 USPQ 585 (CCPA 1964) (an applicant is entitled to know whether the claims are being rejected under 35 U.S.C. 101, 102, 103, or 112); *In re Collier*, 397 F.2d 1003, 1006, 158 USPQ 266, 268 (CCPA 1968) (“[A] rejection for ‘aggregation’ is non-statutory.”).

If a claim omits essential matter or fails to interrelate essential elements of the invention as defined by applicant(s) in the specification, see MPEP § 2172.01.<

### 2173.05(m) Prolix

Examiners should reject claims as prolix only when they contain such long recitations or unimportant details that the scope of the claimed invention is

rendered indefinite thereby. Claims are rejected as prolix when they contain long recitations that the metes and bounds of the claimed subject matter cannot be determined.

### 2173.05(n) Multiplicity [R-2]

37 CFR 1.75. *Claim(s)*.

(a) The specification must conclude with a claim particularly pointing out and distinctly claiming the subject matter which the applicant regards as his invention or discovery.

(b) More than one claim may be presented provided they differ substantially from each other and are not unduly multiplied.

\*\*\*\*\*

Where, in view of the nature and scope of applicant's invention, applicant presents an unreasonable number of claims which \*\* are repetitious and multiplied, the net result of which is to confuse rather than to clarify, a rejection on undue multiplicity based on 35 U.S.C. 112, second paragraph, may be appropriate. As noted by the court in *In re Chandler*, 319 F.2d 211, 225, 138 USPQ 138, 148 (CCPA 1963), "applicants should be allowed reasonable latitude in stating their claims in regard to number and phraseology employed. The right of applicants to freedom of choice in selecting phraseology which truly points out and defines their inventions should not be abridged. Such latitude, however, should not be extended to sanction that degree of repetition and multiplicity which beclouds definition in a maze of confusion. The rule of reason should be practiced and applied on the basis of the relevant facts and circumstances in each individual case." See also *In re Flint*, 411 F.2d 1353, 1357, 162 USPQ 228, 231 (CCPA 1969). Undue multiplicity rejections based on 35 U.S.C. 112, second paragraph, should be applied judiciously and should be rare.

If an undue multiplicity rejection under 35 U.S.C. 112, second paragraph, is appropriate, the examiner should contact applicant by telephone explaining that the claims are unduly multiplied and will be rejected under 35 U.S.C. 112, second paragraph. Note MPEP § 408. The examiner should also request that applicant select a specified number of claims for purpose of examination. If applicant is willing to select, by telephone, the claims for examination, an undue multiplicity rejection on all the claims based on 35 U.S.C. 112, second paragraph, should be made in the next Office action along with an action on the merits on the

selected claims. If applicant refuses to comply with the telephone request, an undue multiplicity rejection of all the claims based on 35 U.S.C. 112, second paragraph, should be made in the next Office action. Applicant's reply must include a selection of claims for purpose of examination, the number of which may not be greater than the number specified by the examiner. In response to applicant's reply, if the examiner adheres to the undue multiplicity rejection, it should be repeated and the selected claims will be examined on the merits. This procedure preserves applicant's right to have the rejection on undue multiplicity reviewed by the Board of Patent Appeals and Interferences.

Also, it is possible to reject one claim on an allowed claim if they differ only by subject matter old in the art. This ground of rejection is set forth in *Ex parte Whitelaw*, 1915 C.D. 18, 219 O.G. 1237 (Comm'r Pat. 1914). The *Ex parte Whitelaw* doctrine is restricted to cases where the claims are unduly multiplied or are substantial duplicates. *Ex parte Kochan*, 131 USPQ 204, 206 (Bd. App. 1961).

### 2173.05(o) Double Inclusion

There is no *per se* rule that "double inclusion" is improper in a claim. *In re Kelly*, 305 F.2d 909, 916, 134 USPQ 397, 402 (CCPA 1962) ("Automatic reliance upon a 'rule against double inclusion' will lead to as many unreasonable interpretations as will automatic reliance upon a 'rule allowing double inclusion'. The governing consideration is not *double inclusion*, but rather is what is a reasonable construction of the language of the claims."). Older cases, such as *Ex parte White*, 759 O.G. 783 (Bd. App. 1958) and *Ex parte Clark*, 174 USPQ 40 (Bd. App. 1971) should be applied with care, according to the facts of each case.

The facts in each case must be evaluated to determine whether or not the multiple inclusion of one or more elements in a claim gives rise to indefiniteness in that claim. The mere fact that a compound may be embraced by more than one member of a Markush group recited in the claim does not lead to any uncertainty as to the scope of that claim for either examination or infringement purposes. On the other hand, where a claim directed to a device can be read to include the same element twice, the claim may be

indefinite. *Ex parte Kristensen*, 10 USPQ2d 1701 (Bd. Pat. App. & Inter. 1989).

### **2173.05(p) Claim Directed to Product-By-Process or Product and Process**

There are many situations where claims are permissively drafted to include a reference to more than one statutory class of invention.

#### **I. PRODUCT-BY-PROCESS**

A product-by-process claim, which is a product claim that defines the claimed product in terms of the process by which it is made, is proper. *In re Luck*, 476 F.2d 650, 177 USPQ 523 (CCPA 1973); *In re Pilkington*, 411 F.2d 1345, 162 USPQ 145 (CCPA 1969); *In re Steppan*, 394 F.2d 1013, 156 USPQ 143 (CCPA 1967). A claim to a device, apparatus, manufacture, or composition of matter may contain a reference to the process in which it is intended to be used without being objectionable under 35 U.S.C. 112, second paragraph, so long as it is clear that the claim is directed to the product and not the process.

An applicant may present claims of varying scope even if it is necessary to describe the claimed product in product-by-process terms. *Ex parte Pantzer*, 176 USPQ 141 (Bd. App. 1972).

#### **II. PRODUCT AND PROCESS IN THE SAME CLAIM**

A single claim which claims both an apparatus and the method steps of using the apparatus is indefinite under 35 U.S.C. 112, second paragraph. In *Ex parte Lyell*, 17 USPQ2d 1548 (Bd. Pat. App. & Inter. 1990), a claim directed to an automatic transmission workstand and the method steps of using it was held to be ambiguous and properly rejected under 35 U.S.C. 112, second paragraph.

Such claims should also be rejected under 35 U.S.C. 101 based on the theory that the claim is directed to neither a "process" nor a "machine," but rather embraces or overlaps two different statutory classes of invention set forth in 35 U.S.C. 101 which is drafted so as to set forth the statutory classes of invention in the alternative only. *Id.* at 1551.

### **2173.05(q) "Use" Claims**

Attempts to claim a process without setting forth any steps involved in the process generally raises an issue of indefiniteness under 35 U.S.C. 112, second paragraph. For example, a claim which read: "A process for using monoclonal antibodies of claim 4 to isolate and purify human fibroblast interferon." was held to be indefinite because it merely recites a use without any active, positive steps delimiting how this use is actually practiced. *Ex parte Erlich*, 3 USPQ2d 1011 (Bd. Pat. App. & Inter. 1986).

Other decisions suggest that a more appropriate basis for this type of rejection is 35 U.S.C. 101. In *Ex parte Dunki*, 153 USPQ 678 (Bd. App. 1967), the Board held the following claim to be an improper definition of a process: "The use of a high carbon austenitic iron alloy having a proportion of free carbon as a vehicle brake part subject to stress by sliding friction." In *Clinical Products Ltd. v. Brenner*, 255 F. Supp. 131, 149 USPQ 475 (D.D.C. 1966), the district court held the following claim was definite, but that it was not a proper process claim under 35 U.S.C. 101: "The use of a sustained release therapeutic agent in the body of ephedrine absorbed upon polystyrene sulfonic acid."

Although a claim should be interpreted in light of the specification disclosure, it is generally considered improper to read limitations contained in the specification into the claims. See *In re Prater*, 415 F.2d 1393, 162 USPQ 541 (CCPA 1969) and *In re Winkhaus*, 527 F.2d 637, 188 USPQ 129 (CCPA 1975), which discuss the premise that one cannot rely on the specification to impart limitations to the claim that are not recited in the claim.

#### **A "USE" CLAIM SHOULD BE REJECTED UNDER ALTERNATIVE GROUNDS BASED ON 35 U.S.C 101 AND 112**

In view of the split of authority as discussed above, the most appropriate course of action would be to reject a "use" claim under alternative grounds based on 35 U.S.C. 101 and 112.

#### **BOARD HELD STEP OF "UTILIZING" WAS NOT INDEFINITE**

It is often difficult to draw a fine line between what is permissible, and what is objectionable from

the perspective of whether a claim is definite. In the case of *Ex parte Porter*, 25 USPQ2d 1144 (Bd. Pat. App. & Inter. 1992), the Board held that a claim which clearly recited the step of “utilizing” was not indefinite under 35 U.S.C. 112, second paragraph. (Claim was to “A method for unloading nonpacked, nonbridging and packed, bridging flowable particle catalyst and bead material from the opened end of a reactor tube which comprises utilizing the nozzle of claim 7.”).

### 2173.05(r) Omnibus Claim

Some applications are filed with an omnibus claim which reads as follows: A device substantially as shown and described. This claim should be rejected under 35 U.S.C. 112, second paragraph, because it is indefinite in that it fails to point out what is included or excluded by the claim language. See *Ex parte Fresola*, 27 USPQ2d 1608 (Bd. Pat. App. & Inter. 1993), for a discussion of the history of omnibus claims and an explanation of why omnibus claims do not comply with the requirements of 35 U.S.C. 112, second paragraph.

Such a claim can be rejected using Form Paragraph 7.35. See MPEP § 706.03(d).

For cancellation of such a claim by examiner’s amendment, see MPEP § 1302.04(b).

### 2173.05(s) Reference to Figures or Tables

Where possible, claims are to be complete in themselves. Incorporation by reference to a specific figure or table “is permitted only in exceptional circumstances where there is no practical way to define the invention in words and where it is more concise to incorporate by reference than duplicating a drawing or table into the claim. Incorporation by reference is a necessity doctrine, not for applicant’s convenience.” *Ex parte Fressola*, 27 USPQ2d 1608, 1609 (Bd. Pat. App. & Inter. 1993) (citations omitted).

Reference characters corresponding to elements recited in the detailed description and the drawings may be used in conjunction with the recitation of the same element or group of elements in the claims. See MPEP § 608.01(m).

### 2173.05(t) Chemical Formula

Claims to chemical compounds and compositions containing chemical compounds often use formulas that depict the chemical structure of the compound. These structures should not be considered indefinite nor speculative in the absence of evidence that the assigned formula is in error. The absence of corroborating spectroscopic or other data cannot be the basis for finding the structure indefinite. See *Ex parte Morton*, 134 USPQ 407 (Bd. App. 1961), and *Ex parte Sobin*, 139 USPQ 528 (Bd. App. 1962).

A claim to a chemical compound is not indefinite merely because a structure is not presented or because a partial structure is presented. For example, the claim language at issue in *In re Fisher*, 427 F.2d 833, 166 USPQ 18 (CCPA 1970) referred to a chemical compound as a “polypeptide of at least 24 amino acids having the following sequence.” A rejection under 35 U.S.C. 112, second paragraph, for failure to identify the entire structure was reversed and the court held: “While the absence of such a limitation obviously broadens the claim and raises questions of sufficiency of disclosure, it does not render the claim indefinite.” Chemical compounds may be claimed by a name that adequately describes the material to one skilled in the art. See *Martin v. Johnson*, 454 F.2d 746, 172 USPQ 391 (CCPA 1972). A compound of unknown structure may be claimed by a combination of physical and chemical characteristics. See *Ex parte Brian*, 118 USPQ 242 (Bd. App. 1958). A compound may also be claimed in terms of the process by which it is made without raising an issue of indefiniteness.

### 2173.05(u) Trademarks or Trade Names in a Claim

The presence of a trademark or trade name in a claim is not, *per se*, improper under 35 U.S.C. 112, second paragraph, but the claim should be carefully analyzed to determine how the mark or name is used in the claim. It is important to recognize that a trademark or trade name is used to identify a source of goods, and not the goods themselves. Thus a trademark or trade name does not identify or describe the goods associated with the trademark or trade name. See definitions of trademark and trade name in MPEP § 608.01(v). A list of some trademarks is found in Appendix I.

If the trademark or trade name is used in a claim as a limitation to identify or describe a particular material or product, the claim does not comply with the requirements of the 35 U.S.C. 112, second paragraph. *Ex parte Simpson*, 218 USPQ 1020 (Bd. App. 1982). The claim scope is uncertain since the trademark or trade name cannot be used properly to identify any particular material or product. In fact, the value of a trademark would be lost to the extent that it became descriptive of a product, rather than used as an identification of a source or origin of a product. Thus, the use of a trademark or trade name in a claim to identify or describe a material or product would not only render a claim indefinite, but would also constitute an improper use of the trademark or trade name.

If a trademark or trade name appears in a claim and is not intended as a limitation in the claim, the question of why it is in the claim should be addressed. Does its presence in the claim cause confusion as to the scope of the claim? If so, the claim should be rejected under 35 U.S.C. 112, second paragraph.

### **2173.05(v) Mere Function of Machine**

Process or method claims are not subject to rejection by U.S. Patent and Trademark Office examiners under 35 U.S.C. 112, second paragraph, solely on the ground that they define the inherent function of a disclosed machine or apparatus. *In re Tarczy-Hornoch*, 397 F.2d 856, 158 USPQ 141 (CCPA 1968). The court in *Tarczy-Hornoch* held that a process claim, otherwise patentable, should not be rejected merely because the application of which it is part discloses apparatus which will inherently carry out the recited steps.

### **2173.06 Prior Art Rejection of Claim Rejected as Indefinite**

All words in a claim must be considered in judging the patentability of a claim against the prior art. *In re Wilson*, 424 F.2d 1382, 165 USPQ 494 (CCPA 1970). The fact that terms may be indefinite does not make the claim obvious over the prior art. When the terms of a claim are considered to be indefinite, at least two approaches to the examination of an indefinite claim relative to the prior art are possible.

First, where the degree of uncertainty is not great, and where the claim is subject to more than one interpretation and at least one interpretation would

render the claim unpatentable over the prior art, an appropriate course of action would be for the examiner to enter two rejections: (A) a rejection based on indefiniteness under 35 U.S.C. 112, second paragraph; and (B) a rejection over the prior art based on the interpretation of the claims which renders the prior art applicable. See, e.g., *Ex parte Ionescu*, 222 USPQ 537 (Bd. App. 1984). When making a rejection over prior art in these circumstances, it is important for the examiner to point out how the claim is being interpreted. Second, where there is a great deal of confusion and uncertainty as to the proper interpretation of the limitations of a claim, it would not be proper to reject such a claim on the basis of prior art. As stated in *In re Steele*, 305 F.2d 859, 134 USPQ 292 (CCPA 1962), a rejection under 35 U.S.C. 103 should not be based on considerable speculation about the meaning of terms employed in a claim or assumptions that must be made as to the scope of the claims.

The first approach is recommended from an examination standpoint because it avoids piecemeal examination in the event that the examiner's 35 U.S.C. 112, second paragraph rejection is not affirmed, and may give applicant a better appreciation for relevant prior art if the claims are redrafted to avoid the 35 U.S.C. 112, second paragraph rejection.

### **2174 Relationship Between the Requirements of the First and Second Paragraphs of 35 U.S.C. 112**

The requirements of the first and second paragraphs of 35 U.S.C. 112 are separate and distinct. If a description or the enabling disclosure of a specification is not commensurate in scope with the subject matter encompassed by a claim, that fact alone does not render the claim imprecise or indefinite or otherwise not in compliance with 35 U.S.C. 112, second paragraph; rather, the claim is based on an insufficient disclosure (35 U.S.C. 112, first paragraph) and should be rejected on that ground. *In re Borkowski*, 422 F.2d 904, 164 USPQ 642 (CCPA 1970). If the specification discloses that a particular feature or element is critical or essential to the practice of the invention, failure to recite or include that particular feature or element in the claims may provide a basis for a rejection based on the ground that those claims are not supported by an enabling disclosure. *In re Mayhew*, 527 F.2d 1229,

188 USPQ 356 (CCPA 1976). In *Mayhew*, the examiner argued that the only mode of operation of the process disclosed in the specification involved the use of a cooling zone at a particular location in the processing cycle. The claims were rejected because they failed to specify either a cooling step or the location of the step in the process. The court was convinced that the cooling bath and its location were essential, and held that claims which failed to recite the use of a cooling zone, specifically located, were not supported by an enabling disclosure (35 U.S.C. 112, first paragraph).

In addition, if a claim is amended to include an invention that is not described in the application as filed, a rejection of that claim under 35 U.S.C. 112, first paragraph, as being directed to subject matter that is not described in the specification as filed may be appropriate. In *re Simon*, 302 F.2d 737, 133 USPQ 524 (CCPA 1962). In *Simon*, which involved a reissue application containing claims to a reaction product of a composition, applicant presented claims to a reaction product of a composition comprising the subcombination A+B+C, whereas the original claims and description of the invention were directed to a composition comprising the combination A+B+C+D+E. The court found no significant support for the argument that ingredients D+E were not essential to the claimed reaction product and concluded that claims directed to the reaction product of a subcombination A+B+C were not described (35 U.S.C. 112, first paragraph) in the application as filed. See also *In re Panagrossi*, 277 F.2d 181, 125 USPQ 410 (CCPA 1960).

## 2181 Identifying a 35 U.S.C. 112, Sixth Paragraph Limitation [R-2]

This section sets forth guidelines for the examination of 35 U.S.C. 112, sixth paragraph, “means or step plus function” limitations in a claim. These guidelines are based on the Office’s current understanding of the law and are believed to be fully consistent with binding precedent of the Supreme Court, the Federal Circuit and the Federal Circuit’s predecessor courts. These guidelines do not constitute substantive rule-making and hence do not have the force and effect of law.

The Court of Appeals for the Federal Circuit, in its *en banc* decision *In re Donaldson Co.*, 16 F.3d 1189, 29 USPQ2d 1845 (Fed. Cir. 1994), decided that a

“means-or-step-plus-function” limitation should be interpreted in a manner different than patent examining practice had previously dictated. The *Donaldson* decision affects only the manner in which the scope of a “means or step plus function” limitation in accordance with 35 U.S.C. 112, sixth paragraph, is interpreted during examination. *Donaldson* does not directly affect the manner in which any other section of the patent statutes is interpreted or applied.

When making a determination of patentability under 35 U.S.C. 102 or 103, past practice was to interpret a “means or step plus function” limitation by giving it the “broadest reasonable interpretation.” Under the PTO’s long-standing practice this meant interpreting such a limitation as reading on any prior art means or step which performed the function specified in the claim without regard for whether the prior art means or step was equivalent to the corresponding structure, material or acts described in the specification. However, in *Donaldson*, the Federal Circuit stated:

Per our holding, the “broadest reasonable interpretation” that an examiner may give means-plus-function language is that statutorily mandated in paragraph six. Accordingly, the PTO may not disregard the structure disclosed in the specification corresponding to such language when rendering a patentability determination.

>

### I. <LANGUAGE FALLING WITHIN 35 U.S.C. 112, SIXTH PARAGRAPH

The USPTO must apply 35 U.S.C. 112, sixth paragraph in appropriate cases, and give claims their broadest reasonable interpretation, in light of and consistent with the written description of the invention in the application. See *Donaldson*, 16 F.3d at 1194, 29 USPQ2d at 1850 (stating that 35 U.S.C. 112, sixth paragraph “merely sets a limit on how broadly the PTO may construe means-plus-function language under the rubric of reasonable interpretation.”). The Federal Circuit has held that applicants (and reexamination patentees) before the USPTO have the opportunity and the obligation to define their inventions precisely during proceedings before the PTO. See *In re Morris*, 127 F.3d 1048, 1056–57, 44 USPQ2d 1023, 1029–30 (Fed. Cir. 1997) (35 U.S.C. 112, second paragraph places the burden of precise claim drafting on the applicant); *In re Zletz*, 893 F.2d 319, 322, 13 USPQ2d 1320, 1322 (Fed. Cir. 1989) (manner

of claim interpretation that is used by courts in litigation is not the manner of claim interpretation that is applicable during prosecution of a pending application before the PTO); *Sage Prods., Inc. v. Devon Indus., Inc.*, 126 F.3d 1420, 1425, 44 USPQ2d 1103, 1107 (Fed. Cir. 1997) (patentee who had a clear opportunity to negotiate broader claims during prosecution but did not do so, may not seek to expand the claims through the doctrine of equivalents, for it is the patentee, not the public, who must bear the cost of failure to seek protection for this foreseeable alteration of its claimed structure). Applicants and reexamination patentees before the USPTO have an opportunity and obligation to specify, consistent with these guidelines, when a claim limitation invokes 35 U.S.C. 112, sixth paragraph.

A claim limitation will be interpreted to invoke 35 U.S.C. 112, sixth paragraph, if it meets the following 3-prong analysis:

(A) the claim limitations must use the phrase “means for” or “step for”;

(B) the “means for” or “step for” must be modified by functional language; and

(C) the phrase “means for” or “step for” must not be modified by sufficient structure, material or acts for achieving the specified function.

With respect to the first prong of this analysis, a claim element that does not include the phrase “means for” or “step for” will not be considered to invoke 35 U.S.C. 112, sixth paragraph. If an applicant wishes to have the claim limitation treated under 35 U.S.C. 112, sixth paragraph, applicant must either: (A) amend the claim to include the phrase “means for” or “step for” in accordance with these guidelines; or (B) show that even though the phrase “means for” or “step for” is not used, the claim limitation is written as a function to be performed and does not recite sufficient structure, material, or acts which would preclude application of 35 U.S.C. 112, sixth paragraph. See *Watts v. XL Systems, Inc.*, 232 F.3d 877, 56 USPQ2d 1836 (Fed. Cir. 2000) (Claim limitations were held not to invoke 35 U.S.C. 112, sixth paragraph, because the absence of the term “means” raised the presumption that the limitations were not in means-plus-function form, nor was the presumption rebutted.); see also *Masco Corp. v. United States*, 303 F.3d 1316, 1327, 64 USPQ2d 1182, 1189 (Fed. Cir. 2002)

(“[W]here a method claim does not contain the term ‘step[s] for,’ a limitation of that claim cannot be construed as a step-plus-function limitation without a showing that the limitation contains no act.”)>.<

While traditional “means for” or “step for” language does not automatically make an element a means-(or step-) plus-function element, conversely, lack of such language does not prevent a limitation from being construed as a means-(or step-) plus-function limitation. See *Signtech USA, Ltd. v. Vutek, Inc.*, 174 F.3d 1352, 1356, 50 USPQ2d 1372, 1374–75 (Fed. Cir.1999) (“ink delivery means positioned on ...” invokes 35 U.S.C. 112, sixth paragraph since the phrase “ink delivery means” is equivalent to “means for ink delivery”); *Al-Site Corp. v. VSI Int’l, Inc.*, 174 F.3d 1308, 1317-19, 50 USPQ2d 1161, 1166-67 (Fed. Cir. 1999) (although the claim elements “eyeglass hanger member” and “eyeglass contacting member” include a function, these claim elements do not invoke 35 U.S.C. 112, sixth paragraph because the claims themselves contain sufficient structural limitations for performing these functions); *Seal-Flex, Inc. v. Athletic Track and Court Construction*, 172 F.3d 836, 850, 50 USPQ2d 1225, 1234 (Fed. Cir. 1999) (Radar, J., concurring) (“claim elements without express step-plus-function language may nevertheless fall within 112 6 if they merely claim the underlying function without recitation of acts for performing that function...In general terms, the underlying function’ of a method claim element corresponds to *what* that element ultimately accomplishes in relationship to what the other elements of the claim and the claim as a whole accomplish. Acts,’ on the other hand, correspond to *how* the function is accomplished...If the claim element uses the phrase step for,’ then § 112, 6 is presumed to apply...On the other hand, the term step’ alone and the phrase steps of’ tend to show that § 112, 6 does not govern that limitation.”); *Personalized Media Communications LLC v. ITC*, 161 F.3d 696, 703–04, 48 USPQ2d 1880, 1886–87 (Fed. Cir. 1998); *Mas-Hamilton Group v. LaGard Inc.*, 156 F.3d 1206, 1213, 48 USPQ2d 1010, 1016 (Fed. Cir. 1998) (“lever moving element for moving the lever” and “movable link member for holding the lever...and for releasing the lever” were construed as means-plus-function limitations invoking 35 U.S.C. 112, sixth paragraph since the claimed limitations were described in terms of their function not their mechani-



cal structure); *Ethicon, Inc. v. United States Surgical Corp.*, 135 F.3d 1456, 1463, 45 USPQ2d 1545, 1550 (Fed. Cir. 1998) (“use of the word means ‘gives rise to a presumption that the inventor used the term advisedly to invoke the statutory mandates for means-plus-function clauses’ ”); *O.I. Corp. v. Tekmar*, 115 F.3d 1576, 1583, 42 USPQ2d 1777, 1782 (Fed. Cir. 1997) (method claim that paralleled means-plus-function apparatus claim but lacked “step for” language did not invoke 35 U.S.C. 112, sixth paragraph). Thus, absent an express recitation of “means for” or “step for” in the limitation, the broadest reasonable interpretation will not be limited to “corresponding structure...and equivalents thereof.” *Morris*, 127 F.3d at 1055, 44 USPQ2d at 1028 (“no comparable mandate in the patent statute that relates the claim scope of non-§ 112 paragraph 6 claims to particular matter found in the specification”).

With respect to the second prong of this analysis, see *York Prod., Inc. v. Central Tractor Farm & Family Center*, 99 F.3d 1568, 1574, 40 USPQ2d 1619, 1624 (Fed. Cir. 1996) (holding that a claim limitation containing the term “means” does not invoke 35 U.S.C. 112, sixth paragraph, if the claim limitation does not link the term “means” to a specific function). It must be clear that the element in the claims is set forth, at least in part, by the function it performs as opposed to the specific structure, material, or acts that perform the function. See also *Caterpillar Inc. v. Detroit Diesel Corp.*, 41 USPQ2d 1876, 1882 (N.D. Ind. 1996) (35 U.S.C. 112, sixth paragraph, “applies to functional method claims where the element at issue sets forth a step for reaching a particular result, but not the specific technique or procedure used to achieve the result.”); *O.I. Corp.*, 115 F.3d at 1582-83, 42 USPQ2d at 1782 (With respect to process claims, “[35 U.S.C. 112, sixth paragraph] is implicated only when steps *plus function* without acts are present...If we were to construe every process claim containing steps described by an ‘ing’ verb, such as passing, heating, reacting, transferring, etc., into a step-plus-function, we would be limiting process claims in a manner never intended by Congress.” (Emphasis in original)). However, “the fact that a particular mechanism...is defined in functional terms is not sufficient to convert a claim element containing that term into a ‘means for performing a specified function’ within the meaning of section 112(6).” *Greenberg v. Ethicon*

*Endo-Surgery, Inc.*, 91 F.3d 1580, 1583, 39 USPQ2d 1783, 1786 (Fed. Cir. 1996) (“detent mechanism” defined in functional terms was not intended to invoke 35 U.S.C. 112, sixth paragraph). See also *Al-Site Corp. v. VSI International Inc.*, 174 F.3d 1308, 1318, 50 USPQ2d 1161, 1166-67 (Fed. Cir. 1999) (although the claim elements “eyeglass hanger member” and “eyeglass contacting member” include a function, these claim elements do not invoke 35 U.S.C. 112, sixth paragraph, because the claims themselves contain sufficient structural limitations for performing those functions). Also, a statement of function appearing only in the claim preamble is generally insufficient to invoke 35 U.S.C. 112, sixth paragraph. *O.I. Corp.*, 115 F.3d at 1583, 42 USPQ2d at 1782 (“[A] statement in a preamble of a result that necessarily follows from performing a series of steps does not convert each of those steps into step-plus-function clauses. The steps of ‘passing’ are not individually associated in the claims with functions performed by the steps of passing.”).

With respect to the third prong of this analysis, see *Seal-Flex*, 172 F.3d at 849, 50 USPQ2d at 1234 (Radar, J., concurring) (“Even when a claim element uses language that generally falls under the step-plus-function format, however, 112 ¶ 6 still does not apply when the claim limitation itself recites sufficient acts for performing the specified function.”); *Envirco Corp. v. Clestra Cleanroom, Inc.*, 209 F.3d 1360, 54 USPQ2d 1449 (Fed. Cir. 2000) (holding “second baffle means” does not invoke 35 U.S.C. 112, sixth paragraph, because the word “baffle” itself imparts structure and the claim further recites the structure of the baffle); *Rodime PLC v. Seagate Technology, Inc.*, 174 F.3d 1294, 1303-04, 50 USPQ2d 1429, 1435-36 (Fed. Cir. 1999) (holding “positioning means for moving” does not invoke 35 U.S.C. 112, sixth paragraph, because the claim further provides a list of the structure underlying the means and the detailed recitation of the structure for performing the moving function removes this element from the purview of 35 U.S.C. 112, sixth paragraph); *Cole v. Kimberly-Clark Corp.*, 102 F.3d 524, 531, 41 USPQ2d 1001, 1006 (Fed. Cir. 1996) (holding “perforation means...for tearing” does not invoke 35 U.S.C. 112, sixth paragraph, because the claim describes the structure supporting the tearing function (i.e., perforation)). In other cases, the Federal Circuit has held otherwise.

See *Unidynamics Corp. v. Automatic Prod. Int'l*, 157 F.3d 1311, 1319, 48 USPQ2d 1099, 1104 (Fed. Cir. 1998) (holding “spring means” does invoke 35 U.S.C. 112, sixth paragraph). During examination, however, applicants have the opportunity and the obligation to define their inventions precisely, including whether a claim limitation invokes 35 U.S.C. 112, sixth paragraph. Thus, if the phrase “means for” or “step for” is modified by sufficient structure, material or acts for achieving the specified function, the USPTO will not apply 35 U.S.C. 112, sixth paragraph, until such modifying language is deleted from the claim limitation.

It is necessary to decide on an element by element basis whether 35 U.S.C. 112, sixth paragraph, applies. Not all terms in a means-plus-function or step-plus-function clause are limited to what is disclosed in the written description and equivalents thereof, since 35 U.S.C. 112, sixth paragraph, applies only to the interpretation of the means or step that performs the recited function. See, e.g., *IMS Technology Inc. v. Haas Automation Inc.*, 206 F.3d 1422, 54 USPQ2d 1129 (Fed. Cir. 2000) (the term “data block” in the phrase “means to sequentially display data block inquiries” was not the means that caused the sequential display, and its meaning was not limited to the disclosed embodiment and equivalents thereof.). Each claim must be independently reviewed to determine the applicability of 35 U.S.C. 112, sixth paragraph, even where the application contains substantially similar process and apparatus claims. *O.I. Corp.*, 115 F.3d at 1583-1584, 42 USPQ2d at 1782 (“We understand that the steps in the method claims are essentially in the same language as the limitations in the apparatus claim, albeit without the ‘means for’ qualification...Each claim must be independently reviewed in order to determine if it is subject to the requirements of section 112, ¶ 6. Interpretation of claims would be confusing indeed if claims that are not means- or step-plus function were to be interpreted as if they were, only because they use language similar to that used in other claims that are subject to this provision.”).

Accordingly, these guidelines provide applicants with the opportunity to either invoke or not invoke 35 U.S.C. 112, sixth paragraph, based upon a clear and simple set of criteria.

Limitations that fall within the scope of 35 U.S.C. 112, sixth paragraph, include:

(A) a jet driving device so constructed and located on the rotor as to drive the rotor . . . [“means” unnecessary]. The term “device” coupled with a function is a proper definition of structure in accordance with the last paragraph of 35 U.S.C. 112. The addition of the words “jet driving” to the term “device” merely renders the latter more definite and specific. *Ex parte Stanley*, 121 USPQ 621 (Bd. App. 1958);

(B) “printing means” and “means for printing” which would have the same connotations. *Ex parte Klumb*, 159 USPQ 694 (Bd. App. 1967). However, the terms “plate” and “wing,” as modifiers for the structureless term “means,” specify no function to be performed, and do not fall under the last paragraph of 35 U.S.C. 112;

(C) force generating means adapted to provide . . . . *De Graffenreid v. United States*, 20 Ct. Cl. 458, 16 USPQ2d 1321 (Ct. Cl. 1990);

(D) call cost register means, including a digital display for providing a substantially instantaneous display for . . . . *Intellicall Inc. v. Phonometrics, Inc.*, 952 F.2d 1384, 21 USPQ2d 1383 (Fed. Cir. 1992);

(E) reducing the coefficient of friction of the resulting film [step plus function; “step” unnecessary], *In re Roberts*, 470 F.2d 1399, 176 USPQ 313 (CCPA 1973); and

(F) raising the pH of the resultant pulp to about 5.0 to precipitate . . . . *Ex parte Zimmerley*, 153 USPQ 367 (Bd. App. 1966).

In the event that it is unclear whether the claim limitation falls within the scope of 35 U.S.C. 112, sixth paragraph, a rejection under 35 U.S.C. 112, second paragraph may be appropriate.

>

## II. <WRITTEN DESCRIPTION NECESSARY TO SUPPORT A CLAIM LIMITATION WHICH INVOKES 35 U.S.C. 112, SIXTH PARAGRAPH

35 U.S.C. 112, sixth paragraph states that a claim limitation expressed in means-plus-function language “shall be construed to cover the corresponding structure...described in the specification and equivalents thereof.” “If one employs means plus function language in a claim, one must set forth in the specification an adequate disclosure showing what is meant by that language. If an applicant fails to set forth an adequate disclosure, the applicant has in effect failed to

particularly point out and distinctly claim the invention as required by the second paragraph of section 112.” *In re Donaldson Co.*, 16 F.3d 1189, 1195, 29 USPQ2d 1845, 1850 (Fed. Cir. 1994) (in banc).

The proper test for meeting the definiteness requirement is that the corresponding structure (or material or acts) of a means (or step)-plus-function limitation must be disclosed in the specification itself in a way that one skilled in the art will understand what structure (or material or acts) will perform the recited function. See *Atmel Corp. v. Information Storage Devices, Inc.*, 198 F.3d 1374, 1381, 53 USPQ2d 1225, 1230 (Fed. Cir. 1999). In *Atmel*, the patentee claimed an apparatus that included a “high voltage generating means” limitation, thereby invoking 35 U.S.C. 112, sixth paragraph. The specification incorporated by reference a non-patent document from a technical journal, which described a particular high voltage generating circuit. The Federal Circuit concluded that the title of the article in the specification may, by itself, be sufficient to indicate to one skilled in the art the precise structure of the means for performing the recited function, and it remanded the case to the district court “to consider the knowledge of one skilled in the art that indicated, based on unrefuted testimony, that the specification disclosed sufficient structure corresponding to the high-voltage means limitation.” *Id.* at 1382, 53 USPQ2d at 1231.

The disclosure of the structure (or material or acts) may be implicit or inherent in the specification if it would have been clear to those skilled in the art what structure (or material or acts) corresponds to the means (or step)-plus-function claim limitation. See *Id.* at 1380, 53 USPQ2d at 1229; *In re Dossel*, 115 F.3d 942, 946-47, 42 USPQ2d 1881, 1885 (Fed. Cir. 1997). If there is no disclosure of structure, material or acts for performing the recited function, the claim fails to satisfy the requirements of 35 U.S.C. 112, second paragraph. *Budde v. Harley-Davidson, Inc.*, 250 F.3d 1369, 1376, 58 USPQ2d 1801, 1806 (Fed. Cir. 2001); *Cardiac Pacemakers, Inc. v. St. Jude Med., Inc.*, 296 F.3d 1106, 1115-18, 63 USPQ2d 1725, 1731-34 (Fed. Cir. 2002) (Court interpreted the language of the “third monitoring means for monitoring the ECG signal...for activating ...” to require the same means to perform both functions and the only entity referenced in the specification that could possibly perform both functions is the physician. The court held that exclud-

ing the physician, no structure accomplishes the claimed dual functions. Because no structure disclosed in the embodiments of the invention actually performs the claimed dual functions, the specification lacks corresponding structure as required by 35 U.S.C. 112, sixth paragraph, and fails to comply with 35 U.S.C. 112, second paragraph.).

Whether a claim reciting an element in means- (or step-) plus-function language fails to comply with 35 U.S.C. 112, second paragraph, because the specification does not disclose adequate structure (or material or acts) for performing the recited function is closely related to the question of whether the specification meets the description requirement in 35 U.S.C. 112, first paragraph. See *In re Noll*, 545 F.2d 141, 149, 191 USPQ 721, 727 (CCPA 1976) (unless the means-plus-function language is itself unclear, a claim limitation written in means-plus-function language meets the definiteness requirement in 35 U.S.C. 112, second paragraph, so long as the specification meets the written description requirement in 35 U.S.C. 112, first paragraph). However, 35 U.S.C. 112, sixth paragraph, does not impose any requirements in addition to those imposed by 35 U.S.C. 112, first paragraph. See *In re Knowlton*, 481 F.2d 1357, 1366, 178 USPQ 486, 492-93 (CCPA 1973). Conversely, the invocation of 35 U.S.C. 112, sixth paragraph, does not exempt an applicant from compliance with 35 U.S.C. 112, first and second paragraphs. See *Donaldson*, 16 F.3d at 1195, 29 USPQ2d at 1850; *Knowlton*, 481 F.2d at 1366, 178 USPQ at 493.

Under certain limited circumstances, the written description does not have to explicitly describe the structure (or material or acts) corresponding to a means- (or step-) plus-function limitation to particularly point out and distinctly claim the invention as required by 35 U.S.C. 112, second paragraph. See *Dossel*, 115 F.3d at 946, 42 USPQ2d at 1885. Under proper circumstances, drawings may provide a written description of an invention as required by 35 U.S.C. 112. *Vas-Cath, Inc. v. Mahurkar*, 935 F.2d 1555, 1565, 19 USPQ2d 1111, 1118 (Fed. Cir. 1991). Rather, disclosure of structure corresponding to a means-plus-function limitation may be implicit in the written description if it would have been clear to those skilled in the art what structure must perform the function recited in the means-plus-function limitation. See *Atmel Corp. v. Information Storage Devices*

*Inc.*, 198 F.3d 1374, 1379, 53 USPQ2d 1225, 1228 (Fed. Cir. 1999) (stating that the “one skilled in the art” analysis should apply in determining whether sufficient structure has been disclosed to support a means-plus-function limitation and that the USPTO’s recently issued proposed Supplemental Guidelines are consistent with the court’s holding on this point); *Dossel*, 115 F.3d at 946–47, 42 USPQ2d at 1885 (“Clearly, a unit which receives digital data, performs complex mathematical computations and outputs the results to a display must be implemented by or on a general or special purpose computer (although it is not clear why the written description does not simply state ‘computer’ or some equivalent phrase.)”).

>

### III. <DETERMINING 35 U.S.C. 112 SECOND PARAGRAPH COMPLIANCE WHEN 35 U.S.C. 112 SIXTH PARAGRAPH IS INVOKED

The following guidance is provided to determine whether applicant has complied with the requirements of 35 U.S.C. 112, second paragraph, when 35 U.S.C. 112, sixth paragraph, is invoked:

(A) If the corresponding structure, material or acts are described in the specification in specific terms (e.g., an emitter-coupled voltage comparator) and one skilled in the art could identify the structure, material or acts from that description, then the requirements of 35 U.S.C. 112, second and sixth paragraphs and are satisfied. See *Atmel*, 198 F.3d at 1382, 53 USPQ2d 1231.

(B) If the corresponding structure, material or acts are described in the specification in broad generic terms and the specific details of which are incorporated by reference to another document (e.g., attachment means disclosed in U.S. Patent No. X, which is hereby incorporated by reference, or a comparator as disclosed in the IBM article, which is hereby incorporated by reference), Office personnel must review the description in the specification, without relying on any material from the incorporated document, and apply the “one skilled in the art” analysis to determine whether one skilled in the art could identify the corresponding structure (or material or acts) for performing the recited function to satisfy the definiteness requirement of 35 U.S.C. 112, second paragraph.

(1) If one skilled in the art would be able to identify the structure, material or acts from the description in the specification for performing the recited function, then the requirements of 35 U.S.C. 112, second paragraph, are satisfied. See *Dossel*, 115 F.3d at 946–47, 42 USPQ2d at 1885 (The function recited in the means-plus-function limitation involved “reconstructing” data. The issue was whether the structure underlying this “reconstructing” function was adequately described in the written description to satisfy 35 U.S.C. 112, second paragraph. The court stated that “[n]either the written description nor the claims uses the magic word ‘computer,’ nor do they quote computer code that may be used in the invention. Nevertheless, when the written description is combined with claims 8 and 9, the disclosure satisfies the requirements of Section 112, Para. 2.” The court concluded that based on the specific facts of the case, one skilled in the art would recognize the structure for performing the “reconstructing” function since “a unit which receives digital data, performs complex mathematical computations and outputs the results to a display must be implemented by or on a general or special purpose computer.”). >See also *Intel Corp. v. VIA Technologies, Inc.*, 319 F.3d 1357, 1366, 65 USPQ2d 1934, 1941 (Fed. Cir. 2003) (The “core logic” structure that was modified to perform a particular program was held to be adequate corresponding structure for a claimed function although the specification did not disclose internal circuitry of the core logic to show exactly how it must be modified.)<

(2) If one skilled in the art would not be able to identify the structure, material or acts from description in the specification for performing the recited function, then applicant will be required to amend the specification to include the material incorporated by reference and to clearly link or associate the structure, material or acts to the function recited in the claim. Applicant should not be required to insert the subject matter described in the entire referenced document into the specification. To maintain a concise specification, applicant should only include the relevant portions of the referenced document that correspond to the means (or step)-plus-function limitation. See *Atmel*, 198 F.3d at 1382, 53 USPQ2d at 1230 (“All one needs to do...is to recite some structure corresponding to the means in the specification...so that one can readily ascertain what the claim means and

comply with the particularity requirement of Para. 2.”).

>

#### IV. <DETERMINING WHETHER 35 U.S.C. 112, FIRST PARAGARPH SUPPORT EXISTS

The claims must still be analyzed to determine whether there exists corresponding adequate support for such claim under 35 U.S.C. 112, first paragraph. In considering whether there is 35 U.S.C. 112, first paragraph support for the claim limitation, the examiner must consider not only the original disclosure contained in the summary and detailed description of the invention portions of the specification, but also the original claims, abstract, and drawings. See *In re Mott*, 539 F.2d 1291, 1299, 190 USPQ 536, 542–43 (CCPA 1976) (claims); *In re Anderson*, 471 F.2d 1237, 1240, 176 USPQ 331, 333 (CCPA 1973) (claims); *Hill-Rom Co. v. Kinetic Concepts, Inc.*, \*\*>209 F.3d 1337<, 54 USPQ2d 1437 (Fed. Cir. 2000) (unpublished) (abstract); *In re Armbruster*, 512 F.2d 676, 678–79, 185 USPQ 152, 153–54 (CCPA 1975) (abstract); *Anderson*, 471 F.2d at 1240, 176 USPQ at 333 (abstract); *Vas-Cath Inc. v. Mahurkar*, 935 F.2d at 1564, 19 USPQ2d at 1117 (drawings); *In re Wolfensperger*, 302 F.2d 950, 955–57, 133 USPQ 537, 541–43 (CCPA 1962) (drawings).

37 CFR 1.75(d)(1) provides, in part, that “the terms and phrases used in the claims must find clear support or antecedent basis in the description so that the meaning of the terms in the claims may be ascertainable by reference to the description.” In the situation in which the written description only implicitly or inherently sets forth the structure, materials, or acts corresponding to a means- (or step-) plus-function, and the examiner concludes that one skilled in the art would recognize what structure, materials, or acts perform the function recited in a means- (or step-) plus-function, the examiner should either: (A) have the applicant clarify the record by amending the written description such that it expressly recites what structure, materials, or acts perform the function recited in the claim element; or (B) state on the record what structure, materials, or acts perform the function recited in the means- (or step-) plus-function limitation. Even if the disclosure implicitly sets forth the structure, materials, or acts corresponding to a means-

(or step-) plus-function claim element in compliance with 35 U.S.C. 112, first and second paragraphs, the USPTO may still require the applicant to amend the specification pursuant to 37 CFR 1.75(d) and MPEP § 608.01(o) to explicitly state, with reference to the terms and phrases of the claim element, what structure, materials, or acts perform the function recited in the claim element. See 35 U.S.C. 112, sixth paragraph (“An element in a claim for a combination may be expressed as a means or step for performing a specified function without the recital of structure, material, or acts in support thereof, and such claim shall be construed to cover the corresponding structure, material, or acts described in the specification and equivalents thereof.” (emphasis added)); see also *B. Braun Medical*, 124 F.3d at 1424, 43 USPQ2d at 1900 (holding that “pursuant to this provision [35 U.S.C. 112, sixth paragraph], structure disclosed in the specification is ‘corresponding’ structure only if the specification or prosecution history clearly links or associates that structure to the function recited in the claim. This duty to link or associate structure to function is the *quid pro quo* for the convenience of employing 112, paragraph 6.”); >*Medical Instrumentation and Diagnostic Corp. v. Elekta AB*, 344 F.3d 1205, 1218, 68 USPQ2d 1263, 1268 (Fed. Cir. 2003)(Although one of skill in the art would have been able to write a software program for digital to digital conversion, such software did not fall within the scope of “means for converting” images as claimed because nothing in the specification or prosecution history clearly linked or associated such software with the function of converting images into a selected format.);< *Wolfensperger*, 302 F.2d at 955, 133 USPQ at 542 (just because the disclosure provides support for a claim element does not mean that the USPTO cannot enforce its requirement that the terms and phrases used in the claims find clear support or antecedent basis in the written description).

>

#### V. <SINGLE MEANS CLAIMS

*Donaldson* does not affect the holding of *In re Hyatt*, 708 F.2d 712, 218 USPQ 195 (Fed. Cir. 1983) to the effect that a single means claim does not comply with the enablement requirement of 35 U.S.C. 112, first paragraph. As *Donaldson* applies only to an interpretation of a limitation drafted to correspond to

35 U.S.C. 112, sixth paragraph, which by its terms is limited to “an element in a claim to a combination,” it does not affect a limitation in a claim which is not directed to a combination.

## 2182 Scope of the Search and Identification of the Prior Art [R-2]

As noted in MPEP § 2181, in *In re Donaldson Co.*, 16 F.3d 1189, 29 USPQ2d 1845 (Fed. Cir. 1994) the Federal Circuit recognized that it is important to retain the principle that claim language should be given its broadest reasonable interpretation. This principle is important because it helps insure that the statutory presumption of validity attributed to each claim of an issued patent is warranted by the search and examination conducted by the examiner. It is also important from the standpoint that the scope of protection afforded by patents issued prior to *Donaldson* are not unnecessarily limited by the latest interpretation of this statutory provision. Finally, it is important from the standpoint of avoiding the necessity for a patent specification to become a catalogue of existing technology. The specification need not describe the equivalents of the structures, material, or acts corresponding to the means- (or step-) plus-function claim element. See *In re Noll*, 545 F.2d 141, 149-50, 191 USPQ 721, 727 (CCPA 1976) (“The meaning of ‘equivalents’ is well understood in patent law, ... and an applicant need not describe in his specification the full range of equivalents of his invention.”) (citation omitted). A patent specification need not teach, and preferably omits, what is well known in the art. *Hybritech Inc. v. Monoclonal Antibodies, Inc.*, 802 F.2d 1367, 1384, 231 USPQ 81, 94 (Fed. Cir. 1986).

The *Donaldson* decision thus does not substantially alter examining practice and procedure relative to the scope of the search. Both before and after *Donaldson*, the application of a prior art reference to a means or step plus function limitation requires that the prior art element perform the identical function specified in the claim. However, if a prior art reference teaches identity of function to that specified in a claim, then under *Donaldson* an examiner carries the initial burden of proof for showing that the prior art structure or step is the same as or equivalent to the structure, material, or acts described in the specification which has been

identified as corresponding to the claimed means or step plus function.

The “means or step plus function” limitation should be interpreted in a manner consistent with the specification disclosure. >The Federal Circuit explained the two step analysis involved in construing means-plus-function limitations in *Golight Inc. v. Wal-Mart Stores Inc.*, 355 F.3d 1327, 1333-34, 69 USPQ2d 1481, 1486 (Fed. Cir. 2004):

The first step in construing a means-plus-function claim limitation is to define the particular function of the claim limitation. *Budde v. Harley-Davidson, Inc.*, 250 F.3d 1369, 1376 [58 USPQ2d 1801, 1806] (Fed. Cir. 2001). “The court must construe the function of a means-plus-function limitation to include the limitations contained in the claim language, and only those limitations.” *Cardiac Pacemakers, Inc. v. St. Jude Med., Inc.*, 296 F.3d 1106, 1113 [63 USPQ2d 1725, 1730] (Fed. Cir. 2002)... The next step in construing a means-plus-function claim limitation is to look to the specification and identify the corresponding structure for that function. “Under this second step, ‘structure disclosed in the specification is “corresponding” structure only if the specification or prosecution history clearly links or associates that structure to the function recited in the claim.’ ” *Med. Instrumentation & Diagnostics Corp. v. Elekta AB*, 344 F.3d 1205, 1210 [68 USPQ2d 1263, 1267] (Fed. Cir. 2003) (quoting *B. Braun Med. Inc. v. Abbott Labs.*, 124 F.3d 1419, 1424 [43 USPQ2d 1896, 1900] (Fed. Cir. 1997)).<

If the specification defines what is meant by the limitation for the purposes of the claimed invention, the examiner should interpret the limitation as having that meaning. If no definition is provided, some judgment must be exercised in determining the scope of the limitation. See, e.g., *B. Braun Medical, Inc. v. Abbott Labs.*, 124 F.3d 1419, 1424, 43 USPQ2d 1896, 1900 (Fed. Cir. 1997) (“We hold that, pursuant to [35 U.S.C. 112, sixth paragraph], structure disclosed in the specification is ‘corresponding’ structure only if the specification or prosecution history clearly links or associates that structure to the function recited in the claim. This duty to link or associate structure to function is the *quid pro quo* for the convenience of employing 112, paragraph 6.” The court refused to interpret a means-plus-function limitation as corresponding to a disclosed valve seat structure, as argued by patentee, since there was no indication in the specification or prosecution history that this structure corresponds to the recited function, and there was an explicitly clear association between that function and

a traverse cross section bar structure disclosed in the specification.).

### 2183 Making a *Prima Facie* Case of Equivalence

If the examiner finds that a prior art element

(A) performs the function specified in the claim,

(B) is not excluded by any explicit definition provided in the specification for an equivalent, and

(C) is an equivalent of the means- (or step-) plus-function limitation,

the examiner should provide an explanation and rationale in the Office action as to why the prior art element is an equivalent. Factors that will support a conclusion that the prior art element is an equivalent are:

(A) the prior art element performs the identical function specified in the claim in substantially the same way, and produces substantially the same results as the corresponding element disclosed in the specification. *Kemco Sales, Inc. v. Control Papers Co.*, 208 F.3d 1352, 54 USPQ2d 1308 (Fed. Cir. 2000) (An internal adhesive sealing the inner surfaces of an envelope pocket was not held to be equivalent to an adhesive on a flap which attached to the outside of the pocket. Both the claimed invention and the accused device performed the same function of closing the envelope. But the accused device performed it in a substantially different way (by an internal adhesive on the inside of the pocket) with a substantially different result (the adhesive attached the inner surfaces of both sides of the pocket)); *Odetics Inc. v. Storage Tech. Corp.*, 185 F.3d 1259, 1267, 51 USPQ2d 1225, 1229-30 (Fed. Cir. 1999); *Lockheed Aircraft Corp. v. United States*, 193 USPQ 449, 461 (Ct. Cl. 1977). The concepts of equivalents as set forth in *Graver Tank & Mfg. Co. v. Linde Air Products*, 339 U.S. 605, 85 USPQ 328 (1950) are relevant to any “equivalents” determination. *Polumbo v. Don-Joy Co.*, 762 F.2d 969, 975 n.4, 226 USPQ 5, 8-9 n.4 (Fed. Cir. 1985).

(B) a person of ordinary skill in the art would have recognized the interchangeability of the element shown in the prior art for the corresponding element disclosed in the specification. *Caterpillar Inc. v. Deere & Co.*, 224 F.3d 1374, 56 USPQ2d 1305 (Fed. Cir. 2000); *Al-Site Corp. v. VSI Int’l, Inc.*, 174 F.3d

1308, 1316, 50 USPQ2d 1161, 1165 (Fed. Cir. 1999); *Chiuminatta Concrete Concepts, Inc. v. Cardinal Indus. Inc.*, 145 F.3d 1303, 1309, 46 USPQ2d 1752, 1757 (Fed. Cir. 1998); *Lockheed Aircraft Corp. v. United States*, 193 USPQ 449, 461 (Ct. Cl. 1977); *Data Line Corp. v. Micro Technologies, Inc.*, 813 F.2d 1196, 1 USPQ2d 2052 (Fed. Cir. 1987).

(C) there are insubstantial differences between the prior art element and the corresponding element disclosed in the specification. *IMS Technology, Inc. v. Haas Automation, Inc.*, 206 F.3d 1422, 1436, 54 USPQ2d 1129, 1138 (Fed. Cir. 2000); *Warner-Jenkinson Co. v. Hilton Davis Chemical Co.*, 117 S. Ct. 1040, 41 USPQ2d 1865, 1875 (1997); *Valmont Industries, Inc. v. Reinke Mfg. Co.*, 983 F.2d 1039, 25 USPQ2d 1451 (Fed. Cir. 1993). See also *Caterpillar Inc. v. Deere & Co.*, 224 F.3d 1374, 56 USPQ2d 1305 (Fed. Cir. 2000) (A structure lacking several components of the overall structure corresponding to the claimed function and also differing in the number and size of the parts may be insubstantially different from the disclosed structure. The limitation in a means-plus-function claim is the overall structure corresponding to the claimed function. The individual components of an overall structure that corresponds to the claimed function are not claim limitations. Also, potential advantages of a structure that do not relate to the claimed function should not be considered in an equivalents determination under 35 U.S.C. 112, sixth paragraph).

(D) the prior art element is a structural equivalent of the corresponding element disclosed in the specification. *In re Bond*, 910 F.2d 831, 15 USPQ2d 1566 (Fed. Cir. 1990). That is, the prior art element performs the function specified in the claim in substantially the same manner as the function is performed by the corresponding element described in the specification.

A showing of at least one of the above-noted factors by the examiner should be sufficient to support a conclusion that the prior art element is an equivalent. The examiner should then conclude that the claimed limitation is met by the prior art element. In addition to the conclusion that the prior art element is an equivalent, examiners should also demonstrate, where appropriate, why it would have been obvious to one of ordinary skill in the art at the time of the invention to substitute applicant’s described structure, material, or

acts for that described in the prior art reference. See *In re Brown*, 459 F.2d 531, 535, 173 USPQ 685, 688 (CCPA 1972). The burden then shifts to applicant to show that the element shown in the prior art is not an equivalent of the structure, material or acts disclosed in the application. *In re Mulder*, 716 F.2d 1542, 219 USPQ 189 (Fed. Cir. 1983). No further analysis of equivalents is required of the examiner until applicant disagrees with the examiner's conclusion, and provides reasons why the prior art element should not be considered an equivalent. See also, *In re Walter*, 618 F.2d 758, 768, 205 USPQ 397, 407-08 (CCPA 1980) (a case treating 35 U.S.C. 112, sixth paragraph, in the context of a determination of statutory subject matter and noting "If the functionally-defined disclosed means and their equivalents are so broad that they encompass any and every means for performing the recited functions . . . the burden must be placed on the applicant to demonstrate that the claims are truly drawn to specific apparatus distinct from other apparatus capable of performing the identical functions"); *In re Swinehart*, 439 F.2d 210, 212-13, 169 USPQ 226, 229 (CCPA 1971) (a case in which the court treated as improper a rejection under 35 U.S.C. 112, second paragraph, of functional language, but noted that "where the Patent Office has reason to believe that a functional limitation asserted to be critical for establishing novelty in the claimed subject matter may, in fact, be an inherent characteristic of the prior art, it possesses the authority to require the applicant to prove that the subject matter shown to be in the prior art does not possess the characteristics relied on"); and *In re Fitzgerald*, 619 F.2d 67, 205 USPQ 594 (CCPA 1980) (a case indicating that the burden of proof can be shifted to the applicant to show that the subject matter of the prior art does not possess the characteristic relied on whether the rejection is based on inherency under 35 U.S.C. 102 or obviousness under 35 U.S.C. 103).

See MPEP § 2184 when determining whether the applicant has successfully met the burden of proving that the prior art element is not equivalent to the structure, material or acts described in the applicant's specification.

## **IF NONEQUIVALENCE SHOWN, EXAMINER MUST CONSIDER OBVIOUSNESS**

However, even where the applicant has met that burden of proof and has shown that the prior art element is not equivalent to the structure, material or acts described in the applicant's specification, the examiner must still make a 35 U.S.C. 103 analysis to determine if the claimed means or step plus function is obvious from the prior art to one of ordinary skill in the art. Thus, while a finding of nonequivalence prevents a prior art element from anticipating a means or step plus function limitation in a claim, it does not prevent the prior art element from rendering the claim limitation obvious to one of ordinary skill in the art. Because the exact scope of an "equivalent" may be uncertain, it would be appropriate to apply a 35 U.S.C. 102/103 rejection where the balance of the claim limitations are anticipated by the prior art relied on. A similar approach is authorized in the case of product-by-process claims because the exact identity of the claimed product or the prior art product cannot be determined by the examiner. *In re Brown*, 450 F.2d 531, 173 USPQ 685 (CCPA 1972). In addition, although it is normally the best practice to rely on only the best prior art references in rejecting a claim, alternative grounds of rejection may be appropriate where the prior art shows elements that are different from each other, and different from the specific structure, material or acts described in the specification, yet perform the function specified in the claim.

### **2184 Determining Whether an Applicant Has Met the Burden of Proving Nonequivalence After a *Prima Facie* Case Is Made [R-2]**

The specification need not describe the equivalents of the structures, material, or acts corresponding to the means-(or step-) plus-function claim element. See *In re Noll*, 545 F.2d 141, 149-50, 191 USPQ 721, 727 (CCPA 1976) (the meaning of equivalents is well understood in patent law, and an applicant need not describe in his specification the full range of equivalents of his invention) (citation omitted). *Cf. Hybritech Inc. v. Monoclonal Antibodies, Inc.*, 802 F.2d 1367, 1384, 231 USPQ 81, 94 (Fed. Cir. 1986) ("a patent need not teach, and preferably omits, what is well known in the art"). Where, however, the



specification is silent as to what constitutes equivalents and the examiner has made out a *prima facie* case of equivalence, the burden is placed upon the applicant to show that a prior art element which performs the claimed function is not an equivalent of the structure, material, or acts disclosed in the specification. See *In re Mulder*, 716 F.2d 1542, 1549, 219 USPQ 189, 196 (Fed. Cir. 1983).

If the applicant disagrees with the inference of equivalence drawn from a prior art reference, the applicant may provide reasons why the applicant believes the prior art element should not be considered an equivalent to the specific structure, material or acts disclosed in the specification. Such reasons may include, but are not limited to:

(A) Teachings in the specification that particular prior art is not equivalent;

(B) Teachings in the prior art reference itself that may tend to show nonequivalence; or

(C) 37 CFR 1.132 affidavit evidence of facts tending to show nonequivalence.

>

## I. <TEACHINGS IN APPLICANT'S SPECIFICATION

When the applicant relies on teachings in applicant's own specification, the examiner must make sure that the applicant is interpreting the "means or step plus function" limitation in the claim in a manner which is consistent with the disclosure in the specification. If the specification defines what is meant by "equivalents" to the disclosed embodiments for the purpose of the claimed means or step plus function, the examiner should interpret the limitation as having that meaning. If no definition is provided, some judgment must be exercised in determining the scope of "equivalents." Generally, an "equivalent" is interpreted as embracing more than the specific elements described in the specification for performing the specified function, but less than any element that performs the function specified in the claim. >See, e.g., *NOMOS Corp. v. BrainLAB USA Inc.*, 357 F.3d, 1364, 1368, 69 USPQ2d 1853, 1856 (Fed. Cir. 2004) (only one embodiment is described, therefore the corresponding structure is limited to that embodiment and equivalents thereof).< To interpret "means plus function" limitations as limited to a particular means set

forth in the specification would nullify the provisions of 35 U.S.C. 112 requiring that the limitation shall be construed to cover the structure described in the specification and equivalents thereof. *D.M.I., Inc. v. Deere & Co.*, 755 F.2d 1570, 1574, 225 USPQ 236, 238 (Fed. Cir. 1985).

The scope of equivalents embraced by a claim limitation is dependent on the interpretation of an "equivalent." The interpretation will vary depending on how the element is described in the supporting specification. The claim may or may not be limited to particular structure, material or acts (e.g., steps) as opposed to any and all structure, material or acts performing the claimed function, depending on how the specification treats that question. See, e.g., *Ishida Co. v. Taylor*, 221 F.3d 1310, 55 USPQ2d 1449 (Fed. Cir. 2000) (The court construed the scope of a means-plus-function claim element where the specification disclosed two structurally very different embodiments for performing the claimed function by looking separately to each embodiment to determine corresponding structures. The court declined to adopt a single claim construction encompassing both embodiments since it would be so broad as to describe systems both with and without the fundamental structural features of each embodiment.).

If the disclosure is so broad as to encompass any and all structure, material or acts for performing the claimed function, the claims must be read accordingly when determining patentability. When this happens the limitation otherwise provided by "equivalents" ceases to be a limitation on the scope of the claim in that an equivalent would be any structure, material or act other than the ones described in the specification that perform the claimed function. For example, this situation will often be found in cases where (A) the claimed invention is a combination of elements, one or more of which are selected from elements that are old, *per se*, or (B) apparatus claims are treated as indistinguishable from method claims. See, for example, *In re Meyer*, 688 F.2d 789, 215 USPQ 193 (CCPA 1982); *In re Abele*, 684 F.2d 902, 909, 214 USPQ 682, 688 (CCPA 1982); *In re Walter*, 618 F.2d 758, 767, 205 USPQ 397, 406-07 (CCPA 1980); *In re Maucorps*, 609 F.2d 481, 203 USPQ 812 (CCPA 1979); *In re Johnson*, 589 F.2d 1070, 200 USPQ 199 (CCPA 1978); and *In re Freeman*, 573 F.2d 1237, 1246, 197 USPQ 464, 471 (CCPA 1978).

On the other end of the spectrum, the “equivalents” limitation as applied to a claim may also operate to constrict the claim scope to the point of covering virtually only the disclosed embodiments. This can happen in circumstances where the specification describes the invention only in the context of a specific structure, material or act that is used to perform the function specified in the claim.

>

## II. <FACTORS TO BE CONSIDERED IN DECIDING EQUIVALENCE

When deciding whether an applicant has met the burden of proof with respect to showing nonequivalence of a prior art element that performs the claimed function, the following factors may be considered. First, unless an element performs the identical function specified in the claim, it cannot be an equivalent for the purposes of 35 U.S.C. 112, sixth paragraph. *Pennwalt Corp. v. Durand-Wayland, Inc.*, 833 F.2d 931, 4 USPQ2d 1737 (Fed. Cir. 1987), *cert. denied*, 484 U.S. 961 (1988).

Second, while there is no litmus test for an “equivalent” that can be applied with absolute certainty and predictability, there are several indicia that are sufficient to support a conclusion that one element is or is not an “equivalent” of a different element in the context of 35 U.S.C. 112, sixth paragraph. Among the indicia that will support a conclusion that one element is or is not an equivalent of another are:

(A) Whether the prior art element performs the identical function specified in the claim in substantially the same way, and produces substantially the same results as the corresponding element disclosed in the specification. *Kemco Sales, Inc. v. Control Papers Co.*, 208 F.3d 1352, 54 USPQ2d 1308 (Fed. Cir. 2000) (An internal adhesive sealing the inner surfaces of an envelope pocket was not held to be equivalent to an adhesive on a flap which attached to the outside of the pocket. Both the claimed invention and the accused device performed the same function of closing the envelope. But the accused device performed it in a substantially different way (by an internal adhesive on the inside of the pocket) with a substantially different result (the adhesive attached the inner surfaces of both sides of the pocket)); *Odetics Inc. v. Storage Tech. Corp.*, 185 F.3d 1259, 1267, 51 USPQ2d 1225, 1229-30 (Fed. Cir. 1999); *Lock-*

*heed Aircraft Corp. v. United States*, 193 USPQ 449, 461 (Ct. Cl. 1977). The concepts of equivalents as set forth in *Graver Tank & Mfg. Co. v. Linde Air Products*, 339 U.S. 605, 85 USPQ 328 (1950) are relevant to any “equivalents” determination. *Polumbo v. Don-Joy Co.*, 762 F.2d 969, 975, n. 4, 226 USPQ 5, 8-9, n. 4 (Fed. Cir. 1985).

(B) Whether a person of ordinary skill in the art would have recognized the interchangeability of the element shown in the prior art for the corresponding element disclosed in the specification. *Caterpillar Inc. v. Deere & Co.*, 224 F.3d 1374, 56 USPQ2d 1305 (Fed. Cir. 2000); *Al-Site Corp. v. VSI Int’l, Inc.*, 174 F.3d 1308, 1316, 50 USPQ2d 1161, 1165 (Fed. Cir. 1999); *Chiuminatta Concrete Concepts, Inc. v. Cardinal Indus. Inc.*, 145 F.3d 1303, 1309, 46 USPQ2d 1752, 1757 (Fed. Cir. 1998); *Lockheed Aircraft Corp. v. United States*, 193 USPQ 449, 461 (Ct. Cl. 1977); *Data Line Corp. v. Micro Technologies, Inc.*, 813 F.2d 1196, 1 USPQ2d 2052 (Fed. Cir. 1987).

(C) Whether there are insubstantial differences between the prior art element and the corresponding element disclosed in the specification. *IMS Technology, Inc. v. Haas Automation, Inc.*, 206 F.3d 1422, 1436, 54 USPQ2d 1129, 1138 (Fed. Cir. 2000); *Warner-Jenkinson Co. v. Hilton Davis Chemical Co.*, 117 S. Ct. 1040, 41 USPQ2d 1865, 1875 (1997); *Valmont Industries, Inc. v. Reinke Mfg. Co.*, 983 F.2d 1039, 25 USPQ2d 1451 (Fed. Cir. 1993). See also *Caterpillar Inc. v. Deere & Co.*, 224 F.3d 1374, 56 USPQ2d 1305 (Fed. Cir. 2000) (A structure lacking several components of the overall structure corresponding to the claimed function and also differing in the number and size of the parts may be insubstantially different from the disclosed structure. The limitation in a means-plus-function claim is the overall structure corresponding to the claimed function. The individual components of an overall structure that corresponds to the claimed function are not claim limitations. Also, potential advantages of a structure that do not relate to the claimed function should not be considered in an equivalents determination under 35 U.S.C. 112, sixth paragraph).

(D) Whether the prior art element is a structural equivalent of the corresponding element disclosed in the specification. *In re Bond*, 910 F.2d 831, 15 USPQ2d 1566 (Fed. Cir. 1990). That is, the prior art element performs the function specified in the

claim in substantially the same manner as the function is performed by the corresponding element described in the specification.

These examples are not intended to be an exhaustive list of the indicia that would support a finding that one element is or is not an equivalent of another element for the purposes of 35 U.S.C. 112, sixth paragraph. A finding according to any of the above examples would represent a sufficient, but not the only possible, basis to support a conclusion that an element is or is not an equivalent. There could be other indicia that also would support the conclusion.

>

### III. <MERE ALLEGATIONS OF NONEQUIVALENCE ARE NOT SUFFICIENT

In determining whether arguments or 37 CFR 1.132 evidence presented by an applicant are persuasive that the element shown in the prior art is not an equivalent, the examiner should consider and weigh as many of the above-indicated or other indicia as are presented by applicant, and should determine whether, on balance, the applicant has met the burden of proof to show nonequivalence. However, under no circumstance should an examiner accept as persuasive a bare statement or opinion that the element shown in the prior art is not an equivalent embraced by the claim limitation. Moreover, if an applicant argues that the “means” or “step” plus function language in a claim is limited to certain specific structural or additional functional characteristics (as opposed to “equivalents” thereof) where the specification does not describe the invention as being only those specific characteristics, the claim should not be allowed until the claim is amended to recite those specific structural or additional functional characteristics. Otherwise, a claim could be allowed having broad functional language which, in reality, is limited to only the specific structure or steps disclosed in the specification. This would be contrary to public policy of granting patents which provide adequate notice to the public as to a claim’s true scope.

>

### IV. <APPLICANT MAY AMEND CLAIMS

Finally, as in the past, applicant has the opportunity during proceedings before the Office to amend the

claims so that the claimed invention meets all the statutory criteria for patentability. An applicant may choose to amend the claim by further limiting the function so that there is no longer identity of function with that taught by the prior art element, or the applicant may choose to replace the claimed means plus function limitation with specific structure, material or acts that are not described in the prior art.

### 2185 Related Issues Under 35 U.S.C. 112, First or Second Paragraphs [R-1]

Interpretation of claims as set forth in MPEP § 2181 may create some uncertainty as to what applicant regards as the invention. If this issue arises, it should be addressed in a rejection under 35 U.S.C. 112, second paragraph. While 35 U.S.C. 112, sixth paragraph, permits a particular form of claim limitation, it cannot be read as creating an exception either to the description, enablement or best mode requirements of the first paragraph or the definiteness requirement of the second paragraph of 35 U.S.C. 112. *In re Knowlton*, 481 F.2d 1357, 178 USPQ 486 (CCPA 1973).

If a “means or step plus function” limitation recited in a claim is not supported by corresponding structure, material or acts in the specification disclosure, the following rejections should be considered:

(A) under 35 U.S.C. 112, first paragraph, as not being supported by an enabling disclosure because the person skilled in the art would not know how to make and use the invention without a description of elements to perform the function. The description of an apparatus with block diagrams describing the function, but not the structure, of the apparatus is not fatal under the enablement requirement of 35 U.S.C. 112, first paragraph, as long as the structure is conventional and can be determined without an undue amount of experimentation. *In re Ghiron*, 442 F.2d 985, 991, 169 USPQ 723, 727 (CCPA 1971);

(B) under 35 U.S.C. 112, second paragraph, as being indefinite. >See< *In re Dossel*, 115 F.3d 942, 946, 42 USPQ2d 1881, 1884 (Fed. Cir. 1997) >and MPEP § 2181<; and

(C) under 35 U.S.C. 102 or 103 where the prior art anticipates or renders obvious the claimed subject matter including the means or step that performs the function specified in the claim, the theory being that

since there is no corresponding structure, etc., in the specification to limit the means or step plus function limitation, an equivalent is any element that performs the specified function.

**2186 Relationship to the Doctrine of Equivalents**

The doctrine of equivalents arises in the context of an infringement action. If an accused product or process does not literally infringe a patented invention, the accused product or process may be found to infringe under the doctrine of equivalents. The essential objective inquiry is: “Does the accused product or process contain elements identical or equivalent to each claimed element of the patented invention?” *Warner-Jenkinson Co. v. Hilton Davis Chemical Co.*, 117 S. Ct. 1040, 41 USPQ2d 1865, 1875 (1997). In determining equivalence, “[a]n analysis of the role played by each element in the context of the specific patent claim will thus inform the inquiry as to whether a substitute element matches the function, way, and result of the claimed element, or whether the substitute plays a role substantially different from the claimed element.” 41 USPQ2d at 1875.

35 U.S.C. 112, sixth paragraph, permits “means or step plus function” limitations in claims to combinations, “with the proviso that application of the broad literal language of such claims must be limited to only

those means that are ‘equivalent’ to the actual means shown in the patent specification. This is an application of the doctrine of equivalents in a restrictive role, narrowing the application of broad literal claim elements.” 41 USPQ2d at 1870. Accordingly, decisions involving the doctrine of equivalents should be considered, but should not unduly influence a determination under 35 U.S.C. 112, sixth paragraph, during *ex parte* examination.

>

**2190 Prosecution Laches [R-1]**

The Federal Circuit affirmed a rejection of claims in a patent application on the ground that applicant had forfeited his right to a patent under the doctrine of prosecution history laches for unreasonable and undue delay in prosecution. *In re Bogese*, 303 F.3d 1362, 1369, 64 USPQ2d 1448, 1453 (Fed. Cir. 2002) (Applicant “filed twelve continuation applications over an eight-year period and did not substantively advance prosecution when required and given an opportunity to do so by the PTO.”). An examiner should obtain approval from the TC Director before making a rejection on the grounds of prosecution history laches.<



MANUAL OF PATENT EXAMINING PROCEDURE

# Chapter 2200 Citation of Prior Art and Ex Parte Reexamination of Patents

---

<p>2201 Introduction</p> <p>2202 Citation of Prior Art</p> <p>2203 Persons Who May Cite Prior Art</p> <p>2204 Time for Filing Prior Art Citation</p> <p>2205 Content of Prior Art Citation</p> <p>2206 Handling of Prior Art Citation</p> <p>2207 Entry of Court Decision in Patent File</p> <p>2208 Service of Citation on Patent Owner</p> <p>2209 &gt;Ex Parte&lt; Reexamination</p> <p>2210 Request for &gt;Ex Parte&lt; Reexamination</p> <p>2211 Time for Requesting * &gt;Ex Parte Reexamination &lt;</p> <p>2212 Persons Who May File a Request &gt;for Ex Parte Reexamination&lt;</p> <p>2213 Representative of Requester</p> <p>2214 Content of Request &gt;for Ex Parte Reexamination&lt;</p> <p>2215 Fee for Requesting &gt;Ex Parte&lt; Reexamination</p> <p>2216 Substantial New Question of Patentability</p> <p>2217 Statement in the Request Applying Prior Art</p> <p>2218 Copies of Prior Art</p> <p>2219 Copy of Printed Patent</p> <p>2220 Certificate of Service</p> <p>2221 Amendments Included in Request by Patent Owner</p> <p>2222 Address of Patent Owner</p> <p>2223 Withdrawal of Attorney or Agent</p> <p>2224 Correspondence</p> <p>2225 Untimely Paper Filed Prior to Order</p> <p>2226 Initial Processing of Request &gt;for Ex Parte Reexamination&lt;</p> <p>2227 Incomplete Request &gt;for Ex Parte Reexamination&lt;</p> <p>2228 Informal Request &gt;for Ex Parte Reexamination&lt;</p> <p>2229 Notice of Request &gt;for Ex Parte Reexamination&lt; in <i>Official Gazette</i></p> <p>2230 Constructive Notice to Patent Owner</p> <p>2231 Processing of Request Corrections</p> <p>2232 Public Access</p> <p>2233 Processing in Technology Center</p> <p>2234 Entry of Amendments</p> <p>2235 Record Systems</p> <p>2236 Assignment of Reexamination</p> <p>2237 Transfer Procedure</p> <p>2238 Time Reporting</p> <p>2239 Reexamination Ordered at the *&gt;Director's&lt; Initiative</p> <p>2240 Decision on Request</p>	<p>2241 Time for Deciding Request</p> <p>2242 Criteria for Deciding Request</p> <p>2243 Claims Considered in Deciding Request</p> <p>2244 Prior Art on Which the Determination Is Based</p> <p>2245 Processing of Decision</p> <p>2246 Decision Ordering Reexamination</p> <p>2247 Decision on Request for Reexamination, Request Denied</p> <p>2247.01 Examples of Decisions on Request for Reexamination</p> <p>2248 Petition From Denial of Request</p> <p>2249 Patent Owner's Statement</p> <p>2250 Amendment by Patent Owner</p> <p>2250.01 Correction of Patent Drawings</p> <p>2250.02 Correction of Inventorship</p> <p>2251 Reply by Third Party Requester</p> <p>2252 Consideration of Statement and Reply</p> <p>2253 Consideration by Examiner</p> <p>2254 Conduct of &gt;Ex Parte&lt; Reexamination Proceedings</p> <p>2255 Who Reexamines</p> <p>2256 Prior Art Patents and Printed Publications *&gt;Reviewed&lt; by Examiner in Reexamination</p> <p>2257 Listing of Prior Art</p> <p>2258 Scope of &gt;Ex Parte&lt; Reexamination</p> <p>&gt;2258.01 Use of Previously Cited/Considered Art in Rejections&lt;</p> <p>2259 &gt;Res Judicata and&lt; Collateral Estoppel In Reexamination Proceedings</p> <p>2260 Office Actions</p> <p>2260.01 Dependent Claims</p> <p>2261 Special Status For Action</p> <p>2262 Form and Content of Office Action</p> <p>2263 Time for Response</p> <p>2264 Mailing of Office Action</p> <p>2265 Extension of Time</p> <p>2266 Responses</p> <p>2266.01 Submission Not Fully Responsive to Non-final Office Action</p> <p>2266.02 Examiner Issues Notice of Defective Paper in &gt;Ex Parte&lt; Reexamination</p> <p>2266.03 Service of Papers</p> <p>2267 Handling of Inappropriate or Untimely Filed Papers</p> <p>2268 Petition for Entry of Late Papers &gt; for Revival of Reexamination Proceeding&lt;</p> <p>2269 Reconsideration</p> <p>2270 Clerical Handling</p> <p>2271 Final Action</p>
--	---

- 2271.01 Patentability Review Conferences
- 2272 After Final Practice
- 2273 Appeal in >Ex Parte< Reexamination
- 2274 Appeal Brief
- 2275 Examiner's Answer
- 2276 Oral Hearing
- 2277 Board of Patent Appeals and Interferences Decision
- 2278 Action Following Decision
- 2279 Appeal to Courts
- 2280 Information Material to Patentability in Reexamination Proceeding
- 2281 Interviews in >Ex Parte< Reexamination Proceedings
- 2282 Notification of Existence of Prior or Concurrent Proceedings and Decisions Thereon
- 2283 Multiple Copending >Ex Parte< Reexamination Proceedings
- 2284 Copending >Ex Parte< Reexamination and Interference Proceedings
- 2285 Copending >Ex Parte< Reexamination and Reissue Proceedings
- 2286 >Ex Parte< Reexamination and Litigation Proceedings
- 2287 Conclusion of >Ex Parte< Reexamination Proceeding
- 2288 Issuance of >Ex Parte< Reexamination Certificate
- 2289 Reexamination Review
- 2290 Format of >Ex Parte Reexamination< Certificate
- 2291 Notice of >Ex Parte Reexamination< Certificate Issuance in *Official Gazette*
- 2292 Distribution of Certificate
- 2293 Intervening Rights
- 2294 Terminated Reexamination Files
- 2295 Reexamination of a Reexamination
- 2296 USPTO Forms To Be Used >in Ex Parte Reexamination<
- 2201 Introduction [R-2]**

Statutory basis for citation of prior >art< patents or printed publications in patent files and reexamination of patents became available on July 1, 1981, as a result of new sections 301-307 of title 35 United States Code which were added by Public Law 96-517 enacted on December 12, 1980. The rules of practice

in patent cases relating to reexamination were initially promulgated on April 30, 1981, at 46 FR 24179-24180 and on May 29, 1981, at 46 FR 29176-29187.

>On November 29, 1999, Public Law 106-113 was enacted, and expanded reexamination by providing an “*inter partes*” option. Public Law 106-113 authorized the extension of reexamination proceedings via an optional *inter partes* reexamination procedure in addition to the present *ex parte* reexamination. 35 U.S.C. 311 - 318 are directed to the optional *inter partes* reexamination procedures. The final rules to implement the optional *inter partes* reexamination were published in the *Federal Register* on December 7, 2000 at 65 FR 76756 and in the *Official Gazette* on January 2, 2001 at 1242 OG 12.

See MPEP Chapter 2600 for guidance on the procedures for *inter partes* reexamination proceedings.

The reexamination statute was amended on November 2, 2002, by Public Law 107-273, 116 Stat. 1758, 1899-1906 (2002) to expand the scope of what qualifies for a substantial new question of patentability upon which a reexamination may be based (see MPEP § 2242, POLICY IN SPECIFIC SITUATIONS, part A), and made technical corrections to the statute. See the 21st Century Department of Justice Appropriations Authorization Act, TITLE III-INTELLECTUAL PROPERTY, Subtitle A - Patent and Trademark Office, Section 13105, of the “Patent and Trademark Office Authorization Act of 2002” - Enacted as part of Public Law 107-273 on November 2, 2002.<

This chapter is intended to be primarily a guide for U.S. Patent and Trademark Office (Office) personnel on the processing of prior art citations and *ex parte* reexamination requests >, as well as handling *ex parte* reexamination proceedings<. Secondly, it is to also serve as a guide on the formal requirements for filing such documents in the Office.

The \*\* >flowcharts show< the general provisions of both the citation of prior art and *ex parte* reexamination proceedings, including reference to the pertinent rule sections.

\*\*

**Ex Parte Reexamination - PROCEDURE PRIOR TO APPEAL**  
(applicable rule section)

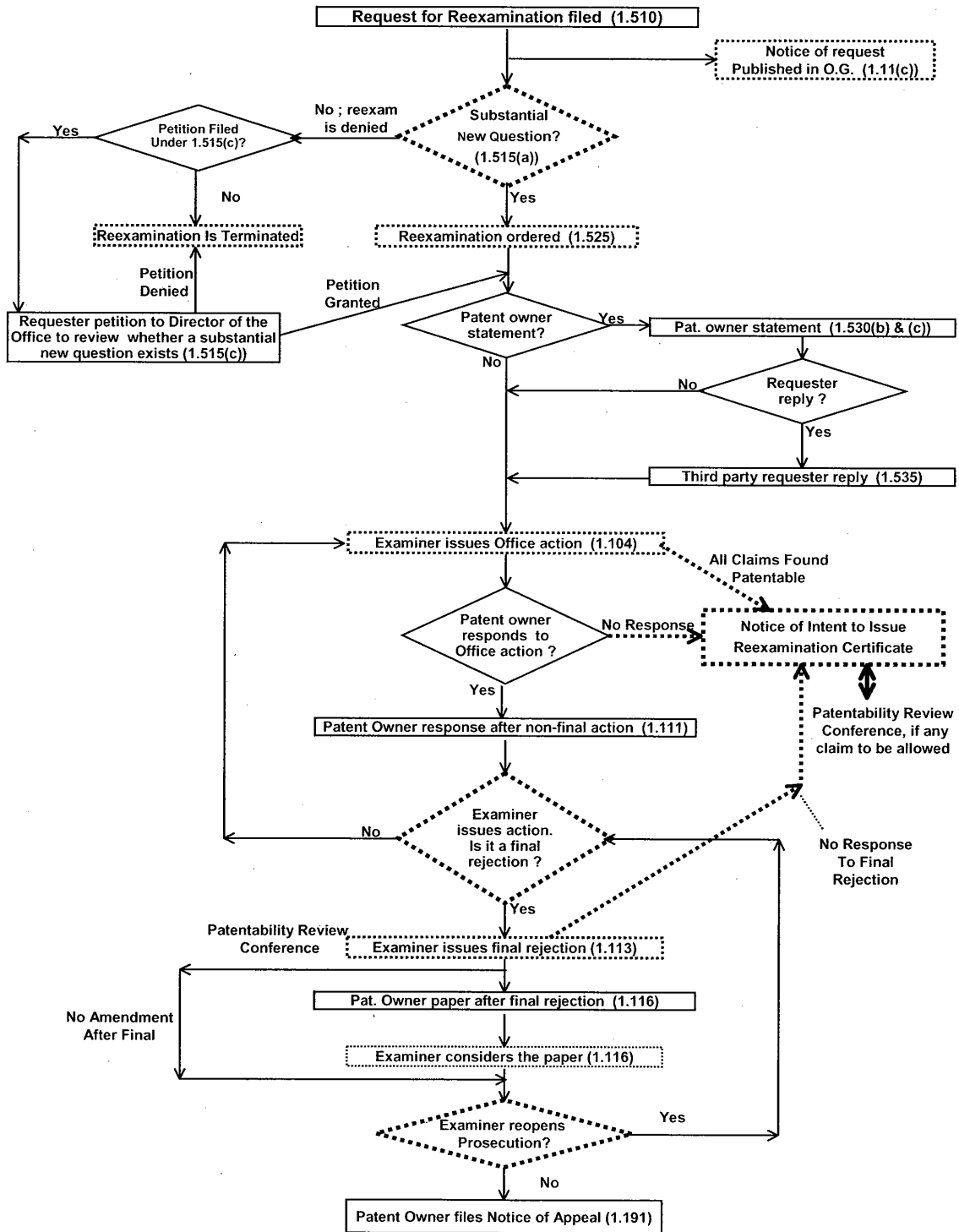



**Ex Parte Reexamination – PROCEDURE FROM TIME OF APPEAL**  
(applicable rule section)

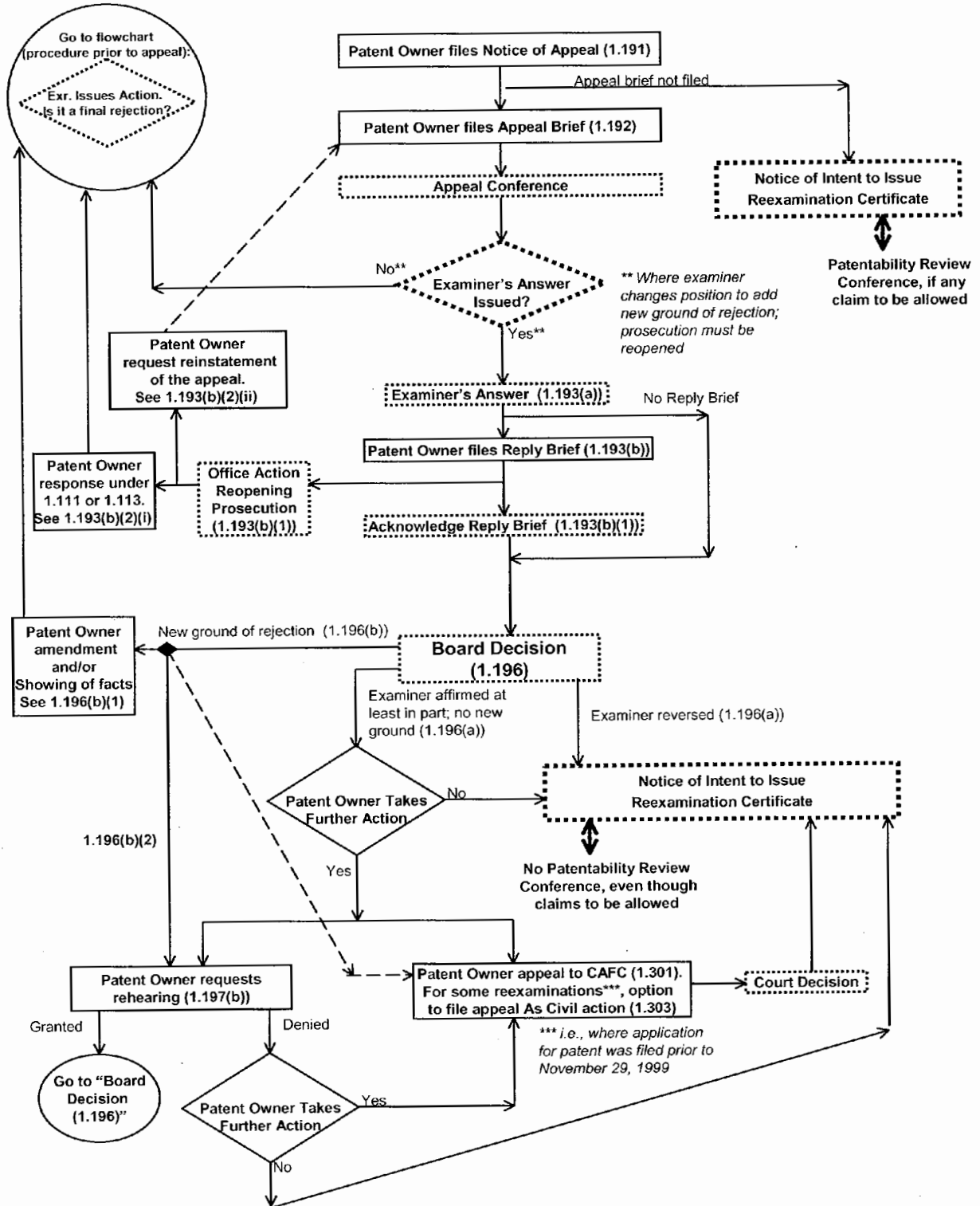

<

## 2202 Citation of Prior Art [R-2]

### 35 U.S.C. 301. Citation of prior art.

Any person at any time may cite to the Office in writing prior art consisting of patents or printed publications which that person believes to have a bearing on the patentability of any claim of a particular patent. If the person explains in writing the pertinency and manner of applying such prior art to at least one claim of the patent, the citation of such prior art and the explanation thereof will become a part of the official file of the patent. At the written request of the person citing the prior art, his or her identity will be excluded from the patent file and kept confidential.

### 37 CFR 1.501. Citation of prior art in patent files.

(a) At any time during the period of enforceability of a patent, any person may cite, to the Office in writing, prior art consisting of patents or printed publications which that person states to be pertinent and applicable to the patent and believes to have a bearing on the patentability of any claim of the patent. If the citation is made by the patent owner, the explanation of pertinency and applicability may include an explanation of how the claims differ from the prior art. Such citations shall be entered in the patent file except as set forth in §§ 1.502 and 1.902.

(b) If the person making the citation wishes his or her identity to be excluded from the patent file and kept confidential, the citation papers must be submitted without any identification of the person making the submission.

(c) Citation of patents or printed publications by the public in patent files should either: (1) Reflect that a copy of the same has been mailed to the patent owner at the address as provided for in § 1.33(c); or in the event service is not possible (2) Be filed with the Office in duplicate.

>

### 37 CFR 1.502. Processing of prior art citations during an *ex parte* reexamination proceeding.

Citations by the patent owner under § 1.555 and by an *ex parte* reexamination requester under either § 1.510 or § 1.535 will be entered in the reexamination file during a reexamination proceeding. The entry in the patent file of citations submitted after the date of an order to reexamine pursuant to § 1.525 by persons other than the patent owner, or an *ex parte* reexamination requester under either § 1.510 or § 1.535, will be delayed until the reexamination proceeding has been terminated. See § 1.902 for processing of prior art citations in patent and reexamination files during an *inter partes* reexamination proceeding filed under § 1.913.

### 37 CFR 1.902.

Citations by the patent owner in accordance with § 1.933 and by an *inter partes* reexamination third party requester under § 1.915 or § 1.948 will be entered in the *inter partes* reexamination file. The entry in the patent file of other citations submitted after the date of an order for reexamination pursuant to § 1.931 by persons other than the patent owner, or the third party requester under either § 1.915 or § 1.948, will be delayed until the *inter partes* reexamination proceeding has been terminated. See § 1.502 for processing of prior art citations in patent and reexamination files during an *ex parte* reexamination proceeding filed under § 1.510.<

Prior art in the form of patents or printed publications may be cited to the Office for placement into the patent files. Such citations may be made without payment of a fee. Citations of prior art may be made separate from and without a request for reexamination.

The basic purpose for citing prior art in patent files is to inform the patent owner and the public in general that such patents or printed publications are in existence and should be considered when evaluating the validity of the patent claims. Placement of citations in the patent file along with copies of the cited prior art will also ensure consideration thereof during any subsequent reissue or reexamination proceeding.

The citation of prior art provisions of 35 U.S.C. 301 and 37 CFR 1.501 do not apply to citations or protests filed in pending applications.

## 2203 Persons Who May Cite Prior Art [R-2]

The patent owner, or any member of the public, may submit prior art citations of patents or printed publications to the Office. 35 U.S.C. 301 states that “Any person at any time may cite to the Office. . . .”

“Any person” may be a corporate or governmental entity as well as an individual.

If a person citing prior art desires his or her identity to be kept confidential, such a person need not identify himself or herself.

“Any person” includes patentees, licensees, reexamination requesters, real parties in interest, persons without a real interest, and persons acting for real parties in interest without a need to identify the real party of interest.

The statute indicates that “at the written request of the person citing the prior art, his or her identity will be excluded from the patent file and kept confidential”. Although an attempt will be made to exclude any such written request from the public files, since the review will be mainly clerical in nature, complete assurance of such exclusion cannot be given. Persons citing art who desire to remain confidential are therefore advised to not identify themselves anywhere in their papers.

Confidential citations should include at least an unsigned statement indicating that the patent owner has been sent a copy of the citation papers. In the event that it is not possible to serve a copy on the patent owner, a duplicate copy should accompany the

original of the prior art citation, when the original is filed with the Office.

Patent examiners should not, at their own initiative, place in a patent file or forward for placement in the patent file, any citations of prior art. Patent examiners are charged with the responsibility of making decisions as to patentability for the \*>Director of the Office<. Any activity by examiners which would appear to indicate that patent claims are not patentable, outside of those cases pending before them, is considered to be inappropriate.

### 2204 Time for Filing Prior Art Citation [R-2]

Citations of prior art may be filed “at any time” under 35 U.S.C. 301. However, this period has been defined by rule (37 CFR 1.501(a)) to be “any time during the period of enforceability of a patent.” The period of enforceability is the length of the term of the patent plus the 6 years under the statute of limitations for bringing an infringement action (35 U.S.C. 286). In addition, if litigation is instituted within the period of the statute of limitations, citations may be submitted after the statute of limitations has expired, as long as the patent is still enforceable against someone. While citations of prior art may be filed at any time during the period of enforceability of the patent, citations submitted after the date of any order to reexamine will not be entered into the patent file until the pending reexamination proceeding has been terminated (37 CFR 1.501(a)), unless the citations are submitted (\*>A<) by the patent owner, (\*>B<) by \*>an *ex parte*< reexamination requester who also submits the fee and other documents required under 37 CFR 1.510, >(C) by an *inter partes* reexamination requester who also submits the fee and other documents required under 37 CFR 1.915, (D) in an *ex parte* third party requester’s reply under 37 CFR 1.535, or (E) as an enterable submission pursuant to 37 CFR 1.948< in an *inter partes* reexamination proceeding. To ensure that prior art cited by a third party is considered without the payment of another reexamination fee, it must be presented before reexamination is ordered.

The purpose of this rule is to prevent harassment of the patent owner due to frequent submissions of prior art citations during reexamination proceedings.

### 2205 Content of Prior Art Citation [R-2]

The prior art which may be submitted under 35 U.S.C. 301 is limited to “written prior art consisting of patents or printed publications.”

An explanation is required of how the person submitting the prior art considers it to be pertinent and applicable to the patent, as well as an explanation of why it is believed that the prior art has a bearing on the patentability of any claim of the patent. >The prior art citation must, at a minimum, contain some broad statement of the pertinency and applicability of the art submitted to the patentability of the claims of the patent for which the prior art citation is made. This would be met, for example, by a statement that the art submitted in the prior art citation under 37 CFR 1.501 was made of record in a foreign or domestic application having the same or related invention to that of the patent.< Citations of prior art by patent owners may also include an explanation of how the claims of the patent differ from the prior art cited.

It is preferred that copies of all the cited prior >art< patents or printed publications and any necessary English translation be included so that the value of the citations may be readily determined by persons inspecting the patent files and by the examiner during any subsequent reissue or reexamination proceeding.

All prior art citations filed by persons other than the patent owner must either indicate that a copy of the citation has been mailed to, or otherwise served on, the patent owner at the correspondence address as defined under 37 CFR 1.33(c), or if for some reason service on the patent owner is not possible, a duplicate copy of the citation must be filed with the Office along with an explanation as to why the service was not possible. The most recent address of the attorney or agent of record may be obtained from the Office’s register of registered patent attorneys and agents maintained by the Office of Enrollment and Discipline pursuant to 37 CFR 10.5 and 10.11(a).

All prior art citations submitted should identify the patent in which the citation is to be placed by the patent number, issue date, and patentee.

A cover sheet with an identification of the patent should have firmly attached to it all other documents relating to the citation so that the documents will not become separated during processing. The documents themselves should also contain, or have placed

thereon, an identification of the patent for which they are intended.

Affidavits or declarations relating to the prior art documents submitted may accompany the citation to explain the contents or pertinent dates in more detail. A commercial success affidavit tied in with a particular prior art document may also be acceptable. For example, the patent owner may wish to cite a patent or printed publication which raises the issue of obviousness of at least one patent claim. Together with the cited art, the >patent< owner may file (\*>A<) an affidavit of commercial success or other evidence of non-obviousness, or (\*>B<) an affidavit which questions the enablement of the teachings of the cited prior art.

No fee is required for the submission of citations under 37 CFR 1.501.

A prior art citation is limited to the citation of patents and printed publications and an explanation of the pertinency and applicability of the patents and printed publications. This may include an explanation by the patent owner as to how the claims differ from the prior art. It may also include affidavits and declarations. The prior art citation cannot include any issue which is not directed to patents and printed publications. Thus, for example, a prior art citation cannot include a statement as to the claims violating 35 U.S.C. 112, a statement as to the public use of the claimed invention, or a statement as to the conduct of the patent owner. A prior art citation must be directed to patents and printed publications and cannot discuss what the patent owner did, or failed to do, with respect to submitting and/or describing patents and printed publications, because that would be a statement as to the conduct of the patent owner. The citation also should not contain argument and discussion of references previously treated in the prosecution of the invention which matured into the patent or references previously treated in a reexamination proceeding as to the patent.

If the prior art citation contains any issue not directed to patents and printed publications, it should not be entered into the patent file, despite the fact that it may otherwise contain a complete submission of patents and printed publications with an explanation of the pertinency and applicability. Rather, the prior art citation should be returned to the sender as described in MPEP § 2206.

Examples of letters submitting prior art under 37 CFR 1.501 follow.

### EXAMPLE I

Submission by a third party:

IN THE UNITED STATES  
PATENT AND TRADEMARK OFFICE

In re patent of  
Joseph Smith  
Patent No. 9,999,999  
Issued: July 7, 2000  
For: Cutting Tool

Submission of Prior Art Under 37 CFR  
1.501

Hon. \* Commissioner for Patents  
\*\* >P.O. Box 1450  
Alexandria, VA 22313-1450<

Sir:

The undersigned herewith submits in the above identified patent the following prior art (including copies thereof) which is pertinent and applicable to the patent and is believed to have a bearing on the patentability of at least claims 1 - 3 thereof:

**Weid et al U.S. 2,585,416 April 15, 1933**  
**McGee U.S. 2, 722,794 May 1, 1934**  
**Paulk et al U.S. 3,625,291 June 16, 1936**

**Each of the references discloses a cutting tool strikingly similar to the device of Smith in having pivotal handles with cutting blades and a pair of dies. It is believed that each of the references has a bearing on the patentability of claims 1-3 of the Smith patent.**

**Insofar as claims 1 and 2 are concerned, each of the references clearly anticipates the claimed subject matter under 35 U.S.C 102.**

As to claim 3, the differences between the subject matter of this claim and the cutting tool of Weid et al are shown in the device of Paulk et al. Further, Weid et al suggests that different cutting blades can be used in their device. A person of ordinary skill in the art at the time the invention was made would have been led by the suggestion of Weid et al to the cutting blades of Paulk et al as obvious substitutes for the blades of Weid et al.

Respectfully submitted,  
(Signed)

Certificate of Service

I hereby certify on this first day of June 1982, that a true and correct copy of the foregoing "Submission of Prior Art" was mailed by first-class mail, postage paid, to:

Ben Schor  
555 Any Lane  
Anytown, VA 22202

(Signed)

John Jones

**EXAMPLE II**

Submission by the patent owner:

IN THE UNITED STATES  
PATENT AND TRADEMARK OFFICE

In re patent of  
Joseph Smith  
Patent No. 9,999,999  
Issued: July 7, 2000  
For: Cutting Tool

Submission of Prior Art Under 37 CFR  
1.501

Hon. \* Commissioner for Patents  
\*\* >P.O. Box 1450  
Alexandria, VA 22313-1450<

Sir:

The undersigned herewith submits in the above identified patent the following prior art (including copies thereof) which is pertinent and applicable to the patent and is believed to have a bearing on the patentability of at least claims 1-3 thereof:

**Weid et al U.S. 2,585,416 April 15, 1933**  
**McGee U.S. 2, 722,794 May 1, 1934**  
**Paulk et al U.S. 3,625,291 June 16, 1936**

Each of the references discloses a cutting tool strikingly similar to the device of Smith in having pivotal handles with cutting blades and a pair of dies. While it is believed that each of the references has a bearing on the patentability of claims 1-3 of the Smith patent, the subject matter claimed differs from the references and is believed patentable thereover

Insofar as claims 1 and 2 are concerned, none of the references show the particular dies claimed and the structure of these claimed dies would not have been obvious to a person of ordinary skill in the art at the time the invention was made.

As to claim 3, while the cutting blades required by this claim are shown in Paulk et al, the remainder of the claimed structure is found only in Weid et al. A person of ordinary skill in the art at the time the invention was made would not have found it obvious to substitute the cutting blades of Paulk et al for those of Weid et al. In fact, the disclosure of Weid et al would lead a person of ordinary skill in the art away from the use of cutting blades such as shown in Paulk et al.

The reference to McGee, while generally similar, lacks the particular cooperation between the elements which is specifically set forth in each of claims 1-3.

Respect fully submitted,

(Signed)

William Green  
Attorney for Patent Owner  
>Reg. No. 29760<

## 2206 Handling of Prior Art Citation [R-2]

Prior art citations received in the Office will be forwarded to the Technology Center (TC) that currently examines the class and subclass in which the patent to which the prior art citations are addressed is classified as an original.

It is the responsibility of the TC to immediately determine whether a citation meets the requirements of the statute and the rules and to enter it into the patent file at the appropriate time if it is proper.

If a proper citation is filed after the date of an order for reexamination but it is not entitled to entry pursuant to the reexamination rules, the citation is retained (stored) in the TC until the reexamination is terminated. Note 37 CFR \*>1.502 and 1.902< and MPEP § 2294. A tag should be placed on the reexamination file as a reminder of the citation to be placed in the patent file after termination of the reexamination proceeding. The citation is then placed in the TC's citation storage file. After the reexamination proceeding is terminated, the citation is removed from the storage file and processed for placement in the patent file. Citations filed after the date of an order for reexamination which are not entitled to entry pursuant to the reexamination rules will not be considered by the examiner during the reexamination.

### I. CITATION QUALIFIES FOR ENTRY UNDER 37 CFR 1.501

#### A. Citations by Third Party

##### 1. Prior to Order in Any Pending Reexamination Proceeding

If the citation is proper (i.e., limited to patents and printed publications) and is filed prior to an order in a reexamination proceeding, it should be immediately entered into the >reexamination file. If no reexamination is pending for the patent, the citation should be placed in the < patent file. If the citation includes an indication of service on the patent owner, the citation is merely timely entered and no notice of such entry is sent to any party. If the citation does not include an indication of service, the patent owner should be notified that a citation of prior art has been entered into the patent file. If a duplicate copy of the citation was filed, the duplicate copy should be sent to the patent owner along with the notification. If no duplicate copy is present, no copy will be sent with the notification. Wording similar to the following should be used:

"A citation of prior art under 35 U.S.C. 301 and 37 CFR 1.501 has been filed on \_\_\_\_ in your patent number \_\_\_\_ entitled\_\_\_\_\_.

This notification is being made to inform you that the citation of prior art has been placed in the file wrapper >/file history< of:

[ ] the above identified patent.

[ ] reexamination control # \_\_\_\_\_.

The person submitting the prior art:

1. [ ] was not identified

2. [ ] is confidential

3. [ ] is \_\_\_\_\_."

##### 2. After the Order in Any Pending Reexamination Proceeding

If the citation is proper but is filed after an order for reexamination in a pending reexamination, the citation is not entered at the time because of the ongoing reexamination>, but rather is stored until the conclusion of the reexamination proceeding, after which the citation is entered into the patent file<. The patent owner and sender (if known) should be alerted of this \*>by a letter providing notification. If there is a third party requester, the third party requester should also be sent a copy of the notification letter pursuant to 37

CFR 1.550(f)<. Such notification is important to enable the patent owner to consider submitting the prior art under 37 CFR 1.555 >or 1.933< during the reexamination. Such notification will also enable the third party sender to consider the desirability of filing a separate request for reexamination. If the citation does not include service of a copy on the patent owner and a duplicate copy is submitted, the duplicate copy should be sent to the patent owner along with the notification. If a duplicate copy is not present, no copy will accompany the notification to the patent owner.

In this situation, the original copy (in storage) should be made available for copying by the patent owner. If the citation includes service of a copy on the patent owner, the citation is placed in storage and not entered until the reexamination is terminated. The patent owner and third party sender (if known) should be given notice of this action.

An example of a letter >(in a patent owner filed reexamination)< giving notice to the patent owner and third party sender >, where the citation was filed after the order for *ex parte* reexamination,< is as follows.

**John A. Jones** (Citation Sender)  
**Jones & Smith**  
**1020 United First Bldg.**  
**1033 Any Street**  
**U.S. Town, Washington 98121**

**Richard A. Davis** (Patent Owner)  
**The A.B. Good Co.**  
**Patent Law Dept.**  
**9921 Any Road**  
**Any City, Ohio 44141**

**In re Doe, et al** :  
**Examination Proceeding** :  
**Control No. 90/999,999** : **NOTIFICATION RE**  
**Filed: February 7, 2000** : **PRIOR ART CITATION**  
**For: U.S. Patent No. 9,999,999** :

The prior art citation filed May 19, 2000, is a proper citation under 37 CFR 1.501(a); however, it was filed after the May 2, 2000, date of the order for reexamination in reexamination control # 90/999,999.

Because the prior art citation was filed after the date of the order for reexamination, the citation is being retained in the Technology Center (TC 1700) until the reexamination is terminated. Note 37 CFR 1.501(a) and MPEP § 2294. At that time, the citation will be processed for placement in the patent file of patent # 9,999,999.

The prior art citation filed May 19, 2000, will not be considered in reexamination control # 90/999,999.

The patent owner and sender of the citation are being provided with a copy of this notification. If appropriate, the patent owner may wish to consider submitting prior art from the prior art citation pursuant to 37 CFR 1.555 during the reexamination proceeding (reexamination control # 90/999,999). In addition, if appropriate, the sender may file a request for reexamination to place the art of the prior art citation before the patent examiner.

**Kenneth M. Schor**  
**Special Programs Examiner**  
**Technology Center 3700**



**B. Citation Filed by Patent Owner**

If a proper prior art citation is filed by the patent owner, it should be entered in the file. This is true whether the citation is filed prior to or after an order

for reexamination has been mailed. No notification to the patent owner is necessary.

The following diagram shows the various situations which can occur when a proper prior art citation is filed and the action to be taken for each alternative situation:

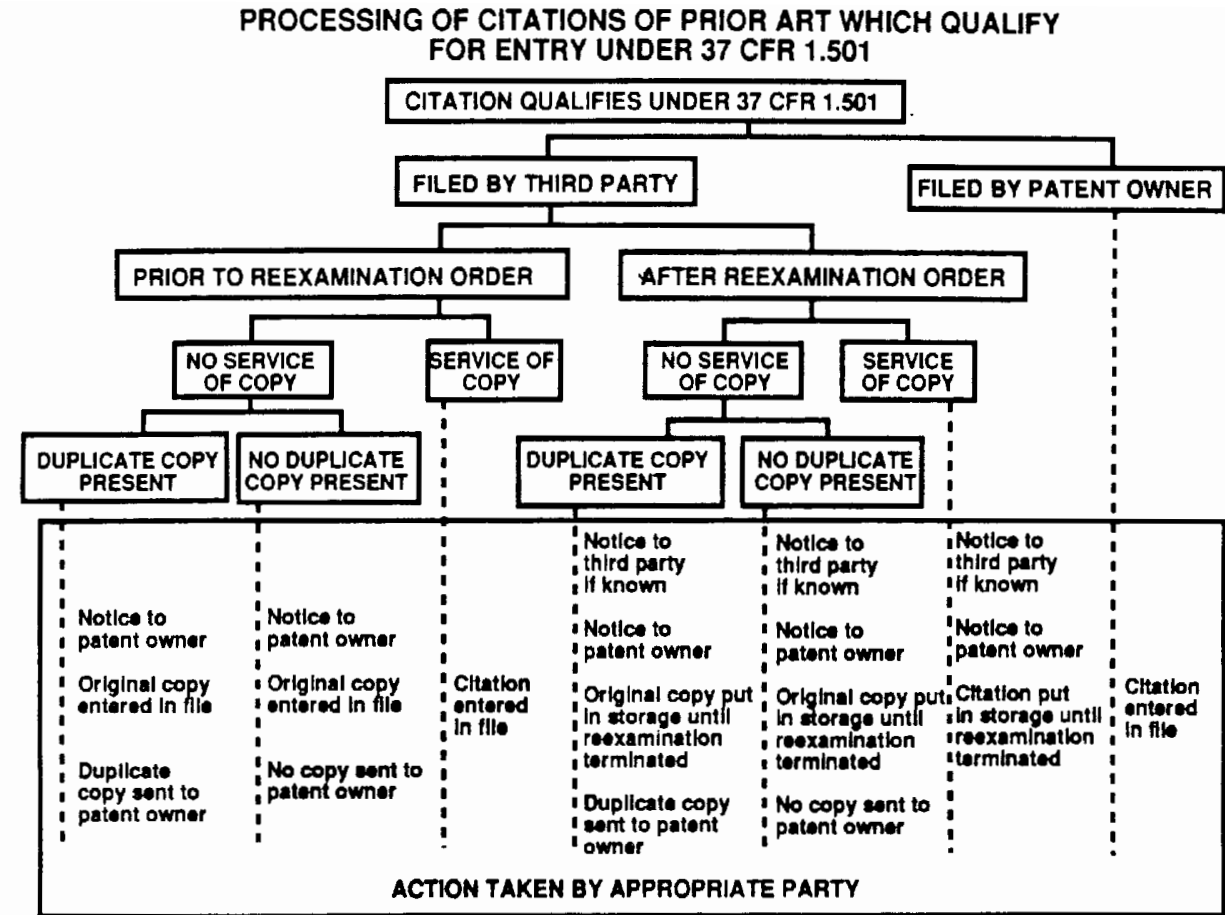

## II. CITATION DOES NOT QUALIFY FOR ENTRY UNDER 37 CFR 1.501

### A. *Citation by Third Party*

If the citation is not proper (i.e., it is not limited to patents or printed publications), it should not be entered in the patent file. The sender (if known) and the patent owner *in all cases* should be notified that the citation is improper and that it is not being entered in the patent file. The handling of the citation will vary depending on the particular following situation.

#### 1. **Service of Copy Included**

Where the citation includes an indication of service of copy on the patent owner and the identity of the third party sender is known, the original citation paper should be returned to the third party sender along with the notification of nonentry. If the identity of the third party sender is not known, the original citation papers should be discarded.

#### 2. **Service of Copy Not Included; Identity of Third Party Sender Known**

Where the citation does not include an indication of service on the patent owner, the identity of the third party sender is known, and a duplicate copy of the citation is present, the original citation papers should be returned to the third party sender and the duplicate copy should be sent to the patent owner along with the notification of nonentry. If the duplicate copy required in 37 CFR 1.501(c) is not present, the original citation papers should be sent to the PATENT OWNER along

with the notification of nonentry. The third party sender should be sent a notification that the citation was not entered and that the original citation papers were sent to the patent owner.

#### 3. **Service of Copy Not Included; Identity of Third Party Sender Not Known**

Where the citation does not include an indication of service, the identity of the third party sender is not known, and a duplicate copy of the citation is or is not present, the duplicate copy (if present) should be discarded and the original citation papers should be sent to the patent owner along with the notification of nonentry.

### B. *Citation Filed by the Patent Owner*

If an improper prior art citation under 37 CFR 1.501 is filed by the patent owner prior to an order for reexamination, it should not be entered in the file.

The patent owner should be notified of the nonentry, and the citation papers should be returned to the patent owner along with the notification. Prior art submission filed by the patent owner after an order for reexamination should be entered in the file under 37 CFR 1.555 >(for *ex parte* reexamination) or under 37 CFR 1.933 (for *inter partes* reexamination)<.

The following diagram shows the various situations which can occur when an improper prior art citation is filed and the action to be taken for each alternative situation. Any unusual problems should be brought to the attention of the Office of Patent Legal Administration.

**PROCESSING OF CITATIONS OF PRIOR ART WHICH DO NOT QUALIFY FOR ENTRY UNDER 37 CFR 1.501**

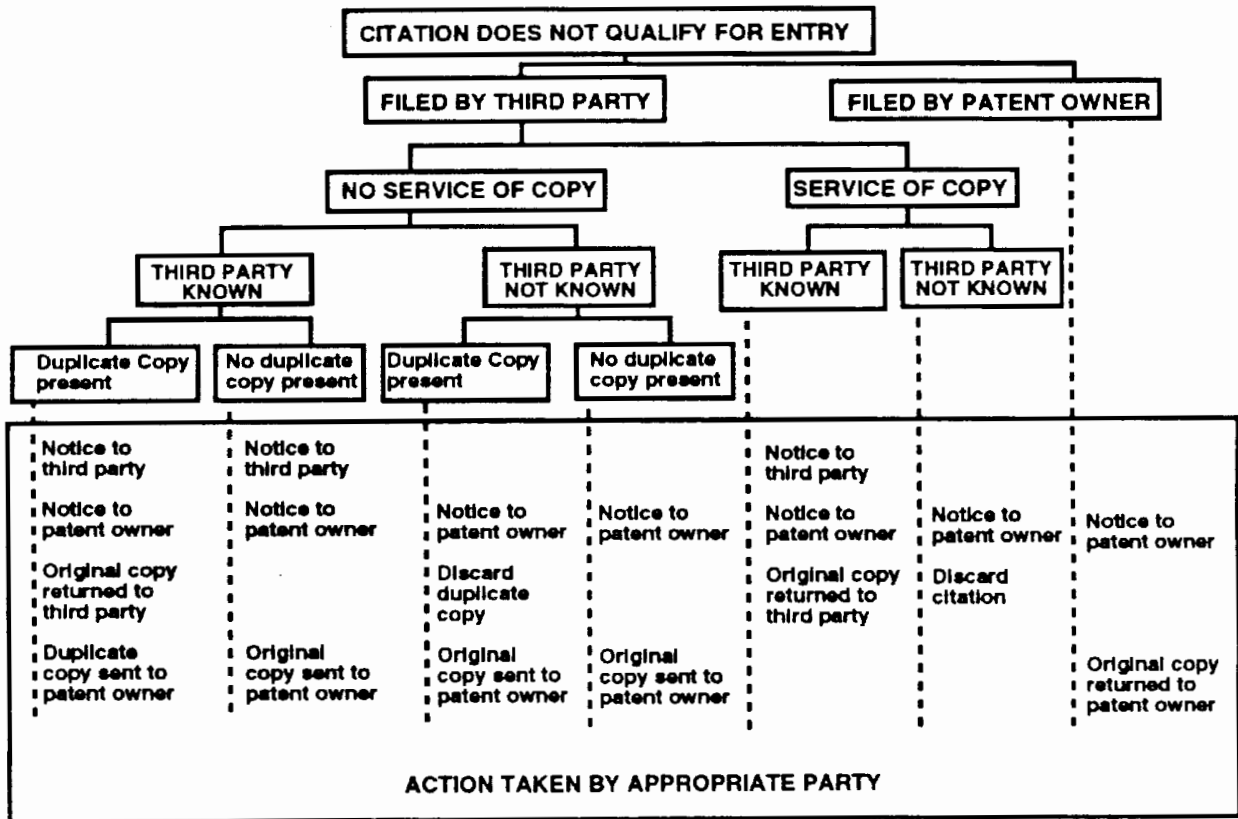

## 2207 Entry of Court Decision in Patent File [R-2]

The Solicitor's Office processes *notices* required by 35 U.S.C. 290, received from the clerks of the various courts, and has them entered in the patent file. However, it is considered desirable that the *entire court decision* be supplied to the Office for entry into the patent file. Accordingly, the Office will accept at *any time* from *any party* for placement in the patent file, submissions of the following: copies of notices of suits and other proceedings involving the patent and copies of decisions or other court papers, or papers filed in the court, from litigations or other proceedings involving the patent. Such submissions must be provided without additional comment. Persons making such submissions must *limit the submission to the notification* and not include further arguments or information. Any proper submission will be promptly placed on record (entered) in the patent file. Entry of these submissions is performed by the Files Repository personnel, unless a reexamination proceeding is pending, in which case, the Technology Center (or other area of the Office) having responsibility for the reexamination enters the submission.

### WHERE A REQUEST FOR REEXAMINATION OF THE PATENT HAS BEEN FILED

It is important for the Office to be aware of any prior court or other proceedings in which a patent undergoing reexamination is or was involved, and any results of such proceedings. In accordance with 37 CFR 1.565(a) and 37 CFR 1.985, the patent owner is required to provide the Office with information regarding the existence of any such proceedings and the results thereof, if known. As to third parties, note as follows. Ordinarily, while a reexamination proceeding is pending, third party submissions filed after the date of the order are not placed in the reexamination or the patent file. However, in order to ensure a complete file, with updated status information as to prior and concurrent proceedings regarding a patent undergoing reexamination, submissions (as above-described) limited to *bare notice* of the proceedings, with copies of the papers of the proceedings, will be accepted and placed in the file at any time during the reexamination from any party. See MPEP § 2240 and § 2242 for handling of requests for

>*ex parte*< reexamination of patents involved in litigation. >See MPEP § 2640 and § 2642 for handling of requests for *inter partes* reexamination of patents involved in litigation.<

## 2208 Service of Citation on Patent Owner [R-2]

A copy of any submission of a citation of prior art patents or printed publications in a patent file should be served on the patent owner so that the patent owner is kept fully informed as to the content of his or her patent file wrapper >/file history<. See MPEP § 2206 for handling of prior art citations.

The service to the patent owner should be addressed to the correspondence address as set forth in 37 CFR 1.33(c). See MPEP § 2222 as to the correspondence address.

## 2209 ~~Ex Parte~~ Reexamination [R-2]

Procedures for reexamination of issued patents began on July 1, 1981, the date when the reexamination provisions of Public Law 96-517 came into effect.

The reexamination statute and rules permit any person to file a request for >an *ex parte*< reexamination containing certain elements and the fee required under 37 CFR 1.20(c)>(1)<. The Office initially determines if "a substantial new question of patentability" (35 U.S.C. 303(a)) is presented. If such a new question has been presented, reexamination will be ordered. The reexamination proceedings which follow the order for reexamination are very similar to regular examination procedures in patent applications; however, there are notable differences. For example, there are certain limitations as to the kind of rejections which may be made, special reexamination forms to be used, and time periods set to provide "special dispatch." When the reexamination proceedings are terminated, a certificate is issued which indicates the status of all claims following the reexamination.

The following sections of this chapter explain the details of reexamination.

The intent of the reexamination procedures covered in this chapter include the following:

(A) To provide procedures for reexamination of patents;

(B) To implement reexamination in an essentially *ex parte* manner;

(C) To minimize the processing costs and complexities of reexamination;

(D) To maximize respect for the reexamined patent;

(E) To provide procedures for prompt and timely determinations by the Office in accordance with the “special dispatch” requirements of 35 U.S.C. 305.

*The basic characteristics of >ex parte< reexamination are as follows:*

(A) Anyone can request reexamination at any time during the period of enforceability of the patent;

(B) Prior art considered during reexamination is limited to prior art patents or printed publications applied under the appropriate parts of 35 U.S.C. 102 and 103;

(C) A substantial new question of patentability must be present for reexamination to be ordered;

(D) If ordered, the actual reexamination proceeding is *ex parte* in nature;

(E) Decision on the request must be made no later than 3 months from its filing, and the remainder of proceedings must proceed with “special dispatch” >within the Office<;

(F) If ordered, a reexamination proceeding will normally be conducted to its conclusion and the issuance of a reexamination certificate;

(G) The scope of a claim cannot be enlarged by amendment;

(H) All reexamination and patent files are open to the public>, but see paragraph (I) below;

(I) The reexamination file is scanned to provide an electronic format copy of the file. All public access to and copying of the reexamination file may be made from the electronic format copy. The paper file is not available to the public.<

## 2210 Request for >Ex Parte< Reexamination [R-2]

### 35 U.S.C. 302. Request for reexamination.

Any person at any time may file a request for reexamination by the Office of any claim of a patent on the basis of any prior art cited under the provisions of section 301 of this title. The request must be in writing and must be accompanied by payment of a reexamination fee established by the Director pursuant to the provisions of section 41 of this title. The request must set forth the pertinency and manner of applying cited prior art to every claim

for which reexamination is requested. Unless the requesting person is the owner of the patent, the Director promptly will send a copy of the request to the owner of record of the patent.

### 37 CFR 1.510. Request for *ex parte* reexamination.

(a) Any person may, at any time during the period of enforceability of a patent, file a request for an *ex parte* reexamination by the Office of any claim of the patent on the basis of prior art patents or printed publications cited under § 1.501. The request must be accompanied by the fee for requesting reexamination set in § 1.20(c)(1).

(b) Any request for reexamination must include the following parts:

(1) A statement pointing out each substantial new question of patentability based on prior patents and printed publications.

(2) An identification of every claim for which reexamination is requested, and a detailed explanation of the pertinency and manner of applying the cited prior art to every claim for which reexamination is requested. If appropriate the party requesting reexamination may also point out how claims distinguish over cited prior art.

(3) A copy of every patent or printed publication relied upon or referred to in paragraph (b)(1) and (2) of this section accompanied by an English language translation of all the necessary and pertinent parts of any non-English language patent or printed publication.

(4) A copy of the entire patent including the front face, drawings, and specification/claims (in double column format) for which reexamination is requested, and a copy of any disclaimer, certificate of correction, or reexamination certificate issued in the patent. All copies must have each page plainly written on only one side of a sheet of paper.

(5) A certification that a copy of the request filed by a person other than the patent owner has been served in its entirety on the patent owner at the address as provided for in § 1.33(c). The name and address of the party served must be indicated. If service was not possible, a duplicate copy must be supplied to the Office.

(c) If the request does not include the fee for requesting reexamination or all of the parts required by paragraph (b) of this section, the person identified as requesting reexamination will be so notified and given an opportunity to complete the request within a specified time. If the fee for requesting reexamination has been paid but the defect in the request is not corrected within the specified time, the determination whether or not to institute reexamination will be made on the request as it then exists. If the fee for requesting reexamination has not been paid, no determination will be made and the request will be placed in the patent file as a citation if it complies with the requirements of § 1.501(a).

(d) The filing date of the request is:

(1) The date on which the request including the entire fee for requesting reexamination is received in the Patent and Trademark Office; or

(2) The date on which the last portion of the fee for requesting reexamination is received.

(e) A request filed by the patent owner may include a proposed amendment in accordance with § 1.530.

(f) If a request is filed by an attorney or agent identifying another party on whose behalf the request is being filed, the attorney or agent must have a power of attorney from that party or be acting in a representative capacity pursuant to § 1.34(a).

Any person, at any time during the period of enforceability of a patent, may file a request for *ex parte* reexamination by the U.S. Patent and Trademark Office of any claim of the patent based on prior art patents or printed publications. The request must include the elements set forth in 37 CFR 1.510(b) (see MPEP § 2214) and must be accompanied by the fee as set forth in 37 CFR 1.20(c)(1). No attempt will be made to maintain a requester's name in confidence.

After the request for reexamination, including the entire fee for requesting reexamination, is received in the Office, no abandonment, withdrawal, or striking of the request is possible, regardless of who requests the same. In some limited circumstances, such as after a final court decision where all of the claims are finally held invalid, a reexamination order may be vacated, see MPEP § 2286.

## 2211 Time for Requesting *Ex Parte* Reexamination [R-2]

Under 37 CFR 1.510(a), any person may, at any time during the period of enforceability of a patent, file a request for *ex parte* reexamination. This period was set by rule, since the Office considered that Congress could not have intended expending Office resources on deciding patent validity questions in patents which cannot be enforced. In this regard see *Patlex Corp. v. Mossinghoff*, 758 F.2d 594, 225 USPQ 243, 249 (Fed. Cir. 1985). The period of enforceability is determined by adding 6 years to the date on which the patent expires. The patent expiration date for a utility patent, for example, is determined by taking into account the term of the patent, whether maintenance fees have been paid for the patent, whether any disclaimer was filed as to the patent to shorten its term, any patent term extensions or adjustments for delays within the Office under 35 U.S.C. 154 (see MPEP § 2710, *et seq.*), and any patent term extensions available under 35 U.S.C. 156 for premarket regulatory review (see MPEP § 2750 *et seq.*). Any other relevant information should also be taken into account. In addition, if litigation is instituted within the period of the statute of limitations, requests for reexamination may be filed after the statute of limita-

tions has expired, as long as the patent is still enforceable against someone.

## 2212 Persons Who May File a Request for *Ex Parte* Reexamination [R-2]

37 CFR 1.510. Request for *ex parte* reexamination.

(a) Any person may, at any time during the period of enforceability of a patent, file a request for an *ex parte* reexamination by the Office of any claim of the patent on the basis of prior art patents or printed publications cited under § 1.501. The request must be accompanied by the fee for requesting reexamination set in § 1.20(c)(1).

\*\*\*\*\*

35 U.S.C. 302 and 37 CFR 1.510(a) both indicate that "any person" may file a request for reexamination of a patent. Accordingly, there are no persons who are excluded from being able to seek reexamination. Corporations and/or governmental entities are included within the scope of the term "any person." The patent owner can ask for reexamination which will be limited to an *ex parte* consideration of prior art patents or printed publications. If the patent owner wishes to have a wider consideration of issues by the Office, including matters such as prior public use or on sale, the patent owner may file a reissue application. It is also possible for the Director of the Office to initiate reexamination on the Director's own initiative under 37 CFR 1.520. Reexamination will be initiated by the Director on a very limited basis, such as where a general public policy question is at issue and there is no interest by "any other person." Some of the persons likely to use reexamination are patentees, licensees, potential licensees, attorneys without identification of their real client in interest, infringers, potential exporters, patent litigants, interference applicants, and International Trade Commission respondents. The name of the person who files the request will not be maintained in confidence.

## 2213 Representative of Requester [R-2]

37 CFR 1.510. Request for *ex parte* reexamination.

\*\*\*\*\*

(f) If a request is filed by an attorney or agent identifying another party on whose behalf the request is being filed, the attorney or agent must have a power of attorney from that party or be acting in a representative capacity pursuant to § 1.34(a).

Where an attorney or agent files a request for an identified client (the requester), he or she may act under either a power of attorney >from the client<, or act in a representative capacity under 37 CFR 1.34(a), >see< 37 CFR 1.510(f). While the filing of the power of attorney is desirable, processing of the reexamination request will not be delayed due to its absence.

If any question of authority to act is raised, proof of authority may be required by the Office.

All correspondence for a requester that is not the patent owner should be addressed to the representative of the requester, unless a specific indication is made to forward correspondence to another address.

If the request is filed by a person on behalf of the patent owner, correspondence will be directed to the patent owner at the address as indicated in 37 CFR 1.33(c), regardless of the address of the person filing the request. See MPEP § 2222 for a discussion of who receives correspondence on behalf of a patent owner and how changes in the correspondence address are to be made.

A patent owner may not be represented during a reexamination proceeding by an attorney or other person who is not registered to practice before the Office, since those individuals are prohibited by 37 CFR 1.33(c) from signing amendments and other papers filed in a reexamination proceeding on behalf of the patent owner.

## 2214 Content of Request >for Ex Parte Reexamination< [R-2]

37 CFR 1.510. Request for ex parte reexamination.

(a) Any person may, at any time during the period of enforceability of a patent, file a request for an *ex parte* reexamination by the Office of any claim of the patent on the basis of prior art patents or printed publications cited under § 1.501. The request must be accompanied by the fee for requesting reexamination set in § 1.20(c)(1).

(b) Any request for reexamination must include the following parts:

(1) A statement pointing out each substantial new question of patentability based on prior patents and printed publications.

(2) An identification of every claim for which reexamination is requested, and a detailed explanation of the pertinency and manner of applying the cited prior art to every claim for which reexamination is requested. If appropriate the party requesting reexamination may also point out how claims distinguish over cited prior art.

(3) A copy of every patent or printed publication relied upon or referred to in paragraph (b)(1) and (2) of this section

accompanied by an English language translation of all the necessary and pertinent parts of any non-English language patent or printed publication.

(4) A copy of the entire patent including the front face, drawings, and specification/claims (in double column format) for which reexamination is requested, and a copy of any disclaimer, certificate of correction, or reexamination certificate issued in the patent. All copies must have each page plainly written on only one side of a sheet of paper.

(5) A certification that a copy of the request filed by a person other than the patent owner has been served in its entirety on the patent owner at the address as provided for in § 1.33(c). The name and address of the party served must be indicated. If service was not possible, a duplicate copy must be supplied to the Office.

\*\*\*\*\*

37 CFR 1.510(a) requires the payment of the fee specified in 37 CFR 1.20(c)(1) for a request for reexamination. See MPEP § 2215.

37 CFR 1.510(b) sets forth the required elements of a request for >ex parte< reexamination. The elements are as follows:

“(1) a statement pointing out each substantial new question of patentability based on prior patents and printed publications.”

This statement should clearly point out what the requester considers to be the substantial new question of patentability which would warrant a reexamination. The cited prior art should be listed on a form PTO-1449 by the requester. See also MPEP § 2217.

A request for reexamination must assert a substantial new question of patentability. A requester may not, in a request for reexamination, argue that the submitted references do not raise a substantial new question of patentability, and that no order for reexamination should be issued.

“(2) An identification of every claim for which reexamination is requested, and a detailed explanation of the pertinency and manner of applying the cited prior art to every claim for which reexamination is requested. If appropriate the party requesting reexamination may also point out how claims distinguish over cited prior art.”

The request should apply the cited prior art to every claim for which reexamination is requested. If the request is filed by the patent owner, he or she may also indicate how the claims distinguish from the cited prior art patents and printed publications.

“(3) A copy of every patent or printed publication relied upon or referred to in paragraph (b)(1) and (2) of



this section accompanied by an English language translation of all the necessary and pertinent parts of any non-English language patent or printed publication.”

A copy of each cited patent or printed publication, as well as a translation of each non-English document (or a translation of at least the portion(s) relied upon) is required so that all materials will be available to the examiner for full consideration. See MPEP § 2218.

“(4) A copy of the entire patent including the front face, drawings, and specification/claims (in double column format) for which reexamination is requested, and a copy of any disclaimer, certificate of correction, or reexamination certificate issued in the patent. All copies must have each page plainly written on only one side of a sheet of paper.”

A copy of the patent, for which reexamination is requested, should be provided with the specification and claims submitted in a **double** column format. The drawing pages of the printed patent are presented as they appear in the printed patent; the same is true for the front page of the patent. Thus, a full copy of the printed patent (including the front page) can be used to provide the abstract, drawings, specification, and claims of the patent for the reexamination request. The printed patent is to be reproduced on only one side of the paper; a two sided copy of the patent is not proper.

Any disclaimer, certificate of correction, or reexamination certificate issued in the patent becomes a part of the patent. Thus, a copy of each must be supplied in order to provide the complete patent. The

copy must have each page plainly written on only one side of a sheet of paper.

“(5) A certification that a copy of the request filed by a person other than the patent owner has been served in its entirety on the patent owner at the address as provided for in § 1.33(c). The name and address of the party served must be indicated. If service was not possible, a duplicate copy must be supplied to the Office.”

If the request is filed by a person other than the patent owner, a certification that a copy of the request papers has been served on the patent owner must be included. The certification must set forth the name and address employed in serving the patent owner. If service was not possible, a duplicate copy of the request must be supplied to the Office. The request should be as complete as possible, since there is no guarantee that the examiner will consider other prior art when making the decision on the request. Also, if no statement under 37 CFR 1.530(b) is filed by the patent owner, no later reply under 37 CFR 1.535 or other submission may be filed by the requester in the *ex parte* reexamination proceeding. See also MPEP § 2220.

Form \* PTO/SB/57 should be helpful to persons filing requests for reexamination. The use of this form as the transmittal form and cover sheet of a request for reexamination is encouraged, but its use is not a requirement of the law nor the rules. Following form PTO/SB/57, is a sample of a statement (on which the request is based) that should be attached to the form PTO/SB/57 cover sheet.

\*\*>

PTO/SB/57 (04-04)

Approved for use through 04/30/2007. OMB 0651-0033  
 U.S. Patent and Trademark Office; U.S. DEPARTMENT OF COMMERCE

Under the Paperwork Reduction Act of 1995, no persons are required to respond to a collection of information unless it displays a valid OMB control number.

(Also referred to as FORM PTO-1485)

**REQUEST FOR EX PARTE REEXAMINATION TRANSMITTAL FORM**

Address to:  
**Mail Stop Ex Parte Reexam**  
**Commissioner for Patents**  
**P.O. Box 1450**  
**Alexandria, VA 22313-1450**

**Attorney Docket No.:**

**Date:**

1.  This is a request for *ex parte* reexamination pursuant to 37 CFR 1.510 of patent number \_\_\_\_\_ issued \_\_\_\_\_. The request is made by:
  - patent owner.
  - third party requester.
2.  The name and address of the person requesting reexamination is:
 

\_\_\_\_\_

\_\_\_\_\_
3.  a. A check in the amount of \$ \_\_\_\_\_ is enclosed to cover the reexamination fee, 37 CFR 1.20(c)(1);
  - b. The Director is hereby authorized to charge the fee as set forth in 37 CFR 1.20(c)(1) to Deposit Account No. \_\_\_\_\_ (submit duplicate of this form for fee processing); or
  - c. Payment by credit card. Form PTO-2038 is attached.
4.  Any refund should be made by  check or  credit to Deposit Account No. \_\_\_\_\_ 37 CFR 1.26(c). If payment is made by credit card, refund must be to credit card account.
5.  A copy of the patent to be reexamined having a double column format on one side of a separate paper is enclosed. 37 CFR 1.510(b)(4)
6.  CD-ROM or CD-R in duplicate, Computer Program (Appendix) or large table
7.  Nucleotide and/or Amino Acid Sequence Submission  
*If applicable, all of the following are necessary.*
  - a.  Computer Readable Form (CRF)
  - b. Specification Sequence Listing on:
    - i.  CD-ROM (2 copies) or CD-R (2 copies); or
    - ii.  paper
  - c.  Statements verifying identity of above copies
8.  A copy of any disclaimer, certificate of correction or reexamination certificate issued in the patent is included.
9.  Reexamination of claim(s) \_\_\_\_\_ is requested.
10.  A copy of every patent or printed publication relied upon is submitted herewith including a listing thereof on Form PTO-1449 or equivalent.
11.  An English language translation of all necessary and pertinent non-English language patents and/or printed publications is included.

[Page 1 of 2]

This collection of information is required by 37 CFR 1.510. The information is required to obtain or retain a benefit by the public which is to file (and by the USPTO to process) an application. Confidentiality is governed by 35 U.S.C. 122 and 37 CFR 1.14. This collection is estimated to take 2 hours to complete, including gathering, preparing, and submitting the completed application form to the USPTO. Time will vary depending upon the individual case. Any comments on the amount of time you require to complete this form and/or suggestions for reducing this burden, should be sent to the Chief Information Officer, U.S. Patent and Trademark Office, U.S. Department of Commerce, P.O. Box 1450, Alexandria, VA 22313-1450. DO NOT SEND FEES OR COMPLETED FORMS TO THIS ADDRESS. SEND TO: Mail Stop Ex Parte Reexam, Commissioner for Patents, P.O. Box 1450, Alexandria, VA 22313-1450.

*If you need assistance in completing the form, call 1-800-PTO-9199 and select option 2.*

PTO/SB/57 (04-04)

Approved for use through 04/30/2007. OMB 0651-0033

U.S. Patent and Trademark Office; U.S. DEPARTMENT OF COMMERCE

Under the Paperwork Reduction Act of 1995, no persons are required to respond to a collection of information unless it displays a valid OMB control number.

12.  The attached detailed request includes at least the following items:

- a. A statement identifying each substantial new question of patentability based on prior patents and printed publications. 37 CFR 1.510(b)(1)
- b. An identification of every claim for which reexamination is requested, and a detailed explanation of the pertinency and manner of applying the cited art to every claim for which reexamination is requested. 37 CFR 1.510(b)(2)

13.  A proposed amendment is included (only where the patent owner is the requester). 37 CFR 1.510(e)

14.  a. It is certified that a copy of this request (if filed by other than the patent owner) has been served in its entirety on the patent owner as provided in 37 CFR 1.33(c).  
The name and address of the party served and the date of service are:

\_\_\_\_\_

\_\_\_\_\_

\_\_\_\_\_

Date of Service: \_\_\_\_\_; or

b. A duplicate copy is enclosed since service on patent owner was not possible.

---

15. Correspondence Address: Direct all communication about the reexamination to:

Customer Number:

**OR**

<input type="checkbox"/> Firm or Individual Name			
Address (line 1)			
Address (line 2)			
City	State	Zip	
Country			
Telephone	Fax		

16.  The patent is currently the subject of the following concurrent proceeding(s):

- a. Copending reissue Application No. \_\_\_\_\_
- b. Copending reexamination Control No. \_\_\_\_\_
- c. Copending Interference No. \_\_\_\_\_
- d. Copending litigation styled: \_\_\_\_\_

\_\_\_\_\_

\_\_\_\_\_

**WARNING: Information on this form may become public. Credit card information should not be included on this form. Provide credit card information and authorization on PTO-2038.**

\_\_\_\_\_ *Authorized Signature*                      \_\_\_\_\_ *Date*

\_\_\_\_\_ *Typed/Printed Name*                      \_\_\_\_\_ *Registration No., if applicable*

For Patent Owner Requester

For Third Party Requester



Attachment to Form PTO 1465  
 providing information of  
 Pat. No. 9, 999, 999

Sir:

Reexamination under 35 U.S.C. 302- 307 and 37 CFR1. 510 is requested of United States patent number 9,999 999 which issued on July 7 1987, to Joseph Smith. This patent is still enforceable.

I. Claims for which reexamination is requested:

- Reexamination is requested of claims 1- 3 of the Smith patent in view of the earlier United States Patent \* number 594 225 to Berridge which is listed on attached Information Disclosure Statement form and of which a copy is enclosed.

- Reexamination is also requested of claim 4 of the Smith patent in view of the earlier Swiss Patent \* 80, 555 to Hotopp in view of the disclosure in "American Machinist" magazine, October 16 1950, issue, on page 169. An English translation of the German language Swiss document is enclosed. Copies of the Hotopp and "American Machinist" documents are also enclosed.

II. Explanation of pertinency and manner of applying cited prior art to every claim for which reexamination is requested based on prior art:

Claims 1- 3 of the Smith patent are considered to be fully anticipated under 35 U. c. 102 by prior art patent document to Berridge.

Claim 3 of the Smith patent, which is more specific than claims 1 and 2 in all features, is set forth below with an explanation as to how the prior art patent document to Berridge meets all the recited features.

Smith, claim 3:

“In a cutting and crimping tool”	(Berridge page 1, lines 10-13 states his invention is “an improved tool for crimping metal which in preferred form of embodiment is combined with a cutting-tool or shears, forming therewith a combination-tool”.)
“the combination with the cutting blades”	(elements 4 and 5 in Berridge)
“and their pivoted handles”	(elements 1 and 2 in Berridge)

- 2 -

Pat. No. 9,999,999

"of bosses arranged at an angle to and offset from the plane of the shear blades"

("bosses" as used in the Smith claim is used to mean a projection. The dies 6 and 7 of the Berridge prior art patent document are arranged at the same angle to the plane of the shear blades and are arranged at an angle in the same manner as shown in the drawing figures of the Smith patent.)

"and crimping dies formed on the meeting faces of said bosses"

(The dies 6 and 7 (bosses) of Berridge have meeting die-faces 12 and 13 (page 1, line 63) for performing crimping operations (page 1, lines 70 - 74.1))

Claim 4 of the Smith patent is considered to be unpatentable under 35 U.S.C. 103 in view of the prior art Swiss patent document to Hotopp and further in view of the prior art American Machinist magazine publication, page 169 of the October 16, 1950 issue.

Claim 4 of Smith reads as quoted below:

"In a cutting and crimping tool,"

(The prior art Swiss patent document to Hotopp discloses cutting jaws (column 1, line 8) and dies "b" and "c" which may be used for crimping.)

"the combination of a pair of pivoted handles"

(elements "a" and "e" in the prior art document to Hotopp).

"with cutting jaws at one end and crimping dies on the opposite side of the pivot"

(The prior art document to Hotopp discloses cutting jaws (column 1 line 8) and crimping dies "b" and "c" on the opposite side of pivot "d" from the cutting jaws.)

- 3 -

Pat. No. 9,999,999

"and rounded prongs projecting  
from said cutting jaws"

(Rounded prongs are not specifically disclosed by Hotopp but are shown to be old in the art by the illustration in "American Machinist" magazine under the title "Double-Purpose Pliers Don't Break Insulation". To provide the cutting jaws of Hotopp with rounded prongs as shown in the "American Machinist" magazine is considered to be a matter which would have been obvious to a person having ordinary skill in the art at the time the invention was made.)

III. Statement pointing out substantial new question of patentability:

The prior art documents referred to above were not of record in the file of the Smith patent. Since claims 1-4 in the Smith patent are not patentable over these prior art documents, a substantial new question of patentability is raised. Further, these prior art documents are closer to the subject matter of Smith than any prior art which was cited during the prosecution of the Smith patent. These prior art documents provide teachings not provided during prosecution of the Smith patent.

(Signed)

John Doe  
Attorney for requester

## 2215 Fee for Requesting *Ex Parte* Reexamination [R-2]

37 CFR 1.510. Request for *ex parte* reexamination.

\*\*\*\*\*

(c) If the request does not include the fee for requesting reexamination or all of the parts required by paragraph (b) of this section, the person identified as requesting reexamination will be so notified and given an opportunity to complete the request within a specified time. If the fee for requesting reexamination has been paid but the defect in the request is not corrected within the specified time, the determination whether or not to institute reexamination will be made on the request as it then exists. If the fee for requesting reexamination has not been paid, no determination will be made and the request will be placed in the patent file as a citation if it complies with the requirements of § 1.501(a).

(d) The filing date of the request is:

(1) The date on which the request including the entire fee for requesting reexamination is received in the Patent and Trademark Office; or

(2) The date on which the last portion of the fee for requesting reexamination is received.

\*\*\*\*\*

In order for a request to be accepted, be given a filing date, and be published in the *Official Gazette*, the entire fee required under 37 CFR 1.20(c)(1) for filing a request for reexamination must be paid.

If the request for *ex parte* reexamination is subsequently denied or vacated, a refund in accordance with 37 CFR 1.26(c) will be made to the identified requester.

If the entire fee for *ex parte* reexamination is not paid, the request will be considered to be incomplete. See 37 CFR 1.510 (c) and (d).

Where the entire filing fee is not paid after the requester has been given an opportunity to do so, no determination on the request will be made. The request papers will ordinarily be placed in the patent file as a prior art citation, if they comply with the requirements for a citation of prior art under 37 CFR 1.501. See MPEP § 2206 for handling of prior art citations.

## 2216 Substantial New Question of Patentability [R-2]

Under 35 U.S.C. 304, the Office must determine whether “a substantial new question of patentability” affecting any claim of the patent has been raised. 37 CFR 1.510(b)(1) requires that a request for *ex*

*parte* reexamination include “a statement pointing out each substantial new question of patentability based on prior patents and printed publications.” If such a new question is found, an order for *ex parte* reexamination of the patent is issued. It is therefore important that the request clearly set forth in detail what the requester considers the “substantial new question of patentability” to be in view of prior patents and printed publications. The request should point out how any questions of patentability raised are substantially different from those raised in the previous examination of the patent before the Office. If a substantial new question of patentability is found as to one claim, all claims will be reexamined during the *ex parte* reexamination process. See also MPEP § 2242.

Questions relating to grounds of rejection other than those based on prior art patents or printed publications should **not** be included in the request and will not be considered by the examiner if included. Examples of such questions that will not be considered are public use, on sale, and fraud.

Affidavits or declarations which explain the contents or pertinent dates of prior art patents or printed publications in more detail may be considered in reexamination. See MPEP § 2258.

## 2217 Statement in the Request Applying Prior Art [R-2]

The third sentence of 35 U.S.C. 302 indicates that the “request must set forth the pertinency and manner of applying cited prior art to every claim for which reexamination is requested.” 37 CFR 1.510(b)(2) requires that the request include “[a]n identification of every claim for which reexamination is requested, and a detailed explanation of the pertinency and manner of applying the cited prior art to every claim for which reexamination is requested.” If the request is filed by the patent owner, the request for reexamination may also point out how claims distinguish over cited prior art.

The prior art applied may only consist of prior art patents or printed publications. Substantial new questions of patentability may be based upon the following portions of 35 U.S.C. 102:

“(a)...patented or described in a printed publication in this or a foreign country, before the invention thereof by the applicant for patent, or”

“(b) the invention was patented or described in a printed publication in this or a foreign country... more than one year prior to the date of the application for patent in the United States, or”

\*\*\*\*\*

“(d) the invention was first patented or caused to be patented, or was the subject of an inventor’s certificate, by the applicant or his legal representatives or assigns in a foreign country prior to the date of the application for patent in this country on an application for patent or inventor’s certificate filed more than twelve months before the filing of the application in the United States, or”

\*\*>“(e) the invention was described in — (1) an application for patent, published under section 122(b), by another filed in the United States before the invention by the applicant for patent or (2) a patent granted on an application for patent by another filed in the United States before the invention by the applicant for patent, except that an international application filed under the treaty defined in section 351(a) shall have the effects for the purposes of this subsection of an application filed in the United States only if the international application designated the United States and was published under Article 21(2) of such treaty in the English language; or”<

“(f) he did not himself invent the subject matter sought to be patented, or”

“(g)(1) during the course of an interference conducted under section 135 or section 291, another inventor involved therein establishes, to the extent permitted in section 104, that before such person’s invention thereof the invention was made by such other inventor and not abandoned, suppressed, or concealed, or (2) before such person’s invention thereof, the invention was made in this country by another inventor who had not abandoned, suppressed, or concealed it. In determining priority of invention under this subsection, there shall be considered not only the respective dates of conception and reduction to practice of the invention, but also the reasonable diligence of one who was first to conceive and last to reduce to practice, from a time prior to conception by the other.”

Where substantial new questions of patentability are presented under 35 U.S.C. 102(f) or (g), the prior invention of another must be disclosed in a patent or printed publication. Substantial new questions of patentability may also be presented under 35 U.S.C. 103 which are based on the above indicated portions of 35 U.S.C. 102. Substantial new questions of patentability may be found under 35 U.S.C. 102(f)/103 or 102(g)/ 103 based on the prior invention of another disclosed in a patent or printed publication if the reference invention and the claimed invention were not commonly owned at the time the claimed invention

was made. See, 35 U.S.C. 103(c) and MPEP § 706.02(l). See MPEP § 706.02(l)(1) for information pertaining to references which qualify as prior art under 35 U.S.C. 102(e)/103.

Substantial new questions of patentability must be based on patents or printed publications. Other matters, such as public use or >on< sale, inventorship, 35 U.S.C. 101, 35 U.S.C. 112, fraud, etc., will not be considered when making the determination on the request and should not be presented in the request. Further, a prior art patent or printed publication cannot be properly applied as a ground for reexamination if it is merely used as evidence of alleged prior public use or >on< sale, insufficiency of disclosure, etc. The prior art patent or printed publication must be applied directly to claims under 35 U.S.C. 103 and/or an appropriate portion of 35 U.S.C. 102 or relate to the application of other prior art patents or printed publications to claims on such grounds.

The statement applying the prior art may, where appropriate, point out that claims in the patent for which reexamination is requested are entitled only to the filing date of the patent and are not supported by an earlier foreign or United States patent application whose filing date is claimed. For example, the effective date of some of the claims in a patent which resulted from a continuing application under 35 U.S.C. 120 could be the filing date of the continuing application since those claims were not supported in the parent application. Therefore, intervening patents or printed publications are available as prior art. See *In re Ruscetta*, 255 F.2d 687, 118 USPQ 101 (CCPA 1958), *In re van \* >Langenhoven<*, 458 F.2d 132, 173 USPQ 426 (CCPA 1972). See also MPEP § 201.11.

Double patenting is normally proper for consideration in reexamination. See *In re Lonardo*, 119 F.3d 960, 43 USPQ2d 1262 (Fed. Cir. 1997). See also the discussion as to double patenting in MPEP § 2258.

The mere citation of new patents or printed publications without an explanation does not comply with 37 CFR 1.510(b)(2). Requester must present an explanation of how the cited patents or printed publications are applied to all claims which requester considers to merit reexamination. This not only sets forth the requester’s position to the Office, but also to the patent owner (where the patent owner is not the requester).



Affidavits or declarations which explain the contents or pertinent dates of prior art patents or printed publications in more detail may be considered in reexamination. See MPEP § 2258.

## ADMISSIONS

The consideration under 35 U.S.C. 303 of a request for *ex parte* reexamination is limited to prior art patents and printed publications. See *Ex parte McGaughey*, 6 USPQ2d 1334, 1337 (Bd. Pat. App. & Inter. 1988). Thus an admission, *per se*, may not be the basis for establishing a substantial new question of patentability. However, an admission by the patent owner of record in the file or in a court record may be utilized in combination with a patent or printed publication.

For handling of admissions during the examination stage of a proceeding (i.e., after reexamination has been ordered), see MPEP § 2258.

The admission can reside in the patent file (made of record during the prosecution of the patent application) or may be presented during the pendency of the reexamination proceeding or in litigation. Admissions by the patent owner as to any matter affecting patentability may be utilized to determine the scope and content of the prior art **in conjunction with patents and printed publications** in a prior art rejection, whether such admissions result from patents or printed publications or from some other source. An admission relating to *any* prior art **\*\*** established in the record or in court may be used by the examiner in combination with patents or printed publications in a reexamination proceeding. The admission must stand on its own. Information supplementing or further defining the admission would be improper.

Any admission submitted by the patent owner is proper. A third party, however, may not submit admissions of the patent owner made outside the record of the file or the court record. Such a submission would be outside the scope of reexamination.

## 2218 Copies of Prior Art [R-2]

It is required that a copy of each patent or printed publication relied on or referred to in the request, < be filed with the request (37 CFR 1.510(b)(3)). If any of the documents are not in the English language, an English language translation of all necessary and pertinent parts is also required. An English language

summary or abstract of a non-English language document is usually not sufficient.

It is also helpful to include copies of the prior art considered during earlier prosecution of the patent for which reexamination is requested. The presence of both the old and the new prior art allows a comparison to be made to determine whether a substantial new question of patentability is indeed present. See MPEP § 2242.

Copies of parent applications should be submitted if the content of the parent application has a bearing on the alleged substantial new question of patentability; for example, if the patent is a continuation-in-part and the question of patentability relates to a rejection based on intervening prior art where support in the parent application is relevant. *In re Ruschetta*, 255 F.2d 687, 118 USPQ 101 (CCPA 1958).

## 2219 Copy of Printed Patent [R-2]

The U.S. Patent and Trademark Office will prepare a separate file wrapper for each reexamination request, < which will become part of the patent file. Since, in some instances, it may not be possible to obtain the patent file promptly, and in order to provide a format which can be amended and used for printing, requesters are required under 37 CFR 1.510(b)(4) to include a copy of the patent for which reexamination is requested, to serve as the specification for the reexamination proceeding. A copy of the patent for which reexamination is requested should be provided in a double column format. Thus, a full copy of the printed patent (including the front page) would be used to provide the abstract, drawings, specification, and claims of the patent for the reexamination request >and the resulting reexamination proceeding<. A copy of any disclaimer, certificate of correction, or reexamination certificate issued for the patent must also be included, so that a complete history of the patent is before the Office for consideration. A copy of any Federal Court decision, complaint in a pending civil action, or interference decision should also be submitted.

## 2220 Certificate of Service [R-2]

If the requester is a person other than the patent owner, the owner of the patent must be served with a copy of the request in its entirety. The service should be made to the correspondence address as indicated in

37 CFR 1.33(c). The third party requester must set forth on the certificate of service the name and address of the party served and the method of service. The certificate of service must be attached to the request submitted to the Office. Further, the copy of the request served on the patent owner must also include a copy of the certificate of service.

The most recent address of the attorney or agent of record can be determined by checking the Office's register >(roster)< of patent attorneys and agents maintained by the Office of Enrollment and Discipline pursuant to 37 CFR 10.5 and 10.11(a). See MPEP § 2266.03 regarding service on the requester and on the patent owner.

## 2221 Amendments Included in Request by Patent Owner [R-2]

Under 37 CFR 1.510(e), a patent owner may include a proposed amendment with his or her request. Any such amendment must be in accordance with 37 CFR 1.530(d) through (j). See MPEP § 2250. Amendments may also be proposed by patent owners in a statement under 37 CFR 1.530(b) and (c) or during the actual *ex parte* reexamination prosecution (37 CFR 1.550(b)). See also MPEP § 2234 and § 2250.

The request should be decided on the wording of the patent claims in effect at that time (without any proposed amendments). The decision on the request will be made on the basis of the patent claims as though the proposed amendment had not been presented. However, if the request for reexamination is granted, **\*\*>all subsequent<** reexamination prosecution and examination should be on the basis of the claims as amended.

## 2222 Address of Patent Owner [R-2]

*37 CFR 1.33. Correspondence respecting patent applications, reexamination proceedings, and other proceedings.*

\*\*\*\*\*

(c) All notices, official letters, and other communications for the patent owner or owners in a reexamination proceeding will be directed to the attorney or agent of record (see § 1.34(b)) in the patent file at the address listed on the register of patent attorneys and agents maintained pursuant to §§ 10.5 and 10.11 or, if no attorney or agent is of record, to the patent owner or owners at the address or addresses of record. Amendments and other papers

filed in a reexamination proceeding on behalf of the patent owner must be signed by the patent owner, or if there is more than one owner by all the owners, or by an attorney or agent of record in the patent file, or by a registered attorney or agent not of record who acts in a representative capacity under the provisions of § 1.34(a). Double correspondence with the patent owner or owners and the patent owner's attorney or agent, or with more than one attorney or agent, will not be undertaken. If more than one attorney or agent is of record and a correspondence address has not been specified, correspondence will be held with the last attorney or agent made of record.

\*\*\*\*\*

In 37 CFR 1.33(c), it is indicated which correspondence address is to be normally used to direct correspondence to the patent owner. In most instances, this will be the address of the first named, most recent attorney or agent of record in the patent file, at his or her current address. As a general rule, the attorney-client relationship terminates when the purpose for which the attorney was employed is accomplished; e.g., the issuance of a patent to the client. However, apart from the attorney-client relationship, the Office has, by regulation, 37 CFR 10.23(c)(8), made it the responsibility of every "practitioner," by virtue of his/her registration, "to inform a client or former client ... of correspondence received from the Office ... when the correspondence (i) could have a significant effect on a matter pending before the Office, (ii) is received by the practitioner on behalf of a client or former client, and (iii) is correspondence of which a reasonable practitioner would believe under the circumstances the client or former client should be notified." (Emphasis added.) This responsibility of a practitioner to a former client manifestly is not eliminated by withdrawing as an attorney or agent of record. The practitioner if he/she so desires, can minimize the need for forwarding correspondence concerning issued patents by having the correspondence address changed after the patent issues if the correspondence address is the practitioner's address, which frequently is the case where the practitioner is the attorney or agent of record.

Further, 37 CFR 10.23(c)(8) requires a practitioner to "timely notify the Office of an inability to notify a client or former client of correspondence received from the Office" (Emphasis added.) As the language of this requirement clearly indicates, the duty to notify the Office is a consequence, not of any attorney-client relationship, but rather arises by virtue of the practi-

tioner's status as a registered >patent< attorney or agent.

If the patent owner desires that a different attorney or agent receive correspondence, then a new power of attorney must be filed. Correspondence will continue to be sent to the attorney or agent of record in the patent file absent a revocation of the same by the patent owner. If the attorney or agent of record specifies a correspondence address to which correspondence is to be directed, such direction should be followed. However, since a change in the correspondence address does not withdraw a power of attorney, a change of the correspondence address by the patent owner does not prevent the correspondence from being directed to the attorney or agent of record in the patent file under 37 CFR 1.33(c).

Submissions to the Office to change the correspondence address or power of attorney in the record of the patent should be addressed as follows:

Where a request for reexamination has been filed and the reexamination has not yet been assigned to \* a Technology Center-

\*\* >Mail Stop *Ex Parte* Reexam  
Commissioner for Patents  
P.O. Box 1450  
Alexandria, VA 22313-1450<

Where a request for reexamination has been filed and the reexamination has already been assigned to \* a Technology Center-

>Commissioner for Patents  
P.O. Box 1450  
Alexandria, VA 22313-1450<

Where no request for reexamination has been filed and the patent is in storage-

>Mail Stop Document Services  
Director of the U.S. Patent and Trademark Office  
P.O. Box 1450  
Alexandria, VA 22313-1450<

A sample form for changing correspondence address or power of attorney is set forth below.

\*\*>

<b>REVOCATION OF POWER OF ATTORNEY WITH NEW POWER OF ATTORNEY AND CHANGE OF CORRESPONDENCE ADDRESS</b>	Application Number	
	Filing Date	
	First Named Inventor	
	Art Unit	
	Examiner Name	
	Attorney Docket Number	

**I hereby revoke all previous powers of attorney given in the above-identified application.**

A Power of Attorney is submitted herewith.

**OR**

I hereby appoint the practitioners associated with the Customer Number:

Please change the correspondence address for the above-identified application to:

The address associated with Customer Number:

**OR**

<input type="checkbox"/> Firm or Individual Name					
Address					
Address					
City		State		Zip	
Country					
Telephone		Fax			

I am the:

Applicant/Inventor.

Assignee of record of the entire interest. See 37 CFR 3.71. *Statement under 37 CFR 3.73(b) is enclosed. (Form PTO/SB/96)*

**SIGNATURE of Applicant or Assignee of Record**

Name					
Signature					
Date		Telephone			

NOTE: Signatures of all the inventors or assignees of record of the entire interest or their representative(s) are required. Submit multiple forms if more than one signature is required, see below\*.

\*Total of \_\_\_\_\_ forms are submitted.

This collection of information is required by 37 CFR 1.36. The information is required to obtain or retain a benefit by the public which is to file (and by the USPTO to process) an application. Confidentiality is governed by 35 U.S.C. 122 and 37 CFR 1.14. This collection is estimated to take 3 minutes to complete, including gathering, preparing, and submitting the completed application form to the USPTO. Time will vary depending upon the individual case. Any comments on the amount of time you require to complete this form and/or suggestions for reducing this burden, should be sent to the Chief Information Officer, U.S. Patent and Trademark Office, U.S. Department of Commerce, P.O. Box 1450, Alexandria, VA 22313-1450. DO NOT SEND FEES OR COMPLETED FORMS TO THIS ADDRESS. **SEND TO: Commissioner for Patents, P.O. Box 1450, Alexandria, VA 22313-1450.**

If you need assistance in completing the form, call 1-800-PTO-9199 and select option 2.

<

See MPEP § 324 for establishing assignee's right to take action when submitting a power of attorney.

**2223 Withdrawal of Attorney or Agent  
[R-2]**

A request by an attorney or agent of record to withdraw from a patent will normally be approved only if

at least 30 days remain in any running period for response. See also MPEP § 402.06.

>A sample form for a request by an attorney or agent of record to withdraw from a patent is set forth below.<

>

PTO/SB/83 (09-03)

Approved for use through 11/30/2005. OMB 0651-0035  
 U.S. Patent and Trademark Office, U.S. DEPARTMENT OF COMMERCE

Under the Paperwork Reduction Act of 1995, no persons are required to respond to a collection of information unless it displays a valid OMB control number.

<b>REQUEST FOR WITHDRAWAL AS ATTORNEY OR AGENT AND CHANGE OF CORRESPONDENCE ADDRESS</b>	Application Number	
	Filing Date	
	First Named Inventor	
	Art Unit	
	Examiner Name	
	Attorney Docket Number	

**To: Commissioner for Patents  
 P.O. Box 1450  
 Alexandria, VA 22313-1450**

Please withdraw me as attorney or agent for the above identified patent application, and

all the attorneys/agents of record.

the attorneys/agents (with registration numbers) listed on the attached paper(s), or

the attorneys/agents associated with Customer Number

NOTE: This box can only be checked when the power of attorney of record in the application is to all the practitioners associated with a customer number.

The reasons for this request are:

**CORRESPONDENCE ADDRESS**

1.  The correspondence address is NOT affected by this withdrawal.

2.  Change the correspondence address and direct all future correspondence to:

Customer Number:

**OR**

<input type="checkbox"/> Firm or Individual Name			
Address			
Address			
City	State	Zip	
Country			
Telephone		Fax	
Name			
Signature		Registration No.	
Date		Telephone No.	

NOTE: Withdrawal is effective when approved rather than when received. Unless there are at least 30 days between approval of withdrawal and the expiration date of a time period for response or possible extension period, the request to withdraw is normally disapproved.

This collection of information is required by 37 CFR 1.36. The information is required to obtain or retain a benefit by the public which is to file (and by the USPTO to process) an application. Confidentiality is governed by 35 U.S.C. 122 and 37 CFR 1.14. This collection is estimated to take 12 minutes to complete, including gathering, preparing, and submitting the completed application form to the USPTO. Time will vary depending upon the individual case. Any comments on the amount of time you require to complete this form and/or suggestions for reducing this burden, should be sent to the Chief Information Officer, U.S. Patent and Trademark Office, U.S. Department of Commerce, P.O. Box 1450, Alexandria, VA 22313-1450. DO NOT SEND FEES OR COMPLETED FORMS TO THIS ADDRESS. **SEND TO: Commissioner for Patents, P.O. Box 1450, Alexandria, VA 22313-1450.**

*If you need assistance in completing the form, call 1-800-PTO-9199 and select option 2.*

<

## 2224 Correspondence [R-2]

\*\*

All requests for *ex parte* reexamination mailed to the U.S. Patent and Trademark Office should be additionally marked “\*Mail Stop *Ex Parte* Reexam” on the face of the outer envelope (the use of “*Ex Parte*” is to distinguish such requests from *inter partes* requests). Such mail will be sorted out immediately and processed by the reexamination preprocessing staff of the Central Reexamination Unit (CRU). The use of “\*Mail Stop *Ex Parte* Reexam” is limited to the filing of \*an original request for *ex parte* reexamination. Subsequent *ex parte* reexamination correspondence should not be marked “\*Mail Stop *Ex Parte* Reexam.” It should be directed to the Technology Center (TC) art unit indicated on the Office letters. Any correction or change of correspondence address for a United States patent should be addressed to the Office at \*Mail Stop “Patent Address Change.”

See MPEP § 2624 for use of “Mail Stop *Inter Partes* Reexam” for *inter partes* reexamination proceedings.

A request for *ex parte* reexamination may not be sent by facsimile transmission. See 37 CFR 1.6(d)(5).

After the filing of the request for *ex parte* reexamination, any letters sent to the U.S. Patent and Trademark Office relating to the resulting *ex parte* reexamination proceeding should identify the proceeding by the number of the patent undergoing reexamination, the reexamination request control number assigned, TC art unit, and the name of the examiner. The certificate of mailing and transmission procedures (37 CFR 1.8) and “Express Mail” mailing procedure (37 CFR 1.10) may be used to file any paper in an *ex parte* reexamination proceeding.

Communications from the U.S. Patent and Trademark Office to the patent owner will be directed to the first named, most recent attorney or agent of record in the patent file at the current address on the Office’s register of patent attorneys and agents, or to the patent owner’s address if no attorney or agent is of record, 37 CFR 1.33(c).

Amendments and other papers filed on behalf of patent owners must be signed by the patent owners, or the registered attorney or agent of record in the patent

file, or any registered attorney or agent acting in a representative capacity under 37 CFR 1.34(a). See MPEP § 2213.

Double correspondence with the patent owners and the attorney or agent normally will not be undertaken by the Office.

Where no correspondence address is otherwise specified, correspondence will be with the most recent attorney or agent made of record by the patent owner.

Note MPEP § 2220 on certificate of service.

## 2225 Untimely Paper Filed Prior to Order [R-2]

After filing of a request for *ex parte* reexamination, no papers directed to the merits of the reexamination other than (\*A) citations of patents or printed publications under 37 CFR 1.501 or 37 CFR 1.555, (\*B) another complete request under 37 CFR 1.510 or 37 CFR 1.915, or (\*C) notifications pursuant to MPEP § 2282, should be filed with the Office prior to the date of the decision on the request for reexamination. Any papers directed to the merits of the reexamination other than those under 37 CFR 1.501 \*\*, 1.555 or 1.915, or MPEP § 2282, filed prior to the decision on the request will be returned to the sender by the Technology Center Director without consideration. A copy of the letter accompanying the returned papers will be made of record in the patent file. However, no copy of the returned papers will be retained by the Office. If the submission of the returned papers is appropriate later in the proceedings, they will be accepted by the Office at that time. See *Patlex Corp. v. Mossinghoff*, 771 F.2d 480, 226 USPQ 985, 989 (Fed. Cir. 1985); *In re Knight*, 217 USPQ 294 (Comm’r Pat. 1982) and *In re Amp* \*, 212 USPQ 826 (Comm’r Pat. 1981).

## 2226 Initial Processing of Request for *Ex Parte* Reexamination [R-2]

The opening of all mail marked “\*Mail Stop *Ex Parte* Reexam,” and all initial clerical processing of requests for reexamination, will be performed by the reexamination preprocessing staff in the Office of Patent Legal Administration, Central Reexamination Unit.

## 2227 Incomplete Request >for Ex Parte Reexamination< [R-2]

37 CFR 1.510. Request for ex parte reexamination.

\*\*\*\*\*

(c) If the request does not include the fee for requesting reexamination or all of the parts required by paragraph (b) of this section, the person identified as requesting reexamination will be so notified and given an opportunity to complete the request within a specified time. If the fee for requesting reexamination has been paid but the defect in the request is not corrected within the specified time, the determination whether or not to institute reexamination will be made on the request as it then exists. If the fee for requesting reexamination has not been paid, no determination will be made and the request will be placed in the patent file as a citation if it complies with the requirements of § 1.501(a).

(d) The filing date of the request is:

(1) The date on which the request including the entire fee for requesting reexamination is received in the Patent and Trademark Office; or

(2) The date on which the last portion of the fee for requesting reexamination is received.

\*\*\*\*\*

If the required fee under 37 CFR 1.20(c)(1) is not paid in full, the request is incomplete, 37 CFR 1.510(c), and will not be considered on its merits or have a notice of its filing announced in the *Official Gazette*. The request is considered to have a “filing date” under 37 CFR 1.510(d) only when the entire fee is paid. Until the entire fee is received, no control number or filing date will be assigned and technically, no reexamination exists.

If no fee is received, or only a portion of the fee is received, the reexamination preprocessing staff of the Office of Patent Legal Administration, Central Reexamination Unit (CRU) will notify the requester of the defect and give the requester a specified time, normally 1 month, to complete the request. This notice does not enter the system. A telephone call may also be made to the requester indicating the amount of the insufficient fee. If the request is not timely completed, any partial fee will be returned by the CRU to the requester along with a notice that the reexamination request has not been accepted and the process has been terminated. If the request otherwise complies with 37 CFR 1.501(a), it will be treated as a citation under 37 CFR 1.501(a). If the request does not comply with 37 CFR 1.501(a), the request papers will be returned to the requester by the CRU.

## 2228 Informal Request >for Ex Parte Reexamination< [R-2]

If the fee under 37 CFR 1.20(c)(1) has been paid, but the request >for ex parte reexamination< does not contain all the elements called for by 37 CFR 1.510(b), the request is considered to be informal. All requests >for ex parte reexamination< which are accompanied with the entire fee will be assigned a filing date from which the 3-month period for making a decision on the request will be computed. \*\*

The reexamination preprocessing staff of the Central Reexamination Unit will attempt to notify the requester of any informality in the request in order to give the requester time to respond before a decision is made on the request. If the requester does not respond and correct the informality, the decision on the request will be made on the information presented >, i.e., all of the art presented with the request and any argument or evidence in support of that art<. If the information presented does not present “a substantial new question of patentability,” the request for reexamination will be denied.

## 2229 Notice of Request >for Ex Parte Reexamination< in Official Gazette [R-2]

37 CFR 1.11. Files open to the public.

\*\*\*\*\*

\*\*>

(c) All requests for reexamination for which the fee under § 1.20(c) has been paid, will be announced in the *Official Gazette*. Any reexaminations at the initiative of the Director pursuant to § 1.520 will also be announced in the *Official Gazette*. The announcement shall include at least the date of the request, if any, the reexamination request control number or the Director initiated order control number, patent number, title, class and subclass, name of the inventor, name of the patent owner of record, and the examining group to which the reexamination is assigned.<

(d) All papers or copies thereof relating to a reexamination proceeding which have been entered of record in the patent or reexamination file are open to inspection by the general public, and copies may be furnished upon paying the fee therefor.

\*\*\*\*\*

>Notice of filing of all complete ex parte reexamination requests will be published in the *Official Gazette*, approximately 4 - 5 weeks after filing.<



Under 37 CFR 1.11(c), both reexamination requests with sufficient fees and \* >Director-initiated< orders made without a request will be announced in the *Official Gazette*. The reexamination preprocessing staff of the Central Reexamination Unit (CRU) will complete a form with the information needed to print the notice. The forms are forwarded at the end of each week to the Office of Publications for printing in the *Official Gazette*.

In addition, a record of requests filed will be located in the Patent Search Room and in the reexamination preprocessing area of the CRU. Office personnel may use the PALM system to determine if a request for reexamination has been filed in a particular patent. The *Official Gazette* notice will appear in the notice section of the *Official Gazette* under the heading of \* Requests >for *Ex Parte* Reexamination< Filed and will include the name of any requestor along with the other items set forth in 37 CFR 1.11(c).

### **2230 Constructive Notice to Patent Owner [R-2]**

In some instances, it may not be possible to deliver mail to the patent owner because no current address is available. If all efforts to correspond with the patent owner fail, the reexamination proceeding will proceed without actual notice to the patent owner. The publication in the *Official Gazette* of (\* >A<) the notice of the filing of a request for reexamination, or (\* >B<) the >notice of the< ordering of reexamination at the initiative of the \* >Director of the Office<, will serve as constructive notice to the patent owner in such an instance.

### **2231 Processing of Request Corrections [R-2]**

Any payment of insufficient request filing fee should be marked “\* >Mail Stop *Ex Parte*< Reexam” so that the fee may be promptly forwarded to the reexamination preprocessing area of the \* >Central Reexamination Unit (CRU)<. If the fee payment completes the payment of the required fee, the request will be processed, notice will be published in the *Official Gazette*, and the request will be forwarded to the appropriate Technology Center (TC) for determination.

Any correction of a defect other than the fee should be directed to the TC where the file is located, after the reexamination has been assigned to a TC. The TC technical support staff will process any timely corrections and enter them in the file of the reexamination.

### **2232 Public Access [R-2]**

Reexamination files are normally NOT open to inspection by the general public until the file has been scanned into the reexamination database in the Central Reexamination Unit (CRU), at which point an electronic copy of the file is made available to the public. A Reexamination Processing System (REPS) terminal is available to the public in the Patent Search Room for accessing/copying reexamination files from the reexamination database. Access is free, and copies are 25 cents per page. \* >Members of the public seeking access to a reexamination file should be referred to the Patent Search Room Online Desk.

In an emergency when the REPS terminal in the Patent Search Room is not operative, member of the public should be referred to the CRU as an alternative for viewing only. The CRU does not have the means nor the authority to sell copies of reexamination files to the public.<

The reexamination files that have been scanned into the reexamination database include an entry in the case contents in PALM of “SCNR” each time that incoming and/or outgoing paper is scanned into the database.

While copying of the \* >actual paper< reexamination file is not permitted (since an electronic copy of the file is made available to the public), reexamination files will be made available only for inspection >(where the electronic copy is not available and access is needed before the electronic copy will be made available)<, and in the area of the Office in which they are located.

The reexamination files will be stored in a separate central location (or other designated storage area) in the Technology Center (TC) unless being acted upon by the examiner or a communication is being processed by the \* >TC< technical support staff. In view of the statutory requirement to conduct the reexamination proceeding with special dispatch and because of other special circumstances, a reexamination file may >, even if not yet scanned,< NOT be available to the

public for inspection, even if the file has been scanned at the following times:

(A) The reexamination file is not available to the public when it is in the reexamination preprocessing area of the CRU. This is because the request papers are being actively processed and compiled into the reexamination file wrapper. Further, the reexamination file has not yet been captured as a permanent record in the USPTO electronic scanning database;

(B) The reexamination file is not available to the public when it is actively being processed, e.g., when the examiner has started consideration of some matter but an action has not been mailed. However, all areas should be as reasonable as possible in allowing inspection (but not copying) of the file;

(C) The reexamination file is not available to the public once the reexamination file has been released and forwarded by the TC for publication of the reexamination certificate. This would include any reexamination files which \*\*>are undergoing< post-issuance review \* in the Office of Patent Legal Administration (see MPEP § 2289). Unless prosecution is reopened, the reexamination files are not available to the public until the reexamination certificate issues. This is because the reexamination file has been put into a special format for printing purposes, and it contains special checklists needed for printing purposes which are not part of the record.

At times other than those identified above, unscanned reexamination files will normally be made available to members of the public upon request. Inspection will be permitted in the TC. If a copy of the reexamination file is requested, it may be ordered from the Document Services Division of the Office of Public Records (OPR), or ordered via e-mail from: dsd@uspto.gov, and the cost of the copy may be charged to a credit card or deposit account. Alternatively, a copy may be \*>obtained< from the scanned database in the Patent Search Room.

>

## I. <SALE OF COPIES OF REEXAMINATION REQUESTS

Copies of reexamination requests, all cited references, and the file wrapper and contents of the patent file for which reexamination is requested are available

at the standard charge per page. >For IFW processing, see IFW manual.< Alternatively, a copy of a file wrapper may be put on a CD, for a standard fee >(37 CFR 1.19(b)(3)<. \*\* Orders for such copies must indicate the control number assigned the reexamination request. Orders should be addressed as follows: \*\* >Mail Stop Document Services, Director of the United States Patent and Trademark Office, P.O. Box 1450, Alexandria, Virginia 22313-1450. Furthermore, requests for copies may be sent via e-mail to: dsd@uspto.gov, and the cost of the copy may be charged to a credit card or deposit account.<

A certified copy of a reexamination file >(in the form of a CD-ROM)< may be purchased from the Document Services Division of OPR.

>

## II. < TO DETERMINE >FROM PAIR OR< PALM IF A REEXAMINATION REQUEST HAS BEEN FILED FOR A GIVEN PATENT NUMBER

\*\*>Both the Internet and the USPTO Intranet can be accessed to determine if a reexamination request has been filed for a particular patent.

### A. *Using the Internet*

- Log on to the Internet.
- Go to USPTO Website located at <http://www.uspto.gov>.
- Click on "Patents" located on the left side of the screen.
- Under "Patenting" click "Status of Patent Application (PAIR)."
- On the next screen, click on "Patent Application Information Retrieval."
- Enter the patent number (e.g., 5806063 - no commas are to be inserted) in "Patent Number Search."
- Click on "Search."
- Under "Search Results for patent number: 5,806,063" click the "Continuity Data" bar (button).
- Scroll to "Child Continuity Data" where any related reexamination will be listed. *Ex parte* reexaminations are identified by the unique "90" series code, e.g., 90/005,727. *Inter partes* reexaminations are identified by the unique "95" series code, e.g., 95/000,001.

- Clicking on the underlined (hyperlinked) reexamination number will reveal the “Contents” for the reexamination file.

### **B. Using the USPTO Intranet**

- From the USPTO Intranet site <http://ptoweb/ptointranet/index.htm>, Office personnel can click on “PALM” and then “General Information” which opens the PALM INTRANET General Information Display.

- From here, enter the patent number in the box labeled Patent #.

- Click on “Search” and when the “Patent Number Information” appears, click on “Continuity Data” to obtain the reexamination number.

Any reexamination for the patent number will be listed.

There will be about a ten (10) day lag between filing and data entry into the PALM database.<

## **2233 Processing in Technology Center [R-2]**

The working groups in the Technology Centers (TCs) have designated the legal instrument examiners to act as reexamination clerks, as part of their assigned duties, and thus to perform those clerical duties and responsibilities in the groups which are unique to reexamination. The TC Special Program Examiners (SPREs) and Paralegal Specialists have the responsibility to oversee clerical processing and serve as a resource for questions.

>

### **I. < FEES**

Under reexamination, there are generally no fees due other than for the request and any appeal, brief, and oral hearing fees under 37 CFR 1.191, 1.192, and 1.194(b). No fees are required for additional claims added, for an extension of time under 37 CFR 1.550(c) (37 CFR 1.136 is not available in reexamination), or for issue of the certificate.

Any petitions filed under **\*\*>37 CFR 1.137<** or 37 CFR 1.182 or 1.183 relating to a reexamination proceeding require fees (37 CFR 1.17(h) **\*>**, (l) and (m)<).

Small entity reductions are available to the patent owner for the **\*\*>37 CFR 1.137<** petition fee, appeal,

brief, and oral hearing fees. Small entity reductions in fees are not available for the reexamination filing fee nor for petition fees for petitions filed under 37 CFR 1.182 and 1.183.

When a fee is required in a merged proceeding (see MPEP § 2283 and § 2285), only a single fee is needed even though multiple copies of the submissions (one for each file) are required.

>

### **II. < MAILING**

A transmittal form with the requester’s address will be used to forward copies of Office actions >(and any references cited in the Office actions)< to the requester. Whenever an Office action is issued, a copy of this form will be made and attached to a copy of the Office action. The use of this form removes the need to retype the requester’s address each time a mailing is required. When the patent owner is the requester, no such form is needed.

The following steps should be taken when processing reexamination requests in the TCs.

(A) Report receipt of the reexamination file in the TC on the PALM terminal and forward the file to the TC reexamination clerk.

(B) Date stamp the date of receipt in the TC on the reexamination file.

(C) Charge file on the PALM terminal to the supervisory patent examiner (SPE) of the TC art unit indicated on the reexamination file and forward the file to the supervisory patent examiner.

(D) The SPE promptly reviews the subject matter of the patent in which reexamination was requested and either transfers the request file (which should rarely occur) or assigns it to a patent examiner other than the examiner who was involved in the examination of the patent application (see MPEP § 2236). The patent examiner is informed and the request file is returned to the TC reexamination clerk for entry of the examiner’s name into PALM.

(E) At about 6 weeks after the filing of the request, the request file should be given to the examiner and charged to him or her on PALM.

(F) The examiner then drafts a decision on the request and returns it to be typed on a “special” basis, normally within 8 weeks after the filing date of the request.

(G) The typed decision is forwarded to the examiner for review. The examiner will sign the action (if the examiner is a primary examiner) or forward the action to the SPE for signature (if examiner is not a primary examiner). After signing, the file is returned to the TC technical support staff for mailing and PALM update, normally within 10 weeks after the filing date of the request.

The initial reexamination \*file wrappers\* were patent application \*file wrappers\* which had orange tape applied to the face. The current reexamination file wrappers are orange in color for easy identification.

## 2234 Entry of Amendments [R-2]

\*\*>

37 CFR 1.121. *Manner of making amendments in applications.*

\*\*\*\*\*

(j) *Amendments in reexamination proceedings.* Any proposed amendment to the description and claims in patents involved in reexamination proceedings must be made in accordance with § 1.530.<

\*\*\*\*\*

37 CFR 1.530. *Statement by patent owner in ex parte reexamination; amendment by patent owner in ex parte or inter partes reexamination; inventorship change in ex parte or inter partes reexamination.*

\*\*\*\*\*

(d) *Making amendments in a reexamination proceeding.* A proposed amendment in an *ex parte* or an *inter partes* reexamination proceeding is made by filing a paper directing that proposed specified changes be made to the patent specification, including the claims, or to the drawings. An amendment paper directing that proposed specified changes be made in a reexamination proceeding may be submitted as an accompaniment to a request filed by the patent owner in accordance with § 1.510(e), as part of a patent owner statement in accordance with paragraph (b) of this section, or, where permitted, during the prosecution of the reexamination proceeding pursuant to § 1.550(a) or § 1.937.

(1) *Specification other than the claims.* Changes to the specification, other than to the claims, must be made by submission of the entire text of an added or rewritten paragraph including markings pursuant to paragraph (f) of this section, except that an entire paragraph may be deleted by a statement deleting the paragraph, without presentation of the text of the paragraph. The precise point in the specification must be identified where any added or rewritten paragraph is located. This paragraph applies whether

the amendment is submitted on paper or compact disc (*see* §§ 1.96 and 1.825).

(2) *Claims.* An amendment paper must include the entire text of each patent claim which is being proposed to be changed by such amendment paper and of each new claim being proposed to be added by such amendment paper. For any claim changed by the amendment paper, a parenthetical expression “amended,” “twice amended,” *etc.*, should follow the claim number. Each patent claim proposed to be changed and each proposed added claim must include markings pursuant to paragraph (f) of this section, except that a patent claim or proposed added claim should be canceled by a statement canceling the claim, without presentation of the text of the claim.

(3) *Drawings.* Any change to the patent drawings must be submitted as a sketch on a separate paper showing the proposed changes in red for approval by the examiner. Upon approval of the changes by the examiner, only new sheets of drawings including the changes and in compliance with § 1.84 must be filed. Amended figures must be identified as “Amended,” and any added figure must be identified as “New.” In the event a figure is canceled, the figure must be surrounded by brackets and identified as “Canceled.”

(4) The formal requirements for papers making up the reexamination proceeding other than those set forth in this section are set out in § 1.52.

(e) *Status of claims and support for claim changes.* Whenever there is an amendment to the claims pursuant to paragraph (d) of this section, there must also be supplied, on pages separate from the pages containing the changes, the status (*i.e.*, pending or canceled), as of the date of the amendment, of all patent claims and of all added claims, and an explanation of the support in the disclosure of the patent for the changes to the claims made by the amendment paper.

(f) *Changes shown by markings.* Any changes relative to the patent being reexamined which are made to the specification, including the claims, must include the following markings:

(1) The matter to be omitted by the reexamination proceeding must be enclosed in brackets; and

(2) The matter to be added by the reexamination proceeding must be underlined.

(g) *Numbering of patent claims preserved.* Patent claims may not be renumbered. The numbering of any claims added in the reexamination proceeding must follow the number of the highest numbered patent claim.

(h) *Amendment of disclosure may be required.* The disclosure must be amended, when required by the Office, to correct inaccuracies of description and definition, and to secure substantial correspondence between the claims, the remainder of the specification, and the drawings.

(i) *Amendments made relative to patent.* All amendments must be made relative to the patent specification, including the claims, and drawings, which are in effect as of the date of filing the request for reexamination.

(j) *No enlargement of claim scope.* No amendment may enlarge the scope of the claims of the patent or introduce new matter. No amendment may be proposed for entry in an expired patent. Moreover, no amendment, other than the cancellation of

claims, will be incorporated into the patent by a certificate issued after the expiration of the patent.

(k) *Amendments not effective until certificate.* Although the Office actions will treat proposed amendments as though they have been entered, the proposed amendments will not be effective until the reexamination certificate is issued.

\*\*\*\*\*

Amendments which comply with 37 CFR 1.530(d) through (j) are entered in the reexamination file wrapper. An amendment is given a Paper No. and is designated by consecutive letters of the alphabet (A, B, C, etc.).

The amendment will be entered by drawing a line in red ink through (\*>A<) any claim(s) or paragraph(s) amended and (\*>B<) the claim(s) or paragraph(s) canceled which are not part of the patent, and the substituted copy being indicated by reference letter. Canceled claim(s) or paragraph(s) which are part of the patent should not be lined through, but rather marked with brackets (i.e., a bracket placed at the beginning and end of each canceled claim or paragraph of the patent). Patent claims must not be renumbered, and the numbering of the claims added during reexamination must follow the number of the highest numbered patent claim.

*ALL* amendments in reexamination proceedings, including examiner's amendments made at the time when the Notice of Intent to Issue *>Ex Parte<* Reexamination Certificate (NIRC) is prepared (37 CFR 1.121(g) does not apply in reexamination proceedings), must be presented in the form of a full copy of the text of each claim which is amended and each paragraph of the description which is amended. In other words, the entire claim or paragraph must be presented for any amendment of the claim or paragraph.

If a portion of the text is amended more than once, each amendment should indicate *ALL* of the changes (insertions and deletions) in relation to the current text of the patent under reexamination.

Although amendments will be entered for purposes of examination, the amendments are not legally effective until the reexamination certificate is issued.

See MPEP § 2250 for manner of making amendments by patent owner and for examples of proper claim amendment format. For clerical handling of amendments, see MPEP § 2270. See also MPEP § 2221 for amendments included in the request by the

patent owner. For entry of amendments in a merged proceeding, see MPEP § 2283 and § 2285.

## 2235 Record Systems [R-2]

### PALM — MONITORING SYSTEMS

The Patent Application Locating and Monitoring (PALM) system is used to support the reexamination process. The sections below delineate PALM related activities.

(A) *Reexamination File Data on PALM* — The routine PALM retrieval transactions are used to obtain data on reexamination files. \*\*>From the USPTO Intranet site <http://ptoweb/ptointranet/index.htm>, Office staff can click on “PALM” and then “General Information” which opens the PALM INTRANET General Information Display. From here, enter the patent number in the box labeled Patent #. Then click on “Search” and when the “Patent Number Information” appears, click on “Continuity Data” to obtain the reexamination number.<

(B) *Reexamination File Location Control* — The location of a reexamination file is monitored in the same manner as regular patent application files. \*\*>Certain< PALM transactions \*\* > differ between regular patent applications and reexamination files. For example, there are separate folders in PALM EXPO for reexaminations and for regular patent applications. In PRE-EXAM, there is a reexamination/reissue folder which does not apply to regular patent applications. Note also that some of the data entry for reexamination in PALM PRE-EXAM is different from that of a regular patent application. There are also differences in the status codes - all reexamination proceedings have status codes in the “400” range, while applications have status codes ranging from “020” to over “100”<

(C) *Patent File Location Control* — The movement of patent files related to requests for reexamination throughout the Office is monitored by the PALM system in the normal fashion. Within the Technology Centers (TCs), the reexamination file and patent file will be kept together, from initial receipt until the reexamination is assigned to an examiner for determination. At this point, the patent file will be charged to the examiner assigned the reexamination file \*\* and will be kept in the examiner's room until the proceeding is terminated. After the reexamination proceeding

has been terminated, the patent file should be forwarded with the reexamination file to the Office of Patent Legal Administration for review (see MPEP § 2289) and then to the Office of Publications. The Office of Publications will forward the patent file and the reexamination file to the Record Room after printing of the certificate.

(D) *Reporting Events to PALM* — The PALM system is used to monitor major events that take place in processing reexamination proceedings. During initial processing all major pre-*ex parte* examination events are reported. During the *ex parte* phase the mailing of examiner's actions are reported as well as owner's responses thereto. The TC reexamination clerk is responsible for reporting these events the reexamination icon and window initiated in the PALM EXPO program. The events that will be reported are as follows:

- (1) Determination Mailed — Denial of request for reexamination.
- (2) Determination Mailed — Grant of request for reexamination.
- (3) Petition for reconsideration of determination received.
- (4) Decision on petition mailed — Denied.
- (5) Decision on petition mailed — Granted.
- (6) Owner response to determination (owner's statement) received.
- (7) Requester response to determination (requester's reply) received.
- (8) The mailing of all examiner actions.
- (9) The receipt of owner's responses to examiner's actions and Office receipt date.

Each of these events, as well as additional events reported by the Reexamination Preprocessing Unit will be permanently recorded and displayed in the "Contents" portion of PALM. In addition, status representative of these events will also be displayed.

(E) *Status Reports* — Various weekly "tickler" reports can be generated for each TC given the event reporting discussed above. The primary purpose of these computer outputs is to assure that reexaminations are, in fact, processed with "special dispatch."

(1) *PALM Reports* — A number of automated reports generated from the PALM system are provided to the TCs at the beginning of each week. These reports serve to indicate to the TCs when certain deadlines are approaching. Each report is subdivided

by TC working group and lists the requests in control number sequence. The following reports have been identified.

(2) *Requests Not Yet Received in TC* — This report serves to indicate to a TC those requests assigned to it for which preprocessing has not been completed and which have not yet been received in the TC. This report provides an indicator of future workload as well as identifying potential, problem stragglers.

(3) *Requests Not Yet Assigned to an Examiner* — This report serves to highlight those requests which have not been assigned to an examiner by the 6th week since their filing. Requests appearing on this report should be located and docketed immediately.

(4) *Requests Which Should Be Taken Up for Determination* — This report lists those requests which have been assigned to an examiner and in which no determination has been mailed and the 6th week since their filing is past. Requests on this report should be taken up for determination by the examiner.

(5) *Requests for Which Determinations Should be Prepared* — This report lists those requests which have been assigned to an examiner and in which no determination has been mailed and the 2nd month since their filing is past. Determinations for requests on this report should be in the final stages of preparation.

(6) *\*Requests for Which Determinations Should Have Been Mailed* — This report lists those requests which have been assigned to an examiner and in which no determination has been mailed and the 10th week since their filing is past. Determinations for requests on this report should be mailed immediately.

(7) *\*Overdue Determinations* — This report lists those requests in which no determination has been mailed and the 3rd month since their filing is past. This report should always be zero.

(8) *Overdue Petitions for Reconsideration of a Denial* — This report lists those requests in which the determination denied reexamination and no petition has been received and 6 weeks have passed since the determination was mailed. Requests on this report should be terminated.

(9) *Overdue Owner Responses to Determinations* — This report lists those requests in which the determination ordered reexamination and the owner

has not filed a response and 10 weeks have passed since the mailing of the determination. These requests should be taken up for immediate *ex parte* action by the examiner.

(10) *Overdue Requester Responses to Statements* — This report lists those requests in which a proper OWNER statement was received and NO requester reply has been received and 10 weeks have passed since the receipt of the owner response. These requests should be taken up for immediate action.

(11) *\*Overdue First Ex Parte Actions* — This report lists those requests in which reexamination has been ordered and a first action has not been mailed and 6 weeks have passed since the request became available for *ex parte* prosecution. These requests should be taken up for immediate action by the examiner.

(12) *\*Overdue Action or Examiner's Answer* — This report lists those reexaminations which are up for second or subsequent action by the examiner and no such action has been mailed and 2 months have passed since the filing of an owner response to a previous action.

(13) *\*Overdue Advisory Action* — This report lists those reexaminations which are up for action by the examiner and no such action has been mailed and 1 month has passed since the filing of an owner response to a previous final action.

(14) *\*Overdue Owner Response* — This report lists those requests in which there has been an action rendered and 4 months have passed without an owner response.

(15) *\*Overdue Certificates* — This report lists those requests in which a Notice of Intent to Issue *\*Ex Parte* Reexamination Certificate has been mailed and 3 months have passed since its mailing and no issue date has been assigned.

(16) *\*Requests With Prolonged Prosecution* — This report lists pending requests which have not matured into a certificate and 15 months have passed since the date of filing.

\*Asterisk items require immediate action and follow-up, if appropriate.

(F) *Historical Reporting* — A variety of historical reports are possible given the event recording described above. Thus, such statistics as the number of requests filed and determinations made in a speci-

fied period or number or kind of reexaminations in which an appeal was filed can be made available.

## 2236 Assignment of Reexamination [R-2]

Reexamination requests should normally be assigned to the art unit which examines the class and subclass in which the patent to be reexamined is currently classified as an original. In that art unit, the Supervisory Patent Examiner (SPE) will assign the reexamination request to a primary examiner, other than the examiner who originally examined the patent application (see "Examiner Assignment Policy" below), who is most familiar with the claimed subject matter of the patent. When no such knowledgeable primary examiner is available, the reexamination may be assigned to an assistant examiner. In such an instance the SPE must sign all actions and take responsibility for all actions taken.

>

### I. < EXAMINER ASSIGNMENT POLICY

It is the policy of the Office that the SPE will assign the reexamination request to an examiner different from the examiner(s) who examined the patent application. Thus, under normal circumstances, the reexamination request will not be assigned to *\*a* SPE, primary examiner, or assistant examiner who was involved in any part of the examination of the patent for which reexamination is requested (e.g., by preparing/signing an action)>, or was so involved in the examination of the parent of the patent. This would preclude assignment of the request to an examiner who was a conferee in an appeal conference or patentability review conference in an earlier concluded examination of the patent (e.g., the application for patent, a reissue, or a prior concluded reexamination proceeding). The conferee is considered to have participated in preparing the Office action which is preceded by the conference.<

**Exceptions to this general policy include** cases where the SPE is the only primary examiner in the art unit, or where the original examiner is the only examiner with adequate knowledge of the relevant technology to examine the case. In the unusual case where there is a need to assign the request to the original examiner, the assignment must be approved by the Technology Center (TC) Director, and the fact that such approval was given by the TC Director must be

stated by the examiner in the decision on the request for reexamination.

>It should be noted that while an examiner who examined an earlier concluded reexamination proceeding is generally excluded from assignment of a newly filed reexamination, if the earlier reexamination is still ongoing, the same examiner will be assigned the new reexamination.

#### ***Copending reissue and reexamination proceedings:***

(A) When a reissue application is pending for a patent, and a reexamination request is filed for the same patent, the reexamination request is generally assigned to a different examiner even though the examiner who examined the patent application is handling the reissue application. If the reexamination request is granted and the reissue and reexamination proceedings are merged (see MPEP § 2285), the merged proceeding will be handled by the examiner assigned the reexamination proceeding. Thus, the reissue application would be transferred (reassigned) from the original examiner to the examiner who ordered reexamination.

(B) When a reexamination proceeding is pending for a patent, and a reissue application is filed for the same patent:

(1) Where reexamination has already been ordered (granted) in the reexamination proceeding, the reexamination file, the reissue application, and the patent file should be delivered to the Office of Patent Legal Administration (OPLA) promptly after the reissue application reaches the TC (see MPEP § 2285). If the reissue and reexamination proceedings are merged by OPLA, the reissue will be assigned in the TC (upon return of the files from OPLA) to the examiner handling the reexamination proceeding. If the reissue and reexamination proceedings are not merged by OPLA, the decision will provide guidance as to assignment of the reissue proceeding depending on the individual fact situation.

(2) If reexamination has not yet been ordered (granted) in the reexamination proceeding, the reissue application will be held in the Office of the TC Special Program Examiner (SPRE), and the decision on the reexamination request will be made. If reexamination is denied, the reexamination proceeding will be terminated pursuant to MPEP § 2294, and the reissue application assigned in accordance with MPEP §

1440. If reexamination is granted, the reexamination and reissue files will be held in the Office of the TC SPRE during the reexamination statement and reply periods (see MPEP §§ 2249 - 2251), and then forwarded with the patent file to OPLA (see MPEP § 2285). If the reissue and reexamination proceedings are merged by OPLA, the reissue will be assigned in the TC (upon return of the files from OPLA) to the examiner handling the reexamination proceeding. If the reissue and reexamination proceedings are not merged by OPLA, the decision will provide guidance as to assignment of the reissue proceeding depending on the individual fact situation.

## **II. < CONSEQUENCES OF INADVERTENT \* >ASSIGNMENT< TO AN “ORIGINAL EXAMINER”**

Should a reexamination be inadvertently assigned to an “original examiner” (in a situation where the TC Director’s approval is not stated in the decision on the request), the patent owner or the third party requester who objects must promptly file a paper alerting the Office of this fact. Any request challenging the assignment of an examiner to the case must be made within two months of the first Office action or other Office communication indicating the examiner assignment, or reassignment will not be considered. Reassignment of the reexamination to a different examiner will be addressed on a case-by-case basis. In no event will the assignment to the original examiner, by itself, be grounds for vacating any Office decision(s) or action(s) and “restarting” the reexamination.

>A situation may arise where a party timely (i.e., within the two months noted above) files a paper alerting the Office to the assignment of a reexamination to the “original examiner,” but that paper does not have a right of entry under the rules. An example of this is where a third party requester becomes aware of the assignment to the “original examiner” via that examiner signing the order for reexamination, and the patent owner does not file a statement under 37 CFR 1.530. In that situation, the third party requester cannot file a reply under 37 CFR 1.535, and thus has no way to present the paper directed to the examiner assignment (no right of entry under the rules). In situations where a paper directed to the examiner assignment has no right of entry under the rules, the Office



may waive the rules to the extent that the paper directed to the examiner assignment will be entered and considered.<

## 2237 Transfer Procedure [R-2]

Although the number of reexamination requests which must be transferred should be very small, the following procedures have been established for an expeditious resolution of any such problems.

No transfer inquiry forms (PTO-447A) should be used in reexamination situations. The supervisory patent examiner (SPE) to whose art unit the reexamination has been assigned should, when transfer is desired, hand-carry the patent file >and the reexamination file< to the SPE of the art unit to which a transfer is desired. Any conflict which cannot be resolved by the supervisory patent examiners will be resolved by the \*>Technology Center (TC)< Directors involved.

If the “new” art unit accepts assignment of the reexamination request, the “new” SPE assigns the request to an examiner, and the “new” TC’s reexamination clerk PALMs in the request. In addition, the Offices of the Special Program Examiner for both TCs must be notified of the transfer by the respective SPEs.

## 2238 Time Reporting [R-2]

>

### I. <CLERICAL TIME REPORTING

Both the Program Management System (PMS) and Payroll systems now used to monitor clerical time have been modified to report reexamination activities. Time devoted to processing actual reexamination files in the Technology Centers (TCs) should be reported using the appropriate PMS Code and Project Code. It should be noted that all clerical time consumed by reexamination activities must be reported in the above manner. Such activities as supervision, copying, typing, and docketing should be included.

>

### II. <PROFESSIONAL TIME REPORTING

(A) Reexamination fees are based on full cost recovery and it is essential that all time expended on reexamination activities be reported accurately. Thus, directors, supervisory patent examiners (SPEs), exam-

iners and members of the Board of Patent Appeals and Interferences should report time spent on >*ex parte*< reexamination on their individual Time and Attendance Report using the following Project Codes:

119051 — Used to report all activities related to a specific reexamination proceeding up until the time *ex parte* prosecution is begun.

119052 — Used to report all activities related to a specific reexamination proceeding from the time it is taken up for first, *ex parte*, action until the issuance of a certificate takes place.

>112084 — Used to report SPE review and training of examiners in the examination of reexamination cases.<

Examiners and SPEs will use the above codes to report their time for reexamination activities on \*\*>their< Biweekly Time \*\* >Worksheets<.

Time reported using codes 119051 and 119052 will also be reported in the Examiner Production System as “Other” time.

(B) TC Special Program Examiners and paralegals will use 1407-30 as the code to report their time for reexamination activities on the Biweekly Time Worksheet Paralegal/Special Program Examiner (PTO-690 P/S).

## 2239 Reexamination Ordered at the \* >Director’s< Initiative [R-2]

\*\*>

37 CFR 1.520. *Ex parte* reexamination at the initiative of the Director.

The Director, at any time during the period of enforceability of a patent, may determine whether or not a substantial new question of patentability is raised by patents or printed publications which have been discovered by the Director or which have been brought to the Director’s attention, even though no request for reexamination has been filed in accordance with § 1.510 or § 1.913. The Director may initiate *ex parte* reexamination without a request for reexamination pursuant to § 1.510 or § 1.913. Normally requests from outside the Office that the Director undertake reexamination on his own initiative will not be considered. Any determination to initiate *ex parte* reexamination under this section will become a part of the official file of the patent and will be mailed to the patent owner at the address as provided for in § 1.33(c).<

The \* >Director of the USPTO< may initiate reexamination without a request being filed and without a fee being paid. Such reexamination may be ordered at any time during the period of enforceability of the patent.

The decision to order reexamination at the \* >Director's< initiative is normally made by the Deputy Commissioner for Patent Examination Policy after a review of all the facts concerning the patent. It may also be made by the \* >Director of the USPTO<, the Deputy \* >Director< or the \* Commissioner for Patents. The number of such \*\* >Director-initiated< orders is expected to be very small.

If an Office employee becomes aware of an unusual fact situation in a patent which he or she considers to clearly warrant reexamination, a memorandum setting forth these facts (including a proposed rejection of all appropriate claims) along with the patent file and any prior >art< patents or printed publications should be forwarded to the \*\* >Office of the Patent Legal Administration (OPLA)< through the >Technology Center (TC)< supervisory chain of command. A disk having the memorandum in electronic format should be included with the paper copy of the memorandum.

If an order to reexamine is to be issued, the decision is prepared in the \*\* >OPLA<. The decision is signed by the Deputy Commissioner for Patent Examination Policy and mailed by the OPLA. The patent file is then forwarded to the reexamination preprocessing staff for preparation of the reexamination file and *Official Gazette* notice.

After the reexamination preprocessing staff of the Central Reexamination Unit (CRU) has completed its preparation of the reexamination file, the file will be forwarded to the appropriate \*\* >TC<. Examination and prosecution will then proceed without further communication with anyone but the patent owner.

If the Deputy Commissioner for Patent Examination Policy refuses to issue an order for reexamination, no record of any consideration of the matter will be placed in the patent file and the patent owner will not be notified.

The \* >Director of the USPTO< will not normally consider requests to order reexamination at the \* >Director's< initiative received from members of the public. If a member of the public desires reexamination, a request and fee should be filed in accordance with 37 CFR 1.510.

## 2240 Decision on Request [R-2]

35 U.S.C. 303. *Determination of issue by Director.*

>

(a) Within three months following the filing of a request for reexamination under the provisions of section 302 of this title, the

Director will determine whether a substantial new question of patentability affecting any claim of the patent concerned is raised by the request, with or without consideration of other patents or printed publications. On his own initiative, and any time, the Director may determine whether a substantial new question of patentability is raised by patents and publications discovered by him or cited under the provisions of section 301 of this title. The existence of a substantial new question of patentability is not precluded by the fact that a patent or printed publication was previously cited by or to the Office or considered by the Office.<

(b) A record of the Director's determination under subsection (a) of this section will be placed in the official file of the patent, and a copy promptly will be given or mailed to the owner of record of the patent and to the person requesting reexamination, if any.

(c) A determination by the Director pursuant to subsection (a) of this section that no substantial new question of patentability has been raised will be final and nonappealable. Upon such a determination, the Director may refund a portion of the reexamination fee required under section 302 of this title.

### 37 CFR 1.515. *Determination of the request for ex parte reexamination.*

(a) Within three months following the filing date of a request for an *ex parte* reexamination, an examiner will consider the request and determine whether or not a substantial new question of patentability affecting any claim of the patent is raised by the request and the prior art cited therein, with or without consideration of other patents or printed publications. The examiner's determination will be based on the claims in effect at the time of the determination, will become a part of the official file of the patent, and will be mailed to the patent owner at the address as provided for in § 1.33(c) and to the person requesting reexamination.

(b) Where no substantial new question of patentability has been found, a refund of a portion of the fee for requesting *ex parte* reexamination will be made to the requester in accordance with § 1.26(c).

>

(c) The requester may seek review by a petition to the Director under § 1.181 within one month of the mailing date of the examiner's determination refusing *ex parte* reexamination. Any such petition must comply with § 1.181(b). If no petition is timely filed or if the decision on petition affirms that no substantial new question of patentability has been raised, the determination shall be final and nonappealable.<

Before making a determination on the request for reexamination, the examiner must request a litigation computer search by the Scientific and Technical Information Center (STIC) to check if the patent has been, or is, involved in litigation. The "Litigation Review" box on the reexamination file wrapper should be completed to indicate that the review was conducted and the results thereof. A copy of the STIC search should be hole-punched and placed on the right side of the

reexamination file. In the rare instance where the record of the reexamination proceeding or the STIC search indicates that additional information is desirable, guidance as to making an additional litigation search may be obtained from the library of the Office of the Solicitor. If the patent is or was involved in litigation, and a paper referring to the court proceeding has been filed, reference to the paper by number should be made in the "Litigation Review" box as "litigation; see paper #1C". If a litigation records search is already noted on the file, the examiner need not repeat or update it.

If litigation has concluded or is taking place in the patent on which a request for reexamination has been filed, the request must be promptly brought to the attention of the Technology Center (TC) \*\* Special Program Examiner, \*\* who should review the decision on the request and any examiner's action to ensure that it conforms to the current Office litigation policy and guidelines. See MPEP § 2286.

35 U.S.C. 303 requires that within 3 months following the filing of a request for reexamination, the \* >Director of the USPTO< will determine whether or not the request raises a "substantial new question of patentability" affecting any claim of the patent of which reexamination is desired. See also MPEP § 2241. Such a determination may be made with or without consideration of other patents or printed publications in addition to those cited in the request. No input from the patent owner is considered prior to the determination, unless the patent owner filed the request. See *Patlex Corp. v. Mossinghoff*, 771 F.2d 480, 226 USPQ 985 (Fed. Cir. 1985).

The patent claims in effect at the time of the determination will be the basis for deciding whether a substantial new question of patentability has been raised. 37 CFR 1.515(a). Amendments which (1) have been presented with the request if by the patent owner, (2) have been filed in a pending reexamination proceeding in which the certificate has not been issued, or (3) have been submitted in a reissue application on which no reissue patent has been issued, will not be considered or commented upon when deciding requests.

The decision on the request for reexamination has as its object either the granting or denial of an order for reexamination. This decision is based on whether or not "a substantial new question of patentability" is found. A final determination as to unpatentability of the claims is not made in the decision; this determination will be made during the examination stage of the reexamination proceedings. Accordingly, no *prima facie* case of unpatentability need be found to grant an order for reexamination. If a decision to deny an order for reexamination is made, the requester may seek review by a petition under CFR 1.181. See 37 CFR 1.515(c). \*\*

It is only necessary to establish that a substantial new question of patentability exists as to any one of the patent claims in order to order reexamination. In the examination stage of the reexamination, normally all patent claims will be reexamined, even where the order has made a finding of a substantial new question for less than all of the patent claims. However, where there has been a prior Federal Court decision as to some claims, see MPEP § 2242 >as to whether those claims are examined<. The decision on the request should discuss ALL patent claims in order to inform the patent owner of the examiner's position, so that a response thereto may be made in the patent owner's statement.

The examiner should indicate, insofar as possible, his or her initial position on all the issues identified in the request or by the requester so that comment thereon may be received in the patent owner's statement and in the requester's reply. \*\* >The examiner should limit the discussion of the claims as to whether or not a substantial new question of patentability has been raised; the examiner **should not** reject the claims in the order for *ex parte* reexamination.<

The \*\* >Director of the USPTO< has the authority to order reexamination only in those cases which raise a substantial new question of patentability. The substantial new question of patentability requirement protects patentees from having to respond to, or participate in unjustified reexaminations. *Patlex Corp. v. Mossinghoff*, 771 F.2d 480, 226 USPQ 985 (Fed. Cir. 1985).

&gt;

### I. REQUEST FOR REEXAMINATION OF THE PATENT AFTER REISSUE OF THE PATENT

Where a request for reexamination is filed on a patent after a reissue patent for that patent has already issued, reexamination will be denied, because the patent on which the request for reexamination is based has been surrendered. Should reexamination of the reissued patent be desired, a new request for reexamination, including and based on the specification and the claims of the reissue patent, must be filed. Where the reissue patent issues after the filing of a request for reexamination, see MPEP § 2285.

### II. < SECOND OR SUBSEQUENT REQUEST FILED DURING REEXAMINATION

If a second or subsequent request for *>ex parte<* reexamination is filed (by any party) while a *>first ex parte<* reexamination is pending, the presence of a substantial new question of patentability depends on the prior art *>(patents and printed publications)<* cited by the second or subsequent requester. If the requester includes in the second or subsequent request prior art which raised a substantial new question in the pending reexamination, reexamination should \* be ordered \*\* *>only if the prior art cited raises a substantial new question of patentability which is different than that raised in the pending reexamination proceeding. If the prior art cited raises the same substantial new question of patentability as that raised in the pending reexamination proceedings, the second or subsequent request should be denied.<* However, in aggravated situations, \*\* *>after a grant of a second or subsequent request for ex parte reexamination, where (A)< the patent owner >files a petition< under 37 CFR 1.182 \* >as part of the statement or as the statement, and (B)< it appears clear that the second or subsequent request was filed for purposes of harassment of the patent owner, \*\*>if the petition is granted, prosecution on the second or subsequent reexamination would be suspended<. The grant of such a request would unduly prolong the conclusion of the pending reexamination and be inconsistent with the requirement that reexamination proceeding be conducted with special dispatch. If the second or subsequent requester does not include the prior art which raised a substantial new question of patentability in the pending reexami-*

nation, reexamination may or may not be ordered depending on whether the different prior art raises a substantial new question of patentability. The second or subsequent request should be determined on its own merits without reference to the pending reexamination.

For cases in which a *>first ex parte<* reexamination is pending at the time a second or subsequent request for *>ex parte<* reexamination is to be decided, see MPEP § 2283.

*>For cases in which either the first or subsequent request for reexamination, or both, is/are an inter partes reexamination proceeding, see MPEP § 2640 and § 2686.01.<*

### 2241 Time for Deciding Request [R-2]

The determination *>of<* whether or not to reexamine must be made within 3 months following the filing date of a request. See 35 U.S.C. 303(a) and 37 CFR 1.515(a). *>If the 3-month period ends on a Saturday, Sunday, or Federal holiday within the District of Columbia, then the determination must be mailed by the preceding business day.<* The examiner should take up a request for decision about 6 weeks after the request was filed. The decision should be mailed within 10 weeks of the filing date of the request. When reexamination for the same patent has already been ordered based on an earlier request and that reexamination is pending, the examiner should immediately take up the new request for decision, i.e., there should be no delay of 6 weeks. See the last portion of MPEP § 2240 and also see MPEP § 2283 for multiple copending reexamination proceedings. A determination to reexamine may be made at any time during the period of enforceability of a patent.

### 2242 Criteria for Deciding Request [R-2]

&gt;

#### I. < SUBSTANTIAL NEW QUESTION OF PATENTABILITY

The presence or absence of “a substantial new question of patentability” determines whether or not reexamination is ordered. The meaning and scope of the term “a substantial new question of patentability” is not defined in the statute and must be developed to

some extent on a case-by-case basis, using the case law to provide guidance as will be discussed in this section.

If the prior art patents and printed publications raise a substantial question of patentability of at least one claim of the patent, then a substantial new question of patentability is present, unless the same question of patentability has already been decided by (\*>A<) a final holding of invalidity \*\*>, after all appeals<, or (\*>B<) by the Office in a previous examination >or pending reexamination< of the patent. A “previous examination” of the patent is: (\*>A<) the original examination of the application which matured into the patent; (\*>B<) the examination >of the patent< in a reissue application that has resulted in a reissue of the patent; or \*>(C) the examination of the patent in< an earlier concluded reexamination. The answer to the question of whether a “substantial new question of patentability” exists, and therefore whether reexamination may be had, is decided by the \*>Director of the USPTO<, and, as 35 U.S.C. 303 provides, that determination is final, i.e., not subject to appeal on the merits of the decision. See *In re Etter*, 756 F.2d 852, 225 USPQ 1 (Fed. Cir. 1985). But see *Heinl v. Godici*, 143 F.Supp.2d 593, 596-98 (E.D.Va. 2001) (35 U.S.C. 303 addresses only USPTO decisions to deny a request for reexamination and does not bar review of USPTO decisions to grant reexamination requests. However, a decision to grant a reexamination request is not a final agency decision and is not ordinarily subject to judicial review.).

A prior art patent or printed publication raises a substantial question of patentability where there is a substantial likelihood that a reasonable examiner would consider the prior art patent or printed publication important in deciding whether or not the claim is patentable. \*\* If the prior art patents and/or publications would be considered important, then the examiner should find “a substantial new question of patentability” unless the same question of patentability has already been decided as to the claim in a final holding of invalidity by \* >the< Federal court >system< or by the Office in a previous examination. For example, the same question of patentability may have already been decided by the Office where the examiner finds the additional >(newly provided)< prior art patents or printed publications are merely cumulative

to similar prior art already fully considered by the Office in a previous examination of the claim.

For “a substantial new question of patentability” to be present, it is only necessary that: (\*>A<) the prior art patents and/or printed publications raise a substantial question of patentability regarding at least one claim, i.e., the teaching of the (prior art) patents and printed publications is such that a reasonable examiner would consider the teaching to be important in deciding whether or not the claim is patentable; and (\*>B<) the same question of patentability as to the claim has not been decided by the Office in a previous examination >or pending reexamination< of the patent or in a final holding of invalidity by the Federal Courts in a decision on the merits involving the claim. It is not necessary that a “*prima facie*” case of unpatentability exist as to the claim in order for “a substantial new question of patentability” to be present as to the claim. Thus, “a substantial new question of patentability” as to a patent claim could be present even if the examiner would not necessarily reject the claim as either fully anticipated by, or obvious in view of, the prior >art< patents or printed publications. As to the importance of the difference between “a substantial new question of patentability” and a “*prima facie*” case of unpatentability see generally *In re Etter*, 756 F.2d 852, 857 n.5, 225 USPQ 1, 4 n.5 (Fed. Cir. 1985).

>

## II. POLICY IN SPECIFIC SITUATIONS<

In order to further clarify the meaning of “a substantial new question of patentability” certain situations are outlined below which, if present, should be considered when making a decision as to whether or not “a substantial new question of patentability” is present.

\*\*

### A. *Prior Favorable Decisions by the U.S. Patent and Trademark Office (Office) on the Same or Substantially Identical Prior Art in Relation to the Same Patent.*

A “substantial new question of patentability” is not raised by prior art presented in a reexamination request if the Office has previously considered (in an earlier examination of the patent) the same question of patentability as to a patent claim favorable to the

patent owner based on the same prior art patents or printed publications. *In re Recreative Technologies*, 83 F.3d 1394, 38 USPQ2d 1776 (Fed. Cir. 1996).

\*\* >In deciding whether to grant a request for reexamination of a patent, the examiner should check the patent's file history to ascertain whether any of the prior art now advanced by requester was previously cited/considered in an earlier concluded Office examination of the patent (e.g., in the examination of the application for the patent). For the sake of expediency, such art is referred to as "old art" throughout, since the term "old art" was coined by the Federal Circuit in its decision of *In re Hiniker*, 150 F.3d 1362, 1365-66, 47 USPQ2d 1523, 1526 (Fed. Cir. 1998).

In a decision to order reexamination made on or after November 2, 2002, reliance on old art does not necessarily preclude the existence of a substantial new question of patentability (SNQ) that is based exclusively on that old art. >See Public Law 107-273, 116 Stat. 1758, 1899-1906 (2002), which expanded the scope of what qualifies for a substantial new question of patentability upon which a reexamination may be based.< Determinations on whether a SNQ exists in such an instance shall be based upon a fact-specific inquiry done on a case-by-case basis. For example, a SNQ may be based solely on old art where the old art is being presented/viewed in a new light, or in a different way, as compared with its use in the earlier concluded examination(s), in view of a material new argument or interpretation presented in the request.

When it is determined that a SNQ based solely on old art is raised, form paragraph 22.01.01 should be included in the order for reexamination.

¶ 22.01.01 *Criteria for Applying "Old Art" as Sole Basis for Reexamination*

The above [1] is based solely on patents and/or printed publications already cited/considered in an earlier concluded examination of the patent being reexamined. On November 2, 2002, Public Law 107-273 was enacted. Title III, Subtitle A, Section 13105, part (a) of the Act revised the reexamination statute by adding the following new last sentence to 35 U.S.C. 303(a) and 312(a):

"The existence of a substantial new question of patentability is not precluded by the fact that a patent or printed publication was previously cited by or to the Office or considered by the Office."

For any reexamination ordered on or after November 2, 2002, the effective date of the statutory revision, reliance on previously

cited/considered art, i.e., "old art," does not necessarily preclude the existence of a substantial new question of patentability (SNQ) that is based exclusively on that old art. Rather, determinations on whether a SNQ exists in such an instance shall be based upon a fact-specific inquiry done on a case-by-case basis.

In the present instance, there exists a SNQ based solely on [2]. A discussion of the specifics now follows:

[3]

**Examiner Note:**

1. In bracket 1, insert "substantial new question of patentability" if the present form paragraph is used in an order granting reexamination (or a TC Director's decision on petition of the denial of reexamination). If this form paragraph is used in an Office action, insert "ground of rejection".
2. In bracket 2, insert the old art that is being applied as the sole basis of the SNQ. For example, "the patent to Schor" or "the patent to Schor when taken with the Jones publication" or "the combination of the patent to Schor and the Smith publication" could be inserted. Where more than one SNQ is presented based solely on old art, the examiner would insert all such bases for SNQ.
3. In bracket 3, for each basis identified in bracket 2, explain how and why that fact situation applies in the proceeding being acted on. The explanation could be for example that the old art is being presented/viewed in a new light, or in a different way, as compared with its use in the earlier concluded examination(s), in view of a material new argument or interpretation presented in the request. See *Ex parte Chicago Rawhide Mfg. Co.*, 223 USPQ 351 (Bd. Pat. App. & Inter. 1984).
4. This form paragraph is only used the first time the "already cited/considered" art is applied, and is not repeated for the same art in subsequent Office actions.

See MPEP § 2258.01 for a discussion of the use of "old art" in the examination stage of an ordered reexamination (as a basis for rejecting the patent claims).<

**B. *Prior Adverse Decisions by the Office on the Same or Substantially Identical Prior Art in the Same Patent.***

A prior decision adverse to the patentability of a claim of a patent by the Office based upon prior art patents or printed publications would usually mean that "a substantially new question of patentability" is present. Such an adverse decision by the Office could, for example, arise from a reissue application which was abandoned after rejection of the claim and without disclaiming the patent claim.

**C. *Prior Adverse Reissue Application Final Decision by the \* >Director of the USPTO< or the Board of Patent Appeals and Interferences***

***Based Upon Grounds Other Than Patents or Printed Publications.***

Any prior adverse final decision by the \*>Director of the USPTO< or the Board of Patent Appeals and Interferences, on an application seeking to reissue the same patent on which reexamination is requested will be considered by the examiner when determining whether or not a “substantial new question of patentability” is present. To the extent that such prior adverse final decision was based upon grounds other than patents or printed publications, the prior adverse final decision will not be a basis for determining whether or not a “substantial new question of patentability” is present.

***D. Prior Favorable or Adverse Decisions on the Same or Substantially Identical Prior >Art< Patents or Printed Publications in Other Cases not Involving the Patent.***

While the Office would consider decisions involving substantially identical patents or printed publications in determining whether a “substantial new question of patentability” is raised, the weight to be given such decisions will depend upon the circumstances. \*\*

>

**III. < POLICY WHERE A FEDERAL COURT DECISION HAS BEEN ISSUED ON THE PATENT**

***A. Final \* Holding of Validity >by the Courts<.***

When the initial question as to whether the prior art raises a substantial new question of patentability as to a patent claim is under consideration, the existence of a final court decision of claim *validity* in view of the same or different prior art does not necessarily mean that no new question is present, because of the different standards of proof employed by the Federal District Courts and the Office. While the Office may accord deference to factual findings made by the district court, the determination of whether a substantial new question of patentability exists will be made independently of the court’s decision on validity, because it is not controlling on the Office.

***B. Nonfinal \* Holding of Invalidity or Unenforceability >by the Courts<.***

A *nonfinal* holding of claim *invalidity* or unenforceability will not be controlling on the question of whether a substantial new question of patentability is present.

***C. Final \* Holding of Invalidity or Unenforceability >by the Courts<.***

A *final* holding of claim *invalidity* or unenforceability>, after all appeals,< is controlling on the Office. In such cases, a substantial new question of patentability would *not* be present as to the claims finally held invalid or unenforceable.

As to A. - C. above, see *Ethicon v. Quigg*, 849 F.2d 1422, 7 USPQ2d 1152 (Fed. Cir. 1988).

Any situations requiring clarification should be brought to the attention of the Office of Patent Legal Administration.

**2243 Claims Considered in Deciding Request**

The claims in effect at the time of the determination will be the basis for deciding whether “a substantial new question of patentability” is present. 37 CFR 1.515(a). While the examiner will ordinarily concentrate on those claims for which reexamination is requested, the finding of “a substantial new question of patentability” can be based upon a claim of the patent other than the ones for which reexamination is requested. For example, the request might seek reexamination of particular claims, but the examiner is not limited to those claims and can make a determination that “a substantial new question of patentability” is present as to other claims in the patent without necessarily finding “a substantial new question” with regard to the claims requested. If a substantial new question of patentability is found as to any claim, reexamination will be ordered and will normally cover all claims except where some claims have been finally held invalid in a Federal Court decision on the merits. The decision should discuss all patent claims in order to inform the patent owner of the examiner’s position. See MPEP § 2242 for patent claims which have been the subject of a prior decision. Amendments or new claims will not be considered or commented upon when deciding a request.

## 2244 Prior Art on Which the Determination Is Based [R-2]

The determination whether or not “a substantial new question of patentability” is present can be based upon any prior art patents or printed publications. 35 U.S.C. 303(a) and 37 CFR 1.515(a) provide that the determination on a request will be made “with or without consideration of other patents or printed publications,” i.e., other than those relied upon in the request. The examiner is not limited in making the determination based on the patents and printed publications relied on in the request. The examiner can find “a substantial new question of patentability” based upon the prior art patents or printed publications relied on in the request, a combination of the prior art relied on in the request and other prior art found elsewhere, or based entirely on different patents or printed publications. The primary source of patents and printed publications used in making the determination are those relied on in the request. For reexamination ordered on or after November 2, 2002, see MPEP § 2242, subsection II.A. for a discussion of “old art.” The examiner can also consider any patents and printed publications of record in the patent file from submissions under 37 CFR 1.501 which are in compliance with 37 CFR 1.98 in making the determination. If the examiner believes that additional prior art patents and publications can be readily obtained by searching to supply any deficiencies in the prior art cited in the request, the examiner can perform such an additional search. Such a search should be limited to that area most likely to contain the deficiency of the prior art previously considered and should be made only where there is a reasonable likelihood that prior art can be found to supply any deficiency necessary to “a substantial new question of patentability.”

The determination should be made on the claims in effect at the time the decision is made (37 CFR 1.515(a)).

The Director of the USPTO has the authority to order reexamination only in those cases which raise a substantial new question of patentability. The substantial new question of patentability requirement protects patentees from having to respond to, or participate in unjustified reexaminations. See, e.g.,

*Patlex Corp. v. Mossinghoff*, 771 F.2d 480, 226 USPQ 985 (Fed. Cir. 1985).

## 2245 Processing of Decision

After the examiner has prepared the decision and proofread and signed the typed version, the reexamination file and decision are given to the Technology Center’s (TC’s) reexamination clerk for coordinating the clerical processing carried out by the technical support staff.

The technical support staff then prints the heading on the decision by using the computer terminal. If the request was made by a third party, the technical support staff makes 3 copies of any prior art documents not already supplied by or to the patent owner or requester. If the patent owner filed the request, only 2 copies are required.

A copy of the decision is then mailed to the patent owner and to any third party, along with any required copies of prior art documents. The original signed copy of the decision and a copy of any prior art enclosed is made of record in the reexamination file.

The reexamination file is then returned to the special storage area in the TC.

## 2246 Decision Ordering Reexamination [R-2]

*35 U.S.C. 304. Reexamination order by Director.*

If, in a determination made under the provisions of subsection 303(a) of this title, the Director finds that a substantial new question of patentability affecting any claim of a patent is raised, the determination will include an order for reexamination of the patent for resolution of the question. The patent owner will be given a reasonable period, not less than two months from the date a copy of the determination is given or mailed to him, within which he may file a statement on such question, including any amendment to his patent and new claim or claims he may wish to propose, for consideration in the reexamination. If the patent owner files such a statement, he promptly will serve a copy of it on the person who has requested reexamination under the provisions of section 302 of this title. Within a period of two months from the date of service, that person may file and have considered in the reexamination a reply to any statement filed by the patent owner. That person promptly will serve on the patent owner a copy of any reply filed.

*37 CFR 1.525. Order for ex parte reexamination.*

(a) If a substantial new question of patentability is found pursuant to § 1.515 or § 1.520, the determination will include an order for *ex parte* reexamination of the patent for resolution of the question. If the order for *ex parte* reexamination resulted from a petition pursuant to § 1.515(c), the *ex parte* reexamination will



ordinarily be conducted by an examiner other than the examiner responsible for the initial determination under § 1.515(a).

(b) The notice published in the *Official Gazette* under § 1.11(c) will be considered to be constructive notice and *ex parte* reexamination will proceed.

If the request is granted, the examiner will conclude that a substantial new question of patentability has been raised by identifying all claims and issues, the patents and/or printed publications relied on, and a brief statement of the rationale supporting each new question.

In the examiner's decision, the examiner must identify at least one substantial new question of patentability and explain how the prior art patents and/or printed publications raise such a question. The examiner should indicate, insofar as possible, his or her initial position on all the issues identified in the request or by the requester (without rejecting claims) so that comment thereon may be received in the patent owner's statement and in the requester's reply. The prior art relied on should be listed on a form PTO-892 if it is not already listed on a form PTO-1449 by the requester. A copy of a reference should be supplied only where it has not been previously supplied to the patent owner and requester.

As to each substantial new question of patentability identified in the decision, the decision should point out:

(A) The prior art patents and printed publications which add some new teaching as to at least one claim;

(B) What that new teaching is;

(C) The claims that the new teaching is directed to;

(D) That the new teaching was not previously considered nor addressed in the prior examination of the patent or a final holding of invalidity by the Federal Courts;

(E) That the new teaching is such that a reasonable examiner would consider the new teaching to be important in deciding to allow the claim being considered; and

(F) Where the question is raised, or where it is not clear that a patent or printed publication pre-dates the patent claims, a discussion should be provided as to why the patent or printed publication is deemed to be available against the patent claims.

See MPEP § 2247.01 for an example of a decision granting a request for reexamination.

In a simple case, the examiner may adopt the reasons provided by the requester in the discussion of the substantial new question of patentability.

In the decision on the request, the examiner will not decide, and no statement should be made as to, whether the claims are rejected over the patents and printed publications. The examiner does not decide on the question of patentability of the claims in the decision on the request. The examiner only decides whether there is a substantial new question of patentability to grant the request to order reexamination.

If arguments are raised by a requester (third party or patent owner) as to grounds not based on the patents or printed publications, such as those based on public use or sale, or abandonment under 35 U.S.C. 102(c), the examiner should note that such grounds are improper for reexamination and are not considered or commented upon. See 37 CFR 1.552(c).

The decision granting the request is made on a decision form and must set forth the time periods for the patent owner and requester to file their statement and any reply thereto.

\*\* Form paragraph 22.01 should be used at the end of each decision letter.

\*\*>

#### ¶ 22.01 New Question of Patentability

A substantial new question of patentability affecting claim [1] of United States Patent Number [2] is raised by the request for *ex parte* reexamination.

Extensions of time under 37 CFR 1.136(a) will not be permitted in these proceedings because the provisions of 37 CFR 1.136 apply only to "an applicant" and not to parties in a reexamination proceeding. Additionally, 35 U.S.C. 305 requires that *ex parte* reexamination proceedings "will be conducted with special dispatch" (37 CFR 1.550(a)). Extensions of time in *ex parte* reexamination proceedings are provided for in 37 CFR 1.550(c).<

Upon determination that a substantial new question of patentability is present, either pursuant to a request under 35 U.S.C. 302 and 37 CFR 1.515, or a *sua sponte* determination under 35 U.S.C. 303(a), second sentence, and 37 CFR 1.520, the Director of the USPTO issues an order to reexamine. The statutory wording is that:

[T]he determination [that a substantial new question of patentability is raised] will include an order for reexami-

nation of the patent for resolution of the question. [35 U.S.C. 304, first sentence]

>

### I. < PETITION TO VACATE THE ORDER GRANTING REEXAMINATION

A substantive determination by the \* >Director of the USPTO< to institute reexamination pursuant to a finding that the prior art patents or printed publications raise a substantial new question of patentability is not subject to review by the courts until a final agency decision in the reexamination proceeding has issued. See *Joy Mfg. Co. v. Nat'l Mine Serv. Co., Inc.*, 810 F.2d 1127, 1 USPQ2d 1627 (Fed. Cir. 1987); *Heinl v. Godici*, 143 Supp.2d 593 (E.D.Va. 2001). Note further the decision of *Patlex Corp. v. Quigg*, 6 USPQ2d 1296, 1298 (D.D.C. 1988) (the legislative scheme leaves the \*>Director's< 35 U.S.C. 303 determination entirely to his or her discretion and not subject to judicial review until a final agency decision on the reexamination proceeding has issued). Accordingly, neither the patent owner nor the requester has a right to petition, or request reconsideration of, a finding that prior art patents or printed publications raise a substantial new question after a request for reexamination is granted. There is no right to petition such a finding after a request for reexamination is granted even if the finding of a substantial new question is based on reasons other than those urged by the requester (or based on less than all the grounds urged by the requester). Where the examiner determines that a date of a reference is early enough such that the reference constitutes prior art, that determination is not petitionable (with respect to vacating the examiner's finding of a substantial new question). Where the examiner determines that a reference is a printed publication (i.e., that the criteria for publication has been satisfied), that determination is also not petitionable. These matters cannot be questioned with respect to vacating the order granting reexamination until a final agency decision on the reexamination proceeding has issued. Rather, these matters can be argued by the patent owner and appealed during the examination phase of the reexamination proceeding.

A petition under 37 CFR 1.181 may, however, be filed to vacate an *ultra vires* reexamination order, such as where the order for reexamination is not based on prior art patents and printed publications. In cases

where no discretion to grant a request for reexamination exists, a petition to vacate the decision to grant, or a request for reconsideration, will be entertained. "Appropriate circumstances" under 37 CFR 1.181(a)(3) exist to vacate the order granting reexamination where, for example:

(A) the reexamination order is not based on prior >art< patents or printed publications;

(B) all claims of the patent were held to be invalid by a final decision of a Federal Court >after all appeals<;

(C) reexamination was ordered for the wrong patent;

(D) reexamination was ordered based on a duplicate copy of the request; or

(E) the reexamination order is based wholly on >the same question of patentability raised by the< prior art previously considered in an earlier concluded examination of the patent by the Office (e.g., the application which matured into the patent, a prior reexamination, an interference proceeding).

As to (E) above, the \*\*>decision of< *In re Recreative Technologies Corp.*, 83 F.3d 1394, 38 USPQ2d 1776 (Fed. Cir. 1996) \*>is< to be noted. See the discussion in MPEP § 2242 >subsection II.A.< as to the criteria for vacating a reexamination order in view of the decisions.

When a petition under 37 CFR 1.181 is filed to vacate an reexamination order, the third party requester (where one is present in the reexamination proceeding) may file a single submission in opposition to the petition. Because reexamination proceedings are conducted with special dispatch, 35 U.S.C. 305, any such opposition by the third party requester must be filed within two weeks of the date upon which a copy of the original 37 CFR 1.181 petition was served on the third party requester to ensure consideration. It is advisable that, upon receipt and review of the served copy of such a 37 CFR 1.181 petition which the third party requester intends to oppose, the requester should immediately place a courtesy telephone call to the Special Program Examiner in the Technology Center in which the reexamination proceeding is pending to notify the Office that an opposition to the 37 CFR 1.181 petition will be filed. Whenever possible, filing of the opposition should be submitted by facsimile transmission.

The filing of a 37 CFR 1.181 petition to vacate an *ultra vires* reexamination order is limited to a single submission, even if an opposition thereto is filed by a third party requester.

>

## II. <PRIOR ART SUBMITTED AFTER THE ORDER

Any prior art citations under 37 CFR 1.501 submitted after the date of the decision on the order should be retained in a separate file by the >Technology Center (usually the TC Special Program Examiner)< and stored until the reexamination proceeding is terminated, at which time the prior art citation is then entered of record on the patent file. See MPEP § 2206.

### 2247 Decision on Request for Reexamination, Request Denied [R-2]

The request for reexamination will be denied if a substantial new question of patentability is not found based on patents or printed publications.

If the examiner concludes that no substantial new question of patentability has been raised, the examiner should >prepare a decision denying the reexamination request. Form paragraph 22.02 should be used as the introductory paragraph in a decision denying reexamination.

#### ¶ 22.02 No New Question of Patentability

No substantial new question of patentability is raised by the request for reexamination and prior art cited therein for the reasons set forth below.

The decision will then indicate, for each patent and printed publication cited in the request, why the citation is:<

(A) Cumulative to the teachings of the art cited in the earlier concluded examination of the patent;

(B) Not available against the claims (e.g., the reference is not available as >prior< art because of its date or the reference is not a publication);

(C) Not important to a reasonable examiner in deciding whether any claim of the patent for which reexamination is requested is patentable>,< even

though the citation is not cumulative and the citation is available against the claim; or

(D) One which was cited in the record of the patent and is barred by the guidelines set forth in MPEP § 2242 >subsection II. A.<

The examiner should also >, in the decision< respond to the substance of each argument raised by the requester which is based on patents or printed publications. If arguments are presented as to grounds not based on prior >art< patents or printed publications, such as those based on public use or >on sale under 35 U.S.C. 102(b)<, or abandonment under 35 U.S.C. 102(c), the examiner should note that such grounds are improper for reexamination and are not considered or commented upon. See 37 CFR 1.552(c).

See MPEP § 2247.01 for an example of a decision denying a request for reexamination.

>The decision denying a request for reexamination is mailed, and the reexamination file is stored in the storage area established by the Technology Center (TC) for reexamination files, to await any petition seeking review of the examiner's determination refusing reexamination. If such a petition is not filed within one (1) month of the examiner's determination denying reexamination, the TC then processes the reexamination file to provide the partial refund set forth in 37 CFR 1.26(c) (the Office of Finance no longer processes reexamination proceedings for a refund). The word "Terminated" is then written in green ink on the face of the file at the top between the word "Reexamination" and the hand-written patent number. After this TC processing is carried out, the reexamination file is given a 420 status and then forwarded by the TC to the files repository (Location 9200) for storage with the patent file.

In the files repository, the reexamination file containing the denied request and the decision thereon are associated with the official patent file, and become part of the patent's record.<

### 2247.01 Examples of Decisions on Request for Reexamination [R-2]

Examples of decisions on requests >for *ex parte* reexamination< are provided below.

**Example (1): Decision Granting Request for Reexamination.**



**UNITED STATES DEPARTMENT OF COMMERCE  
Patent and Trademark Office**

Address: COMMISSIONER OF PATENTS AND TRADEMARKS  
Washington, D.C. 20231

CONTROL NUMBER	FILING DATE	PATENT UNDER REEXAMINATION	ATTORNEY DOCKET NO.
----------------	-------------	----------------------------	---------------------

90/999,999 09/09/99 9,999,999

999

EXAMINER

William Dyre  
2400 Any Street Road  
Anytown, VA 22202

Kenneth Schor

ART UNIT	PAPER NUMBER
----------	--------------

3725

3

DATE MAILED

09/14/99

**ORDER GRANTING/DENYING REQUEST FOR REEXAMINATION**

The request for reexamination has been considered. Identification of the claims, the references relied on, and the rationale supporting the determination are attached.

Attachment(s)  PTO-892.  PTO-1449.  Other: \_\_\_\_\_

1.  The request for reexamination is GRANTED.

RESPONSE TIMES ARE SET TO EXPIRE AS FOLLOWS:

For Patent Owner's Statement (optional): TWO MONTHS from the mailing date hereof. 37 CFR 1.530(b). EXTENSIONS OF TIME ARE GOVERNED BY 37 CFR 1.550(c).

For Requester's reply (optional): TWO MONTHS from the date of service of any patent owner's statement. 37 CFR 1.535. NO EXTENSION OF TIME IS PERMITTED. If patent owner does not file a timely statement under 37 CFR 1.530(b), no reply by requester is permitted.

2.  The request for reexamination is DENIED.

This decision is not appealable. 35 U.S.C. 303(c). Requester may seek review by petition to the Commissioner within ONE MONTH from the mailing date hereof. 37 CFR 1.515(c). EXTENSIONS OF TIME ONLY UNDER 37 CFR 1.183.

In due course, a refund under 37 CFR 1.26(c) will be made to requester (listed below if not patent owner)  
 by Treasury check  by credit to Deposit Account No. \_\_\_\_\_  
 unless notified otherwise. 35 U.S.C. 303(c).

(Third party requester's correspondence address)

John Doe  
12 Seemore Street  
Any City, New York \* >10001 <

DECISION

A substantial new question of patentability affecting Claims 1 - 3 of United States Patent Number 9,999,999 to Key is raised by the request for reexamination.

Extensions of time under 37 CFR 1.136(a) will not be permitted in these proceedings because the provisions of 37 CFR 1.136 apply only to "an applicant" and not to parties in a reexamination proceeding. Additionally, Office policy requires that reexamination proceedings "will be conducted with special dispatch" (37 CFR 1.550(a)) and provides for extensions of time in reexamination proceedings as set forth in 37 CFR 1.550(c).

>The patent owner is reminded of the continuing responsibility under 37 CFR 1.565(a), to apprise the Office of any litigation activity, or other prior or concurrent proceeding, involving Patent No. 9,999,999 throughout the course of this reexamination proceeding.<

The request indicates that Requester considers that Claims 1 - 3 are unpatentable over Smith taken with Jones.

The request further indicates that Requester considers that Claim 4 is unpatentable over the Horn publication.

It is agreed that the consideration of Smith raises a substantial new question of patentability as to Claims 1 - 3 of the Key patent. As pointed out on pages 2 - 3 of the request, Smith teaches using an extruder supported on springs at a 30 degree angle to the horizontal but does not teach the specific polymer of Claims 1 - 3 which is extruded. The teaching as to spring-supporting the extruder at 30 degrees was not present in the prosecution of the application which became the Key patent. Further, there is a substantial likelihood that a reasonable examiner would consider this teaching important in deciding whether or not the claim is patentable. Accordingly, Smith raises a substantial new question of patentability as to Claims 1 - 3, which question has not been decided in a previous examination of the Key patent.

The Horn publication does not raise a new question of patentability as to Claim 4 because its teaching as to the extrusion die is a substantial equivalent of the teaching of the die by the Dorn patent which was considered in the prosecution of the application which became the Key patent. However, Claim 4 will be reexamined along with Claims 1 - 3 of the Key patent.

Kenneth M. Schor  
Primary Examiner, Technology Center \*3700<

Example (2): Decision Denying Request for Reexamination



UNITED STATES DEPARTMENT OF COMMERCE  
Patent and Trademark Office

Address: COMMISSIONER OF PATENTS AND TRADEMARKS  
Washington, D.C. 20231

CONTROL NUMBER	FILING DATE	PATENT UNDER REEXAMINATION	ATTORNEY DOCKET NO.
----------------	-------------	----------------------------	---------------------

90/999,999 09/09/99 9,999,999

999

EXAMINER

William Dyre  
2400 Any Street Road  
Anytown, VA 22202

Kenneth Schor

ART UNIT	PAPER NUMBER
----------	--------------

3725

3

DATE MAILED

09/14/99

**ORDER GRANTING/DENYING REQUEST FOR REEXAMINATION**

The request for reexamination has been considered. Identification of the claims, the references relied on, and the rationale supporting the determination are attached.

Attachment(s)  PTO-892.  PTO-1449.  Other: \_\_\_\_\_

1.  The request for reexamination is GRANTED.

**RESPONSE TIMES ARE SET TO EXPIRE AS FOLLOWS:**

For Patent Owner's Statement (optional): TWO MONTHS from the mailing date hereof. 37 CFR 1.530(b).  
EXTENSIONS OF TIME ARE GOVERNED BY 37 CFR 1.550(c).

For Requester's reply (optional): TWO MONTHS from the date of service of any patent owner's statement.  
37 CFR 1.535. NO EXTENSION OF TIME IS PERMITTED. If patent owner does not file a timely statement  
under 37 CFR 1.530(b), no reply by requester is permitted.

2.  The request for reexamination is DENIED.

This decision is not appealable. 35 U.S.C. 303(c). Requester may seek review by petition to the Commissioner within ONE MONTH from the mailing date hereof. 37 CFR 1.515(c). EXTENSIONS OF TIME ONLY UNDER 37 CFR 1.183.

In due course, a refund under 37 CFR 1.26(c) will be made to requester (listed below if not patent owner)

by Treasury check  by credit to Deposit Account No. \_\_\_\_\_

unless notified otherwise. 35 U.S.C. 303(c).

(Third party requester's correspondence address)

John Doe  
12 Seemore Street  
Any City, New York \* >10001 <

DECISION

No substantial new question of patentability is raised by the request for reexamination and prior art cited therein for the reasons set forth below.

The request indicates that Requester considers that Claims 1 - 2 are unpatentable over Smith taken with Jones.

The request further indicates that Requester considers that Claim 3 is unpatentable over Smith taken with Jones and when further taken with the Horn publication.

The claims of the Key patent, for which reexamination is requested, require that an extruder be supported on springs at an angle of 30 degrees to the horizontal, while a specific chlorinated polymer is extruded through a specific extrusion die.

The Smith patent does not raise a substantial new question of patentability as to the Key claims. Smith's teaching as to the extruder being spring-supported at 30 degrees is a substantial equivalent of the teaching of same by the Dorn patent which was considered in the prosecution of the application which became the Key patent.

In the request for reexamination, it is argued that Jones teaches the extrusion die. However, Jones was also used in the prosecution of the Key application to teach the extrusion die.

The request argued that the Horn publication shows the connection of the support means to the extruder via bolts, as recited in Claim 3 of the Key patent. Although this teaching was not provided in the prosecution of the Key application, the teaching would not be considered to be important to a reasonable examiner in deciding whether or not the Key claims are patentable. The use of a bolt instead of a screw (which was taught by the art of record in the Key application) to provide the connection has not been shown in the request to be important in the context of attaching the support means to the extruder.

The references set forth in the request have been considered both alone and in combination. They fail to raise a substantial new question of patentability as to any one of the Key patent claims. Accordingly, the request for reexamination is DENIED.

Kenneth M. Schor  
Primary Examiner, Technology Center \*3700<

## 2248 Petition From Denial of Request [R-2]

37 CFR 1.515. Determination of the request for *ex parte* reexamination.

\*\*\*\*\*

\*\*>

(c) The requester may seek review by a petition to the Director under § 1.181 within one month of the mailing date of the examiner's determination refusing *ex parte* reexamination. Any such petition must comply with § 1.181(b). If no petition is timely filed or if the decision on petition affirms that no substantial new question of patentability has been raised, the determination shall be final and nonappealable.<

### PROCESSING OF PETITION UNDER 37 CFR 1.515(c)

Once the request for reexamination has been denied, the reexamination file will be stored in the storage area established by the Technology Center (TC) for reexamination files, to await the possibility of a petition seeking review of the examiner's determination refusing reexamination. If \*\*>a petition seeking review of the examiner's determination refusing reexamination is not< filed within one (1) month, \*\*>of the examiner's determination, the TC will then process the reexamination file as a terminated reexamination file. See MPEP § 2247 and § 2294.<

If a petition >seeking review of the examiner's determination refusing reexamination< is filed, it is forwarded (together with the reexamination file) to the office of the TC Director for decision. Where a petition is filed, the TC Director will review the examiner's determination that a substantial new question of patentability has not been raised. The TC Director's review will be *de novo*. Each decision by the TC Director will conclude with the paragraph:

This decision is final and nonappealable. 37 CFR 1.515(c). No further communication on this matter will be acknowledged or considered.

If the petition is granted, the decision of the TC Director should include a sentence setting a 2-month period for filing a statement under 37 CFR 1.530; the reexamination file will then be returned to the supervisory patent examiner (SPE) of the art unit that will handle the reexamination for consideration of reassignment to another examiner.

Reassignment will be the general rule. Only in exceptional circumstances where no other examiner is available and capable to give a proper examination, will the case remain with the examiner who denied the request. If the denial of the request was signed by the SPE, the reexamination ordered by the TC Director will be assigned to a primary examiner.

Under normal circumstances, the reexamination proceeding will not be reassigned to a SPE, primary examiner, or assistant examiner who was involved in any part of the examination of the patent for which reexamination is requested. Only where unusual circumstances are found to exist may the TC Director make an exception to this practice and reassign the reexamination proceeding to an examiner involved with the examination of the patent. For example, if the original examiner of the patent and the examiner who issued the denial are the only examiners with adequate knowledge of the relevant technology, the TC Director may permit reassignment of the reexamination proceeding to the examiner that originally examined the patent.

The requester may seek review of a *denial* of a request for reexamination only by petitioning the \*>Director of the USPTO< under 37 CFR 1.515(c) and 1.181 within 1 month of the mailing date of the decision denying the request for reexamination. Additionally, any request for an extension of the time period to file such a petition from the denial of a request for reexamination can only be entertained by filing a petition under 37 CFR 1.183 with appropriate fee to waive the time provisions of 37 CFR 1.515(c).

After the time for petition has expired without a petition having been filed, or a petition has been filed and the decision thereon affirms the denial of the request, a partial refund of the filing fee for requesting reexamination will be made to the requester. (35 U.S.C. 303(c) and 37 CFR 1.26(c)). A decision on a petition >under 37 CFR 1.515(c)< is final and is not appealable.

>37 CFR 1.515(c) applies only where reexamination is denied; it does not apply to a grant of reexamination where either the patent owner or the requester is not satisfied with one or more findings made in a decision granting reexamination.< Except for the limited exception described in MPEP § 2246, no petition may be filed requesting review of a decision *granting* a request for reexamination, even if the decision



grants the request for reasons other than those advanced by the requester or as to claims other than those for which the requester sought reexamination. No right to review exists if reexamination is ordered in such a case because all claims will be reexamined in view of all prior art during the reexamination under 37 CFR 1.550.

## 2249 Patent Owner's Statement

*37 CFR 1.530. Statement by patent owner in ex parte reexamination; amendment by patent owner in ex parte or inter partes reexamination; inventorship change in ex parte or inter partes reexamination.*

(a) Except as provided in § 1.510(e), no statement or other response by the patent owner in an *ex parte* reexamination proceeding shall be filed prior to the determinations made in accordance with § 1.515 or § 1.520. If a premature statement or other response is filed by the patent owner, it will not be acknowledged or considered in making the determination.

(b) The order for *ex parte* reexamination will set a period of not less than two months from the date of the order within which the patent owner may file a statement on the new question of patentability, including any proposed amendments the patent owner wishes to make.

(c) Any statement filed by the patent owner shall clearly point out why the subject matter as claimed is not anticipated or rendered obvious by the prior art patents or printed publications, either alone or in any reasonable combinations. Where the reexamination request was filed by a third party requester, any statement filed by the patent owner must be served upon the *ex parte* reexamination requester in accordance with § 1.248.

\*\*\*\*\*

The patent owner has no right to file a statement subsequent to the filing of the request but prior to the order for reexamination. Any such premature statement will not be acknowledged nor considered by the Office when making the decision on the request. See MPEP § 2225 and *Patlex Corp. v. Mossinghoff*, 771 F.2d 480, 226 USPQ 985 (Fed. Cir. 1985).

If reexamination is ordered, the decision will set a period of not less than 2 months within which period the patent owner may file a statement and any narrowing amendments to the patent claims. If necessary, an extension of time beyond the 2 months may be requested under 37 CFR 1.550(c) by the patent owner. Such request is decided by the TC Director.

Any statement filed must clearly point out why the patent claims are believed to be patentable, considering the cited prior art patents or printed publications alone or in any reasonable combination.

A copy of the statement must be served by the patent owner on the requester, unless the request was filed by the patent owner.

In the event the decision is made to reexamine, 35 U.S.C. 304 provides that the owner will have a period, not less than 2 months, to file a statement directed to the issue of patentability. Since the 2-month period is the minimum provided by statute, first extensions may be granted up to one (1) month based upon good and sufficient reasons. Further extensions should be granted only in the most extraordinary situations; e.g., death or incapacitation of the representative or owner.

Lack of proof of service especially poses a problem where the patent owner fails to indicate that he or she has served the requester in the statement subsequent to the order for reexamination (37 CFR 1.530(c)). In this situation, the Reexamination Clerk should immediately contact the patent owner by telephone to see whether the indication of proof of service was inadvertently omitted from the patent owner's response. If it was, the patent owner should be advised to submit a supplemental paper indicating the manner and date of service on requester. If the patent owner cannot be contacted, the Reexamination Clerk will then contact the requester to verify that service has in fact been made by the patent owner and indicate that acknowledgment of proof of service should accompany requester's reply (37 CFR 1.248(b)(1)). If the 2-month period for response under 37 CFR 1.530 has expired and requester has not been served, the patent owner's statement is considered inappropriate (37 CFR 1.248) and may be denied consideration; see MPEP § 2267.

See also MPEP § 2266.03 for further discussion as to the patent owner providing service on the third party requester.

It should be noted that the period for response by requester for a reply under 37 CFR 1.535 is 2 months from the owner's service date and not 2 months from the date the patent owner's statement was received in the Office.

## 2250 Amendment by Patent Owner [R-2]

37 CFR 1.121. *Manner of making amendments in application.*

\*\*\*\*\*

\*\*>

(j) *Amendments in reexamination proceedings.* Any proposed amendment to the description and claims in patents involved in reexamination proceedings must be made in accordance with § 1.530.<

37 CFR 1.530. *Statement by patent owner in ex parte reexamination; amendment by patent owner in ex parte or inter partes reexamination; inventorship change in ex parte or inter partes reexamination.*

\*\*\*\*\*

(d) *Making amendments in a reexamination proceeding.* A proposed amendment in an *ex parte* or an *inter partes* reexamination proceeding is made by filing a paper directing that proposed specified changes be made to the patent specification, including the claims, or to the drawings. An amendment paper directing that proposed specified changes be made in a reexamination proceeding may be submitted as an accompaniment to a request filed by the patent owner in accordance with § 1.510(e), as part of a patent owner statement in accordance with paragraph (b) of this section, or, where permitted, during the prosecution of the reexamination proceeding pursuant to § 1.550(a) or § 1.937.

(1) *Specification other than the claims.* Changes to the specification, other than to the claims, must be made by submission of the entire text of an added or rewritten paragraph including markings pursuant to paragraph (f) of this section, except that an entire paragraph may be deleted by a statement deleting the paragraph, without presentation of the text of the paragraph. The precise point in the specification must be identified where any added or rewritten paragraph is located. This paragraph applies whether the amendment is submitted on paper or compact disc (*see* §§ 1.96 and 1.825).

(2) *Claims.* An amendment paper must include the entire text of each patent claim which is being proposed to be changed by such amendment paper and of each new claim being proposed to be added by such amendment paper. For any claim changed by the amendment paper, a parenthetical expression “amended,” “twice amended,” *etc.*, should follow the claim number. Each patent claim proposed to be changed and each proposed added claim must include markings pursuant to paragraph (f) of this section, except that a patent claim or proposed added claim should be canceled by a statement canceling the claim, without presentation of the text of the claim.

(3) *Drawings.* Any change to the patent drawings must be submitted as a sketch on a separate paper showing the proposed changes in red for approval by the examiner. Upon approval of the changes by the examiner, only new sheets of drawings including the changes and in compliance with § 1.84 must be filed.

Amended figures must be identified as “Amended,” and any added figure must be identified as “New.” In the event a figure is canceled, the figure must be surrounded by brackets and identified as “Canceled.”

(4) The formal requirements for papers making up the reexamination proceeding other than those set forth in this section are set out in § 1.52.

(e) *Status of claims and support for claim changes.* Whenever there is an amendment to the claims pursuant to paragraph (d) of this section, there must also be supplied, on pages separate from the pages containing the changes, the status (*i.e.*, pending or canceled), as of the date of the amendment, of all patent claims and of all added claims, and an explanation of the support in the disclosure of the patent for the changes to the claims made by the amendment paper.

(f) *Changes shown by markings.* Any changes relative to the patent being reexamined which are made to the specification, including the claims, must include the following markings:

(1) The matter to be omitted by the reexamination proceeding must be enclosed in brackets; and

(2) The matter to be added by the reexamination proceeding must be underlined.

(g) *Numbering of patent claims preserved.* Patent claims may not be renumbered. The numbering of any claims added in the reexamination proceeding must follow the number of the highest numbered patent claim.

(h) *Amendment of disclosure may be required.* The disclosure must be amended, when required by the Office, to correct inaccuracies of description and definition, and to secure substantial correspondence between the claims, the remainder of the specification, and the drawings.

(i) *Amendments made relative to patent.* All amendments must be made relative to the patent specification, including the claims, and drawings, which are in effect as of the date of filing the request for reexamination.

(j) *No enlargement of claim scope.* No amendment may enlarge the scope of the claims of the patent or introduce new matter. No amendment may be proposed for entry in an expired patent. Moreover, no amendment, other than the cancellation of claims, will be incorporated into the patent by a certificate issued after the expiration of the patent.

(k) *Amendments not effective until certificate.* Although the Office actions will treat proposed amendments as though they have been entered, the proposed amendments will not be effective until the reexamination certificate is issued.

\*\*\*\*\*

>

37 CFR 1.52. *Language, paper, writing, margins, compact disc specifications.*

(a) *Papers that are to become a part of the permanent United States Patent and Trademark Office records in the file of a patent application or a reexamination proceeding.*

(1) All papers, other than drawings, that are submitted on paper or by facsimile transmission, and are to become a part of the permanent United States Patent and Trademark Office records in

the file of a patent application or reexamination proceeding, must be on sheets of paper that are the same size, not permanently bound together, and:

- (i) Flexible, strong, smooth, non-shiny, durable, and white;
- (ii) Either 21.0 cm by 29.7 cm (DIN size A4) or 21.6 cm by 27.9 cm (8 1/2 by 11 inches), with each sheet including a top margin of at least 2.0 cm (3/4 inch), a left side margin of at least 2.5 cm (1 inch), a right side margin of at least 2.0 cm (3/4 inch), and a bottom margin of at least 2.0 cm (3/4 inch);
- (iii) Written on only one side in portrait orientation;
- (iv) Plainly and legibly written either by a typewriter or machine printer in permanent dark ink or its equivalent; and
- (v) Presented in a form having sufficient clarity and contrast between the paper and the writing thereon to permit the direct reproduction of readily legible copies in any number by use of photographic, electrostatic, photo-offset, and microfilming processes and electronic capture by use of digital imaging and optical character recognition.

(2) All papers that are submitted on paper or by facsimile transmission and are to become a part of the permanent records of the United States Patent and Trademark Office should have no holes in the sheets as submitted.

(3) The provisions of this paragraph and paragraph (b) of this section do not apply to the pre-printed information on paper forms provided by the Office, or to the copy of the patent submitted on paper in double column format as the specification in a reissue application or request for reexamination.

(4) See § 1.58 for chemical and mathematical formulae and tables, and § 1.84 for drawings.

(5) If papers that are submitted on paper or by facsimile transmission do not comply with paragraph (a)(1) of this section and are submitted as part of the permanent record, other than the drawings, applicant, or the patent owner, or the requester in a reexamination proceeding, will be notified and given a period of time within which to provide substitute papers that comply with paragraph (a)(1) of this section in order to avoid abandonment of the application in the case of an applicant for patent, termination of proceedings in the case of a patent owner in a reexamination proceeding, or refusal of consideration of the papers in the case of a third party requester in a reexamination proceeding.

\*\*\*\*\*

(b) *The application (specification, including the claims, drawings, and oath or declaration) or reexamination proceeding and any amendments or corrections to the application or reexamination proceeding.*

(1) The application or proceeding and any amendments or corrections to the application (including any translation submitted pursuant to paragraph (d) of this section) or proceeding, except as provided for in § 1.69 and paragraph (d) of this section, must:

- (i) Comply with the requirements of paragraph (a) of this section; and
- (ii) Be in the English language or be accompanied by a translation of the application and a translation of any corrections or amendments into the English language together with a statement that the translation is accurate.

(2) The specification (including the abstract and claims) for other than reissue applications and reexamination proceedings, and any amendments for applications (including reissue applications) and reexamination proceedings to the specification, except as provided for in §§ 1.821 through 1.825, must have:

- (i) Lines that are 1 1/2 or double spaced;
- (ii) Text written in a nonscript type font (*e.g.*, Arial, Times Roman, or Courier) lettering style having capital letters which are at least 0.21 cm (0.08 inch) high; and
- (iii) Only a single column of text.

(3) The claim or claims must commence on a separate physical sheet or electronic page (§ 1.75(h)).

(4) The abstract must commence on a separate physical sheet or electronic page or be submitted as the first page of the patent in a reissue application or reexamination proceeding (§ 1.72(b)).

\*\*\*\*\*

(7) If papers that do not comply with paragraphs (b)(1) through (b)(5) of this section are submitted as part of the application, the applicant, or patent owner, or requester in a reexamination proceeding, will be notified and given a period of time within which to provide substitute papers that comply with paragraphs (b)(1) through (b)(5) of this section in order to avoid abandonment of the application in the case of an applicant for patent, termination of proceedings in the case of a patent owner in a reexamination proceeding, or refusal of consideration of the papers in the case of a third party requester in a reexamination proceeding.

\*\*\*\*\*

<

Amendments to the patent (one which has not expired) may be filed by the patent owner with his or her request. See MPEP § 2221. Such amendments, however, may not enlarge the scope of a claim of the patent or introduce new matter. Amended or new claims which broaden or enlarge the scope of a claim of the patent should be rejected under 35 U.S.C. 305. The test for when an amended or “new claim enlarges the scope of an original claim under 35 U.S.C. 305 is the same as that under the 2-year limitation for reissue applications adding enlarging claims under 35 U.S.C. 251, last paragraph.” *In re Freeman*, 30 F.3d 1459, 1464, 31 USPQ2d 1444, 1447 (Fed. Cir. 1994). See MPEP § 2258 for a discussion of enlargement of claim scope. For handling of new matter, see MPEP § 2270. Additional claims may be added by amendment in a reexamination proceeding, without any fee. Amendments proposed in a reexamination will normally be entered and be considered to be entered for purposes of prosecution before the Office (if they are

timely and comply with the rules); however, the amendments do not become effective in the patent until the reexamination certificate under 35 U.S.C. 307 is issued.

No amendment will be permitted where the certificate issues after expiration of the patent. See 37 CFR 1.530 (d)(3). The patent expiration date for a utility patent, for example, is determined by taking into account the term of the patent, whether maintenance fees have been paid for the patent, \* whether any disclaimer was filed as to the patent to shorten its term>, any patent term extensions or adjustments for delays within the USPTO under 35 U.S.C. 154 (see MPEP § 2710 *et seq.*), and any patent term extensions available under 35 U.S.C. 156 for premarket regulatory review (see MPEP § 2750 *et seq.*)<. Any other relevant information should also be taken into account.

*Amendment Entry* — Amendments which comply with 37 CFR 1.530(d)-(j) >(and are formally presented pursuant to 37 CFR 1.52(a) and (b))< will be entered in the reexamination file wrapper. An amendment will be given a Paper Number and will be designated by consecutive letters of the alphabet (A, B, C, etc.). The amendment will be entered by drawing a line in red ink through the claim(s) or paragraph(s) canceled or amended, and the substituted copy being indicated by reference letter. See MPEP § 2234.

## I. MANNER OF MAKING AMENDMENTS IN REEXAMINATION PROCEEDINGS

\*>Amendments made in a reexamination proceeding must comply with the formal requirements of 37 CFR 1.52(a) and (b), as do all papers that are to become a part of the permanent USPTO file records in a patent application or proceeding. In addition, the< provisions of 37 CFR 1.530(d)-(k) >uniquely< apply to amendments in >both *ex parte* and *inter partes*< reexamination proceedings>, as follows<.

### A. *The Specification*

37 CFR 1.530(d)(1) relates to the manner of making amendments to the reexamination “specification” (other than the claims). It is not to be used for making amendments to the claims or the drawings.

37 CFR 1.530(d)(1) requires that all amendments, which include any deletions or additions, must be made by submission of the full text of any paragraph to be changed in any manner, with markings (brackets

and underlining) showing the changes. It should be noted that examiner’s amendments made at the time when the Notice of Intent to Issue Reexamination Certificate (NIRC) is prepared also require the full text of any paragraph to be changed, with markings. The exception for examiner’s amendment set forth in 37 CFR 1.121(g) does **not** apply to examiner’s amendments in reexamination proceedings. It should further be noted that the requirement of 37 CFR 1.530(d)(1) applies regardless of whether the amendment is submitted on paper or on compact disc (pursuant to 37 CFR 1.96 or 1.825). The only exception to this requirement is that an entire paragraph of specification text may be deleted from the specification by a statement deleting the paragraph without the presentation of the text of the paragraph.

In accordance with 37 CFR 1.530(d)(1), all paragraphs which are added to the specification must be submitted as completely underlined.

37 CFR 1.530(d)(1) requires that the precise point where each amendment is to be made must be indicated.

37 CFR 1.530(d)(1) defines the “markings” by reference to 37 CFR 1.530(f) as being brackets for deletion and underlining for addition. All bracketing and underlining is made in comparison to the original patent; not in comparison with the prior amendment.

Where a change is made in one sentence, paragraph or page of the patent, and the change increases or decreases the size of the sentence, paragraph or page, this will have no effect on the body of the reexamination “specification” (the copy of the patent). This is because all insertions are made as blocked additions of paragraphs, which are not physically inserted within the specification papers. Rather, each blocked paragraph is assigned a letter and number, and a caret written in the specification papers indicates where the blocked paragraph is to be incorporated. Therefore, a reexamination patent owner need not be concerned with page formatting considerations when presenting amendments to the Office.

### B. *The Claims*

37 CFR 1.530(d)(2) relates to the manner of making amendments to the claims in a reexamination proceeding. It is not to be used for making amendments to the remainder of the specification or to the drawings.

37 CFR 1.530(d)(2) requires that:

(A) for each claim that is proposed to be amended by the amendment paper being submitted (the current amendment paper), the entire text of the claim must be presented with appropriate markings showing the changes to the claim;

(B) for each proposed new claim which is added in the reexamination by the amendment paper being submitted (the current amendment paper), the entire text of the proposed new claim must be presented and it must be underlined throughout;

(C) a patent claim is canceled by a direction to cancel that claim, there is no need to present the text of the patent claim surrounded by brackets; and

(D) a proposed new claim (previously added in the reexamination) is canceled by a direction to cancel that claim.

It should be noted that examiner's amendments made at the time when the Notice of Intent to Issue Reexamination Certificate (NIRC) is prepared also require the full text of any claim to be changed, with markings. The exception for examiner's amendment set forth in 37 CFR 1.121(g) does **not** apply to examiner's amendments in reexamination proceedings. It should further be noted that the requirements of 37 CFR 1.530(d)(2) apply regardless of whether the amendment is submitted on paper or on compact disc (pursuant to 37 CFR 1.96 or 1.825).

In accordance with 37 CFR 1.530(e), each amendment submitted must set forth the status of all patent claims and all added claims as of the date of the submission. The status to be set forth is whether the claim is pending, or canceled. The failure to submit the claim status will generally result in a notification to the patent owner of an informal response (see MPEP § 2266.02) prior to final rejection. Such an amendment submitted after final rejection will not be entered.

Also in accordance with 37 CFR 1.530(e), each claim amendment must be accompanied by an explanation of the support in the disclosure of the patent for the amendment (i.e., support for the changes made in the claim(s), support for any insertions and deletions). The failure to submit an explanation will generally result in a notification to the patent owner that the amendment prior to final rejection is not completely responsive since the failure to set forth the support in

the disclosure goes to the merits of the case (see MPEP § 2266.01). Such an amendment submitted after final rejection will not be entered.

37 CFR 1.530(f) identifies the type of markings required in the claim to be amended as underlining for added material and single brackets for material deleted.

37 CFR 1.530(g) states that original patent claims may not be renumbered. A patent claim retains its number even if it is canceled in the reexamination proceeding, and the numbering of any added claims must begin after the last original patent claim.

### C. *The Drawings*

With respect to amendment of the drawings in a reexamination proceeding, see MPEP § 2250.01.

Form paragraph 22.12 may be used to advise patent owner of the proper manner of making amendments in \* >an *ex parte*< reexamination proceeding.

### D. *Form Paragraphs >Ex Parte Reexamination<*

¶ 22.12 *Amendments Proposed in a Reexamination - 37 CFR 1.530(d)-(j)*

Patent owner is notified that any proposed amendment to the specification and/or claims in this reexamination proceeding must comply with 37 CFR 1.530(d)-(j).

#### **Examiner Note:**

This paragraph may be used in the order granting reexamination and/or in the first Office action to advise patent owner of the proper manner of making amendments in a reexamination proceeding.

Form paragraph 22.13 may be used to notify the patent owner in a reexamination proceeding that a proposed amendment in the proceeding filed prior to final rejection does not comply with 37 CFR 1.530(d)-(j).

\*\*>

¶ 22.13 *Improper Amendment in an Ex Parte Reexamination - 37 CFR 1.530(d)-(j)*

The amendment filed [1] proposes amendments to [2] that do not comply with 37 CFR 1.530(d)-(j), which sets forth the manner of making amendments in reexamination proceedings. A supplemental paper correctly proposing amendments in the present *ex parte* reexamination proceeding is required.

A shortened statutory period for response to this letter is set to expire ONE MONTH or THIRTY DAYS, whichever is longer, from the mailing date of this letter. If patent owner fails to timely correct this informality, the amendment will be held not to be an

appropriate response, the present *ex parte* reexamination proceeding will be terminated, and a reexamination certificate will issue. 37 CFR 1.550(d).

#### **Examiner Note:**

This paragraph may be used for any 37 CFR 1.530(d)-(j) informality as to a proposed amendment submitted in a reexamination proceeding prior to final rejection. After final rejection, the amendment should not be entered and patent owner informed of such in an advisory Office action using Form PTOL 467.

<

The cover sheet to be used for mailing the notification to the patent owner will be PTOL-473.

As an alternative to using form paragraph 22.13, it would also be appropriate to use form PTOL-475.

Note that if the informal amendment is submitted after final rejection, form paragraph 22.13 and form PTOL-475 should not be used. Rather an advisory Office action (using form PTOL-467) should be issued indicating that the amendment was not entered. In the "Other" section, it should be explained that the amendment was not entered because it does not comply with 37 CFR 1.530(d)-(j), which sets forth the manner of making amendments in reexamination proceedings.

>

#### ***E. Form Paragraphs - Inter Partes Reexamination***

See MPEP § 2666.01 for the form paragraphs to use in *inter partes* reexamination proceedings, in advising the patent owner as to the manner of making amendments.<

#### **II. ALL CHANGES ARE MADE VIS-A-VIS THE PATENT BEING REEXAMINED**

When a reexamination certificate is printed, all underlined matter is printed in italics and all brackets are printed as they were inserted in the proceeding in order to thereby show exactly which additions and deletions have been made in the patent via the reexamination proceeding. In accordance with 37 CFR 1.530(i), all amendments to the patent being reexamined must be made relative to the patent specification in effect as of the date of the filing of the request for reexamination. The patent specification includes the claims and drawings. If there was a prior change to the patent (made via a prior reexamination certificate, reissue of the patent, certificate of correction, etc.),

the first amendment must be made relative to the patent specification as changed by the prior proceeding or other mechanism for changing the patent. All amendments subsequent to the first amendment must also be made relative to the patent specification in effect as of the date of the filing of the request for reexamination, and not relative to the prior amendment.

#### **III. >AMENDMENT AFTER THE PATENT HAS EXPIRED**

Pursuant to 37 CFR 1.530(j), "[n]o amendment may be proposed for entry in an expired patent." Thus, if a patent expires during the pendency of a reexamination proceeding for a patent, all amendments to the patent claims and all claims added during the proceeding are withdrawn. This is carried out by placing a diagonal line across all amended and new claims (and text added to the specification) residing in the amendment papers. The patent owner should be notified of this in the next Office action. The Office action will hold the amendments to be improper, and state that all subsequent reexamination will be on the basis of the unamended patent claims. This procedure is necessary since no amendments will be incorporated into the patent by a certificate after the expiration of the patent.

37 CFR 1.530(j) further states that "[m]oreover, no amendment, other than the cancellation of claims, will be incorporated into the patent by a certificate issued after the expiration of the patent."

Thus, at the time the NIRC is to be issued, the examiner should ensure that all rejected and objected to claims are canceled. The examiner should issue an examiner's amendment canceling any such claims not already canceled.

The cancellation of the original patent claims is the only "amendatory" change permitted in an expired patent.

#### **IV. < EXAMPLES**

A substantial number of problems arise in the Office because of improper submission of proposed amendments in reexamination proceedings. The following examples are provided to assist in the preparation of proper proposed amendments in reexamination proceedings.

### (A) Original Patent Description Or Patent Claim Amended

(1) Specification - submit a copy of the entire paragraph (of the specification of the patent) being amended with underlining and bracketing. Thus, the amendment would be presented as follows:

Replace the paragraph beginning at column 4, line 23 with the following:

Scanning [is] are controlled by clocks which are, in turn, controlled from the display tube line synchronization. The signals resulting from scanning the scope of the character are delivered in parallel, then converted into serial mode through a shift register, wherein the shift signal frequency is controlled by a clock that is controlled from the display tube line synchronization.

(2) Claims - for changes to the patent claims, one must submit a copy of the entire patent claim with the amendments shown by underlining and bracketing. Thus, the amendment would be presented as follows:

Amend claim 6 as follows:

Claim 6. >(amended),< The apparatus of claim [5] 1 wherein the [first] second piezoelectric element is parallel to the [second] third piezoelectric element.

If the dependency of any original patent claim is to be changed by amendment, it is proper to make that original patent claim dependent upon a later filed higher numbered claim.

### (B) Cancellation of Entire Claim(s)

(1) Original patent claim canceled - in writing, direct cancellation of the entire patent claim.

Cancel claim 6.

(2) Proposed new claim (previously added in the reexamination) canceled - in writing, direct cancellation of the entire claim.

Cancel claim 15.

### (C) Presentation Of New Claims

Each proposed new claim (i.e., a claim not found in the patent, that is newly presented in the reexamination proceeding) should be presented with underlining throughout the claim.

Claim 7. The apparatus of claim 5 further comprising electrodes attaching to said opposite faces of the second and third piezoelectric elements.

Even though an original claim may have been canceled, the numbering of the original claims does not change. Accordingly, any added claims are numbered beginning with the next higher number than the number of claims in the original patent. If new claims have been added to the reexamination proceeding which are later canceled prior to the issuance of the reexamination certificate, the examiner will renumber, at the time of preparing the NIRC for subsequent issuance of the certificate, any remaining new claims in numerical order to follow the highest number of the claims in the original patent.

A claim number previously assigned to a new claim that has been canceled should not be reassigned to a different new claim during the reexamination proceeding. For example, if new claim 5 added in a prior amendment is canceled in a later amendment, a different new claim added in a later amendment during the reexamination proceeding would be claim 6. Of course, at the time of preparing the NIRC, claim 6 would be renumbered for issue of the reexamination certificate as claim 5.

### (D) Amendment Of New Claims

An amendment of a new claim (i.e., a claim not found in the patent, that was previously presented in the reexamination proceeding) must present the entire text of the new claim containing the amendatory material, and it must be underlined throughout the claim. The presentation cannot contain any bracketing or other indication of what was in the previous version of the claim. This is because all changes in the reexamination are made *vis-a-vis* the original patent, and not in comparison with any prior amendment. Although the presentation of the amended claim does not contain any indication of what is changed from a previous version of the claim, patent owner must point out what is changed, in the "Remarks" portion of the amendment. Also, as per 37 CFR 1.530(e), each change made in the claim must be accompanied by an explanation of the support in the disclosure of the patent (i.e., the reexamination specification) for the change.

### (E) Amendment Of Original Patent Claims More Than Once

The following >example< illustrates proper claim amendment of original patent claims in reexamination proceedings>, where more than one amendment to a claim is made<:

## (1) Patent claim.

Claim 1. A cutting means having a handle portion and a blade portion.

## (2) Proper first amendment format.

Claim 1. >(amended),< A [cutting means] knife having a bone handle portion and a notched blade portion.

## (3) Proper second amendment format.

Claim 1. >(twice amended),< A [cutting means] knife having a handle portion and a serrated blade portion.

Note that the second amendment must include

(1) the changes previously presented in the first amendment; i.e., [cutting means] knife, as well as (2) the new changes presented in the second amendment; i.e., serrated.

The word bone was presented in the first amendment and is now to be deleted in the second amendment. Thus, “bone” is NOT to be shown in brackets in the second amendment. Rather, the word “bone” is simply omitted from the claim, since “bone” never appeared in the patent.

The word notched which was presented in the first amendment is replaced by the word serrated in the second amendment. The word notched is being deleted in the second amendment and did not appear in the patent; accordingly, “notched” is not shown in any form in the claim. The word serrated is being added in the second amendment, and accordingly, “serrated” is added to the claim and is underlined.

It should be understood that in the second amendment, the deletions of “notched” and “bone” are not changes from the original patent claim text and therefore, are not shown in the second amendment. In both the first and the second amendments, the entire claim is presented only with the changes from the original patent text.

If the patent expires during \* >an< *ex parte* >or *inter partes*< reexamination \*>proceeding< and the patent claims have been amended in that *ex parte* reexamination proceeding, the Office will hold the amendments as being improper>,< and all subsequent reexamination will be on the basis of the unamended patent claims. This procedure is necessary since no amendments will be incorporated into the patent by certificate after the expiration of the patent.

\*\*>

## V. CROSS REFERENCES TO OTHER AREAS

(A) For clerical handling of amendments, see MPEP § 2270 for *ex parte* reexamination proceedings, and see MPEP § 2670 for *inter partes* reexamination proceedings.

(B) As to amendments in a merged proceeding, see MPEP § 2283 for an *ex parte* reexamination merged with another *ex parte* reexamination and MPEP § 2285 for an *ex parte* reexamination merged with a reissue application. If an *inter partes* reexamination proceeding is included in the merger, see MPEP § 2686.01 and § 2686.03.

(C) As to amendments in a pending reexamination proceeding where a reexamination certificate has issued for the patent based on a prior concluded reexamination, pursuant to MPEP § 2295, any amendment made in the pending reexamination proceeding must be presented as if the changes made to the patent text via the reexamination certificate (for the prior concluded reexamination) are a part of the original patent. All italicized text of the certificate is considered as if the text was present without italics in the original patent. Further, any text of the reexamination certificate found in brackets is considered as if it were never present in the patent at all. Thus, for making an amendment in the pending reexamination, all italicized text of the reexamination certificate is presented in the amendment without italics. Further, any text found in brackets in the reexamination certificate is omitted in the amendment.

(D) As to amendments in a pending reexamination proceeding where a reissue patent has been granted, pursuant to MPEP § 2285, subsection II.A., an amendment in a reexamination of a reissued patent is made the same way as in a reexamination of a reexamined patent (i.e., as per MPEP § 2295). Thus, all italicized text of the reissue patent is presented in the amendment (made in the pending reexamination proceeding) without italics. Further, any text found in brackets in the reissue patent is omitted in the amendment (made in the pending reexamination proceeding).

(E) For handling a dependent claim in reexamination proceedings, see MPEP § 2260.01.<



## 2250.01 Correction of Patent Drawings [R-2]

37 CFR 1.530. *Statement by patent owner in ex parte reexamination; amendment by patent owner in ex parte or inter partes reexamination; inventorship change in ex parte or inter partes reexamination.*

\*\*\*\*\*

(d) *Making amendments in a reexamination proceeding.* A proposed amendment in an *ex parte* or an *inter partes* reexamination proceeding is made by filing a paper directing that proposed changes be made to the patent specification, including the claims, or to the drawings. An amendment paper directing that proposed specified changes be made in a reexamination proceeding may be submitted as an accompaniment to a request filed by the patent owner in accordance with § 1.510(e), as part of a patent owner statement in accordance with paragraph (b) of this section, or, where permitted, during the prosecution of the reexamination proceeding pursuant to § 1.550(a) or § 1.937.

\*\*\*\*\*

(3) *Drawings.* Any change to the patent drawings must be submitted as a sketch on a separate paper showing the proposed changes in red for approval by the examiner. Upon approval of the changes by the examiner, only new sheets of drawings including the changes and in compliance with § 1.84 must be filed. Amended figures must be identified as "Amended," and any added figure must be identified as "New." In the event a figure is canceled, the figure must be surrounded by brackets and identified as "Canceled."

\*\*\*\*\*

In the reexamination proceeding, the copy of the patent drawings submitted pursuant to 37 CFR 1.510(b)(4) will be used for reexamination purposes, provided no change whatsoever is made to the drawings. If there is to be ANY change in the drawings, a new sheet of drawings for each sheet changed must be submitted. The change may NOT be made on the original patent drawings.

37 CFR 1.530(d)(3) sets forth the manner of making amendments to the drawings. Amendments to the original patent drawing sheets are not permitted, and any change to the patent drawings must be in the form of a new sheet of drawings for each drawing sheet that is changed. Any amended figure(s) must be identified as "Amended" and any added figure(s) must be identified as "New." In the event a figure is canceled, the figure must be surrounded by brackets and identified as "Canceled."

Where the patent owner wishes to change/amend the drawings, the patent owner should submit a sketch in permanent ink showing proposed change(s)/ amendment(s) in red, for approval by the examiner. The submitted sketch should be presented as a separate paper, and it will be made part of the record. Once the sketch is approved, sheets of substitute formal drawings must be submitted for each drawing sheet that is to be changed/amended. After receiving the new sheets of drawings from the patent owner, the examiner may have the draftsman review the new sheets of drawings if the examiner would like the draftsman's assistance in identifying errors in the drawings. If a draftsman reviews the drawings and finds the drawings to be unacceptable, the draftsman should complete a PTO-948 for the examiner to include with the next Office action. A draftsman's "stamp" to indicate approval is no longer required on patent drawings, and these stamps are no longer to be used by draftsmen. The new sheets of drawings \*\*>must be entered into the record in the reexamination file prior to the preparation of a Notice of Intent to Issue *Ex Parte* Reexamination Certificate (NIRC). If a proposed drawing correction has been approved but the new sheets of drawings have not been filed, and the proceeding is otherwise in condition for termination by means of a NIRC, an *ex parte Quayle* Office action should be prepared - setting a one month SSP for the filing of the new sheets of drawing. If the new sheets of drawings are not timely filed, the Reexamination Certificate will be issued with drawings that do not reflect the changes/amendments which were proposed by the patent owner<.

## 2250.02 Correction of Inventorship [R-2]

37 CFR 1.530. *Statement by patent owner in ex parte reexamination; amendment by patent owner in ex parte or inter partes reexamination; inventorship change in ex parte or inter partes reexamination.*

\*\*\*\*\*

(l) *Correction of inventorship in an ex parte or inter partes reexamination proceeding.*

\*\*>

(1) When it appears in a patent being reexamined that the correct inventor or inventors were not named through error without deceptive intention on the part of the actual inventor or inventors, the Director may, on petition of all the parties set forth in § 1.324(b)(1)-(3), including the assignees, and satisfactory proof of the facts and payment of the fee set forth in § 1.20(b), or on

order of a court before which such matter is called in question, include in the reexamination certificate to be issued under § 1.570 or § 1.977 an amendment naming only the actual inventor or inventors. The petition must be submitted as part of the reexamination proceeding and must satisfy the requirements of § 1.324.<

(2) Notwithstanding the preceding paragraph (1)(1) of this section, if a petition to correct inventorship satisfying the requirements of § 1.324 is filed in a reexamination proceeding, and the reexamination proceeding is terminated other than by a reexamination certificate under § 1.570 or § 1.977, a certificate of correction indicating the change of inventorship stated in the petition will be issued upon request by the patentee.

Where the inventorship of a patent being reexamined is to be corrected, a petition for correction of inventorship which complies with 37 CFR 1.324 must be submitted during the prosecution of the reexamination proceeding. See 37 CFR 1.530(l)(1). If the petition under 37 CFR 1.324 is granted, a certificate of correction indicating the change of inventorship will **not** be issued, because the reexamination certificate that will ultimately issue will contain the appropriate change of inventorship information. The certificate of correction is in effect merged with the reexamination certificate.

In some instances, the reexamination proceeding terminates but does not result in a reexamination certificate under 37 CFR 1.570 >or 1.977<, e.g., reexamination is vacated, or the order for reexamination is denied. In those instances, patent owner may, after the termination of the reexamination proceeding, request that the inventorship be corrected by a certificate of correction indicating the change of inventorship. See 37 CFR 1.530(l)(2). Alternatively, the failure to name the correct inventive entity is an error in the patent which is correctable by reissue under 35 U.S.C. 251. See MPEP § 1412.04 for a discussion of when correction of inventorship by reissue is appropriate.

## 2251 Reply by Third Party Requester

*37 CFR 1.535. Reply by third party requester in ex parte reexamination.*

A reply to the patent owner's statement under § 1.530 may be filed by the *ex parte* reexamination requester within two months from the date of service of the patent owner's statement. Any reply by the *ex parte* requester must be served upon the patent owner in accordance with § 1.248. If the patent owner does not file a statement under § 1.530, no reply or other submission from the *ex parte* reexamination requester will be considered.

If the patent owner files a statement in a timely manner, the third party requester is given a period of

2 months from the date of service to reply. Since the statute, 35 U.S.C. 304, provides this time period, there will be no extensions of time granted.

The reply need not be limited to the issues raised in the statement. The reply may include additional prior art patents and printed publications and may raise any issue appropriate for reexamination.

If no statement is filed by the patent owner, no reply is permitted from the third party requester.

The third party requester must serve a copy of the reply on the patent owner. See MPEP § 2266.03 for further discussion as to the third party requester providing service on the patent owner.

The third party requester is not permitted to file any further papers after his or her reply to the patent owner's statement. Any further papers will not be considered and will be returned to the requester. The patent owner cannot file papers on behalf of the third party requester and thereby circumvent the rules.

## 2252 Consideration of Statement and Reply

*37 CFR 1.540. Consideration of responses in ex parte reexamination.*

The failure to timely file or serve the documents set forth in § 1.530 or in § 1.535 may result in their being refused consideration. No submissions other than the statement pursuant to § 1.530 and the reply by the *ex parte* reexamination requester pursuant to § 1.535 will be considered prior to examination.

Although 37 CFR 1.540 would appear to be discretionary in stating that late responses "may result in their being refused consideration," patent owners and requesters can expect consideration to be refused if the statement and/or reply is not timely filed. 37 CFR 1.540 restricts the number and kind of submissions to be considered prior to examination to those expressly provided for in 37 CFR 1.530 and 37 CFR 1.535. Untimely submissions will ordinarily not be considered. Untimely submissions, other than untimely papers filed by the patent owner after the period set for response, will not be placed of record in the reexamination file but will be returned to the sender.

Papers filed in which no proof of service is included and proof of service is required may be denied consideration. Where no proof of service is included, inquiry should be made of the sender by the reexamination clerk as to whether service was in fact made. If no service was made, the paper is placed in

the reexamination file but is not considered. See MPEP § 2266.03 and § 2267.

## 2253 Consideration by Examiner [R-2]

Once reexamination is ordered, any submissions properly filed and served in accordance with 37 CFR 1.530 and 37 CFR 1.535 will be considered by the examiner when preparing the first Office action.

With respect to consideration of any proposed amendments to the specification, including claims, made by the patent owner, the examiner will be guided by the provisions of 37 CFR 1.530(d)-(j). With respect to consideration of the patent owner's statement, the examiner will be guided by 37 CFR 1.530(c).

As to consideration of a reply by a third party requester, the examiner will be guided by 37 CFR 1.535. If the requester's reply to the patent owner's statement raises issues not previously presented, such issues will be treated by the examiner in the Office action if they are within the scope of reexamination. However, if an issue raised by the third party requester in the reply is not within the scope of reexamination, it should be treated pursuant to 37 CFR 1.552(c).

For handling of new matter, see MPEP § 2270.

## 2254 Conduct of *Ex Parte* Reexamination Proceedings [R-2]

35 U.S.C. 305. *Conduct of reexamination proceedings.*

After the times for filing the statement and reply provided for by section 304 of this title have expired, reexamination will be conducted according to the procedures established for initial examination under the provisions of sections 132 and 133 of this title. In any reexamination proceeding under this chapter, the patent owner will be permitted to propose any amendment to his patent and a new claim or claims thereto, in order to distinguish the invention as claimed from the prior art cited under the provisions of section 301 of this title, or in response to a decision adverse to the patentability of a claim of a patent. No proposed amended or new claim enlarging the scope of a claim of the patent will be permitted in a reexamination proceeding under this chapter. All reexamination proceedings under this section, including any appeal to the Board of Patent Appeals and Interferences, will be conducted with special dispatch within the Office.

37 CFR 1.550. *Conduct of ex parte reexamination proceedings.*

(a) All *ex parte* reexamination proceedings, including any appeals to the Board of Patent Appeals and Interferences, will be conducted with special dispatch within the Office. After issuance

of the *ex parte* reexamination order and expiration of the time for submitting any responses, the examination will be conducted in accordance with §§ 1.104 through 1.116 and will result in the issuance of an *ex parte* reexamination certificate under § 1.570.

(b) The patent owner in an *ex parte* reexamination proceeding will be given at least thirty days to respond to any Office action. In response to any rejection, such response may include further statements and/or proposed amendments or new claims to place the patent in a condition where all claims, if amended as proposed, would be patentable.

(c) The time for taking any action by a patent owner in an *ex parte* reexamination proceeding will be extended only for sufficient cause and for a reasonable time specified. Any request for such extension must be filed on or before the day on which action by the patent owner is due, but in no case will the mere filing of a request effect any extension. See § 1.304(a) for extensions of time for filing a notice of appeal to the U.S. Court of Appeals for the Federal Circuit or for commencing a civil action.

\*\*>

(d) If the patent owner fails to file a timely and appropriate response to any Office action or any written statement of an interview required under § 1.560(b), the *ex parte* reexamination proceeding will be terminated, and the Director will proceed to issue a certificate under § 1.570 in accordance with the last action of the Office.<

(e) If a response by the patent owner is not timely filed in the Office,\*\*>

(1) The delay in filing such response may be excused if it is shown to the satisfaction of the Director that the delay was unavoidable; a petition to accept an unavoidably delayed response must be filed in compliance with § 1.137(a); or<

(2) The response may nevertheless be accepted if the delay was unintentional; a petition to accept an unintentionally delayed response must be filed in compliance with § 1.137(b).

(f) The reexamination requester will be sent copies of Office actions issued during the *ex parte* reexamination proceeding. After filing of a request for *ex parte* reexamination by a third party requester, any document filed by either the patent owner or the third party requester must be served on the other party in the reexamination proceeding in the manner provided by § 1.248. The document must reflect service or the document may be refused consideration by the Office.

(g) The active participation of the *ex parte* reexamination requester ends with the reply pursuant to § 1.535, and no further submissions on behalf of the reexamination requester will be acknowledged or considered. Further, no submissions on behalf of any third parties will be acknowledged or considered unless such submissions are:

(1) in accordance with § 1.510 or § 1.535; or

(2) entered in the patent file prior to the date of the order for *ex parte* reexamination pursuant to § 1.525.

(h) Submissions by third parties, filed after the date of the order for *ex parte* reexamination pursuant to § 1.525, must meet the requirements of and will be treated in accordance with § 1.501(a).

Once *ex parte* reexamination is ordered pursuant to 35 U.S.C. 304 and the times for submitting any responses to the order have expired, no further active participation by a third party reexamination requester is allowed, and no third party submissions will be acknowledged or considered unless they are in accordance with 37 CFR 1.510. The reexamination proceedings will be *ex parte*, even if ordered based on a request filed by a third party, because this was the intention of the legislation. *Ex parte* proceedings preclude the introduction of multiple arguments and issues by the third party requester which are not within the intent of 35 U.S.C. 305 (“reexamination will be conducted according to the procedures established for initial examination under the provisions of sections 132 and 133 of this title”), and *ex parte* proceedings reduce possible harassment of the patent owner.

The patent owner may not file papers on behalf of the requester and thereby circumvent the intent of the *ex parte* reexamination legislation and the rules. The Court of Appeals for the Federal Circuit held in *Emerson Elec. Co. v. Davoil, Inc.*, 88 F.3d 1051, 39 USPQ2d 1474 (Fed. Cir. 1996) that a federal district court does not have the authority to order a patent owner to file papers prepared by a third party in addition to the patent owner’s own submission in a patent reexamination proceeding. Such papers prepared by the third party and filed by the patent owner will not be entered, and the entire submission will be returned to the patent owner as an inappropriate response. See MPEP § 2266 and § 2267.

The examination will be conducted in accordance with 37 CFR 1.104, 1.105, 1.110-1.113, and 1.116 (35 U.S.C. 132 and 133) and will result in the issuance of a reexamination certificate under 37 CFR 1.570. The proceeding shall be conducted with special dispatch within the Office pursuant to 35 U.S.C. 305, last sentence. A full search will not routinely be made by the examiner. The third party reexamination requester will be sent copies of Office actions and the patent owner must serve responses on the requester. Citations submitted in the patent file prior to issuance of an order for reexamination will be considered by the examiner during the reexamination. Reexamination will proceed even if the copy of the order sent to the patent owner is returned undelivered. The notice under 37 CFR 1.11(c) is constructive notice to the

patent owner and lack of response from the patent owner will not delay reexamination. See MPEP § 2230.

## 2255 Who Reexamines

The examination will ordinarily be conducted by the same patent examiner in the Technology Center who made the decision on whether the reexamination request should be granted. See MPEP § 2236.

However, if a petition under 37 CFR 1.515(c) is granted, the reexamination will normally be conducted by another examiner. See MPEP § 2248.

## 2256 Prior Art Patents and Printed Publications Reviewed by Examiner in Reexamination [R-2]

The primary source of prior art will be the patents and printed publications cited in the request for *ex parte* reexamination.

The examiner must also consider patents and printed publications:

(A) cited by another reexamination requester under 37 CFR 1.510 or 37 CFR 1.915;

(B) cited in a patent owner’s statement under 37 CFR 1.530 or a requester’s reply under 37 CFR 1.535 if they comply with 37 CFR 1.98;

(C) cited by the patent owner under a duty of disclosure (37 CFR 1.555) in compliance with 37 CFR 1.98;

(D) discovered by the examiner in searching;

(E) of record in the patent file from earlier examination; and

(F) of record in the patent file from any 37 CFR 1.501 submission prior to date of an order if it complies with 37 CFR 1.98.

The reexamination file must clearly indicate which prior art patents and printed publications the examiner has considered during the *ex parte* examination of the reexamination proceeding.

## 2257 Listing of Prior Art [R-2]

The examiner must list on a form PTO-892, if not already listed on a form PTO-1449 \*\*, PTO/SB/08A or 08B, or PTO/SB/42 (or on a form having a format equivalent to one of these forms), all prior art patents or printed publications which have been properly

>cited and relied upon by the reexamination requester in the request under 37 CFR 1.510.<

\*\*

The examiner must also list on a form PTO-892, if not already listed on a form PTO-1449 \*\*, PTO/SB/08A or 08B, or PTO/SB/42 (or on a form having a format equivalent to one of these forms), all prior art patents or printed publications which have been cited in the decision on the request, applied in making rejections or cited as being pertinent during the reexamination proceedings. Such prior art patents or printed publications may have come to the examiner's attention because:

(A) they were of record in the patent file due to a prior art submission under 37 CFR 1.501 which was received prior to the date of the order;

(B) they were of record in the patent file as result of earlier examination proceedings; or

(C) they were discovered by the examiner during a prior art search.

\*\*>

All citations listed on form PTO-892, and all citations not lined-through on any form PTO-1449, PTO/SB/08A or 08B, or PTO/SB/42 (or on a form having a format equivalent to one of these forms), will be printed on the reexamination certificate under "References Cited."

A submission of patents and/or publications is entitled to entry and citation in the reexamination certificate (that will be issued) when it complies with 37 CFR 1.98 and is submitted:

(A) by the patent owner in the statement under 37 CFR 1.530;

(B) by the reexamination requester in the reply under 37 CFR 1.535;

(C) prior to the order of reexamination under 37 CFR 1.501 by any party; and/or

(D) by the patent owner under the duty of disclosure requirements of 37 CFR 1.555.<

## 2258 Scope of Reexamination [R-2]

37 CFR 1.552. *Scope of reexamination in ex parte reexamination proceedings.*

(a) Claims in an *ex parte* reexamination proceeding will be examined on the basis of patents or printed publications and, with respect to subject matter added or deleted in the reexamination proceeding, on the basis of the requirements of 35 U.S.C. 112.

(b) Claims in an *ex parte* reexamination proceeding will not be permitted to enlarge the scope of the claims of the patent.

(c) Issues other than those indicated in paragraphs (a) and (b) of this section will not be resolved in a reexamination proceeding. If such issues are raised by the patent owner or third party requester during a reexamination proceeding, the existence of such issues will be noted by the examiner in the next Office action, in which case the patent owner may consider the advisability of filing a reissue application to have such issues considered and resolved.

The reexamination proceeding provides a complete reexamination of the patent claims on the basis of prior art patents and printed publications. Issues relating to 35 U.S.C. 112 are addressed only with respect to new claims or amendatory subject matter in the specification, claims or drawings. Any new or amended claims are examined to ensure that the scope of the original patent claims is not enlarged, i.e., broadened. See 35 U.S.C. 305.

### I. PRIOR ART PATENTS OR PRINTED PUBLICATIONS

Rejections on prior art in reexamination proceedings may only be made on the basis of prior art patents or printed publications. Prior art rejections may be based upon the following portions of 35 U.S.C. 102:

"(a) . . . patented or described in a printed publication in this or a foreign country, before the invention thereof by the applicant for patent, or"

"(b) the invention was patented or described in a printed publication in this or a foreign country . . . more than one year prior to the date of the application for patent in the United States, or"

\*\*\*\*\*

"(d) the invention was first patented or caused to be patented, or was the subject of an inventor's certificate, by the applicant or his legal representatives or assigns in a foreign country prior to the date of the application for patent in this country on an application for patent or inventor's certificate filed more than twelve months before the filing of the application in the United States, or"

\*\*>

"

(e) the invention was described in — (1) an application for patent, published under section 122(b), by another filed in the United States before the invention by the applicant for patent or (2) a patent granted on an application for patent by another filed in the United States before the invention by the applicant for patent, except that an international application filed under the treaty defined in section 351(a) shall have

the effects for the purposes of this subsection of an application filed in the United States only if the international application designated the United States and was published under Article 21(2) of such treaty in the English language; or” <

“(f) he did not himself invent the subject matter sought to be patented, or”

“(g)(1) during the course of an interference conducted under section 135 or section 291, another inventor involved therein establishes, to the extent permitted in section 104, that before such person’s invention thereof the invention was made by such other inventor and not abandoned, suppressed, or concealed, or (2) before such person’s invention thereof, the invention was made in this country by another inventor who had not abandoned, suppressed, or concealed it. In determining priority of invention under this subsection, there shall be considered not only the respective dates of conception and reduction to practice of the invention, but also the reasonable diligence of one who was first to conceive and last to reduce to practice, from a time prior to conception by the other.”

Rejections made under 35 U.S.C. 102(f) or (g) based on the prior invention of another must be disclosed in a patent or printed publication. Similarly, substantial new grounds of patentability may also be made under 35 U.S.C. 103 which are based on the above indicated portions of 35 U.S.C. 102.

A substantial new question of patentability may be found under 35 U.S.C. 102(f) or (g)/103 based on the prior invention of another disclosed in a patent or printed publication, if there was no common ownership at the time the claimed invention was made. See MPEP § 706.02(l). See MPEP § 706.02(l)(1) for information pertaining to references which qualify as prior art under 35 U.S.C. 102(e)/103.

#### **A. Previously Considered Prior Art Patents or Printed Publications**

After reexamination is ordered based on a proper substantial new question of patentability, >the propriety of making a ground of rejection based on prior art previously considered by the Office (in an earlier examination of the patent) is governed by the guidance set forth in MPEP § 2258.01. Note also< *In re Hiniker Co.*, 150 F.3d 1362, 1367, 47 USPQ2d 1523,1527 (Fed. Cir. 1998)(court held the reexamination proceeding was supported by a substantial new question of patentability where the rejection before the court was based on a combination of art that had been before the examiner during the original prosecution, and art newly cited during the reexamination proceeding.) The court further stated that any error in

the Commissioner’s authority to institute a reexamination was “washed clean” during the reexamination procedure.

#### **B. Matters Other Than Patents or Printed Publications**

Rejections will not be based on matters other than patents or printed publications, such as public use or sale, inventorship, 35 U.S.C. 101, fraud, etc. In this regard, see *In re Lanham*, 1 USPQ2d 1877 (Comm’r Pat. 1986), and *Stewart Systems v. Comm’r of Patents and Trademarks*, 1 USPQ2d 1879 (E.D. Va. 1986). A rejection on prior public use or sale, insufficiency of disclosure, etc., cannot be made even if it relies on a prior >art< patent or printed publication. Prior >art< patents or printed publications must be applied under an appropriate portion of 35 U.S.C. 102 and/or 103 when making a rejection.

#### **C. Intervening Patents or Printed Publications**

Rejections may be made in reexamination proceedings based on intervening patents or printed publications where the patent claims under reexamination are entitled only to the filing date of the patent and are not supported by an earlier foreign or United States patent application whose filing date is claimed. For example, under 35 U.S.C. 120, the effective date of these claims would be the filing date of the application which resulted in the patent. Intervening patents or printed publications are available as prior art under *In re Russetta*, 255 F.2d 687, 118 USPQ 101 (CCPA 1958), and *In re van \*Langenhoven*, 458 F.2d 132, 173 USPQ 426 (CCPA 1972). See also MPEP § 201.11.

#### **D. Double Patenting**

Double patenting is normally proper for consideration in reexamination. See *In re Lonardo*, 119 F.3d 960, 43 USPQ2d 1262 (Fed. Cir. 1997). In *Lonardo*, the Federal Circuit reviewed and interpreted the language of 35 U.S.C. 303 and stated that:

Since the statute in other places refers to prior art in relation to reexamination, *see id.*, it seems apparent that Congress intended that the phrases ‘patents and publications’ and ‘other patents or printed publications’ in section 303(a) not be limited to prior art patents or printed publications. . . . Finally, it is reasonable to conclude that Congress intended to include double patenting over a prior patent as a basis for reexamination because maintenance of a patent that creates double patenting is as much of an

imposition on the public as maintenance of patent that is unpatentable over prior art. Thus, we conclude that the PTO was authorized during reexamination to consider the question of double patenting based upon the '762 patent.

*In re Lonardo*, 119 F.3d at 966, 43 USPQ2d at 1266. Accordingly, the issue of double patenting is appropriate for consideration in reexamination, both as a basis for ordering reexamination and during subsequent examination on the merits. The issue of double patenting is to be considered by the examiner when making the decision on the request for reexamination. The examiner should determine whether the issue of double patenting raises a substantial new question of patentability. The issue of double patenting is also to be considered during the examination stage of reexamination proceeding. In the examination stage, the examiner should determine whether a rejection based on double patenting is appropriate.

See also *Ex parte Obiaya*, 227 USPQ 58, 60 (Bd. Pat. App. & Inter. 1985) (“Double patenting rejections are analogous to rejections under 35 U.S.C. 103 and depend on the presence of a prior patent as the basis for the rejection”).

As is the case for an application, a judicially created double patenting rejection (made in a reexamination) can be overcome by the filing of a terminal disclaimer in accordance with 37 CFR 1.321(c). Where a terminal disclaimer is submitted in a reexamination proceeding, form paragraph 14.23.01 should be used if the terminal disclaimer is proper. If the terminal disclaimer is not proper, form paragraph 14.25 should be used, and one or more of the appropriate form paragraphs 14.26 to 14.32 must follow form paragraph 14.25 to indicate why the terminal disclaimer is not accepted. See also MPEP § 1490.

### ***E. Affidavits or Declarations***

Affidavits or declarations which explain the contents or pertinent dates of prior >art< patents or printed publications in more detail may be considered in reexamination, but any rejection must be based upon the prior >art< patents or printed publications as explained by the affidavits or declarations. The rejection in such circumstances cannot be based on the affidavits or declarations as such, but must be based on the prior >art< patents or printed publications.

### ***F. Admissions; Use of Admissions***

#### **1. Initial Reexamination Determination and Order**

The consideration under 35 U.S.C. 303 of a request for reexamination is limited to prior art patents and printed publications. See *Ex parte McGaughey*, 6 USPQ2d 1334, 1337 (Bd. Pat. App. & Inter. 1988). Thus an admission, *per se*, may not be the basis for establishing a substantial new question of patentability. However, an admission by the patent owner of record in the file or in a court record may be utilized in combination with a patent or printed publication.

#### **2. Reexamination Ordered, Examination on the Merits**

After reexamination has been ordered, the examination on the merits is dictated by 35 U.S.C. 305, see *Ex parte McGaughey*, 6 USPQ2d 1334, 1337 (Bd. Pat. App. & Inter. 1988).

Admissions by the patent owner in the record as to matters affecting patentability may be utilized in a reexamination proceeding; see 37 CFR 1.104(c)(3).

37 CFR 1.104(c)(3) provides that admissions by the patent owners as to matters affecting patentability may be utilized in a reexamination proceeding. The Supreme Court when discussing 35 U.S.C. 103 in *Graham v. John Deere Co.*, 383 U.S. 6, 148 USPQ 459 (1966) stated, *inter alia*, “the scope and content of the prior art are to be determined.” Accordingly, a proper evaluation of the scope and content of the prior art in determining obviousness would require a utilization of any “admission” by the patent owner which can be used to interpret or modify a patent or printed publication applied in a reexamination proceeding. This is true whether such admission results from a patent or printed publication or from some other source. An admission as to what is in the prior art is simply that, an admission, and requires no independent proof. It is an acknowledged, declared, conceded, or recognized fact or truth, *Ex parte McGaughey*, 6 USPQ2d 1334, 1337 (Bd. Pat. App. & Inter. 1988). While the scope and content of the admission may sometimes have to be determined, this can be done from the record and from the paper file in the same manner as with patents and printed publications. To ignore an admission by the patent owner, from any source, and not use the admission as part of the prior

art in conjunction with patents and printed publications in reexamination would make it impossible for the examiner to properly determine the scope and content of the prior art as required by *Graham*, supra.

The Board of Appeals upheld the use of an admission in a reexamination proceeding in *Ex parte Seiko Koko Kabushiki Kaisha*, 225 USPQ 1260 (Bd. Pat. App. & Inter. 1984), *Ex parte Kimbell*, 226 USPQ 688 (Bd. Pat. App. & Inter. 1985) and in *Ex parte McGaughey*, 6 USPQ2d 1334 (Bd. Pat. App. & Inter. 1988). In *Seiko*, the Board relied on *In re Nomiya*, 509 F.2d 566, 184 USPQ 607 (CCPA 1975) holding an admission of prior art in the specification of the parent undergoing reexamination is considered prior art which may be considered as evidence of obviousness under 35 U.S.C. 103. In *Kimbell*, the Board referred to the patent specification and noted the admission by appellant that an explosion-proof housing was well known at the time of the invention. In *Ex parte McGaughey*, 6 USPQ2d 1334, 1337 (Bd. Pat. App. & Int. 1988), the Board held that any equivocal admission relating to prior art is a fact which is part of the scope and content of the prior art and that prior art admissions established in the record are to be considered in reexamination. An admission from any source can be used with respect to interpreting or modifying a prior art patent or printed publication, in a reexamination proceeding. The Board expressly overruled the prior Board decision in *Ex parte Horton*, 226 USPQ 697 (Bd. Pat. App. & Inter. 1985) which held that admissions which are used as a basis for a rejection in reexamination must relate to patents and printed publications.

The admission can reside in the patent file (made of record during the prosecution of the patent application) or may be presented during the pendency of the reexamination proceeding or in litigation. Admissions by the patent owner as to any matter affecting patentability may be utilized to determine the scope and content of the prior art in conjunction with patents and printed publications in a prior art rejection, whether such admissions result from patents or printed publications or from some other source. An admission relating to any prior art (e.g., on sale, public use) established in the record or in court may be used by the examiner in combination with patents or printed publications in a reexamination proceeding.

Any admission submitted by the patent owner is proper. A third party, however, may not submit admissions of the patent owner made outside the record. Such a submission would be outside the scope of reexamination.

### G Claim Interpretation and Treatment

Original patent claims will be examined *only* on the basis of prior art patents or printed publications applied under the appropriate parts of 35 U.S.C. 102 and 103. See MPEP § 2217. During reexamination, claims are given the broadest reasonable interpretation consistent with the specification and limitations in the specification are not read into the claims (*In re Yamamoto*, 740 F.2d 1569, 222 USPQ 934 (Fed. Cir. 1984)). In a reexamination proceeding involving claims of an expired patent, which are not subject to amendment, a policy of narrow construction should be applied. Such a policy favors a construction of a patent claim that will render it valid; i.e., a narrow construction, over a broad construction that would render it invalid. See *In re Papst-Motoren*, 1 USPQ2d \*1655 (Bd. Pat. App. & Inter. 1986). The statutory presumption of validity, 35 U.S.C. 282, has no application in reexamination (*In re Etter*, 756 F.2d 852, 225 USPQ 1 (Fed. Cir. 1985)).

## II. COMPLIANCE WITH 35 U.S.C. 112

Where new claims are presented or where any part of the disclosure is amended, the claims of the reexamination proceeding, are to be examined for compliance with 35 U.S.C. 112. Consideration of 35 U.S.C. 112 issues should, however, be limited to the amendatory (e.g., new language) matter. For example, a claim which is amended or a new claim which is presented containing a limitation not found in the original patent claim should be considered for compliance under 35 U.S.C. 112 only with respect to that limitation. To go further would be inconsistent with the statute to the extent that 35 U.S.C. 112 issues would be raised as to matter in the original patent claim. Thus, a term in a patent claim which the examiner might deem to be too broad cannot be considered as too broad in a new or amended claim *unless* the amendatory matter in the new or amended claim creates the issue.



### A. 35 U.S.C. 112 Issues To Be Considered

Compliance of new or amended claims with the enablement and/or description requirements of the first paragraph of 35 U.S.C. 112 should be considered as to the amendatory and new text in the reexamination proceeding. Likewise, the examiner should determine whether the new or amended claims comply with the second paragraph of 35 U.S.C. 112. MPEP § 2163 - § 2173.05(v) provide extensive guidance as to these matters.

### B. New Matter

35 U.S.C. 305 provides for examination under 35 U.S.C. 132, which prohibits the introduction of new matter into the disclosure. Thus, the question of new matter should be considered in a reexamination proceeding. See MPEP § 2163.06 as to the relationship of the written description requirement of the first paragraph of 35 U.S.C. 112 and the new matter prohibition under 35 U.S.C. 132. Where the new matter is added to the claims or affects claim limitations, the claims should be rejected under 35 U.S.C. 112, first paragraph, for failing to meet the written description requirement.

### C. Amendment of the Specification

Where the specification is amended in a reexamination proceeding, the examiner should make certain that the requirements of 35 U.S.C. 112 are met. An amendment to the specification can redefine the scope of the terms in a claim such that the claim is no longer clear or is not supported by the specification. Thus, an amendment to the specification can result in the failure of the claims to comply with 35 U.S.C. 112, even where the claims are not amended in any respect.

## III. CLAIMS IN PROCEEDING MUST NOT ENLARGE SCOPE OF THE CLAIMS OF THE PATENT

Where new or amended claims are presented or where any part of the disclosure is amended, the claims of the reexamination proceeding should be examined under 35 U.S.C. 305, to determine whether they enlarge the scope of the original claims. 35 U.S.C. 305 states that “no proposed amended or new claim enlarging the scope of the claims of the

patent will be permitted in a reexamination proceeding...”.

### A. Criteria for Enlargement of the Scope of the Claims

A claim presented in a reexamination proceeding “enlarges the scope” of the claims of the patent being reexamined where the claim is broader than each and every claim of the patent. See MPEP § 1412.03 for guidance as to when the presented claim is considered to be a broadening claim as compared with the claims of the patent, i.e., what is broadening and what is not. If a claim is considered to be a broadening claim for purposes of reissue, it is likewise considered to be a broadening claim in reexamination.

### B. Amendment of the Specification

Where the specification is amended in a reexamination proceeding, the examiner should make certain that the amendment to the specification does not enlarge the scope of the claims of the patent. An amendment to the specification can enlarge the scope of the claims by redefining the scope of the terms in a claim, even where the claims are not amended in any respect.

### C. Rejection of Claims Where There Is Enlargement

Any claim in a reexamination proceeding which enlarges the scope of the claims of the patent should be rejected under 35 U.S.C. 305. Form paragraph 22.11 is to be employed in making the rejection.

\*\*>

#### ¶ 22.11 Rejection, 35 U.S.C. 305, Claim Enlarges Scope of Patent - Ex Parte Reexamination

Claim [1] rejected under 35 U.S.C. 305 as enlarging the scope of the claim(s) of the patent being reexamined. In 35 U.S.C. 305, it is stated that “[n]o proposed amended or new claim enlarging the scope of a claim of the patent will be permitted in a reexamination proceeding....” A claim presented in a reexamination “enlarges the scope” of the patent claim(s) where the claim is broader than any claim of the patent. A claim is broader in scope than the original claims if it contains within its scope any conceivable product or process which would not have infringed the original patent. A claim is broadened if it is broader in any one respect, even though it may be narrower in other respects.

[2]

**Examiner Note:**

The claim limitations which are considered to broaden the scope should be identified and explained in bracket 2. See MPEP § 2258.

&lt;

**IV. OTHER MATTERS**

&gt;

**A. Patent Under Reexamination Subject Of A Prior Office Or Court Decision<**

Where some of the patent claims in a patent being reexamined have been the subject of a prior Office or court decision, see MPEP § 2242. Where other proceedings involving the patent are copending with the reexamination proceeding, see MPEP § 2282 - § 2286.

>Patent claims not subject to reexamination because of their prior adjudication by a court should be identified. See MPEP § 2242. For handling a “live” claim dependent on a patent claim not subject to reexamination, see MPEP § 2260.01. All added claims will be examined.

Where grounds are set forth in a prior Office decision or Federal Court decision, which are not based on patents or printed publications and which clearly raise questions as to the validity of the claims, the examiner’s Office action should clearly state that the claims have not been examined as to those grounds not based on patents or printed publications that were stated in the prior decision. See 37 CFR 1.552(c). See *In re Knight*, 217 USPQ 294 (Comm’r Pat. 1982). All claims under reexamination should, however, be reexamined, but only on the basis of prior art patents and printed publications.

**B. All “Live” Claims Are Reexamined During Reexamination<**

Even when a request for reexamination does not present a substantial new question as to all \*>“live” claims (i.e., each existing claim not held invalid by a final decision, after all appeals<, each claim of the patent will be reexamined. The resulting reexamination certificate will indicate the status of all of the patent claims and any added patentable claims.

&gt;

**C. Restriction Not Proper In Reexamination<**

Restriction requirements cannot be made in a reexamination proceeding since no statutory basis exists for restriction in a reexamination proceeding.

&gt;

**D. Ancillary Matters<**

There are matters ancillary to reexamination which are necessary and incident to patentability which will be considered. Amendments may be made to the specification to correct, for example, an inadvertent failure to claim foreign priority or the continuing status of the patent relative to a parent application if such correction is necessary to overcome a reference applied against a claim of the patent.

&gt;

**E. Claiming Foreign And Domestic Priority In Reexamination**

The patent owner may obtain the right of foreign priority under 35 U.S.C. 119 (a)-(d) where a claim for priority had been made before the patent was granted, and it is only necessary for submission of the certified copy in the reexamination proceeding to perfect priority. Likewise, patent owner may obtain the right of foreign priority under 35 U.S.C. 119 (a)-(d) where it is necessary to submit for the first time both the claim for priority and the certified copy. However, where it is necessary to submit for the first time both the claim for priority and the certified copy, and the patent to be reexamined matured from a utility or plant application filed on or after November 29, 2000, then the patent owner must also file a grantable petition for an unintentionally delayed priority claim under 37 CFR 1.55(c). See MPEP § 201.14(a).

Also, patent owner may correct the failure to adequately claim (in the application for the patent reexamined) benefit under 35 U.S.C. 120 of an earlier filed copending U.S. patent application. For a patent to be reexamined which matured from a utility or plant application filed on or after November 29, 2000, the patent owner must file a grantable petition for an unintentionally delayed priority claim under 37 CFR 1.78(a)(3). See MPEP § 201.11.

For a patent to be reexamined which matured from a utility or plant application filed before November

29, 2000, the patent owner can correct via reexamination the failure to adequately claim benefit under 35 U.S.C. 119(e) of an earlier filed provisional application. Under no circumstances can a reexamination proceeding be employed to add or correct a benefit claim under 35 U.S.C. 119(e) for a patent matured from a utility or plant application filed on or after November 29, 2000.

Section 4503 of the American Inventor's Protection Act of 1999 (AIPA) amended 35 U.S.C. 119(e)(1) to state that:

No application shall be entitled to the benefit of an earlier filed provisional application under this subsection unless an amendment containing the specific reference to the earlier filed provisional application is submitted at such time during the pendency of the application as required by the Director. The Director may consider the failure to submit such an amendment within that time period as a waiver of any benefit under this subsection. The Director may establish procedures, including the payment of a surcharge, to accept an unintentionally delayed submission of an amendment under this section during the pendency of the application.

35 U.S.C. 119(e)(1), as amended by the AIPA, clearly prohibits the addition or correction of benefit claims under 35 U.S.C. 119(e) when the application is no longer pending, e.g., an issued patent. Therefore, a reexamination is not a valid mechanism for adding or correcting a benefit claim under 35 U.S.C. 119(e) after a patent has been granted (for a patent matured from a utility or plant application filed on or after November 29, 2000).<

No renewal of previously made claims for foreign priority under 35 U.S.C. 119 or \*\*>domestic benefit< under 35 U.S.C. >119(e) or< 120, is necessary during reexamination.

>

#### **F. Correction Of Inventorship<**

Correction of inventorship may also be made during reexamination. See 37 CFR 1.324 and MPEP § 1481 for petition for correction of inventorship in a patent. If a petition filed under 37 CFR 1.324 is granted, a Certificate of Correction indicating the change of inventorship will not be issued, because the reexamination certificate that will ultimately issue will contain the appropriate change-of-inventorship information (i.e., the Certificate of Correction is in effect merged with the reexamination certificate).

>

#### **G Affidavits In Reexamination<**

Affidavits under 37 CFR 1.131 and 1.132 may be utilized in a reexamination proceeding. Note, however, that an affidavit under 37 CFR 1.131 may not be used to "swear back" of a reference patent if the reference patent is claiming the "same invention" as the patent undergoing reexamination. In such a situation, the patent owner may, if appropriate, seek to raise this issue >via an affidavit under 37 CFR 1.130 (see MPEP § 718) or< in an interference proceeding via an appropriate reissue application if such a reissue application may be filed \*\* >(see MPEP § 1449.02).

#### **H. Issues Not Considered In Reexamination<**

If questions other than those indicated above (for example, questions of patentability based on \* public use or >on< sale, fraud, abandonment under 35 U.S.C. 102(c), etc.) are \*>raised by the third party requester or the patent owner< during a reexamination proceeding, the existence of such questions will be noted by the examiner in an Office action, in which case the patent owner may desire to consider the advisability of filing a reissue application to have such questions considered and resolved. Such questions could arise in a reexamination requester's 37 CFR 1.510 request or in a 37 CFR 1.535 reply by the requester. Note form paragraph 22.03.

\*\*>

#### **¶ 22.03 Issue Not Within Scope of Ex Parte Reexamination**

It is noted that an issue not within the scope of reexamination proceedings has been raised. [1]. The issue will not be considered in a reexamination proceeding. 37 CFR 1.552(c). While this issue is not within the scope of reexamination, the patentee is advised that it may be desirable to consider filing a reissue application provided that the patentee believes one or more claims to be partially or wholly inoperative or invalid based upon the issue.

#### **Examiner Note:**

1. In bracket 1, identify the issues.
2. This paragraph may be used either when the patent owner or third party requester raises issues such as public use or on sale, fraud, or abandonment of the invention. Such issues should not be raised independently by the patent examiner.

If questions of patentability based on public use or on sale, fraud, abandonment under 35 U.S.C. 102(c), etc. are independently discovered by the examiner during a reexamination proceeding but were not

raised by the third party requester or the patent owner, the existence of such questions will not be noted by the examiner in an Office action, because 37 CFR 1.552(c) is only directed to such questions “raised by the patent owner or the third party requester.”

### ***I. Request For Reexamination Filed On Patent After It Has Been Reissued***

Where a request for reexamination is filed on a patent after it has been reissued, reexamination will be denied because the patent on which the request for reexamination is based has been surrendered. Should reexamination of the reissued patent be desired, a new request for reexamination including, and based on, the specification and claims of the reissue patent must be filed.

Any amendment made by the patent owner to accompany the initial reexamination request, or in later prosecution of the reexamination proceeding, should treat the changes made by the granted reissue patent as the text of the patent, and all bracketing and underlining made with respect to the patent **as changed by the reissue**.

Where the reissue patent issues after the filing of a request for reexamination, see MPEP § 2285.

>

## **2258.01 Use of Previously Cited/Considered Art in Rejections [R-2]**

In the examining stage of a reexamination proceeding, the examiner will consider whether the claims are subject to rejection based on art. Before making such a rejection, the examiner should check the patent’s file history to ascertain whether the art that will provide the basis for the rejection was previously cited/considered in an earlier concluded Office examination of the patent (e.g., in the examination of the application for the patent). For the sake of expediency, such art is referred to as “old art” throughout, since the term “old art” was coined by the Federal Circuit in its decision of *In re Hiniker*, 150 F.3d 1362, 1365-66, 47 USPQ2d 1523, 1526 (Fed. Cir. 1998).

If the rejection to be made by the examiner will be based on a combination of “old art” and art newly cited during the reexamination proceeding, the rejection is proper, and should be made. See *In re Hiniker*, 150 F.3d at 1367, 47 USPQ2d at 1527. (Court held the reexamination proceeding was supported by a sub-

stantial new question of patentability where the rejection before the court was based on a combination of art that had been before the examiner during the original prosecution, and art newly cited during the reexamination proceeding.)

If the “old art” provides the **sole basis** for a rejection, the following applies:

### **(A) Reexamination was ordered on or after November 2, 2002:**

For a reexamination that was ordered on or after November 2, 2002 (the date of enactment of Public Law 107-273; see Section 13105, of the Patent and Trademark Office Authorization Act of 2002), reliance solely on old art (as the basis for a rejection) does not necessarily preclude the existence of a substantial new question of patentability (SNQ) that is based exclusively on that old art. Determinations on whether a SNQ exists in such an instance shall be based upon a fact-specific inquiry done on a case-by-case basis. For example, a SNQ may be based solely on old art where the old art is being presented/viewed in a new light, or in a different way, as compared with its use in the earlier concluded examination(s), in view of a material new argument or interpretation presented in the request.

When an Office action is being considered, and it is newly determined that a SNQ based solely on old art is raised by a request in a reexamination that was ordered on or after November 2, 2002, form paragraph 22.01.01 should be included in the Office action. Form paragraph 22.01.01 should be included in any Office action in which a SNQ based solely on the old art is first set forth (i.e., it was not set forth in the order granting reexamination or a prior Office action in the proceeding).

#### *¶ 22.01.01 Criteria for Applying “Old Art” as Sole Basis for Reexamination*

The above [1] is based solely on patents and/or printed publications already cited/considered in an earlier concluded examination of the patent being reexamined. On November 2, 2002, Public Law 107-273 was enacted. Title III, Subtitle A, Section 13105, part (a) of the Act revised the reexamination statute by adding the following new last sentence to 35 U.S.C. 303(a) and 312(a):

“The existence of a substantial new question of patentability is not precluded by the fact that a patent or printed publication was previously cited by or to the Office or considered by the Office.”

For any reexamination ordered on or after November 2, 2002, the effective date of the statutory revision, reliance on previously cited/considered art, i.e., “old art,” does not necessarily preclude the existence of a substantial new question of patentability (SNQ) that is based exclusively on that old art. Rather, determinations on whether a SNQ exists in such an instance shall be based upon a fact-specific inquiry done on a case-by-case basis.

In the present instance, there exists a SNQ based solely on [2]. A discussion of the specifics now follows:

[3]

#### Examiner Note:

1. In bracket 1, insert “substantial new question of patentability” if the present form paragraph is used in an order granting reexamination (or a TC Director’s decision on petition of the denial of reexamination). If this form paragraph is used in an Office action, insert “ground of rejection”.
2. In bracket 2, insert the old art that is being applied as the sole basis of the SNQ. For example, “the patent to Schor” or “the patent to Schor when taken with the Jones publication” or “the combination of the patent to Schor and the Smith publication” could be inserted. Where more than one SNQ is presented based solely on old art, the examiner would insert all such bases for SNQ.
3. In bracket 3, for each basis identified in bracket 2, explain how and why that fact situation applies in the proceeding being acted on. The explanation could be for example that the old art is being presented/viewed in a new light, or in a different way, as compared with its use in the earlier concluded examination(s), in view of a material new argument or interpretation presented in the request. See *Ex parte Chicago Rawhide Mfg. Co.*, 223 USPQ 351 (Bd. Pat. App. & Inter. 1984).
4. This form paragraph is only used the first time the “already cited/considered” art is applied, and is not repeated for the same art in subsequent Office actions.

#### (B) Reexamination was ordered **prior to November 2, 2002**:

For a reexamination that was ordered prior to November 2, 2002, old art **cannot** (subject to the exceptions set forth below) be used as the **sole basis** for a rejection.

In determining the presence or absence of “a substantial new question of patentability” on which to base a rejection, the use of “old art” in a reexamination that was ordered prior to November 2, 2002, is controlled by *In re Portola Packaging Inc.*, 110 F.3d 786, 42 USPQ2d 1295 (Fed. Cir. 1997). (Note that *Portola Packaging* was decided based on the reexamination statute as it existed prior to the amendment by Public Law 107-273, Section 13105 of the Patent and Trademark Office Authorization Act of 2002). The amendment by Public Law 107-273, Section 13105, overruled the *Portola Packaging* decision for any

reexamination that was ordered on or after November 2, 2002. See *In re Robert T. Bass*, 314 F.3d 575, 576-77, 65 USPQ2d 1156, 1157 (Fed. Cir. 2002) where the Court stated in the sole footnote:

The following guidelines are provided for reviewing ongoing reexaminations ordered **prior to November 2, 2002**, for compliance with the *Portola Packaging* decision.

On November 2, 2002, 35 U.S.C. 303(a) was amended by the passage of Pub. L. No. 107-273, 13105, (116 Stat.) 1758, 1900, to add “[t]he existence of a substantial new question of patentability is not precluded by the fact that a patent or printed publication was previously cited by or to the Office or considered by the Office,” thereby overruling *Portola Packaging*. The following guidelines are provided for reviewing ongoing reexaminations ordered **prior to November 2, 2002**, for compliance with the *Portola Packaging* decision.

(1) General principles governing compliance with *Portola Packaging* for ongoing reexaminations ordered prior to November 2, 2002.

If prior art was previously relied upon to reject a claim in a concluded prior related Office proceeding, the Office will not conduct reexamination based only on such prior art. “Prior related Office proceedings” include the application which matured into the patent that is being reexamined, any reissue application for the patent, and any reexamination proceeding for the patent.

If prior art was not relied upon to reject a claim, but was cited in the record of a concluded prior related Office proceeding, and its relevance to the patentability of any claim was actually discussed on the record, the Office will not conduct reexamination based only on such prior art. The relevance of the prior art to patentability may have been discussed by either the applicant, patentee, examiner, or any third party. However, 37 CFR 1.2 requires that all Office business be transacted in writing. Thus, the Office cannot presume that a prior art reference was previously relied upon or discussed in a prior Office proceeding if there is no basis in the written record to so conclude other than the examiner’s initials or a check mark on a PTO 1449 form, or equivalent, submitted with an information disclosure statement. Thus, any specific discussion of prior art must appear on the record of a prior related Office proceeding. General-

ized statements such as the prior art is “cited to show the state of the art,” “cited to show the background of the invention,” or “cited of interest” would not preclude reexamination.

The Office may conduct reexamination based on prior art that was cited but whose relevance to patentability of the claims was not discussed in any prior related Office proceeding.

(2) Procedures for determining whether an ongoing reexamination must be terminated in compliance with *Portola Packaging*.

Office personnel must adhere to the following procedures when determining whether an ongoing reexamination should be terminated in compliance with the Federal Circuit’s decision in *Portola Packaging*.

(a) Ascertain that the order granting reexamination was mailed prior to November 2, 2002. If the order granting reexamination was not mailed prior to November 2, 2002, see above “Reexamination was ordered on or after November 2, 2002” for guidance.

(b) Prior to making any rejection in the ongoing reexamination, determine for any prior related Office proceeding what prior art was (i) relied upon to reject any claim, or (ii) cited and discussed.

(c) Base any and all rejections of the patent claims under reexamination at least in part on prior art that was, in any prior related Office proceeding, neither (i) relied upon to reject any claim, nor (ii) cited and its relevance to patentability of any claim discussed.

(d) Withdraw any rejections based only on prior art that was, in any prior related Office proceeding, previously either (i) relied upon to reject any claim, or (ii) cited and its relevance to patentability of any claim discussed.

(e) Terminate any reexamination in which the only remaining rejections are entirely based on prior art that was, in any prior related Office proceeding, previously (i) relied upon to reject any claim, and/or (ii) cited and its relevance to patentability of a claim discussed.

The Director of the USPTO may conduct a search for new art to determine whether a substantial new question of patentability exists prior to terminating any ongoing reexamination proceeding. See 35 U.S.C. 303. See also 35 U.S.C. 305 (indicating that “reexamination will be conducted according to the

procedures established for initial examination,” thereby suggesting that the Director of the USPTO may conduct a search during an ongoing reexamination proceeding).

(3) Application of *Portola Packaging* to unusual fact patterns.

The Office recognizes that each case must be decided on its particular facts and that cases with unusual fact patterns will occur. In such a case, the reexamination should be brought to the attention of the Technology Center (TC) Director who will then determine the appropriate action to be taken.

Unusual fact patterns may appear in cases in which prior art was relied upon to reject any claim or cited and discussed with respect to the patentability of a claim in a prior related Office proceeding, but other evidence clearly shows that the examiner did not appreciate the issues raised in the reexamination request or the ongoing reexamination with respect to that art. Such other evidence may appear in the reexamination request, in the nature of the prior art, in the prosecution history of the prior examination, or in an admission by the patent owner, applicant, or inventor. See 37 CFR 1.104(c)(3).

The following examples are intended to be illustrative and not inclusive.

For example, if a textbook was cited during prosecution of the application which matured into the patent, the record of that examination may show that only select information from the textbook was discussed with respect to the patentability of the claims. The file history of the prior Office proceeding should indicate which portion of the textbook was previously considered. See 37 CFR 1.98(a)(2)(ii) (an information disclosure statement must include a copy of each “publication or that portion which caused it to be listed”). If a subsequent reexamination request relied upon other information in the textbook that actually teaches what is required by the claims, it may be appropriate to rely on this other information in the textbook to order and/or conduct reexamination. However, a reexamination request that merely provides a new interpretation of a reference already previously relied upon or actually discussed by the Office does not create a substantial new question of patentability.

Another example involves the situation where an examiner discussed a reference in a prior Office

proceeding, but did not either reject a claim based upon the reference or maintain the rejection based on the mistaken belief that the reference did not qualify as prior art. For example, the examiner may not have believed that the reference qualified as prior art because: (i) the reference was undated or was believed to have a bad date; (ii) the applicant submitted a declaration believed to be sufficient to antedate the reference under 37 CFR 1.131; or (iii) the examiner attributed an incorrect filing date to the claimed invention. If the reexamination request were to explain how and why the reference actually does qualify as prior art, it may be appropriate to rely on the reference to order and/or conduct reexamination. For example, the request could: (i) verify the date of the reference; (ii) undermine the sufficiency of the declaration filed under 37 CFR 1.131; or (iii) explain the correct filing date accorded a claim. See e.g., *Heinl v. Godici*, 143 Supp.2d 593 (E.D.Va. 2001) (reexamination on the basis of art previously presented without adequate proof of date may proceed if prior art status is now established).

Another example involves foreign language prior art references. If a foreign language prior art reference was cited and discussed in any prior Office proceeding but the foreign language prior art reference was never completely and accurately translated into English during the original prosecution, *Portola Packaging* may not prohibit reexamination over a complete and accurate translation of that foreign language prior art reference. Specifically, if a reexamination request were to explain why a more complete and accurate translation of that same foreign language prior art reference actually teaches what is required by the patent claims, it may be appropriate to rely on the foreign language prior art reference to order and/or conduct reexamination.

Another example of an unusual fact pattern involves cumulative references. To the extent that a cumulative reference is repetitive of a prior art reference that was previously applied or discussed, *Portola Packaging* may prohibit reexamination of the patent claims based only on the repetitive reference. For purposes of reexamination, a cumulative reference that is repetitive is one that substantially reiterates verbatim the teachings of a reference that was either previously relied upon or discussed in a prior Office proceeding even though the title or the citation of the reference

may be different. However, it is expected that a repetitive reference which cannot be considered by the Office during reexamination will be a rare occurrence since most references teach additional information or present information in a different way than other references, even though the references might address the same general subject matter.

(4) Notices regarding compliance with *Portola Packaging*.

(a) If an ongoing reexamination is terminated under (2)(e) above in order to comply with the Federal Circuit's decision in *Portola Packaging*, the Notice of Intent to Issue *Ex Parte* Reexamination Certificate should state:

"This reexamination is terminated based on *In re Portola Packaging, Inc.*, 110 F.3d 786, 42 USPQ2d 1295 (Fed. Cir. 1997). No patentability determination has been made in this reexamination proceeding."

(b) If a rejection in the reexamination has previously been issued and that rejection is withdrawn under (2)(d) above in order to comply with the Federal Circuit's decision in *Portola Packaging*, the Office action withdrawing such rejection should state:

"The rejection(s) based upon \_\_\_\_\_ is/are withdrawn in view of *In re Portola Packaging, Inc.*, 110 F.3d 786, 42 USPQ2d 1295 (Fed. Cir. 1997). No patentability determination of the claims of the patent in view of such prior art has been made in this reexamination proceeding."

## 2259 >Res Judicata and< Collateral Estoppel in Reexamination Proceedings [R-2]

MPEP § 2242 and § 2286 relate to the Office policy controlling the determination on a request for reexamination and the subsequent examination phase of the reexamination where there has been a Federal Court decision on the merits as to the patent for which reexamination is requested.

Since claims finally held invalid by a Federal Court, after all appeals, will be withdrawn from consideration and not reexamined during a reexamination proceeding, \*\*>a **rejection** on the grounds of *res judicata* will not be appropriate in reexamination. In situations, where the issue decided in Court did not invalidate claims, but applies in one or more respects to the claims being reexamined, the doctrine

of collateral estoppel may be applied in reexamination to resolve the issue.<

## 2260 Office Actions [R-2]

### 37 CFR 1.104. Nature of examination.

#### (a) Examiner's action.

(1) On taking up an application for examination or a patent in a reexamination proceeding, the examiner shall make a thorough study thereof and shall make a thorough investigation of the available prior art relating to the subject matter of the claimed invention. The examination shall be complete with respect both to compliance of the application or patent under reexamination with the applicable statutes and rules and to the patentability of the invention as claimed, as well as with respect to matters of form, unless otherwise indicated.

(2) The applicant, or in the case of a reexamination proceeding, both the patent owner and the requester, will be notified of the examiner's action. The reasons for any adverse action or any objection or requirement will be stated in an Office action and such information or references will be given as may be useful in aiding the applicant, or in the case of a reexamination proceeding the patent owner, to judge the propriety of continuing the prosecution.

(3) An international-type search will be made in all national applications filed on and after June 1, 1978.

(4) Any national application may also have an international-type search report prepared thereon at the time of the national examination on the merits, upon specific written request therefor and payment of the international-type search report fee set forth in § 1.21(e). The Patent and Trademark Office does not require that a formal report of an international-type search be prepared in order to obtain a search fee refund in a later filed international application.

(b) *Completeness of examiner's action.* The examiner's action will be complete as to all matters, except that in appropriate circumstances, such as misjoinder of invention, fundamental defects in the application, and the like, the action of the examiner may be limited to such matters before further action is made. However, matters of form need not be raised by the examiner until a claim is found allowable.

#### (c) Rejection of claims.

(1) If the invention is not considered patentable, or not considered patentable as claimed, the claims, or those considered unpatentable will be rejected.

(2) In rejecting claims for want of novelty or for obviousness, the examiner must cite the best references at his or her command. When a reference is complex or shows or describes inventions other than that claimed by the applicant, the particular part relied on must be designated as nearly as practicable. The pertinence of each reference, if not apparent, must be clearly explained and each rejected claim specified.

(3) In rejecting claims the examiner may rely upon admissions by the applicant, or the patent owner in a reexamination proceeding, as to any matter affecting patentability and, insofar as rejections in applications are concerned, may also rely upon

facts within his or her knowledge pursuant to paragraph (d)(2) of this section.

(4) Subject matter which is developed by another person which qualifies as prior art only under 35 U.S.C. 102(e), (f) or (g) may be used as prior art under 35 U.S.C. 103 against a claimed invention unless the entire rights to the subject matter and the claimed invention were commonly owned by the same person or organization or subject to an obligation of assignment to the same person or organization at the time the claimed invention was made.

(5) The claims in any original application naming an inventor will be rejected as being precluded by a waiver in a published statutory invention registration naming that inventor if the same subject matter is claimed in the application and the statutory invention registration. The claims in any reissue application naming an inventor will be rejected as being precluded by a waiver in a published statutory invention registration naming that inventor if the reissue application seeks to claim subject matter:

(i) Which was not covered by claims issued in the patent prior to the date of publication of the statutory invention registration; and

(ii) Which was the same subject matter waived in the statutory invention registration.

#### (d) Citation of references.

(1) If domestic patents are cited by the examiner, their numbers and dates, and the names of the patentees will be stated. If domestic patent application publications are cited by the examiner, their publication number, publication date, and the names of the applicants will be stated. If foreign published applications or patents are cited, their nationality or country, numbers and dates, and the names of the patentees will be stated, and such other data will be furnished as may be necessary to enable the applicant, or in the case of a reexamination proceeding, the patent owner, to identify the published applications or patents cited. In citing foreign published applications or patents, in case only a part of the document is involved, the particular pages and sheets containing the parts relied upon will be identified. If printed publications are cited, the author (if any), title, date, pages or plates, and place of publication, or place where a copy can be found, will be given.

(2) When a rejection in an application is based on facts within the personal knowledge of an employee of the Office, the data shall be as specific as possible, and the reference must be supported, when called for by the applicant, by the affidavit of such employee, and such affidavit shall be subject to contradiction or explanation by the affidavits of the applicant and other persons.

(e) *Reasons for allowance.* If the examiner believes that the record of the prosecution as a whole does not make clear his or her reasons for allowing a claim or claims, the examiner may set forth such reasoning. The reasons shall be incorporated into an Office action rejecting other claims of the application or patent under reexamination or be the subject of a separate communication to the applicant or patent owner. The applicant or patent owner may file a statement commenting on the reasons for allowance within such time as may be specified by the examiner. Failure by the examiner to respond to any statement commenting on reasons for allowance does not give rise to any implication.



It is intended that the examiner's first *ex parte* action on the merits be the primary action to establish the issues which exist between the examiner and the patent owner insofar as the patent is concerned. At the time the first action is issued, the patent owner has already been permitted to file a statement and an amendment pursuant to 37 CFR 1.530; and the reexamination requester, if the requester is not the patent owner, has been permitted to reply thereto pursuant to 37 CFR 1.535. Thus, at this point, the issues should be sufficiently focused to enable the examiner to make a definitive first *ex parte* action on the merits which should clearly establish the issues which exist between the examiner and the patent owner insofar as the patent is concerned. In view of the fact that the examiner's first action will clearly establish the issues, the first action should include a statement cautioning the patent owner that a complete response should be made to the action since the next action is expected to be a final action. The first action should further caution the patent owner that the requirements of 37 CFR 1.116(b) will be strictly enforced after final action and that any amendments after a final action must include "a showing of good and sufficient reasons why they are necessary and were not earlier presented" in order to be considered. The language of form paragraph 22.04 is appropriate for inclusion in the first Office action:

\*\*>

¶ 22.04 Papers To Be Submitted in Response to Action - Ex Parte Reexamination

In order to ensure full consideration of any amendments, affidavits or declarations, or other documents as evidence of patentability, such documents must be submitted in response to this Office action. Submissions after the next Office action, which is intended to be a final action, will be governed by the requirements of 37 CFR 1.116, which will be strictly enforced.

<

## 2260.01 Dependent Claims [R-2]

If \*\* >an unamended base patent claim (i.e., a claim appearing in the reexamination as it appears in the patent)< has been rejected or canceled, any claim which is directly or indirectly dependent thereon should be confirmed or allowed if the dependent claim is otherwise allowable. The dependent claim should *not* be objected to or rejected merely because it depends on a rejected or canceled patent claim. No requirement should be made for rewriting the depen-

dent claim in independent form. As the original patent claim numbers are not changed in a reexamination proceeding, the content of the canceled base claim would remain in the printed patent and would be available to be read as a part of the confirmed or allowed dependent claim.

If a new base claim (a base claim other than a base claim appearing in the patent) has been canceled in a reexamination proceeding, a claim which depends thereon should be rejected as \*>indefinite<. If a new base claim >or an amended patent claim< is rejected, a claim dependent thereon should be objected to if it is otherwise patentable and a requirement made for rewriting the dependent claim in independent form.

## 2261 Special Status for Action

35 U.S.C. 305. Conduct of reexamination proceedings.

\*\*\*\*\*

All reexamination proceedings under this section, including any appeal to the Board of Patent Appeals and Interferences, will be conducted with special dispatch within the Office.

In view of the requirement for "special dispatch," reexamination proceedings will be "special" throughout their pendency in the Office. The examiner's first action on the merits should be completed within *1 month* of the filing date of the requester's reply (37 CFR 1.535), or within *1 month* of the filing date of the patent owner's statement (37 CFR 1.530) if there is no requester other than the patent owner. If no submissions are made under either 37 CFR 1.530 or 37 CFR 1.535, the first action on the merits should be completed within *1 month* of any due date for such submission. Mailing of the first action should occur within 6 WEEKS after the appropriate filing or due date of any statement and any reply thereto.

Any cases involved in litigation, whether they are reexamination proceedings or reissue applications, will have priority over all other cases. Reexamination proceedings not involved in litigation will have priority over all other cases except reexaminations or reissues involved in litigation.

## 2262 Form and Content of Office Action [R-2]

The examiner's first Office action will be a statement of the examiner's position and should be so

complete that the second Office action can properly be made a final action. See MPEP § 2271.

All Office actions are to be written or dictated and then typed. The first Office action must be sufficiently detailed that the pertinency and manner of applying the cited prior art to the claims is clearly set forth therein. If the examiner concludes in any Office action that one or more of the claims are patentable over the cited patents or printed publications, the examiner should indicate why the claim(s) is clearly patentable in a manner similar to that used to indicate reasons for allowance (MPEP § 1302.14). If the record is clear why the claim(s) is/are clearly patentable, the examiner may refer to the particular portions of the record which clearly establish the patentability of the claim(s). The first action should also respond to the substance of each argument raised by the patent owner and requester pursuant to 37 CFR 1.510, 1.530, and 1.535. If arguments are presented which are inappropriate in reexamination, they should be treated in

accordance with 37 CFR 1.552(c). It is especially important that the examiner's action in reexamination be thorough and complete in view of the finality of a reexamination proceeding and the patent owner's inability to file a continuation proceeding.

Normally, the title will not need to be changed during reexamination. If a change of the title is necessary, patent owner should be notified of the need to provide an amendment changing the title as early as possible in the prosecution as a part of an Office Action. If all of the claims are found to be patentable and a Notice of Intent to Issue *>Ex Parte<* Reexamination Certificate has been or is to be mailed, a change to the title of the invention by the examiner may only be done by *\*\*>a formal<* Examiner's Amendment. Changing the title and merely initialing the change is NOT permitted in reexamination.

A sample of a first Office action in a reexamination proceeding is set forth below.

\*\*&gt;



UNITED STATES PATENT AND TRADEMARK OFFICE

COMMISSIONER FOR PATENTS  
UNITED STATES PATENT AND TRADEMARK OFFICE  
P.O. BOX 1450  
ALEXANDRIA, VA 22313-1450  
WWW.USPTO.GOV

**DO NOT USE IN PALM PRINTER**

(THIRD PARTY REQUESTER'S CORRESPONDENCE ADDRESS)

Requester  
12345 Anystreet Road  
Anytown, VA 22222

**EX PARTE REEXAMINATION COMMUNICATION TRANSMITTAL FORM**REEXAMINATION CONTROL NO. 90/999,999.PATENT NO. 9,999,999.ART UNIT 3725.

Enclosed is a copy of the latest communication from the United States Patent and Trademark Office in the above identified *ex parte* reexamination proceeding (37 CFR 1.550(f)).

Where this copy is supplied after the reply by requester, 37 CFR 1.535, or the time for filing a reply has passed, no submission on behalf of the *ex parte* reexamination requester will be acknowledged or considered (37 CFR 1.550(g)).

PTOL-465

&lt;

<b>Office Action in Ex Parte Reexamination</b>	<b>Control No.</b> 90/999,999	<b>Patent Under Reexamination</b> 9,999,999	
	<b>Examiner</b> Kenneth Schor	<b>Art Unit</b> 3725	

**-- The MAILING DATE of this communication appears on the cover sheet with the correspondence address --**

a  Responsive to the communication(s) filed on 19 September 1999.      b  This action is made FINAL.  
c  A statement under 37 CFR 1.530 has not been received from the patent owner.

A shortened statutory period for response to this action is set to expire \_\_\_\_\_ month(s) from the mailing date of this letter. Failure to respond within the period for response will result in termination of the proceeding and issuance of an *ex parte* reexamination certificate in accordance with this action. 37 CFR 1.550(d). **EXTENSIONS OF TIME ARE GOVERNED BY 37 CFR 1.550(c)**. If the period for response specified above is less than thirty (30) days, a response within the statutory minimum of thirty (30) days will be considered timely.

Part I THE FOLLOWING ATTACHMENT(S) ARE PART OF THIS ACTION:

1.  Notice of References Cited by Examiner, PTO-892.      3.  Interview Summary, PTO-474.  
2.  Information Disclosure Statement, PTO-1449.      4.  \_\_\_\_\_.

Part II SUMMARY OF ACTION

1a.  Claims 4-6 are subject to reexamination.  
1b.  Claims 1-3 are not subject to reexamination.  
2.  Claims \_\_\_\_\_ have been canceled in the present reexamination proceeding.  
3.  Claims 5 are patentable and/or confirmed.  
4.  Claims 4 and 6 are rejected.  
5.  Claims \_\_\_\_\_ are objected to.  
6.  The drawings, filed on \_\_\_\_\_ are acceptable.  
7.  The proposed drawing correction, filed on \_\_\_\_\_ has been (7a)  approved (7b)  disapproved.  
8.  Acknowledgment is made of the priority claim under 35 U.S.C. § 119(a)-(d) or (f).  
    a)  All    b)  Some\*    c)  None      of the certified copies have  
    1  been received.  
    2  not been received.  
    3  been filed in Application No. \_\_\_\_\_.  
    4  been filed in reexamination Control No. \_\_\_\_\_.  
    5  been received by the International Bureau in PCT application No. \_\_\_\_\_.  
    \* See the attached detailed Office action for a list of the certified copies not received.  
9.  Since the proceeding appears to be in condition for issuance of an *ex parte* reexamination certificate except for formal matters, prosecution as to the merits is closed in accordance with the practice under *Ex parte* Quayle, 1935 C.D. 11, 453 O.G. 213.  
10.  Other:

cc: Requester (if third party requester)

Claims 1 - 3 of the Smith patent are not being reexamined in view of the final decision in the *ABC Corp. v. Smith*, 999 USPQ2d 99 (Fed. Cir. 1999). Claims 1 - 3 were held not valid by the Court.

The following is a quotation of 35 U.S.C. 103 which forms the basis for all obviousness rejections set forth in this Office action:

A patent may not be obtained though the invention is not identically disclosed or described as set forth in section 102 of this title, if the differences between the subject matter sought to be patented and the prior art are such that the subject matter as a whole would have been obvious at the time the invention was made to a person having ordinary skill in the art to which said subject matter pertains. Patentability shall not be negated by the manner in which the invention was made.

Subject matter developed by another person, which qualifies as prior art only under one or more of subsections (f) or (g) of section 102 of this title, shall not preclude patentability under this section where the subject matter and the claimed invention were, at the time the invention was made, owned by the same person, or subject to an obligation of assignment to the same person.

Claims 4 and 6 are rejected under 35 U.S.C. 103 as being unpatentable over Berridge in view of McGee.

Berridge teaches extruding a chlorinated polymer using the same extrusion structure recited in Claims 4 and 6 of the Smith patent. However, Berridge does not show supporting the extrusion barrel at 30 degrees to the horizontal, using spring supports. McGee teaches spring supporting an extrusion barrel at an angle of 25 - 35 degrees, in order to decrease imperfections in extruded chlorinated polymers. It would have been obvious to one of ordinary skill in the polymer extrusion art to support the extrusion barrel of Berridge on springs and at an angle of 30 degrees because McGee teaches this to be known in the polymer extrusion art for decreasing imperfections in extruded chlorinated polymers.

Claim 5 is patentable over the prior art patents and printed publications because of the specific extrusion die used with the Claim 4 spring-supported barrel. This serves to even further reduce imperfections in the extruded chlorinated polymers and is not taught by the art of record, alone or in combination.

It is noted that an issue not within the scope of reexamination proceedings has been raised. In the above-cited final Court decision, a question is raised as to the possible public use of the invention of Claim 6. This question was also raised by the requester in the reply to the owner's statement. The issue will not be considered in a reexamination proceeding (37 CFR 1.552(c)). While this issue is not within the scope of the reexamination, the patentee is advised that it may be desirable to consider filing a reissue application provided that the patentee believes one or more claims to be partially or wholly inoperative or invalid based upon the issue.

Swiss Patent 80555 and the American Machinist article are cited to show cutting and forming extruder apparatus somewhat similar to that claimed in the Smith patent.

In order to ensure full consideration of any amendments, affidavits, or declarations, or other documents as evidence of patentability, such documents must be submitted in response to this Office action. Submissions after the next Office action, which is intended to be a final action, will be governed by the requirements of 37 CFR 1.116 which will be strictly enforced.

Any inquiry concerning this communication should be directed to Kenneth Schor at telephone number (703) 308-0000.

/s/

Kenneth Schor

Primary Examiner, Technology Center 3700

\*\*



## 2263 Time for Response

A shortened statutory period of 2 months will be set for response to Office actions in reexaminations, except where the reexamination results from a court order or litigation is stayed for purposes of reexamination, in which case the shortened statutory period will be set at 1 month. See MPEP § 2286. Note, however, that this 1-month policy does NOT apply to the 2-month period for the filing of a statement under 37 CFR 1.530, which 2-month period is set by 35 U.S.C. 304.

Where a reexamination proceeding has been stayed because of a copending reissue application, and the reissue application is abandoned, all actions in the reexamination after the stay has been removed will set a 1-month shortened statutory period unless a longer period for response is clearly warranted by nature of the examiner's action; see MPEP § 2285.

## 2264 Mailing of Office Action [R-2]

\* >Ex Parte< reexamination forms are structured so that the PALM printer can be used to print the identifying information for the reexamination file and the mailing address — usually the address of the patent owner's legal representative. Where there is no legal representative, the patent owner's address is printed. Only the first patent owner's address is printed where there are multiple patent owners. A transmittal form PTOL-465 is also provided for each >partial< patent owner in addition to the one named on the top of the Office action.

All actions in a third party requester >ex parte< reexamination will have a copy mailed to the third party requester. A transmittal form PTOL-465 must be used in providing the third party requester with a copy of each Office action.

A completed transmittal form PTOL-465 will be provided as needed for any third party requester and additional >partial< patent owner (discussed above), and the appropriate address will be entered on it. The number of transmittal forms provides a ready reference for the number of copies of each Office action to be made, and the transmittal form permits use of the window envelopes in mailing the copies of the action to parties other than the patent owner.

When the requester is the patent owner, the notation "No copies needed. Requester is Owner" will be

placed on the reexamination file. A blank transmittal form having the control number written on it and being marked "No copies needed - Requester is Owner" could also be placed inside the reexamination file to alert Office personnel and anyone else taking part in the processing of the reexamination that no additional copies are needed.

## 2265 Extension of Time [R-2]

37 CFR 1.550. Conduct of ex parte reexamination proceedings.

\*\*\*\*\*

(c) The time for taking any action by a patent owner in an *ex parte* reexamination proceeding will be extended only for sufficient cause and for a reasonable time specified. Any request for such extension must be filed on or before the day on which action by the patent owner is due, but in no case will the mere filing of a request effect any extension. See § 1.304(a) for extensions of time for filing a notice of appeal to the U.S. Court of Appeals for the Federal Circuit or for commencing a civil action.

\*\*\*\*\*

The provisions of 37 CFR 1.136 (a) and (b) are NOT applicable to >ex parte< reexamination proceedings under any circumstances. Public Law 97-247 amended 35 U.S.C. 41 to authorize the \* >Director< to charge fees for extensions of time to take action in an "application." \* >An ex parte< reexamination proceeding does not involve an "application." 37 CFR 1.136 authorizes extensions of the time period only in an application in which an applicant must respond or take action. There is neither an "application," nor an "applicant" involved in a reexamination proceeding.

An extension of time in \* >an ex parte< reexamination proceeding is requested pursuant to 37 CFR 1.550(c). Accordingly, a request for an extension must be filed (\* >A<) on or before the day on which action by the patent owner is due and (\* >B<) must set forth sufficient reason for the extension. >Since the provisions of 37 CFR 1.136 (a) are NOT applicable to reexamination proceedings, there is no fee for an extension of time in reexamination.< Requests for an extension of time in \* >an ex parte< reexamination proceeding will be considered only after the decision to grant or deny reexamination is mailed. Any request filed before that decision will be denied.

The certificate >of mailing< and the certificate of transmission procedures (37 CFR 1.8) and the



“Express Mail” mailing procedure (37 CFR 1.10) may be used to file a request for extension of time, as well as any other paper in \*\* >a pending *ex parte*< reexamination proceeding (see MPEP § 2266).

With the exception of an automatic 1-month extension of time to take further action which will be granted upon filing a first timely response to a final Office action (see MPEP § 2272), *all* requests for extensions of time to file a patent owner statement under 37 CFR 1.530 or respond to any subsequent Office action in \* >an *ex parte*< reexamination proceeding must be filed under 37 CFR 1.550(c) and will be decided by the Director of the Technology Center (TC) conducting the reexamination proceeding. These requests for an extension of time will be granted only for sufficient cause and must be filed on or before the day on which action by the patent owner is due. In no case>, other than the “after final” practice set forth immediately above,< will mere filing of a request for extension of time automatically effect any extension. Evaluation of whether sufficient cause has been shown for an extension must be made in the context of providing the patent owner with a fair opportunity to present an argument against any attack on the patent, and the requirement of the statute (35 U.S.C. 305) that the proceedings be conducted with special dispatch. \*\*

Any request for an extension of time in a reexamination proceeding must fully state the reasons therefor. All requests must be submitted in a separate paper which will be forwarded to the TC Director for action. A request for an extension of the time period to file a petition from the denial of a request for reexamination can only be entertained by filing a petition under 37 CFR 1.183 with appropriate fee to waive the time provisions of 37 CFR 1.515(c). Since the reexamination examination process >(for a reexamination request filed under 35 U.S.C. 302 and 37 CFR 1.510)< is intended to be essentially *ex parte*, the party requesting reexamination can anticipate that requests for an extension of time to file a petition under 37 CFR 1.515(c) will be granted only in extraordinary situations.

The time >period< for filing a third party requester reply under 37 CFR 1.535 to the patent owner’s statement >(i.e., 2 months from the date of service of the statement on the third party requester)< cannot be extended under any circumstances. No extensions will

be permitted to the time for filing a reply under 37 CFR 1.535 by the requester because the 2-month period for filing the reply is a statutory period. >35 U.S.C. 304.< It should be noted that a statutory period for response cannot be waived. See MPEP § 2251.

*Ex parte* prosecution will be conducted by initially setting either a 1-month or a 2-month shortened period for response, see MPEP § 2263. The patent owner also will be given a 2-month statutory period after the order for reexamination to file a statement. See 37 CFR 1.530(b). First requests for extensions of these statutory time periods will be granted for sufficient cause, and for a reasonable time specified — usually 1 month. The reasons stated in the request will be evaluated by the TC Director, and the requests will be favorably considered where there is a factual accounting of reasonably diligent behavior by all those responsible for preparing a response within the statutory time period. Second or subsequent requests for extensions of time or requests for more than 1 month will be granted only in extraordinary situations. Any request for an extension of time in a reexamination proceeding to file a notice of appeal to the Board of Patent Appeals and Interferences, a brief or reply brief, or a request for reconsideration or rehearing will be considered under the provisions of 37 CFR 1.550(c). The time for filing the notice and reasons of appeal to the U.S. Court of Appeals for the Federal Circuit or for commencing a civil action will be considered under the provisions of 37 CFR 1.304.

Form paragraph 22.04.01 may be used to notify the parties in a reexamination proceeding the extension of time practice in reexamination.

\*\*>

#### ¶ 22.04.01 *Extension of Time in Reexamination*

Extensions of time under 37 CFR 1.136(a) will not be permitted in these proceedings because the provisions of 37 CFR 1.136 apply only to “an applicant” and not to parties in a reexamination proceeding. Additionally, 35 U.S.C. 305 requires that reexamination proceedings “will be conducted with special dispatch” (37 CFR 1.550(a)). Extensions of time in *ex parte* reexamination proceedings are provided for in 37 CFR 1.550(c).

<

## FINAL ACTION — TIME FOR RESPONSE

The after-final practice in reexamination proceedings did not change on October 1, 1982 (at which time a change in practice was made for applications), and

the automatic extension of time policy for response to a final rejection and associated practice are still in effect in reexamination proceedings.

The filing of a timely first response to a final rejection having a shortened statutory period for response is construed as including a request to extend the shortened statutory period for an additional month, which will be granted even if previous extensions have been granted, but in no case may the period for response exceed 6 months from the date of the final action. Even if previous extensions have been granted, the primary examiner is authorized to grant the request for extension of time which is implicit in the filing of a timely first response to a final rejection. It should be noted that the filing of any timely first response to a final rejection will be construed as including a request to extend the shortened statutory period for an additional month, even an informal response and even a response that is not signed. An object of this practice is to obviate the necessity for appeal merely to gain time to consider the examiner's position in reply to an amendment timely filed after final rejection. Accordingly, the shortened statutory period for response to a final rejection to which a proposed first response has been received will be extended 1 month. Note that the Office policy of construing a response after final as inherently including a request for a 1-month extension of time applies only to the first response to the final rejection.

It should be noted that the patent owner is entitled to know the examiner's ruling on a timely response filed after final rejection before being required to file a notice of appeal. Notification of the examiner's ruling should reach the patent owner with sufficient time for the patent owner to consider the ruling and act on it.

Normally, examiners will complete a response to an amendment after final rejection within 5 days after receipt thereof. In those situations where the advisory action cannot be mailed in sufficient time for the patent owner to consider the examiner's position with respect to the amendment after final rejection (or other patent owner paper) and act on it before termination of the proceeding, the granting of additional time to complete the response to the final rejection or to take other appropriate action would be appropriate. See *Theodore Groz & Sohne & Ernst Bechert Nadel-fabrik KG v. Quigg*, 10 USPQ2d 1787 (D.D.C. 1988).

The additional time should be granted by the examiner, and the time granted should be set forth in the advisory Office action. The advisory action form (PTOL-467) states that "THE PERIOD FOR RESPONSE IS EXTENDED TO RUN \_\_\_ MONTHS FROM THE DATE OF THE FINAL REJECTION." The blank before "MONTHS" should be filled in with an integer (2, 3, 4, 5, or 6); fractional months should not be indicated. In no case can the period for reply to the final rejection be extended to exceed 6 months from the mailing date of the final rejection. An appropriate response (e.g., a second or subsequent amendment or a notice of appeal) must be filed within the extended period for response. If patent owner elects to file a second or subsequent amendment, it must place the reexamination in condition for allowance. If the amendment does not place the reexamination in condition for allowance, the reexamination proceeding will stand terminated under 37 CFR 1.550(d) unless an appropriate notice of appeal was filed before the expiration of the response period.

#### **EXTENSIONS OF TIME TO SUBMIT AFFIDAVITS AFTER FINAL REJECTION**

Frequently, patent owners request an extension of time, stating as a reason therefor that more time is needed in which to submit an affidavit. When such a request is filed after final rejection, the granting of the request for extension of time is without prejudice to the right of the examiner to question why the affidavit is now necessary and why it was not earlier presented. If the patent owner's showing is insufficient, the examiner may deny entry of the affidavit, notwithstanding the previous grant of an extension of time to submit it. The grant of an extension of time in these circumstances serves merely to keep the proceeding from becoming terminated while allowing the patent owner the opportunity to present the affidavit or to take other appropriate action. Moreover, prosecution of the reexamination to save it from termination must include such timely, complete and proper action as required by 37 CFR 1.113. The admission of the affidavit for purposes other than allowance of the claims, or the refusal to admit the affidavit, and any proceedings relative, thereto, shall not operate to save the proceeding from termination.

Implicit in the above practice is the fact that affidavits submitted after final rejection are subject to the same treatment as amendments submitted after final rejection. See *In re Affidavit Filed After Final Rejection*, 152 USPQ 292, 1966 C.D. 53 (Comm'r Pat. 1966).

## 2266 Responses [R-2]

*37 CFR 1.111. Reply by applicant or patent owner to a non-final Office action.*

(a)(1) If the Office action after the first examination (§ 1.104) is adverse in any respect, the applicant or patent owner, if he or she persists in his or her application for a patent or reexamination proceeding, must reply and request reconsideration or further examination, with or without amendment. See §§ 1.135 and 1.136 for time for reply to avoid abandonment.

\*\*>

(2) A second (or subsequent) supplemental reply will be entered unless disapproved by the Director. A second (or subsequent) supplemental reply may be disapproved if the second (or subsequent) supplemental reply unduly interferes with an Office action being prepared in response to the previous reply. Factors that will be considered in disapproving a second (or subsequent) supplemental reply include:<

(i) The state of preparation of an Office action responsive to the previous reply as of the date of receipt (§ 1.6) of the second (or subsequent) supplemental reply by the Office; and

(ii) The nature of any changes to the specification or claims that would result from entry of the second (or subsequent) supplemental reply.

(b) In order to be entitled to reconsideration or further examination, the applicant or patent owner must reply to the Office action. The reply by the applicant or patent owner must be reduced to a writing which distinctly and specifically points out the supposed errors in the examiner's action and must reply to every ground of objection and rejection in the prior Office action. The reply must present arguments pointing out the specific distinctions believed to render the claims, including any newly presented claims, patentable over any applied references. If the reply is with respect to an application, a request may be made that objections or requirements as to form not necessary to further consideration of the claims be held in abeyance until allowable subject matter is indicated. The applicant's or patent owner's reply must appear throughout to be a *bona fide* attempt to advance the application or the reexamination proceeding to final action. A general allegation that the claims define a patentable invention without specifically pointing out how the language of the claims patentably distinguishes them from the references does not comply with the requirements of this section.

(c) In amending in reply to a rejection of claims in an application or patent under reexamination, the applicant or patent owner must clearly point out the patentable novelty which he or she thinks the claims present in view of the state of the art disclosed by the references cited or the objections made. The appli-

cant or patent owner must also show how the amendments avoid such references or objections.

*37 CFR 1.550. Conduct of ex parte reexamination proceedings.*

\*\*\*\*\*

(b) The patent owner in an *ex parte* reexamination proceeding will be given at least thirty days to respond to any Office action. In response to any rejection, such response may include further statements and/or proposed amendments or new claims to place the patent in a condition where all claims, if amended as proposed, would be patentable.

(c) The time for taking any action by a patent owner in an *ex parte* reexamination proceeding will be extended only for sufficient cause and for a reasonable time specified. Any request for such extension must be filed on or before the day on which action by the patent owner is due, but in no case will the mere filing of a request effect any extension. See § 1.304(a) for extensions of time for filing a notice of appeal to the U.S. Court of Appeals for the Federal Circuit or for commencing a civil action.

\*\*>

(d) If the patent owner fails to file a timely and appropriate response to any Office action or any written statement of an interview required under § 1.560(b), the *ex parte* reexamination proceeding will be terminated, and the Director will proceed to issue a certificate under § 1.570 in accordance with the last action of the Office.<

(e) If a response by the patent owner is not timely filed in the Office,

\*\*>

(1) The delay in filing such response may be excused if it is shown to the satisfaction of the Director that the delay was unavoidable; a petition to accept an unavoidably delayed response must be filed in compliance with § 1.137(a); or<

(2) The response may nevertheless be accepted if the delay was unintentional; a petition to accept an unintentionally delayed response must be filed in compliance with § 1.137(b).

(f) The reexamination requester will be sent copies of Office actions issued during the *ex parte* reexamination proceeding. After filing of a request for *ex parte* reexamination by a third party requester, any document filed by either the patent owner or the third party requester must be served on the other party in the reexamination proceeding in the manner provided by § 1.248. The document must reflect service or the document may be refused consideration by the Office.

(g) The active participation of the *ex parte* reexamination requester ends with the reply pursuant to § 1.535, and no further submissions on behalf of the reexamination requester will be acknowledged or considered. Further, no submissions on behalf of any third parties will be acknowledged or considered unless such submissions are:

(1) in accordance with § 1.510 or § 1.535; or

(2) entered in the patent file prior to the date of the order for *ex parte* reexamination pursuant to § 1.525.

(h) Submissions by third parties, filed after the date of the order for *ex parte* reexamination pursuant to § 1.525, must meet

the requirements of and will be treated in accordance with § 1.501(a).

The patent owner >in an *ex parte* reexamination proceeding< may not file papers on behalf of a third party. 37 CFR 1.550(g). If a third party paper accompanies, or is submitted as part of a timely filed response, the response and third party paper are considered to be an improper submission under 37 CFR 1.550(g), and the entire submission shall be returned to the patent owner since the Office will not determine which portion of the submission is the third party paper. The third party paper will not be considered. The decision returning the improper response and the third party paper should provide an appropriate extension of time under 37 CFR 1.550(c) to refile the patent owner response without the third party paper. See MPEP § 2254 and § 2267.

The certificate of mailing and certificate of transmission procedures (37 CFR 1.8), and the “Express Mail” mailing procedure (37 CFR 1.10), may be used to file any response in \*\* >a pending *ex parte*< reexamination proceeding.

The patent owner is required to serve a copy of any response made in the reexamination proceeding on the third party requester. 37 CFR 1.550(f). See MPEP § 2266.03 as to service of patent owner responses to an Office action.

The patent owner will normally be given a period of 2 months to respond to the Office action. An extension of time can be obtained only in accordance with 37 CFR 1.550(c). Note that 37 CFR 1.136 does not apply in reexamination proceedings.

If the patent owner fails to file a timely and appropriate response to any Office action, the reexamination proceeding will be terminated, unless the response is “not fully responsive” as defined in MPEP § 2266.01 or is an “informal submission” as defined in MPEP § 2266.02. After the proceeding is terminated, the \*>Director< will proceed to issue a reexamination certificate.

## **2266.01 Submission Not Fully Responsive to Non-Final Office Action [R-2]**

A response by the patent owner will be considered not fully responsive to a non-final Office action where:

(A) a *bona fide* response to an examiner’s non-final action is filed;

(B) before the expiration of the permissible response period;

(C) but through an apparent oversight or inadvertence, some point necessary to a full response has been omitted (i.e., \*\* >appropriate consideration of a matter that the action raised, or compliance with a requirement made by the examiner, has been omitted<).

Where patent owner’s amendment or response **prior to final rejection** is not fully responsive to an Office action in a reexamination and meets all of (A) through (C) above, the reexamination proceeding should not be terminated; but, rather, a practice similar to that of 37 CFR 1.135(c) (which is directed to applications) may be followed. The examiner may treat a patent owner submission which is not fully responsive to a non-final Office action by:

(A) waiving the deficiencies (if not serious) in the response and acting on the patent owner submission;

(B) accepting the amendment as a response to the non-final Office action but notifying the patent owner (via a new Office action setting a new time period for response) that the omission must be supplied; or

(C) notifying the patent owner that the response must be completed within the remaining period for response to the non-final Office action (or within any extension pursuant to 37 CFR 1.550(c)) to avoid termination of the proceeding under 37 CFR 1.550(d). This third alternative should only be used in the *very unusual situation* where there is sufficient time remaining in the period for response (including extensions under 37 CFR 1.550(c)), as is discussed below.

Where a patent owner submission responds to the rejections, objections, or requirements in a non-final Office action and is a *bona fide* attempt to advance the reexamination proceeding to final action, but contains a minor deficiency (e.g., fails to treat every rejection, objection, or requirement), the examiner may simply act on the amendment and issue a new (non-final or final) Office action. The new Office action may simply reiterate the rejection, objection, or requirement not addressed by the patent owner submission>,< or \* >the action may< indicate that such rejection, objection, or requirement is no longer applicable. In the new Office action, the examiner will identify the part

of the previous Office action which was not responded to and make it clear what is needed. Obviously, this course of action would not be appropriate in instances in which a patent owner submission contains a serious deficiency (e.g., the patent owner submission does not appear to have been filed in response to the non-final Office action).

\*\*>Where patent owner's submission contains a serious deficiency (i.e., omission) to be dealt with prior to issuing an action on the merits and the period for response has expired, or there is insufficient time remaining to take corrective action before the expiration of the period for response, the patent owner should be notified of the deficiency and what is needed to correct the deficiency, and given a new time period for response (usually 1 month).< The patent owner must supply the omission within the new time period for response (or any extensions under 37 CFR 1.550(c) thereof) to avoid termination of the proceeding under 37 CFR 1.550(d). The patent owner may also file a further response as permitted under 37 CFR 1.111. This is analogous to 37 CFR 1.135(c) for an application. \*\*

Form paragraph 22.14 may be used where a *bona fide* response is not entirely responsive to a non-final Office action.

\*\*>

#### ¶ 22.14 Submission Not Fully Responsive to Non-Final Office Action - Ex Parte Reexamination

The communication filed on [1] is not fully responsive to the prior Office action. [2]. The response appears to be *bona fide*, but through an apparent oversight or inadvertence, consideration of some matter or compliance with some requirement has been omitted. Patent owner is required to deal with the omission to thereby provide a full response to the prior Office action.

A shortened statutory period for response to this letter is set to expire ONE MONTH, or THIRTY DAYS, whichever is longer, from the mailing date of this letter. If patent owner fails to timely deal with the omission and thereby provide a full response to the prior Office action, the present reexamination proceeding will be terminated. 37 CFR 1.550(d).

#### Examiner Note:

1. In bracket 2, the examiner should explain the nature of the omitted point necessary to complete the response, i.e., what part of the Office action was not responded to. The examiner should also make it clear what is needed to deal with the omitted point.
2. This paragraph may be used for a patent owner communication that is not completely responsive to the outstanding (i.e., prior) Office action. See MPEP § 2266.01.
3. This practice does not apply where there has been a deliberate omission of some necessary part of a complete response.

4. This paragraph is only used for a response made prior to final rejection. After final rejection, an advisory Office action and Form PTOL 467 should be used, and the patent owner informed of any non-entry of the amendment.

<

In the very unusual situation where there is sufficient time remaining in the period for response (including extensions under 37 CFR 1.550(c)), the patent owner may simply be notified that the omission must be supplied within the remaining time period for response. This notification should be made, by telephone, and an interview summary record (see MPEP § 713.04) must be completed and entered into the file of the reexamination proceeding to provide a record of such notification. When notification by telephone is not possible, the procedure set forth above should be followed.

The practice of giving the patent owner a time period to supply an omission in a *bona fide* response (which is analogous to that set forth in 37 CFR 1.135(c) for an application) does not apply where there has been a deliberate omission of some necessary part of a complete response; rather, it is applicable **only** when the missing matter or lack of compliance is considered by the examiner as being "inadvertently omitted." Once an inadvertent omission is brought to the attention of the patent owner, the question of inadvertence no longer exists. Therefore, a second Office action giving another new (1 month) time period to supply the omission would not be appropriate. However, if patent owner's response to the notification of the omission raises a different issue of a different inadvertently omitted matter, a second Office action may be given.

This practice authorizes, but does not require, an examiner to give the patent owner a new time period to supply an omission. Thus, where the examiner concludes that the patent owner is attempting to abuse the practice to obtain additional time for filing a response, the practice should not be followed. If time still remains for response, the examiner may telephone the patent owner and inform the patent owner that the response must be completed within the period for response to the non-final Office action or within any extension pursuant to 37 CFR 1.550(c) to avoid termination of the reexamination proceeding.

The practice of giving the patent owner a time period to supply an omission in a *bona fide* response

does **not** apply after a final Office action. If a *bona fide* response to an examiner's action is filed **after final rejection** (before the expiration of the permissible response period), but through an apparent oversight or inadvertence, some point necessary to fully respond has been omitted, the examiner should **not** issue (to the patent owner) a notice of failure to fully respond. Rather, an advisory Office action (form PTOL-467) should be issued with an explanation of the omission. The time period set in the final rejection continues to run and is extended by 1 month if the response is the first response after the final rejection in accordance with the guidelines set forth in MPEP § 2265. See also MPEP § 2272.

Amendments after final rejection are approved for entry only if they place the proceeding in condition for issuance of a reexamination certificate or in better form for appeal. Otherwise, they are not approved for entry. See MPEP § 714.12 and § 714.13. Thus, an amendment after final rejection should be denied entry if some point necessary for a complete response under 37 CFR 1.113 was omitted, even where the omission was through an apparent oversight or inadvertence. Where a submission after final Office action or appeal (e.g., an amendment filed under 37 CFR 1.116) does not place the proceeding in condition for issuance of a reexamination certificate, the period for response continues to run until a response under 37 CFR 1.113 (i.e., a Notice of Appeal or an amendment that places the proceeding in condition for issuance of a reexamination certificate) is filed. The nature of the omission is immaterial. The examiner cannot give the patent owner a time period to supply the omission.

The examiner has the authority to enter the response, withdraw the final Office action, and issue a new Office action, which may be a final Office action, if appropriate, or an action closing prosecution in an otherwise allowable application under *Ex parte Quayle*, 25 USPQ 74, 1935 C.D. 11 (Comm'r Pat. 1935), if appropriate. This course of action is within the discretion of the examiner. However, the examiner should recognize that substantial patent rights will be at issue with no opportunity for the patent owner to refile under 37 CFR 1.53(b) or 1.53(d) in order to continue prosecution nor to file a request for continued examination under 37 CFR 1.114. Thus, where the time has expired for response and the amendment

submitted would place the proceeding in condition for issuance of a reexamination certificate except for an omission through apparent oversight or inadvertence, the examiner should follow this course of action.

### **2266.02 Examiner Issues Notice of Defective Paper in >Ex Parte< Reexamination [R-2]**

Even if the substance of a submission is complete, the submission can still be defective, i.e., an "informal submission." Defects in the submission can be, for example:

- (A) The paper filed does not include proof of service;
- (B) The paper filed is unsigned;
- (C) The paper filed is signed by a person who is not of record;
- (D) The amendment filed by the patent owner does not comply with 37 CFR 1.530(d)-(j).

Where a submission made **prior to final rejection** is defective (informal), form PTOL-475 is used to provide notification of the defects present in the submission. In many cases, it is only necessary to check the appropriate box on the form and fill in the blanks. However, if >the defect denoted by< one of the entries on form PTOL-475 needs further clarification (such as the specifics of why the amendment does not comply with 37 CFR 1.530(d)-(j)), the additional information should be set forth on a separate sheet of paper which is then attached to the form.

The defects identified above as (A) through (D) are specifically included in form PTOL-475. If the submission contains a defect other than those specifically included on the form, the "other" box on the form is to be checked and the defect explained in the space provided for the explanation. For example, a response might be presented on easily erasable paper, and thus, a new submission would be needed.

A 1-month time period will be set in form PTOL-475 for correction of the defect(s). Extension of time to correct the defect(s) may be requested under 37 CFR 1.550(c).

If a defective (informal) response to an examiner's action is filed **after final rejection** (before the expiration of the permissible response period), the examiner should **not** issue a form PTOL-475 notification to the patent owner. Rather, an advisory Office action (form

PTOL-467) should be issued with an explanation of the defect (informality). The time period set in the final rejection continues to run and is extended by 1 month if the response is the first response after the final rejection in accordance with the guidelines set forth in MPEP § 2265. See also MPEP § 2272.

### 2266.03 Service of Papers [R-2]

37 CFR 1.510. *Request for ex parte reexamination.*

\*\*\*\*\*

(b) Any request for reexamination must include the following parts:

\*\*\*\*\*

(5) A certification that a copy of the request filed by a person other than the patent owner has been served in its entirety on the patent owner at the address as provided for in § 1.33(c). The name and address of the party served must be indicated. If service was not possible, a duplicate copy must be supplied to the Office

\*\*\*\*\*

37 CFR 1.550. *Conduct of ex parte reexamination proceedings.*

\*\*\*\*\*

(f) The reexamination requester will be sent copies of Office actions issued during the *ex parte* reexamination proceeding. After filing of a request for *ex parte* reexamination by a third party requester, any document filed by either the patent owner or the third party requester must be served on the other party in the reexamination proceeding in the manner provided by § 1.248. The document must reflect service or the document may be refused consideration by the Office.

\*\*\*\*\*

Any paper filed >with the Office<, i.e., any submission made, in a third party requested reexamination by either the patent owner or the third party requester, must be served on every other party in the reexamination proceeding.

As proof of service, the party submitting the paper to the Office must attach a certificate of service to the paper. It is required that the name and address of the party served, and the method of service be set forth in the certificate of service. Further, a copy of the certificate of service must be attached with the copy of the paper that is served on the other party.

Papers filed in which no proof of service is included (where proof of service is required) may be denied consideration. Where no proof of service is included, the reexamination clerk should immediately

contact the party making the submission by telephone to see whether the indication of proof of service was inadvertently omitted from the submission but there was actual service.

If service was in fact made, the party making the submission should be advised to submit a supplemental paper indicating the manner and date of service. The reexamination clerk should enter the submission for consideration, and annotate the submission with:

“Service confirmed by [name of person] on [date]”

If no service was made, or the party making the submission cannot be contacted, the submission is placed in the reexamination file and normally is not considered. The reexamination clerk should enter the submission on the contents of the file wrapper and place an “(N/E)” next to it. The “(N/E)” can be crossed through if the appropriate service is later made. The submission itself shall be annotated with “no service,” which also can be crossed through if the appropriate service is later made.

If the party making the submission cannot be contacted, a Notice of Defective Paper (PTOL-475), giving 1 month to complete the paper, with a supplemental paper indicating the manner and date of service, will be mailed to the party.

If it is known that service of a submission was not made, notice of the requirement for service of copy is given (to the party that made the submission), and a 1-month period is set. Form paragraph 22.15 may be used to give notice.

\*\*>

#### ¶ 22.15 Lack of Service - 37 CFR 1.550(f)

The submission filed on [1] is defective because it appears that the submission was not served on the [2]. After the filing of a request for reexamination by a third party requester, any document filed by either the patent owner or the third party requester must be served on the other party (or parties where two or more third party requester proceedings are merged) in the reexamination proceeding in the manner provided in 37 CFR 1.248. See 37 CFR 1.550(f).

It is required that service of the submission be made, and a certificate of service be provided to the Office within a shortened statutory period of ONE MONTH or THIRTY DAYS, whichever is longer, from the mailing date of this letter. If service of the submission is not timely made, the submission may be denied consideration.

#### Examiner Note:

1. This paragraph may be used where a submission to the Office was not served as required in a third party requester reexamination proceeding.

2. In bracket 2, insert --patent owner-- or --third party requester--, whichever is appropriate.

<

The cover sheet to be used for mailing the notice will be form PTOL-473.

The failure of a party to serve the submission in response to the notice will have the following consequences:

(A) For a patent owner statement or a third party reply, the submission may be refused consideration by the Office. Where consideration is refused, the submission will not be addressed in the reexamination proceeding other than to inform parties of the lack of consideration thereof;

(B) For a patent owner response to an Office action, the response may be refused consideration by the Office. Where consideration of a response is refused, the proceeding will be terminated in accordance with 37 CFR 1.550(d), unless the patent owner has otherwise completely responded to the Office action.

See MPEP § 2220 as to the initial third party request.

See MPEP § 2249 as to the patent owner statement.

See MPEP § 2251 as to third party reply.

See MPEP § 2266 as to patent owner responses to an Office action.

## 2267 Handling of Inappropriate or Untimely Filed Papers [R-2]

The applicable regulations (37 CFR 1.501(a), 1.550(e)) provide that certain types of correspondence will not be considered or acknowledged unless timely received. \*\* >Whenever reexamination correspondence is received, a decision is required of the Office as to the action to be taken on the correspondence based on what type of paper it is and whether it is timely.<

The return of inappropriate submissions complies with the regulations that certain papers will not be considered and also reduces the amount of paper which would ultimately have to be stored with the patent file.

>

### I. < DISPOSITION OF PAPERS

Where papers are filed during reexamination proceedings which are inappropriate because of some defect, such papers will either be returned to the sender or forwarded to one of three files, the "Reexamination File," the "Patent File," or the "Storage File." Any papers returned to the sender from a Technology Center (TC) must be accompanied by a letter indicating signature and approval of the TC Director.

The "Reexamination File" and the "Patent File" will remain together in a central storage area prior to the examiner taking up the case for a determination on whether to reexamine. After the files have been forwarded to the examiner for the determination, the "Patent File" will be maintained in the assigned examiner's room until the reexamination proceeding is terminated.

The "Storage Files" will be maintained separate and apart from the other two files at a location selected by the TC Director. For example, the TC Director may want to locate the "Storage File" in a central area in the TC as with the reexamination clerk or in his or her room.

>

### II. < TYPES OF PAPERS RETURNED WITH \* >DIRECTOR OF THE USPTO< OR TC DIRECTOR'S APPROVAL REQUIRED

#### Filed by Owner

§ 1.530(a),  
§ 1.540

#### A. Premature Response by Owner-

Where the patent owner is NOT the requester, any response or amendment filed by owner prior to an order to reexamine is premature and will be returned and will not be considered.

§ 1.550(g)

#### B. Paper Submitted on Behalf of Third Party -



**Filed by  
Owner**

## A. Premature Response by Owner-

Submission filed on behalf of a third party will be returned and will not be considered. Where third party paper is submitted as part of a patent owner response, see MPEP § 2254 and § 2266.

**Filed by  
Third Party**

§ 1.501,  
§ 1.565(a)

Unless a paper submitted by a third party raises only issues appropriate under 37 CFR 1.501, or consists solely of a prior decision on the patent by another forum, e.g., a court (see MPEP § 2207 and § 2286 \*) or presentation of a paper of record in a litigation (see MPEP § 2282), it will be returned to an identified third party or destroyed if the submitter is unidentified.

**Filed by  
Requester**

## A. No Statement Filed by Owner -

§ 1.535

If a patent owner fails to file a statement within the prescribed limit, any reply by the requester is inappropriate and will be returned and will not be considered.

>

## B. Late Response by Requester -

§ 1.535,  
§ 1.540

Any response subsequent to 2 months from the date of service of the patent owner's statement will be returned and will not be considered.

## C. Additional Response by Requester-

§ 1.550(g)

The active participation of the reexamination requester ends with the reply pursuant to § 1.535. Any further submission on behalf of requester will be returned and will not be considered.

**III. < TYPES OF DEFECTIVE PAPERS TO BE  
LOCATED IN THE "REEXAMINATION  
FILE"****Filed by  
Owner**

## A. Unsigned Papers -

§ 1.33

Papers filed by owner which are unsigned or signed by less than all of the owners (no attorney of record or acting in representative capacity).

## B. No Proof of Service -

§ 1.248

Papers filed by the patent owner in which no proof of service on requester is included and proof of service is required may be denied consideration.

## C. Untimely Papers -

**Filed by Owner**

A. Unsigned Papers -

§ 1.530(b),  
§ 1.540

Where owner has filed a paper which is untimely, that is, it was filed after the period set for response, the paper will not be considered.

**Filed by Requester**

A. Unsigned Papers -

Papers filed by requester which are unsigned will not be considered.

B. No Proof of Service -

§ 1.510(b)(5)  
§ 1.33,  
§ 1.248

Papers filed by requester in which no proof of service on owner is included and where proof of service is required may be denied consideration.

>

**IV. < PAPERS LOCATED IN THE “STORAGE FILE”**

§ 1.501	Citations by Third Parties
§ 1.550(h)	Submissions by third parties based solely on prior art patents or publications filed after the date of the order to reexamine are not entered into the patent file but delayed until the reexamination proceedings have been terminated. >See MPEP § 2206.<

Proper timely filed citations by third parties (i.e., filed prior to the order) are placed in the \*\*>reexamination file<.

**2268 Petition for Entry of Late Papers >for Revival of Reexamination Proceeding< [R-2]**

35 U.S.C. 41. Patent fees; patent and trademark search systems.

(a) The Director shall charge the following fees:

\*\*\*\*\*

(7) On filing each petition for the revival of an unintentionally abandoned application for a patent, for the unintentionally delayed payment of the fee for issuing each patent, or for an unintentionally delayed response by the patent owner in any reexamination proceeding, \$1,210, unless the petition is filed under section 133 or 151 of this title, in which case the fee shall be \$110.

\*\*\*\*\*

35 U.S.C. 133. Time for prosecuting application.

Upon failure of the applicant to prosecute the application within six months after any action therein, of which notice has been given or mailed to the applicant, or within such shorter time, not less than thirty days, as fixed by the Director in such action, the application shall be regarded as abandoned by the parties thereto, unless it be shown to the satisfaction of the Director that such delay was unavoidable.

37 CFR 1.137. Revival of abandoned application, terminated reexamination proceeding, or lapsed patent.

(a) Unavoidable. If the delay in reply by applicant or patent owner was unavoidable, a petition may be filed pursuant to this paragraph to revive an abandoned application, a reexamination proceeding terminated under §§ 1.550(d) or 1.957(b) or (c), or a lapsed patent. A grantable petition pursuant to this paragraph must be accompanied by:

(1) The reply required to the outstanding Office action or notice, unless previously filed;

(2) The petition fee as set forth in § 1.17(l);

\*\*>

(3) A showing to the satisfaction of the Director that the entire delay in filing the required reply from the due date for the reply until the filing of a grantable petition pursuant to this paragraph was unavoidable; and<

(4) Any terminal disclaimer (and fee as set forth in § 1.20(d)) required pursuant to paragraph (d) of this section.

(b) Unintentional. If the delay in reply by applicant or patent owner was unintentional, a petition may be filed pursuant to this paragraph to revive an abandoned application, a reexamination proceeding terminated under §§ 1.550(d) or 1.957(b) or (c), or a lapsed patent. A grantable petition pursuant to this paragraph must be accompanied by:

(1) The reply required to the outstanding Office action or notice, unless previously filed;

(2) The petition fee as set forth in § 1.17(m);

\*\*>

(3) A statement that the entire delay in filing the required reply from the due date for the reply until the filing of a grantable

petition pursuant to this paragraph was unintentional. The Director may require additional information where there is a question whether the delay was unintentional; and

(4) Any terminal disclaimer (and fee as set forth in § 1.20(d)) required pursuant to paragraph (d) of this section.

\*\*\*\*\*

(e) *Request for reconsideration.* Any request for reconsideration or review of a decision refusing to revive an abandoned application, a terminated reexamination proceeding, or lapsed patent upon petition filed pursuant to this section, to be considered timely, must be filed within two months of the decision refusing to revive or within such time as set in the decision. Unless a decision indicates otherwise, this time period may be extended under:

(1) The provisions of § 1.136 for an abandoned application or lapsed patent;

(2) The provisions of § 1.550(c) for a terminated *ex parte* reexamination proceeding filed under § 1.510; or

(3) The provisions of § 1.956 for a terminated *inter partes* reexamination proceeding filed under § 1.913.

\*\*\*\*\*

Pursuant to 37 CFR 1.550(d), an *ex parte* reexamination proceeding is terminated if the patent owner fails to file a timely and appropriate response to any Office action or any written statement of an interview required under 37 CFR 1.560(b). An *ex parte* reexamination proceeding terminated under 37 CFR 1.550(d) can be revived if the delay in response by the patent owner (or the failure to timely file the interview statement) was unavoidable in accordance with 37 CFR 1.137(a), or unintentional in accordance with 37 CFR 1.137(b).

The failure to timely file a statement pursuant to 37 CFR 1.530 or a reply pursuant to 37 CFR 1.535, however, would not (under ordinary circumstances) constitute adequate basis to justify a showing of unavoidable/unintentional delay regardless of the reasons for the failure, since failure to file a statement or reply does not result in a “termination” of the reexamination proceeding, to which 37 CFR 1.137 is directed.

All petitions in reexamination proceedings to accept late papers and to revive the proceedings will be decided in the Office of Patent Legal Administration.

>

## I. < PETITION BASED ON UNAVOIDABLE DELAY

The unavoidable delay provisions of 35 U.S.C. 133 are imported into, and are applicable to, *ex parte* reexamination proceedings by 35 U.S.C. 305. See *In re Katrapat*, 6 USPQ2d 1863 (Comm’ r Pat. 1988). Accordingly, the Office will consider, in appropriate circumstances, a petition showing unavoidable delay under 37 CFR 1.137(a) where untimely papers are filed subsequent to the order for reexamination. Any such petition must provide an adequate showing of the cause of unavoidable delay, including the details of the circumstances surrounding the unavoidable delay and evidence to support the showing. Additionally, the petition must be accompanied by the petition fee set forth in 37 CFR 1.17(l) and a proposed response to continue prosecution (unless it has been previously filed).

>

## II. < PETITION BASED ON UNINTENTIONAL DELAY

The unintentional delay fee provisions of 35 U.S.C. 41(a)(7) are imported into, and are applicable to, all *ex parte* reexamination proceedings by section 4605 of the American Inventors Protection Act of 1999. The unintentional delay provisions of 35 U.S.C. 41(a)(7) became effective in reexamination proceedings on November 29, 2000. Accordingly, the Office will consider, in appropriate circumstances, a petition showing unintentional delay under 37 CFR 1.137(b) where untimely papers are filed subsequent to the order for reexamination. Any such petition must provide a verified statement that the delay was unintentional, a proposed response to continue prosecution (unless it has been previously filed), and the petition fee set forth in 37 CFR 1.17(m).

>

## III. < RENEWED PETITION

Reconsideration may be requested of a decision dismissing or denying a petition under 37 CFR 1.137(a) or (b) to revive a terminated reexamination proceeding. The request for reconsideration must be submitted within one (1) month from the mail date of the decision for which reconsideration is requested.

An extension of time may be requested only under 37 CFR 1.550(c); extensions of time under 37 CFR 1.136 are not available in reexamination proceedings. Any reconsideration request which is submitted should include a cover letter entitled “Renewed Petition under 37 CFR 1.137(a)” (for a petition based on unavoidable delay) or “Renewed Petition under 37 CFR 1.137(b)” (for a petition based on unintentional delay).

>

#### **IV. < FURTHER DISCUSSION OF THE PETITION REQUIREMENTS**

See also MPEP § 711.03(c), part III, for a detailed discussion of the requirements of petitions filed under 37 CFR 1.137(a) and (b).

#### **2269 Reconsideration**

In order to be entitled to reconsideration, the patent owner must respond to the Office action. 37 CFR 1.111(b). The patent owner may respond to such Office action with or without amendment and the patent under reexamination will be reconsidered, and so on repeatedly unless the examiner has indicated that the action is final. See 37 CFR 1.112. Any amendment after the second Office action, which will normally be final as provided for in MPEP § 2271, must ordinarily be restricted to the rejection or to the objection or requirement made.

#### **2270 Clerical Handling [R-2]**

The person designated as the reexamination clerk will handle most of the initial clerical processing of the reexamination file.

Amendments which comply with 37 CFR 1.530(d)-(j) will be entered for purposes of reexamination in the reexamination file wrapper. See MPEP § 2234 and § 2250 for manner of entering amendments.

For entry of amendments in a merged reissue-reexamination proceeding, see MPEP § 2283 and § 2285.

Where an amendment is submitted in proper form and it is otherwise appropriate to enter the amendment, the amendment will be entered for purposes of the reexamination proceeding, even though the amendment does not have legal effect until the certificate is issued. Any “new matter” amendment to the disclosure (35 U.S.C. 132) will be required to be canceled, and claims containing new matter will be

rejected under 35 U.S.C. 112. A “new matter” amendment to the drawing is ordinarily not entered. See MPEP § 608.04, § 608.04(a) and (c). >Where an amendment enlarges the scope of the claims of the patent, the amendment will be entered; however the appropriate claims will be rejected under 35 U.S.C. 305.<

#### **2271 Final Action [R-2]**

Before a final action is in order, a clear issue should be developed between the examiner and the patent owner. To bring the prosecution to a speedy conclusion and at the same time deal justly with the patent owner and the public, the examiner will twice provide the patent owner with such information and references as may be useful in defining the position of the Office as to unpatentability before the action is made final. Initially, the decision ordering reexamination of the patent will contain an identification of the new questions of patentability that the examiner considers to be raised by the prior art considered. In addition, the first Office action will reflect the consideration of any arguments and/or amendments contained in the request, the owner’s statement filed pursuant to 37 CFR 1.530, and any reply thereto by the requester, and should fully apply all relevant grounds of rejection to the claims.

The statement which the patent owner may file under 37 CFR 1.530 and the response to the first Office action should completely respond to and/or amend with a view to avoiding all outstanding grounds of rejection.

It is intended that the second Office action in the reexamination proceeding following the decision ordering reexamination will be made final in accordance with the guidelines set forth in MPEP § 706.07(a). The examiner should not prematurely cut off the prosecution with a patent owner who is seeking to define the invention in claims that will offer the patent protection to which the patent owner is entitled. However, both the patent owner and the examiner should recognize that a reexamination proceeding may result in the final cancellation of claims from the patent and that the patent owner does not have the right to renew or continue the proceedings by refiling under 37 CFR 1.53(b) or 1.53(d) or former 37 CFR 1.60 or 1.62, nor by filing a request for continued examination under 37 CFR 1.114. Complete and thor-

ough actions by the examiner coupled with complete responses by the patent owner, including early presentation of evidence under 37 CFR 1.131 or 1.132, will go far in avoiding such problems and reaching a desirable early termination of the reexamination proceeding.

>In making the final rejection, all outstanding grounds of rejection of record should be carefully reviewed and any grounds or rejection relied on should be reiterated. The grounds of rejection must (in the final rejection) be clearly developed to such an extent that the patent owner may readily judge the advisability of an appeal. However, where a single previous Office action contains a complete statement of a ground of rejection, the final rejection may refer to such a statement and also should include a rebuttal of any arguments raised in the patent owner's response.

## I. PATENTABILITY REVIEW CONFERENCE<

After an examiner has determined that the reexamination proceeding is ready for final rejection, the examiner will formulate a draft preliminary decision to issue a final rejection, the preliminary decision setting forth which claims to reject, the grounds of rejection, which claims to allow/confirm and reasons for allowance/confirmation. The examiner will then inform his/her Supervisory Patent Examiner (SPE) of his/her intent to issue the final rejection. The SPE will convene a patentability review conference, and the conference members will review the patentability of the claim(s) pursuant to MPEP § 2271.01. If the conference confirms the examiner's preliminary decision to reject and/or allow the claims, the Office action (Notice of Intent to Issue \*>Ex Parte< Reexamination Certificate (NIRC) or final rejection) shall be issued and signed by the examiner, with the two other conferees initialing the action (as "conferee") to indicate their presence in the conference. If the conference does not confirm the examiner's preliminary decision, the proposed final rejection will not be issued by the examiner; but rather, the examiner will issue the appropriate Office action reflecting the decision of the conference.

\*\*>

## II. FORM PARAGRAPHS<

The final rejection letter should conclude with one of form paragraphs 22.09 or 22.10.

\*\*>

### ¶ 22.09 Ex Parte Reexamination - Action Is Final

#### **THIS ACTION IS MADE FINAL.**

A shortened statutory period for response to this action is set to expire [1] from the mailing date of this action.

**Extensions of time under 37 CFR 1.136(a) do not apply in reexamination proceedings.** The provisions of 37 CFR 1.136 apply only to "an applicant" and not to parties in a reexamination proceeding. Further, in 35 U.S.C. 305 and in 37 CFR 1.550(a), it is required that reexamination proceedings "will be conducted with special dispatch within the Office."

**Extensions of time in reexamination proceedings are provided for in 37 CFR 1.550(c).** A request for extension of time must be filed on or before the day on which a response to this action is due. The mere filing of a request will not effect any extension of time. An extension of time will be granted only for sufficient cause, and for a reasonable time specified.

The filing of a timely first response to this final rejection will be construed as including a request to extend the shortened statutory period for an additional month, which will be granted even if previous extensions have been granted. In no event, however, will the statutory period for response expire later than SIX MONTHS from the mailing date of the final action. See MPEP § 2265.

#### **Examiner Note:**

1. This form paragraph may be used only in reexamination proceedings.
2. In bracket 1, insert the appropriate period for response, which is normally TWO (2) MONTHS. In court sanctioned or stayed litigation situations a ONE (1) MONTH period should be set.

### ¶ 22.10 Ex Parte Reexamination - Action Is Final, Necessitated by Amendment

Patent owner's amendment filed [1] necessitated the new grounds of rejection presented in this Office action. Accordingly, **THIS ACTION IS MADE FINAL.** See MPEP § 706.07(a).

A shortened statutory period for response to this action is set to expire [2] from the mailing date of this action.

**Extensions of time under 37 CFR 1.136(a) do not apply in reexamination proceedings.** The provisions of 37 CFR 1.136 apply only to "an applicant" and not to parties in a reexamination proceeding. Further, in 35 U.S.C. 305 and in 37 CFR 1.550(a), it is required that reexamination proceedings "will be conducted with special dispatch within the Office."

**Extensions of time in reexamination proceedings are provided for in 37 CFR 1.550(c).** A request for extension of time must be filed on or before the day on which a response to this action is due. The mere filing of a request will not effect any extension of time. An extension of time will be granted only for sufficient cause, and for a reasonable time specified.

The filing of a timely first response to this final rejection will be construed as including a request to extend the shortened statutory period for an additional month, which will be granted even if previous extensions have been granted. In no event, however, will the statutory period for response expire later than SIX MONTHS from the mailing date of the final action. See MPEP § 2265.

#### Examiner Note:

1. This form paragraph may be used only in reexamination proceedings.
2. In bracket 1, insert filing date of amendment.
3. In bracket 2, insert the appropriate period for response, which is normally TWO (2) MONTHS. In court sanctioned or stayed litigation situations a ONE (1) MONTH period should be set.
4. As with all other Office correspondence on the merits in a reexamination proceeding, the final Office action must be signed by a primary examiner.

### III. ART CITED BY PATENT OWNER DURING PROSECUTION

Where art is submitted in a prior art citation under 37 CFR 1.501 and/or 37 CFR 1.555 (an IDS filed in a reexamination is construed as a prior art citation) and the submission is not accompanied by a statement similar to that of 37 CFR 1.97(e), the examiner may use the art submitted and make the next Office action final whether or not the claims have been amended, provided that no other new ground of rejection is introduced by the examiner based on the new art not cited in the prior art citation. See MPEP § 706.07(a).

### IV. SIGNATORY AUTHORITY<

As with all other Office correspondence on the merits in a reexamination proceeding, the final Office action must be signed by a primary examiner.

## 2271.01 Patentability Review Conferences [R-2]

A “patentability review conference” will be convened at two stages of the examination in an *ex parte* reexamination proceeding:

(A) A patentability review conference must be convened just prior to issuing a final rejection; and

(B) A patentability review conference must be convened just prior to issuing a Notice of Intent to Issue *\*>Ex Parte<* Reexamination Certificate (NIRC), other than in the exceptions set forth in this section.

In the patentability review conference, the examiner’s preliminary decision to reject and/or allow the claims in the reexamination proceeding will be reviewed, prior to the issuance of the Office action (NIRC or final rejection).

>

### I. < MAKE-UP OF THE PATENTABILITY REVIEW CONFERENCE

The patentability review conference will consist of three members, one of whom may be the supervisory patent examiner (SPE). The first member will be the examiner in charge of the proceeding. The SPE will select the other two members, who will be examiner-conferees. The examiner-conferees will be primary examiners, or examiners who are knowledgeable in the technology of the invention claimed in the patent being reexamined and/or who are experienced in reexamination practice. The majority of those present at the conference will be examiners who were not involved in the examination or issuance of the patent. An “original” examiner (see MPEP § 2236) should be chosen as a conferee only if that examiner is the most knowledgeable in the art, or there is some other specific and justifiable reason to choose an original examiner as a participant in the conference.

The patentability review conference will be similar to the appeal conference carried out prior to the issuance of an examiner’s answer following the filing of a notice of appeal and the appeal brief. See MPEP § 1208. A patentability review conference **must** be held in each instance where a final rejection is about to be issued in a reexamination proceeding. A patentability review conference **must** also be held in each instance where a NIRC is about to be issued, unless the NIRC is being issued: (A) following and consistent with a decision by the Board of Patent Appeals and Interferences (or court) on the merits of the proceeding; or (B) as a consequence of the patent owner’s failure to respond or take other action where such a response or action is necessary to maintain pendency of the proceeding and, as a result of which failure to respond, all of the claims will be canceled. When the patentability review conference results in the issuance of a final rejection or a NIRC, the two conferees will place their initials, followed by the word “conferee,” below the signature of the examiner. The signature of the examiner and initials of the

conferees on the resulting Office action will reflect that the patentability review conference has been conducted.

>

## II. < PATENTABILITY REVIEW CONFERENCE PROCESS

The examiner must inform his/her SPE of his/her intent to issue a final rejection or NIRC. The SPE will then convene a patentability review conference and the conference members will review the patentability of the claim(s). If the conference confirms the examiner's preliminary decision to reject and/or allow the claims, the Office action (NIRC or final rejection) shall be issued and signed by the examiner, with the two other conferees initialing the action (as "conferee") to indicate their participation in the conference. Both conferees will initial, even though one of them may have dissented from the 3-party conference decision as to the patentability of claims. If the conference does not confirm the examiner's preliminary decision, the proposed NIRC or final rejection will not be issued by the examiner; rather, the examiner will issue an appropriate Office action reflecting the decision of the conference.

Where the examiner in charge of the proceeding is not in agreement with the conference decision, the SPE will generally assign the proceeding to another examiner, preferably to one of the other two conference members.

>

## III. < WHAT THE CONFERENCE IS TO ACCOMPLISH

Each conference will provide a forum to consider all issues of patentability as well as procedural issues having an impact on patentability. Review of the patentability of the claims by more than one primary examiner should diminish the perception that the patent owner can disproportionately influence the examiner in charge of the proceeding. The conferences will also provide greater assurance that all matters will be addressed appropriately. All issues in the proceeding will be viewed from the perspectives of three examiners. What the examiner in charge of the proceeding might have missed, the other two confer-

ence members would likely detect. The conference will provide for a comprehensive discussion of, and finding for, each issue.

>

## IV. < CONSEQUENCES OF FAILURE TO HOLD CONFERENCE

Should the examiner issue a final rejection or NIRC without holding a patentability review conference, the patent owner or the third party requester who wishes to object must promptly file a paper alerting the Office of this fact. >(The failure to hold a patentability review conference would be noted by the parties where there are no conferees' initials at the end of the final rejection or NIRC Office action.)< Any challenge of the failure to hold a patentability review conference must be made within two months of the Office action issued, or the challenge will not be considered. In such cases, whether to convene a patentability review conference to reconsider the examiner's decision will be addressed on a case-by-case basis. In no event will the failure to hold a review conference, by itself, be grounds for vacating any Office decision(s) or action(s) and "restarting" the reexamination proceeding.

### 2272 After Final Practice [R-2]

It is intended that prosecution before the examiner in a reexamination proceeding will be concluded with the final action. Once a final rejection that is not premature has been entered in a reexamination proceeding, the patent owner no longer has any right to unrestricted further prosecution. Consideration of amendments submitted after final rejection will be governed by the strict standards of 37 CFR 1.116. Both the examiner and the patent owner should recognize that substantial patent rights will be at issue with no opportunity for the patent owner to refile under 37 CFR 1.53(b), 1.53(d), former 37 CFR 1.60, or former 37 CFR 1.62, and with no opportunity to file a request for continued examination under 37 CFR 1.114. Accordingly, both the examiner and the patent owner should identify and develop all issues prior to the final Office action, including the presentation of evidence under 37 CFR 1.131 and 1.132.

&gt;

## I. < FINAL REJECTION — TIME FOR RESPONSE

The statutory period for response to a final rejection in a reexamination proceeding will normally be two (2) months. If a response to the final rejection is filed, the time period set in the final rejection continues to run. The time period is automatically extended by 1 month (in accordance with the guidelines set forth in MPEP § 2265) if the response is the first response after the final rejection. Any advisory Office action (form PTOL-467) issued in reply to patent owner's response after final rejection will inform the patent owner of the automatic 1 month extension of time. It should be noted that the filing of any timely first response to a final rejection (even an informal response or even a response that is not signed) will automatically result in the extension of the shortened statutory period for an additional month. Note further that the patent owner is entitled to know the examiner's ruling on a timely response filed after final rejection before being required to file a notice of appeal. Notification of the examiner's ruling should reach the patent owner with sufficient time for the patent owner to consider the ruling and act on it. Accordingly, the period for response to the final rejection should be appropriately extended in the examiner's advisory action. See *Theodore Groz & Sohne & Ernst Bechert Nadelfabrik KG v. Quigg*, 10 USPQ2d 1787 (D.D.C. 1988). The period for response may not, however, be extended to run past 6 months from the date of the final rejection.

&gt;

## II. < ACTION BY EXAMINER

It should be kept in mind that a patent owner cannot, as a matter of right, amend any finally rejected claims, add new claims after a final rejection, or reinstate previously canceled claims. A showing under 37 CFR 1.116(b) is required and will be evaluated by the examiner for all proposed amendments after final rejection except where an amendment merely cancels claims, adopts examiner's suggestions, removes issues for appeal, or in some other way requires only a cursory review by the examiner. An amendment filed at any time after final rejection but before an appeal brief is filed, may be entered upon or after filing of an

appeal provided the total effect of the amendment is to (A) remove issues for appeal, and/or (B) adopt examiner suggestions.

The first proposed amendment after final action in a reexamination proceeding will be given sufficient consideration to determine whether it places all the claims in condition where they are patentable and/or whether the issues on appeal are reduced or simplified. Unless the proposed amendment is entered in its entirety, the examiner will briefly explain the reasons for not entering a proposed amendment. For example, if the claims as amended present a new issue requiring further consideration or search, the new issue should be identified and a brief explanation provided as to why a new search or consideration is necessary. The patent owner should be notified if certain portions of the amendment would be entered if a separate paper was filed containing only such amendment.

Any second or subsequent amendment after final will be considered only to the extent that it removes issues for appeal or puts a claim in obvious patentable condition.

Since patents undergoing reexamination cannot become abandoned and cannot be refiled, and since the holding of claims unpatentable and canceled in a certificate is absolutely final, it is appropriate that the examiner consider the feasibility of entering amendments touching the merits after final rejection or after appeal has been taken, where there is a showing why the amendments are necessary and a suitable reason is given why they were not earlier presented.

The practice of giving the patent owner a time period to supply an omission in a *bona fide* response (as set forth in MPEP § 2266.01) does **not** apply after a final Office action. If a *bona fide* response to an examiner's action is filed **after final rejection** (before the expiration of the permissible response period), but through an apparent oversight or inadvertence, some point necessary to fully respond has been omitted, the examiner should **not** issue (to the patent owner) a notice of failure to fully respond. Rather, an advisory Office action (form PTOL-467) should be issued with an explanation of the omission.

Likewise, the practice of notifying the patent owner of the defects present in a submission via form PTOL-475 and setting a time period for correction of the defect(s) (as set forth in MPEP § 2266.02) does **not** apply after a final Office action. If a defective



(informal) response to an examiner's action is filed **after final rejection** (before the expiration of the permissible response period), the examiner should **not** issue a form PTOL-475 notification to the patent owner. Rather, an advisory Office action (form PTOL-467) should be issued with an explanation of the defect (informality) >being provided in the advisory action<.

## 2273 Appeal in >Ex Parte< Reexamination [R-2]

35 U.S.C. 306. Appeal.

The patent owner involved in a reexamination proceeding under this chapter may appeal under the provisions of section 134 of this title, and may seek court review under the provisions of sections 141 to 145 of this title, with respect to any decision adverse to the patentability of any original or proposed amended or new claim of the patent.

A patent owner who is dissatisfied with the primary examiner's decision to reject claims in an *ex parte* reexamination proceeding may appeal to the Board of Patent Appeals and Interferences for review of the examiner's rejection by filing a notice of appeal within the required time. A third party requester may not appeal, and may not participate in the patent owner's appeal.

In an *ex parte* reexamination \*\* filed before November 29, 1999, the patent owner may appeal to the Board either (A) after final rejection of the claims, or (B) after the second rejection of the claims. This is based on the version of 35 U.S.C. 134 in existence prior to the amendment of the reexamination statute on November 29, 1999, by Public Law 106-113. This "prior version" of 35 U.S.C. 134 applies to appeals in reexamination \*\*>where the reexamination was filed in the Office on or after November 29, 1999. See Section 13202(d) of Public Law 107-273<.

In an *ex parte* reexamination of a patent that issued from an original application filed on or after November 29, 1999, the patent owner may appeal to the Board only after the final rejection of the claims. This is based on the current version of 35 U.S.C. 134 as amended by Public Law 106-113. This "current version" of 35 U.S.C. 134 applies to appeals in reexamination of patents issuing from original applications filed in the U.S. on or after November 29, 1999.

The notice of appeal need not be signed by the patent owner or his or her attorney or agent. See

37 CFR 1.191(b). The fee required by 37 CFR 1.17(b) must accompany the notice of appeal. See 37 CFR 1.191(a).

The period for filing the notice of appeal is the period set for response in the last Office action which is normally 2 months. The timely filing of a first response to a final rejection having a shortened statutory period for response is construed as including a request to extend the period for response an additional month, even if an extension has been previously granted, as long as the period for response does not exceed 6 months from the date of the final rejection. The normal *ex parte* appeal procedures set forth at 37 CFR 1.191 through 37 CFR 1.198 apply in *ex parte* reexamination, except as pointed out in this Chapter. A third party requester may not appeal or otherwise participate in the appeal.

The reexamination statute does not provide for review of a patentability decision favoring the patentee. *Greenwood v. Seiko Instruments*, 8 USPQ2d 1455 (D.D.C. 1988).

See MPEP § 1205 for a discussion of the requirements for a proper appeal. However, note that in the unusual circumstances where an appeal is defective (e.g., no proof of service is included, it was filed for the wrong proceeding), patent owner should **not** be advised by the examiner to obtain an extension of time under 37 CFR 1.136(a), because an extension of time under 37 CFR 1.136 cannot be obtained in a reexamination proceeding.

Where a notice of appeal is defective, the patent owner will be so notified. Form \* >PTOL-475< will be used to provide the notification. >The "other" box on the PTOL-475 will be checked where it is appropriate with an explanation as to why the notice of appeal is defective.< A 1-month period will be provided for the patent owner to cure the defect(s) in the appeal.

If the patent owner does not timely file a notice of appeal and/or does not timely file the appropriate appeal fee, the patent owner will be notified that the appeal is dismissed. Form \*>PTOL-468< will be used to provide the notification. The reexamination proceeding is then terminated, and a Notice of Intent to Issue >Ex Parte< Reexamination Certificate (NIRC) will subsequently be issued indicating the status of the claims at the time of final rejection (or after the second rejection of the claims, where an appeal was

taken from that action without waiting for a final rejection). See MPEP § 2287.

## 2274 Appeal Brief [R-2]

>

### I. < AMENDMENT

Where the appeal brief is not filed, but within the period allowed for filing the brief an amendment is presented which places the claims of the patent under reexamination in a patentable condition, the amendment may be entered. Amendments should not be included in the appeal brief.

As to separate amendments, i.e., amendments not included with the appeal brief, filed with or after the appeal, see MPEP § 1207.

>

### II. < TIME FOR FILING APPEAL BRIEF

The time for filing the appeal brief is 2 months from the date of the appeal or alternatively, within the time allowed for response to the action appealed from, if such time is later.

>

### III. < EXTENSION OF TIME FOR FILING APPEAL BRIEF

In the event that the patent owner finds that he or she is unable to file a brief within the time allowed by the rules, he or she may file a petition without any fee, to the Technology Center (TC), requesting additional time (usually 1 month), and give reasons for the request. The petition should be filed in duplicate and contain the address to which the response is to be sent. If sufficient cause is shown and the petition is filed prior to the expiration of the period sought to be extended (37 CFR 1.550(c)), the TC Director is authorized to grant the extension for up to 1 month. Requests for extensions of time for more than 1 month will also be decided by the TC Director, but will not be granted unless extraordinary circumstances are involved; e.g., death or incapacitation of the patent owner. The time extended is added to the last calendar day of the original period, as opposed to being added to the day it would have been due when said last day is a Saturday, Sunday, or Federal holiday.

>

### IV. < FAILURE TO TIMELY FILE APPEAL BRIEF

Failure to file the brief and/or the appeal fee within the permissible time will result in dismissal of the appeal. Form \*>PTOL-468< is used to notify the patent owner that the appeal is dismissed. The reexamination proceeding is then terminated, and a Notice of Intent to Issue >Ex Parte< Reexamination Certificate (NIRC) (see MPEP § 2287) will subsequently be issued indicating the status of the claims at the time of appeal.

>

### V. < REQUIREMENTS FOR THE APPEAL BRIEF

A fee as set forth in 37 CFR 1.17(c) is required when the appeal brief is filed for the first time in a particular reexamination proceeding, 35 U.S.C. 41(a). 37 CFR 1.192 provides that the appellant shall file a brief of the authorities and arguments on which he or she will rely to maintain his or her appeal, including a concise explanation of the invention which must refer to the specification by page and line number, and to the drawing, if any, by reference characters, and a copy of the claims involved. 37 CFR 1.192(a) requires the submission of three copies of the appeal brief. In addition, where the request for reexamination was filed by a third party requester, a copy of the brief must be served on that third party requester.

In the case of a merged proceeding (see MPEP § 2283 and § 2285), one original and two copies of the brief should be provided for each reexamination and reissue in the merged proceeding. In addition, a copy of the brief must be served on any third party requesters who are part of the merged proceeding.

For the sake of convenience, the copy of the claims involved should be double spaced and should start on a new page. Note that claims on appeal in reexamination proceedings should include all underlining and bracketing necessary to reflect the changes made to the original patent claims throughout the prosecution of the reexamination. In addition, any new claims added in the reexamination should be completely underlined. This represents a departure from the procedure set forth in MPEP § 1206 for applications.

The brief, as well as every other paper relating to an appeal, should indicate the number of the TC to which the reexamination is assigned and the reexamination

control number. When the brief is received, it is forwarded to the TC where it is entered in the file and referred to the examiner.

Patent owners are reminded that their briefs in appeal cases must be responsive to every ground of rejection stated by the examiner. A reply brief, if filed, shall be entered, except that amendments or affidavits or other evidence are subject to 37 CFR 1.116 and 1.195. See 37 CFR 1.193(b)(1).

It is essential that the Board of Patent Appeals and Interferences should be provided with a brief fully stating the position of the appellant with respect to each issue involved in the appeal so that no search of the record is required in order to determine that position. The fact that appellant may consider a ground to be clearly improper does not justify a failure on the part of the appellant to point out to the Board the reasons for that view in the brief.

See MPEP § 1206 for further discussion of the requirements for an appeal brief.

>

## VI. < DEFECTIVE APPEAL BRIEF

Where an appeal brief is defective, the examiner will notify the patent owner that the brief is defective, using \*\*>PTOL-462R<. A 1-month period is provided for the patent owner to cure the defect(s). \*>Where items 1-8 in the form do not provide the defect which has been found in the brief, or where more explanation is needed as to one of items 1-8, box 9 should be checked and the< nature of the defect(s) \*\* explained by the examiner in an attachment to form \*>PTOL-462R<. An example of this is where an appellant patent owner >inadvertently< fails to respond by way of brief to any ground of rejection \*\*>under a separate heading, and it is clear from the record which ground has not been responded to<. In such a case, appellant should be notified by the examiner that he or she is given 1 month to correct the defect by filing a supplemental brief.

It is important for the examiner to identify any defects in the brief and give the patent owner 1 month in which to cure the defects. Where this procedure has not been followed, the Board of Patent Appeals and Interferences (Board) should remand the reexamination file to the examiner for compliance (i.e., for corrective action).

When the record clearly indicates *intentional failure* to respond by brief, to any ground of rejection, for example, the examiner should inform the Board of this fact in his or her answer and merely specify the claim(s) affected. Where the failure to respond by brief appears to be intentional, the Board may dismiss the appeal as to the claims involved. Oral argument at the hearing will not remedy such deficiency of a brief.

The mere filing of any paper whatsoever entitled as a brief cannot necessarily be considered as compliance with 37 CFR 1.192. The rule requires that the brief must set forth the authorities and arguments relied on, and to the extent that it fails to do so with respect to any ground of rejection, the appeal as to that ground may be dismissed. A distinction must be made between the lack of any argument and the presentation of arguments that carry no conviction. In the former case dismissal is in order, while in the latter case a decision on the merits is made, although it may well be merely an affirmance based on the grounds relied on by the examiner.

Appellant must traverse *every* ground of rejection set forth in the final rejection. Oral argument at the hearing will not remedy a deficiency of failure to traverse a ground of rejection in the brief. Ignoring or acquiescing in any rejection, even one based upon formal matters which could be cured by subsequent amendment, will invite a dismissal of the appeal as to the claims subject to the rejection.

The reexamination proceedings are considered terminated as of the date of the dismissal of the appeal. After the appeal is dismissed, the examiner will proceed to issue a Notice of Intent to Issue >Ex Parte< Reexamination Certificate for the proceeding; see MPEP § 2287.

## 2275 Examiner's Answer [R-2]

37 CFR 1.193. Examiner's answer and reply brief.

\*\*>

(a)(1) The primary examiner may, within such time as may be directed by the Director, furnish a written statement in answer to appellant's brief including such explanation of the invention claimed and of the references and grounds of rejection as may be necessary, supplying a copy to appellant. If the primary examiner finds that the appeal is not regular in form or does not relate to an appealable action, the primary examiner shall so state.<

(2) An examiner's answer must not include a new ground of rejection, but if an amendment under § 1.116 proposes to add or amend one or more claims and appellant was advised that the amendment under § 1.116 would be entered for purposes of

appeal and which individual rejection(s) set forth in the action from which the appeal was taken would be used to reject the added or amended claim(s), then the appeal brief must address the rejection(s) of the claim(s) added or amended by the amendment under § 1.116 as appellant was so advised and the examiner's answer may include the rejection(s) of the claim(s) added or amended by the amendment under § 1.116 as appellant was so advised. The filing of an amendment under § 1.116 which is entered for purposes of appeal represents appellant's consent that when so advised any appeal proceed on those claim(s) added or amended by the amendment under § 1.116 subject to any rejection set forth in the action from which the appeal was taken.

(b)(1) Appellant may file a reply brief to an examiner's answer or a supplemental examiner's answer within two months from the date of such examiner's answer or supplemental examiner's answer. See § 1.136(b) for extensions of time for filing a reply brief in a patent application and § 1.550(c) for extensions of time for filing a reply brief in a reexamination proceeding. The primary examiner must either acknowledge receipt and entry of the reply brief or withdraw the final rejection and reopen prosecution to respond to the reply brief. A supplemental examiner's answer is not permitted, unless the application has been remanded by the Board of Patent Appeals and Interferences for such purpose.

(2) Where prosecution is reopened by the primary examiner after an appeal or reply brief has been filed, appellant must exercise one of the following two options to avoid abandonment of the application:

(i) File a reply under § 1.111, if the Office action is not final, or a reply under § 1.113, if the Office action is final; or

(ii) Request reinstatement of the appeal. If reinstatement of the appeal is requested, such request must be accompanied by a supplemental appeal brief, but no new amendments, affidavits (§§ 1.130, 1.131 or 1.132) or other evidence are permitted.

MPEP § 1208 through § 1208.02 relate to preparation of examiner's answers in appeals. The procedures covered in these sections apply to appeals in both patent applications and patents undergoing *>ex parte<* reexamination proceedings, except as provided for in this Chapter.

Where appellant files a timely reply brief to an examiner's answer or a supplemental examiner's answer, the examiner may either (A) acknowledge receipt and entry of the reply brief, or (B) withdraw the final rejection and reopen prosecution to respond to the reply brief. A supplemental examiner's answer is not permitted, unless the application has been remanded by the Board of Patent Appeals and Interferences for such purposes.

## 2276 Oral Hearing [R-2]

If appellant (patent owner) desires an oral hearing, appellant must file a written request for such hearing accompanied by the fee set forth in 37 CFR 1.17(d) within 2 months after the date of the examiner's answer.

Where the appeal involves reexamination proceedings, oral hearings are open to the public as observers *>(subject to the admittance procedures established by the Board),<* unless the appellant (A) requests that the hearing not be open to the public and (B) presents valid reasons for such a request.

MPEP § 1209 relates to oral hearings in appeals in both patent applications and *>ex parte<* reexamination proceedings.

## 2277 Board of Patent Appeals and Interferences Decision [R-2]

MPEP § 1213 through § 1213.03 relate to decisions of the Board of Patent Appeals and Interferences for both applications and *>ex parte<* reexamination proceedings.

## 2278 Action Following Decision [R-2]

MPEP § 1214 through § 1214.07 provide the procedures to be followed after the conclusion of the appeal to the Board of Patent Appeals and Interferences, for both patent applications and *>ex parte<* reexamination proceedings, except as provided for in this Chapter.

## 2279 Appeal to Courts [R-2]

A patent owner not satisfied with the decision of the Board of Patent Appeals and Interferences may seek judicial review.

In an *ex parte* reexamination \*\* filed before November 29, 1999, the patent owner may appeal the decision of the Board of Patent Appeals and Interferences to either (A) the United States Court of Appeals for the Federal Circuit pursuant to 35 U.S.C. 141, or (B) the United States District Court for the District of Columbia pursuant to 35 U.S.C. 145. This is based on the version of 35 U.S.C. 141 and 35 U.S.C. 145 in existence prior to the amendment of the reexamination statute on November 29, 1999 by Public Law 106-113. This "prior version" of 35 U.S.C. 141 and 35

U.S.C. 145 applies to appeals in reexamination \*\* >, where the reexamination was filed in the Office before November 29, 1999. See Section 13202(d) of Public Law 107-273<.

In an *ex parte* reexamination \*\* filed on or after November 29, 1999, the patent owner may appeal the decision of the Board of Patent Appeals and Interferences only to the United States Court of Appeals for the Federal Circuit pursuant to 35 U.S.C. 141. This is based on the current version of 35 U.S.C. 141 and 35 U.S.C. 145 as they were amended by Public Law 106-113. This “current version” of 35 U.S.C. 141 and 35 U.S.C. 145 applies to appeals in reexamination\*\*>, where the reexamination was filed in the Office on or after November 29, 1999. See Section 13202(d) of Public Law 107-273<.

A third party >requester of an *ex parte* reexamination< may not seek judicial review. *Yuasa Battery v. Comm’r*, 3 USPQ2d 1143 (D.D.C. 1987).

While the reexamination statutory provisions do not provide for participation by any third party requester during any court review, the courts have permitted intervention by a third party requester in appropriate circumstances. See *In re Etter*, 756 F.2d 852, 225 USPQ 1 (Fed. Cir. 1985) and *>Reed< v. Quigg*, 230 USPQ 62 (D.D.C. 1986). See also MPEP § 1216, § 1216.01, and § 1216.02. A third party requester who is permitted to intervene in a civil action has no standing to appeal the court’s decision, *Boeing Co. v. Comm’r*, 853 F.2d 878, 7 USPQ2d 1487 (Fed. Cir. 1988).

## 2280 Information Material to Patentability in Reexamination Proceeding [R-2]

37 CFR 1.555. *Information material to patentability in ex parte reexamination and inter partes reexamination proceedings.*

(a) A patent by its very nature is affected with a public interest. The public interest is best served, and the most effective reexamination occurs when, at the time a reexamination proceeding is being conducted, the Office is aware of and evaluates the teachings of all information material to patentability in a reexamination proceeding. Each individual associated with the patent owner in a reexamination proceeding has a duty of candor and good faith in dealing with the Office, which includes a duty to disclose to the Office all information known to that individual to be material to patentability in a reexamination proceeding. The individuals who have a duty to disclose to the Office all information known to them to be material to patentability in a reexamination proceeding

are the patent owner, each attorney or agent who represents the patent owner, and every other individual who is substantively involved on behalf of the patent owner in a reexamination proceeding. The duty to disclose the information exists with respect to each claim pending in the reexamination proceeding until the claim is cancelled. Information material to the patentability of a cancelled claim need not be submitted if the information is not material to patentability of any claim remaining under consideration in the reexamination proceeding. The duty to disclose all information known to be material to patentability in a reexamination proceeding is deemed to be satisfied if all information known to be material to patentability of any claim in the patent after issuance of the reexamination certificate was cited by the Office or submitted to the Office in an information disclosure statement. However, the duties of candor, good faith, and disclosure have not been complied with if any fraud on the Office was practiced or attempted or the duty of disclosure was violated through bad faith or intentional misconduct by, or on behalf of, the patent owner in the reexamination proceeding. Any information disclosure statement must be filed with the items listed in § 1.98(a) as applied to individuals associated with the patent owner in a reexamination proceeding, and should be filed within two months of the date of the order for reexamination, or as soon thereafter as possible.

(b) Under this section, information is material to patentability in a reexamination proceeding when it is not cumulative to information of record or being made of record in the reexamination proceeding, and

(1) It is a patent or printed publication that establishes, by itself or in combination with other patents or printed publications, a *prima facie* case of unpatentability of a claim; or

(2) It refutes, or is inconsistent with, a position the patent owner takes in:

(i) Opposing an argument of unpatentability relied on by the Office, or

(ii) Asserting an argument of patentability.

A *prima facie* case of unpatentability of a claim pending in a reexamination proceeding is established when the information compels a conclusion that a claim is unpatentable under the preponderance of evidence, burden-of-proof standard, giving each term in the claim its broadest reasonable construction consistent with the specification, and before any consideration is given to evidence which may be submitted in an attempt to establish a contrary conclusion of patentability.

\*\*>

(c) The responsibility for compliance with this section rests upon the individuals designated in paragraph (a) of this section and no evaluation will be made by the Office in the reexamination proceeding as to compliance with this section. If questions of compliance with this section are raised by the patent owner or the third party requester during a reexamination proceeding, they will be noted as unresolved questions in accordance with § 1.552(c).<

The duty of disclosure in reexamination proceedings applies to the patent owner; to each attorney or agent who represents the patent owner, and to every other individual who is *>*substantively< involved on behalf of the patent owner. That duty is a continuing

obligation on all such individuals throughout the proceeding. The continuing obligation during the reexamination proceeding is that any such individual to whom the duty applies who is aware of, or becomes aware of, patents or printed publications which (A) are material to patentability in a reexamination proceeding, and (B) which have not previously been made of record in the patent file, must bring such patents or printed publications to the attention of the Office.

Such individuals are strongly encouraged to file information disclosure statements, preferably in accordance with 37 CFR 1.98, within two months of the date of the order to reexamine, or as soon thereafter as possible, in order to bring the patents or printed publications to the attention of the Office. An information disclosure statement filed under 37 CFR 1.555 by the patent owner after the order for reexamination and before the first action on the merits may be submitted as part of the statement under 37 CFR 1.530, or it may be filed as a separate paper. If the information disclosure statement is filed as part of a statement under 37 CFR 1.530, the submission may include a discussion of the patentability issues in the reexamination. If, however, the submission is filed as a separate paper, not part of a statement under 37 CFR 1.530, the submission must be limited to a listing of the information disclosed and an explanation of its relevance. See 37 CFR 1.98. Any discussion of the information disclosed relating to patentability issues in the reexamination would be improper.

Any individual *\*>substantively<* involved in the reexamination proceeding may satisfy his or her duty by disclosing the information to the attorney or agent having responsibility for the reexamination proceeding or to a patent owner acting in his or her own behalf. A patent owner may satisfy his or her duty by disclosing the information to the attorney or agent having responsibility for the reexamination proceeding. An attorney, agent, or patent owner who receives information has no duty to submit such information if it is not material to patentability in the reexamination proceeding. See 37 CFR 1.555(b) for the definition of “material to patentability.”

The responsibility of compliance with 37 CFR 1.555 rests on all such individuals. Any fraud practiced or attempted on the Office or any violation of the duty of disclosure through bad faith or intentional

misconduct by any such individual results in noncompliance with 37 CFR 1.555(a). This duty of disclosure is consistent with the duty placed on patent applicants by 37 CFR 1.56. Any such issues raised >by the patent owner or the third party requester< during a reexamination proceeding will merely be noted as unresolved questions under 37 CFR 1.552(c).

All such individuals who fail to comply with 37 CFR 1.555(a) do so at the risk of diminishing the quality and reliability of the reexamination certificate issuing from the proceeding.

See MPEP § 2282 >(ex parte reexamination) and MPEP § 2686 (inter partes reexamination)< for the patent owner’s duty to disclose prior or concurrent proceedings in which the patent is or was involved.

## 2281 Interviews in >Ex Parte< Reexamination Proceedings [R-2]

\*\*>

37 CFR 1.560. *Interviews in ex parte reexamination proceedings.*

(a) Interviews in *ex parte* reexamination proceedings pending before the Office between examiners and the owners of such patents or their attorneys or agents of record must be conducted in the Office at such times, within Office hours, as the respective examiners may designate. Interviews will not be permitted at any other time or place without the authority of the Director. Interviews for the discussion of the patentability of claims in patents involved in *ex parte* reexamination proceedings will not be conducted prior to the first official action. Interviews should be arranged in advance. Requests that reexamination requesters participate in interviews with examiners will not be granted.<

(b) In every instance of an interview with an examiner in an *ex parte* reexamination proceeding, a complete written statement of the reasons presented at the interview as warranting favorable action must be filed by the patent owner. An interview does not remove the necessity for response to Office actions as specified in § 1.111. Patent owner’s response to an outstanding Office action after the interview does not remove the necessity for filing the written statement. The written statement must be filed as a separate part of a response to an Office action outstanding at the time of the interview, or as a separate paper within one month from the date of the interview, whichever is later.

Interviews are permitted in an *ex parte* reexamination proceeding. In the *ex parte* proceeding, only *ex parte* interviews between the examiner and patent owner and/or the patent owner’s representative are permitted. Requests by third party requesters to participate in interviews or to attend interviews will not be granted.

Unless the Office of Patent Legal Administration authorizes otherwise, interviews between examiner and the owners of patents undergoing *ex parte* reexamination or their attorneys or agents must be had in the Office at such times, within Office hours, as the respective examiners may designate.

Interviews for the discussion of the patentability of claims in patents involved in reexamination proceedings will ordinarily not be had prior to the first Office action following the order for reexamination and any submissions pursuant to 37 CFR 1.530 and 1.535. Such interviews will be permitted prior to the first Office action *only* where the examiner initiates the interview for the purpose of providing an amendment which will make the claims patentable and the patent owner's role is passive. The patent owner's role (or patent owner's attorney or agent) is limited to agreeing to the change or not. The patent owner should not otherwise discuss the case on the merits during this interview.

The patent owner's questions on purely procedural matters may be answered by the examiner at any time during the proceeding.

Where any party who is not the patent owner requests information as to the merits of a reexamination proceeding, the examiner will not conduct a personal or telephone interview with that party to provide the information. Only questions on strictly procedural matters may be discussed with that party. <sup>\*\*</sup>The following guidelines are to be followed in determining whether a question is strictly directed to a procedural matter: (A) any information which a person could obtain by reading the file (which is open to the public) is procedural, and it may be discussed; (B) a matter not available from a reading of the file is considered as relating to the merits of the proceeding, and may not be discussed. Thus, for example, a question relating to when the next Office action will be rendered is improper as it relates to the merits of the proceeding (because this information cannot be obtained from a reading of the file). Such a question by a party who is not the patent owner should not be responded to by the examiner.

The examiner must complete an Interview Summary form PTOL-474 for each interview held where a matter of substance has been discussed (see MPEP § 713.04). A copy of the form should be given to the patent owner at the conclusion of the interview. The

original should be made of record in the reexamination file, and a copy should be mailed to any third party requester.

The general procedure for conducting interviews and recording same is described at MPEP § 713.01 - § 713.04.

### **PATENT OWNER'S STATEMENT OF THE INTERVIEW**

In every instance of an interview with the examiner, a patent owner's statement of the interview, including a complete written statement of the reasons presented at the interview as warranting favorable action, **must** be filed by the patent owner. <sup>\*\*</sup> >37 CFR 1.560(b). The written statement must be filed either as a separate paper within one month after the date of the interview, or as a separate part of a response to an outstanding Office action, whichever is later.

The requirement for a patent owner's statement of the interview cannot be waived by the examiner. It should be noted that, pursuant to 37 CFR 1.550(d), the failure to file a written statement of an interview as required under 37 CFR 1.560(b) will result in the termination of the reexamination proceeding (in the same way that failure to timely respond to an Office action results in the termination of the reexamination proceeding).<

### **2282 Notification of Existence of Prior or Concurrent Proceedings and Decisions Thereon [R-2]**

*37 CFR 1.565. Concurrent office proceedings which include an ex parte reexamination proceeding.*

(a) In an *ex parte* reexamination proceeding before the Office, the patent owner must inform the Office of any prior or concurrent proceedings in which the patent is or was involved such as interferences, reissues, *ex parte* reexaminations, *inter partes* reexaminations, or litigation and the results of such proceedings. See § 1.985 for notification of prior or concurrent proceedings in an *inter partes* reexamination proceeding.

\*\*\*\*\*

It is important for the Office to be aware of any prior or concurrent proceedings in which a patent undergoing *ex parte* reexamination is or was involved, such as interferences, reissues, *inter partes* reexaminations, other *ex parte* reexaminations or litigations, and any results of such proceedings. In accordance with 37 CFR 1.565(a), the patent owner

is required to provide the Office with information regarding the existence of any such proceedings, and the results thereof, if known. Ordinarily, no submissions of any kind by third parties filed after the date of the order are placed in the reexamination or patent file while the reexamination proceeding is pending. However, in order to ensure a complete file, with updated status information regarding prior or concurrent proceedings regarding the patent under reexamination, the Office will, at any time, accept >from any parties,< for placement in the reexamination file>,< copies \*\* of notices of suits and other proceedings involving the patent and copies of decisions or papers filed in the court from litigations or other proceedings involving the patent. Persons making such submissions must limit the submissions to the notification, and must not include further arguments or information. Where a submission is not limited to bare notice of the prior or concurrent proceedings (in which a patent undergoing reexamination is or was involved), the submission will be returned by the Office. Any proper submission pursuant to 37 CFR 1.565(a) will be promptly placed of record in the reexamination file>, and will be considered by the examiner as to its content, when the proceeding comes up for action on the merits. Thus, for example, if the patent owner properly files in a reexamination proceeding, pursuant to 37 CFR 1.565(a), an Information Disclosure Statement (IDS) that was submitted by a third party in the discovery stage of litigation of the patent being reexamined, the IDS would be placed in the reexamination file and considered by the examiner, the next time the proceeding comes up for action on the merits<. See MPEP § 2286 for Office investigation for prior or concurrent litigation.

Form paragraph 22.07 or 22.08, if appropriate, may be used to remind the patent owner of the continuing duty under 37 CFR 1.565(a) to apprise the Office of any litigation activity.

>

¶ 22.07 *Litigation Reminder (Patent Owner Request or Director Ordered Reexamination)*

The patent owner is reminded of the continuing responsibility under 37 CFR 1.565(a), to apprise the Office of any litigation activity, or other prior or concurrent proceeding, involving Patent No. [1] throughout the course of this reexamination proceeding. See MPEP §§ 2207, 2282 and 2286.

**Examiner Note:**

This form paragraph is to be used when granting an *ex parte* reexamination request filed by a patent owner and in the first action in a Director Ordered reexamination.

¶ 22.08 *Litigation Reminder (Third Party Requester)*

The patent owner is reminded of the continuing responsibility under 37 CFR 1.565(a), to apprise the Office of any litigation activity, or other prior or concurrent proceeding, involving Patent No. [1] throughout the course of this reexamination proceeding. The third party requester is also reminded of the ability to similarly apprise the Office of any such activity or proceeding throughout the course of this reexamination proceeding. See MPEP §§ 2207, 2282 and 2286.

**Examiner Note:**

This form paragraph is to be used when granting an *ex parte* reexamination request filed by a third party requester.

<

## 2283 Multiple Copending ~~Ex Parte~~ Reexamination Proceedings [R-2]

37 CFR 1.565. *Concurrent Office proceedings which include an ex parte reexamination proceeding.*

\*\*\*\*\*

(c) If *ex parte* reexamination is ordered while a prior *ex parte* reexamination proceeding is pending and prosecution in the prior *ex parte* reexamination proceeding has not been terminated, the *ex parte* reexamination proceedings will be consolidated and result in the issuance of a single certificate under § 1.570. For merger of *inter partes* reexamination proceedings, see § 1.989(a). For merger of *ex parte* reexamination and *inter partes* reexamination proceedings, see § 1.989(b).

\*\*\*\*\*

\*>This section discusses multiple copending reexamination requests which are filed on the same patent, where none of the requests is an *inter partes* request. If one of the multiple copending reexamination requests is an *inter partes* request, see MPEP § 2686.01.

In order for a second or subsequent request for *ex parte* reexamination to be granted, a substantial new question of patentability must be raised by the art (patents and/or printed publications) cited in the second or subsequent request for reexamination.< MPEP § 2240 \*>provides< a discussion as to whether a substantial new question of patentability is raised by the prior art cited in a second or subsequent request for reexamination filed while a reexamination proceeding is pending.



If \*\*>the second or subsequent request is granted<, the decision on whether or not to combine the proceedings will be made by the Technology Center (TC) Director where the reexamination is pending. The TC Director may delegate this to the TC Special Program Examiner. No decision on combining the reexaminations should be made until reexamination is actually ordered in the later filed request for reexamination.

>

### I. < PROCEEDINGS MERGED

If a second request for reexamination is filed where a first certificate will issue for the first reexamination later than 3 months from the filing of the second request, the proceedings normally will be merged. In this situation the second request is decided based on the original patent claims>,< and if reexamination is ordered, the reexamination proceedings normally would be merged. If>, however,< the first reexamination is in “issue” for publication of a certificate, it \*\*>might not be possible to withdraw the first reexamination from issue in some instances.

After the patent owner and second requester have been given an opportunity to file a statement and reply, respectively, the< second reexamination proceeding will be merged with the first reexamination proceeding>,< and prosecution will >then< continue \*\*>at the most advanced point possible for the first proceeding. It should be noted that if a final rejection has been issued in the first proceeding, prosecution will be ordinarily be reopened where any of the new patents or printed publications presented in the second request are applied to the merged proceeding in a new ground of rejection<.

The patent owner will be provided with an opportunity to respond to any new rejection in a merged reexamination proceeding prior to the action being made final. See MPEP § 2271. If the reexamination proceedings are \*>merged<, a single certificate will be issued based upon the \*>merged< proceedings, 37 CFR 1.565(c).

>

### II. < WHEN PROCEEDING IS SUSPENDED

It may also be desirable in certain situations to suspend a proceeding for a short and specified period of time. For example, a suspension of a first reexamination proceeding may be issued to allow time for the

patent owner’s statement and the requester’s reply in a second proceeding prior to merging. Further, after the second proceeding *has been ordered*, it may be desirable to suspend the second proceeding where the first proceeding is presently on appeal before a Federal court to await the court’s decision prior to merging. A suspension will only be granted in extraordinary instances, because of the statutory requirements that examination proceed with “special dispatch.” The express written approval of the TC Director must be obtained. Suspension will not be granted when there is an outstanding Office action.

>

### III. < MERGER OF REEXAMINATIONS

The following guidelines should be observed when two requests for reexamination directed to a single patent have been filed.

The second request (i.e., Request 2) should be processed as quickly as possible and assigned to the same examiner to whom the first request (i.e., Request 1) is assigned. Request 2 should be decided immediately without waiting the usual period >(e.g., for submission of art)<. If Request 2 is denied, *ex parte* prosecution of Request 1 should continue. If Request 2 is granted, the order in the second proceeding should be mailed immediately. The two requests should be held in storage until the patent owner’s statement and any reply by the requester have been received in Request 2, or until the time for filing same expires. Then, the TC Director or the TC Director’s delegate will prepare a decision merging the two proceedings.

The decision by the TC Director merging the reexamination proceedings should include a requirement that the patent owner maintain identical claims in both files. It will further require that responses by the patent owner>, and any other paper filed in the merged proceeding,< must consist of a single response, addressed to both files, filed in duplicate, each bearing a signature >and containing identifying data for both files<, for entry in both files. The decision will point out that both files will be maintained as separate complete files. \*>Where the claims are not the same in both files, the< decision of merger will indicate at its conclusion that the patent owner is given 1 month to provide \*\*>an< amendment to make the claims the same in each file\*\*. Where the claims are already the same in both files, the decision will

indicate at its conclusion that an Office action will be mailed in due course, and that the patent owner need not take any action at present. The decision of merger will be mailed immediately.

Where the merger decision indicates that the patent owner is given 1 month to provide **>an<** amendment **>to** make the claims the same in each file (identical amendments to be placed< in all files), the files will be held in storage to await submission of the amendment. After the amendment is received, it will be processed by the technical support staff and the file returned to the examiner, to issue an Office action. Where the merger decision indicates that an Office action will follow, the files are returned to the examiner immediately after the decision, to issue the action.

Once the files are returned to the examiner for issuance of an Office action, the examiner should prepare an Office action at the most advanced point possible for the first proceeding. Thus, if the first proceeding is ready for a final rejection and the second proceeding does not provide any new information which would call for a new ground of rejection, the examiner should issue a final rejection for the merged proceeding using the guidelines for the prosecution stage set forth below.

If the *ex parte* prosecution stage has not yet begun in Request 1 when Request 2 is received, Request 1 should be processed to the point where it is ready for *ex parte* prosecution. Then, Request 1 is normally held until Request 2 is granted and is ready for *ex parte* action following the statement and reply. Thereafter, the two proceedings would be merged. However, if Request 2 is denied, there would be no merger and prosecution will be carried out solely on Request 1. Note that Request 2 should be determined on its own merits and should not rely on nor refer to the decision >issued< in Request 1.

In the event that **>an<** amendment **>to** make the claims the same in each file< is required by the merger decision (**>to** identical amendments >to be placed< in all files) but is not timely submitted, any claim that does not contain identical text in all of the merged proceedings should be rejected under 35 U.S.C. 112, second paragraph, as being indefinite as to the content of the claim, and thus failing to particularly point out the invention.

&gt;

#### IV. < THE PROSECUTION STAGE, AFTER MERGER

When prosecution is appropriate in merged proceedings, a single combined examiner's action will be prepared. Each action will contain the control number of the two proceedings on every page. A single action cover form (having both control numbers penned in at the top) will be provided by the examiner to the clerical staff. The clerical staff will copy the action cover form, and then use the PALM printer to print the appropriate data (A) on the original for the first request and (B) on the copy for the second request. The appropriate paper number will be entered on the action cover form for each file (these numbers will often be different). Each requester will receive a copy of the action and both action cover forms, with the transmission form PTOL-465 placed on top of the package. The patent owner will get a copy of both action cover forms and the action itself.

When a "Notice Of Intent To Issue >Ex Parte< Reexamination Certificate" (NIRC) is appropriate, plural notices will be printed. Both reexamination files will then be processed. The TC should prepare the file of the concurrent proceedings in the manner specified in MPEP § 2287 before release to Office of Publications.

The above guidelines should be extended to those situations where more than two requests for reexamination are filed for a single patent.

&gt;

#### V. < PROCEEDINGS NOT MERGED

If a second request is filed where the first reexamination certificate will issue within 3 months from the filing of the second request, the proceedings normally will not be merged. If the certificate on the first reexamination proceeding will issue before the decision on the second request must be decided, the reexamination certificate is allowed to issue. The second request is then considered based upon the claims in the patent as indicated in the issued reexamination certificate rather than the original claims of the patent. In such situations the proceedings will not be merged. However, it should be noted that where the second request relies on the *same substantial new question of patentability that the first reexamination proceeding*

*relies upon*, the question as to merger should be referred to the TC Special Program Examiner. In NO case should a decision on the second request be delayed beyond its 3-month deadline.

>For processing of the second reexamination proceeding, see MPEP § 2295.

## VI. < FEES IN MERGED PROCEEDINGS

Where the proceedings have been merged and a paper is filed which requires payment of a fee (e.g., petition fee, appeal fee, brief fee, oral hearing fee), only a single fee need be paid. For example, only one fee need be paid for an appeal brief even though the brief relates to merged multiple proceedings and copies must be filed for each file in the merged proceeding.

>

## VII. <PETITION TO MERGE MULTIPLE COPENDING REEXAMINATION PROCEEDINGS

No petition to merge multiple reexamination proceedings is necessary since the Office will generally, *sua sponte*, make a decision as to whether or not it is appropriate to merge the multiple reexamination proceedings. If any petition to merge the proceedings is filed prior to the determination (37 CFR 1.515) and order to reexamine (37 CFR 1.525) on the second request, it will not be considered but will be returned to the party submitting the same by the TC Director. The decision returning such a premature petition will be made of record in both reexamination files, but no copy of the petition will be retained by the Office. See MPEP § 2267.

While the patent owner can file a petition to merge the proceedings at any time after the order to reexamine (37 CFR 1.525) on the second request, the better practice is to include any such petition with the patent owner's statement under 37 CFR 1.530, in the event the TC Director has not acted prior to that date to merge the multiple reexamination proceedings. If the requester of any of the multiple reexamination proceedings is not the patent owner, that party may petition to merge the proceedings as a part of a reply pursuant to 37 CFR 1.535 in the event the TC Director has not acted prior to that date to merge the multiple proceedings. A petition to merge the multiple proceedings which is filed by a party other than the

patent owner or one of the requesters of the reexamination will not be considered but will be returned to that party by the TC Director as being improper under 37 CFR 1.550(\*>g<).

All decisions on the merits of petitions to merge multiple reexamination proceedings will be made by the TC Director (or to the TC Special Program Examiner, if the TC Director delegates it to him or her).

## 2284 Copending >Ex Parte< Reexamination and Interference Proceedings [R-2]

37 CFR 1.565. *Concurrent office proceedings which include an ex parte reexamination proceeding.*

(a) In an *ex parte* reexamination proceeding before the Office, the patent owner must inform the Office of any prior or concurrent proceedings in which the patent is or was involved such as interferences, reissues, *ex parte* reexaminations, *inter partes* reexaminations, or litigation and the results of such proceedings. See § 1.985 for notification of prior or concurrent proceedings in an *inter partes* reexamination proceeding.

\*\*\*\*\*

(e) If a patent in the process of *ex parte* reexamination is or becomes involved in an interference, the Commissioner may suspend the reexamination or the interference. The Commissioner will not consider a request to suspend an interference unless a motion (§ 1.635) to suspend the interference has been presented to, and denied by, an administrative patent judge, and the request is filed within ten (10) days of a decision by an administrative patent judge denying the motion for suspension or such other time as the administrative patent judge may set. For concurrent *inter partes* reexamination and interference of a patent, see § 1.993.

37 CFR 1.660. *Notice of reexamination, reissue, protest, or litigation.*

(a) When a request for reexamination of a patent involved in an interference is filed, the patent owner shall notify the Board within 10 days of receiving notice that the request was filed.

\*\*\*\*\*

A patent being reexamined in an \*>ex parte< reexamination proceeding may be involved in an interference proceeding with at least one application, where the patent and the application are claiming the same patentable invention, and at least one of the application's claims to that invention are patentable to the applicant. See MPEP § 2306.

The general policy of the Office is that a reexamination proceeding will not be delayed, or stayed, because of an interference or the possibility of an interference. The reasons for this policy are (A) the

relatively long period of time usually required for interferences and (B) the requirement of 35 U.S.C. 305 that all reexamination proceedings be conducted with “special dispatch” within the Office. In general, the Office will follow the practice of making the required and necessary decisions in the reexamination proceeding and, at the same time, going forward with the interference to the extent desirable. Decisions in the interference will take into consideration the status of the reexamination proceeding and what is occurring therein. The decision as to what actions are taken in the interference will, in general, be taken in accordance with normal interference practice.

It must be noted that although a *patent* being reexamined via a reexamination proceeding may become involved in an interference proceeding, the reexamination proceeding itself can never be involved in an interference proceeding. See 35 U.S.C. 135 subsection (a) which states that “[w]henver an application is made for a patent which, in the opinion of the \*>Director<, would interfere with any pending *application*, or with any unexpired *patent*, an interference may be declared” (emphasis added). The reexamination proceeding is neither an application nor a patent.

>

#### **I. < ATTEMPTING TO PROVOKE AN INTERFERENCE WITH A PATENT INVOLVED IN A REEXAMINATION PROCEEDING**

When an amendment seeking to provoke an interference with a patent involved in a reexamination proceeding is filed in a pending application, applicant must comply with 37 CFR 1.607(a) and (c), including identifying the patent under reexamination with which interference is sought. See MPEP § 2307. Upon receipt of such an amendment, the examiner must notify the owner of the patent pursuant to 37 CFR 1.607(d). Form paragraph 23.20 may be used to so notify applicant; see MPEP § 2307.06. The corresponding application claims may be rejected on any applicable ground including, if appropriate, the prior art cited in the reexamination proceeding. See MPEP § 2307.02. Prosecution of the application should continue as far as possible; if the application is placed in condition for allowance and still contains claims which interfere with claims of the patent under reexamination, then an interference should ordinarily be

proposed between the application and the patent. The examiner must notify the Office of Patent Legal Administration (OPLA) before proposing the interference, and such an interference may not be proposed unless authorized by OPLA.

If the interference is not authorized (e.g., resolution of an issue in the reexamination proceeding is necessary to the interference), further action on the application should be suspended until the certificate on the reexamination proceeding has been issued. Form paragraph 23.16 may be used to notify applicant of the suspension.

Once the reexamination certificate has issued, the examiner should review the certificate to see if it makes any changes in the patent claims and then evaluate whether the patent still contains claims which interfere with claims of the application. If the claims do interfere, then the examiner should propose an interference. See MPEP § 2309.02.

If the claims do not interfere, then the examiner should so notify the owner of the patent pursuant to 37 CFR 1.607(d). Form paragraph 23.21 may be used; see MPEP § 2307.06.

>

#### **II. < MOTION/REQUEST TO SUSPEND INTERFERENCE PENDING THE OUTCOME OF A REEXAMINATION PROCEEDING**

A motion under 37 CFR 1.635 to suspend an interference pending the outcome of a reexamination proceeding may be made at any time during the interference by any party thereto. The motion must be presented to the administrative patent judge who will decide the motion based on the particular fact situation. However, no consideration will be given such a motion unless and until a reexamination order is issued, nor will suspension of the interference normally be permitted until after any motions have been disposed of. If the motion under 37 CFR 1.635 is denied by the administrative patent judge, a request to stay the interference may be made to the \*>Director of the USPTO< under 37 CFR 1.565(e).

It is noted that the 37 CFR 1.644(a)(2) petition might appear to overlap the 37 CFR 1.565(e) request to stay an interference; however, 37 CFR 1.644(b) states that “[a] petition under paragraph (a)(2) of this section shall not be filed prior to the party’s brief for

final hearing (see § 1.656).” The request to stay an interference under 37 CFR 1.565(e) is thus not covered by 37 CFR 1.644(a)(1)-(3); and 37 CFR 1.565(e) provides an additional aspect of relief to the public.

A request to stay an interference under 37 CFR 1.565(e) will be decided by the Chief Administrative Patent Judge of the Board of Patent Appeals and Interferences.

>

### III. < ACTION PURSUANT TO 37 CFR 1.641

Normally, examiners should not have to alert the administrative patent judge of the need for action under 37 CFR 1.641 while the reexamination proceeding is pending. Rather, examiners should rely on the parties of the interference to file a notice under 37 CFR 1.660. See also the discussion in the next paragraph.

>

### IV. < REQUEST FOR REEXAMINATION FILED DURING INTERFERENCE

In view of the provisions of 37 CFR 1.510(a), “>[a]ny< person may, at any time during the period of enforceability of a patent” file a request for reexamination. Under 37 CFR 1.660, the patent owner must notify the Board of Patent Appeals and Interferences that a request for reexamination was filed, within 10 days of receiving notice of the request having been filed. Where it is the patent owner that files the request for reexamination, the 10 days run from the filing date of the request, since that is when the patent owner “received the notice” of filing the request. Such requests for reexamination will be processed in the normal manner. No delay, or stay, of the reexamination will occur because the requester is not a party to the interference. If the examiner orders reexamination pursuant to 37 CFR 1.525 and subsequently rejects a patent claim corresponding to a count in the interference, the attention of the administrative patent judge shall be called thereto and appropriate action may be taken under 37 CFR 1.641.

>

### V. < INTERFERENCE DECLARED WHILE REEXAMINATION PROCEEDING IS ONGOING

Under 37 CFR 1.565, the patent owner in a reexamination proceeding before the Office is required to notify the Office when the patent being reexamined becomes involved in an interference. To do so, the patent owner must file in the reexamination proceeding a paper giving notice of the interference proceeding. The requirements of 37 CFR 1.565, and of 37 CFR 1.660 (see the preceding paragraph), are designed to keep the Office and the appropriate parties informed of activity which is relevant to reexamination and interference proceedings and, to the extent possible, to eliminate procedural surprise.

>

### VI. < PETITION TO STAY REEXAMINATION PROCEEDING BECAUSE OF INTERFERENCE

Any petition to stay a reexamination proceeding, because of an interference, which is filed prior to the determination (37 CFR 1.515) and order to reexamine (37 CFR 1.525) will not be considered, but will be returned to the party submitting the same. The decision returning such a premature petition will be made of record in the reexamination file, but no copy of the petition will be retained by the Office. A petition to stay the reexamination proceeding because of the interference may be filed by the patent owner as a part of the patent owner’s statement under 37 CFR 1.530 or subsequent thereto. If a party to the interference, other than the patent owner, is a requester of the reexamination, that party may petition to stay the reexamination proceeding as a part of a reply pursuant to 37 CFR 1.535. If the other party to the interference is not the requester, any petition by that party is improper under 37 CFR 1.550(>g<) and will not be considered. Any such improper petitions will be returned to the party submitting the same. Premature petitions to stay the reexamination proceedings, i.e., those filed prior to the determination (37 CFR 1.515) and order to reexamine (37 CFR 1.525), will be returned by the Technology Center (TC) Director as premature. Petitions to stay filed subsequent to the date of the order for reexamination will be referred to

the OPLA for decision. All decisions on the merits of petitions to stay a reexamination proceeding because of an interference will be made in the OPLA.

>

## VII. < ACTION IN INTERFERENCE FOLLOWING REEXAMINATION

If one or more claims of a patent which is involved in an interference are canceled or amended by the issuance of a reexamination certificate, appropriate action will be taken by the administrative patent judge under 37 CFR 1.641.

Upon issuance of the reexamination certificate, the patent owner must notify the administrative patent judge thereof.

### 2285 Copending >Ex Parte< Reexamination and Reissue Proceedings [R-2]

37 CFR 1.565. *Concurrent office proceedings which include an ex parte reexamination proceeding.*

\*\*\*\*\*

(d) If a reissue application and an *ex parte* reexamination proceeding on which an order pursuant to § 1.525 has been mailed are pending concurrently on a patent, a decision will normally be made to merge the two proceedings or to suspend one of the two proceedings. Where merger of a reissue application and an *ex parte* reexamination proceeding is ordered, the merged examination will be conducted in accordance with §§ 1.171 through 1.179, and the patent owner will be required to place and maintain the same claims in the reissue application and the *ex parte* reexamination proceeding during the pendency of the merged proceeding. The examiner's actions and responses by the patent owner in a merged proceeding will apply to both the reissue application and the *ex parte* reexamination proceeding and be physically entered into both files. Any *ex parte* reexamination proceeding merged with a reissue application shall be terminated by the grant of the reissued patent. For merger of a reissue application and an *inter partes* reexamination, see § 1.991.

\*\*\*\*\*

The general policy of the Office is that a reissue application examination and an *>ex parte<* reexamination proceeding will not be conducted separately at the same time as to a particular patent. The reason for this policy is to permit timely resolution of both proceedings to the extent possible and to prevent inconsistent, and possibly conflicting, amendments from being introduced into the two proceedings on behalf of the patent owner. Accordingly, if both a reissue application and *>an ex parte<* reexamination pro-

ceeding are pending concurrently on a patent, a decision will normally be made (A) to merge the two proceedings or (B) to stay one of the two proceedings. >See *In re Onda*, 229 USPQ 235 (Comm'r Pat. 1985).< The decision as to whether the proceedings are to be merged, or which proceeding (if any) is to be stayed is made in the Office of Patent Legal Administration (OPLA).

\*\* >Where a reissue application and a reexamination proceeding are pending concurrently on a patent, the patent owner, i.e., the reissue applicant, has a responsibility to notify the Office of such. 37 CFR 1.178(b), 1.565(a), and 1.985. The patent owner should file in the reissue application, as early as possible, a Notification of Concurrent Proceedings pursuant to 37 CFR 1.178(b) in order to notify the Office in the reissue application of the existence of the reexamination proceeding on the same patent. See MPEP § 1418. In addition, the patent owner should file in the reexamination proceeding, as early as possible, a Notification of Concurrent Proceedings pursuant to 37 CFR 1.565(a) or 1.985 (depending on whether the reexamination proceeding is an *ex parte* reexamination proceeding or an *inter partes* reexamination proceeding) to notify the Office in the reexamination proceeding of the existence of the two concurrent proceedings.

### I. < TIME FOR MAKING DECISION ON MERGING OR STAYING THE PROCEEDINGS

A decision whether or not to merge the reissue application examination and the *>ex parte<* reexamination proceeding, or to stay one of the two proceedings, will not be made prior to the mailing of an order to reexamine the patent pursuant to 37 CFR 1.525. Until such time as reexamination is ordered, the examination of the reissue application will proceed. A determination on the request must not be delayed because of the existence of a copending reissue application, since 35 U.S.C. 304 and 37 CFR 1.515 *require a determination within 3 months* following the filing date of the request. See MPEP § 2241. If the decision on the request denies reexamination (MPEP § 2247), the examination of the reissue application should be continued. If reexamination is ordered (MPEP § 2246), the reexamination file, the reissue application, and the patent file should be delivered to the

OPLA promptly, following the mailing of the decision ordering reexamination. The delivery of the files to the OPLA should not be delayed awaiting the filing of any statement under 37 CFR 1.530 and any reply under 37 CFR 1.535, or the expiration of the time for same.

If a reissue application is filed during the pendency of a reexamination proceeding, the reexamination file, the reissue application, and the patent file should be delivered to the OPLA as promptly as possible after the reissue application reaches the Technology Center (TC).

The decision on whether or not the proceedings are to be merged, or which proceeding (if any) is to be stayed, will generally be made as promptly as possible after receipt of all of the files in the OPLA. Until a decision is mailed merging the proceedings or staying one of the proceedings, the two proceedings will continue and be conducted simultaneously, but separately.

The Office may in certain situations issue a certificate at the termination of a reexamination proceeding, even if a copending reissue application or another reexamination request has already been filed.

>

## II. < CONSIDERATIONS IN DECIDING WHETHER TO MERGE THE PROCEEDINGS OR WHETHER TO STAY A PROCEEDING

The decision on whether to merge the proceedings or stay a proceeding will be made on a case-by-case basis based upon the status of the various proceedings. Due consideration will be given to the finality of the reexamination requested.

### A. *Reissue About To Issue, Reexamination Requested.*

If the reissue patent will issue before the determination on the reexamination request must be made, the determination on the request should normally be delayed until after the granting of the reissue patent; and then the determination should be made on the basis of the claims *in the reissue patent*. The reexamination, if ordered, would then be on the reissue patent claims rather than the original patent claims. Since the reissue application would no longer be pending, the reexamination would be processed in a normal manner.

Where a reissue patent has been issued, the determination on the request for reexamination should specifically point out that the determination has been made on the claims of the reissue patent and not on the claims of the original patent. Any amendment made in the reexamination proceeding should treat the changes made by the reissue as the text of the patent, and all bracketing and underlining made with respect to the patent **as changed by the reissue**. >Note that the reissue claims used as the starting point in the reexamination proceeding must be presented in the reexamination proceeding as a “clean copy.” Thus, words bracketed in the reissue patent claim(s) would not appear at all in the reexamination clean copy of the claim(s). Also, words that were added via the reissue patent will appear in italics in the reissue patent, but must appear in plain format in the reexamination clean copy of the claim(s).<

If a reissue patent issues on the patent under reexamination after reexamination is ordered>,< the next action from the examiner in the reexamination should point out that further proceedings in the reexamination will be based on the claims of the reissue patent and not on the patent surrendered. Form paragraph 22.05 may be used in the Office action.

\*\*>

### ¶ 22.05 *Reexamination (Ex Parte or Inter Partes) Based on Reissue Claims*

In view of the surrender of original Patent No. [1] and the granting of Reissue Patent No. [2] which issued on [3], all subsequent proceedings in this reexamination will be based on the reissue patent claims.

<

Where the reissue patent has issued prior to the filing of a request for reexamination of the parent patent, see MPEP § 2258.

### B. *Reissue Pending, Reexamination Request Filed.*

Where a reissue patent will not be granted prior to the expiration of the 3-month period for making the determination on the reexamination request, a decision will be made as to whether the \*>reissue application and the reexamination proceeding< are to be merged, or which \* >of the two< (if any) is to be stayed, after an order to reexamine has been issued.

The general policy of the Office is to merge the more narrow reexamination proceeding with the

broader reissue application examination whenever it is desirable to do so in the interests of expediting the conduct of both proceedings. In making a decision on whether or not to merge the reissue application and the reexamination proceeding, consideration will be given to the status of the reissue application examination at the time the order to reexamination the patent pursuant to 37 CFR 1.525 is mailed. For example, if examination of the reissue application has not begun, or if a rejection by the primary examiner has not been appealed to the Board of Patent Appeals and Interferences pursuant to 37 CFR 1.191, it is likely that the OPLA will order a merger of the reissue application examination and the reexamination proceeding. If, however, the reissue application is on appeal to the Board or the courts, that fact would be considered in making a decision whether to merge the reissue application and the reexamination proceeding or stay one of them. See *In re Stoddard*, 213 USPQ 386 (Comm'r Pat. 1982); and *In re Scragg*, 215 USPQ 715 (Comm'r Pat. 1982).

If such a merger of the reissue application and the reexamination proceeding is ordered, the order merging them will also require that the patent owner place the same claims in the reissue application and in the reexamination proceeding for purposes of the merged proceedings. An amendment may be required to be filed to do this within a specified time set in the order merging the proceedings.

If the reissue application examination has progressed to a point where a merger of the two proceedings is not desirable at that time, then the reexamination proceeding will generally be stayed until the reissue application examination is complete on the issues then pending. After completion of the examination on the issues then pending in the reissue application examination, the stay of the reexamination proceeding will be removed and the proceedings will be merged if the reissue application is pending, or the reexamination proceeding will be conducted separately if the reissue application has become abandoned. The reissue application examination will be reopened, if necessary, for merger of the reexamination proceeding therewith.

If a stay of a reexamination proceeding has been removed following a reissue application examination, the first Office action will set a shortened statutory period for response of 1 month unless a longer

period for response clearly is warranted by the nature of the examiner's action. The second Office action will normally be final and also have a 1-month period for response. These shortened periods are considered necessary to prevent undue delay in terminating the proceedings and also to proceed with "special dispatch" in view of the earlier stay.

If the reissue application examination and the reexamination proceeding are merged, the issuance of the reissue patent will also serve as the certificate under 37 CFR 1.570 and the reissue patent will so indicate.

### C. *Reexamination Proceedings Underway, Reissue Application Filed.*

When a reissue application is filed after an *ex parte* reexamination proceeding has begun following an order therefor, the reexamination file, patent file, and the reissue application should be forwarded to the OPLA for consideration as to whether or not to merge the proceedings or stay one proceeding.

Where reexamination has already been ordered prior to the filing of a reissue application, the following factors may be considered in deciding whether to merge the reissue application and the reexamination proceeding or stay one of them:

(A) The status of the reexamination proceeding: For example, consideration will be given as to whether a statement and reply have been received, a first Office action has been mailed, a final rejection has been given, or printing of the certificate has begun;

(B) The nature and scope of the reissue application: For example, consideration will be given as to whether the issues presented in the proceedings are the same, overlapping, or completely separate; and whether the reissue claims are broadened or are related to issues other than rejections based on patents or printed publications.

>

## III. EXAMINER ASSIGNMENT

With respect to the appropriate examiner assignment of the merged reexamination/reissue proceeding, see MPEP § 2236.



#### IV. < CONDUCT OF MERGED REISSUE APPLICATION \* AND REEXAMINATION \* >PROCEEDING<

Where the merger decision indicates that the patent owner is given 1 month to provide \*\* >an< amendment \*\*>to make the claims the same in each file (identical amendments to be placed< in all files), the files will be held in storage to await submission of the amendment. After the amendment is received, it will be processed by the technical support staff and the file returned to the examiner, to issue an Office action. Where the merger decision indicates that an Office action will follow, the files are returned to the examiner immediately after the decision, to issue the action.

Once the files are returned to the examiner for issuance of an Office action, the examiner should prepare an Office action at the most advanced point possible for the first proceeding. Thus, if the first proceeding is ready for a final rejection and the second proceeding does not provide any new information which would call for a new ground of rejection, the examiner should issue a final rejection for the merged proceeding.

In the event that \*\* >an< amendment >to make the claims the same in each file< is required by the merger decision (\*\* identical amendments >to be placed< in all files) but is not timely submitted, any claim that does not contain identical text in all of the merged proceedings should be rejected under 35 U.S.C. 112, paragraph 2, as being indefinite as to the content of the claim, and thus failing to particularly point out the invention.

If a reissue application examination and a reexamination proceeding are merged, the merged examination will be conducted on the basis of the rules relating to the broader reissue application examination. Amendments should be submitted in accordance with the reissue practice under 37 CFR 1.121(\* >i<) and 37 CFR 1.173; see MPEP § 1453. The examiner, in examining the merged proceeding, will apply the reissue statute, rules, and case law to the merged proceeding. This is appropriate in view of the fact that the statutory provisions for reissue applications and reissue application examination include provisions equivalent to 35 U.S.C. 305 relating to the conduct of reexamination proceedings.

In any merged reissue application and reexamination proceeding, each Office action issued by the examiner will take the form of a single action which jointly applies to both the reissue application and the reexamination proceeding. Each action will contain identifying data for both the reissue application and the reexamination proceeding, and each action will be physically entered into both files, which will be maintained as separate files.

Any response by the applicant/patent owner in such a merged proceeding must consist of a single response, filed in duplicate for entry in both files (or provide multiple copies if there are multiple reexamination proceedings being merged with a reissue application), and service of copy must be made on any third party reexamination requester. A copy of all Office actions will be mailed to the third party reexamination requester but not to any other third party.

If the applicant/patent owner in such a merged proceeding fails to file a timely and appropriate response to any Office action, the merged proceeding will be terminated. The reissue application will be held abandoned. A NIRC will be issued (see MPEP § 2287), and the \* >Director< will proceed to issue a reexamination certificate under 37 CFR 1.570 in accordance with the last action of the Office, unless further action is clearly needed in view of the difference in rules relating to reexamination and reissue proceedings.

If the applicant/patent owner in \* a merged proceeding files an express abandonment of the reissue application pursuant to 37 CFR 1.138, the next Office action of the examiner will accept the express abandonment, dissolve the merged proceeding, and continue the reexamination proceeding. \*\* >If the applicant/patent owner files a continued prosecution reissue application (a CPA) of a reissue design application under 37 CFR 1.53(d), whereby the existing reissue design application is considered to be expressly abandoned, this will most likely result in the dissolution of the merged proceeding, a stay of the CPA reissue application, and separate, continued prosecution of the reexamination proceeding.

Where the merged proceeding is dissolved based on abandonment of the reissue application and the reexamination proceeding continues<, any grounds of rejection which are not applicable under reexamination should be withdrawn (e.g., based on public use or >on< sale) and any new grounds of rejection which

are applicable under reexamination (e.g., improper broadened claims) should be made by the examiner. The existence of any questions remaining which cannot be considered under reexamination following dissolution of the merged proceeding would be noted by the examiner as not being proper under reexamination pursuant to 37 CFR 1.552(c).

\*\* >Where the merged proceeding is dissolved based on abandonment of the reissue application and the reexamination proceeding continues, there is no guarantee that any continuation reissue application will be merged with the reexamination proceeding (the continuation reissue application might be stayed pending termination of the reexamination). This policy is necessary to prevent the patent owner from filing reissue continuation applications to delay a decision by the Board on rejected claims.<

If applicant/patent owner files a request for continued examination (RCE) of the reissue application under 37 CFR 1.114 (which may be filed on or after May 29, 2000 for an application filed on or after June 8, 1995), the reissue application is not considered to be expressly abandoned>; rather the finality of the Office action is withdrawn,< and the merged proceeding will continue. This is so, because an RCE is not an abandonment of any application, whether it be a reissue application or a non-reissue application.

>

#### **V. <PETITION TO MERGE REISSUE APPLICATION \* AND REEXAMINATION \* >PROCEEDING< OR TO STAY EITHER \* >OF THE TWO< BECAUSE OF THE EXISTENCE OF THE OTHER**

No petition to merge the \* >reissue application and the reexamination proceeding<, or stay one of them, should be filed before an order directing reexamination is issued because the Office will generally, *sua sponte*, make a decision to merge the \* >reissue application and the reexamination proceeding< or stay one of them. If any petition to merge the \* >reissue application and the reexamination proceeding<, or to stay one \* >of them< because of the other, is filed prior to the determination (37 CFR 1.515) and order to reexamine (37 CFR 1.525), it will not be considered, but will be returned to the party submitting the same by the TC Director, regardless of whether the petition is filed in the reexamination proceeding, the reissue

application, or both. This is necessary to prevent premature papers relating to the reexamination proceeding from being filed. The decision returning such a premature petition will be made of record in both the reexamination file and the reissue application file, but no copy of the petition will be retained by the Office. See MPEP § 2267.

The patent owner may file a petition under 37 CFR 1.182 to merge the \* >reissue application and the reexamination proceeding<, or stay one \* >of them< because of the other, at the time the patent owner's statement under 37 CFR 1.530 is filed or subsequent thereto in the event the Office has not acted prior to that date to merge \*\* or stay \*\*. If the requester of the reexamination is not the patent owner, that party may petition to merge the \* >reissue application and the reexamination proceeding<, or stay one \* >of them< because of the other, as a part of a reply pursuant to 37 CFR 1.535, in the event the Office has not acted prior to that date to merge \*\* or stay \*\*. A petition to merge the \* >reissue application and the reexamination proceeding<, or stay one of them because of the other, which is filed by a party other than the patent owner or the requester of the reexamination will not be considered, but will be returned to that party by the TC Director as being improper under 37 CFR 1.550(\*>g<).

All decisions on the merits of petitions to merge the reissue application examination and the reexamination proceeding, or to stay one \* >of them< because of the other, will be made in the OPLA. Such petitions to merge the \* >reissue application and the reexamination proceeding<, or stay one of \*\* >them< because of the other, which are filed by the patent owner or the requester after the order for reexamination will be referred to the OPLA for decision.

>

#### **VI. < FEES IN MERGED PROCEEDINGS**

Where the proceedings have been merged and a paper is filed which requires payment of a fee (e.g., petition fee, appeal fee, brief fee, oral hearing fee), only a single fee need be paid. For example, only one fee need be paid for an appeal brief even though the brief relates to merged multiple proceedings and copies must be filed for each file in the merged proceeding.

## 2286 >Ex Parte< Reexamination and Litigation Proceedings [R-2]

37 CFR 1.565. Concurrent office proceedings which include an *ex parte* reexamination proceeding.

\*\*\*\*\*

\*\*>

(b) If a patent in the process of *ex parte* reexamination is or becomes involved in litigation, the Director shall determine whether or not to suspend the reexamination. See § 1.987 for *inter partes* reexamination proceedings.<

\*\*\*\*\*

35 U.S.C. 302 permits a request for >*ex parte*< reexamination to be filed “at any time.” Requests for >*ex parte*< reexamination are frequently filed where the patent for which reexamination is requested is involved in concurrent litigation. The guidelines set forth below will generally govern Office handling of >*ex parte*< reexamination requests where there is concurrent litigation in the Federal courts.

>

### I. < COURT-SANCTIONED REEXAMINATION PROCEEDING OR LITIGATION STAYED FOR REEXAMINATION

Any request for >*ex parte*< reexamination which indicates (A) that it is filed as a result of an agreement by parties to litigation which agreement is sanctioned by a court, or (B) that litigation is stayed for the filing of a reexamination request will be taken up by the examiner for decision 6 weeks after the request was filed. See MPEP § 2241. If reexamination is ordered, the examination following the statement by the patent owner under 37 CFR 1.530 and the reply by the requester under 37 CFR 1.535 will be expedited to the extent possible. Office actions in these reexamination proceedings will normally set a 1-month shortened statutory period for response rather than the 2 months usually set in reexamination proceedings. See MPEP § 2263. This 1-month period may be extended only upon a showing of sufficient cause. See MPEP § 2265. See generally *In re Vamco Machine and Tool, Inc.*, 752 F.2d 1564, 224 USPQ 617 (Fed. Cir. 1985); *Gould v. Control Laser Corp.*, 705 F.2d 1340, 217 USPQ 985 (Fed. Cir. 1983); *Loffland Bros. Co. v. Mid-Western Energy Corp.*, 225 USPQ 886 (W.D. Okla. 1985); *The Toro Co. v. L.R. Nelson Corp.*, 223 USPQ 636 (C.D. Ill. 1984); *Digital Mag-*

*netic Systems, Inc. v. Ansley*, 213 USPQ 290 (W.D. Okla. 1982); *Raytek, Inc. v. Solfan Systems Inc.*, 211 USPQ 405 (N.D. Cal. 1981); and *Dresser Industries, Inc. v. Ford Motor Co.*, 211 USPQ 1114 (N.D. Texas 1981).

>

### II. < FEDERAL COURT DECISION KNOWN TO EXAMINER AT THE TIME THE DETERMINATION ON THE REQUEST FOR REEXAMINATION IS MADE

If a Federal Court decision *on the merits* of a patent is known to the examiner at the time the determination on the request for >*ex parte*< reexamination is made, the following guidelines will be followed by the examiner, whether or not the person who filed the request was a party to the litigation. When the initial question as to whether the prior art raises a substantial new question of patentability as to a patent claim is under consideration, the existence of a final court decision of claim *validity* in view of the same or different prior art does not necessarily mean that no new question is present\*\*>. This is true because of the different standards of proof and claim interpretation employed by the District Courts and the Office. See for example *In re Zletz*, 893 F.2d 319, 322, 13 USPQ2d 1320, 1322 (Fed. Cir. 1989) (manner of claim interpretation that is used by courts in litigation is not the manner of claim interpretation that is applicable during prosecution of a pending application before the PTO) and *In re Etter*, 756 F.2d 852, 225 USPQ 1 (Fed. Cir. 1985) (the 35 U.S.C. 282 presumption of patent validity has no application in reexamination proceedings).< Thus, while the Office may accord deference to factual findings made by the court, the determination of whether a substantial new question of patentability exists will be made independently of the court’s decision on validity as it is not controlling on the Office. A *non-final* holding of claim *invalidity* or *unenforceability* will not be controlling on the question of whether a substantial new question of patentability is present. A final holding of claim *invalidity* or *unenforceability* >(after all appeals)<, however, is controlling on the Office. In such cases, a substantial new question of patentability would *not* be present as to the claims held invalid or unenforceable. See *Ethicon v. Quigg*, 849 F.2d 1422, 7 USPQ2d 1152 (Fed. Cir. 1988).

Any determination on a request for reexamination which the examiner makes after a Federal Court decision must be reviewed by the Technology Center (TC) \*>Special Program Examiner (SPRE)< to ensure that it conforms to the current Office litigation policy and guidelines. See MPEP § 2240. \*\*

For a discussion of the policy in specific situations where a Federal Court decision has been issued, see MPEP § 2242.

>

### III. < REEXAMINATION >WITH CONCURRENT LITIGATION BUT< ORDERED PRIOR TO FEDERAL COURT DECISION \*\*

In view of the statutory mandate to make the determination on the request within 3 months, the determination on the request based on the record before the examiner will be made without awaiting a decision by the Federal Court. It is not realistic to attempt to determine what issues will be treated by the Federal Court prior to the court decision. Accordingly, the determination on the request will be made without considering the issues allegedly before the court. If >an *ex parte*< reexamination is ordered, the reexamination will continue until the Office becomes aware that a court decision has issued. At such time, the request will be reviewed in accordance with the guidelines set forth below. The patent owner is required by 37 CFR 1.565(a) to call the attention of the Office to any prior or concurrent proceeding in which the patent is involved or was involved. Thus, the patent owner has an obligation to promptly notify the Office that a decision has been issued in the Federal Court.

>

### IV. < FEDERAL COURT DECISION ISSUES AFTER >EX PARTE< REEXAMINATION ORDERED

Pursuant to 37 CFR 1.565(a), the patent owner in \*>an *ex parte*< reexamination proceeding must promptly notify the Office of any Federal court decision involving the patent. Where the reexamination proceeding is currently pending and the court decision issues, or the Office becomes aware of a court decision relating to a pending reexamination proceeding, the order to reexamine is reviewed to see if a substantial new question of patentability is still present. If no

substantial new question of patentability is still present, the order to reexamine is vacated by the TC Director and reexamination is terminated.

A *non-final* \*\*>Federal Court< decision concerning a patent under reexamination shall have no binding effect on a reexamination proceeding.

The issuance of a *final* \*\*>Federal Court< decision upholding validity during \*>an *ex parte*< reexamination also will have no binding effect on the examination of the reexamination. This is because the court states in *Ethicon v. Quigg*, 849 F.2d 1422, 1428, 7 USPQ2d 1152, 1157 (Fed. Cir. 1988) that the Office is *not* bound by a court's holding of patent *validity* and should continue the reexamination. The court notes that district courts and the Office use different standards of proof in determining invalidity, and thus, on the same evidence, could quite correctly come to different conclusions. Specifically, invalidity in a district court must be shown by "clear and convincing" evidence, whereas in the Office, it is sufficient to show nonpatentability by a "preponderance of evidence." Since the "clear and convincing" standard is harder to satisfy than the "preponderance" standard, deference will ordinarily be accorded to the factual findings of the court where the evidence before the Office and the court is the same. If sufficient reasons are present, claims held valid by the court may be rejected in reexamination.

On the other hand, \*\*>a *final* Federal Court holding of invalidity or unenforceability (after all appeals), is binding on the Office. Upon the issuance of a final holding of invalidity or unenforceability, the claims held invalid or unenforceable will be withdrawn from consideration in the reexamination. The reexamination will continue as to any remaining claims. Thus, the reexamination will continue if any original, new, or amended claim was not found invalid or unenforceable by the Court. If all of the claims in the reexamination proceeding are finally held invalid or unenforceable, the reexamination will be vacated by the TC Director as no longer containing a substantial new question of patentability and the reexamination will be terminated. If not all claims of the reexamination were held invalid (or unenforceable), a substantial new question of patentability may still exist as to the remaining claims. In such a situation, the remaining claims would be examined; and, as to the claims held invalid/unenforceable, form paragraph

22.80 should be used at the beginning of the Office action.

¶ 22.20 *Claims Held Invalid By Court, No Longer Being Reexamined*

Claims [1] of the [2] patent are not being reexamined in view of the final decision of [3]. Claim(s) [1] was/were held invalid/unenforceable by the [4].

**Examiner Note:**

1. In bracket 1, insert the claim(s) held invalid.
2. In bracket 2, insert the patentee (e.g., Rosenthal, Schor et al).
3. In bracket 3, insert the decision (e.g., *ABC Corp. v. Smith*, 999 USPQ2d 99 (Fed. Cir. 1999) or *XYZ Corp. v. Jones*, 999 USPQ2d 1024 (N.D. Cal. 1999)).
4. In bracket 4, insert the name of the court (e.g., the Court of Appeals for the Federal Circuit, or the Federal District Court).

**V. < LITIGATION REVIEW AND TECHNOLOGY CENTER \*>SPRE< APPROVAL**

In order to ensure that the Office is aware of prior or concurrent litigation, the examiner is responsible for conducting a reasonable investigation for evidence as to whether the patent for which *>ex parte<* reexamination is requested has been or is involved in litigation. The investigation will include a review of the reexamination file, the patent file, and the results of the litigation computer search by the STIC.

If the examiner discovers, *at any time* during the reexamination proceeding, that there is litigation or that there has been a federal court decision on the patent, the fact will be brought to the attention of the TC \*>SPRE< prior to any further action by the examiner. The TC \*>SPRE< must review any action taken by the examiner in such circumstances to ensure current Office litigation policy is being followed. \*\*

>

**VI. < FEDERAL COURT DECISION CONTROLLING IN REEXAMINATION PROCEEDING**

Once a federal court has ruled upon the merits of a patent and *>an ex parte<* reexamination is still appropriate under the guidelines set forth above, the federal court decision will be considered controlling and will be followed as to claims finally held to be invalid by the court.

**2287 Conclusion of *>Ex Parte<* Reexamination Proceeding [R-2]**

Upon conclusion of the *>ex parte<* reexamination proceeding, the examiner must prepare a “Notice of Intent to Issue *>Ex Parte<* Reexamination Certificate” (NIRC) by completing form PTOL-469. \* *>If<* appropriate, an examiner’s amendment will also be prepared. Where claims are found patentable, reasons must be given for each claim found patentable. See the discussion as to preparation of an examiner’s amendment and reasons for allowance at the end of this section. In addition, the examiner must prepare the reexamination file so that the Office of Publications can prepare and issue a certificate in accordance with *>35 U.S.C. 307 and< 37 CFR 1.570 \*\** setting forth the results of the reexamination proceeding and the content of the patent following the proceeding. See MPEP § 2288.

If it is the intent of the examiner to find any claim(s) patentable (confirmed or allowed) in concluding the reexamination proceeding, the examiner will so inform his/her supervisory patent examiner (SPE). The SPE will convene a patentability review conference (see MPEP § 2271.01), and the conference members will review the patentability of the claim(s). If the conference confirms the patentability of the claim(s), a NIRC shall be issued and signed by the examiner, with the two other conferees initialing the NIRC (as “conferee”) to indicate their participation in the conference. Both conferees will initial, even though one of them may have dissented from the 3-party conference decision on the patentability of the claim(s). If the conference does not confirm the patentability of the claim(s), a NIRC will not be issued by the examiner; rather, the examiner will issue an appropriate Office action rejecting the claim(s), not confirmed as patentable.

A patentability review conference is not to be held as to any claim that was in the case (proceeding) at the time the case was reviewed by the Board of Patent Appeals and Interferences (Board) or a federal court. The following example will serve to illustrate this point. In a reexamination proceeding, claims 5-10 are allowed by the examiner, and claims 1-4 are rejected. The rejection of claims 1-4 is then appealed to the Board. The Board reverses the rejection of claims 1-4 and imposes a new ground of rejection of claims 1-4

under 37 CFR 1.196(b). The patent owner then elects further prosecution before the examiner pursuant to 37 CFR 1.196(b)(1) and submits an amended set of claims 1-4. The examiner finds amended claims 1-4 to be allowable and wishes to “allow” the entire case by issuing a NIRC. A patentability review conference must be held at this stage of the proceeding. The conferees will review the allowance of amended claims 1-4. The conferees will not, however, review the allowance of claims 5-10, because claims 5-10 were in the case, and before the Board at the time the Board decided the appeal.

A patentability review conference is not to be held where the proceeding is to be concluded by the cancellation of all claims.

Thus, a patentability review conference **must** be held in each instance where a NIRC is about to be issued, unless the NIRC is being issued: (A) following and consistent with a decision by the Board of Patent Appeals and Interferences (or court) on the merits of the proceeding; or (B) as a consequence of the patent owner’s failure to respond or take other action where such a response or action is necessary to maintain pendency of the proceeding and, as a result of which failure to respond, all of the claims will be canceled.

A NIRC informs the patent owner and any third party requester that the reexamination proceeding has been terminated. The rules do not provide for an amendment to be filed in a reexamination proceeding after prosecution has been terminated. The provisions of 37 CFR 1.312 do *not* apply in reexamination. Any amendment, information disclosure statement, or other paper related to the merits of the reexamination proceeding filed after prosecution has been terminated must be accompanied by a petition under 37 CFR 1.182 to have the amendment considered.

Normally the title of the invention will not need to be changed during reexamination. If a change of the title is necessary, the patent owner should be notified of the need to provide an amendment changing the title as early as possible in the prosecution as a part of an Office action. If all of the claims are found to be

patentable and a NIRC has been or is to be mailed, the examiner may change to the title of the invention only by an examiner’s amendment. Changing the title and merely initialing the change is *not* permitted in reexamination.

>An examiner’s amendment can be made to change the abstract, where the patent owner’s narrowing amendments during the prosecution of the reexamination have changed the focus of the invention. An example of this would be where a claim is made more specific during reexamination, and the abstract does not at all focus on the specific limitation that is now required for all the patent claims.<

If all of the claims are disclaimed in a patent under reexamination, a certificate under 37 CFR 1.570 will be issued indicating that fact.

>

## I. PREPARATION OF THE CASE FOR PUBLICATION<

In preparing the reexamination file for publication of the certificate, the examiner must review the reexamination and patent files to be sure that all the appropriate parts are completed. The review should include completion of the following items:

(A) the “Reexamination Field of Search” and the “Search Notes” — to be sure the file wrapper is filled in with the classes and subclasses that were actually searched and other areas consulted;

(B) \*\* the “Drawing Fig. For Certificate and For O.G.” box — to be sure that an appropriate drawing figure is indicated for printing on the certificate cover sheet and in the *Official Gazette*;

\*>

(C) < the “Litigation Review” box — to be sure that the Office is aware of prior or concurrent litigation;

\*>

(D) < the face of the file — to be sure that the necessary data is included thereon;

\*>

(E) < the “Index of Claims” box — to be sure the status of each claim is indicated and the final claim numbers are indicated; and

\*>

(F) < the bibliographic data sheet reprint - to be sure that the data included thereon is correct, and the blank spaces have been initialed.

\*>

(G) The “Claim No. For O.G.” box - to be sure that a representative claim which has been reexamined is indicated for publication in the *Official Gazette*. The claim or claims for the *Official Gazette* < should be selected in accordance with the following instructions:

\*>

(1) < The broadest claim should be selected;

\*>

(2) < Examiners should ordinarily designate but one claim on each invention, although when a plurality of inventions are claimed in one application, additional claims up to a maximum of five may be designated for publication. In the case of reexamination, the examiner must select only one claim;

\*>

(3) < A dependent claim should not be selected unless the independent claim from which it depends is also printed. In the case where a multiple dependent claim is selected, the entire chain of claims for one embodiment should be listed. In the case of reexamination, a dependent patent claim may be selected where the independent original patent claim has been canceled; in such a case, the dependent claim would be printed while the independent claim would not be printed; and

\*>

(4) < In reissue applications, the broadest claim with changes or the broadest additional reissue claim should be selected for printing.

When recording this information in the box provided, the following items should be kept in mind:

(A) Write the claim number clearly in black ink;

(B) If multiple claims are selected, the claim numbers should be separated by commas; and

(C) The claim designated must be referred to by using the renumbered patent claim number rather than the original application claim number.

The examiner must in all cases either fill out (A) the Issuing Classification portion on the face of the reexamination file wrapper where such portion is contained on the face of the file wrapper, or (B) a blue issue slip form PTO-270 or design issue slip form PTO-328 if no Issuing Classification portion is contained on the face of the reexamination file wrapper. The current international classification and U.S. classification must be inserted for both the original classification and all cross-references. Completion of the Issuing Classification portion on the face of the reexamination file wrapper or the issue slip is required, even if all of the claims are canceled.

If any new cross-references are added, the examiner must order a copy of the patent by using form PTO-14B and place the copy in the search file so that the certificate may be attached thereto when it issues. The form PTO-14B should separately be forwarded by the Technology Center (TC) to the appropriate location and should not be attached to the checklist (PTO-1516) or otherwise included in the file when the file is forwarded by the TC to the Office of Patent Legal Administration (OPLA) for review pursuant to MPEP § 2289.

If the patent owner desires the names of the attorneys or agents>, or law firm,< to be printed on the certificate, a separate paper limited to this issue which lists the names and positively states that they should be printed on the certificate must be filed. A mere power of attorney or change of address is not a request that the name appear on the certificate.

If a proper paper has been submitted by the patent owner indicating the names of the attorneys or agents>, or law firm,< to be published on the certificate, that paper should be physically placed on top of the other papers in the center of the reexamination file at the conclusion of the proceedings.

The examiner must also complete a checklist, form PTO-1516, for the reexamination file which will be forwarded to the Office of Publications identifying >*inter alia*<:

(A) Any amendments to the abstract and description;

(B) Any amendments to the drawings;

(C) Any terminal disclaimer or dedication filed during reexamination;

(D) Any certificate(s) of correction to the patent;

(E) The patentability of claim(s) \_\_\_\_\_ (and) \_\_\_\_\_ is confirmed;

(F) Claim(s) \_\_\_\_\_ (and) \_\_\_\_\_ was (were) previously canceled. (Relates to a prior proceeding);

(G) Claim(s) \_\_\_\_\_ (and) \_\_\_\_\_ was (were) previously disclaimed >(relates to statutory disclaimer prior to the present reexamination)<;

(H) Claim(s) \_\_\_\_\_ (and) \_\_\_\_\_ is (are) now disclaimed >(relates to statutory disclaimer filed in the present reexamination)<;

(I) Claim(s) \_\_\_\_\_ (and) \_\_\_\_\_, having been finally determined to be unpatentable, is (are) canceled;

(J) Claim(s) \_\_\_\_\_ (and) \_\_\_\_\_ is (are) determined to be patentable as amended. (Note: these claim(s) to be printed on certificate.);

(K) Claim(s) \_\_\_\_\_ (and) \_\_\_\_\_, dependent on an amended claim, is (are) determined to be patentable. (Note: to be used for \*\*>dependent claims whose text has not changed. Dependent claims with text changes are "amended claims" which must be listed in item (J) above<;

(L) New claim(s) \_\_\_\_\_ (and) \_\_\_\_\_ is (are) added and determined to be patentable. (Note: these claim(s) to be printed on certificate.);

(M) Claim(s) \_\_\_\_\_ (and) \_\_\_\_\_ was (were) not reexamined;

(N) Other (identify claims and status) \_\_\_\_\_ ; and

(O) Any decision of the U.S. Patent and Trademark Office, federal court or other forum which may affect the validity of the patent but which have not been considered during reexamination.

A clean copy of the patent being reexamined should also be provided to be forwarded out of the TC with the file. The clean copy of the patent can be obtained from the TC printer for printing copies of patents; the copy of the printed patent found in the patent file should not be used as the "clean copy" to be placed in the reexamination file. The examiner should inspect the title report in the file (usually paper >number< two or three). If the title report indicates a title in the inventors, but the patent copy shows an assignment to an assignee, a telephone call can be made to the patent owner, and the patent owner can be asked to submit a statement under 37 CFR 3.73(b) indicating that title is in the assignee (i.e., it has not reverted back to the inventors). See MPEP § 320.

After the examiner has prepared the NIRC and attachments for mailing, completed the review and preparation of the case as discussed above, and completed the Examiner Checklist form PTOL-1516, the reexamination and patent files will be given to the reexamination clerk. The reexamination clerk will complete the Reexamination Clerk Checklist form PTO-1517. The reexamination clerk will revise and update the files. The clerk should check to see if any changes in especially:

- (A) the title;
- (B) the inventor;
- (C) the assignee;
- (D) the continuing data;
- (E) the foreign priority;
- (F) the address of the owner's attorney; and
- (G) the requester's address

have been properly entered on the face of the reexamination and patent files and properly entered in the PALM data base. After the clerk has finished his/her processing, he or she will forward the reexamination file, the patent file, the clean copy of the patent, the Examiner Checklist-Reexamination PTO-1516, and the Reexamination Clerk Checklist PTO-1517 to the TC Special Program Examiner for review. After approval by the TC Special Program Examiner, the reexamination clerk will mail the NIRC with attachments and forward the reexamination file with the patent file to the OPLA (see MPEP § 2289), which will ultimately forward same to the Office of Publications for printing.

>

## II. < REEXAMINATION PROCEEDINGS IN WHICH ALL THE CLAIMS ARE CANCELED

There will be instances where all claims in the reexamination proceeding are to be canceled, and a NIRC will be issued indicating that fact. This would occur where the patent owner fails to timely respond to an Office action, and all live claims in the reexamination proceeding are under rejection. It would also occur where all live claims in the reexamination proceeding are to be canceled as a result of a Board decision affirming the examiner, and the time for appeal to the court and for requesting reconsideration or modification has expired.



Prior to canceling the claims and issuing the NIRC, the examiner should telephone the patent owner to inquire if a timely response, timely appeal, etc., was filed with the Office so as to make certain that a timely response has not been misdirected within the Office. Where the patent owner indicates that no such filing was made, or where the patent owner cannot be reached, the examiner will proceed to issue a NIRC terminating prosecution.

\*>A patentability review conference is not to be held, because the proceeding is to be concluded by the cancellation of all claims. Rather, the examiner will issue a NIRC action, and as< an attachment to the NIRC, the examiner will draft an examiner's amendment canceling all live claims in the reexamination proceeding. In the examiner's amendment, the examiner should point out why the claims have been canceled. For example, the examiner might make one of the two following statements, as appropriate:

"Claims 1-5 and 6-8 >(all live claims in the proceeding)< were subject to rejection in the last Office action mailed 9/9/99. Patent owner failed to timely respond to that Office action. Accordingly claims 1-5 and 6-8 have been canceled. See 37 CFR 1.550(d) and MPEP § 2266."

"The rejection of claims 1-5 and 6-8 >(all live claims in the proceeding)< has been affirmed in the Board decision of 9/9/99, and no timely appeal to the court has been filed. Accordingly claims 1-5 and 6-8 have been canceled."

If the patent owner was reached by telephone and indicated that there was no timely filing (as discussed above), the attachment to the NIRC will make the telephone interview of record.

In order to >physically< cancel the live claims >in the file<, brackets should be placed around all the live claims. All other claims in the proceeding should have previously been either replaced or canceled.

The examiner will designate a cancelled original patent claim, to be printed in the *Official Gazette*, on the file wrapper in the appropriate place for the claim chosen.

>

### III. HANDLING OF MULTIPLE DEPENDENT CLAIMS

The following discussion provides guidance on how to treat multiple dependent claims when prepar-

ing a reexamination proceeding for publication of the reexamination certificate.

Assume Patent X issues with the following claims:

Patent claims:

1. A method of sintering a particulate ceramic preform, comprising heating it above 500 degrees F, cooling it to 100 degrees F, and repeating the heating and cooling steps six times.
2. The method of **claim 1**, where a pressure of 300 - 400 psi is applied during the heating steps.
3. The method of **claim 1 or claim 2**, where the pressure applied during the heating steps is 350 - 375 psi.
4. The method of **claim 3**, where the pressure applied during the heating steps is 360 - 365 psi.
5. The method of **claim 1**, where the preform contains lithium and magnesium oxides.
6. The method of **claim 5**, where the preform contains sodium fluoride.
7. The method of **claim 1 or claim 5**, where the sintered preform is machined into a lens.

A reexamination request is then filed for Patent X, and at the point when the claims are ready for issuance of the certificate, the following claims are present in the reexamination file.

In reexamination:

1. (Text Unchanged) A method of sintering a particulate ceramic preform, comprising heating it above 500 degrees F, cooling it to 100 degrees F, and repeating the heating and cooling steps six times.
2. (Amended) The method of **claim 1 or claim 8**, where the sintered preform is machined into a lens.
3. (Amended) The method of [**claim 1 or**] **claim 2**, where the pressure applied during the heating steps is 350 - 375 psi.
4. (Amended) The method of **claim 3 or claim 8**, where the pressure applied during the heating steps is 355 [360] - 365 psi.
5. (Text Unchanged) The method of **claim 1**, where the preform contains lithium and magnesium oxides.
6. (Amended) The method of **claim 8[5]**, where the preform contains sodium fluoride.

7. (Text Unchanged) The method of **claim 1 or claim 5**, where the sintered preform is machined into a lens.

8. (New) A method of sintering a particulate fluoride ceramic preform comprising heating it above 500 degrees F, cooling it to 100 degrees F, and repeating the heating and cooling steps six times.

The status of the claims would be set forth as follows:

Part 1(h) of the Notice of Intent to Issue *Ex Parte* Reexamination Certificate Form PTOL-469 (NIRC) would be completed as follows.

Patent claims confirmed: 1, 2/1, 5, 7

Patent claims amended: 3, 4/3,

Patent claims canceled: 3/1, 6/5

New claims patentable: 2/8, 4/8, 6/8, 8

The parts of the Examiner's checklist (Form PTO-1516) directed to the status of the claims would be completed as follows.

7. Patent claims confirmed: 1, 5, 7

11. Patent claims canceled: None

12. Patent claims amended: 2, 3, 4 and 6

13. Patent claims dependent on amended: None

14. New claims patentable: 8

*Looking at claim 2:*

For the purpose of the NIRC, the addition of a claim of the multiple dependency is viewed as adding a new claim for which protection is now to be provided. Thus, prior to reexamination, only the subject matter of claim 2/1 was protected. As a result of reexamination, claim 2/8 has been added, and its subject matter is now protected. Thus, claim 2/8 is designated as a new claim. Claim 2/1 has not changed as to its content and its scope of protection, and is designated as a confirmed claim.

For the purpose of the Examiner's checklist, the addition or deletion of a claim of the multiple dependency is viewed simply as amending the claim, because of the way claims are printed on the certificate. Thus, claim 2 is designated as an amended claim and is simply printed on the certificate in its amended form as:

2. The method of claim 1 or claim 8, where the sintered preform is machined into a lens.

*Looking at claim 3:*

For the purpose of the NIRC, the deletion of a claim of the multiple dependency is viewed as canceling the claim deleted, and protection is no longer provided for the claim as dependent from the deleted claim. Thus, prior to reexamination, the subject matter of claims 3/1 and 3/2 was protected. As a result of reexamination, claim 3/1 has been deleted, and its subject matter is no longer protected. Thus, claim 3/1 is designated as a canceled claim. Claim 3/2 has not changed as to its content and its scope of protection, and is designated as a confirmed claim.

For the purpose of the Examiner's checklist, the addition or deletion of a claim of the multiple dependency is viewed simply as amending the claim, because of the way claims are printed on the certificate. Thus, claim 3 is designated as an amended claim and is simply printed on the certificate in its amended form as:

3. The method of [claim 1 or] claim 2, where the pressure applied during the heating steps is 350 - 375 psi.

*Looking at claim 4:*

For the purpose of the NIRC, the addition of a claim of the multiple dependency is viewed as adding a new claim for which protection is now to be provided. Thus, prior to reexamination, only the subject matter of claim 4/3 was protected. As a result of reexamination, claim 4/8 has been added, and its subject matter is now protected. Thus, claim 4/8 is designated as a new claim. Claim 4/3 has changed as to its content and its scope of protection due to the expanding of the pressure range from 360 - 365 psi to 355 - 365 psi, and claim 4/3 is designated as an amended claim.

For the purpose of the Examiner's checklist, the addition or deletion of a claim of the multiple dependency is viewed simply as amending the claim, because of the way claims are printed on the certificate. Thus, claim 4 is designated as an amended claim and simply printed on the certificate in its amended form as:

4. (Amended) The method of claim 3 or claim 8, where the pressure applied during the heating steps is 355 [360] - 365 psi.

*Looking at claim 6:*

For the purpose of the NIRC, prior to reexamination, the subject matter of claim 6/5 was protected and claim 6/8 did not exist. As a result of reexamination, claim 6/5 has been deleted and claim 6/8 has been added. Thus, claim 6/5 is designated as a canceled claim, and claim 6/8 is designated as a new claim.

For the Examiner's checklist, claim 6 is designated as an amended claim and is simply printed on the certificate in its amended form as:

6. (Amended) The method of claim 8 [5], where the preform contains sodium fluoride.

*Looking at claim 7:*

It is unchanged as to its text. Claim 7 remains dependent on claim 1 or claim 5, as it did prior to reexamination. Thus, both claims 7/1 and 7/5 are confirmed. Claims 7/1 and 7/5 are listed in the "Confirmed" part of the NIRC. They are not listed separately, but rather simply as "7." This is because the entirety of claim 7 has been confirmed.

As to the Examiner's checklist, claim 7, being unchanged as to its text and not being dependent on an amended claim, is simply listed in the "Confirmed" part of the checklist. Claim 7 will not be printed on the certificate, but will simply be listed as one of the confirmed claims.

#### IV. < REEXAMINATION REMINDERS

The following items deserve special attention. The examiner should ensure they have been correctly completed or followed before **>**forwarding the case to the Legal Instrument Examiner (LIE)<.

(A) All patent claims must **>**have been< examined. See MPEP § 2243.

(B) No renumbering of patent claims is permitted. New claims may require renumbering. See MPEP § 2250.

(C) All amendments to the description and claims must conform to requirements of 37 CFR 1.530(d)-(j). This includes any changes made by Examiner's Amendment. If a portion of the text is amended more than once, each amendment should indicate all of the changes (insertions and deletions) in relation to the current text in the patent under reexamination. See MPEP § 2250.

(D) The prior art must be listed on a **>**form PTO 892, PTO-1449, PTO/SB/08A or 08B, or PTO/SB/42 (or on a form having a format equivalent to one of these forms)<. These forms must be properly completed. See MPEP § 2257.

(E) The examiner and reexamination clerk checklists PTO-1516 and PTO-1517 must be *entirely* and *properly* completed. A careful reading of the instructions contained in these checklists is essential. The clerical checklist is designed as a check and review of the examiner's responses on the examiner checklist. Accordingly, the reexamination clerk should personally review the file before completing an item. The reexamination clerk should check to make certain that the responses to all related items on both checklists are in agreement.

(F) Multiple pending reexamination proceedings must be merged. See MPEP § 2283.

(G) **>**Where the reexamination proceeding is copending with an application for reissue of the patent being reexamined, the files must have been forwarded to the Office of Patent Legal Administration (OPLA) for a consideration of potential merger, with a decision (by a Senior Legal Advisor or Special Projects Examiner) on the question being present in the reexamination file. See MPEP § 2285.

(H) **<** Reasons for patentability and/or confirmation are required for each claim found patentable. See below.

**>**

(I) **<** There is no issue fee in reexamination. See MPEP § 2233.

**>**

(J) **<** The patent claims may not be amended nor new claims added after expiration of the patent. See MPEP § 2250.

\*>

(K) < Original drawings cannot be physically changed. All drawing amendments must be presented on new sheets. The examiner may have the draftsman review the new sheets of drawings if the examiner would like the draftsman's assistance in identifying errors in the drawings. A draftsman's "stamp" to indicate approval is no longer required on patent drawings, and these stamps are no longer to be used by draftsmen. See MPEP § 2250.01.

\*>

(L) < An amended or new claim may not enlarge the scope of the patent claims. See MPEP § 2250.

>

(M) If the patent has expired, all amendments to the patent claims and all claims added during the proceeding must be withdrawn. Further, all presently rejected and objected-to claims are canceled by examiner's amendment. See MPEP § 2250, part III, Amendment after the Patent Has Expired.

## V. < EXAMINER'S AMENDMENT

Where it is necessary to amend the patent in order to place the proceeding in condition to issuance of a reexamination certificate, the examiner may request that the patent owner provide the amendment(s), or the examiner may make the amendments, with the patent owner's approval, by a formal examiner's amendment. If the changes are made by an examiner's amendment, the examiner's amendment must comply with the requirements of 37 CFR 1.530(d)-(j) in amending the patent. Thus, the examiner's amendment requires presentation of the full text of any paragraph or claim to be changed, with the 37 CFR 1.530(f) markings. The exception for examiner's amendments set forth in 37 CFR 1.121(g) does not apply to examiner's amendments in reexamination proceedings. See MPEP § 2250. >The only **exception** to the full text presentation requirement is that an entire claim or an entire paragraph of specification may be deleted from the patent by a statement deleting the claim or paragraph without the presentation of the text of the claim or paragraph.<

Where an examiner's amendment is prepared, Box 7 of form PTOL-469 (Notice of Intent to Issue >Ex Parte< Reexamination Certificate) is checked, and form paragraph 22.06 is used to provide the appropriate attachments.

\*\*>

### ¶ 22.06 Examiner's Amendment Accompanying Notice of Intent To Issue Ex Parte Reexamination Certificate

An examiner's amendment to the record appears below. The changes made by this examiner's amendment will be reflected in the reexamination certificate to issue in due course.

[1]

## VI. < REASONS FOR PATENTABILITY AND/OR CONFIRMATION

Reasons for patentability must be provided, unless all claims are canceled in the proceeding. Box 2 of form PTOL-469 is checked, and the reasons are provided as an attachment. In the attachment to the NIRC, the examiner should indicate why the claims found patentable in the reexamination proceeding are clearly patentable over the cited patents or printed publications. This is done in a manner similar to that used to indicate reasons for allowance in an application. See MPEP § 1302.14. Where the record is clear as to why a claim is patentable, the examiner may refer to the particular portions of the record which clearly establish the patentability of that claim.

The reasons for patentability \*>may be< set forth on form PTOL-476, entitled "REASONS FOR PATENTABILITY AND/OR CONFIRMATION." \*\*>However, as a preferred alternative to using form PTOL-476, the examiner may instead use form paragraph 22.16.

### ¶ 22.16 Reasons For Patentability and/or Confirmation

#### STATEMENT OF REASONS FOR PATENTABILITY AND/OR CONFIRMATION

The following is an examiner's statement of reasons for patentability and/or confirmation of the claims found patentable in this reexamination proceeding: [1]

Any comments considered necessary by PATENT OWNER regarding the above statement must be submitted promptly to avoid processing delays. Such submission by the patent owner should be labeled: "Comments on Statement of Reasons for Patentability and/or Confirmation" and will be placed in the reexamination file.

#### Examiner Note:

This form paragraph may be used as an attachment to the Notice of Intent to Issue *Ex Parte* Reexamination Certificate, PTOL-469 (item number 2).

Original patent claims that are found patentable in a reexamination proceeding are generally to be designated as "confirmed" claims, while new claims and amended patent claims are generally to be designated

as “patentable” claims. However, for purposes of the examiner setting forth reasons for patentability or confirmation, the examiner may use “patentable” to refer to any claim that defines over the cited patents or printed publications. There is no need to separate the claims into “confirmed” and “patentable” categories when setting forth the reasons.<

Obviously, where all claims are canceled in the proceeding, no reasons for patentability are provided.

>Any “Comments on Statement of Reasons for Patentability and/or Confirmation” which are received will be placed in the reexamination file, without comment. This will be done even where the reexamination certificate has already issued.<

## 2288 Issuance of ~~Ex Parte~~ Reexamination Certificate [R-2]

35 U.S.C. 307. Certificate of patentability, unpatentability, and claim cancellation.

(a) In a reexamination proceeding under this chapter, when the time for appeal has expired or any appeal proceeding has terminated, the Director will issue and publish a certificate canceling any claim of the patent finally determined to be unpatentable, confirming any claim of the patent determined to be patentable, and incorporating in the patent any proposed amended or new claim determined to be patentable.

\*\*\*\*\*

37 CFR 1.570. Issuance of *ex parte* reexamination certificate after *ex parte* reexamination proceedings.

\*\*>

(a) Upon the conclusion of *ex parte* reexamination proceedings, the Director will issue an *ex parte* reexamination certificate in accordance with 35 U.S.C. 307 setting forth the results of the *ex parte* reexamination proceeding and the content of the patent following the *ex parte* reexamination proceeding.<

(b) An *ex parte* reexamination certificate will be issued in each patent in which an *ex parte* reexamination proceeding has been ordered under § 1.525 and has not been merged with any *inter partes* reexamination proceeding pursuant to § 1.989(a). Any statutory disclaimer filed by the patent owner will be made part of the *ex parte* reexamination certificate.

(c) The *ex parte* reexamination certificate will be mailed on the day of its date to the patent owner at the address as provided for in § 1.33(c). A copy of the *ex parte* reexamination certificate will also be mailed to the requester of the *ex parte* reexamination proceeding.

(d) If an *ex parte* reexamination certificate has been issued which cancels all of the claims of the patent, no further Office proceedings will be conducted with that patent or any reissue applications or any reexamination requests relating thereto.

(e) If the *ex parte* reexamination proceeding is terminated by the grant of a reissued patent as provided in § 1.565(d), the re-

sued patent will constitute the *ex parte* reexamination certificate required by this section and 35 U.S.C. 307.

(f) A notice of the issuance of each *ex parte* reexamination certificate under this section will be published in the *Official Gazette* on its date of issuance.

Since abandonment is not possible in a reexamination proceeding, a reexamination certificate will be issued at the conclusion of the proceeding in each patent in which a reexamination proceeding has been ordered under 37 CFR 1.525 except where the reexamination has been terminated >by vacating the reexamination proceeding or< by the grant of a reissue patent on the same patent >in which case the reissue patent also serves as the reexamination certificate<.

Where the reexamination is terminated for a failure to timely respond to an Office action, see MPEP § 2266.

The reexamination certificate will set forth the results of the proceeding and the content of the patent following the reexamination proceeding. The certificate will:

(A) cancel any >patent< claims determined to be unpatentable;

(B) confirm any patent claims determined to be patentable;

(C) incorporate into the patent any amended or new claims determined to be patentable;

(D) make any changes in the description approved during reexamination;

(E) include any statutory disclaimer >or terminal disclaimer< filed by the patent owner;

(F) \*\* >identify< unamended claims which were held invalid on final holding by another forum on >any< grounds \*\*;

(G) \*\* >identify< any patent claims not reexamined;

(H) be mailed on the day it is dated to the patent owner at the address provided for in 37 CFR 1.33(c) and a copy will be mailed to the third party requester; and

(I) \*\* >identify< patent claims, dependent on amended claims, determined to be patentable.

If a certificate issues which cancels all of the claims of the patent, no further Office proceedings will be conducted with regard to that patent or any reissue application or reexamination request directed thereto. See 37 CFR 1.570(d).

If a reexamination proceeding is terminated by the grant of a reissued patent as provided for in 37 CFR 1.565(b), the reissued patent will constitute the reexamination certificate required by 35 U.S.C. 307 and this section. See 37 CFR 1.570(e).

A notice of the issuance of each reexamination certificate will be published in the *Official Gazette* on its date of issuance in a format similar to that used for reissue patents. See 37 CFR 1.570(f) and MPEP § 2291.

## 2289 Reexamination Review [R-2]

All reexamination cases are monitored and reviewed in the Technology Center (TC) by the Office of the TC Special Program *\*>Examiners (SPRE)<* (includes SPRE, paralegal or other technical support who might be assigned as backup) at several stages during the prosecution. *>This is done to ensure that practice and procedure unique to reexamination has been carried out for the reexamination proceeding. In addition to the SPRE review of the reexamination cases, a patentability review is made in a sample of reexamination cases by the TC Quality Assurance Specialist (QAS) in the manner previously carried out by the former Office of Patent Quality Review.<*

In order to ensure that SPREs are aware of the reexamination cases in their TCs, a pair of terminal-specific PALM flags have been created which must be set by the SPRE before certain PALM transactions can be completed. First, when a new reexamination request enters the TC, a SPRE must set a PALM *\*>“flag”<* by entering the reexamination control number in an Office-wide computer grouping *<* before a docketing transaction will be accepted. By having to set this first flag, the SPRE is made aware of the assignment of the reexamination case to the TC and can take steps, as may be appropriate, to instruct the examiner on reexamination-specific procedures before the determination process begins, as well as throughout the period that the examiner is handling the proceeding. Second, the SPRE must *\*\*>remove the above-described PALM “flag”<* before the reexamination file can be given a reexamination terminated status and sent to the Office of Publications *>.* This is carried out for the purpose of *<* ensuring that the SPRE is informed when the reexamination case is being processed for Notice of Intent to Issue *>Ex Parte<* Reexamination Certifi-

cate (NIRC) so the SPRE may be able to conduct a final review of the file, if appropriate.

After leaving the TCs, all reexamination cases go through a screening process currently performed in the Office of Patent Legal Administration (OPLA) for obvious errors and proper preparation in order to issue a reexamination certificate. *\*\**

The *\*\* >above identified review processes<* are appropriate vehicles for correcting errors, identifying problem areas and recognizing trends, providing information on the uniformity of practice, and providing feedback to the *\*>TC personnel that process and examine reexamination cases<*.

## 2290 Format of *Ex Parte* Reexamination Certificate [R-2]

*>An ex parte reexamination certificate is issued at the close of each ex parte reexamination proceeding in which reexamination has been ordered under 37 CFR 1.525, except for the following two cases:*

(A) The *ex parte* reexamination proceeding is merged with a reissue application pursuant to 37 CFR 1.565(d). If the *ex parte* reexamination proceeding is terminated by the grant of a reissue patent, the reissue patent will constitute the reexamination certificate;

(B) The *ex parte* reexamination proceeding is merged with an *inter partes* reexamination proceeding pursuant to 37 CFR 1.989(a). If the *ex parte* reexamination proceeding is terminated as part of a merged proceeding containing an *inter partes* reexamination proceeding, a single reexamination certificate will issue for both proceedings; see MPEP § 2690.

The *ex parte<* reexamination certificate is formatted much the same as the title page of current U.S. patents.

The certificate is titled *>“Ex Parte Reexamination Certificate.”* The title is followed by an “ordinal” number in parentheses, such as “(235th),” which indicates that it is the two hundred and thirty fifth *ex parte* reexamination certificate that has issued. *Inter partes* reexamination certificates are numbered in a separate and new ordinal sequence, beginning with “(1st).” *Ex parte* reexamination certificates continue the ordinal numbering sequence that has already been established for *ex parte* reexamination certificates.

The *ex parte* reexamination certificate number will always be the patent number of the original

patent followed by a two-character “kind code” suffix. The first letter of the “kind code” suffix is “B” for reexamination certificates published prior to January 2, 2001, and “C” for reexamination certificates published on or after January 2, 2001. The second letter of the “kind code” suffix is the number of the reexamination proceeding of that patent, and thus shows how many times that patent has been reexamined.

Note that where the first reexamination certificate was a “B1” certificate and a second reexamination certificate then issues, the second reexamination certificate will be designated “C2” and NOT “C1.” Thus, by looking at the number following the “C,” one will be able to ascertain the number of reexamination certificates that preceded the certificate being viewed, i.e., how many prior reexamination certificates have been issued for the patent. (If this were not the practice and C1 were used, one would not be able to ascertain from the number on the certificate how many B certificates came before.)

It should also be noted that the next higher number will be given to the reexamination proceeding for which the reexamination certificate is issued, regardless of whether the proceeding is an *ex parte* reexamination or an *inter partes* reexamination proceeding.

See MPEP § 901.04(a) for a complete list of the kind codes used by the United States Patent and Trademark Office.

The certificate denotes the date the certificate was issued at INID code [45] (see MPEP § 901.04). The

title, name of inventor, international and U.S. classification, the abstract, and the list of prior art documents appear at their respective INID code designations, much the same as is presently done in utility patents.

The primary differences, other than as indicated above, are:

(A) the filing date and number of the request is preceded by “Reexamination Request;”

(B) the patent for which the certification is now issued is identified under the heading “Reexamination Certificate for”; and

(C) the prior art documents cited at INID code [56] will be only those which are part of the reexamination file and cited on forms PTO-1449 (and have not been crossed out because they were not considered) and PTO-892.

Finally, the certificate will \*\* >identify the patent< claims which were confirmed as patentable \*\* >, canceled, disclaimed, and those claims not examined. Only the status of the confirmed, canceled, disclaimed, and not examined claims will be indicated in the certificate. The text of the new and amended claims will be printed in the certificate<. Any new claims will be printed in the certificate completely in italics, and any amended claims will be printed in the certificate with italics and bracketing indicating the amendments thereto. Any prior court decisions will be identified, as well as the citation of the court decisions.

# REEXAMINATION CERTIFICATE (24th)

**United States Patent** [19]

[11] **B1 4,182,460**

**Holk, Jr. et al.**

[45] **Certificate Issued Oct. 19, 1982**

[54] **LEVER ACTION TAB SYSTEM FOR EASY OPENING ENDS**

[56] **References Cited**

[75] **Inventors:** Albert J. Holk, Jr., Frankfort;  
Arnold R. Boik, Chicago, both  
of Ill.

**U.S. PATENT DOCUMENTS**

2,772,808 12/1956 Fried.  
3,089,609 5/1963 D'Andrea.  
3,416,699 12/1968 Bozek.

[73] **Assignee:** The Continental Group, Inc., New  
York, N.Y.

*Primary Examiner*—George T. Hall

[57] **ABSTRACT**

**Reexamination Request**

No. 90/000,076, Sep. 28, 1981

This disclosure has to do with an easy opening container end wherein substantially the entire end panel is removed. The removable panel portion has rigidly attached thereto a pull tab which is first utilized as a lever to obtain the initial rupture of the end panel and then as a handle to tear out the removable panel portion. The removable panel portion is provided with a weakening line immediately adjacent the connection between the pull tab and the removable panel portion for the purpose of first venting the interior of a container and then forming a hinge which will permit the necessary pivoting of the pull tab relative to the end panel.

**Reexamination Certificate for:**

Patent No.: 4,182,460  
Issued: Jan. 8, 1980  
Appl. No.: 656,388  
Filed: Jul. 27, 1967

- [51] Int. Cl.<sup>3</sup>.....B65D 41/32
- [52] U.S. Cl.....220/271; 220/273
- [58] Field of Search.....220/265-273

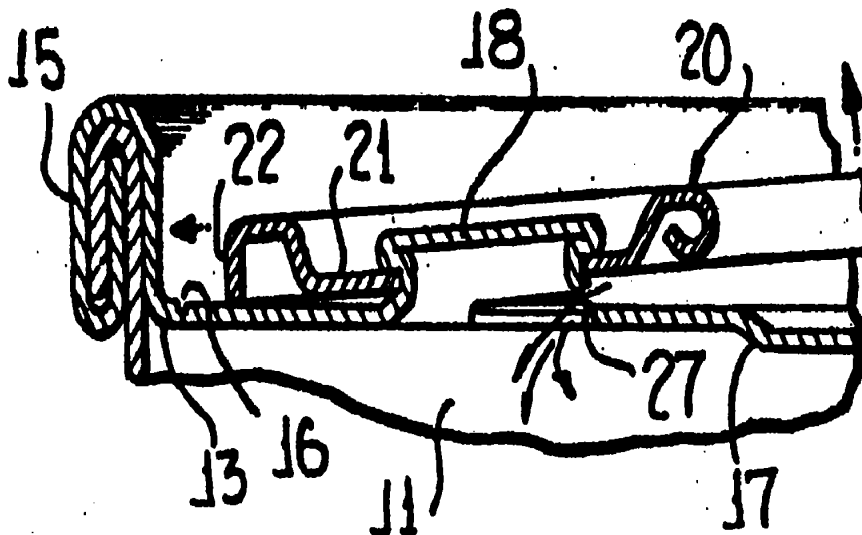



B1 4,182,460

1

**REEXAMINATION CERTIFICATE  
ISSUED UNDER 35 U.S.C. 307.**

**THE PATENT IS HEREBY AMENDED AS  
INDICATED BELOW.**

Matter enclosed in heavy brackets appeared in the patent, but has been deleted and is no longer a part of the patent; matter printed in italics indicates additions made to the patent.

**AS A RESULT OF REEXAMINATION, IT HAS  
BEEN DETERMINED THAT:**

The patentability of claims 1-10, 16, 18, 19 and 21-54 is confirmed.

Claims 11-15, 17 and 20 are determined to be patentable as amended:

11. In a container end including an end panel defined by an upstanding chuck wall, a [weakening] score line formed in said end panel and defining a removable panel portion, said [weakening] score line including a starting portion disposed closely adjacent said chuck wall, a pull tab having a nose for engaging said panel along said [weakening] score line starting portion for effecting the rupture of said panel in the removal of said panel portion, and securing means securing said pull tab to said panel; the improvement comprising said securing means rigidly securing said pull tab to said panel portion and including hinge forming means in said removable panel portion for facilitating the hinging of said pull tab relative to said end panel to rupture said end panel along said [weakening] score line starting portion.

12. The container end of claim 11 wherein said hinge forming means includes a generally U-shaped [weakening] score line opening towards said [weakening] score line starting portion.

13. The container end of claim 11 wherein said hinge forming means includes a generally U-shaped [weakening] score line opening towards said [weakening] score line starting portion and having terminal

2

ends directed away from said [weakening] score line starting portion for preventing the accidental tearing out of a narrow portion only of said removable panel portion between said [weakening] score lines.

14. The container end of claim 11 wherein said score line [of weakening] includes a generally U-shaped central portion and diverging adjacent portions.

15. The assembly of claim 1 wherein said removable panel portion is defined by a second score line [of weakening] formed separate and apart from the first-mentioned score line [of weakening], and said score lines [of weakening] define an intermediate strap-like hinge strip.

17. In a container, the combination of:

a container wall of sheet material;

a first score line [of weakness] in said container wall defining a tear strip manually removable therefrom;

a second score line [of weakness] in said container wall adjacent said first score line [of weakness] and defining a hinge, said hinge being spaced from said first score line [of weakness] by a portion of said tear strip;

a separate tab lying at least partially within the area of said tear strip, said tab having a handle end and a force applying end with the force applying end lying at a preselected location closely adjacent said first score line [of weakness]; and

means integral with said tear strip for securing said tab to said tear strip, movement of said handle end of said tab urging said force applying end firmly against said container wall to cause hinged movement of said portion of said container wall about said hinge to initiate severance of the tear strip along said first score line [of weakness].

20. A combination as defined in claim 18 wherein said hinge lies intermediate said last mentioned means and said first score line [of weakness] and said preselected location is on said tear strip.

\* \* \* \* \*

45



US005506049C1

(12) **REEXAMINATION CERTIFICATE** (4368th)

**United States Patent**  
Swei et al.

(10) Number: **US 5,506,049 C1**  
(45) Certificate Issued: **May 29, 2001**

(54) **PARTICULATE FILLED COMPOSITE FILM AND METHOD OF MAKING SAME**

2,945,831 7/1960 Evans et al. .  
2,980,965 4/1961 Infantino et al. .  
3,290,165 12/1966 Iannicelli .

(75) Inventors: **Gwo S. Swei, Northboro; David J. Arthur, Norwood, both of MA (US)**

(List continued on next page.)

(73) Assignee: **World Properties, Inc., Lincolnwood, IL (US)**

**FOREIGN PATENT DOCUMENTS**

**Reexamination Request:**  
No. 90/005,295, Mar. 16, 1999

0198375 5/1987 (EP) .  
0 598 464 5/1994 (EP) .  
1119260 7/1968 (GB) .  
2071112 4/1984 (GB) .  
6-263464 9/1994 (JP) .  
WO 90/02102 3/1990 (WO) .  
WO 95/07177 3/1995 (WO) .

**Reexamination Certificate for:**  
Patent No.: **5,506,049**  
Issued: **Apr. 9, 1996**  
Appl. No.: **08/177,198**  
Filed: **Dec. 30, 1993**

**OTHER PUBLICATIONS**

(\*) Notice: This patent is subject to a terminal disclaimer.

"Production Refinement of Very Thin Teflon Film", American Machine and Foundry Co, Stamford, CT, Mar., 1963.  
"Silane Coupling Agents", Edwin P. Plueddemann, Dow Corning Corporation, Midland, Michigan, Plenum Press, New York, 1982.

**Related U.S. Application Data**

(List continued on next page.)

(62) Division of application No. 07/705,624, filed on May 24, 1991, now abandoned.

*Primary Examiner*—H. Thi Le

(51) **Int. Cl.<sup>7</sup>** ..... **B32B 5/16**

(57) **ABSTRACT**

(52) **U.S. Cl.** ..... **428/323; 428/325; 428/335; 428/901**

A particulate filled fluoropolymeric matrix composite article and method of making the same is presented. Preferably, the article comprises an electrical substrate material. The method for making the particulate filled polymeric matrix composite film includes mixing a polymeric matrix material with a dispersion of particulate filler in a carrier liquid to form a casting composition and adjusting the viscosity of the casting composition to retard separation of the particulate filler from the composition. A layer of the viscosity-adjusted casting composition is cast on a substrate and the layer is consolidated to form the particulate filled polymer matrix composite film. Films made by the method include very thin, e.g. less than 1.0 mil, fluoropolymeric matrix films highly filled with very small diameter, preferably spherical, particles for use as, e.g. dielectric substrate materials in laminar electrical circuits.

(58) **Field of Search** ..... **428/323, 325, 428/335, 403, 404, 901, 405, 406, 421, 422, 457**

(56) **References Cited**

**U.S. PATENT DOCUMENTS**

Re. 30,450 12/1980 Iannicelli .  
2,539,329 1/1951 Sanders .  
2,739,073 3/1956 Bertorelli .  
2,832,754 4/1958 Jex et al. .  
2,843,502 7/1958 Fay, Jr. .  
2,848,346 8/1958 Bertorelli .  
2,930,809 3/1960 Jex et al. .



## US 5,506,049 C1

Page 2

## U.S. PATENT DOCUMENTS

3,340,222	9/1967	Fang .	5,069,702	12/1991	Block et al. .
3,489,595	1/1970	Brown, Jr. .	5,071,635	12/1991	Yamanaka et al. .... 423/592
3,518,332	6/1970	Sklarchuk et al. .	5,075,065	12/1991	Effenberger et al. .
3,556,161	1/1971	Roberts .	5,126,192	6/1992	Chellis .
3,655,604	4/1972	Strolle .	5,256,180	10/1993	Garnier et al. .
3,780,156	12/1973	Cameron .	5,280,414	1/1994	Davis et al. .
3,801,427	4/1974	Morishita et al. .	5,421,507	6/1995	Davis et al. .
3,830,770	8/1974	Ribbans, III .	5,496,403	3/1996	Gaedcke et al. .
3,838,998	10/1974	Matthews et al. .	5,534,348	7/1996	Miller et al. .... 65/21.4
3,886,103	5/1975	Koizumi et al. .			
3,896,071	7/1975	Poirier .			
3,928,703	12/1975	Cook .			
3,929,721	12/1975	Leverett .			
3,970,627	7/1976	Seymus .			
4,036,807	7/1977	Atherton .			
4,038,244	7/1977	Ogden et al. .			
4,039,713	8/1977	Vassiliou .			
4,118,537	10/1978	Vary et al. .			
4,123,401	10/1978	Berghmans et al. .			
4,128,519	12/1978	Bartoszek et al. .			
4,134,848	1/1979	Adicoff .			
4,141,873	2/1979	Dohany .			
4,143,110	3/1979	Morozumi et al. .			
4,151,154	4/1979	Berger .			
4,169,087	9/1979	Richter .			
4,179,542	12/1979	Christofas et al. .			
4,183,991	1/1980	Smiley et al. .			
4,194,040	3/1980	Breton et al. .			
4,214,914	7/1980	Ivanchev et al. .			
4,216,024	8/1980	Ivanchev et al. .			
4,233,366	11/1980	Sample, Jr. et al. .			
4,309,328	1/1982	Carson et al. .			
4,333,857	6/1982	Lim et al. .			
4,335,180	6/1982	Traut .			
4,352,717	10/1982	Watanabe et al. .			
4,391,930	7/1983	Olson .			
4,440,879	4/1984	Kawachi et al. .			
4,469,747	9/1984	Sasaki et al. .			
4,495,247	1/1985	Vasta .			
4,529,774	7/1985	Evans et al. .			
4,546,144	10/1985	Knight .			
4,556,603	12/1985	Thorsrud .			
4,587,286	5/1986	Wilkinson .			
4,623,390	11/1986	Delmonico .			
4,649,037	3/1987	Marsh et al. .			
4,654,235	3/1987	Effenberger et al. .			
4,661,137	4/1987	Garnier et al. .... 65/21.4			
4,665,113	5/1987	Eberl .			
4,715,878	12/1987	Kopatz et al. .... 65/21.1			
4,756,980	7/1988	Niksa et al. .			
4,772,322	9/1988	Bellis et al. .			
4,788,764	12/1988	Niksa et al. .			
4,824,511	4/1989	Hartman et al. .			
4,868,350	9/1989	Hoffarth et al. .			
4,879,345	11/1989	Connelly et al. .			
4,923,520	5/1990	Anzai et al. .			
4,985,190	1/1991	Ishikawa et al. .			
5,055,342	10/1991	Markovich .			

## OTHER PUBLICATIONS

"A Guide to Dow Corning Silane Coupling Agents", Dow Corning Corporation, 1985.

"Silane Coupling Agents in Mineral-Filled Composites", Union Carbide Corporation, 1973, 1979.

"Silane Adhesion Promoters in Mineral-Filled Composites", Union Carbide Corporation, 1973.

"Handbook of Fillers and Reinforcements for Plastics", Van Nostrand Reinhold Company, 1978.

"The Use of Mixed Silane Coupling Agents", Edwin P. Plueddemann and Peter G. Pape, 40th Annual Conference, Reinforced Plastics/Composites Institute, The Society of the Plastics Industry, Inc. Jan. 28-Feb. 1, 1985, Session 17-F, pp. 1-4.

"Microwave Substrates—Present and Future", Thomas E. Nowicki, *New Electronics*, May 27, 1980, pp. 85-88.

MIL-P 13949F, Military Specification, Plastic Sheet, Laminated, Metal Clad (For Printed Wiring Boards), General Specification For (Mar. 10, 1981)(superseding MIL-P 13949E (Jul. 15, 1971), MIL-P-55636B (Sep. 10, 1976), and MIL-P -55617B (Sep. 10, 1976).

Murray Olyphant, Jr. & Thomas E. Nowicki, "Microwave Substrates Support MIC Technology", in *Microwave Tech Topics*, also published in *Microwaves Magazine*, Nov./Dec. 1980.

Ex. 1—World Properties, Inc. & Rogers Corp. v. Tonoga Limited D/B/A Taconic Plastics—3:98CV1218 (JBA), Ruling On Defendant's Motion To Compel Return Of Inadvertently Produced Privileged Documents dated May 30, 2000.

Ex. 2—Letter dated Aug. 25, 1998 from John C. Hilton at McCormick, Paulding & Huber LLP to Mr. Andrew Russell.

Ex. 3—World Properties et al v. Tonoga, et al—3:98cv1218 (JBA), Endorsement Order [Doc. #76, #80] dated Jul. 5, 2000.

Ex. 4—World Properties, et al v. Tonoga, et al—3:98cv1218 (JBA), portion of Deposition of Malcolm Green transcript on Nov. 19, 1998.

Ex. 5—World Properties, et al v. Tonoga, et al—3:98cv1218 (JBA), Declaration of Thomas McCarthy dated May 10, 2000.

Ex. 6—World Properties, et al v. Tonoga, et al—3:98cv1218 (JBA), Order Returning Pleading dated Jul. 7, 2000.

Ex. 7—World Properties et al v. Tonoga, et al—3:98cv1218 (JBA), Amended Answer And Counterclaim dated Jun. 1, 2000.

US 5,506,049 C1

1

**REEXAMINATION CERTIFICATE  
ISSUED UNDER 35 U.S.C. 307**

THE PATENT IS HEREBY AMENDED AS  
INDICATED BELOW.

Matter enclosed in heavy brackets [ ] appeared in the patent, but has been deleted and is no longer a part of the patent; matter printed in italics indicates additions made to the patent.

AS A RESULT OF REEXAMINATION, IT HAS BEEN DETERMINED THAT:

Claims 1-40 are cancelled.

New claims 41-53 are added and determined to be patentable.

41. A particulate filled fluoropolymeric matrix composite circuit material, comprising:

- (1) an electric substrate including a nonfibrillated fluoropolymer matrix and about 15 to about 95 volume percent filler particles distributed throughout the matrix, said particles having a maximum equivalent spherical diameter of less than about 10  $\mu\text{m}$ , said filler particles comprising inorganic filler particles treated with a coating selected from the group consisting of silane coatings, zirconate coatings, and titanate coatings;
- (2) a layer of metal being disposed on at least one surface of said substrate; and
- (3) said substrate being formed by a casting composition, wherein the viscosity of said casting composition is adjusted by a polymeric viscosity modifier to adjust the viscosity of the casting composition to retard separation of the particulate filler from the composition to provide a stabilized, homogeneous casting composition, said polymeric viscosity modifier being substantially removed after the completion of

2

processing, and wherein a surfactant is added to said casting composition to modify the surface tension of the carrier liquid so that the carrier liquid wets the filler particles.

42. The circuit material of claim 41, wherein the fluoropolymer comprises polytetrafluoroethylene.

43. The circuit material of claim 41, wherein the fluoropolymer comprises polychlorotrifluoroethylene.

44. The circuit material of claim 41, wherein the fluoropolymer comprises a copolymer of tetrafluoroethylene and a monomer selected from the group consisting of hexafluoropropylene and perfluoroalkylvinylethers.

45. The circuit material of claim 41, wherein the fluoropolymer comprises a copolymer of tetrafluoroethylene and a monomer selected from the group consisting of vinylidene fluoride, vinyl fluoride and ethylene.

46. The circuit material of claim 41, wherein the fluoropolymer comprises a copolymer of chlorotrifluoroethylene and a monomer selected from the group consisting of hexafluoropropylene, perfluoroalkylvinylethers, vinylidene fluoride, vinyl fluoride, and ethylene.

47. The circuit material of claim 41, wherein the substrate comprises a film having a thickness of less than about 2 mil.

48. The circuit material of claim 41, wherein the substrate comprises a film having a thickness of less than about 1 mil.

49. The circuit material of claim 41 wherein said metal comprises copper.

50. The circuit material of claim 41, wherein each of the filler particles has an equivalent spherical diameter of less than 5  $\mu\text{m}$ .

51. The circuit material of claim 41, wherein none of the filler particles has a single linear dimension greater than 10  $\mu\text{m}$ .

52. The circuit material of claim 41, wherein none of the filler particles has a single linear dimension greater than 5  $\mu\text{m}$ .

53. The circuit material of claim 41, wherein all of the filler particles are of substantially the same particle size.

\* \* \* \* \*

## 2291 Notice of >Ex Parte Reexamination< Certificate Issuance in *Official Gazette* [R-2]

The *Official Gazette* notice will include bibliographic information, and an indication of the status of each claim after the termination of the reexamination proceeding. Additionally, a representative claim will be published along with an indication of any changes to the specification or drawing.

>The notice of *ex parte* reexamination certificate will clearly indicate that it is a certificate for a concluded *ex parte* reexamination proceeding, as opposed to an *inter partes* reexamination proceeding.<

## 2292 Distribution of Certificate

A copy of the reexamination certificate should be stapled to each copy of the patent in the search files. A copy of the certificate will also be made a part of any patent copies prepared by the Office subsequent to the issuance of the certificate.

A copy of the certificate will also be forwarded to all depository libraries and to those foreign offices which have an exchange agreement with the U.S. Patent and Trademark Office.

## 2293 Intervening Rights

35 U.S.C. 307. *Certificate of patentability, unpatentability, and claim cancellation.*

\*\*\*\*\*

(b) Any proposed amended or new claim determined to be patentable and incorporated into a patent following a reexamination proceeding will have the same effect as that specified in section 252 of this title for reissued patents on the right of any person who made, purchased, or used within the United States, or imported into the United States, anything patented by such proposed amended or new claim, or who made substantial preparation for the same, prior to issuance of a certificate under the provisions of subsection (a) of this section.

The situation of intervening rights resulting from reexamination proceedings parallels the intervening rights situation resulting from reissue proceedings, and the rights detailed in 35 U.S.C. 252 apply equally in reexamination and reissue situations. See *Fortel Corp. v. Phone-Mate, Inc.*, 825 F.2d 1577, 3 USPQ2d 1771 (Fed. Cir. 1987); *Kaufman Co., Inc. v. Lantech, Inc.*, 807 F.2d 970, 1 USPQ2d 1202 (Fed. Cir. 1986);

*Tennant Co. v. Hako Minuteman, Inc.*, 4 USPQ2d 1167 (N.D. Ill. 1987); *Key Mfg. Group, Inc. v. Micro-dot, Inc.*, 679 F. Supp. 648, 4 USPQ2d 1687 (E.D. Mich. 1987).

## 2294 Terminated Reexamination Files [R-2]

\*\*>*Ex parte* reexamination proceedings may be terminated in one of four ways:

(A) The proceeding may be terminated by a denial of reexamination or vacating the reexamination proceeding. (In either case, no Reexamination Certificate is issued).

Terminated reexamination files in which reexamination has been denied or vacated are processed by the Technology Center (TC) to provide the partial refund set forth in 37 CFR 1.26(c). The word "Terminated" is then written in green ink on the face of the file at the top between the word "Reexamination" and the hand-written patent number. The reexamination file is then given either a 420 status (reexamination denied) or a 422 status (reexamination vacated) and forwarded by the TC to the Files Repository Unit (Location Code 9200) for storage with the patent file.

(B) The proceeding may be terminated under 37 CFR 1.570(b) with the issuance of a Reexamination Certificate.

A reexamination proceeding that is terminated in this manner should be processed as set forth in MPEP § 2287, reviewed by the TC Special Program Examiner (SPRE), and then forwarded to the Office of Patent Legal Administration (OPLA).

(C) The proceeding may be terminated under 37 CFR 1.570(e) where the reexamination proceeding has been merged with a reissue proceeding and a reissue patent is granted; an individual reexamination certificate is not issued, but rather the reissue patent serves as the certificate.

A reexamination proceeding that is terminated in this manner should be processed, together with the reissue proceeding, as set forth in MPEP § 1455 and forwarded to the OPLA in accordance with MPEP § 1456.

(D) The proceeding may be terminated under 37 CFR 1.997(b) where the *ex parte* reexamination proceeding has been merged with an *inter partes* reexamination proceeding and a single reexamination certificate is issued.

A reexamination proceeding that is terminated in this manner should be processed, together with the *inter partes* reexamination, into a merged certificate of the nature set forth in MPEP § 2690 and MPEP § 2694.<

## 2295 Reexamination of a Reexamination [R-2]

This section provides guidance for the processing and examination of a reexamination request filed on a patent for which a reexamination certificate has already issued>, or a reexamination certificate issues on a prior reexamination, while the new reexamination is pending<. This reexamination request is generally referred to as a “Reexamination of a reexamination.”

The reexamination request is to be considered based on the claims in the patent *as modified by the previously issued reexamination certificate*, and not based on the original claims of the patent. Accordingly, when the file for the new reexamination proceeding (reexamination of a reexamination) is first received by the Technology Center (TC), the reexamination clerk will promptly incorporate into the reexamination specification all of the changes to the patent made by the issued reexamination certificate. Such incorporation must be done prior to forwarding the proceeding to the examiner for action.

The examiner should review the reexamination clerk’s entry of the reexamination certificate to ensure that all certificate changes are properly entered so that (A) the reexamination will be given on an accurate specification and claims, and (B) the appropriate version of the patent will be printed in any future reexamination certificate that will ultimately issue. The examiner will issue a decision on the reexamination request **based on the patent claims (and specification) with the certificate changes entered.**

Once reexamination is ordered, the reexamination proceeding is conducted in accordance with 35 U.S.C. 305, 37 CFR 1.550 and MPEP § 2254 - § 2294.

>

### I. PRIOR REEXAMINATION MATURES TO CERTIFICATE WHILE LATER REEXAMINATION IS PENDING

If a second request for reexamination of a patent is filed where the certificate for the first reexamination of the patent will issue within 3 months from the filing of the second request, the proceedings normally will not be merged. If the certificate for the first reexamination proceeding will issue before the decision on the second request must be decided, the reexamination certificate is allowed to issue. The second request is then considered based upon the claims in the patent as indicated in the issued reexamination certificate rather than the original claims of the patent. The TC Legal Instrument Examiner (LIE) will print out a copy of the issued reexamination certificate and make it of record in the second reexamination file wrapper as a preliminary amendment.

In the order/denial decision on the second request, it should be noted that this preliminary amendment (the certificate) was entered into the reexamination file, and that the determination (order/denial) was based upon the new patent claims in the certificate.

A copy of the reexamination certificate should be included as an attachment to the order/denial decision to ensure that any third party requester of the second reexamination has a copy of the certificate claims.

### II. < PATENT OWNER’S SUBMISSION OF AMENDMENTS

Any amendment to the claims (or specification) of the reexamination proceeding must be presented as if the changes made to the patent text via the reexamination certificate are a part of the original patent. Thus, all italicized text in the certificate is considered as if the text was present without italics in the original patent. Further, any certificate text placed in brackets is considered as if it were never present in the patent at all.

For example, an amendment in a “reexamination of a reexamination” might include italicized text of claim 1 of the reexamination certificate as underlined (or italicized) in the copy of claim 1 submitted in the amendment. This would indicate that text already present in the patent (via the reexamination certificate) is again being added. This would be an improper

amendment, and as such, an “informal submission.” Accordingly, the examiner would notify the patent owner that the amendment does not comply with 37 CFR 1.530. Form PTOL-475 would be used to provide the notification of the defect in the amendment, and a 1-month time period would be set for correction of the defect. See also MPEP § 2266.02.

>

### III. < COMPLETION OF THE CHECKLISTS

Upon conclusion of the reexamination proceeding, the reexamination file will be processed by the TC so that the Office of Publication can prepare and issue a certificate in accordance with 35 U.S.C. 307 and 37 CFR 1.570. The certificate will set forth the results of the reexamination proceeding and the content of the patent following the proceeding. See MPEP § 2287. The examiner will complete a checklist, Form PTO-1516, and the reexamination clerk will complete the reexamination clerk checklist Form PTO-1517. In completing the checklists, the examiner and reexamination clerk should keep in mind that the “patent” is the *original patent as modified by the reexamination certificate*. For example, claims canceled by the prior reexamination certificate should be listed in Item 8 - “Claim(s) \_\_\_\_\_ (and) \_\_\_\_\_ was (were) previously canceled.” Likewise, in Item 12 of the examiner checklist - “Claim(s) \_\_\_\_\_ (and) \_\_\_\_\_ is (are) determined to be patentable as amended.”; any claims amended **only** by the prior reexamination certificate (i.e., not further amended in the present reexamination) **should not be listed**.

Each “reexamination of a reexamination” must be reviewed by \*>a< TC Special Program Examiner and \* >a TC< paralegal to ensure compliance with the above guidelines.

## 2296 USPTO Forms To Be Used >InEx Parte Reexamination< [R-2]

The following forms must be used in >ex parte< reexamination actions and processing (these forms are not reproduced below):

- (A) Order - PTOL 471
- (B) General Office Action - PTOL 466
- (C) Advisory Action - PTOL 467
- (D) Notice re Appeal & re Defective Brief - PTOL 468
- (E) >Notification of Non-Compliance With 37 CFR 1.192(c) – PTOL 462
- (F) < NIRC - PTOL 469
- \*>
- (G) < Transmittal of Communication to Third Party Requester - PTOL 465
- \*>
- (H) < Interview Summary - PTOL 474
- \*>
- (I) < Notice of Defective Paper - PTOL 475
- \*>
- (J) < General Reexam Communication (with SSP) - PTOL 473
- \*>
- (K) < Clerical Checklist - PTOL 1517
- \*>
- (L) < Examiner Checklist - PTOL 1516

A Request for *Ex Parte* Reexamination Transmittal Form, PTO/SB/57, is available on the USPTO web site at <http://www.uspto.gov> for use in the filing of a request for reexamination; its use, however, is not mandatory.



# Chapter 2300 Interference Proceedings

- 2300.01 Introduction
- 2300.02 Provoking an Interference
- 2301.01 Preliminaries to an Interference
- 2301.01(a) In Different Technology Centers
- 2301.01(b) The Interference Search
- 2301.02 Definitions
- 2302 Ownership of Applications and Patents Involved in an Interference**
- 2303 Interference Between Applications**
- 2303.01 Interference on Nonelected Subject Matter
- 2304 Applicant Requests Interference Between Applications**
- 2305 Examiner Suggests Claim to Applicant**
- 2305.01 Action To Be Made at Time of Suggesting Claims
- 2305.02 Time Limit Set for Presenting Suggested Claims
- 2305.03 Suggested Claims Presented After Period for Reply Running Against Application
- 2305.04 Suggestion of Claims, Application in Issue or in Interference
- 2306 Interference Between an Application and a Patent**
- 2306.01 Patent Has Filing Date Later Than Application
- 2307 Applicant Requests Interference With a Patent**
- 2307.01 Presentation of Claims Corresponding to Patent Claims Not a Reply to Last Office Action
- 2307.02 Rejection of Claims Corresponding to Patent Claims
- 2307.03 Presentation of Claims for Interference With a Patent, After Prosecution of Application is Closed
- 2307.04 Presentation of Claims for Interference With a Patent Involved in a Reexamination Proceeding
- 2307.05 Corresponding Patent Claims Not Identified
- 2307.06 Presentation of Claims for Interference with a Patent, Patentee Must Be Notified
- 2308 Interference Between an Application and a Patent; Prima Facie Showing by Applicant**
- 2308.01 Patent Has Filing Date Earlier Than Application
- 2308.02 Showing Under 37 CFR 1.608(b)
- 2309 Proposed Interference**
- 2309.02 Preparation of Papers
- 2309.03 Affidavits and Declarations Retained in File
- 2309.06 Interfering Subject Matter in "Secrecy Order" Cases
- 2311 Declaration of Interference**
- 2312 Public Access to Files**

- 2314 Jurisdiction Over Interference**
- 2315 Suspension of Ex Parte Prosecution**
- 2315.01 Suspension - Overlapping Applications
- 2333 Preliminary Motions - Related to Application Not Involved in Interference**
- 2340 Motions, Hearing and Decision**
- 2341 Unpatentability Discovered**
- 2342 Addition to Interference**
- 2358 Final Decision**
- 2359 Board Recommendation**
- 2360 Reexamination, Reissue, Protest, or Litigation During Interference**
- 2361 Termination of Interference After Judgment**
- 2363 Action After Interference**
- 2363.01 No Interference in Fact
- 2363.02 The Winning Party
- 2363.03 The Losing Party
- 2364 Entry of Amendments**
- 2364.01 Amendments Filed During Interference
- 2365 Second Interference**

## 2300.01 Introduction

35 U.S.C. 135. *Interferences.*

(a) Whenever an application is made for a patent which, in the opinion of the Director, would interfere with any pending application, or with any unexpired patent, an interference may be declared and the Director shall give notice of such declaration to the applicants, or applicant and patentee, as the case may be. The Board of Patent Appeals and Interferences shall determine questions of priority of the inventions and may determine questions of patentability. Any final decision, if adverse to the claim of an applicant, shall constitute the final refusal by the Patent and Trademark Office of the claims involved, and the Director may issue a patent to the applicant who is adjudged the prior inventor. A final judgment adverse to a patentee from which no appeal or other review has been or can be taken or had shall constitute cancellation of the claims involved in the patent, and notice of such cancellation shall be endorsed on copies of the patent distributed after such cancellation by the Patent and Trademark Office.

(b)(1) A claim which is the same as, or for the same or substantially the same subject matter as, a claim of an issued patent may not be made in any application unless such a claim is made prior to one year from the date on which the patent was granted.

(2) A claim which is the same as, or for the same or substantially the same subject matter as, a claim of an application published under section 122(b) of this title may be made in an application filed after the application is published only if the claim is made before 1 year after the date on which the application is published.

(c) Any agreement or understanding between parties to an interference, including any collateral agreements referred to therein, made in connection with or in contemplation of the termination of the interference, shall be in writing and a true copy thereof filed in the Patent and Trademark Office before the termi-



nation of the interference as between the said parties to the agreement or understanding. If any party filing the same so requests, the copy shall be kept separate from the file of the interference, and made available only to Government agencies on written request, or to any person on a showing of good cause. Failure to file the copy of such agreement or understanding shall render permanently unenforceable such agreement or understanding and any patent of such parties involved in the interference or any patent subsequently issued on any application of such parties so involved. The Director may, however, on a showing of good cause for failure to file within the time prescribed, permit the filing of the agreement or understanding during the six-month period subsequent to the termination of the interference as between the parties to the agreement or understanding.

The Director shall give notice to the parties or their attorneys of record, a reasonable time prior to said termination, of the filing requirement of this section. If the Director gives such notice at a later time, irrespective of the right to file such agreement or understanding within the six-month period on a showing of good cause, the parties may file such agreement or understanding within sixty days of the receipt of such notice.

Any discretionary action of the Director under this subsection shall be reviewable under section 10 of the Administrative Procedure Act.

(d) Parties to a patent interference, within such time as may be specified by the Director by regulation, may determine such contest or any aspect thereof by arbitration. Such arbitration shall be governed by the provisions of title 9 to the extent such title is not inconsistent with this section. The parties shall give notice of any arbitration award to the Director, and such award shall, as between the parties to the arbitration, be dispositive of the issues to which it relates. The arbitration award shall be unenforceable until such notice is given. Nothing in this subsection shall preclude the Director from determining patentability of the invention involved in the interference.

This chapter is designed to aid examiners in identifying potential interferences and in preparing to discuss potential interferences with Interference Practice Specialists and with the Board of Patent Appeals and Interferences. Since each interference is unique and must be declared and decided on its own facts, any given interference may have features that vary significantly from those discussed in this chapter.

Interferences are quite rare during patent prosecution. At present, fewer than one percent of all applications become involved in interferences. Consequently, the examiner should focus on identifying when an interference is necessary, not on the actual mechanics of proposing an interference. Each Technology Center (TC) has at least one Interference Practice Specialist (IPS), who has received special training in preparing cases for an interference. The examiner should consult with the IPS to ensure that an interference exists and

that the examiner has satisfied the requirements for proposing an interference. See MPEP § 2309 through § 2309.02 regarding procedures for preparation of interference papers by the examiner.

An interference is a proceeding, conducted before the Board of Patent Appeals and Interferences (Board), to determine priority of invention between a pending application and one or more pending applications and/or one or more unexpired patents. Jurisdiction to decide an interference is granted by 35 U.S.C. 135(a), which also grants the Board discretion to determine questions of patentability in the proceeding.

The United States Patent and Trademark Office (USPTO) does not have jurisdiction to conduct interferences which involve only patents, i.e., which do not involve at least one pending application. Jurisdiction over those proceedings is conferred on the Federal courts by 35 U.S.C. 291.

Since the Board is the body which has jurisdiction over interferences conducted in the USPTO, the examiner's involvement in the proceeding, once the interference has been declared, is minimal. This chapter therefore is generally limited to information concerning those aspects of an interference, including preliminary and subsequent proceedings, which are within the jurisdiction of, or are relevant to, the examiner. It does not include the procedure which is followed before the Board during the interference. Persons seeking information concerning that procedure should consult the text of the pertinent rules, 37 CFR subpart E, the notices of rulemaking and accompanying comments adopting those rules. These notices and comments, as well as other notices pertinent to current interference practice and procedure, are as follows:

Final Rule, 49 FR 48416 (Dec.12, 1984), 1050 O.G. 385 (Jan.29, 1985);

Correction Notice, 50 FR 23122 (May 31, 1985), 1059 O.G. 27 (Oct. 22, 1985);

Notices of Rulemaking: 52 FR 13833 (Apr. 27, 1987), 1080 O.G. 15 (July 14, 1987);

53 FR 23728 (June 23, 1988), 1092 O.G. 26 (July 12, 1988);

54 FR 29548 (July 13, 1989), 1105 O.G. 5 (Aug. 1, 1989);

56 FR 42528 (Aug. 28, 1991)\*, 1136 O.G. 40 (Mar. 17, 1992);

\*corrected, 56 FR 46823 (Sep. 16, 1991)  
 58 FR 49432 (Sep. 23, 1993), 1155 O.G. 65 (Oct. 19, 1993);  
 60 FR 14488 (Mar. 17, 1995), 1173 O.G. 36 (Apr. 11, 1995);  
 64 FR 12901 (Mar. 16, 1999);  
 65 FR 56792 (Sept. 20, 2000), 1239 O.G. 125 (Oct. 17, 2000);  
 65 FR 70489 (Nov. 24, 2000), 1241 O.G. 68 (Dec. 19, 2000).

Notices: *Access to Interference Settlement Agreements by Government Agencies*, 972 O.G. 2 (July 4, 1978); *Interference Practice: Response to Order to Show Cause Under 37 CFR 1.640*, 1074 O.G. 4 (Jan. 6, 1987); *Interference Practice: Fraud and Inequitable Conduct Allegations*, 1074 O.G. 42 (Jan. 27, 1987); *Interferences - Preliminary Motions for Judgment*, 1118 O.G. 19 (Sep. 11, 1990); *Consideration of Fraud and Inequitable Conduct in Patent Interference Cases*, 1133 O.G. 21 (Dec. 10, 1991); *Interference Practice: Consideration of Fraud and Inequitable Conduct (Id.)*; *Interference Practice: Matters Relating to Belated Preliminary Motions*, 1144 O.G. 8 (Nov. 3, 1992); *Availability of Interference Files and Interference Related Application and Patent Files*, 1184 O.G. 15 (Mar. 5, 1996); *Admissibility of Electronic Records in Interferences*, 1208 O.G. 35 (Mar. 10, 1998); *Publication of Opinions and Orders Entered by the Board of Patent Appeals and Interferences*, 1217 O.G. 17 (Dec. 1, 1998); *Interference Practice – Interference Rules Which Require a Party to “Show the Patentability” of a Claim*, 1217 O.G. 17 (Dec. 1, 1998); *Interference Practice – New Procedures for Handling Interference Cases at the Board of Patent Appeals and Interferences*, 1217 O.G. 18 (Dec. 1, 1998).

The text of the notices listed above is available on the USPTO web page at [www.uspto.gov](http://www.uspto.gov).

### 2300.02 Provoking an Interference

An interference may be provoked in several different ways, depending upon the circumstances. Each of these is covered in detail in the subsequent sections.

(A) An interference between pending applications may be requested by an applicant who has become aware of another application which may be claiming the same invention. See MPEP § 2303 and § 2304. If the applications are not claiming the same patentable

invention, it may be necessary for the examiner to suggest a claim in one or more of the applications. See MPEP § 2305.

(B) An interference between a pending application and a patent is normally provoked by the applicant. See MPEP § 2306 - § 2308.

### 2301.01 Preliminaries to an Interference

An interference is an expensive and time-consuming proceeding. Yet, it may be necessary to determine priority when two applicants, or an applicant and a patentee, are claiming the same patentable subject matter and their filing dates are so close together that there is a reasonable possibility that the first to file is not the first inventor. The fact that an application is a reissue application does not preclude it from being involved in an interference.

The greatest care must therefore be exercised both in the search for interfering applications and in determining whether an interference should be declared. Also the claims in recently issued patents, especially those used as references against the application claims, should be considered for possible interference.

The question of the propriety of proposing an interference in any given case is affected by so many factors that a discussion of all of them here is impracticable. Some circumstances which render an interference unnecessary are hereafter noted, but each instance must be carefully considered if serious errors are to be avoided.

In determining whether an interference is necessary, a claim should be given the broadest interpretation which it reasonably will support, bearing in mind the following general principles:

- (A) The interpretation should not be strained;
- (B) Express limitations in the claim should not be ignored nor should limitations be read therein;
- (C) Before a claim (unless it is a patented claim) is considered as the basis for the count of an interference, the claim should be allowable and in good form. No pending claim which is indefinite, ambiguous or otherwise defective should be the basis for a count of an interference;
- (D) A claim copied from a patent, if ambiguous, should be interpreted in the light of the patent in which it originated for purposes of determining whether a party has a right to copy a claim;

(E) An interference will not normally be instituted between cases which have the same inventive entity, or a common assignee. See 37 CFR 1.602(a). Such cases should be treated as set forth in MPEP § 804 *et seq.* Also see MPEP § 2302; and

(F) If doubts exist as to whether there is an interference, an interference should not be declared.

### **2301.01(a) In Different Technology Centers**

If there is a prospective interference between applications assigned to different Technology Centers (TCs), the applications should be transferred to the TC where the controlling interfering claim would be classified. After termination of the interference, further transfer may be necessary depending upon the outcome.

### **2301.01(b) The Interference Search**

The search for interfering applications must not be limited to the class or subclass in which the application is classified, but must be extended to all classes, in and out of the TC, which it has been necessary to search in the examination of the application. See MPEP § 1302.08.

Moreover, the possibility of the existence of interfering applications should be kept in mind throughout the prosecution. Where the examiner at any time finds that two or more applications are claiming the same invention and the examiner does not deem it expedient to institute interference proceedings at that time, the examiner should make a record of the possible interference on the face of the file wrapper in the space reserved for class and subclass designations. Such notations, however, if made on the file wrapper or drawings, must not be such as to give any hint of the date or identity of a supposedly interfering application. Application numbers or filing dates of conflicting applications must never be placed upon drawings or file wrappers. A book of “Prospective Interferences” should be maintained containing complete data concerning possible interferences and the page and line of this book should be referred to on the respective file wrappers or drawings. For future reference, this book may include notes as to why prospective interferences were not declared.

In determining whether to propose an interference, the primary examiner must be of the opinion that an

interference exists. The examiner should consult with an Interference Practice Specialist to confirm the existence of interfering subject matter. See MPEP § 2309.

The TC Director should be consulted if it is believed that the circumstances justify an interference between applications neither of which is ready for allowance.

## **2301.02 Definitions**

*37 CFR 1.601. Scope of rules, definitions.*

This subpart governs the procedure in patent interferences in the Patent and Trademark Office. This subpart shall be construed to secure the just, speedy, and inexpensive determination of every interference. For the meaning of terms in the Federal Rules of Evidence as applied to interferences, see § 1.671(c). Unless otherwise clear from the context, the following definitions apply to this subpart:

(a) *Additional discovery* is discovery to which a party may be entitled under § 1.687 in addition to discovery to which the party is entitled as a matter of right under § 1.673(a) and (b).

(b) *Affidavit* means affidavit, declaration under § 1.68, or statutory declaration under 28 U.S.C. § 1746. A transcript of an *ex parte* deposition may be used as an affidavit.

(c) *Board* means the Board of Patent Appeals and Interferences.

(d) *Case-in-chief* means that portion of a party’s case where the party has the burden of going forward with evidence.

(e) *Case-in-rebuttal* means that portion of a party’s case where the party presents evidence in rebuttal to the case-in-chief of another party.

(f) A *count* defines the interfering subject matter between two or more applications or between one or more applications and one or more patents. When there is more than one count, each count shall define a separate patentable invention. Any claim of an application or patent that is designated to correspond to a count is a claim involved in the interference within the meaning of 35 U.S.C. 135(a). A claim of a patent or application that is designated to correspond to a count and is identical to the count is said to correspond exactly to the count. A claim of a patent or application that is designated to correspond to a count but is not identical to the count is said to correspond substantially to the count. When a count is broader in scope than all claims which correspond to the count, the count is a phantom count.

(g) The *effective filing date* of an application is the filing date of an earlier application, benefit of which is accorded to the application under 35 U.S.C. 119, 120, 121, or 365 or, if no benefit is accorded, the filing date of the application. The effective filing date of a patent is the filing date of an earlier application, benefit of which is accorded to the patent under 35 U.S.C. 119, 120, 121, or 365 or, if no benefit is accorded, the filing date of the application which issued as the patent.

(h) In the case of an application, *filing date* means the filing date assigned to the application. In the case of a patent, “filing

date” means the filing date assigned to the application which issued as the patent.

(i) An *interference* is a proceeding instituted in the Patent and Trademark Office before the Board to determine any question of patentability and priority of invention between two or more parties claiming the same patentable invention. An interference may be declared between two or more pending applications naming different inventors when, in the opinion of an examiner, the applications contain claims for the same patentable invention. An interference may be declared between one or more pending applications and one or more unexpired patents naming different inventors when, in the opinion of an examiner, any application and any unexpired patent contain claims for the same patentable invention.

(j) An *interference-in-fact* exists when at least one claim of a party that is designated to correspond to a count and at least one claim of an opponent that is designated to correspond to the count define the same patentable invention.

(k) A *lead* attorney or agent is a registered attorney or agent of record who is primarily responsible for prosecuting an interference on behalf of a party and is the attorney or agent whom an administrative patent judge may contact to set times and take other action in the interference.

(l) A *party* is an applicant or patentee involved in the interference or a legal representative or an assignee of record in the Patent and Trademark Office of an applicant or patentee involved in an interference. Where acts of a party are normally performed by an attorney or agent, “party” may be construed to mean the attorney or agent. An inventor is the individual named as inventor in an application involved in an interference or the individual named as inventor in a patent involved in an interference.

(m) A *senior party* is the party with the earliest effective filing date as to all counts or, if there is no party with the earliest effective filing date as to all counts, the party with the earliest filing date. A *junior party* is any other party.

(n) Invention “A” is the *same patentable invention* as invention “B” when invention “A” is the same as (35 U.S.C. 102) or is obvious (35 U.S.C. 103) in view of invention “B” assuming invention “B” is prior art with respect to invention “A”. Invention “A” is a *separate patentable invention* with respect to invention “B” when invention “A” is new (35 U.S.C. 102) and non-obvious (35 U.S.C. 103) in view of invention “B” assuming invention “B” is prior art with respect to invention “A”.

(o) *Sworn* means sworn or affirmed.

(p) *United States* means the United States of America, its territories and possessions.

(q) A *final decision* is a decision awarding judgment as to all counts. An *interlocutory order* is any other action taken by an administrative patent judge or the Board in an interference, including the notice declaring an interference.

(r) *NAFTA country* means NAFTA country as defined in section 2(4) of the North American Free Trade Agreement Implementation Act, Pub. L. 103-182, 107 Stat. 2060 (19 U.S.C. 3301).

(s) *WTO member country* means WTO member country as defined in section 2(10) of the Uruguay Round Agreements Act, Pub. L. 103-465, 108 Stat. 4813 (19 U.S.C. 3501).

37 CFR 1.601 defines various terms used in Subpart E of Title 37, Code of Federal Regulation, including “same patentable invention,” “separate patentable invention,” “sworn,” “United States,” “final decision,” “interlocutory order,” “NAFTA country” and “WTO member country.” “Affidavits” include declarations filed under 35 U.S.C. 25 and 37 CFR 1.68 as well as statutory declarations under 28 U.S.C. 1746. The definition “United States” is the same as the definition of United States in 35 U.S.C. 100(c). “NAFTA country” is defined in section 2(4) of the NAFTA Implementation Act, which includes United States, Mexico and Canada. For purposes of 35 U.S.C. 104, inventions made abroad in a NAFTA country would include only Mexico and Canada.

The definition of “interference” permits an interference between one or more applications and one or more patents provided it does not create an interference between patents. Thus, the revised rules follow the policy of *Wilson v. Yakel*, 1876 C.D. 245 (Comm’r Pat. 1876) and, to the extent inconsistent therewith, do not follow the policy announced in *Touval v. Newcombe*, 194 USPQ 509 (Comm’r Pat. 1976). An interference exists between two applications, or an application and a patent, if at least one claim from each would have anticipated or rendered obvious the subject matter of at least one claim of the other. The test is analogous to a statutory or obviousness type double patenting analysis. Note that the claims need not be identical in language or scope for an interference to exist. See *Aelony v. Arni*, 547 F.2d 566, 192 USPQ 486 (CCPA 1977) (finding an interference where the claims did not even overlap).

A “count” defines interfering subject matter. An interference may have two counts only if the second count defines a “separate patentable invention” from the first count. The reason the second count must define a separate patentable invention is to permit the USPTO to lawfully issue separate patents to different parties in an interference when a single party does not prevail as to all counts. A “separate patentable invention” is defined in 37 CFR 1.601(n):

Invention “A” is a *separate patentable invention* with respect to invention “B” when invention “A” is new (35 U.S.C. 102) and non-obvious (35 U.S.C. 103) in view of invention “B” assuming invention “B” is prior art with respect to invention “A”.

## 2302 Ownership of Applications and Patents Involved in an Interference

*37 CFR 1.602. Interest in applications and patents involved in an interference.*

(a) Unless good cause is shown, an interference shall not be declared or continued between (1) applications owned by a single party or (2) applications and an unexpired patent owned by a single party.

(b) The parties, within 20 days after an interference is declared, shall notify the Board of any and all right, title, and interest in any application or patent involved or relied upon in the interference unless the right, title, and interest is set forth in the notice declaring the interference.

(c) If a change of any right, title, and interest in any application or patent involved or relied upon in the interference occurs after notice is given declaring the interference and before the time expires for seeking judicial review of a final decision of the Board, the parties shall notify the Board of the change within 20 days after the change.

37 CFR 1.602 continues the previous USPTO practice (former 37 CFR 1.201(c)) of not declaring or continuing an interference between (A) two or more applications owned by the same party or (B) an application and a patent owned by a single party unless good cause is shown. A corporation and its wholly owned subsidiary are considered a “single party” within the meaning of 37 CFR 1.602(a).

### COMMON OWNERSHIP

Where applications by different inventive entities but of common ownership claim the same subject matter or subject matter that is not patentably different:

(A) Interference therebetween is normally not instituted since there is no conflict of interest. Elimination of conflicting claims from all except one application should usually be required. 37 CFR 1.78(c). The common assignee must determine the application in which the conflicting claims are properly placed. Treatment by rejection is set forth in MPEP § 804.03.

(B) Where an interference with a third party is found to exist, the commonly owned application having the earliest effective filing date will be placed in interference with the third party. The common assignee may move during the interference under 37 CFR 1.633(d) to substitute the other commonly owned application, if desired.

## 2303 Interference Between Applications

*37 CFR 1.603. Interference between applications; subject matter of the interference.*

Before an interference is declared between two or more applications, the examiner must be of the opinion that there is interfering subject matter claimed in the applications which is patentable to each applicant subject to a judgment in the interference. The interfering subject matter shall be defined by one or more counts. Each application must contain, or be amended to contain, at least one claim that is patentable over the prior art and corresponds to each count. All claims in the applications which define the same patentable invention as a count shall be designated to correspond to the count.

Where two or more applications are found to be claiming the same patentable invention, they may be put in interference, dependent on the status of the respective applications and the difference between their filing dates. One of the applications should be in condition for allowance. Unusual circumstances may justify an exception to this if the approval of the TC Director is obtained.

Interferences will not be declared between pending applications if there is a difference of more than 3 months in the effective filing dates of the oldest and the next oldest applications, in the case of inventions of a simple character, or a difference of more than 6 months in the effective filing dates of the applications in other cases, except in exceptional situations, as determined and approved by the TC Director. One such exceptional situation would be where one application has the earliest effective filing date based on foreign priority and the other application has the earliest effective United States filing date. If an interference is to be declared, all applications having the interfering subject matter should be identified.

Before proposing an interference, it is essential that the examiner make certain that each of the applications contains a claim to the same patentable invention (as defined in 37 CFR 1.601(n)) and that each of those claims is clearly readable upon the disclosure of that party and allowable in its application. See *Rowe v. Dror*, 112 F.3d 473, 479, 42 USPQ2d 1550, 1554 (Fed. Cir. 1997).

If the applications each contain at least one claim drawn to the same patentable invention (37 CFR 1.601(n)), the examiner proceeds to propose the interference; otherwise, one or more claims must be suggested to some or all of the parties. See MPEP § 2305. Since two applications do not have to contain

an identical claim in order to be placed in interference, the suggestion of a claim should not normally be necessary.

### **2303.01 Interference on Nonelected Subject Matter**

Where the subject matter found to be allowable in one application is disclosed and claimed in another application, but the claims therein to such subject matter are either nonelected or subject to election, the question of interference should be considered. The requirement of 37 CFR 1.601(i) that the conflicting applications shall contain claims for the same patentable invention should be interpreted as meaning generally that the conflicting claimed subject matter is sufficiently supported in each application and is patentable to each applicant over the prior art. The statutory requirement of first inventorship should be given primary emphasis and every effort should be made to avoid prematurely issuing a patent where there is an adverse claimant.

Following are illustrative situations where the examiner should take action toward instituting interference:

(A) Application filed with claims to divisible inventions I and II. Before action requiring restriction is made, examiner discovers another application having claims to invention I.

The situation is not altered by the fact that a requirement for restriction had actually been made but had not been replied to. Nor is the situation materially different if an election of noninterfering subject matter had been made without traverse but no action given on the merits of the elected invention.

(B) Application filed with claims to divisible inventions I and II and in reply to a requirement for restriction, applicant traverses the same and elects invention I. Examiner gives an action on the merits of I. Examiner subsequently finds an application to another containing allowed claims to invention II and which is ready for issue.

The situation is not altered by the fact that the election is made without traverse and the nonelected claims possibly canceled.

(C) Application filed with generic claims and claimed species a, b, c, d, and e. Generic claims rejected and election of a single species required.

Applicant elects species a, but continues to urge allowability of generic claims. Examiner finds another application claiming species b which is ready for issue.

An interference may be proposed even though the generic claims in the first application are not allowable.

(D) Application filed with generic claims and claims to five species and other species disclosed but not specifically claimed. Examiner finds another application the disclosure and claims of which are restricted to one of the unclaimed species and have been found allowable.

The prosecution of generic claims is taken as indication of an intention to cover all species disclosed which come under the generic claim.

In all the above situations, the applicant has shown an intention to claim the subject matter which is actually being claimed in another application. These are to be distinguished from situations where a distinct invention is claimed in one application but merely disclosed in another application without evidence of an intent to claim the same. The question of interference should not be considered in the latter instance. However, if the application disclosing but not claiming the invention is senior, and the junior application is ready for issue, the matter should be discussed with the TC Director to determine the action to be taken.

### **2304 Applicant Requests Interference Between Applications**

*37 CFR 1.604. Request for interference between applications by an applicant.*

(a) An applicant may seek to have an interference declared with an application of another by,

(1) Suggesting a proposed count and presenting at least one claim corresponding to the proposed count or identifying at least one claim in its application that corresponds to the proposed count,

(2) Identifying the other application and, if known, a claim in the other application which corresponds to the proposed count, and

(3) Explaining why an interference should be declared.

(b) When an applicant presents a claim known to the applicant to define the same patentable invention claimed in a pending application of another, the applicant shall identify that pending application, unless the claim is presented in response to a suggestion by the examiner. The examiner shall notify the Commissioner of any instance where it appears an applicant may have failed to comply with the provisions of this paragraph.

See MPEP § 2309 through § 2309.02 regarding procedures for preparation of interference papers by the examiner. If the applicant presents a new claim to provoke an interference with a published application, the examiner should determine whether the new claim is barred under 35 U.S.C. 135(b)(2). Note the one year from publication date limitation found in 35 U.S.C. 135(b) regarding applications published under 35 U.S.C. 122(b).

## 2305 Examiner Suggests Claim to Applicant

37 CFR 1.605. *Suggestion of claim to applicant by examiner.*

(a) If no claim in an application is drawn to the same patentable invention claimed in another application or patent, the examiner may suggest that an applicant present a claim drawn to an invention claimed in another application or patent for the purpose of an interference with another application or a patent. The applicant to whom the claim is suggested shall amend the application by presenting the suggested claim within a time specified by the examiner, not less than one month. Failure or refusal of an applicant to timely present the suggested claim shall be taken without further action as a disclaimer by the applicant of the invention defined by the suggested claim. At the time the suggested claim is presented, the applicant may also call the examiner's attention to other claims already in the application or presented with the suggested claim and explain why the other claims would be more appropriate to be designated to correspond to a count in any interference which may be declared.

(b) The suggestion of a claim by the examiner for the purpose of an interference will not stay the period for response to any outstanding Office action. When a suggested claim is timely presented, *ex parte* proceedings in the application will be stayed pending a determination of whether an interference will be declared.

While the claims of two or more applications may not be identical, if they are directed to the same patentable invention, as defined in 37 CFR 1.601(n), an interference exists. See MPEP § 2303. Therefore, it should be emphasized that it should not be necessary to suggest a claim to an applicant in most situations. If an applicant is not claiming the same patentable invention as another applicant, the examiner, in deciding whether to suggest a claim or claims to the first applicant, should bear in mind that mere disclosure by an applicant of an invention which he or she is not claiming does not afford a ground for suggesting to that applicant a claim for the said invention based upon claims from another application that is claiming the invention. The intention of the parties to claim the

same patentable invention, as expressed in the summary of the invention or elsewhere in the disclosure or in the claims, is essential to declaring an interference or suggesting interfering claims in every instance.

The question of what claim or claims to suggest in the interfering application is one of great importance, and failure to suggest claims that will clearly define the matter in issue leads to confusion and to prolongation of the contest.

Before deciding what claim or claims to suggest to an applicant, the examiner should decide what the count or counts of the prospective interference will be, keeping in mind that the count must be patentable over the prior art and define the parties' common invention. The claim suggested to the applicant need not be identical to the prospective count, but rather should be the broadest claim within the scope of the prospective count which the applicant's disclosure will support, and which is otherwise patentable to the applicant. In general, only one claim should be suggested for each prospective count. Moreover, if the other application has been published, the examiner should ensure that the suggested claim is not barred under 35 U.S.C. 135(b)(2).

Under 37 CFR 1.605, timely filing of an amendment presenting a claim suggested by the examiner for purposes of an interference would stay *ex parte* proceedings in the application in which the claim is presented pending a determination by the examiner of whether an interference will be declared. Also under 37 CFR 1.605(a), when an examiner suggests a claim, the applicant will be required to copy verbatim the suggested claim. At the time the suggested claim is copied, however, the applicant may also (A) call the examiner's attention to other claims already in the application or which are presented with the copied claim and (B) explain why the other claims would be more appropriate to be designated to correspond to a count in any interference which may be declared.

A reply to the examiner's suggestion of a claim is not complete unless it includes an amendment adding the exact claim suggested to the application. Even though the applicant may consider the suggested claim unpatentable, too narrow, or otherwise unsuitable, it must be presented; otherwise, the invention defined by the suggested claim is considered to be disclaimed. The applicant must make known any such

objections to the examiner, and may at the same time present other claims, or call the examiner's attention to other claims already in the application, and explain why those claims would be more appropriately designated to correspond to a count in the interference. The examiner may then determine whether the applicant's alternatively proposed claims are more appropriate than the claim suggested.

If, in copying a suggested claim, an error is introduced by the applicant, the examiner should correct the applicant's claim to correspond to the suggested claim.

It should be noted at this point that if an applicant presents a claim which allegedly corresponds exactly or substantially to a claim in another application or patent without suggestion by the examiner, 37 CFR 1.604(b) and 37 CFR 1.607(c) require him or her to identify the other application or patent. See MPEP § 2307.05.

If the parties have the same attorney, notification of this fact should be given to both parties at the time claims are suggested even though claims are suggested to only one party. Notation of the persons to whom this letter is mailed should be made on all copies.

The content of Form Paragraph 23.05 is usually added to the letter suggesting claims where the same attorney or agent is of record in applications of different ownership which have conflicting subject matter.

¶ *23.05 Same Attorney, Both Applications*

Attention is called to the fact that the attorney (or agent) in this application is also the attorney (or agent) in an application of another party and of different ownership claiming substantially the same patentable invention as claimed in the above identified application.

The examiner should raise the fact that two conflicting parties have the same attorney by drawing the matter to the attention of the Board when proposing the interference as explained in MPEP § 2309.02.

Form Paragraphs 23.04 and 23.06 may be used to suggest claims for purposes of interference to applicants. If the Office action incorporating these Form Paragraphs addresses other issues, such as a rejection of other claims, Form Paragraph 23.07 should be included at the end of the action.

¶ *23.04 Suggestion of Claim*

The following allowable claim is suggested for the purpose of an interference:

[1]

The suggested claim must be copied exactly, although other claims may be proposed under 37 CFR 1.605(a).

Applicant is given ONE MONTH or THIRTY DAYS, whichever is longer, from the mailing date of this communication to make the suggested claim. Failure to do so will be considered a disclaimer of the subject matter of this claim under the provisions of 37 CFR 1.605(a), but will **not** result in abandonment of this application. THE PROVISIONS OF 37 CFR 1.136 DO NOT APPLY TO THE TIME SPECIFIED IN THIS ACTION.

Claim [2] considered unpatentable over this suggested claim.

**Examiner Note:**

1. In bracket 1, insert the suggested claim.
2. In bracket 2, list all claims pending in the application not considered to be patentably distinct from the suggested claim.
3. Only one claim should be suggested unless claims to separate patentably distinct inventions are present. See 37 CFR 1.601(n). To suggest an additional claim to a separate distinct invention, form paragraph 23.06 should follow this paragraph.
4. If the Office action addresses other issues, such as a rejection of other claims, form paragraph 23.07 should be included at the end of the action.

¶ *23.06 Suggestion of Additional Claim for a Distinct Invention*

The following claim is considered allowable and directed to a separate patentable invention from the claim suggested above:

[1]

The additionally suggested claim must be copied exactly, although other claims may be proposed under 37 CFR 1.605(a).

Applicant is given ONE MONTH or THIRTY DAYS, whichever is longer, from the mailing date of this communication to make this additionally suggested claim. Failure to do so will be considered a disclaimer of the subject matter of this claim under the provisions of 37 CFR 1.605(a), but will **not** result in abandonment of this application. THE PROVISIONS OF 37 CFR 1.136 DO NOT APPLY TO THE TIME SPECIFIED IN THIS ACTION.

Claim [2] considered unpatentable over this additionally suggested claim.

**Examiner Note:**

This paragraph must be preceded by form paragraph 23.04 and should only be used to suggest a patentably distinct claim from the one suggested in form paragraph 23.04.

¶ *23.07 Suggestion of Claims - Prosecution Suspended*

Applicant need not respond to the remaining issues in this action if a suggested claim is copied for the purpose of an interference within the time limit specified above (37 CFR 1.605(b)).

**Examiner Note:**

This paragraph should be used at the end of any Office action where claims are suggested using either form paragraph 23.04 or 23.09 and where additional issues (e.g., a rejection of other claims) are addressed in the action that will be suspended should applicant copy the suggested claim.



### **2305.01 Action To Be Made at Time of Suggesting Claims**

At the same time that the claims are suggested, an action is made on each of the applications that are up for action by the examiner, whether they be new or amended applications. In this way, possible motions under 37 CFR 1.633(c) and (d) may be forestalled. That is, the action on the new or amended application may bring to light patentable claims that should be included as corresponding to the count, or as forming the basis for an additional count, of the interference, and, on the other hand, the rejection of unpatentable claims will serve to indicate to the opposing parties the position of the examiner with respect to such claims.

When an examiner suggests that an applicant present a claim for interference, the examiner should state which of the claims already in the application are, in his or her opinion, unpatentable over the claim suggested. This statement does not constitute a formal rejection of the claims, but if the applicant presents the suggested claim but disagrees with the examiner's statement, the applicant should so state on the record, not later than the time the claim is presented. *In re Bandel*, 348 F.2d 563, 146 USPQ 389 (CCPA 1965). If the applicant does not present the suggested claim by the expiration of the period fixed for its presentation, the examiner should then reject those claims which were previously stated as being unpatentable over the suggested claim on the basis that the failure to present constituted a concession that the subject matter of those claims is the prior invention of another in this country under 35 U.S.C. 102(g) and thus prior art to the applicant under 35 U.S.C. 103. *In re Oguie*, 517 F.2d 1382, 186 USPQ 227 (CCPA 1975). If the applicant does present the suggested claim, when the interference is declared, the claims stated to be unpatentable over the suggested claim will be designated as corresponding to the count.

### **2305.02 Time Limit Set for Presenting Suggested Claims**

Where claims are suggested for interference, a limited period determined by the examiner, not less than one month, is set for reply. See MPEP § 710.02(c).

Should any one of the applicants fail to present the claim or claims suggested within the time specified, all claims not patentable thereover are rejected on the ground that the applicant has disclaimed the invention to which they are directed. If the applicant presents the suggested claims later they will be rejected on the same ground. See MPEP § 706.03(u).

### **2305.03 Suggested Claims Presented After Period for Reply Running Against Application**

Claims may be suggested in an application near the end of the period for reply. If the time limit for presenting the claims extends beyond the end of the period, such claims will be admitted if presented within the time limit for making the claims. This is true even though the claims are presented outside the period for reply to the rejection (usually a 3-month shortened statutory period) and even though no amendment was filed in reply to the Office action outstanding against the application at the time the claims were suggested. However, if the suggested claims are not thus presented within the specified time, the application becomes abandoned in the absence of a reply filed within the period for reply to the rejection. 37 CFR 1.605(b).

### **2305.04 Suggestion of Claims, Application in Issue or in Interference**

An application will not be withdrawn from issue for the purpose of suggesting claims for an interference. When an application pending before the examiner contains one or more claims defining an invention to which claims may be presented in an application in issue, the examiner may write a letter suggesting such claims to the applicant whose application is in issue. The letter should state that if such claims are presented within a certain specified time, the application will be withdrawn from issue, the amendment entered, and the interference declared. Such letters must be submitted to the TC Director for approval. If the suggested claims are not presented in the application in issue, it may be necessary to withdraw it from issue for the purpose of rejecting other claims on the implied disclaimer resulting from the failure to present the suggested claims.

When the examiner suggests one or more claims for the purpose of interference with an application in issue to an applicant whose application is pending before him or her, the application in issue will not be withdrawn for the purpose of interference unless the suggested claims are presented in the pending application within the time specified by the examiner. The letter suggesting claims should be submitted to the TC Director for approval.

In either of the above cases, the Office of Patent Publication should be notified when the claims are suggested, so that in case the issue fee is paid during the time in which the suggested claims may be presented, proper steps may be taken to prevent the issue fee from being applied.

The examiner should borrow the allowed application from the Office of Patent Publication and hold the file until the claims are presented or the time limit expires. This avoids any possible issuance of the application as a patent should the issue fee be paid. To further ensure against issuance of the application, the examiner may pencil in the blank space labeled, "Date paid" in the lower right-hand corner of the face of the file wrapper, the initialed request: "Defer for interference." The issue fee is not applied to such an application until the following procedure is carried out.

When notified that the issue fee has been received, the examiner shall prepare a memo to the Office of Patent Publication requesting that issue of the patent be deferred for a period of 3-months due to possible interference. This allows a period of 2 months to complete any action needed. At the end of this 2-month period, the application must either be released to the Office of Patent Publication or be withdrawn from issue.

When an application is found claiming an invention for which claims are to be suggested to other applications already involved in interference, to form another interference, the TC Interference Practice Specialist, after obtaining the consent of the administrative patent judge in charge of the interference, borrows the last named applications from the Service Branch of the Board of Patent Appeals and Interferences. In case the application is to be added to an existing interference, the examiner should consult with the Interference Practice Specialist in accordance with MPEP § 2309. The Interference Practice Specialist will con-

sult with the administrative patent judge in charge of the interference who will determine the action to be taken. Also, see MPEP § 2342 and § 2364.01.

Form paragraph 23.08 may be used to withdraw an application from issue for consideration of a potential interference based on suggested claims. Form paragraph 23.19 may be used to notify applicant that the foreign priority claim has not been substantiated yet.

*¶ 23.08 Suggestion of Claims - Application in Issue*

This application has been withdrawn from issue for consideration of a potential interference based on the claims suggested in this action.

**Examiner Note:**

1. If a conflicting application is in issue, it should be withdrawn using form paragraph 10.01 prior to suggesting claims for interference.
2. Either form paragraph 23.04 or 23.09 must be used in conjunction with this paragraph.

*¶ 23.19 Foreign Priority Not Substantiated*

Should applicant desire to obtain the benefit of foreign priority under 35 U.S.C. 119(a)-(d) prior to declaration of an interference, a translation of the foreign application should be submitted under 37 CFR 1.55 in reply to this action.

**Examiner Note:**

This paragraph may be used when claims are suggested to applicant from either an application or a patent and applicant has a claim for priority, but has not filed a translation of the priority document.

## **2306 Interference Between an Application and a Patent**

*37 CFR 1.606. Interference between an application and a patent; subject matter of the interference.*

Before an interference is declared between an application and an unexpired patent, an examiner must determine that there is interfering subject matter claimed in the application and the patent which is patentable to the applicant subject to a judgment in the interference. The interfering subject matter will be defined by one or more counts. The application must contain, or be amended to contain, at least one claim that is patentable over the prior art and corresponds to each count. The claim in the application need not be, and most often will not be, identical to a claim in the patent. All claims in the application and patent which define the same patentable invention as a count shall be designated to correspond to the count.

An interference may be declared between an application and a patent if the application and patent are claiming the same patentable invention, as defined in 37 CFR 1.601(n), and at least one of the applicant's claims to that invention are patentable to the appli-

cant. Since at least one of the applicant's claims must be patentable, an interference between an application and a patent cannot be declared if:

(A) The patent is a reference against the application under 35 U.S.C. 102(b)/103;

(B) The applicant's claims are not supported by the application disclosure, or otherwise do not comply with 35 U.S.C. 112;

(C) The applicant was not claiming the same or substantially the same invention as claimed in the patent within 1 year after the date on which the patent was issued (35 U.S.C. 135(b); see also MPEP § 2307);

(D) The patent is a reference against the application under 35 U.S.C. 102(e)/103, unless the applicant has filed a showing under 37 CFR 1.608. See MPEP § 2307.02 concerning the rejection of claims in an application which correspond to claims of a patent.

Since the claims of a patent may not be altered (except by reissue or reexamination), the applicant must claim the same patentable invention as is claimed in one or more claims of a patent in order to provoke an interference with the patent. The fact that the patent may disclose subject matter claimed by the applicant is not a basis for interference if the patent does not claim that subject matter.

The counts of the interference are formulated based on essentially the same criteria regardless of whether or not a patent is involved. As stated in 37 CFR 1.601(f), "each count shall define a separate patentable invention." Therefore, instead of having the same number of counts as copied patent claims, the examiner determines how many separate patentable inventions are claimed by the applicant and the patentee. When the interference is declared, there will be only one count for each separate patentable invention, with all the claims of the applicant and of the patentee which claim each invention designated as corresponding to the count for that invention.

An interference between an application and a patent may arise in one of the following ways:

(A) During examination of an application, the examiner may determine that the application contains one or more allowable claims which are drawn to the same invention as claimed in a patent. In that event, the examiner may propose the interference as described in MPEP § 2309.

(B) The examiner may discover a patent having an effective U.S. filing date later than the effective filing date of an application which claims an invention which is disclosed by the applicant and to which the applicant could present patentable claims. In that event, the examiner should proceed in accordance with MPEP § 2306.01.

(C) The applicant may provoke an interference with a patent by presenting a proposed count and either presenting a claim corresponding to the proposed count, or identifying a claim already in the application that corresponds to the proposed count. See 37 CFR 1.607 and MPEP § 2307.

37 CFR 1.601(i) includes the possibility that an interference may include more than one unexpired patent. The USPTO does not have jurisdiction to determine interferences between patents. However, if the examiner discovers two or more patents which are claiming the same invention as an application, interferences may be instituted between the application and the patents. The TC Director's approval must be obtained before interferences involving multiple patents will be proposed.

## **PATENT IN DIFFERENT TECHNOLOGY CENTER**

When an applicant seeks to provoke an interference with a patent classified in another TC, the propriety of proposing the interference is decided by and the interference is proposed by the TC where the patent is classified. In such a case, it may be necessary to transfer the application, including the drawings, temporarily to the TC which will propose the interference.

### **2306.01 Patent Has Filing Date Later Than Application**

Although a patent which has an effective U.S. filing date later than the effective filing date of an application is not prior art against that application, the application should not be issued if the application and patent contain claims to the same patentable inven-

tion. In order to avoid the issuance of two patents to the same patentable invention, the examiner should take steps to propose an interference between the application and the patent.

If the application contains at least one allowable claim drawn to the same patentable invention as at least one patent claim, the examiner may propose the interference by proceeding as described in MPEP § 2309.

If the application discloses, but does not claim, an invention claimed in the patent, the examiner should suggest a claim or claims to the applicant (see MPEP § 2305), and include a statement that failure of the applicant to make the claim or claims will be taken as a concession that the subject matter of the claim or claims is the prior invention of another. Form Paragraphs 23.09 and 23.10 should be used for this purpose.

#### ¶ 23.09 Requirement To Copy Patent Claim

The following claim number [1] from U.S. Patent No. [2] is suggested to applicant under 35 U.S.C. 135(a) for the purposes of an interference:

[3]

The suggested claim must be copied exactly, although other claims may be proposed under 37 CFR 1.605(a).

Applicant is given ONE MONTH or THIRTY DAYS, whichever is longer, from the mailing date of this communication to copy this patent claim. Failure to do so will be considered a concession that the subject matter of this claim is the prior invention of another under 35 U.S.C. 102(g), and thus also prior art under 35 U.S.C. 103(a) (*In re Oguie*, 517 F.2d 1382, 186 USPQ 227 (CCPA 1975)), but will **not** result in the abandonment of this application. THE PROVISIONS OF 37 CFR 1.136 DO **NOT** APPLY TO THE TIME SPECIFIED IN THIS ACTION.

#### Examiner Note:

1. In bracket 1, insert the number from the patent of the suggested claim.
2. In bracket 2, insert the number of the patent.
3. In bracket 3, insert a copy of the patent claim.
4. Only one claim from the patent should be suggested for interference unless other claims to a separate patentably distinct invention are claimed in the patent and can be made by the applicant. To suggest an additional claim, form paragraph 23.10 should follow this paragraph.
5. If the Office action addresses other issues, such as a rejection of other claims, form paragraph 23.07 should be included at the end of the Office action.

#### ¶ 23.10 Copying Additional Patent Claims for a Distinct Invention

Claim number [1] from U.S. Patent No. [2] is suggested under 35 U.S.C. 135(a) in addition to claim [3] of the patent, suggested above. The inventions defined by these patent claims are consid-

ered to be "separate patentable inventions" under 37 CFR 1.601(n) which could form the basis for plural counts in an interference.

The suggested claim, reproduced below, must be copied exactly, although other claims may be proposed under 37 CFR 1.605(a).

[4]

Applicant is given ONE MONTH or THIRTY DAYS, whichever is longer, from the mailing date of this communication to copy this additional patent claim. Failure to do so will be considered a concession that the subject matter of this claim is the prior invention of another under 35 U.S.C. 102(g), and thus also prior art under 35 U.S.C. 103(a) (*In re Oguie*, 517 F.2d 1382, 186 USPQ 227 (CCPA 1975)). THE PROVISIONS OF 37 CFR 1.136 DO **NOT** APPLY TO THE TIME SPECIFIED IN THIS ACTION.

#### Examiner Note:

1. In bracket 1, insert the number of the patent claim that is patentably distinct from the claim specified in form paragraph 23.09.
2. This paragraph must follow form paragraph 23.09 and should only be used in those rare instances where both the patent and the application claim distinct, interfering inventions.

## 2307 Applicant Requests Interference With a Patent

*37 CFR 1.607. Request by applicant for interference with patent.*

(a) An applicant may seek to have an interference declared between an application and an unexpired patent by,

- (1) Identifying the patent,
- (2) Presenting a proposed count,
- (3) Identifying at least one claim in the patent corresponding to the proposed count,
- (4) Presenting at least one claim corresponding to the proposed count or identifying at least one claim already pending in its application that corresponds to the proposed count, and, if any claim of the patent or application identified as corresponding to the proposed count does not correspond exactly to the proposed count, explaining why each such claim corresponds to the proposed count, and
- (5) Applying the terms of any application claim,
  - (i) Identified as corresponding to the count, and
  - (ii) Not previously in the application to the disclosure of the application.
- (6) Explaining how the requirements of 35 U.S.C. 135(b) are met, if the claim presented or identified under paragraph (a)(4) of this section was not present in the application until more than one year after the issue date of the patent.

(b) When an applicant seeks an interference with a patent, examination of the application, including any appeal to the Board, shall be conducted with special dispatch within the Patent and Trademark Office. The examiner shall determine whether there is interfering subject matter claimed in the application and the patent which is patentable to the applicant subject to a judgment in an interference. If the examiner determines that there is any interfering subject matter, an interference will be declared. If the exam-

iner determines that there is no interfering subject matter, the examiner shall state the reasons why an interference is not being declared and otherwise act on the application.

(c) When an applicant presents a claim which corresponds exactly or substantially to a claim of a patent, the applicant shall identify the patent and the number of the patent claim, unless the claim is presented in response to a suggestion by the examiner. The examiner shall notify the Commissioner of any instance where an applicant fails to identify the patent.

(d) A notice that an applicant is seeking to provoke an interference with a patent will be placed in the file of the patent and a copy of the notice will be sent to the patentee. The identity of the applicant will not be disclosed unless an interference is declared. If a final decision is made not to declare an interference, a notice to that effect will be placed in the patent file and will be sent to the patentee.

If the applicant does not apply the terms of the claim presented to the disclosure of the application, i.e., does not state how each term of the copied claim is supported by the specification, as required by 37 CFR 1.607(a)(5), a one-month time period should be set for correction of this deficiency. Form Paragraph 23.12 should be used for this purpose.

### COMPLIANCE WITH 35 U.S.C. 135(b)

If the claim presented or identified as corresponding to the proposed count was added to the application by an amendment filed more than one year after issuance of the patent, or the application was not filed until more than one year after issuance of the patent (but the patent is not a statutory bar), then under the provisions of 35 U.S.C. 135(b), an interference will not be declared unless at least one of the claims which were in the application, or in a parent application, prior to expiration of the one-year period was for “substantially the same subject matter” as at least one of the claims of the patent. Therefore, 37 CFR 1.607(a)(6) requires that the request for interference with the patent include an explanation of how the requirements of 35 U.S.C. 135(b) are met. If this explanation is not provided, a one-month time period should be set for correction of this deficiency.

Further, if the patent issued from an application which was published under 35 U.S.C. 122(b), note the one year from publication date limitation found in 35 U.S.C. 135(b)(2) with respect to applications filed after the date of publication.

The explanation under 37 CFR 1.607(a)(6) must be considered by the examiner to determine whether the “substantially the same subject matter” requirement of

35 U.S.C. 135(b) has been met. In order for an application claim to be for “substantially the same subject matter” as a patent claim, it must contain all the material limitations of the patent claim. *Parks v. Fine*, 773 F.2d 1577, 227 USPQ 432 (Fed. Cir. 1985), *modified*, 783 F.2d 1036, 228 USPQ 677 (1986). See also *Corbett v. Chisholm*, 568 F.2d 759, 196 USPQ 337 (CCPA 1977); *In re Sitz*, 331 F.2d 617, 141 USPQ 505 (CCPA 1964); *Stalego v. Heymes*, 263 F.2d 334, 120 USPQ 473 (CCPA 1959); *Rieser v. Williams*, 255 F.2d 419, 118 USPQ 96 (CCPA 1958); *Emerson v. Beach*, 215 F.2d 290, 103 USPQ 45 (CCPA 1955); *In re Tanke*, 213 F.2d 551, 102 USPQ 93 (CCPA 1954); *Andrews v. Wickenden*, 194 F.2d 729, 93 USPQ 27 (CCPA 1952); *In re Frey*, 182 F.2d 184, 86 USPQ 99 (CCPA 1950); *Thompson v. Hamilton*, 152 F.2d 994, 68 USPQ 161 (CCPA 1946). The fact that the application claim may be broad enough to cover the patent claim is not sufficient. *In re Frey*, 182 F.2d 184, 86 USPQ 99 (CCPA 1950).

If none of the claims which were present in the application, or in a parent application, prior to expiration of the one-year period meets the “substantially for the same subject matter” test, the claims presented or identified as corresponding to the proposed count should be rejected under 35 U.S.C. 135(b). *In re McGrew*, 120 F.3d 1236, 43 USPQ2d 1632 (Fed. Cir. 1997).

Note that the expression “prior to one year from the date on which the patent was granted” in 35 U.S.C. 135(b) includes the one-year anniversary date of the issuance of a patent. *Switzer v. Sockman*, 333 F.2d 935, 142 USPQ 226 (CCPA 1964).

### SPECIAL DISPATCH

Examiners should note that 37 CFR 1.607 requires that examination of an application in which applicant seeks an interference with a patent “shall be conducted with special dispatch.”

See MPEP § 708.01.

Form paragraph 23.12 may be used to notify applicant of the failure to specifically apply each limitation of each of the copied claims to the disclosure of the application.

¶ 23.12 *Failure To Apply Terms of Proposed Claim to the Disclosure*

Claim [1] of this application has been copied from U.S. Patent No. [2] for the purpose of an interference.

Applicant has failed to specifically apply each limitation or element of each of the copied claim(s) to the disclosure of the application.

Applicant is given ONE MONTH or THIRTY DAYS, whichever is longer, to specifically apply each limitation or element of each of the copied claim(s) to the disclosure of the application. THE PROVISIONS OF 37 CFR 1.136 DO NOT APPLY TO THE TIME SPECIFIED IN THIS ACTION.

### **2307.01 Presentation of Claims Corresponding to Patent Claims Not a Reply to Last Office Action**

The presentation of claims corresponding to claims of a patent when not suggested by the Office does not constitute a reply to the last Office action unless the last Office action relied solely on the patent for the rejection of all the claims rejected in that action.

### **2307.02 Rejection of Claims Corresponding to Patent Claims**

When claims corresponding to claims of a patent are presented, the application is taken up at once and the examiner must determine whether the presented claims are unpatentable to the applicant on any ground(s), e.g., under 35 U.S.C. 102, 35 U.S.C. 103, 35 U.S.C. 112, 35 U.S.C. 135(b), double patenting, etc. If at least one of the presented claims is not rejectable on any such ground and is claiming the same invention as at least one claim of the patent, the examiner should proceed to propose an interference.

If all of the claims presented are rejectable on any grounds, they should be so rejected. The ground of rejection of the claims presented may or may not be one which would also be applicable to the corresponding claims in the patent. If the ground of rejection is also applicable to the corresponding claims in the patent, any letter including the rejection must have the approval of the TC Director. See MPEP § 1003. Examples of grounds of rejection which would not also be applicable to the patent are double patenting, insufficient disclosure in the application, a reference whose date is junior to that of the patent, or a bar under 35 U.S.C. 135(b) (see MPEP § 2307).

The examiner should not proceed to propose an interference where the examiner is aware of a reference or other ground of unpatentability for the appli-

cation claims which correspond to the patent claims, even if the ground of unpatentability would also be applicable to the patent claims. Although an applicant may wish to have his or her application placed in interference with a patent in order to raise a ground of unpatentability against the patent claims, an interference will not be proposed unless at least one of the claims in the application corresponding to the claims of the patent is allowable.

If the patent has a filing date earlier than the application effective filing date, see MPEP § 2308.01.

37 CFR 1.607(b) requires that “[w]hen an applicant seeks an interference with a patent, examination of the application, including any appeal to the Board, shall be conducted with special dispatch within the Patent and Trademark Office.” Therefore, when all the claims presented are rejected the examiner sets a time limit for reply, not less than 30 days, and all subsequent actions, including action of the Board on appeal, are special. Failure by the applicant to reply or appeal within the time limit, will, in the absence of a satisfactory showing, be deemed a disclaimer of the invention claimed.

While the time limit for an appeal from the final rejection of a claim corresponding to a patent claim is usually set under the provisions of 37 CFR 1.607(b), where the remainder of the application is ready for final action, it may be advisable to set a shortened statutory period for the entire application in accordance with 37 CFR 1.134.

There is an important distinction between a limited time for reply under 37 CFR 1.607(b) and a shortened statutory period under 37 CFR 1.134. The penalty resulting from failure to reply within the time limit under 37 CFR 1.607(b) is loss of the claim or claims involved, on the doctrine of disclaimer, and this is appealable; while failure to reply within the set statutory period (37 CFR 1.134) results in abandonment of the entire application. This is not appealable.

The rejection of claims presented for interference with a patent sometimes creates a situation where two different periods for reply are running against the application - one, the statutory period dating from the last full action on the application; the other, the limited period set for the reply to the rejection (either first or final) of the presented claims. This situation should be avoided where possible, for example, by setting a shortened period for the entire application, but where

the situation is unavoidable, it should be emphasized in the examiner's letter.

In this connection it is to be noted that a reply to a rejection or an appeal from the final rejection of the presented claims will not stay the running of the regular statutory period if there is an unanswered Office action in the application at the time of reply or appeal, nor does such reply or appeal relieve the examiner from the duty of acting on the application if it is up for action, when reached in its regular order.

Where an Office action sets a time limit for reply to or appeal from that action or a portion thereof, the examiner should note at the end of the letter the date when the time limit period ends and also the date when the statutory period ends. See MPEP § 710.04.

Form paragraph 23.13 may be used to reject a claim corresponding to a proposed count. Form paragraph 23.14 may be used to reject a claim as not being made prior to one year of the patent issue date. Form paragraph 23.14.01 may be used to reject a claim as not being made prior to one year from the application publication date. Form paragraph 23.15 may be used to notify applicant that the copied claims are drawn to a different invention.

¶ 23.13 *Rejection of Claim Corresponding to Proposed Count*

Claim [1] of this application has been copied by the applicant from U.S. Patent No. [2]. This claim is not patentable to the applicant because [3].

An interference cannot be initiated since a prerequisite for interference under 37 CFR 1.606 is that the claim be patentable to the applicant subject to a judgment in the interference.

**Examiner Note:**

This paragraph must be preceded by a rejection of the claim.

¶ 23.14 *Claims Not Copied Within One Year of Patent Issue Date*

Claim [1] rejected under 35 U.S.C. 135(b) as not being made prior to one year from the date on which U.S. Patent No. [2] was granted. See *In re McGrew*, 120 F.3d 1236, 1238, 43 USPQ2d 1632,1635 (Fed. Cir. 1997) where the Court held that the application of 35 U.S.C. 135(b) is not limited to *inter partes* interference proceedings, but may be used as a basis for *ex parte* rejections.

¶ 23.14.01 *Claims Not Copied Within One Year of Application Publication Date*

Claim [1] rejected under 35 U.S.C. 135(b) as not being made prior to one year from the date on which [2] was published under 35 U.S.C. 122(b). See *In re McGrew*, 120 F.3d 1236, 1238, 43 USPQ2d 1632,1635 (Fed. Cir. 1997) where the Court held that the

application of 35 U.S.C. 135(b) is not limited to *inter partes* interference proceedings, but may be used as a basis for *ex parte* rejections.

**Examiner Note:**

1. In bracket 2, insert the publication number of the published application.
2. This form paragraph should only be used if the application being examined was filed after the publication date of the published application.

¶ 23.15 *Copied Claims Drawn to Different Invention*

Claim [1] of this application is asserted by applicant to correspond to claim(s) of U.S. Patent No. [2].

The examiner does not consider this claim to be directed to the same invention as that of U.S. Patent No. [3] because [4]. Accordingly, an interference cannot be initiated based upon this claim.

### 2307.03 Presentation of Claims for Interference With a Patent, After Prosecution of Application is Closed

An amendment presenting a claim to provoke an interference in an application not in issue is usually admitted and promptly acted on. However, if the application had been closed to further prosecution as by final rejection or allowance of all the claims, or by appeal, such amendment is not entered as a matter of right.

An interference may result when an applicant presents claims to provoke an interference with a patent which provided the basis for final rejection. Where this occurs, if the rejection in question has been appealed, the Board of Patent Appeals and Interferences should be notified of the withdrawal of this rejection so that the appeal may be dismissed as to the involved claims.

Where the prosecution of the application is closed and the presented claims relate to an invention distinct from that claimed in the application, entry of the amendment may be denied. See *Ex parte Shohan*, 48 USPQ 326, 1941 C.D. 1 (Comm'r Pat. 1940). Admission of the amendment may very properly be denied in an application where prosecution is closed, if *prima facie*, the claims are not supported by the applicant's disclosure. An applicant may not present a claim corresponding to a patent claim which applicant has no right to make as a means to reopen or prolong the prosecution of his or her application. See MPEP § 714.19.

## AFTER NOTICE OF ALLOWANCE

When an amendment which includes one or more claims presented to provoke an interference with a patent is received after the Notice of Allowance and the examiner finds one or more of the claims patentable to the applicant and an interference to exist, the examiner should prepare a letter, requesting that the application be withdrawn from issue for the purpose of interference. This letter, which should designate the claims to be involved, together with the file and the proposed amendments, should be sent to the TC Director.

When an amendment which includes one or more claims presented to provoke an interference with a patent is received after Notice of Allowance, and the examiner finds basis for refusing the interference on any ground, the examiner should make an oral report to the supervisory patent examiner of the reasons for refusing the requested interference. Notification to applicant is made on Form PTOL-271 if the entire amendment or a portion of the amendment (including all the presented claims) is refused. Form Paragraph 23.01 should be employed to express the adverse recommendation as to the entry of the presented claims.

### ¶ 23.01 Entry of Claims Disapproved

Entry of claim [1] disapproved because [2]. This application will not be withdrawn from issue.

#### Examiner Note:

In bracket 2, insert brief statement of basic reasons for disapproval. See MPEP § 2307.03.

## 2307.04 Presentation of Claims for Interference With a Patent Involved in a Reexamination Proceeding

An interference will not be proposed for a patent which is involved in a reexamination proceeding except upon specific authorization from the Office of the Deputy Commissioner for Patent Examination Policy. Claims which would interfere with the patent may be rejected on any applicable ground, including, if appropriate, the prior art cited in the reexamination proceeding. See MPEP § 2307.02. Prosecution of the application should continue as far as possible, but if the application is placed in condition for allowance and still contains claims which interfere with the

patent under reexamination, further action on the application should be suspended until the reexamination proceeding is terminated. See MPEP § 2284.

Form paragraph 23.16 may be used to notify applicant that the prosecution of the application is suspended until the reexamination proceeding of the patent with the conflicting claims is terminated.

### ¶ 23.16 Patent Claims Undergoing Reexamination

This application contains claims which conflict with the claims of U.S. Patent No. [1], now involved in a reexamination proceeding.

Prosecution in this application is SUSPENDED until termination of the reexamination proceeding.

Applicant should inquire as to the status of this application SIX MONTHS from the date of this letter.

#### Examiner Note:

This paragraph should only be used when the application is otherwise in condition for allowance.

## 2307.05 Corresponding Patent Claims Not Identified

37 CFR 1.607(c) requires that “[w]hen an applicant presents a claim which corresponds exactly or substantially to a claim of a patent, the applicant shall identify the patent and the number of the patent claim, unless the claim is presented in response to a suggestion by the examiner.”

This requirement of 37 CFR 1.607(c) applies to claims presented in an application at the time of filing as well as to claims presented in an amendment to a pending application. If an applicant, attorney, or agent presents a claim corresponding exactly or substantially to a patent claim without complying with 37 CFR 1.607(c), the examiner may be led into making an action different from what would have been made had the examiner been in possession of all the facts. Therefore, failure to comply with 37 CFR 1.607, when presenting a claim corresponding to a patent claim, may result in the issuance of a requirement for information as to why an identification of the source of the claim was not made. Also see 37 CFR 10.23(c)(7).

The examiner should require the applicant to supply a full identification of the copied patent claims by using Form Paragraph 23.11.

### ¶ 23.11 Failure To Identify Source of Patent Claims

Claim [1] of this application [2] apparently been copied from a U.S. patent without being suggested by the examiner. The patent



number and the number of the copied claims have not been properly identified. 37 CFR 1.607(c).

Applicant is required to identify the patent and claim numbers and supply information explaining why a complete identification of the copied patent claim(s) has not been presented. Following applicant's reply to this requirement or the abandonment thereof, this application will be forwarded by the examiner to the Office of the Assistant Commissioner for Patents for appropriate review as noted under 37 CFR 1.607(c).

Applicant is given a TIME PERIOD of ONE MONTH or THIRTY DAYS, whichever is longer, from the mailing date of this communication for reply to avoid abandonment of this application.

**Examiner Note:**

1. The primary examiner must refrain from commenting as to the reasons for applicant's failure to disclose the U. S. patent identification.
2. In bracket 2, insert --has-- or --have--, as appropriate.

After the applicant's reply or abandonment of the application, the examiner is required to "notify the Commissioner of any instance where an applicant fails to identify the patent" under 37 CFR 1.607(c). The examiner's notification should be in the form of a memorandum directed to the Office of the Deputy Commissioner for Patent Examination Policy. The memorandum must be accompanied by the application and a copy of the patent from which the claim(s) was copied.

## 2307.06 Presentation of Claims for Interference with a Patent, Patentee Must Be Notified

When an applicant seeks to provoke an interference with a patent, 37 CFR 1.607(d) requires that the patentee be notified (1) when the attempt to provoke the interference is first made, and (2) if an interference is not declared, of the final decision not to declare an interference.

This rule provides a patentee with notice as soon as an applicant attempts to provoke an interference with the patent so that the patentee can preserve the invention records from the moment the notice is received until the time, in some instances many years later,

when the interference is ultimately declared between the patentee and the applicant.

Form paragraphs 23.20 and 23.21 should be used to notify the patentee.

¶ 23.20 *Notice to Patentee, Interference Sought*

**[USPTO Letterhead]**

[1]

You are hereby notified under 37 CFR 1.607(d) that an applicant is seeking to provoke an interference with your U. S. Patent No. [2].

The identity of the applicant will not be disclosed unless an interference is declared.

If a final decision is made not to declare an interference, a notice to that effect will be placed in the patent file and will be sent to the patentee.

If an interference is declared, notice thereof will be made under 37 CFR 1.611.

---

[3]

Primary Examiner  
Art Unit [4]  
(703) [5]

**Examiner Note:**

1. This form paragraph is printed with the USPTO Letterhead.
2. In bracket 1, insert the mailing address of the patentee.
3. In bracket 3, insert the name of the Primary Examiner.

¶ 23.21 *Notice to Patentee, Interference Not Declared*

**[USPTO Letterhead]**

[1]

Notice was communicated to you under 37 CFR 1.607(d) on [2] that an applicant was seeking to provoke an interference with your U.S. Patent No. [3].

A final determination of this issue has resulted in a decision not to declare an interference.

No inquiries regarding the identity of the applicant will be entertained.

---

[4]

Primary Examiner  
Art Unit [5]  
(703) [6]

**Examiner Note:**

1. This form paragraph is printed with the USPTO Letterhead.
2. In bracket 1, insert the mailing address of the patentee.
3. In bracket 2, insert the date of mailing of the earlier notice that claims had been copied from that patent.
4. In bracket 4, insert the name of the Primary Examiner.

It is anticipated that patentees may make inquiries as to the status of the application after the first notification has been received. Since the Technology Center (TC) having responsibility for the application will be indicated on the letter and the letter will not contain any information pertaining to that application, it will be necessary for each TC to establish and maintain some type of permanent record. The type of permanent record is left to the discretion of the TC Director. This permanent record must be independent of the application file and the patented file in order to provide adequate information for patentee inquiries relative to nonreceipt of either a second notice or a notice of declaration of interference either before or after either is mailed from the United States Patent and Trademark Office. Additionally, the permanent record must associate the appropriate patent number and the application number. This record could be a separate TC file for 37 CFR 1.607(d) notices sent to patentees having appropriate identification of the patent and application.

In summary, a 37 CFR 1.607(d) notice (Form Paragraph 23.20) is prepared by a person in the TC having jurisdiction over the application attempting to provoke an interference with a patent. The original is placed of record in the patented file, one copy is sent to the patentee, and an entry is made in the permanent TC record for 37 CFR 1.607(d) notices.

If a final decision is made that no interference will be declared, a primary examiner will prepare and sign a 37 CFR 1.607(d) notice (Form Paragraph 23.21). The original of this notice is entered of record in the patented file, one copy is sent to the patentee, and another entry is made in the permanent record for 37 CFR 1.607(d) notices. If an interference is to be instituted, the declaration of interference notice will be sent by an administrative patent judge and no additional form will be sent by the examiner.

**Although the permanent record for 37 CFR 1.607(d) notices includes identification both of the patent and application, the patentee cannot and should not be given any information concerning the party or application attempting to provoke an interference unless and until an interference is declared. 35 U.S.C. 122.**

## **2308 Interference Between an Application and a Patent; Prima Facie Showing by Applicant**

*37 CFR 1.608. Interference between an application and a patent; prima facie showing by applicant.*

(a) When the effective filing date of an application is three months or less after the effective filing date of a patent, before an interference will be declared, either the applicant or the applicant's attorney or agent of record shall file a statement alleging that there is a basis upon which the applicant is entitled to a judgment relative to the patentee.

(b) When the effective filing date of an application is more than three months after the effective filing date of a patent, the applicant, before an interference will be declared, shall file evidence which may consist of patents or printed publications, other documents, and one or more affidavits which demonstrate that applicant is *prima facie* entitled to a judgment relative to the patentee and an explanation stating with particularity the basis upon which the applicant is *prima facie* entitled to the judgment. Where the basis upon which an applicant is entitled to judgment relative to a patentee is priority of invention, the evidence shall include affidavits by the applicant, if possible, and one or more corroborating witnesses, supported by documentary evidence, if available, each setting out a factual description of acts and circumstances performed or observed by the affiant, which collectively would *prima facie* entitle the applicant to judgment on priority with respect to the effective filing date of the patent. To facilitate preparation of a record (§ 1.653(g)) for final hearing, an applicant should file affidavits on paper which is 21.8 by 27.9 cm. (8 1/2 x 11 inches). The significance of any printed publication or other document which is self-authenticating within the meaning of Rule 902 of the Federal Rules of Evidence or § 1.671(d) and any patent shall be discussed in an affidavit or the explanation. Any printed publication or other document which is not self-authenticating shall be authenticated and discussed with particularity in an affidavit. Upon a showing of good cause, an affidavit may be based on information and belief. If an examiner finds an application to be in condition for declaration of an interference, the examiner will consider the evidence and explanation only to the extent of determining whether a basis upon which the application would be entitled to a judgment relative to the patentee is alleged and, if a basis is alleged, an interference may be declared.

Under 37 CFR 1.608, an applicant seeking to provoke an interference with a patent is required to submit evidence which demonstrates that the applicant is *prima facie* entitled to a judgment relative to the patentee. Evidence must be submitted when the effective filing date of the application is more than 3 months after the effective filing date of the patent. The evidence may relate to patentability and need not be restricted to priority, but if the evidence shows that

the claims of the application are not patentable, the claims in the application will be rejected. The applicant can file a request for reexamination of the patent, if applicable.

### **2308.01 Patent Has Filing Date Earlier Than Application**

When an applicant attempts to provoke an interference with a patent, the examiner must determine the effective filing dates of the application and of the patent; only the patent's effective United States filing date will be considered. Any claim of foreign priority by the patentee under 35 U.S.C. 119(a) will not be taken into account when determining whether or not an interference should be declared, in order to be consistent with the holding in *In re Hilmer*, 359 F.2d 859, 149 USPQ 480 (CCPA 1966), that the effective date of a United States patent *as a reference* is not affected by the foreign filing date to which the patentee is entitled under 35 U.S.C. 119(a). If the patentee is determined to be entitled to the benefit of a prior United States application as to claimed subject matter involved in the interference, that application must be listed on the PTO-850 form (see MPEP § 2309.02).

If the effective filing date of the application is 3 months or less after the effective filing date of the patent, the applicant must submit a statement alleging that there is a basis upon which the applicant is entitled to a judgment relative to the patentee. 37 CFR 1.608(a). The statement may be made by persons other than the applicant. See MPEP § 715.04.

If the effective filing date of the application is more than 3 months after the effective filing date of the patent, 37 CFR 1.608(b) requires that the applicant must file (A) evidence, such as patents, publications and other documents, and one or more affidavits or declarations which demonstrate that applicant is *prima facie* entitled to a judgment relative to the patentee, and (B) an explanation stating with particularity the basis upon which the applicant is *prima facie* entitled to the judgment.

If an applicant is claiming the same invention as a patent which has an earlier effective United States filing date but there is not a statutory bar against the application, and the applicant has not submitted the items required by 37 CFR 1.608(a) or (b), as appropriate, the application should be rejected under 35 U.S.C. 102(e)/103. A statement should be included

in the rejection that the patent cannot be overcome by an affidavit or declaration under 37 CFR 1.131 but only through interference proceedings. Note, however, 35 U.S.C. 135(b) and MPEP § 2307. The applicant should also be advised that an affidavit under 37 CFR 1.608(b) or evidence *and* an explanation under 37 CFR 1.608(b), as appropriate, must be submitted and it should be stated, if applicable, that the patentee has been accorded the benefit of an earlier U.S. application.

If the applicant does not agree he or she is claiming the same invention as the patent, and files an affidavit under 37 CFR 1.131, the rejection should be repeated and made final. The rejection should specify what the count or counts of the interference between the application and the patent would be. If the applicant still disagrees with the examiner, the rejection may be appealed to the Board of Patent Appeals and Interferences, and the question of whether the application and the reference patent are claiming the same invention may be argued on appeal, inasmuch as the 37 CFR 1.131 affidavit cannot be considered unless the applicant is found to be claiming an invention which is patentably distinct from that claimed in the patent. See *In re Clark*, 457 F.2d 1004, 173 USPQ 359 (CCPA 1972) and *In re Hidy*, 303 F.2d 954, 133 USPQ 650 (CCPA 1962).

### **2308.02 Showing Under 37 CFR 1.608(b)**

The showing under 37 CFR 1.608(b) must be such as to show that the applicant is *prima facie* entitled to a judgment relative to the patentee. 35 U.S.C. 135(a) gives the Board jurisdiction in an interference proceeding over questions of both priority and patentability. Therefore, the 37 CFR 1.608(b) showing need not attempt to show prior invention by the applicant. Instead, it may demonstrate that the applicant would be entitled to a judgment against the patentee on a ground of unpatentability which does not apply to applicant's claims (as, for example, that the claims of the patent which will correspond to the count or counts are unpatentable over prior art or prior public use, or that the patent does not comply with 35 U.S.C. 112). Note, however, the last paragraph of this section.

An applicant in preparing affidavits or declarations under 37 CFR 1.608(b) to provoke an interference with a patentee whose effective U.S. filing date ante-

dates the applicant's by more than 3 months, should have in mind the provisions of 37 CFR 1.617, and especially the following:

(A) After these affidavits or declarations are forwarded by the primary examiner for the declaration of an interference, they will be examined by an administrative patent judge.

(B) If the affidavits or declarations fail to establish that applicant would *prima facie* be entitled to a judgment relative to the patentee, an order will be issued concurrently with the notice of interference, requiring applicant to show cause why summary judgment should not be entered against the applicant.

(C) Additional evidence in response to such order will not be considered unless justified by a showing under the provisions of 37 CFR 1.617(b). If the applicant responds, the applicant must serve the patentee and any other opponents with a copy of the original showing under 37 CFR 1.608(b) and of the response, and they will be entitled to present their views with respect thereto (37 CFR 1.617(d)).

(D) All affidavits or declarations submitted must describe acts which the affiants performed or observed, or circumstances observed, such as structure used and results of use or test, except on a proper showing as provided in 37 CFR 1.608(b). Statements of conclusion, for example, that the invention of the counts was reduced to practice, are generally considered to be not acceptable. It should also be kept in mind that documentary exhibits which are not self-authenticated must be authenticated and discussed with particularity by an affiant having direct knowledge of the matters involved. However, it is not necessary that the exact date of conception or reduction to practice be revealed in the affidavits, declarations, or exhibits if the affidavits or declarations aver observation of the necessary acts and facts, including documentation when available, before the patentee's effective filing date. On the other hand, where reliance is placed upon diligence, the affidavits or declarations and documentation should be precise as to dates from a date just prior to patentee's effective filing date. The showing should relate to the essential factors in the determination of the question of priority of invention as set out in 35 U.S.C. 102(g).

(E) The explanation required by 37 CFR 1.608(b) should be in the nature of a brief or of explanatory remarks accompanying an amendment. The explana-

tion should set forth the manner in which the requirements of the counts are satisfied and how the requirements for conception, reduction to practice, or diligence are met, or otherwise explain the basis on which the applicant is *prima facie* entitled to a judgment.

(F) Published decisions of the Court of Appeals for the Federal Circuit, Court of Customs and Patent Appeals and the Board of Patent Interferences concerning the quantum of proof required by an applicant to make out a *prima facie* showing entitling the applicant to an award of priority with respect to the filing date of a patent so as to allow the interference to proceed, 37 CFR 1.617(a), second sentence, include *Schendel v. Curtis*, 83 F.3d 1399, 38 USPQ2d 1743 (Fed. Cir. 1996); *Hahn v. Wong*, 892 F.2d 1028, 13 USPQ2d 1313 (Fed. Cir. 1989); *Wetmore v. Quick*, 536 F.2d 937, 190 USPQ 223 (CCPA 1976); *Golota v. Strom*, 489 F.2d 1287, 180 USPQ 396 (CCPA 1974); *Schwab v. Pittman*, 451 F.2d 637, 172 USPQ 69 (CCPA 1971); *Kistler v. Weber*, 412 F.2d 280, 162 USPQ 214 (CCPA 1969); *Azar v. Burns*, 188 USPQ 601 (Bd. Pat. Int. 1975); *Horvitz v. Pritchard*, 182 USPQ 505 (Bd. Pat. Int. 1974); and *Murphy v. Eiseman*, 166 USPQ 149 (Bd. Pat. Int. 1970).

As noted above, the evaluation of a showing under 37 CFR 1.608(b) is made by an administrative patent judge. However, when a showing under 37 CFR 1.608(b) is filed, the examiner must inspect it to determine whether the applicant is relying upon prior invention or unpatentability as a basis for the showing. If the applicant alleges prior invention, the examiner should merely determine that (A) at least one date prior to the effective filing date of the patent is alleged and (B) the showing contains at least one affidavit or declaration by a corroborating witness, i.e., by someone other than a named inventor. If these conditions are met the examiner should proceed to propose the interference as described in MPEP § 2309. If the showing is based on alleged unpatentability of the patent claim or claims, the examiner should determine whether any ground of unpatentability alleged is such that it would also apply to the applicant; for example, if the applicant alleges that the claims of the patent are statutorily barred by a reference which would also be a bar to the applicant. If the examiner finds that an alleged ground of unpatentability would also apply to the applicant, the interference

should not be proposed and the applicant's claims which are drawn to the same invention as the claims of the patent should be rejected on this admission of unpatentability, without regard to the merits of the matter. Compare *Ex parte Grall*, 202 USPQ 701 (Bd. App. 1978). Although the applicant may wish to contest the question of whether the common invention is patentable to the patentee, an interference cannot be declared unless the common invention is patentable to the applicant. *Hilborn v. Dann*, 546 F.2d 401, 192 USPQ 132 (CCPA 1976). If the alleged unpatentability is based on patents or printed publications, the applicant may still be able to file a request for reexamination of the patent under 35 U.S.C. 302.

### 2309 Proposed Interference

Once an examiner has identified a potential interference, the examiner should take the following steps:

(A) Obtain all relevant files. Before an interference is declared, the examiner must have on hand all of the files to be included in the interference, including the application file for any involved patent. The examiner must also have all of the files for which the applicant (or patentee) will be accorded benefit. It is also useful to look at related applications and patents of the same inventors or assignees to ensure that all necessary issues are resolved.

(B) Confirm that the proposed involved claims are still active. The involved applications must not be abandoned. The patents must not be expired for, among other things, failure to pay a maintenance fee. Also check that the involved claims have not been disclaimed.

(C) If one of the involved files is a published application or a patent, check for compliance with 35 U.S.C. 135(b). A claim must have been first presented within one year of the date of publication for the published application or patent, unless a substantially similar claim was previously pending.

(D) Obtain a certified copy of any foreign benefit documents where necessary. 37 CFR 1.55(a).

(E) Discuss the proposed interference with an Interference Practice Specialist in the examiner's TC. The examiner should address all of the Interference Practice Specialist's suggestions on proposing the interference, including a suggestion that no interference be proposed.

(F) When the examiner has addressed the Interference Practice Specialist's suggestions, the Interference Practice Specialist will initiate a conference with the Board by sending a copy of the proposed involved claims, and usually a draft Form PTO-850, to the Board and by scheduling a conference.

(G) If the Board agrees that an interference may be proper, a conference will occur with a representative from the Board and an Interference Practice Specialist, and usually with the examiner as well. The purposes of the conference are

(1) to confirm the existence of and need for an interference,

(2) to ensure compliance with all procedural requisites, and

(3) to identify any facts that need to be found or conclusions that need to be reached on the record before the interference may be declared.

(H) Prepare the necessary fact-findings and conclusions for transmittal to the Board along with all of the involved and benefit files.

An applicant seeking to have an interference declared may facilitate the examiner's proposal of an interference by providing as much of the foregoing information as possible in a convenient form, e.g., providing certified copies of the foreign benefit documents and clean copies of the involved claims.

After the conclusion of the interference, the files will ordinarily be returned to an Interference Practice Specialist in the TC, who will also be able to assist the examiner in applying estoppels or recommendations that result from the interference.

#### 2309.02 Preparation of Papers

##### INTERFERENCE INITIAL MEMORANDUM

If the proposed interference will involve a patent, the examiner should first determine whether the maintenance fees have been paid, by using the patent number with PALM Intranet, PALM screen 2970, or contacting the USPTO Status and Entity Division. See MPEP § 1730. If fees are due and they have not been paid, the interference cannot be declared since it would involve an expired patent (35 U.S.C. 135(a); 37 CFR 1.606).

A sample of a Form PTO-850 is shown at the end of this section.

A separate form is used for each count of the interference. The form need not be typed. If the count is identical to a claim of one of the parties, the number of that claim is circled. If the count is not identical to any claim of any of the parties, the count should be typed on a plain sheet and attached to the form.

The files to be included in the interference should be listed by last name (of the first listed inventor if application is joint), application number, filing date, and, if applicable, patent number and issue date.

The sequence in which the parties are listed on the form is completely immaterial. If the examiner has determined that a party is entitled to the benefit of the filing date of one or more applications (or patents) as to the counts, the blanks provided on the form for indicating this fact should be filled in as to all such applications. It is particularly important to list all intermediate applications necessary to provide continuity of pendency to the earliest benefit application to which a party is entitled.

An applicant may be accorded the benefit of a foreign application on the Form PTO-850 and the declaration notices only if the papers required by 37 CFR 1.55, including an English translation of the foreign application, have been filed and the primary examiner has determined that the applicant is in fact entitled to the benefit of such application. In addition, for utility or plant applications filed on or after November 29, 2000, the applicant must submit the priority claim within the time required by 37 CFR 1.55(a)(1) or file a grantable petition, including the surcharge set forth in 37 CFR 1.17(t), for an unintentionally delayed priority claim under 37 CFR 1.55(c). A patentee may be accorded the benefit of the filing date of a foreign application in the notice of interference provided he or she has complied with the requirements of 37 CFR 1.55, has filed an English translation, if required, and the primary examiner has determined that at least one species within the count involved in the interference is supported by the disclosure of the foreign application.

All claims in each party's application or patent must be listed in the spaces provided on the form as either corresponding or not corresponding to the count. A claim corresponds to a count if, considering the count as prior art, the claim would be unpatentable

over the count under 35 U.S.C. 102 or 35 U.S.C. 103. If the examiner is in doubt as to whether a party's claim does or does not correspond to a count, it should be listed as corresponding to the count. If the party disagrees with this listing, a motion may be filed under 37 CFR 1.633(c)(4) during the interference to designate the claim as not corresponding to the count.

Note that for each count, every claim in a party's application or patent must be designated as either corresponding or not corresponding to the count; this includes any claims of the application which may be under rejection. For every claim of an application which is listed on the form, the examiner must indicate whether or not that claim is allowable by writing its number in either the "patented or patentable pending claims" box or the "unpatentable pending claims" box on the form. All patent claims and at least one of the application claims designated as corresponding to the count must be listed in the "patented or patentable pending claims" box.

If an involved application or patent contains multiple dependent claims, the examiner should be careful to indicate which embodiments of each multiple dependent claim correspond or do not correspond to each count. An embodiment of a multiple dependent claim should not be circled on form PTO-850 as being the count, but rather, the embodiment should be written out in independent form in the space provided.

After Form PTO-850 is filled out for each count of the proposed interference, it must be signed by the primary examiner and an Interference Practice Specialist in the space provided. The form must also be signed by the TC Director, if the TC Director's approval is required (as when the interference involves two applications whose effective filing dates are more than 6 months apart).

The examiner should keep a copy of the form or forms and all attachments for his/her records.

If two of the parties have the same attorney or agent, the examiner will in a separate memorandum call the attention of the Board to that fact when the Interference Initial Memorandum is forwarded. The administrative patent judge, when the interference is declared, can then take such action as may be appropriate under 37 CFR 1.613(b).

Form PTO-850-(Rev. 11-28-2000)

**INTERFERENCE INITIAL MEMORANDUM**

Count # \_\_\_\_\_

**To the Board of Patent Appeals and Interferences:**

An interference is proposed involving the following parties—

PARTY	APPLICATION NO.	FILING DATE	PATENT NO., IF ANY	ISSUE DATE, IF ANY

If the involved case is a patent, have its maintenance fees been paid? Yes \_\_\_ No \_\_\_ Not due yet \_\_\_\_\_

Proposed priority benefit (list all intervening applications necessary for continuity):

COUNTRY	APPLICATION NO.	FILING DATE	PATENT NO., IF ANY	ISSUE DATE, IF ANY

The claim(s) of this party corresponding to this count:

PATENTED OR PATENTABLE PENDING CLAIMS	UNPATENTABLE PENDING CLAIMS
---------------------------------------	-----------------------------

The claim(s) of this party NOT corresponding to this count:

PATENTED OR PATENTABLE PENDING CLAIMS	UNPATENTABLE PENDING CLAIMS
---------------------------------------	-----------------------------

PARTY	APPLICATION NO.	FILING DATE	PATENT NO., IF ANY	ISSUE DATE, IF ANY

If the involved case is a patent, have its maintenance fees been paid? Yes \_\_\_ No \_\_\_ Not due yet \_\_\_\_\_

Proposed priority benefit (list all intervening applications necessary for continuity):

COUNTRY	APPLICATION NO.	FILING DATE	PATENT NO., IF ANY	ISSUE DATE, IF ANY

The claim(s) of this party corresponding to this count:

PATENTED OR PATENTABLE PENDING CLAIMS	UNPATENTABLE PENDING CLAIMS
---------------------------------------	-----------------------------

The claim(s) of this party NOT corresponding to this count:

PATENTED OR PATENTABLE PENDING CLAIMS	UNPATENTABLE PENDING CLAIMS
---------------------------------------	-----------------------------

(Check off each step, if applicable) INSTRUCTIONS

- 1. Obtain all files listed above.
- 2. Confirm that the proposed involved claims are still active and all corrections and entered amendments have been considered. The patents must not be expired for, among other things, failure to pay a maintenance fee (Check PALM screen 2970).
- 3. If one of the involved files is a published application or a patent, check for compliance with 35 U.S.C. 135(b).
- 4. Obtain a certified copy of any foreign benefit documents where necessary (37 CFR 1.55(a)).
- 5. Discuss the proposed interference with an Interference Practice Specialist in your Technology Center.

DATE	PRIMARY EXAMINER (signature)	ART UNIT	TELEPHONE NO.
------	------------------------------	----------	---------------

DATE	INTERFERENCE PRACTICE SPECIALIST or TECHNOLOGY CENTER DIRECTOR (signature)	TELEPHONE NO.
------	--	---------------

Page \_\_\_ of \_\_\_

### 2309.03 Affidavits and Declarations Retained in File

When there are of record in the file of the application affidavits or declarations under 37 CFR 1.131 or 1.608, they should not be sealed but should be left in the file for consideration by the Board.

Affidavits and declarations under 37 CFR 1.131 and 1.608 are available for inspection by an opposing party to an interference after the preliminary motions under 37 CFR 1.633 are decided. See 37 CFR 1.612(b).

Affidavits or declarations in the file of a patent are not removed, inasmuch as they have been available to the public since the date the patent issued.

### 2309.06 Interfering Subject Matter in "Secrecy Order" Cases

37 CFR 5.3. *Prosecution of application under secrecy order; withholding patent.*

\*\*\*\*\*

(b) An interference will not be declared involving national applications under secrecy order. However, if an applicant whose application is under secrecy order seeks to provoke an interference with an issued patent, a notice of that fact will be placed in the file wrapper of the patent. (See § 1.607(d)).

\*\*\*\*\*

Since declaration of an interference gives immediate access to applications by opposing parties, no interference will be declared involving an application which has a secrecy order therein. See MPEP § 120 and § 130. Claims will be suggested, if necessary, so that all parties will be claiming the same patentable invention. See MPEP § 2303 - § 2305.04. When each application contains at least one claim to the same patentable invention, the following letter will be sent to all parties:

Claims 1, 2, etc. (including the conflicting claims and claims not patentable over the application under secrecy order) conflict with those of another application. However, the secrecy order (of the other application/of your application) does not permit the declaration of an interference. Accordingly, action on the application is suspended for so long as this situation continues.

Upon removal of the secrecy order and markings, if applicable, from all applications, an interference will be declared.

The letter should also indicate the allowability of the remaining claims, if any.

A notice that claims have been presented in an application under secrecy order for the purpose of interference with a patent should be placed in the patented file. Also, in accordance with 37 CFR 1.607(d), the patentee should be notified. See MPEP § 2307.06. The question of an interference is taken up upon termination of the secrecy order in the application in which patent claims are presented. The suggested notices should be modified accordingly.

The notices should be signed by the primary examiner. The copy of the notice retained separately in the TC should, in addition, contain the identification of the applications and patents involved and the interfering claims.

### 2311 Declaration of Interference

37 CFR 1.611. *Declaration of interference.*

(a) Notice of declaration of an interference will be sent to each party.

(b) When a notice of declaration is returned to the Patent and Trademark Office undelivered, or in any other circumstance where appropriate, an administrative patent judge may send a copy of the notice to a patentee named in a patent involved in an interference or the patentee's assignee of record in the Patent and Trademark Office or order publication of an appropriate notice in the *Official Gazette*.

(c) The notice of declaration shall specify:

(1) The name and residence of each party involved in the interference;

(2) The name and address of record of any attorney or agent of record in any application or patent involved in the interference;

(3) The name of any assignee of record in the Patent and Trademark Office;

(4) The identity of any application or patent involved in the interference;

(5) Where a party is accorded the benefit of the filing date of an earlier application, the identity of the earlier application;

(6) The count or counts and, if there is more than one count, the examiner's explanation why the counts define different patentable inventions;

(7) The claim or claims of any application or any patent which correspond to each count;

(8) The examiner's explanation as to why each claim designated as corresponding to a count is directed to the same patentable invention as the count and why each claim designated as not corresponding to any count is not directed to the same patentable invention as any count; and

(9) The order of the parties.

(d) The notice of declaration may also specify the time for:

(1) Filing a preliminary statement as provided in § 1.621(a);



(2) Serving notice that a preliminary statement has been filed as provided in § 1.621(b); and

(3) Filing preliminary motions authorized by § 1.633.

(e) Notice may be given in the *Official Gazette* that an interference has been declared involving a patent.

The papers necessary in declaring an interference are prepared at the Board.

Once an interference is declared involving an application, *ex parte* prosecution of the application is suspended, and the applicant need not reply to any USPTO action outstanding as of the date the interference is declared.

## 2312 Public Access to Files

37 CFR 1.11. Files open to the public.

\*\*\*\*\*

(e) The file of any interference involving a patent, a statutory invention registration, a reissue application, or an application on which a patent has been issued or which has been published as a statutory invention registration, is open to inspection by the public, and copies may be obtained upon paying the fee therefor, if:

(1) The interference has terminated or

(2) An award of priority or judgment has been entered as to all parties and all counts.

During the pendency of an interference, the public is entitled to access to the file of any patent, reissue application, or statutory invention registration involved in the proceeding as provided in 37 CFR 1.11. However, such access does not also entitle members of the public to access to the interference file, or to the file of a non-reissue application involved in the interference. The extent to which members of the public may be granted access to the file of an involved application is governed by the provisions of 37 CFR 1.14. See MPEP § 103.

Once the Board enters judgment in the interference as to all parties and all counts, the interference file becomes accessible to the public if a patent, statutory invention registration, or reissue application was involved in the interference. If not, the interference file is not open to the public until one of the involved applications issues as a patent or is published as a statutory invention registration. Note that even though an interference file may be open to the public, access to the file of an application which is or was involved in the proceeding is still subject to the provisions of 37 CFR 1.14.

## 2314 Jurisdiction Over Interference

37 CFR 1.614. Jurisdiction over interference.

(a) The Board acquires jurisdiction over an interference when the interference is declared under § 1.611.

(b) When the interference is declared the interference is a contested case within the meaning of 35 U.S.C. 24.

(c) The examiner shall have jurisdiction over any pending application until the interference is declared. An administrative patent judge may for a limited purpose restore jurisdiction to the examiner over any application involved in the interference.

37 CFR 1.614 specifies when the Board gains jurisdiction over an interference. The section also indicates when an interference becomes a contested case within the meaning of 35 U.S.C. 24. A remand to the examiner is authorized and may be useful in certain situations, such as when a party moves under 37 CFR 1.633(c) to add a proposed count which is broader than any count in an interference. Alternatively, an administrative patent judge can obtain informal opinions from examiners during the course of an interference. Nothing in the rules, however, is intended to authorize informal conferences between an administrative patent judge and an examiner with respect to the merits of an application before the Board in an *ex parte* appeal from an adverse decision of the examiner.

Examiners are admonished that *inter partes* questions should not be discussed *ex parte* with any of the interested parties and that they should so inform applicants or their attorneys if any attempt is made to discuss *ex parte* these *inter parte* questions.

If, independent of the interference, action as to one or more of the involved cases becomes necessary, the examiner should consult the administrative patent judge in charge of the interference.

After obtaining the administrative patent judge's consent, the examiner merely borrows the file, if needed, as where a patent is to be involved in a new interference. See MPEP § 2342 and § 2364.01.

## 2315 Suspension of Ex Parte Prosecution

37 CFR 1.615. Suspension of *ex parte* prosecution.

(a) When an interference is declared, *ex parte* prosecution of an application involved in the interference is suspended. Amendments and other papers related to the application received during pendency of the interference will not be entered or considered in the interference without the consent of an administrative patent judge.

(b) Ex parte prosecution as to specified matters may be continued concurrently with the interference with the consent of the administrative patent judge.

Under 37 CFR 1.615, upon declaration of an interference, *ex parte* prosecution of an application involved in the interference is suspended and any outstanding Office actions are considered as withdrawn by operation of the rule. *Ex parte Peterson*, 49 USPQ 119, 1941 C.D. 8 (Comm'r Pat. 1941). Upon termination of the interference, the examiner will reinstate the action treated as withdrawn by operation of 37 CFR 1.615 and set a shortened statutory period for reply.

The treatment of amendments filed during an interference is considered in detail in MPEP § 2364 - § 2364.01.

The approval of the administrative patent judge in charge of the interference must be obtained before undertaking any concurrent prosecution of the application.

### **2315.01 Suspension - Overlapping Applications**

Where one of several applications of the same inventor or assignee which contain overlapping claims gets into an interference, the prosecution of all the cases not in the interference should be carried as far as possible, by treating as prior art the counts of the interference for the purpose of making provisional rejections and by insisting on proper lines of division or distinction between the applications. In some instances, suspension of action by the Office cannot be avoided. See MPEP § 709.01.

Where an application involved in an interference includes, in addition to the subject matter of the interference, a separate and divisible invention, prosecution of the second invention may be had during the pendency of the interference by filing a divisional application for the second invention or by filing a divisional application for the subject matter of the interference and moving to substitute the latter divisional application for the application originally involved in the interference. However, the application for the second invention may not be passed to issue if it contains claims broad enough to dominate matter claimed in the application involved in the interference.

#### **¶ 23.17 Rejection Based on Count of an Interference**

The rejection of claim [1] above based upon count [2] of Interference No. [3], to which applicant is a party, is a provisional rejection for the purpose of resolving all remaining issues in this application. The provisional assumption that the count is prior art under 35 U.S.C. 102(g) against this application may or may not be true, and the prosecution in this case will be suspended pending final determination of priority in the interference if and when no other issues remain.

#### **Examiner Note:**

1. This paragraph must follow all rejections under 35 U.S.C. 102 or 103 using the count of the interference as prior art.
2. This paragraph is applicable only to an application which is commonly owned by a party in the interference but is not involved in the interference.

#### **¶ 23.18 Suspension of Prosecution Pending Outcome of Interference**

The outcome of Interference No. [1] has a material bearing on the patentability of the claims in this application. Prosecution in this application is SUSPENDED pending a final judgment in the interference.

Applicant should call this case up for action upon termination of the interference.

#### **Examiner Note:**

This paragraph should only be used in an application that is not in the interference but is commonly owned by one of the parties thereto.

### **2333 Preliminary Motions - Related to Application Not Involved in Interference**

Whenever a party in interference brings a motion under 37 CFR 1.633(d) or (e) concerning an application not already included in the interference, the administrative patent judge will normally send the primary examiner a written notice of such motion and the primary examiner should place this notice in said application file.

The notice is customarily sent to the Technology Center (TC) which declared the interference, since the application referred to in the motion is generally examined in the same TC. However, if the application is not being examined in the same TC, then the correct TC should be ascertained and the notice forwarded to that TC.

This notice serves useful and essential purposes, and due attention must be given to it by the examiner when it is received. First, the examiner is cautioned by this notice not to consider *ex parte*, questions which are pending before the Office in *inter partes*

proceedings involving the same applicant or party in interest. Second, if the application which is the subject of the motion is in issue and the last date for paying the issue fee will not permit determination of the motion, it will be necessary to withdraw the application from issue. Third, if the application contains an affidavit or declaration under 37 CFR 1.131 or 1.608, this must be sealed because the opposing parties have access to the application.

## 2340 Motions, Hearing and Decision

37 CFR 1.640. *Motions, hearing and decision, redeclaration of interference, order to show cause.*

(a) A hearing on a motion may be held in the discretion of the administrative patent judge. The administrative patent judge shall set the date and time for any hearing. The length of oral argument at a hearing on a motion is a matter within the discretion of the administrative patent judge. An administrative patent judge may direct that a hearing take place by telephone.

(b) Unless an administrative patent judge or the Board is of the opinion that an earlier decision on a preliminary motion would materially advance the resolution of the interference, decision on a preliminary motion shall be deferred to final hearing. Motions not deferred to final hearing will be decided by an administrative patent judge. An administrative patent judge may consult with an examiner in deciding motions. An administrative patent judge may take up motions for decisions in any order, may grant, deny, or dismiss any motion, and may take such other action which will secure the just, speedy, and inexpensive determination of the interference. A matter raised by a party in support of or in opposition to a motion that is deferred to final hearing will not be entitled to consideration at final hearing unless the matter is raised in the party's brief at final hearing. If the administrative patent judge determines that the interference shall proceed to final hearing on the issue of priority or derivation, a time shall be set for each party to file a paper identifying any decisions on motions or on matters raised *sua sponte* by the administrative patent judge that the party wishes to have reviewed at final hearing as well as identifying any deferred motions that the party wishes to have considered at final hearing. Any evidence that a party wishes to have considered with respect to the decisions and deferred motions identified by the party or by an opponent for consideration or review at final hearing shall be filed or, if appropriate, noticed under § 1.671(e) during the testimony-in-chief period of the party.

(1) When appropriate after the time expires for filing replies to oppositions to preliminary motions, the administrative patent judge will set a time for filing any amendment to an application involved in the interference and for filing a supplemental preliminary statement as to any new counts which may become involved in the interference if a preliminary motion to amend or substitute a count has been filed. Failure or refusal of a party to timely present an amendment required by an administrative patent judge shall be taken without further action as a disclaimer by that party of the invention involved. A supplemental preliminary statement shall meet the requirements specified in § 1.623, 1.624,

1.625, or 1.626, but need not be filed if a party states that it intends to rely on a preliminary statement previously filed under § 1.621(a). At an appropriate time in the interference, and when necessary, an order will be entered redeclaring the interference.

(2) After the time expires for filing preliminary motions, a further preliminary motion under § 1.633 will not be considered except as provided by § 1.645(b).

(c) When a decision on any motion under §§ 1.633, 1.634, or 1.635 or on any matter raised *sua sponte* by an administrative patent judge is entered which does not result in the issuance of an order to show cause under paragraph (d) of this section, a party may file a request for reconsideration within 14 days after the date of the decision. The request for reconsideration shall be filed and served by hand or Express Mail. The filing of a request for reconsideration will not stay any time period set by the decision. The request for reconsideration shall specify with particularity the points believed to have been misapprehended or overlooked in rendering the decision. No opposition to a request for reconsideration shall be filed unless requested by an administrative patent judge or the Board. A decision ordinarily will not be modified unless an opposition has been requested by an administrative patent judge or the Board. The request for reconsideration normally will be acted on by the administrative patent judge or the panel of the Board which issued the decision.

(d) An administrative patent judge may issue an order to show cause why judgment should not be entered against a party when:

(1) A decision on a motion or on a matter raised *sua sponte* by an administrative patent judge is entered which is dispositive of the interference against the party as to any count;

(2) The party is a junior party who fails to file a preliminary statement; or

(3) The party is a junior party whose preliminary statement fails to overcome the effective filing date of another party.

(e) When an order to show cause is issued under paragraph (d) of this section, the Board shall enter judgment in accordance with the order unless, within 20 days after the date of the order, the party against whom the order issued files a paper which shows good cause why judgment should not be entered in accordance with the order.

(1) If the order was issued under paragraph (d)(1) of this section, the paper may:

(i) Request that final hearing be set to review any decision which is the basis for the order as well as any other decision of the administrative patent judge that the party wishes to have reviewed by the Board at final hearing or

(ii) Fully explain why judgment should not be entered.

(2) Any opponent may file a response to the paper within 20 days of the date of service of the paper. If the order was issued under paragraph (d)(1) of this section and the party's paper includes a request for final hearing, the opponent's response must identify every decision of the administrative patent judge that the opponent wishes to have reviewed by the Board at a final hearing. If the order was issued under paragraph (d)(1) of this section and the paper does not include a request for final hearing, the opponent's response may include a request for final hearing, which must identify every decision of the administrative patent judge

that the opponent wishes to have reviewed by the Board at a final hearing. Where only the opponent's response includes a request for a final hearing, the party filing the paper shall, within 14 days from the date of service of the opponent's response, file a reply identifying any other decision of the administrative patent judge that the party wishes to have reviewed by the Board at a final hearing.

(3) The paper or the response should be accompanied by a motion (§ 1.635) requesting a testimony period if either party wishes to introduce any evidence to be considered at final hearing (§ 1.671). Any evidence that a party wishes to have considered with respect to the decisions and deferred motions identified for consideration or review at final hearing shall be filed or, if appropriate, noticed under § 1.671(e) during the testimony period of the party. A request for a testimony period shall be construed as including a request for final hearing.

(4) If the paper contains an explanation of why judgment should not be entered in accordance with the order, and if no party has requested a final hearing, the decision that is the basis for the order shall be reviewed based on the contents of the paper and the response. If the paper fails to show good cause, the Board shall enter judgment against the party against whom the order issued.

Where appropriate, an administrative patent judge may consult with an examiner on a question which arises in the first instance in the interference. For example, a party may allege unpatentability over a reference not previously considered, or may attempt to add a count drawn to subject matter which was not previously examined.

The extent of the consultation will be determined by the administrative patent judge; the examiner may be consulted merely on one point of patentability, or may be asked to conduct a search of newly-presented counts or claims. The consultation may be informal, as by a telephone call, or may be by a more formal written memorandum to the examiner.

It should be noted that nothing in 37 CFR 1.640 authorizes conferences between administrative patent judges and examiners in *ex parte* appeals under 35 U.S.C. 134 from an adverse decision of an examiner.

## 2341 Unpatentability Discovered

*37 CFR 1.641. Unpatentability discovered by administrative patent judge.*

(a) During the pendency of an interference, if the administrative patent judge becomes aware of a reason why a claim designated to correspond to a count may not be patentable, the administrative patent judge may enter an order notifying the parties of the reason and set a time within which each party may present its views, including any argument and any supporting evi-

dence, and, in the case of the party whose claim may be unpatentable, any appropriate preliminary motions under §§ 1.633(c), (d) and (h).

(b) If a party timely files a preliminary motion in response to the order of the administrative patent judge, any opponent may file an opposition (§ 1.638(a)). If an opponent files an opposition, the party may reply (§ 1.638(b)).

(c) After considering any timely filed views, including any timely filed preliminary motions under § 1.633, oppositions and replies, the administrative patent judge shall decide how the interference shall proceed.

If the examiner, while the interference is pending, discovers a reference or other reason which he or she believes would render one or more of the parties' claims corresponding to the count(s) unpatentable, the reference or other reason should be brought to the attention of the administrative patent judge in charge of the interference. The administrative patent judge will determine what action, if any, should be taken in the interference.

## 2342 Addition to Interference

*37 CFR 1.642. Addition of application or patent to interference.*

During the pendency of an interference, if the administrative patent judge becomes aware of an application or a patent not involved in the interference which claims the same patentable invention as a count in the interference, the administrative patent judge may add the application or patent to the interference on such terms as may be fair to all parties.

37 CFR 1.642 permits an administrative patent judge to add a newly discovered patent, as well as newly discovered applications, to an interference.

## EXAMINER DISCOVERS ANOTHER APPLICATION OR PATENT DURING INTERFERENCE

If, during the pendency of an interference, the examiner discovers another application or patent claiming subject matter which is the same as, or not patentably distinct from, the invention defined in a count of the interference, the examiner should bring the application or patent to the attention of the administrative patent judge in charge of the interference. The administrative patent judge will determine what action, if any, should be taken in the interference.

If the application in question is for reissue of a patent involved in the interference, see MPEP § 2360.

## 2358 Final Decision

### 37 CFR 1.658. Final decision.

(a) After final hearing, the Board shall enter a decision resolving the issues raised at final hearing. The decision may enter judgment, in whole or in part, remand the interference to an administrative patent judge for further proceedings, or take further action not inconsistent with law. A judgment as to a count shall state whether or not each party is entitled to a patent containing the claims in the party's patent or application which correspond to the count. When the Board enters a decision awarding judgment as to all counts, the decision shall be regarded as a final decision for the purpose of judicial review (35 U.S.C. 141-144, 146) unless a request for reconsideration under paragraph (b) of this section is timely filed.

(b) Any request for reconsideration of a decision under paragraph (a) of this section shall be filed within one month after the date of the decision. The request for reconsideration shall specify with particularity the points believed to have been misapprehended or overlooked in rendering the decision. Any opposition to a request for reconsideration shall be filed within 14 days of the date of service of the request for reconsideration. Service of the request for reconsideration shall be by hand or Express Mail. The Board shall enter a decision on the request for reconsideration. If the Board shall be of the opinion that the decision on the request for reconsideration significantly modifies its original decision under paragraph (a) of this section, the Board may designate the decision on the request for reconsideration as a new decision. A decision on reconsideration is a final decision for the purpose of judicial review (35 U.S.C. 141-144, 146).

(c) A judgment in an interference settles all issues which (1) were raised and decided in the interference, (2) could have been properly raised and decided in the interference by a motion under § 1.633 (a) through (d) and (f) through (j) or § 1.634, and (3) could have been properly raised and decided in an additional interference with a motion under § 1.633(e). A losing party who could have properly moved, but failed to move, under § 1.633 or 1.634, shall be estopped to take *ex parte* or *inter partes* action in the Patent and Trademark Office after the interference which is inconsistent with that party's failure to properly move, except that a losing party shall not be estopped with respect to any claims which correspond, or properly could have corresponded, to a count as to which that party was awarded a favorable judgment.

In its final decision, the Board can (A) enter judgment, in whole or in part, (B) remand the interference to an administrative patent judge or (C) take further action not inconsistent with law.

A judgment as to a count will state whether or not each party is entitled to a patent containing claims which correspond to the count. When judgment is entered as to all counts, the decision of the Board is considered final for the purpose of judicial review. A judgment that does not resolve all counts or that remands the interference for further proceedings is not

final for purposes of judicial review and not immediately appealable to the courts. 37 CFR 1.658(c) defines the doctrine of interference estoppel as it is to be applied in the USPTO after an interference is terminated. See MPEP § 2363.03. The definition of interference estoppel is designed to encourage parties in interference cases to settle as many issues as possible in one proceeding. 37 CFR 1.658(c) creates an estoppel both as to senior and junior parties. An estoppel will *not* apply with respect to any claims which correspond, or which properly could have corresponded, to a count as to which the party is awarded a favorable judgment.

After the Board has rendered a final decision in an interference, the losing party may either appeal to the Court of Appeals for the Federal Circuit, under 35 U.S.C. 141, or file a civil action in a United States district court, under 35 U.S.C. 146. Upon the filing of an appeal to the Court of Appeals for the Federal Circuit, the opposing party may elect to have the proceeding conducted in a district court. (The USPTO may, but normally does not, issue the application of a winning party in an interference involving only applications, notwithstanding the filing of a civil action under 35 U.S.C. 146 by the losing party. See *Monaco v. Watson*, 270 F.2d 335, 122 USPQ 564 (D.C. Cir. 1959).) See MPEP § 1216.

## 2359 Board Recommendation

### 37 CFR 1.659. Recommendation.

(a) Should the Board have knowledge of any ground for rejecting any application claim not involved in the judgment of the interference, it may include in its decision a recommended rejection of the claim. Upon resumption of *ex parte* prosecution of the application, the examiner shall be bound by the recommendation and shall enter and maintain the recommended rejection unless an amendment or showing of facts not previously of record is filed which, in the opinion of the examiner, overcomes the recommended rejection.

(b) Should the Board have knowledge of any ground for reexamination of a patent involved in the interference as to a patent claim not involved in the judgment of the interference, it may include in its decision a recommendation to the Commissioner that the patent be reexamined. The Commissioner will determine whether reexamination will be ordered.

(c) The Board may make any other recommendation to the examiner or the Commissioner as may be appropriate.

Under 37 CFR 1.659, the Board can make recommendations to examiners and the Commissioner, including recommendations that application claims

not involved in the interference be rejected and that a patent be reexamined as to patent claims not involved in the interference.

When a patent is involved in an interference each claim of the patent will be designated to (A) correspond to a count or (B) not correspond to a count. All claims which are ultimately determined to correspond to a count will be involved in the judgment of the interference. Inasmuch as they are involved in the judgment of the interference, there is no need to recommend reexamination of those claims. The claims involved in the interference are either patentable or unpatentable based on the final decision of the Board.

### **2360 Reexamination, Reissue, Protest, or Litigation During Interference**

*37 CFR 1.660. Notice of reexamination, reissue, protest or litigation.*

(a) When a request for reexamination of a patent involved in an interference is filed, the patent owner shall notify the Board within 10 days of receiving notice that the request was filed.

(b) When an application for reissue is filed by a patentee involved in an interference, the patentee shall notify the Board within 10 days of the day the application for reissue is filed.

(c) When a protest under § 1.291 is filed against an application involved in an interference, the applicant shall notify the Board within 10 days of receiving notice that the protest was filed.

(d) A party in an interference shall notify the Board promptly of any litigation related to any patent or application involved in an interference, including any civil action commenced under 35 U.S.C. 146.

(e) The notice required by this section is designed to assist the administrative patent judge and the Board in efficiently handling interference cases. Failure of a party to comply with the provisions of this section may result in sanctions under § 1.616. Knowledge by, or notice to, an employee of the Office other than an employee of the Board, of the existence of the reexamination, application for reissue, protest, or litigation shall not be sufficient. The notice contemplated by this section is notice addressed to the administrative patent judge in charge of the interference in which the application or patent is involved.

Under 37 CFR 1.660, a party is required to notify the Board when the party's patent or application becomes involved in other USPTO proceedings (reexamination, reissue, or protest) or litigation.

Before taking any action on the reexamination, reissue, or protest, the primary examiner should consult the administrative patent judge in charge of the interference. It is particularly important that a reissue application not be granted without the approval of the

administrative patent judge. Also see MPEP § 2284 concerning requests for reexamination of a patent involved in an interference.

### **2361 Termination of Interference After Judgment**

*37 CFR 1.661. Termination of interference after judgment.*

After a final decision is entered by the Board, an interference is considered terminated when no appeal (35 U.S.C. 141) or other review (35 U.S.C. 146) has been or can be taken or had.

37 CFR 1.661 sets forth when an interference is considered terminated after a judgment is entered in the interference. For the purpose of filing copies of settlement agreements under 35 U.S.C. 135(c), if an appeal or civil action is not filed, the interference is considered terminated as of the date the time for filing an appeal or civil action expired. 37 CFR 1.661; *Tallent v. Lamoine*, 204 USPQ 1058 (Comm'r Pat. 1979). See also *Nelson v. Bowler*, 212 USPQ 760 (Comm'r Pat. 1981). If an appeal is taken to the Court of Appeals for the Federal Circuit, the interference terminates on the date of receipt of the court's mandate by the U.S. Patent and Trademark Office. See MPEP § 1216.01. If a civil action is filed, and the decision of the district court is not appealed, the interference terminates on the date the time for filing an appeal from the court's decision expires. *Hunter v. Beissbarth*, 15 USPQ2d 1343 (Comm'r Pat. 1990).

### **2363 Action After Interference**

*37 CFR 1.664. Action after interference.*

(a) After termination of an interference, the examiner will promptly take such action in any application previously involved in the interference as may be necessary. Unless entered by order of an administrative patent judge, amendments presented during the interference shall not be entered, but may be subsequently presented by the applicant subject to the provisions of this subpart provided prosecution of the application is not otherwise closed.

(b) After judgment, the application of any party may be held subject to further examination, including an interference with another application.

The files are returned to the Technology Center (TC) after termination of the interference. Jurisdiction of the examiner is automatically restored with the return of the files, and the cases of all parties are subject to such *ex parte* action as their respective conditions may require. The date when the interference terminates does not mark the beginning of a statutory

period for reply by the applicant. See *Ex parte Peterson*, 49 USPQ 119, 1941 C.D. 8 (Comm'r Pat. 1941).

Under 37 CFR 1.664(a), the examiner must promptly take such action in any application which was involved in the interference as may be necessary. The action to be taken by the examiner depends upon how the interference was terminated, and in some instances, the basis of the termination. See MPEP § 2363.01 to § 2363.03. All interferences conducted under 37 CFR subpart E will be terminated by judgment. If the interference is one which was conducted under the former interference rules, 37 CFR 1.201 to 1.288 (generally these were interferences declared prior to February 11, 1985), an administrative patent judge should be consulted before taking any action on the involved application(s).

Before allowing a losing party's application, the examiner should carefully consider whether the grounds of estoppel have been fully applied. In order to promote uniform application of the doctrines of lost counts and estoppel, the examiner must consult the administrative patent judge who was in charge of the interference before allowing a losing party's application.

If an application has been withdrawn from issue for interference and is again passed to issue, a notation "Re-examined and passed for issue" is placed on the file wrapper together with a new signature of the primary examiner in the box provided for this purpose. Such notation will be relied on by the Office of Patent Publication as showing that the application is intended to be passed for issue and makes it possible to screen out those applications which are mistakenly forwarded to the Office of Patent Publication during the pendency of the interference.

See MPEP § 1302.12 with respect to listing references discussed in motion decisions, and MPEP § 2364 concerning the entry of amendments.

Form Paragraph 23.02 may be used to resume *ex parte* prosecution.

#### ¶ 23.02 *Ex Parte Prosecution Is Resumed*

Interference No. [1] has been terminated by a decision [2] to applicant. *Ex parte* prosecution is resumed.

#### **Examiner Note:**

In bracket 2, insert whether favorable or unfavorable.

### **2363.01 No Interference in Fact**

The Board may, if it finds that there is no interference in fact, award judgment to both parties. In such a case, each party-applicant may be granted a patent on the claims of the application designated to correspond to the count, if those claims are otherwise patentable.

### **2363.02 The Winning Party**

If prosecution of the winning party's application had not been closed, the winning party generally may be allowed additional and broader claims to the common patentable subject matter. Note, however, *In re Hoover Co.*, 134 F.2d 624, 57 USPQ 111 (CCPA 1943). The winning party of the interference is not denied anything he or she was in possession of prior to the interference, nor does he or she acquire any additional rights as a result of the interference. His or her application thus stands as it was prior to the interference. If the application was under final rejection as to some of its claims at the time the interference was formed, the institution of the interference acted to suspend, but not vacate, the final rejection. After termination of the interference, a letter is written the applicant, as in the case of any other action unanswered at the time the interference was instituted, setting a shortened period of 2 months within which to file an appeal or cancel the finally rejected claims.

#### ¶ 23.03 *Office Action Unanswered*

This application contains an unanswered Office action mailed on [1]. A shortened statutory period for reply to such action is set to expire TWO MONTHS from the mailing date of this letter.

#### **Examiner Note:**

This paragraph must be preceded by paragraph 23.02.

### **2363.03 The Losing Party**

*37 CFR 1.663. Status of claim of defeated applicant after interference.*

Whenever an adverse judgment is entered as to a count against an applicant from which no appeal (35 U.S.C. 141) or other review (35 U.S.C. 146) has been or can be taken or had, the claims of the application corresponding to the count stand finally disposed of without further action by the examiner. Such claims are not open to further *ex parte* prosecution.

The Board's judgment in an interference conducted under 37 CFR subpart E will state that the losing party is not entitled to a patent containing the claims corresponding to the count or counts. Under 37 CFR 1.663,

such claims “stand finally disposed of without further action by the examiner.” See also 35 U.S.C. 135(a). When the files are returned to the TC after termination of the interference, a pencil line should be drawn through the claims as to which a judgment of priority adverse to an applicant has been rendered, and the notation “37 CFR 1.663” should be written in the margin to indicate the reason for the pencil line. If these claims have not been canceled by the applicant and the application is otherwise ready for issue, these notations should be replaced by a line in red ink and the notation “37 CFR 1.663” in red ink before passing the application to issue, and the applicant notified of the cancellation by an Examiner’s Amendment. If an action is necessary in the application after the interference, the applicant should also be informed that “Claims (designated by numerals), as to which a judgment adverse to the applicant has been rendered, stand finally disposed of in accordance with 37 CFR 1.663.”

If all the claims in the application are eliminated, a letter should be written informing the applicant that all the claims in the application have been disposed of, indicating the circumstances, that no claims remain subject to prosecution, and that the application will be sent to the abandoned files with the next group of abandoned applications. Proceedings are terminated as of the date the interference terminated. See MPEP § 2361.

If the losing party’s application was under rejection at the time the interference was declared, such rejection is ordinarily repeated (either in full or by reference to the previous action) and, in addition, any other suitable rejections, as discussed below, are made. If the losing party’s application was under final rejection or ready for issue, his or her right to reopen the prosecution is restricted to subject matter related to the issue of the interference.

Where the losing party failed to get a copy of the opponent’s drawing or specification during the interference, the losing party may order a copy thereof to enable said party to respond to a rejection based on the successful party’s disclosure. Such order is referred to the administrative patent judge who has authority to approve orders of this nature.

In addition to repeating any outstanding rejection, the examiner should consider whether any remaining claims in the losing party’s application should be

rejected on the ground of unpatentability under 35 U.S.C. 102/103, or on the ground of estoppel.

#### **UNPATENTABILITY UNDER 35 U.S.C. 102/103**

The examiner should determine from the Board’s decision the basis on which judgment was rendered against the applicant. If the judgment was that applicant was not the first inventor of the subject matter in issue, the application claims may be rejected under 35 U.S.C. 102(g)/103 as unpatentable over the lost counts. If the judgment was based on a holding that applicant derived the invention from another, a rejection of claims as unpatentable over the lost counts under 35 U.S.C. 102(f)/103 may be in order. Where the Board rendered judgment against the applicant because his or her claims were unpatentable over prior art, under 35 U.S.C. 112, or on other grounds, the other claims in the application should be reviewed to determine whether any of those grounds may be applicable to them.

#### **ESTOPPEL**

Claims which cannot be rejected as unpatentable over the lost counts may still be subject to rejection on the ground of estoppel. As stated in 37 CFR 1.658(c), a losing party who could have properly moved under 37 CFR 1.633 or 1.634, but failed to do so, is estopped from taking subsequent action in the USPTO which is inconsistent with the party’s failure to properly move. However, in the event of a “split award,” the losing party is not estopped as to claims which corresponded, or properly could have corresponded, to a count which he or she won.

The following examples illustrate the application of estoppel to the losing party:

##### ***Example 1***

Junior party applicant AL and senior party applicant AK both disclose separate patentable inventions “A” and “B” and claim only invention A in their respective applications. An interference is declared with a single count to invention A. Neither party files a motion under 37 CFR 1.633(c)(1) to add a count to invention B. Judgment as to all of AL’s claims corresponding to the sole count is awarded to junior party applicant AL. Senior party applicant AK will be estopped to thereafter obtain a patent containing claims to invention B, because



applicant AK failed to move to add a count to invention B in the interference. Junior party applicant AL will not be estopped to obtain a patent containing claims to invention B.

**Example 2**

In this example, the facts are the same as in example 1 except that judgment is awarded as to all AK's claims corresponding to the count to senior party applicant AK. Junior party applicant AL will be estopped to obtain a patent containing claims to invention B in the interference. Senior party applicant AK will not be estopped to obtain a patent containing claims to invention B.

**Example 3**

Junior party applicant AM and senior party applicant AP both disclose separate patentable inventions "C", "D", and "E" and claim inventions C and D in their respective applications. An interference is declared with two counts. Count 1 is to invention C and Count 2 is to invention D. Neither party files a preliminary motion to add a proposed Count 3 to invention E. Judgment as to all AM's claims corresponding to Counts 1 and 2 is awarded to junior party AM. Senior party applicant AP will be estopped to thereafter obtain a patent containing claims to invention E, because applicant AP failed to move to add a count to invention E to the interference. Junior party applicant AM will not be estopped to obtain a patent containing a claim to invention E.

**Example 4.**

In this example, the facts are the same as in Example 3 except that judgment is awarded as to all AP's claims corresponding to Counts 1 and 2 to senior party applicant AP. Junior party applicant AM will be estopped to obtain a patent containing claims to invention E, because applicant AM failed to move to add a count to invention E in the interference. Senior party applicant AP will not be estopped to obtain a patent containing claims to invention E.

**Example 5.**

In this example, the facts are the same as in Example 3 except that judgment is awarded on all of AM's claims corresponding to Count 1 to junior party applicant AM and judgment is awarded to all

AP's claims corresponding to Count 2 to senior party applicant AP. Both parties will be estopped to obtain a patent containing claims to invention E, because neither moved to add a count to invention E during the interference. Assume that junior party AM could have properly moved under 37 CFR 1.633(f) to be accorded the benefit of an earlier application, but did not do so during the interference. Junior party AM will not be estopped in subsequent *ex parte* prosecution from asking for benefit of the earlier application as to the invention defined by Count 1. Accordingly, if the examiner were to reject junior party AM's claim corresponding to Count 1 on the basis of some newly discovered art, junior party AM could properly antedate the prior art by seeking the benefit under 35 U.S.C. 120 of the earlier application. Thus even though junior party AM was a "losing party" as to Count 2 (an adverse judgment as to junior party AM's claims corresponding to Count 2 having been entered), junior party AM was awarded a favorable judgment (37 CFR 1.658(c)) as to Count 1. Junior party AM will be estopped in subsequent *ex parte* prosecution from attempting to be accorded the benefit of the earlier application as to the invention of Count 2.

**Example 6.**

Applicant AQ discloses and claims invention "F." Applicant AR discloses and claims separate patentable inventions "F" and "G." The assignee of applicant AQ also owns an application of applicant AS which discloses and claims invention "G." An interference is declared between applicant AQ and applicant AR. The sole count is directed to invention F. No motion is filed by applicant AQ or its assignee to declare an additional interference between applicant AR and applicant AS with a count to invention G. A judgment as to all AR's claims corresponding to the sole count is awarded to applicant AR. Applicant AS and the assignee will be estopped to obtain a patent containing claims to invention G, because applicant AQ and the assignee failed to move to declare an additional interference with a count to invention G.

**Example 7**

The facts in this example are the same as the facts in Example 6 except that judgment as to all of

AQ's claims corresponding to the sole count is awarded to applicant AQ. Applicant AS and the assignee would not be estopped, because applicant AQ was not a "losing party" (37 CFR 1.658(c)).

**Example 8**

Applicant AT discloses a generic invention to "solvent" and a species to "benzene." Application AT contains a patentable claim 1 (solvent) and no other claims. Applicant AU discloses the generic invention to "solvent" and species to "benzene" and "toluene." Application AU contains patentable claim 3 (solvent) and no other claims. An interference is declared with a single count (solvent). Claim 1 of application AT and claim 3 of application AU are designated to correspond to the count. No preliminary motions are filed. A judgment is entered in favor of applicant AT on the claim corresponding to the sole count. Applicant AU would be estopped to obtain a patent containing a claim to benzene, because applicant AU failed to file a preliminary motion under 37 CFR 1.633(c)(1) seeking to add a count to benzene and benzene was disclosed in winning party AT's application. Applicant AU would also be estopped to obtain a patent containing a claim to toluene, unless "toluene" defines a "separate patentable invention" from "solvent." A basis for interference estoppel (37 CFR 1.658(c)) exists if "toluene" and "solvent" define the "same patentable invention" because a claim to "toluene" could properly have been added and designated to correspond to the count. See 37 CFR 1.633(c)(2).

The following two examples illustrate the application of estoppel against an applicant who lost the interference based solely on the fact that the applicant was unable to establish a date of invention prior to the opponent's foreign filing date (see *Ex parte Tytgat*, 225 USPQ 907 (Bd. App. 1985)):

**Example 9.**

Application AV discloses engines in general and in particular a 6-cylinder engine. Application AV contains only claim 1 (engine). Application AW discloses engines in general, but does not specifically disclose a 6-cylinder engine. Application AW contains only a single claim 3 (engine). The U.S. "filing date" (37 CFR 1.601(h)) of the AV application is prior to the U.S. filing date of the AW appli-

cation, but the AW application claims a foreign priority date under 35 U.S.C. 119 based on an application filed in a foreign country prior to the filing date of the AV application. An interference is declared. The sole count of the interference is to "an engine." Claim 1 of the AV application and claim 3 of the AW application are designated to correspond to the count. During the interference, applicant AV does not move under 37 CFR 1.633(c)(2) to add a claim to a 6-cylinder engine and to designate the claim to correspond to the count. Applicant AW is awarded a judgment in the interference based on the earlier filing date of the foreign application. After the interference, applicant AV adds claim 2 (6-cylinder engine) to the AV application. Whether AV would be entitled to a patent containing a claim to a 6-cylinder engine will depend solely on whether a 6-cylinder engine is a "separate patentable invention" from "engine" - the subject matter of the count. If a 6-cylinder engine is a "separate patentable invention" within the meaning of 37 CFR 1.601(n), applicant AV could not have successfully moved under 37 CFR 1.633(c)(2) to add claim 2 and to designate it to correspond to the count. Therefore applicant AV could obtain a patent containing claim 2. If, on the other hand, a 6-cylinder engine is not a "separate patentable invention," claim 2 of the AV application would be rejected on the basis of interference estoppel because claim 2 could have been added by a motion under 37 CFR 1.633(c)(2). See 37 CFR 1.658(c).

**Example 10.**

This example is basically the same as Example 9, except that application AV initially contains claim 1 (engine) and claim 2 (6-cylinder engine). When the interference is declared, both claims 1 and 2 of application AV are designated to correspond to the count. During the interference, applicant AV does not move under 37 CFR 1.633(c)(4) to designate claim 2 as not corresponding to the count. A judgment in the interference is entered for applicant AW based on the earlier filing date of the foreign patent application. After the interference, applicant AV would not be able to obtain a patent containing claim 2, because the claim was designated to correspond to a count and entry of the judgment constitutes a final decision by the PTO

refusing to grant applicant AV a patent containing claim 2.

## ALLOWANCE OF LOSING PARTY'S APPLICATION

Before allowing a losing party's application, the examiner should carefully consider whether the grounds of estoppel have been fully applied. In order to promote uniform application of the doctrines of lost counts and estoppel, the examiner must consult the administrative patent judge who was in charge of the interference before allowing the losing party's application.

### 2364 Entry of Amendments

Under 37 CFR 1.637(c)(1) and (c)(2), (d)(3), (e)(1) and (e)(2), or (h), a moving party is required to submit with his or her motion as a separate paper, an amendment embodying the proposed claims if the claims are not already in the application concerned. In the case of an application involved in the interference, this amendment is not entered at that time but is placed in the application file.

An amendment filed in connection with a motion to add or substitute counts in an interference must include any claim or claims to be added and be accompanied by the appropriate fees (or fee authorization), if any, which would be due if the amendment were to be entered, even though it may be that the amendment will never be entered. Only upon the granting of the motion may it be necessary for the other party or parties to present claims, but the fees (or fee authorization) must be paid whenever claims are presented. Claims which have been submitted in reply to a suggestion by the Office for inclusion in an application must be accompanied by the fee due (or fee authorization), if any. Money paid in connection with the filing of a proposed amendment will not be refunded by reason of the nonentry of the amendment.

If the motion is granted, the amendment is entered at the time decision on the motion is rendered. If the motion is not granted, the amendment, though left in the file, is not entered and is so marked.

If the motion is granted only in part and denied as to another part, only so much of the amendment as is covered in the grant of the motion is entered, the remaining part being indicated and marked "not entered" in pencil. See 37 CFR 1.644.

In each instance, the applicant is informed of the disposition of the amendment in the first action in the application following the termination of the interference. If the application is otherwise ready for issue, the applicant is notified that the application is allowed and the Notice of Allowance will be sent in due course, that prosecution is closed, and to what extent the amendment has been entered.

As a corollary to this practice, it follows that where prosecution of the winning application had been closed prior to the declaration of the interference, as by being in condition for issue, that application may not be reopened to further prosecution following the interference, even though additional claims had been presented in connection with a motion in the interference.

It should be noted at this point that, under 37 CFR 1.663, the entry of an adverse judgment against a party who requests same pursuant to 37 CFR 1.662(a) finally disposes of all claims of that party's application which are designated as corresponding to the count.

### 2364.01 Amendments Filed During Interference

When an amendment to an application involved in an interference is received, the examiner inspects the amendment and, if necessary, the application, to determine whether or not the amendment affects the pending or any prospective interference. If the amendment is an ordinary one properly responsive to the last regular *ex parte* action preceding the declaration of the interference and does not affect the pending or any prospective interference, the amendment is marked in pencil "not entered" and placed in the file, a corresponding entry being endorsed in ink in the contents column of the wrapper. After termination of the interference, the amendment may be permanently entered and considered as in the case of ordinary amendments filed during the *ex parte* prosecution of the application.

Under 37 CFR 1.615(a), amendments related to an application involved in a pending interference will not be entered without the consent of an administrative patent judge. See MPEP § 2315. Therefore, the examiner should receive the approval of the administrative patent judge in charge of an

interference before entering any amendments in any of the cases involved in the interference.

If the amendment is filed in reply to a letter by the primary examiner, suggesting a claim or claims for interference with another party and for the purpose of declaring an additional interference, the examiner, after obtaining the consent of the administrative patent judge, enters the amendment and takes the proper steps to propose the second interference.

If the amendment is one filed in an application where the administrative patent judge has consented to *ex parte* prosecution of an appeal to the Board of Patent Appeals and Interferences being conducted concurrently with the interference proceeding (see MPEP § 2315) and if it relates to the appeal, it should be treated like any similar amendment in an ordinary appealed application.

When an amendment filed during interference purports to put the application in condition for another interference either with a pending application or with a patent, the primary examiner must personally consider the amendment sufficiently to determine whether, in fact, it does so, and should then consult with the administrative patent judge. With the consent of the administrative patent judge, one of the following three actions may be appropriate.

(A) If the amendment presents allowable claims directed to an invention claimed in a patent or in another pending application in issue or ready for issue, the examiner borrows the file, enters the amendment, and takes the proper steps to propose the second interference.

(B) Where in the opinion of the examiner, the proposed amendment does not put the application in condition for interference with another application not involved in the interference, the amendment is placed in the file and marked “not entered” and the applicant is informed why it will not be now entered and acted upon.

(C) When the amendment seeks to provoke an interference with a patent not involved in the interference and the examiner believes that the claims presented are not patentable to the applicant, and where the application is open to further *ex parte* prosecution, the file should be obtained, the amendment entered, and the claims rejected, setting a time period for reply. If reconsideration is requested and rejection made final, a time period for appeal should be set. Where the application at the time of forming the interference was closed to further *ex parte* prosecution and the disclosure of the application will *prima facie* not support the claim presented, or where the claims presented are drawn to a nonelected invention, the amendment will not be entered and the applicant will be so informed. That communication will give briefly the reason for the nonentry of the amendment.

## 2365 Second Interference

*37 CFR 1.665. Second interference.*

A second interference between the same parties will not be declared upon an application not involved in an earlier interference for an invention defined by a count of the earlier interference. See § 1.658(c).



MANUAL OF PATENT EXAMINING PROCEDURE

# Chapter 2400 Biotechnology

<b>2401</b>	<b>Introduction</b>		
<b>2402</b>	<b>The Deposit Rules</b>		
<b>2403</b>	<b>Deposit of Biological Material</b>		
2403.01	Material Capable of Self-Replication		
2403.02	Plant Material		
<b>2404</b>	<b>Need or Opportunity to Make a Deposit</b>		
2404.01	Biological Material That Is Known and Readily Available to the Public		
2404.02	Biological Material That Can Be Made or Isolated Without Undue Experimentation		
2404.03	Reference to a Deposit in the Specification		
<b>2405</b>	<b>Acceptable Depository</b>		
<b>2406</b>	<b>Time of Making an Original Deposit</b>		
2406.01	Description in Application Specification		
2406.02	Deposit After Filing Date - Corroboration		
2406.03	Possible Loss of U.S. Filing Date in Other Countries		
<b>2407</b>	<b>Replacement or Supplement of Deposit</b>		
2407.01	In a Pending Application		
2407.02	After a Patent Has Issued		
2407.03	Failure to Replace		
2407.04	Treatment of Replacement		
2407.05	Exemption From Replacement		
2407.06	Replacement May Not Be Recognized		
<b>2408</b>	<b>Term of Deposit</b>		
<b>2409</b>	<b>Viability of Deposit</b>		
<b>2410</b>	<b>Furnishing of Samples</b>		
2410.01	Conditions of Deposit		
2410.02	Certification of Statement of Availability of Deposit		
<b>2411</b>	<b>Examination Procedures</b>		
2411.01	Rejections Based on Deposit Issue		
2411.02	Replies to Rejections Based on Deposit Issue		
2411.03	Application in Condition for Allowance Except for Deposit		
2411.04	After a Patent Has Been Granted		
2411.05	Content of Application with Respect to Deposited Material		
<b>2420</b>	<b>The Requirements for Patent Applications Containing Nucleotide Sequence and/or Amino Acid Sequence Disclosures - the Sequence Rules</b>		
<b>2421</b>	<b>Overview of the Sequence Rules</b>		
2421.01	Applications Affected		
2421.02	Summary of the Requirements of the Sequence Rules		
2421.03	Notification of a Failure to Comply		
2421.04	Future Changes to the Sequence Rules		
<b>2422</b>	<b>Nucleotide and/or Amino Acid Sequence Disclosures in Patent Applications</b>		
2422.01	Definitions of Nucleotide and/or Amino Acids for Purpose of Sequence Rules		
2422.02	The Requirement for Exclusive Conformance; Sequences Presented in Drawing Figures		
2422.03	The Requirements for a Sequence Listing and Sequence Identifiers; Sequences Embedded in Application Text; Variants of a Presented Sequence		
2422.04	The Requirement for a Computer Readable Copy of the Official Copy of the Sequence Listing		
2422.05	Reference to Previously Filed Identical Computer Readable Form; Continuing or Derivative Applications; Request for Transfer of Computer Readable Form		
2422.06	Requirement for Statement Regarding Content of Official and Computer Readable Copies of Sequence Listing		
2422.07	Requirements for Compliance, Statements Regarding New Matter, and Sanctions for Failure to Comply		
2422.08	Presumptions Regarding Compliance		
2422.09	Box Sequence; Hand Delivery of Sequence Listings and Computer Readable Forms		
<b>2423</b>	<b>Symbols and Format To Be Used for Nucleotide and/or Amino Acid Sequence Data</b>		
2423.01	Format and Symbols To Be Used in Sequence Listings		
2423.02	Depiction of Coding Regions		
2423.03	Presentation and Enumeration of Sequences		
<b>2424</b>	<b>Requirements for Nucleotide and/or Amino Acid Sequences as Part of the Application Papers</b>		
2424.01	Informational Requirements for the Sequence Listing		
2424.02	Sequence Listing Numeric Identifiers		
2424.03	Additional Miscellaneous Requirements		
<b>2425</b>	<b>Form and Format for Nucleotide and/or Amino Acid Sequence Submissions in Computer Readable Form</b>		
<b>2426</b>	<b>Amendments to or Replacement of Sequence Listing and Computer Readable Copy Thereof</b>		
<b>2427</b>	<b>Form Paragraphs and Notice to Comply</b>		
2427.01	Form Paragraphs		
2427.02	Notice To Comply		
<b>2428</b>	<b>Sample Statements</b>		
<b>2429</b>	<b>Helpful Hints for Compliance</b>		
<b>2430</b>	<b>Patent Information; Utilities Programs;</b>		

**Training**

- 2431 **Sample Sequence Listing**
- 2434 **Examination of Patent Applications Claiming Large Numbers of Nucleotide Sequences**
- 2435 **Publishing of Patents and Patent Application Publications With Lengthy Sequence Listings**

**2401 Introduction**

This chapter provides guidance on the practices and procedures for implementation of the deposit rules (37 CFR 1.801 - 1.809) and the sequence rules (37 CFR 1.821 - 1.825). The final rule for deposits of biological materials for patent purposes was published in the *Federal Register*, 54 FR 34864 (August 22, 1989) and in the *Official Gazette*, 1106 O.G. 37 (September 12, 1989). The deposit rules went into effect on January 1, 1990. Revised deposit rules were published in the *Federal Register* at 66 FR 21090 (April 27, 2001) and in the *Official Gazette* at 1246 O.G. 104 (May 22, 2001) and went into effect on May 29, 2001. The final rule for the requirements for patent applications containing nucleotide sequence and/or amino acid sequence disclosures was published in the *Federal Register*, 55 FR 18230 (May 1, 1990) and in the *Official Gazette*, 1114 O.G. 29 (May 15, 1990) and went into effect on October 1, 1990. Revised sequence rules were published in the *Federal Register* at 63 FR 29620 (June 1, 1998) and in the *Official Gazette* at 1121 O.G. 82 (June 23, 1998) and went into effect on July 1, 1998.

Further revisions to the sequence rules were published in the *Federal Register* at 65 FR 54604 (September 8, 2000) and in the *Official Gazette* at 1238 O.G. 145 (September 19, 2000) and went into effect on September 8, 2000.

Additional information regarding the development of the deposit rules can be obtained in the text of the draft policy statement, published in BNA's *Patent, Trademark and Copyright Journal*, 32 PTCJ 781 at 76, 90 (May 22, 1986), the advanced notice of proposed rulemaking, published in the *Federal Register*, 52 FR 34080 (September 9, 1987), and in the *Official Gazette*, 1082 O.G. 47 (September 29, 1987) and in the notice of proposed rulemaking, published in the *Federal Register*, 53 FR 39420 (October 6, 1988), and in the *Official Gazette*, 1095 O.G. 47 (October 25,

1988). Additional information regarding the development of the sequence rules can be obtained in the text of the notice of proposed rulemaking, published in the *Federal Register*, 54 FR 18671 (May 2, 1989) and in the *Official Gazette*, 1102 O.G. 34 (May 16, 1989).

See MPEP § 803.04 and § 1850 for restriction and unity of invention practice respectively in patent applications claiming independent and distinct nucleotide sequences. See also MPEP § 2434.

**2402 The Deposit Rules**

Every patent must contain a written description of the invention sufficient to enable a person skilled in the art to which the invention pertains to make and use the invention. Where the invention involves a biological material and words alone cannot sufficiently describe how to make and use the invention in a reproducible manner, access to the biological material may be necessary for the satisfaction of the statutory requirements for patentability under 35 U.S.C. 112. Courts have recognized the necessity and desirability of permitting an applicant for a patent to supplement the written disclosure in an application with a deposit of biological material which is essential to meet some requirement of the statute with respect to the claimed invention. See, e.g., *Ajinomoto Co. v. Archer-Daniels-Midland Co.*, 228 F.3d 1338, 1345-46, 56 USPQ2d 1332, 1337-38 (Fed. Cir. 2000), *cert. denied*, 121 S.Ct. 1957 (2001)(explaining how deposit may help satisfy enablement requirement); *Merck and Co., Inc. v. Chase Chemical Co.*, 273 F. Supp. 68, 155 USPQ 139 (D. N.J. 1967); *In re Argoudelis*, 434 F.2d 666, 168 USPQ 99 (CCPA 1970). To facilitate the recognition of deposited biological material in patent applications throughout the world, the Budapest Treaty on the International Recognition of the Deposit of Microorganisms for the Purposes of Patent Procedure was established in 1977, and became operational in 1981. The Treaty requires signatory countries, like the United States, to recognize a deposit with any depository which has been approved by the World Intellectual Property Organization (WIPO).

The deposit rules (37 CFR 1.801 - 1.809) set forth examining procedures and conditions of deposit which must be satisfied in the event a deposit is required. The rules do not address the substantive issue of whether a deposit is required under any particular set of facts.

The rules are effective for all applications filed on or after January 1, 1990, and for all reexamination proceedings in which the request for reexamination was filed on or after January 1, 1990, except that deposits made prior to the effective date which were acceptable under the then current practice will be acceptable in such applications and proceedings. Since most of the provisions of the rules reflect policy and practice existing prior to January 1, 1990, little change in practice or burden on applicants for patent and patent owners relying on the deposit of biological material has occurred. Applicants and patent owners are encouraged to comply with these rules even if their applications and reexamination proceedings were filed prior to January 1, 1990.

## 2403 Deposit of Biological Material

### *37 CFR 1.801. Biological material.*

For the purposes of these regulations pertaining to the deposit of biological material for purposes of patents for inventions under 35 U.S.C. 101, the term biological material shall include material that is capable of self-replication either directly or indirectly. Representative examples include bacteria, fungi including yeast, algae, protozoa, eukaryotic cells, cell lines, hybridomas, plasmids, viruses, plant tissue cells, lichens and seeds. Viruses, vectors, cell organelles and other non-living material existing in and reproducible from a living cell may be deposited by deposit of the host cell capable of reproducing the non-living material.

37 CFR 1.801 indicates that the rules pertaining to deposits for purposes of patents for inventions under 35 U.S.C. 101 are intended to relate to biological material. For the purposes of these rules, the term "biological material" is defined in terms of a non-exhaustive list of representative materials which can be deposited in accordance with the procedures defined in these rules. These rules are intended to address procedural matters in the deposit of biological material for patent purposes. They are not designed to decide substantive issues such as whether a deposit of a particular organism or material would be recognized or necessary for the purposes of satisfying the statutory requirements for patentability under 35 U.S.C. 112. Although the issue of the need to make a deposit of biological material typically arises under the enablement requirement of the first paragraph of 35 U.S.C. 112, the issue could also arise under the description requirement (35 U.S.C. 112, first paragraph), best mode requirement (35 U.S.C. 112, first

paragraph) or the requirements of the second paragraph of 35 U.S.C. 112 with respect to the claims.

37 CFR 1.801 does not attempt to identify what biological material either needs to be or may be deposited to comply with the requirements of 35 U.S.C. 112. For the most part, this issue must be addressed on a case-by-case basis. Thus, while the Office does not currently contemplate that there would be any situations where a material that is not capable of self-replication either directly or indirectly would be acceptable as a deposit, an applicant is clearly not precluded by these rules from attempting to show in any given application why the deposit of such a material should be acceptable to satisfy the requirements of 35 U.S.C. 112.

### 2403.01 Material Capable of Self-Replication

Biological material includes material that is capable of self-replication either directly or indirectly. Direct self-replication includes those situations where the biological material reproduces by itself. Representative examples of materials capable of self-replication are defined in the rule. Indirect self-replication is meant to include those situations where the biological material is only capable of replication when another self-replicating biological material is present. Self-replication after insertion in a host is one example of indirect self-replication. Examples of indirect replicating biological materials include viruses, phages, plasmids, symbionts, and replication defective cells. The list of representative examples of each type of replicating material includes viruses to demonstrate that the two lists in the rule are not intended to be mutually exclusive.

### 2403.02 Plant Material

Although plant material is included within the scope of the definition of biological material for purposes of patents for plant inventions under 35 U.S.C. 101, the rules on deposits are not applicable to applications filed under the Plant Patent Act (35 U.S.C. 161-164). The Office is of the view that a deposit is not required under the present provisions of 35 U.S.C. 162. Thus, a deposit is not necessary for the grant of a plant patent under the provisions of 35 U.S.C. 161-164. As with other biological material deposited for



purposes of patents for inventions under 35 U.S.C. 101, the deposit of plant material together with the written specification must enable those skilled in the art to make and use the claimed invention, in accordance with the requirements of 35 U.S.C. 112.

As with some types of reproducible biological material, seeds can be reproduced only after a growing season which may be relatively long. Although the rules do not specify a specific number of seeds to be deposited to meet the requirements of these rules, the Office will consider 2500 to be a minimum number in the normal case, but will give an applicant the opportunity to provide justification why a lesser number would be suitable under the circumstances of a particular case. The Department of Agriculture requires a deposit of 2500 seeds for the grant of a Plant Variety Protection Certificate under the Plant Variety Protection Act (7 U.S.C. 2321 *et seq.*). As the reproduction of seeds will often take a substantial period of time, the Office will require, at a minimum for the grant of a patent, a number of seeds that is likely to satisfy demand for samples once the patent is granted. In one instance, the Office accepted a deposit of 600 seeds coupled with an undertaking to deposit 1900 more seeds with due diligence. The particular situation involved a “seedless” vegetable with very few seeds per “fruit;” about two growing seasons were required to provide the additional 1900 seeds.

## 2404 Need or Opportunity to Make a Deposit

*37 CFR 1.802. Need or opportunity to make a deposit.*

(a) Where an invention is, or relies on, a biological material, the disclosure may include reference to a deposit of such biological material.

(b) Biological material need not be deposited unless access to such material is necessary for the satisfaction of the statutory requirements for patentability under 35 U.S.C. 112. If a deposit is necessary, it shall be acceptable if made in accordance with these regulations. Biological material need not be deposited, *inter alia*, if it is known and readily available to the public or can be made or isolated without undue experimentation. Once deposited in a depository complying with these regulations, a biological material will be considered to be readily available even though some requirement of law or regulation of the United States or of the country in which the depository institution is located permits access to the material only under conditions imposed for safety, public health or similar reasons.

(c) The reference to a biological material in a specification disclosure or the actual deposit of such material by an applicant or patent owner does not create any presumption that such material is

necessary to satisfy 35 U.S.C. 112 or that deposit in accordance with these regulations is or was required.

37 CFR 1.802(a) permits a deposit of a biological material to be referenced in a patent application where an invention is, or relies on, a biological material. The invention may rely on a biological material for the purposes of making or using the invention, either as a preferred mode or an alternative mode of operation. A reference to a deposit may be included in a specification even though the deposit is not required to satisfy the requirements of 35 U.S.C. 112.

There is no necessary implication or presumption that can or should be made about the need for a deposit simply because reference to a deposit is made in an application disclosure, as noted in paragraph (c). As noted in paragraph (b), biological material need not be deposited unless access to such material is necessary for the satisfaction of the statutory requirements for patentability under 35 U.S.C. 112 and that access is not otherwise available in the absence of a deposit. Where a deposit is required to provide the necessary access, a deposit is acceptable for patent purposes only where it is made in accordance with these regulations. Even where access to biological material is required to satisfy these statutory requirements, a deposit may not be necessary if access sufficient to satisfy these requirements is otherwise available.

### 2404.01 Biological Material That Is Known and Readily Available to the Public

In an application where the invention required access to specific biological material, an applicant could show that the biological material is accessible because it is known and readily available to the public. The concepts of “known and readily available” are considered to reflect a level of public accessibility to a necessary component of an invention disclosure that is consistent with an ability to make and use the invention. To avoid the need for a deposit on this basis, the biological material must be both known and readily available - neither concept alone is sufficient. A material may be known in the sense that its existence has been published, but is not available to those who wish to obtain that particular known biological material. Likewise, a biological material may be

available in the sense that those having possession of it would make it available upon request, but no one has been informed of its existence.

The Board of Patent Appeals and Interferences has held that a description of the precise geographic location of marine tunicates, as a biological material, used in a claimed invention was adequate to satisfy the enablement requirement of 35 U.S.C. 112. *Ex Parte Rinehart*, 10 USPQ2d 1719 (Bd. Pat. App. & Int. 1985). The term “readily” used in the phrase “known and readily available” is considered appropriate to define that degree of availability which would be reasonable under the circumstances. If the biological material and its natural location can be adequately described so that one skilled in the art could obtain it using ordinary skill in the art, the disclosure would appear to be sufficient to meet the enablement requirement of 35 U.S.C. 112 without a deposit so long as its degree of availability is reasonable under the circumstances.

By showing that a biological material is known and readily available or by making a deposit in accordance with these rules, applicant does not guarantee that such biological material will be available forever. Public access during the term of the patent may affect the enforceability of the patent. Although there is a public interest in the availability of a deposited biological material during and after the period of enforceability of the patent, there should not be any undue concern about continued access to the public. See 37 CFR 1.806 (the term of deposit is “at least thirty (30) years and at least five (5) years after the most recent request” for a sample; the agreement sufficiently ensures that the deposit will be “available beyond the enforceable life of the patent”). Unless there is a reasonable basis to believe that the biological material will cease to be available during the enforceable life of the patent, current availability would satisfy the requirement. The incentives provided by the patent system should not be constrained by the mere possibility that a disclosure that was once enabling would become non-enabling over a period of time through no fault of the patentee. *In re Metcalfe*, 410 F.2d 1378, 161 USPQ 789 (CCPA 1969).

If an applicant has adequately established that a biological material is known and readily available, the Office will accept that showing. In those instances, however, the applicant takes the risk that the material

may cease to be known and readily available. Such a defect cannot be cured by reissue after the grant of a patent.

On the other hand, *Ex parte Humphreys*, 24 USPQ2d 1255 (Bd. Pat. App. & Int. 1992), held that the only manner in which applicants could satisfy their burden of assuring public access to the needed biological material, and, thereby, compliance with the enablement requirement of 35 U.S.C. 112, was by making an appropriate deposit. The fact that applicants and other members of the public were able to obtain the material in question from a given depository prior to and after the filing date of the application in issue did not establish that upon issuance of a patent on the application that such material would continue to be accessible to the public. The applicants did not make of record any of the facts and circumstances surrounding their access to the material in issue from the depository, nor was there any evidence as to the depository’s policy regarding the material if a patent would have been granted. Further, there was no assurance that the depository would have allowed unlimited access to the material if the application had matured into a patent.

There are many factors that may be used as indicia that a biological material is known and readily available to the public. Relevant factors include commercial availability, references to the biological material in printed publications, declarations of accessibility by those working in the field, evidence of predictable isolation techniques, or an existing deposit made in accordance with these rules. Each factor alone may or may not be sufficient to demonstrate that the biological material is known and readily available. Those applicants that rely on evidence of accessibility other than a deposit take the risk that the patent may no longer be enforceable if the biological material necessary to satisfy the requirements of 35 U.S.C. 112 ceases to be accessible.

The Office will accept commercial availability as evidence that a biological material is known and readily available only when the evidence is clear and convincing that the public has access to the material. See the final rule entitled “Deposit of Biological Materials for Patent Purposes,” 54 FR 34864, 34875 (August 22, 1989). A product could be commercially available but only at a price that effectively eliminates accessibility to those desiring to obtain a sample. The

relationship between the applicant relying on a biological material and the commercial supplier is one factor that would be considered in determining whether the biological material was known and readily available. However, the mere fact that the biological material is commercially available only through the patent holder or the patent holder's agents or assigns shall not, by itself, justify a finding that the necessary material is not readily available, absent reason to believe that access to the biological material would later be improperly restricted.

The mere reference to a deposit or the biological material itself in any document or publication does not necessarily mean that the deposited biological material is readily available. Even a deposit made under the Budapest Treaty and referenced in a United States or foreign patent document would not necessarily meet the test for known and readily available unless the deposit was made under conditions that are consistent with those specified in these rules, including the provision that requires, with one possible exception (37 CFR 1.808(b)), that all restrictions on the accessibility be irrevocably removed by the applicant upon the granting of the patent. *Ex parte Hildebrand*, 15 USPQ2d 1662 (Bd. Pat. App. & Int. 1990).

A Budapest Treaty deposit cited in a U.S. patent need not be made available if it was not required to satisfy 35 U.S.C. 112. For this reason, 37 CFR 1.808(c) provides that upon request made to the Office, the Office will certify whether a deposit has been stated to have been made under conditions which make it available to the public as of the issue date. See 37 CFR 1.808(c) and MPEP § 2410.02 for the requirements of the request. The Office will not certify that the aforementioned statement has been made unless

(A) the deposit was necessary to overcome a rejection under 35 U.S.C. 112,

(B) there is, in the record, a statement by the examiner that a rejection would have been made "but for" the deposit (assumes deposit information in record, as filed), or

(C) the record otherwise clearly indicates that the deposit was made under Budapest Treaty, and that all restrictions imposed by the depositor on the availability to the public of the deposited material will be irrevocably removed upon the granting of the patent (with the possible exception of requiring the request

for the deposit to be in the format specified in 37 CFR 1.808(b)).

If a deposit is not made under the conditions set forth in 37 CFR 1.808(a), the deposit cannot be relied upon for other purposes, e.g., the deposit cannot be relied upon by a third party to establish "known" and "readily available" in another application. See 37 CFR 1.808 and MPEP § 2410 and § 2410.02.

Once a deposit is made in a depository complying with these rules, and under conditions complying with these rules, a biological material will be considered to be readily available even though some requirement of law or regulation in the United States or in the country where the depository institution is located permits access to the material only under conditions imposed for health, safety or similar reasons. This provision is consistent with the Budapest Treaty (Article 5) and is designed to permit the patenting of inventions involving materials having restricted distribution, where the restrictions are imposed for the public, as opposed to the private, welfare.

#### **2404.02 Biological Material That Can Be Made or Isolated Without Undue Experimentation**

Applicant may show that a deposit is not necessary even though specific biological materials are required to practice the invention if those biological materials can be made or isolated without undue experimentation. Deposits may be required to support the claims if an isolation procedure requires undue experimentation to obtain the desired biological material. *Ex Parte Jackson*, 217 USPQ 804 (Bd. App. 1982). No deposit is required, however, where the required biological materials can be obtained from publicly available material with only routine experimentation and a reliable screening test. *Tabuchi v. Nubel*, 559 F.2d 1183, 194 USPQ 521 (CCPA 1977); *Ex Parte Hata*, 6 USPQ2d 1652 (Bd. Pat. App. & Int. 1987).

#### **2404.03 Reference to a Deposit in the Specification**

37 CFR 1.802(c) specifically provides that the mere reference to a biological material in the specification disclosure or the actual deposit of such material does not create any presumption that such referenced or deposited material is necessary to satisfy 35 U.S.C.

112, or that a deposit in accordance with these regulations is or was required. It should be noted, however, that a reference to a biological material, present in an application upon filing, may form the basis for making a deposit, where required, after the filing date of a given application but that the reference to the biological material, itself, cannot be added after filing without risking the prohibited introduction of new matter (35 U.S.C. 132). See the discussion of the Lundak application in MPEP § 2406.01.

## 2405 Acceptable Depository

### 37 CFR 1.803. Acceptable depository.

(a) A deposit shall be recognized for the purposes of these regulations if made in

(1) any International Depository Authority (IDA) as established under the Budapest Treaty on the International Recognition of the Deposit of Microorganisms for the Purposes of Patent Procedure, or

(2) any other depository recognized to be suitable by the Office. Suitability will be determined by the Commissioner on the basis of the administrative and technical competence, and agreement of the depository to comply with the terms and conditions applicable to deposits for patent purposes. The Commissioner may seek the advice of impartial consultants on the suitability of a depository. The depository must:

- (i) Have a continuous existence;
- (ii) Exist independent of the control of the depositor;
- (iii) Possess the staff and facilities sufficient to examine the viability of a deposit and store the deposit in a manner which ensures that it is kept viable and uncontaminated;
- (iv) Provide for sufficient safety measures to minimize the risk of losing biological material deposited with it;
- (v) Be impartial and objective;
- (vi) Furnish samples of the deposited material in an expeditious and proper manner; and
- (vii) Promptly notify depositors of its inability to furnish samples, and the reasons why.

(b) A depository seeking status under paragraph (a)(2) of this section must direct a communication to the Commissioner which shall:

- (1) Indicate the name and address of the depository to which the communication relates;
- (2) Contain detailed information as to the capacity of the depository to comply with the requirements of paragraph (a)(2) of this section, including information on its legal status, scientific standing, staff and facilities;
- (3) Indicate that the depository intends to be available, for the purposes of deposit, to any depositor under these same conditions;
- (4) Where the depository intends to accept for deposit only certain kinds of biological material, specify such kinds;
- (5) Indicate the amount of any fees that the depository will, upon acquiring the status of suitable depository under para-

graph (a)(2) of this section, charge for storage, viability statements and furnishings of samples of the deposit.

(c) A depository having status under paragraph (a)(2) of this section limited to certain kinds of biological material may extend such status to additional kinds of biological material by directing a communication to the Commissioner in accordance with paragraph (b) of this section. If a previous communication under paragraph (b) of this section is of record, items in common with the previous communication may be incorporated by reference.

(d) Once a depository is recognized to be suitable by the Commissioner or has defaulted or discontinued its performance under this section, notice thereof will be published in the Official Gazette of the Patent and Trademark Office.

37 CFR 1.803 indicates that a depository will be recognized as acceptable for the purposes of these regulations if it is either an International Depository Authority (IDA) established under the Budapest Treaty, or if it is a depository recognized as suitable by the Commissioner. After the effective date of these regulations, a deposit of biological material which is made in a depository which is not recognized as acceptable under this regulation will not be considered as satisfying the requirements of 35 U.S.C. 112. See *Ex parte Humphreys*, 24 USPQ2d 1255 (Bd. Pat. App. & Int. 1992). On the other hand, if a deposit is not required to satisfy the requirements of 35 U.S.C. 112, it is permissible to make reference to such a deposit even though it may not be in a depository or made under the conditions which are acceptable under these regulations. As new depositories are recognized as suitable by the Commissioner, their identity will be announced in the *Official Gazette*.

An organization may be recognized as suitable by the Office if the procedure and conditions specified in 37 CFR 1.803(a)(2) and 37 CFR 1.803(b) are followed. Generally, it is not the intention of the Office to recognize as suitable any organization where the need for a suitable depository for patent purposes is being met by depositories recognized as IDAs under the Budapest Treaty. Suitability will be judged by the Commissioner, based on need and the information supplied by the organization seeking status, and information obtained from other sources that may be consulted.

While there is a desire to provide flexibility to a patent applicant in selecting an appropriate depository, these rules are not intended to permit each patent applicant to become its own depository since both the patent owner and the public have an interest in the continued availability and accessibility of the deposit

during the enforceable life of the patent, and the public has a continuing interest in its availability when the patent is no longer enforceable. The concept of a depository independent of the control of the depositor or an IDA as an acceptable depository is based on the need and desire to ensure the safe and reliable storage of a deposited biological material under circumstances that are substantially free of the opportunity for intentional mishandling or negligent handling of the deposited material. The use of an independent depository or internationally recognized depository will tend to preserve the integrity of the deposit process against those that may accidentally alter the deposited material, may wish to tamper with the deposited material or may wish to resume control of its availability when the patent is no longer enforceable, and will tend to preserve the interest of the public in the access to the biological material once the term of the patent expires.

When a depository having status under 37 CFR 1.803(a)(2) seeks to change the kinds of biological materials that it will accept and maintain for the purposes of these rules, a communication requesting such a change should be directed to the Commissioner containing the information requested in 37 CFR 1.803(b). When such a change is requested, the requesting depository should provide a complete list of the kinds of biological materials it will accept.

37 CFR 1.803(d) indicates that once a depository is recognized as suitable for the purposes of this rule, or has defaulted or discontinued its performance under this section, notice thereof will be published in the *Official Gazette* of the Patent and Trademark Office. A current list (as of January, 1998) of IDAs recognized under the Budapest Treaty, with addresses, is included below. The mere fact that a deposit has been made in one of these depositories does not mean that the terms of the deposit meet either the requirements of the Budapest Treaty or the deposit regulations. Many of the depositories recognized under the Budapest Treaty have many different arrangements under which biological material may be stored.

The World Intellectual Property Organization (WIPO) publishes a Guide to the Deposit of Microorganisms under the Budapest Treaty (WIPO Publication No. 661 (E)) on the procedures and requirements concerning the deposit of biological material, including procedures for obtaining a sample of deposited

material, in each of the international depository authorities.

### **CURRENT IDAs**

The following constitutes the list of IDAs recognized under the Budapest Treaty. The list is current as of July, 2001.

Advanced Biotechnology Center (ABC)  
Interlab Cell Line Collection  
(Biotechnology Dept.)  
Largo Rossana Benzi, 10  
16132 Genova  
Italy

Agricultural Research Service  
Culture Collection (NRRL)  
1815 North University Street  
Peoria, Illinois 61604  
USA

American Type Culture Collection (ATCC)  
10801 University Blvd.  
Manassas, Virginia 20110-2209  
USA

Australian Government Analytical  
Laboratories (AGAL)  
The New South Wales Regional Laboratory  
1, Suakin Street  
Pymble, NSW 2073  
Australia

Belgian Coordinated Collections of  
Microorganisms (BCCM)  
Prime Minister's Services  
Federal Office for Scientific, Technical and  
Cultural Affairs (OSTC)  
Rue de la Science 8  
B-1000 Brussels  
Belgium

Bureau of Microbiology at Health Canada (BMHC)  
Federal Laboratories for Health Canada  
Room H5190  
1015 Arlington Street  
Winnipeg, Manitoba  
Canada R3E 3R2

Centraalbureau voor Schimmelcultures (CBS)

Oosterstraat 1  
Postbus 273  
NL-3740 AG Baarn  
Netherlands

China Center for Type Culture Collection (CCTCC)  
Wuhan University  
Wuhan 430072  
China

China General Microbiological Culture  
Center (CGMCC)  
China Committee for Culture Collection of  
Microorganisms  
P.O. Box 2714  
Beijing 100080  
China

Colección Española de Cultivos Tipo (CECT)  
Universidad de Valencia  
Edificio de Investigación  
Campus de Burjasot  
46100 Burjasot (Valencia)  
Spain

Collection Nationale De Cultures  
De Micro-organismes (CNCM)  
Institut Pasteur  
28, rue du Dr Roux  
75724 Paris Cédex 15  
France

Collection of Industrial Yeasts DBVPG  
Applied Microbiology Section  
Department of Plant Biology  
Faculty of Agriculture  
University of Perugia  
Borgo 20 Giugno, 74  
06122 Perugia  
Italy

Culture Collection of Algae and Protozoa (CCAP)  
Institute of Freshwater Ecology  
Windermere Laboratory  
Ambleside, Cumbria LA22 0LP  
United Kingdom and Dunstaffnage Marine Labora-  
tory  
P.O. Box 3  
Oban, Argyll PA34 4AD  
United Kingdom

Culture Collection of Yeasts (CCY)  
Institute of Chemistry  
Slovak Academy of Sciences  
Dúbravská cesta 9  
842 38 Bratislava,  
Slovakia

Czech Collection of Microorganisms (CCM)  
Masaryk University  
ul. Tvrdého 14  
602 00 Brno  
Czech Republic

DSMZ-Deutsche Sammlung von Mikroorganismen  
und Zellkulturen GmbH (DSMZ)  
Mascheroder Weg 1b  
D-38124 Braunschweig  
Germany

European Collection of Cell Cultures (ECACC)  
Vaccine Research and Production Laboratory  
Public Health Laboratory Service  
Centre for Applied Microbiology and Research  
Porton Down  
Salisbury, Wiltshire SP4 0JG  
United Kingdom

Institute of Agriculture and Food Biotechnology  
(IAFB)  
Collection of Industrial Microorganisms  
Ul. Rakowiecka 36  
02-532 Warsaw, Poland

International Mycological Institute (IMI)  
Bakeham Lane  
Englefield Green  
Egham, Surrey TW20 9TY  
United Kingdom

International Patent Organism Depository (IPOD)  
AIST Tsukuba Central 6  
1-1, Higashi 1-chome  
Tsukuba-shi, Ibaraki-Ken 305-8566  
Japan

Korean Cell Line Research Foundation (KCLRF)  
Cancer Research Institute  
Seoul National University College of Medicine  
28 Yungon-dong, Chongno-gu  
Seoul 110-799  
Republic of Korea

Korean Collection for Type Cultures (KCTC)  
52, Oun-dong,  
Yusong-Ku  
Taejon 305-333  
Republic of Korea

Korean Culture Center of Microorganisms (KCCM)  
College of Engineering  
Yonsei University  
Sodaemun gu  
Seoul 120-749  
Republic of Korea

Microbial Strain Collection of Latvia (MSCL)  
University of Latvia  
Faculty of Biology  
Blvd. Kronvalda 4  
LV-1586 Riga  
Latvia

National Bank for Industrial Microorganisms and  
Cell Cultures (NBIMCC)  
125, Tsarigradskochausse Blvd.  
Block 2  
1113 Sofia  
Bulgaria

National Collection of Agricultural and Industrial  
Microorganisms (NCAIM)  
Department of Microbiology and Biotechnology  
University of Horticulture and the Food Industry  
Somlói út 14-16  
H-1118 Budapest  
Hungary

National Collection of Type Cultures (NCTC)  
Central Public Health Laboratory  
61 Colindale Avenue  
London, NW9 5HT  
United Kingdom

National Collection of Yeast Cultures (NCYC)  
AFRC Institute of Food Research  
Norwich Laboratory  
Colney Lane  
Norwich NR4 7UA  
United Kingdom

National Collections of Industrial, Food and  
Marine Bacteria (NCIMB)  
23 St. Machar Drive

Aberdeen AB2 1RY  
Scotland, United Kingdom

National Research Center of Antibiotics  
Nagatinskaya Street 3-a  
Moscow 113105  
Russian Federation

Polish Collection of Microorganisms (PCM)  
Institute of Immunology and Experimental Therapy  
Polish Academy of Sciences  
Ul. Weigla 12  
53-114 Wroclaw  
Poland

Russian Collection of Microorganisms (VKM)  
Prospekt Naouki, 5  
142292 Puschino (Moscow Region)  
Russian Federation

Russian National Collection of Industrial  
Microorganisms (VKPM)  
GNII Genetika  
Dorozhny proezd. 1  
Moscow 113545  
Russian Federation

## 2406 Time of Making an Original Deposit

*37 CFR 1.804. Time of making an original deposit.*

(a) Whenever a biological material is specifically identified in an application for patent as filed, an original deposit thereof may be made at any time before filing the application for patent or, subject to § 1.809, during pendency of the application for patent.

(b) When the original deposit is made after the effective filing date of an application for patent, the applicant must promptly submit a statement from a person in a position to corroborate the fact, stating that the biological material which is deposited is a biological material specifically identified in the application as filed.

37 CFR 1.804 specifies the time for making an original deposit to fulfill the requirements of 35 U.S.C. 112. For the reasons discussed throughout this section, it is recommended that a deposit be made before the filing date of the application. However, for the purposes of complying with the requirements of 35 U.S.C. 112, a deposit of a biological material may be made at any time before filing the application for patent or during the pendency of the application

subject to the conditions of 37 CFR 1.809. Where a deposit is needed to satisfy the requirements of 35 U.S.C. 112 and it is made during the pendency of the application, it must be made no later than the time period set by the examiner at the time the Notice of Allowance and Issue Fee Due is mailed. A necessary deposit need not be made by an applicant until the application is in condition for allowance so long as the applicant provides a written assurance that an acceptable deposit will be made on or before the payment of the issue fee. This written assurance must provide sufficiently detailed information to convince the examiner that there is no outstanding issue regarding deposits that needs to be resolved.

These rules are equally applicable in the cases of international and national stage applications filed under the Patent Cooperation Treaty. Insofar as the rules do not permit post-issuance original deposits, the failure to make an original deposit in an application cannot be cured by filing a reissue application or instituting a reexamination proceeding. However, if an amendment of claims in a reexamination proceeding raises the need for a deposit, an original deposit may be made during the reexamination proceeding.

### **2406.01 Description in Application Specification**

37 CFR 1.804(a) specifies not only a permissible time frame for making an original deposit, but also specifies that the biological material deposited must be specifically identified in the application for patent as filed. The requirement for a specific identification is consistent with the description requirement of the first paragraph of 35 U.S.C. 112 and provides an antecedent basis for the biological material which either has been or will be deposited before the patent is granted.

The description in the Lundak application as filed (now patent 4,594,325) provides a suitable illustration of the specific identification and description which are required in an application as filed. In that application, an immortal B-cell line was disclosed and claimed. The cell line was referred to in the application, as filed, as WI-L2-729 HF2. The methods of obtaining and using this cell line were also described in the

application as filed. A deposit of the cell line was made with the American Type Culture Collection (ATCC) about a week after the application was filed in the United States. The United States Court of Appeals for the Federal Circuit held that the requirements of access by the Office to a sample of the cell line during pendency, and public access after grant, were met by Lundak's procedures. The Court further held that the addition of information designating the depository, accession number, and deposit date of the deposited cell line in ATCC after the filing date did not violate the prohibition against new matter in 35 U.S.C. 132. *In re Lundak*, 773 F.2d 1216, 227 USPQ 90 (Fed. Cir. 1985). However, it must be clear from the application as filed that the invention claimed and described in the specification "was fully capable of being reduced to practice (i.e., no technological problems, the resolution of which would require more than ordinary skill and reasonable time, remained in order to obtain an operative, useful process)." *Feldman v. Aunstrup*, 517 F.2d 1351, 1355, 186 USPQ 108, 113 (CCPA 1975), *cert. denied*, 424 U.S. 912 (1976).

### **2406.02 Deposit After Filing Date - Corroboration**

When the original deposit is made after the effective filing date of an application for patent, an applicant is required to promptly submit a statement from a person in a position to corroborate that the biological material which is deposited is a biological material specifically identified in the application (the filing date of which is relied upon) as filed. The nature of this corroboration will depend on the circumstances in the particular application under consideration, including the length of time between the application filing date and the date of deposit. While few, if any, situations can be imagined where the description requirement of 35 U.S.C. 112 can be satisfied where the biological material was not in existence at the time of filing, the rules will not preclude such a situation as there is no requirement in the patent law that an actual reduction to practice occur as a condition precedent to filing a patent application.



### 2406.03 Possible Loss of U.S. Filing Date in Other Countries

Those applicants intending to file patent applications in a country foreign to the United States relying upon biological material that must be deposited to satisfy the requirements of 35 U.S.C. 112 when the application is filed in the United States are cautioned that in many countries the deposit must be made before the filing date of the priority application in order to obtain foreign priority rights. Thus, while the deposit of a biological material subsequent to the effective filing date of a United States application is sufficient to comply with 35 U.S.C. 112, an applicant may not be able to rely on the filing date of such a U.S. application if a patent is sought in certain countries foreign to the United States.

### 2407 Replacement or Supplement of Deposit

#### 37 CFR 1.805. *Replacement or supplement of deposit.*

(a) A depositor, after receiving notice during the pendency of an application for patent, application for reissue patent or reexamination proceeding, that the depository possessing a deposit either cannot furnish samples thereof or can furnish samples thereof but the deposit has become contaminated or has lost its capability to function as described in the specification, shall notify the Office in writing, in each application for patent or patent affected. In such a case, or where the Office otherwise learns, during the pendency of an application for patent, application for reissue patent or reexamination proceeding, that the depository possessing a deposit either cannot furnish samples thereof or can furnish samples thereof but the deposit has become contaminated or has lost its capability to function as described in the specification, the need for making a replacement or supplemental deposit will be governed by the same considerations governing the need for making an original deposit under the provisions set forth in § 1.802(b). A replacement or supplemental deposit made during the pendency of an application for patent shall not be accepted unless it meets the requirements for making an original deposit under these regulations, including the requirement set forth under § 1.804(b). A replacement or supplemental deposit made in connection with a patent, whether or not made during the pendency of an application for reissue patent or a reexamination proceeding or both, shall not be accepted unless a certificate of correction under § 1.323 is requested by the patent owner which meets the terms of paragraphs (b) and (c) of this section.

(b) A request for certificate of correction under this section shall not be granted unless the certificate identifies:

- (1) The accession number for the replacement or supplemental deposit;
- (2) The date of the deposit; and
- (3) The name and address of the depository.

(c) A request for a certificate of correction under this section shall not be granted unless the request is made promptly after the replacement or supplemental deposit has been made and the request:

(1) Includes a statement of the reason for making the replacement or supplemental deposit;

(2) Includes a statement from a person in a position to corroborate the fact, and stating that the replacement or supplemental deposit is of a biological material which is identical to that originally deposited;

(3) Includes a showing that the patent owner acted diligently —

(i) In the case of a replacement deposit, in making the deposit after receiving notice that samples could no longer be furnished from an earlier deposit; or

(ii) In the case of a supplemental deposit, in making the deposit after receiving notice that the earlier deposit had become contaminated or had lost its capability to function as described in the specification;

(4) Includes a statement that the term of the replacement or supplemental deposit expires no earlier than the term of the deposit being replaced or supplemented; and

(5) Otherwise establishes compliance with these regulations.

(d) A depositor's failure to replace a deposit, or in the case of a patent, to diligently replace a deposit and promptly thereafter request a certificate of correction which meets the terms of paragraphs (b) and (c) of this section, after being notified that the depository possessing the deposit cannot furnish samples thereof, shall cause the application or patent involved to be treated in any Office proceeding as if no deposit were made.

(e) In the event a deposit is replaced according to these regulations, the Office will apply a rebuttable presumption of identity between the original and the replacement deposit where a patent making reference to the deposit is relied upon during any Office proceeding.

(f) A replacement or supplemental deposit made during the pendency of an application for patent may be made for any reason.

(g) In no case is a replacement or supplemental deposit of a biological material necessary where the biological material, in accordance with § 1.802(b), need not be deposited.

(h) No replacement deposit of a biological material is necessary where a depository can furnish samples thereof but the depository for national security, health or environmental safety reasons is unable to provide samples to requesters outside of the jurisdiction where the depository is located.

(i) The Office will not recognize in any Office proceeding a replacement deposit of a biological material made by a patent owner where the depository could furnish samples of the deposit being replaced.

37 CFR 1.805 relates to the deposit of a biological material to replace or supplement a previous deposit. The term "replacement" is directed to those situations where one deposit is being substituted for another. An applicant may have greater latitude in replacing a

deposit during the pendency of an application than after the patent is granted. Replacement will typically take place where the earlier deposit is no longer viable. The term “supplement” is directed to those situations where the earlier deposit is still viable in the sense that it is alive and capable of replication either directly or indirectly, but has lost a quality (e.g., purity, functionality) it allegedly possessed at the time the application was filed.

### **2407.01 In a Pending Application**

37 CFR 1.805(a) relates to the procedure for replacing or supplementing a deposit with respect to a pending application or a patent. An applicant or patent owner is required to notify the Office when it obtains information that the depository possessing a deposit cannot furnish samples of the deposit to satisfy the requirements of 35 U.S.C. 112. When the Office is so informed or otherwise becomes aware that samples of the deposited material cannot be furnished by the depository, the examiner will treat the application or reexamination proceeding, whichever is applicable, as if no deposit existed. A replacement or supplemental deposit will be accepted if it meets all the requirements for making an original deposit.

It should be noted that in a pending application, an applicant need not replace the identical material previously deposited, but may make an original deposit of a biological material which is specifically identified and described in the application as filed. Whether this alternative deposit will meet the requirements of 35 U.S.C. 112 with respect to the claimed subject matter must be resolved by the examiner on a case-by-case basis. The conditions in 37 CFR 1.802(b) and 37 CFR 1.804(b) must be satisfied.

### **2407.02 After a Patent Has Issued**

A replacement deposit made in connection with an application for reissue patent or a reexamination proceeding or both shall not be accepted unless a certificate of correction is requested which meets the terms of 37 CFR 1.805(b) and 37 CFR 1.805 (c) for replacement deposits. Any correction made to the original patent will be automatically incorporated into the reissued or reexamined patent unless changes are made during examination of the reissue application or reexamination proceeding.

37 CFR 1.805(b) and 37 CFR 1.805(c) specify the procedures that a patent owner may follow to ensure that a patent contains the appropriate information about a deposited biological material in the event that a replacement or supplemental deposit is made after the patent is granted. 37 CFR 1.805(b) describes the information which must be contained in the certificate of correction, whereas 37 CFR 1.805(c) describes the information which must be provided in the request to make the correction.

### **2407.03 Failure to Replace**

37 CFR 1.805(d) sets forth the Office position that the failure to make a replacement deposit in a case pending before the Office, for example a reissue or reexamination proceeding, where a deposit is considered to be necessary to satisfy the requirements of 35 U.S.C. 112, shall cause the application or patent involved to be treated in any Office proceeding as if no deposit were made. The provisions of 37 CFR 1.805(g) indicate that a replacement need not be made where, at the point in time when replacement would otherwise be necessary, access to the necessary biological material was otherwise available. For example, a replacement deposit would not be required under the circumstances where access to the necessary biological material was established through commercial suppliers.

### **2407.04 Treatment of Replacement**

37 CFR 1.805(e) indicates that the Office will apply a rebuttable presumption of identity between the replacement deposit and an original deposit where a patent making reference to the deposit is relied on during any Office proceeding. This means that where a replacement deposit is permitted and made, the examiner will assume that the same material as described in the patent is accessible from the identified depository unless evidence to the contrary comes to the attention of the Office.

An applicant for patent may make a replacement deposit during the pendency of the application for any reason. The provisions of 37 CFR 1.805(f) recognize that since an original deposit may be made during the pendency of the application subject to the conditions of 37 CFR 1.809, a replacement deposit logically cannot be held to any higher standard or any further requirements.

### 2407.05 Exemption From Replacement

The provisions of 37 CFR 1.805(h) indicate that a replacement deposit is not required even though the depository cannot furnish samples, under certain conditions, to those requesting a sample outside of the jurisdiction where the depository is located. The conditions are specified in this paragraph as being limited to national security, health or environmental safety reasons. See also Article 5 of the Budapest Treaty.

### 2407.06 Replacement May Not Be Recognized

Finally, 37 CFR 1.805(i) indicates that the Office will not recognize in any Office proceeding a replacement deposit made by the patent owner where the depository could furnish samples of the original deposit being replaced. The best evidence of what was originally deposited should not be lost through destruction or replacement if made in association with an existing patent. A supplemental deposit may be accepted in an Office proceeding, however, depending on the circumstances in each case.

### 2408 Term of Deposit

*37 CFR 1.806. Term of deposit.*

A deposit made before or during pendency of an application for patent shall be made for a term of at least thirty (30) years and at least five (5) years after the most recent request for the furnishing of a sample of the deposit was received by the depository. In any case, samples must be stored under agreements that would make them available beyond the enforceable life of the patent for which the deposit was made.

The term of deposit must satisfy the requirements of the Budapest Treaty which sets a term of at least 30 years from the date of deposit and at least 5 years after the most recent request for the furnishing of a sample of the deposit was received by the depository. In the event that the 30-year term covers the 17-year term or 20-year term of the patent plus 6 years to include the Statute of Limitations, no further requirement is necessary. Unless applicant indicates that the deposit has been made under the Budapest Treaty, applicant must indicate the term for which the deposit has been made. The mere possibility of patent term extension or extended litigation involving the patent should not be considered in this analysis.

In the event that the 30-year term of deposit measured from the date of deposit would necessarily terminate within the period of enforceability of the patent (the normal 17-year term or 20-year term plus 6 years to include the Statute of Limitations), samples must be stored under agreements that would make them available beyond the enforceable life of the patent (i.e., until 23 years after issuance or 26 years after application filing) for which the deposit was made. No requirement should be made as to any particular period of time beyond the enforceable life of the patent. The purpose of the requirement is to insure that a deposited biological material necessary for the practice of a patented invention would be available to the public after expiration of the patent for which the deposit was made. The term of the deposit must comply with the requirements of each sentence of 37 CFR 1.806 whether or not the deposit is made under the Budapest Treaty. A specific statement that the deposit complies with the second sentence of this section is required only where the 30-year term would terminate within the enforceable life of the patent.

### 2409 Viability of Deposit

*37 CFR 1.807. Viability of deposit.*

(a) A deposit of biological material that is capable of self-replication either directly or indirectly must be viable at the time of deposit and during the term of deposit. Viability may be tested by the depository. The test must conclude only that the deposited material is capable of reproduction. No evidence is necessarily required regarding the ability of the deposited material to perform any function described in the patent application.

(b) A viability statement for each deposit of a biological material defined in paragraph (a) of this section not made under the Budapest Treaty on the International Recognition of the Deposit of Microorganisms for the Purposes of Patent Procedure must be filed in the application and must contain:

- (1) The name and address of the depository;
- (2) The name and address of the depositor;
- (3) The date of deposit;
- (4) The identity of the deposit and the accession number given by the depository;
- (5) The date of the viability test;
- (6) The procedures used to obtain a sample if the test is not done by the depository; and
- (7) A statement that the deposit is capable of reproduction.

(c) If a viability test indicates that the deposit is not viable upon receipt, or the examiner cannot, for scientific or other valid reasons, accept the statement of viability received from the applicant, the examiner shall proceed as if no deposit has been made.

The examiner will accept the conclusion set forth in a viability statement issued by a depository recognized under § 1.803(a).

37 CFR 1.807 requires that the deposit of biological material that is capable of self-replication either directly or indirectly must be viable at the time of deposit and during the term of deposit. This requirement for viability is essentially a requirement that the deposited material is capable of reproduction. For the purpose of making a deposit under these rules, there is no requirement that evidence be provided that the deposited material is capable or has the ability to perform any function described in the patent application. However, as with any other issue of description or enablement, if the examiner has evidence or reason to question the objective statements made in the patent application, applicants may be required to demonstrate that the deposited biological material will perform in the manner described.

Under the Budapest Treaty, there is a requirement that the deposit be tested for viability before it is accepted. Thus, a mere statement by an applicant, an authorized representative of applicant or the assignee that the deposit has been accepted under the Budapest Treaty would satisfy 37 CFR 1.807.

For each deposit which is not made under the Budapest Treaty, a viability statement must be filed in the patent application and contain the information listed in paragraph (b) of this section. Under 37 CFR 1.807(c), the examiner will accept the conclusion set forth in a viability statement which is issued by a depository recognized under 37 CFR 1.803(a). If the viability test indicates that the deposit is not viable upon receipt, or the examiner cannot, for scientific or other valid reasons, accept the statement of viability received from the applicant, the examiner shall so notify the applicant stating the reasons for not accepting the statement and proceed with the examination process as if no deposit had been made.

## 2410 Furnishing of Samples

*37 CFR 1.808. Furnishing of samples.*

(a) A deposit must be made under conditions that assure that:

(1) Access to the deposit will be available during pendency of the patent application making reference to the deposit to one determined by the Commissioner to be entitled thereto under § 1.14 and 35 U.S.C. 122, and

(2) Subject to paragraph (b) of this section, all restrictions imposed by the depositor on the availability to the public of the

deposited material will be irrevocably removed upon the granting of the patent.

(b) The depositor may contract with the depository to require that samples of a deposited biological material shall be furnished only if a request for a sample, during the term of the patent:

(1) Is in writing or other tangible form and dated;

(2) Contains the name and address of the requesting party and the accession number of the deposit; and

(3) Is communicated in writing by the depository to the depositor along with the date on which the sample was furnished and the name and address of the party to whom the sample was furnished.

(c) Upon request made to the Office, the Office will certify whether a deposit has been stated to have been made under conditions which make it available to the public as of the issue date of the patent grant provided the request contains:

(1) The name and address of the depository;

(2) The accession number given to the deposit;

(3) The patent number and issue date of the patent referring to the deposit; and

(4) The name and address of the requesting party.

## 2410.01 Conditions of Deposit

37 CFR 1.808 requires that the deposit of biological material be made under two conditions:

(A) access to the deposit will be available during pendency of the patent application making reference to the deposit to one determined by the Commissioner to be entitled thereto under 37 CFR 1.14 and 35 U.S.C. 122, and

(B) with one exception, that all restrictions imposed by the depositor on the availability to the public of the deposited biological material be irrevocably removed upon the granting of the patent.

The one exception that is permitted is specified in 37 CFR 1.808(b) which permits the depositor to contract with the depository to require that samples of a deposited biological material shall be furnished only if a request for a sample, during the term of the patent, meets any one or all of the three conditions specified in this paragraph. These conditions are:

(A) the request is in writing or other tangible form and dated; and/or

(B) the request contains the name and address of the requesting party and the accession number of the deposit; and/or

(C) the request is communicated in writing by the depository to the depositor along with the date on which the sample was furnished and the name and

address of the party to whom the sample was furnished.

It should be noted that this exception to the general rule that all restrictions will be removed must be strictly followed and that no variations of this explicit exception will be accepted as meeting the conditions of this section. Although this exception is consistent with the provisions in the Budapest Treaty and its implementing regulations (Rule 11.4), other conditions on accessibility are permitted under the Budapest Treaty as prescribed by national law. Consequently, the mere indication that a deposit has been made under conditions prescribed by the Budapest Treaty would satisfy all conditions of these regulations except the requirement that all restrictions on access be removed on grant of the patent. *Ex parte Hildebrand*, 15 USPQ2d 1662 (Bd. Pat. App. & Int. 1990).

### 2410.02 Certification of Statement of Availability of Deposit

Since the mere description of a deposit or identity of a deposit in a patent specification is not necessarily an indication that a requirement for deposit was made or that a deposit which complies with these rules has been made, accessibility to a deposited material referenced in a patent may depend on the satisfaction of conditions not apparent on the face of the patent. For these reasons, and upon request made to the U.S. Patent and Trademark Office, the Office will certify whether a deposit has been stated to have been made under conditions which would make it available to the public as of the issue date of the patent grant provided the request is made to a Director of Technology Center (TC) 1600, and contains the following information:

- (A) the name and address of the depository;
- (B) the accession number given to the deposit;
- (C) the patent number and issue date of the patent referring to the deposit; and
- (D) the name and address of the requesting party.

See also MPEP § 2404.01.

For those deposits made pursuant to the Budapest Treaty, the World Intellectual Property Organization provides a form (Form BP-12) for requesting a certification of legal entitlement to receive samples of deposited microorganisms pursuant to Rule 11.3(a) of

the Regulations under the Budapest Treaty. Copies of this form are available from a TC 1600 Director.

## 2411 Examination Procedures

*37 CFR 1.809. Examination procedures.*

(a) The examiner shall determine pursuant to § 1.104 in each application for patent, application for reissue patent or reexamination proceeding if a deposit is needed, and if needed, if a deposit actually made is acceptable for patent purposes. If a deposit is needed and has not been made or replaced or supplemented in accordance with these regulations, the examiner, where appropriate, shall reject the affected claims under the appropriate provision of 35 U.S.C. 112, explaining why a deposit is needed and/or why a deposit actually made cannot be accepted.

(b) The applicant for patent or patent owner shall reply to a rejection under paragraph (a) of this section by—

(1) In the case of an applicant for patent, either making an acceptable original, replacement, or supplemental deposit, or assuring the Office in writing that an acceptable deposit will be made; or, in the case of a patent owner, requesting a certificate of correction of the patent which meets the terms of paragraphs (b) and (c) of § 1.805, or

(2) Arguing why a deposit is not needed under the circumstances of the application or patent considered and/or why a deposit actually made should be accepted. Other replies to the examiner's action shall be considered nonresponsive. The rejection will be repeated until either paragraph (b)(1) of this section is satisfied or the examiner is convinced that a deposit is not needed.

(c) If an application for patent is otherwise in condition for allowance except for a needed deposit and the Office has received a written assurance that an acceptable deposit will be made, applicant will be notified and given a period of time within which the deposit must be made in order to avoid abandonment. This time period is not extendable under § 1.136(a) or (b) if set forth in a "Notice of Allowability" or in an Office action having a mail date on or after the mail date of a "Notice of Allowability" (see § 1.136(c)).

(d) For each deposit made pursuant to these regulations, the specification shall contain:

- (1) The accession number for the deposit;
- (2) The date of the deposit;
- (3) A description of the deposited biological material sufficient to specifically identify it and to permit examination; and
- (4) The name and address of the depository.

(e) Any amendment required by paragraphs (d)(1), (d)(2) or (d)(4) of this section must be filed before or with the payment of the issue fee (see § 1.312).

37 CFR 1.809 sets forth procedures that will be used by the examiner to address a deposit issue. The burden is initially on the Office to establish that access to a biological material is necessary for the satisfaction of the statutory requirements for patentability under 35 U.S.C. 112. Once the Office has met this burden, the burden shifts to the applicant or patent

owner to demonstrate that access to such biological material either is not necessary, or is already available, or that a deposit of such material will be made in accordance with these regulations.

### 2411.01 Rejections Based on Deposit Issue

Under 37 CFR 1.809(a), once the examiner has determined that access to a biological material is necessary, and there is no information that would support the conclusion that access is currently available in accordance with these regulations, the examiner should make an appropriate rejection under 35 U.S.C. 112 until such time as a deposit in accordance with these regulations is actually made or a written assurance is received in the patent application that such a deposit will be made upon an indication of allowability of the application. The examiner should clearly indicate the statutory basis for the rejection and the reasons that are relied upon by the examiner to conclude that the application does not comply with some requirement of 35 U.S.C. 112. Although not exhaustive, the following grounds of rejection may be applicable in appropriate circumstances:

(A) 35 U.S.C. 112, first paragraph - lack of an enabling disclosure without access to a specific biological material. This ground of rejection should be accompanied by evidence of scientific reasoning to support the conclusion that a person skilled in the art could not make or use the invention defined in and commensurate with the claims without access to the specific biological material.

(B) 35 U.S.C. 112, first paragraph - description requirement. This ground of rejection typically arises in the context that the application as filed does not contain a description to support an amendment to the specification or claims. An amendment to the claims that is not described in the application as filed would justify a rejection of the affected claims under 35 U.S.C. 112, first paragraph. If an amendment is made to the application, other than the claims, that is not described in the application as filed, this would justify an objection under 35 U.S.C. 112, first paragraph and/or 35 U.S.C. 132 (prohibition against the introduction of new matter) and a requirement that the amendment be canceled.

(C) 35 U.S.C. 112, first paragraph - best mode requirement. This ground of rejection will be rare in the *ex parte* examination process because it requires (1) a finding by the examiner that, at the time the application was filed, the inventor(s) knew of a specific material that was considered by the inventor(s) to be better than any other, and (2) if a best mode was contemplated at that time, that the inventor(s) concealed the best mode (accidentally or intentionally) by failing to adequately describe that best mode. See *Chemcast Corp. v. Arco Industries Corp.*, 913 F.2d 923, 16 USPQ2d 1033 (Fed. Cir. 1990). The Court of Appeals for the Federal Circuit has at least twice resolved a best mode issue arising in the context of a biotechnology invention in favor of the patentee. See *Scripps Clinic and Research Foundation v. Genentech Inc.*, 927 F.2d 1565, 18 USPQ2d 1001 (Fed. Cir. 1991) with respect to monoclonal antibodies, and *Amgen Inc. v. Chugai Pharmaceutical Co. Ltd.*, 927 F.2d 1200, 18 USPQ2d 1016 (Fed. Cir. 1991) with respect to mammalian host cells.

(D) 35 U.S.C. 112, second paragraph - indefiniteness. This ground of rejection, as applied to a deposit issue, requires the examiner to provide reasons why the terms in the claims and/or scope of the invention are unclear because of an incomplete or inaccurate description or the absence of a reference to a biological material.

(E) 35 U.S.C. 112, second paragraph - claims do not set forth what applicants regard as their invention. This ground of rejection requires the citation of some evidence, not contained in the application as filed, that the claims do not set forth what applicants regard as their invention. *In re Prater*, 415 F.2d 1393, 162 USPQ 541 (CCPA 1969). Any disagreement between the content of the application disclosure and the scope of the claims should be addressed under 35 U.S.C. 112, first paragraph. See *In re Ehrreich*, 590 F.2d 902, 200 USPQ 504 (CCPA 1979).

Where a deposit is required to satisfy 35 U.S.C. 112, a deposit must be made in accordance with these regulations. A deposit accepted in any IDA under the Budapest Treaty shall be accepted for patent purposes if made under conditions which comply with 37 CFR 1.806 and 37 CFR 1.808(a) concerning term of deposit and permissible conditions on access once the patent is granted.

## 2411.02 Replies to Rejections Based on Deposit Issue

Once a rejection under 35 U.S.C. 112 has been made by the examiner directed to the absence of access to a biological material, applicant may reply, pursuant to 37 CFR 1.809 (b)(1), by either making an acceptable original or replacement deposit in accordance with these regulations, or assuring the Office in writing that an acceptable deposit will be made on or before the date of payment of the issue fee, or by submitting an argument of why a deposit is not required under the circumstances of the application being considered. Other replies to such a rejection by the examiner shall be considered nonresponsive and may result in abandonment of the application. The rejection will be repeated and made final until the requirements of 37 CFR 1.809(b)(1) are satisfied or the examiner is convinced that a deposit is not required for the claimed subject matter. Once the rejection is made final, the requirements of 37 CFR 1.116 apply to further submissions. The written assurance will be accepted by the Office if it clearly states that an acceptable deposit will be made within the required time and under conditions which satisfy these rules. In the case that an acceptable written assurance has been made by the applicant, the rejection under 35 U.S.C. 112 directed to the absence of access to the biological material should be removed.

## 2411.03 Application in Condition for Allowance Except for Deposit

As set forth in 37 CFR 1.809(c), in the event that an application for patent is otherwise in condition for allowance except for a required deposit and the Office has received a written assurance that an acceptable deposit will be made, applicant will be notified and given a period of time within which the deposit must be made in order to avoid abandonment. This time period is not extendable under 37 CFR 1.136(a) or (b) if set forth in a "Notice of Allowability" or in an Office action having a mail date on or after the mail date of a "Notice of Allowability" (see 37 CFR 1.136(c)). Failure to make the needed deposit in accordance with this requirement will be considered a failure to prosecute the application under 35 U.S.C. 133 and result in abandonment of the application.

Once the deposit has been made, information regarding the deposit, such as the name and address of the depository, the accession number and the date of the deposit, that is to be added to the specification must be added by means of filing an amendment under the provisions of 37 CFR 1.312. Such an amendment must be filed before or with the payment of the issue fee. Therefore, applicants need to make any necessary deposit of biological material well prior to payment of the issue fee such that the accession number is received with sufficient time remaining to amend the specification as required by 37 CFR 1.809(d) on or before the date the issue fee payment is paid. See 37 CFR 1.809(e).

## 2411.04 After a Patent Has Been Granted

In a proceeding involving a patent, it may not be possible to request a certificate of correction of the patent which meets the terms of 37 CFR 1.805(b) and 37 CFR 1.805(c). For example, if the patent owner is on notice that samples of an original deposit can no longer be furnished by the depository, failure to diligently make a replacement deposit will preclude grant of a certificate of correction. A replacement deposit subsequently made will not be recognized by the Office nor will a request for certificate of correction, even if made promptly thereafter, be granted. It would also not be possible to request a certificate of correction of the patent which meets the terms of 37 CFR 1.805(b) and 37 CFR 1.805(c) where no original deposit was made before or during the pendency of the application which matured into the patent.

A patent defective because of lack of a necessary deposit is necessarily fatally defective for failure to comply with the first paragraph of 35 U.S.C. 112. Reissue is not available in such cases. See *In re Hay*, 534 F.2d 917, 189 USPQ 790 (CCPA 1976). Whether reissue is available where a biological material necessary for compliance with 35 U.S.C. 112 was known and readily available at the time of issuance of the patent and subsequently ceased to be readily available is problematic. Nevertheless, the rules do not provide for post-issuance original deposits.

Where an applicant for patent has any doubt as to whether access to a biological material specifically identified in the specification is necessary to satisfy 35 U.S.C. 112 or whether such a material, while currently freely available, may become unavailable in the

future, the applicant would be well-advised to make a deposit thereof before any patent issues. Similarly, where a patent owner has any doubt whether a deposit referred to in the specification is a biological material necessary to satisfy 35 U.S.C. 112 and, if the material is necessary, whether it is otherwise known and readily available, the patent owner would be well-advised to follow the procedures set forth in 37 CFR 1.805(b) and 37 CFR 1.805(c) after receiving the notice specified in those paragraphs.

### **2411.05 Content of Application with Respect to Deposited Material**

37 CFR 1.809(d) sets forth the requirements for the content of the specification with respect to a deposited biological material. Specifically, the specification shall contain the accession number for the deposit, the date of the deposit, the name and address of the depository, and a description of the deposited biological material sufficient to specifically identify it and to permit examination. The description also must be sufficient to permit verification that the deposited biological material is in fact that disclosed. Once the patent issues, the description must be sufficient to aid in the resolution of questions of infringement. As a general rule, the more information that is provided about a particular deposited biological material, the better the examiner will be able to compare the identity and characteristics of the deposited biological material with the prior art.

### **2420 The Requirements for Patent Applications Containing Nucleotide Sequence and/or Amino Acid Sequence Disclosures - the Sequence Rules**

Prior to the effective date (October 1, 1990) and implementation of the sequence rules (37 CFR 1.821 through 1.825), applications for patents that included nucleotide or amino acid sequence information posed special problems for the Office. While not related to the disclosure requirements of an invention, problems existed in the presentation, examination and printing of nucleotide and amino acid sequence data that appeared in patent applications because of the lack of uniformity in submission of sequence data to the Office and the impracticality of properly searching

and examining sequences submitted in paper form. In summary, the diversity and complexity of nucleotide and amino acid sequence data resulted in searching and analysis difficulties both within the Office and outside the Office, decreased accuracy of search and reproduction and increased costs. These difficulties made the development and implementation of the sequence rules a critical necessity for the Office. As such, the Office amended its regulations to establish a standardized format for descriptions of nucleotide and amino acid sequence data submitted as a part of patent applications, in conjunction with the required submission of that data in computer readable form. The final rules were published in the *Federal Register* at 55 FR 18230 (May 1, 1990) and in the *Official Gazette* at 1114 O.G. 29 (May 15, 1990). The sequence rules went into effect on October 1, 1990. The sequence rules were subsequently revised effective July 1, 1998. See 63 FR 29634 (June 1, 1998) and 1121 O.G. 82 (June 23, 1998).

The sequence rules were further revised on September 8, 2000 to allow submissions of the nucleotide and/or amino acid sequences and associated information on compact discs. See 65 FR 54604 (Sept. 8, 2000) and 1238 O.G. 145 (Sept. 19, 2000). See also MPEP § 608.05 and § 2422.03.

## **2421 Overview of the Sequence Rules**

### **2421.01 Applications Affected**

The sequence rules require the use of standard symbols and a standard format for sequence data in most sequence-type patent applications. They further require the submission of that data in computer readable form. Compliance is required for most disclosures of sequence data in new applications filed on or after October 1, 1990. The revised sequence rules apply to most new applications filed on or after July 1, 1998. See the final rule publications as cited in MPEP § 2420 for more detailed applicability information.

The Office encourages voluntary compliance for applications not subject to the rules, but all aspects of the rules must be complied with before data will be entered into the database. This includes submission of all statements required by the rules. In exceptional circumstances, it should be noted that the Office may waive the rules via a 37 CFR 1.183 petition.



## 2421.02 Summary of the Requirements of the Sequence Rules

Basically, the sequence rules define a set of symbols and procedures that are both mandatory and the only way that an applicant is permitted to describe information about a sequence that falls within the definitions used in the rules. Thus, 37 CFR 1.821 defines a “sequence” and a “Sequence Listing” for the purpose of the rules, the requirements for specific symbols, and formats for the “Sequence Listing,” the requirement for a computer readable form (CRF) of the “Sequence Listing,” and the deadlines for complying with the requirements. 37 CFR 1.822 to 37 CFR 1.824 set forth detailed descriptions of the requirements that are mandatory for the presentation of sequence data, and 37 CFR 1.825 sets forth procedures that are available to an applicant in the event that amendments to the sequence information or replacement of the computer readable copy become necessary.

The sequence rules embrace all unbranched nucleotide sequences with ten or more bases and all unbranched, non-D amino acid sequences with four or more amino acids, provided that there are at least 4 “specifically defined” nucleotides or amino acids. The rules apply to all sequences in a given application, whether claimed or not. All such sequences are relevant for the purposes of building a comprehensive database and properly assessing prior art. It is therefore essential that all sequences, whether only disclosed or also claimed, be included in the database.

### 2421.03 Notification of a Failure to Comply

With respect to the Office’s determination of compliance with the sequence rules and the opportunities afforded applicants to satisfy the requirements of the rules, applicants will be notified of easily detectable deficiencies early in the application process. Applicants whose computer readable forms are damaged in the mail, are not readable, or are missing mandatory elements will be notified shortly after receipt of the application by the Office. Applications filed on or after November 29, 2000, will be retained in the Office of Initial Patent Examination (OIPE) until any noncompliant sequence listing that renders an application unsuitable for examination is corrected. Deficien-

cies of a more sophisticated nature will likely only be detected by the examiner to whom the application is assigned. Applicant will be notified of any errors or inconsistencies detected by the examiner early in the examination process. Other errors or inconsistencies will be noted by the examiner early in the examination process.

Upon detection of damage or a deficiency, a notice will be sent to the applicant detailing the damage or deficiency and setting at least a 30-day period for reply. The period for reply will usually be 2 months when sent during the preexamination processing of an application. However, if the notice is sent out with an Office communication having a longer period for reply, the period for reply may be longer than 2 months, e.g., where the notice is sent with an Office action on the merits setting a 3-month period for reply. Extensions of time in which to reply will be available pursuant to 37 CFR 1.136. When an action by the applicant, such as a reply to a Notice to Comply from the Office, is determined to be a *bona fide* attempt to comply with the rules and it is apparent that compliance with some requirement has inadvertently been omitted, the applicant may be given a new time period to correct the omission. See 37 CFR 1.135(c). The relevant form paragraphs and a copy of the Notice to Comply to be used in applications subject to the sequence rules are included in MPEP § 2427 through § 2427.02.

A notification of a failure to comply with the sequence rules will be accompanied by an analysis of any submitted computer readable form. Any inquiries regarding a specific computer readable form that has been processed by the Office should be directed to the Systems Branch of the Chemical/Biotechnology Division of the Scientific and Technical Information Center.

### 2421.04 Future Changes to the Sequence Rules

With general regard to the symbols and format to be used for nucleotide and/or amino acid sequence data set forth in 37 CFR 1.822 and the form and format for sequence submissions in computer readable form set forth in 37 CFR 1.824, the Office intends to accommodate progress in the areas of both standardization and computerization as they relate to sequence data by subsequently amending the rules to take into

account any such progress. This progress will probably be reflected in the refinement of or liberalization of the rules. For example, progress in the area of the standardization of sequence data will likely result in a more comprehensive rule. For example, the D-amino acids and branched sequences that are currently excluded from the rule may, in the future, be brought within the scope of the rule once the necessary standardization technology becomes available. As a further example, the computer readable form is currently limited to certain forms of electronic media, but it can readily be seen that progress in the technology for developing databases of the type the Office has envisioned will likely permit a broadening of the permissible types of computer readable forms that may be submitted. The same can be said for the computer/operating-system configurations that are currently permitted by the rules. As the Office becomes able to provide greater refinement and liberality in these areas, the Office will do so by the publication of notices in the *Official Gazette* or formal rulemaking proposals, as appropriate.

## 2422 Nucleotide and/or Amino Acid Sequence Disclosures in Patent Applications

*37 CFR 1.821. Nucleotide and/or amino acid sequence disclosures in patent applications.*

(a) Nucleotide and/or amino acid sequences as used in §§ 1.821 through 1.825 are interpreted to mean an unbranched sequence of four or more amino acids or an unbranched sequence of ten or more nucleotides. Branched sequences are specifically excluded from this definition. Sequences with fewer than four specifically defined nucleotides or amino acids are specifically excluded from this section. "Specifically defined" means those amino acids other than "Xaa" and those nucleotide bases other than "n" defined in accordance with the World Intellectual Property Organization (WIPO) Handbook on Industrial Property Information and Documentation, Standard ST.25: Standard for the Presentation of Nucleotide and Amino Acid Sequence Listings in Patent Applications (1998), including Tables 1 through 6 in Appendix 2, herein incorporated by reference. (Hereinafter "WIPO Standard ST.25 (1998)"). This incorporation by reference was approved by the Director of the Federal Register in accordance with 5 U.S.C. 552(a) and 1 CFR part 51. Copies of WIPO Standard ST.25 (1998) may be obtained from the World Intellectual Property Organization; 34 chemin des Colombettes; 1211 Geneva 20 Switzerland. Copies of ST.25 may be inspected at the Patent Search Room; Crystal Plaza 3, Lobby Level; 2021 South Clark Place; Arlington, VA 22202. Copies may also be inspected at the Office of the Federal Register, 800 North Capitol Street,

NW, Suite 700, Washington, DC. Nucleotides and amino acids are further defined as follows:

(1) *Nucleotides*: Nucleotides are intended to embrace only those nucleotides that can be represented using the symbols set forth in WIPO Standard ST.25 (1998), Appendix 2, Table 1. Modifications, e.g., methylated bases, may be described as set forth in WIPO Standard ST.25 (1998), Appendix 2, Table 2, but shall not be shown explicitly in the nucleotide sequence.

(2) *Amino acids*: Amino acids are those L-amino acids commonly found in naturally occurring proteins and are listed in WIPO Standard ST.25 (1998), Appendix 2, Table 3. Those amino acid sequences containing D-amino acids are not intended to be embraced by this definition. Any amino acid sequence that contains post-translationally modified amino acids may be described as the amino acid sequence that is initially translated using the symbols shown in WIPO Standard ST.25 (1998), Appendix 2, Table 3 with the modified positions; e.g., hydroxylations or glycosylations, being described as set forth in WIPO Standard ST.25 (1998), Appendix 2, Table 4, but these modifications shall not be shown explicitly in the amino acid sequence. Any peptide or protein that can be expressed as a sequence using the symbols in WIPO Standard ST.25 (1998), Appendix 2, Table 3 in conjunction with a description in the Feature section to describe, for example, modified linkages, cross links and end caps, non-peptidyl bonds, etc., is embraced by this definition.

(b) Patent applications which contain disclosures of nucleotide and/or amino acid sequences, in accordance with the definition in paragraph (a) of this section, shall, with regard to the manner in which the nucleotide and/or amino acid sequences are presented and described, conform exclusively to the requirements of §§ 1.821 through 1.825.

(c) Patent applications which contain disclosures of nucleotide and/or amino acid sequences must contain, as a separate part of the disclosure, a paper copy disclosing the nucleotide and/or amino acid sequences and associated information using the symbols and format in accordance with the requirements of §§ 1.822 and 1.823. This paper copy is hereinafter referred to as the "Sequence Listing." Each sequence disclosed must appear separately in the "Sequence Listing." Each sequence set forth in the "Sequence Listing" shall be assigned a separate sequence identifier. The sequence identifiers shall begin with 1 and increase sequentially by integers. If no sequence is present for a sequence identifier, the code "000" shall be used in place of the sequence. The response for the numeric identifier <160> shall include the total number of SEQ ID NOs, whether followed by a sequence or by the code "000."

(d) Where the description or claims of a patent application discuss a sequence that is set forth in the "Sequence Listing" in accordance with paragraph (c) of this section, reference must be made to the sequence by use of the sequence identifier, preceded by "SEQ ID NO:" in the text of the description or claims, even if the sequence is also embedded in the text of the description or claims of the patent application.

(e) A copy of the "Sequence Listing" referred to in paragraph (c) of this section must also be submitted in computer readable form in accordance with the requirements of § 1.824. The computer readable form is a copy of the "Sequence Listing" and

will not necessarily be retained as a part of the patent application file. If the computer readable form of a new application is to be identical with the computer readable form of another application of the applicant on file in the Patent and Trademark Office, reference may be made to the other application and computer readable form in lieu of filing a duplicate computer readable form in the new application if the computer readable form in the other application was compliant with all of the requirements of these rules. The new application shall be accompanied by a letter making such reference to the other application and computer readable form, both of which shall be completely identified. In the new application, applicant must also request the use of the compliant computer readable "Sequence Listing" that is already on file for the other application and must state that the paper copy of the "Sequence Listing" in the new application is identical to the computer readable copy filed for the other application.

(f) In addition to the paper copy required by paragraph (c) of this section and the computer readable form required by paragraph (e) of this section, a statement that the content of the paper and computer readable copies are the same must be submitted with the computer readable form, *e.g.*, a statement that "the information recorded in computer readable form is identical to the written sequence listing."

(g) If any of the requirements of paragraphs (b) through (f) of this section are not satisfied at the time of filing under 35 U.S.C. 111(a) or at the time of entering the national stage under 35 U.S.C. 371, applicant will be notified and given a period of time within which to comply with such requirements in order to prevent abandonment of the application. Any submission in reply to a requirement under this paragraph must be accompanied by a statement that the submission includes no new matter.

(h) If any of the requirements of paragraphs (b) through (f) of this section are not satisfied at the time of filing an international application under the Patent Cooperation Treaty (PCT), which application is to be searched by the United States International Searching Authority or examined by the United States International Preliminary Examining Authority, applicant will be sent a notice necessitating compliance with the requirements within a prescribed time period. Any submission in reply to a requirement under this paragraph must be accompanied by a statement that the submission does not include matter which goes beyond the disclosure in the international application as filed. If applicant fails to timely provide the required computer readable form, the United States International Searching Authority shall search only to the extent that a meaningful search can be performed without the computer readable form and the United States International Preliminary Examining Authority shall examine only to the extent that a meaningful examination can be performed without the computer readable form.

37 CFR 1.821 incorporates by reference the World Intellectual Property Organization (WIPO) Handbook on Industrial Property Information and Documentation, Standard ST.25 (1998), including Tables 1 through 6 of Appendix 2. Copies may be obtained from the World Intellectual Property Organization; 34

chemin des Colombettes; 1211 Geneva 20 Switzerland. Copies may be inspected at the Patent Search Room; Crystal Plaza 3, Lobby Level; 2021 South Clark Place; Arlington, VA 22202. Copies may also be inspected at the Office of the Federal Register, 800 North Capitol Street, NW, Suite 700, Washington, DC 20408. These tables are reproduced below.

WIPO Standard ST.25 (1998), Appendix 2, Table 1, provides that the bases of a nucleotide sequence should be represented using the following one-letter code for nucleotide sequence characters:

**Table 1: List of Nucleotides**

Symbol	Meaning	Origin of designation
a	a	<u>a</u> denine
g	g	g <u>u</u> anine
c	c	<u>c</u> ytosine
t	t	<u>t</u> hymine
u	u	<u>u</u> racil
r	g or a	pur <u>i</u> ne
y	t/u or c	pyr <u>i</u> midine
m	a or c	<u>a</u> mino
k	g or t/u	<u>k</u> eto
s	g or c	<u>s</u> trong interactions 3H-bonds
w	a or t/u	<u>w</u> eak interactions 2H-bonds
b	g or c or t/u	not a
d	a or g or t/u	not c
h	a or c or t/u	not g
v	a or g or c	not t, not u
n	a or g or c or t/u, unknown, or other	<u>a</u> ny

WIPO Standard ST.25 (1998), Appendix 2, Table 2, provides that modified bases may be represented as

the corresponding unmodified bases in the sequence itself, if the modified base is one of those listed below and the modification is further described in the Feature section of the Sequence Listing. The codes from the list below may be used in the description (i.e., the specification and drawing, or in the Sequence Listing) but these codes may not be used in the sequence itself.

**Table 2: List of Modified Nucleotides**

Symbol	Meaning
ac4c	4-acetylcytidine
chm5u	5-(carboxyhydroxymethyl)uridine
cm	2'-O-methylcytidine
cmnm5s2u	5-carboxymethylaminomethyl-2-thiouridine
cmnm5u	5-carboxymethylaminomethyluridine
d	dihydrouridine
fm	2'-O-methylpseudouridine
gal q	beta, D-galactosylqueuosine
gm	2'-O-methylguanosine
i	inosine
i6a	N6-isopentenyladenosine
m1a	1-methyladenosine
m1f	1-methylpseudouridine
m1g	1-methylguanosine
m1i	1-methylinosine
m22g	2,2-dimethylguanosine
m2a	2-methyladenosine
m2g	2-methylguanosine
m3c	3-methylcytidine
m5c	5-methylcytidine
m6a	N6-methyladenosine
m7g	7-methylguanosine

mam5u	5-methylaminomethyluridine
mam5s2u	5-methoxyaminomethyl-2-thiouridine
man q	beta, D-mannosylqueuosine
mcm5s2u	5-methoxycarbonylmethyl-2-thiouridine
mcm5u	5-methoxycarbonylmethyluridine
mo5u	5-methoxyuridine
ms2i6a	2-methylthio-N6-isopentenyladenosine
ms2t6a	N-((9-beta-D-ribofuranosyl-2-methylthiopurine-6-yl)carbamoyl)threonine
mt6a	N-((9-beta-D-ribofuranosylpurine-6-yl)N-methylcarbamoyl)threonine
mv	uridine-5-oxyacetic acid-methylester
o5u	uridine-5-oxyacetic acid
osyw	wybutoxosine
p	pseudouridine
q	queuosine
s2t	5-methyl-2-thiouridine
s2c	2-thiocytidine
s2t	5-methyl-2-thiouridine
s2u	2-thiouridine
s4u	4-thiouridine
t	5-methyluridine
t6a	N-((9-beta-D-ribofuranosylpurine-6-yl)-carbamoyl)threonine
tm	2'-O-methyl-5-methyluridine
um	2'-O-methyluridine
yw	wybutosine
x	3-(3-amino-3-carboxy-propyl)uridine, (acp3)u

WIPO Standard ST.25 (1998), Appendix 2, Table 3, provides that the amino acids should be represented using the following three-letter code with the first letter as a capital.

**Table 3: List of Amino Acids**

Symbol	Meaning
Ala	Alanine
Cys	Cysteine
Asp	Aspartic Acid
Glu	Glutamic Acid
Phe	Phenylalanine
Gly	Glycine
His	Histidine
Ile	Isoleucine
Lys	Lysine
Leu	Leucine
Met	Methionine
Asn	Asparagine
Pro	Proline
Gln	Glutamine
Arg	Arginine
Ser	Serine
Thr	Threonine
Val	Valine
Trp	Tryptophan
Tyr	Tyrosine
Asx	Asp or Asn
Glx	Glu or Gln
Xaa	unknown or other

WIPO Standard ST.25 (1998), Appendix 2, Table 4, provides that modified and unusual amino acids may

be represented as the corresponding unmodified amino acids in the sequence itself if the modified or unusual amino acid is one of those listed below and the modification is further described in the Feature section of the Sequence Listing. The codes from the list below may be used in the description (i.e., the specification and drawings, or in Sequence Listing) but these codes may not be used in the sequence itself.

**Table 4: List of Modified and Unusual Amino Acids**

Symbol	Meaning
Aad	2-Aminoadipic acid
bAad	3-Aminoadipic acid
bAla	beta-Alanine, beta-Aminopropionic acid
Abu	2-Aminobutyric acid
4Abu	4-Aminobutyric acid, piperidinic acid
Acp	6-Aminocaproic acid
Ahe	2-Aminoheptanoic acid
Aib	2-Aminoisobutyric acid
bAib	3-Aminoisobutyric acid
Apm	2-Aminopimelic acid
Dbu	2,4-Diaminobutyric acid
Des	Desmosine
Dpm	2,2'-Diaminopimelic acid
Dpr	2,3-Diaminopropionic acid
EtGly	N-Ethylglycine
EtAsn	N-Ethylasparagine
Hyl	Hydroxylysine
aHyl	allo-Hydroxylysine
3Hyp	3-Hydroxyproline
4Hyp	4-Hydroxyproline

Ide	Isodesmosine
alle	allo-Isoleucine
MeGly	N-Methylglycine, sarcosine
MeIle	N-Methylisoleucine
MeLys	6-N-Methyllysine
MeVal	N-Methylvaline

Nva	Norvaline
Nle	Norleucine
Orn	Ornithine

WIPO Standard ST.25 (1998), Appendix 2, Table 5, provides for feature keys related to DNA sequences.

**Table 5: List of Feature Keys Related to Nucleotide Sequences**

Key	Description
allele	a related individual or strain contains stable, alternative forms of the same gene which differs from the presented sequence at this location (and perhaps others)
attenuator	(1) region of DNA at which regulation of termination of transcription occurs, which controls the expression of some bacterial operons; (2) sequence segment located between the promoter and the first structural gene that causes partial termination of transcription
C_region	constant region of immunoglobulin light and heavy chains, and T-cell receptor alpha, beta, and gamma chains; includes one or more exons depending on the particular chain
CAAT_signal	CAAT box; part of a conserved sequence located about 75 bp up-stream of the start point of eukaryotic transcription units which may be involved in RNA polymerase binding; consensus=GG (C or T) CAATCT
CDS	coding sequence; sequence of nucleotides that corresponds with the sequence of amino acids in a protein (location includes stop codon); feature includes amino acid conceptual translation
conflict	independent determinations of the "same" sequence differ at this site or region
D-loop	displacement loop; a region within mitochondrial DNA in which a short stretch of RNA is paired with one strand of DNA, displacing the original partner DNA strand in this region; also used to describe the displacement of a region of one strand of duplex DNA by a single stranded invader in the reaction catalyzed by RecA protein
D-segment	diversity segment of immunoglobulin heavy chain, and T-cell receptor beta chain
enhancer	a cis-acting sequence that increases the utilization of (some) eukaryotic promoters, and can function in either orientation and in any location (upstream or downstream) relative to the promoter

Key	Description
exon	region of genome that codes for portion of spliced mRNA; may contain 5'UTR, all CDSs, and 3'UTR
GC_signal	GC box; a conserved GC-rich region located upstream of the start point of eukaryotic transcription units which may occur in multiple copies or in either orientation; consensus=GGGCGG
gene	region of biological interest identified as a gene and for which a name has been assigned
iDNA	intervening DNA; DNA which is eliminated through any of several kinds of recombination
intron	a segment of DNA that is transcribed, but removed from within the transcript by splicing together the sequences (exons) on either side of it
J_segment	joining segment of immunoglobulin light and heavy chains, and T-cell receptor alpha, beta, and gamma chains
LTR	long terminal repeat, a sequence directly repeated at both ends of a defined sequence, of the sort typically found in retroviruses
mat_peptide	mature peptide or protein coding sequence; coding sequence for the mature or final peptide or protein product following post-translational modification; the location does not include the stop codon (unlike the corresponding CDS)
misc_binding	site in nucleic acid which covalently or non-covalently binds another moiety that cannot be described by any other Binding key (primer_bind or protein_bind)
misc_difference	feature sequence is different from that presented in the entry and cannot be described by any other Difference key (conflict, unsure, old_sequence, mutation, variation, allele, or modified_base)
misc_feature	region of biological interest which cannot be described by any other feature key; a new or rare feature
misc_recomb	site of any generalized, site-specific or replicative recombination event where there is a breakage and reunion of duplex DNA that cannot be described by other recombination keys (iDNA and virion) or qualifiers of source key (/insertion_seq, /transposon, /proviral)
misc_RNA	any transcript or RNA product that cannot be defined by other RNA keys (prim_transcript, precursor_RNA, mRNA, 5'clip, 3'clip, 5'UTR, 3'UTR, exon, CDS, sig_peptide, transit_peptide, mat_peptide, intron, polyA_site, rRNA, tRNA, scRNA, and snRNA)
misc_signal	any region containing a signal controlling or altering gene function or expression that cannot be described by other Signal keys (promoter, CAAT_signal, TATA_signal, -35_signal, -10_signal, GC_signal, RBS, polyA_signal, enhancer, attenuator, terminator, and rep_origin)

Key	Description
misc_structure	any secondary or tertiary structure or conformation that cannot be described by other Structure keys (stem_loop and D-loop)
modified_base	the indicated nucleotide is a modified nucleotide and should be substituted for by the indicated molecule (given in the mod_base qualifier value)
mRNA	messenger RNA; includes 5' untranslated region (5'UTR), coding sequences (CDS, exon) and 3' untranslated region (3'UTR)
mutation	a related strain has an abrupt, inheritable change in the sequence at this location
N_region	extra nucleotides inserted between rearranged immunoglobulin segments
old_sequence	the presented sequence revises a previous version of the sequence at this location
polyA_signal	recognition region necessary for endonuclease cleavage of an RNA transcript that is followed by polyadenylation; consensus=AATAAA
polyA_site	site on an RNA transcript to which will be added adenine residues by post-transcriptional polyadenylation
precursor_RNA	any RNA species that is not yet the mature RNA product; may include 5' clipped region (5'clip), 5' untranslated region (5'UTR), coding sequences (CDS, exon), intervening sequences (intron), 3' untranslated region (3'UTR), and 3' clipped region (3'clip)
prim_transcript	primary (initial, unprocessed) transcript; includes 5' clipped region (5'clip), 5' untranslated region (5'UTR), coding sequences (CDS, exon), intervening sequences (intron), 3' untranslated region (3'UTR), and 3' clipped region (3'clip)
primer_bind	non-covalent primer binding site for initiation of replication, transcription, or reverse transcription; includes site(s) for synthetic, for example, PCR primer elements
promoter	region on a DNA molecule involved in RNA polymerase binding to initiate transcription
protein_bind	non-covalent protein binding site on nucleic acid
RBS	ribosome binding site
repeat_region	region of genome containing repeating units
repeat_unit	single repeat element
rep_origin	origin of replication; starting site for duplication of nucleic acid to give two identical copies
rRNA	mature ribosomal RNA; the RNA component of the ribonucleoprotein particle (ribosome) which assembles amino acids into proteins



Key	Description
S_region	switch region of immunoglobulin heavy chains; involved in the rearrangement of heavy chain DNA leading to the expression of a different immunoglobulin class from the same B-cell
satellite	many tandem repeats (identical or related) of a short basic repeating unit; many have a base composition or other property different from the genome average that allows them to be separated from the bulk (main band) genomic DNA
scRNA	small cytoplasmic RNA; any one of several small cytoplasmic RNA molecules present in the cytoplasm and (sometimes) nucleus of a eukaryote
sig_peptide	signal peptide coding sequence; coding sequence for an N-terminal domain of a secreted protein; this domain is involved in attaching nascent polypeptide to the membrane; leader sequence
snRNA	small nuclear RNA; any one of many small RNA species confined to the nucleus; several of the snRNAs are involved in splicing or other RNA processing reactions
source	identifies the biological source of the specified span of the sequence; this key is mandatory; every entry will have, as a minimum, a single source key spanning the entire sequence; more than one source key per sequence is permissible
stem_loop	hairpin; a double-helical region formed by base-pairing between adjacent (inverted) complementary sequences in a single strand of RNA or DNA
STS	Sequence Tagged Site; short, single-copy DNA sequence that characterizes a mapping landmark on the genome and can be detected by PCR; a region of the genome can be mapped by determining the order of a series of STSs
TATA_signal	TATA box; Goldberg-Hogness box; a conserved AT-rich septamer found about 25 bp before the start point of each eukaryotic RNA polymerase II transcript unit which may be involved in positioning the enzyme for correct initiation; consensus=TATA(A or T)A(A or T)
terminator	sequence of DNA located either at the end of the transcript or adjacent to a promoter region that causes RNA polymerase to terminate transcription; may also be site of binding of repressor protein
transit_peptide	transit peptide coding sequence; coding sequence for an N-terminal domain of a nuclear-encoded organellar protein; this domain is involved in post-translational import of the protein into the organelle
tRNA	mature transfer RNA, a small RNA molecule (75-85 bases long) that mediates the translation of a nucleic acid sequence into an amino acid sequence
unsure	author is unsure of exact sequence in this region
V_region	variable region of immunoglobulin light and heavy chains, and T-cell receptor alpha, beta, and gamma chains; codes for the variable amino terminal portion; can be made up from V_segments, D_segments, N_regions, and J_segments

Key	Description
V_segment	variable segment of immunoglobulin light and heavy chains, and T-cell receptor alpha, beta, and gamma chains; codes for most of the variable region (V_region) and the last few amino acids of the leader peptide
variation	a related strain contains stable mutations from the same gene (for example, RFLPs, polymorphisms, etc.) which differ from the presented sequence at this location (and possibly others)
3'clip	3'-most region of a precursor transcript that is clipped off during processing
3'UTR	region at the 3' end of a mature transcript (following the stop codon) that is not translated into a protein
5'clip	5'-most region of a precursor transcript that is clipped off during processing
5'UTR	region at the 5' end of a mature transcript (preceding the initiation codon) that is not translated into a protein
-10_signal	pribnow box; a conserved region about 10 bp upstream of the start point of bacterial transcription units which may be involved in binding RNA polymerase; consensus=TAtAaT
-35_signal	a conserved hexamer about 35 bp upstream of the start point of bacterial transcription units; consensus=TTGACa [ ] or TGTTGACA [ ]

WIPO Standard ST.25 (1998), Appendix 2, Table 6 provides for feature keys related to protein sequences

**Table 6: List of Feature Keys Related to Protein Sequences**

Key	Description
CONFLICT	different papers report differing sequences
VARIANT	authors report that sequence variants exist
VARSPLIC	description of sequence variants produced by alternative splicing
MUTAGEN	site which has been experimentally altered
MOD_RES	post-translational modification of a residue
ACETYLATION	N-terminal or other
AMIDATION	generally at the C-terminal of a mature active peptide
BLOCKED	undetermined N- or C-terminal blocking group
FORMYLATION	of the N-terminal methionine

GAMMA-CARBOXYGLUTAMIC ACID HYDROXYLATION	of asparagine, aspartic acid, proline or lysine
METHYLATION	generally of lysine or arginine
PHOSPHORYLATION	of serine, threonine, tyrosine, aspartic acid or histidine
PYRROLIDONE CARBOXYLIC ACID	N-terminal glutamate which has formed an internal cyclic lactam
SULFATATION	generally of tyrosine
LIPID	covalent binding of a lipidic moiety
MYRISTATE	myristate group attached through an amide bond to the N-terminal glycine residue of the mature form of a protein or to an internal lysine residue
PALMITATE	palmitate group attached through a thioether bond to a cysteine residue or through an ester bond to a serine or threonine residue
FARNESYL	farnesyl group attached through a thioether bond to a cysteine residue
GERANYL-GERANYL	geranyl-geranyl group attached through a thioether bond to a cysteine residue
GPI-ANCHOR	glycosyl-phosphatidylinositol (GPI) group linked to the alpha-carboxyl group of the C-terminal residue of the mature form of a protein
N-ACYL DIGLYCERIDE	N-terminal cysteine of the mature form of a prokaryotic lipoprotein with an amide-linked fatty acid and a glyceryl group to which two fatty acids are linked by ester linkages
DISULFID	disulfide bond; the 'FROM' and 'TO' endpoints represent the two residues which are linked by an intra-chain disulfide bond; if the 'FROM' and 'TO' endpoints are identical, the disulfide bond is an interchain one and the description field indicates the nature of the cross-link
THIOLEST	thiolester bond; the 'FROM' and 'TO' endpoints represent the two residues which are linked by the thiolester bond
THIOETH	thioether bond; the 'FROM' and 'TO' endpoints represent the two residues which are linked by the thioether bond
CARBOHYD	glycosylation site; the nature of the carbohydrate (if known) is given in the description field
METAL	binding site for a metal ion; the description field indicates the nature of the metal

BINDING	binding site for any chemical group (co-enzyme, prosthetic group, etc.); the chemical nature of the group is given in the description field
SIGNAL	extent of a signal sequence (prepeptide)
TRANSIT	extent of a transit peptide (mitochondrial, chloroplastic, or for a microbody)
PROPEP	extent of a propeptide
CHAIN	extent of a polypeptide chain in the mature protein
PEPTIDE	extent of a released active peptide
DOMAIN	extent of a domain of interest on the sequence; the nature of that domain is given in the description field
CA_BIND	extent of a calcium-binding region
DNA_BIND	extent of a DNA-binding region
NP_BIND	extent of a nucleotide phosphate binding region; the nature of the nucleotide phosphate is indicated in the description field
TRANSMEM	extent of a transmembrane region
ZN_FING	extent of a zinc finger region
SIMILAR	extent of a similarity with another protein sequence; precise information, relative to that sequence is given in the description field
REPEAT	extent of an internal sequence repetition
HELIX	secondary structure: Helices, for example, Alpha-helix, 3(10) helix, or Pi-helix
STRAND	secondary structure: Beta-strand, for example, Hydrogen bonded beta-strand, or Residue in an isolated beta-bridge
TURN	secondary structure: Turns, for example, H-bonded turn (3-turn, 4-turn, or 5-turn)
ACT_SITE	amino acid(s) involved in the activity of an enzyme
SITE	any other interesting site on the sequence
INIT_MET	the sequence is known to start with an initiator methionine

NON_TER	the residue at an extremity of the sequence is not the terminal residue; if applied to position 1, this signifies that the first position is not the N-terminus of the complete molecule; if applied to the last position, it signifies that this position is not the C-terminus of the complete molecule; there is no description field for this key
NON_CONS	non consecutive residues; indicates that two residues in a sequence are not consecutive and that there are a number of unsequenced residues between them
UNSURE	uncertainties in the sequence; used to describe region(s) of a sequence for which the authors are unsure about the sequence assignment

### FILING INTERNATIONALLY

The revisions to 37 CFR 1.821 through 1.825 are the result of an effort to harmonize the PTO, PCT, EPO and JPO Sequence Listing requirements to the extent possible. The requirements of WIPO Standard ST.25 are substantially identical to the requirements of 37 CFR 1.821 through 1.825. PatentIn Version 3.1 software, now available (see MPEP § 2430), generates sequence listings that meet all of the requirements of WIPO Standard ST.25 (1998). The requirements of 37 CFR 1.821 through 1.825, however, are less stringent than the requirements of WIPO Standard ST.25 (1998). Thus, applicants who wish to file in countries which adhere to WIPO Standard ST.25 (1998) should consider the following when not using PatentIn Version 3.1:

(A) The WIPO Standard ST.25 (1998) does not permit submissions using a Macintosh computer;

(B) The WIPO Standard ST.25 (1998) does not accept the range of media permitted by 37 CFR 1.821 through 1.825;

(C) The answers in fields <221> and <222> must use selections from Tables 5 and 6 of WIPO Standard ST.25 (1998) to comply with that standard. The terms from these Tables are considered language neutral vocabulary;

(D) Any free text in numeric identifier <223> of a Sequence Listing will not be translated and thus must also appear in the specification of applications filed under WIPO Standard ST.25 (1998) for compliance;

(E) A CRF filed after the filing of an application under the PCT is not considered to be part of the disclosure and will not be published in the pamphlet;

(F) Paragraph 39 of WIPO Standard ST.25 (1998) requires the specific wording “the information recorded on the form is identical to the written sequence listing”; and

(G) WIPO Standard ST.25 (1998), paragraph 24, requires spaces between specified numeric identifiers in the Sequence Listing.

### 2422.01 Definitions of Nucleotide and/or Amino Acids for Purpose of Sequence Rules

37 CFR 1.821(a) presents a definition for “nucleotide and/or amino acid sequences.” This definition sets forth limits, in terms of numbers of amino acids and/or numbers of nucleotides, at or above which compliance with the sequence rules is required. Nucleotide and/or amino acid sequences as used in 37 CFR 1.821 through 1.825 are interpreted to mean an unbranched sequence of four or more amino acids or an unbranched sequence of ten or more nucleotides. Branched sequences are specifically excluded from this definition. Sequences with fewer than four specifically defined nucleotides or amino acids are specifically excluded from this section. “Specifically defined” means those amino acids other than “Xaa” and those nucleotide bases other than “n” defined in accordance with the World Intellectual Property Organization (WIPO) Handbook on Industrial Property Information and Documentation, Standard ST.25: Standard for the Presentation of Nucleotide and Amino Acid Sequence Listings in Patent Applications (1998), including Tables 1 through 6 in Appendix 2 (see MPEP § 2422).

The limit of four or more amino acids was established for consistency with limits in place for industry database collections whereas the limit of ten or more nucleotides, while lower than certain industry database limits, was established to encompass those nucleotide sequences to which the smallest probe will bind in a stable manner. The limits for amino acids and nucleotides are also consistent with those established for sequence data exchange with the Japanese Patent Office and the European Patent Office.

37 CFR 1.821(a)(1) and 37 CFR 1.821(a)(2) present further definitions for those nucleotide and amino acid sequences that are intended to be embraced by the sequence rules. Situations in which the applicability of the rules are in issue will be resolved on a case-by-case basis.

Nucleotide sequences are further limited to those that can be represented by the symbols set forth in 37 CFR 1.822(b), which incorporates by reference WIPO Standard ST.25 (1998), Appendix 2, Table 1 (see MPEP § 2422). The presence of other than typical 5' to 3' phosphodiester linkages in a nucleotide sequence does not render the rules inapplicable. The Office does not want to exclude linkages of the type commonly found in naturally occurring nucleotides, e.g., eukaryotic end capped sequences.

Amino acid sequences are further limited to those listed in 37 CFR 1.822(b), which incorporates by reference WIPO Standard ST.25 (1998), Appendix 2, Table 3 (see MPEP § 2422), and those L-amino acids that are commonly found in naturally occurring proteins. The limitation to L-amino acids is based upon the fact that there currently exists no widely accepted standard nomenclature for representing the scope of amino acids encompassed by non-L-amino acids, and, as such, the process of meaningfully encoding these other amino acids for computerized searching and printing is not currently feasible. The presence of one or more D-amino acids in a sequence will exclude that sequence from the scope of the rules. (Voluntary compliance is, however, encouraged in these situations; the symbol "Xaa" can be used to represent D-amino acids.) The sequence rules embrace "[a]ny peptide or protein that can be expressed as a sequence using the symbols in WIPO Standard ST.25 (1998), Appendix 2, Table 3 in conjunction with a description in the Feature section to describe, for example, modified

linkages, cross links and end caps, non-peptidyl bonds, etc." 37 CFR 1.821(a)(2).

With regard to amino acid sequences, the use of the terms "peptide or protein" implies, however, that the amino acids in a given sequence are linked by at least three consecutive peptide bonds. Accordingly, an amino acid sequence is not excluded from the scope of the rules merely due to the presence of a single non-peptidyl bond. If an amino acid sequence can be represented by a string of amino acid abbreviations, with reference, where necessary, to a features table to explain modifications in the sequence, the sequence comes within the scope of the rules. However, the rules are not intended to encompass the subject matter that is generally referred to as synthetic resins.

## **2422.02 The Requirement for Exclusive Conformance; Sequences Presented in Drawing Figures**

37 CFR 1.821(b) requires exclusive conformance, with regard to the manner in which the nucleotide and/or amino acid sequences are presented and described, with the sequence rules for all applications that include nucleotide and amino acid sequences that fall within the definitions. This requirement is necessary to minimize any confusion that could result if more than one format for representing sequence data was employed in a given application. It is also expected that the required standard format will be more readily and widely accepted and adopted if its use is exclusive, as well as mandatory.

In view of the fact that many significant sequence characteristics may only be demonstrated by a figure, the exclusive conformance requirement of this section may be relaxed for drawing figures. This is especially true in view of the fact that the representation of double stranded nucleotides is not permitted in the "Sequence Listing" and many significant nucleotide features, such as "sticky ends" and the like, will only be shown effectively by reference to a drawing figure. Further, the similarity or homology between/among sequences can only be depicted in an effective manner in a drawing figure. Similarly, drawing figures are recommended for use with amino acid sequences to depict structural features of the corresponding protein, such as finger regions and Kringle regions. The situations discussed herein are given by way of example only and there may be many other reasons for

relaxing the requirements of this section for the drawing figures. It should be noted, though, that when a sequence is presented in a drawing, regardless of the format or the manner of presentation of that sequence in the drawing, the sequence must still be included in the Sequence Listing and the sequence identifier (“SEQ ID NO:X”) must be used, either in the drawing or in the Brief Description of the Drawings.

### **2422.03 The Requirements for a Sequence Listing and Sequence Identifiers; Sequences Embedded in Application Text; Variants of a Presented Sequence**

37 CFR 1.821(c) requires that applications containing nucleotide and/or amino acid sequences that fall within the above definitions, contain, as a separate part of the disclosure on paper or compact disc, a disclosure of the nucleotide and/or amino acid sequences, and associated information, using the format and symbols that are set forth in 37 CFR 1.822 and 37 CFR 1.823. This separate part of the disclosure is referred to as the “Sequence Listing.” The “Sequence Listing” submitted pursuant to 37 CFR 1.821(c), whether on paper or compact disc, is the official copy of the “Sequence Listing.”

37 CFR 1.821(c) requires that each sequence disclosed in the application appear separately in the “Sequence Listing,” with each sequence further being assigned a sequence identification number, referred to as “SEQ ID NO.” The sequence identifiers must begin with 1 and increase sequentially by integers. The requirement for sequence identification numbers, at a minimum, requires that each sequence be assigned a different number for purposes of identification. However, where practical and for ease of reference, sequences should be presented in the separate part of the application in numerical order and in the order in which they are discussed in the application.

If submitted on paper, the “Sequence Listing” is a separate part of the disclosure which must begin on a new page within the specification. A plurality of sequences may, if feasible, be presented on a single page; the separate presentation of both nucleotide and amino acid sequences on the same page is also permitted.

If the “Sequence Listing” is submitted on compact disc, the specification must contain an incorporation by reference of the material on the compact disc in a separate paragraph, identifying each compact disc by the names of the files contained on each of the compact discs, their date of creation and their sizes in bytes (37 CFR 1.52(e)). The total number of compact discs including duplicates and the files on each compact disc shall be specified (37 CFR 1.77(b)(4)). The compact disc used to submit the sequence listing may also contain table information if the table has more than 50 pages of text. See 37 CFR 1.823(a)(2) and 1.52(e)(1)(iii). The compact disc and duplicate copy must be labeled “Copy 1” and “Copy 2,” respectively, and a statement stating that the copies are identical must be included. If the two compact discs are not identical, the Office will use the disc labeled “Copy 1” for further processing (37 CFR 1.52(e)(4)). See also MPEP § 608.05.

The compact disc submitted under 37 CFR 1.821(c) may, if it contains no tables, be identical to the computer readable form (CRF) submitted under 37 CFR 1.821(e) and 37 CFR 1.824, if that CRF is submitted on a compact disc. Even if the compact discs submitted under both 37 CFR 1.821(c) and (e) are identical, each compact disc submitted under 37 CFR 1.821(c) must be submitted in duplicate, in addition to the CRF under 37 CFR 1.821(e).

The requirement for compliance in 37 CFR 1.821(c) is directed to “disclosures of nucleotide and/or amino acid sequences.” (Emphasis added.) All sequence information, whether claimed or not, that meets the length thresholds in 37 CFR 1.821(a) is subject to the rules. The goal of the Office is to build a comprehensive database that can be used for, inter alia, the purpose of assessing the prior art. It is therefore essential that all sequence information, whether only disclosed or also claimed, be included in the database. In those instances in which prior art sequences are only referred to in a given application by name and a publication or accession reference, they need not be included as part of the “Sequence Listing,” unless an examiner considers the referred-to sequence to be “essential material,” per MPEP § 608.01(p). However, if the applicant presents the sequence as a string of particular bases or amino acids, it is necessary to include the sequence in the “Sequence Listing,” regardless of whether the

applicant considers the sequence to be prior art. In general, any sequence that is disclosed and/or claimed as a sequence, i.e., as a string of particular bases or amino acids, and that otherwise meets the criteria of 37 CFR 1.821(a), must be set forth in the "Sequence Listing."

It is generally acceptable to present a single, general sequence in accordance with the sequence rules and to discuss and/or claim variants of that general sequence without presenting each variant as a separate sequence in the "Sequence Listing." By way of example only, the following types of sequence disclosures would be treated as noted herein by the Office. With respect to "conservatively modified variants thereof" of a sequence, the sequences may be described as SEQ ID NO:X and "conservatively modified variants thereof," if desired. With respect to a sequence that "may be deleted at the C-terminus by 1, 2, 3, 4, or 5 residues," all of the implied variations do not need to be included in the "Sequence Listing." If such a situation were encompassed by the rules, it would introduce far too much complexity into the "Sequence Listing" and the Office's database. The possible mathematical variations that could result from this type of language could reasonably require a "Sequence Listing" that would be thousands of pages in length. In this latter example, only the undeleted sequence needs to be included in the "Sequence Listing," and the sequences may be described as SEQ ID NO:X from which deletions have been made at the C-terminus by 1, 2, 3, 4, or 5 residues. The Office's database will only contain the undeleted sequence.

37 CFR 1.821(d) requires the use of the assigned sequence identifier in all instances where the description or claims of a patent application discuss sequences regardless of whether a given sequence is also embedded in the text of the description or claims of an application. This requirement is also intended to permit references, in both the description and claims, to sequences set forth in the "Sequence Listing" by the use of assigned sequence identifiers without repeating the sequence in the text of the description or claims. Sequence identifiers can also be used to discuss and/or claim parts or fragments of a properly presented sequence. For example, language such as "residues 14 to 243 of SEQ ID NO:23" is permissible and the fragment need not be separately presented in the "Sequence Listing." Where a sequence is embed-

ded in the text of an application, it must be presented in a manner that complies with the requirements of the sequence rules.

The rules do not alter, in any way, the requirements of 35 U.S.C. 112. The implementation of the rules has had no effect on disclosure and/or claiming requirements. The rules, in general, or the use of sequence identifiers throughout the specification and claims, specifically, should not raise any issues under 35 U.S.C. 112, first or second paragraphs. The use of sequence identification numbers (SEQ ID NO:X) only provides a shorthand way for applicants to discuss and claim their inventions. These identification numbers do not in any way restrict the manner in which an invention can be claimed.

#### **2422.04 The Requirement for a Computer Readable Copy of the Official Copy of the Sequence Listing**

37 CFR 1.821(e) requires the submission of a copy of the "Sequence Listing" in computer readable form. The information on the computer readable form will be entered into the Office's database for searching and printing nucleotide and amino acid sequences. This electronic database will also enable the Office to exchange patented sequence data, in electronic form, with the Japanese Patent Office and the European Patent Office. It should be noted that the Office's database complies with the confidentiality requirement imposed by 35 U.S.C. 122. Pending application sequences are maintained in the database separately from published or patented sequences. That is, the Office will not exchange or make public any information on any sequence until the patent application containing that information is published or matures into a patent, or as otherwise allowed by 35 U.S.C. 122.

The "Sequence Listing" submitted pursuant to 37 CFR 1.821(c), whether on paper or compact disc, is the official copy of the "Sequence Listing." However, the Office may permit correction of the official copy, at the least, during the pendency of a given application by reference to the computer readable copy thereof submitted pursuant to 37 CFR 1.821(e) if both the official copy and computer readable form were submitted at the time of filing of the application and the totality of the circumstances otherwise



substantiate the proposed correction. A mere discrepancy between the official copy and the computer readable form may not, in and of itself, be sufficient to justify a proposed correction. In this regard, the Office will assume that the computer readable form has been incorporated by reference into the application when the official copy and computer readable form were submitted at the time of filing of the application. The Office will attempt to accommodate or address all correction issues, but it must be kept in mind that the real burden rests with the applicant to ensure that any discrepancies between the official copy and the computer readable form are eliminated or minimized. Applicants should be aware that there will be instances where the applicant may have to suffer the consequences of any discrepancies between the two.

The Office does not desire to be bound by a requirement to permanently preserve computer readable forms for support, priority or correction purposes. For example, the Office will make corrections, where appropriate, by reference to the computer readable form as long as the computer readable form is still available to the Office. However, once use of the computer readable form by the Office for processing has ended, i.e., once the Office has entered the data contained on the computer readable form into the appropriate database, the Office does not intend to further preserve the computer readable form submitted by the applicant.

#### **2422.05 Reference to Previously Filed Identical Computer Readable Form; Continuing or Derivative Applications; Request for Transfer of Computer Readable Form**

The last three sentences of 37 CFR 1.821(e) set forth the procedure to be followed when a computer readable form of a given application is identical with a computer readable form of another application. In that situation, an applicant may make reference to the other application and computer readable form therein in lieu of filing a duplicate computer readable form in the given application. That is, additional computer readable forms will not be required in derivative or continuing applications if the sequence information is exactly the same, i.e., with no additions or deletions,

as that in a parent or previously filed application in which a complying computer readable form had been filed. If sequence information is deleted from or added to that submitted in a previously filed application, the procedure in this paragraph is not available and a new computer readable form is required. To take advantage of the procedure outlined in this section, applicants must request that the previously submitted sequence information be used in the given application. A letter must be submitted in the given application requesting use of the previously filed sequence information. The letter must completely identify the other application, by application number, and the computer readable form, by indicating whether it was the only computer readable form filed in that application or whether it was the second, or subsequent, computer readable form filed.

A sample letter requesting transfer of the previously filed sequence information is set forth below:

The paper or compact disc copy of the Sequence Listing in this application [application number], is identical to the computer readable copy of the Sequence Listing filed in application [application number], filed [date]. In accordance with 37 CFR 1.821(e), please use the [first-filed, last-filed or only, whichever is applicable] computer readable form filed in that application as the computer readable form for the instant application. It is understood that the Patent and Trademark Office will make the necessary change in application number and filing date for the instant application. A paper or compact disc copy of the Sequence Listing is [included in the originally-filed specification of the instant application, included in a separately filed preliminary amendment for incorporation into the specification, whichever is applicable].

#### **2422.06 Requirement for Statement Regarding Content of Official and Computer Readable Copies of Sequence Listing**

37 CFR 1.821(f) requires that the official "Sequence Listing" (submitted on paper or compact disc pursuant to 37 CFR 1.821(c)) and computer readable copies of the "Sequence Listing" (submitted pursuant to 37 CFR 1.821(e)) be accompanied by a statement that the content of the official and computer readable copies are the same, at the time when the computer readable form is submitted. Such a statement may be made by the applicant. See MPEP

§ 2428 for further information and Sample Statements.

### **2422.07 Requirements for Compliance, Statements Regarding New Matter, and Sanctions for Failure to Comply**

37 CFR 1.821(g) requires compliance with the requirements of 37 CFR 1.821(b) through (f), as discussed above, if they are not satisfied at the time of filing under 35 U.S.C. 111(a) or at the time of entering the national stage of an international application under 35 U.S.C. 371, within the period of time set in a notice requiring compliance. Failure to comply will result in the abandonment of the application. Submissions in reply to requirements under this paragraph must be accompanied by a statement that the submission includes no new matter. Such a statement may be made by the applicant. Extensions of time in which to reply to a requirement under this paragraph are available pursuant to 37 CFR 1.136. When an action by the applicant is a *bona fide* attempt to comply with these rules and it is apparent that compliance with some requirement has inadvertently been omitted, the applicant may be given a new time period to correct the omission. See 37 CFR 1.135(c).

Provisional applications filed under 35 U.S.C. 111(b) need not comply with 37 CFR 1.821 through 1.825, however, applicants are encouraged to file a Sequence Listing as defined in 37 CFR 1.821(c) for ease of identification of the sequence information contained in the provisional application.

37 CFR 1.821(h) requires compliance with the requirements of 37 CFR 1.821(b) through (f), as discussed above, within the time period prescribed in a notice requiring compliance in an international application filed in the United States Receiving Office under the Patent Cooperation Treaty (PCT), if the above noted requirements are not satisfied at the time of filing. Submissions in reply to requirements under this paragraph must be accompanied by a statement that the submission does not include matter which goes beyond the disclosure in the international application as filed. Such a statement may be made by an applicant. International applications that fail to com-

ply with any of the requirements of 37 CFR 1.821(b)-(f) will be searched to the extent possible without the benefit of the information in computer readable form. See PCT Administrative Instructions Section 513(c).

The requirement to submit a statement that a submission in reply to the requirements of this section does not include new matter or matter which goes beyond the disclosure in the application as filed is not the first instance in which the applicant has been required to ensure that there is not new matter upon amendment. The requirement is analogous to that found in 37 CFR 1.125 regarding substitute specifications. When a substitute specification is required because the number or nature of amendments would make it difficult to examine the application, the applicant must include a statement that the substitute specification includes no new matter. The necessity of requiring a substitute "Sequence Listing," or pages thereof, is similar to the necessity of requiring a substitute specification and, likewise, the burden is on the applicant to ensure that no new matter is added. Applicants have a duty to comply with the statutory prohibition (35 U.S.C. 132 and 35 U.S.C. 251) against the introduction of new matter.

It should be noted that the treatment accorded errors in sequencing or any other errors prior to the implementation date of the sequence rules will be no different for those applications filed on or after the implementation date of these rules. The correction of errors in sequencing or any other errors that are made in describing an invention are, as they have always been, subject to the statutory prohibition (35 U.S.C. 132 and 35 U.S.C. 251) against the introduction of new matter.

### **2422.08 Presumptions Regarding Compliance**

Neither the presence nor absence of information which is not required under the sequence rules will create a presumption that such information is necessary to satisfy any of the requirements of 35 U.S.C. 112. Further, the grant of a patent on an application that is subject to 37 CFR 1.821 through 37 CFR 1.825 constitutes a presumption that the granted patent complies with the requirements of these rules.

## 2422.09 Box Sequence; Hand Delivery of Sequence Listings and Computer Readable Forms

To facilitate administrative processing of all papers and compact discs associated with sequence rule compliance, all computer readable forms, compact discs, fees, and papers accompanying them filed in the Office should be marked "Box SEQUENCE."

Correspondence relating to the sequence rules may also be hand-delivered to the Technology Center (TC). In cases of hand delivery to the Customer Service Window or to the TC, the compact disc, floppy disk or tape should be placed in a protective mailer labeled with at least the application number, if available. The labeling requirements of 37 CFR 1.52(e) and 1.824(a)(6) must also be complied with. The use of staples and clips, if any, should be confined to carefully attaching the mailer to the submitted papers without contact or compression of the magnetic media which may cause the disk or tape to be unreadable. In no situations should additional or complimentary electronic copies be delivered to examiners or other Office personnel.

## 2423 Symbols and Format To Be Used for Nucleotide and/or Amino Acid Sequence Data

37 CFR 1.822. *Symbols and format to be used for nucleotide and/or amino acid sequence data.*

(a) The symbols and format to be used for nucleotide and/or amino acid sequence data shall conform to the requirements of paragraphs (b) through (e) of this section.

(b) The code for representing the nucleotide and/or amino acid sequence characters shall conform to the code set forth in the tables in WIPO Standard ST.25 (1998), Appendix 2, Tables 1 and 3. This incorporation by reference was approved by the Director of the Federal Register in accordance with 5 U.S.C. 552(a) and 1 CFR part 51. Copies of ST.25 may be obtained from the World Intellectual Property Organization; 34 chemin des Colombettes; 1211 Geneva 20 Switzerland. Copies of ST.25 may be inspected at the Patent Search Room; Crystal Plaza 3, Lobby Level; 2021 South Clark Place; Arlington, VA 22202. Copies may also be inspected at the Office of the Federal Register, 800 North Capitol Street, NW, Suite 700, Washington, DC. No code other than that specified in these sections shall be used in nucleotide and amino acid sequences. A modified base or modified or unusual amino acid may be presented in a given sequence as the corresponding unmodified base or amino acid if the modified base or modified or unusual amino acid is one of those listed in WIPO Standard ST.25 (1998), Appendix 2, Tables 2 and 4, and the modification is also

set forth in the Feature section. Otherwise, each occurrence of a base or amino acid not appearing in WIPO Standard ST.25 (1998), Appendix 2, Tables 1 and 3, shall be listed in a given sequence as "n" or "Xaa," respectively, with further information, as appropriate, given in the Feature section, preferably by including one or more feature keys listed in WIPO Standard ST.25 (1998), Appendix 2, Tables 5 and 6.

(c) *Format representation of nucleotides.* (1) A nucleotide sequence shall be listed using the lower-case letter for representing the one-letter code for the nucleotide bases set forth in WIPO Standard ST.25 (1998), Appendix 2, Table 1.

(2) The bases in a nucleotide sequence (including introns) shall be listed in groups of 10 bases except in the coding parts of the sequence. Leftover bases, fewer than 10 in number, at the end of noncoding parts of a sequence shall be grouped together and separated from adjacent groups of 10 or 3 bases by a space.

(3) The bases in the coding parts of a nucleotide sequence shall be listed as triplets (codons). The amino acids corresponding to the codons in the coding parts of a nucleotide sequence shall be typed immediately below the corresponding codons. Where a codon spans an intron, the amino acid symbol shall be typed below the portion of the codon containing two nucleotides.

(4) A nucleotide sequence shall be listed with a maximum of 16 codons or 60 bases per line, with a space provided between each codon or group of 10 bases.

(5) A nucleotide sequence shall be presented, only by a single strand, in the 5 to 3 direction, from left to right.

(6) The enumeration of nucleotide bases shall start at the first base of the sequence with number 1. The enumeration shall be continuous through the whole sequence in the direction 5 to 3. The enumeration shall be marked in the right margin, next to the line containing the one-letter codes for the bases, and giving the number of the last base of that line.

(7) For those nucleotide sequences that are circular in configuration, the enumeration method set forth in paragraph (c)(6) of this section remains applicable with the exception that the designation of the first base of the nucleotide sequence may be made at the option of the applicant.

(d) *Representation of amino acids.* (1) The amino acids in a protein or peptide sequence shall be listed using the three-letter abbreviation with the first letter as an upper case character, as in WIPO Standard ST.25 (1998), Appendix 2, Table 3.

(2) A protein or peptide sequence shall be listed with a maximum of 16 amino acids per line, with a space provided between each amino acid.

(3) An amino acid sequence shall be presented in the amino to carboxy direction, from left to right, and the amino and carboxy groups shall not be presented in the sequence.

(4) The enumeration of amino acids may start at the first amino acid of the first mature protein, with the number 1. When presented, the amino acids preceding the mature protein, *e.g.*, pre-sequences, pro-sequences, pre-pro-sequences and signal sequences, shall have negative numbers, counting backwards starting with the amino acid next to number 1. Otherwise, the enumeration of amino acids shall start at the first amino acid at the amino terminal as number 1. It shall be marked below the sequence every 5 amino acids. The enumeration method for amino

acid sequences that is set forth in this section remains applicable for amino acid sequences that are circular in configuration, with the exception that the designation of the first amino acid of the sequence may be made at the option of the applicant.

(5) An amino acid sequence that contains internal terminator symbols (*e.g.*, “Ter”, “\*”, or “.”, etc.) may not be represented as a single amino acid sequence, but shall be presented as separate amino acid sequences.

(e) A sequence with a gap or gaps shall be presented as a plurality of separate sequences, with separate sequence identifiers, with the number of separate sequences being equal in number to the number of continuous strings of sequence data. A sequence that is made up of one or more noncontiguous segments of a larger sequence or segments from different sequences shall be presented as a separate sequence.

Tables 1-6 of WIPO Standard ST.25 (1998), Appendix 2, are reproduced in MPEP § 2422.

### 2423.01 Format and Symbols To Be Used in Sequence Listings

37 CFR 1.822 sets forth the format and symbols to be used for listing nucleotide and/or amino acid sequence data. The codes for representing the nucleotide and/or amino acid characters in the sequences are set forth in the tables of WIPO Standard ST.25 (1998), Appendix 2, Tables 1 and 3. See MPEP § 2422. No other symbols shall be used in nucleotide and amino acid sequences. The “modified base” and “modified and unusual amino acid” codes appearing in WIPO Standard ST.25 (1998), Appendix 2, Tables 2 and 4 (see 37 CFR 1.822 and MPEP § 2422) are not to be set forth in the sequences recited in the Sequence Listing. However, “modified base” or “modified and unusual amino acid” codes may be used in the written description and/or drawing portions of the specification. To properly enter notations for modified codes in the Sequence Listing, the Feature section of the Sequence Listing should be used. That is, a modified base or amino acid may be presented in a given sequence as the corresponding unmodified base or amino acid if the modified base or amino acid is one of those listed in WIPO Standard ST.25 (1998), Appendix 2, Table 2 or 4 and the modification is also set forth in the Feature section of the Sequence Listing. Otherwise, all bases or amino acids not appearing in WIPO Standard ST.25 (1998), Appendix 2, Table 1 or 3 must be listed in a given sequence as “n” or “Xaa,” respectively, with further

information given in the Feature section of the “Sequence Listing.” See 37 CFR 1.823(b).

In 37 CFR 1.822(b) and 37 CFR 1.822(d), the use of three-letter codes for amino acids is required. The use of the three-letter codes for amino acids is preferred over the one-letter codes from the perspective of facilitating the examiner’s review of the application papers, including the “Sequence Listing”, and the public’s, as well as the examiner’s, use of the printed patents. The three-letter codes must be presented using the upper case for the first character and lower case for the remaining two characters.

37 CFR 1.822(c) through (e) set forth the format for presenting sequence data. These paragraphs set forth the manner in which the characters in sequences are to be grouped, spaced, presented and numbered.

### 2423.02 Depiction of Coding Regions

If applicant chooses to depict coding regions, 37 CFR 1.822 (c)(3) requires the amino acids corresponding to the codons in the coding parts of a nucleotide sequence to be typed immediately below the corresponding codons. Further, in 37 CFR 1.822 (c)(3), the situation in which a codon spans an intron has been addressed. In those situations, the “amino acid symbol shall be typed below the portion of the codon containing two nucleotides.” This requirement clarifies the representation of an amino acid that corresponds to a codon that spans an intron.

It should be noted that the sequence rules do not, in any way, require the depiction of coding regions or the amino acids corresponding to the codons in those coding regions. 37 CFR 1.822 (d) only requires that where amino acids corresponding to the codons in the coding parts of a nucleotide sequence are depicted, they must be depicted below the corresponding codons. There is absolutely no requirement in the rules to depict coding regions. Nor is there a requirement to separately list the amino acids corresponding to the codons in the coding parts of a nucleotide sequence unless the applicant desires to discuss the amino acids as a separate sequence. That is, when the coding parts of a nucleotide sequence and their corresponding amino acids have been identified, if applicant desires to discuss those amino acids in the coding parts of the nucleotide as a separate sequence, those amino acids must also be set forth as a separate sequence. The separate submission of the amino acid

sequence that corresponds to the coding parts of a nucleotide sequence is, however, recommended and encouraged because the amino acid sequence may not be captured in the sequence database if it is only presented in the “Sequence Listing” as a mixed nucleotide and amino acid sequence.

### 2423.03 Presentation and Enumeration of Sequences

37 CFR 1.822(c)(5) provides that nucleotide sequences shall only be represented by a single strand, in the 5' to 3' direction, from left to right. That is, double stranded nucleotides shall not be represented in the “Sequence Listing.” A double stranded nucleotide may be represented as two single stranded nucleotides, and any relationship between the two may be shown in the drawings.

The procedures for presenting and numbering amino acid sequences are set forth in 37 CFR 1.822(d). Two alternatives are presented for numbering amino acid sequences. Amino acid sequences may be numbered with respect to the identification of the first amino acid of the first mature protein or with respect to the first amino acid appearing at the amino terminal. The enumeration procedure for nucleotides is set forth in 37 CFR 1.822(c)(6). Sequences that are circular in configuration are intended to be encompassed by these rules, and numbering procedures for them are provided in 37 CFR 1.822(c)(7) and (d)(4). The numbering procedures set forth in 37 CFR 1.822(c) and (d) are not necessarily intended to be consistent with all currently employed numbering procedures. The objective here is to establish a reasonable numbering procedure that can readily be followed and adhered to. These formatting procedures also reflect those that have been agreed to for electronic data exchange with the JPO and the EPO.

In 37 CFR 1.822(e) the procedures for presenting and numbering hybrid and gapped sequences are set forth. A sequence that is made up of one or more non-contiguous segments of a larger sequence or segments from different sequences, i.e., a hybrid sequence, shall be presented as a separate sequence. A “gap” for the purpose of this section is not intended to embrace a gap or gaps that is/are introduced into the presentation of otherwise continuous sequence information in, e.g., a drawing figure, to show alignments or similarities

with other sequences. The “gaps” referred to in this section are gaps representing unknown or undisclosed regions in a sequence between regions that are known or disclosed. In the situation where a contiguous fragment of a sequence that has already been properly set forth in a “Sequence Listing” is discussed and/or claimed, the fragment does not need to be separately included in the “Sequence Listing.” It may be referred to in the specification, claims or drawings as, e.g., “residues 2 through 33 of SEQ ID NO:12,” assuming that SEQ ID NO:12 has been properly included in the “Sequence Listing.”

### 2424 Requirements for Nucleotide and/or Amino Acid Sequences as Part of the Application Papers

*37 CFR 1.823. Requirements for nucleotide and/or amino acid sequences as part of the application.*

(a)(1) If the “Sequence Listing” required by § 1.821(c) is submitted on paper: The “Sequence Listing,” setting forth the nucleotide and/or amino acid sequence and associated information in accordance with paragraph (b) of this section, must begin on a new page and must be titled “Sequence Listing.” The pages of the “Sequence Listing” preferably should be numbered independently of the numbering of the remainder of the application. Each page of the “Sequence Listing” shall contain no more than 66 lines and each line shall contain no more than 72 characters. A fixed-width font should be used exclusively throughout the “Sequence Listing.”

(2) If the “Sequence Listing” required by § 1.821(c) is submitted on compact disc: The “Sequence Listing” must be submitted on a compact disc in compliance with § 1.52(e). The compact disc may also contain table information if the application contains table information that may be submitted on a compact disc (§ 1.52(e)(1)(iii)). The specification must contain an incorporation-by-reference of the Sequence Listing as required by § 1.52(e)(5). The presentation of the “Sequence Listing” and other materials on compact disc under § 1.821(c) does not substitute for the Computer Readable Form that must be submitted on disk, compact disc, or tape in accordance with § 1.824.

(b) The “Sequence Listing” shall, except as otherwise indicated, include the actual nucleotide and/or amino acid sequence, the numeric identifiers and their accompanying information as shown in the following table. The numeric identifier shall be used only in the “Sequence Listing.” The order and presentation of the items of information in the “Sequence Listing” shall conform to the arrangement given below. Each item of information shall begin on a new line and shall begin with the numeric identifier enclosed in angle brackets as shown. The submission of those items of information designated with an “M” is mandatory. The submission of those items of information designated with an “O” is optional. Numeric identifiers <110> through <170> shall only

be set forth at the beginning of the "Sequence Listing." The following table illustrates the numeric identifiers.

Numeric Identifier	Definition	Comments and format	Mandatory (M) or Optional (O)
<110>	Applicant.....	Preferably max. of 10 names; one name per line; preferable format: Surname, Other Names and/or Initials.	M.
<120>	Title of Invention.....	..... .....	M.
<130>	File Reference.....	Personal file reference.....	M when filed prior to assignment or appl. number
<140>	Current Application Number.	Specify as: US 07/999,999 or PCT/US96/99999.	M, if available.
<141>	Current Filing Date.....	Specify as: yyyy-mm-dd.....	M, if available.
<150>	Prior Application Number.	Specify as: US 07/999,999 or PCT/US96/99999.	M, if applicable include priority documents under 35 U.S.C. 119 and 120
<151>	Prior Application Filing Date.	Specify as: yyyy-mm-dd.....	M, if applicable
<160>	Number of SEQ ID NOs.	Count includes total number of SEQ ID NOs..... .	M.
<170>	Software.....	Name of software used to create the Sequence Listing.	O.
<210>	SEQ ID NO:#:.....	Response shall be an integer representing the SEQ ID NO shown.	M.
<211>	Length..... ....	Respond with an integer expressing the number of bases or amino acid residues.	M.

Numeric Identifier	Definition	Comments and format	Mandatory (M) or Optional (O)
<212>	Type..... ...	Whether presented sequence molecule is DNA, RNA, or PRT (protein). If a nucleotide sequence contains both DNA and RNA fragments, the type shall be "DNA." In addition, the combined DNA/RNA molecule shall be further described in the <220> to <223> feature section.	M.
<213>	Organism.....	Scientific name, i.e. Genus/ species, Unknown or Artificial Sequence. In addition, the "Unknown" or "Artificial Sequence" organisms shall be further described in the <220> to <223> feature section.	M.
<220>	Feature.....	Leave blank after <220>. <221-223> provide for a description of points of biological significance in the sequence.	M, under the following conditions: if "n," "Xaa," or a modified or unusual L-amino acid or modified base was used in a sequence; if ORGANISM is "Artificial Sequence" or "Unknown"; if molecule is combined DNA/RNA.
<221>	Name/ Key.....	Provide appropriate identifier for feature, preferably from WIPO Standard ST.25 (1998), Appendix 2, Tables 5 and 6.	M, under the following conditions: if "n," "Xaa," or a modified or unusual L-amino acid or modified base was used in a sequence.
Numeric Identifier	Definition	Comments and format	Mandatory (M) or Optional (O)
<222>	Location.....	Specify location within sequence; where appropriate state number of first and last bases/amino acids in feature.	M, under the following conditions: if "n," "Xaa," or a modified or unusual L-amino acid or modified base was used in a sequence.
<223>	Other Information.....	Other relevant information; four lines maximum.....	M, under the following conditions: if "n," "Xaa," or a modified or unusual L-amino acid or modified base was used in a sequence; if ORGANISM is "Artificial Sequence" or "Unknown"; if molecule is combined DNA/RNA.

Numeric Identifier	Definition	Comments and format	Mandatory (M) or Optional (O)
<300>	Publication Information	Leave blank after <300>	O.
<301>	Authors..... ...	Preferably max. of ten named authors of publication; specify one name per line; preferable format: Surname, Other Names and/or Initials.	O.
<302>	Title..... ....	..... .....	O.
<303>	Journal.....	..... .....	O.
<304>	Volume .....	..... .....	O.
<305>	Issue .....	..... .....	O.
<306>	Pages .....	..... .....	O.
<307>	Date.....	Journal date on which data published; specify as yyyy- mm-dd, MMM-yyyy or Season- yyyy.	O.
<308>	Database Accession Number.	Accession number assigned by database including database name.	O.
<309>	Database Entry Date.....	Date of entry in database; specify as yyyy-mm-dd or MMM-yyyy.	O.
<310>	Patent Document Number.	Document number; for patent-type citations only. Specify as, for example, US 07/ 999,999.	O.
<311>	Patent Filing Date.....	Document filing date, for patent-type citations only; specify as yyyy-mm-dd.	O.
<312>	Publication Date.....	Document publication date, for patent-type citations only; specify as yyyy-mm-dd.	O.
<313>	Relevant Residues.....	FROM (position) TO (position).....	O.



Numeric Identifier	Definition	Comments and format	Mandatory (M) or Optional (O)
<400>	Sequence..... ....	SEQ ID NO should follow the numeric identifier and should appear on the line preceding the actual sequence.	M.

### 2424.01 Informational Requirements for the Sequence Listing

37 CFR 1.823 sets forth the informational requirements for inclusion in the separate part of the disclosure on paper or compact disc (the “Sequence Listing”) that must be submitted in accordance with 37 CFR 1.821(c). 37 CFR 1.823(a)(1) sets forth page and line length requirements for any “Sequence Listing” submitted on paper. The requirement to use a fixed width font to present sequence data is also set forth therein. This latter requirement is made to ensure that the desired sequence character spacing and numbering is maintained. 37 CFR 1.823(a)(2) requires any “Sequence Listing” submitted on compact disc to be in compliance with 37 CFR 1.52(e). The compact disc “Sequence Listing” submitted under 37 CFR 1.821(c) may also contain table information if the application contains table information that is over 50 pages. See 37 CFR 1.52(e)(1)(iii). 37 CFR 1.823(b) lists the items of information that are to be included in the “Sequence Listing” in the order in which those items are to appear. The numeric identi-

fier for each item of information shall not include the explanatory information included in 37 CFR 1.823(b).

### 2424.02 Sequence Listing Numeric Identifiers

37 CFR 1.823(b) sets forth the order and presentation of the items of information in the Sequence Listing. Each item of information in the Sequence Listing must include the appropriate numeric identifier and its accompanying information as shown in the table below. Each item of information must begin on a new line with the numeric identifier enclosed in angle brackets. The submission of those items of information designated with an “M” is mandatory. The submission of those items of information designated with an “O” is optional. Numeric identifiers <110> through <170> must be set forth at the beginning of the Sequence Listing.

The following table illustrates the numeric identifiers. See MPEP § 2431 for a sample Sequence Listing.

Numeric Identifier	Definition	Comments and format	Mandatory (M) or Optional (O)
<110>	Applicant.....	Preferably max. of 10 names; one name per line; preferable format: Surname, Other Names and/or Initials.	M.
<120>	Title of Invention.....	..... .....	M.
<130>	File Reference.....	Personal file reference.....	M when filed prior to assignment or appl. number
<140>	Current Application Number.	Specify as: US 07/999,999 or PCT/US96/99999.	M, if available.

Numeric Identifier	Definition	Comments and format	Mandatory (M) or Optional (O)
<141>	Current Filing Date.....	Specify as: yyyy-mm-dd.....	M, if available.
<150>	Prior Application Number.	Specify as: US 07/999,999 or PCT/US96/99999.	M, if applicable include priority documents under 35 U.S.C. 119 and 120
<151>	Prior Application Filing Date.	Specify as: yyyy-mm-dd.....	M, if applicable
<160>	Number of SEQ ID NOs.	Count includes total number of SEQ ID NOs..... .	M.
<170>	Software.....	Name of software used to create the Sequence Listing.	O.
<210>	SEQ ID NO:#:.....	Response shall be an integer representing the SEQ ID NO shown.	M.
<211>	Length..... ....	Respond with an integer expressing the number of bases or amino acid residues.	M.
<212>	Type..... ...	Whether presented sequence molecule is DNA, RNA, or PRT (protein). If a nucleotide sequence contains both DNA and RNA fragments, the type shall be "DNA." In addition, the combined DNA/RNA molecule shall be further described in the <220> to <223> feature section.	M.
<213>	Organism.....	Scientific name, i.e. Genus/ species, Unknown or Artificial Sequence. In addition, the "Unknown" or "Artificial Sequence" organisms shall be further described in the <220> to <223> feature section.	M.

Numeric Identifier	Definition	Comments and format	Mandatory (M) or Optional (O)
<220>	Fea- ture.....	Leave blank after <220>. <221-223> provide for a description of points of biological significance in the sequence.	M, under the following conditions: if “n,” “Xaa,” or a modified or unusual L-amino acid or modified base was used in a sequence; if ORGANISM is “Artificial Sequence” or “Unknown”; if molecule is combined DNA/RNA.
<221>	Name/ Key.....	Provide appropriate identifier for feature, preferably from WIPO Standard ST.25 (1998), Appendix 2, Tables 5 and 6.	M, under the following conditions: if “n,” “Xaa,” or a modified or unusual L-amino acid or modified base was used in a sequence.
Numeric Identifier	Definition	Comments and format	Mandatory (M) or Optional (O)
<222>	Loca- tion.....	Specify location within sequence; where appropriate state number of first and last bases/amino acids in feature.	M, under the following conditions: if “n,” “Xaa,” or a modified or unusual L-amino acid or modified base was used in a sequence.
<223>	Other Informa- tion.....	Other relevant information; four lines maxi- mum.....	M, under the following conditions: if “n,” “Xaa,” or a modified or unusual L-amino acid or modified base was used in a sequence; if ORGANISM is “Artificial Sequence” or “Unknown”; if molecule is combined DNA/RNA.
<300>	Publication Informa- tion	Leave blank after <300>	O.
<301>	Authors..... ...	Preferably max. of ten named authors of publication; specify one name per line; preferable format: Surname, Other Names and/or Initials.	O.
<302>	Title..... ....	..... .....	O.
<303>	Jour- nal.....	..... .....	O.
<304>	Volume .....	..... .....	O.
<305>	Issue .....	..... .....	O.

Numeric Identifier	Definition	Comments and format	Mandatory (M) or Optional (O)
<306>	Pages .....	..... .....	O.
<307>	Date.....	Journal date on which data published; specify as yyyy- mm-dd, MMM-yyyy or Season- yyyy.	O.
<308>	Database Accession Number.	Accession number assigned by database including database name.	O.
<309>	Database Entry Date.....	Date of entry in database; specify as yyyy-mm-dd or MMM-yyyy.	O.
<310>	Patent Document Number.	Document number; for patent-type citations only. Specify as, for example, US 07/ 999,999.	O.
<311>	Patent Filing Date.....	Document filing date, for patent-type citations only; specify as yyyy-mm-dd.	O.
<312>	Publication Date.....	Document publication date, for patent-type citations only; specify as yyyy-mm-dd.	O.
<313>	Relevant Residues.....	FROM (position) TO (position).....	O.
<400>	Sequence..... ....	SEQ ID NO should follow the numeric identifier and should appear on the line preceding the actual sequence.	M.

### 2424.03 Additional Miscellaneous Requirements

Throughout 37 CFR 1.823(b), the items of information relating to patent applications and patent publications should be provided keeping in mind the appropriate standards that have been established by the World Intellectual Property Organization (WIPO). In general, an application should be identified by a country code, a number and a filing date, while a published patent document should be identified by a country code, a number and kind code. Proper citation of priority patent applications is covered in MPEP § 201.14(d). For published patent documents, the country code, number and kind code will appear on

the front page of the document. Unpublished PCT applications are identified by the letters PCT, the country code of the Receiving Office, the last two digits of the year of filing and a number, e.g., PCT/AT81/00033, PCT/FR88/00100. A published PCT application is identified by the letters WO, the last two digits of the year of publication, a number and a kind code, e.g., WO82/02827A, WO88/06811A. Country codes from WIPO Standard ST.3 Annex A and kind codes from WIPO Standard ST.16 are reproduced in MPEP § 1851. Questions on proper citation of patent documents should be directed to the Search and Information Resources Administration, International Liaison Staff.

In 37 CFR 1.823(b), numeric identifier <110>, the item of information relating to “APPLICANT” should be limited to a maximum of the first ten named applicants in the application. Similarly, in numeric identifier <301>, the item of information relating to “AUTHORS” should be limited to a maximum of the first ten named authors in the publication.

In 37 CFR 1.823(b) “yyyy-mm-dd” is the format for the presentation of patent related date information in the “Sequence Listing.” Other date information may also be presented as MMM-yyyy or Season-yyyy. The lower case letters designate numeric responses and the upper case letters designate alphabetical responses. As such, March 2, 1988, would be presented as 1988-03-02 or MAR 1988.

In numeric identifiers <220> - <223>, relating to “Features” or the description of the points of biological significance in a given sequence, it is recommended, but not required, that the information that is provided by the applicant conform to the controlled vocabulary that is set forth in GenBank's “Feature Representation in Nucleotide Sequence Data Libraries,” Release 57.0, as may be amended. Further, the feature “LOCATION” should be specified using the syntax of the DDBJ/EMBL/GenBank Feature Table Definition. See MPEP § 2422 when filing in countries which adhere to WIPO Standard ST.25.

In numeric identifiers <300> - <312>, publication information for a given sequence is collected. The publication information encompasses both patent-type publications and non-patent literature publications. Numeric identifier <313>, Relevant Residues, is intended to collect information relating to the correspondence between a sequence set forth in the “Sequence Listing” and published sequence information. The starting (FROM) and end (TO) positions in the listed sequence that correspond to the published sequence information should be set forth.

## **2425 Form and Format for Nucleotide and/or Amino Acid Sequence Submissions in Computer Readable Form**

*37 CFR 1.824. Form and format for nucleotide and/or amino acid sequence submissions in computer readable form.*

(a) The computer readable form required by § 1.821(e) shall meet the following requirements:

(1) The computer readable form shall contain a single “Sequence Listing” as either a diskette, series of diskettes, or other permissible media outlined in paragraph (c) of this section.

(2) The “Sequence Listing” in paragraph (a)(1) of this section shall be submitted in American Standard Code for Information Interchange (ASCII) text. No other formats shall be allowed.

(3) The computer readable form may be created by any means, such as word processors, nucleotide/amino acid sequence editors' or other custom computer programs; however, it shall conform to all requirements detailed in this section.

(4) File compression is acceptable when using diskette media, so long as the compressed file is in a self-extracting format that will decompress on one of the systems described in paragraph (b) of this section.

(5) Page numbering must not appear within the computer readable form version of the “Sequence Listing” file.

(6) All computer readable forms must have a label permanently affixed thereto on which has been hand-printed or typed: the name of the applicant, the title of the invention, the date on which the data were recorded on the computer readable form, the operating system used, a reference number, and an application number and filing date, if known. If multiple diskettes are submitted, the diskette labels must indicate their order (*e.g.*, “1 of X”).

(b) Computer readable form submissions must meet these format requirements:

(1) Computer Compatibility: IBM PC/XT/AT or Apple Macintosh;

(2) Operating System Compatibility: MS-DOS, MS-Windows, Unix or Macintosh;

(3) Line Terminator: ASCII Carriage Return plus ASCII Line Feed; and

(4) Pagination: Continuous file (no “hard page break” codes permitted).

(c) Computer readable form files submitted may be in any of the following media:

(1) Diskette: 3.50 inch, 1.44 Mb storage; 3.50 inch, 720 Kb storage; 5.25 inch, 1.2 Mb storage; 5.25 inch, 360 Kb storage.

(2) Magnetic tape: 0.5 inch, up to 24000 feet; Density: 1600 or 6250 bits per inch, 9 track; Format: Unix tar command; specify blocking factor (not “block size”); Line Terminator: ASCII Carriage Return plus ASCII Line Feed.

(3) 8mm Data Cartridge: Format: Unix tar command; specify blocking factor (not “block size”); Line Terminator: ASCII Carriage Return plus ASCII Line Feed.

(4) Compact disc: Format: ISO 9660 or High Sierra Format.

(5) Magneto Optical Disk: Size/Storage Specifications: 5.25 inch, 640 Mb.

(d) Computer readable forms that are submitted to the Office will not be returned to the applicant.

37 CFR 1.824 sets forth the requirements for sequence submissions in computer readable form. Any computer operating system may be utilized to produce a sequence submission, provided that the system is capable of producing a file having the characteristics specified in 37 CFR 1.824, and is capable of

writing the properly formatted file to one of the acceptable electronic media. If a given sequence and its associated information cannot practically or possibly fit on the electronic media required in 37 CFR 1.824(c), an exception via a non-fee petition to waive this provision will normally be granted. As set forth in 37 CFR 1.824(d), the computer readable forms that are submitted in accordance with these rules will not be returned to the applicant. 37 CFR 1.824(a)(6) requires the labeling, with appropriate identifying information, of the computer readable forms that are submitted in accordance with these rules.

## **2426 Amendments to or Replacement of Sequence Listing and Computer Readable Copy Thereof**

*37 CFR 1.825. Amendments to or replacement of sequence listing and computer readable copy thereof.*

(a) Any amendment to a paper copy of the "Sequence Listing" (§ 1.821(c)) must be made by the submission of substitute sheets and include a statement that the substitute sheets include no new matter. Any amendment to a compact disc copy of the "Sequence Listing" (§ 1.821(c)) must be made by the submission of a replacement compact disc (2 copies) in compliance with § 1.52(e). Amendments must also be accompanied by a statement that indicates support for the amendment in the application, as filed, and a statement that the replacement compact disc includes no new matter.

(b) Any amendment to the paper copy of the "Sequence Listing," in accordance with paragraph (a) of this section, must be accompanied by a substitute copy of the computer readable form (§ 1.821(e)) including all previously submitted data with the amendment incorporated therein, accompanied by a statement that the copy in computer readable form is the same as the substitute copy of the "Sequence Listing."

(c) Any appropriate amendments to the "Sequence Listing" in a patent; *e.g.*, by reason of reissue or certificate of correction, must comply with the requirements of paragraphs (a) and (b) of this section.

(d) If, upon receipt, the computer readable form is found to be damaged or unreadable, applicant must provide, within such time as set by the Commissioner, a substitute copy of the data in computer readable form accompanied by a statement that the substitute data is identical to that originally filed.

37 CFR 1.825 sets forth the procedures for amending the "Sequence Listing" and the computer readable copy thereof. The procedures that have been defined in 37 CFR 1.825 involve the submission of either substitute sheets or substitute compact discs of the "Sequence Listing" or substitute copies of the computer readable form, in conjunction with statements

that indicate support for the amendment in the application, as filed, and that the substitute sheets or copies include no new matter. (See MPEP § 608.05 and § 2428 for further information.) An amendment to the material on a compact disc must be done by submitting a replacement compact disc with the amended file(s). The amendment should include a corresponding amendment to the description of the compact disc and the files contained thereon in the paper portion of the specification. *A replacement compact disc containing the amended files also must contain all of the files of the original compact disc that were not amended.* This will insure that the Office, printer, and public can quickly access all of the current files in an application or patent by referencing only the latest compact disc. The requirement for statements regarding the absence of new matter follows current practice relating to the submission of substitute specifications, as set forth in 37 CFR 1.125. 37 CFR 1.825 (c) addresses the situation where amendments to the "Sequence Listing" are made after a patent has been granted, *e.g.*, by a certificate of correction, reissue or reexamination. 37 CFR 1.825 (d) addresses the possibility and presents a remedy for the situation where the computer readable form may be found by the Office to be damaged or unreadable.

## **2427 Form Paragraphs and Notice to Comply**

### **2427.01 Form Paragraphs**

See MPEP § 608.05 for form paragraphs which should be used when notifying applicant that a compact disc submitted in accordance with 37 CFR 1.52(e) (*i.e.*, containing a computer program listing, Sequence Listing, and/or table) does not comply with all of the requirements of the 37 CFR 1.52(e). See also MPEP § 608.05(b) for form paragraphs which should be used when a table submitted on compact disc does not comply with 37 CFR 1.52(e).

In order to expedite the processing of applications, minor errors pertaining to compliance with the sequence rules may be handled with the first Office action. Examples of minor errors are: when the "Sequence Listing" under 37 CFR 1.821(c) is submitted on compact disc, missing statement in the transmittal letter stating that the two compact discs are identical, missing an incorporation-by-reference of

the “Sequence Listing” in the specification, or missing a listing of the files and required information in the transmittal letter; missing statement in the transmittal letter stating that the sequence listing information in computer readable form is identical to the written (on paper or compact disc) “Sequence Listing,” etc. Since the application is ready for examination, the examiner may act on the application and include any objections to the application based on minor errors related to the “Sequence Listing” with his/her Office action. In addition to the form paragraphs reproduced in MPEP § 608.05 and § 608.05(b), the following form paragraphs are particular to Sequence Listings and should be used as appropriate when notifying applicant of errors in the Sequence Listing:

24.01 - This form paragraph should be used for the first mailing of a Notice to Comply.

24.02 - This form paragraph should be used for the first mailing of a CRF Diskette Problem Report.

24.03 - This form paragraph should be used when an applicant has made a *bona fide* attempt to comply but the reply generates an error listing from the Scientific and Technical Information Center (STIC). This should be used for a second mailing to applicant unless it is evident that there has been a deliberate omission; this form paragraph may also be used to extend the period for reply for the initially mailed notice.

24.04 - This form paragraph should be used when there has been a deliberate omission in the reply or where the reason the reply is incomplete cannot be characterized as an apparent oversight or instance of inadvertence.

24.05 – This form paragraph should be used whenever there is no statement in the transmittal letter that the sequence listing information recorded in computer readable form is identical to the written (on paper or compact disc) sequence listing.

24.05.01 – This form paragraph should be used whenever an amendment is filed with a CRF and there is no statement in the transmittal letter stating that the Sequence Listing information recorded in the CRF is identical to the written sequence listing.

¶ 24.01 *Cover Letter for Use With Notice To Comply With Sequence Rules*

This application contains sequence disclosures that are encompassed by the definitions for nucleotide and/or amino acid sequences set forth in 37 CFR 1.821(a)(1) and (a)(2). However, this application fails to comply with the requirements of 37 CFR 1.821 through 1.825 for the reason(s) set forth below or on the attached Notice To Comply With Requirements For Patent Applications Containing Nucleotide Sequence And/Or Amino Acid Sequence Disclosures. [1]

Applicant is given ONE MONTH, or THIRTY DAYS, whichever is longer, from the mailing date of this letter within which to comply with the sequence rules, 37 CFR 1.821 - 1.825. Failure to comply with these requirements will result in ABANDONMENT of the application under 37 CFR 1.821(g). Extensions of time may be obtained by filing a petition accompanied by the extension fee under the provisions of 37 CFR 1.136(a). In no case may an applicant extend the period for reply beyond the SIX MONTH statutory period. Direct the reply to the undersigned. Applicant is requested to return a copy of the attached Notice to Comply with the reply.

**Examiner Note:**

1. Use this form paragraph **only for the initial communication to the applicant**. Use either form paragraph 24.03 or 24.04 for subsequent communications.
2. In bracket 1, insert how the application fails to comply with the requirements of 37 CFR 1.821 through 1.825.
3. Conclude action with appropriate form paragraph(s) 7.100-7.102.
4. When mailing the Office action, attach a Notice To Comply With Requirements for Patent Applications Containing Nucleotide And/Or Amino Acid Sequence Disclosures, along with a marked-up copy of the Raw Sequence Listing, if any.

¶ 24.02 *Cover Letter for Use with CRF Diskette Problem Report*

This application contains sequence disclosures that are encompassed by the definitions for nucleotide and/or amino acid sequences set forth in 37 CFR 1.821(a)(1) and (a)(2). A computer readable form (CRF) of the sequence listing was submitted. However, the CRF could not be processed by the Scientific and Technical Information Center (STIC) for the reason(s) set forth on the attached CRF Diskette Problem Report.

Applicant is given ONE MONTH, or THIRTY DAYS, whichever is longer, from the mailing date of this letter within which to comply with the sequence rules, 37 CFR 1.821 - 1.825. Failure to comply with these requirements will result in ABANDONMENT of the application under 37 CFR 1.821(g). Extensions of time may be obtained by filing a petition accompanied by the extension fee under the provisions of 37 CFR 1.136(a). In no case may an applicant extend the period for reply beyond the SIX MONTH statutory period. Direct the reply to the undersigned. Applicant is requested to return a copy of the attached CRF Diskette Problem Report with the reply.

**Examiner Note:**

1. Use this form paragraph **only for the initial communication to the applicant**. Use either form paragraph 24.03 or 24.04 for subsequent communications.
2. Conclude action with appropriate form paragraph(s) 7.100-7.102.
3. When mailing the Office action, attach the CRF Diskette Problem Report.

¶ *24.03 Compact Disc/CRF Submission Is Not Fully Responsive, Bona Fide Attempt*

The reply filed [1] is not fully responsive to the Office communication mailed [2] for the reason(s) set forth below or on the attached Notice To Comply With The Sequence Rules or CRF Diskette Problem Report.

Since the above-mentioned reply appears to be *bona fide*, applicant is given a TIME PERIOD of **ONE (1) MONTH** or **THIRTY (30) DAYS** from the mailing date of this notice, whichever is longer, within which to supply the omission or correction in order to avoid abandonment. EXTENSIONS OF THIS TIME PERIOD MAY BE GRANTED UNDER 37 CFR 1.136(a).

**Examiner Note:**

1. This form paragraph may be used whether or not the six-month period for reply has expired. It is intended for use whenever a **bona fide** reply has been submitted. This practice does not apply where there has been a deliberate omission of some necessary part of a complete reply or where the reason the reply is incomplete cannot be characterized as an apparent oversight or apparent inadvertence. Under such cases the examiner has no authority to grant an extension if the six-month period for reply has expired. Use form paragraph 24.04 under such circumstances.
2. In bracket 1, insert the date of the reply and in bracket 2, insert the mail date of the communication requiring compliance.
3. When mailing the Office action, attach a Notice To Comply With Requirements For Patent Applications Containing Nucleotide Sequence And/Or Amino Acid Sequence Disclosures, if any, along with a marked-up copy of the Raw Sequence Listing, or CRF Diskette Problem Report.
4. See 37 CFR 1.135(c), 1.821(g); MPEP §§ 710.02(c), 711.02(a), 714.02 and 714.03.

¶ *24.04 Compact Disc/CRF Submission Is Not Fully Responsive*

The communication filed [1] is not fully responsive to the communication mailed [2] for the reason(s) set forth below or on the attached Notice To Comply With The Sequence Rules or CRF Diskette Problem Report.

If a complete reply has not been submitted by the time the shortened statutory period set in the communication mailed [3] has expired, this application will become abandoned unless applicant corrects the deficiency and obtains an extension of time

under 37 CFR 1.136(a). In no case may an applicant extend the period for reply beyond the SIX MONTH statutory period.

**Examiner Note:**

1. This form paragraph may not be used when the six month period for reply has expired. Use this form paragraph in the situation where, in the reply (within the six-months), there has been a deliberate omission of some necessary part of a complete reply. When the reply appears to be *bona fide*, but through an apparent oversight or inadvertence failed to provide a complete reply, use form paragraph 24.03.
2. In bracket 1, insert the date of the reply and in brackets 2 and 3, insert the mail date of the communication requiring compliance.
3. When mailing the Office action, attach a Notice To Comply With Requirements For Patent Applications Containing Nucleotide Sequence And/Or Amino Acid Sequence Disclosures, if any, along with a marked-up copy of the Raw Sequence Listing, or CRF Diskette Problem Report.

¶ *24.05 CD-ROM/CD-R Requirements (Missing Sequence Listing/CRF Statement)*

This application is objected to because it does not include the statement “the sequence listing information recorded in computer readable form is identical to the written (on paper or compact disc) sequence listing” and, where applicable, a statement that the submission includes no new matter, as required by 37 CFR 1.821(e), 1.821(f), 1.821(g), 1.825(b) or 1.825(d). Correction is required.

**Examiner Note:**

Use this form paragraph when there is no statement in the transmittal letter stating that the sequence listing information recorded in the CRF is identical to the written sequence listing

¶ *24.05.01 CD-ROM/CD-R Requirements (Missing Sequence Listing/CRF Statement in an Amendment Filed with a CRF)*

The amendment filed [1] is objected to because it does not include the statement “the sequence listing information recorded in computer readable form is identical to the written (on paper or compact disc) sequence listing” and, where applicable, a statement that the submission includes no new matter, as required by 37 CFR 1.821(e), 1.821(f), 1.821(g), 1.825(b) or 1.825(d). A statement that the sequence listing information is identical is required.

**Examiner Note:**

1. Use this form paragraph when there is no statement in the transmittal letter stating that the sequence listing information recorded in the CRF is identical to the written sequence listing.
2. In bracket 1, insert the date of the amendment.



**2427.02 Notice To Comply**

The text of the Notice to Comply With Requirements For Patent Applications Containing Nucleotide Sequence and for Amino Acid Sequence Disclosures, Form PTO-1661, follows. The appropriate box on the notice should be checked depending upon the particular deficiencies that have been identified. In the alter-

native, a letter may be written notifying applicant of any deficiencies that have been identified. A copy of the "Raw Sequence Listing," where available, should also be sent to the applicant. The "Raw Sequence Listing" should also be entered into the application file upon receipt from STIC.



**UNITED STATES DEPARTMENT OF COMMERCE**  
**Patent and Trademark Office**  
 Address: COMMISSIONER OF PATENTS AND TRADEMARKS  
 Washington, D.C. 20231

APPLICATION NUMBER	FILING/RECEIPT DATE	FIRST NAMED APPLICANT	ATTY. DOCKET NO./TITLE
--------------------	---------------------	-----------------------	------------------------

**DATE MAILED:**

**NOTICE TO COMPLY WITH REQUIREMENTS FOR PATENT APPLICATIONS  
 CONTAINING NUCLEOTIDE SEQUENCE AND/OR AMINO ACID SEQUENCE DISCLOSURES**

The nucleotide and/or amino acid sequence disclosure contained in this application does not comply with the requirements for such a disclosure as set forth in 37 CFR 1.821–1.825 for the following reason(s):

- 1. This application fails to comply with the requirements of 37 CFR 1.821–1.825.
- 2. This application does not contain, as a separate part of the disclosure on paper copy, a “Sequence Listing” as required by 37 CFR 1.821(c).
- 3. A copy of the “Sequence Listing” in computer readable form has not been submitted as required by 37 CFR 1.821(e).
- 4. A copy of the “Sequence Listing” in computer readable form has been submitted. The content of the computer readable form, however, does not comply with the requirements of 37 CFR 1.822 and/or 1.832, as indicated on the attached marked-up copy of the “Raw Sequence Listing.”
- 5. The computer readable form that has been filed with this application has been found to be damaged and/or unreadable as indicated on the attached CRF Diskette Problem Report. A substitute computer readable form must be submitted as required by 37 CFR 1.825(d).
- 6. The paper copy of the “Sequence Listing” is not the same as the computer readable form of the “Sequence Listing” as required by 37 CFR 1.821(e).
- 7. OTHER: \_\_\_\_\_

**APPLICANT MUST PROVIDE:**

- An initial or substitute computer readable form (CRF) copy of the “Sequence Listing.”
- An initial or substitute paper copy of the “Sequence Listing,” as well as an amendment directing its entry into the specification.
- A statement that the content of the paper and computer readable copies are the same and, where applicable, include no new matter, as required by 37 CFR 1.821(e), 1.821(f), 1.821(g), 1.825(b) or 1.825(d).

**FOR QUESTIONS REGARDING COMPLIANCE WITH THESE REQUIREMENTS, PLEASE CONTACT:**

- For Rules Interpretation, call (703) 308–1123.
- For CRF submission help, call (703) 308–4212.
- For PatentIn software help, call (703) 308–6856.

Customer Service Center  
 Initial Patent Examination Division (703) 308–1202

FORMPTO–166 (Rev. 7/97)

PART 1 – ATTORNEY/APPLICANT COPY

## 2428 Sample Statements

Sample language for the statements required to support sequence rule submissions is provided below. These statements are given by way of example only; other language may, of course, be used. For the statements that relate to the assertion that the content of the paper or compact disc and computer readable copies are the “same,” it is acknowledged that there may be some nonsubstantive differences between the two, e.g., page numbers and page breaks may be present in the paper copy but not in the computer readable copy thereof. This requirement for sameness relates to the informational content of the paper or compact disc and computer readable copies relevant to the requirements of the sequence rules.

**37 CFR 1.821(f) - I hereby state that the information recorded in computer readable form is identical to the written (on paper or compact disc) sequence listing.**

**37 CFR 1.52(e)(4) - I hereby state that the two compact discs are identical.**

**37 CFR 1.821(g) [or (h)] - I hereby state that the submission, filed in accordance with 37 CFR 1.821(g) [or (h)], herein does not include new matter [or matter which goes beyond the disclosure in the international application].**

**37 CFR 1.825(a) - I hereby state that the amendments, made in accordance with 37 CFR 1.825(a), included in the substitute sheet(s) or compact disc(s) of the Sequence Listing are supported in the application, as filed, at \_\_\_\_\_. I hereby state that the substitute sheet(s) of the Sequence Listing does (do) not include new matter.**

**37 CFR 1.825(b) - I hereby state that the substitute copy of the computer readable form, submitted in accordance with 37 CFR 1.825(b), is the same as the amended Sequence Listing.**

**37 CFR 1.825(d) - I hereby state that the substitute copy of the computer readable form, submitted in accordance with 37 CFR 1.825(d), is identical to that originally filed.**

## 2429 Helpful Hints for Compliance

The Office has now had a good deal of experience in the implementation of the sequence rules. The following list sets forth helpful hints, for both examiners

and applicants, for compliance. For the most part, the list is a compilation of frequently asked questions.

—Compliance is not a filing date issue.

—Compliance is not a 35 U.S.C. 112 issue.

—Compliance is not a 35 U.S.C. 119/120 issue.

—Compliance is not *per se* a new matter issue. The standard for resolution of inconsistencies between the official “Sequence Listing” (submitted on paper or compact disc pursuant to 37 CFR 1.821(c)) and the computer readable form thereof and/or errors in the official copy of sequence information is based on the new matter standard. If there are inconsistencies in compact discs submitted in accordance with 37 CFR 1.52(e) between “Copy 1” and “Copy 2”, the compact disc labeled “Copy 1” will be used for further processing.

—Compliance can be achieved via amendment.

—The paper or compact disc copy of the Sequence Listing is an integral part of the application. If submitted on paper, the Sequence Listing must begin on a new page, should appear at the end of the application, and preferably should be numbered independently of the numbering of the remainder of the application. The new page that begins the “Sequence Listing” should be entitled “Sequence Listing.” If not submitted as such at filing, the Sequence Listing must be inserted into the application via amendment, e.g., by preliminary amendment. If submitted on compact disc, the specification must contain an incorporation by reference of the material on the compact disc in a separate paragraph identifying each compact disc.

—Substitute pages or replacement compact discs must be used for changes to the Sequence Listing for each respective format.

—Angle brackets and numeric identifiers listed in 37 CFR 1.823 are very important for our database. Extra punctuation should not be used in Sequence Listings.

—The computer readable form cannot contain page numbers. Page numbers should only be placed on the paper copy of the Sequence Listing. Page numbers should not be placed on the compact disc copy of the Sequence Listing.

—The PatentIn computer program is not the only means by which to comply with the rules. Any word processing program can be used to generate a Sequence Listing if it has the capability to convert a file into ASCII text.

—If a word processing program is used to generate a “Sequence Listing,” hard page break controls should not be used and margins should be adjusted to the smallest setting.

—Word processing files should not be submitted to the Office; the Sequence Listing generated by a word processing file should be saved as an ASCII text file for submission. Most word processing programs provide this feature.

—Statements in accordance with 37 CFR 1.821(f), (g), (h) and 37 CFR 1.825 and proper labeling in accordance with 37 CFR 1.824(a)(6) should be noted. Sample statements to support filings and submissions in accordance with 37 CFR 1.821 through 1.825 are provided in MPEP § 2428 Sample Statements.

—Use Box SEQUENCE.

—Three and a half inch disks are less fragile than five and a quarter inch disks.

—On nucleotide sequences, since only single strands may be depicted in the “Sequence Listing,” show strands in 5′ to 3′ direction.

—The single stranded nucleotide depicted in the “Sequence Listing” may represent a strand of a nucleotide sequence that may be single or double stranded which may be, further, linear or circular. An amino acid sequence or peptide may be linear or circular. In some instances, a sequence may be both single stranded and double stranded and/or both linear and circular. The response “not relevant” is also an acceptable response for both “Strandedness” and “Topology.”

—Numeric identifiers “<140>, Current Application Number,” “<141>, Current Filing Date,” “<150>, Prior Application Number,” and “<151>, Prior Application Filing Date,” should appear in the “Sequence Listing” in all cases. If the information about the current application is not known or is unavailable at the time of completing the Sequence Listing, then the lines following numeric identifiers <140> and <141> should be left blank. This would normally be the case when the “Sequence Listing” is included in a newly filed application. Similarly, if information regarding prior applications is inapplicable, or not known at the time of completing the “Sequence Listing” but will be later filed, then the numeric identifiers <150> and <151> should appear with the line following the numeric identifiers left blank.

—If you receive a Notice to Comply that should not have been sent to you, send a letter in the form of a request for reconsideration of the notice to the organization sending the notice.

—There are a limited number of mandatory items of information. They are identified in MPEP § 2424.02 Sequence Listing Numeric Identifiers.

—Figures can be used to convey information not readily conveyed by the Sequence Listing. The exclusive conformance requirement of 37 CFR 1.821(b) will be relaxed for drawing figures. However, the sequence information so conveyed must still be included in a “Sequence Listing” and the sequence identifier (“SEQ ID NO:X”) must be used, either in the drawing or in the “Brief Description of the Drawings.”

—Extra copies of computer readable forms should not be sent to examiners.

—Inosine may be represented by the use of “I” in the features section, otherwise use “n.”

—Stop codons, represented by an asterisk, are not permitted in amino acid sequences.

—Punctuation should not be used in a sequence to indicate unknown nucleotide bases or amino acid residues nor should punctuation be used to delimit active or functional regions of a sequence. These regions should be noted as Features of the sequence per 37 CFR 1.823(b) (see numeric identifiers <220> - <223>).

—The presence of an unnatural amino acid in a sequence does not have the same effect as the presence of a D-amino acid. The sequence may still be subject to the rules even though one or more of the amino acids is not naturally occurring.

—Cyclic and branched peptides are causing some confusion in the application of the rules. Specific questions should be directed to Group 1650 personnel.

—A cyclic peptide with a tail is regarded as a branched sequence, and thereby exempt from the rules, if all bonds adjacent to the amino acid from which the tail emanates are normal peptide bonds.

—Sequences that have variable-length regions depicted as, for example, Ala Ala Leu Leu (Xaa Xaa)<sub>n</sub> Ile Pro where n=0-234 or agccttgggaca(nnnnn)<sub>m</sub>gtcatt where m=0-354 or Ser Met Ala Xaa Ser where Xaa could be 1, 2, 3, 4 and/or 5 amino acids must still comply with the Sequence Rules. The method to use

is to repeat the variable-length region as many times as the maximum length and specify in the Features section that the amino acid (or nucleotide) at a specified position is either absent or present. The variables Xaa and n may stand for only one residue, hence the need to repeat the variable. The correct way to submit the third example is Ser Met Ala Xaa Xaa Xaa Xaa Xaa Ser combined with an explanation in the Features section of the listing that any one or all of amino acids 4-8 can either be present or absent.

—Single letter amino acid abbreviations are not acceptable within the Sequence Listing but may appear elsewhere in the application.

—Zero (0) is not used when the numbering of amino acids uses negative numbers to distinguish the mature protein.

—Subscripts or superscripts are not permitted in a Sequence Listing.

—If a “Sequence Listing” is amended, an entirely new computer readable form is required regardless of the triviality of the amendment. Amendments to the paper copy of the “Sequence Listing” must be made by replacement section in compliance with 37 CFR 1.121. Amendments to the compact disc copy of the “Sequence Listing” must be made by replacement discs.

—Note field length limitations. For specific instances, they may be waived, but compliance is encouraged.

—The exclusive conformance requirement of 37 CFR 1.821(b) requires that any amendment of the sequence information in a “Sequence Listing” be accompanied by an amendment to the corresponding information, if any, embedded in the text of the specification or presented in a drawing figure.

—Any inquiries regarding a specific computer readable form that has been processed by the Office should be directed to the Systems Branch of the Chemical/Biotechnology Division of the Scientific and Technical Information Center.

### **2430 PatentIn Information; Utilities Programs; Training**

In those areas of biotechnology in which nucleotide and/or amino acid sequence information is significant, many patent applicants are accustomed to, or familiar with, the submission of such sequence information, in electronic form, to various sequence databases, such

as GenBank, which is produced by the National Institutes of Health. In order to facilitate such submissions, or merely for the purpose of researching and developing sequence information, many eventual patent applicants also generate or encode sequence information in computer readable form. In order to further facilitate compliance with the sequence rules, the Office previously made available to the public an input program based on the AuthorIn program produced by GenBank. This input program, called PatentIn version 1.3, was specifically tailored to the requirements of the sequence rules which were in effect between October 1, 1990 and July 1, 1998.

The current sequence rules, which are embodied in 37 CFR 1.821-1.825 and World Intellectual Property Organization (WIPO) Standard ST.25, became effective July 1, 1998. The rules simplify the Sequence Listing requirements, and harmonize the format among all Trilateral Offices and many other patent offices around the world. The Office deployed PatentIn versions 2.0 and 2.1, in 1998 and 1999, respectively, incorporating changes in the required format for the Sequence Listing to ensure compliance with the sequence rules that became effective July 1, 1998. These versions operated under Microsoft Windows 3.1x, 95, 98 and NT. By using PatentIn version 2.0 or 2.1, customers were able to generate a Sequence Listing once and use that same listing to file at multiple patent offices worldwide. Applications filed in the U.S. after July 1, 1998 containing Sequence Listings prepared using PatentIn version 1.3 will not be in compliance with the U.S. sequence rules. Applications filed in the member countries of WIPO after July 1, 1998 containing Sequence Listings prepared using PatentIn version 1.3 will not be in compliance with ST.25.

In June 2000 another update of PatentIn was deployed, version 3.0. This version differs from earlier versions in that the capabilities have been extended. PatentIn 3.0 has several advantages over PatentIn 2.1. PatentIn 3.0 processes large sequences (over one million bases) and applications with a large number of sequences (over 100,000); it imports multiple sequences from a single file as well as multiple sequences from multiple files. Features defined for nucleic acid sequences are carried over to the supplemental amino acid sequences generated by the CDS feature. PatentIn 3.0 is more user-friendly than

PatentIn 2.1 and looks and feels more like other Windows-based programs. Unlike PatentIn 2.1, projects are portable from one computer to another provided PatentIn 3.0 is installed. From a programming viewpoint, the advantages include that the overall lines of code have been reduced to 25 percent of that required by PatentIn 2.1, maintenance of the code is easier since it is written in Visual C++ and it is easier to modify the code.

In March of 2001 PatentIn 3.1 was released. This newest version builds on the success of PatentIn 3.0 and expands its capabilities. One difference is that the capability to import a single sequence from a single file without a header has been added. The definition of variable characters has been enhanced in PatentIn 3.1. If the nucleotide sequence has the variable "n" and the CDS feature is selected, PatentIn 3.1 will calculate the position of the necessary Xaa in the supplemental protein sequence and provide the definition automatically based on the codon in which the "n" appears.

PatentIn version 3.1, and the companion User's Manual, are available on the Office World Wide Web site ([www.uspto.gov](http://www.uspto.gov)) for free downloading. Copies of both the program and the user manual may also be purchased from the Office on 3 1/2-inch floppy diskette or compact disc. PatentIn 3.1 operates in a Windows 95/98/NT/2000 environment and has similar space, memory and system requirements as those for PatentIn version 3.0. A minimum of 64 MB of memory is recommended for smaller projects. Otherwise

128 MB is recommended. Even more additional memory may be required for larger sequence listings. The disk space required to install PatentIn 3.0 is 1.6 MB. Additional disk space is required to store project files and sequence listing files.

See MPEP § 1730 for additional information regarding ordering and using PatentIn.

While use of the PatentIn program is not required for compliance with the sequence rules, its use is highly recommended as Office experience has shown that submissions developed with PatentIn are far less likely to include errors than those developed without the program. The many automatic features of the PatentIn program also greatly ease the generation of Sequence Listings when compared to generating them by hand in a word processing environment. This is especially true for Sequence Listings that include many sequences and/or sequences having great lengths.

The Office provides hands-on training in the use of the PatentIn and associated utilities programs. The classes are held in Washington D.C. as demand warrants. In addition, on site training may be arranged at locations outside Washington, D.C. To express interest in such classes, please contact the Search and Information Resources Administration.

## **2431 Sample Sequence Listing**

A sample "Sequence Listing" is included below.

## SAMPLE SEQUENCE LISTING

```

<110> Smith, John
      Smith, Jane

<120> Example of a Sequence Listing

<130> 01-00001

<140> US 08/999,999

<141> 1998-02-28

<150> EP 91000000
<151> 1997-12-31

<160> 2

<170> PatentIn ver. 2.0

<210> 1
<211> 403
<212> DNA
<213> Paramecium aurelia

<220>
<221> CDS
<222> 341..394

<300>
<301> Doe, Richard
<302> Isolation and Characterization of a Gene Encoding a
      Protease from Paramecium sp.
<303> Journal of Fictional Genes
<304> 1
<305> 4
<306> 1 - 7
<307> 1988-06-20

<400> 1
ctactctact ctactctcat ctactatctt ctttggatct ctgagtctgc ctgagtggta 60

ctcttgagtc ctggagatct ctctctcac atgtgatcgt cgagactgac cgatagatcg 120

ctgactgact ctgagatagt cgagcccgta cgagaccctg cgaggggtgac agagagtggg 180

cgcgtgcgcg cagagcgcgg cgccggtgcg cgcgcgagtg cgcggtgggc cgcgcgaggg 240

ctttcgcggc agcggcgggc ctttcgggcg cgcgcccgtc cgcccctaga cctgagaggt 300

cttctcttcc ctctcttcca ctagagaggt ctatatatac atg gtt tca atg ttc 355

                                     Met Val Ser Met Phe
                                     1           5

```

```

agc ttg tct ttc aaa tgg cct gga ttt tgt ttg ttt gtt tgtttgctc   403
Ser Leu Ser Phe Lys Trp Pro Gly Phe Cys Leu Phe Val
                10                15

```

```

<210> 2
<211> 18
<212> PRT
<213> Paramecium aurelia

```

```

<400> 2

```

```

Met Val Ser Met Phe Ser Leu Ser Phe Lys Trp Pro Gly Phe Cys Leu
1                5                10                15
Phe Val

```

## 2434 Examination of Patent Applications Claiming Large Numbers of Nucleotide Sequences

The U.S. Patent and Trademark Office published its policy for the examination of patent applications that claim large numbers of nucleotide sequences in the *Official Gazette*, 1192 O.G. 68 (November 19, 1996). Nucleotide sequences encoding different proteins are structurally distinct chemical compounds and are unrelated to one another. These sequences are thus deemed to normally constitute independent and distinct inventions within the meaning of 35 U.S.C. 121. Absent evidence to the contrary, each such nucleotide sequence is presumed to represent an independent and distinct invention, subject to a restriction requirement pursuant to 35 U.S.C. 121 and 37 CFR 1.141. In establishing the new policy, the Commissioner has partially waived the requirements of 37 CFR 1.141 and will permit a reasonable number of such nucleotide sequences to be claimed in a single application. Under this policy, in most cases, up to 10 independent and distinct nucleotide sequences will be examined in a single application without restriction. Those sequences which are patentably indistinct from the sequences selected by the applicant will also be examined. Nucleotide sequences encoding the same protein are not considered to be independent and distinct and will continue to be examined together. In some exceptional cases, the complex nature of the claimed mate-

rial may necessitate that the reasonable number of sequences to be selected be less than 10. In other cases, applicants may petition pursuant to 37 CFR 1.181 for examination of additional nucleotide sequences by providing evidence that the different nucleotide sequences do not cover independent and distinct inventions. For examples of typical nucleotide sequence claims and additional information on the search and examination procedures, see the above cited O.G. Notice. See also MPEP § 803.04.

## 2435 Publishing of Patents and Patent Application Publications with Lengthy Sequence Listings

Due to the high cost and limited usefulness of the printed paper or composed electronic image versions of nucleotide and/or amino acid sequences, if the "Sequence Listing" portion is lengthy (i.e., at least 600 Kb (about 300 typed pages)), it will no longer be printed with the paper and composed electronic image (page image) versions of patents and patent application publications. The "Sequence Listing" will only be published in electronic form and will be available on the USPTO sequence homepage (<http://seqdata.uspto.gov>) as an ASCII text file.

Neither the paper copies of patents and patent application publications that are in the search rooms nor those sold through the Office of Public Records, Certification Division, will include a sequence listing if the sequence listing is not included in the composed



electronic image (page image) version of the patent or patent application publication. Furthermore, any copy used as a reference in an Office action will include only the paper portion of the document. If an applicant requires an electronic copy of a “Sequence Listing” that was not printed in the document, applicant must specifically request and pay for the electronic copy. Both applicants and members of the general public can obtain an electronic copy of the “Sequence Listing” through the Certification Division for a separate fee as set forth in 37 CFR 1.19(b)(3). See the paragraph entitled “Copies of Documents” in MPEP § 1730 for contact information for Certification Division.

The patent mailed to applicant will include a copy of the patent on paper and a copy of the sequence listing on an electronic medium (e.g., compact disc), if the “Sequence Listing” is not printed in the patent.

If the “Sequence Listing” is not included in the page images of a patent or patent application publication, a standardized statement will appear. Additionally, in the electronic text version of the patent or patent application publication, the statement will include an active hyperlink to a web page containing the “Sequence Listing.” The standardized statement for a patent will read, for example:

#### **SEQUENCE LISTING**

The patent contains a lengthy “Sequence Listing” section. A copy of the “Sequence Listing” is available in electronic form

from the USPTO web site (<http://seqdata.uspto.gov/sequence.html?DocID=6183957B1>). An electronic copy of the “Sequence Listing” will also be available from the USPTO upon request and payment of the fee set forth in 37 CFR 1.19(b)(3).

The standardized statement for a patent application publication will read, for example:

#### **SEQUENCE LISTING**

The patent application contains a lengthy “Sequence Listing” section. A copy of the “Sequence Listing” is available in electronic form from the USPTO web site (<http://seqdata.uspto.gov/sequence.html?DocID=20010000241>). An electronic copy of the “Sequence Listing” will also be available from the USPTO upon request and payment of the fee set forth in 37 CFR 1.19(b)(3).

Sequence data may also be accessed in a more readily searchable manner from the National Center for Biotechnology Information (NCBI) at <http://www.ncbi.nlm.nih.gov> or from a commercial vendor. The USPTO forwards a copy of the sequence data to NCBI when a patent including a “Sequence Listing” is granted, and when an application containing a sequence is published pursuant to 35 U.S.C. 122(b). If NCBI elects to include the sequence data in one of its databases, NCBI indexes the sequence data according to patent or patent application publication number. There is currently no fee for the public to use the NCBI site.



# Chapter 2500 Maintenance Fees

\*\*

- 2501 Introduction
- 2504 Patents Subject to Maintenance Fees
- 2506 Times for Submitting Maintenance Fee Payments
- 2510 Submission of Maintenance Fee >Payments and< Documents
- 2515 Information Required for Submission of Maintenance Fee Payment
- 2520 Maintenance Fee Amounts
- 2522 Methods of Payment
- 2530 >Special Acceptance of Maintenance Fee Payments Containing< Informalities
- >2531 Payment Late or Insufficient
- 2532 Duplicate Payments<
- 2540 Fee Address for Maintenance Fee Purposes
- 2542 Change of Correspondence Address
- 2550 Small Entity Status
- 2560 Revocation of Power of Attorney and Withdrawal of Attorney
- 2570 >Maintenance Fee Payment< Status Requests
- 2575 Notices
- 2580 Review of Decision Refusing to Accept and Record Payment of a Maintenance Fee Filed Prior to Expiration of Patent
- 2590 Acceptance of Delayed Payment of Maintenance Fee in Expired Patent to Reinstate Patent
- 2591 Intervening Rights in Reinstated Patents
- 2595 Forms

## 2501 Introduction [R-2]

35 U.S.C. 41. Patent fees; patent and trademark search systems.

\*\*\*\*\*

(b) The Director shall charge the following fees for maintaining in force all patents based on applications filed on or after December 12, 1980:

- (1) 3 years and 6 months after grant, \$830 [\* >\$910.00<].
- (2) 7 years and 6 months after grant, \$1,900 [\* >\$2,090.00<].
- (3) 11 years and 6 months after grant, \$2,910 [\* >\$3,220.00<].

Unless payment of the applicable maintenance fee is received in the Patent and Trademark Office on or before the date the fee is due or within a grace period of six months thereafter, the patent will expire as of the end of such grace period. The Director may require the payment of a surcharge as a condition of accepting within such 6-month grace period the payment of an applicable maintenance fee. No fee may be established for maintaining a design or plant patent in force.

(c)(1)The Director may accept the payment of any maintenance fee required by subsection (b) of this section which is made within twenty-four months after the six-month grace period if the delay is shown to the satisfaction of the Director to have been unintentional, or at any time after the six-month grace period if the delay is shown to the satisfaction of the Director to have been unavoidable. The Director may require the payment of a surcharge as a condition of accepting payment of any maintenance fee after the six-month grace period. If the Director accepts payment of a maintenance fee after the six-month grace period, the patent shall be considered as not having expired at the end of the grace period.

(2) A patent, the term of which has been maintained as a result of the acceptance of a payment of a maintenance fee under this subsection, shall not abridge or affect the right of any person or that person's successors in business who made, purchased, offered to sell, or used anything protected by the patent within the United States, or imported anything protected by the patent into the United States after the 6-month grace period but prior to the acceptance of a maintenance fee under this subsection, to continue the use of, to offer for sale, or to sell to others to be used, offered for sale, or sold, the specific thing so made, purchased, offered for sale, used, or imported. The court before which such matter is in question may provide for the continued manufacture, use, offer for sale, or sale of the thing made, purchased, offered for sale, or used within the United States, or imported into the United States, as specified, or for the manufacture, use, offer for sale, or sale in the United States of which substantial preparation was made after the 6-month grace period but before the acceptance of a maintenance fee under this subsection, and the court may also provide for the continued practice of any process that is practiced, or for the practice of which substantial preparation was made, after the 6-month grace period but before the acceptance of a maintenance fee under this subsection, to the extent and under such terms as the court deems equitable for the protection of investments made or business commenced after the 6-month grace period but before the acceptance of a maintenance fee under this subsection.

\*\*\*\*\*

**Note: The fees in brackets in 35 U.S.C. 41(b) as reproduced above are the fees that went into effect on October 1, \* >2003<. See 37 CFR 1.20(e)-(g) for the current fee amounts.**

Public Law 96-517, enacted December 12, 1980, established the requirement to pay maintenance fees for applications filed on or after that date. The statutory provisions regarding maintenance fees have been subsequently modified by Public Law 97-247, enacted August 27, 1982; Public Law 98-622, enacted November 8, 1984; Public Law 102-204, enacted December 10, 1991; Public Law 102-444, enacted October 23, 1992; Public Law 105-358, enacted November 10, 1998; and Public Law 106-113, enacted November 29, 1999.

**\*\* >MAINTENANCE FEE BRANCH<**

The \*\* >Maintenance Fee Branch of the Receipts Accounting Division of the Office of Finance< provides specialized advice and guidance to the public on maintenance fee matters.

The \*\* >Maintenance Fee Branch< determines the proper status of issued patents which are subject to payment of maintenance fees, receives and processes fee transmittals, determines small entity status, responds to public inquiries on post-issuance status and maintenance fees, determines if patents have expired, and determines if maintenance fees are timely and properly computed. This \* >Branch< also generates the data necessary to produce *Official Gazette* notices of maintenance fees due and of expiration of patents due to failure to pay maintenance fees.

**OFFICE OF PUBLIC RECORDS DOCUMENT SERVICES DIVISION SPECIAL HANDLING BRANCH**

The Special Handling Branch updates patent post issuance automated files with the following information:

- (A) Changes of Address
- (B) Powers of Attorney and Revocations Thereof
- (C) Withdrawals of Attorneys and Agents
- (D) Changes to Small Entity Status

The official mailing address for submitting requests to update all post-issuance patent information is:

\*\* >Director of the United States Patent and Trademark Office  
Mail Stop Document Services  
P.O. Box 1450  
Alexandria, Virginia 22313-1450<

**2504 Patents Subject to Maintenance Fees [R-2]**

*37 CFR 1.362. Time for payment of maintenance fees.*

(a) Maintenance fees as set forth in §§ 1.20(e) through (g) are required to be paid in all patents based on applications filed on or after December 12, 1980, except as noted in paragraph (b) of this section, to maintain a patent in force beyond 4, 8 and 12 years after the date of grant.

(b) Maintenance fees are not required for any plant patents or for any design patents. Maintenance fees are not required for a

reissue patent if the patent being reissued did not require maintenance fees.

(c) The application filing dates for purposes of payment of maintenance fees are as follows:

(1) For an application not claiming benefit of an earlier application, the actual United States filing date of the application.

(2) For an application claiming benefit of an earlier foreign application under 35 U.S.C. 119, the United States filing date of the application.

(3) For a continuing (continuation, division, continuation-in-part) application claiming the benefit of a prior patent application under 35 U.S.C. 120, the actual United States filing date of the continuing application.

(4) For a reissue application, including a continuing reissue application claiming the benefit of a reissue application under 35 U.S.C. 120, the United States filing date of the original non-reissue application on which the patent reissued is based.

(5) For an international application which has entered the United States as a Designated Office under 35 U.S.C. 371, the international filing date granted under Article 11(1) of the Patent Cooperation Treaty which is considered to be the United States filing date under 35 U.S.C. 363.

(d) Maintenance fees may be paid in patents without surcharge during the periods extending respectively from:

(1) 3 years through 3 years and 6 months after grant for the first maintenance fee,

(2) 7 years through 7 years and 6 months after grant for the second maintenance fee, and

(3) 11 years through 11 years and 6 months after grant for the third maintenance fee.

(e) Maintenance fees may be paid with the surcharge set forth in § 1.20(h) during the respective grace periods after:

(1) 3 years and 6 months and through the day of the 4th anniversary of the grant for the first maintenance fee.

(2) 7 years and 6 months and through the day of the 8th anniversary of the grant for the second maintenance fee, and

(3) 11 years and 6 months and through the day of the 12th anniversary of the grant for the third maintenance fee.

(f) If the last day for paying a maintenance fee without surcharge set forth in paragraph (d) of this section, or the last day for paying a maintenance fee with surcharge set forth in paragraph (e) of this section, falls on a Saturday, Sunday, or a federal holiday within the District of Columbia, the maintenance fee and any necessary surcharge may be paid under paragraph (d) or paragraph (e) respectively on the next succeeding day which is not a Saturday, Sunday, or Federal holiday.

(g) Unless the maintenance fee and any applicable surcharge is paid within the time periods set forth in paragraphs (d), (e) or (f) of this section, the patent will expire as of the end of the grace period set forth in paragraph (e) of this section. A patent which expires for the failure to pay the maintenance fee will expire at the end of the same date (anniversary date) the patent was granted in the 4th, 8th, or 12th year after grant.

(h) The periods specified in §§1.362 (d) and (e) with respect to a reissue application, including a continuing reissue application thereof, are counted from the date of grant of the original non-reissue application on which the reissued patent is based.

Maintenance fees are required to be paid on all patents based on applications filed on or after December 12, 1980, except for plant patents and design patents. Furthermore, maintenance fees are not required for a reissue patent if the patent being reissued did not require maintenance fees. >No payment of additional maintenance fees is required for second or subsequent reissue patents, i.e., continuation or divisional reissues (see MPEP 1451), which are derived from a first reissue patent which has issued.<

Application filing dates for purposes of determining whether a patent is subject to payment of maintenance fees are as follows:

(A) For an application not claiming benefit of an earlier application, the actual United States filing date of the application.

(B) For an application claiming benefit of an earlier foreign application under 35 U.S.C. 119(a)-(d), the actual United States filing date of the application.

(C) For a continuing (continuation, division, continuation-in-part) application claiming the benefit of a prior patent application under 35 U.S.C. 120, the actual United States filing date of the continuing application.

(D) For a reissue application, including a continuing reissue application claiming the benefit of a reissue application under 35 U.S.C. 120, the United States filing date of the original nonreissue application on which the patent reissued is based.

(E) For an international application that has entered the United States as a Designated Office under 35 U.S.C. 371, the international filing date granted under Article 11(1) of the Patent Cooperation Treaty which is considered to be the United States filing date under 35 U.S.C. 363.

## **2506 Times for Submitting Maintenance Fee Payments [R-2]**

>Maintenance fees cannot be paid in advance since 35 U.S.C. 41(f) permits maintenance fees to be adjusted every year on October 1 to reflect any fluctuations during the previous 12 months in the Consumer Price Index as determined by the Secretary of Labor.<

37 CFR 1.362(d) sets forth the time periods when the maintenance fees for a utility patent can be paid without surcharge. Those periods, referred to generally as the “window period,” are the 6-month periods

preceding each due date. The “due dates” are defined in 35 U.S.C. 41(b). The window periods are (1) 3 years to 3 1/2 years after the date of issue for the first maintenance fee payment, (2) 7 years to 7 1/2 years after the date of issue for the second maintenance fee payment, and (3) 11 years to 11 1/2 years after the date of issue for the third and final maintenance fee payment. A maintenance fee paid on the last day of a window period can be paid without surcharge. The last day of a window period is the same day of the month the patent was granted 3 years and 6 months, 7 years and 6 months, or 11 years and 6 months after grant of the patent.

37 CFR 1.362(e) sets forth the time periods when the maintenance fees for a utility patent can be paid with surcharge. Those periods, referred to generally as the “grace period,” are the 6-month periods immediately following each due date. The grace periods are (1) 3 1/2 years and through the day of the 4th anniversary of the grant of the patent, (2) 7 1/2 years and through the day of the 8th anniversary of the grant of the patent and, (3) 11 1/2 years and through the day of the 12th anniversary of the grant of the patent. A maintenance fee may be paid with the surcharge on the same date (anniversary date) the patent was granted in the 4th, 8th, or 12th year after grant to prevent the patent from expiring.

Maintenance fees for a reissue patent are due based upon the schedule established for the original utility patent. The filing of a request for *ex parte* or *inter partes* reexamination and/or the publication of a reexamination certificate does not alter the schedule of maintenance fee payments of the original patent.

If the day for paying a maintenance fee falls on a Saturday, Sunday, or a Federal holiday within the District of Columbia, the maintenance fee may be paid on the next succeeding day that is not a Saturday, Sunday, or Federal holiday. For example, if the window period for paying a maintenance fee without a surcharge ended on a Saturday, Sunday, or a Federal holiday within the District of Columbia, the maintenance fee can be paid without surcharge on the next succeeding day that is not a Saturday, Sunday, or a Federal holiday within the District of Columbia. Likewise, if the grace period for paying a maintenance fee with a surcharge ended on a Saturday, Sunday, or a Federal holiday within the District of Columbia, the maintenance fee can be paid with surcharge on the

next succeeding day that is not a Saturday, Sunday, or a Federal holiday within the District of Columbia. In the latter situation, the failure to pay the maintenance fee and surcharge on the next succeeding day that is not a Saturday, Sunday, or a Federal holiday within the District of Columbia will result in the patent expiring on a date (4, 8, or 12 years after the date of grant) earlier than the last date on which the maintenance fee and surcharge could be paid. This situation results from the provisions of 35 U.S.C. 21, but those provisions do not extend the expiration date of the patent if the maintenance fee and any required surcharge are not paid when required. For example, if the grace period for paying a maintenance fee with a surcharge ended on a Saturday, the maintenance fee and surcharge could be paid on the next succeeding business day, e.g., Monday, but the patent will have expired at midnight on Saturday if the maintenance fee and surcharge were not paid on the following Monday. Therefore, if the maintenance fee and any applicable surcharge are not paid, the patent will expire as of the end of the grace period as listed above. A patent that expires for failure of payment will expire on the anniversary date the patent was granted in the 4th, 8th, or 12th year after the grant.

## **2510 Submission of Maintenance Fee >Payments and< Documents [R-2]**

### **\*\* >SUBMISSION OVER THE INTERNET**

Maintenance fee payments can be made quickly and easily over the Internet at [www.uspto.gov](http://www.uspto.gov) by electronic funds transfer (EFT), credit card or deposit account payment methods. See MPEP § 509 and § 2522 for additional information pertaining to payments by credit card and payments by deposit account.

### **SUBMISSION BY MAIL**

As provided in 37 CFR 1.1(d)(1), the mailing address for maintenance fee payments not electronically submitted over the Internet is:

United States Patent and Trademark Office  
P.O. Box 371611  
Pittsburgh, Pennsylvania 15250-1611

Correspondence related to maintenance fees other than payments of maintenance fees in patents must be mailed to:

Mail Stop M Correspondence  
Director of the United States Patent and Trademark Office  
Alexandria, Virginia 22313-1450<

37 CFR 1.366(b) provides that the certificate of mailing procedures of 37 CFR 1.8 or the mailing by "Express Mail" provisions of 37 CFR 1.10 may be utilized in paying maintenance fees. The specific requirements of either 37 CFR 1.8 or 1.10 must be fully complied with if the benefits of either are desired. See MPEP § 512 and § 513.

### **SUBMISSION BY FACSIMILE**

Payment of a maintenance fee is accepted via facsimile, when charged to a deposit account or to a credit card. \*\* >Credit Card Payment Form (PTO-2038)< should be used if payment is made by credit card. See MPEP § 509 and § 2522. In addition, requests pertaining to post-issuance documents, such as change of correspondence address, assignment of fee address, etc., may be submitted by facsimile.

37 CFR 1.366(b) provides that the certificate of transmission procedure of 37 CFR 1.8 may be utilized in paying maintenance fees. The specific requirements of 37 CFR 1.8 must be fully complied with if the benefits thereof are desired. See MPEP § 512.

\*\*

## **2515 Information Required for Submission of Maintenance Fee Payment [R-2]**

*37 CFR 1.366. Submission of maintenance fees.*

(a) The patentee may pay maintenance fees and any necessary surcharges, or any person or organization may pay maintenance fees and any necessary surcharges on behalf of a patentee. Authorization by the patentee need not be filed in the Patent and Trademark Office to pay maintenance fees and any necessary surcharges on behalf of the patentee.

\*\*>

(b) A maintenance fee and any necessary surcharge submitted for a patent must be submitted in the amount due on the date the maintenance fee and any necessary surcharge are paid. A maintenance fee or surcharge may be paid in the manner set forth in § 1.23 or by an authorization to charge a deposit account estab-

lished pursuant to § 1.25. Payment of a maintenance fee and any necessary surcharge or the authorization to charge a deposit account must be submitted within the periods set forth in § 1.362(d), (e), or (f). Any payment or authorization of maintenance fees and surcharges filed at any other time will not be accepted and will not serve as a payment of the maintenance fee except insofar as a delayed payment of the maintenance fee is accepted by the Director in an expired patent pursuant to a petition filed under § 1.378. Any authorization to charge a deposit account must authorize the immediate charging of the maintenance fee and any necessary surcharge to the deposit account. Payment of less than the required amount, payment in a manner other than that set forth § 1.23, or in the filing of an authorization to charge a deposit account having insufficient funds will not constitute payment of a maintenance fee or surcharge on a patent. The procedures set forth in § 1.8 or § 1.10 may be utilized in paying maintenance fees and any necessary surcharges.<

(c) In submitting maintenance fees and any necessary surcharges, identification of the patents for which maintenance fees are being paid must include the patent number, and the application number of the United States application for the patent on which the maintenance fee is being paid. If the payment includes identification of only the patent number (*i.e.*, does not identify the application number of the United States application for the patent on which the maintenance fee is being paid), the Office may apply the payment to the patent identified by patent number in the payment or may return the payment.

(d) Payment of maintenance fees and any surcharges should identify the fee being paid for each patent as to whether it is the 3 1/2-, 7 1/2-, or 11 1/2-year fee, whether small entity status is being changed or claimed, the amount of the maintenance fee and any surcharge being paid, and any assigned customer number. If the maintenance fee and any necessary surcharge is being paid on a reissue patent, the payment must identify the reissue patent by reissue patent number and reissue application number as required by paragraph (c) of this section and should also include the original patent number.

(e) Maintenance fee payments and surcharge payments relating thereto must be submitted separate from any other payments for fees or charges, whether submitted in the manner set forth in § 1.23 or by an authorization to charge a deposit account. If maintenance fee and surcharge payments for more than one patent are submitted together, they should be submitted on as few sheets as possible with the patent numbers listed in increasing patent number order. If the payment submitted is insufficient to cover the maintenance fees and surcharges for all the listed patents, the payment will be applied in the order the patents are listed, beginning at the top of the listing.

(f) Notification of any change in status resulting in loss of entitlement to small entity status must be filed in a patent prior to paying, or at the time of paying, the earliest maintenance fee due after the date on which status as a small entity is no longer appropriate. See § 1.27(g).

(g) Maintenance fees and surcharges relating thereto will not be refunded except in accordance with §§1.26 and 1.28(a).

37 CFR 1.366 establishes the guidelines and procedures for submission of maintenance fees, including any necessary surcharges. The patentee may pay maintenance fees and any necessary surcharges or any person or organization may pay maintenance fees and any necessary surcharges on behalf of the patentee without filing in the Office evidence of authorization by the patentee to pay maintenance fees. This will enable patentees to pay the maintenance fees and any necessary surcharges themselves or authorize some person or organization to pay maintenance fees and any necessary surcharges on their behalf. No verification of the authority to pay maintenance fees and any necessary surcharges in a particular patent will be made by the Office. While anyone may pay the maintenance fees and any necessary surcharges on a patent, if the payment is accepted by the Office, any Office notices relating to maintenance fees and any necessary surcharges will be mailed to the “fee address” set forth in 37 CFR 1.363. If the payment is not accepted by the Office, it will be returned to the person who submitted the payment if a return address is available. It is >strongly< recommended that the payor should include a return address along with his or her telephone number since the Office may contact the payor in some instances when it is unclear to which patent the fees are to be applied. See MPEP § 2530.

A maintenance fee and any necessary surcharge for a patent must be submitted in the amount due on the date the maintenance fee and any necessary surcharge are paid, and at the proper time, *i.e.*, within the periods set forth in 37 CFR 1.362. If the amount of the maintenance fee is correct on the date it is paid and credited to the patent, a later change in the maintenance fees to reflect a new fee amount will not require a modification in the amount paid. \*\*

37 CFR 1.366(c) provides that a maintenance fee payment must include the patent number and the application number on which the maintenance fee is being paid. If the payment includes identification of only the patent number (*i.e.*, does not identify the application number for the patent on which the maintenance fee is being paid), the Office may apply the payment to the patent identified by patent number in the payment or may return the payment. See MPEP § 2530. The application number required to be submitted is not that of a prior parent application, but

rather the application number of the actual application that matured into the patent for which maintenance fees are to be paid. If the maintenance fee and any necessary surcharge is being paid on a reissue patent, the application number required is that of the reissue application.

If a patent expires because the maintenance fee and any necessary surcharge have not been paid in the manner required by 37 CFR 1.366, the patentee could proceed under 37 CFR 1.378 (see MPEP § 2590), if appropriate, or could file a petition under 37 CFR 1.377 (see MPEP § 2580) within the period set therein seeking to have the maintenance fee accepted as timely even though not all of the required identifying data was present prior to expiration of the grace period.

Under 37 CFR 1.366(d), the following information should also be submitted for each patent on which a maintenance fee or surcharge is paid (37 CFR 1.366(d)):

(A) the Fee Year (e.g., 3 1/2, 7 1/2, or 11 1/2 year fee);

(B) the amount of the maintenance fee and any surcharge being submitted;

(C) any assigned customer number; and

(D) whether small entity status is being changed or claimed with the payment.

Where the payment is a maintenance fee and any necessary surcharge on a reissue patent, in addition to the information requested for all payments, it is requested that the original patent number be furnished. Although the submission of the information requested under 37 CFR 1.366(d) is not mandatory, it would expedite the processing of maintenance fee payments.

The Maintenance Fee Transmittal Form, PTO/SB/45 should be used when submitting maintenance fees. This form is available, upon request, from the \*\* >Maintenance Fee Branch<. It is also available from the USPTO website (<http://www.uspto.gov>).

The Office processes fees in the order in which they are presented. If the payment submitted is insufficient to cover the maintenance fees and surcharges for all patents listed, and there is no >general< authorization to charge a deposit account \*\*, the payment will be applied in the order the patents are listed, beginning at the top of the listing.

## 2520 Maintenance Fee Amounts [R-2]

37 CFR 1.20(e)-(h) sets the fee amounts for the maintenance fees and the grace period surcharge. The maintenance fee amounts are subject to adjustment to reflect fluctuations occurring in the Consumer Price Index pursuant to 35 U.S.C. 41(f). The maintenance fee amounts (37 CFR 1.20(e)-(h)) are subject to a 50% reduction for small entities pursuant to 35 U.S.C. 41(h). The >Maintenance Fee Branch< and the USPTO website ([www.uspto.gov](http://www.uspto.gov)) may be contacted for the current maintenance fee amounts.

>The term of a patent might be shortened, e.g., by a terminal disclaimer. If a patent will expire part way between the due dates set in 35 U.S.C. 41(b), or between the latest due date and the term set in 35 U.S.C. 154, it is still required that the entire maintenance fee amount for the due date be paid. The maintenance fee amount is set by statute (subject to periodic adjustment), and cannot be prorated to cover only the amount of time past the due date before the patent expires.<

37 CFR 1.366(g) provides that maintenance fees and surcharges relating thereto will not be refunded except in accordance with 37 CFR 1.26 and 1.28(a). A patentee cannot obtain a refund of a maintenance fee which was due and payable on the patent. Any duplicate payment will be refunded to the fee address.

## 2522 Methods of Payment [R-2]

The method of payment for the maintenance fee and any necessary surcharge is set forth in 37 CFR 1.23. The payment shall be made in U.S. dollars and in the form of a cashier's or certified check, Treasury note, national bank notes, or United States Postal Service money order as provided in 37 CFR 1.23(a). If the maintenance fee and any necessary surcharge is sent in any other form, the Office may delay or cancel the credit until collection is made. For example, a personal or other uncertified check drawn on a U.S. bank that is not immediately negotiable, e.g., because it lacks a signature or due to insufficient funds, will not constitute payment of a maintenance fee and/or surcharge.

The maintenance fee can be charged to a credit card as set forth in 37 CFR 1.23(b), but credit for the payment is subject to actual receipt of the fee by the Office. Credit Card Payment Form (PTO-2038)

should be used for payment of fees by credit card >unless the payment is submitted over the internet<. If credit card information is provided on a form or document other than the form provided by the Office for the payment of fees by credit card, the Office will not be liable if the credit card number becomes public knowledge. See MPEP § 509.

Any remittance from a foreign country must be payable and immediately negotiable in the United States for the full amount of the maintenance fee and/or surcharge required.

37 CFR 1.366(b) provides that maintenance fees and any necessary surcharge may be paid by authorization to charge a deposit account established pursuant to 37 CFR 1.25. The authorization to charge the deposit account must be submitted within an appropriate window or grace period and must be limited to maintenance fees and surcharges payable on the date of submission. The authorization to charge the deposit account cannot be submitted prior to the third, seventh, or eleventh year after grant of the patent. If an authorization to charge a deposit account were submitted to pay the maintenance due at 3 years and 6 months after grant, a new authorization to charge a deposit account or other form of payment will have to be submitted at the appropriate time for each of the maintenance fees due at 7 years and 6 months and 11 years and 6 months. Any payment or authorization filed at any time other than that set forth in 37 CFR 1.362(d), (e), or (f) will not serve as a payment of the maintenance fee, except insofar as a delayed payment of the maintenance fee is accepted by the Commissioner pursuant to 37 CFR 1.378. See MPEP § 2590. A payment of less than the required amount, a payment in a manner other than that set forth in 37 CFR 1.23, or the filing of an authorization to charge a deposit account having insufficient funds, will not constitute payment of a maintenance fee on a patent. The authorization is required to permit the immediate charging of the maintenance fee to the deposit account. An authorization would be improper if it only authorized the maintenance fee to be charged at a later date, e.g., on the last possible day of payment without surcharge. Such an authorization would not serve as payment of the maintenance fee. Any payment which fails to result in the entire proper amount of the maintenance fee being present on the due date will not constitute payment of the maintenance fee.

Maintenance fee payments and any surcharges relating thereto must be submitted separately from any other payments for fees or charges, whether submitted in the manner set forth in 37 CFR 1.23 or by authorization to charge a deposit account. >See< 37 CFR 1.366(e). Maintenance fee payments and surcharge payments relating thereto that are commingled with payments for other fees or charges, e.g., application filing fees, issue fees, document supply fees, etc., will not be accepted. Maintenance fees require processing by a separate area of the Office and are not processed in the same manner as other fees and charges. Maintenance fees for a number of patents can be submitted together in one submission and one payment. 37 CFR 1.366(e) specifies that if maintenance fee payments for more than one patent are submitted together, they should be submitted on as few sheets as possible, listing the patent numbers in increasing patent number order. If the payment submitted is insufficient to cover the maintenance fees and any surcharges for all the listed patents, the payment will be applied in the order the patents are listed. In such a circumstance the maintenance fee and any surcharge for one or more of the last listed patents will not be paid.

Money orders and checks must be made payable to the \*\* >Director of the United States Patent and Trademark Office. (Checks made payable to the Commissioner of Patents and Trademarks will continue to be accepted. See 37 CFR 1.23 (a))<. Remittances from foreign countries must be payable and immediately negotiable in the United States for the full amount required.

It is not suggested that cash be sent by mail. However, if cash is sent it will be at the risk of the sender and should be sent via registered mail.

### **2530 >Special Acceptance of Maintenance Fee Payments Containing< Informalities [R-2]**

\*\* >It is strongly recommended that a maintenance fee submission include both a telephone number and a mailing address for the fee submitter because, provided the fee is sufficient, the Office will often attempt to contact the submitter by telephone and/or by mail to confirm the patent to which the fee is to be applied.



If a maintenance fee payment identifies only the patent number (i.e., does not identify the application number for the patent on which the maintenance fee is being paid), the Office may apply the payment to the patent identified by the patent number in the payment or may return the payment. See 37 CFR 1.366 (c). If the Office specially accepts a payment, a Notice of Special Acceptance of Patent Maintenance Fee (PTO-2143) will be mailed to the fee submitter identifying the patent number and application number to which the maintenance fee was applied and requesting the fee submitter to verify that the payment was applied as intended. The Notice of Special Acceptance of Patent Maintenance Fee (PTO-2143) will set a time period within which to file a petition under 37 CFR 1.377 along with the petition fee if the maintenance fee was not applied to the patent for which the payment was intended. The Office intends to specially accept maintenance fee payments according to the following guidelines.

#### **I. PATENT NUMBER SUPPLIED BUT NO APPLICATION NUMBER SUPPLIED**

If the maintenance fee payment is sufficient for the maintenance fee due for the patent identified by only the patent number, the Office will specially accept and apply the payment.

#### **II. PATENT NUMBER AND APPLICATION NUMBER SUPPLIED BUT THEY DO NOT CORRESPOND**

When a patent number and an application number are both supplied, but they do not correspond to the same patent, the Office will make a reasonable attempt to confirm the correct patent by telephoning the submitter (e.g., patentee or agent), provided the payment is sufficient to pay the maintenance fee due on either the patent identified by the patent number or the patent identified by the application number.

(A) If *verbal* confirmation of the patent identified by the patent number is obtained during the telephone call and the payment submitted is sufficient, the Office will specially accept and apply the payment as confirmed.

(B) If *written* (e.g., facsimile or email) confirmation of the patent identified by the application num-

ber is obtained immediately following the telephone call, and the payment submitted is sufficient, the Office will specially accept and apply the payment as confirmed.

(C) If the telephone call is not successful (e.g., no contact is made with the fee submitter) but a maintenance fee is due on the patent identified by the patent number, provided the payment submitted is sufficient, the Office may specially accept and apply the payment to the patent identified by the patent number.

#### **III. NO PATENT NUMBER SUPPLIED BUT APPLICATION NUMBER SUPPLIED**

If a maintenance fee is due on the patent identified by the application number and the payment submitted is sufficient, the Office will telephone the fee submitter to confirm the payment. If *written* (e.g., facsimile) confirmation is obtained immediately following the telephone call, the Office will specially accept and apply payment as confirmed. Otherwise, the Office will return the payment to the fee submitter.

>

#### **2531 Payment Late or Insufficient [R-2]**

Examples of when a payment of maintenance fees and any necessary surcharges will be considered to be late or insufficient include instances when:

(A) Though a payment was received, additional funds are required due to surcharge or fee increase;

(B) Though a payment was received in an amount for small entity, the patented file records do not indicate that an assertion of small entity status was received; or

(C) The payment was received after the patent expired.

If the Office considers a payment to be late or insufficient, a notice (e.g., a Notice of Non-Acceptance of Patent Maintenance Fee (PTO-2142)) will be sent to the "fee submitter." Reply to the notice is required prior to expiration of the grace period provided by 37 CFR 1.362(e) in order to avoid the expiration of the patent. If a reply is not received prior to expiration of the patent, then an appropriate petition under 37 CFR 1.377 or 37 CFR 1.378 is required. See MPEP § 2580 and § 2590.

If a payment is deemed insufficient because the payment was submitted in the small entity amount but no written assertion of entitlement to small entity status has been filed, a Notice of Non-Acceptance of Small Entity Patent Maintenance Fee (PTO-2140) will be mailed to the fee submitter. See MPEP § 2550 for information on establishing or changing an entity status for the purpose of paying a maintenance fee.<

&gt;

## 2532 Duplicate Payments [R-2]

In the event a maintenance fee is submitted (hereafter, duplicate payment) in the required amount (including any necessary surcharge) within the payment window for the patent identified for payment, but the same maintenance fee for that patent was already paid by a previous fee submitter (hereafter, first fee submitter), the Office intends to treat the duplicate from the second fee submitter as follows:

(A) If the duplicate payment does not comply with 37 CFR 1.366(c) by not containing both the patent number and the corroborating application number, the Office will return the duplicate payment to the second fee submitter with an indication that the maintenance fee for the patent was already paid.

(B) If the duplicate payment does comply with 37 CFR 1.366(c) by containing both the patent number and the corroborating application number, the Office will verify that the first payment was properly processed.

(1) If the first payment was properly processed, the Office will return the duplicate payment to the second fee submitter. In this event the returned payment will be accompanied by identification of the first fee submitter.

(2) If a review of the Office record of the first maintenance fee payment reveals that the first payment was not properly processed (e.g., did not comply with 37 CFR 1.366(c) or was not specially accepted in accordance with MPEP § 2530), the Office will attempt to determine whether the first payment should have been applied to a patent other than the patent identified under 37 CFR 1.366(c) by the second fee submitter. Based on this determination the Office will: (a) attempt to apply the duplicate payment (and retract the first payment); or (b) return the duplicate payment to the second fee submitter with identification of the first fee submitter.<

## 2540 Fee Address for Maintenance Fee Purposes [R-2]

37 CFR 1.363. *Fee address for maintenance fee purposes.*

(a) All notices, receipts, refunds, and other communications relating to payment or refund of maintenance fees will be directed to the correspondence address used during prosecution of the application as indicated in § 1.33(a) unless:

(1) A “fee address” for purposes of payment of maintenance fees is set forth when submitting the issue fee, or

(2) A change in the correspondence address for all purposes is filed after payment of the issue fee, or

(3) A “fee address” or a change in the “fee address” is filed for purposes of receiving notices, receipts and other correspondence relating to the payment of maintenance fees after the payment of the issue fee, in which instance, the latest such address will be used.

(b) An assignment of a patent application or patent does not result in a change of the “correspondence address” or “fee address” for maintenance fee purposes.

All notices, receipts, refunds and other communications relating to the payment or refund of a maintenance fee will be directed to the correspondence address used during the prosecution of the application, unless a “fee address” for the purpose of payment of the maintenance fee has been designated or a change in the correspondence address has been made (see MPEP § 2542). 37 CFR 1.33(d) allows a correspondence address or change thereto to be filed during the enforceable life of the patent. Patentees should ensure that the Office is properly notified of the proper “fee address” to which all maintenance fee communications are to be directed.

Under the statutes and rules, the Office has no duty to notify patentee of the requirement to pay maintenance fees or to notify patentee when the maintenance fee is due. It is solely the responsibility of the patentee to ensure that the maintenance fee is paid timely to prevent expiration of the patent. The failure to receive the reminder notice will not shift the burden of monitoring the time for paying a maintenance fee from the patentee to the Office. The Office will attempt to assist patentees through the mailing of a Maintenance Fee Reminder in the grace period. However, the failure to receive a Maintenance Fee Reminder will not relieve the patentee of the obligation to timely pay the appropriate maintenance fee to prevent expiration of the patent, nor will it constitute unavoidable delay if the patentee seeks to reinstate the patent under 37 CFR 1.378(b). See *In re Patent No. 4,409,763*,

7 USPQ2d 1798 (Comm'r Pat. 1988), *aff'd sub nom. Rydeen v. Quigg*, 748 F. Supp. 900, 16 USPQ2d 1876 (D.D.C. 1990), *aff'd*, 937 F.2d 623 (Fed. Cir. 1991) (table), *cert. denied*, 502 U.S. 1075 (1992). Maintenance fee correspondence will not be directed to more than one address.

\*\* >The use of the following form(s) is suggested when requesting establishment of a fee address: a current version of the "Fee Address" Indication Form (PTO/SB/47), and if necessary, a Request for Customer Number (PTO/SB/125). The Office's record-keeping database does not permit the Office to establish a fee address for a patent or allowed application without a customer number. If a customer number was previously acquired from the Office for the address being designated as the fee address, that customer number should be entered on the "Fee Address" Indication Form (PTO/SB/47) to make the fee address designation. If no customer number exists for the address being designated as the fee address, then the "Fee Address" Indication Form (PTO/SB/47) should be accompanied by a completed Request for Customer Number (form PTO/SB/125). See MPEP § 403 concerning customer number practice.

A "Fee Address" Indication Form (PTO/SB/47) having a revision date of March 2002 reflects the requirement that a customer number be used to establish a fee address. Earlier versions of the "Fee Address" Indication Form (PTO/SB/47), however, do not reflect this requirement, and are outdated. A March 2002 revision date is shown by the notation "(03-02)" in the upper right-hand corner of the form, following the form number (PTO/SB/47). It is recommended that only a current version of the "Fee Address" Indication Form (PTO/SB/47) showing a revision date of 03-02, or more recent, be used when designating a fee address.

At the time of issue fee payment, applicants may designate a fee address by submitting a "Fee Address" Indication Form (PTO/SB/47) as an attachment to the Issue Fee Transmittal (PTOL-85B). After issue fee payment, applicants may designate a fee address by submitting a "Fee Address" Indication Form (PTO/SB/47), and if necessary, a Request for Customer Number (PTO/SB/125), to the address specified on the "Fee Address" Indication Form (PTO/SB/47).

All fee addresses established at the Office will be represented by a customer number, even if the fee

address designation lacks an explicit request that a customer number be used for this purpose (e.g., in the event that an outdated "Fee Address" Indication Form (PTO/SB/47), or equivalent form, is submitted without an accompanying Request for Customer Number (PTO/SB/125)).

The current version of the "Fee Address" Indication Form (PTO/SB/47) is available upon request from the Maintenance Fee Branch and from the USPTO website ([www.uspto.gov](http://www.uspto.gov)). The Request for Customer Number (PTO/SB/125) is available upon request from the Electronic Business Center and from the USPTO website ([www.uspto.gov](http://www.uspto.gov)). Requests for the establishment of a fee address should be submitted to the Maintenance Fee Branch prior to or at the time of payment of maintenance fees in order to ensure that receipt of payment is directed to the fee address.

Additional patent numbers may be assigned to a customer number at any time, upon written request.

The customer number of the fee address should be referred to on all future maintenance fee payments in order to expedite the payment.<

## 2542 Change of Correspondence Address [R-2]

Unless a fee address has been designated, all notices, receipts, refunds, and other communications relating to the patent will be directed to the correspondence address (37 CFR 1.33) used during the prosecution of the application. Practitioners of record when the patent issues who do not wish to receive correspondence relating to maintenance fees must change the correspondence address in the patented file or provide a fee address to which such correspondence should be sent. It is not required that a practitioner file a request for permission to withdraw pursuant to 37 CFR 1.36 solely for the purpose of changing the correspondence address in a patented file.

The correspondence address should be updated or changed as necessary to ensure that all communications are received in a timely manner. A change of correspondence address may be made as provided in 37 CFR 1.33(a). The correspondence address may be changed as provided in 37 CFR 1.33(a)(1) prior to the filing of an oath or declaration. After an oath or declaration has been executed and filed by at least one inventor, the correspondence address may be changed as provided in 37 CFR 1.33(a)(2).

Requests for a change of the correspondence address may be sent to the Office of Public Records, Document Services Division, Special Handling Branch during the enforceable life of the patent. To ensure accuracy and to expedite requests for change to the correspondence address, it is suggested that the request include both the patent number and the application number. \*\* >The Office form, Change of Correspondence Address, Application (PTO/SB/122)< may be used to request a change of correspondence address in a patent application. \*\* >The Office form, Change of Correspondence Address, Patent (PTO/SB/123)< may be used to request a change of correspondence address for an issued patent.

## 2550 Small Entity Status [R-2]

In order to establish small entity status for the purpose of paying a maintenance fee, a written assertion of entitlement to small entity status must be filed prior to or with the maintenance fee paid as a small entity. A written assertion is only required to be filed once and will remain effective until changed.

37 CFR 1.366(f) serves as a reminder to patentees of the necessity to check for the loss of small entity status prior to paying each maintenance fee on a patent. This is also a requirement of 37 CFR 1.27(g). The notification of any change in status resulting in loss of entitlement to small entity status must be filed in a patent prior to paying, or at the time of paying, the earliest maintenance fee due after the date on which status as a small entity is no longer appropriate. If status as a small entity has been previously established by filing an assertion of small entity status and such status is checked and found to be proper, no notification is required. It is not necessary to file a new assertion establishing small entity status at this point if the status as a small entity has been established and is still proper even if rights have been transferred to a small entity after the assertion of small entity status. The requirement is to notify the Office of the loss of entitlement and to pay the maintenance fee in the proper amount for other than a small entity where appropriate. The refund provisions of 37 CFR 1.28(a) for later submitted small entity assertions do apply to maintenance fees.

>If a payment is submitted that conflicts with the Office record of the patentee's entity status, a notice relating to entity status will be sent to the fee submit-

ter. A Notice of Overpayment of Patent Maintenance Fee (PTO-211) will be sent if the payment was submitted in the large entity amount, but Office records indicate that the patentee is a small entity. A Notice of Non-Acceptance of Small Entity Patent Maintenance Fee (PTO-2140) will be sent if the payment was submitted in the small entity amount, but Office records indicate that the patentee is a large entity.

Where a Notice of Overpayment of Patent Maintenance Fee (PTO-211) is sent, the time period for reply depends on whether the reply requires additional money for sufficient payment of the large entity maintenance fee. Where no additional money is required, the fee submitter will be given a non-extendable ONE MONTH period from the mailing date of the notice to file a written notification of change in status from small to large entity. Note that if no additional money was required for sufficient payment of the large entity maintenance fee on the date the payment was received, no additional money will be required with the timely reply even if the patent entered the grace period under 37 CFR 1.362 (e) after the mailing date of the notice. Where additional money is required, the reply (including the additional money and the written notification of change in status from small to large entity) must be filed within the earlier of: (A) a non-extendable ONE MONTH period from the mailing date of the notice; or (B) any time remaining under 37 CFR 1.362, including the grace period provided by 37 CFR 1.362(e). Note that if a previously unpaid surcharge has come due by the time the reply requiring additional money is filed, sufficient payment will require payment of the surcharge as well as any additional money required to complete the large entity maintenance fee amount. Absent a timely reply to the Notice of Overpayment of Patent Maintenance Fee (PTO-211), the Office will apply the small entity maintenance fee payment amount to the patent and refund the overpayment amount. Accordingly, if the patentee is actually entitled to small entity status, no reply to the Notice of Overpayment of Patent Maintenance Fee (PTO-211) is necessary. In the event money was refunded by the Office as an "overpayment amount," but the patentee is a large entity, provided the patent has not already expired, the fee submitter must file a resubmission of the refunded money together with the required written notification of change in status from small to large entity within

the time remaining under 37 CFR 1.362, including the grace period provided by 37 CFR 1.362(e). In this situation, if the original payment amount received by the Office is less than the current amount required for sufficient payment of the large entity maintenance fee, the resubmitted money previously refunded by the Office as an “overpayment amount” must be accompanied by additional money.

Where a Notice of Non-Acceptance of Small Entity Patent Maintenance Fee (PTO-2140) is sent, the reply must be filed within the earlier of: (A) a non-extendable ONE MONTH period from the mailing date of the notice; or (B) any time remaining under 37 CFR 1.362, including the grace period provided by 37 CFR 1.362(e). The requirements of the reply depend on whether the patentee is entitled to small entity status. If the patentee is entitled to small entity status, a written assertion of entitlement to small entity status is required together with any additional money required for sufficient payment of the small entity maintenance fee. If the patentee is a large entity patentee, the reply must include payment of the additional money required for sufficient payment of the large entity maintenance fee. Note that if a previously unpaid surcharge under 37 CFR 1.362(e) has come due by the time the reply is filed, sufficient payment will require payment of the surcharge as well as any additional money required to complete the required maintenance fee amount. Absent a timely reply to the Notice of Non-Acceptance of Small Entity Patent Maintenance Fee (PTO-2140), the Office will refund the amount received. If the amount received was refunded and the patentee is a small entity, provided the patent has not already expired, sufficient payment of the small entity maintenance fee and the required written assertion of entitlement to small entity status must be filed within the time remaining under 37 CFR 1.362, including the grace period provided by 37 CFR 1.362(e). If the amount received was refunded and the patentee is a large entity, provided the patent has not already expired, sufficient payment of the large entity maintenance fee must be filed within the time remaining under 37 CFR 1.362, including the grace period provided by 37 CFR 1.362(e).

## **2560 Revocation of Power of Attorney and Withdrawal of Attorney [R-2]**

The revocation or withdrawal of an attorney may be submitted at any time; however, it is recommended that it be done well prior to the date a maintenance fee is due.

When processing a revocation of a power of attorney, the Office of Public Records, Document Services Division, Special Handling Branch forwards copies of the completed action to the requester and the attorney being removed. Also, a copy is placed in the \* >original< file \*.

When processing a withdrawal of an attorney, the Office of Public Records, Document Services Division, Special Handling Branch forwards copies of the completed action to the attorney and the patent owner. \*\*

It should be noted that an assignment does not act as a revocation of power of attorney for authorization previously given. However, the assignee may revoke a previous power of attorney. See 37 CFR 3.71 and 3.73.

## **2570 >Maintenance Fee Payment< Status Requests [R-2]**

The \*\* >Maintenance Fee Branch< will respond to requests for the >maintenance fee payment< status of patents. \*\* >Maintenance fee status can be requested by telephone, facsimile, or e-mail. In addition, maintenance fee status information is available over the Internet at [www.uspto.gov](http://www.uspto.gov). Telephone status requests are limited to two patent numbers per telephone call. \*\* See MPEP § 1730 for the telephone and facsimile numbers.

The \*\* >Maintenance Fee Branch< has a form available, for the user’s convenience, when submitting requests in person or via facsimile.

## **2575 Notices**

Under the statutes and the regulations, the Office has no duty to notify patentees when their maintenance fees are due. It is the responsibility of the patentee to ensure that the maintenance fees are paid to prevent expiration of the patent. The Office will, however, provide some notices as reminders that maintenance fees are due, but the notices, errors in the notices or in their delivery, or the lack or tardiness of

notices will in no way relieve a patentee from the responsibility to make timely payment of each maintenance fee to prevent the patent from expiring by operation of law. The notices provided by the Office are courtesies in nature and intended to aid patentees. The Office's provision of notices in no way shifts the burden of monitoring the time for paying maintenance fees on patents from the patentee to the Office.

### PREPRINTED STANDARD NOTICES

The patent grant currently includes a reminder notice that maintenance fees may be due. The Notice of Allowance currently includes a reminder notice that maintenance fees may be due.

### OFFICIAL GAZETTE NOTICE

A notice will appear in each issue of the *Official Gazette* which will indicate which patents have been granted 3, 7, and 11 years earlier, that the window period has opened, and that maintenance fee payments will now be accepted for those patents.

Another *Official Gazette* notice published after expiration of the grace period will indicate any patent which has expired due to nonpayment of maintenance fees and any patents which have been reinstated. An annual compilation of such expirations and reinstatements will also be published.

### MAINTENANCE FEE REMINDERS

Since patentees are expected to maintain their own record and docketing systems and since it is expected that most patentees will pay their maintenance fees during the window period to avoid payment of a surcharge, the Office will not send any reminder notices to the patentee until after the grace period has begun. This will reduce and simplify the mailing of notices but still give patentees an opportunity to pay their maintenance fee with surcharge during the grace period before expiration of their patents. The Office will mail any Maintenance Fee Reminder to the fee address as set forth in 37 CFR 1.363. See MPEP § 2540.

### RECEIPT NOTICES

The Office will issue a receipt for payment of maintenance fees after entry of the maintenance fee payment. Such a receipt will provide an opportunity for

the patentee to check if the Office has properly credited the payment. The original document submitted by the patentee when paying the maintenance fee will also be appropriately marked and returned to the fee address as set forth in 37 CFR 1.363

### EXPIRATION NOTICES

The Office will mail a Notice of Patent Expiration to the fee address as set forth in 37 CFR 1.363 when Office records indicate that a patent has expired for failure to pay a required maintenance fee.

## 2580 Review of Decision Refusing to Accept and Record Payment of a Maintenance Fee Filed Prior to Expiration of Patent [R-2]

*37 CFR 1.377. Review of decision refusing to accept and record payment of a maintenance fee filed prior to expiration of patent.*

\*\*>

(a) Any patentee who is dissatisfied with the refusal of the Patent and Trademark Office to accept and record a maintenance fee which was filed prior to the expiration of the patent may petition the Director to accept and record the maintenance fee.<

(b) Any petition under this section must be filed within 2 months of the action complained of, or within such other time as may be set in the action complained of, and must be accompanied by the fee set forth in § 1.17(h). The petition may include a request that the petition fee be refunded if the refusal to accept and record the maintenance fee is determined to result from an error by the Patent and Trademark Office.

(c) Any petition filed under this section must comply with the requirements of § 1.181(b) and must be signed by an attorney or agent registered to practice before the Patent and Trademark Office, or by the patentee, the assignee, or other party in interest.

37 CFR 1.377 provides a mechanism for review of a decision refusing to accept and record payment of a maintenance fee filed prior to the expiration of a patent. 37 CFR 1.377(a) permits a patentee who is dissatisfied with the refusal of the Office to accept and record a maintenance fee which was filed prior to the expiration of the patent to petition the \* >Director< to accept and record the maintenance fee. This petition may be used, for example, in situations where an error is present in the identifying data required by 37 CFR 1.366(c) with the maintenance fee payment, i.e., either the patent number or the application number \* >is< incorrect. See MPEP § 2515 and § 2530. A petition under 37 CFR 1.377 would not be appropriate

where there is a complete failure to include at least one correct mandatory identifier as required by 37 CFR 1.366(c) for the patent since no evidence would be present as to the patent on which the maintenance fee was intended to be paid. If the maintenance fee payment with an incorrect mandatory identifier was made near the end of the grace period, the patent might expire since the Office would not credit the fee to the patent. A petition under 37 CFR 1.377 would not be appropriate where the patentee paid a maintenance fee on one patent when the patentee intended to pay the maintenance fee on a different patent but through error identified the wrong patent number and application number. Likewise, a petition under 37 CFR 1.377 would not be appropriate where the entire maintenance fee payment, including any necessary surcharge, was not filed prior to expiration of the patent.

Any petition filed under 37 CFR 1.377 must be filed within 2 months of the action complained of, or within such other time as may be set in the action complained of. The petition must be accompanied by the proper petition fee. The petition may include a request that the petition fee be refunded if the refusal to accept and record the maintenance fee is determined to have resulted from an error by the Office.

Any petition filed under 37 CFR 1.377 must comply with the requirements of 37 CFR 1.181(b) and must be signed by an attorney or agent registered to practice before the Office, or by the patentee, the assignee, or other party in interest. A person or organization whose only responsibility insofar as the patent is concerned is the payment of a maintenance fee is not a party in interest for purposes 37 CFR 1.377. If the petition is signed by a person not registered to practice before the Office, the petition must indicate whether the person signing the petition is the patentee, assignee, or other party in interest. An assignee must comply with the requirements of 37 CFR 3.73(b) which is discussed in MPEP § 324.

Any petition under 37 CFR 1.377 should be marked on the front page of the communication to the attention of the Office of Petitions and addressed as follows:

\*\* >Mail Stop Petition  
Commissioner for Patents  
P.O. Box 1450  
Alexandria, Virginia 22313-1450<

## 2590 Acceptance of Delayed Payment of Maintenance Fee in Expired Patent to Reinstate Patent [R-2]

*37 CFR 1.378. Acceptance of delayed payment of maintenance fee in expired patent to reinstate patent.*

\*\*>

(a) The Director may accept the payment of any maintenance fee due on a patent after expiration of the patent if, upon petition, the delay in payment of the maintenance fee is shown to the satisfaction of the Director to have been unavoidable (paragraph (b) of this section) or unintentional (paragraph (c) of this section) and if the surcharge required by § 1.20(i) is paid as a condition of accepting payment of the maintenance fee. If the Director accepts payment of the maintenance fee upon petition, the patent shall be considered as not having expired, but will be subject to the conditions set forth in 35 U.S.C. 41(c)(2). <

(b) Any petition to accept an unavoidably delayed payment of a maintenance fee filed under paragraph (a) of this section must include:

- (1) the required maintenance fee set forth in § 1.20 (e)-(g);
- (2) the surcharge set forth in § 1.20(i)(1); and
- (3) a showing that the delay was unavoidable since reasonable care was taken to ensure that the maintenance fee would be paid timely and that the petition was filed promptly after the patentee was notified of, or otherwise became aware of, the expiration of the patent. The showing must enumerate the steps taken to ensure timely payment of the maintenance fee, the date and the manner in which patentee became aware of the expiration of the patent, and the steps taken to file the petition promptly.

(c) Any petition to accept an unintentionally delayed payment of a maintenance fee filed under paragraph (a) of this section must be filed within twenty-four months after the six-month grace period provided in § 1.362(e) and must include:

- (1) the required maintenance fee set forth in § 1.20 (e)-(g);
- (2) the surcharge set forth in § 1.20(i)(2); and
- (3) a statement that the delay in payment of the maintenance fee was unintentional.

(d) Any petition under this section must be signed by an attorney or agent registered to practice before the Patent and Trademark Office, or by the patentee, the assignee, or other party in interest.

\*\*>

(e) Reconsideration of a decision refusing to accept a maintenance fee upon petition filed pursuant to paragraph (a) of this section may be obtained by filing a petition for reconsideration within two months of, or such other time as set in, the decision refusing to accept the delayed payment of the maintenance fee. Any such petition for reconsideration must be accompanied by the petition fee set forth in § 1.17(h). After decision on the petition for reconsideration, no further reconsideration or review of the matter will be undertaken by the Director. If the delayed payment of the maintenance fee is not accepted, the maintenance fee and the surcharge set forth in § 1.20(i) will be refunded following the decision on the petition for reconsideration, or after the expiration of

the time for filing such a petition for reconsideration, if none is filed. Any petition fee under this section will not be refunded unless the refusal to accept and record the maintenance fee is determined to result from an error by the Patent and Trademark Office.<

37 CFR 1.378(a) provides that the \* >Director of the Office< may accept the payment of any maintenance fee due on a patent based on an expiration of the patent if, upon petition, the delay in payment of the maintenance fee is shown to the satisfaction of the \* >Director of the Office< to have been unavoidable or unintentional. The appropriate surcharge set forth in § 1.20(i) must be paid as a condition of accepting payment of the maintenance fee. The surcharges set at 37 CFR 1.20(i) are established pursuant to 35 U.S.C. 41(c) and, therefore, are not subject to small entity provisions of 35 U.S.C. 41(h). No separate petition fee is required for this petition. If the \* >Director of the Office< accepts payment of the maintenance fee upon petition, the patent shall be considered as not having expired but will be subject to the intervening rights and provisions of 35 U.S.C. 41(c)(2).

Any petition under 37 CFR 1.378(b) or (c) should be marked on the front page of the communication to the attention of the Office of Petitions and addressed as follows:

\*\* >Mail Stop Petition

Commissioner for Patents

P.O. Box 1450

Alexandria, Virginia 22313-1450<

Any petition under 37 CFR 1.378 must be signed by an attorney or agent registered to practice before the U.S. Patent and Trademark Office, or by the patentee, the assignee, or other party in interest. A person or organization whose only responsibility insofar as the patent is concerned is the payment of a maintenance fee is not a party in interest for purposes of 37 CFR 1.378. If the petition is signed by a person not registered to practice before the Office, the petition must indicate that the person signing the petition is the patentee, assignee, or other party in interest. An assignee must comply with the requirements of 37 CFR 3.73(b) which is discussed in MPEP § 324.

37 CFR 1.378(e) provides a mechanism for obtaining reconsideration of a decision refusing to accept a maintenance fee upon petition filed pursuant to paragraph (a). This mechanism is a petition for reconsider-

ation which may be filed within 2 months of, or such other time as set in, the decision refusing to accept the delayed payment of the maintenance fee. In contrast to petitions filed under paragraph (a), the petition for reconsideration requires the petition fee set forth in 37 CFR 1.17(h). After a decision on the petition for reconsideration, no further reconsideration or review of the matter will be undertaken by the \* >Director of the Office<. The maintenance fee and the surcharge submitted will be refunded if the delayed payment of the maintenance fee is not accepted. The refund will be made following the decision on the petition for reconsideration, or after the expiration of the time for filing such a petition for reconsideration, if none is filed. The petition fee for filing a petition for reconsideration will not be refunded unless, on reconsideration, the refusal to accept and record the maintenance fee is determined to result from an error by the Office.

#### UNAVOIDABLE DELAY

37 CFR 1.378(b) provides that a patent may be reinstated at any time following expiration of the patent for failure to timely pay a maintenance fee. A petition to accept late payment of a maintenance fee, where the delay was unavoidable, must include:

(A) the required maintenance fee set forth in 37 CFR 1.20(e)-(g);

(B) the surcharge set forth in 37 CFR 1.20(i)(1); and

(C) a showing that the delay was unavoidable since reasonable care was taken to ensure that the maintenance fee would be paid timely and that the petition was filed promptly after the patentee was notified of, or otherwise became aware of, the expiration of the patent.

The required showing must enumerate the steps taken to ensure timely payment of the maintenance fee, the date and the manner in which patentee became aware of the expiration of the patent, and the steps taken to file the petition promptly. Furthermore, an adequate showing requires a statement by all persons with direct knowledge of the cause of the delay, setting forth the facts as they know them. Copies of all documentary evidence referred to in a statement should be furnished as exhibits to the statement.

As language in 35 U.S.C. 41(c)(1) is identical to that in 35 U.S.C. 133 (i.e., “unavoidable” delay), a



late maintenance fee for the unavoidable delay standard is considered under the same standard for reviving an abandoned application under 35 U.S.C. 133. See *Ray v. Lehman*, 55 F.3d 606, 608-09, 34 USPQ2d 1786, 1787 (Fed. Cir. 1995) (quoting *In re Patent No. 4,409,763*, 7 USPQ2d 1798, 1800 (Comm'r Pat. 1988), *aff'd sub nom. Rydeen v. Quigg*, 748 F. Supp. 900, 16 USPQ2d 1876 (D.D.C. 1990), *aff'd*, 937 F.2d 623 (Fed. Cir. 1991) (table), *cert. denied*, 502 U.S. 1075 (1992)). See MPEP § 711.03(c) for a general discussion of the “unavoidable” delay standard.

As 35 U.S.C. 41(c) requires the payment of fees at specified intervals to maintain a patent in force, rather than some response to a specific action by the Office under 35 U.S.C. 133, a reasonably prudent person in the exercise of due care and diligence would have taken steps to ensure the timely payment of such maintenance fees. *Ray*, 55 F.3d at 609, 34 USPQ2d at 1788. That is, an adequate showing that the delay in payment of the maintenance fee at issue was “unavoidable” within the meaning of 35 U.S.C. 41(c) and 37 CFR 1.378(b)(3) requires a showing of the steps taken to ensure the timely payment of the maintenance fees for this patent. *Id.* Thus, where the record fails to disclose that the patentee took reasonable steps, or discloses that the patentee took no steps, to ensure timely payment of the maintenance fee, 35 U.S.C. 41(c) and 37 CFR 1.378(b)(3) preclude acceptance of the delayed payment of the maintenance fee under 37 CFR 1.378(b).

In view of the requirement to enumerate the steps taken to ensure timely payment of the maintenance fee, the patentee’s lack of knowledge of the need to pay the maintenance fee and the failure to receive the Maintenance Fee Reminder do not constitute unavoidable delay. See *Patent No. 4,409,763*, *supra*. See also Final Rule entitled “Final Rules for Patent Maintenance Fees,” published in the *Federal Register* at 49 *Fed. Reg.* 34716, 34722-23 (August 31, 1984), and republished in the *Official Gazette* at 1046 *Off. Gaz. Pat. Office* 28, 34 (September 25, 1984). Under the statutes and rules, the Office has no duty to notify patentees of the requirement to pay maintenance fees or to notify patentees when the maintenance fees are due. It is solely the responsibility of the patentee to assure that the maintenance fee is timely paid to prevent expiration of the patent. The lack of knowledge of the requirement to pay a maintenance fee and the

failure to receive the Maintenance Fee Reminder will not shift the burden of monitoring the time for paying a maintenance fee from the patentee to the Office.

Thus, evidence that despite reasonable care on behalf of the patentee and/or the patentee’s agents, and reasonable steps to ensure timely payment, the maintenance fee was unavoidably not paid, could be submitted in support of an argument that the delay in payment was unavoidable. For example, an error in a docketing system could possibly result in a finding that a delay in payment was unavoidable if it were shown that reasonable care was exercised in designing and operating the system and that the patentee took reasonable steps to ensure that the patent was entered into the system to ensure timely payment of the maintenance fees.

## UNINTENTIONAL DELAY

\*\* >Under 35 U.S.C. 41(c)(1), the director of the Office may< accept late payment of any maintenance fee filed within 24 months after the 6-month grace period, if the delay in payment is shown to the satisfaction of the \* >Director of the Office< to have been unintentional. See MPEP § 711.03(c) for a general discussion of the “unintentional” delay standard.

In addition to the timeliness deadline set forth in the preceding paragraph, a petition filed under the unintentional standard of 37 CFR 1.378(c) must include:

- (A) the required maintenance fee set forth in 37 CFR 1.20 (e) through (g);
- (B) the surcharge for an unintentionally expired patent as set forth in 37 CFR 1.20(i)(2); and
- (C) a statement that the delay in payment of the maintenance fee was unintentional.

A person seeking reinstatement of an expired patent should not make a statement that the delay in payment of the maintenance fee was unintentional unless the entire delay was unintentional, including the period from discovery that the maintenance fee was not timely paid until payment of the maintenance fee. For example, a statement that the delay in payment of the maintenance fee was unintentional would not be proper when the patentee becomes aware of an unintentional failure to timely pay the maintenance fee and then intentionally delays filing a petition for reinstatement of the patent under 37 CFR 1.378.

## **2591 Intervening Rights in Reinstated Patents**

Intervening rights in reinstated patents are provided by 35 U.S.C. 41(c)(2) which is reproduced in MPEP § 2501. No patent, the term of which has been maintained as a result of the acceptance of a late payment of a maintenance fee, shall abridge or affect the right of any person or his or her successors in business who made, purchased, imported, or used after the 6-month grace period but prior to the acceptance of the late maintenance fee anything protected by the patent, to continue the use or importation of, or to sell to others to be used or sold, the specific things made, purchased, imported, or used. A court before which such matter is in question may provide for the continued manufacture, use, importation, or sale of the thing made, purchased, imported, or used as specified, or for the manufacture, use, importation, or sale of which

substantial preparation was made after the 6-month grace period but before the acceptance of the late maintenance fee, and it may also provide for the continued practice of any process, practiced, or for the practice of which substantial preparation was made, after the 6-month grace period but prior to the acceptance of the late maintenance fee, to the extent and under such terms as the court deems equitable for the protection of investments made or business commenced after the 6-month grace period but before the acceptance of the late maintenance fee.

## **2595 Forms [R-2]**

The following forms are suggested when submitting a maintenance fee or establishing a fee address for maintenance fee purposes. “Maintenance Fee Transmittal Form,” Form PTO/SB 45; and “Fee Address’ Indication Form,” Form PTO/SB/47.

\*\*>

PTO/SB/45 (09-03)  
 Approved for use through 06/30/2006. OMB 0651-0016  
 U.S. Patent and Trademark Office; U.S. DEPARTMENT OF COMMERCE

Under the Paperwork Reduction Act of 1995, no persons are required to respond to a collection of information unless it displays a valid OMB control number.

**MAINTENANCE FEE TRANSMITTAL FORM**

Address to: United States Patent and Trademark Office, P.O. Box 371611, Pittsburgh, PA 15250-1611  
 I hereby certify that this correspondence is being deposited with the United States Postal Service with sufficient postage as first class mail in an envelope addressed to "United States Patent and Trademark Office, P.O. Box 371611, Pittsburgh, PA 15250-1611" on \_\_\_\_\_.

Signature \_\_\_\_\_

Typed or printed name \_\_\_\_\_

Enclosed herewith is the payment of the maintenance fee(s) for the listed patent(s).

- 1.  A check for the amount of \$ \_\_\_\_\_ for the full payment of the maintenance fee(s) and any necessary surcharge on the following patents is enclosed.
- 2.  The Director is hereby authorized to charge \$ \_\_\_\_\_ to cover the payment of the fee(s) indicated below to Deposit Account No. \_\_\_\_\_.
- 3.  The Director is hereby authorized to charge any deficiency in the payment of the required fee(s) or credit any overpayment to Deposit Account No. \_\_\_\_\_.
- 4.  Payment by credit card. Form PTO-2038 is attached.

\* Information required by 37 CFR 1.366(c) (columns 1 & 4), Information requested under 37 CFR 1.366(d) (columns 2, 3, 5, & 6)

Item	Patent Number* Column 1	Maintenance Fee Amount (37 CFR 1.20 (e)-(g)) Column 2	Surcharge Amount (37 CFR 1.20 (h)-(i)) Column 3	U.S. Application Number* [06/555,555] Column 4	Payment Year			Small Entity? ** Column 6
					Column 5	3.5 yrs	7.5 yrs	
1								
2								
3								
4								
5								
6								

Subtotals: Columns 2 & 3 \$0.00  
 Total Payment \$0.00

\_\_\_\_\_ additional sheets attached for listing additional patents.

**WARNING:**  
 Information on this form may become public. Credit card information should not be included on this form. Provide credit card information and authorization on PTO-2038

Respectfully submitted\*\*\*:

Customer's name:

Telephone:

Fax:

Customer's Signature:

Registration Number, if applicable:

Note: \*All correspondence will be forwarded to the "Fee Address" or to the "Correspondence Address" if no "Fee Address" has been provided. 37 CFR 1.363.

\*\* Payment of small entity fee is appropriate if small entity status still exists, see 37 CFR 1.27(g). To establish small entity status or to change status from small to large entity, note the requirements of 37 CFR 1.27 and 1.33(b).

\*\*\* WHERE MAINTENANCE FEE PAYMENTS ARE TO BE MADE BY AUTHORIZATION TO CHARGE A DEPOSIT ACCOUNT, BOTH CUSTOMER'S NAME AND SIGNATURE ARE REQUIRED.

This collection of information is required by 37 CFR 1.366. The information is required to obtain or retain a benefit by the public which is to file (and by the USPTO to process) an application. Confidentiality is governed by 35 U.S.C. 122 and 37 CFR 1.14. This collection is estimated to take 0.8 minutes to complete, including gathering, preparing, and submitting the completed application form to the USPTO. Time will vary depending upon the individual case. Any comments on the amount of time you require to complete this form and/or suggestions for reducing this burden, should be sent to the Chief Information Officer, U.S. Patent and Trademark Office, U.S. Department of Commerce, P.O. Box 1450, Alexandria, VA. 22313-1450. DO NOT SEND FEES OR COMPLETED FORMS TO THIS ADDRESS. SEND TO: United States Patent and Trademark Office, P.O. Box 371611, Pittsburgh, PA 15250-1611.

If you need assistance in completing the form, call 1-800-PTO-9199 and select option 2.

PTO/SB/47 (07-03)

Approved for use through 05/31/2006. OMB 0651-0016

U.S. Patent and Trademark Office; U. S. DEPARTMENT OF COMMERCE

Under the Paperwork Reduction Act of 1995, no persons are required to respond to a collection of information unless it displays a valid OMB control number.

**“FEE ADDRESS” INDICATION FORM**

**Address to:**  
**Mail Stop M Correspondence**  
**Commissioner for Patents**  
**P.O. Box 1450**  
**Alexandria, VA 22313-1450**

**INSTRUCTIONS :** Only an address associated with a Customer Number can be established as the fee address for maintenance fee purposes (hereafter, fee address). A fee address should be specified when the patentee would like correspondence related to maintenance fees to be mailed to a different address than the correspondence address for the application. If there is a Customer Number already associated with the fee address for the patent or allowed application, check the first box below and provide the Customer Number in the space provided. If there is no Customer Number associated with the fee address for the patent or allowed application, you must check the second box below and attach a Request for Customer Number form (PTO/SB/125). For more information on Customer Numbers, see the Manual of Patent Examining Procedure (MPEP) § 403.

Please recognize as the “Fee Address” under the provisions of 37 CFR 1.363 the address associated with:

Customer Number:

**OR**

Request for Customer Number (PTO/SB/125) attached hereto in the following listed application(s) for which the Issue Fee has been paid for patent(s).

PATENT NUMBER (if known)	APPLICATION NUMBER

Completed by (check one):

<input type="checkbox"/> Applicant/Inventor	_____ Signature
<input type="checkbox"/> Attorney or Agent of record _____ (Reg. No.)	_____ Typed or printed name
<input type="checkbox"/> Assignee of record of the entire interest. See 37 CFR 3.71. Statement under 37 CFR 3.73(b) is enclosed. (Form PTO/SB/96)	_____ Requester's telephone number
<input type="checkbox"/> Assignee recorded at Reel _____ Frame _____	_____ Date

NOTE: Signatures of all the inventors or assignees of record of the entire interest or their representative(s) are required. Submit multiple forms if more than one signature is required, see below\*.

\* Total of \_\_\_\_\_ forms are submitted.

This collection of information is required by 37 CFR 1.363. The information is required to obtain or retain a benefit by the public which is to file (and by the USPTO to process) an application. Confidentiality is governed by 35 U.S.C. 122 and 37 CFR 1.14. This collection is estimated to take 5 minutes to complete, including gathering, preparing, and submitting the completed application form to the USPTO. Time will vary depending upon the individual case. Any comments on the amount of time you require to complete this form and/or suggestions for reducing this burden, should be sent to the Chief Information Officer, U.S. Patent and Trademark Office, U.S. Department of Commerce, P.O. Box 1450, Alexandria, VA 22313-1450. DO NOT SEND FEES OR COMPLETED FORMS TO THIS ADDRESS. SEND TO: Mail Stop M Correspondence, Commissioner for Patents, P.O. Box 1450, Alexandria, VA 22313-1450.

*If you need assistance in completing the form, call 1-800-PTO-9199 and select option 2.*

<

MANUAL OF PATENT EXAMINING PROCEDURE

# Chapter 2600 Optional Inter Partes Reexamination

<b>2601</b>	<b>Introduction</b>		
2601.01	Flowcharts		
<b>2602</b>	<b>Citation of Prior Art</b>		
<b>2609</b>	<b><i>Inter Partes</i> Reexamination</b>		
<b>2610</b>	<b>Request for <i>Inter Partes</i> Reexamination</b>		
<b>2611</b>	<b>Time for Requesting <i>Inter Partes</i> Reexamination</b>		
<b>2612</b>	<b>Persons Who May File a Request</b>		
<b>2613</b>	<b>Representative of Requester</b>		
<b>2614</b>	<b>Content of Request for <i>Inter Partes</i> Reexamination</b>		
<b>2615</b>	<b>Fee for Requesting <i>Inter Partes</i> Reexamination</b>		
<b>2616</b>	<b>Substantial New Question of Patentability</b>		
<b>2617</b>	<b>Statement in the Request Applying Prior Art</b>		
<b>2618</b>	<b>Copies of Prior Art (Patents and Printed Publications)</b>		
<b>2619</b>	<b>Copy of Printed Patent</b>		
<b>2620</b>	<b>Certificate of Service</b>		
<b>2622</b>	<b>Address of Patent Owner</b>		
<b>2623</b>	<b>Withdrawal of Power of Attorney</b>		
<b>2624</b>	<b>Correspondence</b>		
<b>2625</b>	<b>Untimely Paper Filed Prior to First Office Action</b>		
<b>2626</b>	<b>Initial Processing of Request for <i>Inter Partes</i> Reexamination</b>		
<b>2627</b>	<b>Incomplete Request for <i>Inter Partes</i> Reexamination</b>		
<b>2628</b>	<b>Informal Request for <i>Inter Partes</i> Reexamination</b>		
<b>2629</b>	<b>Notice of Request for <i>Inter Partes</i> Reexamination in Official Gazette</b>		
<b>2630</b>	<b>Constructive Notice to Patent Owner</b>		
<b>2631</b>	<b>Processing of Request Corrections</b>		
<b>2632</b>	<b>Public Access</b>		
<b>2633</b>	<b>Processing in Technology Center</b>		
<b>2634</b>	<b>Fee Processing and Procedure</b>		
<b>2635</b>	<b>Record Systems</b>		
<b>2636</b>	<b>Assignment of Reexamination</b>		
<b>2637</b>	<b>Transfer Procedure</b>		
<b>2638</b>	<b>Time Reporting</b>		
<b>2640</b>	<b>Decision on Request</b>		
<b>2641</b>	<b>Time for Deciding Request</b>		
<b>2642</b>	<b>Criteria for Deciding Request</b>		
<b>2643</b>	<b>Claims Considered in Deciding Request</b>		
<b>2644</b>	<b>Prior Art on Which the Determination Is Based</b>		
<b>2646</b>	<b>Decision Ordering Reexamination</b>		
<b>2647</b>	<b>Decision Denying Reexamination</b>		
2647.01	Examples of Decisions on Requests		
2647.02	Processing of Decision		
<b>2648</b>	<b>Petition From Denial of Request</b>		
<b>2654</b>	<b>Conduct of <i>Inter Partes</i> Reexamination</b>		
			<b>Proceedings</b>
<b>2655</b>	<b>Who Reexamines</b>		
<b>2656</b>	<b>Prior Art Patents and Printed Publications Reviewed by Examiner in Reexamination</b>		
<b>2657</b>	<b>Listing of Prior Art</b>		
<b>2658</b>	<b>Scope of <i>Inter Partes</i> Reexamination</b>		
<b>2659</b>	<b><i>Res Judicata</i> and Collateral Estoppel in Reexamination Proceedings</b>		
<b>2660</b>	<b>First Office Action</b>		
2660.02	The Title		
2660.03	Dependent Claims		
<b>2661</b>	<b>Special Status for Action</b>		
<b>2662</b>	<b>Time for Response and Comments</b>		
<b>2664</b>	<b>Mailing of Office Action</b>		
<b>2665</b>	<b>Extension of Time for Patent Owner Response</b>		
<b>2666</b>	<b>Patent Owner Response to Office Action</b>		
2666.01	Amendment by Patent Owner		
2666.02	Correction of Patent Drawings		
2666.03	Correction of Inventorship		
2666.05	Third Party Comments After Patent Owner Response		
2666.06	Service of Papers		
2666.10	Patent Owner Does Not Respond to Office Action		
2666.20	Third Party Does Not Comment After Patent Owner Response		
2666.30	Submission Not Fully Responsive to Non-final Office Action		
2666.40	Patent Owner Completion of Response and Third Party Comments Thereon		
2666.50	Examiner Issues Notice of Defective Paper in <i>Inter Partes</i> Reexamination		
2666.60	Response by Patent Owner/Third Party to Notice of Defective Paper		
<b>2667</b>	<b>Handling of Inappropriate or Untimely Filed Papers</b>		
<b>2668</b>	<b>Petition for Entry of Late Papers for Revival of Reexamination Proceeding</b>		
<b>2670</b>	<b>Clerical Handling</b>		
<b>2671</b>	<b>Examiner Action Following Response/ Comments or Expiration of Time For Same</b>		
2671.01	Examiner Issues Action on Merits That Does Not Close Prosecution		
2671.02	Examiner Issues Action Closing Prosecution (ACP)		
2671.03	Patentability Review Conferences		
<b>2672</b>	<b>Patent Owner Comments/Amendment After ACP and Third Party Requester Responsive Comments</b>		
<b>2673</b>	<b>Examiner Consideration of Submissions After ACP and Further Action</b>		
2673.01	Reopening Prosecution After ACP		

- 2673.02 Examiner Issues Right of Appeal Notice (RAN)
- 2674 Appeal in *Inter Partes* Reexamination**
- 2674.01 Cross Appeal After Original Appeal
- 2675 Appellant Brief**
- 2675.01 Respondent Brief
- 2675.02 Informalities in One or More of the Briefs
- 2676 Appeal Conference**
- 2677 Examiner's Answer**
- 2678 Rebuttal Brief**
- 2679 Office Treatment of Rebuttal Brief**
- 2680 Oral Hearing**
- 2681 Board of Patent Appeals and Interferences Decision**
- 2682 Action Following Decision**
- 2683 Appeal to Courts**
- 2684 Information Material to Patentability in Reexamination Proceeding**
- 2685 No Interviews on Merits in *Inter Partes* Reexamination Proceedings**
- 2686 Notification of Existence of Prior or Concurrent Proceedings and Decisions Thereon**
- 2686.01 Multiple Copending Reexamination Proceedings
- 2686.02 Copending Reexamination and Interference Proceedings
- 2686.03 Copending Reexamination and Reissue Proceedings
- 2686.04 Reexamination and Litigation Proceedings
- 2687 Notice of Intent To Issue *Inter Partes* Reexamination Certificate (NIRC) and Conclusion of Reexamination Proceeding**
- 2687.01 Examiner Consideration of Submissions After NIRC
- 2688 Issuance of *Inter Partes* Reexamination Certificate**
- 2689 Reexamination Review**
- 2690 Format of *Inter Partes* Reexamination Certificate**
- 2691 Notice of *Inter Partes* Reexamination Certificate Issuance in *Official Gazette***
- 2692 Distribution of Certificate**
- 2693 Intervening Rights**
- 2694 Terminated Reexamination Files**
- 2695 Reexamination of a Reexamination**

## **2696 USPTO Forms To Be Used in *Inter Partes* Reexamination**

### **2601 Introduction [Added R-2]**

The reexamination statute was amended on November 29, 1999 by Public Law 106-113. Public Law 106-113 expanded reexamination by providing an “*inter partes*” option; it authorized the extension of reexamination proceedings via an optional *inter partes* reexamination procedure in addition to the existing *ex parte* reexamination procedure. See Title IV, subtitle F (§§ 4601 through 4608) of the “Intellectual Property and Communications Omnibus Reform Act of 1999,” S. 1948 (106th Cong. 1st Sess. (1999)). Section 1000(a)(9), Division B, of Public Law 106-113 incorporated and enacted into law the “Intellectual Property and Communications Omnibus Reform Act of 1999” (S. 1948). As a result, new sections 311-318 of title 35 United States Code directed to the optional *inter partes* reexamination proceeding were added by Public Law 106-113.

The reexamination statute was again amended on November 2, 2002, by Public Law 107-273, 116 Stat. 1758, 1899-1906 (2002). Public Law 107-273 expanded the scope of what qualifies for a substantial new question of patentability upon which a reexamination may be based (see MPEP § 2642, POLICY IN SPECIFIC SITUATIONS, part A), expanded the third party requester's appeal rights to include appeal to the Court of Appeals for the Federal Circuit (see MPEP § 2679), and made technical corrections to the statute. See the 21st Century Department of Justice Appropriations Authorization Act, TITLE III - INTELLECTUAL PROPERTY, Subtitle A - Patent and Trademark Office, Section 13105, of the “Patent and Trademark Office Authorization Act of 2002” - Enacted as part of Public Law 107-273 on November 2, 2002.

The optional *inter partes* alternative provides third party requesters with a greater opportunity to participate in reexamination proceedings, while maintaining most of the features which make reexamination a desirable alternative to litigation in the Federal Courts (e.g., low cost relative to Court proceedings, expedited procedure).

The optional *inter partes* alternative also provides third party requesters with appeal rights to appeal to the Board of Patent Appeals and Interferences (Board)

and to participate in the patent owner's appeal to the Board.

For any *inter partes* reexamination proceeding commenced on or after November 2, 2002, the third party requester also has the appeal rights to appeal to the Court of Appeals for the Federal Circuit and to participate in the patent owner's appeal to the Federal Circuit. For an *inter partes* reexamination proceeding commenced prior to November 2, 2002, however, no appeal rights are provided for the third party requester to appeal to the Court of Appeals for the Federal Circuit, nor to participate in the patent owner's appeal to the Court. See MPEP § 2683.

Exercising the *inter partes* option is conditioned (by Public Law 106-113) on the third party requester accepting a statutory estoppel against subsequent review, either by the Office or by a Federal Court, of the issues that were or could have been raised in the reexamination proceeding. These limits, which will be discussed in this Chapter are aimed at preventing *inter partes* reexamination proceedings from being used to harass patent owners.

The final rules to implement the statutory *inter partes* reexamination option was published in the Federal Register on December 7, 2000 (65 Fed. Reg. 76756) and in the *Official Gazette* on January 2, 2001 (1243 O.G. 12). The final rule notice stated that the changes to the rules of practice to implement the optional *inter partes* reexamination provisions of the American Inventors Protection Act of 1999 would become effective on February 5, 2001. The notice

includes not only the text of the final rules, but also a discussion of the rules and analysis of the comments received, which serve as guidance in the implementation of the rules.

Both the statutory *inter partes* reexamination option, 35 U.S.C., Chapter 31, and the new *inter partes* reexamination rules, 37 CFR, Sub-part H, apply to all reexamination proceedings for patents issuing from applications filed on or after November 29, 1999. For a patent issued from an application filed prior to November 29, 1999, the statutory *inter partes* reexamination option is not available, only the *ex parte* reexamination is available (see 37 CFR, Sub-part D, 37 CFR 1.510 *et seq.*).

See MPEP Chapter 2200 (section 2209 *et seq.*) for guidance on the procedures for *ex parte* reexamination proceedings.

## 2601.01 Flowcharts [Added R-2]

The flowcharts show the general flow for the various stages of *inter partes* reexamination proceedings. The first flowchart shows the procedures before appeal. The second flowchart shows the appeal procedure with a single 3<sup>rd</sup> party requester. The third flowchart shows the procedures following a Board decision for reexamination proceedings commenced prior to November 2, 2002. The fourth flowchart shows the procedures following a Board decision for reexamination proceedings commenced on or after November 2, 2002.



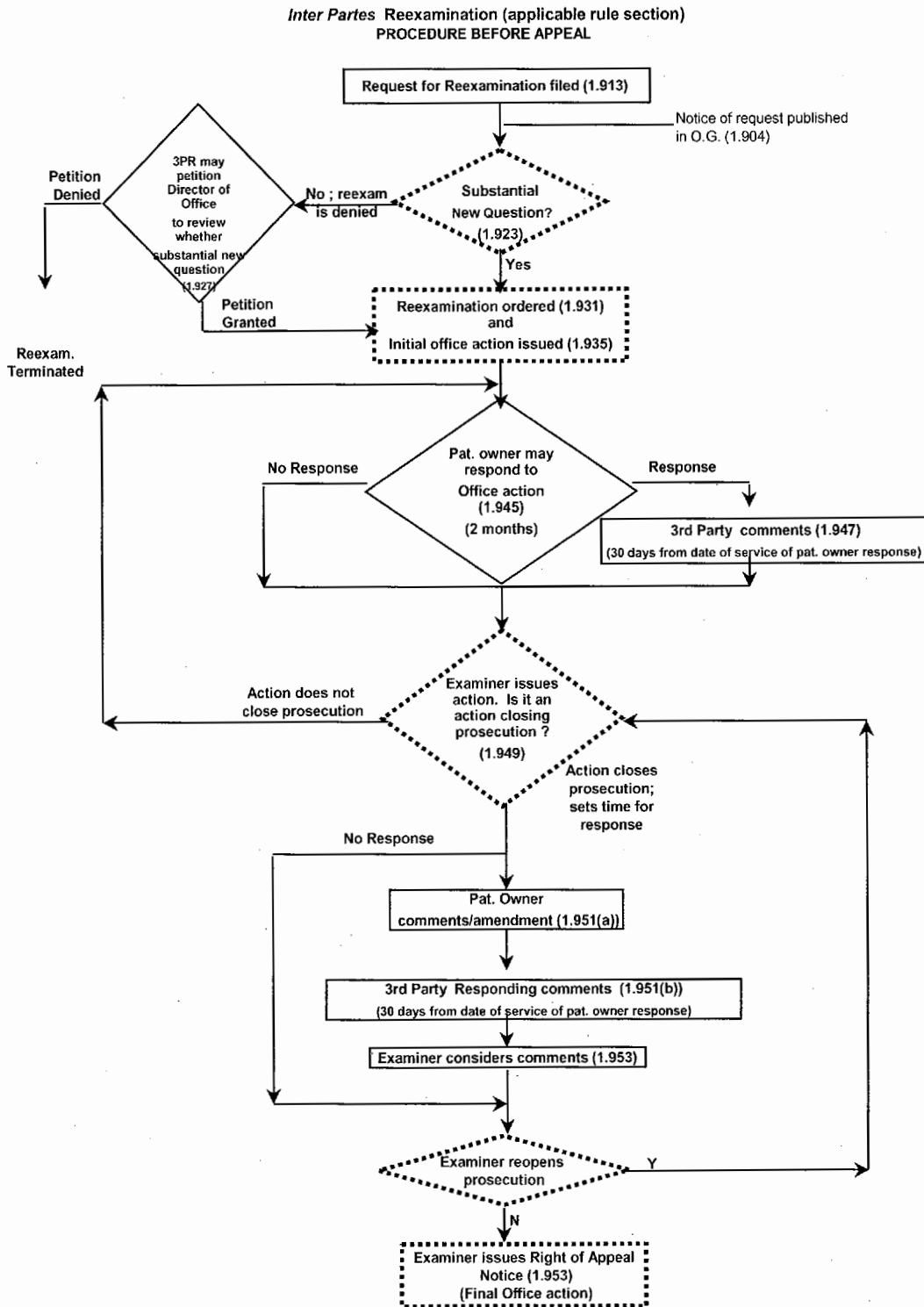

*Inter Partes* Reexamination (applicable rule section)  
**APPEAL PROCEDURE**  
 Single Third Party Requester

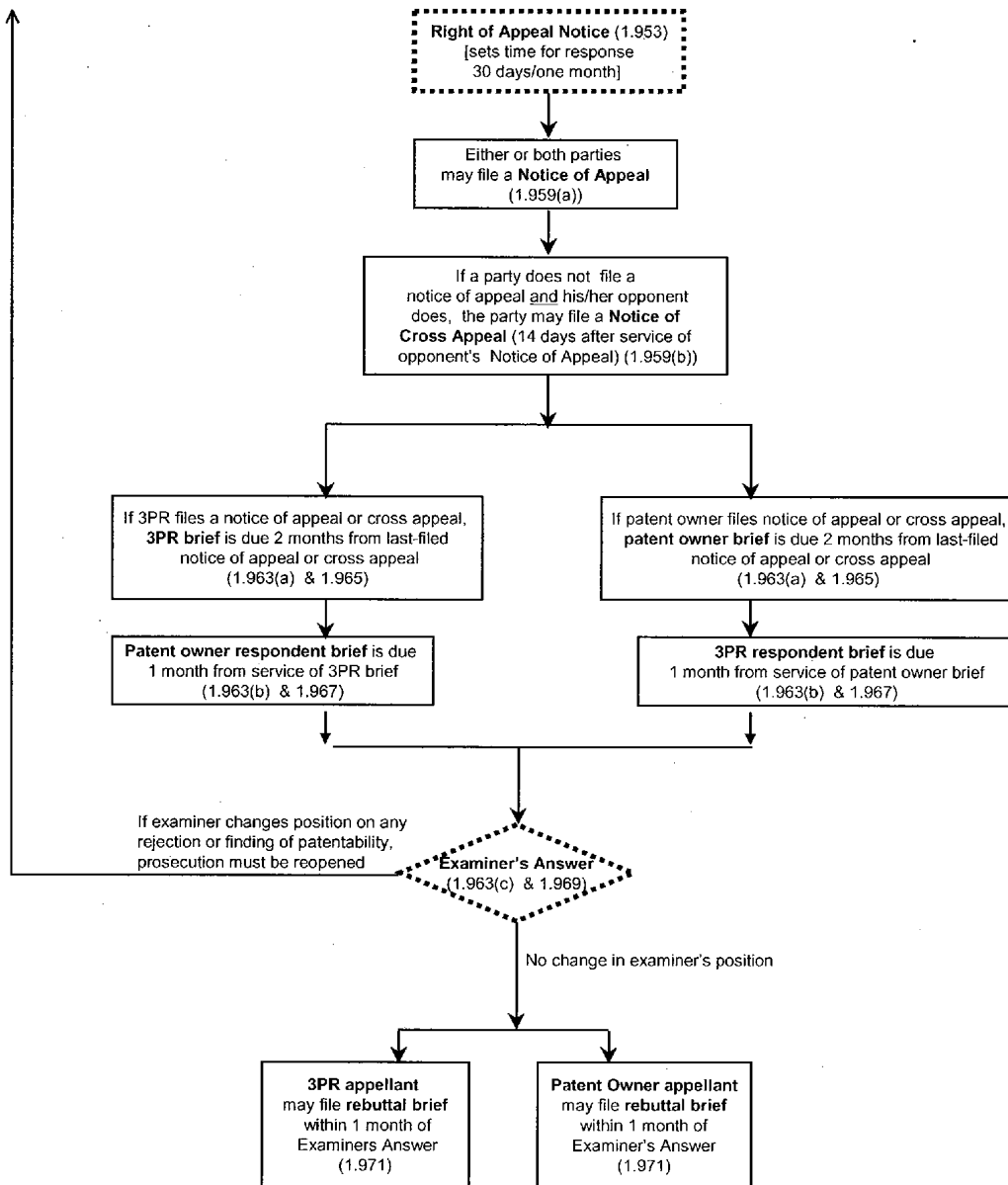

**Inter Partes Reexamination (applicable rule section)  
Procedures Following Board Decision for Reexaminations  
Commenced Prior to November 2, 2002**

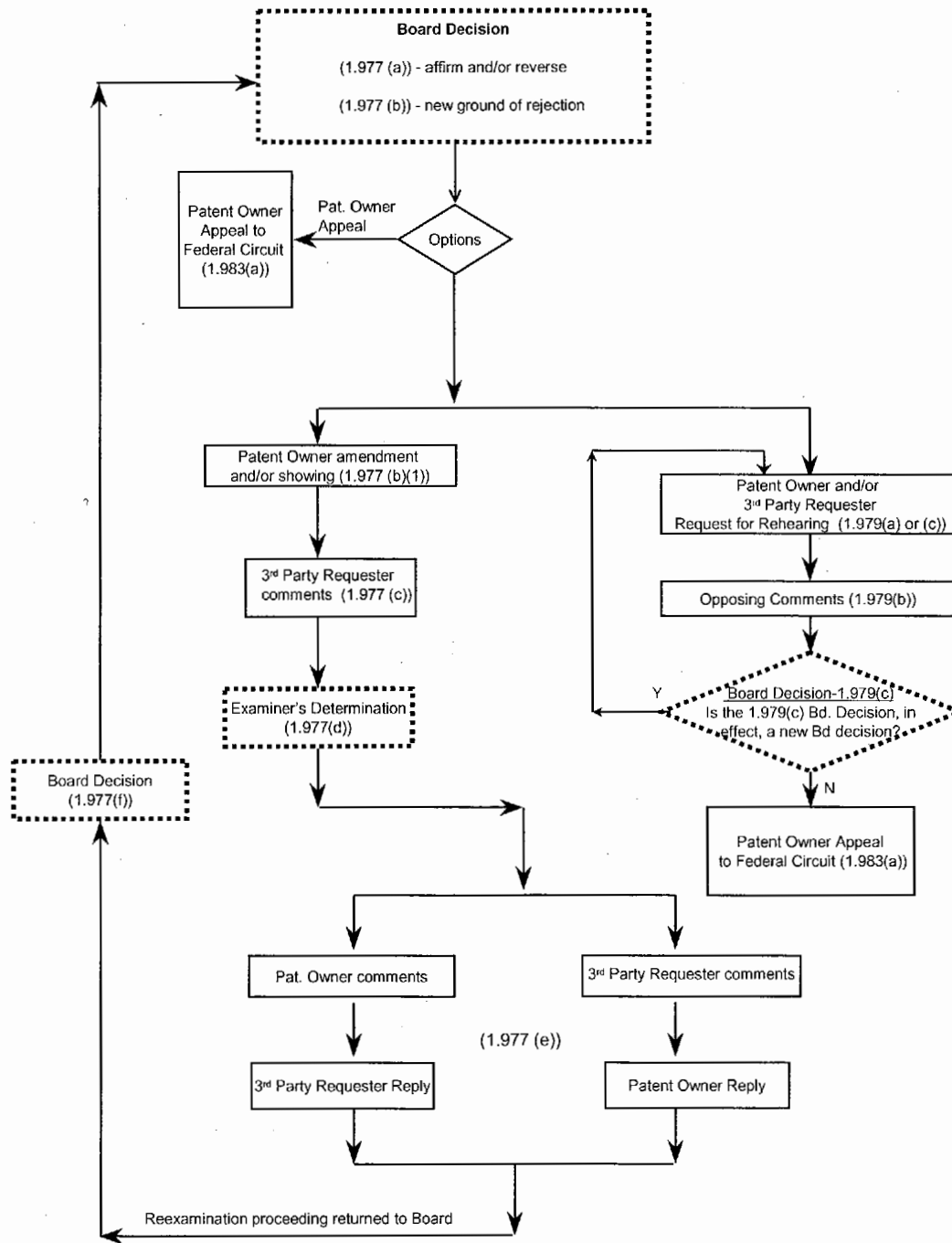

**Inter Partes Reexamination (applicable rule section)  
 Procedure Following Board Decision for Reexaminations  
 Commenced On or After November 2, 2002**

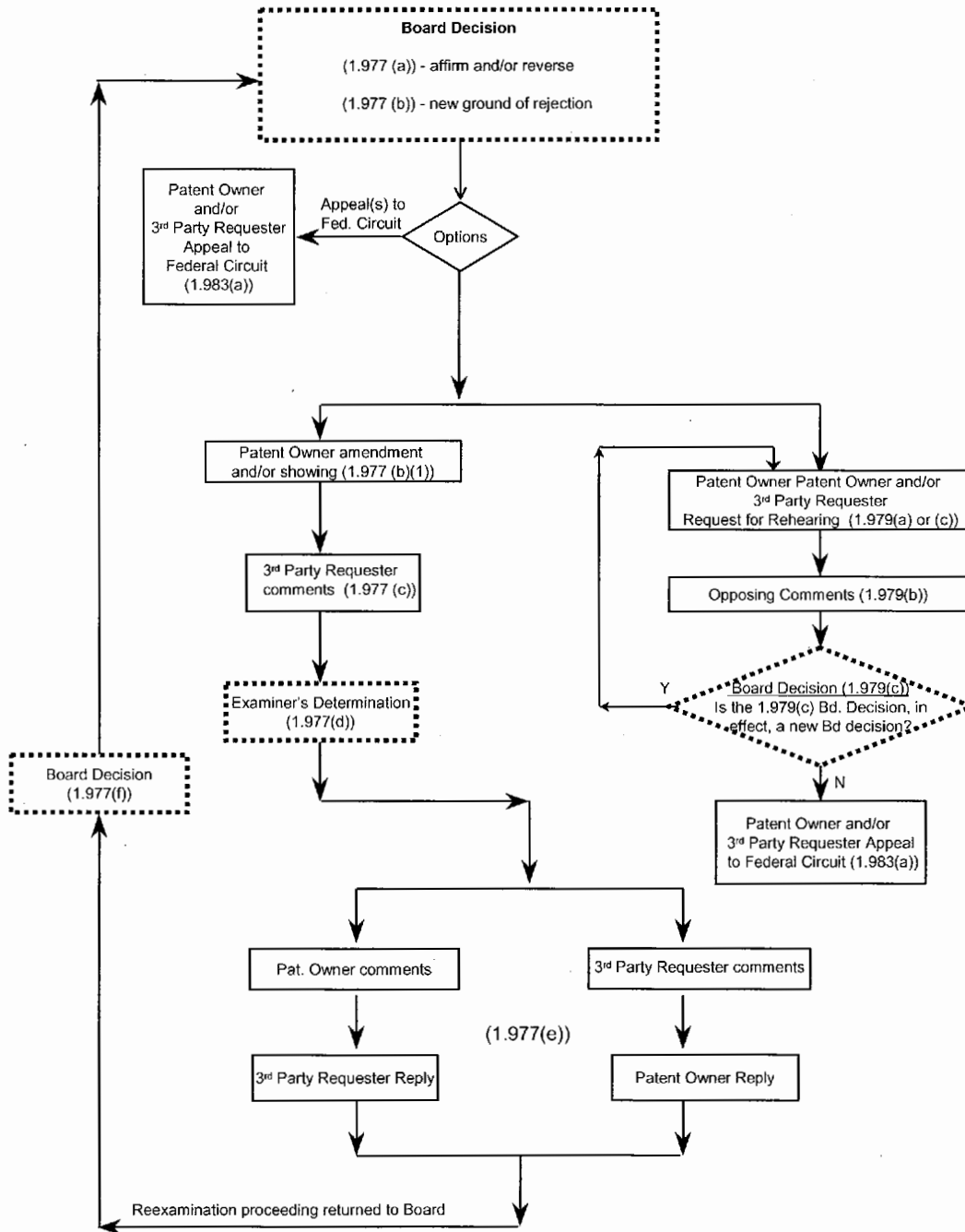

## 2602 Citation of Prior Art [Added R-2]

### 35 U.S.C. 301. Citation of prior art.

Any person at any time may cite to the Office in writing prior art consisting of patents or printed publications which that person believes to have a bearing on the patentability of any claim of a particular patent. If the person explains in writing the pertinency and manner of applying such prior art to at least one claim of the patent, the citation of such prior art and the explanation thereof will become a part of the official file of the patent. At the written request of the person citing the prior art, his or her identity will be excluded from the patent file and kept confidential.

### 37 CFR 1.501. Citation of prior art in patent files.

(a) At any time during the period of enforceability of a patent, any person may cite, to the Office in writing, prior art consisting of patents or printed publications which that person states to be pertinent and applicable to the patent and believes to have a bearing on the patentability of any claim of the patent. If the citation is made by the patent owner, the explanation of pertinency and applicability may include an explanation of how the claims differ from the prior art. Such citations shall be entered in the patent file except as set forth in §§ 1.502 and 1.902.

(b) If the person making the citation wishes his or her identity to be excluded from the patent file and kept confidential, the citation papers must be submitted without any identification of the person making the submission.

(c) Citation of patents or printed publications by the public in patent files should either: (1) Reflect that a copy of the same has been mailed to the patent owner at the address as provided for in § 1.33(c); or in the event service is not possible (2) Be filed with the Office in duplicate.

### 37 CFR 1.902. Processing of prior art citations during an *inter partes* reexamination proceeding.

Citations by the patent owner in accordance with § 1.933 and by an *inter partes* reexamination third party requester under § 1.915 or § 1.948 will be entered in the *inter partes* reexamination file. The entry in the patent file of other citations submitted after the date of an order for reexamination pursuant to § 1.931 by persons other than the patent owner, or the third party requester under either § 1.915 or § 1.948, will be delayed until the *inter partes* reexamination proceeding has been terminated. See § 1.502 for processing of prior art citations in patent and reexamination files during an *ex parte* reexamination proceeding filed under § 1.510.

Public Law 106-113 did not affect the manner of the public's citation of prior art under 37 CFR 1.501 in a patent. Likewise, it did not affect the Office's handling of a 37 CFR 1.501 prior art citation in a patent where no reexamination proceeding is pending for that patent when the citation is filed.

Where an *inter partes* reexamination proceeding is pending when a prior art citation is filed, the following applies:

If the prior art citation satisfies 37 CFR 1.501 and is submitted prior to an order to reexamine, the cited documents (citations) will be considered in an *inter partes* reexamination proceeding as a prior art citation would be considered in an *ex parte* reexamination proceeding. See MPEP § 2206.

If the prior art citation satisfies 37 CFR 1.501 and is submitted **after an order to reexamine**, the citation will be considered as follows:

(A) A patent owner citation will normally be considered if it is submitted in time to do so before the reexamination certificate issues.

(B) A third party requester citation will be considered if it is submitted as part of a third party requester comments submission under 37 CFR 1.947 or 1.951(b) (made as required by 37 CFR 1.948), or in a properly filed request for reexamination under 37 CFR 1.915 or 1.510.

(C) Any other prior art citation satisfying 37 CFR 1.501 which is submitted after an order to reexamine will be retained (stored) in the Technology Center (in which the reexamination proceeding is being examined) until the reexamination is terminated, after which it will be placed in the file of the patent. 37 CFR 1.902.

See MPEP §§ 2202 through 2206 and 2208 for the manner of making such citations and Office handling of same.

## 2609 *Inter Partes* Reexamination [Added R-2]

The *inter partes* reexamination statute and rules permit any third party requester to request *inter partes* reexamination of a patent which issued from an original application was filed on or after November 29, 1999, where the request contains certain elements (see 37 CFR 1.915(b)) and is accompanied by the fee required under 37 CFR 1.20(c)(2). The Office initially determines if "a substantial new question of patentability" (35 U.S.C. 312(a)) is presented. If such a new question has been presented, reexamination will be ordered. The reexamination proceedings which follow the order for reexamination are somewhat similar to regular examination procedures in patent applications; however, there are notable differences. For example, there are certain limitations as to the kind of rejections which may be made, a third party requester

may participate throughout the proceeding, there is an “action closing prosecution” and a “right of appeal notice” rather than a final rejection, special reexamination forms are to be used, and time periods are set to provide “special dispatch.” When the reexamination proceedings are terminated, an *inter partes* reexamination certificate is issued to indicate the status of all claims following the reexamination.

The basic characteristics of *inter partes* reexamination are as follows:

(A) Any third party requester can request *inter partes* reexamination at any time during the period of enforceability of the patent (for a patent issued from an original application filed on or after November 29, 1999);

(B) Prior art considered during reexamination is limited to prior patents or printed publications applied under the appropriate parts of 35 U.S.C. 102 and 103;

(C) A substantial new question of patentability must be present for reexamination to be ordered;

(D) If ordered, the actual reexamination proceeding is essentially *inter partes* in nature;

(E) Decision on the request must be made not later than *three months* from its filing date, and the remainder of proceedings must proceed with “special dispatch” within the Office;

(F) If ordered, a reexamination proceeding will normally be conducted to its conclusion and the issuance of an *inter partes* reexamination certificate;

(G) The scope of the patent claims cannot be enlarged by amendment;

(H) Reexamination and patent files are open to the public, but see paragraph (I) below;

(I) The reexamination file is scanned to provide an electronic copy of the file. All public access to and copying of reexamination proceedings may be had from the electronic copy. The paper file is not available to the public.

## 2610 Request for *Inter Partes* Reexamination [Added R-2]

### 35 U.S.C. 311. Request for *inter partes* reexamination

(a) IN GENERAL.— Any third-party requester at any time may file a request for *inter partes* reexamination by the Office of a patent on the basis of any prior art cited under the provisions of section 301.

(b) REQUIREMENTS.— The request shall—

(1) be in writing, include the identity of the real party in interest, and be accompanied by payment of an *inter partes* reexamination fee established by the Director under section 41; and

(2) set forth the pertinency and manner of applying cited prior art to every claim for which reexamination is requested.

(c) COPY.— The Director promptly shall send a copy of the request to the owner of record of the patent.

### 37 CFR 1.913. Persons eligible to file request for *inter partes* reexamination.

Except as provided for in § 1.907, any person other than the patent owner or its privies may, at any time during the period of enforceability of a patent which issued from an original application filed in the United States on or after November 29, 1999, file a request for *inter partes* reexamination by the Office of any claim of the patent on the basis of prior art patents or printed publications cited under § 1.501.

### 37 CFR 1.915. Content of request for *inter partes* reexamination.

(a) The request must be accompanied by the fee for requesting *inter partes* reexamination set forth in § 1.20(c)(2).

(b) A request for *inter partes* reexamination must include the following parts:

(1) An identification of the patent by patent number and every claim for which reexamination is requested.

(2) A citation of the patents and printed publications which are presented to provide a substantial new question of patentability.

(3) A statement pointing out each substantial new question of patentability based on the cited patents and printed publications, and a detailed explanation of the pertinency and manner of applying the patents and printed publications to every claim for which reexamination is requested.

(4) A copy of every patent or printed publication relied upon or referred to in paragraphs (b)(1) through (3) of this section, accompanied by an English language translation of all the necessary and pertinent parts of any non-English language document.

(5) A copy of the entire patent including the front face, drawings, and specification/claims (in double column format) for which reexamination is requested, and a copy of any disclaimer, certificate of correction, or reexamination certificate issued in the patent. All copies must have each page plainly written on only one side of a sheet of paper.

(6) A certification by the third party requester that a copy of the request has been served in its entirety on the patent owner at the address provided for in § 1.33(c). The name and address of the party served must be indicated. If service was not possible, a duplicate copy of the request must be supplied to the Office.

(7) A certification by the third party requester that the estoppel provisions of § 1.907 do not prohibit the *inter partes* reexamination.

(8) A statement identifying the real party in interest to the extent necessary for a subsequent person filing an *inter partes* reexamination request to determine whether that person is a privy.

(c) If an *inter partes* request is filed by an attorney or agent identifying another party on whose behalf the request is being

filed, the attorney or agent must have a power of attorney from that party or be acting in a representative capacity pursuant to § 1.34(a).

(d) If the *inter partes* request does not meet all the requirements of subsection 1.915(b), the person identified as requesting *inter partes* reexamination may be so notified and given an opportunity to complete the formal requirements of the request within a specified time. Failure to comply with the notice may result in the *inter partes* reexamination proceeding being vacated.

Any third-party requester, at any time during the period of enforceability of a **patent issued from an original application filed on or after November 29, 1999**, may file a request for an *inter partes* reexamination by the Office of any claim of the patent based on prior patents or printed publications. (Note: “original application” is defined in MPEP § 2611.)

The request must include the elements set forth in 37 CFR 1.915(b) (see MPEP § 2614) and must be accompanied by the fee as set forth in 37 CFR 1.20(c)(2). See MPEP § 2612 for situations where a party may be barred from filing a request for *inter partes* reexamination.

After the request for *inter partes* reexamination, including the entire fee for requesting reexamination, is received in the Office, no abandonment, withdrawal, or striking, of the request is possible, regardless of who requests the same. In some limited circumstances, such as after a final court decision where all of the claims are held invalid, a reexamination order may be vacated. See MPEP § 2686.04.

## 2611 Time for Requesting *Inter Partes* Reexamination [Added R-2]

An *inter partes* reexamination can be filed for a patent issued from an original application filed on or after November 29, 1999. For a patent which issued from an original application filed prior to November 29, 1999, the statutory *inter partes* reexamination option is **not available**, only the *ex parte* reexamination is available. See Chapter 2200, section 2209 *et seq.* as to *ex parte* reexamination.

Public Law 106-113, see section 4608 of S.1948, states the effective date and applicability of the Optional *Inter Partes* Reexamination Procedure established by Subtitle F of the Act. Specifically, Section 4608 states that the changes in Subtitle F... “shall take effect on the date of enactment of this Act and shall apply to any patent that issues from an original application filed in the United States on or after that

date.” The phrase “original application” is interpreted to encompass utility, plant and design applications, including first filed applications, continuations, divisionals, continuations-in-part, continued prosecution applications (CPAs) and the national stage phase of international applications. This interpretation is consistent with the use of the phrase in 35 U.S.C. 251 and the federal rules pertaining to reexamination. In addition, MPEP § 201.04(a) defines an original application as “... an application which is not a reissue application.” MPEP § 201.04(a) further states that “[a]n original application may be a first filing or a continuing application”. Therefore, the optional *inter partes* reexamination is available to patents which issued from all applications (except for reissues) filed on or after November 29, 1999. A patent which issued from an application filed prior to November 29, 1999, in which a request for continued examination (RCE) under 37 CFR 1.114 was filed on or after May 29, 2000, however, is not eligible for optional *inter partes* reexamination. An RCE is not considered a filing of an original application; rather it is a continuation of the prosecution of the application in which it is filed. See 35 U.S.C. 132(b), 37 CFR 1.114 and MPEP § 706.07(h).

Under 37 CFR 1.913, any third-party requester may, during the period of enforceability of a patent, file a request for *inter partes* reexamination. This period of enforceability was set by rule since no useful purpose was seen for expending Office resources on deciding patent validity questions in patents which cannot be enforced. In this regard, see *Patlex Corporation v. Mossinghoff*, 758 F.2d 594, 225 USPQ 243, 249 (Fed. Cir. 1985). The period of enforceability is determined by adding 6 years to the date on which the patent expires. The patent expiration date for a utility patent, for example, is determined by taking into account the term of the patent, whether maintenance fees have been paid for the patent, whether any disclaimer was filed as to the patent to shorten its term, any patent term extensions or adjustments for delays within the Office under 35 U.S.C. 154 (see MPEP § 2710, *et seq.*), and any patent term extensions available under 35 U.S.C. 156 for premarket regulatory review (see MPEP § 2750 *et seq.*). Any other relevant information should also be taken into account. In addition, if litigation is instituted within the period of the statute of limitations, requests for *inter partes*

reexamination may be filed after the statute of limitations has expired, as long as the patent is still enforceable against someone.

## 2612 Persons Who May File a Request [Added R-2]

*37 CFR 1.913. Persons eligible to file request for inter partes reexamination.*

Except as provided for in § 1.907, any person other than the patent owner or its privies may, at any time during the period of enforceability of a patent which issued from an original application filed in the United States on or after November 29, 1999, file a request for *inter partes* reexamination by the Office of any claim of the patent on the basis of prior art patents or printed publications cited under § 1.501.

*37 CFR 1.907. Inter partes reexamination prohibited.*

(a) Once an order to reexamine has been issued under § 1.931, neither the third party requester, nor its privies, may file a subsequent request for *inter partes* reexamination of the patent until an *inter partes* reexamination certificate is issued under § 1.997, unless authorized by the Director.

(b) Once a final decision has been entered against a party in a civil action arising in whole or in part under 28 U.S.C. 1338 that the party has not sustained its burden of proving invalidity of any patent claim-in-suit, then neither that party nor its privies may thereafter request *inter partes* reexamination of any such patent claim on the basis of issues which that party, or its privies, raised or could have raised in such civil action, and an *inter partes* reexamination requested by that party, or its privies, on the basis of such issues may not thereafter be maintained by the Office.

(c) If a final decision in an *inter partes* reexamination proceeding instituted by a third party requester is favorable to patentability of any original, proposed amended, or new claims of the patent, then neither that party nor its privies may thereafter request *inter partes* reexamination of any such patent claims on the basis of issues which that party, or its privies, raised or could have raised in such *inter partes* reexamination proceeding.

As stated in 37 CFR 1.913, except as provided in 37 CFR 1.907, any person other than the patent owner may file a request for *inter partes* reexamination of a patent. The patent owner is precluded from initiating an *inter partes* reexamination of its patent because 35 U.S.C. 311(a)(as technically corrected by Section 13202 of Public Law 107-273) provides that “[a]ny third party requester at any time may file a request for *inter partes* reexamination by the Office of a patent on the basis of any prior art cited under the provisions of section 301.” *Ex parte* reexamination (see Chapter 2200) and reissue (see Chapter 1400) are available to the patent owner to have its patent reviewed.

37 CFR 1.907 defines specific situations where a third party is prohibited from filing a request for an *inter partes* reexamination. 37 CFR 1.915(b)(7) requires the third party requester to certify that the estoppel provisions of 37 CFR 1.907 do not prohibit the filing of the *inter partes* reexamination request. The certification identified in 37 CFR 1.915(7) will constitute a *prima facie* showing that the party requesting the *inter partes* reexamination is not barred from doing so under 37 CFR 1.907. The Office does not intend to look beyond this required certification. It is only in the rare instance where a challenge to the accuracy of the certification is raised by the patent owner, that the question would then need to be addressed.

Some of the persons likely to use *inter partes* reexamination are: licensees, potential licensees, infringers, potential exporters, patent litigants, interference applicants, and International Trade Commission respondents. The name of the person who files the request will not be maintained in confidence, and pursuant to 37 CFR 1.915(b)(8), the filing of the request must include a “statement identifying the real party in interest to the extent necessary for a subsequent person filing an *inter partes* reexamination request to determine whether that person is a privy.”

## 2613 Representative of Requester [Added R-2]

*37 CFR 1.915. Content of request for inter partes reexamination.*

\*\*\*\*\*

(c) If an *inter partes* request is filed by an attorney or agent identifying another party on whose behalf the request is being filed, the attorney or agent must have a power of attorney from that party or be acting in a representative capacity pursuant to § 1.34(a).

Where an attorney or agent files a request for an *inter partes* reexamination for an identified client (the third party requester), he or she may act under a power of attorney from the client or may act in a representative capacity under 37 CFR 1.34(a). See 37 CFR 1.915(c). While the filing of the power of attorney is desirable, processing of the reexamination request will not be delayed due to its absence.

If any question of authority to act is raised, proof of authority may be required by the Office.



All correspondence for a third party requester should be addressed to the representative of the requester, unless a specific indication is made to forward correspondence to another address.

A third party requester may not be represented during a reexamination proceeding by an attorney or other person who is not registered to practice before the Office.

## 2614 Content of Request for *Inter Partes* Reexamination [Added R-2]

37 CFR 1.915. Content of request for *inter partes* reexamination.

(a) The request must be accompanied by the fee for requesting *inter partes* reexamination set forth in § 1.20(c)(2).

(b) A request for *inter partes* reexamination must include the following parts:

(1) An identification of the patent by patent number and every claim for which reexamination is requested.

(2) A citation of the patents and printed publications which are presented to provide a substantial new question of patentability.

(3) A statement pointing out each substantial new question of patentability based on the cited patents and printed publications, and a detailed explanation of the pertinency and manner of applying the patents and printed publications to every claim for which reexamination is requested.

(4) A copy of every patent or printed publication relied upon or referred to in paragraphs (b)(1) through (3) of this section, accompanied by an English language translation of all the necessary and pertinent parts of any non-English language document.

(5) A copy of the entire patent including the front face, drawings, and specification/claims (in double column format) for which reexamination is requested, and a copy of any disclaimer, certificate of correction, or reexamination certificate issued in the patent. All copies must have each page plainly written on only one side of a sheet of paper.

(6) A certification by the third party requester that a copy of the request has been served in its entirety on the patent owner at the address provided for in § 1.33(c). The name and address of the party served must be indicated. If service was not possible, a duplicate copy of the request must be supplied to the Office.

(7) A certification by the third party requester that the estoppel provisions of § 1.907 do not prohibit the *inter partes* reexamination.

(8) A statement identifying the real party in interest to the extent necessary for a subsequent person filing an *inter partes* reexamination request to determine whether that person is a privy.

(c) If an *inter partes* request is filed by an attorney or agent identifying another party on whose behalf the request is being filed, the attorney or agent must have a power of attorney from that party or be acting in a representative capacity pursuant to § 1.34(a).

(d) If the *inter partes* request does not meet all the requirements of subsection 1.915(b), the person identified as requesting *inter partes* reexamination may be so notified and given an opportunity to complete the formal requirements of the request within a specified time. Failure to comply with the notice may result in the *inter partes* reexamination proceeding being vacated.

### I. FEE FOR REQUEST FOR *INTER PARTES* REEXAMINATION

37 CFR 1.915(a) requires the payment of a fee specified in 37 CFR 1.20(c)(2). See MPEP § 2615 for a discussion of the fee to be paid.

### II. REQUIRED ELEMENTS OF REQUEST FOR *INTER PARTES* REEXAMINATION

37 CFR 1.915(b) sets forth the required elements of a request for *inter partes* reexamination. The elements are as follows:

“(1) An identification of the patent by patent number and every claim for which reexamination is requested.”

The request should identify the patent by stating the patent number. Although not required by rule, it is strongly suggested that the request should also state the patentee and the title of the patent, so that they are available for comparison, in the event there is an error in the typing of the patent number. The patentee who would be stated is the first named inventor on the patent.

The request should clearly identify every claim that requester wants reexamined.

“(2) A citation of the patents and printed publications which are presented to provide a substantial new question of patentability.”

The patents and printed publications which are presented in the request to provide a substantial new question of patentability must be listed. A form PTO-1449, or its equivalent, should be provided by the requester as part of the request, and all the art (patents and printed publications) cited would be listed thereon.

“(3) A statement pointing out each substantial new question of patentability based on the cited patents and printed publications, and a detailed explanation of the pertinency and manner of applying the patents and printed publications to every claim for which reexamination is requested.”

The request must assert a substantial new question of patentability. A statement which clearly points out what the requester considers to be the substantial new question of patentability which would warrant a reexamination should be included. The statement should apply the cited art (patents and printed publications) to each claim that requester wants reexamined based on prior patents and printed publications. See also MPEP § 2616 and § 2617.

“(4) A copy of every patent or printed publication relied upon or referred to in paragraphs (b)(1) through (3) of this section, accompanied by an English language translation of all the necessary and pertinent parts of any non-English language document.”

A copy of each cited patent or printed publication, as well as a translation of each non-English document (or a translation of at least the portion(s) relied upon), is required so that all materials will be available to the examiner for full consideration. See MPEP § 2618.

“(5) A copy of the entire patent including the front face, drawings, and specification/claims (in double column format) for which reexamination is requested, and a copy of any disclaimer, certificate of correction, or reexamination certificate issued in the patent. All copies must have each page plainly written on only one side of a sheet of paper.”

A copy of the patent, for which reexamination is requested, should be provided with the specification and claims submitted in a **double** column format. The drawing pages of the printed patent should be presented as they appear in the printed patent; the same is true for the front page of the patent. Thus, a full copy of the printed patent (including the front page) can be used to provide the abstract, drawings, specification, and claims of the patent for the reexamination request. The printed patent is to be reproduced on only one side of the paper; a two-sided copy of the patent is not proper.

A copy of any prior disclaimer, certificate of correction, or reexamination certificate issued for the patent should also be included with the request; since these are a part of the patent. Again, the copy must have each page plainly written on only one side of a sheet of paper. See also MPEP § 2619.

“(6) A certification by the third party requester that a copy of the request has been served in its entirety on the patent owner at the address provided for in § 1.33(c). The name and address of the party served must be indicated. If service was not possible, a duplicate copy of the request must be supplied to the Office.”

The request must include a certification that a copy of the request papers has been served on the patent owner. The certification must set forth the name and address employed in serving patent owner. If service was not possible, a duplicate copy of the request must be supplied to the Office.

“(7) A certification by the third party requester that the estoppel provisions of § 1.907 do not prohibit the *inter partes* reexamination.”

The third party requester must make the certification required by 37 CFR 1.915(b)(7) in order to certify that the requester is not precluded from filing the request for reexamination by: 37 CFR 1.907 and the statute upon which those rules are based (35 U.S.C. 317). See MPEP § 2612.

“(8) A statement identifying the real party in interest to the extent necessary for a subsequent person filing an *inter partes* reexamination request to determine whether that person is a privy.”

The reexamination request must identify the real party in interest who is responsible for filing the reexamination request. This information will be used by future parties requesting reexamination of the same patent, in making the certifications required by 37 CFR 1.915(b)(8).

The request should be as complete as possible, since there is no guarantee that the examiner will consider other art (patents and printed publications) when making the decision on the request.

Form PTO/SB/58, reproduced following this page, is encouraged for use as the transmittal form and cover sheet of a request for *inter partes* reexamination. The use of this form is encouraged; however, its use is not a requirement of the law nor of the rules. Following the Form PTO/SB/58, is a sample of a statement on which the request for *inter partes* reexamination is based, which statement would be attached to the Form PTO/SB/58 cover sheet (that would be filled out by requester).

Under the Paperwork Reduction Act of 1995, no persons are required to respond to a collection of information unless it displays a valid OMB control number.

(Also referred to as FORM PTO-1465)

**REQUEST FOR INTER PARTES REEXAMINATION TRANSMITTAL FORM**

Address to:

**Mail Stop *Inter Partes* Reexam  
Commissioner for Patents  
P. O. Box 1450  
Alexandria, VA 22313-1450**

Attorney Docket No.

Date:

1.  This is a request for *inter partes* reexamination pursuant to 37 CFR 1.913 of patent number \_\_\_\_\_ issued \_\_\_\_\_. The request is made by a third party requester, identified herein below.
2.  a. The name and address of the person requesting reexamination is:  
\_\_\_\_\_  
\_\_\_\_\_  
\_\_\_\_\_
- b. The real party in interest (37 CFR 1.915(b)(8)) is: \_\_\_\_\_
3.  a. A check in the amount of \$ \_\_\_\_\_ is enclosed to cover the reexamination fee, 37 CFR 1.20(c)(2);
- b. The Director is hereby authorized to charge the fee as set forth in 37 CFR 1.20(c)(2) to Deposit Account No. \_\_\_\_\_ (submit duplicate of this form for fee processing); or
- c. Payment by credit card. Form PTO-2038 is attached.
4.  Any refund should be made by  check or  credit to Deposit Account No. \_\_\_\_\_.  
37 CFR 1.26(c). If payment is made by credit card, refund must be made to credit card account.
5.  A copy of the patent to be reexamined having a double column format on one side of a separate paper is enclosed. 37 CFR 1.915(b)(5)
6.  CD-ROM or CD-R in duplicate, Computer Program (Appendix) or large table
7.  Nucleotide and/or Amino Acid Sequence Submission  
*If applicable, all of the following are necessary*
- a.  Computer Readable Form (CRF)
- b. Specification Sequence Listing on:  
i  CD-ROM (2 copies) or CD-R (2 copies); or  
ii  paper
- c.  Statements verifying identity of above copies
8.  A copy of any disclaimer, certificate of correction or reexamination certificate issued in the patent is included.
9.  Reexamination of claim(s) \_\_\_\_\_ is requested.
10.  A copy of every patent or printed publication relied upon is submitted herewith including a listing thereof on Form PTO-1449 or equivalent.
11.  An English language translation of all necessary and pertinent non-English language patents and/or printed publications is included.

[Page 1 of 2]

This collection of information is required by 37 CFR 1.915. The information is required to obtain or retain a benefit by the public which is to file (and by the USPTO to process) an application. Confidentiality is governed by 35 U.S.C. 122 and 37 CFR 1.14. This collection is estimated to take 2 hours to complete, including gathering, preparing, and submitting the completed application form to the USPTO. Time will vary depending upon the individual case. Any comments on the amount of time you require to complete this form and/or suggestions for reducing this burden, should be sent to the Chief Information Officer, U.S. Patent and Trademark Office, U.S. Department of Commerce, P.O. Box 1450, Alexandria, VA 22313-1450. DO NOT SEND FEES OR COMPLETED FORMS TO THIS ADDRESS. SEND TO: **Mail Stop *Inter Partes* Reexam, Commissioner for Patents, P.O. Box 1450, Alexandria, VA 22313-1450.**

If you need assistance in completing the form, call 1-800-PTO-9199 and select option 2.

OPTIONAL INTER PARTES REEXAMINATION

2614

PTO/SB/58 (04-04)  
 Approved for use through 4/30/2007. OMB 0651-0033  
 U.S. Patent and Trademark Office; U.S. DEPARTMENT OF COMMERCE

Under the Paperwork Reduction Act of 1995, no persons are required to respond to a collection of information unless it displays a valid OMB control number.

12.  The attached detailed request includes at least the following items:

- a. A statement identifying each substantial new question of patentability based on prior patents and printed publications. 37 CFR 1.915(b)(3)
- b. An identification of every claim for which reexamination is requested, and a detailed explanation of the pertinency and manner of applying the cited art to every claim for which reexamination is requested. 37 CFR 1.915(b)(1) and (3)

13.  It is certified that the estoppel provisions of 37 CFR 1.907 do not prohibit this reexamination. 37 CFR 1.915(b)(7)

14.  a. It is certified that a copy of this request has been served in its entirety on the patent owner as provided in 37 CFR 1.33(c).  
 The name and address of the party served and the date of service are:

\_\_\_\_\_

\_\_\_\_\_

\_\_\_\_\_

Date of Service: \_\_\_\_\_; or

b. A duplicate copy is enclosed since service on patent owner was not possible.

15. Correspondence Address: Direct all communications about the application to:

Customer Number:

**OR**

<input type="checkbox"/> Firm or Individual Name			
Address (line 1)			
Address (line 2)			
City	State	Zip	
Country			
Telephone	Fax		

16.  The patent is currently the subject of the following concurrent proceeding(s):

- a. Copending reissue Application No. \_\_\_\_\_
- b. Copending reexamination Control No. \_\_\_\_\_
- c. Copending Interference No. \_\_\_\_\_
- d. Copending litigation styled: \_\_\_\_\_

\_\_\_\_\_

\_\_\_\_\_

**WARNING: Information on this form may become public. Credit card information should not be included on this form. Provide credit card information and authorization on PTO-2038.**

\_\_\_\_\_  
*Authorized Signature For Third Party Requester*

\_\_\_\_\_  
*Date*

\_\_\_\_\_  
*Typed/Printed Name*

\_\_\_\_\_  
*Registration Number, if applicable*

Attachment to Request for  
*Inter Partes* Reexamination Transmittal Form,  
providing information  
as to Patent No. 9,999,999

Sir:

*Inter Partes* reexamination under 35 U.S.C. 311-318 and 37 CFR 1.913 is requested of United States patent number 9,999,999 which issued on July 7, 2001, to Joseph Smith from an application filed November 29, 1999. This patent is still enforceable.

A: Claims for which reexamination is requested.

- Reexamination is requested of claims 1-3 of the Smith patent in view of the earlier United States Patent 594,225 to Berridge which is listed on the attached Information Disclosure form and of which a copy is enclosed.

-Reexamination is also requested of claim 4 of the Smith patent in view of the earlier Swiss Patent 80,555 to Hotopp in view of the disclosure in "American Machinist" magazine, October 16, 1950, issue, on page 169. An English translation of the (German language) Swiss document is enclosed. Copies of the Hotopp and "American Machinist" documents are also enclosed.

B: Explanation of pertinency and manner of applying cited prior art to every claim for which reexamination is requested.

Claims 1-3 of the Smith patent are considered to be fully anticipated under 35 U.S.C. 102 by the prior art patent to Berridge.

Claim 3 of the Smith patent, which is more specific than claims 1 and 2 in all features, is set forth below with an explanation as to how the prior art patent to Berridge meets all the recited feature.

Smith, claim 3:

"In a cutting and crimping tool"

(Berridge page 1, lines 10-13 states his invention is "an improved tool for crimping metal which in preferred form of embodiment is combined with a cutting-tool or shears, forming therewith a combination-tool".)

"the combination with the cutting blades"

(elements 4 and 5 in Berridge)

"and their pivoted handles"

(elements 1 and 2 in Berridge)

“of bosses arranged at an angle to and offset from the plane of the shear blades”

(“bosses” as used in the Smith claim is used to mean a projection. The dies 6 and 7 of the Berridge prior art patent document are arranged at the same angle to the plane of the shear blades and are arranged at an angle in the same manner as shown in the drawing figures of the Smith patent.)

“and crimping dies formed meeting faces of said bosses”

(The dies 6 and 7 (bosses) of Berridge have meeting die-faces 12 and 13 (page 1, line 63) for performing crimping operations (page 1, lines 70-74).)

Claim 4 of the Smith patent is considered to be unpatentable under 35 U.S.C. 103 in view of the prior art Swiss patent document to Hotopp and further in view of the prior art magazine publication on page 169 of the October 16, 1950, issue of American Machinist magazine.

Claim 4 of Smith reads as quoted below:

“In a cutting and crimping tool,”

(The prior art Swiss patent document to Hotopp discloses cutting jaws (column 1, line 8) and dies “b” and “c” which may be used for crimping.)

“the combination of a pair of pivoted handles”

(elements “a” and “e” in the prior art document to Hotopp.)

“with cutting jaws at one end and crimping dies on the opposite side of the pivot”

(The prior art document to Hotopp discloses cutting jaws (column 1 line 8) and crimping dies “b” and “c” on the opposite side of pivot “d” from the cutting jaws.)

“and rounded prongs projecting from said cutting jaws”

(Rounded prongs are not specifically disclosed by Hotopp but are shown to be old in the art by the illustration in “American Machinist” magazine under the title “Double-Purpose Pliers Don’t Break Insulation”. To provide the cutting jaws of Hotopp with rounded prongs as shown in the “American Machinist” magazine is considered to be a matter which would have been obvious to a person having ordinary skill in the art at the time the invention was made.)

C: Statement pointing out substantial new question of patentability:

The prior art documents referred to above were not of record in the file of the Smith patent. Since claims 1-4 in the Smith patent are not patentable over these prior art documents, a substantial new question of patentability is raised. Further, these prior art documents are closer to the subject matter of Smith than any prior art which was cited during the prosecution of the Smith patent. These prior art documents provide teachings not provided during the prosecution of the Smith patent.

(Signed)  
 Kenneth M. Schor  
 Attorney for Requester  
 Reg. No. 29760

## 2615 Fee for Requesting *Inter Partes* Reexamination [Added R-2]

37 CFR 1.915. *Content of request for inter partes reexamination.*

(a) The request must be accompanied by the fee for requesting *inter partes* reexamination set forth in § 1.20(c)(2).

\*\*\*\*\*

37 CFR 1.919. *Filing date of request for inter partes reexamination.*

(a) The filing date of a request for *inter partes* reexamination is the date on which the request satisfies the fee requirement of § 1.915(a).

(b) If the request is not granted a filing date, the request will be placed in the patent file as a citation of prior art if it complies with the requirements of § 1.501.

In order for a request to be accepted, given a filing date, and published in the *Official Gazette*, it is necessary to have paid the fee required under 37 CFR 1.20(c)(2) for filing a request for *inter partes* reexamination. If the entire filing fee is not paid, the request will be considered to be incomplete.

If the entire fee for requesting reexamination has not been paid after requester has been given an opportunity to do so, no determination on the request will be made. The request papers will ordinarily be placed in the patent file as a prior art citation if they comply with the requirements of 37 CFR 1.501. See MPEP § 2206 for handling of prior art citations.

If the request for reexamination is denied or vacated, a refund in accordance with 37 CFR 1.26(c) will be made to the identified requester. See 37 CFR 1.925.

See MPEP § 2634 for processing of the filing fee.

## 2616 Substantial New Question of Patentability [Added R-2]

Under 35 U.S.C. 312 and 313, the Office must determine whether “a substantial new question of patentability” affecting any claim of the patent has been raised. 37 CFR 1.915(b)(3) requires that the request include “a statement pointing out each substantial new question of patentability based on the cited patents and printed publications....” Accordingly, it is extremely important that the request clearly set forth in detail exactly what the third party requester considers the “substantial new question of patentability” to

be. The request should point out how any questions of patentability raised are substantially different from those raised in the previous examination of the patent before the Office. If a substantial new question of patentability is found as to one claim, all claims will be reexamined during the reexamination process. See also MPEP § 2642.

Questions relating to grounds of rejection other than those based on prior art patents or printed publications should not be included in the request and will not be considered by the examiner if included. Examples of such questions that will not be considered are questions as to public use, on sale, fraud, and compliance of the claims with 35 U.S.C. 112.

Affidavits or declarations which explain the contents or pertinent dates of prior art patents or printed publications in more detail may be considered in reexamination. See MPEP § 2258.

See MPEP § 2617 for a discussion of the statement in the request which applies the prior art patents or printed publications (the art) to establish the substantial new question(s) of patentability upon which the request for reexamination is based.

## 2617 Statement in the Request Applying Prior Art [Added R-2]

35 U.S.C. 311(b)(2) states that the request for *inter partes* reexamination must “set forth the pertinency and manner of applying cited prior art to every claim for which reexamination is requested.” 37 CFR 1.915(b)(3) requires that the request include “[a] statement pointing out each substantial new question of patentability based on the cited patents and printed publications, and a detailed explanation of the pertinency and manner of applying the patents and printed publications to every claim for which reexamination is requested.”

The prior art applied may only consist of prior art patents or printed publications. Substantial new questions of patentability may be based upon the following portions of 35 U.S.C. 102:

35 U.S.C. 102. *Conditions for patentability; novelty and loss of right to patent.*

A person shall be entitled to a patent unless —

(a) the invention was known or used by others in this country, or patented or described in a printed publication in this or a foreign country, before the invention thereof by the applicant for patent, or

(b) the invention was patented or described in a printed publication in this or a foreign country or in public use or on sale in this country, more than one year prior to the date of the application for patent in the United States, or

\*\*\*\*\*

(d) the invention was first patented or caused to be patented, or was the subject of an inventor's certificate, by the applicant or his legal representatives or assigns in a foreign country prior to the date of the application for patent in this country on an application for patent or inventor's certificate filed more than twelve months before the filing of the application in the United States, or

(e) the invention was described in — (1) an application for patent, published under section 122(b), by another filed in the United States before the invention by the applicant for patent or (2) a patent granted on an application for patent by another filed in the United States before the invention by the applicant for patent, except that an international application filed under the treaty defined in section 351(a) shall have the effects for the purposes of this subsection of an application filed in the United States only if the international application designated the United States and was published under Article 21(2) of such treaty in the English language; or

(f) he did not himself invent the subject matter sought to be patented, or

(g)(1) during the course of an interference conducted under section 135 or section 291, another inventor involved therein establishes, to the extent permitted in section 104, that before such person's invention thereof the invention was made by such other inventor and not abandoned, suppressed, or concealed, or (2) before such person's invention thereof, the invention was made in this country by another inventor who had not abandoned, suppressed, or concealed it. In determining priority of invention under this subsection, there shall be considered not only the respective dates of conception and reduction to practice of the invention, but also the reasonable diligence of one who was first to conceive and last to reduce to practice, from a time prior to conception by the other.

Similarly, substantial new questions of patentability may also be made under 35 U.S.C. 103 which are based on the above-indicated portions of 35 U.S.C. 102. See also Chapter 2100.

Substantial new questions of patentability must be based on prior art patents or printed publications. Other matters, such as public use or sale, inventorship, 35 U.S.C. 101, 35 U.S.C. 112, fraud, etc., will not be considered when making the determination on the request and should not be presented in the request. Further, a prior art patent or printed publication cannot be properly applied as a ground for reexamination if it is merely used as evidence of alleged prior public use or on sale. The prior art patent or printed publication must be applied directly to claims under 35 U.S.C. 103 and/or an appropriate portion of 35 U.S.C.

102 or relate to the application of other prior art patents or printed publications to claims on such grounds.

The statement applying the prior art may, where appropriate, point out that claims in the patent for which reexamination is requested are entitled only to the filing date of that patent and are not supported by an earlier foreign or United States patent application whose filing date is claimed. For example, even where a patent is a continuing application under 35 U.S.C. 120, the effective date of some of the claims could be the filing date of the child application which resulted in the patent, because those claims were not supported in the parent application. Therefore, any intervening patents or printed publications would be available as prior art. See *In re Ruschetta*, 255 F.2d 687, 118 USPQ 101 (CCPA 1958), *In re van Langenhoven*, 458 F.2d 132, 173 USPQ 426 (CCPA 1972). See also MPEP § 201.11.

Double patenting is normally proper for consideration in reexamination. See *In re Lonardo*, 119 F.3d 960, 43 USPQ2d 1262 (Fed. Cir. 1997). See also the discussion as to double patenting in MPEP § 2258.

The mere citation of new patents or printed publications without an explanation does not comply with 37 CFR 1.915(b)(3). Requester should present *an explanation of how* the cited patents or printed publications are *applied* to all claims which the requester considers to merit reexamination based on patents or printed publications. This not only sets forth the requester's position to the Office, but also to the patent owner.

Affidavits or declarations which explain the contents or pertinent dates of prior art patents or printed publications in more detail may be considered in any reexamination. See MPEP § 2258.

## ADMISSIONS

The consideration under 35 U.S.C. 312 of a request for reexamination is limited to prior art patents and printed publications. See *Ex parte McGaughey*, 6 USPQ2d 1334, 1337 (Bd. Pat. App. & Inter. 1988). An admission by the patent owner of record in the file or in a court record may be utilized in combination with a patent or printed publication, for establishing a substantial new question of patentability. An admission, *per se*, may not be the basis for establishing a substantial new question of patentability.



For handling of admissions during the examination stage of a reexamination proceeding (i.e., after reexamination has been ordered), see MPEP § 2258.

The admission can reside in the patent file (made of record during the prosecution of the patent application) or may be presented during the pendency of the reexamination proceeding or in litigation. Admissions by the patent owner as to any matter affecting patentability may be utilized to determine the scope and content of the prior art **in conjunction with patents and printed publications**, whether such admissions are found in patents or printed publications or in some other source. An admission relating to any prior art established in the record of the file or in a court record may be used by the examiner in combination with patents or printed publications in a reexamination proceeding. Information supplementing or further defining the admission would be improper.

Any admission submitted by the patent owner is proper. A third party, however, may not submit admissions of the patent owner made outside the record of the file or a court record. Such a submission would be outside the scope of reexamination.

### **2618 Copies of Prior Art (Patents and Printed Publications) [Added R-2]**

It is required that a copy of each patent or printed publication relied upon, or referred to, in the request be filed with the request (37 CFR 1.915(b)(4)). If any of the documents are not in the English language, an English language translation of all necessary and pertinent parts is also required. An English language summary, or abstract of a non-English language document, is usually **not** sufficient.

It is also helpful to include copies of the prior art considered during earlier prosecution of the patent for which reexamination is requested. The presence of both the old and the new prior art allows a comparison to be made to determine whether a substantial new question of patentability is indeed present.

Copies of parent applications should also be submitted if the parent applications relate to the alleged substantial new question of patentability. For example, a parent application relates to the alleged substantial new question where the patent is a continuation-in-part and the question of patentability relates to support in the parent application for the claims.

### **2619 Copy of Printed Patent [Added R-2]**

The Office will prepare a separate file wrapper for each reexamination request, which will become part of the patent file. Since in some instances it may not be possible to obtain the patent file promptly, requesters are required under 37 CFR 1.915(b)(5) to include a copy of the printed patent for which reexamination is requested. The copy of the patent for which reexamination is requested should be provided in a double column format. The full copy of the printed patent (including the front page) is employed to provide the abstract, drawings, specification, and claims of the patent for the reexamination request and resulting reexamination proceeding.

A copy of any disclaimer, certificate of correction, or reexamination certificate issued in the patent must also be included, so that a complete history of the patent (for which reexamination is requested) is before the Office for consideration. A copy of any Federal Court decision, complaint in a pending civil action, or interference decision should also be submitted.

### **2620 Certificate of Service [Added R-2]**

The third party requester must serve the owner of the patent with a copy of the request in its entirety. See 37 CFR 1.915(b)(6). The service should be made to the correspondence address as indicated in 37 CFR 1.33(c). The name and address of the person served and the certificate of service should be indicated on the request.

The most recent address of the attorney or agent of record can be determined by checking the Office's register (roster) of patent attorneys and agents maintained by the Office of Enrollment and Discipline pursuant to 37 CFR 10.5 and 10.11(a). See also MPEP §2666.06 regarding service on the requester and patent owner.

It is required that third party requester set forth the name and address of the party served and the mode method of service on the certificate of service attached to the request. Further, the requester must include a copy of the certificate of service with the copy of the request served on the patent owner.

## 2622 Address of Patent Owner [Added R-2]

37 CFR 1.33. Correspondence respecting patent applications, reexamination proceedings, and other proceedings.

\*\*\*\*\*

(c) All notices, official letters, and other communications for the patent owner or owners in a reexamination proceeding will be directed to the attorney or agent of record (see § 1.34(b)) in the patent file at the address listed on the register of patent attorneys and agents maintained pursuant to §§ 10.5 and 10.11 or, if no attorney or agent is of record, to the patent owner or owners at the address or addresses of record. Amendments and other papers filed in a reexamination proceeding on behalf of the patent owner must be signed by the patent owner, or if there is more than one owner by all the owners, or by an attorney or agent of record in the patent file, or by a registered attorney or agent not of record who acts in a representative capacity under the provisions of § 1.34(a). Double correspondence with the patent owner or owners and the patent owner's attorney or agent, or with more than one attorney or agent, will not be undertaken. If more than one attorney or agent is of record and a correspondence address has not been specified, correspondence will be held with the last attorney or agent made of record.

\*\*\*\*\*

In 37 CFR 1.33(c), it is indicated which correspondence address is to be normally used to direct correspondence to the patent owner. In most instances, this will be the address of the first named, most recent attorney or agent of record in the patent file, at his or her current address. As a general rule, the attorney-client relationship terminates when the purpose for which the attorney was employed is accomplished; e.g., the issuance of a patent to the client. However, apart from the attorney-client relationship, the Office has, by regulation, 37 CFR 10.23(c)(8), made it the responsibility of every "practitioner," by virtue of his/her registration, "to inform a client or former client... of correspondence received from the Office... when the correspondence (i) could have a significant effect on a matter pending before the Office, (ii) is received by the practitioner on behalf of a client or former client, and (iii) is correspondence of which a reasonable practitioner would believe under the circumstances the client or former client should be notified." (Emphasis added.) This responsibility of a practitioner to a former client manifestly is not eliminated by withdrawing as an attorney or agent of record. The practitioner if he/she so desires, can minimize the

need for forwarding correspondence concerning issued patents by having the correspondence address changed after the patent issues if the correspondence address is the practitioner's address, which frequently is the case where the practitioner is the attorney or agent of record.

Further, 37 CFR 10.23(c)(8) requires a practitioner to "timely notify the Office of an inability to notify a client or former client of correspondence received from the Office." (Emphasis added.) As the language of this requirement clearly indicates, the duty to notify the Office is a consequence, not of any attorney-client relationship, but rather arises by virtue of the practitioner's status as a registered patent attorney or agent.

If the patent owner desires that a different attorney or agent receive correspondence, then a new power of attorney must be filed. Correspondence will continue to be sent to the attorney or agent of record in the patent file absent a revocation of the same by the patent owner. If the attorney or agent of record specifies a correspondence address to which correspondence is to be directed, such direction should be followed. However, since a change in the correspondence address does not withdraw a power of attorney, a change of the correspondence address by the patent owner does not prevent the correspondence from being directed to the attorney or agent of record in the patent file under 37 CFR 1.33(c).

Submissions to the Office to change the correspondence address or power of attorney in the record of the patent should be addressed as follows:

Where a request for reexamination has been filed and a reexamination proceeding is accordingly pending as to a patent.

Mail Stop *Inter Partes* Reexam  
Commissioner for Patents  
P.O. Box 1450  
Alexandria, VA 22313-1450

Where no request for reexamination has been filed and the patent is in storage-

Mail Stop Document Services  
Director of the U.S. Patent and Trademark Office  
P.O. Box 1450  
Alexandria, VA 22313-1450

A sample form for changing correspondence address or power of attorney is set forth below.

PTO/SB/82 (09-03)

Approved for use through 11/30/2005. OMB 0651-0035

U.S. Patent and Trademark Office; U.S. DEPARTMENT OF COMMERCE

Under the Paperwork Reduction Act of 1995, no persons are required to respond to a collection of information unless it displays a valid OMB control number.

<b>REVOCAION OF POWER OF ATTORNEY WITH NEW POWER OF ATTORNEY AND CHANGE OF CORRESPONDENCE ADDRESS</b>	Application Number	
	Filing Date	
	First Named Inventor	
	Art Unit	
	Examiner Name	
	Attorney Docket Number	

**I hereby revoke all previous powers of attorney given in the above-identified application.**

A Power of Attorney is submitted herewith.

**OR**

I hereby appoint the practitioners associated with the Customer Number:

Please change the correspondence address for the above-identified application to:

The address associated with Customer Number:

**OR**

<input type="checkbox"/> Firm or Individual Name					
Address					
Address					
City		State		Zip	
Country					
Telephone		Fax			

I am the:

Applicant/Inventor.

Assignee of record of the entire interest. See 37 CFR 3.71. *Statement under 37 CFR 3.73(b) is enclosed. (Form PTO/SB/96)*

**SIGNATURE of Applicant or Assignee of Record**

Name					
Signature					
Date		Telephone			

NOTE: Signatures of all the inventors or assignees of record of the entire interest or their representative(s) are required. Submit multiple forms if more than one signature is required, see below\*.

\*Total of \_\_\_\_\_ forms are submitted.

This collection of information is required by 37 CFR 1.36. The information is required to obtain or retain a benefit by the public which is to file (and by the USPTO to process) an application. Confidentiality is governed by 35 U.S.C. 122 and 37 CFR 1.14. This collection is estimated to take 3 minutes to complete, including gathering, preparing, and submitting the completed application form to the USPTO. Time will vary depending upon the individual case. Any comments on the amount of time you require to complete this form and/or suggestions for reducing this burden, should be sent to the Chief Information Officer, U.S. Patent and Trademark Office, U.S. Department of Commerce, P.O. Box 1450, Alexandria, VA 22313-1450. DO NOT SEND FEES OR COMPLETED FORMS TO THIS ADDRESS. **SEND TO: Commissioner for Patents, P.O. Box 1450, Alexandria, VA 22313-1450.**

*If you need assistance in completing the form, call 1-800-PTO-9199 and select option 2.*

See MPEP § 324 for establishing assignee's right to take action when submitting a power of attorney.

**2623 Withdrawal of Attorney or Agent  
[Added R-2]**

Any request by an attorney or agent of record to withdraw from a patent will normally be approved

only if at least 30 days remain in any running period for response. See also MPEP § 402.06.

A sample form for a request by an attorney or agent of record to withdraw from a patent is set forth below.

Under the Paperwork Reduction Act of 1995, no persons are required to respond to a collection of information unless it displays a valid OMB control number.

<b>REQUEST FOR WITHDRAWAL AS ATTORNEY OR AGENT AND CHANGE OF CORRESPONDENCE ADDRESS</b>	Application Number	
	Filing Date	
	First Named Inventor	
	Art Unit	
	Examiner Name	
	Attorney Docket Number	

**To: Commissioner for Patents  
P.O. Box 1450  
Alexandria, VA 22313-1450**

Please withdraw me as attorney or agent for the above identified patent application, and

all the attorneys/agents of record.

the attorneys/agents (with registration numbers) listed on the attached paper(s), or

the attorneys/agents associated with Customer Number

NOTE: This box can only be checked when the power of attorney of record in the application is to all the practitioners associated with a customer number.

The reasons for this request are:

**CORRESPONDENCE ADDRESS**

1.  The correspondence address is NOT affected by this withdrawal.

2.  Change the correspondence address and direct all future correspondence to:

Customer Number:

**OR**

<input type="checkbox"/> Firm or Individual Name			
Address			
Address			
City	State	Zip	
Country			
Telephone		Fax	
Name			
Signature	Registration No.		
Date	Telephone No.		

*NOTE: Withdrawal is effective when approved rather than when received. Unless there are at least 30 days between approval of withdrawal and the expiration date of a time period for response or possible extension period, the request to withdraw is normally disapproved.*

This collection of information is required by 37 CFR 1.36. The information is required to obtain or retain a benefit by the public which is to file (and by the USPTO to process) an application. Confidentiality is governed by 35 U.S.C. 122 and 37 CFR 1.14. This collection is estimated to take 12 minutes to complete, including gathering, preparing, and submitting the completed application form to the USPTO. Time will vary depending upon the individual case. Any comments on the amount of time you require to complete this form and/or suggestions for reducing this burden, should be sent to the Chief Information Officer, U.S. Patent and Trademark Office, U.S. Department of Commerce, P.O. Box 1450, Alexandria, VA 22313-1450. DO NOT SEND FEES OR COMPLETED FORMS TO THIS ADDRESS. **SEND TO: Commissioner for Patents, P.O. Box 1450, Alexandria, VA 22313-1450.**

*If you need assistance in completing the form, call 1-800-PTO-9199 and select option 2.*

## 2624 Correspondence [Added R-2]

All requests to initiate an *inter partes* reexamination proceeding should be marked “Mail Stop *Inter Partes* Reexam” on the face of the outer envelope. Such mail will be sorted out immediately and processed by the reexamination preprocessing staff of the Central Reexamination Unit (CRU).

The use of “Mail Stop *Inter Partes* Reexam” is **not** limited to the filing of the original request for *inter partes* reexamination. Subsequent *inter partes* reexamination correspondence should also be marked “Mail Stop *Inter Partes* Reexam,” and such subsequent correspondence will be directed to the CRU, which processes all *inter partes* reexamination incoming mail.

See MPEP § 2224 for use of “Mail Stop *Ex Parte* Reexam” for requests for *ex parte* reexamination, but not for subsequent *ex parte* reexamination correspondence.

A request for *inter partes* reexamination may **not** be sent by facsimile transmission. See 37 CFR 1.6(d)(5). Facsimile transmission may, however, be used for filing later submissions.

After the filing of the request for *inter partes* reexamination, any letters sent to the Office relating to the reexamination proceeding should identify the proceeding by the number of the patent undergoing reexamination, the reexamination request control number assigned, the name of the examiner, and the examiner’s Art Unit. The certificate of mailing or transmission procedures (37 CFR 1.8) and “Express Mail” procedure (37 CFR 1.10) may be used to file any paper in the existing *inter partes* reexamination proceeding.

Communications from the Office to the patent owner will be directed to the first named, most recent attorney or agent of record in the patent file at the current address on the Office’s register of patent attorneys and agents, or to the patent owner’s address if no attorney or agent is of record, 37 CFR 1.33(c).

Amendments and other papers filed on behalf of patent owners must be signed by the patent owners, or the registered attorney or agent of record in the patent file, or any registered attorney or agent acting in a representative capacity under 37 CFR 1.34(a).

Double correspondence with the patent owners and the attorney or agent normally will not be undertaken by the Office.

Where no correspondence address is otherwise specified, correspondence will be with the most recent attorney or agent made of record by the patent owner.

Note MPEP § 2620 for certificate of service.

## 2625 Untimely Paper Filed Prior to First Office Action [Added R-2]

37 CFR 1.939. *Unauthorized papers in inter partes reexamination*

(a) If an unauthorized paper is filed by any party at any time during the *inter partes* reexamination proceeding it will not be considered and may be returned.

(b) Unless otherwise authorized, no paper shall be filed prior to the initial Office action on the merits of the *inter partes* reexamination.

37 CFR 1.902. *Processing of prior art citations during an inter partes reexamination proceeding.*

Citations by the patent owner in accordance with § 1.933 and by an *inter partes* reexamination third party requester under § 1.915 or § 1.948 will be entered in the *inter partes* reexamination file. The entry in the patent file of other citations submitted after the date of an order for reexamination pursuant to § 1.931 by persons other than the patent owner, or the third party requester under either § 1.915 or § 1.948, will be delayed until the *inter partes* reexamination proceeding has been terminated. See § 1.502 for processing of prior art citations in patent and reexamination files during an *ex parte* reexamination proceeding filed under § 1.510.

Pursuant to 37 CFR 1.939, after filing of a request for *inter partes* reexamination, no papers directed to the merits of the reexamination other than (A) citations of patents or printed publications under 37 CFR 1.501 and 1.933, (B) another complete request under 37 CFR 1.510 or 37 CFR 1.915, or (C) notifications pursuant to MPEP § 2682, should be filed with the Office prior to the date of the first Office action in the reexamination proceeding. Any papers directed to the merits of the reexamination, other than those under 37 CFR 1.501, 1.933, 1.510 or 1.915, or under MPEP § 2682, filed prior to the date of the first Office action will be returned to the sender without consideration. A copy of the letter accompanying the returned papers will be made of record in the patent file. However, no copy of the returned papers will be retained by the Office. If the submission of the returned papers is appropriate later in the proceedings, they may be filed, and accepted by the Office, at that time. See *Patlex Corp. v. Mossinghoff*, 771 F.2d 480, 226 USPQ 985 (Fed. Cir. 1985); *In re Knight*, 217 USPQ 294

(Comm'r Pat.1982); and *In re Amp*, 212 USPQ 826 (Comm'r Pat. 1981).

## 2626 Initial Processing of Request for *Inter Partes* Reexamination [Added R-2]

The opening of all mail marked "Mail Stop *Inter Partes* Reexam" and all initial clerical processing of requests for *inter partes* reexamination will be performed by the reexamination preprocessing staff in the Office of Patent Legal Administration, Central Reexamination Unit.

## 2627 Incomplete Request for *Inter Partes* Reexamination [Added R-2]

*37 CFR 1.915. Content of request for inter partes reexamination.*

(a) The request must be accompanied by the fee for requesting *inter partes* reexamination set forth in § 1.20(c)(2).

\*\*\*\*\*

*37 CFR 1.919. Filing date of request for inter partes reexamination.*

(a) The filing date of a request for *inter partes* reexamination is the date on which the request satisfies the fee requirement of § 1.915(a).

\*\*\*\*\*

If the required fee under 37 CFR 1.20(c)(2) is not paid in full, the request for *inter partes* reexamination is incomplete and will not be considered on its merits nor have a notice of its filing announced in the *Official Gazette*. The request is considered to have a "filing date" under 37 CFR 1.919(a) only when the entire fee is paid. Until the entire fee is received, no control number or filing date will be assigned, and technically, no reexamination proceeding exists.

If no fee is received, or only a portion of the fee is received, the reexamination preprocessing staff of the Central Reexamination Unit (CRU) will notify the requester of the defect in writing and give the requester a specified time, normally one month, to complete the request. This notice is not entered in the system. A telephone call may also be made to the requester indicating the amount of the insufficient fee. If the request is not timely completed, any partial fee will be returned by the CRU to the requester along with a notice that the reexamination request has not

been accepted and the process has been terminated. The request itself will be treated as a citation under 37 CFR 1.501 if it complies therewith. If the request does not comply with 37 CFR 1.501, the request papers will also be returned to the requester by the CRU.

## 2628 Informal Request for *Inter Partes* Reexamination [Added R-2]

*37 CFR 1.915. Content of request for inter partes reexamination.*

\*\*\*\*\*

(b) A request for *inter partes* reexamination must include the following parts:

(1) An identification of the patent by patent number and every claim for which reexamination is requested.

(2) A citation of the patents and printed publications which are presented to provide a substantial new question of patentability.

(3) A statement pointing out each substantial new question of patentability based on the cited patents and printed publications, and a detailed explanation of the pertinency and manner of applying the patents and printed publications to every claim for which reexamination is requested.

(4) A copy of every patent or printed publication relied upon or referred to in paragraphs (b)(1) through (3) of this section, accompanied by an English language translation of all the necessary and pertinent parts of any non-English language document.

(5) A copy of the entire patent including the front face, drawings, and specification/claims (in double column format) for which reexamination is requested, and a copy of any disclaimer, certificate of correction, or reexamination certificate issued in the patent. All copies must have each page plainly written on only one side of a sheet of paper.

(6) A certification by the third party requester that a copy of the request has been served in its entirety on the patent owner at the address provided for in § 1.33(c). The name and address of the party served must be indicated. If service was not possible, a duplicate copy of the request must be supplied to the Office.

(7) A certification by the third party requester that the estoppel provisions of § 1.907 do not prohibit the *inter partes* reexamination.

(8) A statement identifying the real party in interest to the extent necessary for a subsequent person filing an *inter partes* reexamination request to determine whether that person is a privy.

\*\*\*\*\*

(d) If the *inter partes* request does not meet all the requirements of subsection 1.915(b), the person identified as requesting *inter partes* reexamination may be so notified and given an opportunity to complete the formal requirements of the request within a specified time. Failure to comply with the notice may result in the *inter partes* reexamination proceeding being vacated.

All requests for *inter partes* reexamination which are accompanied with the entire fee under 37 CFR 1.20(c)(2) will be assigned a filing date. If the fee under 37 CFR 1.20(c)(2) has been paid, but the request for *inter partes* reexamination does not contain all the elements required by 37 CFR 1.915(b), the request is considered to be informal. The reexamination preprocessing staff of the Central Reexamination Unit will attempt to notify the requester of any informality in the request in order to give the requester time to respond before a decision is made on the request. If the requester does not timely respond and correct the informality, the decision on the request will be made on the information presented. The decision on the request will either:

(A) Vacate the reexamination proceeding based upon the informality of the request; or

(B) Decide the request as to whether the information which is presented raises “a substantial new question of patentability.” If yes, the request for reexamination will be granted, if not the request will be denied.

The choice as to which of the above options to exercise will be made at the Office’s sole discretion. In making the decision, the Office will take into account the nature of the informality, and how it affects or impacts the reexamination proceeding.

In the event the certification required by 37 CFR 1.915(b)(7) has not been included with the request for reexamination, and is not later provided even after request by the Office for same; the Office may (at its option) construe the filing of the reexamination request as a constructive certification under 37 CFR 1.915(b)(7), absent evidence to the contrary. If so, the requester and patent owner shall be so-notified in the decision on the request.

## **2629 Notice of Request for *Inter Partes* Reexamination in *Official Gazette* [Added R-2]**

*37 CFR 1.11. Files open to the public.*

(c) All requests for reexamination for which the fee under § 1.20(c) has been paid, will be announced in the *Official Gazette*. Any reexaminations at the initiative of the Director pursuant to § 1.520 will also be announced in the *Official Gazette*. The announcement shall include at least the date of the request, if any, the reexamination request control number or the Director initiated order control number, patent number, title, class and subclass,

name of the inventor, name of the patent owner of record, and the examining group to which the reexamination is assigned.

\*\*\*\*\*

(d) All papers or copies thereof relating to a reexamination proceeding which have been entered of record in the patent or reexamination file are open to inspection by the general public, and copies may be furnished upon paying the fee therefor.

\*\*\*\*\*

Notice of filing of all complete requests for *inter partes* reexamination will be published in the *Official Gazette*, approximately 4-5 weeks after filing.

Under 37 CFR 1.11(c), reexamination requests will be announced in the *Official Gazette*. The reexamination preprocessing staff of the Office of Patent Legal Administration, Central Reexamination Unit (CRU) will complete a form with the information needed to print the notice. The forms are forwarded at the end of each week to the Office of Publications for printing in the *Official Gazette*. The *Official Gazette* notice will appear in the notice section of the *Official Gazette* under the heading of Requests for *Inter Partes* Reexamination Filed and will include the name of any requester along with the other items set forth in 37 CFR 1.11(c).

In addition, a record of requests filed will be located in the Patent Search Room and in the reexamination preprocessing area of the CRU. Office personnel may use the PALM system to determine if a request for reexamination has been filed in a particular patent. See MPEP § 2632.

## **2630 Constructive Notice to Patent Owner [Added R-2]**

In some instances, it may not be possible to deliver mail to the patent owner because no current address is available. If all efforts to correspond with the patent owner fail, the reexamination proceeding will proceed without the patent owner. The publication in the *Official Gazette* of the notice of the filing of the *inter partes* reexamination request will serve as constructive notice to the patent owner in such an instance.

## **2631 Processing of Request Corrections [Added R-2]**

Any payment of the balance of the *inter partes* reexamination request fee should be marked “Mail Stop *Inter Partes* Reexam,” so that the fee may be



promptly forwarded to the reexamination preprocessing staff of the Central Reexamination Unit (CRU). If the fee payment completes the payment of the required fee, the reexamination request will be processed, notice will be published in the *Official Gazette*, and the request will be forwarded to the appropriate Technology Center (TC) for determination.

A correction of a defect other than the fee (see 37 CFR 1.915(b)(1)-(8)) should likewise be marked "Mail Stop *Inter Partes* Reexam." The CRU, upon receipt of the correction submission, will process it and direct it to a CRU Legal Instruments Examiner (LIE). The LIE will check the correction submission for timeliness and then perform the appropriate clerical processing, including entering the submission in the file of the reexamination.

## 2632 Public Access [Added R-2]

*Inter partes* reexamination folders, i.e., paper files, will be stored in the Central Reexamination Unit (CRU), when the reexamination is not being processed or examined elsewhere.

### I. SCANNING OF *INTER PARTES* REEXAMINATIONS

An electronic image of the file contents of each *inter partes* reexamination is generated and retained by the CRU.

When the initial request for *inter partes* reexamination is filed, the request is scanned. When the file containing the request has been compiled and processed in the CRU preprocessing area, the file jacket and its contents will be scanned. All correspondence mailed by the Office and all papers filed in the reexamination proceeding will also be scanned. The reexamination files that have been scanned into the reexamination database include an entry in the case contents in PALM of "SCNR" each time that incoming and/or outgoing papers are scanned into the database. The scanning will store the file and its contents as electronic image format. The electronic image format can be retrieved and printed at Reexamination Processing System (REPS) terminals in the Patent Search Room.

### II. ACCESS TO ELECTRONIC FILE AND COPYING

When a request for copying a reexamination case file is received in a Technology Center (TC) or elsewhere in the Office, the party requesting the copies should be (A) notified of the Office's policy of supplying copies from the scanned file, and (B) informed that a REPS terminal is available to the public in the Patent Search Room for accessing/copying reexamination files from the reexamination database. Access is free. Copies are 25 cents per page.

In an emergency where the terminals in the Patent Search Room are not operative, the party should be referred to the CRU to inquire as to whether the CRU can provide an alternative terminal for viewing only. The CRU does not have the means, or the authority, to sell copies to the public.

### III. ACCESS TO ACTUAL PAPER FILE

In view of the need to conduct the reexamination proceeding with special dispatch, the reexamination paper file is generally NOT available to the public. A request for actual access to the reexamination paper file should be **rare**, since copies of the file can be obtained electronically. In the rare instance where access is necessary, a request for actual access of the reexamination file must be in writing and directed to the CRU. The request must specifically point out the reason why access is needed, and why an electronically generated copy of file records would not be sufficient for the requesting party's needs. A decision on the request will be made by the CRU. Where access to the actual paper file is granted, the decision granting access will point out the guidelines for access and the extent of access. The CRU will oversee the access under the guidance of a Reexamination Legal Advisor (RLA). If the reexamination file is in a TC, the CRU will notify the TC that it is needed. The requested reexamination file should then be retrieved by TC support staff and forwarded to the CRU as soon as possible. Where the case is being acted on by the examiner or is being processed by TC clerical personnel, this may result in a delay in the retrieval of the case, and the CRU should be notified accordingly.

#### IV. SALE OF COPIES OF REEXAMINATION REQUESTS

Copies of reexamination requests, all cited references, and the file wrapper and contents of the patent file for which reexamination is requested are available at the standard charge per page. Alternatively, a copy of a file wrapper may be put on a CD, for a standard fee (37 CFR 1.19(b)(3)).

Orders for such copies must indicate the control number assigned the reexamination request. Orders should be addressed as follows:

Mail Stop Document Services  
Director of the U.S. Patent and Trademark Office  
P.O. Box 1450  
Alexandria, VA 22313-1450

Alternatively, requests for a copy of a request may be sent via e-mail to: [dsd@uspto.gov](mailto:dsd@uspto.gov), and the cost of the copy may be charged to a credit card or deposit account.

To obtain a “certified copy” of a reexamination file, a CD-ROM may be purchased from Document Services Division.

#### V. DETERMINING ON PALM IF A REEXAMINATION REQUEST HAS BEEN FILED FOR A GIVEN PATENT NUMBER

Both the Internet and the USPTO Intranet can be accessed to determine if a reexamination request has been filed for a particular patent.

##### A. Using the Internet

- Log on to the Internet.
- Go to USPTO Website located at <http://www.uspto.gov>.
- Click on “Patents” located on the left side of the screen.
- Under “Patenting” click “Patent Application Status (PAIR).”
- On the next screen, click on “Patent Application Information Retrieval.”
- Enter the patent number (e.g., 5,806,063) in “Patent Number Search.”
- Click on “Search.”
- Under ‘Search Results for patent number: 5,806,063’ click the “Continuity Data” bar (button).

- Scroll to “Child Continuity Data” where any related reexamination will be listed. *Ex parte* reexaminations are identified by the unique “90” series code, e.g., 90/005,727. *Inter partes* reexaminations are identified by the unique “95” series code, e.g., 95/000,001.

- Clicking on the underlined (hyper linked) reexamination number will reveal the “Contents” for the reexamination file.

##### B. Using the USPTO Intranet

- From the USPTO Intranet site <http://ptoweb/ptointranet/index.htm>, Office personnel can click on “PALM” and then “General Information” which opens the PALM INTRANET General Information Display.

- From here, enter the patent number in the box labeled Patent #.

- Click on “Search” and when the “Patent Number Information” appears, click on “Continuity Data” to obtain the reexamination number.

Any reexamination for the patent number will be listed.

There will be about a ten (10) day lag between filing and data entry into the PALM database.

#### 2633 Processing in Technology Center [Added R-2]

The processing and handling of an *inter partes* reexamination in the Technology Center (TC) will include:

- (A) Initial Supervisory Patent Examiner (SPE) assignment of the case to a primary examiner;
- (B) Examination of the case by the patent examiner;
- (C) Clerical activity needed to support that examination;
- (D) The *inter partes* reexamination functions of the Special Program Examiners (SPREs) who are supported in these functions by the Paralegal Specialists;
- (E) The administrative functions of reexamination performed by the TC Directors and SPEs; and
- (F) Other instances that the Central Reexamination Unit (CRU) Reexamination Legal Advisor (RLA) deems it appropriate for the TC to have possession of the case.

The working groups in the TCs have designated the legal instrument examiners (LIEs) to act as reexamination clerks, as part of their assigned duties, and thus to perform those clerical duties and responsibilities in the TCs which are unique to reexamination.

*Inter Partes* reexamination PALM processing in the TC will be limited to charging the case to the examiner, PALM transactions to indicate receipt of the case in the TC, case flagging as needed by the SPREs, and return of the case to the CRU.

## I. CRU INTERFACE WITH TECHNOLOGY CENTER OPERATION

The CRU will administer, oversee, and monitor *inter partes* reexamination. Additionally, in conjunction with and in support of TC handling of *inter partes* reexaminations, the CRU will perform, in *inter partes* reexamination proceedings, (A) all processing of papers filed by parties and entry of amendments, (B) all mailing of Office actions and other correspondence, and (C) all processing of fees. CRU personnel will be available to respond to inquiries by TC personnel as to TC handling of *inter partes* reexaminations. Such inquiries to the CRU should be forwarded via the TC SPREs, so that they will be aware of all reexamination practice in the TC and thus serve as a focal point for the TC in reexamination.

## II. TECHNOLOGY CENTER HANDLING OF INTER PARTES REEXAMINATION

After the case file has been reviewed in the CRU to ensure it is ready for examination, the CRU will forward the case to the TC for docketing of the case to the examiner assigned to the reexamination proceeding.

In the event the SPE believes that another Art Unit should examine the case, see MPEP § 2637 for procedures for transferring the case.

After the examiner receives the new *inter partes* reexamination case file from his/her SPE, the examiner will, no later than one week after receipt of the *inter partes* reexamination file, prepare for an initial consultation conference with the RLA and notify the SPRE that he/she is ready for the conference and specify the days and times that he/she is available. The SPRE will schedule the consultation conference. At the scheduled conference, the consultation will be conducted with the examiner, a TC SPRE, and the

RLA being present. The SPE may also attend the conference but the SPEs attendance is not mandatory. At the consultation conference, the RLA will provide instructions as to preparation of the decision on the request for *inter partes* reexamination and (where reexamination is granted) a first action which would accompany an order granting reexamination. In the rare circumstances where a first action is not to be provided with the grant of reexamination (see MPEP § 2660), the RLA will so instruct the examiner. The consultation conference should be completed within two weeks of when the case was initially forwarded to the TC SPRE by the CRU.

After the consultation conference, the examiner will prepare a decision on the request for reexamination, and, where reexamination is granted, a first Office action to accompany the decision no later than two weeks from the date of the consultation conference. The decision and the Office action are typed in the TC on a “special” basis and the typed decision and Office action are forwarded to a **primary examiner** for signature. Although a non-primary examiner may be assigned a reexamination to examine (where that examiner is the only examiner who did not examine the application for the patent being reexamined and yet is familiar with the art), a primary examiner must review and sign every action in the reexamination proceeding. After the primary examiner signs the decision and/or action, the appropriate materials will be compiled and any needed copying will be performed by the TC support staff. Thereafter, the case file will be forwarded to the TC SPRE for review. The TC SPRE will then arrange for the file to be PALMed out and **hand-carried** directly to the CRU.

The SPRE will have one (1) week from the SPRE’s receipt of the case from the examiner to perform the review, to obtain needed corrections, and to forward the case to the CRU. **At the very latest**, the decision and action prepared by the examiner must be forwarded to the CRU within nine (9) weeks of the filing date of the request. After the SPRE approves the Office action, the file (containing the examiner’s decision and action) is **hand-carried** directly to the CRU for a final review and mailing. In the CRU, the RLA performs a general review of the decision and action, and then the decision and action are mailed from the CRU. In conjunction with the mailing, any

appropriate processing (e.g., PALM work, update scanning) is carried out by the staff of the CRU.

After the mailing of the decision and the first action, the file will be stored in the central storage area of the CRU. Upon receipt of a patent owner response to the action (and third party requester comments where permitted) by the CRU, or upon the expiration of the time to submit same, the SPE and the examiner will be notified and the case file is forwarded to the TC. The examiner will review the response and comments, decide on a proposed course of action, consult with the RLA (with the SPRE being present) and then prepare the appropriate action for the case. The action will be reviewed and mailed as discussed above. Further prosecution and examination will follow in a similar manner. See MPEP § 2671.03 for handling of patentability review conferences prior to Action Closing Prosecution (ACP) and prior to Right of Appeal Notice (RAN). See MPEP § 2676 for appeal conferences and MPEP § 2677 Examiner's Answers. Appeal conferences and patentability review conferences will be conducted in the presence of the SPRE and RLA, and will serve as the pre-action consultation prior to an the action to be issued by the examiner.

Ordinarily, there is no counting of actions in a reexamination proceeding; all time spent on reexamination is reported as set forth in MPEP § 2638. Where the reexamination has been merged with a reissue (see MPEP § 2686.03), the reissue counting will be done by the TC.

### III. TECHNOLOGY CENTER PREPARATION OF THE ACTION FOR MAILING PRIOR TO FORWARDING TO THE CRU

After an action by the examiner is completed, the TC clerical staff will make copies of references cited and a copy of the Office action for the patent owner and the third party requester. Copying of the Office action and any references will be performed in the TC to ensure that copies are provided for the file and for all parties entitled to receive copies.

A transmittal form PTOL-501 with the third party requester's address will be completed, if a copy for mailing is not already in the case file. The transmittal form PTOL-501 is used to forward copies of Office actions (and any references cited in the actions) to the third party requester. Whenever an Office action is

issued, a copy of this form will be made and attached to a copy of the Office action. The use of this form removes the need to retype the third party requester's address each time a mailing is required.

### 2634 Fee Processing and Procedure [Added R-2]

All fees in an *inter partes* reexamination proceeding (including the fee for filing the request for *inter partes* reexamination (see MPEP § 2615)) are processed by the Central Reexamination Unit (CRU), prior to sending the case to the Technology Center (TC). The fees will be posted by the CRU via the Revenue Accounting and Managing (RAM) program.

In an *inter partes* reexamination proceeding, fees are due for the request (37 CFR 1.915(a)), for any appeal, brief, and oral hearing under 37 CFR 1.959, 1.965, 1.967, 1.973 and 1.977(c), and for a petition to accept a late response under 37 CFR 1.958. Any petitions filed under 37 CFR 1.137, 37 CFR 1.182 or 37 CFR 1.183 relating to a reexamination proceeding require fees (37 CFR 1.17(h), (l) and (m)).

No fees are required for additional claims added, or for the issuance of a reexamination certificate.

Small entity reductions under 35 U.S.C. 41(h)(1) are available to the patent owner for appeal fees, brief fees, oral hearing fees, and the petition fee under 37 CFR 1.958. Small entity reductions are available to the third party requester for appeal fees, brief fees, and oral hearing fees. Small entity reductions in fees are not available for the reexamination filing fee, nor for petition fees for petitions filed under 37 CFR 1.182 and 1.183.

When a fee is required in a merged proceeding, only a single fee is needed, even though multiple copies of the submissions (one for each file) are required. See MPEP § 2686.01.

### 2635 Record Systems [Added R-2]

The Patent Application Locating and Monitoring (PALM) system is used to support the reexamination process. The sections below delineate PALM related activities.

(A) *Reexamination File Data on PALM* - The routine PALM retrieval transactions are used to obtain data on reexamination files. From the USPTO Intranet site <http://ptoweb/ptointranet/index.htm> "PALM" and

then “General Information” which opens the PALM INTRANET General Information Display. From here, enter the patent number in the box labeled Patent #. Then click on “Search” and when the “Patent Number Information” appears, click on “Continuity Data” to obtain the reexamination number.

(B) *Reexamination File Location Control* - The location of a reexamination file is monitored in the same manner as regular patent application files. Certain PALM transactions differ between regular patent applications and reexamination files. For example, there are separate folders in PALM EXPO for reexaminations and for regular patent applications. In PRE-EXAM, there is a reexamination/reissue folder which does not apply to regular patent applications. Note also that some of the data entry for reexamination in PALM PRE EXAM is different from that of a regular patent application. There are also differences in the status codes - all reexamination proceedings have status codes in the “400” range, while patent applications have status codes ranging from “020” to over “100.”

(C) *Patent File Location Control* - The movement of patent files related to requests for reexamination throughout the Office is monitored by the PALM system in the normal fashion. The reexamination file and patent file will be kept together, from initial receipt until the reexamination is assigned to an examiner for determination. At this point, the patent file will be charged to the examiner assigned the reexamination file, and the patent file will be kept in the examiner’s room until the proceeding is terminated. After the reexamination proceeding has been terminated, the patent file should be forwarded by the examiner, via the SPRE, with the reexamination file to the Central Reexamination Unit (CRU). After review and processing in the CRU and by the Office of Patent Legal Administration as appropriate, the patent and reexamination files will be forwarded to the Office of Publications. The Office of Publications will forward the patent file and the reexamination file to the Record Room after printing of the certificate.

(D) *Reporting Events to PALM* - The PALM system is used to monitor major events that take place in processing reexamination proceedings. All major examination events are reported. The mailing of examiner’s actions are reported, as well as owner’s responses and third party requester comments. The

CRU support staff, and the Technology Center (TC) reexamination clerks and paralegals, are responsible for reporting these events using the reexamination icon and window initiated in the PALM EXPO program. Events that will be reported include the following:

- (1) Determination Mailed-Denial of request for reexamination;
- (2) Determination Mailed-Grant of request for reexamination;
- (3) Petition for reconsideration of determination received;
- (4) Decision on petition mailed-Denied;
- (5) Decision on petition mailed-Granted;
- (6) Mailing of all examiner actions;
- (7) Patent owner responses to Office Actions
- (8) Third party requester comments after a patent owner response.

All events will be permanently recorded and displayed in the “Contents” portion of PALM. In addition, status representative of these events will also be displayed.

(E) *Status Reports* - Various weekly “tickler” reports can be generated for each TC, given the event reporting discussed above. The primary purpose of these computer outputs is to assure that reexaminations are, in fact, processed with “special dispatch”.

(F) *Historical Reporting* - A variety of historical reports are possible given the event recording described above. Thus, such statistics as the number of requests for *inter partes* reexamination filed and determinations made in a specified period or number or kind of reexaminations in which an appeal was filed can be made available.

## **2636 Assignment of Reexamination [Added R-2]**

### **I. EXAMINER ASSIGNMENT OF THE RE-EXAMINATION PROCEEDING**

Reexamination requests will normally be assigned to the art unit which examines the class and subclass in which the patent to be reexamined is currently classified as an original. In that art unit, the Supervisory Patent Examiner (SPE) assigns the reexamination request to a primary examiner, other than the examiner that originally examined the patent (see “Examiner Assignment Policy” below), who is most familiar

with the claimed subject matter of the patent. Where no such knowledgeable primary examiner is available, the reexamination may be assigned to an assistant examiner. In such an instance the SPE must sign all actions and take responsibility for all actions taken.

**(A) Examiner Assignment Policy**

It is the policy of the Office that the SPE will assign the reexamination request to an examiner different from the examiner(s) who examined the patent application. Thus, under normal circumstances, the reexamination request will not be assigned to a SPE, primary examiner, or assistant examiner who was involved in any part of the examination of the patent for which reexamination is requested (e.g., by preparing/signing an action), or was so involved in the examination of the parent of the patent. This would preclude assignment of the request to an examiner who was a conferee in an appeal conference or patentability review conference in an earlier concluded examination of the patent (e.g., the application for patent, a reissue, or a prior concluded reexamination proceeding). The conferee is considered to have participated in preparing the Office action which is preceded by the conference.

**Exceptions to this general policy include** cases where the SPE is the only primary examiner in the art unit, or where the original examiner is the only examiner with adequate knowledge of the relevant technology to examine the case. In the unusual case where there is a need to assign the request to the original examiner, the assignment must be approved by the TC Director, and the fact that such approval was given by the TC Director must be stated (by the examiner) in the decision on the request for reexamination.

It should be noted that while an examiner who examined an earlier **concluded** reexamination proceeding is generally excluded from assignment of a newly filed reexamination, *if the earlier reexamination is still ongoing, the same examiner will be assigned the new reexamination.*

Copending reissue and reexamination proceeding:

(1) When a reissue application is pending for a patent, and a reexamination request is filed for the same patent, the reexamination request generally is assigned to a different examiner even though the

examiner who examined the patent application is handling the reissue application. If the reexamination request is granted and the reissue and reexamination proceedings are merged (see MPEP § 2686.03), the merged proceeding will be handled by the examiner assigned the reexamination proceeding. Thus, the reissue application would be transferred (reassigned) from the original examiner to the examiner who ordered reexamination

(2) When a reexamination proceeding is pending for a patent, and a reissue application is filed for the same patent:

(a) Where reexamination has already been ordered (granted) in the reexamination proceeding, the reexamination file, the reissue application, and the patent file should be delivered to the Office of Patent Legal Administration (OPLA) promptly after the reissue application reaches the TC (see MPEP § 2686.03). If the reissue and reexamination proceedings are merged by OPLA, the reissue will be assigned in the TC (upon return of the files from OPLA) to the examiner handling the reexamination proceeding. If the reissue and reexamination proceedings are not merged by OPLA, the decision will provide guidance as to assignment of the reissue proceeding depending on the individual fact situation.

(b) If reexamination has not yet been ordered (granted) in the reexamination proceeding, the reissue application will be held in the Office of the TC SPRE, and the decision on the reexamination request will be made. If reexamination is denied, the reexamination proceeding will be terminated pursuant to MPEP § 2694, and the reissue application assigned in accordance with MPEP § 1440. If reexamination is granted, a first Office action will not accompany the order granting reexamination. Rather, the reexamination and reissue files will be forwarded with the patent file to OPLA (see MPEP § 2686.03). If the reissue and reexamination proceedings are merged by OPLA, the reissue will be assigned in the TC (upon return of the files from OPLA) to the examiner handling the reexamination proceeding. If the reissue and reexamination proceedings are not merged by OPLA, the decision will provide guidance as to assignment of the reissue proceeding depending on the individual fact situation.

**(B) Consequences of Inadvertent Assignment to an “Original Examiner”**

Should a reexamination be inadvertently assigned to an “original examiner” (in a situation where the TC Director’s approval is not stated in the decision on the request), the patent owner or the third party requester who objects must promptly file a paper alerting the Office of this fact. Any request challenging the assignment of an examiner to the case must be made within two months of the first Office action or other Office communication indicating the examiner assignment, or reassignment will not be considered. Reassignment of the reexamination to a different examiner will be addressed on a case-by-case basis. In no event will the assignment to the original examiner, by itself, be grounds for vacating any Office decision(s) or action(s) and “restarting” the reexamination.

A situation may arise where a party timely (i.e., within the two months noted above) files a paper alerting the Office to the assignment of a reexamination to the “original examiner,” but that paper does not have a right of entry under the rules (e.g., where an order granting reexamination was issued by the “original examiner” but a first action on the merits did not accompany the order, the patent owner timely files a paper alerting the Office of the fact that the “original examiner” has been assigned the reexamination proceeding. Pursuant to 37 CFR 1.939(b), that paper does not have a right of entry since a first Office action on the merits has not yet been issued.) In such situations, the Office may waive the rules to the extent that the paper directed to the examiner assignment will be entered and considered.

## II. MECHANICS OF ASSIGNMENT

When a request for reexamination is received in the Office, it will be processed by the Central Reexamination Unit (CRU) support staff. After the case file has been reviewed in the CRU to ensure it is ready for examination in the TC, the CRU will forward the case to the TC for docketing of the case to the examiner assigned to the reexamination proceeding.

In the event the SPE believes that another Art Unit should examine the case, see MPEP § 2637 for procedures for transferring the case.

## 2637 Transfer Procedure [Added R-2]

Although the number of reexamination requests which must be transferred should be very small, the following procedures have been established for an expeditious resolution of any such problems.

As pointed out in MPEP § 2636, an *inter partes* reexamination request is normally assigned in the Central Reexamination Unit (CRU) to the Art Unit which examines the class and subclass in which the patent to be reexamined is currently classified as an original. The CRU forwards the case to the Technology Center Special Program Examiner (TC SPRE). The TC SPRE then delivers the case to the Supervisory Patent Examiner (SPE). **At that point**, if the SPE believes that the reexamination should be assigned to another art unit, he/she must obtain the consent of the SPE of the art unit to which a transfer is desired (the “new” art unit). The reexamination file is then delivered to the TC having the “new” art unit for processing.

Any conflict which cannot be resolved by the SPEs will be resolved by the TC Directors involved.

## 2638 Time Reporting [Added R-2]

### I. CLERICAL TIME REPORTING

Both the Program Management System (PMS) and Payroll systems now used to monitor clerical time have been modified to report reexamination activities. Time devoted to processing actual reexamination files in the Technology Centers (TCs) should be reported using the appropriate PMS Code and Project Code. It should be noted that all clerical time consumed by reexamination activities must be reported in the above manner. Activities such as supervision, copying, typing, and docketing should be included.

### II. CENTRAL REEXAMINATION UNIT (CRU) TIME REPORTING

CRU personnel will use 1190-55 as the code to report their time for reexamination activities on the Biweekly Time Worksheet.

### III. PROFESSIONAL TIME REPORTING

Reexamination fees are based on full cost recovery, and it is essential that all time expended on reexamination activities be reported accurately. Thus, examiners, supervisory patent examiners (SPEs), special program examiners (SPREs), and paralegals should

report all time spent on reexamination on their individual Time and Attendance Report.

Examiners, SPEs, SPREs and paralegals will use the following Project Codes to report their time for reexamination activities on their Biweekly Time Worksheets (PTO-690 forms) by making appropriate entries in the space for reexamination:



<b>Person</b>	<b>Activity</b>	<b>Charge Code</b>
<u>Examiner</u> (prior to order denial)	Examination activity prior to the <i>inter partes</i> reexamination order or denial.	1121-01
<u>Examiner</u> (after reexam order)	All examination activity after the <i>inter partes</i> reexamination order (including all conference times).	1121-02
<u>Examiner Conferee</u> in Patentability Review Conference	Conferee examiner's patentability review conference time in the <i>inter partes</i> reexamination.	1121-08
<u>Examiner Conferee</u> in Appeal Conference	Conferee-examiner's appeal conference time in the <i>inter partes</i> reexamination.	1121-06
<u>Supervisory Patent Examiner</u> (SPE)	<u>All time</u> applied to the <i>inter partes</i> reexamination, including training and review of examiner activity, and participation in any conferences.	1121-03
<u>Special Program Examiner</u> (SPRE) and Paralegal Specialist	All time applied to the <i>inter partes</i> reexamination, including participation in any conferences.	1121-04

Where the first Office action accompanies the decision on the request granting reexamination, the examiner will estimate how much time was devoted to the preparation of each of the Office action and the decision on the request, and thereby allocate the time entered for codes 1121-01 and 1121-02 accordingly.

Note that TC SPREs and paralegals will use 1121-04 as the code to report all their time (including participation in appeal and patentability review conferences) for *inter partes* reexamination activities on the Biweekly Time Worksheet Paralegal/Special Program Examiner, PTO-690 P/S.

## 2640 Decision on Request [Added R-2]

### 35 U.S.C. 312. Determination of issue by Director

(a) REEXAMINATION.— Not later than 3 months after the filing of a request for *inter partes* reexamination under section 311, the Director shall determine whether a substantial new question of patentability affecting any claim of the patent concerned is raised by the request, with or without consideration of other patents or printed publications. The existence of a substantial new question of patentability is not precluded by the fact that a patent or printed publication was previously cited by or to the Office or considered by the Office.

(b) RECORD.— A record of the Director's determination under subsection (a) shall be placed in the official file of the patent, and a copy shall be promptly given or mailed to the owner of record of the patent and to the third-party requester.

(c) FINAL DECISION.— A determination by the Director under subsection (a) shall be final and non-appealable. Upon a determination that no substantial new question of patentability has been raised, the Director may refund a portion of the *inter partes* reexamination fee required under section 311.

### 37 CFR 1.923. Examiner's determination on the request for *inter partes* reexamination.

Within three months following the filing date of a request for *inter partes* reexamination under § 1.919, the examiner will consider the request and determine whether or not a substantial new question of patentability affecting any claim of the patent is raised by the request and the prior art citation. The examiner's determination will be based on the claims in effect at the time of the determination, will become a part of the official file of the patent, and will be mailed to the patent owner at the address as provided for in § 1.33(c) and to the third party requester. If the examiner determines that no substantial new question of patentability is present, the examiner shall refuse the request and shall not order *inter partes* reexamination.

### 37 CFR 1.925. Partial refund if request for *inter partes* reexamination is not ordered.

Where *inter partes* reexamination is not ordered, a refund of a portion of the fee for requesting *inter partes* reexamination will be made to the requester in accordance with § 1.26(c).

### 37 CFR 1.927. Petition to review refusal to order *inter partes* reexamination

The third party requester may seek review by a petition to the Director under § 1.181 within one month of the mailing date of the examiner's determination refusing to order *inter partes* reexamination. Any such petition must comply with § 1.181(b). If no petition is timely filed or if the decision on petition affirms that no substantial new question of patentability has been raised, the determination shall be final and nonappealable.

Prior to making a determination on the request for reexamination, the examiner must request a litigation computer search by the Scientific and Technical Information Center (STIC) to check if the patent has been, or is, involved in litigation. The "Litigation Review" box on the reexamination file wrapper should be completed to indicate that the review was conducted and the results thereof. A copy of the STIC search should be hole-punched and placed in the reexamination file. In the rare instance where the record of the reexamination proceeding or the STIC search indicates that additional information is desirable, guidance as to making an additional litigation search may be obtained from the library of the Office of the Solicitor. If the patent is or was involved in litigation, and a paper referring to the Court proceeding has been filed, reference to the paper by number should be made in the "Litigation Review" box as, for example, "litigation; see paper #1C." If a litigation records search is already noted on the file, the examiner need not repeat or update it.

If litigation has concluded or is taking place in the patent on which a request for reexamination has been filed, the request must be promptly brought to the attention of the Reexamination Legal Advisor assigned to the case who should review the decision on the request and any examiner's action to ensure conformance to the current Office litigation policy and guidelines. See MPEP § 2686.04.

35 U.S.C. 312 requires that the Director of the Office determine whether or not a "substantial new question of patentability" affecting any claim of the patent of which reexamination is desired, is raised in the request not later than 3 months after the filing date of a request. See also MPEP § 2641. Such a determination may be made with or without consideration of other patents or printed publications in addition to those cited in the request. No input from the patent owner is considered prior to the determination. See

*Patlex v. Mossinghoff*, 771 F.2d 480, 226 USPQ 985 (Fed. Cir. 1985).

The patent claims in effect at the time of the determination will be the basis for deciding whether a substantial new question of patentability has been raised (37 CFR 1.923). See MPEP § 2643. Amendments which (A) have been filed in a copending reexamination proceeding in which the reexamination certificate has not been issued, or (B) have been submitted in a reissue application on which no reissue patent has been issued, will not be considered or commented upon when deciding a request for reexamination.

The decision on the request for reexamination has as its main object either the granting or denial of the request for reexamination. This decision is based on whether or not “a substantial new question of patentability” is found. A final finding as to unpatentability of the claims is **not** made in the decision; rather, it is made later, during the examination stage of the reexamination proceeding. Accordingly, no *prima facie* case of unpatentability need be found to grant an order for reexamination. It should be noted that a decision to deny the request for reexamination is equivalent to a final holding (subject to a petition pursuant to 37 CFR 1.927 for review of the denial), that the patent claims are patentable over the cited art (patents and printed publications).

Where there have been prior decisions relating to the patent, see MPEP § 2642.

It is only necessary to establish that a substantial new question of patentability exists as to one of the patent claims in order to order reexamination. In the examination stage of the reexamination, usually **all** patent claims will be examined, even though the order found a substantial new question of patentability only as to (for example) one of the patent claims. Where, however, there has been a prior Federal Court decision as to some claims, see MPEP § 2642 as to whether those claims are examined.

Where there have been prior decisions relating to the patent, see MPEP § 2642.

It is only necessary to establish that a substantial new question of patentability exists as to one of the patent claims in order to order reexamination. In the examination stage of the reexamination, usually **all** patent claims will be examined, even though the order found a substantial new question of patentability only

as to (for example) one of the patent claims. Where, however, there has been a prior Federal Court decision as to some claims, see MPEP § 2642 as to whether those claims are examined.

The decision on the request for reexamination should discuss all the patent claims. The examiner should limit the discussion of the claims to whether or not a substantial new question of patentability has been raised; the examiner **SHOULD NOT** reject claims in the order for reexamination. Rather, any rejection of the claims will be made in the first Office action that normally will accompany the order for reexamination. See MPEP § 2660.

The Director of the Office has the authority to order reexamination only in those cases which raise a substantial new question of patentability. The substantial new question of patentability requirement protects patentees from having to respond to, or participate in, unjustified reexaminations. See *Patlex v. Mossinghoff*, 771 F.2d 480, 226 USPQ 985, 989 (Fed. Cir. 1985).

## **I. REQUEST FOR REEXAMINATION OF THE PATENT AFTER REISSUE OF THE PATENT**

Where a request for reexamination is filed on a patent after a reissue patent for that patent has already issued, reexamination will be denied, because the patent on which the request for reexamination is based has been surrendered. Should reexamination of the reissued patent be desired, a new request for reexamination, including and based on the specification and claims of the reissue patent, must be filed. Where the reissue patent issues after the filing of a request for reexamination, see MPEP § 2686.03.

## **II. SECOND OR SUBSEQUENT REQUEST FILED DURING REEXAMINATION**

See MPEP § 2686.01 for a comprehensive discussion of the situation where a first reexamination is pending at the time a second or subsequent request for reexamination is to be decided, and one of the two is an *inter partes* reexamination. The present subsection merely provides guidance on the standard for the substantial new question of patentability to be applied in the decision on the second or subsequent request.

If a second or subsequent request for reexamination is filed (by any party permitted to do so) while a first reexamination is pending, the presence of a substantial new question of patentability depends on the art (patents and printed publications) cited by the second or subsequent request. The cited art will be reviewed for a substantial new question of patentability based on the following guidelines:

**A. *If one of the two reexaminations is an inter partes reexamination, the following possibilities exist:***

(1) An ordered *inter partes* reexamination is pending, and an *ex parte* reexamination request is subsequently filed.

(2) An ordered *inter partes* reexamination is pending, and an *inter partes* reexamination request is subsequently filed.

(3) An ordered *ex parte* reexamination is pending, and an *inter partes* reexamination request is subsequently filed.

In all three instances, if the subsequent request includes the art which raised a substantial new question in the earlier pending reexamination, then reexamination should be ordered only if the art cited raises a substantial new question of patentability which is different than that raised in the earlier pending reexamination. If the art cited in the subsequent request raises the same substantial new question of patentability as that raised in the earlier pending reexamination, the subsequent request should be denied. If the subsequent request does **not** include the art which raised the substantial new question of patentability in the earlier pending reexamination, reexamination may or may not be ordered, depending on whether the different art cited raises a substantial new question of patentability.

In an aggravated situation, where reexamination is granted on a second or subsequent request, but the patent owner can clearly show that the second or subsequent request was filed for purposes of harassment, the patent owner *can petition under 37 CFR 1.182* that the second or subsequent request should be suspended. If such a petition is granted, prosecution on the second or subsequent reexamination would be suspended until termination of proceedings in the first reexamination. In such an instance, merger of the second (or subsequent) reexamination with the first

would unduly prolong the conclusion of the pending reexamination and be inconsistent with the requirement that the reexamination proceeding be conducted with special dispatch.

Where an ordered *inter partes* reexamination is pending, and an *inter partes* reexamination request is subsequently filed, the prohibition provision of 37 CFR 1.907(a) must be borne in mind. Once an order for *inter partes* reexamination has been issued, neither the third party requester of the *inter partes* reexamination, nor its privies, may file a subsequent request for *inter partes* reexamination of the patent until an *inter partes* reexamination certificate has been issued, unless expressly authorized by the Director of the Office. Note that 37 CFR 1.907(a) tracks the statutory provision of 35 U.S.C. 317(a).

## **2641 Time for Deciding Request [Added R-2]**

The determination of whether or not to reexamine must be made (completed and mailed) not later than three (3) months after the filing date of a request. See 35 U.S.C. 312(a) and 37 CFR 1.923. *If the 3-month period ends on a Saturday, Sunday or Federal holiday within the District of Columbia*, then the determination must be mailed by the ***preceding*** business day.

Generally, the Central Reexamination Unit (CRU) forwards the *inter partes* reexamination case to the Technology Center (TC) Special Program Examiner (SPRE) within two (2) weeks of the filing date of the request. The SPRE processes the case as needed and delivers it to the appropriate Supervisory Patent Examiner (SPE) for docketing of the case to an appropriate examiner.

(A) The examiner has one (1) week from his/her receipt of the reexamination case to prepare for an initial consultation conference with a Reexamination Legal Advisor (RLA).

After the consultation with the RLA, the examiner has two (2) weeks from the date of the consultation conference to prepare the decision on the request and an Office action (if reexamination is granted), and forwards the case to the TC SPRE.

The decision and the action will be reviewed by the SPRE and the case will be forwarded (hand carried) to the CRU.

(B) **At the very latest**, the decision and action prepared by the examiner must be forwarded (hand carried) by the SPRE to the CRU within nine (9) weeks from the filing date of the request.

(C) It should be noted that the first Office action ordinarily accompanies an order for reexamination; however, if the issuance of the first Office action would delay the order to the extent that a critical deadline will not be met, the order will be mailed and the first action will follow in due course, as per the guidance set forth in MPEP § 2660.

## 2642 Criteria for Deciding Request [Added R-2]

### I. SUBSTANTIAL NEW QUESTION OF PATENTABILITY

The presence or absence of “a substantial new question of patentability” determines whether or not reexamination is ordered. The meaning and scope of the term “a substantial new question of patentability” is not defined in the statute and must be developed to some extent on a case-by-case basis, using the case law to provide guidance as will be discussed in this section.

If the prior art patents and printed publications raise a substantial question of patentability of at least one claim of the patent, then a substantial new question of patentability is present, unless the same question of patentability has already been decided by (A) a final holding of invalidity, after all appeals, or (B) by the Office in a previous examination or pending reexamination of the patent. A “previous examination” of the patent is: (A) the original examination of the application which matured into the patent; (B) the examination of the patent in a reissue application that has resulted in a reissue of the patent; or (C) the examination of the patent in an earlier concluded reexamination. The answer to the question of whether a “substantial new question of patentability” exists, and therefore whether reexamination may be had, is decided by the Director of the Office, and as 35 U.S.C. 312(c) provides, that determination is final, i.e., not subject to appeal on the merits of the decision. See *In re Etter*, 756 F.2d 852, 225 USPQ 1 (Fed. Cir. 1985) which was decided for the *ex parte* reexamination statute (note that 35 U.S.C. 312(c) for the *inter partes* reexamination statute contains the same lan-

guage as 35 U.S.C. 303(c) for *ex parte* reexamination).

A prior art patent or printed publication raises a substantial question of patentability where there is a substantial likelihood that a reasonable examiner would consider the prior art patent or printed publication **important** in deciding whether or not the claim is patentable. If the prior art patents and/or publications would be considered important, then the examiner should find “a substantial new question of patentability” unless the same question of patentability has already been decided as to the claim in a final holding of invalidity by the Federal court system or by the Office in a previous examination. For example, the same question of patentability may have already been decided by the Office where the examiner finds the additional (newly provided) prior art patents or printed publications to be merely cumulative to similar prior art already fully considered by the Office in a previous examination of the claim.

Accordingly, for “a substantial new question of patentability” to be present, it is only necessary that:

(A) The prior art patents and/or printed publications raise a substantial question of patentability regarding at least one claim, i.e., the teaching of the prior art patents and printed publications is such that a reasonable examiner would consider the teaching to be **important** in deciding whether or not the claim is patentable; and

(B) The same question of patentability as to the claim has not been decided by the Office in a previous examination or pending reexamination of the patent or in a final holding of invalidity by the Federal Courts in a decision on the merits involving the claim.

It is not necessary that a “*prima facie*” case of unpatentability exist as to the claim in order for “a substantial new question of patentability” to be present as to the claim. Thus, “a substantial new question of patentability” as to a patent claim could be present even if the examiner would not necessarily reject the claim as either anticipated by, or obvious in view of, the prior art patents or printed publications. The difference between “a substantial new question of patentability” and a “*prima facie*” case of unpatentability is important. See generally *In re Etter*, 756 F.2d 852, 857 n.5, 225 USPQ 1, 4 n.5 (Fed. Cir. 1985).

It should be noted that the “substantial new question of patentability” standard for granting reexamination on a request for an *inter partes* reexamination is the same as the “substantial new question of patentability” standard for granting reexamination on a request for an *ex parte* reexamination.

## II. POLICY IN SPECIFIC SITUATIONS

In order to further clarify the meaning of “a substantial new question of patentability,” certain situations are outlined below which, if present, should be considered when making a decision as to whether or not “a substantial new question of patentability” is present.

### A. *Prior Favorable Decisions by the U.S. Patent and Trademark Office on the Same or Substantially Identical Prior Art in Relation to the Same Patent.*

A “substantial new question of patentability” is not raised by the prior art if the Office has previously considered (in an earlier examination of the patent) the same question of patentability as to a patent claim favorable to the patent owner based on the same prior art patents or printed publications. *In re Recreative Technologies*, 83 F.3d 1394, 38 USPQ2d 1776 (Fed. Cir. 1996).

In deciding whether to grant a request for reexamination of a patent, the examiner should check the patent’s file history to ascertain whether any of the prior art now advanced by requester *was* previously cited/considered in an earlier concluded Office examination of the patent (e.g., in the examination of the application for the patent). For the sake of expediency, such art is referred to as “old art” throughout, since the term “old art” was coined by the Federal Circuit in its decision of *In re Hiniker Co.*, 150 F.3d 1362, 1365-66, 47 USPQ2d 1523, 1526 (Fed. Cir. 1998).

In a decision to order reexamination made on or after November 2, 2002, reliance on old art does not necessarily preclude the existence of a substantial new question of patentability (SNQ) that is based exclusively on that old art. See Public Law 107-273, 116 Stat. 1758, 1899-1906 (2002), which expanded the scope of what qualifies for a substantial new question of patentability upon which a reexamination may be based. Determinations on whether a SNQ exists in

such an instance shall be based upon a fact-specific inquiry done on a case-by-case basis. For example, a SNQ may be based solely on old art where the old art is being presented/viewed in a new light, or in a different way, as compared with its use in the earlier concluded examination(s), in view of a material new argument or interpretation presented in the request.

When it is determined that a SNQ based solely on old art is raised, form paragraph 22.01.01 should be included in the order for reexamination.

#### ¶ 22.01.01 *Criteria for Applying “Old Art” as Sole Basis for Reexamination*

The above [1] is based solely on patents and/or printed publications already cited/considered in an earlier concluded examination of the patent being reexamined. On November 2, 2002, Public Law 107-273 was enacted. Title III, Subtitle A, Section 13105, part (a) of the Act revised the reexamination statute by adding the following new last sentence to 35 U.S.C. 303(a) and 312(a):

“The existence of a substantial new question of patentability is not precluded by the fact that a patent or printed publication was previously cited by or to the Office or considered by the Office.”

For any reexamination ordered on or after November 2, 2002, the effective date of the statutory revision, reliance on previously cited/considered art, i.e., “old art,” does not necessarily preclude the existence of a substantial new question of patentability (SNQ) that is based exclusively on that old art. Rather, determinations on whether a SNQ exists in such an instance shall be based upon a fact-specific inquiry done on a case-by-case basis.

In the present instance, there exists a SNQ based solely on [2]. A discussion of the specifics now follows:

[3]

#### **Examiner Note:**

1. In bracket 1, insert “substantial new question of patentability” if the present form paragraph is used in an order granting reexamination (or a TC Director’s decision on petition of the denial of reexamination). If this form paragraph is used in an Office action, insert “ground of rejection”.
2. In bracket 2, insert the old art that is being applied as the sole basis of the SNQ. For example, “the patent to Schor” or “the patent to Schor when taken with the Jones publication” or “the combination of the patent to Schor and the Smith publication” could be inserted. Where more than one SNQ is presented based solely on old art, the examiner would insert all such bases for SNQ.
3. In bracket 3, for each basis identified in bracket 2, explain how and why that fact situation applies in the proceeding being acted on. The explanation could be for example that the old art is being presented/viewed in a new light, or in a different way, as compared with its use in the earlier concluded examination(s), in view of a material new argument or interpretation presented in the request. See *Ex parte Chicago Rawhide Mfg. Co.*, 223 USPQ 351 (Bd. Pat. App. & Inter. 1984).

4. This form paragraph is only used the first time the “already cited/considered” art is applied, and is not repeated for the same art in subsequent Office actions.

See MPEP § 2258.01 for a discussion of the use of “old art” in the examination stage of an ordered reexamination (as a basis for rejecting patent claims).

**B. *Prior Adverse Decisions by the Office on the Same or Substantially Identical Prior Art in the Same Patent.***

A prior decision adverse to the patentability of a claim of a patent by the Office based upon prior art patents or printed publications would usually mean that “a substantially new question of patentability” is present. Such an adverse decision by the Office could arise from a reissue application which was abandoned after rejection of the claim and without disclaiming the patent claim.

**C. *Prior Adverse Reissue Application Final Decision by the Director of the Office or the Board of Patent Appeals and Interferences Based Upon Grounds Other Than Patents or Printed Publications.***

Any prior adverse final decision by the Director of the Office, or the Board of Patent Appeals and Interferences, on an application seeking to reissue the same patent on which reexamination is requested will be considered by the examiner when determining whether or not a “substantial new question of patentability” is present. To the extent that such prior adverse final decision was based upon grounds other than patents or printed publications, the prior adverse final decision will not be considered in determining whether or not a “substantial new question of patentability” is present.

**D. *Prior Favorable or Adverse Decisions on the Same or Substantially Identical Prior Art Patents or Printed Publications in Other Cases not Involving the Patent.***

While the Office would consider decisions involving substantially identical patents or printed publications in determining whether a “substantial new question of patentability” is raised, the weight to be given such decisions will depend upon the circumstances.

**IV. POLICY WHERE A FEDERAL COURT DECISION HAS BEEN ISSUED ON THE PATENT**

As to A - C which follow, see *Ethicon v. Quigg*, 849 F.2d 1422, 7 USPQ2d 1152 (Fed. Cir. 1988).

**A. *Final Holding of Validity by the Courts.***

When the initial question as to whether the prior art raises a substantial new question of patentability as to a patent claim is under consideration, the existence of a final court decision of claim *validity* in view of the same or different prior art does not necessarily mean that no new question is present, because of the different standards of proof employed by the Federal District Courts and the Office. While the Office may accord deference to factual findings made by the court, the determination of whether a substantial new question of patentability exists will be made independently of the court’s decision on validity, because it is not controlling on the Office.

**B. *Non-final Holding of Invalidity or Unenforceability by the Courts.***

A *non-final* holding of claim invalidity or unenforceability will not be controlling on the question of whether a substantial new question of patentability is present.

**C. *Final Holding of Invalidity or Unenforceability by the Courts.***

A final holding of claim invalidity or unenforceability, after all appeals, is controlling on the Office. In such cases, a substantial new question of patentability would not be present as to the claims finally held invalid or unenforceable.

**Note:** Any situations requiring clarification should be brought to the attention of the Office of Patent Legal Administration.

**2643 Claims Considered in Deciding Request [Added R-2]**

The claims in effect at the time of the determination will be the basis for deciding whether “a substantial new question of patentability” is present. 37 CFR 1.923. While the examiner will ordinarily concentrate on those claims for which reexamination is requested, the finding of “a substantial new question

of patentability” can be based upon a claim of the patent other than the ones for which reexamination is requested. For example, the request might seek reexamination of particular claims (i.e., claims 1-4), but the examiner is not limited to those claims. The examiner can make a determination that “a substantial new question of patentability” is present as to other claims in the patent (i.e., claims 5-7), without necessarily finding “a substantial new question” with regard to the claims requested (i.e., claims 1-4). If a substantial new question of patentability is found as to any claim, reexamination will be ordered and will normally cover all claims except for claims that have been finally held invalid in a Federal Court decision on the merits. The decision on the request should discuss all patent claims in order to inform the patent owner of the examiner’s position. See MPEP § 2642 for patent claims which have been the subject of a prior decision.

Amendments and/or new claims present in any copending reexamination or reissue proceeding for the patent (to be reexamined) will not be considered nor commented upon when deciding a request for reexamination. Accordingly, a request is decided on the wording of the claims without any amendment. Where a request for reexamination is granted and reexamination is ordered, the first Office action (which ordinarily accompanies the order) and any subsequent reexamination prosecution should be on the basis of the claims as amended by any copending reexamination or reissue proceeding.

## **2644 Prior Art on Which the Determination Is Based [Added R-2]**

The determination of whether or not “a substantial new question of patentability” is present can be based upon any prior art patents or printed publications. 35 U.S.C. 312(a) provides that the determination on a request will be made “with or without consideration of other patents or printed publications,” i.e., other than those relied upon in the request. The examiner is not limited in making the determination based on the patents and printed publications relied upon in the request. The examiner can find “a substantial new question of patentability” based upon the prior art patents or printed publications relied upon in the request, a combination of the prior art relied upon in the request and other prior art found elsewhere, or based

entirely on different patents or printed publications. The primary source of patents and printed publications used in making the determination are those relied on in the request. For reexamination ordered on or after November 2, 2002, see MPEP § 2642, subsection II.A. for a discussion of “old art.” The examiner can also consider any patents and printed publications of record in the patent file from submissions under 37 CFR 1.501 which are in compliance with 37 CFR 1.98 in making the determination. If the examiner believes that additional prior art patents and publications can be readily obtained by searching to supply any deficiencies in the prior art cited in the request, the examiner can perform such an additional search. Such a search should be limited to that area most likely to contain the deficiency of the prior art previously considered and should be made only where there is a reasonable likelihood that prior art can be found to supply any deficiency necessary to “a substantial new question of patentability.”

The determination should be made on the claims in effect at the time the determination is made. 37 CFR 1.923.

## **2646 Decision Ordering Reexamination [Added R-2]**

*35 U.S.C. 313. Inter partes reexamination order by Director*

If, in a determination made under section 312(a), the Director finds that a substantial new question of patentability affecting a claim of a patent is raised, the determination shall include an order for inter partes reexamination of the patent for resolution of the question. The order may be accompanied by the initial action of the Patent and Trademark Office on the merits of the inter partes reexamination conducted in accordance with section 314.

*37 CFR 1.931. Order for inter partes reexamination*

(a) If a substantial new question of patentability is found, the determination will include an order for *inter partes* reexamination of the patent for resolution of the question.

(b) If the order for *inter partes* reexamination resulted from a petition pursuant to § 1.927, the *inter partes* reexamination will ordinarily be conducted by an examiner other than the examiner responsible for the initial determination under § 1.923.

If the request is granted, the examiner’s decision on the request will conclude that a substantial new question of patentability has been raised by (A) identifying all claims and issues, (B) identifying the patents and/or printed publications relied upon, and (C) providing



a brief statement of the rationale supporting each new question.

In the examiner's decision, the examiner must identify at least one substantial new question of patentability and explain how the prior art patents and/or printed publications raise that question. In a simple case, this may entail adoption of the reasons provided by the third party requester. The references relied on by the examiner should be cited on a PTO-892 form, unless already listed on a form PTO-1449 submitted by the third party requester. A copy of the reference should be supplied only where it has not been previously supplied to the patent owner and third party requester.

As to each substantial new question of patentability identified in the decision, the decision should point out:

(A) The prior art patents and printed publications which add some new teaching as to at least one claim;

(B) What that new teaching is;

(C) The claims that the new teaching is directed to;

(D) That the new teaching was not previously considered nor addressed in the prior examination of the patent or a final holding of invalidity by the Federal Courts;

(E) That the new teaching is such that a reasonable examiner would consider the new teaching to be important in deciding to allow the claim being considered; and

(F) Where the question is raised, or where it is not clear that a patent or printed publication pre-dates the patent claims, a discussion should be provided as to why the patent or printed publication is deemed to be available against the patent claims.

If arguments are raised by the third party requester as to grounds not based on patents or printed publications, such as those based on public use or on sale under 35 U.S.C. 102(b), or abandonment under 35 U.S.C. 102(c), the examiner should note that such grounds are improper for reexamination and are not considered or commented upon. See 37 CFR 1.906(c).

In the decision on the request, the examiner will not decide, and no statement should be made as to, whether the claims are rejected over the patents and printed publications. The examiner does not decide on the question of patentability of the claims in the deci-

sion on the request. The examiner only decides whether there is a substantial new question of patentability to grant the request to order reexamination.

The decision granting the request is made using form PTOL-2063 as a cover sheet. See MPEP § 2647.01 for an example of a decision granting a request for *inter partes* reexamination.

Form Paragraph 26.01 should be used at the end of each decision letter granting reexamination.

#### ¶ 26.01 New Question of Patentability

A substantial new question of patentability affecting claim [1] of United States Patent Number [2] is raised by the present request for *inter partes* reexamination.

Extensions of time under 37 CFR 1.136(a) will not be permitted in *inter partes* reexamination proceedings because the provisions of 37 CFR 1.136 apply only to "an applicant" and not to the patent owner in a reexamination proceeding. Additionally, 35 U.S.C. 314(c) requires that *inter partes* reexamination proceedings "will be conducted with special dispatch" (37 CFR 1.937). Patent owner extensions of time in *inter partes* reexamination proceedings are provided for in 37 CFR 1.956. Extensions of time are not available for third party requester comments, because a comment period of 30 days from service of patent owner's response is set by statute. 35 U.S.C. 314(b)(3).

Upon determination that a substantial new question of patentability is present pursuant to a request under 35 U.S.C. 311, an order to reexamine is issued pursuant to 35 U.S.C. 313 which provides:

[T]he determination [that a substantial new question of patentability is raised] shall include an order for *inter partes* reexamination of the patent for resolution of the question. [35 U.S.C. 313, first sentence]

### I. PETITION TO VACATE THE ORDER GRANTING REEXAMINATION

A substantive determination by the Director of the Office to institute reexamination pursuant to a finding that the prior art patents or printed publications raise a substantial new question of patentability is not subject to review by petition or otherwise. See *Joy Mfg. Co. v. Nat'l Mine Serv. Co., Inc.*, 810 F.2d 1127, 1 USPQ2d 1627 (Fed. Cir. 1987); *Heinl v. Godici*, 143 F.Supp. 2d 593 (E.D. Va. 2001). Note further the decision of *Patlex Corp. v. Quigg*, 6 USPQ2d 1296, 1298 (D.D.C. 1988) (the legislative scheme leaves the Director's 35 U.S.C. 303 determination entirely to his discretion and not subject to judicial review). These decisions were rendered for *ex parte* reexamination; however, the holdings of these decisions apply equally in *inter*

*partes* reexamination proceedings, since the language of 35 U.S.C. 302(c) (i.e., the *ex parte* reexamination statute) is also found in 35 U.S.C. 312(c) (i.e., the *inter partes* reexamination statute). Because the substantive determination is not subject to review by petition or otherwise, neither the patent owner nor the third party requester has a right to petition, or request reconsideration of, a finding that the prior art patents or printed publications raise a substantial new question. There is no right to petition such a finding even if the finding of a substantial new question is based on reasons other than those urged by the third party requester (or based on less than all the grounds urged by the third party requester). Where the examiner determines that a date of a reference is early enough such that the reference constitutes prior art, that determination is not petitionable (with respect to vacating the examiner's finding of a substantial new question). Where the examiner determines that a reference is a printed publication (i.e., that the criteria for publication has been satisfied), that determination is also not petitionable. These matters cannot be questioned with respect to vacating the order granting reexamination until a final agency decision on the reexamination proceeding has issued. Rather, these matters can be argued by the patent owner and appealed during the examination phase of the reexamination proceeding.

A petition under 37 CFR 1.181 may, however, be filed to vacate an *ultra vires* reexamination order, such as where the order for reexamination is not based on prior art patents and printed publications. In cases where no discretion to grant a request for reexamination exists, a petition to vacate the decision to grant, or a request for reconsideration, will be entertained. "Appropriate circumstances" under 37 CFR 1.181(a)(3) exist to vacate the order granting reexamination where, for example:

(A) the reexamination order is not based on prior art patents or printed publications;

(B) reexamination is prohibited under 37 CFR 1.907;

(C) all claims of the patent were held to be invalid by a final decision of a Federal Court after all appeals;

(D) reexamination was ordered for the wrong patent;

(E) reexamination was ordered based on a duplicate copy of the request; or

(F) the reexamination order was based **wholly** on the same question of patentability raised by the prior art *previously considered* in an earlier concluded examination of the patent by the Office (e.g., the application which matured into the patent, a prior reexamination, an interference proceeding).

As to (F), the decision of *In re Recreative Technologies Corp.*, 83 F.3d 1394, 38 USPQ2d 1776 (Fed. Cir. 1996) is to be noted. See the discussion in MPEP § 2642, subsection II.A. as to the criteria for vacating a reexamination order in view of the decisions.

When a petition under 37 CFR 1.181 is filed to vacate a reexamination order, the third party requester may file a single submission in opposition to the petition. Because reexamination proceedings are conducted with special dispatch, 35 U.S.C. 314(c), any such opposition by the third party requester must be filed within two weeks of the date upon which a copy of the original 37 CFR 1.181 petition was served on the third party requester to ensure consideration. It is advisable that, upon receipt and review of the served copy of such a 37 CFR 1.181 petition which the third party requester intends to oppose, the requester should immediately place a courtesy telephone call to the Special Program Examiner (SPRE) in the Technology Center (TC) in which the reexamination proceeding is pending to notify the Office that an opposition to the 37 CFR 1.181 petition will be filed. Whenever possible, filing of the opposition should be submitted by facsimile transmission.

The filing of a 37 CFR 1.181 petition to vacate an *ultra vires* reexamination order is limited to a single submission, even if an opposition thereto is filed by a third party requester.

## II. PRIOR ART SUBMITTED AFTER THE ORDER

Any prior art citations under 37 CFR 1.501 submitted after the date of the decision ordering *inter partes* reexamination should be retained in a separate file by the TC (usually the TC SPRE) and stored until the reexamination proceeding is terminated, at which time the prior art citation is then entered of record in the patent file. See MPEP § 2206. Note that 37 CFR 1.902 governs submissions of prior art that can be made by *patent owners* and *third party requesters* after reexamination has been ordered.

## 2647 Decision Denying Reexamination [Added R-2]

The request for reexamination will be denied if a substantial new question of patentability is not found based on patents or printed publications.

If the examiner concludes that no substantial new question of patentability has been raised, the examiner should prepare a decision denying the reexamination request. Form paragraph 26.02 should be used as the introductory paragraph in a decision denying reexamination.

### ¶ 26.02 No New Question of Patentability

No substantial new question of patentability is raised by the present request for *inter partes* reexamination and the prior art cited therein for the reasons set forth below.

The decision will then indicate, for each patent or publication cited in the request, why the citation:

(A) Is cumulative to the teachings of the art cited in the earlier concluded examination of the patent;

(B) Is not available against the claims (e.g., the reference is not available as prior art because of its date or the reference is not a publication);

(C) Would not be important to a reasonable examiner. Even if the citation is available against the claims and it is not cumulative, it still cannot be the basis for a substantial new question of patentability if the additional teaching of the citation would not be important to a reasonable examiner in deciding whether any claim (of the patent for which reexamination is requested) is patentable; or

(D) Is one which was cited in the record of the patent and is barred by the guidelines set forth in MPEP § 2642, subsection II.A.

The examiner should also, in the decision, respond to the substance of each argument raised by the third party requester which is based on patents or printed publications.

If arguments are presented as to grounds not based on prior art patents or printed publications, such as

those based on public use or on sale under 35 U.S.C. 102(b), or abandonment under 35 U.S.C. 102(c), the examiner should note that such grounds are improper for reexamination and are not considered or commented upon. See 37 CFR 1.906(c).

See MPEP § 2647.01 for an example of a decision denying a request for *inter partes* reexamination.

The decision denying the request is mailed by the Central Reexamination Unit (CRU), and the file (after scanning) is stored in the CRU, to await any petition seeking review of the examiner's determination refusing reexamination. If such a petition is not filed within one (1) month of the examiner's determination denying reexamination, the CRU then processes the reexamination file to provide the partial refund set forth in 37 CFR 1.26(c) (the Office of Finance no longer processes reexamination proceedings for a refund). The word "Terminated" is then written in green ink on the face of the file at the top between the word 'Reexamination' and the hand-written patent number. After this CRU processing is carried out, the reexamination file is given a 420 status and then forwarded by the CRU to the files repository unit for storage with the patent file.

In the files repository unit, the reexamination file containing the denied request and the decision thereon are associated with the official patent file, and become part of the patent's record.

### 2647.01 Examples of Decisions on Requests [Added R-2]

Examples of decisions on requests for *inter partes* reexamination are provided below. The first example is a **grant** of an *inter partes* reexamination. The second example is a **denial** of an *inter partes* reexamination. The examiner should leave the paper number blank, and the Central Reexamination Unit (CRU) will insert the appropriate paper number upon mailing.



UNITED STATES PATENT AND TRADEMARK OFFICE

COMMISSIONER FOR PATENTS  
 UNITED STATES PATENT AND TRADEMARK OFFICE  
 P. O. Box 1450  
 ALEXANDRIA, VA 22313-1450  
 www.uspto.gov

CONTROL NO.	FILING DATE	PATENT IN REEXAMINATION	ATTORNEY DOCKET NO.
95/999,999	09/09/09	9,999,999	999

John Able  
 2400 Any Street Road  
 Anytown, VA 22202

EXAMINER	
Kenneth M. Schor	
ART UNIT	PAPER
3725	

DATE MAILED:

**ORDER GRANTING/DENYING REQUEST FOR  
 INTER PARTES REEXAMINATION**

The request for *inter partes* reexamination has been considered. Identification of the claims, the references relied on, and the rationale supporting the determination are attached.

Attachment(s):     PTO-892         PTO-1449         Other: \_\_\_\_\_

1.  The request for *inter partes* reexamination is GRANTED.
- An Office action is attached with this order.
- An Office action will follow in due course.

2.  The request for *inter partes* reexamination is DENIED.

This decision is not appealable. 35 U.S.C. 312(c). Requester may seek review of a denial by petition to the Director of the USPTO within ONE MONTH from the mailing date hereof. 37 CFR 1.927. EXTENSIONS OF TIME ONLY UNDER 37 CFR 1.183. In due course, a refund under 37 CFR 1.26(c) will be made to requester.

**All correspondence** relating to this *inter partes* reexamination proceeding should be directed to the **Central Reexamination Unit** at the mail, FAX, or hand-carry addresses given at the end of this Order.

PTOL-2063 (5/03)

DECISION GRANTING *INTER PARTES* REEXAMINATION

A substantial new question of patentability affecting claims 1-3 of United States Patent Number 9,999,999 to Key is raised by the present request for *inter partes* reexamination.

Extensions of time under 37 CFR 1.136(a) will not be permitted in *inter partes* reexamination proceedings because the provisions of 37 CFR 1.136 apply only to “an applicant” and not to parties in a reexamination proceeding. Additionally, 35 U.S.C. 314(c) requires that *inter partes* reexamination proceedings “will be conducted with special dispatch” (37 CFR 1.937). Patent owner extensions of time in *inter partes* reexamination proceedings are provided for in 37 CFR 1.956. Extensions of time are not available for third party requester comments, because a comment period of 30 days from service of patent owner’s response is set by statute. 35 U.S.C. 314(b)(3).

The patent owner is reminded of the continuing responsibility under 37 CFR 1.985(a), to apprise the Office of any litigation activity, or other prior or concurrent proceeding, involving Patent 9,999,999 throughout the course of this reexamination proceeding. The third party requester is also reminded of the ability to similarly apprise the Office of any such activity or proceeding throughout the course of this reexamination proceeding. See MPEP § 2686 and 2686.04.

The request indicates that the third party requester considers claims 1-3 of the Key patent to be unpatentable over Smith taken with Jones.

The request further indicates that the requester considers claim 4 of the Key patent to be unpatentable over the Horn publication.

It is agreed that the consideration of Smith raises a substantial new question of patentability as to claims 1-3 of the Key patent. As pointed out on pages 2-3 of the request, Smith teaches using an extruder supported on springs at a 30 degree angle to the horizontal but does not teach the specific polymer of claims 1-3 which is extruded. The teaching as to spring-supporting the extruder at 30 degrees was not present in the prosecution of the application which became the Key patent. Further, there is a substantial likelihood that a reasonable examiner would consider this teaching important in deciding whether or not the claim is patentable. Accordingly, Smith raises a substantial new question of patentability as to claims 1-3, which question has not been decided in a previous examination of the Key patent.

The Horn publication does not raise a new question of patentability as to claim 4 because its teaching as to the extrusion die is a substantial equivalent of the teaching of the die by the Dorn patent which was considered in the prosecution of the application which became the Key patent. Further, the request does not present any other new question of patentability as to claim 4, and none has been found. Claim 4 will, however, be reexamined along with claims 1-3 of the Key patent.

All correspondence relating to this *inter partes* reexamination proceeding should be directed:

By Mail to: Mail Stop *Inter Partes* Reexam  
Central Reexamination Unit  
Office of Patent Legal Administration  
United States Patent & Trademark Office  
P.O. Box 1450  
Alexandria, VA 22313-1450

By FAX to: (703) 305-1013  
Central Reexamination Unit

By hand: Central Reexamination Unit  
Crystal Plaza Three-Four, 3D68  
2201 South Clark Place  
Arlington, VA 22202

Any inquiry concerning this communication or earlier communications from the examiner, or as to the status of this proceeding, should be directed to the Central Reexamination Unit at telephone number (703) 308-9692.

\_\_\_\_\_/s/\_\_\_\_\_  
Kenneth M. Schor  
Primary Examiner  
Technology Center 3700



UNITED STATES PATENT AND TRADEMARK OFFICE

COMMISSIONER FOR PATENTS  
 UNITED STATES PATENT AND TRADEMARK OFFICE  
 P.O. Box 1450  
 ALEXANDRIA, VA 22313-1450  
 www.uspto.gov

CONTROL NO.	FILING DATE	PATENT IN REEXAMINATION	ATTORNEY DOCKET NO.
95/999,999	09/09/09	9,999,999	999

John Able  
 2400 Any Street Road  
 Anytown, VA 22202

EXAMINER	
Kenneth M. Schor	
ART UNIT	PAPER
3725	

DATE MAILED:

### ORDER GRANTING/DENYING REQUEST FOR INTER PARTES REEXAMINATION

The request for *inter partes* reexamination has been considered. Identification of the claims, the references relied on, and the rationale supporting the determination are attached.

Attachment(s):  PTO-892  PTO-1449  Other: \_\_\_\_\_

1.  The request for *inter partes* reexamination is GRANTED.

An Office action is attached with this order.

An Office action will follow in due course.

2.  The request for *inter partes* reexamination is DENIED.

This decision is not appealable. 35 U.S.C. 312(c). Requester may seek review of a denial by petition to the Director of the USPTO within ONE MONTH from the mailing date hereof. 37 CFR 1.927. EXTENSIONS OF TIME ONLY UNDER 37 CFR 1.183. In due course, a refund under 37 CFR 1.26(c) will be made to requester.

**All correspondence** relating to this *inter partes* reexamination proceeding should be directed to the **Central Reexamination Unit** at the mail, FAX, or hand-carry addresses given at the end of this Order.

PTOL-2063 (5/03)

DECISION DENYING *INTER PARTES* REEXAMINATION

No substantial new question of patentability is raised by the present request for *inter partes* reexamination for the reasons set forth below.

The request indicates that the third party requester considers claims 1-2 of the Key patent (Patent # 9,999,999) to be unpatentable over Smith taken with Jones.

The request further indicates that the requester considers claim 3 of the Key patent to be unpatentable over Smith taken with Jones and when further taken with the Horn publication.

The claims of the Key patent, for which reexamination is requested, require that an extruder be supported on springs at an angle of 30 degrees to the horizontal, while a specific chlorinated polymer is extruded through a specific extrusion die.

The Smith patent does not raise a substantial new question of patentability as to the Key claims. Smith's teaching as to the extruder being spring-supported at 30 degrees is a substantial equivalent of the teaching of same by the Dorn patent which was considered in the prosecution of the application which became the Key patent.

In the request for reexamination, it is argued that Jones teaches the extrusion die. However, Jones was previously used, in the prosecution of the Key application, to teach the extrusion die. Further, there is no argument in the reexamination request that Jones is being applied in a manner different than it was applied in the prosecution of the Key application.

The Horn publication has been argued to show the connection of the support means to the extruder via bolts, as recited in claim 3 of the Key patent. Although this teaching was not provided in the prosecution of the Key application, the teaching would not be considered to be important to a reasonable examiner in deciding whether or not the Key claims are patentable.

The references set forth in the request have been considered both alone and in combination. They fail to raise a substantial new question of patentability as to any one of the Key patent claims.

In view of the above, the request for reexamination is DENIED.

All correspondence relating to this *inter partes* reexamination proceeding should be directed:

By Mail to: Mail Stop *Inter Partes* Reexam  
Central Reexamination Unit  
Office of Patent Legal Administration  
United States Patent & Trademark Office  
P.O. Box 1450  
Alexandria, VA 22313-1450

By FAX to: (703) 305-1013  
Central Reexamination Unit

By hand: Central Reexamination Unit  
Crystal Plaza Three-Four, 3D68  
2201 South Clark Place  
Arlington, VA 22202



Any inquiry concerning this communication or earlier communications from the examiner, or as to the status of this proceeding, should be directed to the Central Reexamination Unit at telephone number (703) 308-9692.

\_\_\_\_\_/s/\_\_\_\_\_  
\_\_\_\_\_

Kenneth M. Schor  
Primary Examiner  
Technology Center 3700

## 2647.02 Processing of Decision [Added R-2]

After the examiner has prepared the decision (and any Office action to accompany the decision) and signed the typed decision, the case is forwarded to the Technology Center (TC) clerical staff. The TC clerical staff prepares the decision (and any Office action) for mailing, but does not mail it. See MPEP § 2670.

The clerical staff will make a copy of the decision and any Office action for the patent owner and for the third party requester. The clerical staff will also make any copies of references which are needed. Thus, the clerical staff makes 3 copies of any prior art documents not already supplied by the third party requester, one for the file, one for the patent owner, and one for the third party requester.

After the case is prepared for mailing, the case file will be forwarded to the TC Special Program Examiner (SPRE) for review. Thereafter, the TC SPRE will arrange for the file to be PALMed out and **hand-carried** directly to the Central Reexamination Unit (CRU). The file is forwarded to the CRU for review and mailing within nine (9) weeks of the filing date of the request. The decision (and any Office action) is given a general review by a Reexamination Legal Advisor (RLA) and (if proper) mailed by the CRU support staff. The CRU staff prints the heading on the cover page (PTOL-2063) of the decision by using the computer terminal, attaches all parts of the decision, and mails it. Where the first Office action accompanies the decision, the heading is also printed on the cover page (PTOL-2064) of the first Office action, and the first Office action is mailed with the decision.

A transmittal form PTOL-501 with the third party requester's address will be completed (if a copy for mailing is not already in the case file). The transmittal form PTOL-501 is used to forward copies of Office actions and other communications to the third party requester. Whenever an Office action is issued, a copy of this form will be made and attached to a copy of the Office action. The use of this form removes the need to retype the third party requester's address each time a mailing is made.

The original signed copy of the decision, the original signed copy of any first Office action accompany-

ing the decision, and a copy of any prior art enclosed are made of record in the reexamination file.

Where the decision is a grant of reexamination, the first Office action on the merits will ordinarily be prepared and mailed with the order granting reexamination. See MPEP § 2660.

After the CRU mails the decision, the file will be appropriately annotated, update scanning will be effected, and appropriate PALM entries will be made. The file will generally be stored in the central storage area of the CRU.

## 2648 Petition From Denial of Request [Added R-2]

*37 CFR 1.927. Petition to review refusal to order inter partes reexamination.*

The third party requester may seek review by a petition to the Director under § 1.181 within one month of the mailing date of the examiner's determination refusing to order *inter partes* reexamination. Any such petition must comply with § 1.181(b). If no petition is timely filed or if the decision on petition affirms that no substantial new question of patentability has been raised, the determination shall be final and nonappealable.

### PROCESSING OF PETITION UNDER 37 CFR 1.927

Once a request for *inter partes* reexamination has been denied, the reexamination file will be stored in the Central Reexamination Unit (CRU) to await any petition seeking review of the examiner's determination refusing reexamination. If no petition is filed within one (1) month, the CRU will process the reexamination to make a partial refund of the filing fee for requesting reexamination to the third party requester (35 U.S.C. 312(c) and 37 CFR 1.26(c)); the reexamination file is then forwarded to the files repository (Location 9200) for storage with the patent file. If a petition is timely filed, the petition (together with the reexamination file) is forwarded to the office of the Technology Center (TC) Director for decision. The TC Director will then review the examiner's determination that a substantial new question of patentability has not been raised. The TC Director's review will be *de novo*. Each decision by the TC Director will conclude with the following paragraph:

This decision is final and nonappealable. 37 CFR 1.927. No further communication on this matter will be acknowledged or considered.

If the petition is granted, the decision of the TC Director should include a sentence stating that an Office action will be mailed in due course.

The TC Director will sign the decision granting the petition, and then forward the reexamination file, together with the decision, to the CRU for mailing of the decision, update scanning and PALM processing. The reexamination file will then be returned to the supervisory patent examiner (SPE) of the art unit that will handle the reexamination. The SPE will ordinarily reassign the reexamination to another examiner pursuant to 37 CFR 1.931(b), notify the CRU of the assignment so that the new assignment can be entered in the PALM records, and forward the file to the new examiner to prepare a first Office action.

Reassignment to another examiner will be the general rule. Only in exceptional circumstances where no other examiner is available and capable to give a proper examination, will the case remain with the examiner who denied the request. If the denial of the request was signed by the SPE, the reexamination ordered by the TC Director will be assigned to a primary examiner.

Under normal circumstances, the reexamination proceeding will not be reassigned to a SPE, primary examiner, or assistant examiner who was involved in any part of the examination of the patent for which reexamination is requested, or was so-involved in the examination of the parent of the patent. The TC Director can make an exception to this practice and reassign the reexamination proceeding to an examiner involved with the original examination (of the patent) only where unusual circumstances are found to exist. For example, where there are no examiners other than an original examiner of the patent and the examiner who issued the denial with adequate knowledge of the relevant technology, the TC Director may permit reassignment of the reexamination proceeding to an examiner that originally examined the patent.

It should be noted that the requester may seek review of a denial of a request for reexamination only by petitioning the Director of the Office under 37 CFR 1.927 and 1.181 within one (1) month of the mailing date of the decision denying the request for reexamination. Additionally, any request for an extension of the time period to file such a petition from the denial of a request for reexamination can only be entertained by filing a petition under 37 CFR 1.183

with the appropriate fee to waive the time provisions of 37 CFR 1.927.

After the time for petition has expired without a petition having been filed, or a petition has been filed and the decision thereon affirms the denial of the request, a partial refund of the filing fee for the request for reexamination will be made to the third party requester. 35 U.S.C. 312(c) and 37 CFR 1.26(c). A decision on a petition under 37 CFR 1.927 and 1.181 is final and is not appealable.

Except for the limited *ultra vires* exception described in MPEP § 2646, no petition may be filed requesting review of a decision **granting** a request for reexamination even if the decision grants the request for reasons other than those advanced by the third party requester or as to claims other than those for which the third party requester sought reexamination. No right to review exists if reexamination is ordered in such a case, because all claims will be reexamined in view of all prior art during the reexamination under 37 CFR 1.937.

## 2654 Conduct of *Inter Partes* Reexamination Proceedings [Added R-2]

*35 U.S.C. 314. Conduct of inter partes reexamination proceedings*

(a) IN GENERAL.— Except as otherwise provided in this section, reexamination shall be conducted according to the procedures established for initial examination under the provisions of sections 132 and 133. In any inter partes reexamination proceeding under this chapter, the patent owner shall be permitted to propose any amendment to the patent and a new claim or claims, except that no proposed amended or new claim enlarging the scope of the claims of the patent shall be permitted.

(b) RESPONSE.—

(1) With the exception of the inter partes reexamination request, any document filed by either the patent owner or the third-party requester shall be served on the other party. In addition, the Office shall send to the third-party requester a copy of any communication sent by the Office to the patent owner concerning the patent subject to the inter partes reexamination proceeding.

(2) Each time that the patent owner files a response to an action on the merits from the Patent and Trademark Office, the third-party requester shall have one opportunity to file written comments addressing issues raised by the action of the Office or the patent owner's response thereto, if those written comments are received by the Office within 30 days after the date of service of the patent owner's response.

(c) SPECIAL DISPATCH.— Unless otherwise provided by the Director for good cause, all inter partes reexamination proceedings under this section, including any appeal to the Board of

Patent Appeals and Interferences, shall be conducted with special dispatch within the Office.

*37 CFR 1.937. Conduct of inter partes reexamination.*

(a) All *inter partes* reexamination proceedings, including any appeals to the Board of Patent Appeals and Interferences, will be conducted with special dispatch within the Office, unless the Director makes a determination that there is good cause for suspending the reexamination proceeding.

(b) The *inter partes* reexamination proceeding will be conducted in accordance with §§ 1.104 through 1.116, the sections governing the application examination process, and will result in the issuance of an *inter partes* reexamination certificate under § 1.997, except as otherwise provided.

(c) All communications between the Office and the parties to the *inter partes* reexamination which are directed to the merits of the proceeding must be in writing and filed with the Office for entry into the record of the proceeding.

Once *inter partes* reexamination is ordered, a first Office action on the merits will be given (the first Office action will ordinarily be mailed with the order; see MPEP § 2660), and prosecution will proceed. Each time the patent owner responds to an Office action, the third party requester may comment on the Office action and the patent owner response, and thereby participate in the proceeding.

Reexamination will proceed even if the order is returned undelivered. As pointed out in MPEP § 2630, the notice under 37 CFR 1.11(c) is constructive notice to the patent owner, and lack of response from the patent owner will not delay reexamination.

The examination will be conducted in accordance with 37 CFR 1.104, 1.105, 1.110-1.113, 1.115, and 1.116 (35 U.S.C. 132 and 133) and will result in the issuance of a reexamination certificate under 37 CFR 1.997. The proceeding shall be conducted with special dispatch within the Office pursuant to 35 U.S.C. 314(c). The patent owner and the third party requester will be sent copies of all Office actions. Also, the patent owner and the third party requester must serve copies of all their submissions to the Office on each other. Citations of art submitted in the patent file prior to issuance of an order for reexamination will be considered by the examiner during the reexamination.

## **2655 Who Reexamines [Added R-2]**

The examination will ordinarily be conducted by the same patent examiner in the Technology Center (TC) who made the decision on whether the reexamination request should be granted. See MPEP § 2636.

However, if a petition under 37 CFR 1.927 is granted, the reexamination will normally be conducted by another examiner. See MPEP § 2648.

## **2656 Prior Art Patents and Printed Publications Reviewed by Examiner in Reexamination [Added R-2]**

The primary source of prior art will be the patents and printed publications cited in the request for *inter partes* reexamination.

The examiner must also consider patents and printed publications:

(A) cited by another reexamination requester under 37 CFR 1.510 or 37 CFR 1.915;

(B) cited by the patent owner under a duty of disclosure (37 CFR 1.933) in compliance with 37 CFR 1.98;

(C) discovered by the examiner in searching;

(D) of record in the patent file from earlier examination;

(E) of record in the patent file from any 37 CFR 1.501 submission prior to date of an order if it complies with 37 CFR 1.98; and

(F) cited by the third party requester under appropriate circumstances pursuant to 37 CFR 1.948.

The reexamination file must clearly indicate which prior art patents and printed publications the examiner has considered during the examination of the *inter partes* reexamination proceeding.

## **2657 Listing of Prior Art [Added R-2]**

The examiner must list on a form PTO-892, if not already listed on a form PTO-1449, PTO/SB/08A or 08B, or PTO/SB/42 (or on a form having format equivalent to one of these forms), all prior art patents or printed publications which have been properly cited and relied upon by the reexamination requester in the request under 37 CFR 1.915.

The examiner must also list on a form PTO-892, if not already listed on a form PTO-1449, PTO/SB/08A or 08B, or PTO/SB/42 (or on a form having a format equivalent to one of these forms), all prior art patents or printed publications which have been cited in the decision on the request, applied in making rejections or cited as being pertinent during the reexamination proceedings. Such prior art patents or printed

publications may have come to the examiner's attention because they were:

(A) of record in the patent file due to a prior art submission under 37 CFR 1.501 which was received prior to the date of the order;

(B) of record in the patent file as result of earlier examination proceedings as to the patent;

(C) discovered by the examiner during a prior art search; or

(D) submitted pursuant to 37 CFR 1.948.

All citations listed on form PTO-892, and all citations not lined-through on any form PTO-1449, PTO/SB/08A or 08B, or PTO/SB/42 (or on a form having a format equivalent to one of these forms), will be printed on the reexamination certificate under "References cited."

## 2658 Scope of *Inter Partes* Reexamination [Added R-2]

37 CFR 1.906. *Scope of reexamination in inter partes reexamination proceeding.*

(a) Claims in an *inter partes* reexamination proceeding will be examined on the basis of patents or printed publications and, with respect to subject matter added or deleted in the reexamination proceeding, on the basis of the requirements of 35 U.S.C. 112.

(b) Claims in an *inter partes* reexamination proceeding will not be permitted to enlarge the scope of the claims of the patent.

(c) Issues other than those indicated in paragraphs (a) and (b) of this section will not be resolved in an *inter partes* reexamination proceeding. If such issues are raised by the patent owner or the third party requester during a reexamination proceeding, the existence of such issues will be noted by the examiner in the next Office action, in which case the patent owner may desire to consider the advisability of filing a reissue application to have such issues considered and resolved.

*Inter partes* reexamination differs from *ex parte* reexamination in matters of procedure, such as when the third party requester can participate, the types of Office actions and the timing of issuance of the Office actions, and the requirement for identification of the real party in interest. *Inter partes* reexamination also differs from *ex parte* reexamination in the estoppel effect it provides as to the third party requesters and when the initiation of a reexamination is prohibited.

*Inter partes* reexamination **does not**, however, differ from *ex parte* reexamination as to the substance to be considered in the proceeding.

## I. PRIOR ART PATENTS OR PRINTED PUBLICATIONS

Rejections on art in reexamination proceedings may only be made on the basis of prior art patents or printed publications. See MPEP § 2258 and § 2258.01 for a discussion of art rejections in reexamination proceedings based on prior art patents or printed publications. The discussion there includes making double patenting rejections and the use of admissions.

It is to be noted that the decisions cited in MPEP §§ 2258 and 2258.01 for determining the presence or absence of "a substantial new question of patentability" in *ex parte* reexamination proceedings apply equally in *inter partes* reexamination proceedings, since the statutory language relied upon in those decisions, which is taken from the *ex parte* reexamination statute, is also found in the *inter partes* reexamination statute.

## II. COMPLIANCE WITH 35 U.S.C. 112

Where new or amended claims are presented or where any part of the disclosure is amended, the claims of the reexamination proceeding are to be examined for compliance with 35 U.S.C. 112. See MPEP § 2258 for a discussion of the examination in a reexamination proceeding based upon 35 U.S.C. 112.

## III. CLAIMS IN PROCEEDING MUST NOT ENLARGE SCOPE OF THE CLAIMS OF THE PATENT

Where new claims are presented, or where any part of the disclosure is amended, the claims of the *inter partes* reexamination proceeding should be examined under 35 U.S.C. 314, to determine whether they enlarge the scope of the original claims. 35 U.S.C. 314(a) states that "no proposed amended or new claim enlarging the scope of the claims of the patent shall be permitted" in an *inter partes* reexamination proceeding.

### A. *Criteria for Enlargement of the Scope of the Claims*

A claim presented in a reexamination proceeding **enlarges the scope** of the claims of the patent being reexamined where the claim is broader than each and every claim of the patent. See MPEP § 1412.03 for guidance as to when the presented claim is considered

to be a broadening claim as compared with the claims of the patent, i.e., what is broadening and what is not. If a claim is considered to be a broadening claim for purposes of reissue, it is likewise considered to be a broadening claim in reexamination.

### ***B. Amendment of the Specification***

Where the specification is amended in a reexamination proceeding, the examiner should make certain that the amendment to the specification does not enlarge the scope of the claims of the patent. An amendment to the specification can enlarge the scope of the claims by redefining the scope of the terms in a claim, even where the claims are not amended in any respect.

### ***C. Rejection of Claims Where There Is Enlargement***

Any claim which enlarges the scope of the claims of the patent should be rejected under 35 U.S.C. 314(a). Form paragraph 26.03.01 is to be employed in making the rejection.

¶ 26.03.01 *Rejection, 35 U.S.C. 314(a), Claim Enlarges Scope of Patent*

Claim [1] rejected under 35 U.S.C. 314(a) as enlarging the scope of the claims of the patent being reexamined. 35 U.S.C. 314(a) states that “no proposed amended or new claim enlarging the scope of the claims of the patent shall be permitted” in an *inter partes* reexamination proceeding. A claim presented in a reexamination “enlarges the scope” of the patent claims where the claim is broader than the claims of the patent. A claim is broadened if it is broader in any one respect, even though it may be narrower in other respects. [2].

#### **Examiner Note:**

The claim limitations which are considered to broaden the scope should be identified and explained in bracket 2. See MPEP § 2658.

## **IV. OTHER MATTERS**

### ***A. Patent Under Reexamination Subject of a Prior Office or Court Decision***

Where some of the patent claims in a patent being reexamined have been the subject of a prior Office or court decision, see MPEP § 2642. Where other proceedings involving the patent are pending with the

reexamination proceeding, see MPEP § 2686 - § 2686.04.

Patent claims not subject to reexamination because of their prior adjudication by a court should be identified. See MPEP § 2642. For handling a “live” claim dependent on a patent claim not subject to reexamination, see MPEP § 2660.03. All added claims will be examined.

Where grounds set forth in a prior Office or Federal Court decision, are not based on patents or printed publications, yet clearly raise questions as to the claims, the examiner’s Office action should clearly state that the claims have not been examined as to those grounds not based on patents or printed publications nor applicable portions of 35 U.S.C. 112 stated in the prior decision. See 37 CFR 1.906(c). See *In re Knight*, 217 USPQ 294 (Comm’r Pat. 1982). All claims under reexamination should, however, be reexamined on the basis of prior patents and printed publications.

### ***B. All “Live” Claims Are Reexamined During Reexamination***

Although a request for reexamination may not specify all claims as presenting a substantial new question, each “live” claim (i.e., each existing claim not held invalid by a final decision, after all appeals) of the patent will be reexamined. The resulting reexamination certificate will indicate the status of all of the patent claims and any added patentable claims.

### ***C. Restriction Not Proper in Reexamination***

Restriction requirements cannot be made in a reexamination proceeding since no statutory basis exists for restriction in a reexamination proceeding.

### ***D. Ancillary Matters***

There are matters ancillary to reexamination which are necessary and incident to patentability which will be considered. Amendments may be made to the specification to correct, for example, an inadvertent failure to claim foreign priority or the continuing status of the patent relative to a parent application if such correction is necessary to overcome a reference applied against a claim of the patent.

### ***E. Claiming Foreign and Domestic Priority in Reexamination***

The patent owner may obtain the right of foreign priority under 35 U.S.C. 119 (a)-(d) where a claim for priority had been made before the patent was granted, and it is only necessary for submission of the certified copy in the reexamination proceeding to perfect priority. Likewise, patent owner may obtain the right of foreign priority under 35 U.S.C. 119 (a)-(d) where it is necessary to submit for the first time both the claim for priority and the certified copy. However, where it is necessary to submit for the first time both the claim for priority and the certified copy, and the patent to be reexamined matured from a **utility or plant application filed on or after November 29, 2000**, then the patent owner will have to also file a grantable petition for an unintentionally delayed priority claim under 37 CFR 1.55(c). See MPEP § 201.14(a).

Also, patent owner may correct the failure to adequately claim (in the application for the patent to be reexamined) benefit under 35 U.S.C. 120 of an earlier filed copending U.S. patent application. For a patent to be reexamined which matured from a utility or plant applications filed on or after November 29, 2000, the patent owner will have to file a petition for an unintentionally delayed benefit claim under 37 CFR 1.78(a)(3). See MPEP § 201.11.

For a patent to be reexamined which matured from a utility or plant application filed **before** November 29, 2000, the patent owner can correct via reexamination the failure to adequately claim benefit under 35 U.S.C. 119(e) of an earlier filed provisional application. Under no circumstances can a reexamination proceeding be employed to correct or add a benefit claim under 35 U.S.C. 119(e) for a patent matured from a utility or plant application filed on or after November 29, 2000.

No renewal of previously made claims for foreign priority under 35 U.S.C. 119 or domestic benefit under 35 U.S.C. 119(e) or 120, is necessary during reexamination.

### ***F. Correction of Inventorship***

Correction of inventorship may also be made during reexamination. See 37 CFR 1.324 and MPEP § 1481 for petition for correction of inventorship in a patent. If a petition filed under 37 CFR 1.324 is granted, a Certificate of Correction indicating the

change of inventorship will not be issued, because the reexamination certificate that will ultimately issue will contain the appropriate change-of-inventorship information (i.e., the Certificate of Correction is in effect merged with the reexamination certificate).

### ***G. Affidavits in Reexamination***

Affidavits under 37 CFR 1.131 and 1.132 may be utilized in a reexamination proceeding. Note, however, that an affidavit under 37 CFR 1.131 may not be used to “swear back” of a reference patent if the reference patent is claiming the same invention as the patent undergoing reexamination. In such a situation, the patent owner may, if appropriate, seek to raise this issue via an affidavit under 37 CFR 1.130 (see MPEP § 718) or in an interference proceeding via an appropriate reissue application if such a reissue application may be filed (see MPEP § 1449.02).

### ***H. Issues Not Considered in Reexamination***

If questions other than those indicated above (for example, questions of patentability based on public use or on sale, fraud, abandonment under 35 U.S.C. 102(c), etc.) are raised by the third party requester or the patent owner during a reexamination proceeding, the existence of such questions will be noted by the examiner in the next Office action, in which case the patent owner may desire to consider the advisability of filing a reissue application to have such questions considered and resolved. Such questions could arise in a reexamination requester’s 37 CFR 1.915 request or in 37 CFR 1.947 comments by the third party requester.

Note Form paragraph 26.03.

#### *¶ 26.03 Issue Not Within Scope of Inter Partes Reexamination*

It is noted that an issue not within the scope of reexamination proceedings has been raised. [1].The issue will not be considered in a reexamination proceeding. 37 CFR 1.906(c). While this issue is not within the scope of reexamination, the patentee is advised that it may be desirable to consider filing a reissue application provided that the patentee believes one or more claims to be partially or wholly inoperative or invalid.

#### **Examiner Note:**

1. In bracket 1, identify the issues.
2. This paragraph may be used either when the patent owner or the third party requester raises issues such as (but not limited to) public use or on sale, fraud, or abandonment of the invention.

Such issues should not be raised independently by the patent examiner.

If questions of patentability based on public use or on sale, fraud, abandonment under 35 U.S.C. 102(c), etc. are independently discovered by the examiner during a reexamination proceeding but were not raised by the third party requester or the patent owner, the existence of such questions will not be noted by the examiner in an Office action, because 37 CFR 1.906(c) is only directed to such questions “raised by the patent owner or the third party requester”.

### ***I. Request for Reexamination Filed on Patent after it Has Been Reissued***

Where a request for reexamination is filed on a patent after it has been reissued, reexamination will be denied because the patent on which the request for reexamination is based has been surrendered. Should reexamination of the reissued patent be desired, a new request for reexamination including, and based on, the specification and claims of the reissue patent must be filed.

Any amendment made by the patent owner in the prosecution of the reexamination proceeding, should treat the changes made by the granted reissue patent as the text of the patent, and all bracketing and underlining made with respect to the patent as changed by the reissue.

Where the reissue patent issues after the filing of a request for reexamination, see MPEP § 2686.03.

### **2659 *Res Judicata* and Collateral Estoppel in Reexamination Proceedings [Added R-2]**

MPEP § 2642 and § 2686.04 relate to the Office policy controlling the determination on a request for reexamination and the subsequent examination phase of the reexamination, where there has been a Federal Court decision on the merits as to the patent for which reexamination is requested.

Since claims finally held invalid by a Federal Court, after all appeals, will be withdrawn from consideration and not reexamined during a reexamination proceeding, a **rejection** on the grounds of *res judicata* will not be appropriate in reexamination. In situations, where the issue decided in Court did not invalidate claims, but applies in one or more respects to the

claims being reexamined, the doctrine of collateral estoppel may be applied in reexamination to resolve the issue. Thus, for example, where a finding that reference X meets a limitation of a claim was necessary to the final decision of the Court invalidation of claim 5, collateral estoppel would attach to the same limitation in claim 2, which was not invalidated (e.g., because claim 2 contained additional limitations not found in claim 5).

### **2660 First Office Action [Added R-2]**

*37 CFR 1.935. Initial Office action usually accompanies order for inter partes reexamination.*

The order for *inter partes* reexamination will usually be accompanied by the initial Office action on the merits of the reexamination.

*37 CFR 1.104. Nature of examination.*

#### *(a) Examiner's action.*

(1) On taking up an application for examination or a patent in a reexamination proceeding, the examiner shall make a thorough study thereof and shall make a thorough investigation of the available prior art relating to the subject matter of the claimed invention. The examination shall be complete with respect both to compliance of the application or patent under reexamination with the applicable statutes and rules and to the patentability of the invention as claimed, as well as with respect to matters of form, unless otherwise indicated.

(2) The applicant, or in the case of a reexamination proceeding, both the patent owner and the requester, will be notified of the examiner's action. The reasons for any adverse action or any objection or requirement will be stated in an Office action and such information or references will be given as may be useful in aiding the applicant, or in the case of a reexamination proceeding the patent owner, to judge the propriety of continuing the prosecution.

(3) An international-type search will be made in all national applications filed on and after June 1, 1978.

(4) Any national application may also have an international-type search report prepared thereon at the time of the national examination on the merits, upon specific written request therefor and payment of the international-type search report fee set forth in § 1.21(e). The Patent and Trademark Office does not require that a formal report of an international-type search be prepared in order to obtain a search fee refund in a later filed international application.

*(b) Completeness of examiner's action.* The examiner's action will be complete as to all matters, except that in appropriate circumstances, such as misjoinder of invention, fundamental defects in the application, and the like, the action of the examiner may be limited to such matters before further action is made. However, matters of form need not be raised by the examiner until a claim is found allowable.

#### *(c) Rejection of claims.*



(1) If the invention is not considered patentable, or not considered patentable as claimed, the claims, or those considered unpatentable will be rejected.

(2) In rejecting claims for want of novelty or for obviousness, the examiner must cite the best references at his or her command. When a reference is complex or shows or describes inventions other than that claimed by the applicant, the particular part relied on must be designated as nearly as practicable. The pertinence of each reference, if not apparent, must be clearly explained and each rejected claim specified.

(3) In rejecting claims the examiner may rely upon admissions by the applicant, or the patent owner in a reexamination proceeding, as to any matter affecting patentability and, insofar as rejections in applications are concerned, may also rely upon facts within his or her knowledge pursuant to paragraph (d)(2) of this section.

(4) Subject matter which is developed by another person which qualifies as prior art only under 35 U.S.C. 102(e), (f) or (g) may be used as prior art under 35 U.S.C. 103 against a claimed invention unless the entire rights to the subject matter and the claimed invention were commonly owned by the same person or organization or subject to an obligation of assignment to the same person or organization at the time the claimed invention was made.

(5) The claims in any original application naming an inventor will be rejected as being precluded by a waiver in a published statutory invention registration naming that inventor if the same subject matter is claimed in the application and the statutory invention registration. The claims in any reissue application naming an inventor will be rejected as being precluded by a waiver in a published statutory invention registration naming that inventor if the reissue application seeks to claim subject matter:

(i) Which was not covered by claims issued in the patent prior to the date of publication of the statutory invention registration; and

(ii) Which was the same subject matter waived in the statutory invention registration.

(d) *Citation of references.*

(1) If domestic patents are cited by the examiner, their numbers and dates, and the names of the patentees will be stated. If domestic patent application publications are cited by the examiner, their publication number, publication date, and the names of the applicants will be stated. If foreign published applications or patents are cited, their nationality or country, numbers and dates, and the names of the patentees will be stated, and such other data will be furnished as may be necessary to enable the applicant, or in the case of a reexamination proceeding, the patent owner, to identify the published applications or patents cited. In citing foreign published applications or patents, in case only a part of the document is involved, the particular pages and sheets containing the parts relied upon will be identified. If printed publications are cited, the author (if any), title, date, pages or plates, and place of publication, or place where a copy can be found, will be given.

(2) When a rejection in an application is based on facts within the personal knowledge of an employee of the Office, the data shall be as specific as possible, and the reference must be supported, when called for by the applicant, by the affidavit of

such employee, and such affidavit shall be subject to contradiction or explanation by the affidavits of the applicant and other persons.

(e) *Reasons for allowance.* If the examiner believes that the record of the prosecution as a whole does not make clear his or her reasons for allowing a claim or claims, the examiner may set forth such reasoning. The reasons shall be incorporated into an Office action rejecting other claims of the application or patent under reexamination or be the subject of a separate communication to the applicant or patent owner. The applicant or patent owner may file a statement commenting on the reasons for allowance within such time as may be specified by the examiner. Failure by the examiner to respond to any statement commenting on reasons for allowance does not give rise to any implication.

## I. PREPARATION AND MAILING OF FIRST OFFICE ACTION

The first Office action on the merits will ordinarily be mailed together with the order granting reexamination. In some instances, however, it may not be practical or possible to mail the first Office action together with the order. For example, the reexamination file may have been provided to the examiner too late to include an Office action together with the order and still meet the deadline of ten weeks from the filing date of the request for mailing the order granting the request. Another example is where certain information or copies of prior art may not be available until after the ten week time-deadline. In these situations, the order would be prepared and mailed, and the Office action would be mailed at a later date. In addition, a first Office action is not mailed with the order where the files will be forwarded for decision on merger of a reexamination proceeding with another reexamination proceeding and/or a reissue application. Rather, an Office action would be issued after the merger decision, as a single action for the merged proceeding. See MPEP § 2686.01 and MPEP § 2686.02.

Where the order will be mailed **without** the first Office action, the order must indicate that an Office action will issue in due course. Form paragraph 26.04 should be used to inform patent owner and requester that the action was not inadvertently left out or separated from the order.

### ¶ 26.04 *First Action Not Mailed With Order*

An Office action on the merits does not accompany this order for *inter partes* reexamination. An Office action on the merits will be provided in due course.

Where the Office action cannot be mailed with the order, the Office action should, in any event, be issued

within **two months** from the mailing of the order, unless the case is awaiting merger, in which case the Office action should be issued within **one month** from the mailing of the merger decision.

## II. TYPES OF FIRST ACTION ON THE MERITS

Where all of the patent claims are found patentable in the first action, the examiner will issue an Action Closing Prosecution (ACP). The ACP is discussed in MPEP § 2671.02.

Where the examiner determines that one or more of the patent claims are to be rejected, the first Office action on the merits will be similar to a first action on the merits in an application (or *ex parte* reexamination) where a rejection is made. In this situation, even though the action will follow the format of an action in an application, *inter partes* reexamination practice must be followed. Accordingly, *inter partes* reexamination forms will be used, special *inter partes* reexamination time periods will be set, *inter partes* reexamination form paragraphs will be used, and the patent owner and the third party requester must be sent a copy of the action.

## III. FORM AND CONTENT OF FIRST OFFICE ACTION ON THE MERITS THAT IS NOT AN ACP

The examiner's first Office action will be a statement of the examiner's position, and it should be so complete that the second Office action can properly be made an Action Closing Prosecution (ACP). See MPEP § 2671.02. Accordingly, it is intended that the first Office action be the primary action to establish the issues which exist, such that the patent owner response and any third party comments can place the proceeding in condition for the issuance of an ACP.

The examiner's first action should be comprehensive and address all issues as to the prior art patents and/or printed publications. The action will clearly set forth each ground of rejection and/or ground of objection, and the reasons supporting the ground. The action will also clearly set forth each determination favorable to the patentability of claims, i.e., each rejection proposed by the third party requester that the examiner refuses to adopt. Reasons why the rejection proposed by the third party requester is not appropriate (i.e., why the claim cannot be rejected under the

ground proposed by the third party requester) must be clearly stated for each rejection proposed by the third party requester that the examiner refuses to adopt. Comprehensive reasons for patentability must be given for each determination favorable to patentability of claims. See MPEP § 1302.14 for examples of suitable statements of reasons.

In addition to the grounds and determinations set forth in the action, the first action should respond to the substance of each argument raised in the request by the third party requester pursuant to 37 CFR 1.915. Also, it should address any issues proper for reexamination that the examiner becomes aware of independent of the request.

Ordinarily, there will be no patent owner amendment to address in the first Office action of the *inter partes* reexamination, because 37 CFR 1.939(b) prohibits a patent owner amendment prior to first Office action. Thus, the first Office action will ordinarily contain no rejection based on 35 U.S.C. 112; a rejection based on 35 U.S.C. 112 is proper in reexamination only when it is raised by an amendment of the patent. The only exception is where the newly requested and granted reexamination is merged with an existing reexamination proceeding which already contains an amendment. In such a case, the first Office action for the new reexamination would be a subsequent action for the existing reexamination, and the amendment in the merged proceeding would be examined for any 35 U.S.C. 112 issues raised by the amendment and any improper broadening of the claims under 35 U.S.C. 314.

In view of the requirement for "special dispatch" in *inter partes* reexamination proceedings (35 U.S.C. 314(c)), it is intended that the examiner will issue an ACP at the earliest possible time. Accordingly, the first action should include a statement cautioning the patent owner that a complete response should be made to the action, since the next action is expected to be an ACP. The first action should further caution the patent owner that the requirements of 37 CFR 1.116(b) will be strictly enforced after an ACP and that any amendment after the ACP must include "a showing of good and sufficient reasons why they are necessary and were not earlier presented" in order to be considered. Form paragraph 26.05 should be inserted at the end of the first Office action followed by form paragraph 26.73.

*¶ 26.05 Papers To Be Submitted in Response to Action*

In order to ensure full consideration of any amendments, affidavits or declarations, or other documents as evidence of patentability, such documents must be submitted in response to this Office action. Submissions after the next Office action, which is intended to be an Action Closing Prosecution (ACP), will be governed by 37 CFR 1.116, which will be strictly enforced.

*¶ 26.73 Correspondence and inquiry as to Office actions*

All correspondence relating to this *inter partes* reexamination proceeding should be directed:

By Mail to: Mail Stop *Inter Partes* Reexam  
Central Reexamination Unit  
Office of Patent Legal Administration  
United States Patent & Trademark Office  
P.O. Box 1450  
Alexandria, VA 22313-1450

By FAX to: (703) 305-1013  
Central Reexamination Unit

By hand: Central Reexamination Unit  
Crystal Plaza Three-Four, 3D68  
2201 South Clark Place  
Arlington, VA

Any inquiry concerning this communication or earlier communications from the examiner, or as to the status of this proceeding, should be directed to the Central Reexamination Unit at telephone number (703) 308-9692.

The Office action cover sheet is PTOL-2064. Where the Office action is a first Office action, the space on the PTOL-2064 for the date of the communication to which the Office action is responsive to should not be filled in, since it is the order for reexamination that responds to the request for reexamination, not the first Office action.

As with all other Office correspondence on the merits in a reexamination proceeding, the first Office action must be signed by a primary examiner.

**IV. SAMPLE FIRST OFFICE ACTION**

A sample of a first Office action in an *inter partes* reexamination proceeding is set forth below. The examiner should leave the paper number blank, and the Central Reexamination Unit will insert the appropriate paper number upon mailing.



UNITED STATES PATENT AND TRADEMARK OFFICE

COMMISSIONER FOR PATENTS  
 UNITED STATES PATENT AND TRADEMARK OFFICE  
 P.O. BOX 1450  
 ALEXANDRIA, VA 22313-1450  
 www.uspto.gov

CONTROL NO.	FILING DATE	PATENT IN REEXAMINATION	ATTORNEY DOCKET NO.
95/999,999	09/09/09	9,999,999	999

John Able  
 2400 Any Street Road  
 Anytown, VA 22202

EXAMINER

Kenneth M. Schor

ART UNIT PAPER

1713

DATE MAILED:

**OFFICE ACTION IN INTER PARTES REEXAMINATION**

Responsive to the communication(s) filed by:

Patent Owner on \_\_\_\_\_  
 Third Party(ies) on \_\_\_\_\_

**RESPONSE TIMES ARE SET TO EXPIRE AS FOLLOWS:**

*For Patent Owner's Response:*

Two MONTH(S) from the mailing date of this action. 37 CFR 1.945. EXTENSIONS OF TIME ARE GOVERNED BY 37 CFR 1.956.

*For Third Party Requester's Comments on the Patent Owner Response:*

30 DAYS from the date of service of any patent owner's response. 37 CFR 1.947. NO EXTENSIONS OF TIME ARE PERMITTED. 35 U.S.C. 314(b)(3).

**All correspondence** relating to this inter partes reexamination proceeding should be directed to the **Central Reexamination Unit** at the mail, FAX, or hand-carry addresses given at the end of this Office action.

This action is not an Action Closing Prosecution under 37 CFR 1.949, nor is it a Right of Appeal Notice under 37 CFR 1.953.

**PART I. THE FOLLOWING ATTACHMENT(S) ARE PART OF THIS ACTION:**

1.  Notice of References Cited by Examiner, PTO-892.
2.  Information Disclosure Citation, PTO-1449.
3.  \_\_\_\_\_

**PART II. SUMMARY OF ACTION:**

- 1a.  Claims 4-6 are subject to reexamination.
- 1b.  Claims 1-3 are not subject to reexamination.
2.  Claims \_\_\_\_\_ have been canceled.
3.  Claims 5 are confirmed. [Unamended patent claims]
4.  Claims \_\_\_\_\_ are patentable. [Amended or new claims]
5.  Claims 4 and 6 are rejected.
6.  Claims \_\_\_\_\_ are objected to.
7.  The drawings filed on \_\_\_\_\_  are acceptable  are not acceptable.
8.  The drawing correction request filed on \_\_\_\_\_ is:  approved.  disapproved.
9.  Acknowledgment is made of the claim for priority under 35 U.S.C. 119 (a)-(d). The certified copy has:  been received.  not been received.  been filed in Application/Control No \_\_\_\_\_.
10.  Other \_\_\_\_\_

PTOL-2064 (12/03)

This first Office action on the merits is being mailed together with the order granting reexamination. 37 CFR 1.935.

Claims 1-3:

Claims 1-3 of the Smith patent are not being reexamined in view of the final decision in the *ABC Corp. v. Smith*, 999 USPQ2d 99 (Fed. Cir. 2008). Claims 1-3 were held invalid by the Court of Appeals for the Federal Circuit.

Claims 4 and 6:

The following is a quotation of 35 U.S.C. 103 which forms the basis for all obviousness rejections set forth in this Office action:

35 U.S.C. 103. Conditions for patentability, non-obvious subject matter.

(a) A patent may not be obtained though the invention is not identically disclosed or described as set forth in section 102 of this title, if the differences between the subject matter sought to be patented and the prior art are such that the subject matter as a whole would have been obvious at the time the invention was made to a person having ordinary skill in the art to which said subject matter pertains. Patentability shall not be negated by the manner in which the invention was made.

Claims 4 and 6 are rejected under 35 U.S.C. 103 as being unpatentable over Berridge in view of McGee.

Berridge teaches extruding a chlorinated polymer using the same extrusion structure recited in Claims 4 and 6 of the Smith patent. However, Berridge does not show supporting the extrusion barrel at an angle of 25-35 degrees to the horizontal, using spring supports. McGee teaches spring supporting an extrusion barrel at an angle of 30 degrees, in order to decrease imperfections in extruded chlorinated polymers. It would have been obvious to one of ordinary skill in the polymer extrusion art to support the extrusion barrel of Berridge on springs and at an angle of 30 degrees because McGee teaches this to be known in the polymer extrusion art for decreasing imperfections in extruded chlorinated polymers.

This rejection was proposed by the third party requester in the request for reexamination, and it is being adopted essentially as proposed in the request.

Claim 5:

Claim 5 is patentable over the prior art patents and printed publications because of the recitation of the specific octagonal extrusion die used with the Claim 4 spring-supported barrel. This serves to reduce imperfections in the extruded chlorinated polymers and is not taught by the art of record, alone or in combination.

Proposed third party requester rejection:

In the request, at pages 10-14, the third party requester proposes the claim 5 be rejected based upon Berridge in view of McGee, and further taken with Bupkes or Gornisht. The third party requester points out that both Bupkes and Gornisht teach the use of an octagonal extrusion die to provide a smooth unified extrusion product.

This rejection of claim 5 proposed by the third party requester is not adopted.

While Bupkes and Gornisht do in fact teach the use of an octagonal extrusion die to provide smooth unified extrusion product, Bupkes teaches such for glass making and Gornisht teaches such for a food product. Despite the argument presented at pages 12-13 of the request and the demonstration of exhibit A, the skilled artisan would not equate the advantages obtained by Bupkes and Gornisht for glass and food, respectively, to the removal of imperfections in a polymer melt being extruded to a solid plastic product. Thus, Bupkes and Gornisht are not deemed to be combinable with Berridge and McGee for purposes of rejecting claim 5.

Issue not within the scope of reexamination proceedings:

It is noted that an issue not within the scope of reexamination proceedings has been raised. In the above-cited final Court decision, a question is raised as to the possible public use of the invention of Claim 4. This was pointed out by the third party requester in the request for reexamination. The issue will not be considered in a reexamination proceeding (37 CFR 1.906(c)). While this issue is not within the scope of reexamination, the patentee is advised that it may be desirable to consider filing a reissue application provided that the patentee believes one or more claims to be partially or wholly inoperative or invalid based upon the issue.

Other art made of record:

Swiss Patent 80555 and the American Machinist article are cited to show cutting and forming extruder apparatus somewhat similar to that claimed in the Smith patent.

**Conclusion:**

In order to ensure full consideration of any amendments, affidavits or declarations, or other documents as evidence of patentability, such documents must be submitted in response to this Office action. Submissions after the next Office action, which is intended to be an action closing prosecution (ACP), will be governed by 37 CFR 1.116, which will be strictly enforced.

**All** correspondence relating to this *inter partes* reexamination proceeding should be directed:

By Mail to:	Mail Stop <i>Inter Partes</i> Reexam Central Reexamination Unit Office of Patent Legal Administration United States Patent & Trademark Office P.O. Box 1450 Alexandria, VA 22313-1450
By FAX to:	(703) 305-1013 Central Reexamination Unit
By hand:	Central Reexamination Unit Crystal Plaza Three-Four, 3D68 2201 South Clark Place Arlington, VA 22202

Any inquiry concerning this communication or earlier communications from the examiner, or as to the status of this proceeding, should be directed to the Central Reexamination Unit at telephone number (703) 308-9692.

\_\_\_\_\_/s/\_\_\_\_\_  
Kenneth M. Schor  
Primary Examiner,  
Technology Center 1700

## V. ACTIVITY AFTER THE DRAFT (TEXT) OF THE FIRST OFFICE ACTION HAS BEEN PREPARED

The examiner will prepare the action, ensure that Technology Center (TC) clerical processing is done, and forward the case to the TC Special Program Examiner (SPRE) no later than two (2) weeks from the date of the consultation conference. The action is reviewed by the SPRE (see MPEP § 2614.02), who then arranges for the file to be PALMed out and hand-carried directly to the Central Reexamination Unit (CRU). The case is forwarded to the Central Reexamination Unit by the SPRE within three (3) days of the SPRE's receipt of the case from the examiner.

### 2660.02 The Title [Added R-2]

Normally, the title of the patent will not need to be changed during reexamination. In those very rare instances where a change of the title does become necessary, the examiner should point out the need for the change as early as possible in the prosecution, as a part of an Office action. This will give the patent owner an opportunity to comment on the change prior to the examiner's formal change in the title via an examiner's amendment accompanying the Notice of Intent to Issue *Inter Partes* Reexamination Certificate (NIRC) at the time that the proceeding is to be terminated. A change in the title in a reexamination can only be effected via a formal examiner's amendment accompanying the NIRC. Changing the title and merely initialing the change is not permitted in reexamination.

While a change in the title may be commented on by the patent owner, the final decision as to the change is that of the examiner, and the examiner's decision is not subject to review. Accordingly, where the examiner notes the need for a change at the time of issuing the NIRC, the examiner may make the change at that point, even though the patent owner will not have an opportunity to comment on the change.

An example of a situation where it would be appropriate to change the title is where all the claims directed to one of the categories of invention (in the patent) are canceled via the reexamination proceeding, it would be appropriate to change the title to delete reference to that category.

### 2660.03 Dependent Claims [Added R-2]

If an unamended base patent claim (i.e., a claim appearing in the patent) has been rejected or canceled, any claim which is directly or indirectly dependent thereon should be indicated as patentable if it is otherwise patentable. The dependent claim should not be objected to nor rejected merely because it depends upon a rejected or canceled original patent claim. *No requirement should be made for rewriting the dependent claim in independent form.* As the original patent claim numbers are not changed in a reexamination proceeding, the content of the canceled base claim would remain in the printed patent and would be available to be read as a part of the dependent claim.

If a new base claim has been canceled in a reexamination proceeding, a claim which depends thereon should be rejected as indefinite. If an *amended* base patent claim or a new base claim is rejected, a claim dependent thereon should be objected to if it is otherwise patentable, and a requirement should be made for rewriting the dependent claim in independent form.

### 2661 Special Status for Action [Added R-2]

35 U.S.C. 314. *Special Status For Action*

\*\*\*\*\*

(c) SPECIAL DISPATCH.— Unless otherwise provided by the Director for good cause, all inter partes reexamination proceedings under this section, including any appeal to the Board of Patent Appeals and Interferences, shall be conducted with special dispatch within the Office.

In view of the requirement for "special dispatch," all reexamination proceedings will be "special" throughout their pendency in the Office. In order to further the requirement for special dispatch, the examiner's first Office action on the merits in an *inter partes* reexamination should ordinarily be mailed together with the order for reexamination. See MPEP § 2660.

Any cases involved in litigation, whether they are reexamination proceedings or reissue applications, will have priority over all other cases. Reexamination proceedings not involved in litigation will have priority over all other cases except for reexaminations or reissues involved in litigation.

## 2662 Time for Response and Comments [Added R-2]

The time periods for response and comments for the various stages of an *inter partes* reexamination proceeding are as follows:

(A) After an Office action that is not an Action Closing Prosecution (non-ACP Office action).

(1) Patent owner may file a patent owner's response within the time for response set in the non-ACP Office action. The time period set for response will normally be two (2) months from the mailing date of the action.

(2) Where patent owner files a timely response to the non-ACP Office action, the third party requester may once file written comments addressing issues raised by the Office action or by the patent owner response to the action. The third party requester's written comments must be submitted within 30 days from the date of service of the patent owner's response on the third party requester. The date of service can be found on the Certificate of Service that accompanies the patent owner's response.

(B) After an Office letter indicating that a response by the patent owner is not proper.

After an Office letter indicates that a response filed by the patent owner is not completely responsive to a prior Office action (i.e., an incomplete response), the patent owner is required to complete the response within the time period set in the Office letter. 37 CFR 1.957(d). A time period of 30 days or one month (whichever is longer) is normally set. Any third party requester comments on a supplemental patent owner response that completes the initial response must be filed within 30 days from the date of service of the patent owner's supplemental response on the third party requester.

(C) After an Action Closing Prosecution (ACP).

The patent owner may once file written comments and/or present a proposed amendment to the claims within the time period set in the ACP. 37 CFR 1.951(a). Normally, the ACP will set a period of 30 days or one month (whichever is longer) from the mailing date of the ACP. Where the patent owner files comments and/or a proposed amendment, the third party requester may once file comments responsive to the patent owner's submission within 30 days from

the date of service of the patent owner's submission on the third party requester. 37 CFR 1.951(b).

(D) Appeal to the Board of Patent Appeals and Interferences (Board) after the examiner issues Right of Appeal Notice.

(1) After the examiner issues a Right of Appeal Notice (RAN), the patent owner and the third party requester may each file a notice of appeal within 30 days or one month (whichever is longer) from the mailing date of the RAN. 37 CFR 1.953(c). The time for filing a notice of appeal cannot be extended. 37 CFR 1.959(e).

(2) A patent owner who has not filed a timely notice of appeal may file a notice of cross appeal (with respect to any decision adverse to the patentability of any claim) within fourteen days of service of a third party requester's notice of appeal. 37 CFR 1.959(b)(1).

A third party requester who has not filed a timely notice of appeal may file a notice of cross appeal (with respect to any final decision favorable to the patentability of any claim) within fourteen days of service of a patent owner's notice of appeal. 37 CFR 1.959(b)(2).

The time for filing a notice of cross-appeal cannot be extended. 37 CFR 1.959(e).

(E) After an Office notification of defective notice of appeal or notice of cross appeal (to the Board).

A party who is notified of a defective notice of appeal, or defective notice of cross appeal, must cure the defect within one month from the mail date of the Office letter notifying the party. (Form PTOL-2067 should be used to notify the parties.)

The time for curing a defective notice of appeal or cross-appeal cannot be extended, since the paper curing the defect is in-effect a substitute notice of appeal or cross-appeal.

(F) Filing of briefs after notice of appeal or notice of cross appeal (to the Board).

(1) Each party that filed a notice of appeal or notice of cross appeal may file an appellant brief and fee within two months after the last-filed notice of appeal or cross appeal. Additionally, if any party to the reexamination is entitled to file an appeal or cross appeal but fails to timely do so, the appellant brief and



fee may be filed within two months after the expiration of time for filing (by the last party entitled to do so) of the notice of appeal or cross appeal. 37 CFR 1.963(a).

(2) Once an appellant brief has been properly filed, an opposing party may file a respondent brief and fee within one month from the date of service of the appellant brief. 37 CFR 1.963(b).

(3) The times for filing appellant and respondent briefs may not be extended. 37 CFR 1.963(a) and (b).

(G) After an Office notification of non-compliance of appellant brief or respondent brief.

A party who is notified of non-compliance of an appellant brief or respondent brief must file an amended brief within a non-extendable time period of one month from the date of the Office letter notifying the party of the non-compliance of the brief.

(H) Rebuttal brief after the examiner issues an examiner's answer.

A third-party requester appellant and/or a patent owner appellant may each file a rebuttal brief within one month of the date of the examiner's answer. The time for filing a rebuttal brief may not be extended. 37 CFR 1.963(d).

(I) Oral Hearing.

If an appellant or a respondent (who has filed a respondent brief) desires an oral hearing by the Board, he or she must file a written request for an oral hearing accompanied by the fee set forth in 37 CFR 1.17(d) within two months after the date of the examiner's answer. The time for filing a request for oral hearing may not be extended. 37 CFR 1.973(b).

(J) Appeal to Court.

The time for the patent owner and/or the third party requester to file a notice of appeal to the U.S. Court of Appeals for the Federal Circuit is two months from the date of the Board decision. If a timely request for rehearing (37 CFR 1.979) is filed, the time for the patent owner and/or the third party requester to file a notice of appeal to the Federal Circuit is two months from final Board action on the request for rehearing. 37 CFR 1.304(a)(1).

(K) Extensions of Time.

See MPEP § 2665 as to extensions of time in *inter partes* reexamination.

## **2664 Mailing of Office Action [Added R-2]**

The Technology Center (TC) does not mail the Office action for an *inter partes* reexamination case. After an Office Action is completed and processed in a TC, the TC's Special Program Examiner (SPRE) arranges for the case to be PALMed out of the TC and hand-carried directly to the Central Reexamination Unit (CRU). In the CRU, the Office action is given a general review by a Reexamination Legal Advisor (RLA) and (if proper) mailed by the CRU support staff. In conjunction with mailing, any appropriate processing (e.g., PALM work, update scanning) is carried out.

*Inter partes* reexamination forms are structured so that the PALM printer can be used to print the identifying information for the reexamination file and the mailing address (usually the address of the patent owner's attorney or agent of record). Where there is no attorney or agent of record, the patent owner's address is printed. Only the first owner's address is printed where there are multiple partial owners; a transmittal form PTOL-2070 is also provided for each partial owner in addition to the one named on the top of the Office action.

All actions in an *inter partes* reexamination proceeding will have a copy mailed to the third party requester. A transmittal form PTOL-2070 must be used in providing the third party requester with a copy of each Office action.

A completed transmittal form PTOL-2070 will be provided for each requester (there can be multiple requesters in a merged reexamination proceeding; see MPEP § 2686.01) and each additional partial owner as discussed above, and the appropriate address will be entered on the transmittal form(s). The number of transmittal forms provides a ready reference for the number of copies of each Office action to be made, and the transmittal form permits use of the window envelopes in mailing the copies of the action to parties other than the patent owner.

## 2665 Extension of Time for Patent Owner Response [Added R-2]

37 CFR 1.956. Patent owner extensions of time in *inter partes* reexamination.

The time for taking any action by a patent owner in an *inter partes* reexamination proceeding will be extended only for sufficient cause and for a reasonable time specified. Any request for such extension must be filed on or before the day on which action by the patent owner is due, but in no case will the mere filing of a request effect any extension. See § 1.304(a) for extensions of time for filing a notice of appeal to the U.S. Court of Appeals for the Federal Circuit.

The provisions of 37 CFR 1.136(a) and 1.136(b) are NOT applicable to *inter partes* reexamination proceedings under any circumstances. Public Law 97-247 amended 35 U.S.C. 41 to authorize the Director of the USPTO to charge fees for extensions of time to take action in an “application.” An *inter partes* reexamination proceeding does not involve an “application.” The provisions of 37 CFR 1.136 authorize extensions of the time period only in an application in which an applicant must respond or take action. There is neither an “application,” nor an “applicant” involved in an *inter partes* reexamination proceeding.

The times for filing a notice of appeal or cross-appeal, an appellant brief, a respondent brief, submissions curing a defective appeal or brief, a rebuttal brief, and a request for oral hearing **cannot** be extended.

A request for an extension of time for filing an appeal to the U.S. Court of Appeals for the Federal Circuit is governed by 37 CFR 1.304(a). A request for an extension of time to petition from the denial of a request for reexamination can be obtained only by filing a grantable petition under 37 CFR 1.183 (with fee) to waive the time provisions of 37 CFR 1.927.

Extensions of time in an *inter partes* reexamination proceeding are otherwise governed by 37 CFR 1.956. It should be noted that **extensions of time under 37 CFR 1.956 are not available to the third party requester.**

An extension of time in an *inter partes* reexamination proceeding is requested, where applicable, pursuant to 37 CFR 1.956. Any request for extension of time pursuant to 37 CFR 1.956 will be decided by the Technology Center (TC) Director of the TC conducting the reexamination. The request (A) must be filed on or before the day on which action by the patent

owner is due, and (B) must set forth sufficient cause for the extension. Since the provisions of 37 CFR 1.136 (a) are *NOT* applicable to reexamination proceedings, there is no fee for an extension of time in reexamination.

Requests for an extension of time in an *inter partes* reexamination proceeding will be considered only after the first Office action on the merits in the reexamination is mailed. Any request for an extension of time filed prior to the first action will be denied.

The certificate of mailing and the certificate of transmission procedures (37 CFR 1.8), and the “Express Mail” mailing procedure (37 CFR 1.10), may be used to file a request for extension of time, as well as any other paper in an existing *inter partes* reexamination proceeding (see MPEP § 2666).

As noted above, a request for extension of time under 37 CFR 1.956 will be granted only for sufficient cause, and *the request must be filed on or before the day on which action by the patent owner is due.* In no case, will the mere filing of a request for extension of time automatically effect any extension, because the showing of cause may be insufficient or incomplete. In the prosecution of an *ex parte* reexamination, an automatic 1-month extension of time to take further action is granted upon filing a first timely response to a final Office action (see MPEP § 2272). The automatic extension given in *ex parte* reexamination does not apply to the first response to an Action Closing Prosecution (ACP) in an *inter partes* reexamination. The reason is that in *inter partes* reexamination, parties do not file an appeal in response to an ACP, and a further Office action (Right of Appeal Notice) will issue even if the parties make no response at all. Thus, there is no time period to appeal running against the parties after the ACP is issued, unlike *ex parte* reexamination where an appeal is due after final rejection and the time is thus automatically extended one month to provide time for the patent owner to review the Office’s response to the amendment before deciding whether to appeal.

Evaluation of whether “sufficient cause” has been shown for an extension must be made by **balancing** the desire to provide the patent owner with a fair opportunity to respond, **against** the requirement of the statute, 35 U.S.C. 314(c), that the proceedings be conducted with special dispatch.

Any request for an extension of time in a reexamination proceeding must fully state the reasons therefor. The reasons should include a statement of what action the patent owner has taken, and why in spite of the action taken thus far, the additional time is needed. All requests must be submitted as a separate paper, not directed to any matter other than the request for the extension.

Prosecution will be conducted by initially setting a time period of at least 30 days or one month (whichever is longer), see MPEP § 2662. First requests for extensions of these time periods will be granted for sufficient cause, and for a reasonable time specified—usually 1 month. The reasons stated in the request will be evaluated, and the request will be favorably considered where there is a factual accounting of reasonably diligent behavior by all those responsible for preparing a response or comments within the statutory time period. Second or subsequent requests for extensions of time, or requests for more than one month, will be granted only in extraordinary situations.

#### **EXTENSIONS OF TIME TO SUBMIT AFFIDAVITS AFTER ACTION CLOSING PROSECUTION**

Frequently, a request for an extension of time is made, stating as a reason therefor, that more time is needed in which to submit an affidavit. When such a request is filed after an ACP, the granting of the request for extension of time is without prejudice to the right of the examiner to question why the affidavit is now necessary and why it was not earlier presented. If the showing by the patent owner is insufficient, the examiner may deny entry of the affidavit, notwithstanding the previous grant of an extension of time to submit it. The grant of an extension of time in these circumstances serves merely to give the patent owner an extended opportunity to present the affidavit or to take other appropriate action.

Affidavits submitted after an ACP are subject to the same treatment as amendments submitted after an ACP. This is analogous to the treatment of affidavits submitted after a final rejection in an application. See *In re Affidavit Filed After Final Rejection*, 152 USPQ 292, 1966 C.D. 53 (Comm'r Pat. 1966).

#### **2666 Patent Owner Response to Office Action [Added R-2]**

*37 CFR 1.111. Reply by applicant or patent owner to a non-final Office action.*

(a)(1) If the Office action after the first examination (§ 1.104) is adverse in any respect, the applicant or patent owner, if he or she persists in his or her application for a patent or reexamination proceeding, must reply and request reconsideration or further examination, with or without amendment. See §§ 1.135 and 1.136 for time for reply to avoid abandonment.

(2) A second (or subsequent) supplemental reply will be entered unless disapproved by the Director. A second (or subsequent) supplemental reply may be disapproved if the second (or subsequent) supplemental reply unduly interferes with an Office action being prepared in response to the previous reply. Factors that will be considered in disapproving a second (or subsequent) supplemental reply include:

(i) The state of preparation of an Office action responsive to the previous reply as of the date of receipt (§ 1.6) of the second (or subsequent) supplemental reply by the Office; and

(ii) The nature of any changes to the specification or claims that would result from entry of the second (or subsequent) supplemental reply.

(b) In order to be entitled to reconsideration or further examination, the applicant or patent owner must reply to the Office action. The reply by the applicant or patent owner must be reduced to a writing which distinctly and specifically points out the supposed errors in the examiner's action and must reply to every ground of objection and rejection in the prior Office action. The reply must present arguments pointing out the specific distinctions believed to render the claims, including any newly presented claims, patentable over any applied references. If the reply is with respect to an application, a request may be made that objections or requirements as to form not necessary to further consideration of the claims be held in abeyance until allowable subject matter is indicated. The applicant's or patent owner's reply must appear throughout to be a *bona fide* attempt to advance the application or the reexamination proceeding to final action. A general allegation that the claims define a patentable invention without specifically pointing out how the language of the claims patentably distinguishes them from the references does not comply with the requirements of this section.

(c) In amending in reply to a rejection of claims in an application or patent under reexamination, the applicant or patent owner must clearly point out the patentable novelty which he or she thinks the claims present in view of the state of the art disclosed by the references cited or the objections made. The applicant or patent owner must also show how the amendments avoid such references or objections.

*37 CFR 1.945. Response to Office action by patent owner in inter partes reexamination.*

The patent owner will be given at least thirty days to file a response to any Office action on the merits of the *inter partes* reexamination.

## I. SUBSTANCE OF THE RESPONSE

The patent owner may request reconsideration of the position stated in the Office action, with or without amendment to the claims and/or specification. As to amendments in reexamination proceedings, see MPEP § 2666.01.

Any request for reconsideration must be in writing and must distinctly and specifically point out each supposed error in the examiner's action. A general allegation that the claims define a patentable invention, without specifically pointing out how the language of the claims patentably distinguishes them over the references, is inadequate and is not in compliance with 37 CFR 1.111(b).

Reasons must be given as to how and why the claims define over the references, and why any rejections made under 35 U.S.C. 112 are incorrect or inapplicable.

Affidavits under 37 CFR 1.131 and 1.132 may be utilized in a reexamination proceeding. Note, however, that an affidavit under 37 CFR 1.131 may not be used to "swear back" of a reference patent if the reference patent is claiming the same invention as the patent undergoing reexamination. In such a situation, the patent owner may, if appropriate, seek to raise this issue via an affidavit under 37 CFR 1.130 (see MPEP § 718) or in an interference proceeding via an appropriate reissue application if such a reissue application may be filed (see MPEP § 1449.02).

The patent owner cannot file papers on behalf of a third party. If a third party paper accompanies or is submitted as part of a timely filed response, the response and third party paper are considered to be an improper (i.e., informal) submission, and the **entire** submission shall be returned to the patent owner since the Office will not determine which portion of the submission is the third party paper. The third party paper filed as part of the patent owner's response will not be considered. The improper response with the third party paper in it should be returned to patent owner as a defective (informal) response, using form PTOL-2069 as the cover letter. See MPEP § 2666.50. The appropriate box on the form should be checked and an explanation for the return of the paper given. The patent owner should be provided an appropriate period of time to refile the patent owner response without the third party paper.

## II. PROCEDURAL CONSIDERATIONS OF THE RESPONSE

The certificate of mailing and the certificate of transmission procedures (37 CFR 1.8), and the 'Express Mail' mailing procedure (37 CFR 1.10), may be used to file a patent owner's response, as well as any other paper in an existing *inter partes* reexamination proceeding.

A copy of the response must be served on the third party requester in accordance with 37 CFR 1.248, - see also MPEP § 2666.06. Lack of service poses a problem, since a third party requester must file written comments within a period of 30 days from the date of service of the patent owner's response, in order to be timely. Where the record does not show the response to have been served on the third party requester, see MPEP § 2666.06.

The patent owner will normally be given a period of two months to respond to an Office action. An extension of time can be obtained only in accordance with 37 CFR 1.956. Note that 37 CFR 1.136 does not apply in reexamination proceedings.

See MPEP § 2666.10 for the consequences of the failure by the patent owner to respond to the Office action.

### 2666.01 Amendment by Patent Owner [Added R-2]

*37 CFR 1.941. Amendments by patent owner in inter partes reexamination.*

Amendments by patent owner in *inter partes* reexamination proceedings are made by filing a paper in compliance with §§ 1.530(d)-(k) and 1.943.

*37 CFR 1.121. Manner of making amendments in applications.*

\*\*\*\*\*

(j) *Amendments in reexamination proceedings.* Any proposed amendment to the description and claims in patents involved in reexamination proceedings must be made in accordance with § 1.530.

\*\*\*\*\*

*37 CFR 1.530. Statement by patent owner in ex parte reexamination; amendment by patent owner in ex parte or inter partes reexamination; inventorship change in ex parte or inter partes reexamination.*

\*\*\*\*\*

(d) *Making amendments in a reexamination proceeding.* A proposed amendment in an *ex parte* or an *inter partes* reexamination proceeding is made by filing a paper directing that proposed specified changes be made to the patent specification, including the claims, or to the drawings. An amendment paper directing that proposed specified changes be made in a reexamination proceeding may be submitted as an accompaniment to a request filed by the patent owner in accordance with § 1.510(e), as part of a patent owner statement in accordance with paragraph (b) of this section, or, where permitted, during the prosecution of the reexamination proceeding pursuant to § 1.550(a) or § 1.937.

(1) *Specification other than the claims.* Changes to the specification, other than to the claims, must be made by submission of the entire text of an added or rewritten paragraph including markings pursuant to paragraph (f) of this section, except that an entire paragraph may be deleted by a statement deleting the paragraph, without presentation of the text of the paragraph. The precise point in the specification must be identified where any added or rewritten paragraph is located. This paragraph applies whether the amendment is submitted on paper or compact disc (*see* §§ 1.96 and 1.825).

(2) *Claims.* An amendment paper must include the entire text of each patent claim which is being proposed to be changed by such amendment paper and of each new claim being proposed to be added by such amendment paper. For any claim changed by the amendment paper, a parenthetical expression “amended,” “twice amended,” *etc.*, should follow the claim number. Each patent claim proposed to be changed and each proposed added claim must include markings pursuant to paragraph (f) of this section, except that a patent claim or proposed added claim should be canceled by a statement canceling the claim, without presentation of the text of the claim.

(3) *Drawings.* Any change to the patent drawings must be submitted as a sketch on a separate paper showing the proposed changes in red for approval by the examiner. Upon approval of the changes by the examiner, only new sheets of drawings including the changes and in compliance with § 1.84 must be filed. Amended figures must be identified as “Amended,” and any added figure must be identified as “New.” In the event a figure is canceled, the figure must be surrounded by brackets and identified as “Canceled.”

(4) The formal requirements for papers making up the reexamination proceeding other than those set forth in this section are set out in § 1.52.

(e) *Status of claims and support for claim changes.* Whenever there is an amendment to the claims pursuant to paragraph (d) of this section, there must also be supplied, on pages separate from the pages containing the changes, the status (*i.e.*, pending or canceled), as of the date of the amendment, of all patent claims and of all added claims, and an explanation of the support in the disclosure of the patent for the changes to the claims made by the amendment paper.

(f) *Changes shown by markings.* Any changes relative to the patent being reexamined which are made to the specification, including the claims, must include the following markings:

(1) The matter to be omitted by the reexamination proceeding must be enclosed in brackets; and

(2) The matter to be added by the reexamination proceeding must be underlined.

(g) *Numbering of patent claims p.* Patent claims may not be renumbered. The numbering of any claims added in the reexamination proceeding must follow the number of the highest numbered patent claim.

(h) *Amendment of disclosure may be required.* The disclosure must be amended, when required by the Office, to correct inaccuracies of description and definition, and to secure substantial correspondence between the claims, the remainder of the specification, and the drawings.

(i) *Amendments made relative to patent.* All amendments must be made relative to the patent specification, including the claims, and drawings, which are in effect as of the date of filing the request for reexamination.

(j) *No enlargement of claim scope.* No amendment may enlarge the scope of the claims of the patent or introduce new matter. No amendment may be proposed for entry in an expired patent. Moreover, no amendment, other than the cancellation of claims, will be incorporated into the patent by a certificate issued after the expiration of the patent.

(k) *Amendments not effective until certificate.* Although the Office actions will treat proposed amendments as though they have been entered, the proposed amendments will not be effective until the reexamination certificate is issued.

(l) *Correction of inventorship in an ex parte or inter partes reexamination proceeding.*

(1) When it appears in a patent being reexamined that the correct inventor or inventors were not named through error without deceptive intention on the part of the actual inventor or inventors, the Director may, on petition of all the parties set forth in § 1.324(b)(1)-(3), including the assignees, and satisfactory proof of the facts and payment of the fee set forth in § 1.20(b), or on order of a court before which such matter is called in question, include in the reexamination certificate to be issued under § 1.570 or § 1.977 an amendment naming only the actual inventor or inventors. The petition must be submitted as part of the reexamination proceeding and must satisfy the requirements of § 1.324.

(2) Notwithstanding the preceding paragraph (1)(1) of this section, if a petition to correct inventorship satisfying the requirements of § 1.324 is filed in a reexamination proceeding, and the reexamination proceeding is terminated other than by a reexamination certificate under § 1.570 or § 1.977, a certificate of correction indicating the change of inventorship stated in the petition will be issued upon request by the patentee.

Amendments to the patent being reexamined (where the patent has not expired) may be filed by the patent owner in the reexamination proceeding. Such amendments may be provided by the patent owners after the first Office action on the merits has been issued. The first Office action on the merits will ordinarily be mailed with the order. In some instances, however, it may not be practical or possible to mail the first Office action together with the order. In the event that the first Office action is mailed after the

order, it would not be proper to provide an amendment prior to the first Office action. Such an amendment would not be considered, and it would be returned to the patent owner as an improper paper.

Additional claims may be added by amendment in a reexamination proceeding, without any fee. Amendments proposed in a reexamination will normally be entered if timely, and will be considered to be entered for purposes of prosecution before the Office (if they are timely and comply with the rules); however, amendments do not become effective in the patent until the certificate under 35 U.S.C. 316 is issued.

Amendments must not enlarge the scope of a claim of the patent nor introduce new matter. Amended or new claims which broaden or enlarge the scope of a claim of the patent should be rejected under 35 U.S.C. 314(a). The test for when an amended or “new claim enlarges the scope of an original claim under 35 U.S.C. 314(a) is the same as that under the 2-year limitation for reissue applications adding enlarging claims under 35 U.S.C. 251, last paragraph.” *In re Freeman*, 30 F.3d 1459, 1464, 31 USPQ2d 1444, 1447 (Fed. Cir. 1994). See MPEP § 2658 for a discussion of enlargement of the claim scope. For handling of new matter, see MPEP § 2670.

If the patent expires during the reexamination procedure, and the patent claims have been amended, the Office will hold the amendments as being improper and all subsequent reexamination will be on the basis of the unamended patent claims. This procedure is necessary since no amendments will be incorporated into the patent by certificate after the expiration of the patent. See 37 CFR 1.941 and 37 CFR 1.530(j). The patent expiration date for a utility patent, for example, is determined by taking into account the term of the patent, whether maintenance fees have been paid for the patent, whether any disclaimer was filed as to the patent to shorten its term, any patent term extensions or adjustments for delays within the USPTO under 35 U.S.C. 154 (see MPEP § 2710, *et seq.*), and any patent term extensions available under 35 U.S.C. 156 for premarket regulatory review (see MPEP § 2750 *et seq.*). Any other relevant information should also be taken into account.

Once the patent expires, a narrow claim construction is applied. See MPEP § 2258, Part I, Subpart G “Claim Interpretation and Treatment.”

*Amendment Entry* - Amendments which comply with 37 CFR 1.530(d)-(j) and 37 CFR 1.943 will be entered in the reexamination file wrapper. The amendment will be entered by drawing a line in red ink through the claim(s) or paragraph(s) canceled or amended, and the substituted copy being indicated by reference letter.

*Manner of Making Amendments* - Amendments in an *inter partes* reexamination proceeding are made in the same manner that amendments in an *ex parte* reexamination proceeding are made. See MPEP § 2250 for guidance as to the manner of making amendments in a reexamination proceeding.

Form paragraph 22.12 may be used to advise the patent owner of the proper manner of making amendments in an *inter partes* reexamination proceeding.

¶ 22.12 Amendments Proposed in a Reexamination - 37 CFR 1.530(d)-(j)

Patent owner is notified that any proposed amendment to the specification and/or claims in this reexamination proceeding must comply with 37 CFR 1.530(d)-(j).

**Examiner Note:**

This paragraph may be used in the order granting reexamination and/or in the first Office action to advise patent owner of the proper manner of making amendments in a reexamination proceeding.

Form paragraph 26.05.01 may be used to notify patent owner in an *inter partes* reexamination proceeding that a proposed amendment in the proceeding does not comply with 37 CFR 1.530(d)-(j).

¶ 26.05.01 Improper Amendment in an Inter Partes Reexamination - 37 CFR 1.530(d)-(j)

The amendment filed [1] proposes amendments to [2] that do not comply with 37 CFR 1.530(d)-(j), which sets forth the manner of making amendments in reexamination proceedings. A supplemental paper correctly proposing amendments in the present *inter partes* reexamination proceeding is required.

A shortened statutory period for response to this letter is set to expire ONE MONTH or THIRTY DAYS, whichever is longer, from the mailing date of this letter. If the patent owner fails to timely correct this informality, the amendment will be held not to be an appropriate response, and the consequences set forth in 37 CFR 1.957(b) or (c) will result.

**Examiner Note:**

This paragraph may be used for any 37 CFR 1.530(d)-(j) informality as to a proposed amendment submitted in a reexamination proceeding.

The cover sheet to be used for mailing the notification to the patent owner will be PTOL-2069.

As an alternative to using form paragraph 26.05.01, it would also be appropriate to use form PTOL-2069, box 4.

For clerical handling of amendments, see MPEP § 2670. For entry of an amendment in a merged reexamination proceeding, see MPEP § 2686.01 and § 2686.03. For handling of a dependent claim in reexamination proceedings, see MPEP § 2660.03.

## 2666.02 Correction of Patent Drawings [Added R-2]

*37 CFR 1.941. Amendments by patent owner in inter partes reexamination.*

Amendments by patent owner in *inter partes* reexamination proceedings are made by filing a paper in compliance with §§ 1.530(d)-(k) and 1.943.

*37 CFR 1.530. Statement by patent owner in ex parte reexamination; amendment by patent owner in ex parte or inter partes reexamination; inventorship change in ex parte or inter partes reexamination.*

\*\*\*\*\*

(d) *Making amendments in a reexamination proceeding.* A proposed amendment in an *ex parte* or an *inter partes* reexamination proceeding is made by filing a paper directing that proposed specified changes be made to the patent specification, including the claims, or to the drawings. An amendment paper directing that proposed specified changes be made in a reexamination proceeding may be submitted as an accompaniment to a request filed by the patent owner in accordance with § 1.510(e), as part of a patent owner statement in accordance with paragraph (b) of this section, or, where permitted, during the prosecution of the reexamination proceeding pursuant to § 1.550(a) or § 1.937.

\*\*\*\*\*

(3) *Drawings.* Any change to the patent drawings must be submitted as a sketch on a separate paper showing the proposed changes in red for approval by the examiner. Upon approval of the changes by the examiner, only new sheets of drawings including the changes and in compliance with § 1.84 must be filed. Amended figures must be identified as “Amended,” and any added figure must be identified as “New.” In the event a figure is canceled, the figure must be surrounded by brackets and identified as “Canceled.”

\*\*\*\*\*

In the reexamination proceeding, the copy of the patent drawings submitted pursuant to 37 CFR 1.915(b)(5) will be used for reexamination purposes, provided no change is made to the drawings. If there is **any** change in the drawings, a new sheet of drawing for each sheet changed must be submitted. The

change may **not** be made on the original patent drawings. Drawing changes in an *inter partes* reexamination proceeding are made in the same manner that drawing changes in an *ex parte* reexamination proceeding are made. 37 CFR 1.530(d)(3) sets forth the manner of making amendments to the drawings. Any amended figure(s) must be identified as “Amended” and any added figure(s) must be identified as “New.” In the event a figure is canceled, the figure must be surrounded by brackets and identified as “Canceled.”

Where the patent owner wishes to change/amend the drawings, the patent owner should submit a sketch in permanent ink showing the proposed change(s)/ amendment(s) in red, for approval by the examiner. The submitted sketch should be presented as a separate paper, and it will be made part of the record. Once the sketch is approved, sheets of substitute formal drawings must be submitted for each drawing sheet that is to be changed/amended. After receiving the new sheets of drawings from the patent owner, the examiner may have the draftsman review the new sheets of drawings if the examiner would like the draftsman’s assistance in identifying errors in the drawings. If a draftsman reviews the drawings, and finds the drawings to be unacceptable, the draftsman should complete a PTO-948 for the examiner to include with the next Office action. A draftsman’s “stamp” to indicate approval is no longer required on patent drawings, and these stamps are no longer to be used by draftsmen. The new sheets of drawings should be entered in the reexamination file.

## 2666.03 Correction of Inventorship [Added R-2]

Correction of inventorship in an *inter partes* reexamination proceeding is effected in the same manner that correction of inventorship in an *ex parte* reexamination proceeding is effected. See MPEP § 2250.02 for the manner of correcting inventorship in both *inter partes* and *ex parte* reexamination proceedings.

## 2666.05 Third Party Comments After Patent Owner Response [Added R-2]

*37 CFR 1.947. Comments by third party requester to patent owner’s response in inter partes reexamination.*

Each time the patent owner files a response to an Office action on the merits pursuant to § 1.945, a third party requester may once

file written comments within a period of 30 days from the date of service of the patent owner's response. These comments shall be limited to issues raised by the Office action or the patent owner's response. The time for submitting comments by the third party requester may not be extended. For the purpose of filing the written comments by the third party requester, the comments will be considered as having been received in the Office as of the date of deposit specified in the certificate under § 1.8.

*37 CFR 1.948. Limitations on submission of prior art by third party requester following the order for inter partes reexamination.*

(a) After the *inter partes* reexamination order, the third party requester may only cite additional prior art as defined under § 1.501 if it is filed as part of a comments submission under § 1.947 or § 1.951(b) and is limited to prior art:

(1) which is necessary to rebut a finding of fact by the examiner;

(2) which is necessary to rebut a response of the patent owner; or

(3) which for the first time became known or available to the third party requester after the filing of the request for *inter partes* reexamination proceeding. Prior art submitted under paragraph (a)(3) of this section must be accompanied by a statement as to when the prior art first became known or available to the third party requester and must include a discussion of the pertinency of each reference to the patentability of at least one claim.

(b) [Reserved].

## I. TIMELINESS

A third party requester may once file written comments on any patent owner response to an Office action, during the examination stage of an *inter partes* reexamination proceeding. The third party requester comments must be filed within a period of 30 days from the **date of service** of the patent owner's response on the third party requester. 37 CFR 1.947. The date that the Office receives the patent owner's response has no bearing on the time period for which the third party requester must file the comments.

The certificate of mailing and the certificate of transmission procedures (37 CFR 1.8), and the "Express Mail" mailing procedure (37 CFR 1.10), may be used to file comments. Any comments by the third party requester must be served upon the patent owner in accordance with 37 CFR 1.248, - see also MPEP § 2666.06.

If the third party requester comments are filed after 30 days from the **date of service** of the patent owner's response on the third party requester, the comments will not be considered. See 37 CFR 1.957(a).

## II. CONTENT

The third party requester comments must be directed to points and issues covered by the Office action and/or the patent owner's response. The written comments filed by a third party requester should specify the issues and points in the Office action or the patent owner's response to which each comment is directed. Thus, the third party requester should (A) set forth the point or issue, (B) state the page of the Office action and/or the patent owner response where the point or issue is recited, and (C) then present the third party requester's discussion and argument as to the point or issue. If this is not done by the third party requester, the comments should not be held defective if the examiner can ascertain that all of the comments filed by the third party requester are directed to the issues and points in the Office action and/or the patent owner's response.

Third party requester comments are limited to issues covered by the Office action or the patent owner's response. New prior art can be submitted with the comments **only** where the prior art (A) is necessary to rebut a finding of fact by the examiner, (B) is necessary to rebut a response of the patent owner, or (C) for the first time became known or available to the third party requester after the filing of the request for *inter partes* reexamination. Prior art submitted under (C) must be accompanied by a statement as to when the prior art first became known or available to the third party requester, and must include a discussion of the pertinency of each reference to the patentability of at least one claim.

Where the third party requester written comments are directed to matters other than issues and points covered by the Office action or the patent owner's response, or where the prior art submitted with the comments does not satisfy at least one of (A) - (C) above, the written comments are improper. If the written comments are improper, the examiner should return the written comments (the entire paper) with an explanation of what is not proper, and should provide a time period of 30 days for the third party requester to rectify and refile the comments. If, upon the second submission, the comments are still not proper, the comments will be returned to third party with an explanation of what is not proper, and at that point the comments can no longer be resubmitted. The loss of



right to submit further comments applies only to the patent owner response at hand. See MPEP § 2666.20.

The practice of giving the third party requester a time period of 30 days to rectify and refile comments that are “responsive but informal” should not be confused with the situation where the third party requester files comments that are late (untimely), or such comments are “inappropriate” within the meaning of 37 CFR 1.957(a) and the time for response has expired. Where the comments are late or inappropriate, an additional 30 days is not given; rather, the comments must be refused consideration pursuant to 37 CFR 1.957(a).

The third party requester is not permitted to file further papers to supplement the third party requester’s written comments. Any such improper supplemental comments will not be considered, and will be returned. A third party requester may, however, file written comments to any supplemental response filed by the patent owner.

See MPEP § 2666.20 for the situation where a third party requester elects not to file written comments on a patent owner response.

Where the patent owner does not respond to an Office action, the third party requester is prohibited from filing written comments under 37 CFR 1.947.

Note that a prior art citation which is proper under 37 CFR 1.501 and is submitted by any party as a separate paper and does not include argument and comments and does not go to the merits of the case, will not be returned, but rather will be stored until the present reexamination proceeding is terminated. See MPEP § 2204 and 2206. Also note that prior art returned by the examiner in connection with the third party requester comments as discussed above can be resubmitted as a separate prior art citation under 37 CFR 1.501, and it will be stored until the ongoing reexamination proceeding is terminated.

### III. EXAMINER WITHDRAWS A GROUND OF REJECTION

If the examiner withdraws a ground of rejection at any time in the prosecution of the *inter partes* reexamination proceeding, the third party requester’s next set of comments that may be filed (after a patent owner response to an action) may propose the withdrawn rejection as a “rejection proposed by the third party requester.” In the event the patent owner fails to

respond to all actions leading to the Right of Appeal Notice (RAN), including the Action Closing Prosecution (ACP), and a RAN is then issued, the third party requester may appeal this withdrawal of rejection as a final decision favorable to patentability - see 37 CFR 1.959(a)(2).

### 2666.06 Service of Papers [Added R-2]

*37 CFR 1.903. Service of papers on parties in inter partes reexamination.*

The patent owner and the third party requester will be sent copies of Office actions issued during the *inter partes* reexamination proceeding. After filing of a request for *inter partes* reexamination by a third party requester, any document filed by either the patent owner or the third party requester must be served on every other party in the reexamination proceeding in the manner provided in § 1.248. Any document must reflect service or the document may be refused consideration by the Office. The failure of the patent owner or the third party requester to serve documents may result in their being refused consideration.

Any paper filed with the Office, i.e., any submission made, by either the patent owner or the third party requester must be served on every other party in the reexamination proceeding including any other third party requester that is part of the proceeding due to merger of reexamination proceedings.

As proof of service, the party submitting the paper to the Office must attach a certificate of service to the paper. It is required that the certificate of service set forth the name and address of the party served and the method of service. Further, a copy of the certificate of service must be attached with the copy of the paper that is served on the other party.

Papers filed in which no proof of service is included (where proof of service is required) may be denied consideration. Where no proof of service is included, the Central Reexamination Unit (CRU) will contact the party making the submission by telephone to see whether the indication of proof of service was inadvertently omitted from the party’s submission (however, there was actual service).

-If service was in fact made, the party making the submission should be advised to submit a supplemental paper indicating the manner and date of service. The CRU should enter the submission for consideration, and annotate the paper with: “Service confirmed by [name of person] on [date]”.

-If service was not made, or the party making the submission cannot be contacted, the submission is placed in the reexamination file and normally would not be considered. The CRU should enter the submission on the contents of the file wrapper and place an “(N/E)” next to it. The “(N/E)” can be crossed through if service is later made. The submission itself shall be annotated with “no service” which also can be crossed through if service is later made.

If the party making the submission cannot be contacted, a Notice of Defective Paper (PTOL-2069) will be mailed to the party, providing the party with a time period of one month or 30 days, whichever is longer, to complete the paper via a supplemental paper indicating the manner and date of service.

If it is known that service of a submission was not made, form paragraph 26.68 should be used to give notice to the party that made the submission of the requirement for service under 37 CFR 1.903.

¶ 26.68 *Lack of Service in inter partes examination-37 CFR 1.903*

The submission filed [1] is defective because it appears that the submission was not served on [2]. After the filing of a request for *inter partes* reexamination by a third party requester, any document filed by either the patent owner or the third party requester must be served on the other party (or parties where two third party requester proceedings are merged) in the *inter partes* reexamination proceeding in the manner provided in 37 CFR 1.248. See 37 CFR 1.903.

It is required that service of the submission be made, and a certificate of service be provided to the Office, within ONE MONTH from the date of this letter or within the time remaining in the response period of the last Office action (if applicable), whichever is longer.

**Examiner Note:**

1. This paragraph may be used where a submission to the Office was not served as required in an *inter partes* reexamination proceeding.
2. In bracket 2, insert “patent owner” or “third party requester,” whichever is appropriate.

PTOL-2071 should be used as the cover sheet for mailing the notice.

See MPEP § 2620 for service of the initial request on the patent owner.

## 2666.10 Patent Owner Does Not Respond to Office Action [Added R-2]

37 CFR 1.957. *Failure to file a timely, appropriate or complete response or comment in inter partes reexamination.*

(a) If the third party requester files an untimely or inappropriate comment, notice of appeal or brief in an *inter partes* reexamination, the paper will be refused consideration.

(b) If no claims are found patentable, and the patent owner fails to file a timely and appropriate response in an *inter partes* reexamination proceeding, the reexamination proceeding will be terminated and the Director will proceed to issue a certificate under § 1.997 in accordance with the last action of the Office.

(c) If claims are found patentable and the patent owner fails to file a timely and appropriate response to any Office action in an *inter partes* reexamination proceeding, further prosecution will be limited to the claims found patentable at the time of the failure to respond, and to any claims added thereafter which do not expand the scope of the claims which were found patentable at that time.

(d) When action by the patent owner is a *bona fide* attempt to respond and to advance the prosecution and is substantially a complete response to the Office action, but consideration of some matter or compliance with some requirement has been inadvertently omitted, an opportunity to explain and supply the omission may be given.

### I. OFFICE ACTION PRIOR TO ACTION CLOSING PROSECUTION

If the patent owner fails to file a timely response to any Office action prior to an Action Closing Prosecution (ACP), it will result in the following consequences set forth in 37 CFR 1.957(b) or (c):

(A) Where there were no claims found patentable in the Office action, the examiner will issue a Notice of Intent to Issue *Inter Partes* Reexamination Certificate (NIRC) terminating prosecution and indicating the status of the claims as canceled. See MPEP § 2687.

(B) Where at least one claim is found patentable, all future prosecution will be limited to the claim(s) found patentable at the time of the failure to respond and to claims which do not expand the scope of the claim(s) found patentable at that time. The patent owner will not be permitted to add claims broader in the scope than the patentable claims which remain in the proceeding at the time of the patent owner’s failure to timely respond. The examiner will proceed to issue an ACP indicating that:

(1) Any claims under rejection or objection are withdrawn from consideration and will be canceled upon publication of the certificate; and

(2) Prosecution will be limited to the claim(s) found patentable at the time of the failure to respond and to claims which do not expand the scope of the claim(s) found patentable at that time.

The ACP will set a period for the patent owner response and the third party requester comments under 37 CFR 1.951. See also MPEP § 2671.02 and § 2671.03.

## II. ACTION CLOSING PROSECUTION

A response to an ACP is not required. Where the patent owner does not respond to an ACP, the Office will issue an Right of Appeal Notice (see MPEP § 2673.02) in due course. Accordingly, the consequences of 37 CFR 1.957(b) and (c), do NOT apply to the patent owner's failure to respond to an ACP.

## III. RIGHT OF APPEAL NOTICE AND APPEAL

Where the patent owner fails to make a timely appeal after the issuance of a Right of Appeal Notice, or where a timely patent owner's appeal is subsequently dismissed, the following consequences would result:

(A) If no claim was found patentable at the time that the patent owner fails to take the timely action, a NIRC will immediately be issued. See MPEP § 2687.

(B) Where at least one claim was found patentable and the third party requester does not appeal, or fails to continue its appeal, the proceeding should be terminated in accordance with 37 CFR 1.957(b). In order to do so, a NIRC will be issued. See MPEP § 2687.

(C) Where at least one claim was found patentable and the third party appellant continues its appeal, the claims in the proceeding will be limited to the claim(s) found patentable at the time that the patent owner fails to take the timely action, and all other claims will be withdrawn from consideration pending cancellation of same when the NIRC is issued. Any future prosecution is limited to the claims that do not expand the scope of the claim(s) found patentable at that time.

## IV. FAILURE OF THIRD PARTY REQUESTER TO TIMELY SUBMIT PAPER

See MPEP § 2666.20 for a discussion of the consequences where the third party requester fails to timely submit a paper where a time period is set for same.

### 2666.20 Third Party Does Not Comment After Patent Owner Response [Added R-2]

*37 CFR 1.957. Failure to file a timely, appropriate or complete response or comment in inter partes reexamination.*

(a) If the third party requester files an untimely or inappropriate comment, notice of appeal or brief in an *inter partes* reexamination, the paper will be refused consideration.

\*\*\*\*\*

Where a third party requester does not timely file written comments on a patent owner response, any subsequent submission of comments on **that response** will be refused consideration. The third party requester does not, however, lose any rights as to commenting on *future* patent owner responses. The failure to file the comments applies only to the specific response which the third party requester elects not to comment upon.

Note that where the third party requester did not file comments on a response that was determined by the Office to be incomplete, the third party requester may file comments on the response once it is completed (by patent owner's submission of a supplemental response). However, where only a fee is needed to complete the response, the third party requester may not file comments after the fee is submitted; see MPEP § 2666.40 for a detailed discussion.

Where the third party requester fails to make a timely appeal or the third party requester's appeal is dismissed, the third party requester loses further rights as **the appellant** in the appeal. However, where a patent owner appellant continues its appeal, the third party requester as the respondent can file a respondent brief. Also, the third party requester can enter the appeal pursuant to 37 CFR 1.977 (submission after a Board of Patent Appeals and Interferences decision). In addition, the third party requester can comment on any subsequent patent owner response to any Office action, where the action is issued after the appeal.

Where the third party requester fails to timely appeal, or the requester's appeal is dismissed, and *no other appeal is pending in the proceeding*, the proceeding should be terminated by the issuance of a NIRC.

### **2666.30 Submission Not Fully Responsive to Non-final Office Action [Added R-2]**

*37 CFR 1.957. Failure to file a timely, appropriate or complete response or comment in inter partes reexamination.*

\*\*\*\*\*

(d) When action by the patent owner is a *bona fide* attempt to respond and to advance the prosecution and is substantially a complete response to the Office action, but consideration of some matter or compliance with some requirement has been inadvertently omitted, an opportunity to explain and supply the omission may be given.

A response by the patent owner will be considered not fully responsive to a non-final Office action where a *bona fide* response to an examiner's Office action is filed before the expiration of the permissible response period but through an apparent oversight or inadvertence, some point necessary to a full response has been omitted (i.e., appropriate consideration of a matter that the action raised, or compliance with some requirement, has been omitted). In this situation, the reexamination proceeding should not be terminated. Rather, the examiner may, pursuant to 37 CFR 1.957(d), treat the patent owner submission which is not fully responsive to an Office action by:

(A) waiving the deficiencies (if not serious) in the response and acting on the patent owner submission;

(B) treating the amendment/response as an incomplete response to the Office action and notifying the patent owner (via a written notification action pursuant to 37 CFR 1.957(d)) that the response must be completed within the period for response set in the notification action (or within any extension pursuant to 37 CFR 1.956)) to avoid conclusion of the prosecution (pursuant to 37 CFR 1.957(b)) or limiting prosecution of the claims to those found patentable (pursuant to 37 CFR 1.957(c)).

*Discussion of Option (A).* Where a patent owner submission responds to the rejections, objections, or requirements in an Office action and is a *bona fide*

attempt to advance the reexamination proceeding to final action, but contains a minor deficiency (e.g., fails to treat every rejection, objection, or requirement), the examiner may simply act on the amendment and issue a new Office action. The new Office action may simply reiterate the rejection, objection, or requirement not addressed by the patent owner submission, or the action may indicate that such rejection, objection, or requirement is no longer applicable. In the new Office action, the examiner will identify the part of the previous Office action which was not responded to and clearly indicate what is needed. This course of action would not be appropriate in instances in which a patent owner submission contains a serious deficiency (e.g., the patent owner submission does not appear to have been filed in response to the Office action).

*Discussion of Option (B).* Where the patent owner's submission contains a serious deficiency, i.e., omission, to be dealt with prior to issuing an action on the merits and the period for response has expired, or there is insufficient time remaining to take corrective action before the expiration of the period for response, *the patent owner should be notified of the deficiency and the correction needed, and given a new time period for response (usually 1 month)* pursuant to 37 CFR 1.957(d). The patent owner must then supply the omission within the new time period for response or any extensions under 37 CFR 1.956 thereof to avoid conclusion of the prosecution (pursuant to 37 CFR 1.957(b)) or limiting prosecution of the claims to those found patentable (pursuant to 37 CFR 1.957(c)).

Form paragraph 26.06 may be used where option (B) is employed by the examiner to obtain correction of the deficiency.

#### *¶ 26.06 Submission Not Fully Responsive to Office Action*

The communication filed on [1] is not fully responsive to the prior Office action. [2]. The response appears to be *bona fide*, but through an apparent oversight or inadvertence, consideration of some matter or compliance with some requirement has been omitted. Patent owner is required to supply the omission or correction to thereby provide a full response to the prior Office action.

A shortened statutory period for response to this letter is set to expire (a) ONE MONTH, or THIRTY DAYS (whichever is longer), from the mailing date of this letter, or (b) after the due date for response to the last Office action, whichever of (a) or (b) is longer. THE PERIOD FOR RESPONSE SET IN THIS LETTER MAY BE EXTENDED UNDER 37 CFR 1.956.

If patent owner fails to timely supply the omission or correction and thereby provide a full response to the prior Office action,

the present reexamination proceeding will be terminated pursuant to 37 CFR 1.957(b) or all non-allowed claims will be terminated pursuant to 37 CFR 1.957(c). See MPEP § 2666.10.

#### Examiner Note:

1. In bracket 2, the examiner should explain the nature of the omitted point necessary to complete the response, i.e., what part of the Office action was not responded to. The examiner should also clearly indicate what is needed to correct the omission.
2. This paragraph may be used for a patent owner communication that is not completely responsive to the outstanding (i.e., prior) Office action. See MPEP § 2666.30.
3. This practice does not apply where there has been a deliberate omission of some necessary part of a complete response. See MPEP § 2666.30.

### I. NO NOTIFICATION BY TELEPHONE

It should be noted that the patent owner cannot simply be notified by telephone that the omission must be supplied within the remaining time period for response. This notification would be an interview, and interviews are prohibited in *inter partes* reexamination. 37 CFR 1.955.

### II. FURTHER DISCUSSION

The practice of giving the patent owner a time period to supply an omission in a *bona fide* response (pursuant to 37 CFR 1.957(d)) does not apply where there has been a deliberate omission of some necessary part of a complete response. It is applicable **only** when the missing matter or lack of compliance is considered by the examiner as being “inadvertently omitted” pursuant to 37 CFR 1.957(d). Once an inadvertent omission is brought to the attention of the patent owner, the question of inadvertence no longer exists. Therefore, a second written notification action giving another new (1 month) time period to supply the omission would not be appropriate. However, if the patent owner’s response to the notification of the omission raises a **different** issue of a different inadvertently omitted matter, a second written notification action may be given.

This practice authorizes, but does not require, an examiner to give the patent owner a new time period to supply an omission. Thus, where the examiner concludes that the patent owner is attempting to abuse the practice to obtain additional time for filing a response, the practice should not be followed.

### 2666.40 Patent Owner Completion of Response and Third Party Comments Thereon [Added R-2]

In most cases, the patent owner will have 30-days or one month (whichever is longer) to complete the response. After the owner completes the response, the examiner will wait two months from the date of service of the patent owner’s completion of the response, and then take up the case for action, since the 30 days for the third party requester comments on the response as completed will have expired by that time.

The third party requester may file comments on the response as completed. This is true whether or not the third party requester filed comments on the response that was incomplete. The response as completed is treated as a new response on-the-merits to the Office action; thus, the third party requester is entitled to respond and has 30 days to do so.

In some instances, only a fee will be needed for the patent owner to complete the response. In these instances, any third party requester comments must be filed within 30 days from the date of service of the patent owner’s original response (which was indicated by the Office as incomplete due to the omission of the necessary fee). The third party requester is not permitted to file comments in response to the submission of the fee, because the submission of a fee clearly adds nothing on the merits. An example of this would be where a terminal disclaimer is newly required in a reexamination proceeding and is submitted, but the fee is inadvertently omitted. The response would then be incomplete only as to the omitted fee. Any third party requester comments on the terminal disclaimer must be filed within 30 days from the date of service of the patent owner’s terminal disclaimer on the third party requester. Where the patent owner then completes the response by filing the fee, the third party requester is not permitted to then comment. However, if the patent owner’s response is not limited to the bare submission of the fee, i.e., if the response also includes argument, then the third party can comment since the patent owner has addressed the merits of the case.

**2666.50 Examiner Issues Notice of Defective Paper in *Inter Partes* Reexamination [Added R-2]**

Even if the substance of a submission is complete, the submission can still be defective, i.e., an “informal submission.” Defects in the submission can be, for example:

- (A) The paper filed does not include proof of service;
- (B) The paper filed is unsigned;
- (C) The paper filed is signed by a person who is not of record; or
- (D) The amendment filed by the patent owner does not comply with 37 CFR 1.530(d)-(j).

Where a submission made is defective (informal), form PTOL-2069 is used to provide notification of the defects present in the submission. In many cases, it is only necessary to check the appropriate box on the form and fill in the blanks. However, if the defect denoted by one of the entries on form PTOL-2069 needs further clarification (such as the specifics of why the amendment does not comply with 37 CFR 1.530(d)-(j)), the additional information should be set forth on a separate sheet of paper which is then attached to the form PTOL-2069.

The defects identified in (A) through (D) above are specifically included in form PTOL-2069. If the submission contains a defect other than those specifically included on the form, the “Other” box on the form is to be checked and the defect explained in the space provided for the explanation. For example, a response

might be presented on easily erasable paper, and thus, a new submission would be needed.

Where both the patent owner response and the third party comments are defective, a first form PTOL-2069 should be completed for the patent owner (setting forth the defects in the patent owner response), and a second form PTOL-2069 completed for the third party requester (setting forth the defects in the third party requester’s comments). A copy of both completed forms would then be sent to all parties.

The Office action’s two month period for response usually will have expired by the time the examiner notes the defects and issues a letter. Accordingly, a time period of 30-days or one month, whichever is longer, will be set for correction of the defect(s). The patent owner may request an extension of time to correct the defect(s) under 37 CFR 1.956. The third party requester, however, is barred from requesting an extension of time by statute. 35 U.S.C. 314(b)(2).

If the defect in the patent owner response or the third party requester comments is limited to a problem with the signature, claim format, or some other obvious defect (easily corrected), and such is noted by the staff of the Office of Patent Legal Administration (OPLA) processing the papers, then the staff of OPLA may, in some instances, issue form PTOL-2069 to notify parties of the defect, and obtain a response to the form, prior to forwarding the case to the examiner. Otherwise, the responsibility is with the examiner to obtain the needed correction of the defects in the papers, which defects are either identified to the examiner by the staff of OPLA in an informal memo, or noted independently by the examiner.



UNITED STATES PATENT AND TRADEMARK OFFICE

Commissioner for Patents  
 United States Patent and Trademark Office  
 P.O. Box 1450  
 Alexandria, VA 22313-1450  
 www.uspto.gov

CONTROL NUMBER	FILING DATE	PATENT UNDER REEXAMINATION	ATTORNEY DOCKET NO.

EXAMINER	
ART UNIT	PAPER NUMBER

DATE MAILED:

**NOTICE RE DEFECTIVE PAPER IN INTER PARTES REEXAMINATION**

1.  No proof of service is included with the paper filed by  owner  requester on \_\_\_\_\_, 37 CFR 1.248 and 1.903. Proof of service is required within a time period of 30-days or one month from the date of this letter or within the time remaining in the response/comments period set in the last Office action, whichever is longest. Failure to serve the paper may result in the paper being refused consideration.
2.  The paper filed on \_\_\_\_\_ by the  owner  requester is unsigned. A duplicate paper or ratification, properly signed, is required within a time period of 30-days or one month from the date of this letter or within the time remaining in the response/comments period set in the last Office action, whichever is longest. **Note:** An unsigned requester notice of appeal or cross appeal may not be ratified where the time set for appeal in the Right of Appeal Notice has expired. 37 CFR 1.957(a) and 1.959(c) and (e).
3.  The paper filed on \_\_\_\_\_ by the  owner  requester is signed by \_\_\_\_\_ who is not of record. A ratification or a new power of attorney with a ratification, or a duplicate paper signed by a person of record, is required within a time period of 30-days or one month from the date of this letter or within the time remaining in the response/comments period set in the last Office action, whichever is longest. **Note:** An improperly signed requester notice of appeal or cross appeal may not be ratified where the time set for appeal in the Right of Appeal Notice has expired. 37 CFR 1.957(a) and 1.959(c) and (e).
4.  The amendment filed by owner on \_\_\_\_\_, does not comply with 37 CFR 1.530(d)-(j). Patent owner is given a time period of 30-days or one month from the date of this letter or the time remaining in the response period of the last Office action, whichever is longest, to correct this informality, or the amendment will not be entered, although the argument will be considered as it applies to the proceeding without the amendment.
5.  Other:

**NOTE: PATENT OWNER EXTENSIONS OF TIME ARE GOVERNED BY 37 CFR 1.956. NO EXTENSION OF TIME IS PERMITTED FOR THIRD PARTY REQUESTER. 35 U.S.C. 314(b)(3). All correspondence relating to this *inter partes* reexamination proceeding should be directed to the Central Reexamination Unit at the mail, FAX, or hand-carry addresses given at the end of this Office action.**

PTOL-2069 (12/03)

### 2666.60 Response by Patent Owner/ Third Party to Notice of Defective Paper [Added R-2]

The patent owner and/or the third party requester will be given a time period of 30-days or one month from the mailing date of the notice of defective paper or the time remaining in the response/comments period set in the last Office action, whichever is longest, to correct the defect in a submission. If, in response to the notice, the defect still is not corrected, the submission will not be entered. Where the defect is not corrected within the time permitted by the notice, the submission will not be considered, except for the case of an improper amendment which does not comply with 37 CFR 1.530(d)-(j). The amendment directed by the submission will not be entered; however, the argument (presented in the submission) will be considered as best it can be applied to the case without entry of the amendment. Thus, the patent owner will still be considered to have responded to the Office action (though the response might be incomplete).

After the patent owner or the third party requester has provided a submission directed solely to correcting the defect, the other party is not permitted to comment on the submission correcting the defect, since the submission correcting the defect is directed to form and does not go to the merits of the case. This would be the case, for example, where the failure to provide a signature or a certificate of service is corrected, or where a permanent copy is submitted to replace an “easily erasable” paper that was originally submitted.

In the case of correcting a defective amendment, however, other issues come into play. Where for example, new claims 10-20 are improperly presented in a patent owner response (e.g., not properly underlined), they generally will not be entered and form PTOL-2069 (Box 4) will be used to notify the patent owner of the need to correct this defect. Until the defect is corrected, claims 10-20 do not yet exist in the proceeding for the third party requester to comment on. Likewise, any argument that was directed to such claims is not truly ripe for the third party requester comment. After the patent owner corrects the defect, claims 10-20 come into existence in the proceeding, and the argument presented by the patent

owner becomes relevant. At this point, the third party requester has a right to provide comments in response to the patent owner’s argument, whether or not the argument that was included in the original patent owner submission is re-presented with the paper correcting the defect. Thus, any third party requester comments submitted either in response to the patent owner’s initial paper (presenting the informal claims) or in response to the patent owner’s supplemental paper (correcting the informality) will be considered by the examiner.

Any submission correcting the defect which provides a discussion of the merits should (A) set forth that discussion separately from the portion of the response that corrects the defect, and (B) clearly identify the additional discussion as going to the merits. The additional discussion going to the merits must, in and of itself, have an entry right, or the entire submission will be returned to the party that submitted it, and **one** additional opportunity (30-days or one month, whichever is longer) will be provided, to correct the defect without a discussion of the merits. If the portion directed to the merits is not clearly delineated and identified, the entire submission may be returned to the party that submitted it, and **one** additional opportunity (30-days or one month, whichever is longer) is then given for that party to correct the defect without intermixed discussion of the merits. The examiner may, however, choose to permit entry of such a paper.

### 2667 Handling of Inappropriate or Untimely Filed Papers [Added R-2]

*37 CFR 1.939. Unauthorized papers in inter partes reexamination.*

(a) If an unauthorized paper is filed by any party at any time during the *inter partes* reexamination proceeding it will not be considered and may be returned.

(b) Unless otherwise authorized, no paper shall be filed prior to the initial Office action on the merits of the *inter partes* reexamination.

The applicable regulations (such as 37 CFR 1.501, 1.902 and 1.905, 1.948 and 1.939) provide that certain types of correspondence will not be considered. Whenever reexamination correspondence is received, a decision is required of the Office as to the action to be taken on the correspondence based on what type of paper it is and whether it is timely. In certain instances, the submitted correspondence



(submission) will be entered into the reexamination file and be considered. In other instances, the correspondence will be entered into the reexamination file, but will not be considered. In still other instances, the correspondence will not be entered into the reexamination file and will be returned to the party that sent it. The return of certain inappropriate submissions, not being considered, reduces the amount of paper which would ultimately have to be stored with the patent file.

Where papers are filed during reexamination proceedings which are inappropriate because of some defect, such papers will either be returned to the sender or be forwarded to one of three places: the reexamination file; the patent file; or the storage area. Any papers returned to the sender must be accompanied by a letter as to the return. The letter is prepared by the Technology Center (TC) Director (or in some instances, by the Office of Patent Legal Administration) and is forwarded to the Central Reexamination Unit (CRU) for mailing. The original of the letter returning the paper will be retained in the file and given a paper number.

## **I. TYPES OF PAPERS RETURNED WITH DIRECTOR OF THE USPTO OR TECHNOLOGY CENTER DIRECTOR APPROVAL REQUIRED**

### **A. Filed by Patent Owner**

#### **1. Premature Response/Comments by Patent Owner**

Any response/comments as to materials of record or any amendment filed by the patent owner prior to the first Office action is premature and will be returned and will not be considered. 37 CFR 1.939.

Any petition requesting merger of a reexamination with a reexamination or reissue, or a stay of a reexamination or reissue in place of merger, that is filed prior the order to reexamine (37 CFR 1.931) will be returned and will not be considered. See MPEP § 2686.01 and § 2686.03.

#### **2. Response Is Too Long**

Where the length of the patent owner submission exceeds that permitted by 37 CFR 1.943, the pages of the submission that exceed the maximum limit will be

returned and will not be considered. The signature page (which would be at the end of the submission) will be redacted to exclude any arguments/comments, and a copy of the same placed with the retained portion of the submission. The retained portion of the submission will be reconsidered.

### **3. Improper Patent Owner Response**

The patent owner can only file once under 37 CFR 1.951(a). Any second or supplemental submission after ACP by the patent owner will be returned, unless prosecution has been reopened. See MPEP § 2672.

#### **B. Filed by Third Party Requester**

##### **1. Premature Comments by Third Party Requester**

Any comments filed by a third party requester subsequent to the request for reexamination (i.e., not part of it) and prior to the first Office action is premature, and it will be returned and will not be considered. 37 CFR 1.939. Any petition to stay a reexamination proceeding because of an interference (MPEP § 2686.02), which is filed prior to the first Office action in the reexamination proceeding will be returned and will not be considered.

Any petition requesting merger of a reexamination with a reexamination or reissue or a stay of a reexamination or reissue in place of merger, that is filed prior the order to reexamine (37 CFR 1.931) will be returned and will not be considered. See MPEP § 2686.01 and § 2686.03.

Any submission of comments filed by a third party requester where the patent owner has not responded to the outstanding Office action is premature, and it will be returned and will not be considered. 37 CFR 1.947.

##### **2. Response Is Too Long**

Where the length of the third party requester submission exceeds that permitted by 37 CFR 1.943, the pages of the submission that exceed the maximum limit will be returned and will not be considered. The signature page (which would be at the end of the submission) will be redacted to exclude any arguments/comments, and a copy of the same placed with the retained portion of the submission. The retained portion of the submission will be reconsidered.

### 3. Improper Comments

Where the third party requester comments are not limited to the scope provided by the rules, they are improper and will be returned and will not be considered. 37 CFR 1.947 and 1.951(b). For example, comments following the patent owner's response to a first Office action must be limited to issues and/or points covered by the first action and/or the patent owner's response (in accordance with 37 CFR 1.947); if they are not, they will be returned. See MPEP § 2666.05 for action to be taken by the examiner.

For any third party requester comments containing a submission of prior art, the prior art must be limited solely to prior art which is necessary to rebut a finding of fact by the examiner, which is necessary to rebut a response of the patent owner, or, which for the first time became known or available to the third party requester after the filing of the request for *inter partes* reexamination. Prior art submitted for the reason that it became known or available to the third party requester for the first time after the filing of the request for *inter partes* reexamination must be accompanied by a statement as to when the prior art first became known or available to the third party requester and must include a discussion of the pertinency of each reference to the patentability of at least one claim. If the prior art submission does not satisfy at least one of the criteria noted above, the comments are improper and will be returned and will not be considered. See MPEP § 2666.05 for action to be taken by the examiner.

Supplemental third party requester comments are improper since 37 CFR 1.947 states that comments can "once" be filed. Such supplemental comments are improper, will not be considered, and will be returned. However, supplemental third party comments are permitted in response to the patent owner's completion of a response, even where the initial third party comments were provided after the incomplete patent owner response. Supplemental third party comments are also permitted in response to a supplemental patent owner response.

The third party requester can only respond to a patent owner submission after an Action Closing Prosecution (ACP), and may only do so once under 37 CFR 1.951(b). Any original third party requester comments (where the patent owner does not respond) or any second or supplemental responsive comments

after ACP are improper and will be returned. See MPEP § 2672.

Third party comments in response to a patent owner submission which does not respond to an Office action are not permitted, since 37 CFR 1.947 only permits comments in response to the patent owner's response to an Office action. For example, where the patent owner submits a new power of attorney, the third party requester is not permitted to submit a set of comments, because the patent owner submission is not a response to an Office action. If the third party requester does comment, it will be returned.

### 4. Improper Petition

Any petition to stay a reexamination proceeding because of an interference (MPEP § 2686.02), which is filed prior to the first Office action in the reexamination proceeding will be returned and will not be considered. 37 CFR 1.939.

Any petition by a third party requester to stay a reexamination proceeding because of an interference where the third party is not a party to the interference will be returned and will not be considered. See MPEP § 2686.02.

Any petition requesting merger of a reexamination with a reexamination or reissue, or a stay of a reexamination or reissue in place of merger, that is filed prior to the order to reexamine (37 CFR 1.931) will be returned and will not be considered. See MPEP § 2686.01 and 2686.03. Note, also, that a petition by the third party requester requesting that a later-filed case should not be merged (see MPEP § 2640 "Second Or Subsequent Request...") will be returned and will not be considered, where it is filed prior to the order to reexamine. Prior to the order, such a petition is not ripe for decision because it is possible that reexamination will not be granted and there will be nothing to merge.

#### C. Filed by Third Party Other Than Third Party Requester

No submissions on behalf of any third parties other than third party requesters as defined in 35 U.S.C. 100(e) will be considered unless such submissions are in accordance with 37 CFR 1.915 or are one of the exceptions noted below. Thus, a petition to merge a reexamination, or stay one of them because of the other, which is filed by a party other than the patent owner or the third party requester of reexamination

will not be considered, but will be returned to that party as being improper under 37 CFR 1.905. See also MPEP § 2686.01 and MPEP § 2686.03.

A paper submitted by a third party other than a third party requester must be (1) a 37 CFR 1.501 art citation limited to the citation of patents and printed publications and an explanation of the pertinency and applicability of the patents and printed publications, or (2) bare notice of suits and other proceedings involving the patent (see MPEP § 2686 and § 2686.04) which may include copies of decisions or other court papers, or papers filed in the court, from litigations or other proceedings involving the patent. Such submissions must be without additional comment and cannot include further arguments or information. If the submission by the third party is not one of the above-described two types of papers, it will be returned to an identified third party or destroyed if the submitter is unidentified. If a submission by the third party of either of the above-described two types of papers contains additional material that goes beyond the scope of what is permitted, the paper will be returned to an identified third party, or destroyed if the third party submitter is unidentified. If a proper 37 CFR 1.501 submission is filed by a third party after the order to reexamine, it will be stored in the storage area-see below.

## II. TYPES OF DEFECTIVE PAPERS TO BE LOCATED IN THE “REEXAMINATION FILE”

### A. *Filed by Patent Owner*

#### 1. **Unsigned Papers**

Papers filed by the patent owner which are unsigned, or signed by less than all of the patent owners where no attorney or agent is of record or acting in representative capacity, will be denied consideration, but will be retained in the file. 37 CFR 1.33.

#### 2. **No Proof of Service**

Papers filed by the patent owner in which no proof of service is included, and proof of service is required, may be denied consideration. Such papers should be denied consideration where it cannot be determined that service was in fact made and the third party requester’s response/comment/appeal/brief period is

to be set by the date of service. See 37 CFR 1.248 and MPEP § 2666.06.

### 3. **Late Papers**

Where patent owner has filed a paper which was filed after the period for response set by the Office, the paper will be retained in the file but will not be considered.

A patent owner submission following a third party requester submission, where the patent owner submission is filed subsequent to the permitted time from the date of service of third party requester’s submission, will be retained in the file but will not be considered. The date that the Office actually receives the third party requester’s submission has no bearing here; it is the date of service on the patent owner which is critical.

### 4. **Defective Amendment**

A proposed amendment to the description and claims which does not comply with 37 CFR 1.530(d)-(k) will be retained in the file, but the amendment will not be considered. An exception to this is where the only defect in the amendment is that it enlarges the scope of the claims of the patent or introduces new matter. Such an amendment *will be considered*, and a rejection will be made in the next Office action.

### 5. **Premature Appeal**

Where a notice of appeal or notice of cross appeal is filed before a Right of Appeal Notice (RAN) has been issued, the paper will be retained in the file but will not be considered (other than to inform the parties that the appeal is not acceptable).

### B. *Filed by Third Party Requester*

#### 1. **Unsigned Papers**

Papers filed by a third party requester which are unsigned or not signed by the third party requester or requester’s attorney/agent of record or attorney/agent acting in representative capacity will be denied consideration. 37 CFR 1.33.

#### 2. **No Proof of Service**

Papers filed by a third party requester in which no proof of service is included as to the patent owner and/or any other third party requester, and proof of

service is required, may be denied consideration. Such papers should be denied consideration where it cannot be determined that service was in fact made and another party's response/comment/appeal/brief period is to be set by the date of service. 37 CFR 1.248.

### 3. Late Papers

Any third party requester submission following a patent owner's submission, where the third party requester submission is filed subsequent to the permitted time from the date of service of the patent owner's submission, will be retained in the file, but will not be considered. Note, for example, a 37 CFR 1.947 submission of third party comments following the patent owner's response. Where the third party comments are submitted subsequent to 30 days from the date of service of the patent owner's response, they will be retained in the file but will not be considered. The date that the Office actually receives the patent owner's response has no bearing here; it is the date of service on the third party requester which is critical.

Where the third party requester has filed a paper which is untimely, that is, it was filed after the period set by the Office for response, the paper will be retained in the file, but will not be considered.

### 4. Premature Appeal

Where a notice of appeal or notice of cross appeal is filed before a Right of Appeal Notice (RAN) has been issued, the paper will be retained in the file, but will not be considered (other than to inform the parties that the appeal is not acceptable). 37 CFR 1.959.

## III. PAPERS LOCATED IN THE "STORAGE AREA"

A storage area for submissions of art citations in an *inter partes* reexamination will be maintained separate and apart from the reexamination and patent files, and at a location in the CRU.

Submission of art citations in an *inter partes* reexamination is permitted by the patent owner and the third party requester to the extent stated in the regulations. 37 CFR 1.501 and 1.902. All other submissions of art citations based solely on prior patents or publications filed after the date of the order to reexamine are retained in the storage area. Such citations are not entered into the patent file, but rather are delayed until

the reexamination proceedings have been terminated. See MPEP § 2602. (Proper timely filed submissions of art citations made prior to the order to reexamine are placed in the reexamination file.)

## 2668 Petition for Entry of Late Papers for Revival of Reexamination Proceeding [Added R-2]

35 U.S.C. 41. *Patent fees; patent and trademark search systems.*

\*\*\*\*\*

(7) On filing each petition for the revival of an unintentionally abandoned application for a patent, for the unintentionally delayed payment of the fee for issuing each patent, or for an unintentionally delayed response by the patent owner in any reexamination proceeding, \$1,210, unless the petition is filed under section 133 or 151 of this title, in which case the fee shall be \$110.

\*\*\*\*\*

35 U.S.C. 133. *Time for prosecuting application.*

Upon failure of the applicant to prosecute the application within six months after any action therein, of which notice has been given or mailed to the applicant, or within such shorter time, not less than thirty days, as fixed by the Director in such action, the application shall be regarded as abandoned by the parties thereto, unless it be shown to the satisfaction of the Director that such delay was unavoidable.

37 CFR 1.137. *Revival of abandoned application, terminated reexamination proceeding, or lapsed patent.*

(a) *Unavoidable.* If the delay in reply by applicant or patent owner was unavoidable, a petition may be filed pursuant to this paragraph to revive an abandoned application, a reexamination proceeding terminated under §§ 1.550(d) or 1.957(b) or (c), or a lapsed patent. A grantable petition pursuant to this paragraph must be accompanied by:

(1) The reply required to the outstanding Office action or notice, unless previously filed;

(2) The petition fee as set forth in § 1.17(l);

(3) A showing to the satisfaction of the Director that the entire delay in filing the required reply from the due date for the reply until the filing of a grantable petition pursuant to this paragraph was unavoidable; and

(4) Any terminal disclaimer (and fee as set forth in § 1.20(d)) required pursuant to paragraph (d) of this section.

(b) *Unintentional.* If the delay in reply by applicant or patent owner was unintentional, a petition may be filed pursuant to this paragraph to revive an abandoned application, a reexamination proceeding terminated under §§ 1.550(d) or 1.957(b) or (c), or a lapsed patent. A grantable petition pursuant to this paragraph must be accompanied by:

(1) The reply required to the outstanding Office action or notice, unless previously filed;

(2) The petition fee as set forth in § 1.17(m);

(3) A statement that the entire delay in filing the required reply from the due date for the reply until the filing of a grantable petition pursuant to this paragraph was unintentional. The Director may require additional information where there is a question whether the delay was unintentional; and

(4) Any terminal disclaimer (and fee as set forth in § 1.20(d)) required pursuant to paragraph (d) of this section.

\*\*\*\*\*

(e) *Request for reconsideration.* Any request for reconsideration or review of a decision refusing to revive an abandoned application, a terminated reexamination proceeding, or lapsed patent upon petition filed pursuant to this section, to be considered timely, must be filed within two months of the decision refusing to revive or within such time as set in the decision. Unless a decision indicates otherwise, this time period may be extended under:

(1) The provisions of § 1.136 for an abandoned application or lapsed patent;

(2) The provisions of § 1.550(c) for a terminated *ex parte* reexamination proceeding filed under § 1.510; or

(3) The provisions of § 1.956 for a terminated *inter partes* reexamination proceeding filed under § 1.913.

\*\*\*\*\*

If the patent owner in an *inter partes* reexamination proceeding fails to file a timely and appropriate response to any Office action and no claims are allowable, then pursuant to 37 CFR 1.957(b), the proceeding is terminated, and a certificate under 37 CFR 1.997 is issued canceling all claims of the patent.

An *inter partes* reexamination proceeding terminated under 37 CFR 1.957(b) can be revived if the delay in response by the patent owner was unavoidable in accordance with 37 CFR 1.137(a), or unintentional in accordance with 37 CFR 1.137(b).

If the patent owner in an *inter partes* reexamination proceeding fails to file a timely and appropriate response to any Office action and at least one claim is allowable, then pursuant to 37 CFR 1.957(c), the proceeding continues but is limited to the claim(s) found allowable at the time of the failure to respond (i.e., in the Office action).

Rejected claims terminated under 37 CFR 1.957(c) can be revived if the delay in response by the patent owner was unavoidable in accordance with 37 CFR 1.137(a), or unintentional in accordance with 37 CFR 1.137(b).

All petitions in reexamination proceedings to accept late papers and revive will be decided in the Office of Patent Legal Administration (OPLA).

## I. PETITION BASED ON UNAVOIDABLE DELAY

The unavoidable delay provisions of 35 U.S.C. 133 are imported into, and are applicable to, reexamination proceedings by 35 U.S.C. 305 and 314. See *In re Katrapat*, 6 USPQ2d 1863 (Comm'r Pat. 1988). Accordingly, the Office will consider, in appropriate circumstances, a petition showing unavoidable delay under 37 CFR 1.137(a) where untimely papers are filed by the patent owner subsequent to the order for reexamination. Any such petition must provide an adequate showing of the cause of unavoidable delay, including the details of the circumstances surrounding the unavoidable delay and evidence to support the showing. Additionally, the petition must be accompanied by a proposed response to continue prosecution (unless it has been previously filed) and by the petition fee required by 37 CFR 1.17(l).

## II. PETITION BASED ON UNINTENTIONAL DELAY

The unintentional delay fee provisions of 35 U.S.C. 41(a)(7) are imported into, and are applicable to, any reexamination proceeding by Sec. 4605(a) of the American Inventors Protection Act of 1999. Accordingly, the Office will consider, in appropriate circumstances, a petition showing unintentional delay under 37 CFR 1.137(b) where untimely papers are filed by the patent owner subsequent to the order for reexamination. Any such petition must provide a verified statement that the delay was unintentional, a proposed response to continue prosecution (unless it has been previously filed), and the petition fee required by 37 CFR 1.17(m).

## III. RENEWED PETITION

Reconsideration may be requested of a decision dismissing or denying a petition under 37 CFR 1.137(a) or (b) to revive a terminated reexamination proceeding. The request for reconsideration must be submitted within one (1) month from the mail date of the decision for which reconsideration is requested. An extension of time may be requested only under 37 CFR 1.956; extensions of time under 37 CFR 1.136 are not available in reexamination proceedings. Any reconsideration request which is submitted should include a cover letter entitled "Renewed Petition

under 37 CFR 1.137(a)” (for an “unavoidable” petition) or “Renewed Petition under 37 CFR 1.137(b)” (for an “unintentional” petition).

#### IV. PETITION REQUIREMENTS

See also MPEP § 711.03(c), part III, for a detailed discussion of the requirements of petitions filed under 37 CFR 1.137(a) and 37 CFR 1.137(b).

### 2670 Clerical Handling [Added R-2]

#### I. CENTRAL REEXAMINATION UNIT PROCESSING

Central Reexamination Unit (CRU) support staff, will carry out clerical handling and processing of *inter partes* reexamination cases. When the case is in the Technology Center (TC), the TC support staff will do the clerical processing needed for the reexamination, and the Special Program Examiner (SPRE) and paralegal will oversee the clerical processing.

#### II. TECHNOLOGY CENTER PROCESSING

The TC clerical staff will provide support for the examiner’s preparation of Office actions, and for handling the case as needed within the TC. The clerical staff will perform all PALM matters needed for the case in the TC, e.g., PALMing in the file and PALMing it to the examiner. After the examiner has completed a decision on the request for *inter partes* reexamination and/or an Office action, the TC clerical staff will make a copy of the decision and/or Office action for the patent owner and for the third party requester(s). The clerical staff will also make copies of any references which are needed. A transmittal form PTOL-2070 with the third party requester’s address will be completed by the TC (if a copy for mailing is not already in the case file). The clerical staff will coordinate its activities with those of the examiner and the TC SPRE and paralegal.

#### III. AMENDMENT ENTRY

While amendments in an *ex parte* reexamination proceeding are entered by the TC clerical staff, amendments in an *inter partes* reexamination proceeding (which comply with 37 CFR 1.941) are entered by the CRU. Otherwise, the entry of amend-

ments in an *ex parte* reexamination proceeding is the same as entry of amendments in an *inter partes* reexamination proceeding. See MPEP § 2234 and § 2250 for manner of entering amendments.

For entry of amendments in a merged *inter partes* reexamination proceeding (i.e., an *inter partes* reexamination proceeding merged with another reexamination proceeding or with a reissue application), see MPEP § 2686.01 and § 2686.03.

Where an amendment is submitted in proper form and it is otherwise appropriate to enter the amendment, the amendment will be entered for purposes of the reexamination proceeding, even though the amendment does not have legal effect until the certificate is issued. Any “new matter” amendment to the disclosure (35 U.S.C. 132) will be required to be canceled, and claims containing new matter will be rejected under 35 U.S.C. 112. A “new matter” amendment to the drawing is ordinarily not entered. See MPEP § 608.04, § 608.04(a) and § 608.04(c). Where an amendment enlarges the scope of the claims of the patent, the claims will be rejected under 35 U.S.C. 314(a).

### 2671 Examiner Action Following Response/Comments or Expiration of Time for Same [Added R-2]

#### I. RECONSIDERATION

After response by the patent owner and any third party comments, the patent under reexamination will be reconsidered. The patent owner and the third party requester will be notified as to any claims rejected, any claims found patentable and any objections or requirements made. The patent owner may respond to such Office action with or without amendment, and the third party requester may provide comments after the patent owner’s response. If the patent owner response contains an amendment, the examiner will consider the amendment to determine whether the amendment raises issues of 35 U.S.C. 112 and/or broadening of the claims under 35 U.S.C. 314. The patent under reexamination will be reconsidered until the proceeding is ready for closing prosecution, at which point the examiner will issue an Action Closing Prosecution (ACP). See MPEP § 2671.02.

## II. CASE IS TAKEN UP FOR ACTION

The case should be acted on promptly, in accordance with the statutory requirement for “special dispatch within the Office” (35 U.S.C. 314(c)).

After the examiner receives the case file (having the patent owner’s response to the Office action and any third party requester comments on that response), he/she will prepare for a pre-action consultation conference with a Reexamination Legal Adviser (RLA). At the consultation conference, the RLA will provide instructions as to preparation of the Office action addressing the patent owner’s response and any third party requester comments on that response. The consultation should be completed within two (2) weeks of when the case was initially forwarded to the TC by the Central Reexamination Unit (CRU).

After the consultation conference, the examiner will promptly take up the case for action. The examiner will prepare an Office action no later than two weeks from the date of the consultation conference. The case, with the completed action, will be forwarded to the TC SPRE for review. If the SPRE returns the case to the examiner for correction/revision, the correction/revision must be handled expeditiously and returned to the SPRE within the time set for such by the SPRE.

## III. OPTIONS AS TO OFFICE ACTION TO ISSUE

*At this point in the proceeding, the examiner will have the following options as to the next Office action to issue:*

(A) There is **no** timely response by the patent owner (since the patent owner did not respond, no third party requester comments may be filed):

(1) If **all** claims are under rejection, the examiner will issue a Notice of Intent to Issue *Inter Partes* Reexamination Certificate (NIRC). See MPEP § 2687. All claims will be canceled by formal examiner’s amendment (attached as part of the NIRC).

(2) If at least one claim is free of rejection and objection, the examiner will issue an Action Closing Prosecution (ACP). In the ACP, it will be stated that any claims under rejection or objection are withdrawn from consideration and will be canceled upon issuance of a NIRC. It will further be stated that the proceeding will be limited to the claims found patentable

at the time of the failure to respond, and to claims (added or amended) which do not expand the scope of the claims found patentable at that time. See MPEP § 2666.10.

It should be noted that even in a situation where there has been no patent owner response, the examiner is always free to issue a supplemental Office action providing a new rejection of claims **previously found patentable**, where new information comes to the attention of the examiner warranting the new rejection. Of course, such an action would ordinarily not be made an ACP.

(B) There is a timely response by the patent owner, and the third party requester does **not** timely provide comments:

(1) If the response by the patent owner is incomplete, the examiner may issue an incomplete-response action. See MPEP § 2666.30.

(2) If there is a formality defect in the response by the patent owner, the examiner will issue a Notice of Defective Paper in Reexam. See MPEP § 2666.50.

(3) If the patent owner’s response is complete and defect-free, and the proceeding is ready for closing prosecution, the examiner will issue an ACP. See MPEP § 2671.02. This is true if all claims are determined to be patentable, all claims are determined to be rejected, or if some claims are determined to be patentable and some claims are determined to be rejected. After the ACP has been issued, the patent owner can submit comments with or without a proposed amendment in accordance with MPEP § 2672, and the third party requester can then file comments responsive to the patent owner’s submission.

(4) If the patent owner’s response is complete and defect-free, and the proceeding is **not** ready for closing prosecution, the examiner will issue a new office action that does not close prosecution. See MPEP § 2671.01.

(C) There is a timely response by the patent owner, and the third party requester does provide timely comments:

(1) If the response by the patent owner is incomplete, the examiner may issue an incomplete-response action. See MPEP § 2666.30.

(2) If the comments by third party requester go beyond the scope of what is permitted for the third party comments, the examiner will follow the

procedures set forth in MPEP § 2666.05 for improper comments.

(3) If there is a formality defect in the response by the patent owner, the examiner will issue a Notice of Defective Paper in Reexam. See MPEP § 2666.50.

(4) If there is a formality defect in the comments by the third party requester, the examiner will issue a Notice of Defective Paper in Reexam. See MPEP § 2666.50.

(5) If the response and comments are in order, and the proceeding is ready for closing prosecution, the examiner will issue an ACP. See MPEP § 2671.02. This is true if all claims are determined to be patentable, all claims are determined to be rejected, or if some claims are determined to be patentable and some claims are determined to be rejected. After the ACP has been issued, the patent owner can submit comments with or without a proposed amendment in accordance with MPEP § 2672 and the third party requester can then file comments responsive to the patent owner's submission.

(6) If the response and comments are in order and the proceeding is **not** ready for closing prosecution, the examiner will issue a new office action that does not close prosecution. See MPEP § 2671.01.

(D) There is a timely request for issuance of an Expedited Right of Appeal Notice:

37 CFR 1.953(b) provides for the issuance of an expedited Right of Appeal Notice (RAN), where the criteria for the same is satisfied. At any time after the patent owner's response to the first Office action on the merits in an *inter partes* reexamination, the patent owner and third party requester(s) may request the immediate issuance of a RAN. Where such a request is presented in the proceeding, see MPEP § 2673.02 for guidance as to whether an expedited Right of Appeal Notice will be issued.

### **2671.01 Examiner Issues Action on Merits That Does Not Close Prosecution [Added R-2]**

*37 CFR 1.949. Examiner's Office action closing prosecution in inter partes reexamination.*

Upon consideration of the issues a second or subsequent time, or upon a determination of patentability of all claims, the examiner shall issue an Office action treating all claims present in the *inter partes* reexamination, which may be an action closing prosecution. The Office action shall set forth all rejections and determinations not to make a proposed rejection, and the grounds

therefor. An Office action will not usually close prosecution if it includes a new ground of rejection which was not previously addressed by the patent owner, unless the new ground was necessitated by an amendment.

#### **I. WHEN A NON-ACP ACTION IS ISSUED**

After reviewing the patent owner's response and third party requester comments (if such comments are filed), the examiner may determine that the proceeding is not ready for issuing an Action Closing Prosecution (ACP). Such a determination would be based upon the following:

(A) In accordance with 37 CFR 1.949, an action will not normally close prosecution if it includes a new ground of rejection which was not previously addressed by the patent owner, unless the new ground was necessitated by an amendment. The examiner will not close prosecution where a new ground of rejection not necessitated by an amendment is made, because the patent owner's right to amend the claims becomes limited after prosecution is closed.

(B) Where an ACP would be proper, but the examiner feels that the issues are not yet clearly defined, it is always within the discretion of the examiner to issue an Office action that does not close prosecution (rather than an ACP).

#### **II. OVERALL CONTENT**

Where the examiner determines that the proceeding is not ready for issuing an ACP, the examiner will issue an Office action that will be similar in form to a first Office action, but will differ in that it addresses the positions and argument set forth in the patent owner's response and the third party requester comments (if such comments are filed). This Office action will be a statement of the examiner's position, so complete that the next Office action can properly be made an action closing prosecution.

The action should be comprehensive. It should address all issues as to the patents or printed publications. The action will clearly set forth each ground of rejection and/or ground of objection, and the reasons supporting the ground(s). The action will also clearly set forth each rejection proposed by the third party requester that the examiner refuses to adopt. Reasons why the rejection proposed by the third party is not appropriate (i.e., why the claim cannot be rejected under the ground proposed by the third party



requester) must be clearly stated for each rejection proposed by the third party requester that the examiner refuses to adopt. Comprehensive reasons for patentability must be given for each determination favorable to patentability of claims. See MPEP § 1302.14 for examples of suitable statements of reasons for allowance.

### III. REVIEW OF AMENDATORY MATTER UNDER 35 U.S.C. 112

Where an amendment has been submitted in the patent owner's response, the amendatory matter (i.e., matter revised or newly added) should be reviewed for compliance with 35 U.S.C. 112. As to the content of the patent that has not been revised, a review based upon 35 U.S.C. 112 is not proper in reexamination, and no such review should be made.

### IV. WITHDRAWAL OF REJECTION

Where the examiner withdraws a ground of rejection originally initiated by the examiner, such withdrawal should be clearly stated in the Office action as a decision favorable to patentability with respect to the withdrawn rejection. The third party requester's next set of comments that may be filed (after a patent owner response to an action) may propose the withdrawn rejection as a "rejection proposed by the third party requester." In the event the patent owner fails to respond to all actions leading to the Right of Appeal Notice (RAN), including the ACP, and a RAN is then issued, the third party requester may appeal this withdrawal of rejection as a final decision favorable to patentability - see 37 CFR 1.959(a)(2).

Where the examiner withdraws a ground of rejection previously proposed by the third party requester, the examiner should treat the issue as rejection proposed by the third party requester that the examiner refuses to adopt.

### V. ISSUES NOT WITHIN SCOPE OF REEXAMINATION

If questions not within the scope of reexamination proceedings (for example, questions of patentability based on public use or on sale, fraud, abandonment under 35 U.S.C. 102(c)) have been **newly** raised by the **patent owner response** or the **third party requester comments** being addressed by the present Office action, the existence of such questions will be

noted by the examiner in the Office action, using form paragraph 26.03.

#### ¶ 26.03 Issue Not Within Scope of Inter Partes Reexamination

It is noted that an issue not within the scope of reexamination proceedings has been raised. [1]. The issue will not be considered in a reexamination proceeding. 37 CFR 1.906(c). While this issue is not within the scope of reexamination, the patentee is advised that it may be desirable to consider filing a reissue application provided that the patentee believes one or more claims to be partially or wholly inoperative or invalid.

#### Examiner Note:

1. In bracket 1, identify the issues.
2. This paragraph may be used either when the patent owner or the third party requester raises issues such as (but not limited to) public use or on sale, fraud, or abandonment of the invention. Such issues should not be raised independently by the patent examiner.

Note that if questions of patentability based on public use or on sale, fraud, abandonment under 35 U.S.C. 102(c), etc., have been independently discovered by the examiner during a reexamination proceeding but were not raised by the third party requester or the patent owner, the existence of such questions will not be noted by the examiner in any Office action, because 37 CFR 1.906(c) is only directed to such questions "raised by the patent owner or the third party requester."

### VI. COVER SHEET

Form PTOL-2064 should be used as the Office action cover sheet. Since the Office action is responsive to a patent owner response, and possibly the third party requester comments, the space on the PTOL-2064 for the date of the communication(s) to which the Office action is responsive to should be filled in. Generally, the patent owner is given two months to respond to the action, and thus "Two" should be inserted in the appropriate space.

### VII. SIGNATORY AUTHORITY

As with all other Office correspondence on the merits in a reexamination proceeding, the action must be signed by a primary examiner.

### VIII. CONCLUDING PARAGRAPHS

In view of the requirement for "special dispatch" in *inter partes* reexamination proceedings (35 U.S.C.

314(c)), it is intended that the examiner be able to close prosecution at the earliest possible time. Accordingly, the Office action should include a statement cautioning the patent owner that a complete response should be made to the action, since the next action is expected to be an ACP. The action should further caution the patent owner that the requirements of 37 CFR 1.116(b) will be strictly enforced after an ACP and that any amendment after an ACP must include “a showing of good and sufficient reasons why they are necessary and were not earlier presented” in order to be considered. Form paragraph 26.05 should be inserted at the end of the Office action followed by form paragraph 26.73.

¶ 26.05 *Papers To Be Submitted in Response to Action*

In order to ensure full consideration of any amendments, affidavits or declarations, or other documents as evidence of patentability, such documents must be submitted in response to this Office action. Submissions after the next Office action, which is intended to be an Action Closing Prosecution (ACP), will be governed by 37 CFR 1.116, which will be strictly enforced.

¶ 26.73 *Correspondence and Inquiry as to Office Actions*

All correspondence relating to this *inter partes* reexamination proceeding should be directed:

By Mail to: Mail Stop *Inter Partes* Reexam  
Central Reexamination Unit  
Office of Patent Legal Administration  
United States Patent & Trademark Office  
P.O. Box 1450  
Alexandria, VA 22313-1450

By FAX to: (703) 305-1013  
Central Reexamination Unit

By hand: Central Reexamination Unit  
Crystal Plaza Three-Four, 3D68  
2201 South Clark Place  
Arlington, VA

Any inquiry concerning this communication or earlier communications from the examiner, or as to the status of this proceeding, should be directed to the Central Reexamination Unit at telephone number (703) 308-9692.

## IX. NO RESPONSE BY PATENT OWNER

Where the patent owner fails to timely respond to an action requiring a response and there are no patentable claims, a Notice of Intent to Issue *Inter Parte* Reexamination Certificate (NIRC) will be issued as the action that does not close prosecution.

## 2671.02 Examiner Issues Action Closing Prosecution (ACP) [Added R-2]

37 CFR 1.949. *Examiner’s Office action closing prosecution in inter partes reexamination.*

Upon consideration of the issues a second or subsequent time, or upon a determination of patentability of all claims, the examiner shall issue an Office action treating all claims present in the *inter partes* reexamination, which may be an action closing prosecution. The Office action shall set forth all rejections and determinations not to make a proposed rejection, and the grounds therefor. An Office action will not usually close prosecution if it includes a new ground of rejection which was not previously addressed by the patent owner, unless the new ground was necessitated by an amendment.

Although an Action Closing Prosecution (ACP) has many attributes similar to a “final rejection” made in an *ex parte* reexamination proceeding or in a non-provisional application, it is not a final action, and, as such, **it cannot be appealed from**. An appeal can only be taken after the examiner issues a Right of Appeal Notice (RAN). See MPEP § 2673.02.

Before an ACP is in order, a clear issue should be developed. When all claims are found patentable in the first action, the examiner will, at that point, issue an ACP, since the patent owner has nothing to respond to. Otherwise, it is intended that the second Office action in the reexamination proceeding will ordinarily be an ACP. The criteria for issuing an ACP is analogous to that set forth in MPEP § 706.07(a) for making a rejection final in an application.

The examiner should not prematurely cut off the prosecution with a patent owner who is seeking to define the invention in the claims that will offer the patent protection to which the patent owner is entitled. However, the examiner and all other parties to the reexamination should recognize that a reexamination proceeding may result in the final cancellation of claims from the patent **and** that the patent owner does not have the right to continue the proceeding by refiling under 37 CFR 1.53(b) or 1.53(d) nor by filing a Request for Continued Examination under 37 CFR 1.114, and the patent owner cannot file an *inter partes* reexamination request (see MPEP § 2612). Complete and thorough actions by the examiner, coupled with complete responses by the patent owner and complete comments by the third party requester (including early presentation of evidence under 37 CFR 1.131 or 1.132) will go far in reaching a desirable early termination of the reexamination proceeding.

In making an ACP (A) all outstanding grounds of rejection of record should be carefully reviewed, (B) all outstanding determinations of patentability (decisions to not make a proposed rejection) of record should be carefully reviewed, and (C) any grounds of rejection relied upon and any determinations of patentability relied upon should be reiterated.

## I. CONTENT

The grounds of rejection and determinations of patentability must (in the ACP) be clearly developed to such an extent that the patent owner and the third party requester may readily judge the advisability of filing comments after an ACP pursuant to 37 CFR 1.951(a) and (b), respectively.

The ACP should address all issues as to the patents or printed publications. The ACP will clearly set forth each rejection proposed by the third party requester that the examiner refuses to adopt. Reasons why the rejection proposed by the third party requester is not appropriate (i.e., why the claim cannot be rejected under the ground proposed by the third party requester) must be clearly stated for each rejection proposed by the third party requester that the examiner refuses to adopt. Comprehensive reasons for patentability must be given for each determination favorable to patentability of claims. See MPEP 1302.14 for examples of suitable statements of reasons for allowance.

Where a single previous Office action contains a complete statement of a ground of rejection or of reasons for not making a proposed rejection, the ACP may incorporate by reference that statement. In any event, the ACP must also include a rebuttal of any arguments raised in the patent owner's response and must reflect consideration of any comments made by the third party requester.

## II. REVIEW OF AMENDATORY MATTER UNDER 35 U.S.C. 112

Where an amendment has been submitted in the patent owner's response, the amendatory matter (i.e., matter revised or newly added) should be reviewed for compliance with 35 U.S.C. 112. As to the content of the patent that has not been revised, a review based upon 35 U.S.C. 112 is not proper in reexamination, and no such review should be made.

## III. WITHDRAWAL OF REJECTION

Where the examiner withdraws a ground of rejection originally initiated by the examiner, such withdrawal should be clearly stated in the ACP as a decision favorable to patentability with respect to the withdrawn rejection. The third party requester's next set of comments that may be filed (after a patent owner response to an action) may propose the withdrawn rejection as a "rejection proposed by the third party requester." In the event the patent owner fails to respond to the ACP and a Right of Appeal Notice (RAN) is then issued, the third party requester may appeal this withdrawal of rejection as a final decision favorable to patentability - see 37 CFR 1.959(a)(2). Where the examiner withdraws a ground of rejection previously proposed by the third party requester, the examiner should treat the issue as rejection proposed by the third party requester that the examiner refuses to adopt.

## IV. ISSUES NOT WITHIN SCOPE OF REEXAMINATION

If questions not within the scope of reexamination proceedings (for example, questions of patentability based on public use or on sale, fraud, abandonment under 35 U.S.C. 102(c)) have been **newly** raised by the **patent owner** response or the **third party requester** comments being addressed by the ACP, the existence of such questions will be noted by the examiner in the ACP, using form paragraph 26.03.

### *¶ 26.03 Issue Not Within Scope of Inter Partes Reexamination*

It is noted that an issue not within the scope of reexamination proceedings has been raised. [1]. The issue will not be considered in a reexamination proceeding. 37 CFR 1.906(c). While this issue is not within the scope of reexamination, the patentee is advised that it may be desirable to consider filing a reissue application provided that the patentee believes one or more claims to be partially or wholly inoperative or invalid.

### **Examiner Note:**

1. In bracket 1, identify the issues.
2. This paragraph may be used either when the patent owner or the third party requester raises issues such as (but not limited to) public use or on sale, fraud, or abandonment of the invention. Such issues should not be raised independently by the patent examiner.

## V. COVER SHEET

Form PTOL-2065 should be used as the cover sheet for the ACP. Since the Office action is responsive to a patent owner response, and possibly the third party requester comments, the space on the PTOL-2065 for the date of the communication(s) to which the Office action is responsive to should be filled in. Generally, the patent owner is given one month to respond to the action, and thus “One” should be inserted in the appropriate space for such.

## VI. SIGNATORY AUTHORITY

As with all other Office correspondence on the merits in a reexamination proceeding, the ACP must be signed by a primary examiner.

## VII. CONCLUDING PARAGRAPH

The ACP should conclude with the following form paragraph:

### ¶ 26.07 Action Closing Prosecution

**This is an ACTION CLOSING PROSECUTION (ACP);** see MPEP § 2671.02.

(1) Pursuant to 37 CFR 1.951(a), the patent owner may once file written comments limited to the issues raised in the reexamination proceeding and/or present a proposed amendment to the claims which amendment will be subject to the criteria of 37 CFR 1.116 as to whether it shall be entered and considered. Such comments and/or proposed amendments must be filed within a time period of 30 days or one month (whichever is longer) from the mailing date of this action. Where the patent owner files such comments and/or a proposed amendment, the third party requester may once file comments under 37 CFR 1.951(b) responding to the patent owner's submission within 30 days from the date of service of the patent owner's submission on the third party requester.

(2) If the patent owner does not timely file comments and/or a proposed amendment pursuant to 37 CFR 1.951(a), then the third party requester is precluded from filing comments under 37 CFR 1.951(b).

(3) Appeal **cannot** be taken from this action, since it is not a final Office action.

## VIII. WHERE PATENT OWNER FAILS TO RESPOND AND CLAIMS HAVE BEEN FOUND PATENTABLE

Where the patent owner fails to respond to the first Office action (or any subsequent Office action which is prior to ACP) and any claims have been found patentable in the first action (or a subsequent action), the examiner will issue an ACP (see MPEP § 2671). The ACP should repeat all determinations of patentability

(decisions to not make a proposed rejection) applicable to the patentable claims and incorporate by reference the reasons for each determination (the reasons for not making each proposed rejection). If the examiner realizes that more explanation would be helpful, the examiner should include it. Since the patent owner failed to respond to the first Office action, the proceeding will be limited to the claims found patentable and to new claims which do not expand the scope of the claims found patentable (if the new claims have an entry right or are otherwise entered at the option of the examiner). See MPEP § 2666.10.

## 2671.03 Patentability Review Conferences [Added R-2]

A “patentability review conference” will be convened at two stages of the examination in an *inter partes* reexamination proceeding:

(A) A patentability review conference must be convened just prior to issuing an action closing prosecution (ACP); and

(B) A patentability review conference must be convened just prior to issuing a right of appeal notice which includes a final rejection (RAN).

In the patentability review conference, the examiner's preliminary decision to reject and/or allow the claims in the reexamination proceeding will be reviewed, prior to the issuance of the Office action (ACP or RAN).

### I. MAKE-UP OF THE PATENTABILITY REVIEW CONFERENCE

The patentability review conference will consist of three members, one of whom may be the Supervisory Patent Examiner (SPE). The first member will be the examiner in charge of the proceeding. The SPE will select the other two members, who will be examiner-conferees. The examiner-conferees will be primary examiners, or examiners who are knowledgeable in the technology of the invention claimed in the patent being reexamined, and/or who are experienced in reexamination practice. The majority of those present at the conference will be examiners who were not involved in the examination or issuance of the patent. An “original” examiner (see MPEP § 2636) should be chosen as a conferee only if that examiner is the most knowledgeable in the art, or there is some other

specific and justifiable reason to choose an original examiner as a participant in the conference.

The patentability review conference will be similar to the appeal conference carried out prior to the issuance of an examiner's answer following the filing of a Notice of Appeal and Brief. See MPEP § 1208. A patentability review conference **must** be held in each instance where an ACP is about to be issued in an *inter partes* reexamination proceeding, **and** in each instance where a RAN is about to be issued in the proceeding. When the patentability review conference results in the issuance of the ACP or the RAN, the two conferees will place their initials, followed by the word "conferee," below the signature of the examiner. The signature of the examiner and initials of the conferees on the resulting Office action will reflect that the patentability review conference has been conducted.

## II. PATENTABILITY REVIEW CONFERENCE PROCESS

The examiner must inform his/her SPE of his/her intent to issue an ACP, or RAN. The SPE will then convene a patentability review conference and the conference members will review the patentability of the claim(s). If the conference confirms the examiner's preliminary decision to reject and/or allow the claims, the Office action (ACP or RAN) shall be issued and signed by the examiner, with the two other conferees initialing the action (as "conferee") to indicate their presence in the conference. Both conferees will initial, even though one of them may have dissented from the 3-party conference decision as to the patentability of claims. If the conference does not confirm the examiner's preliminary decision, the proposed ACP or RAN will not be issued by the examiner; but rather, the examiner will issue the appropriate Office action reflecting the decision of the conference.

Where the examiner in charge of the proceeding is not in agreement with the conference decision, the SPE will generally assign the proceeding to another examiner, which would preferably be one of the other two conference members.

Patentability review conferees in *inter partes* reexamination proceedings will use 1121-08 to report time spent with respect to the conference. **The examiner in charge of the case will use the standard 1121-02 activity code to report time.** A SPE attending the conference should use 1121-03. See MPEP § 2638.

## III. WHAT THE CONFERENCES SHOULD ACCOMPLISH

Each conference will provide a forum to consider all issues of patentability as well as procedural issues having an impact on patentability. Review of the patentability of the claims by more than one primary examiner should diminish any perception that the patent owner can disproportionately influence the examiner in charge of the proceeding. The conferences will also provide greater assurance that all matters will be addressed appropriately. All issues in the proceeding will be viewed from the perspectives of three examiners. What the examiner in charge of the proceeding might have missed, one of the other two conference members would likely detect. The conference will provide for a comprehensive discussion of, and finding for, each issue.

## IV. CONSEQUENCES OF FAILURE TO HOLD CONFERENCE

Should the examiner issue an ACP or RAN without holding a patentability review conference, the patent owner or the third party requester who wishes to object must promptly file a paper alerting the Office of this fact. (The failure to hold a patentability review conference would be noted by the parties where there are no conferees' initials at the end of the ACP or RAN Office action.) Any challenge of the failure to hold a patentability review conference must be made within two months of the Office action issued, or the challenge will not be considered. In such cases, convening a patentability review conference to reconsider the examiner's decision will be addressed on a case-by-case basis. In no event will the failure to hold a patentability review conference, by itself, be grounds for vacating any Office decision(s) or action(s) and "restarting" the reexamination proceeding.

## 2672 Patent Owner Comments/Amendment After ACP and Third Party Requester Responsive Comments [Added R-2]

37 CFR 1.951. *Options after Office action closing prosecution in inter partes reexamination.*

(a) After an Office action closing prosecution in an *inter partes* reexamination, the patent owner may once file comments limited to the issues raised in the Office action closing prosecution. The comments can include a proposed amendment to the claims, which amendment will be subject to the criteria of § 1.116 as to whether or not it shall be admitted. The comments must be filed within the time set for response in the Office action closing prosecution.

(b) When the patent owner does file comments, a third party requester may once file comments responsive to the patent owner's comments within 30 days from the date of service of patent owner's comments on the third party requester.

### I. ONE OPPORTUNITY TO MAKE SUBMISSIONS UNDER 37 CFR 1.951(a) AND (b)

After an Action Closing Prosecution (ACP), the patent owner may once file (pursuant to 37 CFR 1.951(a)) written comments limited to the issues raised in the reexamination proceeding and/or present a proposed amendment to the claims. Where the patent owner does so, the third party requester may once file (pursuant to 37 CFR 1.951(b)) comments responsive to the patent owner's comments. Any second or supplemental submission after ACP by either the patent owner or the third party requester will thus be returned.

### II. TIME FOR MAKING PATENT OWNER SUBMISSION UNDER 37 CFR 1.951(a)

The patent owner submission under 37 CFR 1.951(a) of comments and/or proposed amendment must be filed within the time period set for response to the ACP. Normally, the ACP will set a period of 30 days or one month (whichever is longer) from the mailing date of the ACP.

An extension of the time period for filing the patent owner's submission under 37 CFR 1.951(a) may be requested under 37 CFR 1.956. The time period may not, however, be extended to run past 6 months from the date of the ACP.

The examiner and all other parties to the reexamination should recognize that a reexamination proceeding may result in the final cancellation of claims from the patent **and** that the patent owner does not have the right to continue the proceeding by refiling under 37 CFR 1.53(b) or 1.53(d), nor by filing a Request for Continued Examination under 37 CFR 1.114, and the patent owner cannot file an *inter partes* reexamination request (see MPEP § 2612). Accordingly, the examiner and other parties should identify and develop all issues prior to the ACP, including the presentation of evidence under 37 CFR 1.131 and 1.132.

### III. PATENT OWNER MAKES SUBMISSION AFTER ACP; LIMITATION ON PATENT OWNER'S SUBMISSION

Once an ACP that is not premature has been entered in a reexamination proceeding, the patent owner no longer has a right to unrestricted further prosecution. Consideration of the proposed amendments submitted after ACP (pursuant to 37 CFR 1.951(a)) will be governed by the strict standards of 37 CFR 1.116. The patent owner's submission of comments under 37 CFR 1.951(a) must be limited to the issues raised in the ACP. If the submission addresses issues not already raised in the ACP, then the comments will be returned. No additional opportunity will be given for the patent owner to correct the defect unless a petition under 37 CFR 1.183 is granted to waive 37 CFR 1.951 as to its one opportunity limitation for the patent owner comment. If such a petition under 37 CFR 1.183 is granted and the patent owner submits corrected comments under 37 CFR 1.951(a), the third party requester may then once file supplemental comments responding to the patent owner's corrected comments within one month from the **date of service** of the patent owner's corrected comments on the third party requester.

### IV. PATENT OWNER MAKES SUBMISSION AFTER ACP; THIRD PARTY REQUESTER COMMENTS ARE LIMITED TO RESPONDING TO PATENT OWNER'S SUBMISSION

Where the patent owner files comments and/or a proposed amendment pursuant to 37 CFR 1.951(a), the third party requester may once file comments (pursuant to 37 CFR 1.951(b)) responding to the

patent owner's comments and/or proposed amendment. Such third party requester comments must be filed within 30 days from the **date of service** of the patent owner's comments and/or proposed amendment on the third party requester. If the third party requester's comments go beyond the scope of responding to the patent owner's comments and/or proposed amendments, then the third party requester's comments will be returned. No additional opportunity will be given for the third party requester to correct the defect unless a petition under 37 CFR 1.183 is granted to waive 37 CFR 1.951 as to its one opportunity limitation.

#### **V. PATENT OWNER DOES NOT MAKE SUBMISSION AFTER ACP**

If the patent owner does not timely file comments and/or a proposed amendment pursuant to 37 CFR 1.951(a), then the third party requester is precluded from filing comments under 37 CFR 1.951(b). Accordingly, a Right of Appeal Notice (RAN) will be issued where the time for filing the patent owner comments and/or amendment has expired and no patent owner paper containing comments and/or amendment has been received. It should be noted that where the patent owner chooses not to file a submission pursuant to 37 CFR 1.951(a), no rights of appeal are lost.

#### **VI. ACTION CLOSING PROSECUTION - PREMATURE**

If the patent owner is of the opinion that the Office action closing prosecution in the *inter partes* reexamination proceeding is premature, the patent owner may, in addition to the comments submitted under 37 CFR 1.951(a), file a petition under 37 CFR 1.181 within the time period for filing the comments under 37 CFR 1.951(a). The third party requester may then once file, as a paper separate from any submission under 37 CFR 1.951(b), comments responsive to the patent owner's petition under 37 CFR 1.181 within 30 days from the date of service of the patent owner's petition under 37 CFR 1.181 on the third party requester.

### **2673 Examiner Consideration of Submissions After ACP and Further Action [Added R-2]**

#### **I. WHEN THE CASE IS TAKEN UP FOR ACTION**

The patent owner is given 30 days or one month, whichever is longer, to make the 37 CFR 1.951(a) submission after Action Closing Prosecution (ACP). If no patent owner submission under 37 CFR 1.951(a) is received after two months from the ACP, the examiner will take up the case for action. The case should be acted on promptly, in accordance with the statutory requirement for "special dispatch within the Office" (35 U.S.C. 314(c)). Where a patent owner obtained an extension of time under 37 CFR 1.956, the examiner will wait until the extended time plus one month expires before taking up the case for action.

If the patent owner submission under 37 CFR 1.951(a) is received, the third party requester will then have 30 days from service of the patent owner's submission to file the third party requester's 37 CFR 1.951(b) submission. If no third party requester submission under 37 CFR 1.951(b) is received after two months from the date of service of the patent owner's 37 CFR 1.951(a) submission, the examiner will take up the case for action.

Where both the 37 CFR 1.951(a) and (b) submissions have been received, the case should be taken up for action as soon as possible.

#### **II. OPTIONS AS TO WHICH ACTION TO ISSUE**

(A) Right of Appeal Notice - Where no 37 CFR 1.951(a) submission has been filed by the patent owner, or where a submission under 37 CFR 1.951(a) (and 37 CFR 1.951(b)) has been filed and the examiner will not modify his/her position; the examiner should issue a Right of Appeal Notice (RAN). See MPEP § 2673.02. If the patent owner's submission included a proposed amendment, the RAN will indicate whether or not it was entered.

Where a submission has been filed under 37 CFR 1.951(a) (or 37 CFR 1.951(b)) and that submission is incomplete or is defective, the examiner should notify the parties, in the RAN, that the submission has not been considered, and that no additional opportunity is

available to correct the defect(s) in the submission, because 37 CFR 1.951(a) and (b) provide that comments may only be filed “once.”

(B) Office action reopening of prosecution - See MPEP § 2673.01 for a discussion of when the examiner should issue an action reopening prosecution.

### III. ACTION TAKEN BY EXAMINER

It should be kept in mind that a patent owner cannot, as a matter of right, amend claims rejected in the ACP, add new claims after an ACP, nor reinstate previously canceled claims. A showing under 37 CFR 1.116(b) is required and will be evaluated by the examiner for all proposed amendments after the ACP, except where an amendment merely cancels claims, adopts examiner’s suggestions, removes issues for appeal, or in some other way requires only a cursory review by the examiner.

Where the entry of the proposed amendment (after the ACP) would result in any ground of rejection being withdrawn or any additional claim indicated as patentable, the proposed amendment generally raises new issues requiring more than cursory review by the examiner. The examiner would need to indicate new grounds for patentability for any claim newly found patentable and/or the reason why the rejection was withdrawn and would also need to deal with any third party requester’s comments on the proposed amendment (made pursuant to 37 CFR 1.951(b) in response to owner’s proposed amendment). Thus, the examiner is not required to enter the proposed amendment.

In view of the fact that the patent owner cannot continue the proceeding by refiling under 37 CFR 1.53(b) or 1.53(d) nor by filing a Request for Continued Examination under 37 CFR 1.114 and the patent owner cannot file an *inter partes* reexamination request (see MPEP § 2612), the examiner should consider the feasibility of entering a proposed amendment paper, where the entirety of the amendment would result *only* in an additional claim (or claims) being indicated as patentable. The examiner is encouraged to enter such an amendment unless the entry would cause an “undue burden” on the examiner. Where the examiner does not enter the amendment, the examiner should explain the “undue burden.” Where the examiner does enter the amendment, see MPEP § 2673.01 as to whether a Right of

Appeal Notice (RAN) can be issued or whether there is a need to reopen prosecution.

Where multiple amendments are submitted after the ACP, all amendments except for the first one will be returned without consideration, since they are improper submissions. Thus, if prosecution is reopened, only the first amendment will be present for entry.

An amendment filed at any time after the ACP and prior to the RAN may be entered (where appropriate for entry). An amendment filed *after* the RAN will not be entered at all, in the absence of a grantable petition under 37 CFR 1.183 because 37 CFR 1.953(c) prohibits an amendment after the RAN in *inter partes* reexamination. If the examiner wishes to have the patent owner provide an amendment after the RAN, the examiner can reopen prosecution, enter the amendment, and issue a new ACP.

Where a proposed amendment is not entered, the examiner will provide a detailed explanation of the reasons for not entering the proposed amendment. For example, if the claims as amended would present a new issue requiring further consideration or search, the new issue should be identified, and an explanation provided as to why a new search is necessary and/or why more than nominal consideration is necessary.

The parties to the reexamination will be notified in the RAN, or the Office action issued in lieu of the RAN (e.g., action reopening prosecution), as to whether the proposed amendment will be entered or will not be entered.

## 2673.01 Reopening Prosecution After ACP [Added R-2]

### I. MANDATORY REOPENING

Where a submission after Action Closing Prosecution (ACP) has been filed pursuant 37 CFR 1.951(a) (and 37 CFR 1.951(b)) and the examiner decides to modify his/her position, the examiner should ordinarily reopen prosecution, in accordance with the following guidelines.

The patent owner must be given an opportunity to adequately address any change in position adverse to the patent owner’s position. A Right of Appeal Notice (RAN) cannot be issued until the patent owner has had the opportunity to address each and every rejection prior to the appeal stage. Thus, the examiner



should reopen prosecution where any new ground of rejection is made or any additional claim is rejected.

Prosecution is ordinarily reopened in this situation by issuing a non-ACP action, i.e., an Office action prior to the ACP stage. If prosecution were reopened at the ACP stage, the patent owner loses rights as to amending the claims in response to the change in the examiner's position, because the patent owner's amendment rights are limited after ACP, - see MPEP § 2673.

As opposed to the examiner making a new ground of rejection, if a new finding of patentability is made (i.e., a ground of rejection is withdrawn or an additional claim is indicated as patentable), prosecution need not be reopened. The third party requester has no right to comment on and address a finding of patentability made during the reexamination proceeding *until the appeal stage*, unless the patent owner responds (after which the third party requester may file comments). Thus, the third party requester may address any new finding of patentability at the appeal stage in the same manner that it would address a finding of patentability made during the reexamination proceeding where the patent owner does not respond (e.g., all claims are allowed on the first Office action and the patent owner sees no reason to respond).

## II. DISCRETIONARY REOPENING

In addition to the above situation which *requires* reopening of prosecution, the examiner should be liberal in reopening prosecution where the equities of the situation make such appropriate, because patent owner cannot continue the proceeding by refiling under 37 CFR 1.53(b) or 1.53(d), nor by filing a Request for Continued Examination under 37 CFR 1.114.

An example of this would be as follows. Patent owner might submit an amendment after the ACP which would make at least one claim patentable, except for one or two minor changes needed to obviate a rejection. The examiner **cannot** telephone the owner to obtain the minor change(s) and then issue a RAN because interviews are not permitted in an *inter partes* reexamination proceeding. Also, the examiner **cannot** make the changes by issuing an examiner's amendment coupled with a Notice of Intent to Issue *Inter Partes* Reexamination Certificate (NIRC) because of the presence of the third party requester,

i.e., the third party requester is entitled to a RAN so that the claims found patentable can be appealed. Yet, in this situation, it would be inequitable to send the claims to appeal based on the minor points that could be easily corrected. Accordingly, the examiner would reopen prosecution (since 37 CFR 1.953 requires reopening where a RAN is not issued) and issue a new ACP suggesting the amendment which will make the claims patentable. The third party requester would then have an opportunity to comment on the newly-found-patentable claims after the patent owner submits the suggested amendment pursuant to 37 CFR 1.951(a).

See MPEP § 2673 for a discussion of the examiner not exercising his/her discretion to reopen prosecution in those situations where an "undue burden" on the Office would result if prosecution were reopened.

## 2673.02 Examiner Issues Right of Appeal Notice (RAN) [Added R-2]

*37 CFR 1.953. Examiner's Right of Appeal Notice in inter partes reexamination.*

(a) Upon considering the comments of the patent owner and the third party requester subsequent to the Office action closing prosecution in an *inter partes* reexamination, or upon expiration of the time for submitting such comments, the examiner shall issue a Right of Appeal Notice, unless the examiner reopens prosecution and issues another Office action on the merits.

(b) Expedited Right of Appeal Notice: At any time after the patent owner's response to the initial Office action on the merits in an *inter partes* reexamination, the patent owner and all third party requesters may stipulate that the issues are appropriate for a final action, which would include a final rejection and/or a final determination favorable to patentability, and may request the issuance of a Right of Appeal Notice. The request must have the concurrence of the patent owner and all third party requesters present in the proceeding and must identify all the appealable issues and the positions of the patent owner and all third party requesters on those issues. If the examiner determines that no other issues are present or should be raised, a Right of Appeal Notice limited to the identified issues shall be issued. Any appeal by the parties shall be conducted in accordance with §§ 1.959-1.983.

(c) The Right of Appeal Notice shall be a final action, which comprises a final rejection setting forth each ground of rejection and/or final decision favorable to patentability including each determination not to make a proposed rejection, an identification of the status of each claim, and the reasons for decisions favorable to patentability and/or the grounds of rejection for each claim. No amendment can be made in response to the Right of Appeal Notice. The Right of Appeal Notice shall set a one-month time period for either party to appeal. If no notice of appeal is filed, the *inter partes* reexamination proceeding will be terminated, and the

Director will proceed to issue a certificate under § 1.997 in accordance with the Right of Appeal Notice.

A Right of Appeal Notice (RAN) is a final Office action which presents a final decision to reject the claims (i.e., a final decision that the claims are rejected) and/or a final decision favorable to patentability as to the claims (i.e., a final decision not to make a proposed rejection).

The RAN will identify the status of each claim. It will set forth:

(A) the grounds of rejection for all claims rejected in the RAN;

(B) the reasons why a proposed rejection is not made for all decisions favorable to patentability as to claims that were contested by the third party requester; and

(C) the reasons for patentability for all claims “allowed” and not contested by the third party requester.

The RAN will also advise parties of their rights of appeal at this stage in the reexamination proceeding, and the consequences of failure to appeal.

See MPEP § 2673 as to matters that should be taken into account by the examiner before deciding to issue a RAN. Before the examiner actually issues a RAN, all outstanding grounds of rejection of record and findings of patentability that are of record should be carefully reviewed, after consideration of all submissions of record by the parties. Where it is appropriate to retain the grounds of rejection and findings of patentability, and the examiner’s position will not be changed, the examiner is permitted to issue a RAN. Any grounds of rejection and findings of patentability relied upon should be restated in the RAN. The reasons for each rejection and finding should be set forth in detail. The grounds of rejection and findings of patentability should, at this point, be clearly developed to such an extent that the patent owner and the third party requester may readily judge the advisability of filing an appeal. The examiner’s position as to any arguments and comments raised by the patent owner and the third party requester should be clearly set forth, so that any appeal taken can address the examiner’s position as to the arguments and comments.

In the RAN, it should also be point out which submissions after the Action Closing Prosecution (ACP) have been entered and considered, and which have

not. At this point, the examiner should check the record to ensure that parties have been made aware of which amendments, evidence (affidavits, declarations, exhibits, etc.), references and argument are before the examiner for consideration. The case should be ready for appeal after the RAN issues.

In the event that an amendment submitted by the patent owner after the ACP has not been entered because the amendment does not comply with the requirements of 37 CFR 1.116 (see 37 CFR 1.951(a)), the patent owner may file a petition under 37 CFR 1.181 requesting entry of the amendment. The petition under 37 CFR 1.181 must be filed within the time period for filing a notice of appeal or cross appeal, if appropriate (see 37 CFR 1.953(c)). Note that the filing of a petition under 37 CFR 1.181 does **not** toll the time period for filing a notice of appeal or cross appeal, if appropriate. Thus, in addition to the petition under 37 CFR 1.181, the patent owner is encouraged to file (1) a petition under 37 CFR 1.183 requesting waiver of the prohibition of an extension of time for filing an appeal brief (37 CFR 1.963(a)), and (2) a request for an extension of the period to file the appeal brief until after a decision on the petition under 37 CFR 1.181. The third party requester may once file comments responsive to the patent owner’s petition under 37 CFR 1.181 within 30 days from the date of service of the patent owner’s petition under 37 CFR 1.181 on the third party requester. When rendering a decision on the petition under 37 CFR 1.181, the deciding official should be mindful that a patent owner in an *inter partes* reexamination proceeding may not be able to proceed effectively if the amendment submitted after the ACP is not entered since the patent owner in an *inter partes* reexamination proceeding does not have the right to continue the proceeding by refiling under 37 CFR 1.53(b) or 1.53(d) nor by filing a Request for Continued Examination under 37 CFR 1.114, and the patent owner cannot file an *inter partes* reexamination.

Form PTOL-2066 should be used as the cover sheet for the RAN. The RAN should conclude with the following form paragraph advising the parties of their right to appeal:

¶ 26.08 Right of Appeal Notice

**This is a RIGHT OF APPEAL NOTICE (RAN);** see MPEP § 2673.02 and § 2674. The decision in this Office action as to the patentability or unpatentability of any original patent claim, any

proposed amended claim and any new claim in this proceeding is a FINAL DECISION.

Each party has a **thirty-day or one-month time period, whichever is longer**, to file a notice of appeal. The patent owner may appeal to the Board of Patent Appeals and Interferences with respect to any decision adverse to the patentability of any original or proposed amended or new claim of the patent by filing a notice of appeal and paying the fee set forth in 37 CFR 1.17(b). The third party requester may appeal to the Board of Patent Appeals and Interferences with respect to any decision favorable to the patentability of any original or proposed amended or new claim of the patent by filing a notice of appeal and paying the fee set forth in 37 CFR 1.17(b).

In addition, a patent owner who has not filed a notice of appeal may file a notice of cross appeal within **fourteen days of service** of a third party requester's timely filed notice of appeal and pay the fee set forth in 37 CFR 1.17(b). A third party requester who has not filed a notice of appeal may file a **notice of cross appeal within fourteen days of service** of a patent owner's timely filed notice of appeal and pay the fee set forth in 37 CFR 1.17(b).

Any appeal in this proceeding must identify the claim(s) appealed, and must be signed by the patent owner (for a patent owner appeal) or the third party requester (for a third party requester appeal), or their duly authorized attorney or agent.

Any party that does not file a timely notice of appeal or a timely notice of cross appeal will lose the right to appeal from any decision adverse to that party, but will not lose the right to file a respondent brief and fee where it is appropriate for that party to do so. If no party files a timely appeal, the reexamination proceeding will be terminated, and the Director will proceed to issue a certificate under 37 CFR 1.997 in accordance with this Office action.

An amendment filed *after* the RAN will not be entered at all, in the absence of a grantable petition under 37 CFR 1.183, because 37 CFR 1.953(c) prohibits an amendment after the RAN in an *inter partes* reexamination. If the examiner wishes to have the patent owner provide an amendment after the RAN, the examiner can reopen prosecution, accept the amendment (for entry), and issue a new Action Closing Prosecution (ACP). See MPEP § 2673.01 for discussion as to discretionary reopening of prosecution.

## I. EXAMINER NEVER ISSUES A NIRC AFTER ACP

Once an ACP has been issued, there is no requirement for the patent owner to respond; where the patent owner does not respond to the rejection of the patent claims, a RAN will still be issued and the patent owner can appeal at that point to the Board of Patent Appeals and Interferences. Because there is no requirement for the patent owner to respond, there is no situation in which a Notice of Intent to Issue *Inter*

*Partes* Reexamination Certificate (NIRC) can be issued after an ACP and prior to the RAN. Even if (after an ACP has been issued) the examiner finds the patent owner's subsequent argument to be persuasive as to all of the claims, a NIRC would still not be issued, but rather, a RAN would be issued to provide the third party requester with an opportunity to appeal the "allowed" claims to the Board of Patent Appeals and Interferences.

## II. EXPEDITED RIGHT OF APPEAL NOTICE

37 CFR 1.953(b) provides for an expedited RAN. At any time after the patent owner's response to the first Office action on the merits in an *inter partes* reexamination, the patent owner and the third party requester (all third party requesters, if there is more than one due to a merged proceeding) may request the immediate issuance of a RAN.

The request for an expedited RAN must:

- (A) stipulate that the issues are appropriate for a final action, which would include a final rejection and/or a final determination favorable to patentability;
- (B) state that the patent owner and the third party requester (all third party requesters, if there is more than one) join in making the request;
- (C) identify all of the appealable issues; and
- (D) identify and discuss the positions of the patent owner and the third party requester(s) on the identified issues.

If the examiner determines that no other issues are present or should be raised in the proceeding, a RAN limited to the identified issues will be issued.

If the examiner determines that other issues are in fact present, or that other issues need to be raised in the proceeding, the examiner should deny the request, and examination and prosecution will continue as if the request had not been submitted.

In no event will the request for an expedited RAN be construed to extend the time for any response/comments due at the time the request is made.

## 2674 Appeal in Reexamination [Added R-2]

35 U.S.C. 315. *Appeal.*

(a) PATENT OWNER.— The patent owner involved in an *inter partes* reexamination proceeding under this chapter—

(1) may appeal under the provisions of section 134 and may appeal under the provisions of sections 141 through 144, with respect to any decision adverse to the patentability of any original or proposed amended or new claim of the patent; and

(2) may be a party to any appeal taken by a third-party requester under subsection (b).

(b) **THIRD-PARTY REQUESTER.**— A third-party requester—

(1) may appeal under the provisions of section 134, and may appeal under the provisions of sections 141 through 144, with respect to any final decision favorable to the patentability of any original or proposed amended or new claim of the patent; and

(2) may, subject to subsection (c), be a party to any appeal taken by the patent owner under the provisions of section 134 or sections 141 through 144.

(c) **CIVIL ACTION.**— A third-party requester whose request for an inter partes reexamination results in an order under section 313 is estopped from asserting at a later time, in any civil action arising in whole or in part under section 1338 of title 28, the invalidity of any claim finally determined to be valid and patentable on any ground which the third-party requester raised or could have raised during the inter partes reexamination proceedings. This subsection does not prevent the assertion of invalidity based on newly discovered prior art unavailable to the third-party requester and the Patent and Trademark Office at the time of the inter partes reexamination proceedings.

*37 CFR 1.959. Notice of appeal and cross appeal to Board of Patent Appeals and Interferences in inter partes reexamination.*

(a)(1) Upon the issuance of a Right of Appeal Notice under § 1.953, the patent owner involved in an *inter partes* reexamination proceeding may appeal to the Board of Patent Appeals and Interferences with respect to the final rejection of any claim of the patent by filing a notice of appeal within the time provided in the Right of Appeal Notice and paying the fee set forth in § 1.17(b).

(2) Upon the issuance of a Right of Appeal Notice under § 1.953, a third party requester involved in an *inter partes* reexamination proceeding may appeal to the Board of Patent Appeals and Interferences with respect to any final decision favorable to the patentability, including any final determination not to make a proposed rejection, of any original, proposed amended, or new claim of the patent by filing a notice of appeal within the time provided in the Right of Appeal Notice and paying the fee set forth in § 1.17(b).

(b)(1) Within fourteen days of service of a third party requester's notice of appeal under paragraph (a)(2) of this section and upon payment of the fee set forth in § 1.17(b), a patent owner who has not filed a notice of appeal may file a notice of cross appeal with respect to the final rejection of any claim of the patent.

(2) Within fourteen days of service of a patent owner's notice of appeal under paragraph (a)(1) of this section and upon payment of the fee set forth in § 1.17(b), a third party requester who has not filed a notice of appeal may file a notice of cross appeal with respect to any final decision favorable to the patent-

ability, including any final determination not to make a proposed rejection, of any original, proposed amended, or new claim of the patent.

(c) The notice of appeal or cross appeal in an *inter partes* reexamination proceeding must identify the appealed claim(s) and must be signed by the patent owner, the third party requester, or their duly authorized attorney or agent.

(d) An appeal or cross appeal, when taken, must be taken from all the rejections of the claims in a Right of Appeal Notice which the patent owner proposes to contest or from all the determinations favorable to patentability, including any final determination not to make a proposed rejection, in a Right of Appeal Notice which a third party requester proposes to contest. Questions relating to matters not affecting the merits of the invention may be required to be settled before an appeal is decided.

(e) The times for filing a notice of appeal or cross appeal may not be extended.

(f) If a notice of appeal or cross appeal is timely filed but does not comply with any requirement of this section, appellant will be notified of the reasons for non-compliance and provided with a non-extendable period of one month within which to file an amended notice of appeal or cross appeal. If the appellant does not then file an amended notice of appeal or cross appeal within the one-month period, or files a notice which does not overcome all the reasons for non-compliance stated in the notification of the reasons for non-compliance, that appellant's appeal or cross appeal will stand dismissed.

An appeal cannot be taken by parties to the reexamination until a Right of Appeal Notice (RAN) has been issued. Once a RAN has been issued, the patent owner and any third party requester will have, in accordance with 37 CFR 1.953, a time period of one month or thirty days (whichever is longer) to file a notice of appeal (with the fee set forth in 37 CFR 1.17(b)). Pursuant to 37 CFR 1.959(e), the time for filing a notice of appeal may not be extended.

In the event that no party to the reexamination files a timely notice of appeal, the proceeding will be terminated, with the examiner issuing a Notice of Intent to Issue *Inter Partes* Reexamination Certificate (NIRC); see MPEP § 2687. However, if **one** of the parties does file a notice of appeal within the one month/thirty day period, an **opposing party** can enter into the appeal by filing a notice of cross appeal pursuant to 37 CFR 1.959(b) within fourteen (14) days from service of the first party's notice of appeal, see MPEP § 2674.01. Pursuant to 37 CFR 1.959(e), the time for filing a notice of cross appeal may not be extended.

The procedure for taking appeal is set forth in 37 CFR 1.959.

(A) The notice of appeal must identify the appealed claim(s).

(B) The appeal must be taken from (1) the rejection(s) of the claims in the Right of Appeal Notice (RAN) which the *patent owner* proposes to contest, or (2) the finding(s) of patentability of claims in the RAN which the *third party requester* proposes to contest. Therefore:

- A notice of appeal by the patent owner must identify each claim rejected by the examiner that the patent owner intends to contest;

- A notice of appeal by a third party requester must identify each rejection *that was previously proposed by that third party requester* which the third party requester intends to contest. It is not sufficient to merely appeal from the allowance of a claim (i.e., the examiner's finding of a claim patentable); the third party requester must identify each previously proposed rejection to be contested.

(C) The notice of appeal must be signed by the patent owner or the third party requester, or their duly authorized attorney or agent.

“Appellant” and “respondent” are defined in 37 CFR 1.962. Where the patent owner appeals from the rejection of the claims, a third party requester responding to the patent owner's appeal is termed the respondent as to the rejected claims. Where a third party requester appeals from a favorable determination with respect to the claims, the patent owner responding to the third party requester's appeal is termed the respondent as to the favorable determination.

Where a party fails to file a timely notice of appeal or notice of cross appeal, that party may no longer file an appellant brief to appeal a claim determination adverse to that party; however, that party *is permitted to file a respondent brief* in accordance with 37 CFR 1.963(b) (with the fee as required by 37 CFR 1.967(a)), to respond to issues raised by an opposing party's appellant brief.

Where a notice of appeal or notice of cross appeal is timely filed but is defective, e.g., missing fee or missing portion of the fee, no proof of service is included, it is signed by an inappropriate party or is unsigned, failure to identify the appealed claims; 37 CFR 1.959(f) provides the appropriate party one

opportunity to file, within a nonextendable period of one month, an amended notice of appeal or cross appeal that corrects the defect(s). Form PTOL-2067 should be used to provide the notification.

Where a notice of appeal or notice of cross appeal is filed before a RAN has been issued, the appropriate party will be notified in writing that the appeal is not acceptable. The paper will be placed in the file and be given a paper number, but it will not be considered at all in the proceeding, other than to inform the party that the appeal is not acceptable.

It should be noted that under 37 CFR 1.975, affidavits, declarations, or exhibits submitted after the case has been appealed will not be admitted without a showing of good and sufficient reasons why they were not earlier presented.

## 2674.01 Cross Appeal After Original Appeal [Added R-2]

*37 CFR 1.959. Notice of appeal and cross appeal to Board of Patent Appeals and Interferences in inter partes reexamination.*

\*\*\*\*\*

(b)(1) Within fourteen days of service of a third party requester's notice of appeal under paragraph (a)(2) of this section and upon payment of the fee set forth in § 1.17(b), a patent owner who has not filed a notice of appeal may file a notice of cross appeal with respect to the final rejection of any claim of the patent.

(2) Within fourteen days of service of a patent owner's notice of appeal under paragraph (a)(1) of this section and upon payment of the fee set forth in § 1.17(b), a third party requester who has not filed a notice of appeal may file a notice of cross appeal with respect to any final decision favorable to the patentability, including any final determination not to make a proposed rejection, of any original, proposed amended, or new claim of the patent.

\*\*\*\*\*

The cross appeal provision of 37 CFR 1.959(b) permits a party to the reexamination to wait and see if an opposing party will appeal, before committing to the appeal process.

Within fourteen days of service of a third party requester's notice of appeal, a patent owner who has not filed a notice of appeal, may file a notice of cross appeal, the cross appeal being with respect to any final decision (i.e., decision in the RAN) **adverse** to

the patentability of any claim of the patent. Pursuant to 37 CFR 1.959(e), the time for filing the patent owner's notice of cross appeal may not be extended.

Within fourteen days of service of a patent owner's notice of appeal, a third party requester who has not filed a notice of appeal may file a notice of cross appeal, the cross appeal being with respect to any final decision (i.e., decision in the RAN) **favorable** to the patentability of any claim of the patent. Pursuant to 37 CFR 1.959(e), the time for filing the requester's notice of cross appeal may not be extended.

Where the notice of cross appeal is timely filed but is defective, e.g., missing fee or missing portion of the fee, no proof of service, signed by an inappropriate party or unsigned, failure to identify the appealed claims; 37 CFR 1.959(f) provides the appropriate party one opportunity to file, within a non-extendable period of one month, an amended cross appeal that corrects the defect(s).

Where there are more than two parties to the proceeding, i.e., the patent owner and more than one *inter partes* third party requester in a merged proceeding, then a third party cross appeal must be filed within fourteen days of service of a patent owner's notice of appeal. If a first third party requester filed an appeal later than the patent owner's appeal, then the second third party requester's time for cross appeal runs from the earlier-in-time patent owner appeal, **not** from the later-in-time first requester appeal.

In addition, 37 CFR 1.959(b) only provides for a cross appeal from a "notice of appeal," not from a "notice of cross appeal." Thus, if the patent owner files a notice of cross appeal after the original one month/thirty days period for appeal has expired, but within the fourteen days of a first requester's appeal (which was filed within the original period); a second third party requester does **not** have fourteen days from the patent owner's cross appeal. In such a situation, the time for the second requester to appeal (the original one month/thirty days) has expired and the second requester cannot appeal.

The content of a notice of cross appeal is the same as that for a notice of appeal, except that the notice of cross appeal is titled as such and identifies the original appeal from which the cross appeal is taken. Where a party inadvertently fails to title or identify a notice of cross appeal as such (i.e., the format for an *original* appeal is used), in an appeal filed after the original

one month/thirty days has expired but before the "fourteen days" have expired, the examiner will construe the notice of appeal as the filing of a notice of cross appeal timely filed within the fourteen days.

## 2675 Appellant Brief [Added R-2]

*37 CFR 1.963. Time for filing briefs in inter partes reexamination.*

(a) An appellant's brief in an *inter partes* reexamination must be filed no later than two months from the latest filing date of the last-filed notice of appeal or cross appeal or, if any party to the *inter partes* reexamination is entitled to file an appeal or cross appeal but fails to timely do so, the expiration of time for filing (by the last party entitled to do so) such notice of appeal or cross appeal. The time for filing an appellant's brief may not be extended.

\*\*\*\*\*

*37 CFR 1.965. Appellant's brief in inter partes reexamination.*

(a) Appellant(s) may once, within time limits for filing set forth in § 1.963, file a brief in triplicate and serve the brief on all other parties to the *inter partes* reexamination proceeding in accordance with § 1.903. The brief must be signed by the appellant, or the appellant's duly authorized attorney or agent and must be accompanied by the requisite fee set forth in § 1.17(c). The brief must set forth the authorities and arguments on which appellant will rely to maintain the appeal. Any arguments or authorities not included in the brief will be refused consideration by the Board of Patent Appeals and Interferences, unless good cause is shown.

(b) A party's appeal shall stand dismissed upon failure of that party to file an appellant's brief, accompanied by the requisite fee, within the time allowed.

(c) The appellant's brief shall contain the following items under appropriate headings and in the order indicated below, unless the brief is filed by a party who is not represented by a registered practitioner. The brief may include an appendix containing only those portions of the record on which reliance has been made.

(1) *Real Party in Interest.* A statement identifying the real party in interest.

(2) *Related Appeals and Interferences.* A statement identifying by number and filing date all other appeals or interferences known to the appellant, the appellant's legal representative, or assignee which will directly affect or be directly affected by or have a bearing on the decision of the Board of Patent Appeals and Interferences in the pending appeal.

(3) *Status of Claims.* A statement of the status of all the claims, pending or canceled. If the appellant is the patent owner, the appellant must also identify the rejected claims whose rejection is being appealed. If the appellant is a third party requester, the appellant must identify the claims that the examiner has made a determination favorable to patentability, which determination is being appealed.

(4) *Status of Amendments.* A statement of the status of any amendment filed subsequent to the close of prosecution.

(5) *Summary of Invention.* A concise explanation of the invention or subject matter defined in the claims involved in the appeal, which shall refer to the specification by column and line number, and to the drawing(s), if any, by reference characters.

(6) *Issues.* A concise statement of the issues presented for review. No new ground of rejection can be proposed by a third party requester appellant.

(7) *Grouping of Claims.* If the appellant is the patent owner, for each ground of rejection in the Right of Appeal Notice which appellant contests and which applies to a group of two or more claims, the Board of Patent Appeals and Interferences shall select a single claim from the group and shall decide the appeal as to the ground of rejection on the basis of that claim alone unless a statement is included that the claims of the group do not stand or fall together; and, in the argument under paragraph (c)(8) of this section, appellant explains why the claims of this group are believed to be separately patentable. Merely pointing out differences in what the claims cover is not an argument as to why the claims are separately patentable.

(8) *Argument.* The contentions of appellant with respect to each of the issues presented for review in paragraph (c)(6) of this section, and the bases therefor, with citations of the authorities, statutes, and parts of the record relied on. Each issue should be treated under a separate, numbered heading.

(i) For each rejection under 35 U.S.C. 112, first paragraph, or for each determination favorable to patentability, including a determination not to make a proposed rejection under 35 U.S.C. 112, first paragraph, which appellant contests, the argument shall specify the errors in the rejection or the determination and how the first paragraph of 35 U.S.C. 112 is complied with, if the appellant is the patent owner, or is not complied with, if the appellant is a third party requester, including, as appropriate, how the specification and drawing(s), if any,

(A) Describe, if the appellant is the patent owner, or fail to describe, if the appellant is a third party requester, the subject matter defined by each of the appealed claims; and

(B) Enable, if the appellant is the patent owner, or fail to enable, if the appellant is a third party requester, any person skilled in the art to make and use the subject matter defined by each of the appealed claims.

(ii) For each rejection under 35 U.S.C. 112, second paragraph, or for each determination favorable to patentability including a determination not to make a proposed rejection under 35 U.S.C. 112, second paragraph, which appellant contests, the argument shall specify the errors in the rejection, if the appellant is the patent owner, or the determination, if the appellant is a third party requester, and how the claims do, if the appellant is the patent owner, or do not, if the appellant is a third party requester, particularly point out and distinctly claim the subject matter which the inventor regards as the invention.

(iii) For each rejection under 35 U.S.C. 102 or for each determination favorable to patentability including a determination not to make a proposed rejection under 35 U.S.C. 102 which appellant contests, the argument shall specify the errors in the rejection, if the appellant is the patent owner, or determination, if

the appellant is a third party requester, and why the appealed claims are, if the appellant is the patent owner, or are not, if the appellant is a third party requester, patentable under 35 U.S.C. 102, including any specific limitations in the appealed claims which are or are not described in the prior art.

(iv) For each rejection under 35 U.S.C. 103 or for each determination favorable to patentability, including a determination not to make a proposed rejection under 35 U.S.C. 103 which appellant contests, the argument shall specify the errors in the rejection, if the appellant is the patent owner, or determination, if the appellant is a third party requester. If appropriate, also state the specific limitations in the appealed claims which are or are not described in the prior art and explain how such limitations render the claimed subject matter obvious, if the appellant is a third party requester, or unobvious, if the appellant is the patent owner, over the prior art. If the rejection or determination is based upon a combination of references, the argument shall explain why the references, taken as a whole, do or do not suggest the claimed subject matter. The argument should include, as may be appropriate, an explanation of why features disclosed in one reference may or may not properly be combined with features disclosed in another reference. A general argument that all the limitations are or are not described in a single reference does not satisfy the requirements of this paragraph.

(v) For any rejection other than those referred to in paragraphs (c)(8)(i) to (iv) of this section or for each determination favorable to patentability, including any determination not to make a proposed rejection other than those referred to in paragraphs (c)(8)(i) to (iv) of this section which appellant contests, the argument shall specify the errors in the rejection, if the appellant is the patent owner, or determination, if the appellant is a third party requester, and the specific limitations in the appealed claims, if appropriate, or other reasons, which cause the rejection or determination to be in error.

(9) *Appendix.* An appendix containing a copy of the claims appealed by the appellant.

(10) *Certificate of Service.* A certification that a copy of the brief has been served in its entirety on all other parties to the reexamination proceeding. The names and addresses of the parties served must be indicated.

(d) If a brief is filed which does not comply with all the requirements of paragraphs (a) and (c) of this section, appellant will be notified of the reasons for non-compliance and provided with a non-extendable period of one month within which to file an amended brief. If the appellant does not file an amended brief during the one-month period, or files an amended brief which does not overcome all the reasons for non-compliance stated in the notification, that appellant's appeal will stand dismissed.

In order to file an appellant brief, it is necessary to have first filed a timely and proper notice of appeal or notice of cross appeal; see MPEP § 2674 and § 2674.01. Each party that filed a timely and proper notice of appeal or notice of cross appeal must then file its appellant brief with fee (set forth in 37 CFR 1.17(c)) by the later of:

(A) within two months from the date of the last-filed notice of appeal or cross appeal; or

(B) if a patent owner or third party requester is entitled to file an appeal or cross appeal but fails to timely do so, until the expiration of time for filing (by the last party entitled to do so) such notice of appeal or cross appeal.

The time for filing an appellant brief may not be extended. 37 CFR 1.963(a).

Pursuant to 37 CFR 1.965(d), if a brief is filed which does not comply with all the requirements of 37 CFR 1.965(a) and (c), appellant will be notified and given a nonextendable period of one month within which to file an amended brief to correct the defect(s). Failure to timely file the appellant brief and fee within the time allowed will result in dismissal of the appeal of the party that failed to take the timely action. Note that if an appellant brief is late, or if an amended appellant brief is not submitted after a requirement to correct the defect(s), the respondent brief will be placed in the file and given a paper number; however, it will be marked as “not entered” since it is not formally received into the record, and it will not be considered. The same is true for an amended appellant brief which is late.

Where all parties who filed an appeal or cross appeal fail to timely file an appellant brief and fee within the time allowed, the reexamination proceeding is terminated by a Notice of Intent to Issue *Inter Partes* Reexamination Certificate (NIRC), and a certificate is issued indicating the status of the claims at the time of appeal.

The appellant brief, as well as every other paper relating to an appeal, should indicate the number of the Technology Center (TC) and Art Unit to which the reexamination is assigned and the reexamination control number. When an appellant brief is received, it is scanned and then entered into the file by the Central Reexamination Unit (CRU) and then forwarded to the TC.

The submission of 3 copies of the appellant brief is required. A fee as set forth in 37 CFR 1.17(c) is required when the appellant brief is filed for the first time in a particular reexamination proceeding, 35 U.S.C. 41(a). 37 CFR 1.965 requires that the appellant shall provide, in the appellant brief, the authorities and arguments on which the appellant will rely to maintain the appeal, a concise explanation of

the invention which must refer to the specification by column and line number (and to the drawing, if any, by reference characters), and a copy of the claims involved. The copy of the claims (involved in the appeal) required in the brief Appendix by 37 CFR 1.965(c)(9) should be a clean copy. The clean copy must include all brackets and underlining as required by 37 CFR 1.530(d) *et seq.* For the sake of convenience, the copy of the claims involved should start on a new page, and it should be double spaced.

The provisions of 37 CFR 1.965(c) should be carefully reviewed to ensure that a complete appellant brief is provided. Patent owners are reminded that their briefs in appeal cases must be responsive to every ground of rejection stated by the examiner which the patent owner-appellant contests. Third party requesters are reminded that their briefs in appeal cases must be responsive to each examiner determination of patentability (determination of inapplicability of a proposed rejection) which the third party requester-appellant contests. Oral argument at the hearing will not remedy such a deficiency in the appellant brief.

Where the appellant brief is not complete as to the provisions of 37 CFR 1.965(a) and (c), appellant will be notified (in accordance with 37 CFR 1.965(d)) by the examiner that he/she is given one (1) month to correct the defect(s) by filing a supplemental appellant brief. Where this procedure has not been followed, the Board of Patent Appeals and Interferences should remand the reexamination file to the examiner for appropriate action.

When the record clearly indicates an *intentional* failure to respond by appellant brief to any ground of rejection or determination of patentability, the examiner should so inform the Board of Patent Appeals and Interferences in his/her answer and specify the claim(s) affected. Where the failure to respond by appellant brief appears to be intentional, the Board of Patent Appeals and Interferences may dismiss the appeal (of the appropriate party) as to the claims involved. Oral argument at a hearing will not remedy such a deficiency in a brief.

It is essential that the Board of Patent Appeals and Interferences should be provided with a brief fully stating the position of the appellant with respect to each issue involved in the appeal so that no search of the record is required in order to determine that



position. The fact that appellant may consider a ground or determination to be clearly improper does not justify a failure on the part of the appellant to point out to the Board the argument, i.e., reasons, for that view. A distinction must be made between the lack of any argument and the presentation of arguments which carry no conviction. In the former case, dismissal is in order, while in the latter case a decision on the merits is made, although it may well be merely an affirmance based on the grounds or determination relied upon by the examiner.

Ignoring or acquiescing in any rejection or determination, even one based upon formal matters which could be corrected by subsequent amendments, will invite a dismissal of the appeal as to the appropriate party. The reexamination proceedings will be considered terminated as of the date of the dismissal of the appeal of all parties who filed an appeal or cross appeal.

## I. AMENDMENTS

An amendment filed during the appeal stage will not be entered, in the absence of a petition under 37 CFR 1.182, because the rules do not provide for an amendment during the appeal stage in reexamination. If the examiner wishes to have the patent owner provide an amendment during the appeal stage, the examiner must reopen prosecution, accept the amendment for entry, permit timely comment on the new amendment by the third party requester, and then issue a new Action Closing Prosecution (ACP). See MPEP § 2673.01.

## II. AFFIDAVITS, DECLARATIONS, OR EXHIBITS

Affidavits, declarations, or exhibits submitted after the case has been appealed are provided for in the rules and will be admitted only with a showing of good and sufficient reasons why they were not earlier presented. 37 CFR 1.975. However, the affidavits, declarations, or exhibits will not be considered if they raise new issues requiring more than nominal consideration. Note also *In re Affidavit Filed After Final Rejection*, 152 USPQ 292, 1966 C.D. 53 (Comm'r Pat. 1966) which states that affidavits submitted after a final rejection in an application (i.e., after an ACP, in an *inter partes* reexamination) are treated in a man-

ner analogous to the treatment of an amendment after a final rejection in an application.

## 2675.01 Respondent Brief [Added R-2]

37 CFR 1.963. *Time for filing briefs in inter partes reexamination.*

\*\*\*\*\*

(b) Once an appellant's brief has been properly filed, any brief must be filed by respondent within one month from the date of service of the appellant's brief. The time for filing a respondent's brief may not be extended.

\*\*\*\*\*

37 CFR 1.967. *Respondent's brief in inter partes reexamination.*

(a) Respondent(s) in an *inter partes* reexamination appeal may once, within the time limit for filing set forth in § 1.963, file a respondent brief in triplicate and serve the brief on all parties in accordance with § 1.903. The brief must be signed by the party, or the party's duly authorized attorney or agent, and must be accompanied by the requisite fee set forth in § 1.17(c). The brief must state the authorities and arguments on which respondent will rely. Any arguments or authorities not included in the brief will be refused consideration by the Board of Patent Appeals and Interferences, unless good cause is shown. The respondent brief shall be limited to issues raised in the appellant brief to which the respondent brief is directed. A third party respondent brief may not address any brief of any other third party.

(b) The respondent brief shall contain the following items under appropriate headings and in the order here indicated, and may include an appendix containing only those portions of the record on which reliance has been made.

(1) *Real Party in Interest.* A statement identifying the real party in interest.

(2) *Related Appeals and Interferences.* A statement identifying by number and filing date all other appeals or interferences known to the respondent, the respondent's legal representative, or assignee (if any) which will directly affect or be directly affected by or have a bearing on the decision of the Board of Patent Appeals and Interferences in the pending appeal.

(3) *Status of claims.* A statement accepting or disputing appellant's statement of the status of claims. If appellant's statement of the status of claims is disputed, the errors in appellant's statement must be specified with particularity.

(4) *Status of amendments.* A statement accepting or disputing appellant's statement of the status of amendments. If appellant's statement of the status of amendments is disputed, the errors in appellant's statement must be specified with particularity.

(5) *Summary of invention.* A statement accepting or disputing appellant's summary of the invention or subject matter defined in the claims involved in the appeal. If appellant's summary of the invention or subject matter defined in the claims

involved in the appeal is disputed, the errors in appellant's summary must be specified.

(6) *Issues.* A statement accepting or disputing appellant's statement of the issues presented for review. If appellant's statement of the issues presented for review is disputed, the errors in appellant's statement must be specified. A counter statement of the issues for review may be made. No new ground of rejection can be proposed by a third party requester respondent.

(7) *Argument.* A statement accepting or disputing the contentions of the appellant with each of the issues. If a contention of the appellant is disputed, the errors in appellant's argument must be specified, stating the basis therefor, with citations of the authorities, statutes, and parts of the record relied on. Each issue should be treated under a separate heading. An argument may be made with each of the issues stated in the counter statement of the issues, with each counter-stated issue being treated under a separate heading. The provisions of § 1.965 (c)(8)(iii) and (iv) of these regulations shall apply to any argument raised under 35 U.S.C. 102 or § 103.

(8) *Certificate of Service.* A certification that a copy of the respondent brief has been served in its entirety on all other parties to the reexamination proceeding. The names and addresses of the parties served must be indicated.

(c) If a respondent's brief is filed which does not comply with all the requirements of paragraphs (a) and (b) of this section, respondent will be notified of the reasons for non-compliance and provided with a non-extendable period of one month within which to file an amended brief. If the respondent does not file an amended brief during the one-month period, or files an amended brief which does not overcome all the reasons for non-compliance stated in the notification, the respondent brief will not be considered.

After an appellant brief has been properly filed, a party opposing the appellant may file a respondent brief in support of the claim determination(s) made in the Right of Appeal Notice (RAN) which are in favor of the opposing party. The respondent brief must, however, be limited to issues raised in the appellant brief to which the respondent brief is directed. 37 CFR 1.967(a).

The respondent brief must be accompanied by the requisite fee set forth in 37 CFR 1.17(c), and it must be filed within one month from the date of service of the appellant brief on the opposing party.

Pursuant to 37 CFR 1.963(b), the time for filing a respondent brief may not be extended. If a respondent brief is filed which does not comply with all the requirements of 37 CFR 1.967(a) and (b), respondent will be notified and given a nonextendable period of one month within which to file an amended brief to correct the defect(s). See 37 CFR 1.967(c). Failure to

timely file a respondent brief and fee (or failure to timely complete the respondent brief, where it is noted by the examiner as being incomplete under 37 CFR 1.967(c)) will result in the respondent brief not being considered. Note that if the respondent brief is late, or if an amended respondent brief is not submitted after a requirement to correct the defect(s) (following a timely respondent brief), the respondent brief will be placed in the file and given a paper number; however, it will be marked as "not entered" since it is not formally received into the record, and it will not be considered. The same is true for an amended respondent brief which is late.

It should be noted that where a party fails to file a timely notice of appeal or notice of cross appeal, that party may no longer file *an appellant brief* to appeal a claim determination adverse to that party; **however**, that party is permitted to file a *respondent brief* in accordance with 37 CFR 1.963(b).

A fee as set forth in 37 CFR 1.17(c) is required when the respondent brief is filed for the first time in a particular reexamination proceeding, 35 U.S.C. 41(a). The submission of 3 copies of the respondent brief is required under 37 CFR 1.967(a). The respondent brief should indicate the number of the Technology Center (TC) and Art Unit to which the reexamination is assigned and the reexamination control number. A statement of what in the appellant brief is accepted and what is disputed must be provided in the respondent brief. Respondent must set forth the authorities and arguments upon which he/she will rely to dispute the contentions of the appellant with respect to the issues.

The provisions of 37 CFR 1.967(a) and (b) should be carefully reviewed to ensure that a complete respondent brief is provided. Where the respondent brief is not complete as to the provisions of 37 CFR 1.967(a) and (b), respondent will be notified (in accordance with 37 CFR 1.967(c)) by the examiner that respondent is given a non-extendable period of one month to correct the defect(s) by filing an amended respondent brief. Where this procedure has not been followed, the Board of Patent Appeals and Interferences should remand the reexamination file to the examiner for appropriate action.

## 2675.02 Informalities in One or More of the Briefs [Added R-2]

37 CFR 1.965. *Appellant's brief in inter partes reexamination.*

\*\*\*\*\*

(d) If a brief is filed which does not comply with all the requirements of paragraphs (a) and (c) of this section, appellant will be notified of the reasons for non-compliance and provided with a non-extendable period of one month within which to file an amended brief. If the appellant does not file an amended brief during the one-month period, or files an amended brief which does not overcome all the reasons for non-compliance stated in the notification, that appellant's appeal will stand dismissed.

37 CFR 1.967. *Respondent's brief in inter partes reexamination.*

\*\*\*\*\*

(c) If a respondent's brief is filed which does not comply with all the requirements of paragraphs (a) and (b) of this section, respondent will be notified of the reasons for non-compliance and provided with a non-extendable period of one month within which to file an amended brief. If the respondent does not file an amended brief during the one-month period, or files an amended brief which does not overcome all the reasons for non-compliance stated in the notification, the respondent brief will not be considered.

Where an appellant or respondent brief does not comply with all the requirements of 37 CFR 1.965(a) and (c) or 37 CFR 1.967(a) and (b), respectively, such as missing fee or missing portion of the fee, a missing signature, inappropriate signature, less than three copies of the brief, no proof of service on a party; the appropriate party should be notified of the reasons for non-compliance and provided with a nonextendable period of one month within which to file an amended brief. The reasons for non-compliance and/or the defect(s) will be pointed out to the appropriate party in *one comprehensive action* (notification). Form PTOL-2067 will be used as the cover sheet for the notification action. A separate PTOL-2067 with notification action will be sent to each party, where the brief(s) of more than one party are non-compliant and/or defective. Where the same party's appellant and respondent briefs are both informal, the examiner may combine the notifications for both into one notification action with PTOL-2067.

If an appellant does not file an *amended* appellant brief during the one-month period, or files an amended brief which does not overcome all the rea-

sons for non-compliance or does not correct all defects stated in the notification, the appeal will stand dismissed **as to that party**.

If a respondent does not file an amended respondent brief during the one-month period, or files an amended brief which does not overcome all the reasons for non-compliance or does not correct all defects stated in the notification, the respondent brief will not be formally received into the record and will not be considered (though it will be placed in the file and given a paper number).

Where a party does timely file an amended brief and overcomes all the reasons for non-compliance and corrects all defects stated in the notification, the amended brief will be entered and will be considered along with the original appellant or respondent brief, when the case is taken up by the examiner.

The following form paragraphs should be used in drafting the notification:

### ¶ 26.09 Brief is Defective and/or is Not Complete

The [1] brief filed [2] by [3] is defective and/or is not complete as to the provisions of 37 CFR 1.965(a) and (c) (for appellant brief) or 37 CFR 1.967(a) and (b) (for respondent brief) for the following reasons:

#### Examiner Note:

1. In bracket 1, fill in either "appellant" or "respondent".
2. In bracket 2, fill in the date the brief was filed.
3. In bracket 3, fill in either "the patent owner" or "the third party requester".
4. This form paragraph should be followed by a statement of all instances of non-compliance and all defects, and an explanation detailed enough for the party to understand how to deal with each non-compliance and defect noted in the letter.
5. One of form paragraphs or should be used at the end of this action.

### ¶ 26.10 Informal Appellant Brief-Period for Response Under 37 CFR 1.965(d)

Appellant, [1] is required to comply with the provisions of 37 CFR 1.965 (a) and (c) and to correct all defects noted in this letter as to the appellant brief. Appellant, [2] is given a period of ONE MONTH from the date of this letter or the time remaining in the original two month period (whichever is the longer) for filing an amended complete appellant brief. If an amended complete brief that fully complies with the requirements of this letter is not timely submitted, the appellant's appeal will be dismissed as of the date of expiration of the presently set time period. THE PERIOD FOR RESPONSE SET IN THIS LETTER CANNOT BE EXTENDED. 37 CFR 1.965(d).

#### Examiner Note:

In brackets 1 and 2, fill in either "the patent owner" or "the third party requester".

¶ 26.11 *Informal Respondent Brief-Period for Response Under 37 CFR 1.967(c)*

Respondent, [1] is required to comply with the provisions of 37 CFR 1.967(a) and (b) and to correct all defects noted in this letter as to the respondent brief. Respondent [2] is given a period of ONE MONTH from the date of this letter for filing an amended complete respondent brief. If an amended complete brief that fully complies with the requirements of this letter is not timely submitted, the respondent brief will not be formally received into the record and will not be considered. THE PERIOD FOR RESPONSE SET IN THIS LETTER CANNOT BE EXTENDED. 37 CFR 1.967(c).

**Examiner Note:**

1. In brackets 1 and 2, fill in either “the patent owner” or “the third party requester”.
2. In the case of the respondent brief, the new one month period will always extend longer than the original one month period, thus the longer of the two need not be given, as was done in form paragraph where the original period for the appellant brief is two months.

## 2676 Appeal Conference [Added R-2]

All appellant and respondent briefs will be processed in the Central Reexamination Unit (CRU). The CRU will forward the reexamination file to the examiner after all appellant and respondent briefs have been filed or after the time for filing them has expired.

As long as one timely appellant brief has been filed, the case must be considered for appeal by the examiner. The examiner will consult with the Reexamination Legal Advisor (RLA) as to the procedural considerations and should then formulate an initial opinion as to whether an examiner’s answer should be prepared, or prosecution should be reopened and a non-final Office action issued.

If the examiner reaches the conclusion that the appeal should **go forward** and an examiner’s answer should be prepared, the examiner will arrange (via the Supervisory Patent Examiner) for an appeal conference to be conducted pursuant to the procedures set forth in MPEP § 1208. The SPE will notify the RLA of the appeal conference, which the RLA will attend to ensure that all issues are properly addressed in the examiner’s answer. In preparing for the appeal conference, the examiner should review the case so that he/she will be prepared to discuss the issues raised in all the briefs. The examiner should be prepared to propose to the conferees how he/she will address each issue raised in the appellant and respondent briefs. The appeal conference will be held in accordance with

the procedures as set forth in MPEP § 1208 with the exception that an RLA will also attend the appeal conference. The examiner will have two weeks following the appeal conference to prepare the examiner’s answer.

If the examiner reaches the conclusion that the appeal should **not go forward**, no appeal conference is held. Prosecution is reopened, and the examiner issues of a new non-final Office action. The examiner should, at this point, consult with the RLA to discuss at what point in the prosecution the prosecution should be reopened, and then the examiner will prepare an appropriate Office action.

See MPEP § 2638 for the appropriate code to use for reporting time spent with respect to the appeal conference.

## 2677 Examiner’s Answer [Added R-2]

37 CFR 1.969. *Examiner’s answer in inter partes reexamination.*

(a) The primary examiner in an *inter partes* reexamination appeal may, within such time as directed by the Director, furnish a written statement in answer to the patent owner’s and/or third party requester’s appellant brief or respondent brief including, as may be necessary, such explanation of the invention claimed and of the references, the grounds of rejection, and the reasons for patentability, including grounds for not adopting a proposed rejection. A copy of the answer shall be supplied to all parties to the reexamination proceeding. If the primary examiner finds that the appeal is not regular in form or does not relate to an appealable action, he or she shall so state.

(b) An examiner’s answer may not include a new ground of rejection.

(c) An examiner’s answer may not include a new determination not to make a proposed rejection of a claim.

(d) Any new ground of rejection, or any new determination not to make a proposed rejection, must be made in an Office action reopening prosecution.

Where the term “brief” is used in this section, it shall refer to any appellant briefs and/or respondent briefs in the reexamination proceeding, unless specific identification of an “appellant brief” or a “respondent brief” is made.

Before preparing an examiner’s answer, the examiner should make certain that all amendments approved for entry have in fact been physically entered by the Central Reexamination Unit (CRU). The clerk of the Board will return to the Technology Center (TC) any reexamination proceeding in which approved amendments have not been entered.

The examiner should furnish each party to the reexamination (even a party that has not filed an appellant nor respondent brief) with a comprehensive examiner's answer that provides a written statement in answer to each appellant brief and each respondent brief. The examiner's answer is to be completed by the examiner within two weeks after the appeal conference. After the answer is completed (and signed), the examiner obtains the initials of the appeal conference participants (the conferees) and then forwards the reexamination file with the answer to the TC Special Program Examiner (SPRE). The SPRE reviews the answer, and if the answer is in order, forwards the reexamination file with the answer to the CRU.

The examiner's answer may incorporate from any of the briefs the most accurate and most comprehensive information. It should contain a response to the allegations or arguments made in all of the briefs and should call attention to any errors in an appellant's copy of the claims. If a ground of rejection or reason for patentability is not addressed in the examiner's answer, the proceeding will be remanded by the Board of Appeals and Patent Interferences (Board) to the examiner.

The examiner should report his/her conclusions on any affidavits, declarations, or exhibits that were admitted to the record. Any affidavits or declarations in the file swearing behind a patent should be clearly identified by the examiner as being considered under either 37 CFR 1.131 or 37 CFR 1.608(b). The distinction is important since the Board will usually consider holdings on 37 CFR 1.131 affidavits or declarations but not holdings on 37 CFR 1.608(b) affidavits or declarations in appeal cases.

If the appellant brief fails to respond (in the patent owner's brief) to any or all grounds of rejection or (in the third party requester's brief) to any or all determinations of patentability made by the examiner, or otherwise fails to comply with 37 CFR 1.965(c), the procedure for handling such briefs set forth in MPEP § 2675.02 should be followed. If the respondent brief fails to give reasons for disputing any or all contentions of an appellant that are disputed in the respondent brief, or otherwise fails to comply with 37 CFR 1.967(b), the procedure for handling such briefs is also set forth in MPEP § 2675.02.

It sometimes happens that an examiner will state a position (e.g., reasoning) in the answer in a manner

that represents a shift from the position stated in the Right of Appeal Notice (RAN). In such a case, the answer must indicate that the last stated position supersedes the former. Failure to do this confuses the issue since it is not clear exactly what the examiner's ultimate position is.

If there is a complete and thorough development of the issues at the time of the RAN, it is possible to save time in preparing the examiner's answer. Examiners may incorporate in the answer their statement of the grounds of rejection or determinations of patentability merely by reference to the RAN. An examiner's answer should not refer, either directly or indirectly, to more than one prior Office action. Thus, if a statement of the ground of rejection or a determination of patentability set forth in the RAN refers back to a prior action it cannot be incorporated by reference. The page(s) and paragraph(s) of the RAN which it is desired to incorporate by reference should be explicitly identified. If the examiner feels that further explanation is necessary, he/she should include it in the answer. The examiner's answer should also include rebuttal of any and all arguments presented in all of the briefs.

All correspondence with the Board, whether by the examiner or an appellant or respondent, must be on the record. No unpublished decisions which are unavailable to the general public by reason of 35 U.S.C. 122 can be cited by the examiner or the parties.

The examiner should reevaluate his/her position in the light of the arguments presented in the briefs, and should expressly withdraw any rejections or determinations of patentability not adhered to. Such a withdrawal would be a new finding of patentability (determination not to make a rejection) or new ground of rejection, respectively. Pursuant to 37 CFR 1.969(b), an examiner's answer "may not include a new ground of rejection." Pursuant to 37 CFR 1.969(c), an examiner's answer "may not include a new determination not to make a proposed rejection of a claim." Accordingly, prosecution must be reopened for any withdrawal of a rejection or of a determination of patentability. Before issuing the action reopening prosecution, the examiner will consult with the Reexamination Legal Advisor (RLA) to discuss at what point in the prosecution the prosecution should be reopened, and then the examiner will

prepare an appropriate Office action. Note that the examiner may withdraw the Action Closing Prosecution (ACP) and reopen prosecution at any time prior to the mailing of the examiner's answer.

If the examiner requests to be present at the oral hearing, the request should appear in the last paragraph of the examiner's answer. The examiner should make a pencil notation "Examiner requests an Oral Hearing" on the face of the file wrapper below the box for the examiner's name when an oral hearing is requested.

MPEP § 1208 - § 1208.02 relate to preparation of examiner's answers on appeal in patent applications and *ex parte* reexamination proceedings.

All examiner's answers in *inter partes* reexamination proceedings must comply with the guidelines set forth below.

## I. REQUIREMENTS FOR EXAMINER'S ANSWER

The examiner may incorporate from any of the briefs information required for the examiner's answer, as needed to provide accurate and comprehensive information. The examiner's answer must include, in the order indicated, the following items. Again, the term "brief" or "briefs" shall refer to any appellant briefs and/or respondent briefs in the reexamination proceeding, unless specific identification of an "appellant brief" or a "respondent brief" is made.

(A) Real Party in Interest: For each appellant and respondent brief, a statement by the examiner acknowledging the identification of the real party in interest, or indicating that the party named in the caption of the brief is the real party in interest. Alternatively, if the brief contains a proper heading but no real party in interest is identified, a statement by the examiner that it is presumed that the party named in the caption of the brief is the real party in interest. While the examiner will make this presumption, appellants and respondents should note that the Board has discretion to require an explicit statement on this item from an appellant or respondent.

(B) Related Appeals and Interferences: A statement acknowledging each appellant's and/or respondent's identification of related cases which will directly affect, or be directly affected by, or have a bearing on the decision in the pending appeal. Alternatively, if all appellants and respondents set forth the

required heading but do not identify any related appeals or interferences, a statement that it is presumed that there are none. While the examiner will make this presumption, appellants and respondents should note that the Board has discretion to require an explicit statement on this item from an appellant or respondent.

(C) Status of Claims: A statement of whether the examiner agrees or disagrees with the statement of the status of claims contained in the briefs and a correct statement of the status of all the claims pending or canceled, if necessary. The examiner may incorporate from any of the briefs the statement of the status of the claims.

(D) Status of Amendments: A statement of whether the examiner agrees or disagrees with the statement of the status of amendments contained in any of the briefs, and an explanation of any disagreement with any of the briefs. The examiner may incorporate from any of the briefs the statement of the status of the amendments. If there are no amendments, the examiner shall so state.

(E) Summary of Invention: A statement of whether the examiner agrees or disagrees with the summary of invention contained in any of the briefs, an explanation of why the examiner disagrees, and a correct summary of the invention, if necessary.

(F) Issues: A statement of whether the examiner agrees or disagrees with the statement of the issues in the briefs and an explanation of why the examiner disagrees if he/she disagrees, including:

(1) Identification of any issues which are petitionable rather than appealable; and

(2) Identification of any issues, grounds of rejection or determinations of patentability on appeal which the examiner no longer considers applicable.

(G) Grouping of Claims: A statement of whether the examiner agrees or disagrees with the grouping of claims and any statement in the briefs that certain claims do not stand or fall together, and, if the examiner disagrees, an explanation as to why those claims are not separately patentable.

(H) Claims Appealed: A statement of whether the copy of the appealed claims contained in the appendix to the appellant briefs is correct, and if any claim is not correct in any of the briefs, a copy of the correct claim.

(I) References of Record: A listing of the references of record relied on. Note that new references cannot be applied in an examiner's answer. 37 CFR 1.969(b). If new references are to be applied, prosecution must be reopened. Also note that both the art relied upon by the examiner in making rejections, and the art relied upon by the third party requester in the proposed rejections, will be listed by the examiner.

(J) Grounds of rejection: For each ground of rejection applicable to the appealed claims, an explanation of the ground of rejection, or reference to the RAN for a clear explanation of the rejection.

(1) For each rejection under 35 U.S.C. 112, first paragraph, the examiner's answer, or the RAN referred to, shall explain why the first paragraph of 35 U.S.C. 112 is not complied with, including, as appropriate, how the specification and drawings, if any, do not *describe* the subject matter defined by each of the rejected claims, and/or would not *enable* a person skilled in the art to make and use the subject matter defined by each of the rejected claims without undue experimentation.

(2) For each rejection under 35 U.S.C. 112, second paragraph, the examiner's answer, or the RAN referred to, shall explain why the claims do not particularly point out and distinctly claim the subject matter which "applicant" regards as the invention.

(3) For each rejection under 35 U.S.C. 102, the examiner's answer, or the RAN referred to, shall explain why the rejected claims are anticipated or not patentable under 35 U.S.C. 102, pointing out where all of the specific limitations recited in the rejected claims are found in the prior art relied upon in the rejection.

(4) For each rejection under 35 U.S.C. 103, the examiner's answer, or the RAN referred to, shall state the ground of rejection and point out where each of the specific limitations recited in the rejected claims is found in the art relied on in the rejection, shall identify any difference between the rejected claims and the art relied on and shall explain why the claimed subject matter is rendered unpatentable over the art. If the rejection is based upon a combination of references, the examiner's answer, or the RAN referred to, shall explain the suggestion or motivation to combine the teachings of the references.

(5) For each rejection under 35 U.S.C. 102 or 103 where there are questions as to how limitations in

the claims correspond to features in the art even after the examiner complies with the requirements of paragraphs (J)(3) and (4) above, the examiner shall compare at least one of the rejected claims feature-by-feature with the art relied upon in the rejection. The comparison shall align the language of the claim side-by-side with a reference to the specific page or column, line number, drawing reference number, and quotation from the reference, as appropriate.

(6) For each rejection, other than those referred to in paragraphs (J)(1) to (J)(5), the examiner's answer, or the RAN referred to, shall specifically explain the basis for the particular rejection.

(K) Determinations of patentability: For each determination of patentability, **i.e., each determination of inapplicability of a proposed rejection to the appealed claims**, a clear explanation of the determination.

(1) For each determination of inapplicability of a proposed rejection of the appealed claims under 35 U.S.C. 112, first paragraph; the examiner's answer, or the RAN referred to, shall explain how the first paragraph of 35 U.S.C. 112 is complied with, including, as appropriate, how the specification and drawings, if any, do *describe* the subject matter defined by each of the proposed-for-rejection claims, and/or would in fact enable a person skilled in the art to make and use the subject matter defined by each of the proposed-for-rejection claims without undue experimentation.

(2) For each determination of inapplicability of a proposed rejection of the appealed claims under 35 U.S.C. 112, second paragraph; the examiner's answer, or the RAN referred to, shall explain how the claims do particularly point out and distinctly claim the subject matter which "applicant" regards as the invention.

(3) For each determination of inapplicability of a proposed rejection of the appealed claims under 35 U.S.C. 102; the examiner's answer, or the RAN referred to, shall explain why the proposed-for-rejection claims are not anticipated and why they are patentable under 35 U.S.C. 102, pointing out which limitations recited in the patentable claims are not found in the art relied upon by the third party requester for the proposed rejection.

(4) For each determination of inapplicability of a proposed rejection of the appealed claims under 35 U.S.C. 103; the examiner's answer, or the RAN referred to, shall point out which limitations recited in

the proposed-for-rejection claims are not found in the art relied upon by the third party requester for the proposed rejection, shall identify the difference between the claims and the art relied upon by the third party requester and shall explain why the claimed subject matter is patentable over the art relied on by the third party requester. If the third party requester's proposed rejection is based upon a combination of references, the examiner's answer, or RAN relied upon, shall explain the rationale for not making the combination.

(5) For each rejection proposed under 35 U.S.C. 102 or 103 where there are questions as to how limitations in the claims define over features in the art even after the examiner complies with the requirements of paragraphs (K)(3) and (K)(4) above, the examiner shall compare at least one of the proposed-for-rejection claims feature-by-feature with the art relied on in the proposed rejection. The comparison will align the language of the claim side-by-side with a reference to the specific page or column, line number, drawing reference number, and quotation from the reference, as appropriate.

(6) For each determination of inapplicability of a proposed rejection, other than those referred to in paragraphs (K)(1) to (K)(5), the examiner's answer, or the RAN referred to, shall specifically explain why there is insufficient basis for making that particular proposed rejection.

(L) No new ground of rejection or new finding of patentability: The examiner's answer will provide an explicit statement that it does not contain any new ground of rejection, and it does not contain any new finding of patentability (i.e., no new determination of inapplicability of a proposed rejection). This statement will serve as a reminder to the examiner that if a new ground of rejection or new finding of patentability is made, prosecution must be reopened. It will also provide appropriate notification to parties that no new ground of rejection or new finding of patentability was made.

(M) Response to Argument: A statement of whether the examiner disagrees with each of the contentions of appellants and respondents in their briefs with respect to the issues presented, and an explanation of the reasons for disagreement with any such contentions. If any ground of rejection or inapplicability of proposed rejection is not argued and responded

to by the appropriate party, the examiner shall point out each claim affected.

(N) Period for Providing a Rebuttal Brief: The examiner will set forth the period for the appropriate appellant party, or appellant parties, to file a rebuttal brief after the examiner's answer, and that no further papers will be permitted subsequent to the rebuttal brief.

## II. PROCESSING OF COMPLETED ANSWER

When the examiner's answer is complete, the examiner will sign it. On the examiner's answer, each conferee who was present at the appeal conference will place his/her initials below the signature of the examiner who prepared the answer. Thus: "John Smith (conferee)" should be typed, and "JS" should be initialed. (The initialing by the conferee does not necessarily indicate concurrence with the position taken in the examiner's answer.)

The TC clerical staff will make a copy of the examiner's answer for the patent owner and for the third party requester(s). The clerical staff will make two additional copies for use by the Board. TC clerical staff should attach form PTOL-2070 to the copy of the answer to be mailed to the third party requester by the CRU.

The examiner must prepare the examiner's answer, ensure that the clerical processing is done, and forward the case to the TC SPRE no later than two weeks from the date of the appeal conference. The examiner's answer is reviewed by the SPRE and the case is forwarded to the CRU within three days of the SPRE's receipt of the case from the examiner. When files are forwarded, copies of the references should remain in the file wrapper.

If an examiner's answer is believed to contain a new interpretation or application of the existing patent law, the examiner's answer, the case file, and an explanatory memorandum should be forwarded to the Group Director for consideration. See MPEP § 1003. If approved by the Group Director, the examiner's answer should be forwarded by the SPRE to the Office of the Deputy Commissioner for Patent Examination Policy for final approval, prior to forwarding the case to the CRU.



### III. FORM PARAGRAPHS

The following form paragraphs may be used to prepare an examiner's answer in an *inter partes* reexamination proceeding:

¶ 26.50 *Heading for Examiner's Answer*

EXAMINER'S ANSWER

This is in response to the following appellant (and respondent) brief(s) on appeal: [1]

**Examiner Note:**

In bracket 1, identify for each brief (a) the party (patent owner or third party requester), (b) the type of brief (appellant or respondent), and (c) the date it was filed. Where there is one third party requester (the usual situation), indicate "third party requester"; where there are two or more third party requesters (a merged proceeding), indicate "third party requester" followed by the name of the third party requester (e.g., "third party requester Smith" or "third party requester XYZ Corporation").

¶ 26.50.01 *Real Party in Interest*

- (1) Real Party in Interest.

**Examiner Note:**

Follow this paragraph with one or more of form paragraphs 26.50.02 and/or 26.50.03.

¶ 26.50.02 *Acknowledgment of Identification of a Real Party in Interest in a Brief*

A statement identifying the real party in interest is contained in [1] brief(s).

**Examiner Note:**

In bracket 1, identify the brief or briefs containing a statement identifying the real party in interest. For example, "the appellant third party requester Jones" or "the appellant patent owner and the respondent third party requester Smith" or "all of the" can be used where appropriate.

¶ 26.50.03 *No Identification of a Real Party in Interest in the Briefs*

In the present appeal, [1] brief(s) does/do not contain a statement identifying the real party in interest. It is presumed that the party named in the caption of the brief(s) is the real party in interest at the time the brief was filed. The Board of Patent Appeals and Interferences, however, may subsequently exercise its discretion to require an explicit statement as to the real party in interest.

**Examiner Note:**

In bracket 1, identify the brief or briefs not containing a statement identifying the real party in interest. For example, "the appellant third party requester Jones" or "the appellant patent owner and the respondent third party requester Smith" or "all of the" can be used where appropriate.

¶ 26.50.04 *Related Appeals and Interferences*

- (2) Related appeals and interferences.

**Examiner Note:**

Follow this paragraph with one or more of form paragraphs 26.50.05 and/or 26.50.06.

¶ 26.50.05 *Acknowledgment of the Appellant's Statement Identifying the Related Appeals and Interferences*

A statement identifying the related appeals and interferences which will directly affect, or be directly affected by, or have a bearing on, the decision in the pending appeal is contained in [1] brief(s).

**Examiner Note:**

In bracket 1, identify the brief or briefs containing a statement identifying the related appeals and interferences. For example, "the appellant third party requester Jones" or "the appellant patent owner and the respondent third party requester Smith" or "all of the" can be used where appropriate.

¶ 26.50.06 *No Related Appeals and Interferences Identified*

In the present appeal, [1] brief(s) does/do not contain a statement identifying any related appeals and interferences which will directly affect or be directly affected by or have a bearing on the decision in the pending appeal. It is thus presumed that there are none. The Board of Patent Appeals and Interferences may, however, exercise its discretion to require an explicit statement as to the existence, or lack thereof, of any related appeals and interference.

**Examiner Note:**

In bracket 1, identify the brief or briefs not containing a statement identifying the related appeals and interferences. For example, "the appellant third party requester Jones" or "the appellant patent owner and the respondent third party requester Smith" or "all of the" can be used where appropriate.

¶ 26.51 *Status of Claims*

- (3) Status of claims.

**Examiner Note:**

Follow form paragraph 26.51 with one or more of form paragraphs 26.51.01 and/or 26.51.02.

¶ 26.51.01 *Agreement With Statement of Status of Claims*

The statement of the status of claims contained in the [1] brief(s) is correct.

**Examiner Note:**

1. In bracket 1, identify the brief or briefs containing the correct status of the claims. For example, "appellant third party requester Jones" or "appellant patent owner and respondent third party requester Smith" can be used where appropriate.
2. Use form paragraph 26.51.02 where there is a disagreement with the statement of status of the claims stated in the brief(s).

¶ 26.51.02 *Disagreement With Statement of Status of Claims Stated in Briefs*

The statement of the status of claims contained in the [1] briefs is incorrect. [2].

A correct statement of the status of the claims is as follows: [3]

**Examiner Note:**

1. In bracket 1, identify the brief or briefs containing the incorrect statement of the status of the claims. For example, “appellant third party requester Jones” or “appellant patent owner and respondent third party requester Smith” can be used where appropriate.
2. In bracket 2, identify the area of disagreement with each brief and the reasons for the disagreement.
3. For bracket 3, see form paragraphs 12.51.03 - 12.51.10 for the type of material that should be included. Remember that a “final rejection” is not made in a reexamination. Thus, use “Action Closing Prosecution” and “Right of Appeal Notice” where each is appropriate.

¶ 26.52 *Status of Amendments*

(4) Status of Amendments After Action Closing Prosecution.

**Examiner Note:**

Identify status of all amendments submitted after Action Closing Prosecution. Use one or more of form paragraphs 26.52.01 - 26.52.04, if appropriate.

¶ 26.52.01 *Agreement With Statement of the Status of Amendments After Action Closing Prosecution*

The statement of the status of amendments after Action Closing Prosecution contained in the [1] brief(s) is correct.

**Examiner Note:**

1. In bracket 1, identify the brief or briefs containing the correct statement of the status of amendments after Action Closing Prosecution. For example, “appellant third party requester Jones” or “appellant patent owner and respondent third party requester Smith” can be used where appropriate.
2. Use form paragraph 26.52.02 where there is a disagreement with the statement of the status of the amendments after ACP stated in the brief(s).

¶ 26.51.02 *Disagreement With Statement of Status of Claims Stated in Briefs*

The statement of the status of claims contained in the [1] briefs is incorrect. [2].

A correct statement of the status of the claims is as follows: [3]

**Examiner Note:**

1. In bracket 1, identify the brief or briefs containing the incorrect statement of the status of the claims. For example, “appellant third party requester Jones” or “appellant patent owner and respondent third party requester Smith” can be used where appropriate.
2. In bracket 2, identify the area of disagreement with each brief and the reasons for the disagreement.
3. For bracket 3, see form paragraphs 12.51.03 - 12.51.10 for the type of material that should be included. Remember that a “final rejection” is not made in a reexamination. Thus, use “Action Closing Prosecution” and “Right of Appeal Notice” where each is appropriate.

¶ 26.52.02 *Disagreement With Statement of the Status of Amendments After Action Closing Prosecution Stated in Briefs*

The statement of the status of amendments after Action Closing Prosecution contained in the [1] brief(s) is incorrect. [2]

**Examiner Note:**

1. In bracket 1, identify the brief or briefs containing the incorrect statement of the status of amendments after Action Closing Prosecution. For example, “appellant third party requester Jones” or “appellant patent owner and respondent third party requester Smith” can be used where appropriate.
2. In bracket 2, identify the area of disagreement with each brief and the reasons for the disagreement.

¶ 26.52.03 *Amendment After Action Closing Prosecution Entered*

The amendment after Action Closing Prosecution filed on [1] has been entered.

**Examiner Note:**

In bracket 1, insert the date of any entered amendment.

¶ 26.52.04 *Amendment After Action Closing Prosecution Not Entered*

The amendment after Action Closing Prosecution filed on [1] has not been entered.

**Examiner Note:**

In bracket 1, insert the date of any amendment denied entry.

¶ 26.53 *Summary of Invention*

(5) Summary of invention.

**Examiner Note:**

Follow form paragraph 26.53 with either form paragraphs 26.53.01 or 26.53.02.

¶ 26.53.01 *Agreement With the Summary of Invention In Brief(s)*

The summary of invention contained in the [1] brief(s) is correct.

**Examiner Note:**

1. In bracket 1, identify the brief or briefs containing the incorrect summary of invention. For example, “appellant third party requester Jones” or “appellant patent owner and respondent third party requester Smith” can be used where appropriate.
2. Use form paragraph 26.53.02 where there is disagreement as to the summary.

¶ 26.53.02 *Disagreement With the Summary of Invention In Brief(s)*

The summary of invention contained in the [1] brief(s) is deficient because [2].

**Examiner Note:**

1. In bracket 1, identify the brief or briefs containing the incorrect summary of invention. For example, “appellant third party

requester Jones” or “appellant patent owner and respondent third party requester Smith” can be used where appropriate.

2. In bracket 2, explain the deficiency of the summary of the invention. Include a correct summary of the invention if necessary for a clear understanding of the claimed invention.

¶ 26.54 Issues

(6) Issues.

**Examiner Note:**

Follow form paragraph 26.54 with one or more of form paragraphs 26.54.01, 26.54.02, or 26.54.03.

¶ 26.54.01 Agreement With Statement of the Issues

The statement of the issues contained in the [1] brief(s) is correct.

**Examiner Note:**

1. In bracket 1, identify the brief or briefs containing the correct statement of the issues. For example, “appellant third party requester Jones” or “appellant patent owner and respondent third party requester Smith” can be used where appropriate.
2. Use form paragraph where there is disagreement as to the statement of the issues.

¶ 26.54.02 Disagreement With Statement of the Issues in Brief(s)

The [1] brief(s) does/do not provide a correct statement of the issues. [2] The issues are as follows: [3].

**Examiner Note:**

1. In bracket 1, identify the brief or briefs containing the incorrect statement of the issues.
2. In bracket 2, indicate the area of disagreement and the reasons for the disagreement.
3. In bracket 3 set forth the correct statement of the issues, including:
  - (i) an identification of any issues which are appealable;
  - (ii) an identification of any issues which are petitionable rather than appealable; and
  - (iii) an identification of any issues on appeal which the examiner no longer considers applicable.

¶ 26.54.03 Nonappealable Issue in Brief

The [1] brief presents arguments relating to [2]. This issue relates to petitionable subject matter under 37 CFR 1.181 and not to appealable subject matter. See MPEP § 1002 and § 1201.

**Examiner Note:**

1. In bracket 1, identify the brief containing the petitionable issues. For example, “appellant third party requester Jones” or “appellant patent owner” can be used where appropriate.
2. Where more than one brief has a petitionable issue, this form paragraph should be used for each of these briefs.

¶ 26.55 Grouping of Claims

(7) Grouping of Claims.

**Examiner Note:**

Follow form paragraph 25.55 with appropriate form paragraphs 26.55.01 to 26.55.05.

¶ 26.55.01 No Statement in Patent Owner’s Appellant Brief That Claims Do Not Stand or Fall Together

Patent owner concedes that the rejection of claims [1] stand or fall together, since the patent owner’s appellant brief does not include a statement that this grouping of claims does not stand or fall together, accompanied by reasons in support thereof. See 37 CFR 1.965 (c)(7).

**Examiner Note:**

1. Use this paragraph for each grouping of claims (i.e., ground of rejection which the patent owner contests) wherein the brief includes neither a statement that a grouping of claims does not stand or fall together nor arguments in support thereof.
2. If the patent owner appellant brief includes a statement that a grouping of claims does not stand or fall together but does not provide reasons in support thereof, the examiner should notify the patent owner of the noncompliance with 37 CFR 1.965 (c)(7).

¶ 26.55.02 No Statement in Third Party Requester Appellant Brief That Claims Do Not Stand or Fall Together

Third party requester [1] concedes that the finding of patentability of claims [2] stand or fall together since the requester’s appellant brief does not include a statement that this grouping of claims does not stand or fall together, accompanied by reasons in support thereof. See 37 CFR 1.965 (c)(7).

**Examiner Note:**

1. Use this paragraph for each grouping of claims (i.e., finding of patentability which appellant contests) wherein the brief includes neither a statement that a grouping of claims does not stand or fall together nor arguments in support thereof.
2. In bracket 1, identify the name of the third party requester.
3. If the third party requester appellant brief includes a statement that a grouping of claims does not stand or fall together but does not provide reasons in support thereof, the examiner should notify the third party requester appellant of the noncompliance with 37 CFR 1.965 (c)(7).

¶ 26.55.03 Dispute with Statement in Brief of Why Claims Do Not Stand or Fall Together

The statement in the [1] brief that certain claims do not stand or fall together is not agreed with because [2].

**Examiner Note:**

1. In bracket 1, identify the brief containing the disputed grouping of claims. For example, “appellant third party requester Jones” or “appellant patent owner” can be used where appropriate.
2. In bracket 2, identify the claim grouping listed in the brief that is not agreed with by the examiner, and explain why the grouping is disputed, i.e., why the claims as listed by the brief are not believed to be separately patentable.

*¶ 26.55.04 Appellant Brief Does Give Reasons Why Claims Do Not Stand or Fall Together; Claim Grouping(s) Not Disputed*

The [1] brief(s) include(s) a statement that claims [2] do not stand or fall together and provides reasons as set forth in 37 CFR 1.965 (c)(7) and (c)(8).

**Examiner Note:**

1. In bracket 1, identify the appellant brief containing the statement. For example, “appellant third party requester Jones” or “appellant patent owner” can be used where appropriate.
2. This paragraph is for appellant briefs, not for respondent briefs; see form paragraph for respondent briefs.

*¶ 26.55.05 Respondent Brief Disputes Appellant Brief and Gives Reasons Why Claims Do Not Stand or Fall Together*

The respondent [1] brief disputes the statement in the appellant [2] brief that claims [3] do not stand or fall together and provides reasons as set forth in 37 CFR 1.967 (b)(7).

**Examiner Note:**

1. In bracket 1, identify the respondent brief disputing the statement in the appellant brief. For example, “third party requester,” “third party requester Smith” or “patent owner” can be used where appropriate.
2. In bracket 2, identify the appellant brief containing the statement disputed. For example, “third party requester,” “third party requester Smith” or “patent owner” can be used where appropriate.

*¶ 26.56 Claims Appealed*

(8) Claims appealed.

**Examiner Note:**

Follow form paragraph 26.56 with form paragraphs 26.56.01, 26.56.02, and/or 26.56.03, as is appropriate.

*¶ 26.56.01 Copy of the Appealed Claims in the Appendix of Appellant Brief is Correct*

The copy of the appealed claims [1] is contained in the Appendix to the appellant brief of [2] is correct.

**Examiner Note:**

1. In bracket 1, identify the claims appealed found in the appellant brief.
2. In bracket 2, identify the appellant brief containing the claims appealed. For example, “third party requester,” “third party requester Smith” or “patent owner” can be used where appropriate.
3. This paragraph is for appellant briefs; not for respondent briefs.
4. Where there is more than one appellant brief, the patent examiner may choose any appellant brief that has a correct copy of claims appealed. The examiner may use this form paragraph more than once, as needed to set forth each claim or group of claims appealed by the appellants. Where a claim is correct in one appellant brief but is incorrect in another appellant brief, the examiner will draw a diagonal line in pencil through the incorrect

claim in the Appendix of the incorrect appellant brief, and place the date, the word “Incorrect,” and the examiner’s initials in the margin.

*¶ 26.56.02 Copy of the Appealed Claims in the Appendix of Appellant Brief is Substantially Correct*

A substantially correct copy of the appealed claim(s) is contained in the Appendix of the appellant brief of [1]. Claim(s) [2] appear on pages [3] of the appendix contain minor errors. The minor errors are as follows: [4]

**Examiner Note:**

1. Use this paragraph where all appellant briefs contain errors in the claim(s) but at least one appellant brief is substantially correct and contains only minor errors.
2. In bracket 1, identify the appellant brief containing the substantially correct copy of the appealed claims. For example, “third party requester Smith” or “patent owner” can be used where appropriate.
3. In bracket 2, indicate the claim or claims with the minor errors.
4. In bracket 3, identify the page(s) in the Appendix where the substantially correct appealed claims appear.
5. In bracket 4, indicate the nature of the errors.
6. This paragraph is for appellant briefs; not for respondent briefs.
7. Where there is more than one appellant brief having the same claim recited incorrectly but at least one appellant brief is substantially correct and contains only minor errors, the examiner can apply the present form paragraph to the brief that has only minor errors in the appealed claim. The examiner would draw a diagonal line in pencil through the incorrect claim in any other (incorrect) appellant brief, and place the date, the word “Incorrect,” and the examiner’s initials in the margin.

*¶ 26.56.03 Copy of the Appealed Claims in the Appendix Contains Substantial Errors*

Claim(s) [1] contain(s) substantial errors as presented in the Appendix to all the appellant briefs. Accordingly, claim(s) [2] is/are correctly written in the Appendix to the examiner’s answer.

**Examiner Note:**

1. This form paragraph is used where all appellants fail to include a correct copy of an appealed claim or claims in the Appendix to the brief.
2. Attach a correct copy of the claims incorrect in all the appellant briefs as an Appendix to the examiner’s answer. Draw a diagonal line in pencil through the incorrect claim in the Appendix of each appellant’s appeal brief, and place the date, the word “Incorrect,” and the examiner’s initials in the margin.
3. In brackets 1 and 2, identify the claims that contain substantial errors.
4. Rather than using this form paragraph, if the errors in the claim(s) are significant, appellant(s) should be required to submit a corrected brief (amended brief). Where the brief includes arguments based upon the incorrect version of the claims (i.e., argument directed toward the errors in the claims), a corrected brief should always be required.

¶ 26.57 *Art of Record Relied Upon - Heading*

(9) Art of Record (Patents and Printed Publications)

**Examiner Note:**

Follow form paragraph 26.57 with one or more of form paragraphs 26.57.01 - 26.57.04.

¶ 26.57.01 *No Art Relied Upon in the Examiner's Answer*

No art is relied upon in the rejection of claims under appeal.

¶ 26.57.02 *Listing of the Art of Record Relied Upon by Examiner*

The following is a listing of the art of record relied upon by the examiner in the rejection of claims under appeal.

**Examiner Note:**

1. Use the following format for providing information on each reference cited:

Number	Name	Date
--------	------	------

2. The following are example formats for listing reference citations:

2,717,847	VARIAN	9-1955
1,345,890	MUTHER (Fed. Rep. of Germany)	7-1963

(Figure 2 labeled as Prior Art in this document)

3. See MPEP § 707.05(e) for additional examples.

¶ 26.57.03 *Listing of the Art of Record Relied Upon by Requester*

The following is a listing of the art of record relied upon by the third party requester(s) in the proposed rejection of claims which were not made by the examiner, and are now under appeal.

**Examiner Note:**

1. Use the following format for providing information on each reference cited:

Number	Name	Date
--------	------	------

2. The following are example formats for listing reference citations:

2,717,847	VARIAN	9-1955
1,345,890	MUTHER (Fed. Rep. of Germany)	7-1963

(Figure 2 labeled as Prior Art in this document)

3. See MPEP § 707.05(e) for additional examples.

4. As an alternative to the examiner's actual listing the art relied upon by the third party requester, the examiner can list such art by incorporation by reference to the third party requester's brief(s) using form paragraph 26.57.04.

¶ 26.57.04 *Incorporation by Reference of Requester's Listing of Art of Record Relied Upon*

Incorporated by reference herein is the third party requester's listing of art of record relied upon by the third party requester in the proposed rejection of claims which were not made by the examiner, and are now under appeal. The third party requester's listing of art can be found [1].

**Examiner Note:**

In bracket 1, identify the third party requester brief(s) and the pages of same where the third party requester's listing of art of record relied upon is located.

¶ 26.59 *Grounds of Rejection*

(10) Grounds of rejection.

The following ground(s) of rejection are applicable to the appealed claims. [1].

In bracket 1, explain each ground of rejection or refer to the RAN if it clearly and completely sets forth the rejection and complies with appropriate paragraphs i-vi below:

(i) For each rejection under 35 U.S.C. 112, first paragraph, the examiner's answer shall explain why the first paragraph of 35 U.S.C. 112 is not complied with, including, as appropriate, how the specification and drawings, if any, (a) do not describe the subject matter defined by each of the rejected claims, and/or (b) would not enable a person skilled in the art to make and use the subject matter defined by each of the rejected claims.

(ii) For each rejection under 35 U.S.C. 112, second paragraph, the examiner's answer shall explain why the claims do not particularly point out and distinctly claim the subject matter which "applicant" regards as the invention.

(iii) For each rejection under 35 U.S.C. 102, the examiner's answer shall explain why the rejected claims are anticipated or not patentable under 35 U.S.C. 102, pointing out where all of the specific limitations recited in the rejected claims are found in the art relied upon in the rejection.

(iv) For each rejection under 35 U.S.C. 103, the examiner's answer shall state the ground of rejection and point out where each of the specific limitations recited in the rejected claims is found in the art relied on in the rejection, shall identify any difference between the rejected claims and the art relied on and shall explain why the claimed subject matter is rendered unpatentable over the art. If the rejection is based upon a combination of references, the examiner's answer shall explain the suggestion or motivation to combine the teachings of the references.

(v) For each rejection under 35 U.S.C. 102 or 103 where there may be questions as to how limitations in the claims correspond to features in the art, the examiner, in addition to the requirements of (iii) and (iv) above, shall compare at least one of the rejected claims feature-by-feature with the art relied upon in the rejection. The comparison shall align the language of the claim side-by-side with a reference to the specific page or column, line number, drawing reference number and quotation from the reference, as appropriate.

(vi) For each rejection, other than those referred to in paragraphs (i) to (v) of this section, the examiner's answer shall specifically explain the basis for the particular rejection.

¶ 26.59.01 *Grounds of Rejection*

(11) Findings of Patentability.

The following findings of patentability, i.e., determinations of inapplicability of a proposed rejection, are applicable to the appealed claims.

[1]

**Examiner Note:**

In bracket 1, explain each determination of inapplicability of a proposed rejection, or refer to the RAN if it clearly and completely sets forth the determination of inapplicability of a pro-

posed rejection and complies with appropriate paragraphs i-vi below:

(i) For each determination of inapplicability of a proposed rejection of the appealed claims under 35 U.S.C. 112, first paragraph; the examiner's answer shall explain how the first paragraph of 35 U.S.C. 112 is complied with, including, as appropriate, how the specification and drawings, if any, (a) do describe the subject matter defined by each of the claims proposed for rejection, and/or (b) would in fact enable any person skilled in the art to make and use the subject matter defined by each of the claims proposed for rejection without undue experimentation.

(ii) For each determination of inapplicability of a proposed rejection of the appealed claims under 35 U.S.C. 112, second paragraph; the examiner's answer shall explain how the claims do particularly point out and distinctly claim the subject matter which "applicant" regards as the invention.

(iii) For each determination of inapplicability of a proposed rejection of the appealed claims under 35 U.S.C. 102; the examiner's answer shall explain why the claims proposed for rejection are not anticipated and patentable under 35 U.S.C. 102, pointing out which limitations recited in the claims proposed for rejection are not found in the art relied upon in the proposed rejection.

(iv) For each determination of inapplicability of a proposed rejection of the appealed claims under 35 U.S.C. 103; the examiner's answer shall point out which limitations recited in the patentable claims are not found in the art relied upon in the proposed rejection, shall identify the difference between the patentable claims and the art relied upon by the third party requester and shall explain why the claimed subject matter is patentable over the art relied on by the third party requester. If the third party requester's proposed rejection is based upon a combination of references, the examiner's answer shall explain the rationale for not making the combination.

(v) For each third party requester proposed rejection under 35 U.S.C. 102 or 103 where there are questions as to how limitations in the claims define over features in the art even after the examiner complies with the requirements of (iii) and (iv) above, the examiner shall compare at least one of the claims proposed for rejection feature-by-feature with the art relied on in the proposed rejection. The comparison shall align the language of the claim side-by-side with a reference to the specific page or column, line number, drawing reference number, and quotation from the reference, as appropriate.

(vi) For each determination of inapplicability of a proposed rejection, other than those referred to in paragraphs (i) to (v) of this section, the examiner's answer shall specifically explain why there is insufficient basis for making the particular proposed rejection.

*¶ 26.60 No New Ground of Rejection; No New Finding of Patentability*

(12) No new ground of rejection; no new finding of patentability.

This examiner's answer does not contain any new ground of rejection. This examiner's answer does not contain any new finding of patentability (i.e., no new determination of inapplicability of a proposed rejection).

**Examiner Note:**

If a new ground of rejection or new finding of patentability is made, prosecution must be reopened. See MPEP 2677.

*¶ 26.61 Response to Argument*

(13) Response to argument.

**Examiner Note:**

1. If an issue raised by the appellant was fully responded to under "Grounds of Rejection" or under "Findings of Patentability", no additional response is required here, except to point out where the issue was responded to.

2. If an issue has been raised by any appellant and/or respondent that was not fully responded to under the "Grounds of Rejection" or under "Findings of Patentability", a full response must be provided after this form paragraph.

*¶ 26.62 Notification Regarding Rebuttal Brief*

(14) Period for providing a Rebuttal Brief.

Appellant(s) is/are given a period of ONE MONTH from the mailing date of this examiner's answer within which to file a rebuttal brief in response to the examiner's answer. Prosecution otherwise remains closed.

The rebuttal brief of the patent owner may be directed to the examiner's answer and/or any respondent brief. The rebuttal brief of the third party requester(s) may be directed to the examiner's answer and/or the respondent brief of the patent owner. The rebuttal brief must (1) clearly identify each issue, and (2) point out where the issue was raised in the examiner's answer and/or in the respondent brief. In addition, the rebuttal brief must be limited to issues raised in the examiner's answer or in the respondent brief.

The time for filing the rebuttal brief may not be extended. No further submission (other than the rebuttal brief(s)) will be considered, and any such submission will be treated in accordance with 37 CFR 1.939.

*¶ 26.63 Request to Present Oral Arguments*

The examiner requests the opportunity to present arguments at the oral hearing.

**Examiner Note:**

1. Use this form paragraph only if:
  - a. an oral hearing has been requested by a party to the appeal; and
  - b. the primary examiner intends to present an oral argument.
2. If the request for an oral hearing of a party to the appeal has been made before or with a brief, this form paragraph may be included at the end of the examiner's answer.
3. If the request for an oral hearing has been made after the examiner's answer, this form paragraph may be included in an acknowledgment of rebuttal brief, or in a separate letter.

*¶ 26.64 Examiner's Answer, Conclusion*

For the above reasons, it is believed that the rejections and/or findings of patentability discussed above should be sustained.

Respectfully submitted,

## 2678 Rebuttal Briefs [Added R-2]

37 CFR 1.963. *Time for filing briefs in inter partes reexamination.*

\*\*\*\*\*

(d) Any appellant may file a rebuttal brief under § 1.971 within one month of the date of the examiner's answer. The time for filing a rebuttal brief may not be extended.

(e) No further submission will be considered and any such submission will be treated in accordance with § 1.939.

37 CFR 1.971. *Rebuttal brief in inter partes reexamination.*

(a) Within one month of the examiner's answer in an *inter partes* reexamination appeal, any appellant may once file a rebuttal brief in triplicate. The rebuttal brief of the patent owner may be directed to the examiner's answer and/or any respondent brief. The rebuttal brief of any third party requester may be directed to the examiner's answer and/or the respondent brief of the patent owner. The rebuttal brief of a third party requester may not be directed to the respondent brief of any other third party requester. No new ground of rejection may be proposed by a third party requester. The time for filing a rebuttal brief may not be extended. The rebuttal brief must include a certification that a copy of the rebuttal brief has been served in its entirety on all other parties to the reexamination proceeding. The names and addresses of the parties served must be indicated.

(b) If a rebuttal brief is filed which does not comply with all the requirements of paragraph (a) of this section, appellant will be notified of the reasons for non-compliance and provided with a non-extendable period of one month within which to file an amended rebuttal brief. If the appellant does not file an amended rebuttal brief during the one-month period, or files an amended rebuttal brief which does not overcome all the reasons for non-compliance stated in the notification, that appellant's rebuttal brief will not be considered.

In the examiner's answer, each appellant is given a period of one month from the mailing date of the examiner's answer within which to file a rebuttal brief in response to the issues raised in the examiner's answer and/or in the respondent brief of an opposing party. The one month period may not be extended. 37 CFR 1.971.

The rebuttal brief must (A) clearly identify each issue, and (B) point out where the issue was raised in the examiner's answer and/or in the respondent brief. In addition, the rebuttal brief must be limited to issues raised in the examiner's answer or in any respondent brief. A rebuttal brief will not be entered if it does not clearly identify each issue and/or is not limited to issues raised in the examiner's answer or in any respondent brief. Such a rebuttal brief will remain in

the file, but it will not be addressed nor considered, except to inform the appropriate party that it was not entered and why.

The rebuttal brief of a third party requester may not be directed to the respondent brief or any other third party requester. No new ground of rejection may be proposed by a third party requester.

After the examiner's answer, only a rebuttal brief (or an amended rebuttal brief, where appellant is given one opportunity to correct a defective original rebuttal brief (MPEP § 2679)) will be received into the reexamination proceeding. No other submission will be considered, and any such other submission will be returned as an improper paper. 37 CFR 1.939.

If no rebuttal brief is received within the one month period set in the examiner's answer, the Central Reexamination Unit (CRU) will issue a notification letter to parties using form paragraph 26.67, and will then forward the reexamination proceeding to the Board of Patent Appeals and Interferences for decision on the appeal(s).

### ¶ 26.67 No Receipt of Rebuttal Brief(s)

Appellant(s) was given a period of one month from the mailing date of the examiner's answer within which to file a rebuttal brief in response to the examiner's answer. No rebuttal brief has been received within that time period. Accordingly, the reexamination proceeding is being forwarded to the Board of Patent Appeals and Interferences for decision on the appeal(s).

Prosecution remains closed. Any further reply/comments by any party will not be considered, and may be returned to the party that submitted it.

---

Central Reexamination Unit

If one or more rebuttal briefs is/are timely received, see MPEP § 2679 for treatment of the rebuttal brief(s).

## 2679 Office Treatment of Rebuttal Brief [Added R-2]

When a rebuttal brief is received in response to an examiner's answer, it is entered by the Central Reexamination Unit (CRU). The reexamination case file is retained in the CRU until all potential rebuttal briefs are submitted and entered, or the time for filing a rebuttal brief has expired. The case file is then forwarded to the examiner, who will then review the submission(s) and consult with the Reexamination Legal Advisor (RLA) of the CRU. If the examiner

determines that the rebuttal brief (A) does not clearly identify each issue raised in the examiner's answer or in the respondent brief of an opposing party (and point out *where* the issue was raised in those papers), or (B) is not limited to the issues raised in the examiner's answer or the respondent brief; the examiner may *refuse* entry of the rebuttal brief. If entry is approved, the examiner will issue a notification letter to that effect. If entry is refused, the examiner will issue a notification letter that appellant is given a non-extendable period of one month to correct the defect in the rebuttal brief by filing an amended rebuttal brief. If the amended rebuttal brief filed in response to the examiner's letter does not overcome all the reasons for noncompliance with 37 CFR 1.971(a) stated in the examiner's letter, appellant will be so notified, but will not be given a second opportunity to file an amended rebuttal brief. That appellant's amended rebuttal brief will not be considered. 37 CFR 1.971(b). The examiner's notification letter will be mailed from the CRU.

After all rebuttal briefs and amended rebuttal briefs (where appellant is given an opportunity to correct a defective original rebuttal brief) have been received and the appropriate notification letters mailed, or the time for filing such briefs has expired, the proceeding will be forwarded by the CRU to the Board of Patent Appeals and Interferences.

In a very rare situation, where the examiner finds that it is essential to address a rebuttal brief, the examiner must reopen prosecution. In order to reopen prosecution after an examiner's answer, the Technology Center (TC) Director must approve the same in writing, at the end of the action that reopens prosecution.

Form paragraphs 26.65 and 26.65.01 may be used to notify the parties of receipt and entry of the rebuttal brief(s).

¶ 26.65 *Acknowledgment of Rebuttal Brief*

The rebuttal brief filed [1] by [2] has been entered.

**Examiner Note:**

1. Use a separate form paragraph 26.65 for each rebuttal brief that is received.
2. In bracket 1, insert the date the rebuttal brief was filed.
3. In bracket 2, insert the party that filed the rebuttal brief.

¶ 26.65.01 *No Further Response*

No further response by the examiner is appropriate. Any further reply/comments by any party will be not be considered, and may be returned to the party that submitted it. The reexamination

proceeding is being forwarded to the Board of Patent Appeals and Interferences for decision on the appeal(s).

Form paragraph 26.66 may be used to notify the parties of receipt of the rebuttal brief(s) that are defective.

¶ 26.66 *Defective Rebuttal Brief-Opportunity to Correct*

A rebuttal brief must (1) clearly identify each issue and (2) point out *where* the issue was raised in the examiner's answer and/or in the respondent brief. In addition, the rebuttal brief must be limited to issues raised in the examiner's answer or in the respondent brief. The rebuttal brief of Appellant [1] is defective because [2].

Appellant [3] is given a period of ONE MONTH from the mailing date of this examiner's answer within which to file an amended rebuttal brief in response to this letter. Prosecution otherwise remains closed. The time for filing the amended rebuttal brief may not be extended.

If the amended rebuttal brief filed in response to the this letter does not remedy the defect or raises a new one, appellant will be so notified, but will not be given a second opportunity to file an amended rebuttal brief.

**Examiner Note:**

1. In brackets 1 and 3, insert the "patent owner" or the appropriate third party requester. Where there is one third party requester (the usual situation) insert "third party requester"; where there are two or more third party requesters (a merged proceeding), insert "third party requester" followed by the name of the third party requester (e.g., "third party requester Smith" or "third party requester XYZ Corporation").
2. This form paragraph is to be used once for each appellant filing a defective **original** rebuttal brief, to provide notification thereof.
3. For an appellant filing a defective **amended** rebuttal brief, use form paragraph 26.66.01.

Form paragraph 26.66.01 may be used to notify the appellant that the amended rebuttal brief is defective.

¶ 26.66.01 *Defective Amended Rebuttal Brief-No Opportunity to Correct*

A rebuttal brief must (1) clearly identify each issue and (2) point out *where* the issue was raised in the examiner's answer and/or in the respondent brief. In addition, the rebuttal brief must be limited to issues raised in the examiner's answer or in the respondent brief. The amended rebuttal brief of Appellant [1] is defective because [2].

The original and amended rebuttal briefs have been placed in the file but will not be considered. There is **no** opportunity to file a second amended rebuttal brief, and any such submission will be returned.

**Examiner Note:**

1. In bracket 1, insert the "patent owner" or the appropriate third party requester. Where there is one third party requester (the usual situation) insert "third party requester"; where there are two



or more third party requesters (a merged proceeding), insert “third party requester” followed by the name of the requester (e.g., “third party requester Smith” or “third party requester XYZ Corporation”).

2. This form paragraph is to be used once for each defective **amended** rebuttal brief, to provide notification thereof. The notification letter should conclude with form paragraph 26.66.02, unless such is inappropriate for some reason.

3. For an appellant filing a defective **original** rebuttal brief, use form paragraph 26.66.

Form paragraph 26.66.02 may be used to notify the parties that the proceeding is being forwarded to the Board of Appeals and Interferences for decision on the appeal(s).

#### ¶ 26.66.02 Forward to the Board for Decision

The reexamination proceeding is being forwarded to the Board of Patent Appeals and Interferences for decision on the appeal(s).

## 2680 Oral Hearing [Added R-2]

37 CFR 1.973. *Oral hearing in inter partes reexamination.*

(a) An oral hearing in an *inter partes* reexamination appeal should be requested only in those circumstances in which an appellant or a respondent considers such a hearing necessary or desirable for a proper presentation of the appeal. An appeal decided without an oral hearing will receive the same consideration by the Board of Patent Appeals and Interferences as an appeal decided after oral hearing.

(b) If an appellant or a respondent desires an oral hearing, he or she must file a written request for such hearing accompanied by the fee set forth in § 1.17(d) within two months after the date of the examiner’s answer. The time for requesting an oral hearing may not be extended.

(c) An oral argument may be presented at oral hearing by, or on behalf of, the primary examiner if considered desirable by either the primary examiner or the Board of Patent Appeals and Interferences.

(d) If an appellant or a respondent has requested an oral hearing and has submitted the fee set forth in § 1.17(d), a hearing date will be set, and notice given to all parties to the reexamination proceeding, as well as the primary examiner. The notice shall set a non-extendable period within which all requests for oral hearing shall be submitted by any other party to the appeal desiring to participate in the oral hearing. A hearing will be held as stated in the notice, and oral argument will be limited to thirty minutes for each appellant and respondent who has requested an oral hearing, and twenty minutes for the primary examiner unless otherwise ordered before the hearing begins. No appellant or respondent will be permitted to participate in an oral hearing unless he or she has requested an oral hearing and submitted the fee set forth in § 1.17(d).

(e) If no request and fee for oral hearing have been timely filed by an appellant or a respondent, the appeal will be assigned for consideration and decision on the written record.

If an appellant or a respondent desires an oral hearing in an appeal of an *inter partes* reexamination proceeding, he/she must file a written request for such hearing, accompanied by the fee set forth in 37 CFR 1.17(d), within two months after the date of the examiner’s answer. There is no extension of the time for requesting a hearing. 37 CFR 1.973(b). No appellant or respondent will be permitted to participate in an oral hearing, unless he or she has requested an oral hearing and submitted the fee set forth in 37 CFR 1.17(d).

In reexamination proceedings, oral hearings (on appeal) are open to the public as observers (subject to the admittance procedures established by the Board), unless one of the appellants and/or the respondents (A) requests that the hearing not be open to the public and (B) presents valid reasons for such a request.

## 2681 Board of Patent Appeals and Interferences Decision [Added R-2]

37 CFR 1.977. *Decision by the Board of Patent Appeals and Interferences; remand to examiner in inter partes reexamination.*

(a) The Board of Patent Appeals and Interferences, in its decision, may affirm or reverse each decision of the examiner on all issues raised on each appealed claim, or remand the reexamination proceeding to the examiner for further consideration. The reversal of the examiner’s determination not to make a rejection proposed by the third party requester constitutes a decision adverse to the patentability of the claims which are subject to that proposed rejection which will be set forth in the decision of the Board of Patent Appeals and Interferences as a new ground of rejection under paragraph (b) of this section. The affirmance of the rejection of a claim on any of the grounds specified constitutes a general affirmance of the decision of the examiner on that claim, except as to any ground specifically reversed.

(b) Should the Board of Patent Appeals and Interferences have knowledge of any grounds not raised in the appeal for rejecting any pending claim, it may include in the decision a statement to that effect with its reasons for so holding, which statement shall constitute a new ground of rejection of the claim. A decision which includes a new ground of rejection shall not be considered final for purposes of judicial review. When the Board of Patent Appeals and Interferences makes a new ground of rejection, the patent owner, within one month from the date of the decision, must exercise one of the following two options with respect to the new ground of rejection to avoid termination of the appeal proceeding as to the rejected claim:

(1) The patent owner may submit an appropriate amendment of the claim so rejected or a showing of facts relating to the claim, or both.

(2) The patent owner may file a request for rehearing of the decision of the Board of Patent Appeals and Interferences under § 1.979(a).

(c) Where the patent owner has responded under paragraph (b)(1) of this section, any third party requester, within one month of the date of service of the patent owner response, may once file comments on the response. Such written comments must be limited to the issues raised by the decision of the Board of Patent Appeals and Interferences and the patent owner's response. Any third party requester that had not previously filed an appeal or cross appeal and is seeking under this subsection to file comments or a reply to the comments is subject to the appeal and brief fees under § 1.17(b) and (c), respectively, which must accompany the comments or reply.

(d) Following any response by the patent owner under paragraph (b)(1) of this section and any written comments from a third party requester under paragraph (c) of this section, the reexamination proceeding will be remanded to the examiner. The statement of the Board of Patent Appeals and Interferences shall be binding upon the examiner unless an amendment or showing of facts not previously of record be made which, in the opinion of the examiner, overcomes the new ground of rejection. The examiner will consider any response under paragraph (b)(1) of this section and any written comments by a third party requester under paragraph (c) of this section and issue a determination that the rejection should be maintained or has been overcome.

(e) Within one month of the examiner's determination pursuant to paragraph (d) of this section, the patent owner or any third party requester may once submit comments in response to the examiner's determination. Within one month of the date of service of comments in response to the examiner's determination, any party may file a reply to the comments. No third party requester reply may address the comments of any other third party requester reply. Any third party requester that had not previously filed an appeal or cross appeal and is seeking under this subsection to file comments or a reply to the comments is subject to the appeal and brief fees under § 1.17(b) and (c), respectively, which must accompany the comments or reply.

(f) After submission of any comments and any reply pursuant to paragraph (e) of this section, or after time has expired, the reexamination proceeding will be returned to the Board of Patent Appeals and Interferences which shall reconsider the matter and issue a new decision. The new decision will incorporate the earlier decision, except for those portions specifically withdrawn.

(g) The time period set forth in paragraph (b) of this section is subject to the extension of time provisions of § 1.956, when the patent owner is responding under paragraph (b)(1) of this section. The time period set forth in paragraph (b) of this section may not be extended when the patent owner is responding under paragraph (b)(2) of this section. The time periods set forth in paragraphs (c) and (e) of this section may not be extended.

After consideration of the record of the *inter partes* reexamination proceeding, including all briefs and the examiner's answer, the Board of Patent Appeals and Interferences (Board) issues its decision, affirming the examiner in whole or in part, or reversing the exam-

iner's decision, sometimes also setting forth a new ground of rejection. Where there is reason to do so, the Board will sometimes remand the reexamination proceeding to the examiner for further consideration, prior to rendering a decision.

On occasion, the Board has refused to consider an appeal until after the conclusion of a pending civil action or appeal to the United States Court of Appeals for the Federal Circuit involving issues identical with, or similar to, those presented in the later appeal. Such suspension of action, postponing consideration of the appeal until the Board has the benefit of a court decision which may be determinative of the issues involved, has been recognized as sound practice.

## I. BOARD DECISION MAY CONTAIN NEW GROUND OF REJECTION

37 CFR 1.977(b) provides express authority for the Board to include, in its decision, a recommendation for rejecting any claim found patentable by the examiner that the Board believes should be again considered by the examiner. 37 CFR 1.977(b) is not intended as an instruction to the Board to revisit every patentable claim in every appealed proceeding. It is, rather, intended to give the Board express authority to act when it becomes apparent, during the consideration of the claims, that one or more patentable claims may be subject to rejection on either the same grounds or on different grounds from those applied against the rejected claims.

It should be noted that, pursuant to 37 CFR 1.977(a), the reversal of the examiner's determination not to make a rejection proposed by the requester constitutes a decision adverse to the patentability of the claims which are subject to that proposed rejection. Accordingly, such reversal will be set forth in the Board's decision as a new ground of rejection under 37 CFR 1.977(b).

## II. NON-FINAL BOARD DECISIONS

A decision of the Board which includes a new ground of rejection or a remand will not be considered as a final decision in the case. The Board, following conclusion of the proceedings before the examiner, will either adopt its earlier decision as final or will render a new decision based on all appealed claims, as it considers appropriate. In either case, final action by the Board will give rise to the alternatives available to

a party to the appeal following a decision by the Board.

### III. NO BOARD RECOMMENDATION OF AMENDMENT TO MAKE CLAIM PATENTABLE

It should be noted that, unlike the practice for applications and *ex parte* reexaminations, the decision of the Board of Patent Appeals and Interferences **cannot** include an explicit statement that a claim may be allowed in amended form, whereby the patent owner would have the right to amend in conformity with that statement and it would be binding on the examiner in the absence of new references or grounds of rejection. The reason that the Board decision cannot make such a recommendation is that to permit the patent owner and the third party comment on a Board determination of the patentability of a hypothetical amended claim would be unduly complicated so late in the proceedings.

Additionally, in the absence of an express recommendation, a remark by the Board that a certain feature does not appear in a claim is **not** to be taken as a recommendation that the claim be allowed if the feature is supplied by amendment. *Ex parte Norlund*, 1913 C.D. 161, 192 O.G. 989 (Comm'r Pat. 1913).

### IV. REVIEW OF BOARD DECISION BY PETITION

Since review of the decisions of the Board is committed by statute to the Court of Appeals for the Federal Circuit, the Board's decisions are properly reviewable on petition **only to the extent of** determining whether they involve a convincing showing of error, abuse of discretion, or policy issue appropriate for higher level determination. Reasonable rulings made by the Board on matters resting in its discretion will not be disturbed upon petition. Thus, for example, the Board's opinion as to whether it has employed a new ground of rejection will not be set aside on petition unless said opinion is found to be clearly unwarranted.

### V. PUBLICATION OF BOARD DECISIONS

Decisions of the Board may be published at the discretion of the Director of the Office. Requests by members of the public or parties to the reexamination

proceeding to publish a decision of the Board should be referred to the Office of the Solicitor.

### 2682 Action Following Decision [Added R-2]

*37 CFR 1.979. Action following decision by the Board of Patent Appeals and Interferences or dismissal of appeal in inter partes reexamination.*

(a) Parties to the appeal may file a request for rehearing of the decision within one month of the date of:

(1) The original decision of the Board of Patent Appeals and Interferences under § 1.977(a),

(2) The original § 1.977(b) decision under the provisions of § 1.977(b)(2),

(3) The expiration of the time for the patent owner to take action under § 1.977(b)(2), or

(4) The new decision of the Board of Patent Appeals and Interferences under § 1.977(f).

(b) Within one month of the date of service of any request for rehearing under paragraph (a) of this section, or any further request for rehearing under paragraph (c) of this section, any party to the appeal may once file comments in opposition to the request for rehearing or the further request for rehearing. The comments in opposition must be limited to the issues raised in the request for rehearing or the further request for rehearing.

(c) If a party to an appeal files a request for rehearing under paragraph (a) of this section, or a further request for rehearing under this section, the Board of Patent Appeals and Interferences will issue a decision on rehearing. This decision is deemed to incorporate the earlier decision, except for those portions specifically withdrawn. If the decision on rehearing becomes, in effect, a new decision, and the Board of Patent Appeals and Interferences so states, then any party to the appeal may, within one month of the new decision, file a further request for rehearing of the new decision under this subsection.

(d) Any request for rehearing shall state the points believed to have been misapprehended or overlooked in rendering the decision and also state all other grounds upon which rehearing is sought.

(e) The parties to an appeal to the Board of Patent Appeals and Interferences may not appeal to the U.S. Court of Appeals for the Federal Circuit under § 1.983 until all parties rights to request rehearing have been exhausted, at which time the decision of the Board of Patent Appeals and Interferences is final and appealable by any party to an appeal to the Board of Patent Appeals and Interferences who is dissatisfied with the final decision of the Board of Patent Appeals and Interferences.

(f) An appeal to the Board of Patent Appeals and Interferences by a party is considered terminated by the dismissal of that party's appeal, the failure of the party to timely request rehearing under § 1.979(a) or (c), or the failure of the party to timely file an appeal to the U.S. Court of Appeals for the Federal Circuit under § 1.983. The date of such termination is the date on which the appeal is dismissed, the date on which the time for rehearing expires, or the date on which the time for the appeal to the U.S.

Court of Appeals for the Federal Circuit expires. If an appeal to the U.S. Court of Appeals for the Federal Circuit has been filed, the appeal is considered terminated when the mandate is issued by the U.S. Court of Appeals for the Federal Circuit. Upon termination of an appeal, if no other appeal is present, the reexamination proceeding will be terminated and the Director will issue a certificate under § 1.997.

(g) The times for requesting rehearing under paragraph (a) of this section, for requesting further rehearing under paragraph (c) of this section, and for submitting comments under paragraph (b) of this section may not be extended.

*37 CFR 1.981. Reopening after decision by the Board of Patent Appeals and Interferences in inter partes reexamination.*

Cases which have been decided by the Board of Patent Appeals and Interferences will not be reopened or reconsidered by the primary examiner except under the provisions of § 1.977 without the written authority of the Director, and then only for the consideration of matters not already adjudicated, sufficient cause being shown.

The provisions of 37 CFR 1.977 through 1.983 deal with action by the parties and the examiner following a decision by the Board of Patent Appeals and Interferences (Board) in an *inter partes* reexamination proceeding.

After an appeal to the Board has been decided, a copy of the decision is mailed to all parties to the reexamination proceeding, and the original of the decision is placed in the file. The clerk of the Board notes the decision on the file wrapper and in the record of appeals. The clerk then forwards the file to the Central Reexamination Unit (CRU), immediately, if the examiner is reversed, and after about 6 weeks if the examiner is affirmed or after a decision on a request for rehearing is rendered. The decision is processed in the CRU, and the file is then forwarded to the examiner through the office of the Technology Center (TC) Director.

The Board, in its decision, may affirm or reverse the decision of the examiner, in whole or in part, on the grounds of rejection specified by the examiner and/or on the proposed grounds presented by a third party requester but not adopted by the examiner. A rejection of claims by the examiner may also be affirmed on the basis of the argument presented by the third party requester, and a finding of patentability may also be affirmed on the basis of the arguments presented by the patent owner. Further handling of the reexamination proceeding will depend upon the nature of the Board's decision.

## **I. THE BOARD AFFIRMS, REVERSES A REJECTION, OR AFFIRMS-IN-PART (AND REVERSES ONLY AS TO REJECTION(S))**

Where the Board decision (A) affirms the examiner in whole, (B) reverses the examiner in whole where only rejections were appealed, or (C) affirms in part and reverses in part, where the only examiner decision overturned is that of rejecting claims, in these situations, the case is forwarded to the CRU which processes the decision and then stores the case file. The CRU will retain the case file until the expiration of **both** the period for requesting rehearing of the decision by the Board (in accordance with 37 CFR 1.979), and the period for the patent owner seeking court review of the decision of the Board (in accordance with 37 CFR 1.983) - with no further action having been taken by any party to the appeal. The time period for seeking review of a decision of the Board by the Court of Appeals for the Federal Circuit is 2 months from the date of the decision of the Board plus any extension obtained under 37 CFR 1.304. See MPEP § 1216. The time period for requesting rehearing under 37 CFR 1.979 is one month and the one month period may not be extended. 37 CFR 1.979(a) and (g).

### **A. No Action Taken by Parties to the Appeal**

Two weeks after the time for action by any party (to the appeal) has expired, the CRU will forward the case (via the TC Director) to the examiner. The two week delay is to permit any information as to requesting rehearing, or the filing of an appeal, to reach the CRU. Upon receipt of the case, the examiner will take up the reexamination proceeding for action so that a Notice of Intent to Issue *Inter Partes* Reexamination Certificate (NIRC) can be issued in accordance with MPEP § 2687, to conclude (terminate) the reexamination proceeding.

The following form paragraph should be used where the NIRC is issued:

#### *¶ 26.67.01 Periods for Seeking Court Review or Rehearing Have Lapsed*

The periods for seeking court review of, or a rehearing of, the decision of the Board of Patent Appeals and Interferences rendered [I] have expired and no further action has been taken by any party to the appeal. Accordingly, the appeal in this reexamination proceeding is considered terminated; see 37 CFR 1.979 (f). The present Notice of Intent to Issue *Inter Partes* Reexamination Cer-

tificate (NIRC) is issued in accordance with MPEP § 2687 in order to conclude the present reexamination proceeding.

**Examiner Note:**

In bracket 1, enter the date of the Board decision.

The NIRC will indicate the status of all the claims in the case as a result of the Board decision. A red-ink line should be drawn by the examiner through any refused claims, and the notation “Board Decision” written in the margin in red ink. A statement will be included in the NIRC that “Claims \_\_\_\_ have been canceled as a result of the decision of the Board of Patent Appeals and Interferences dated \_\_\_\_\_.”

Claims indicated as patentable prior to appeal except for their dependency from rejected claims *not in the original patent* will be treated as if they were rejected. See MPEP § 1214.06. The following two examples should be noted:

- Claim 10 has been added to the patent during the reexamination, or claim 10 is a patent claim that was amended during the reexamination. Claim 11 depends on claim 10. If the Board affirms a rejection of claim 10 and claim 11 was objected to prior to appeal as being patentable except for its dependency from claim 10, the examiner should cancel both claims 10 and 11 by formal examiner’s amendment attached as part of the NIRC.

- On the other hand, if both claims 10 and 11 were rejected prior to the appeal, then the patent owner was never put on notice that claim 11 could be made allowable by placing it in independent form. Thus, where the Board affirms a rejection against claim 10 but reverses the rejections against dependent claim 11, the examiner should convert dependent claim 11 into independent form by formal examiner’s amendment and cancel claim 10 (for which the rejection was affirmed) in the NIRC. In this instance, the examiner could also set a time period of one month or 30 days (whichever is longer) in which the patent owner may rewrite dependent claim 11 in independent form. Extensions of time under 37 CFR 1.956 will be permitted. If no timely response is received, the examiner will cancel both claims 10 and 11 in the NIRC.

See MPEP § 2687 for further guidance in issuing the NIRC and terminating the reexamination.

**B. A Request for Rehearing of the Decision**

Any party to the appeal not satisfied with the Board decision may file a single request for rehearing of the

decision. The request must be filed within one month from the date of the original decision under 37 CFR 1.977(a) or a new decision under 37 CFR 1.977(f). The one month period may not be extended. 37 CFR 1.979(g). The provisions of 37 CFR 1.979(d) require that any request must specifically state the points believed to have been misapprehended or overlooked in the Board’s decision, as well as all other grounds which rehearing is sought.

If a party does file a request for rehearing of the decision, any opposing party appellant or opposing party respondent may, within one month from the date of *service* of the request for rehearing, file responsive comments on the request for rehearing. 37 CFR 1.979(b). This one month period may not be extended. 37 CFR 1.979(g).

Where at least one request for rehearing of the decision is granted, the original Board decision, as modified by the decision on rehearing, becomes, in effect, a new decision under 37 CFR 1.977(f); and the provisions of 37 CFR 1.979 will thus apply. Where no request for rehearing of its decision is granted, the Board may enter an order making its decision final under 37 CFR 1.979(e). If the Board’s final decision is then not timely appealed to the Court, the case is returned to the CRU for processing and subsequent forwarding to the examiner. When the examiner receives the case from the CRU, the examiner will proceed to issue a NIRC and terminate the reexamination. 37 CFR 1.979(f).

Where a request for rehearing is submitted, all copies of references in the file wrapper should be retained in the file throughout the reconsideration of the case.

**II. NEW GROUND OF REJECTION BY BOARD**

Pursuant to 37 CFR 1.977(b), the Board may, in its decision on appeal, make a new rejection of one or more appealed claims on grounds not raised in the appeal, in which case the patent owner has the option of:

(A) requesting rehearing under 37 CFR 1.979(a);  
or

(B) submitting an appropriate amendment of the rejected claims, and/or a showing of facts relating to the claim.

The parties do not have the option of an immediate appeal to the U.S. Court of Appeals for the Federal Circuit because the decision under 37 CFR 1.977(b) is not a final decision.

**A. A Request for Rehearing of the Decision Which Includes a New Ground of Rejection**

A patent owner's request for rehearing by the Board must be filed within a nonextendable one month period set by 37 CFR 1.979(a). By proceeding in this manner, the patent owner waives his or her right to further prosecution before the examiner. *In re Greenfield*, 40 F.2d 775, 5 USPQ 474 (CCPA 1930). If the patent owner does file a request for rehearing of the decision, any third party requester that is a party to the appeal may, within a non-extendable one month period from the date of service of the request for rehearing, file responsive comments on the request. 37 CFR 1.979(b).

**B. Submission of Amendment or Showing of Facts After Decision Which Includes a New Ground of Rejection**

If the patent owner elects to proceed before the examiner, the patent owner must take action within the one month period for response which will be set in the Board's decision. Extensions of time under 37 CFR 1.956 are available to extend the period. 37 CFR 1.977(g). The extension(s) may not, however exceed six months from the Board's decision.

When the patent owner submits a response pursuant to 37 CFR 1.977(b)(1), prosecution and examination will then be carried out under 37 CFR 1.977(c) through 37 CFR 1.977(f). Under 37 CFR 1.977(b)(1), the patent owner may amend the claims involved, or substitute new claims to avoid the art or reasons stated by the Board. *Ex parte Burrowes*, 110 O.G. 599, 1904 C.D. 155 (Comm'r Pat. 1904). Such amended or new claims must be directed to the same subject matter as the appealed claims, *Ex parte Comstock*, 317 O.G. 4, 1923 C.D. 82 (Comm'r Pat. 1923). The patent owner may also submit a showing of facts under 37 CFR 1.131 or 1.132, as may be appropriate. Argument without either amendment (of the claims so rejected) or the submission of a showing of facts (as to the claims so rejected) can result only in the examiner's determination to maintain the Board's rejection of the claims, since the examiner is without authority to find

the claims patentable unless the claims are amended or unless the rejection is overcome by a showing of facts not before the Board. The new ground of rejection raised by the Board does not "reopen the prosecution" (under 37 CFR 1.977(b)(1) and 37 CFR 1.977(c) through 37 CFR 1.977(f)) *except as to that subject matter to which the new rejection was applied*. Accordingly, any amendment or showing of facts **not** directed to that subject matter to which the new rejection was applied will be refused entry and will not be considered.

**III. BOARD DECISION REVERSES EXAMINER'S DETERMINATION NOT TO MAKE PROPOSED REJECTION**

Where the Board decision reverses the examiner in whole (or affirms in part and reverses in part, with at least one examiner decision overturned as to the proposed rejections the examiner refused to adopt) as to the proposed rejections the examiner refused to adopt, pursuant to 37 CFR 1.977(a), the Board's reversal of the examiner's determination not to adopt a rejection proposed by the third party requester constitutes a decision adverse to the patentability of the claims (which are subject to that proposed rejection). Accordingly, such reversal will be set forth in the Board's decision as a new ground of rejection under 37 CFR 1.977(b). See subsection II. above for the action taken after a new ground of rejection.

**IV. REMAND BY BOARD**

In accordance with 37 CFR 1.977(a), the Board, in its decision, may remand the reexamination proceeding to the examiner for further consideration. A Board decision which includes a remand in accordance with 37 CFR 1.977(a) will not be considered a "final decision" in the case.

The Board may remand the case to an examiner where appropriate procedure has not been followed, where further information is needed, or where the examiner is to consider something which the examiner did not yet consider (or it is not clear that the examiner had considered it).

After the examiner has addressed the remand, the examiner will either return the case to the Board (via the CRU) or reopen prosecution as appropriate. The Board, following conclusion of the proceedings before the examiner, will either adopt its

earlier decision as final (if the remand decision lends itself to same) or will render a new decision based on all appealed claims, as it considers appropriate. In either case, final action by the Board will give rise to the alternatives available following a decision by the Board.

#### A. *Reopening Prosecution of Case*

Reopening prosecution of a case after decision by the Board should be a rare occurrence. Cases which have been decided by the Board will not be reopened or reconsidered by the primary examiner, unless the provisions of 37 CFR 1.977 apply, or the written consent of the Director of the USPTO is obtained for the consideration of matters not already adjudicated, where sufficient cause has been shown.

A rejection under 37 CFR 1.977(b)(1) in effect nullifies the ACP and RAN and automatically reopens the prosecution of the subject matter of the claims so rejected by the Board. Accordingly, the written consent of the TC Director is not required on the next Office action.

The written consent of the TC Director is, however, required for an action reopening prosecution where the reexamination proceeding has been remanded to the examiner for a failure to follow appropriate procedure, to provide more information, or to consider something not yet considered, and the examiner then concludes after consideration of all the evidence and argument that a decision as to patentability made in the RAN should be changed. If so, the prosecution would be reopened with the written consent of the TC Director and an ACP issued, so that any party adversely affected by the change in the examiner's position will have an opportunity to consider it and subsequently appeal the examiner's new decision.

The TC Director will decide any petition to reopen prosecution of an *inter partes* reexamination proceeding after decision by the Board, where no court action has been filed. MPEP § 1002.02(c), item 1. In addition, the Director of the USPTO entertains petitions to reopen certain cases in which an appellant has sought review by the court. This procedure is restricted to cases which have been decided by the Board and which are amenable to settlement without the need for going forward with the court proceeding. See MPEP § 1214.07.

## 2683 Appeal to Courts [Added R-2]

*35 U.S.C. 141. Appeal to the Court of Appeals for the Federal Circuit.*

\*\*\*\*\*

A patent owner, or a third-party requester in an inter partes reexamination proceeding, who is in any reexamination proceeding dissatisfied with the final decision in an appeal to the Board of Patent Appeals and Interferences under section 134 may appeal the decision only to the United States Court of Appeals for the Federal Circuit.

\*\*\*\*\*

*37 CFR 1.983. Appeal to the United States Court of Appeals for the Federal Circuit in inter partes reexamination.*

(a) The patent owner or third party requester in an inter partes reexamination proceeding who is a party to an appeal to the Board of Patent Appeals and Interferences and who is dissatisfied with the decision of the Board of Patent Appeals and Interferences may, subject to § 1.979(e), appeal to the U.S. Court of Appeals for the Federal Circuit and may be a party to any appeal thereto taken from a reexamination decision of the Board of Patent Appeals and Interferences.

(b) The appellant must take the following steps in such an appeal:

(1) In the U.S. Patent and Trademark Office, timely file a written notice of appeal directed to the Director in accordance with §§ 1.302 and 1.304;

(2) In the U.S. Court of Appeals for the Federal Circuit, file a copy of the notice of appeal and pay the fee, as provided for in the rules of the U.S. Court of Appeals for the Federal Circuit; and

(3) Serve a copy of the notice of appeal on every other party in the reexamination proceeding in the manner provided in § 1.248.

(c) If the patent owner has filed a notice of appeal to the U.S. Court of Appeals for the Federal Circuit, the third party requester may cross appeal to the U.S. Court of Appeals for the Federal Circuit if also dissatisfied with the decision of the Board of Patent Appeals and Interferences.

(d) If the third party requester has filed a notice of appeal to the U.S. Court of Appeals for the Federal Circuit, the patent owner may cross appeal to the U.S. Court of Appeals for the Federal Circuit if also dissatisfied with the decision of the Board of Patent Appeals and Interferences.

(e) A party electing to participate in an appellant's appeal must, within fourteen days of service of the appellant's notice of appeal under paragraph (b) of this section, or notice of cross appeal under paragraphs (c) or (d) of this section, take the following steps:

(1) In the U.S. Patent and Trademark Office, timely file a written notice directed to the Director electing to participate in the appellant's appeal to the U.S. Court of Appeals for the Federal Circuit by mail to, or hand service on, the General Counsel as provided in § 104.2;

(2) In the U.S. Court of Appeals for the Federal Circuit, file a copy of the notice electing to participate in accordance with the rules of the U.S. Court of Appeals for the Federal Circuit; and

(3) Serve a copy of the notice electing to participate on every other party in the reexamination proceeding in the manner provided in § 1.248.

(f) Notwithstanding any provision of the rules, in any reexamination proceeding commenced prior to November 2, 2002, the third party requester is precluded from appealing and cross appealing any decision of the Board of Patent Appeals and Interferences to the U.S. Court of Appeals for the Federal Circuit, and the third party requester is precluded from participating in any appeal taken by the patent owner to the U.S. Court of Appeals for the Federal Circuit.

## I. APPEAL TO UNITED STATES COURT OF APPEALS FOR THE FEDERAL CIRCUIT IS AVAILABLE

### A. *For Any Inter Partes Reexamination Proceeding “Commenced” on or After November 2, 2002*

Section 13106 of Public Law 107-273, 116 Stat. 1758, 1899-1906 (2002), newly granted the *inter partes* reexamination **third party requester** the right to appeal an adverse decision of the Board of Patent Appeals and Interferences (Board) to the Court of Appeals for the Federal Circuit (Federal Circuit). 35 U.S.C. 315(b)(1). It further authorized the third party requester to be a party to any appeal taken by the patent owner to the Federal Circuit. 35 U.S.C. 315(b)(2). Also, section 13106 of Public Law 107-273 implicitly permitted the patent owner to be a party to the newly provided for appeal taken by the third party requester to the Federal Circuit. This is because 35 U.S.C. 315(a)(2) states that the patent owner involved in an *inter partes* reexamination proceeding “may be a party to any appeal taken by a third party requester under subsection (b).” The effective date for this revision to the statute is provided in section 13106 of Public Law 107-273 as follows: “The amendments made by this section apply with respect to any reexamination proceeding commenced on or after the date of enactment of this Act.”

#### 1. Appeal to the Federal Circuit

A patent owner and/or a third party requester in an *inter partes* reexamination proceeding who is a party

to an appeal to the Board and who is dissatisfied with the decision of the Board may, subject to 37 CFR 1.979(e), appeal to the Federal Circuit. Pursuant to 37 CFR 1.979(e), the patent owner and/or third party requester may **not** appeal to the Federal Circuit until all parties’ rights to request rehearing have been exhausted, at which time the decision of the Board is final and appealable to the Federal Circuit.

A patent owner or a third party requester appellant must take the following steps in such an appeal to the Federal Circuit (37 CFR 1.983(b)):

(A) In the Office, timely file a written notice of appeal directed to the Director of the USPTO in accordance with 37 CFR 1.302 and 1.304;

(B) In the Federal Circuit, file a copy of the notice of appeal and pay the fee, as provided for in the rules of the Federal Circuit; and

(C) Serve a copy of the notice of appeal on every other party in the reexamination proceeding in the manner provided in 37 CFR 1.248.

#### 2. Cross Appeal

If the patent owner has filed a notice of appeal to the Federal Circuit, the third party requester may cross appeal to the Federal Circuit if also dissatisfied with the decision of the Board. 37 CFR 1.983(c).

If the third party requester has filed a notice of appeal to the Federal Circuit, the patent owner may cross appeal to the Federal Circuit if also dissatisfied with the decision of the Board. 37 CFR 1.983(d).

Such cross appeals would be taken under the rules of the Federal Circuit for cross appeals.

#### 3. Participation in Other Party’s Appeal

The patent owner and the third party requester may each be a party to, i.e., participate in, each other’s appeal to the Federal Circuit from an *inter partes* reexamination decision of the Board (37 CFR 1.983(e)).

A party electing to participate in an appellant’s appeal must, within fourteen days of service of the appellant’s notice of appeal (37 CFR 1.983(b)(3)) or notice of cross appeal (37 CFR 1.983(c) or (d)), take the following steps:



(A) In the Office, timely file a written notice directed to the Director of the USPTO electing to participate in the appellant's appeal to the Federal Circuit;

(B) In the Federal Circuit, file a copy of the notice electing to participate; and

(C) Serve a copy of the notice electing to participate on every other party in the reexamination proceeding in the manner provided in 37 CFR 1.248.

**B. For Any Inter Partes Reexamination Proceeding "Commenced" Prior to November 2, 2002**

In any reexamination proceeding commenced **prior** to November 2, 2002, only the patent owner can appeal to the U.S. Court of Appeals for the Federal Circuit. Pursuant to 35 U.S.C. 134(c), as it existed **prior** to its November 2, 2002 revision via Public Law 107-273, the third party requester is expressly precluded from appealing (and cross appealing) any decision of the Board in an *inter partes* reexamination proceeding commenced **prior** to November 2, 2002, to the Federal Circuit. The third party requester is also precluded from participating in any appeal taken by the patent owner to the Federal Circuit.

Pursuant to 37 CFR 1.983, a patent owner in a reexamination proceeding commenced **prior** to November 2, 2002, who is dissatisfied with the decision of the Board may, subject to 37 CFR 1.979(e), appeal to the Federal Circuit. Under 37 CFR 1.979(e), the patent owner may **not** appeal to the Federal Circuit until all parties' rights to request rehearing of the Board's decision have been exhausted, at which time the decision of the Board is final and appealable by the patent owner to the Federal Circuit.

The patent owner must take the following steps in such an appeal:

(A) In the Office, timely file a written notice of appeal directed to the Director of the USPTO in accordance with 37 CFR 1.302 and 1.304;

(B) In the Federal Circuit, file a copy of the notice of appeal and pay the fee, as provided for in the rules of the Federal Circuit; and

(C) Serve a copy of the notice of appeal on the third party requester(s) in the reexamination proceeding in the manner provided in 37 CFR 1.248.

**II. APPEAL TO U.S. DISTRICT COURT FOR THE DISTRICT OF COLUMBIA IS NOT AVAILABLE**

The remedy by civil action under 35 U.S.C. 145 is not available to the patent owner and the third party requester in an *inter partes* reexamination proceeding. Patent owners and third party requesters dissatisfied with a decision of the Board in an *inter partes* reexamination proceeding are not permitted to file a civil action against the Director of the USPTO in the U.S. District Court for the District of Columbia. Instead, they are limited to appealing decisions of the Office to the Federal Circuit.

When the optional *inter partes* reexamination alternative was added to the reexamination statute, the legislation did not provide the parties an avenue of judicial review by civil action under 35 U.S.C. 145 in *inter partes* reexamination proceedings (nor is this avenue available for *ex parte* reexamination of a patent that issued from an original application filed on or after November 29, 1999; see MPEP § 2279). Federal District Court proceedings are generally complicated and time consuming and, therefore, are contrary to the goal of expeditious resolution of reexamination proceedings. Accordingly, the first sentence of 35 U.S.C. 145 was amended to read: "An **applicant** dissatisfied with the decision of the Board of Patent Appeals and Interferences in an appeal under **134(a)** of this title may, unless appeal has been taken to the United States Court of Appeals for the Federal Circuit, have remedy by civil action against the Director in the United States District Court for the District of Columbia if commenced within such time after such decision, not less than sixty days, as the Director appoints." (emphasis added). Note that 35 U.S.C. 134 part (a), which **is** included by 35 U.S.C. 145 is limited to applicants and applications, while 35 U.S.C. 134 parts (b) and (c) which **are not** included by 35 U.S.C. 145 are directed to reexamination and the patent owner and the third party requester, respectively.

## 2684 Information Material to Patentability in Reexamination Proceeding [Added R-2]

37 CFR 1.933. *Patent owner duty of disclosure in inter partes reexamination proceedings.*

(a) Each individual associated with the patent owner in an *inter partes* reexamination proceeding has a duty of candor and good faith in dealing with the Office, which includes a duty to disclose to the Office all information known to that individual to be material to patentability in a reexamination proceeding as set forth in § 1.555(a) and (b). The duty to disclose all information known to be material to patentability in an *inter partes* reexamination proceeding is deemed to be satisfied by filing a paper in compliance with the requirements set forth in § 1.555(a) and (b).

(b) The responsibility for compliance with this section rests upon the individuals designated in paragraph (a) of this section, and no evaluation will be made by the Office in the reexamination proceeding as to compliance with this section. If questions of compliance with this section are raised by the patent owner or the third party requester during a reexamination proceeding, they will be noted as unresolved questions in accordance with § 1.906(c).

Duty of disclosure considerations as to *inter partes* reexamination proceedings parallel those of *ex parte* reexamination proceedings. In this regard, 37 CFR 1.933 incorporates the provisions of 37 CFR 1.555(a) and (b). See MPEP § 2280 for a discussion of the duty of disclosure in reexamination.

Any fraud practiced or attempted on the Office or any violation of the duty of disclosure through bad faith or intentional misconduct results in noncompliance with 37 CFR 1.555(a). This duty of disclosure is consistent with the duty placed on patent applicants by 37 CFR 1.56. Any such issues raised by the patent owner or the third party requester during an *inter partes* reexamination proceeding will merely be noted as unresolved questions under 37 CFR 1.906(c).

## 2685 No Interviews on Merits in *Inter Partes* Reexamination Proceedings [Added R-2]

37 CFR 1.955. *Interviews prohibited in inter partes reexamination proceedings.*

There will be no interviews in an *inter partes* reexamination proceeding which discuss the merits of the proceeding.

Pursuant to 37 CFR 1.955, an interview which discusses the merits of a proceeding will not be permitted in *inter partes* reexamination proceedings. Thus,

in an *inter partes* reexamination proceeding, there will be no *inter partes* interview as to the substance of the proceeding. Also, there will be no separate *ex parte* interview as to the substance of the proceeding with either the patent owner or the third party requester. Accordingly, where a party requests any information as to the merits of a reexamination proceeding, the examiner will not conduct a personal or telephone interview with that party to provide the information. Further, an informal amendment by the patent owner will not be accepted, because that would be tantamount to an *ex parte* interview. All communications between the Office and the patent owner (and the third party requester) which are directed to the merits of the proceeding must be in writing and filed with the Office for entry into the record of the proceeding.

Questions on strictly procedural matters may be discussed with the parties. The guidance to follow is that any information which a person could obtain *by reading the file* (which is open to the public) is procedural, and it *may be discussed*. Matters *not available from a reading of the file* are considered as relating to the merits of the proceeding, and *may not be discussed*. Thus, for example, a question relating to when the next Office action will be rendered is improper as it relates to the merits of the proceeding (because this information cannot be obtained from a reading of the file).

## 2686 Notification of Existence of Prior or Concurrent Proceedings and Decisions Thereon [Added R-2]

37 CFR 1.985. *Notification of prior or concurrent proceedings in inter partes reexamination.*

(a) In any *inter partes* reexamination proceeding, the patent owner shall call the attention of the Office to any prior or concurrent proceedings in which the patent is or was involved, including but not limited to interference, reissue, reexamination, or litigation and the results of such proceedings.

(b) Notwithstanding any provision of the rules, any person at any time may file a paper in an *inter partes* reexamination proceeding notifying the Office of a prior or concurrent proceedings in which the same patent is or was involved, including but not limited to interference, reissue, reexamination, or litigation and the results of such proceedings. Such paper must be limited to merely providing notice of the other proceeding without discussion of issues of the current *inter partes* reexamination proceeding. Any paper not so limited will be returned to the sender.

It is important for the Office to be aware of any prior or concurrent proceedings in which a patent undergoing *inter partes* reexamination is or was involved, such as interferences, reissues, reexaminations or litigations, and any results of such proceedings. In accordance with 37 CFR 1.985, the patent owner is required to provide the Office with information regarding the existence of any such proceedings, and the results thereof, if known. Ordinarily, while an *inter partes* reexamination proceeding is pending, third party submissions filed after the date of the order are not placed in the reexamination file or the patent file, unless the third party is a third party reexamination requester. However, in order to ensure a complete file, with updated status information regarding prior or concurrent proceedings regarding the patent under reexamination, the Office will, at any time, accept from any parties, for placement in the reexamination file, copies of notices of suits and other proceedings involving the patent and copies of decisions or papers filed in the court from litigations or other proceedings involving the patent. Persons making such submissions must limit the submissions to the notification, and must not include further arguments or information. Where a submission is not limited to bare notice of the prior or concurrent proceedings (in which a patent undergoing reexamination is or was involved), the submission will be returned by the Office. Any proper submission pursuant to 35 CFR 1.985 will be promptly placed of record in the reexamination file. See MPEP § 2686.04 for Office investigation for prior or concurrent litigation.

## 2686.01 Multiple Copending Reexamination Proceedings [Added R-2]

37 CFR 1.989. *Merger of concurrent reexamination proceedings.*

(a) If any reexamination is ordered while a prior *inter partes* reexamination proceeding is pending for the same patent and prosecution in the prior *inter partes* reexamination proceeding has not been terminated, a decision may be made to merge the two proceedings or to suspend one of the two proceedings. Where merger is ordered, the merged examination will normally result in the issuance of a single reexamination certificate under § 1.997.

(b) An *inter partes* reexamination proceeding filed under § 1.913 which is merged with an *ex parte* reexamination proceeding filed under § 1.510 will result in the merged proceeding being governed by §§ 1.902 through 1.997, except that the rights of any third party requester of the *ex parte* reexamination shall be governed by §§ 1.510 through 1.560.

This section discusses multiple copending reexamination requests which are filed on the same patent, where at least one of the multiple copending reexamination requests is an *inter partes* request. If all of the multiple copending reexamination requests are *ex parte* requests, see MPEP § 2283.

Initially, it is appropriate to point out who can file a second or subsequent request for reexamination while a first reexamination proceeding is pending.

Case (1) - The earlier (pending) reexamination is an *inter partes* reexamination:

(1)(a) The subsequent request is an *inter partes* reexamination request. Pursuant to 35 U.S.C. 317(a), once an order for *inter partes* reexamination has been issued in a first reexamination proceeding, neither the third party requester, nor its privy, may file a subsequent request for an *inter partes* reexamination of the patent until an *inter partes* reexamination certificate is issued, unless authorized by the Director of the USPTO. In addition, the patent owner is not entitled to file any *inter partes* reexamination request (see MPEP § 2612). Thus, only a third party who is not a party to the earlier pending *inter partes* reexamination proceeding (nor a privy) can file the subsequent *inter partes* reexamination request.

(1)(b) The subsequent request is an *ex parte* reexamination request. Any party (including the patent owner) can file the subsequent *ex parte* reexamination request.

Case (2) - The earlier (pending) reexamination is an *ex parte* reexamination:

(2)(a) The subsequent request is an *inter partes* reexamination request. Any party other than the patent owner can file the subsequent *inter partes* reexamination request.

(2)(b) The subsequent (later) request is an *ex parte* reexamination request. Any party (including the patent owner) can file the subsequent *ex parte* reexamination request.

In order for the second or subsequent request to be granted, a substantial new question of patentability must be raised by the art (patents and/or printed publications) cited in the second or subsequent request for reexamination. See MPEP § 2640 regarding whether a substantial new question of patentability is raised by the art cited in a second or subsequent request filed while a first reexamination proceeding is pending.

If the second or subsequent request is granted, the decision on whether or not to merge the proceedings will be made by the Office of Patent Legal Administration. (OPLA). No decision on merging the reexaminations should be made until such time as reexamination is actually ordered in the later filed request for reexamination.

## I. WHEN PROCEEDINGS ARE MERGED

If a second request for reexamination is filed where a certificate will issue for a first reexamination later than 3 months from the filing of the second request, the proceedings normally will be merged once reexamination has been ordered in both proceedings. In this situation the second request is decided based on the original patent claims and if reexamination is ordered in the second proceeding, the reexamination proceedings normally would be merged. If, however, the first reexamination is in “issue” for publication of a certificate, it might not be possible to withdraw the first reexamination from issue in some instances.

After the second reexamination proceeding is merged with the first reexamination proceeding, prosecution will be conducted at the most advanced point possible for the first proceeding. Thus, if a final rejection (a Right of Appeal Notice) has been issued in the first proceeding, prosecution will ordinarily be reopened to consider the substantial new question of patentability presented in the second request unless the examiner concludes that no new rejection or change of position is warranted. Also, the patent owner will be provided with an opportunity to respond to any new rejection in a merged reexamination proceeding prior to an Action Closing Prosecution (ACP) being issued. See MPEP § 2671.02.

Where the reexamination proceedings are merged, a single certificate will be issued based upon the merged proceedings, 37 CFR 1.989(a).

## II. WHEN PROCEEDING IS SUSPENDED

It may also be desirable in certain situations to suspend one of the proceedings for a short and specified period of time. For example, a suspension of a first reexamination proceeding may be issued to allow time for the decision on the second request. Further, after the second proceeding has been ordered, it may be desirable to suspend the second proceeding prior to merging, where the first proceeding is presently on

appeal before a Federal court to await the court’s decision prior to merging. A suspension will only be granted in exceptional (extraordinary) instances because of the statutory requirements that examination proceed with “special dispatch”, and the express written approval by the OPLA must be obtained. Suspension will not be granted when there is an outstanding Office action.

## III. MERGER OF REEXAMINATIONS

The following guidelines should be observed when two requests for reexamination directed to a single patent have been filed:

The second request (i.e., Request 2) should be processed as quickly as possible, and assigned to the same examiner to whom the first request (i.e., Request 1) is assigned. Request 2 should be decided immediately after consultation with the Reexamination Legal Advisor (RLA). If Request 2 is denied, prosecution of Request 1 should continue. If Request 2 is granted, a first Office action on the merits will not be sent with the order granting reexamination in the second proceeding. Instead, the order will indicate that an Office action will follow in due course. MPEP § 2660. The order granting the second proceeding will be prepared, reviewed by the Special Program Examiner (SPRE) and then **hand-carried** with the file directly to the Central Reexamination Unit (CRU). In the CRU, the order will be mailed specially, and the file will be forwarded to OPLA for preparation of a decision merging the two proceedings.

The decision merging the reexamination proceedings should include a requirement that the patent owner maintain identical claims in both files. It will further require that responses/comments by the patent owner and the third party requester(s) must consist of a single response/comment paper, addressed to both files, filed in duplicate each bearing a signature, for entry in both files. The same applies to any other paper filed in the merged proceeding. The decision will point out that both files will be maintained as separate complete files. Where the claims are already the same in both reexamination files, the decision on merger will indicate at its conclusion that an Office action will be mailed in due course, and that the patent owner need not take any action at present. Where the claims are not the same in both files, the decision will state at its conclusion that patent owner is given one

month to provide an amendment to make the claims the same in each file. After the decision of merger is prepared and signed, the file will be hand-carried directly to the CRU, where the decision will be mailed specially.

Where the decision indicates that the patent owner is given one month to provide an amendment to make the claims the same in each file, the file will be held in storage by the CRU to await presentation of the amendment. After the amendment is received, it will be processed by the CRU and the file returned to the examiner, to issue an Office action. Where the decision indicates that an Office action will follow, the file will be returned to the examiner immediately after the CRU mailing and processing of the merger decision, to issue an Office action.

Once the file is returned to the examiner for issuance of an Office action, the examiner should after consultation with the RLA, prepare the action at the most advanced point possible for the first proceeding. Thus, if the first proceeding is ready for an Action Closing Prosecution (ACP) and the second proceeding does not provide any new information which would call for a new ground of rejection, the examiner should issue an ACP for the merged proceeding using the guidance for the prosecution stage set forth below.

If the decision on the reexamination request has not yet been made in Request 1 and Request 1 is grantable, it should be processed to the point where an order granting reexamination is mailed. *An Office action should not be mailed with the order.* Then, Request 1 is normally held until Request 2 is ready for the prosecution stage following an order granting reexamination, or until Request 2 is denied. Request 2 should be determined on its own merits *without reference* in the decision to Request 1. As before, an Office action should not be mailed with the order in Request 2.

#### A. *The Prosecution Stage, After Merger*

When prosecution is appropriate in merged proceedings, a single combined examiner's action will be prepared. Each action will contain the control number of the two proceedings on every page. A single action cover form (having both control numbers penned in at the top) will be provided by the examiner to the clerical staff. The clerical staff will copy the action cover

form, and then use the PALM printer to print the appropriate data on the original for the first request, and on the copy for the second request. The appropriate paper number will be entered on the action cover form for each file (these numbers will often be different). Each requester will receive a copy of the action and both action cover forms, with the transmission form PTOL-2070 placed on top of the package. The patent owner will get a copy of both action cover forms and the action itself.

When a "Notice Of Intent To Issue *Inter Partes* Reexamination Certificate" (NIRC) is appropriate, plural notices will be printed. Both reexamination files will then be processed. The TC should prepare the file of the concurrent proceedings in the manner specified in MPEP § 2687, before release to Office of Publications (via the CRU).

The above guidance should be extended to situations where more than two requests for reexamination are filed for a single patent. The guidance should also be extended to situations where one of the requests is a request for *ex parte* reexamination. However, where an *ex parte* reexamination is to be included in the merger, allowance must be made for the statement and reply periods provided for in an *ex parte* reexamination after the order granting reexamination is issued. If all the reexamination proceedings to be merged are *ex parte* reexaminations, the present section does not apply, but rather see MPEP § 2283.

#### IV. PROCEEDINGS NOT MERGED

If a second request for reexamination is filed, and the first reexamination certificate will issue within 3 months from the filing of the second request, the proceedings normally will not be merged. If the certificate on the first reexamination proceeding will issue before the decision on the second request must be decided, the reexamination certificate is generally permitted to issue. The second request is then considered based upon the claims in the patent *as indicated in the issued reexamination certificate*, rather than the original claims of the patent. In such situations, the proceedings will not be merged. In **NO** case should a decision on the second request be delayed beyond its 3 month deadline.

For processing of the second reexamination proceeding, see MPEP § 2295 and § 2695.

## V. FEES IN MERGED PROCEEDINGS

Where the proceedings have been merged and a paper is filed which requires payment of a fee (e.g., petition fee, appeal fee, brief fee, oral hearing fee), only a single fee need be paid. For example, only one fee need be paid for the patent owner's appellant brief (or that of the third party requester), even though the brief relates to merged multiple proceedings and copies must be filed for each file in the merged proceeding.

## VI. PETITION TO MERGE MULTIPLE COPENDING REEXAMINATION PROCEEDINGS

No petition to merge multiple reexamination proceedings is necessary since the Office will generally, *sua sponte*, make a decision as to whether or not it is appropriate to merge the multiple reexamination proceedings. If any petition to merge the proceedings is filed prior to the order to reexamine the second request, it will not be considered but will be returned to the party submitting the same by the OPLA. The decision returning such a premature petition will be made of record in both reexamination files, but no copy of the petition will be retained by the Office. See MPEP § 2667.

The patent owner can file a petition to merge the proceedings at any time after the order to reexamine the second request. A requester of any of the multiple reexamination proceedings may also petition to merge the proceedings at any time after the order to reexamine the second request. A petition to merge the multiple proceedings which is filed by a party other than the patent owner or one of the third party requesters of the reexaminations will not be considered but will be returned to that party by the OPLA. Note that the acceptance of a petition to merge the multiple proceedings at any time after the order to reexamine the second request is contrary to 37 CFR 1.939 since such acceptance can be prior to the issuance of the first Office action. Accordingly, the requirement of 37 CFR 1.939 is hereby waived to the extent that a petition for merger of a reexamination proceeding with a reexamination proceeding or with a reissue (see MPEP § 2686.03) can be submitted after the order to reexamine has been issued in all the reexamination proceedings to be merged. This waiver is made to assure merger at the earliest possible stage.

All decisions on the merits of petitions to merge multiple reexamination proceedings, where at least one of the proceedings is an *inter partes* reexamination, will be made by the OPLA.

Decisions on the merits of petitions to merge multiple reexamination proceedings, where none of the proceedings is an *inter partes* reexamination, will be made by the TC Director (or by the SPRE, if the TC Director delegates such to the SPRE); see MPEP § 2283.

## 2686.02 Copending Reexamination and Interference Proceedings [Added R-2]

*37 CFR 1.993. Suspension of concurrent interference and inter partes reexamination proceeding.*

If a patent in the process of *inter partes* reexamination is or becomes involved in an interference, the Director may suspend the *inter partes* reexamination or the interference. The Director will not consider a request to suspend an interference unless a motion under § 1.635 to suspend the interference has been presented to, and denied by, an administrative patent judge and the request is filed within ten (10) days of a decision by an administrative patent judge denying the motion for suspension or such other time as the administrative patent judge may set.

*37 CFR 1.660. Notice of reexamination, reissue, protest, or litigation.*

(a) When a request for reexamination of a patent involved in an interference is filed, the patent owner shall notify the Board within 10 days of receiving notice that the request was filed.

\*\*\*\*\*

A patent being reexamined in an *inter partes* reexamination proceeding may be involved in an interference proceeding with at least one application, where the patent and the application are claiming the same patentable invention, and at least one of the application's claims to that invention are patentable to the applicant. See MPEP § 2306.

The general policy of the Office is that a reexamination proceeding will not be delayed, or stayed, because of an interference or the possibility of an interference. The reasons for this policy are (A) the relatively long period of time usually required for interferences, and (B) the requirement of 35 U.S.C. 314(c) that all reexamination proceedings be conducted with "special dispatch" within the Office. The decision of *Shaked v. Taniguchi*, 21 USPQ2d 1289 (Bd. Pat. App. & Int. 1991) should be noted, where it

was pointed out that neither the reexamination nor the interference will ordinarily be stayed where both proceedings are before the Office.

In general, the Office will follow the practice of making the required and necessary decisions in the *inter partes* reexamination proceeding and, at the same time, going forward with the interference to the extent desirable. Decisions in the interference will take into consideration the status of the reexamination proceeding and what is occurring therein. The decision as to what actions are taken in the interference will, in general, be taken in accordance with normal interference practice.

It must be noted that although a patent being reexamined via a reexamination proceeding may become involved in an interference proceeding, the reexamination proceeding itself can never be involved in an interference proceeding. See 35 U.S.C. 135(a) which states that “[w]henver an application is made for a patent which, in the opinion of the Director, would interfere with any pending application, or with any unexpired patent, an interference may be declared” (emphasis added). The reexamination proceeding is neither an application nor a patent.

### **I. ATTEMPTING TO PROVOKE AN INTERFERENCE WITH A PATENT INVOLVED IN A REEXAMINATION PROCEEDING**

See MPEP § 2284 for a discussion of the situation where an amendment seeking to provoke an interference with a patent involved in a reexamination proceeding is filed in a pending application. The practice and procedure in this area as to *inter partes* reexamination proceedings parallels that of *ex parte* reexamination proceedings.

### **II. MOTION TO SUSPEND INTERFERENCE UNDER 37 CFR 1.635 PENDING THE OUTCOME OF A REEXAMINATION PROCEEDING**

A motion under 37 CFR 1.635 to suspend an interference pending the outcome of a reexamination proceeding may be made at any time during the interference by any party thereto. The motion must be presented to the Administrative Patent Judge (APJ) who will decide the motion based on the particular fact situation. However, no consideration will be given such a motion unless and until a reexamination

order is issued, nor will suspension of the interference normally be permitted until after any motions have been disposed of. If the motion under 37 CFR 1.635 is denied by the APJ, a request to stay the interference may be made to the Director of the USPTO under 37 CFR 1.993.

It is noted that the 37 CFR 1.644(a)(2) petition might appear to overlap the 37 CFR 1.993 request to stay an interference; however, 37 CFR 1.644(b) states that “[a] petition under paragraph (a)(2) of this section shall not be filed prior to the party’s brief for final hearing (see § 1.656).” The request to stay an interference under 37 CFR 1.993 is thus not covered by 37 CFR 1.644(a)(1)-(3); and 37 CFR 1.993 provides an additional aspect of relief to the public.

Just as petitions under 37 CFR 1.644 are decided by the Chief Administrative Patent Judge of the Board of Patent Appeals and Interferences (Board), a request to stay an interference under 37 CFR 1.993 will likewise be decided by the Chief Administrative Patent Judge of the Board.

### **III. REQUEST BY THE EXAMINER FOR ACTION PURSUANT TO 37 CFR 1.641**

Normally, examiners should not have to alert the APJ for action under 37 CFR 1.641 while the reexamination proceeding is pending. Rather, examiners should rely on the parties of the interference to file a notice under 37 CFR 1.660. See also the discussion in the next paragraph.

### **IV. REQUEST FOR REEXAMINATION FILED DURING INTERFERENCE**

In view of the provisions of 37 CFR 1.913, “[a]ny person may, at any time during the period of enforceability of a patent” file a request for *inter partes* reexamination. Under 37 CFR 1.660, the patent owner must notify the Board that a request for reexamination was filed within **ten** days of receiving notice of the request having been filed. Such requests for reexamination will be processed in the normal manner. No delay, or stay, of the reexamination will occur where the third party requester is not a party to the interference, or where the requester is a party to the interference but does not timely petition for a stay or delay. If the examiner orders reexamination pursuant to 37 CFR 1.931 and subsequently, in the reexamination proceeding, rejects a patent claim corresponding to a

count in the interference, the attention of the APJ shall be called to the rejection and appropriate action may be taken under 37 CFR 1.641.

#### V. PETITION TO STAY REEXAMINATION PROCEEDING BECAUSE OF INTERFERENCE

Any petition to stay an *inter partes* reexamination proceeding, because of an interference, which is filed prior to the first Office action in the reexamination proceeding will not be considered, but will be returned to the party submitting the petition. See 37 CFR 1.939 and MPEP § 2625. The decision returning such a premature petition will be made of record in the reexamination file, but no copy of the petition will be retained by the Office. A petition to stay the reexamination proceeding because of the interference may be filed by the patent owner after the first Office action in the reexamination proceeding. If a party to the interference, other than the patent owner, is also a requester of the reexamination, that party may also petition to stay the reexamination proceeding after the first Office action. If the party to the interference other than patent owner is not the reexamination requester, any petition by that party is improper under 37 CFR 1.905 and will not be considered. Any such improper petitions will be returned to the party submitting the same. Premature petitions to stay the reexamination proceedings, i.e., those filed prior to the first Office action in the reexamination proceeding, will be returned by a Legal Advisor of the Office of Patent Legal Administration (OPLA) as premature. Petitions to stay filed subsequent to the date of the first Office action in the reexamination proceeding will be referred to the OPLA for decision by a Senior Legal Advisor of that Office. All decisions on the merits of petitions to stay a reexamination proceeding because of an interference will be made in the OPLA.

#### VI. ACTION IN INTERFERENCE FOLLOWING REEXAMINATION

If one or more claims of a patent which is involved in an interference are canceled or amended by the issuance of a reexamination certificate, appropriate action will be taken by the APJ under 37 CFR 1.641.

Upon issuance of the reexamination certificate, the patent owner must notify the APJ of such issuance.

### 2686.03 Copending Reexamination and Reissue Proceedings [Added R-2]

*37 CFR 1.991. Merger of concurrent reissue application and inter partes reexamination proceeding.*

When a third party requester is involved in one or more proceedings, including an *inter partes* reexamination proceeding, the merger of such proceedings will be accomplished so as to preserve the third party requester's right to participate to the extent specifically provided for in these regulations. In merged proceedings involving different requesters, any paper filed by one party in the merged proceeding shall be served on all other parties of the merged proceeding.

*37 CFR 1.937. Conduct of inter partes reexamination.*

(a) All *inter partes* reexamination proceedings, including any appeals to the Board of Patent Appeals and Interferences, will be conducted with special dispatch within the Office, unless the Director makes a determination that there is good cause for suspending the reexamination proceeding.

\*\*\*\*\*

*37 CFR 1.995. Third party requester's participation rights preserved in merged proceeding.*

When a third party requester is involved in one or more proceedings, including an *inter partes* reexamination proceeding, the merger of such proceedings will be accomplished so as to preserve the third party requester's right to participate to the extent specifically provided for in these regulations. In merged proceedings involving different requesters, any paper filed by one party in the merged proceeding shall be served on all other parties of the merged proceeding.

*37 CFR 1.997. Issuance of inter partes reexamination certificate.*

(a) Upon the conclusion of an *inter partes* reexamination proceeding, the Director will issue a certificate in accordance with 35 U.S.C. 316 setting forth the results of the *inter partes* reexamination proceeding and the content of the patent following the *inter partes* reexamination proceeding.

\*\*\*\*\*

(d) If a certificate has been issued which cancels all of the claims of the patent, no further Office proceedings will be conducted with that patent or any reissue applications or any reexamination requests relating thereto.

(e) If the *inter partes* reexamination proceeding is terminated by the grant of a reissued patent as provided in § 1.991, the reissued patent will constitute the reexamination certificate required by this section and 35 U.S.C. 316.

\*\*\*\*\*



*37 CFR 1.176. Examination of reissue.*

(a) A reissue application will be examined in the same manner as a non-reissue, non-provisional application, and will be subject to all the requirements of the rules related to non-reissue applications. Applications for reissue will be acted on by the examiner in advance of other applications.

\*\*\*\*\*

The general policy of the Office is that the examination of a reissue application and an *inter partes* reexamination proceeding will not be conducted separately at the same time as to a particular patent. The reason for this policy is to permit timely resolution of both the reissue and the reexamination to the extent possible and to prevent inconsistent, and possibly conflicting, amendments from being introduced into the two files on behalf of the patent owner. Accordingly, if both a reissue application and a reexamination proceeding are pending concurrently on a patent, a decision will normally be made to merge the reissue application examination and the reexamination or to stay one of the two. See *In re Onda*, 229 USPQ 235 (Comm'r Pat. 1985). The decision as to whether the reissue application examination and the reexamination proceeding are to be merged, or which of the two (if any) is to be stayed, is made in the Office of Patent Legal Administration (OPLA).

Where a reissue application and a reexamination proceeding are pending concurrently on a patent, the patent owner, i.e., the reissue applicant, has a responsibility to notify the Office of such. 37 CFR 1.178(b), 1.565(a), and 1.985. The patent owner should file in the reissue application, as early as possible, a Notification of Concurrent Proceedings pursuant to 37 CFR 1.178(b) in order to notify the Office in the reissue application of the existence of the reexamination proceeding on the same patent. See MPEP § 1418. In addition, the patent owner should file in the reexamination proceeding, as early as possible, a Notification of Concurrent Proceedings pursuant to 37 CFR 1.565(a) or 1.985 (depending on whether the reexamination proceeding is an *ex parte* reexamination proceeding or an *inter partes* reexamination proceeding) to notify the Office in the reexamination proceeding of the existence of the two concurrent proceedings.

## I. TIME FOR MAKING DECISION ON MERGING OR STAYING THE PROCEEDINGS

A decision whether or not to merge the examination of a reissue application and an *inter partes* reexamination proceeding, or to stay one of the two, will not be made prior to the mailing of the order to reexamine the patent pursuant to 37 CFR 1.931. Until such time as the reexamination is ordered, the examination of the reissue application will proceed. A determination on the request for reexamination should not be delayed despite the existence of a copending reissue application, since 35 U.S.C. 312(a) requires a determination within 3 months following the filing date of the request. See MPEP § 2641. If the decision on the request denies reexamination (MPEP § 2647), the examination of the reissue application should be continued. If reexamination is to be ordered (MPEP § 2646), the reexamination, reissue, and patent files should be delivered promptly to the Central Reexamination Unit (CRU) for mailing of the decision ordering the reexamination, and the files then forwarded to the OPLA. The delivery of the files to the OPLA should not be delayed; accordingly, **no first Office action will accompany the decision ordering reexamination.**

If a reissue application is filed during the pendency of a reexamination proceeding in which reexamination has already been ordered, the reexamination file, reissue application, and patent file should be delivered to the OPLA as promptly as possible after the reissue application reaches the Technology Center (TC).

The decision on whether or not to merge the reissue application examination and the reexamination proceeding or which (if any) is to be stayed (suspended), will generally be made as promptly as possible after receipt of all of the files by the OPLA.

Until a decision is mailed merging the reissue application examination and the reexamination proceeding, or staying one of them, prosecution in the reissue application and the reexamination proceeding will continue and be conducted simultaneously, but separately.

The Office may in certain situations issue a certificate at the termination of a reexamination proceeding, even if a copending reissue application or another reexamination request has already been filed.

## II. CONSIDERATIONS IN DECIDING WHETHER TO MERGE THE REISSUE AND REEXAMINATION OR WHETHER TO STAY ONE OF THEM

The decision on whether to merge the reissue application examination and reexamination proceeding, or stay one of them, will be made on a case-by-case basis. Where issues are raised in the reissue application that would not be proper for consideration in reexamination and/or not be proper for comment by the reexamination third party requester, merger would ordinarily **not** be ordered, and one of the two proceedings stayed. A decision to stay the reexamination proceeding will **only** be issued in exceptional instances because of the statutory requirements that examination proceed with “special dispatch.” Where there is “good cause” to stay the reexamination proceeding, the Director may do so pursuant to 35 U.S.C. 314(c). The status of the reissue application and the reexamination proceeding will also be taken into account in the decision as to whether merger will be ordered.

### A. *Reissue About To Issue, Reexamination Requested*

If the reissue patent will issue before the determination on the reexamination request must be made, the determination on the request should normally be made after the granting of the reissue patent; and then the determination should be made on the basis of the claims in the reissue patent. The reexamination, if ordered, would then be based on the reissue patent claims rather than the original patent claims. Since the reissue application would no longer be pending, the reexamination would be processed in a normal manner.

Where a reissue patent has been issued, the determination on the request for reexamination should specifically point out that the determination has been made on the claims of the reissue patent and not on the claims of the original patent. Any amendment made in the reexamination proceeding should treat the changes made by the reissue as the text of the patent, and all bracketing and underlining made with respect to the patent **as changed by the reissue**. Note that the reissue claims used as the starting point in the reexamination proceeding must be presented in the reexamination proceeding as a “clean copy.” Thus, words bracketed in the reissue patent claim(s) would not

appear at all in the reexamination clean copy of the claim(s). Also, words that were added via the reissue patent will appear in italics in the reissue patent, but must appear in plain format in the reexamination clean copy of the claim(s).

If a reissue patent issues on the patent under reexamination after reexamination is ordered, the next action from the examiner in the reexamination should point out that further proceedings in the reexamination will be based on the claims of the reissue patent and not on the patent surrendered. Form paragraph 22.05 may be used in the Office action.

### *¶ 22.05 Reexamination (Ex Parte or Inter Partes) Based on Reissue Claims*

In view of the surrender of original Patent No. [1] and the granting of Reissue Patent No. [2] which issued on [3], all subsequent proceedings in this reexamination will be based on the reissue patent claims.

Where the reissue patent has issued prior to the filing of a request for reexamination of the original patent, see MPEP § 2640.

### B. *Reissue Pending, Reexamination Request Filed*

Where a reissue patent will not be granted prior to the expiration of the 3-month period for making the determination on the reexamination request, a decision will be made *after an order to reexamine is issued* as to whether the reissue application examination and the reexamination proceeding are to be merged, or which of the two (if any) is to be stayed. In this situation, no first Office action will have accompanied the order for reexamination.

In making a decision on whether or not to merge the reissue application examination and the reexamination proceeding, consideration will be given as to whether issues are raised in the reissue application that would not be proper for consideration in reexamination and/or not be proper for comment by the reexamination third party requester. If such issues are raised, merger would ordinarily **not** be ordered, and one of the two proceedings stayed. Consideration will also be given to the status of the reissue application examination at the time the order to reexamine the patent pursuant to 37 CFR 1.931 is mailed. For example, if the reissue application is on appeal to the Board of Patent Appeals and Interferences (Board) or to the courts, that fact would be considered in making a

decision whether to merge the reissue application examination and the reexamination proceeding or stay one of them. See *In re Scragg*, 215 USPQ 715 (Comm'r Pat. 1982), *In re Stoddard*, 213 USPQ 386 (Comm'r Pat. 1982).

If merger of the reissue application examination and the reexamination proceeding is ordered, the order merging them will also require that the patent owner place the same claims in the reissue application and in the reexamination proceeding for purposes of the merger. The decision to merge may require an amendment to be filed by the patent owner to provide identical sets of claims, within a specified time set in the decision to merge.

If merger would be appropriate, but the examination of the reissue application has progressed to a point where a merger is not desirable at that time, then the reexamination proceeding will generally be stayed until the reissue application examination is complete on the issues then pending. After completion of the examination on the issues then pending in the reissue application examination, the stay of the reexamination proceeding will be removed. The proceedings would be merged if the reissue application is pending, or the reexamination proceeding will be conducted separately if the reissue application has become abandoned. The reissue application examination would be reopened, if necessary, for merger of the reexamination proceeding therewith. If a stay of a reexamination proceeding has been removed following a reissue application examination, the first Office action will set a shortened statutory period for response of one month or thirty days (whichever is longer) unless a longer period for response clearly is warranted by the nature of the examiner's action. The second Office action will normally be final and will also set a one month or thirty days period for response. These shortened periods are considered necessary to prevent undue delay in terminating the proceedings and also to proceed with "special dispatch" in view of the earlier stay.

If the reissue application examination and reexamination proceedings are merged, the issuance of the reissue patent will also serve as the *inter partes* reexamination certificate under 37 CFR 1.997, and the reissue patent will so indicate.

### C. *Reexamination Proceedings Underway, Reissue Application Filed*

When a reissue application is filed after an *inter partes* reexamination request has been filed, a determination will be made as to whether reexamination should be ordered. If reexamination is ordered, the reexamination, reissue, and patent files should be delivered promptly to the CRU for mailing of the decision ordering the reexamination, and the files then forwarded to the OPLA for consideration as to whether or not to merge the proceedings or stay one proceeding. The delivery of the files to the OPLA should not be delayed; accordingly, no first Office action will accompany the decision ordering reexamination.

Where reexamination has already been ordered prior to the filing of a reissue application, the reexamination, reissue, and patent files should be delivered promptly to the OPLA for consideration of the merger issue.

In making a decision on whether or not to merge the reissue application examination and the reexamination proceeding, consideration will be given as to whether issues are raised in the reissue application that would not be proper for consideration in reexamination and/or not be proper for comment by the reexamination third party requester. If such issues are raised, merger would ordinarily **not** be ordered, and one of the two proceedings stayed. In addition, consideration will also be given to the status of the reexamination proceeding. For example, if the reexamination proceeding is on appeal to the Board or to the Court of Appeals for the Federal Circuit, that fact would be considered in making a decision whether to merge the reissue application examination and the reexamination proceeding or stay one of them.

### D. *Examiner Assignment*

With respect to the appropriate examiner assignment of the merged reexamination proceeding and the reissue application examination, see MPEP § 2636.

## III. CONDUCT OF MERGED REISSUE AND REEXAMINATION PROCEEDING

The decision ordering merger will set forth the practice and procedure to be followed in the examination and prosecution of the merged reissue and *inter*

*partes* reexamination proceeding. Any questions as to the practice and procedure set forth should be referred to the OPLA Reexamination Legal Advisor (RLA) assigned to the *inter partes* reexamination proceeding that is merged with the reissue application. In addition, the examiner will consult with the RLA assigned to the *inter partes* reexamination prior to issuing any Office action in the merged proceeding, in the same manner as he or she would consult with the RLA in an *inter partes* reexamination proceeding that has not been merged.

#### IV. INTER PARTES REEXAMINATION, EX PARTE REEXAMINATION, AND REISSUE APPLICATION FOR THE SAME PATENT

It will sometimes happen that an *inter partes* reexamination, an *ex parte* reexamination and a reissue application will all be copending. In these situations, the three files are forwarded (together with the patent file) to the OPLA where a decision is made whether to merge the newest proceeding with the two earlier proceedings. The three most common examples of this are as follows:

(A) A reissue application was previously merged with an *ex parte* reexamination, and then an *inter partes* reexamination is filed. After an order to reexamine has been issued, the files should be promptly forwarded to the OPLA for consideration as to whether or not to merge the proceedings.

(B) A reissue application was previously merged with an *inter partes* reexamination, and then a request for *ex parte* reexamination is filed. After an order to reexamine has been issued, the files should be held in storage until the patent owner's statement and any reply by the *ex parte* third party requester have been received for the *ex parte* reexamination request, or until the time for filing the same expires. The files should then be forwarded to the OPLA for consideration as to whether or not to merge the proceedings.

(C) An *inter partes* reexamination was merged with an *ex parte* reexamination, and then a reissue application is filed. Once the reissue application is received, the files should be promptly forwarded to the OPLA for consideration as to whether or not to merge the proceedings.

The decision to merge the three proceedings by the OPLA will provide the guidance for conducting the merged proceeding. It is to be noted that the merger will **not** be carried out pursuant to MPEP Chapter 2200. Prosecution prior to the point of merger will remain as-is, in the files.

In the event the *inter partes* reexamination is terminated and only the *ex parte* reexamination and the reissue application remain, the prosecution will no longer be governed by the present section. Any further prosecution will be governed by MPEP Chapter 2200; specifically see MPEP § 2285.

#### V. PETITION TO MERGE REISSUE APPLICATION AND INTER PARTES REEXAMINATION PROCEEDING OR TO STAY EITHER OF THE TWO BECAUSE OF THE EXISTENCE OF THE OTHER

No petition to merge the reexamination proceeding and the reissue application examination, or stay one of them, is necessary, since the Office will generally, *sua sponte*, make a decision to merge the reexamination proceeding and the reissue application examination or to stay one of them. If any petition to merge the reexamination proceeding and the reissue application examination, or to stay one of them because of the other, is filed prior to the determination (37 CFR 1.923) and the order to reexamine (37 CFR 1.931), it will not be considered, but will be returned to the party submitting the same by the OPLA, regardless of whether the petition is filed in the reexamination proceeding, the reissue application, or both. This is necessary in order to prevent premature papers relating to the reexamination proceeding from being filed. The decision returning such a premature petition will be made of record in both the reexamination file and the reissue application file, but no copy of the petition will be retained by the Office. See MPEP § 2667.

The patent owner or the third party requester may file a petition under 37 CFR 1.182 to merge a reexamination proceeding and a reissue application examination, or stay one of them because of the other, after the order to reexamine (37 CFR 1.931), in the event the Office has not acted prior to that date to merge or stay. Any petition to merge or stay which is filed by a party **other than** the patent owner or the third party requester of the reexamination will not be considered, but will be returned to that party by the OPLA.

All petitions to merge or stay which are filed by the patent owner or the third party requester subsequent to the date of the order for reexamination will be referred to the OPLA for decision.

## VI. FEES IN MERGED PROCEEDINGS

Where the proceedings have been merged and a paper is filed which requires payment of a fee (e.g., petition fees, appeal fees, brief fees, oral hearing fees), only a single fee need be paid. For example, only one fee need be paid for an appellant brief, even though the brief relates to merged multiple examinations and copies of the brief are filed for each file in the merger (as is required).

## VII. INTERVIEWS IN MERGED PROCEEDINGS

Pursuant to 37 CFR 1.955, an interview which discusses the merits of a proceeding is not permitted in an *inter partes* reexamination proceeding. Thus, in a merged proceeding of an *inter partes* reexamination and a reissue application, there will be no *inter partes* interview as to the substance of the proceeding. Also, there will be no separate *ex parte* interview as to the substance of the proceeding with either the patent owner (the reissue applicant) or the third party requester (of the reexamination). Accordingly, where a party requests any information as to the merits of the merged proceeding, the examiner will not conduct a personal or telephone interview with that party to provide the information. Further, an informal amendment by the patent owner (the reissue applicant) will not be accepted, because that would be tantamount to an *ex parte* interview. All communications between the Office and the patent owner (and the third party requester) which are directed to the merits of the merged proceeding must be in writing and filed with the Office for entry into the record of the proceeding.

## VIII. EXAMINER'S AMENDMENT TO PLACE PROCEEDING IN CONDITION FOR ALLOWANCE

As pointed out immediately above, interviews, both personal and telephone are **not** permitted in a merged reissue/*inter partes* reexamination proceeding. Thus, the examiner is not permitted to telephone the patent owner/reissue applicant and obtain authorization to

make an amendment. Accordingly, the only times that an examiner's amendment can be made in conjunction with a Notice of Allowability are where the patent owner authorization need not be obtained. Such amendments include:

(A) An examiner's amendment to deal with formal matters such as grammar, incorrect spelling, or incorrect number; i.e., matters that do not involve a rejection, do not go to the merits, and do not require the examiner to obtain approval.

(B) An examiner's amendment to change the title.

See also MPEP § 1302.04 *et seq.* as to examiner's amendments not needing authorization by an applicant or a patent owner. Note, however, that in a merged reissue/*inter partes* reexamination proceeding (as opposed to an application *per se*) all such examiner's amendments must be made by **formal examiner's amendment accompanying the Notice of Allowability**, in order to provide notice of the changes made in the patent being reexamined to both the patent owner/reissue applicant and the third party requester.

Note that any change going to the merits of the case (i.e., more than a formal matter) could not be made by examiner's amendment accompanying the Notice of Allowability. Rather, a change going to the merits would require (A) reopening of prosecution with the approval of the TC Director, (B) an Office action suggesting the change to the patent owner/reissue applicant, (C) a formal amendment submitted by patent owner/reissue applicant, and (D) an opportunity for the third party requester to comment on the patent owner/applicant's submission.

## 2686.04 Reexamination and Litigation Proceedings [Added R-2]

35 U.S.C. 314. *Conduct of inter partes reexamination proceedings.*

\*\*\*\*\*

(c) SPECIAL DISPATCH.— Unless otherwise provided by the Director for good cause, all *inter partes* reexamination proceedings under this section, including any appeal to the Board of Patent Appeals and Interferences, shall be conducted with special dispatch within the Office.

35 U.S.C. 317. *Inter partes reexamination prohibited.*

\*\*\*\*\*

(b) FINAL DECISION.— Once a final decision has been entered against a party in a civil action arising in whole or in part under section 1338 of title 28, that the party has not sustained its burden of proving the invalidity of any patent claim in suit or if a final decision in an inter partes reexamination proceeding instituted by a third-party requester is favorable to the patentability of any original or proposed amended or new claim of the patent, then neither that party nor its privies may thereafter request an inter partes reexamination of any such patent claim on the basis of issues which that party or its privies raised or could have raised in such civil action or inter partes reexamination proceeding, and an inter partes reexamination requested by that party or its privies on the basis of such issues may not thereafter be maintained by the Office, notwithstanding any other provision of this chapter. This subsection does not prevent the assertion of invalidity based on newly discovered prior art unavailable to the third-party requester and the Patent and Trademark Office at the time of the inter partes reexamination proceedings.

*35 U.S.C. 318. Stay of litigation.*

Once an order for inter partes reexamination of a patent has been issued under section 313, the patent owner may obtain a stay of any pending litigation which involves an issue of patentability of any claims of the patent which are the subject of the inter partes reexamination order, unless the court before which such litigation is pending determines that a stay would not serve the interests of justice.

*37 CFR 1.987. Suspension of inter partes reexamination proceeding due to litigation.*

If a patent in the process of *inter partes* reexamination is or becomes involved in litigation, the Director shall determine whether or not to suspend the *inter partes* reexamination proceeding.

*37 CFR 1.907. Inter partes reexamination prohibited.*

\*\*\*\*\*

(b) Once a final decision has been entered against a party in a civil action arising in whole or in part under 28 U.S.C. 1338 that the party has not sustained its burden of proving invalidity of any patent claim-in-suit, then neither that party nor its privies may thereafter request *inter partes* reexamination of any such patent claim on the basis of issues which that party, or its privies, raised or could have raised in such civil action, and an *inter partes* reexamination requested by that party, or its privies, on the basis of such issues may not thereafter be maintained by the Office.

35 U.S.C. 311 permits a request for *inter partes* reexamination to be filed “at any time.” Thus, requests for *inter partes* reexamination can be filed where the patent (for which reexamination is requested) is involved in concurrent litigation. The guidelines set forth below will generally govern Office handling of *inter partes* reexamination requests where there is concurrent litigation.

## I. COURT ORDERED REEXAMINATION PROCEEDING OR LITIGATION STAYED FOR REEXAMINATION

Where a request for reexamination indicates that it is filed as a result of an order by a court, or that litigation is stayed for the purpose of reexamination, all aspects of the proceeding will be expedited to the extent possible. Cases will be taken up for action at the earliest time possible, and time periods set in actions may be extended only upon a strong showing of sufficient cause (see MPEP § 2665). Action on such a proceeding will take precedence to any other action taken by the examiner in the Office. See generally *In re Vamco Machine and Tool, Inc.*, 752 F.2d 1564, 224 USPQ 617 (Fed. Cir. 1985); *Gould v. Control Laser Corp.*, 705 F.2d 1340, 217 USPQ 985 (Fed. Cir. 1983); *Loffland Bros. Co. v. Mid-Western Energy Corp.*, 225 USPQ 886 (W.D. Okla. 1985); *The Toro Co. v. R.L. Nelson Corp.*, 223 USPQ 636 (C.D. Ill. 1984); *Digital Magnetic Systems, Inc. v. Ansley*, 213 USPQ 290 (W.D. Okla. 1982); *Raytek, Inc. v. Solfan Systems Inc.*, 211 USPQ 405 (N.D. Cal. 1981); and *Dresser Industries, Inc. v. Ford Motor Co.*, 211 USPQ 1114 (N.D. Texas 1981).

## II. FEDERAL COURT DECISION KNOWN TO EXAMINER AT THE TIME THE DETERMINATION ON THE REQUEST FOR REEXAMINATION IS MADE

If a Federal Court decision *on the merits* of a patent is known to the examiner at the time the determination on the request for *inter partes* reexamination is made, the following guidelines will be followed by the examiner:

(A) The Third Party Requester Was Not a Party to the Litigation.

When the initial question as to whether the art raises a substantial new question of patentability as to a patent claim is under consideration, the existence of a final court decision of claim validity in view of the same or different art does not necessarily preclude the presence of a new question. This is true because of the different standards of proof and claim interpretation employed by the District Courts and the Office. See for example *In re Zletz*, 893 F.2d 319, 322, 13 USPQ2d 1320, 1322 (Fed. Cir. 1989) (manner of claim interpretation that is used by courts in litigation

is not the manner of claim interpretation that is applicable during prosecution of a pending application before the PTO) and *In re Etter*, 756 F.2d 852, 225 USPQ 1 (Fed. Cir. 1985) (the 35 U.S.C. 282 presumption of patent validity has no application in reexamination proceedings). Thus, while the Office may accord deference to factual findings made by the court, the determination of whether a substantial new question of patentability exists will be made independently of the court's decision on *validity*, since the decision is not controlling on the Office.

A *non-final* holding of claim *invalidity* or *unenforceability* will also not be controlling on the question of whether a substantial new question of patentability is present.

*Only a final holding of claim invalidity or unenforceability (after all appeals) is controlling on the Office.* In such cases, a substantial new question of patentability would not be present as to the claims held invalid or unenforceable. See *Ethicon v. Quigg*, 849 F.2d 1422, 7 USPQ2d 1152 (Fed. Cir. 1988).

(B) The Third Party Requester Was a Party to the Litigation.

Final Holding of validity: The provisions of 37 CFR 1.907(b) apply. Where a final decision was entered against a party in a Federal Court civil action (arising in whole or in part under 28 U.S.C. 1338) that the party did not sustain its burden of proving invalidity of a patent claim in suit, that party and its privies may **not** request *inter partes* reexamination of any such patent claim on the basis of issues which that party or its privies raised or could have raised in the civil action. Further, an *inter partes* reexamination already requested by that party, or its privies, on the basis of such issues will not be maintained by the Office, i.e., the proceeding will be terminated. Note, however, that the statute does not preclude an *ex parte* reexamination by the same third party requester.

In view of the above, when the examiner is aware that the third party requester was a party to previous Federal Court litigation as to the patent for which *inter partes* reexamination has been requested, the examiner must determine:

(1) Was the Federal Court decision adverse to the third party requester as to at least one claim of the patent?

(2) Was the Federal Court decision a final decision, after all appeals?

(3) Is the issue being raised in the reexamination request the same issue as was raised in the Federal Court during the civil action, or an issue that the third party requester could have raised in the Federal Court during the civil action?

- If the answer to each of questions (1)-(3) is "yes" for all claims in the proceeding, then the *inter partes* reexamination must be terminated. In such a case, the TC Director will prepare a decision discussing the above considerations (1)-(3) and vacating the reexamination proceeding.

- If the answer to all of questions (1)-(3) is "yes" for one or more (but not all) of the claims in the proceeding; those claims will not be treated. The examiner's action will point out the claims not treated and the reason why, i.e., a discussion of the above considerations (1)-(3). The guidelines set forth above in subsection II.(A) will be used for the claims remaining.

- If the answer to question (1) or to question (3) is "no" for all claims, then the examination of the reexamination proceeding will proceed without any discussion on the record of considerations (1)-(3), using the guidelines set forth above in subsection II.(A).

- If, for any claim, the answer to both of questions (1) and (3) is "yes", but the answer to question (2) is "no", then examination of the reexamination proceeding will proceed using the guidelines set forth above in subsection II.(A). The examiner's action will contain a discussion of considerations (1)-(3). If the examiner subsequently becomes aware that the Federal Court decision has become final, reexamination of the affected claims must be discontinued. If all claims are affected, the reexamination will be vacated by the TC Director as discussed above.

Final Holding of invalidity: A *final holding of claim invalidity or unenforceability* (after all appeals) is controlling on the Office. In such cases, a substantial new question of patentability would not be present as to the claims held invalid or unenforceable. See *Ethicon v. Quigg*, 849 F.2d 1422, 7 USPQ2d 1152 (Fed. Cir. 1988). Where all claims are affected, the reexamination will be vacated by the TC Director. A non-final holding of claim invalidity or unenforceability, however, will not be controlling on the question of whether a substantial new question of patentability is present.

## (C) Specific Situations.

For a discussion of the policy in specific situations where a Federal Court decision has been issued, see MPEP § 2642.

### III. REEXAMINATION WITH CONCURRENT LITIGATION BUT ORDERED PRIOR TO FEDERAL COURT DECISION

In view of the statutory mandate to make the determination on a request for reexamination within 3 months, the determination on the request based on the record before the examiner will be made without awaiting a decision by the Federal Court. It is not realistic to attempt to determine what issues will be treated by the Federal Court prior to the Court's decision. Accordingly, the determination on the request will be made without considering the issues allegedly before the Court. If reexamination is ordered, the reexamination generally (see discussion immediately below) will continue until the Office becomes aware that a court decision has issued. At such time, the request will be reviewed in accordance with the guidelines set forth below.

In *Ethicon v. Quigg*, 849 F.2d 1422, 7 USPQ2d 1152 (Fed. Cir. 1988), the Court of Appeals for the Federal Circuit stated the following as to the Office's authority to stay a reexamination process pending the outcome of a Federal District Court case where invalidity is an issue:

"Whatever else special dispatch means, it does not admit of an indefinite suspension of reexamination proceedings pending conclusion of litigation. If it did, one would expect to find some intimation to that effect in the statute, for it would suggest the opposite of the ordinary meaning. But there is none."

"The Commissioner... has no inherent authority, only that which Congress gives. It did not give him authority to stay reexaminations; it told him to conduct them with special dispatch. Its silence about stays cannot be used to countermand that instruction."

The *Ethicon* case was decided as to *ex parte* reexamination, for which 35 U.S.C. 305 dictates in its last sentence:

"All reexamination proceedings under this section, including any appeal to the Board of Patent Appeals and Interferences, will be conducted with special dispatch within the Office."

For *inter partes* reexamination, however, 35 U.S.C. 314 states:

**"Unless otherwise provided by the Director for good cause,** all *inter partes* reexamination proceedings under this section, including any appeal to the Board of Patent Appeals and Interferences, shall be conducted with special dispatch within the Office."

35 U.S.C. 314 provides for *inter partes* reexamination the clause "Unless otherwise provided by the Director for good cause" which clause is not present in 35 U.S.C. 305 for *ex parte* reexamination. Accordingly, where there is good cause for the Director of the USPTO to suspend (stay) reexamination proceedings pending the conclusion of litigation, a suspension will be effected. A "good cause" might be present, for example, where there is an issue that cannot be decided in the reexamination proceeding but affects the resolution of the proceeding. Another example is where there is an issue common to the litigation and the reexamination that can best be decided in court due to the availability in court of discovery and subpoena power (e.g., an issue heavily dependent on presentation of conflicting/contested evidence by the two parties). If the examiner believes there is good cause to suspend (stay) reexamination proceedings, the case should be brought to the Office of Patent Legal Administration (OPLA) for consideration of such by a Reexamination Legal Advisor (RLA).

It should be noted that if, pursuant to 35 U.S.C. 318, a court stays litigation as to the patent being reexamined, action in the reexamination proceeding would not be suspended. This is so because action in the reexamination proceeding would be needed to resolve the "issue of patentability of any claims of the patent which are the subject of the *inter partes* reexamination order" set forth in 35 U.S.C. 318.

### IV. FEDERAL COURT DECISION ISSUES AFTER INTER PARTES REEXAMINATION ORDERED

Pursuant to 37 CFR 1.985(a), the patent owner in an *inter partes* reexamination proceeding must promptly notify the Office of any Federal Court decision involving the patent.

Upon the issuance of a holding of claim invalidity or unenforceability by a Federal Court, reexamination of those claims will continue in the Office until the decision becomes final. A *non-final* Court decision



concerning a patent under reexamination shall have no binding effect on a reexamination proceeding.

Where an *inter partes* reexamination proceeding is currently pending and a **final** Federal Court decision issues after all appeals, the reexamination proceeding is reviewed to see if no substantial new question of patentability remains (as to one or more claims) due to holding of claims invalid, and to determine whether the provisions of 37 CFR 1.907(b) apply as a result of a decision in a civil action arising in whole or in part under 28 U.S.C. 1338.

A *final Court holding of invalidity/unenforceability* is binding on the Office. Upon the issuance of a final holding of invalidity or unenforceability, the claims held invalid or unenforceable will be withdrawn from consideration in the reexamination. The reexamination will continue as to any remaining claims. If all of the claims are finally held invalid or unenforceable, the reexamination will be vacated by the TC Director as no longer containing a substantial new question of patentability and the reexamination will be terminated. If not all claims were held invalid, a substantial new question of patentability may still exist as to the remaining claims. In such a situation, the remaining claims would be examined; and, as to the claims held invalid, form paragraph 26.80 should be used at the beginning of the Office action.

¶ 26.80 *Claims Held Invalid by Court, No Longer Being Reexamined*

Claims [1] of the [2] patent are not being reexamined in view of the final decision of [3]. Claims [1] were held invalid by the [4].

**Examiner Note:**

1. In bracket 1, insert the claims held invalid.
2. In bracket 2, insert the patentee (e.g., Rosenthal, Schor et al).
3. In bracket 3, insert the decision (e.g., *ABC Corp. v. Kery Fries*, 999 USPQ2d 99 (Fed. Cir. 1999) or *XYZ Corp. v. Jones*, 999 USPQ2d 1024 (N.D. Cal. 1999)).
4. In bracket 4, insert the name of the court (e.g., the Court of Appeals for the Federal Circuit, or the Federal District Court).

The issuance of a *final* Court decision (in a civil action arising in whole or in part under 28 U.S.C. 1338) upholding validity during an *inter partes* reexamination, where the person who filed the request **was a party to the litigation**, will have the effect that the Office will discontinue examination of all claims affected by the holding of validity. If the provisions of 37 CFR 1.907(b) apply such that all of

the claims in the reexamination proceeding cannot be maintained, the order to reexamine is vacated by the TC Director, and reexamination is terminated. If the provisions of 37 CFR 1.907(b) apply to some of the claims, but not all of the claims in the proceeding; those claims to which 37 CFR 1.907(b) applies will not be treated. The examiner's action will point out the claims not treated, and the reason why those claims cannot be maintained in the reexamination under 37 CFR 1.907(b). Action will be given on the remaining claims. Note that the provisions of 37 CFR 1.907(b) cannot be waived since they track the statute, 35 U.S.C. 317.

The issuance of a final Court decision **upholding validity** during an *inter partes* reexamination, where the person who filed the request **was not a party to the litigation**, will have no binding effect on the examination of the reexamination. This is because the Court stated in *Ethicon v. Quigg*, 849 F.2d 1422, 1428, 7 USPQ2d 1152, 1157 (Fed. Cir. 1988) that the Office is not bound by a court's holding of patent validity and should continue the reexamination. The Court noted that District Courts and the Office use different standards of proof in determining invalidity, and thus, on the same evidence, could quite correctly come to different conclusions. Specifically, invalidity in a District Court must be shown by "clear and convincing" evidence, whereas in the Office it is sufficient to show non-patentability by a "preponderance" of the evidence. Since the "clear and convincing" standard is harder to satisfy than the "preponderance standard," a court's holding of patent validity is not controlling. Deference will, however, ordinarily be accorded to the factual findings of the court, where the evidence before the Office and the court is the same. If sufficient reasons are present, claims held valid by the court may be rejected in reexamination.

## V. LITIGATION REVIEW AND CRU APPROVAL

In order to ensure that the Office is aware of prior or concurrent litigation, the examiner is responsible for conducting a reasonable investigation for evidence as to whether the patent for which reexamination is requested has been, or is, involved in litigation. The investigation will include a review of the reexamination file, the patent file, and the results of the litigation computer search by the Scientific and Technical

Information Center (STIC). If the examiner discovers, at any time during the reexamination proceeding, that there is litigation or that there has been a Federal Court decision on the patent, the fact will be brought to the attention of a Reexamination Legal Advisor (RLA) of the Central Reexamination Unit (CRU) prior to *any* further action by the examiner. The RLA will provide the examiner with guidance as to compliance with Office policy where there is concurrent litigation.

## **2687 Notice of Intent to Issue *Inter Partes* Reexamination Certificate (NIRC) and Conclusion of Reexamination Proceeding [Added R-2]**

Upon conclusion of the *inter partes* reexamination proceeding, the examiner must complete a Notice of Intent to Issue *Inter Partes* Reexamination Certificate (NIRC) by filling out Form PTOL-2068. If appropriate, an examiner's amendment will also be prepared. Where the claims are found patentable, reasons must be given for each claim found patentable. See the discussion as to preparation of an examiner's amendment and reasons for allowance found at the end of this section. In addition, the examiner must prepare the reexamination file so that the Office of Publications can prepare and issue a certificate in accordance with 35 U.S.C. 316 and 37 CFR 1.997 and setting forth the results of the reexamination proceeding and the content of the patent following the proceeding. See MPEP § 2688.

### **I. INSTANCES WHERE A NIRC WOULD BE APPROPRIATE**

The following are the only instances when issuance of a NIRC action would be proper in an *inter partes* reexamination proceeding:

(A) There is **no** timely response by the patent owner to an Office action requiring a response. If **all** claims are under rejection, the examiner will issue a Notice of Intent to Issue *Inter Partes* Reexamination Certificate (NIRC). All claims will be canceled by formal examiner's amendment.

(B) After a Right of Appeal Notice (RAN) where no party to the reexamination timely files a notice of appeal.

(C) After filing of a notice of appeal, where all parties who filed a notice of appeal or notice of cross appeal fail to timely file an appellant brief (or fail to timely complete the brief, where the appellant brief is noted by the examiner as being incomplete).

(D) After a final decision by the Board of Patent Appeals and Interferences (Board), where there is no further timely appeal to the Court of Appeals for the Federal Circuit nor is there a timely request for rehearing by the Board.

(E) After the Federal Court appeal process has been completed and the case is returned to the examiner.

### **II. PREPARATION OF THE NIRC ACTION**

#### **A. No Allowed Claims**

Where **all** claims are rejected or objected to in the prior Office action, the examiner will issue a NIRC indicating that all claims have been canceled and terminating the prosecution. The cover sheet to be used is Notice of Intent to Issue Reexamination Certificate Form PTOL-2068. As an attachment to the NIRC cover sheet, the examiner will draft an examiner's amendment canceling all live claims in the reexamination proceeding. Check the appropriate box on PTOL-2068. In the remarks of the examiner's amendment, the examiner should point out why the claims have been canceled. Since all claims are being canceled in the proceeding, no reasons for patentability are attached.

#### **B. At Least One Allowed Claim**

If at least one claim is free of rejection and objection, the examiner will issue a NIRC, in which all patentable claims and canceled claims will be identified. All rejected or objected claims will be canceled by formal examiner's amendment (attached as part of the NIRC). Check the appropriate box on Form PTOL-2068. In the remarks section of the examiner's amendment, the examiner should point out why the claims have been canceled. As to the patentable claims, reasons for patentability must be provided for all such claims.

### III. EXAMINER'S AMENDMENT TO PLACE PROCEEDING IN CONDITION FOR NOTICE OF INTENT TO ISSUE *INTER PARTES* REEXAMINATION CERTIFICATE

Interviews, both personal and telephone are not permitted in an *inter partes* reexamination proceeding (see MPEP § 2685). Thus, the examiner is not permitted to telephone the patent owner to obtain authorization to make an amendment. Accordingly, the only times that an examiner's amendment can be made in conjunction with a NIRC are where the patent owner authorization need not be obtained. Such amendments include:

(A) An examiner's amendment to deal with formal matters such as grammar, incorrect spelling, or incorrect number; i.e., matters that do not involve a rejection, do not go to the merits, and do not require the examiner to obtain approval.

(B) An examiner's amendment to change the title.

(C) An examiner's amendment to cancel all rejected and objected claims in the proceeding, when the patent owner fails (1) to timely respond (where a response is required), (2) to timely appeal, or (3) to take further action to maintain an appeal.

See also MPEP § 1302.04 *et. seq.* as to examiner's amendments not needing authorization by an applicant or a patent owner. Note, however, that in an *inter partes* reexamination proceeding (as opposed to an application) all such examiner's amendments must be made by **formal examiner's amendment accompanying the NIRC**, in order to provide notice of the changes made in the patent being reexamined to both the patent owner and the third party requester.

Note that any change going to the merits of the case (i.e., more than a formal matter) could not be made by examiner's amendment accompanying the NIRC. Rather, a change going to the merits would require (1) reopening of prosecution with the approval of the Technology Center (TC) Director, (2) an Office action suggesting the change to patent owner, (3) a formal amendment submitted by the patent owner, and (4) an opportunity for the third party requester to comment on the patent owner's submission.

Where an examiner's amendment is to be prepared, Box 9 of Form PTOL-2068 (Notice of Intent to Issue a Reexamination Certificate) is checked, and form

paragraph 26.69 is used to provide the appropriate attachment:

#### ¶ 26.69 Examiner's Amendment Accompanying Notice of Intent to Issue Reexamination Certificate

An examiner's amendment to the record appears below. The changes made by this examiner's amendment will be reflected in the reexamination certificate to issue in due course.

[1]

The examiner's amendment must comply with the requirements of 37 CFR 1.530(d)-(j) in amending the patent.

Thus, if a portion of the text is amended more than once, the examiner's amendment should indicate all changes (insertions and deletions) in relation to the current text in the patent under reexamination, **not** in relation to a prior amendment made during the proceeding.

In addition, the examiner's amendment requires presentation of the **full text** of any paragraph or claim to be changed, with 37 CFR 1.530(f) markings. Examiners' amendments in reexamination are not subject to the exceptions to this requirement which are provided for applications in 37 CFR 1.121(g) and which do not apply to reexamination proceedings. See MPEP § 2250. The only **exception** to the full text presentation requirement is that an entire claim or an entire paragraph of specification may be deleted from the patent by a statement deleting the claim or paragraph without the presentation of the text of the claim or paragraph.

### IV. REASONS FOR PATENTABILITY AND/OR CONFIRMATION

Reasons for patentability must be provided, unless all claims are canceled in the proceeding. Check the appropriate box on Form PTOL-2068 and provide the reasons as an attachment. In the attachment to the Notice of Intent to Issue *Inter Partes* Reexamination Certificate (NIRC), the examiner should indicate why the claims found patentable in the reexamination proceeding are clearly patentable over the cited patents or printed publications. This is done in a manner similar to that used to indicate reasons for allowance in an application. See MPEP § 1302.14. Where the record is clear as to why a claim is patentable (which should be the usual situation, in view of the *inter partes* nature of the proceeding), the examiner may simply refer to the particular portions of the record which

clearly establish the patentability of that claim. **In any event, reasons for patentability must be provided for every claim identified as patentable in the NIRC, and the patent owner must be notified in the NIRC that it has an opportunity to provide comments on the statement of the reasons for patentability.**

The reasons for patentability may be set forth on Form PTOL-476, entitled “REASONS FOR PATENTABILITY AND/OR CONFIRMATION.” However, as a preferred alternative to using Form PTOL-476, the examiner may instead use form paragraph 26.70.

¶ 26.70 *Reasons for Patentability and/or Confirmation in Inter Partes Reexamination*

STATEMENT OF REASONS FOR PATENTABILITY AND/OR CONFIRMATION

The following is an examiner’s statement of reasons for patentability and/or confirmation of the claims found patentable in this reexamination proceeding: [1]

Any comments considered necessary by the PATENT OWNER regarding the above statement must be submitted promptly to avoid processing delays. Such submission by the patent owner should be labeled: “Comments on Statement of Reasons for Patentability and/or Confirmation” and will be placed in the reexamination file.

**Examiner Note:**

This form paragraph may be used as an attachment to the Notice of Intent to Issue *Inter Partes* Reexamination Certificate, PTOL-2068 (item number 3).

Original patent claims that are found patentable in a reexamination proceeding are generally to be designated as “confirmed” claims, while new claims and amended patent claims are generally to be designated as “patentable” claims. However, for purposes of the examiner setting forth reasons for patentability or confirmation, the examiner may use “patentable” to refer to any claim that defines over the cited patents or printed publications. There is no need to separate the claims into “confirmed” and “patentable” categories when setting forth the reasons.

Where all claims are canceled in the proceeding, no reasons for patentability are provided.

**V. PREPARATION OF THE CASE FOR PUBLICATION**

As to preparing the *inter partes* reexamination file for publication of the certificate, see MPEP § 2287 for guidance. The preparation of an *inter partes* reexami-

nation proceeding for publication is carried out in the same manner that an *ex parte* reexamination proceeding is prepared for publication.

The examiner must complete the examiner preparation of the case for reexamination certificate by completing an Examiner Checklist Reexamination form, PTOL-1516. The TC Legal Instrument Examiner (LIE) (the reexamination clerk) must complete a Reexamination Clerk Checklist form, PTOL-1517. The case is reviewed by the TC Special Program Examiner (SPRE) and if all is in order, the case will be forwarded by the SPRE to the Central Reexamination Unit (CRU).

In the CRU, the reexamination file and its contents will be reviewed, the NIRC will be mailed, and appropriate PALM work and update scanning will be carried out. The reexamination file with the patent file will then be forwarded, via the appropriate Office, to the Office of Publications for printing.

If the CRU returns the case to the TC for correction/revision, the correction/revision must be handled specially and returned to the CRU within the time set for such by the CRU.

**VI. REEXAMINATION REMINDERS**

The following items deserve special attention. The examiner should ensure they have been correctly completed or followed before forwarding the case to the SPRE for review.

(A) All patent claims must have been examined. See MPEP § 2643.

(B) No renumbering of patent claims is permitted. New claims may require renumbering. See MPEP § 2666.01 and § 2250.

(C) Amendments to the description and claims must conform to requirements of 37 CFR 1.530(d)-(k). This includes any changes made by examiner’s amendment. If a portion of the text is amended more than once, each amendment should indicate all of the changes (insertions and deletions) in relation to the current text in the patent under reexamination. See MPEP § 2666.01 and § 2250.

(D) The prior art must be listed on a form PTO-892, PTO-1449, PTO/SB/08A or 08B, or PTO/SB/42 (or on a form having format equivalent to one of these forms). These forms must be properly completed. See MPEP § 2657.

(E) The examiner and clerk checklists PTO-1516 and PTO-1517 must be *entirely and properly* completed. A careful reading of the instructions contained in these checklists is essential. The clerk checklist is designed as a check and review of the examiner's responses on the examiner checklist. Accordingly, the clerk should personally review the file before completing an item. The clerk should check to make certain that the responses to all related items on both checklists are in agreement.

(F) Multiple copending reexamination proceedings should be merged. See MPEP § 2686.01.

(G) Where the reexamination proceeding is copending with an application for reissue of the patent being reexamined, the files must have been forwarded to the Office of Patent Legal Administration (OPLA) for a consideration of potential merger, with a decision on the question being present in the reexamination file. See MPEP § 2686.03.

(H) Reasons for patentability and/or confirmation are required for each claim found patentable.

(I) There is no issue fee in reexamination. See MPEP § 2634.

(J) The patent claims may not be amended nor new claims added after expiration of the patent. See MPEP § 2666.01 and § 2250.

(K) Original drawings cannot be physically changed. All drawing amendments must be presented on new sheets. The examiner may have the draftsman review the new sheets of drawings if the examiner would like the draftsman's assistance in identifying errors in the drawings. A draftsman's "stamp" to indicate approval is no longer required on patent drawings, and these stamps are no longer to be used by draftsmen. See MPEP § 2666.02.

(L) An amended or new claim may not enlarge the scope of the patent claims. See MPEP § 2658, § 2666.01, and § 2250.

(M) If the patent has expired, all amendments to the patent claims and all claims added during the proceeding must be withdrawn. Further, all presently rejected and objected claims are canceled by examiner's amendment. See MPEP § 2250, subsection on "Amendment After the Patent Has Expired."

#### A. *Handling of Multiple Dependent Claims*

For treatment of multiple dependent claims when preparing a reexamination proceeding for publication

of the reexamination certificate, see the discussion in MPEP § 2287.

#### B. *The Title of the Patent*

Normally, the title will not need to be changed during reexamination. If a change of the title is necessary, it should have been pointed out as early as possible in the prosecution, as a part of an Office Action. An informal examiner's amendment (i.e., changing the title and merely initialing the change) is **not** permitted in reexamination.

### VII. REEXAMINATION PROCEEDINGS IN WHICH ALL THE CLAIMS ARE CANCELED

There will be instances where all claims in the reexamination proceeding are to be canceled. This would occur where the patent owner fails to timely respond to an Office action, and all live claims in the reexamination proceeding are under rejection. This would also occur where all live claims in the reexamination proceeding are to be canceled as a result of a decision of the Board affirming the examiner, and the time for appeal to the court and for requesting rehearing has expired. In these instances the examiner will issue a NIRC indicating that all claims have been canceled and terminating the prosecution. As an attachment to the NIRC, the examiner will draft an examiner's amendment canceling all live claims in the reexamination proceeding. In the examiner's amendment, the examiner should point out why the claims have been canceled. For example, the examiner might state one of the two following examples, as is appropriate:

"Claims 1-8 (all live claims in the proceeding) were subject to rejection in the last Office action mailed 9/9/99. Patent owner failed to timely respond to that Office action. Accordingly, claims 1-8 have been canceled. See 37 CFR 1.957(b) and MPEP § 2666.10."

"The rejection of claims 1-8 (all live claims in the proceeding) has been affirmed in the Board decision of 9/9/99, and no timely appeal to the court has been filed. Accordingly claims 1-8 have been canceled."

In order to physically cancel the live claims in the reexamination file, brackets should be placed around all the live claims. All other claims in the proceeding should have previously been either replaced or canceled.

The examiner will designate a canceled original patent claim, to be printed in the *Official Gazette*, on the file wrapper in the appropriate place for the claim chosen.

### **2687.01 Examiner Consideration of Submissions After NIRC [Added R-2]**

The rules do not provide for an amendment to be filed in an *inter partes* reexamination proceeding after a Notice of Intent to Issue *Inter Partes* Reexamination Certificate (NIRC) has been issued. Note that 37 CFR 1.312 does not apply in reexamination. Any amendment, information disclosure statement, or other paper related to the merits of the reexamination proceeding filed after the NIRC (except as indicated immediately below) must be accompanied by a petition under 37 CFR 1.182. The petition must be granted, in order to have the amendment, information disclosure statement, or other paper related to the merits considered. Where an amendment, information disclosure statement, or other paper related to the merits of the reexamination proceeding is filed after the NIRC, and the accompanying petition under 37 CFR 1.182 is granted, the examiner will reconsider the case in view of the new information, and if appropriate, will reopen prosecution.

Interviews, both personal and telephone, are **not** permitted in an *inter partes* reexamination proceeding (see MPEP § 2685). Thus, the examiner is not permitted to telephone the patent owner and obtain authorization to make an amendment. The only time an examiner's amendment can be made in an *inter partes* reexamination after the NIRC has been issued is where an examiner's amendment is needed to address matters that do not require the patent owner's approval. However, matters that do not require the patent owner's approval are generally minor formal matters. Thus, it would be rare for an examiner to need to withdraw the issued NIRC for issuance of a new NIRC with an examiner's amendment, since withdrawal of the NIRC should not be done for minor formal matters. In view of this, any examiner's amendment in an *inter partes* reexamination proceeding to be made after a NIRC (has been issued) requires the TC SPRE to approve the examiner's amendment.

Any "Comments on Statement of Reasons for Patentability and/or Confirmation" which are received will be placed in the reexamination file, without comment. This will be done even where the reexamination certificate has already issued.

### **2688 Issuance of *Inter Partes* Reexamination Certificate [Added R-2]**

*35 U.S.C. 316. Certificate of patentability, unpatentability and claim cancellation.*

(a) IN GENERAL.— In an *inter partes* reexamination proceeding under this chapter, when the time for appeal has expired or any appeal proceeding has terminated, the Director shall issue and publish a certificate canceling any claim of the patent finally determined to be unpatentable, confirming any claim of the patent determined to be patentable, and incorporating in the patent any proposed amended or new claim determined to be patentable.

\*\*\*\*\*

*37 CFR 1.997. Issuance of inter partes reexamination certificate.*

(a) Upon the conclusion of an *inter partes* reexamination proceeding, the Director will issue a certificate in accordance with 35 U.S.C. 316 setting forth the results of the *inter partes* reexamination proceeding and the content of the patent following the *inter partes* reexamination proceeding.

(b) A certificate will be issued in each patent in which an *inter partes* reexamination proceeding has been ordered under § 1.931. Any statutory disclaimer filed by the patent owner will be made part of the certificate.

(c) The certificate will be sent to the patent owner at the address as provided for in § 1.33(c). A copy of the certificate will also be sent to the third party requester of the *inter partes* reexamination proceeding.

(d) If a certificate has been issued which cancels all of the claims of the patent, no further Office proceedings will be conducted with that patent or any reissue applications or any reexamination requests relating thereto.

(e) If the *inter partes* reexamination proceeding is terminated by the grant of a reissued patent as provided in § 1.991, the reissued patent will constitute the reexamination certificate required by this section and 35 U.S.C. 316.

(f) A notice of the issuance of each certificate under this section will be published in the *Official Gazette*.

Since abandonment is not possible in a reexamination proceeding, an *inter partes* reexamination certificate will be issued at the conclusion of the proceeding for each patent in which a reexamination proceeding has been ordered under 37 CFR 1.931, except where the reexamination has been terminated by vacating the reexamination proceeding, or by the grant of a reissue

patent on the same patent in which case the reissue patent also serves as the reexamination certificate.

The *inter partes* reexamination certificate will set forth the results of the proceeding and the content of the patent following the reexamination proceeding. The certificate will:

(A) cancel any patent claims determined to be unpatentable;

(B) confirm any patent claims determined to be patentable;

(C) incorporate into the patent any amended or new claims determined to be patentable;

(D) make any changes in the description approved during reexamination;

(E) include any statutory disclaimer or terminal disclaimer filed by the patent owner;

(F) identify unamended claims which were held invalid on final holding by another forum on any grounds;

(G) identify any patent claims not reexamined;

(H) be mailed on the day of its date to the patent owner at the address provided for in 37 CFR 1.33(c), and a copy will be mailed to the requester; and

(I) refer to patent claims, dependent on amended claims, determined to be patentable.

If a certificate issues which cancels all of the claims of the patent, no further Office proceedings will be conducted with regard to that patent or any reissue application or reexamination request directed thereto.

If a reexamination proceeding is terminated by the grant of a reissue patent as provided for in 37 CFR 1.991, the reissue patent will constitute the reexamination certificate required by 35 U.S.C. 316.

If all of the claims are disclaimed in a patent under reexamination, a certificate under 37 CFR 1.997 will be issued indicating that fact.

A notice of the issuance of each reexamination certificate will be published in the *Official Gazette* on its date of issuance in a format similar to that used for reissue patents. See MPEP § 2691.

## 2689 Reexamination Review [Added R-2]

After a reexamination case is acted on by the examiner and all Technology Center (TC) clerical processing is completed, the case is forwarded to the office of the TC Special Program Examiners (SPRE). The TC SPRE (with the aid of the paralegals or other technical

support who might be assigned as backup) will then (A) procedurally review the examiner's action for compliance with the applicable provisions of the reexamination statute and regulations, and with reexamination policy, practice and procedure, (B) do a completeness review of the action to ensure that all issues and arguments raised by all parties are appropriately developed, considered and addressed, and that all materials of the action (e.g., references, forms and cover sheets) are present and appropriately completed and (C) arrange for the file to be PALMed out and hand-carried directly to the Central Reexamination Unit (CRU). In the CRU, the Reexamination Legal Advisor (RLA) will do a general review of the examiner's action for correct application of reexamination law, rules, procedure and policy.

In addition to the SPRE review of the reexamination cases, a patentability review is made in a sample of reexamination cases by the TC Quality Assurance Specialist (QAS) in the manner previously carried out by the former Office of Patent Quality Review.

After a Notice of Intent to Issue *Inter Partes* Reexamination Certificate (NIRC) has been issued and prosecution has been terminated, the reexamination case is screened in the CRU for obvious errors and proper preparation, in order to issue a reexamination certificate. The above identified review processes are appropriate vehicles for providing information on the uniformity of practice, identifying problem areas and providing feedback to the TC personnel that process and examine reexamination cases.

## 2690 Format of *Inter Partes* Reexamination Certificate [Added R-2]

An *inter partes* reexamination certificate is issued at the close of each *inter partes* reexamination proceeding in which reexamination has been ordered under 37 CFR 1.931, unless the *inter partes* reexamination proceeding is merged with a reissue application pursuant to 37 CFR 1.991. In that situation, the *inter partes* reexamination proceeding is terminated by the grant of a reissue patent, the reissue patent will constitute the reexamination certificate. It should be noted that where an *ex parte* reexamination is merged with an *inter partes* reexamination proceeding, an *inter partes* reexamination certificate will issue for the merged proceeding.

The *inter partes* reexamination certificate is formatted much the same as the title page of current U.S. patents.

The certificate is titled “*INTER PARTES REEXAMINATION CERTIFICATE*.” The title is followed by an “ordinal” number in parentheses, such as “(5<sup>th</sup>)”, which indicates that it is the fifth *inter partes* reexamination certificate that has issued. The *inter partes* reexamination certificates will be numbered in a separate and new ordinal sequence, beginning with “(1<sup>st</sup>)”. The *ex parte* reexamination certificates will continue the ordinal numbering sequence that has already been established for *ex parte* reexamination certificates.

The certificate number will always be the patent number of the original patent followed by a two-character “kind code” suffix. The “kind code” suffix is **C1** for a first reexamination certificate, **C2** for a second reexamination certificate for the same patent, etc.

For example, “1” is provided in the certificate for the first reexamination certificate and “2” for the second reexamination certificate. Thus, a second reexamination certificate for the same patent would be designated as “C2” preceded by the patent number. The next higher number will be given to the reexamination proceeding for which the reexamination certificate is issued, regardless of whether the proceeding is an *ex parte* reexamination or an *inter partes* reexamination proceeding.

Note that “B1” *ex parte* reexamination certificates that were issued prior to January 1, 2001, included the patent number of the original patent followed by the letter “B.” Where the first reexamination certificate was a “B1” certificate and an *inter partes* reexamination certificate then issues, the *inter partes* reexamination certificate will be designated “C2” and NOT “C1.” Thus, by looking at the number following the “C,” one will be able to ascertain the number of reexamination certificates that preceded the certificate being viewed, i.e., how many prior reexamination certificates have been issued for the patent. (If this were not the practice and C1 were used, one would not be able to ascertain from the number on the certificate how many B certificates came before.)

The certificate denotes the date the certificate was issued at INID code [45] (see MPEP § 901.04). The title, name of inventor, international and U.S. classification, the abstract, and the list of prior art documents

appear at their respective INID code designations, much the same as is presently done in utility patents.

The primary differences, other than as indicated above, are:

(A) The filing date and number of the request is preceded by “Reexamination Request;”

(B) The patent for which the certificate is now issued is identified under the heading “Reexamination Certificate for”; and

(C) The prior art documents cited at INID code [56] will be only those which are part of the reexamination file and cited on forms PTO-1449 (and have not been crossed out because they were not considered) and PTO-892.

Finally, the certificate will identify the patent claims which were confirmed as patentable, canceled, disclaimed, and those claims not examined. Only the status of the confirmed, canceled, disclaimed, and not examined claims will be indicated in the certificate. The text of the new and amended claims will be printed in the certificate. Any new claims will be printed in the certificate completely in italics, and any amended claims will be printed in the certificate with italics and bracketing indicating the amendments thereto. Any prior court decisions will be identified, as well as the citation of the court decisions.

### **2691 Notice of *Inter Partes* Reexamination Certificate Issuance in *Official Gazette* [Added R-2]**

The *Official Gazette* notice will include bibliographic information, and an indication of the status of each claim after the termination of the reexamination proceeding. Additionally, a representative claim will be published along with an indication of any changes to the specification or drawing.

The notice of reexamination certificate will clearly state that it is a certificate for a concluded *inter partes* reexamination proceeding (as opposed to an *ex parte* reexamination proceeding).

### **2692 Distribution of Certificate [Added R-2]**

A copy of the *inter partes* reexamination certificate should be stapled to each copy of the patent in the search files. A copy of the certificate will also be



made a part of any patent copies prepared by the Office subsequent to the issuance of the certificate.

A copy of the *inter partes* reexamination certificate will also be forwarded to all depository libraries and to those foreign offices which have an exchange agreement with the Office.

## 2693 Intervening Rights [Added R-2]

35 U.S.C. 316. *Certificate of patentability, unpatentability and claim cancellation.*

\*\*\*\*\*

(b) AMENDED OR NEW CLAIM.— Any proposed amended or new claim determined to be patentable and incorporated into a patent following an *inter partes* reexamination proceeding shall have the same effect as that specified in section 252 of this title for reissued patents on the right of any person who made, purchased, or used within the United States, or imported into the United States, anything patented by such proposed amended or new claim, or who made substantial preparation therefor, prior to issuance of a certificate under the provisions of subsection (a) of this section.

The situation of intervening rights resulting from *inter partes* reexamination proceedings parallels the intervening rights situation resulting from reissue patents or from *ex parte* reexamination proceedings. The rights detailed in 35 U.S.C. 252 for reissue apply equally in reexamination and reissue situations. See *Fortel Corp. v. Phone-Mate, Inc.*, 825 F.2d 1577, 3 USPQ2d 1771 (Fed. Cir. 1987); *Kaufman Co., Inc. v. Lantech, Inc.*, 807 F.2d 970, 1 USPQ2d 1202 (Fed. Cir. 1986); *Tennant Co. v. Hako Minuteman, Inc.*, 4 USPQ2d 1167 (N.D. Ill. 1987); and *Key Mfg. Group, Inc. v. Microdot, Inc.*, 679 F.Supp. 648, 4 USPQ2d 1687 (E.D. Mich. 1987).

## 2694 Terminated Reexamination Files [Added R-2]

*Inter partes* reexamination proceedings may be terminated in one of three ways:

(A) The proceeding may be terminated by a denial of reexamination or vacating the reexamination proceeding. In either case, no reexamination certificate is issued.

A terminated reexamination file in which reexamination has been denied or vacated should be forwarded to the Central Reexamination Unit (CRU) if the file is not already there. The CRU will process the

file to provide the partial refund set forth in 37 CFR 1.26(c). The word “Terminated” will be written in green ink on the face of the file at the top, between the word “Reexamination” and the hand-written patent number. The reexamination file will then be given a 420 status (reexamination denied) or a 422 status (reexamination vacated) and forwarded to the Files Repository Unit for storage with the patent file.

(B) The proceeding may be terminated under 37 CFR 1.997(b) with the issuance of a reexamination certificate.

A reexamination proceeding that is terminated in this manner should be processed as set forth in MPEP § 2687 and then forwarded to the CRU for review, mailing of the NIRC, and forwarding the file to the Office of Publication.

(C) The proceeding may be terminated under 37 CFR 1.997(e) where the reexamination proceeding has been merged with a reissue proceeding and a reissue patent is granted; an individual reexamination certificate is not issued, but rather the reissue patent serves as the certificate.

A reexamination proceeding that is terminated in this manner should be processed, together with the reissue proceeding, as set forth in MPEP § 1455 and forwarded to the Office of Patent Legal Administration in accordance with MPEP § 1456.

## 2695 Reexamination of a Reexamination [Added R-2]

See MPEP § 2295 for guidance for the processing and examination of a reexamination request filed on a patent for which a reexamination certificate has already issued, or a reexamination certificate issues on a prior reexamination, while the new reexamination is pending. This reexamination request is generally referred to as a “reexamination of a reexamination.” A reexamination of a reexamination is processed in accordance with the guidelines set forth in MPEP § 2295 regardless of whether the reexamination certificate was issued for an *ex parte* reexamination or an *inter partes* reexamination, and regardless of whether the pending reexamination proceeding is an *ex parte* reexamination or an *inter partes* reexamination.

**2696 USPTO Forms To Be Used in *Inter Partes* Reexamination [Added R-2]**

cessing are as follows (these forms are not reproduced below):

The correct forms which are to be used by the Office in *inter partes* reexamination actions and pro-

(A) NOTICE OF FAILURE TO COMPLY WITH <i>INTER PARTES</i> REEXAMINATION REQUEST FEE REQUIREMENTS.....	PTOL 2057
(B) NOTICE OF <i>INTER PARTES</i> REEXAMINATION REQUEST FILING DATE.....	PTOL 2058
(C) NOTICE OF INCOMPLETE REQUEST FOR <i>INTER PARTES</i> REEXAMINATION.....	PTOL 2059
(D) NOTICE OF ASSIGNMENT OF <i>INTER PARTES</i> REEXAMINATION REQUEST.....	PTOL 2060
(E) NOTE TO SPRE/EXAMINER/TC PERSONNEL OF <i>INTER PARTES</i> REEXAMINATION DEADLINES.....	PTOL 2061
(F) NOTICE OF CONCURRENT PROCEEDING(S).....	PTOL 2062
(G) ORDER GRANTING/DENYING REQUEST FOR <i>INTER PARTES</i> REEXAMINATION.....	PTOL 2063
(H) OFFICE ACTION IN <i>INTER PARTES</i> REEXAMINATION.....	PTOL 2064
(I) ACTION CLOSING PROSECUTION (37 CFR 1.949).....	PTOL 2065
(J) RIGHT OF APPEAL NOTICE (37 CFR 1.953).....	PTOL 2066
(K) <i>INTER PARTES</i> REEXAMINATION NOTIFICATION REAPPEAL.....	PTOL 2067
(L) NOTICE OF INTENT TO ISSUE <i>INTER PARTES</i> REEXAMINATION CERTIFICATE.....	PTOL 2068
(M) REEXAMINATION REASONS FOR PATENTABILITY/CONFIRMATION.....	PTOL 476
(N) NOTICE OF DEFECTIVE PAPER IN <i>INTER PARTES</i> REEXAMINATION.....	PTOL 2069
(O) TRANSMITTAL OF COMMUNICATION TO THIRD PARTY REQUESTER – <i>INTER PARTES</i> REEXAMINATION.....	PTOL 2070
(P) <i>INTER PARTES</i> REEXAMINATION COMMUNICATION (WITH SSP).....	PTOL 2071
(Q) <i>INTER PARTES</i> REEXAMINATION COMMUNICATION (NO SSP).....	PTOL 2072
(R) EXAMINER CHECKLIST – REEXAMINATION.....	PTOL 1516
(S) REEXAMINATION CLERK CHECKLIST.....	PTOL 1517

A user Request for Reexamination Transmittal Form, PTO/SB/58, is provided for public use in filing

a request for *inter partes* reexamination; its use, however, is not mandatory.



MANUAL OF PATENT EXAMINING PROCEDURE

# Chapter 2700 Patent Terms and Extensions

- 2701 Patent Term
  - 2710 Term Extensions or Adjustments for Delays Within the USPTO Under 35 U.S.C. 154
  - 2720 Applications Filed Between June 8, 1995, and May 28, 2000
  - 2730 Applications Filed On or After May 29, 2000; Grounds for Adjustment
  - >2731 Period of Adjustment
  - 2732 Reduction of Period of Adjustment of Patent Term
  - 2733 Determination of Patent Term Adjustment
  - 2734 Application for Patent Term Adjustment; Due Care Showing
  - 2735 Request for Reconsideration of Patent Term Adjustment Determination
  - 2736 Third Party Papers<
  - 2750 Patent Term Extension for Delays at other Agencies Under 35 U.S.C. 156
  - 2751 Eligibility Requirements
  - 2752 Patent Term Extension Applicant
  - 2753 Application Contents
  - 2754 Filing Date
    - 2754.01 Deadline for Filing an Application Under 35 U.S.C. 156(d)(1)
    - 2754.02 Filing Window for an Application Under 35 U.S.C. 156(d)(5)
    - 2754.03 Filing of a Request for an Extension Under 35 U.S.C. 156(e)(2)
  - 2755 Eligibility Determination
    - 2755.01 Interim Extension of Patent Term During the Processing of the Application
    - 2755.02 Interim Extension of Patent Term Before Product Approval
  - 2756 Correspondence Between the USPTO and the Regulatory Agency
  - 2757 Regulatory Agency Determination of the Length of the Regulatory Review Period
    - 2757.01 Due Diligence Determination
  - 2758 Notice of Final Determination - Calculation of Patent Term Extension
  - 2759 Certificate of Extension of Patent Term
  - 2760 Trade Secret, Confidential, and Protective Order Material
  - 2761 Multiple Applications for Extension of Term of the Same Patent or of Different Patents for the Same Regulatory Review Period for a Product
  - 2762 Duty of Disclosure in Patent Term Extension Proceedings
  - 2763 Limitation of Third Party Participation
  - 2764 Express Withdrawal of Application for Extension of Patent Term
- 2701 Patent Term [R-2]**
- 35 U.S.C. 154. Contents and term of patent; provisional rights.*
- (a) IN GENERAL.—
- \*\*\*\*\*
- (2) TERM.—Subject to the payment of fees under this title, such grant shall be for a term beginning on the date on which the patent issues and ending 20 years from the date on which the application for the patent was filed in the United States or, if the application contains a specific reference to an earlier filed application or applications under section 120, 121, or 365(c) of this title, from the date on which the earliest such application was filed.
- (3) PRIORITY.—Priority under section 119, 365(a), or 365(b) of this title shall not be taken into account in determining the term of a patent.
- \*\*\*\*\*
- (c) CONTINUATION.—
- (1) DETERMINATION.—The term of a patent that is in force on or that results from an application filed before the date that is 6 months after the date of the enactment of the Uruguay Round Agreements Act shall be the greater of the 20-year term as provided in subsection (a), or 17 years from grant, subject to any terminal disclaimers.
- (2) REMEDIES.—The remedies of sections 283, 284, and 285 of this title shall not apply to acts which —
- (A) were commenced or for which substantial investment was made before the date that is 6 months after the date of the enactment of the Uruguay Round Agreements Act; and
- (B) became infringing by reason of paragraph (1).
- (3) REMUNERATION.—The acts referred to in paragraph (2) may be continued only upon the payment of an equitable remuneration to the patentee that is determined in an action brought under chapter 28 and chapter 29 (other than those provisions excluded by paragraph (2)) of this title.
- \*\*\*\*\*
- For applications filed on or after June 8, 1995, Section 532(a)(1) of the Uruguay Round Agreements Act (Pub. L. 103-465, 108 Stat. 4809 (1994)) amended 35 U.S.C. 154 to provide that the term of a patent (other than a design patent) begins on the date the patent issues and ends on the date that is twenty years from the date on which the application for the patent was filed in the United States or, if the application contains a specific reference to an earlier filed application or applications under 35 U.S.C. 120, 121, or 365(c), twenty years from the filing date of the

earliest of such application(s). This patent term provision is referred to as the “twenty-year term.” Design patents have a term of fourteen years from the date of patent grant. See 35 U.S.C. 173 and MPEP § 1505.

All patents (other than design patents) that were in force on June 8, 1995, or that issued on an application that was filed before June 8, 1995, have a term that is the greater of the “twenty-year term” or seventeen years from the patent grant. See 35 U.S.C. 154(c). A patent granted on an international application filed before June 8, 1995, and which entered the national stage under 35 U.S.C. 371 before, on or after June 8, 1995, will have a term that is the greater of seventeen years from the date of grant or twenty years from the international filing date or any earlier filing date relied upon under 35 U.S.C. 120, 121 or 365(c). The terms of these patents are subject to reduction by any applicable terminal disclaimers (discussed below).

### **CONTINUING APPLICATIONS**

A patent granted on a continuation, divisional, or continuation-in-part application that was filed on or after June 8, 1995, will have a term which ends twenty years from the filing date of earliest application for which a benefit is claimed under 35 U.S.C. 120, 121, or 365(c), regardless of whether the application for which a benefit is claimed under 35 U.S.C. 120, 121, or 365(c) was filed prior to June 8, 1995.

### **INTERNATIONAL APPLICATIONS**

A patent granted on an international application filed on or after June 8, 1995 and which enters the national stage under 35 U.S.C. 371 will have a term which ends twenty years from the filing date of the international application. A continuation or a continuation-in-part application claiming benefit under 35 U.S.C. 365(c) of an international application filed under 35 U.S.C. 363 designating the United States will have a term which ends twenty years from the filing date of the parent international application.

### **FOREIGN PRIORITY**

Foreign priority under 35 U.S.C. 119(a)-(d), 365(a), or 365(b) is not considered in determining the term of a patent. Accordingly, an application claiming priority under 35 U.S.C. 365(a) or 365(b) has a term which ends twenty years from the filing date of the applica-

tion in the United States and not the prior international application.

### **DOMESTIC PRIORITY UNDER 35 U.S.C. 119(e)**

Domestic priority under 35 U.S.C. 119(e) to one or more U.S. provisional applications is not considered in the calculation of the twenty-year term. See 35 U.S.C. 154(a)(3).

### **EXPIRATION DATE OF PATENTS WITH TERMINAL DISCLAIMERS**

To determine the “original expiration date” of a patent subject to a terminal disclaimer, it is generally necessary to examine the language of the terminal disclaimer in the patent file history. If the disclaimer disclaims the terminal portion of the term of the patent which would extend beyond the expiration date of an earlier issued patent, then the expiration date of the earlier issued patent determines the expiration date of the patent subject to the terminal disclaimer. Before June 8, 1995, the terminal disclaimer date was printed on the face of the patent; the date was determined from the expected expiration date of the earlier issued patent based on a seventeen year term measured from grant. When 35 U.S.C. 154 was amended such that all patents (other than design patents) that were in force on June 8, 1995, or that issued on an application that was filed before June 8, 1995, have a term that is the greater of the “twenty year term” or seventeen years from the patent grant, the terminal disclaimer date as printed on many patents became incorrect. If the terminal disclaimer of record in the patent file disclaims the terminal portion of the patent subsequent to the full statutory term of a referenced patent (without identifying a specific date), then the date printed on the face of the patent is incorrect when the full statutory term of the referenced patent is changed as a result of 35 U.S.C. 154(c). That is, the referenced patent’s “twenty year term” is longer than the seventeen year term. In such a case, a patentee may request a Certificate of Correction under 37 CFR 1.323 to correct the information printed on the face of the patent. However, if the terminal disclaimer of record in the patent file disclaims the terminal portion of the patent subsequent to a specific date, without reference to the full statutory term of a referenced patent, then the expiration date is the date specified. Several decisions related to disclaimers are posted in the Freedom

of Information Act (FOIA) section of the USPTO Internet site (www.uspto.gov).

## PATENT TERM EXTENSIONS OR ADJUSTMENTS

See MPEP § 2710, *et seq.*, for patent term extensions or adjustments for delays within the USPTO under 35 U.S.C. 154 for utility and plant patents issuing on applications filed on or after June 8, 1995. Patents that issue from applications filed before June 8, 1995, are not eligible for >patent term extension or patent< term adjustment under 35 U.S.C. 154.

See MPEP § 2750 *et. seq.* for patent term extensions available under 35 U.S.C. 156 for premarket regulatory review. The patent term extension that may be available under 35 U.S.C. 156 for premarket regulatory review is separate from and will be added to any extension that may be available under former and current 35 U.S.C. 154. While patents that issue from applications filed before June 8, 1995, are not eligible for term adjustment under 35 U.S.C. 154, such patents may be extended under 35 U.S.C. 156.

### 2710 Term Extensions or Adjustments for Delays Within the USPTO Under 35 U.S.C. 154 [R-2]

Utility and plant patents issuing on applications filed on or after June 8, 1995, but before May 29, 2000, are eligible for the patent term \*\* extension \* provisions of former 35 U.S.C. 154(b) and 37 CFR 1.701. See MPEP § 2720. Utility and plant patents issuing on applications filed on or after May 29, 2000 are eligible for the patent term adjustment provisions of 35 U.S.C. 154(b)(amended, effective May 29, 2000) and 37 CFR 1.702-1.705. See MPEP § 2730.

Plant and utility patents issuing on applications filed before June 8, 1995 which have a term that is the greater of the “twenty-year term” (see MPEP § 2701) or seventeen years from patent grant are not eligible for term extension or adjustment due to delays in processing the patent application by the United States Patent and Trademark Office.

Since the term of a design patent is not affected by the length of time prosecution takes place, there are no patent term adjustment provisions for design patents.

### 2720 Applications Filed Between June 8, 1995, and May 28, 2000 [R-2]

*Former 35 U.S.C. 154. Contents and term of patent.*

\*\*\*\*\*

#### (b) TERM EXTENSION.—

(1) INTERFERENCE DELAY OR SECRECY ORDERS.—If the issue of an original patent is delayed due to a proceeding under section 135(a) of this title, or because the application for patent is placed under an order pursuant to section 181 of this title, the term of the patent shall be extended for the period of delay, but in no case more than 5 years.

(2) EXTENSION FOR APPELLATE REVIEW.—If the issue of a patent is delayed due to appellate review by the Board of Patent Appeals and Interferences or by a Federal court and the patent is issued pursuant to a decision in the review reversing an adverse determination of patentability, the term of the patent shall be extended for a period of time but in no case more than 5 years. A patent shall not be eligible for extension under this paragraph if it is subject to a terminal disclaimer due to the issue of another patent claiming subject matter that is not patentably distinct from that under appellate review.

(3) LIMITATIONS.—The period of extension referred to in paragraph (2)—

(A) shall include any period beginning on the date on which an appeal is filed under section 134 or 141 of this title, or on which an action is commenced under section 145 of this title, and ending on the date of a final decision in favor of the applicant;

(B) shall be reduced by any time attributable to appellate review before the expiration of 3 years from the filing date of the application for patent; and

(C) shall be reduced for the period of time during which the applicant for patent did not act with due diligence, as determined by the Commissioner.

(4) LENGTH OF EXTENSION.—The total duration of all extensions of a patent under this subsection shall not exceed 5 years.

\*\*\*\*\*

*37 CFR 1.701. Extension of patent term due to examination delay under the Uruguay Round Agreements Act (original applications, other than designs, filed on or after June 8, 1995, and before May 29, 2000).*

(a) A patent, other than for designs, issued on an application filed on or after June 8, 1995, is entitled to extension of the patent term if the issuance of the patent was delayed due to:

(1) Interference proceedings under 35 U.S.C. 135(a); and/or

(2) The application being placed under a secrecy order under 35 U.S.C. 181; and/or

(3) \*\*>Appellate review by the Board of Patent Appeals and Interferences or by a Federal court under 35 U.S.C. 141 or 145, if the patent was issued pursuant to a decision in the review reversing an adverse determination of patentability and if the patent is not subject to a terminal disclaimer due to the issuance of



another patent claiming subject matter that is not patentably distinct from that under appellate review. If an application is remanded by a panel of the Board of Patent Appeals and Interferences and the remand is the last action by a panel of the Board of Patent Appeals and Interferences prior to the mailing of a notice of allowance under 35 U.S.C. 151 in the application, the remand shall be considered a decision in the review reversing an adverse determination of patentability as that phrase is used in 35 U.S.C. 154(b)(2) as amended by section 532(a) of the Uruguay Round Agreements Act, Public Law 103-465, 108 Stat. 4809, 4983-85 (1994), and a final decision in favor of the applicant under paragraph (c)(3) of this section. A remand by a panel of the Board of Patent Appeals and Interferences shall not be considered a decision in the review reversing an adverse determination of patentability as provided in this paragraph if there is filed a request for continued examination under 35 U.S.C. 132(b) that was not first preceded by the mailing, after such remand, of at least one of an action under 35 U.S.C. 132 or a notice of allowance under 35 U.S.C. 151.<

(b) The term of a patent entitled to extension under paragraph (a) of this section shall be extended for the sum of the periods of delay calculated under paragraphs (c)(1), (c)(2), (c)(3) and (d) of this section, to the extent that these periods are not overlapping, up to a maximum of five years. The extension will run from the expiration date of the patent.

(c)(1) The period of delay under paragraph (a)(1) of this section for an application is the sum of the following periods, to the extent that the periods are not overlapping:

(i) With respect to each interference in which the application was involved, the number of days, if any, in the period beginning on the date the interference was declared or redeclared to involve the application in the interference and ending on the date that the interference was terminated with respect to the application; and

(ii) The number of days, if any, in the period beginning on the date prosecution in the application was suspended by the Patent and Trademark Office due to interference proceedings under 35 U.S.C. 135(a) not involving the application and ending on the date of the termination of the suspension.

(2) The period of delay under paragraph (a)(2) of this section for an application is the sum of the following periods, to the extent that the periods are not overlapping:

(i) The number of days, if any, the application was maintained in a sealed condition under 35 U.S.C. 181;

(ii) The number of days, if any, in the period beginning on the date of mailing of an examiner's answer under § 1.193 in the application under secrecy order and ending on the date the secrecy order and any renewal thereof was removed;

(iii) The number of days, if any, in the period beginning on the date applicant was notified that an interference would be declared but for the secrecy order and ending on the date the secrecy order and any renewal thereof was removed; and

(iv) The number of days, if any, in the period beginning on the date of notification under § 5.3(c) and ending on the date of mailing of the notice of allowance under § 1.311.

(3) The period of delay under paragraph (a)(3) of this section is the sum of the number of days, if any, in the period begin-

ning on the date on which an appeal to the Board of Patent Appeals and Interferences was filed under 35 U.S.C. 134 and ending on the date of a final decision in favor of the applicant by the Board of Patent Appeals and Interferences or by a Federal court in an appeal under 35 U.S.C. 141 or a civil action under 35 U.S.C. 145.

(d) The period of delay set forth in paragraph (c)(3) shall be reduced by:

(1) Any time during the period of appellate review that occurred before three years from the filing of the first national application for patent presented for examination; and

\*\*>

(2) Any time during the period of appellate review, as determined by the Director, during which the applicant for patent did not act with due diligence. In determining the due diligence of an applicant, the Director may examine the facts and circumstances of the applicant's actions during the period of appellate review to determine whether the applicant exhibited that degree of timeliness as may reasonably be expected from, and which is ordinarily exercised by, a person during a period of appellate review.<

(e) The provisions of this section apply only to original patents, except for design patents, issued on applications filed on or after June 8, 1995, and before May 29, 2000.

The twenty-year term of a patent issuing from an application filed on or after June 8, 1995, and before May 29, 2000, may be extended for a maximum of five years for delays in the issuance of the patent due to interferences, secrecy orders and/or successful appeals to the Board of Patent Appeals and Interferences >(Board)< or the Federal courts in accordance with 37 CFR 1.701. See former 35 U.S.C. 154(b), as reproduced above. Extensions for successful appeals are limited in that the patent must not be subject to a terminal disclaimer. Further, the period of extension will be reduced by any time attributable to appellate review within three years of the filing date of the >first national< application >for patent<, and the period of extension for appellate review will be reduced by any time during which the applicant did not act with due diligence. The patent term extension that may be available under 35 U.S.C. 156 for premarket regulatory review is separate from and will be added to any extension that may be available under former and current 35 U.S.C. 154. See MPEP § 2750 *et seq.* 35 U.S.C. 154(b) was amended, effective May 29, 2000, to provide for patent term adjustment for applications filed on or after May 29, 2000, but the provisions of former 35 U.S.C. 154(b), as reproduced above, continue to apply to applications filed between and including June 8, 1995 and May 28, 2000.

Examiners make no decisions regarding patent term extensions. Extensions under former 35 U.S.C. 154 will be calculated by PALM and will be printed on the Notice of Allowance and Issue Fee Due. Any patent term extension granted as a result of administrative delay pursuant to 37 CFR 1.701 will also be printed on the face of the patent in generally the same location as the terminal disclaimer information. The term of a patent will be readily discernible from the face of the patent (i.e., from the filing date, continuing data, issue date and any patent term extensions printed on the patent).

If applicant disagrees with the patent term extension \*\* information printed on the Notice of Allowance and \*\*>Fee(s)< Due, applicant may request review by way of a petition under 37 CFR 1.181. To avoid loss of patent term, however, any such petitions filed during the pendency of the application will not be decided until after issuance of the patent. If the petition is granted, a Certificate of Correction pursuant to 37 CFR 1.322 will be issued. If \*\*>the patent issues with a different patent term extension value than that indicated on the Notice of Allowance or Office computer records (Patent Application Information Retrieval (PAIR))<, patentee may seek correction of the patent term extension information by filing a request for a Certificate of Correction pursuant to 37 CFR 1.322.

>Effective May 24, 2004, 37 CFR 1.701(a)(3) was amended to indicate that certain remands by the Board shall be considered “a decision in the review reversing an adverse determination of patentability” for patent term extension purposes. Any request for reconsideration of the patent term extension indicated on a patent resulting from an application in which the notice of allowance was mailed before May 24, 2004 on the basis of the changes to 37 CFR 1.701 must be filed no later than July 21, 2004.<

Petitions and Certificates of Correction regarding patent term extension under former 35 U.S.C. 154(b) should be addressed to \*\*>Mail Stop Patent Ext., Commissioner for Patents, P.O. Box 1450, Alexandria, Virginia 22313-1450<.

## 2730 Applications Filed on or After May 29, 2000; Grounds for Adjustment [R-2]

35 U.S.C. 154. *Contents and term of patent; provisional rights.*

\*\*\*\*\*

(b) ADJUSTMENT OF PATENT TERM.—

(1) PATENT TERM GUARANTEES.—

(A) GUARANTEE OF PROMPT PATENT AND TRADEMARK OFFICE RESPONSES.— Subject to the limitations under paragraph (2), if the issue of an original patent is delayed due to the failure of the Patent and Trademark Office to—

(i) provide at least one of the notifications under section 132 of this title or a notice of allowance under section 151 of this title not later than 14 months after—

(I) the date on which an application was filed under section 111(a) of this title; or

(II) the date on which an international application fulfilled the requirements of section 371 of this title;

(ii) respond to a reply under section 132, or to an appeal taken under section 134, within 4 months after the date on which the reply was filed or the appeal was taken;

(iii) act on an application within 4 months after the date of a decision by the Board of Patent Appeals and Interferences under section 134 or 135 or a decision by a Federal court under section 141, 145, or 146 in a case in which allowable claims remain in the application; or

(iv) issue a patent within 4 months after the date on which the issue fee was paid under section 151 and all outstanding requirements were satisfied, the term of the patent shall be extended 1 day for each day after the end of the period specified in clause (i), (ii), (iii), or (iv), as the case may be, until the action described in such clause is taken.

(B) GUARANTEE OF NO MORE THAN 3-YEAR APPLICATION PENDENCY.— Subject to the limitations under paragraph (2), if the issue of an original patent is delayed due to the failure of the United States Patent and Trademark Office to issue a patent within 3 years after the actual filing date of the application in the United States, not including—

(i) any time consumed by continued examination of the application requested by the applicant under section 132(b);

(ii) any time consumed by a proceeding under section 135(a), any time consumed by the imposition of an order under section 181, or any time consumed by appellate review by the Board of Patent Appeals and Interferences or by a Federal court; or

(iii) any delay in the processing of the application by the United States Patent and Trademark Office requested by the applicant except as permitted by paragraph (3)(C), the term of the patent shall be extended 1 day for each day after the end of that 3-year period until the patent is issued.

(C) GUARANTEE OR ADJUSTMENTS FOR DELAYS DUE TO INTERFERENCES, SECRECY ORDERS,

AND APPEALS.— Subject to the limitations under paragraph (2), if the issue of an original patent is delayed due to—

- (i) a proceeding under section 135(a);
- (ii) the imposition of an order under section 181; or
- (iii) appellate review by the Board of Patent Appeals and Interferences or by a Federal court in a case in which

the patent was issued under a decision in the review reversing an adverse determination of patentability, the term of the patent shall be extended 1 day for each day of the pendency of the proceeding, order, or review, as the case may be.

(2) LIMITATIONS.—

(A) IN GENERAL.— To the extent that periods of delay attributable to grounds specified in paragraph (1) overlap, the period of any adjustment granted under this subsection shall not exceed the actual number of days the issuance of the patent was delayed.

(B) DISCLAIMED TERM.— No patent the term of which has been disclaimed beyond a specified date may be adjusted under this section beyond the expiration date specified in the disclaimer.

(C) REDUCTION OF PERIOD OF ADJUSTMENT.—

(i) The period of adjustment of the term of a patent under paragraph (1) shall be reduced by a period equal to the period of time during which the applicant failed to engage in reasonable efforts to conclude prosecution of the application.

(ii) With respect to adjustments to patent term made under the authority of paragraph (1)(B), an applicant shall be deemed to have failed to engage in reasonable efforts to conclude processing or examination of an application for the cumulative total of any periods of time in excess of 3 months that are taken to respond to a notice from the Office making any rejection, objection, argument, or other request, measuring such 3-month period from the date the notice was given or mailed to the applicant.

(iii) The Director shall prescribe regulations establishing the circumstances that constitute a failure of an applicant to engage in reasonable efforts to conclude processing or examination of an application.

(3) PROCEDURES FOR PATENT TERM ADJUSTMENT DETERMINATION.—

(A) The Director shall prescribe regulations establishing procedures for the application for and determination of patent term adjustments under this subsection.

(B) Under the procedures established under subparagraph (A), the Director shall—

(i) make a determination of the period of any patent term adjustment under this subsection, and shall transmit a notice of that determination with the written notice of allowance of the application under section 151; and

(ii) provide the applicant one opportunity to request reconsideration of any patent term adjustment determination made by the Director.

(C) The Director shall reinstate all or part of the cumulative period of time of an adjustment under paragraph (2)(C) if the applicant, prior to the issuance of the patent, makes a showing that, in spite of all due care, the applicant was unable to respond

within the 3-month period, but in no case shall more than three additional months for each such response beyond the original 3-month period be reinstated.

(D) The Director shall proceed to grant the patent after completion of the Director's determination of a patent term adjustment under the procedures established under this subsection, notwithstanding any appeal taken by the applicant of such determination.

(4) APPEAL OF PATENT TERM ADJUSTMENT DETERMINATION.—

(A) An applicant dissatisfied with a determination made by the Director under paragraph (3) shall have remedy by a civil action against the Director filed in the United States District Court for the District of Columbia within 180 days after the grant of the patent. Chapter 7 of title 5, United States Code, shall apply to such action. Any final judgment resulting in a change to the period of adjustment of the patent term shall be served on the Director, and the Director shall thereafter alter the term of the patent to reflect such change.

(B) The determination of a patent term adjustment under this subsection shall not be subject to appeal or challenge by a third party prior to the grant of the patent.

\*\*\*\*\*

*37 CFR 1.702. Grounds for adjustment of patent term due to examination delay under the Patent Term Guarantee Act of 1999 (original applications, other than designs, filed on or after May 29, 2000).*

(a) *Failure to take certain actions within specified time frames.* Subject to the provisions of 35 U.S.C. 154(b) and this subpart, the term of an original patent shall be adjusted if the issuance of the patent was delayed due to the failure of the Office to:

(1) Mail at least one of a notification under 35 U.S.C. 132 or a notice of allowance under 35 U.S.C. 151 not later than fourteen months after the date on which the application was filed under 35 U.S.C. 111(a) or fulfilled the requirements of 35 U.S.C. 371 in an international application;

(2) Respond to a reply under 35 U.S.C. 132 or to an appeal taken under 35 U.S.C. 134 not later than four months after the date on which the reply was filed or the appeal was taken;

(3) Act on an application not later than four months after the date of a decision by the Board of Patent Appeals and Interferences under 35 U.S.C. 134 or 135 or a decision by a Federal court under 35 U.S.C. 141, 145, or 146 where at least one allowable claim remains in the application; or

(4) Issue a patent not later than four months after the date on which the issue fee was paid under 35 U.S.C. 151 and all outstanding requirements were satisfied.

(b) *Failure to issue a patent within three years of the actual filing date of the application.* Subject to the provisions of 35 U.S.C. 154(b) and this subpart, the term of an original patent shall be adjusted if the issuance of the patent was delayed due to the failure of the Office to issue a patent within three years after the date on which the application was filed under 35 U.S.C. 111(a) or the national stage commenced under 35 U.S.C. 371(b) or (f) in an international application, but not including:

(1) Any time consumed by continued examination of the application under 35 U.S.C. 132(b);

(2) Any time consumed by an interference proceeding under 35 U.S.C. 135(a);

(3) Any time consumed by the imposition of a secrecy order under 35 U.S.C. 181;

(4) Any time consumed by review by the Board of Patent Appeals and Interferences or a Federal court; or

(5) Any delay in the processing of the application by the Office that was requested by the applicant.

(c) *Delays caused by interference proceedings.* Subject to the provisions of 35 U.S.C. 154(b) and this subpart, the term of an original patent shall be adjusted if the issuance of the patent was delayed due to interference proceedings under 35 U.S.C. 135(a).

(d) *Delays caused by secrecy order.* Subject to the provisions of 35 U.S.C. 154(b) and this subpart, the term of an original patent shall be adjusted if the issuance of the patent was delayed due to the application being placed under a secrecy order under 35 U.S.C. 181.

(e) *Delays caused by successful appellate review.* Subject to the provisions of 35 U.S.C. 154(b) and this subpart, the term of an original patent shall be adjusted if the issuance of the patent was delayed due to review by the Board of Patent Appeals and Interferences under 35 U.S.C. 134 or by a Federal court under 35 U.S.C. 141 or 145, if the patent was issued under a decision in the review reversing an adverse determination of patentability. If an application is remanded by a panel of the Board of Patent Appeals and Interferences and the remand is the last action by a panel of the Board of Patent Appeals and Interferences prior to the mailing of a notice of allowance under 35 U.S.C. 151 in the application, the remand shall be considered a decision by the Board of Patent Appeals and Interferences as that phrase is used in 35 U.S.C. 154(b)(1)(A)(iii), a decision in the review reversing an adverse determination of patentability as that phrase is used in 35 U.S.C. 154(b)(1)(C)(iii), and a final decision in favor of the applicant under § 1.703(e). A remand by a panel of the Board of Patent Appeals and Interferences shall not be considered a decision in the review reversing an adverse determination of patentability as provided in this paragraph if there is filed a request for continued examination under 35 U.S.C. 132(b) that was not first preceded by the mailing, after such remand, of at least one of an action under 35 U.S.C. 132 or a notice of allowance under 35 U.S.C. 151.<

(f) The provisions of this section and §§1.703 through 1.705 apply only to original applications, except applications for a design patent, filed on or after May 29, 2000, and patents issued on such applications.

35 U.S.C. 154(b), as amended effective May 29, 2000, and 37 CFR 1.702-1.705 apply to utility and plant patent applications filed on or after May 29, 2000. All references to 35 U.S.C. 154(b) hereinafter are to 35 U.S.C. 154(b), as amended effective May 29, 2000.

37 CFR 1.702 sets forth the bases for patent term adjustment under 35 U.S.C. 154(b)(1).

37 CFR 1.702(a) indicates that a patent is entitled to patent term adjustment if the Office fails to perform certain acts of examination within specified time frames (35 U.S.C. 154(b)(1)(A)).

37 CFR 1.702(b) indicates that a patent is entitled to patent term adjustment if, subject to a number of limitations, the Office fails to issue a patent within three years of the actual filing date of the application (35 U.S.C. 154(b)(1)(B)). In the case of an international application, the phrase “actual filing date of the application in the United States” means the date the national stage commenced under 35 U.S.C. 371(b) or (f). See *Changes to Implement Patent Term Adjustment Under Twenty-Year Patent Term*, 65 FR 56366, 56382-84, (Sept. 18, 2000), 1239 *Off. Gaz. Pat. Office* 14, 28-30 (Oct. 3, 2000).

37 CFR 1.702(c) indicates that a patent is entitled to patent term adjustment if the issuance of the patent was delayed by an interference proceeding (35 U.S.C. 154(b)(1)(C)(i)). 37 CFR 1.702(d) indicates that a patent is entitled to patent term adjustment if the issuance of the patent was delayed by the application being placed under a secrecy order under 35 U.S.C. 181 (35 U.S.C. 154(b)(1)(C)(ii)). 37 CFR 1.702(e) indicates that a patent is entitled to patent term adjustment if the issuance of the patent was delayed by successful appellate review under 35 U.S.C. 134, 141, or 145 (35 U.S.C. 154(b)(1)(C)(iii)).

>Effective May 24, 2004, 37 CFR 1.702(e) was amended to indicate that certain remands by the Board of Patent Appeals and Interferences shall be considered “a decision in the review reversing an adverse determination of patentability” for patent term adjustment purposes. Any request for reconsideration of the patent term adjustment indicated on a patent resulting from an application in which the notice of allowance was mailed before May 24, 2004 on the basis of the changes to 37 CFR 1.702 must be filed no later than July 21, 2004.<

37 CFR 1.702(f) provides that the provisions of 37 CFR 1.702 through 1.705 apply only to original (i.e., non-reissue) applications, except applications for a design patent, filed on or after May 29, 2000, and patents issued on such applications. Since a continued prosecution application (CPA) filed under 37 CFR 1.53(d) is a new (continuing) application, a CPA filed on or after May 29, 2000, >and before July 14, 2003,< is entitled to the benefits of the patent term adjustment

provisions of 35 U.S.C. 154(b) and 37 CFR 1.702 through 1.705. Since a request for continued examination (RCE) filed under 35 U.S.C. 132(b) and 37 CFR 1.114 is **not** a new application (it is a submission in a previously filed application), filing an RCE in an application filed before May 29, 2000, does **not** cause that application to be entitled to the benefits of the patent term adjustment provisions of 35 U.S.C. 154(b) and 37 CFR 1.702 through 1.705.

*37 CFR 1.703. Period of adjustment of patent term due to examination delay.*

(a) The period of adjustment under § 1.702(a) is the sum of the following periods:

(1) The number of days, if any, in the period beginning on the day after the date that is fourteen months after the date on which the application was filed under 35 U.S.C. 111(a) or fulfilled the requirements of 35 U.S.C. 371 and ending on the date of mailing of either an action under 35 U.S.C. 132, or a notice of allowance under 35 U.S.C. 151, whichever occurs first;

(2) The number of days, if any, in the period beginning on the day after the date that is four months after the date a reply under § 1.111 was filed and ending on the date of mailing of either an action under 35 U.S.C. 132, or a notice of allowance under 35 U.S.C. 151, whichever occurs first;

(3) The number of days, if any, in the period beginning on the day after the date that is four months after the date a reply in compliance with § 1.113(c) was filed and ending on the date of mailing of either an action under 35 U.S.C. 132, or a notice of allowance under 35 U.S.C. 151, whichever occurs first;

(4) The number of days, if any, in the period beginning on the day after the date that is four months after the date an appeal brief in compliance with § 1.192 was filed and ending on the date of mailing of any of an examiner's answer under § 1.193, an action under 35 U.S.C. 132, or a notice of allowance under 35 U.S.C. 151, whichever occurs first;

(5) The number of days, if any, in the period beginning on the day after the date that is four months after the date of a final decision by the Board of Patent Appeals and Interferences or by a Federal court in an appeal under 35 U.S.C. 141 or a civil action under 35 U.S.C. 145 or 146 where at least one allowable claim remains in the application and ending on the date of mailing of either an action under 35 U.S.C. 132 or a notice of allowance under 35 U.S.C. 151, whichever occurs first; and

(6) The number of days, if any, in the period beginning on the day after the date that is four months after the date the issue fee was paid and all outstanding requirements were satisfied and ending on the date a patent was issued.

(b) The period of adjustment under § 1.702(b) is the number of days, if any, in the period beginning on the day after the date that is three years after the date on which the application was filed under 35 U.S.C. 111(a) or the national stage commenced under 35 U.S.C. 371(b) or (f) in an international application and ending on the date a patent was issued, but not including the sum of the following periods:

(1) The number of days, if any, in the period beginning on the date on which a request for continued examination of the application under 35 U.S.C. 132(b) was filed and ending on the date the patent was issued;

(2)(i) The number of days, if any, in the period beginning on the date an interference was declared or redeclared to involve the application in the interference and ending on the date that the interference was terminated with respect to the application; and

(ii) The number of days, if any, in the period beginning on the date prosecution in the application was suspended by the Office due to interference proceedings under 35 U.S.C. 135(a) not involving the application and ending on the date of the termination of the suspension;

(3)(i) The number of days, if any, the application was maintained in a sealed condition under 35 U.S.C. 181;

(ii) The number of days, if any, in the period beginning on the date of mailing of an examiner's answer under § 1.193 in the application under secrecy order and ending on the date the secrecy order was removed;

(iii) The number of days, if any, in the period beginning on the date applicant was notified that an interference would be declared but for the secrecy order and ending on the date the secrecy order was removed; and

(iv) The number of days, if any, in the period beginning on the date of notification under § 5.3(c) of this chapter and ending on the date of mailing of the notice of allowance under 35 U.S.C. 151; and,

(4) The number of days, if any, in the period beginning on the date on which a notice of appeal to the Board of Patent Appeals and Interferences was filed under 35 U.S.C. 134 and § 1.191 and ending on the date of the last decision by the Board of Patent Appeals and Interferences or by a Federal court in an appeal under 35 U.S.C. 141 or a civil action under 35 U.S.C. 145, or on the date of mailing of either an action under 35 U.S.C. 132, or a notice of allowance under 35 U.S.C. 151, whichever occurs first, if the appeal did not result in a decision by the Board of Patent Appeals and Interferences.

(c) The period of adjustment under § 1.702(c) is the sum of the following periods, to the extent that the periods are not overlapping:

(1) The number of days, if any, in the period beginning on the date an interference was declared or redeclared to involve the application in the interference and ending on the date that the interference was terminated with respect to the application; and

(2) The number of days, if any, in the period beginning on the date prosecution in the application was suspended by the Office due to interference proceedings under 35 U.S.C. 135(a) not involving the application and ending on the date of the termination of the suspension.

(d) The period of adjustment under § 1.702(d) is the sum of the following periods, to the extent that the periods are not overlapping:

(1) The number of days, if any, the application was maintained in a sealed condition under 35 U.S.C. 181;

(2) The number of days, if any, in the period beginning on the date of mailing of an examiner's answer under § 1.193 in the

application under secrecy order and ending on the date the secrecy order was removed;

(3) The number of days, if any, in the period beginning on the date applicant was notified that an interference would be declared but for the secrecy order and ending on the date the secrecy order was removed; and

(4) The number of days, if any, in the period beginning on the date of notification under § 5.3(c) of this chapter and ending on the date of mailing of the notice of allowance under 35 U.S.C. 151.

(e) The period of adjustment under § 1.702(e) is the sum of the number of days, if any, in the period beginning on the date on which a notice of appeal to the Board of Patent Appeals and Interferences was filed under 35 U.S.C. 134 and § 1.191 and ending on the date of a final decision in favor of the applicant by the Board of Patent Appeals and Interferences or by a Federal court in an appeal under 35 U.S.C. 141 or a civil action under 35 U.S.C. 145.

(f) ~~\*\*>~~The adjustment will run from the expiration date of the patent as set forth in 35 U.S.C. 154(a)(2). To the extent that periods of delay attributable to the grounds specified in §1.702 overlap, the period of adjustment granted under this section shall not exceed the actual number of days the issuance of the patent was delayed. The term of a patent entitled to adjustment under § 1.702 and this section shall be adjusted for the sum of the periods calculated under paragraphs (a) through (e) of this section, to the extent that such periods are not overlapping, less the sum of the periods calculated under § 1.704. The date indicated on any certificate of mailing or transmission under § 1.8 shall not be taken into account in this calculation.<

(g) No patent, the term of which has been disclaimed beyond a specified date, shall be adjusted under § 1.702 and this section beyond the expiration date specified in the disclaimer.

#### *37 CFR 1.704. Reduction of period of adjustment of patent term.*

(a) The period of adjustment of the term of a patent under § 1.703(a) through (e) shall be reduced by a period equal to the period of time during which the applicant failed to engage in reasonable efforts to conclude prosecution (processing or examination) of the application.

(b) With respect to the grounds for adjustment set forth in §§ 1.702(a) through (e), and in particular the ground of adjustment set forth in § 1.702(b), an applicant shall be deemed to have failed to engage in reasonable efforts to conclude processing or examination of an application for the cumulative total of any periods of time in excess of three months that are taken to reply to any notice or action by the Office making any rejection, objection, argument, or other request, measuring such three-month period from the date the notice or action was mailed or given to the applicant, in which case the period of adjustment set forth in § 1.703 shall be reduced by the number of days, if any, beginning on the day after the date that is three months after the date of mailing or transmission of the Office communication notifying the applicant of the rejection, objection, argument, or other request and ending on the date the reply was filed. The period, or shortened statutory period, for reply that is set in the Office action or notice has no effect on the three-month period set forth in this paragraph.

(c) Circumstances that constitute a failure of the applicant to engage in reasonable efforts to conclude processing or examination of an application also include the following circumstances, which will result in the following reduction of the period of adjustment set forth in § 1.703 to the extent that the periods are not overlapping:

(1) Suspension of action under § 1.103 at the applicant's request, in which case the period of adjustment set forth in § 1.703 shall be reduced by the number of days, if any, beginning on the date a request for suspension of action under § 1.103 was filed and ending on the date of the termination of the suspension;

(2) Deferral of issuance of a patent under § 1.314, in which case the period of adjustment set forth in § 1.703 shall be reduced by the number of days, if any, beginning on the date a request for deferral of issuance of a patent under § 1.314 was filed and ending on the date the patent was issued;

(3) Abandonment of the application or late payment of the issue fee, in which case the period of adjustment set forth in § 1.703 shall be reduced by the number of days, if any, beginning on the date of abandonment or the date after the date the issue fee was due and ending on the earlier of:

(i) The date of mailing of the decision reviving the application or accepting late payment of the issue fee; or

(ii) The date that is four months after the date the grantable petition to revive the application or accept late payment of the issue fee was filed;

(4) Failure to file a petition to withdraw the holding of abandonment or to revive an application within two months from the mailing date of a notice of abandonment, in which case the period of adjustment set forth in § 1.703 shall be reduced by the number of days, if any, beginning on the day after the date two months from the mailing date of a notice of abandonment and ending on the date a petition to withdraw the holding of abandonment or to revive the application was filed;

(5) Conversion of a provisional application under 35 U.S.C. 111(b) to a nonprovisional application under 35 U.S.C. 111(a) pursuant to 35 U.S.C. 111(b)(5), in which case the period of adjustment set forth in § 1.703 shall be reduced by the number of days, if any, beginning on the date the application was filed under 35 U.S.C. 111(b) and ending on the date a request in compliance with §1.53(c)(3) to convert the provisional application into a nonprovisional application was filed;

(6) Submission of a preliminary amendment or other preliminary paper less than one month before the mailing of an Office action under 35 U.S.C. 132 or notice of allowance under 35 U.S.C. 151 that requires the mailing of a supplemental Office action or notice of allowance, in which case the period of adjustment set forth in § 1.703 shall be reduced by the lesser of:

(i) The number of days, if any, beginning on the day after the mailing date of the original Office action or notice of allowance and ending on the date of mailing of the supplemental Office action or notice of allowance; or

(ii) Four months;

(7) Submission of a reply having an omission (§1.135(c)), in which case the period of adjustment set forth in § 1.703 shall be reduced by the number of days, if any, beginning on the day after the date the reply having an omission was filed and ending on the

date that the reply or other paper correcting the omission was filed;

(8) Submission of a supplemental reply or other paper, other than a supplemental reply or other paper expressly requested by the examiner, after a reply has been filed, in which case the period of adjustment set forth in § 1.703 shall be reduced by the number of days, if any, beginning on the day after the date the initial reply was filed and ending on the date that the supplemental reply or other such paper was filed;

(9) Submission of an amendment or other paper after a decision by the Board of Patent Appeals and Interferences, other than a decision designated as containing a new ground of rejection under § 1.196(b) or statement under § 1.196(c), or a decision by a Federal court, less than one month before the mailing of an Office action under 35 U.S.C. 132 or notice of allowance under 35 U.S.C. 151 that requires the mailing of a supplemental Office action or supplemental notice of allowance, in which case the period of adjustment set forth in § 1.703 shall be reduced by the lesser of:

(i) The number of days, if any, beginning on the day after the mailing date of the original Office action or notice of allowance and ending on the mailing date of the supplemental Office action or notice of allowance; or

(ii) Four months;

(10) Submission of an amendment under § 1.312 or other paper after a notice of allowance has been given or mailed, in which case the period of adjustment set forth in § 1.703 shall be reduced by the lesser of:

(i) The number of days, if any, beginning on the date the amendment under § 1.312 or other paper was filed and ending on the mailing date of the Office action or notice in response to the amendment under § 1.312 or such other paper; or

(ii) Four months; and

(11) Further prosecution via a continuing application, in which case the period of adjustment set forth in § 1.703 shall not include any period that is prior to the actual filing date of the application that resulted in the patent.

(d) **\*\*>**A paper containing only an information disclosure statement in compliance with §§ 1.97 and 1.98 will not be considered a failure to engage in reasonable efforts to conclude prosecution (processing or examination) of the application under paragraphs (c)(6), (c)(8), (c)(9), or (c)(10) of this section if it is accompanied by a statement that each item of information contained in the information disclosure statement was first cited in any communication from a foreign patent office in a counterpart application and that this communication was not received by any individual designated in § 1.56(c) more than thirty days prior to the filing of the information disclosure statement. This thirty-day period is not extendable.<

(e) Submission of an application for patent term adjustment under § 1.705(b) (with or without request under § 1.705(c) for reinstatement of reduced patent term adjustment) will not be considered a failure to engage in reasonable efforts to conclude prosecution (processing or examination) of the application under paragraph (c)(10) of this section.

### *37 CFR 1.705. Patent term adjustment determination*

(a) The notice of allowance will include notification of any patent term adjustment under 35 U.S.C. 154(b).

(b) Any request for reconsideration of the patent term adjustment indicated in the notice of allowance, except as provided in paragraph (d) of this section, and any request for reinstatement of all or part of the term reduced pursuant to § 1.704(b) must be by way of an application for patent term adjustment. An application for patent term adjustment under this section must be filed no later than the payment of the issue fee but may not be filed earlier than the date of mailing of the notice of allowance. An application for patent term adjustment under this section must be accompanied by:

(1) The fee set forth in § 1.18(e); and

(2) A statement of the facts involved, specifying:

(i) The correct patent term adjustment and the basis or bases under § 1.702 for the adjustment;

(ii) The relevant dates as specified in §§ 1.703(a) through (e) for which an adjustment is sought and the adjustment as specified in § 1.703(f) to which the patent is entitled;

(iii) Whether the patent is subject to a terminal disclaimer and any expiration date specified in the terminal disclaimer; and

(iv)(A) Any circumstances during the prosecution of the application resulting in the patent that constitute a failure to engage in reasonable efforts to conclude processing or examination of such application as set forth in § 1.704; or

(B) That there were no circumstances constituting a failure to engage in reasonable efforts to conclude processing or examination of such application as set forth in § 1.704.

(c) Any application for patent term adjustment under this section that requests reinstatement of all or part of the period of adjustment reduced pursuant to § 1.704(b) for failing to reply to a rejection, objection, argument, or other request within three months of the date of mailing of the Office communication notifying the applicant of the rejection, objection, argument, or other request must also be accompanied by:

(1) The fee set forth in § 1.18(f); and

**\*\*>**

(2) A showing to the satisfaction of the Director that, in spite of all due care, the applicant was unable to reply to the rejection, objection, argument, or other request within three months of the date of mailing of the Office communication notifying the applicant of the rejection, objection, argument, or other request. The Office shall not grant any request for reinstatement for more than three additional months for each reply beyond three months from the date of mailing of the Office communication notifying the applicant of the rejection, objection, argument, or other request.

(d) If there is a revision to the patent term adjustment indicated in the notice of allowance, the patent will indicate the revised patent term adjustment. If the patent indicates or should have indicated a revised patent term adjustment, any request for reconsideration of the patent term adjustment indicated in the patent must be filed within two months of the date the patent issued and must comply with the requirements of paragraphs (b)(1) and (b)(2) of this section. Any request for reconsideration

under this section that raises issues that were raised, or could have been raised, in an application for patent term adjustment under paragraph (b) of this section shall be dismissed as untimely as to those issues.

(e) The periods set forth in this section are not extendable.

(f) No submission or petition on behalf of a third party concerning patent term adjustment under 35 U.S.C. 154(b) will be considered by the Office. Any such submission or petition will be returned to the third party, or otherwise disposed of, at the convenience of the Office.

>

## 2731 Period of Adjustment [R-2]

*37 CFR 1.703. Period of adjustment of patent term due to examination delay.*

(a) The period of adjustment under § 1.702(a) is the sum of the following periods:

(1) The number of days, if any, in the period beginning on the day after the date that is fourteen months after the date on which the application was filed under 35 U.S.C. 111(a) or fulfilled the requirements of 35 U.S.C. 371 and ending on the date of mailing of either an action under 35 U.S.C. 132, or a notice of allowance under 35 U.S.C. 151, whichever occurs first;

(2) The number of days, if any, in the period beginning on the day after the date that is fourteen months after the date on which the application was filed under 35 U.S.C. 111(a) or fulfilled the requirements of 35 U.S.C. 371 and ending on the date of mailing of either an action under 35 U.S.C. 132, or a notice of allowance under 35 U.S.C. 151, whichever occurs first;

(3) The number of days, if any, in the period beginning on the day after the date that is four months after the date a reply in compliance with § 1.113(c) was filed and ending on the date of mailing of either an action under 35 U.S.C. 132, or a notice of allowance under 35 U.S.C. 151, whichever occurs first;

(4) The number of days, if any, in the period beginning on the day after the date that is four months after the date an appeal brief in compliance with § 1.192 was filed and ending on the date of mailing of any of an examiner's answer under § 1.193, an action under 35 U.S.C. 132, or a notice of allowance under 35 U.S.C. 151, whichever occurs first;

(5) The number of days, if any, in the period beginning on the day after the date that is four months after the date of a final decision by the Board of Patent Appeals and Interferences or by a Federal court in an appeal under 35 U.S.C. 141 or a civil action under 35 U.S.C. 145 or 146 where at least one allowable claim remains in the application and ending on the date of mailing of either an action under 35 U.S.C. 132 or a notice of allowance under 35 U.S.C. 151, whichever occurs first; and

(6) The number of days, if any, in the period beginning on the day after the date that is four months after the date the issue fee was paid and all outstanding requirements were satisfied and ending on the date a patent was issued.

(b) The period of adjustment under § 1.702(b) is the number of days, if any, in the period beginning on the day after the date that is three years after the date on which the application was filed under 35 U.S.C. 111(a) or the national stage commenced under

35 U.S.C. 371(b) or (f) in an international application and ending on the date a patent was issued, but not including the sum of the following periods:

(1) The number of days, if any, in the period beginning on the date on which a request for continued examination of the application under 35 U.S.C. 132(b) was filed and ending on the date the patent was issued;

(2)(i) The number of days, if any, in the period beginning on the date an interference was declared or redeclared to involve the application in the interference and ending on the date that the interference was terminated with respect to the application; and

(ii) The number of days, if any, in the period beginning on the date prosecution in the application was suspended by the Office due to interference proceedings under 35 U.S.C. 135(a) not involving the application and ending on the date of the termination of the suspension;

(3)(i) The number of days, if any, the application was maintained in a sealed condition under 35 U.S.C. 181;

(ii) The number of days, if any, in the period beginning on the date of mailing of an examiner's answer under § 1.193 in the application under secrecy order and ending on the date the secrecy order was removed;

(iii) The number of days, if any, in the period beginning on the date applicant was notified that an interference would be declared but for the secrecy order and ending on the date the secrecy order was removed; and

(iv) The number of days, if any, in the period beginning on the date of notification under § 5.3(c) of this chapter and ending on the date of mailing of the notice of allowance under 35 U.S.C. 151; and,

(4) The number of days, if any, in the period beginning on the date on which a notice of appeal to the Board of Patent Appeals and Interferences was filed under 35 U.S.C. 134 and § 1.191 and ending on the date of the last decision by the Board of Patent Appeals and Interferences or by a Federal court in an appeal under 35 U.S.C. 141 or a civil action under 35 U.S.C. 145, or on the date of mailing of either an action under 35 U.S.C. 132, or a notice of allowance under 35 U.S.C. 151, whichever occurs first, if the appeal did not result in a decision by the Board of Patent Appeals and Interferences.

(c) The period of adjustment under § 1.702(c) is the sum of the following periods, to the extent that the periods are not overlapping:

(1) The number of days, if any, in the period beginning on the date an interference was declared or redeclared to involve the application in the interference and ending on the date that the interference was terminated with respect to the application; and

(2) The number of days, if any, in the period beginning on the date prosecution in the application was suspended by the Office due to interference proceedings under 35 U.S.C. 135(a) not involving the application and ending on the date of the termination of the suspension.

(d) The period of adjustment under § 1.702(d) is the sum of the following periods, to the extent that the periods are not overlapping:

(1) The number of days, if any, the application was maintained in a sealed condition under 35 U.S.C. 181;



(2) The number of days, if any, in the period beginning on the date of mailing of an examiner's answer under § 1.193 in the application under secrecy order and ending on the date the secrecy order was removed;

(3) The number of days, if any, in the period beginning on the date applicant was notified that an interference would be declared but for the secrecy order and ending on the date the secrecy order was removed; and

(4) The number of days, if any, in the period beginning on the date of notification under § 5.3(c) of this chapter and ending on the date of mailing of the notice of allowance under 35 U.S.C. 151.

(e) The period of adjustment under § 1.702(e) is the sum of the number of days, if any, in the period beginning on the date on which a notice of appeal to the Board of Patent Appeals and Interferences was filed under 35 U.S.C. 134 and § 1.191 and ending on the date of a final decision in favor of the applicant by the Board of Patent Appeals and Interferences or by a Federal court in an appeal under 35 U.S.C. 141 or a civil action under 35 U.S.C. 145.

(f) The adjustment will run from the expiration date of the patent as set forth in 35 U.S.C. 154(a)(2). To the extent that periods of delay attributable to the grounds specified in § 1.702 overlap, the period of adjustment granted under this section shall not exceed the actual number of days the issuance of the patent was delayed. The term of a patent entitled to adjustment under § 1.702 and this section shall be adjusted for the sum of the periods calculated under paragraphs (a) through (e) of this section, to the extent that such periods are not overlapping, less the sum of the periods calculated under § 1.704. The date indicated on any certificate of mailing or transmission under § 1.8 shall not be taken into account in this calculation.

(g) No patent, the term of which has been disclaimed beyond a specified date, shall be adjusted under § 1.702 and this section beyond the expiration date specified in the disclaimer.

37 CFR 1.703 specifies the period of adjustment if a patent is entitled to patent term adjustment under 35 U.S.C. 154(b)(1) and 37 CFR 1.702. When a period is indicated (in 37 CFR 1.703 or 1.704) as "beginning" on a particular day, that day is included in the period, in that such day is "day one" of the period and not "day zero." For example, a period beginning on April 1 and ending on April 10 is ten (and not nine) days in length.

35 U.S.C. 154(b)(1)(A) and (B) provide for an adjustment of one day for each day after the end of the period set forth in 35 U.S.C. 154(b)(1)(A)(i), (ii), (iii), (iv), and (B) until the prescribed action is taken, whereas 35 U.S.C. 154(b)(1)(C) provides for an adjustment of one day for each day of the pendency of the proceeding, order, or review prescribed in 35 U.S.C. 154(b)(1)(C)(i) through (iii). Therefore, the end of the period set forth in 37 CFR 1.703(a) and

1.703(b) (which correspond to 35 U.S.C. 154(b)(1)(A) and (B)) is "day zero" (not "day one") as to the period of adjustment, whereas the first day of the proceeding, order, or review set forth in 37 CFR 1.703(c), 1.703(d), and 1.703(e) (which correspond to 35 U.S.C. 154(b)(1)(C)(i) through (iii)) is "day one" of the period of adjustment.

37 CFR 1.703(a) pertains to 35 U.S.C. 154(b)(1)(A) and indicates that the period of adjustment under 37 CFR 1.702(a) is the sum of the periods specified in 37 CFR 1.703(a)(1) through 37 CFR 1.703(a)(6).

37 CFR 1.703(a)(1) pertains to the provisions of 35 U.S.C. 154(b)(1)(A)(i) and specifies that the period is the number of days, if any, beginning on the date after the day that is fourteen months after the date on which the application was filed under 35 U.S.C. 111(a) or fulfilled the requirements of 35 U.S.C. 371 in an international application and ending on the mailing date of either an action under 35 U.S.C. 132, or a notice of allowance under 35 U.S.C. 151, whichever occurs first. For purposes of 35 U.S.C. 154(b)(1)(A)(i)(II), an international application fulfills the requirements of 35 U.S.C. 371 on the date of commencement of the national stage under 35 U.S.C. 371(b) or (f), or the date the application fulfills the requirements of 35 U.S.C. 371(c) if that date is later than the date of commencement of the national stage under 35 U.S.C. 371(b) or (f). In other words, the requirements of 35 U.S.C. 371 are met when applicant has met all of the requirements of 35 U.S.C. 371(c) and, unless applicant requests early processing under 35 U.S.C. 371(f), the time limit set forth in the applicable one of PCT Articles 22 and 39 has expired. Accordingly, the requirements of 35 U.S.C. 371 are met when the Office can begin examination of the patent application. If, for example, an applicant files the required oath or declaration (35 U.S.C. 115) and any necessary English translation after the expiration of the time limit set forth in Article 22 of the PCT or the time limit under Article 39 of the PCT, the date the requirements of 35 U.S.C. 371 are met is the date the requirements of 35 U.S.C. 371(c) are met. If, however, an applicant files the required declaration, filing fee, and any required English translation before the expiration of the relevant PCT Article 22 or Article 39 time period, but does not request early processing under 35

U.S.C. 371, the requirements of 35 U.S.C. 371 will be met once the applicable time period has expired.

A written restriction requirement, a written election of species requirement, a requirement for information under 37 CFR 1.105, an action under *Ex parte Quayle*, 1935 Comm'r Dec. 11 (1935), and a notice of allowability (PTOL-37) are each an action issued as a result of the examination conducted pursuant to 35 U.S.C. 131. As such, each of these Office actions is a notification under 35 U.S.C. 132. Office notices and letters issued as part of the pre-examination processing of an application are not notices issued as a result of an examination conducted pursuant to 35 U.S.C. 131, and thus are not notifications under 35 U.S.C. 132. Examples of such pre-examination processing notices are: a Notice of Incomplete Nonprovisional Application, a Notice of Omitted Item(s) in a Nonprovisional Application, a Notice to File Missing Parts of Application, a Notice of Informal Application, a Notice to File Corrected Application Papers Filing Date Granted, or a Notice to Comply with Requirements for Patent Applications Containing Nucleotide Sequence and/or Amino Acid Sequence Disclosures.

37 CFR 1.703(a)(2) pertains to the provisions of 35 U.S.C. 154(b)(1)(A)(ii) and specifies that the period is the number of days, if any, beginning on the day after the date that is four months after the date a reply under 37 CFR 1.111 was filed and ending on the mailing date of either an action under 35 U.S.C. 132, or a notice of allowance under 35 U.S.C. 151, whichever occurs first.

37 CFR 1.703(a)(3) also pertains to the provisions of 35 U.S.C. 154(b)(1)(A)(ii) and specifies that the period is the number of days, if any, beginning on the day after the date that is four months after the date a reply in compliance with 37 CFR 1.113(c) was filed and ending on the date of mailing of either an action under 35 U.S.C. 132, or a notice of allowance under 35 U.S.C. 151, whichever occurs first. A reply under 37 CFR 1.113 is a reply to a final Office action, and a reply in compliance with 37 CFR 1.113 is a reply that cancels all of the rejected claims and removes all outstanding objections and requirements or otherwise places the application in condition for allowance. Any amendment after final that does not cancel all of the rejected claims and remove all outstanding objections and requirements or otherwise place the application in

condition for allowance is not a reply in compliance with 37 CFR 1.113(c).

37 CFR 1.703(a)(4) also pertains to the provisions of 35 U.S.C. 154(b)(1)(A)(ii) and specifies that the period is the number of days, if any, beginning on the day after the date that is four months after the date an appeal brief in compliance with 37 CFR 1.192 was filed and ending on the mailing date of any of an examiner's answer under 37 CFR 1.193, an action under 35 U.S.C. 132, or a notice of allowance under 35 U.S.C. 151, whichever occurs first. As discussed below, the phrase "the date on which" an "appeal was taken" in 35 U.S.C. 154(b)(1)(A)(ii) means the date on which an appeal brief (and not a notice of appeal) was filed. The phrase "appeal brief in compliance with 37 CFR 1.192" requires that: (1) the appeal brief fee (37 CFR 1.17(c)) be paid (37 CFR 1.192(a)); and (2) the appeal brief complies with 37 CFR 1.192(c)(1) through (c)(9).

37 CFR 1.703(a)(5) pertains to the provisions of 35 U.S.C. 154(b)(1)(A)(iii) and specifies that the period is the number of days, if any, beginning on the day after the date that is four months after the date of a final decision by the Board of Patent Appeals and Interferences or by a Federal court in an appeal under 35 U.S.C. 141 or a civil action under 35 U.S.C. 145 or 146, where at least one allowable claim remains in the application and ending on the mailing date of either an action under 35 U.S.C. 132, or a notice of allowance under 35 U.S.C. 151, whichever occurs first.

The phrase "allowable claims remain in the application" for purposes of 35 U.S.C. 154(b)(1)(A)(iii) means that after the decision there is at least one pending claim (for purposes of statutory construction, "words importing the plural include the singular" (1 U.S.C. 1)) that is not withdrawn from consideration and is not subject to a rejection, objection, or other requirement. This applies in the following situations: (1) at least one claim is allowable (not merely objected to) at the time the examiner's answer is mailed and is not canceled before, or made subject to a rejection as a result of, the appellate review; or (2) when all of the rejections applied to at least one claim are reversed, and such claim is not made subject to a rejection, as a result of the appellate review. For example:

(A) If claims 1 and 2 (both independent) are pending, the decision affirms the rejection of claim 1,

and claim 2 was indicated as allowable prior to the appeal, “allowable claims remain in the application” for purposes of 35 U.S.C. 154(b)(1)(A)(iii).

(B) If claims 1 and 2 are pending, the decision affirms the rejection of claim 1, and claim 2 was objected to by the examiner prior to the appeal as being allowable except for its dependency from claim 1, “allowable claims” do not “remain in the application” for purposes of 35 U.S.C. 154(b)(1)(A)(iii) (claim 2 is not allowable because there is an outstanding objection to it).

(C) If claims 1 and 2 are pending, and the decision affirms the rejection of claim 1 and reverses the rejection of claim 2, “allowable claims remain in the application” for purposes of 35 U.S.C. 154(b)(1)(A)(iii) (claim 2 is “allowable” within the meaning of 37 CFR 1.703(a)(5) because there is no outstanding objection or requirement as to it (see MPEP § 1214.06, paragraph (I)(B))).

37 CFR 1.703(a)(6) pertains to the provisions of 35 U.S.C. 154(b)(1)(A)(iv) and specifies that the period is the number of days, if any, beginning on the day after the date that is four months after the date the issue fee was paid and all outstanding requirements were satisfied and ending on the date the patent was issued. The date the issue fee was paid and all outstanding requirements were satisfied is the later of the date the issue fee was paid or the date all outstanding requirements were satisfied. Note that the filing of a priority document (and processing fee) is not considered an outstanding requirement under 35 U.S.C. 154(b)(1)(A)(iv) and 37 CFR 1.703(a)(6) because if the priority document is not filed the patent simply issues without the priority claim (the application is not abandoned) and since no petition is required to add a priority claim after payment of the issue fee. If prosecution in an application is reopened after allowance (see MPEP § 1308), all outstanding requirements are not satisfied until the application is again in condition for allowance as indicated by the issuance of a new notice of allowance under 35 U.S.C. 151 (see MPEP § 1308).

37 CFR 1.703(b) pertains to the provisions of 35 U.S.C. 154(b)(1)(B) and indicates that the period of adjustment under 37 CFR 1.702(b) is the number of days, if any, in the period beginning on the day after the date that is three years after the actual filing date of the application and ending on the date a patent was

issued. 37 CFR 1.703(b) also sets forth the limitations on patent term adjustment specified in 35 U.S.C. 154(b)(1)(B)(i) and (ii). Specifically, 37 CFR 1.703(b) provides that the period of adjustment of the term of a patent shall not include the period equal to the sum of the following periods: (1) The period of pendency consumed by continued examination of the application under 35 U.S.C. 132(b) (35 U.S.C. 154(b)(1)(B)(i)); (2) the period of pendency consumed by interference proceedings (35 U.S.C. 154(b)(1)(B)(ii)); (3) the period of pendency consumed by imposition of a secrecy order (35 U.S.C. 154(b)(1)(B)(ii)); and (4) the period of pendency consumed by appellate review under 35 U.S.C. 134, 141, 145, whether successful or unsuccessful (35 U.S.C. 154(b)(1)(B)(ii)). The provisions of 35 U.S.C. 154(b)(1)(B)(iii) concerning the period of pendency consumed by delays in the processing of the application requested by the applicant are treated in 37 CFR 1.704 as such delays are also circumstances constituting a failure of an applicant to engage in reasonable efforts to conclude processing or examination of an application.

37 CFR 1.703(c) pertains to the provisions of 35 U.S.C. 154(b)(1)(C)(i) and indicates that the period of adjustment under 37 CFR 1.702(c) is the sum of the following periods (to the extent that such periods are not overlapping): (1) the number of days, if any, in the period beginning on the date an interference was declared or redeclared to involve the application in the interference and ending on the date that the interference was terminated with respect to the application; and (2) the number of days, if any, in the period beginning on the date prosecution in the application was suspended by the Office due to interference proceedings under 35 U.S.C. 135(a) not involving the application and ending on the date of the termination of the suspension.

37 CFR 1.703(d) pertains to the provisions of 35 U.S.C. 154(b)(1)(C)(ii) and indicates that the period of adjustment under 37 CFR 1.702(d) is the sum of the following periods (to the extent that such periods are not overlapping): (1) the number of days, if any, the application was maintained in a sealed condition under 35 U.S.C. 181; (2) the number of days, if any, in the period beginning on the date of mailing of an examiner’s answer under 37 CFR 1.193 in the application under secrecy order and ending on the date the

secrecy order was removed; (3) the number of days, if any, in the period beginning on the date applicant was notified that an interference would be declared but for the secrecy order and ending on the date the secrecy order was removed; and (4) the number of days, if any, in the period beginning on the date of notification under 37 CFR 5.3(c) and ending on the date of mailing of the notice of allowance under 35 U.S.C. 151 and 37 CFR 1.311.

37 CFR 1.703(e) pertains to the provisions of 35 U.S.C. 154(b)(1)(C)(iii) and indicates that the period of adjustment under 37 CFR 1.702(e) is the sum of the number of days, if any, in the period beginning on the date on which a notice of appeal to the Board of Patent Appeals and Interferences was filed under 35 U.S.C. 134 and 37 CFR 1.191 and ending on the date of a final decision in favor of the applicant by the Board of Patent Appeals and Interferences or by a Federal court in an appeal under 35 U.S.C. 141 or a civil action under 35 U.S.C. 145.

37 CFR 1.703(f) indicates that the adjustment will run from the expiration date of the patent as set forth in 35 U.S.C. 154(a)(2) and also indicates that to the extent that periods of \*delay attributable to the grounds specified in 37 CFR 1.702 overlap, the period of adjustment will not exceed the actual number of days the issuance of the patent was delayed (35 U.S.C. 154(b)(2)(A)). 37 CFR 1.703(f) also specifically indicates that the term of a patent entitled to adjustment under 37 CFR 1.702 and 1.703 shall be adjusted for the sum of the periods calculated under 37 CFR 1.703(a) through (e), to the extent that such periods are not overlapping, less the sum of the periods calculated under 37 CFR 1.704.

Moreover, 37 CFR 1.703(f) provides that the date indicated on any certificate of mailing or transmission under 37 CFR 1.8 shall not be taken into account in this calculation. The date indicated on a certificate of mailing is used only to determine whether the correspondence is timely (including whether any extension of the time and fee are required) so as to avoid abandonment of the application or termination or dismissal of proceedings. The actual date of receipt of the correspondence in the Office is used for all other purposes. See 37 CFR 1.8(a). Thus, while the date indicated on any certificate of mailing or transmission under 37 CFR 1.8 will continue to be taken into account in determining timeliness, the date of filing (37 CFR

1.6) will be the date used in a patent term adjustment calculation. Applicant may wish to consider the use of the “Express Mail Post Office to Addressee” service of the United States Postal Service (37 CFR 1.10) or facsimile transmission (37 CFR 1.6(d)) for replies to be accorded the earliest possible filing date for patent term adjustment calculations. Alternatively, applicant may choose to mail correspondence with sufficient time to ensure that the correspondence is received in the Office (and stamped with a date of receipt) before the expiration of the three-month period. Applicants are encouraged to check PAIR to verify the date of deposit entered in PALM for the correspondence. Applicants should contact the Office for correction of any such entries prior to the mailing of the notice of allowance. At the time of the mailing of the notice of allowance, the patent term adjustment calculation will be made with the dates in PALM. Thereafter, a patent term adjustment application (37 CFR 1.705(b) or (c)), accompanied by the requisite fee and statement or showing, will be necessary to have any reduction of patent term reinstated.

Finally, 37 CFR 1.703(g) indicates that no patent, the term of which has been disclaimed beyond a specified date, shall be adjusted under 37 CFR 1.702 and 1.703 beyond the expiration date specified in the disclaimer (35 U.S.C. 154(b)(2)(B)).<

>

## **2732 Reduction of Period of Adjustment of Patent Term [R-2]**

*37 CFR 1.704. Reduction of period of adjustment of patent term.*

(a) The period of adjustment of the term of a patent under § 1.703(a) through (e) shall be reduced by a period equal to the period of time during which the applicant failed to engage in reasonable efforts to conclude prosecution (processing or examination) of the application.

(b) With respect to the grounds for adjustment set forth in §§ 1.702(a) through (e), and in particular the ground of adjustment set forth in § 1.702(b), an applicant shall be deemed to have failed to engage in reasonable efforts to conclude processing or examination of an application for the cumulative total of any periods of time in excess of three months that are taken to reply to any notice or action by the Office making any rejection, objection, argument, or other request, measuring such three-month period from the date the notice or action was mailed or given to the applicant, in which case the period of adjustment set forth in § 1.703 shall be reduced by the number of days, if any, beginning on the day after the date that is three months after the date of mailing or transmission of the Office communication notifying the applicant of the rejection,

objection, argument, or other request and ending on the date the reply was filed. The period, or shortened statutory period, for reply that is set in the Office action or notice has no effect on the three-month period set forth in this paragraph.

(c) Circumstances that constitute a failure of the applicant to engage in reasonable efforts to conclude processing or examination of an application also include the following circumstances, which will result in the following reduction of the period of adjustment set forth in § 1.703 to the extent that the periods are not overlapping:

(1) Suspension of action under § 1.103 at the applicant's request, in which case the period of adjustment set forth in § 1.703 shall be reduced by the number of days, if any, beginning on the date a request for suspension of action under § 1.103 was filed and ending on the date of the termination of the suspension;

(2) Deferral of issuance of a patent under § 1.314, in which case the period of adjustment set forth in § 1.703 shall be reduced by the number of days, if any, beginning on the date a request for deferral of issuance of a patent under § 1.314 was filed and ending on the date the patent was issued;

(3) Abandonment of the application or late payment of the issue fee, in which case the period of adjustment set forth in § 1.703 shall be reduced by the number of days, if any, beginning on the date of abandonment or the date after the date the issue fee was due and ending on the earlier of:

(i) The date of mailing of the decision reviving the application or accepting late payment of the issue fee; or

(ii) The date that is four months after the date the grantable petition to revive the application or accept late payment of the issue fee was filed;

(4) Failure to file a petition to withdraw the holding of abandonment or to revive an application within two months from the mailing date of a notice of abandonment, in which case the period of adjustment set forth in § 1.703 shall be reduced by the number of days, if any, beginning on the day after the date two months from the mailing date of a notice of abandonment and ending on the date a petition to withdraw the holding of abandonment or to revive the application was filed;

(5) Conversion of a provisional application under 35 U.S.C. 111(b) to a nonprovisional application under 35 U.S.C. 111(a) pursuant to 35 U.S.C. 111(b)(5), in which case the period of adjustment set forth in § 1.703 shall be reduced by the number of days, if any, beginning on the date the application was filed under 35 U.S.C. 111(b) and ending on the date a request in compliance with § 1.53(c)(3) to convert the provisional application into a nonprovisional application was filed;

(6) Submission of a preliminary amendment or other preliminary paper less than one month before the mailing of an Office action under 35 U.S.C. 132 or notice of allowance under 35 U.S.C. 151 that requires the mailing of a supplemental Office action or notice of allowance, in which case the period of adjustment set forth in § 1.703 shall be reduced by the lesser of:

(i) The number of days, if any, beginning on the day after the mailing date of the original Office action or notice of

allowance and ending on the date of mailing of the supplemental Office action or notice of allowance; or

(ii) Four months;

(7) Submission of a reply having an omission (§ 1.135(c)), in which case the period of adjustment set forth in § 1.703 shall be reduced by the number of days, if any, beginning on the day after the date the reply having an omission was filed and ending on the date that the reply or other paper correcting the omission was filed;

(8) Submission of a supplemental reply or other paper, other than a supplemental reply or other paper expressly requested by the examiner, after a reply has been filed, in which case the period of adjustment set forth in § 1.703 shall be reduced by the number of days, if any, beginning on the day after the date the initial reply was filed and ending on the date that the supplemental reply or other such paper was filed;

(9) Submission of an amendment or other paper after a decision by the Board of Patent Appeals and Interferences, other than a decision designated as containing a new ground of rejection under § 1.196(b) or statement under § 1.196(c), or a decision by a Federal court, less than one month before the mailing of an Office action under 35 U.S.C. 132 or notice of allowance under 35 U.S.C. 151 that requires the mailing of a supplemental Office action or supplemental notice of allowance, in which case the period of adjustment set forth in § 1.703 shall be reduced by the lesser of:

(i) The number of days, if any, beginning on the day after the mailing date of the original Office action or notice of allowance and ending on the mailing date of the supplemental Office action or notice of allowance; or

(ii) Four months;

(10) Submission of an amendment under § 1.312 or other paper after a notice of allowance has been given or mailed, in which case the period of adjustment set forth in § 1.703 shall be reduced by the lesser of:

(i) The number of days, if any, beginning on the date the amendment under § 1.312 or other paper was filed and ending on the mailing date of the Office action or notice in response to the amendment under § 1.312 or such other paper; or

(ii) Four months; and

(11) Further prosecution via a continuing application, in which case the period of adjustment set forth in § 1.703 shall not include any period that is prior to the actual filing date of the application that resulted in the patent.

(d) A paper containing only an information disclosure statement in compliance with §§ 1.97 and 1.98 will not be considered a failure to engage in reasonable efforts to conclude prosecution (processing or examination) of the application under paragraphs (c)(6), (c)(8), (c)(9), or (c)(10) of this section if it is accompanied by a statement that each item of information contained in the information disclosure statement was first cited in any communication from a foreign patent office in a counterpart application and that this communication was not received by any individual designated in § 1.56(c) more than thirty days prior to the filing of the information disclosure statement. This thirty-day period is not extendable.

(e) Submission of an application for patent term adjustment under § 1.705(b) (with or without request under § 1.705(c) for reinstatement of reduced patent term adjustment) will not be considered a failure to engage in reasonable efforts to conclude prosecution (processing or examination) of the application under paragraph (c)(10) of this section.

37 CFR 1.704 implements the provisions of 35 U.S.C. 154(b)(2)(C) which provides that the period of patent term adjustment under 35 U.S.C. 154(b)(1) “shall be reduced by a period equal to the period of time during which the applicant failed to engage in reasonable efforts to conclude prosecution of the application,” and specifies certain circumstances as constituting a failure of an applicant to engage in reasonable efforts to conclude processing or examination of an application. Further, 35 U.S.C. 154(b)(2)(C)(iii) gives the Office the authority to prescribe regulations establishing circumstances that constitute “a failure of an applicant to engage in reasonable efforts to conclude processing or examination of an application.” 35 U.S.C. 154(b)(2)(C) does not require the applicant’s action or inaction (that amounts to a failure to engage in reasonable efforts to conclude prosecution of the application) to have caused or contributed to patent term adjustment for the period of adjustment to be reduced due to such action or inaction. The patent term adjustment provisions of 35 U.S.C. 154(b) create a balanced system allowing for patent term adjustment due to Office delays for a reasonably diligent applicant. Since the public has an interest in the technology disclosed and covered by a patent being available to the public at the earliest possible date, 35 U.S.C. 154(b)(2)(C)(i) provides that patent term adjustment is reduced by any period of time during which applicant failed to engage in reasonable efforts to conclude prosecution of the application, regardless of whether the applicant’s actions or inactions caused or contributed to patent term adjustment.

37 CFR 1.704(a) implements the provisions of 35 U.S.C. 154(b)(2)(C)(i) and sets forth that the period of adjustment shall be reduced by a period equal to the period of time during which the applicant failed to engage in reasonable efforts to conclude prosecution (i.e., processing or examination) of an application.

37 CFR 1.704(b) provides that with respect to the ground for adjustments set forth in 37 CFR 1.702(a) through (e), and in particular 37 CFR 1.702(b), an applicant shall be deemed to have failed to engage in reasonable efforts to conclude prosecution for the

cumulative total of any periods of time in excess of three months that are taken to reply to any notice or action by the Office making any rejection, objection, argument, or other request, measuring such three-month period from the date the notice or action was mailed or given to the applicant. A Notice of Omitted Items in a Nonprovisional Application, however, is not a notice or action by the Office making a rejection, objection, argument, or other request within the meaning of 35 U.S.C. 154(b)(2)(C)(ii) or 37 CFR 1.704(b), since the Office does not require a reply to that notice to continue the processing and examination of an application. 37 CFR 1.704(b) indicates that the period of adjustment set forth in 37 CFR 1.703 shall be reduced by the number of days, if any, beginning on the day after the date that is three months after the date of mailing or transmission of the Office communication notifying the applicant of the rejection, objection, argument, or other request and ending on the date the reply was filed. As discussed above, a reply is considered filed on the date of its actual receipt in the Office as defined by 37 CFR 1.6, and the date indicated on any certificate of mailing or transmission under 37 CFR 1.8 will not be taken into account for patent term adjustment purposes.

The three-month period in 37 CFR 1.704(b) applies to the Office notices and letters issued as part of the pre-examination processing of an application (except a Notice of Omitted Items in a Nonprovisional Application as discussed above). These notices include: (1) a Notice of Incomplete Nonprovisional Application (except as to any period prior to the filing date ultimately accorded to the application); (2) a Notice to File Missing Parts of Non-Provisional Application; (3) a Notice of Informal Application; (4) a Notice to File Corrected Application Papers Filing Date Granted; or (5) a Notice to Comply with Requirements for Patent Applications Containing Nucleotide Sequence and/or Amino Acid Sequence Disclosures.

In addition, the three-month period in 35 U.S.C. 154(b)(2)(C)(ii) and 37 CFR 1.704(b) applies regardless of the period for reply set in the Office action or notice. For example, if an Office action sets a one-month period for reply (restriction requirement), the applicant may obtain a two-month extension of time under 37 CFR 1.136(a) before being subject to a reduction of patent term adjustment under 35 U.S.C. 154(b)(2)(C)(ii) and 37 CFR 1.704(b). If, however, an

Office action sets a six-month period for reply, as is commonly set in applications subject to secrecy orders (see MPEP §130), the applicant is subject to a reduction of patent term adjustment under 35 U.S.C. 154(b)(2)(C)(ii) and 37 CFR 1.704(b) if the applicant does not reply to the Office action within three months, notwithstanding that a reply may be timely filed six months after the mailing date of the Office action.

37 CFR 1.704(c) establishes further circumstances that constitute a failure of an applicant to engage in reasonable efforts to conclude processing or examination of an application. 37 CFR 1.704(c)(1) through (c)(11) set forth actions or inactions by an applicant that interfere with the Office's ability to process or examine an application (and thus circumstances that constitute a failure of an applicant to engage in reasonable efforts to conclude processing or examination of an application), as well as the period by which a period of adjustment set forth in 37 CFR 1.703 shall be reduced if an applicant engages in any of the enumerated actions or inactions. 37 CFR 1.704(c) requires that an applicant refrain from engaging in actions or inactions that prevent or interfere with the Office's ability to process or examine an application. An applicant who is engaging in actions or inactions that prevent or interfere with the Office's ability to process or examine an application cannot reasonably be characterized as "engag[ing] in reasonable efforts to conclude processing or examination of an application" (35 U.S.C. 154(b)(2)(C)(i)).

37 CFR 1.704(c)(1) through 1.704(c)(11) address situations that occur with sufficient frequency to warrant being specifically provided for in the rules of practice. These situations do not represent an exhaustive listing of actions or inactions that interfere with the Office's ability to process or examine an application, since there are a myriad of actions or inactions that occur infrequently but will interfere with the Office's ability to process or examine an application (e.g., applicant files and persists in requesting reconsideration of a meritless petition under 37 CFR 1.10; parties to an interference obtain an extension for purposes of settlement negotiations which do not result in settlement of the interference; and when the scope of the broadest claim in the application at the time an application is placed in condition for allowance is substantially the same as suggested or allowed by the

examiner more than six months earlier than the date the application was placed in condition for allowance). Thus, the actions or inactions set forth in 37 CFR 1.704(c) are exemplary circumstances that constitute a failure of an applicant to engage in reasonable efforts to conclude processing or examination of an application. The Office may also reduce a period of adjustment provided in 37 CFR 1.703 on the basis of conduct that interferes with the Office's ability to process or examine an application under the authority provided in 35 U.S.C. (b)(2)(C)(iii), even if such conduct is not specifically addressed in 37 CFR 1.704(c).

37 CFR 1.704(c)(1) establishes suspension of action under 37 CFR 1.103 at the applicant's request as a circumstance that constitutes a failure of an applicant to engage in reasonable efforts to conclude processing or examination of an application. Obviously, if action is suspended at the applicant's request, the Office is precluded from processing or examining the application as a result of an action by the applicant. 37 CFR 1.704(c)(1) also provides that in such a case the period of adjustment set forth in 37 CFR 1.703 shall be reduced by the number of days, if any, beginning on the date a request for suspension of action under 37 CFR 1.103 was filed and ending on the date of the termination of the suspension.

37 CFR 1.704(c)(2) establishes deferral of issuance of a patent under 37 CFR 1.314 as a circumstance that constitutes a failure of an applicant to engage in reasonable efforts to conclude processing or examination of an application. Obviously, if issuance of the patent is deferred under 37 CFR 1.314, the Office is precluded from issuing the application as a result of an action by the applicant. When a petition under 37 CFR 1.314 is granted, the petition decision generally states that the application will be held for a period of a month to await the filing of a paper. At the end of the period, the application is returned to the issue process without a further communication from the Office to the applicant. 37 CFR 1.704(c)(2) also provides that in such a case the period of adjustment set forth in 37 CFR 1.703 shall be reduced by the number of days, if any, beginning on the date a request for deferral of issuance of a patent under 37 CFR 1.314 was filed and ending on the issue date of the patent.

37 CFR 1.704(c)(3) establishes abandonment of the application or late payment of the issue fee as a circumstance that constitutes a failure of an applicant to

engage in reasonable efforts to conclude processing or examination of an application. Obviously, if the application is abandoned (either by failure to prosecute or late payment of the issue fee), the Office is precluded from processing or examining the application as a result of an action or inaction by the applicant. 37 CFR 1.704(c)(3) also provides that in such a case the period of adjustment set forth in 37 CFR 1.703 shall be reduced by the number of days, if any, beginning on the date of abandonment or the date after the day the issue fee was due, and ending on the earlier of: (1) the date of mailing of the decision reviving the application or accepting late payment of the issue fee; or (2) the date that is four months after the date the grantable petition to revive the application or accept late payment of the issue fee was filed. The phrase “earlier of...[t]he date that is four months after the date the grantable petition to revive the application or accept late payment of the issue fee was filed” is to place a cap (measured from the filing date of the grantable petition) on the reduction if the Office does not act on (grant) the grantable petition to revive within four months of the date it was filed.

37 CFR 1.704(c)(4) establishes failure to file a petition to withdraw a holding of abandonment or to revive an application within two months from the mailing date of a notice of abandonment as a circumstance that constitutes a failure of an applicant to engage in reasonable efforts to conclude processing or examination of an application. Any applicant who considers an application to have been improperly held abandoned (the reduction in 37 CFR 1.704(c)(3) is applicable to the revival of an application properly held abandoned) is expected to file a petition to withdraw the holding of abandonment (or to revive the application) within two months from the mailing date of a notice of abandonment. See MPEP § 711.03(c), paragraph (I). 37 CFR 1.704(c)(4) also provides that in such a case the period of adjustment set forth in 37 CFR 1.703 shall be reduced by the number of days, if any, beginning on the day after the date two months from the mailing date of a notice of abandonment and ending on the date a petition to withdraw the holding of abandonment or to revive the application was filed.

If a petition to withdraw the holding of abandonment is granted, the Office’s PALM system records should be checked to ensure that the correct term adjustment determination is made. Applicants are

encouraged to check the Office’s PALM system records for their applications through PAIR (see MPEP § 2733). For example, if applicant shows that a reply was filed in the Office on March 2, but the March 2 reply was never matched with the file, when the petition to withdraw the holding of abandonment is granted, the receipt of a paper on March 2 should be recorded on the Office’s PALM system records. If the papers or dates are recorded incorrectly, applicant should contact the examiner, the examiner’s supervisor or the Technology Center customer service representative to have the entry corrected. If an applicant receives a Notice of Abandonment and does not request that the holding of abandonment be withdrawn within two months of the mailing date of the notice, the applicant has failed to engage in reasonable efforts to conclude prosecution and any patent term adjustment will be reduced pursuant to 37 CFR 1.704(c)(4).

37 CFR 1.704(c)(5) establishes conversion of a provisional application under 35 U.S.C. 111(b) to a nonprovisional application under 35 U.S.C. 111(a) (pursuant to 35 U.S.C. 111(b)(5)); (see MPEP § 201.04(b)) as a circumstance that constitutes a failure of an applicant to engage in reasonable efforts to conclude processing or examination of an application. Conversion of a provisional application to a nonprovisional application will require the Office to reprocess the application (as a nonprovisional application) up to one year after the filing date that will be accorded to such nonprovisional application as a result of an action by the applicant. 37 CFR 1.704(c)(5) also provides that in such a case the period of adjustment set forth in 37 CFR 1.703 shall be reduced by the number of days, if any, beginning on the date the application was filed under 35 U.S.C. 111(b) and ending on the date a request in compliance with 37 CFR 1.53(c)(3) to convert the provisional application into a nonprovisional application was filed.

37 CFR 1.704(c)(6) establishes submission of a preliminary amendment or other preliminary paper less than one month before the mailing of an Office action under 35 U.S.C. 132 or a notice of allowance under 35 U.S.C. 151 that requires the mailing of a supplemental Office action or notice of allowance as a circumstance that constitutes a failure of an applicant to engage in reasonable efforts to conclude processing or examination of an application. If the submission of



a preliminary amendment or other paper requires the Office to issue a supplemental Office action or notice of allowance, the submission of that preliminary amendment or other paper has interfered with the processing and examination of an application. 37 CFR 1.704(c)(6) also provides that in such a case the period of adjustment set forth in 37 CFR 1.703 shall be reduced by the lesser of the number of days, if any, beginning on the day after the mailing date of the original Office action or notice of allowance and ending on the date of mailing of the supplemental Office action or notice of allowance or four months. The phrase “lesser of... or [f]our months” is to provide a four-month cap for a reduction under 37 CFR 1.704(c)(6) if the Office takes longer than four months to issue a supplemental Office action or notice of allowance.

37 CFR 1.704(c)(7) establishes submission of a reply having an omission (37 CFR 1.135(c)) as a circumstance that constitutes a failure of an applicant to engage in reasonable efforts to conclude processing or examination of an application. Submitting a reply having an omission requires the Office to issue an action under 37 CFR 1.135(c) and await and process the applicant’s reply to the action under 37 CFR 1.135(c) before the initial reply (as corrected) can be treated on its merits. In addition, 37 CFR 1.704(c)(7) provides that in such a case the period of adjustment set forth in 37 CFR 1.703 shall be reduced by the number of days, if any, beginning on the day after the date the reply having an omission was filed and ending on the date that the reply or other paper correcting the omission was filed. The reference to 37 CFR 1.135(c) is parenthetical because 37 CFR 1.704(c)(7) is not limited to Office actions under 37 CFR 1.135(c) but applies when the Office issues any action or notice indicating that a reply has an omission which must be corrected: e.g., (1) a decision on a petition under 37 CFR 1.47 dismissing the petition as lacking an item necessary to grant the petition; or (2) a notice indicating that the computer readable format sequence listing filed in reply to a Notice to Comply with Requirements for Patent Applications Containing Nucleotide Sequence and/or Amino Acid Sequence Disclosures (PTO-1661) does not comply with 37 CFR 1.821 et seq.

37 CFR 1.704(c)(8) establishes submission of a supplemental reply or other paper after a reply has

been filed as a circumstance that constitutes a failure of an applicant to engage in reasonable efforts to conclude processing or examination of an application. The submission of a supplemental reply or other paper (e.g., an information disclosure statement (IDS) or petition) after an initial reply was filed requires the Office to restart consideration of the initial reply in view of the supplemental reply or other paper, which will result in a delay in the Office’s response to the initial reply. 37 CFR 1.704(c)(8) does not apply to a supplemental reply or other paper that was expressly requested by the examiner. If an amendment is requested by an examiner, the examiner will have the paper processed so that it is included as part of an interview summary or examiner’s amendment and not a separate paper for PALM to flag in the patent term adjustment calculation. 37 CFR 1.704(c)(8) also provides that in such a case the period of adjustment set forth in 37 CFR 1.703 shall be reduced by the number of days, if any, beginning on the day after the date the initial reply was filed and ending on the date that the supplemental reply or such other paper was filed.

37 CFR 1.704(c)(9) establishes submission of an amendment or other paper in an application containing allowed claims after a decision by the Board of Patent Appeals and Interferences (other than a decision containing a rejection under 37 CFR 1.196(b)) or a Federal court less than one month before the mailing of an Office action under 35 U.S.C. 132 or notice of allowance under 35 U.S.C. 151, that requires the mailing of a supplemental Office action or supplemental notice of allowance as a circumstance that constitutes a failure of an applicant to engage in reasonable efforts to conclude processing or examination of an application. The submission of an amendment or other paper (e.g., IDS or petition) in an application after a Board of Patent Appeals and Interferences or court decision requires the Office to restart consideration of the application in view of the amendment or other paper, which will result in a delay in the Office’s taking action on the application. 37 CFR 1.704(c)(9) also provides that in such a case the period of adjustment set forth in 37 CFR 1.703 shall be reduced by the lesser of the number of days, if any, beginning on the day after the mailing date of the original Office action or notice of allowance and ending on the mailing date of the supplemental Office action or notice of allowance or four months. The phrase “lesser of...or

[f]our months” is to provide a four-month cap for a reduction under 37 CFR 1.704(c)(9) if the Office takes longer than four months to issue a supplemental Office action or notice of allowance. If the amendment is requested by an examiner, the examiner will have the paper processed so that it is included as part of an interview summary or examiner’s amendment and not a separate paper for PALM to flag in the patent term adjustment calculation.

37 CFR 1.704(c)(10) establishes submission of an amendment under 37 CFR 1.312 or other paper after a notice of allowance has been given or mailed as a circumstance that constitutes a failure of an applicant to engage in reasonable efforts to conclude processing or examination of an application. The submission of amendments (or other papers) after an application is allowed may cause substantial interference with the patent issue process. Certain papers filed after allowance are not considered to be a failure to engage in reasonable efforts to conclude processing or examination of an application. See Clarification of 37 CFR 1.704(c)(10) – Reduction of Patent Term Adjustment for Certain Types of Papers Filed After a Notice of Allowance has been Mailed, 1247 Off. Gaz. Pat. Office 111 (June 26, 2001). The submission of the following papers after a “Notice of Allowance” is **not** considered a failure to engage in reasonable efforts to conclude processing or examination of an application: (1) Fee(s) Transmittal (PTOL-85B); (2) Power of Attorney; (3) Power to Inspect; (4) Change of Address; (5) Change of Status (small/not small entity status); (6) a response to the examiner’s reasons for allowance or a request to correct an error or omission in the “Notice of Allowance” or “Notice of Allowability;” and (7) letters related to government interests (e.g., those between NASA and the Office). Papers that **will be** considered a failure to engage in reasonable efforts to conclude processing or examination of an application include: (1) a request for a refund; (2) a status letter; (3) amendments under 37 CFR 1.312; (4) late priority claims; (5) a certified copy of a priority document; (6) drawings; (7) letters related to biologic deposits; and (8) oaths or declarations. 37 CFR 1.704(c)(10) provides that in such a case the period of adjustment set forth in 37 CFR 1.703 shall be reduced by the lesser of: (1) the number of days, if any, beginning on the date the amendment under 37 CFR 1.312 was filed and ending on the mail-

ing date of the Office action or notice in response to the amendment under 37 CFR 1.312 or such other paper; or (2) four months. The phrase “lesser of ...or [f]our months” is to provide a four-month cap for a reduction under 37 CFR 1.704(c)(10) if the Office takes longer than four months to issue an Office action or notice in response to the amendment under 37 CFR 1.312 or other paper.

37 CFR 1.704(c)(11) establishes further prosecution via a continuing application as a circumstance that constitutes a failure of an applicant to engage in reasonable efforts to conclude processing or examination of an application. Currently, a continuing application may be used to: (1) obtain further examination of an invention disclosed and claimed in the prior application (continuation application); (2) obtain examination (for the first time) of an invention disclosed but not claimed or not elected for examination in the prior application (divisional application); or (3) obtain examination of an invention neither disclosed nor claimed in the prior application (continuation-in-part application). The provisions of 35 U.S.C. 132(b) and 37 CFR 1.114 permit an applicant to obtain further or continued examination of an invention disclosed and claimed in an application, which renders it unnecessary for an applicant whose application is eligible for patent term adjustment under 35 U.S.C. 154(b) to file a continuing application to obtain further examination of an invention disclosed and claimed in an application. If an applicant is filing a continuing application to obtain examination (for the first time) of an invention disclosed but not claimed or not elected for examination in the prior application or an invention neither disclosed nor claimed in the prior application, it is not appropriate for that applicant to obtain any benefit in the continuing application for examination delays that might have occurred in the prior application. Thus, the Office has established further prosecution via a continuing application as a circumstance that constitutes a failure of an applicant to engage in reasonable efforts to conclude processing or examination of an application, in that the period of adjustment set forth in 37 CFR 1.703 shall not include any period that is prior to the actual filing date of the application that resulted in the patent. Thus, if the application that resulted in the patent is a continuing application (including a CPA), the period of adjustment set forth in 37 CFR 1.703 (if any) will not

include any period that is prior to the actual filing date of the application (in the case of a CPA, the filing date of the request for a CPA) that resulted in the patent.

A CPA under 37 CFR 1.53(d) filed on or after May 29, 2000 and before July 14, 2003 is entitled to the patent term adjustment provisions of 35 U.S.C. 154(b) as amended by § 4402 of the American Inventors Protection Act of 1999 (CPAs can only be filed in design patent applications on or after July 14, 2003, and design applications are not entitled to PTA). The period of patent term adjustment set forth in 37 CFR 1.703 (if any), however, will not include any period that is prior to the filing date of the request for that CPA.

Delays before the filing date of an application are not relevant to whether an application is entitled to patent term adjustment. Patent term adjustment will not be reduced by applicant actions or inactions (that amount to a failure to engage in reasonable efforts to conclude processing or examination of the application) occurring in a prior (or other) application.

37 CFR 1.704(d) provides that a paper containing only an information disclosure statement in compliance with 37 CFR 1.97 and 1.98 will not be considered (result in a reduction) under 37 CFR 1.704(c)(6), 1.704(c)(8), 1.704(c)(9), or 1.704(c)(10) if it is accompanied by a statement that each item of information contained in the information disclosure statement was >first< cited in a communication from a foreign patent office in a counterpart application and that this communication was not received by any individual designated in 37 CFR 1.56(c) more than thirty days prior to the filing of the information disclosure statement. This provision will permit applicants to submit information >first< cited in a communication from a foreign patent office in a counterpart application to the Office without a reduction in patent term adjustment if an information disclosure statement is promptly (within thirty days of receipt of the >first< communication) submitted to the Office. Compliance with the statement requirement of 37 CFR 1.704(d) does not substitute for compliance with any relevant requirement of 37 CFR 1.97 or 1.98. 37 CFR 1.704(d) also provides that this thirty-day period is not extendable.

37 CFR 1.704(e) provides that submission of an application for patent term adjustment under 37 CFR 1.705(b) (with or without request under 37 CFR

1.705(c) for reinstatement of reduced patent term adjustment) will not be considered a failure to engage in reasonable efforts to conclude prosecution (processing or examination) of the application under 37 CFR 1.704(c)(10). Due to the time constraints on the Office under 35 U.S.C. 154(b)(1)(A)(iv) and (B) to complete its patent term adjustment determination and issue the patent, the Office must require applicants to follow the specific procedure set forth in 37 CFR 1.705 for requesting reconsideration of the Office's initial patent term adjustment determination and for requesting reinstatement of patent term adjustment reduced under 37 CFR 1.704(b). Thus, while submission of an application for patent term adjustment under 37 CFR 1.705(b) (regardless of whether it contains a request under 37 CFR 1.705(c) for reinstatement of reduced patent term adjustment) will interfere with the patent printing process, submission of the application will not be considered a failure to engage in reasonable efforts to conclude prosecution (processing or examination) of the application under 37 CFR 1.704(c)(10). Other papers concerning patent term adjustment (e.g., status letters, untimely applications for patent term adjustment, requests for reconsideration of the Office's decisions on applications for patent term adjustment, petitions under 37 CFR 1.181, 1.182, or 1.183 concerning patent term adjustment, or miscellaneous letters concerning patent term adjustment), however, will be considered a failure to engage in reasonable efforts to conclude prosecution (processing or examination) of the application under 37 CFR 1.704(c)(10).<

>

## **2733 Patent Term Adjustment Determination [R-2]**

*37 CFR 1.705. Patent term adjustment determination.*

(a) The notice of allowance will include notification of any patent term adjustment under 35 U.S.C. 154(b).

\*\*\*\*\*

37 CFR 1.705 implements the provisions of 35 U.S.C. 154(b)(3) and (b)(4)(B) and indicates that the notice of allowance will include notification of any patent term adjustment under 35 U.S.C. 154(b) (35 U.S.C. 154(b)(3)(B)(i)). The patent term adjustment determinations required by 35 U.S.C. 154(b)(3)(B)(i) are made by a computer program that uses the infor-

mation (dates of receipt and nature of applicant correspondence and of the dates of mailing and nature of Office actions or notices) recorded in the PALM system. The Office currently issues a notice of allowance using a form entitled, Notice of Allowance and Fee(s) Due (PTOL-85). Since November 13, 2001, the Notice of Allowance and Fee(s) Due (PTOL-85) includes the patent term adjustment information on the third page of the form.

37 CFR 1.705(b) provides that any request for review or reconsideration of the patent term adjustment indicated in the notice of allowance (except as provided in 37 CFR 1.705(d)) and any request for reinstatement of all or part of the term reduced pursuant to 37 CFR 1.704(a) must be filed no later than the payment of the issue fee but may not be filed earlier than the date of mailing of the notice of allowance. See MPEP § 2734 for a discussion of the requirements of any such request.

If a registered practitioner receives a notice of allowance with a patent term adjustment that is longer than expected, the practitioner should disclose the error to the Office in compliance with the practitioner's duty of candor and good faith in practice before the Office. Where the correct patent term adjustment is thought to be less than indicated by the Office, an application for term adjustment under 37 CFR 1.705(b) need not be filed. Instead, a letter could be filed with the issue fee payment, indicating that the term adjustment is thought to be longer than appropriate. The Office does not require the practitioner to determine whether the Office's patent term adjustment determination is correct. Alternatively, if a notice of allowance indicates a patent term adjustment that is longer than expected, since the Office frequently corrects the error after mailing the notice of allowance, the practitioner (or applicant) may wait until the patent issues, and if the patent issues with a value that is incorrect, request a certificate of correction.

Information as to how the patent term adjustment calculation has been made will be available through Patent Application Information Retrieval (PAIR) at <http://pair.uspto.gov>. This system is available to all patent applicants who have a customer number as the correspondence address for the application. Applicants should routinely use PAIR to check the accuracy of the data entered in the PALM system for their

applications (i.e., the type of the paper and date of receipt in the Office) throughout prosecution. If any errors are detected, they should be brought to the Office's attention (e.g., the examiner or the Technology Center's customer service representative) as soon as possible to ensure that they are corrected before allowance of the application and the initial determination of the patent term adjustment. In checking Office records, applicants should keep in mind that the date that should be recorded in the Office computer records is the date of receipt of the paper, not the date that it was mailed under 37 CFR 1.8. In addition, if an original paper is misplaced by the Office and a duplicate is filed with a post card receipt showing the date of receipt of the original paper, the date shown on the post-card receipt for the original paper is the date that should be shown in the Office computer records. If Express Mail service was used, then the date shown as the "date in" on the Express Mail label will be entered into the Office computer records. Otherwise, the date reflected in the Office computer records for a duplicate copy of correspondence will normally be the date that the duplicate was received in the USPTO.<

>

## 2734 Application for Patent Term Adjustment; Due Care Showing [R-2]

37 CFR 1.705. *Patent term adjustment determination.*

\*\*\*\*\*

(b) Any request for reconsideration of the patent term adjustment indicated in the notice of allowance, except as provided in paragraph (d) of this section, and any request for reinstatement of all or part of the term reduced pursuant to § 1.704(b) must be by way of an application for patent term adjustment. An application for patent term adjustment under this section must be filed no later than the payment of the issue fee but may not be filed earlier than the date of mailing of the notice of allowance. An application for patent term adjustment under this section must be accompanied by:

- (1) The fee set forth in § 1.18(e); and
- (2) A statement of the facts involved, specifying:
  - (i) The correct patent term adjustment and the basis or bases under § 1.702 for the adjustment;
  - (ii) The relevant dates as specified in §§ 1.703(a) through (e) for which an adjustment is sought and the adjustment as specified in § 1.703(f) to which the patent is entitled;
  - (iii) Whether the patent is subject to a terminal disclaimer and any expiration date specified in the terminal disclaimer; and

(iv)(A) Any circumstances during the prosecution of the application resulting in the patent that constitute a failure to engage in reasonable efforts to conclude processing or examination of such application as set forth in § 1.704; or

(B) That there were no circumstances constituting a failure to engage in reasonable efforts to conclude processing or examination of such application as set forth in § 1.704.

(c) Any application for patent term adjustment under this section that requests reinstatement of all or part of the period of adjustment reduced pursuant to § 1.704(b) for failing to reply to a rejection, objection, argument, or other request within three months of the date of mailing of the Office communication notifying the applicant of the rejection, objection, argument, or other request must also be accompanied by:

(1) The fee set forth in § 1.18(f); and

(2) A showing to the satisfaction of the Director that, in spite of all due care, the applicant was unable to reply to the rejection, objection, argument, or other request within three months of the date of mailing of the Office communication notifying the applicant of the rejection, objection, argument, or other request. The Office shall not grant any request for reinstatement for more than three additional months for each reply beyond three months from the date of mailing of the Office communication notifying the applicant of the rejection, objection, argument, or other request.

\*\*\*\*\*

37 CFR 1.705(b) provides that any request for review or reconsideration of the patent term adjustment indicated in the notice of allowance (except as provided in 37 CFR 1.705(d)) and any request for reinstatement of all or part of the term reduced pursuant to 37 CFR 1.704(a) must be filed no later than the payment of the issue fee but may not be filed earlier than the date of mailing of the notice of allowance. 37 CFR 1.705(b) provides that any such request must be by way of an application for patent term adjustment accompanied by the fee set forth in 37 CFR 1.18(e) and a statement of the facts involved. 37 CFR 1.705(b) also provides that such statement of facts must specify: (1) the basis or bases under 37 CFR 1.702 for the adjustment; (2) the relevant dates as specified in 37 CFR 1.703(a) through (e) for which an adjustment is sought and the adjustment as specified in 37 CFR 1.703(f) to which the patent is entitled; (3) whether the patent is subject to a terminal disclaimer and any expiration date specified in the terminal disclaimer; and (4) any circumstances during the prosecution of the application resulting in the patent that constitute a failure to engage in reasonable efforts to conclude processing or examination of such application as set forth in 37 CFR 1.704 (or a statement that

there were no such circumstances). Since the Office must complete its determination of patent term adjustment before proceeding to issue the patent (35 U.S.C. 154(b)(3)(D)), the Office must require that such application for patent term adjustment be filed within a non-extendable time period and set forth with particularity why the Office's patent term adjustment determination is not correct. In the absence of these requirements, the issuance of the patent will be further delayed by a protracted patent term adjustment determination proceeding.

## DUE CARE SHOWING

37 CFR 1.705(c) implements the provisions of 35 U.S.C. 154(b)(3)(C) and specifically provides that a request for reinstatement of all or part of the period of adjustment reduced pursuant to 37 CFR 1.704(b) for failing to reply to a rejection, objection, argument, or other request within three months of the date of mailing of the Office communication notifying the applicant of the rejection, objection, argument, or other request must include: (1) the fee set forth in 37 CFR 1.18(f); and (2) a showing to the satisfaction of the Director that, in spite of all due care, the applicant was unable to reply to the rejection, objection, argument, or other request within three months of the date of mailing of the Office communication notifying the applicant of the rejection, objection, argument, or other request. 37 CFR 1.705(c) also provides that the Office shall not grant any request for reinstatement for more than three additional months for each reply beyond three months of the date of mailing of the Office communication notifying the applicant of the rejection, objection, argument, or other request (35 U.S.C. 154(b)(3)(C)).

Filing a reply outside of three months after an Office action is *per se* a failure to engage in reasonable efforts to conclude prosecution under 35 U.S.C. 154(b)(2)(C)(ii) unless applicant can establish that the delay was "in spite of all due care." The Office "shall reinstate all or part of the cumulative period of time of an adjustment reduced under [35 U.S.C. 154(b)(2)(C)] if the applicant... makes a showing that, in spite of all due care, the applicant was unable to respond within the 3-month period..." See 35 U.S.C. 154(b)(3)(C). The "due care" of a reasonably prudent person standard has been applied in deciding petitions under the "unavoidable delay" standard of

35 U.S.C. 133. See *In re Mattullath*, 38 App. D.C. 497, 514-15 (1912) (“the word ‘unavoidable’ ... is applicable to ordinary human affairs, and requires no more or greater care or diligence than is generally used and observed by prudent and careful men in relation to their most important business”) (quoting and adopting *Ex parte Pratt*, 1887 Dec. Comm’r Pat. 31, 32-33); see also *Ray v. Lehman*, 55 F.3d 606, 609, 34 USPQ2d 1786, 1787 (Fed. Cir. 1995) (“in determining whether a delay...was unavoidable, one looks to whether the party...exercised the due care of a reasonably prudent person”). While the legislative history of the American Inventors Protection Act of 1999 is silent as to the meaning of the phrase “in spite of all due care,” the phrases “all due care” and “unable to respond” invoke a higher degree of care than the ordinary due care standard of 35 U.S.C. 133, as well as the “reasonable efforts to conclude processing or examination [or prosecution] of an application” standard of 35 U.S.C. 154(b)(2)(C)(i) and (iii). Therefore, applicants should not rely upon decisions relating to the “unavoidable delay” standard of 35 U.S.C. 133 as controlling in a request to reinstate reduced patent term adjustment on the basis of a showing that the applicant was unable to respond within the three-month period in spite of all due care.

### Examples

Examples of showings that may establish that the applicant was unable to respond within the three-month period in spite of all due care are as follows:

(A) a showing that the original three-month period was insufficient to obtain the test data necessary for an affidavit or declaration under 37 CFR 1.132 that was submitted with a reply filed outside the original three-month period;

(B) a showing that the applicant was unable to reply within the original three-month period due to a natural disaster;

(C) a showing that applicant was unable to reply within the original three-month period because testing was required to reply to an Office action, and the testing necessarily took longer than three months; or

(D) a showing that the applicant was unable to reply within the original three-month period due to illness or death of a sole practitioner of record who was responsible for prosecuting the application.

The patent term adjustment term reinstated would be limited to the period in which the showing establishes that applicant was acting with all due care to reply to the Office notice or action, but circumstances (outside applicant’s control) made applicant unable to reply in spite of such due care. An applicant will not be able to show that he or she was unable to respond within the three-month period “in spite of all due care” if the reply was not filed within the three-month period due to reasons within the control of applicant or agencies within the applicant’s control.

Examples of circumstances that would **NOT** establish that the applicant was unable to respond within the three-month period in spite of all due care are:

(A) an applicant’s or representative’s preoccupation with other matters (e.g., an inter partes lawsuit or interference) that is given priority over the application;

(B) illness or death of the practitioner in charge of the application if the practitioner is associated (in a law firm) with other practitioners (since the other practitioners could have taken action to reply within the three-month period);

(C) time consumed with communications between the applicant and his or her representative, regardless of whether the applicant resides in the United States or chooses to communicate with the United States representative via a foreign representative;

(D) vacation or other non-attention to an application that results in a failure to reply within the three-month period;

(E) applicant filing a reply on or near the last day of the three-month period using first class mail with a certificate of mailing under 37 CFR 1.8, rather than by Express Mail under 37 CFR 1.10 or facsimile (if permitted), and the reply is not received (filed) in the Office until after the three-month period; or

(F) failure of clerical employees of applicant or applicant’s representative to properly docket the Office action or notice for reply or perform other tasks necessary for reply within the three-month period.

Rarely is the power of attorney given to a single attorney and often many attorneys are given power of attorney in an application. An attorney in litigation, working on an interference or taking a vacation is generally aware of that fact before the event and

should make plans for another to take over his or her work so that it is completed and filed in the Office within the three-month period. Thus, failure to reply within the three-month period in 35 U.S.C. 154(b)(2)(C)(ii) due to preoccupation with other matters (e.g., an *inter partes* lawsuit or interference) given priority over the application, or vacation or other non-attention to an application, cannot be relied upon to show that applicant was unable to reply “in spite of all due care” under 35 U.S.C. 154(b)(3)(C).<

&gt;

### **2735 Request for Reconsideration of Patent Term Adjustment Determination [R-2]**

*37 CFR 1.705. Patent term adjustment determination.*

\*\*\*\*\*

(d) If there is a revision to the patent term adjustment indicated in the notice of allowance, the patent will indicate the revised patent term adjustment. If the patent indicates or should have indicated a revised patent term adjustment, any request for reconsideration of the patent term adjustment indicated in the patent must be filed within two months of the date the patent issued and must comply with the requirements of paragraphs (b)(1) and (b)(2) of this section. Any request for reconsideration under this section that raises issues that were raised, or could have been raised, in an application for patent term adjustment under paragraph (b) of this section shall be dismissed as untimely as to those issues.

(e) The periods set forth in this section are not extendable.

\*\*\*\*\*

Since the Office is obligated to provide a determination of patent term adjustment under 35 U.S.C. 154(b) in the notice of allowance (i.e., before the actual patent issue date), the Office must project (or estimate) the actual patent issue date and base its patent term adjustment determination on that projection. Additionally, there are a number of papers which if submitted by an applicant after the mailing of the notice of allowance will result in a reduction of any patent term adjustment, and there may be Office delays occurring after mailing the notice of allowance resulting in an increase in the amount of patent term adjustment. Thus, 37 CFR 1.705(d) provides for a revision of the patent term adjustment when revision is necessitated by events occurring after the mailing of the notice of allowance. 37 CFR 1.705(d) specifically provides that if there is a revision to the patent

term adjustment indicated in the notice of allowance, the patent will indicate the revised patent term adjustment. 37 CFR 1.705(d) also provides that if the patent indicates or should have indicated a revised patent term adjustment, any request for reconsideration of the patent term adjustment indicated in the patent must be filed within two months of the date the patent issued and must comply with the requirements of 37 CFR 1.705(b). The two month period is not extendable. 37 CFR 1.705(e).

Any request for reconsideration under 37 CFR 1.705(d) that raises issues that were raised, or could have been raised, in an application for patent term adjustment under 37 CFR 1.705(b) shall be dismissed as untimely as to those issues.<

&gt;

### **2736 Third Party Papers [R-2]**

*37 CFR 1.705. Patent term adjustment determination.*

\*\*\*\*\*

(f) No submission or petition on behalf of a third party concerning patent term adjustment under 35 U.S.C. 154(b) will be considered by the Office. Any such submission or petition will be returned to the third party, or otherwise disposed of, at the convenience of the Office.

\*\*\*\*\*

37 CFR 1.705(f) implements the provisions of 35 U.S.C. 154(b)(4)(B) and provides that no submission or petition on behalf of a third party concerning patent term adjustment under 35 U.S.C. 154(b) will be considered by the Office, and that any such submission or petition will be returned to the third party, or otherwise disposed of, at the convenience of the Office.<

### **2750 Patent Term Extension for Delays at other Agencies under 35 U.S.C. 156 [R-2]**

The right to a patent term extension based upon regulatory review is the result of the Drug Price Competition and Patent Term Restoration Act of 1984, Pub. L. No. 98-417, 98 Stat. 1585 (codified at 21 U.S.C. 355(b), (j), (l); 35 U.S.C. 156, 271, 282)(Hatch-Waxman Act). The act sought to eliminate two distortions to the normal “patent term produced by the requirement that certain products must receive premarket regulatory approval.” *Eli Lilly &*

*Co. v. Medtronic Inc.*, 496 U.S. 661, 669, 15 USPQ2d 1121, 1126 (1990). The first distortion was that the patent owner loses patent term during the early years of the patent because the product cannot be commercially marketed without approval from a regulatory agency. The second distortion occurred after the end of the patent term because competitors could not immediately enter the market upon expiration of the patent because they were not allowed to begin testing and other activities necessary to receive FDA approval before patent expiration.

The part of the act codified as 35 U.S.C. 156 was designed to create new incentives for research and development of certain products subject to premarket government approval by a regulatory agency. The statute enables the owners of patents on certain human drugs, food or color additives, medical devices, animal drugs, and veterinary biological products to restore to the terms of those patents some of the time lost while awaiting premarket government approval from a regulatory agency. The rights derived from extension of the patent term are limited to the approved product (as defined in 35 U.S.C. 156(a)(4) and (a)(5)). See 35 U.S.C. 156(b). Accordingly, if the patent claims other products in addition to the approved product, the exclusive patent rights to the additional products expire with the original expiration date of the patent.

In exchange for extension of the term of the patent, Congress legislatively overruled *Roche Products v. Bolar Pharmaceuticals*, 733 F.2d 858, 221 USPQ 937 (Fed. Cir. 1984) as to products covered by 35 U.S.C. 271(e) and provided that it shall not be an act of infringement, for example, to make and test a patented drug solely for the purpose of developing and submitting information for an Abbreviated New Drug Application (ANDA). 35 U.S.C. 271(e)(1). See Donald O. Beers, *Generic and Innovator Drugs: A Guide to FDA Approval Requirements*, Fifth Edition, Aspen Law & Business, 1999, 4.3[2] for a discussion of the Hatch-Waxman Act and infringement litigation. Furthermore, Congress provided that an ANDA cannot be filed until five years after the approval date of the product if the active ingredient or a salt or ester of the active ingredient had not been previously approved under section 505(b) of the Federal Food, Drug and Cosmetic Act. 21 U.S.C. 355(j)(4)(D)(ii). See also Lourie, *Patent Term Restoration: History,*

*Summary, and Appraisal*, 40 Food, Drug and Cosmetic L. J. 351, 353-60 (1985). See also Lourie, *Patent Term Restoration*, 66 J. Pat. Off. Soc'y 526 (1984).

On November 16, 1988, 35 U.S.C. 156 was amended by Public Law 100-670, essentially to add animal drugs and veterinary biologics to the list of products that can form the basis of patent term extension. Animal drug products which are primarily manufactured through biotechnology are excluded from the provisions of patent term extension.

On December 3, 1993, 35 U.S.C. 156 was further amended to provide for interim extension of a patent where a product claimed by the patent was expected to be approved, but not until after the original expiration date of the patent. Public Law 103-179, Section 5.

An application for the extension of the term of a patent under 35 U.S.C. 156 must be submitted by the owner of record of the patent or its agent within the sixty-day period beginning on the date the product received permission for commercial marketing or use under the provision of law under which the applicable regulatory review period occurred for commercial marketing or use. See 35 U.S.C. 156(d)(1). The USPTO initially determines whether the application is formally complete and whether the patent is eligible for extension. The statute requires the \*>Director of the United States Patent and Trademark Office< to notify the Secretary of Agriculture or the Secretary of Health and Human Services of the submission of an application for extension of patent term which complies with 35 U.S.C. 156 within sixty days and to submit to the Secretary a copy of the application. Not later than thirty days after receipt of the application from the \*>Director<, the Secretary will determine the length of the applicable regulatory review period and notify the \*>Director< of the determination. If the \*>Director< determines that the patent is eligible for extension, the \*>Director< calculates the length of extension for which the patent is eligible under the appropriate statutory provision and issues an appropriate Certificate of Extension.

Patent term extensions provided by private relief legislation, public laws other than as enacted by 35 U.S.C. 156, such as 35 U.S.C. 155 and 155A, are not addressed herein.



## 2751 Eligibility Requirements [R-2]

### 35 U.S.C. 156. Extension of patent term

(a) The term of a patent which claims a product, a method of using a product, or a method of manufacturing a product shall be extended in accordance with this section from the original expiration date of the patent, which shall include any patent term adjustment granted under section 154(b) if —

(1) the term of the patent has not expired before an application is submitted under subsection (d)(1) for its extension;

(2) the term of the patent has never been extended under subsection (e)(1) of this section;

(3) an application for extension is submitted by the owner of record of the patent or its agent and in accordance with the requirements of paragraphs (1) through (4) of subsection (d);

(4) the product has been subject to a regulatory review period before its commercial marketing or use;

(5)(A) except as provided in subparagraph (B) or (C), the permission for the commercial marketing or use of the product after such regulatory review period is the first permitted commercial marketing or use of the product under the provision of law under which such regulatory review period occurred;

(B) in the case of a patent which claims a method of manufacturing the product which primarily uses recombinant DNA technology in the manufacture of the product, the permission for the commercial marketing or use of the product after such regulatory period is the first permitted commercial marketing or use of a product manufactured under the process claimed in the patent; or

(C) for purposes of subparagraph (A), in the case of a patent which —

(i) claims a new animal drug or a veterinary biological product which (I) is not covered by the claims in any other patent which has been extended, and (II) has received permission for the commercial marketing or use in non-food-producing animals and in food-producing animals, and

(ii) was not extended on the basis of the regulatory review period for use in non-food-producing animals, the permission for the commercial marketing or use of the drug or product after the regulatory review period for use in food-producing animals is the first permitted commercial marketing or use of the drug or product for administration to a food-producing animal.

The product referred to in paragraphs (4) and (5) is hereinafter in this section referred to as the “approved product.”

\*\*\*\*\*

(f) For purposes of this section:

(1) The term “product” means:

(A) A drug product.

(B) Any medical device, food additive, or color additive subject to regulation under the Federal Food, Drug, and Cosmetic Act.

(2) The term “drug product” means the active ingredient of—

(A) a new drug, antibiotic drug, or human biological product (as those terms are used in the Federal Food, Drug, and Cosmetic Act and the Public Health Service Act) or

(B) a new animal drug or veterinary biological product (as those terms are used in the Federal Food, Drug, and Cosmetic Act and the Virus-Serum-Toxin Act) which is not primarily manufactured using recombinant DNA, recombinant RNA, hybridoma technology, or other processes involving site specific genetic manipulation techniques, including any salt or ester of the active ingredient, as a single entity or in combination with another active ingredient.

(3) The term “major health or environmental effects test” means a test which is reasonably related to the evaluation of the health or environmental effects of a product, which requires at least six months to conduct, and the data from which is submitted to receive permission for commercial marketing or use. Periods of analysis or evaluation of test results are not to be included in determining if the conduct of a test required at least six months.

(4)(A) Any reference to section 351 is a reference to section 351 of the Public Health Service Act.

(B) Any reference to section 503, 505, 512, or 515 is a reference to section 503, 505, 512, or 515 of the Federal Food, Drug and Cosmetic Act.

(C) Any reference to the Virus-Serum-Toxin Act is a reference to the Act of March 4, 1913 (21 U.S.C. 151 - 158).

(5) The term “informal hearing” has the meaning prescribed for such term by section 201(y) of the Federal Food, Drug and Cosmetic Act.

(6) The term “patent” means a patent issued by the United States Patent and Trademark Office.

(7) The term “date of enactment” as used in this section means September 24, 1984, for human drug product, a medical device, food additive, or color additive.

(8) The term “date of enactment” as used in this section means the date of enactment of the Generic Animal Drug and Patent Term Restoration Act for an animal drug or a veterinary biological product.

\*\*\*\*\*

### 37 CFR 1.710. Patents subject to extension of the patent term

(a) A patent is eligible for extension of the patent term if the patent claims a product as defined in paragraph (b) of this section, either alone or in combination with other ingredients that read on a composition that received permission for commercial marketing or use, or a method of using such a product, or a method of manufacturing such a product, and meets all other conditions and requirements of this subpart.

(b) The term *product* referred to in paragraph (a) of this section means —

(1) The active ingredient of a new human drug, antibiotic drug, or human biological product (as those terms are used in the Federal Food, Drug, and Cosmetic Act and the Public Health Service Act) including any salt or ester of the active ingredient, as a single entity or in combination with another active ingredient; or

(2) The active ingredient of a new animal drug or veterinary biological product (as those terms are used in the Federal Food, Drug, and Cosmetic Act and the Virus-Serum-Toxin Act) that is not primarily manufactured using recombinant DNA, recombinant RNA, hybridoma technology, or other processes

including site specific genetic manipulation techniques, including any salt or ester of the active ingredient, as a single entity or in combination with another active ingredient; or

(3) Any medical device, food additive, or color additive subject to regulation under the Federal Food, Drug, and Cosmetic Act.

### *37 CFR 1.720. Conditions for extension of patent term*

The term of a patent may be extended if:

(a) The patent claims a product or a method of using or manufacturing a product as defined in § 1.710;

(b) The term of the patent has never been previously extended, except for extensions issued pursuant to §§ 1.701, 1.760, or 1.790;

(c) An application for extension is submitted in compliance with § 1.740;

(d) The product has been subject to a regulatory review period as defined in 35 U.S.C. 156(g) before its commercial marketing or use;

(e) The product has received permission for commercial marketing or use and —

(1) The permission for the commercial marketing or use of the product is the first received permission for commercial marketing or use under the provision of law under which the applicable regulatory review occurred, or

(2) In the case of a patent other than one directed to subject matter within § 1.710(b)(2) claiming a method of manufacturing the product that primarily uses recombinant DNA technology in the manufacture of the product, the permission for the commercial marketing or use is the first received permission for the commercial marketing or use of a product manufactured under the process claimed in the patent, or

(3) In the case of a patent claiming a new animal drug or a veterinary biological product that is not covered by the claims in any other patent that has been extended, and has received permission for the commercial marketing or use in non-food-producing animals and in food-producing animals, and was not extended on the basis of the regulatory review period for use in non-food-producing animals, the permission for the commercial marketing or use of the drug or product after the regulatory review period for use in food-producing animals is the first permitted commercial marketing or use of the drug or product for administration to a food-producing animal.

(f) The application is submitted within the sixty-day period beginning on the date the product first received permission for commercial marketing or use under the provisions of law under which the applicable regulatory review period occurred; or in the case of a patent claiming a method of manufacturing the product which primarily uses recombinant DNA technology in the manufacture of the product, the application for extension is submitted within the sixty-day period beginning on the date of the first permitted commercial marketing or use of a product manufactured under the process claimed in the patent; or in the case of a patent that claims a new animal drug or a veterinary biological product that is not covered by the claims in any other patent that has been extended, and said drug or product has received permission for the commercial marketing or use in non-food-producing animals, the

application for extension is submitted within the sixty-day period beginning on the date of the first permitted commercial marketing or use of the drug or product for administration to a food-producing animal;

(g) The term of the patent, including any interim extension issued pursuant to § 1.790, has not expired before the submission of an application in compliance with § 1.741; and

(h) No other patent term has been extended for the same regulatory review period for the product.

35 U.S.C. 156(a) sets forth what patents can be extended and the conditions under which they may be extended. 37 CFR 1.710 also addresses the patents that may be extended, and 37 CFR 1.720 describes the conditions under which a patent may be extended. As set forth in 35 U.S.C. 156 and 37 CFR 1.710, a patent which claims a human drug product, medical device, food or color additive first approved for marketing or use after September 24, 1984, or an animal drug or veterinary biological product (which was not primarily manufactured through biotechnology) first approved for marketing or use after November 16, 1988, may qualify for patent term extension. Furthermore, 35 U.S.C. 156(a)(1) - (5) require that the applicant establish that:

(1) the patent has not expired before an application under 35 U.S.C. 156(d) was filed (this may be an application for patent term extension under subsection (d)(1) or an application for interim extension under subsection (d)(5));

(2) the patent has never been extended under 35 U.S.C. 156(e)(1);

(3) the application for extension is submitted by the owner of record of the patent or its agent to the Office within 60 days of regulatory agency approval of the commercial marketing application and the application includes details relating to the patent, the approved product, and the regulatory review time spent in securing regulatory agency approval;

(4) the product has been subject to a regulatory review period within the meaning of 35 U.S.C. 156(g) before its commercial marketing or use;

(5) the approval is the first permitted commercial marketing or use of the product (35 U.S.C. 156(a)(5)(A)), except in the case of human drug products manufactured using recombinant DNA technology where the provisions of 35 U.S.C. 156(a)(5)(B) apply, or in the case of a new animal drug or a veterinary biological product where the provisions of 35 U.S.C. 156(a)(5)(C) apply.

35 U.S.C. 156(c)(4) also requires that no other patent term has been extended for the same regulatory review period for the product. See MPEP § 2761.

### >TERMINALLY DISCLAIMED PATENTS ARE ELIGIBLE

A patent may be extended under 35 U.S.C. 156, even though it has been terminally disclaimed. A patent term extension under 35 U.S.C. 156 is a limited extension of the patent rights associated with the approved product that is attached onto the original term of the patent. See 35 U.S.C. 156(b). Only one patent may be extended for a regulatory review period for any product, and 35 U.S.C. 156 sets the expiration date of a patent term extension. Although 35 U.S.C. 154(b)(2)(June 8, 1995) precludes a patent from being extended under 35 U.S.C. 154(b) if the patent has been terminally disclaimed due to an obviousness-type double patenting rejection (see MPEP § 2720), there is no such exclusion in 35 U.S.C. 156. Additionally, 35 U.S.C. 154(b)(2)(B)(May 29, 2000) provides that a patent cannot be adjusted beyond the date set by the disclaimer (see MPEP § 2730), but there is no similar provision in 35 U.S.C. 156. Thus patents may receive a patent term extension under 35 U.S.C. 156 beyond an expiration date set by a terminal disclaimer.<

### MEANING OF “PRODUCT” AS DEFINED IN 35 U.S.C. 156(f)

As required by 35 U.S.C. 156(a), patents eligible for extension of patent term are those which:

(A) claim a “product” as defined in 35 U.S.C. 156(f)(1), either alone or in combination with other ingredients, wherein the product reads on a composition (product) that received permission for commercial marketing or use, or a method of using such a product, or a method of manufacturing such a product, and

(B) meet all other conditions and requirements of the statute.

The term “claims a product” is not synonymous with “infringed by a product.” A patent which claims a metabolite of an approved drug does not claim the approved drug. *Hoechst-Roussel Pharmaceuticals Inc. v. Lehman*, 109 F.3d 756, 759, 42 USPQ2d 1220, 1223 (Fed. Cir. 1997).

The term “product” means:

(A) The active ingredient of a new human drug, antibiotic drug, or human biological product (as those terms are used in the Federal Food, Drug, and Cosmetic Act and the Public Health Service Act) including any salt or ester of the active ingredient, as a single entity or in combination with another active ingredient; or

(B) The active ingredient of a new animal drug or veterinary biological product (as those terms are used in the Federal Food, Drug, and Cosmetic Act and the Virus-Serum-Toxin Act) that is not primarily manufactured using recombinant DNA, recombinant RNA, hybridoma technology, or other processes including site specific genetic manipulation techniques, including any salt or ester of the active ingredient, as a single entity or in combination with another active ingredient; or

(C) Any medical device, food additive, or color additive subject to regulation under the Federal Food, Drug, and Cosmetic Act.

See 21 CFR 60.3(b) for definitions of terms such as active ingredient, color additive, food additive, human drug product, and medical device.

Essentially, a “product” is a “drug product,” medical device, food additive, or color additive requiring Food and Drug Administration or Department of Agriculture (Plant and Animal Inspection Service) approval of an order or regulation prior to commercial marketing or use. “Drug product” is the active ingredient of a human drug, animal drug (excluding those primarily manufactured using recombinant DNA, recombinant RNA, hybridoma technology, or other processes including site specific genetic manipulation techniques), or biological product (as defined by the Federal Food, Drug and Cosmetics Act and the Public Health Service Act) including any salt or ester of the active ingredient, as a single entity or in combination with another active ingredient. Animal biological products are approved by the Plant and Animal Inspection Service of the Department of Agriculture.

A “drug product” means the active ingredient found in the final dosage form prior to administration of the product to the patient, not the resultant form the drug may take after administration. In this regard, a drug in the ester form which is used for oral administration is a different drug product from the same active moiety

in a salt form which is administered by injection, even though both the salt and the ester are used to treat the same disease condition. The ester form is a different active ingredient from the salt form. Both the ester and the salt active ingredient may each support an extension of patent term of different patents provided the acid itself has not previously been approved. See *Glaxo Operations UK Ltd. v. Quigg*, 706 F.Supp. 1224, 1232-33, 10 USPQ2d 1100, 1107 (E.D. Va. 1989); *aff'd.*, 894 F.2d 392, 13 USPQ2d 1628 (Fed. Cir. 1990).

Furthermore, a “drug product” is the active ingredient of a particular new drug, rather than the entire composition of the drug product approved by the Food and Drug Administration. See *Fisons plc v. Quigg*, 1988 U.S. Dist. LEXIS 10935; 8 USPQ2d 1491, 1495 (D.D.C. 1988); *aff'd.*, 876 F.2d 99, 110; 10 USPQ2d 1869, 1870 (Fed. Cir. 1989). An active ingredient of a drug is the ingredient in the drug product that becomes therapeutically active when administered. *Glaxo Operations UK Ltd. v. Quigg*, 894 F.2d 392, 393, 13 USPQ2d 1628, 1629 (Fed. Cir. 1990); *but c.f.*, *Abbott Laboratories v. Young*, 920 F.2d 984, 989 n.7 (D.C. Cir. 1990), *cert denied*, 112 S. Ct. 76 (1991) (The court rejected the approach of *Glaxo* in considering whether *Abbott* was entitled to exclusivity).

A patent is considered to claim the product at least in those situations where the patent claims the active ingredient per se, or claims a composition or formulation which contains the active ingredient(s) and reads on the composition or formulation approved for commercial marketing or use.

#### **NO PREVIOUS EXTENSIONS (WITH LIMITED EXCEPTIONS)**

37 CFR 1.720(b) explains that patent term extension pursuant to 35 U.S.C. 156 is available only if the term of the patent has never been previously extended, except for extensions issued pursuant to 37 CFR 1.701, 1.760, or 1.790. An extension issued pursuant to 37 CFR 1.701 is an extension of the patent due to administrative delay within the Office. Note that the term of a patent is “adjusted,” not extended, pursuant to 37 CFR 1.702-1.705. An extension issued pursuant to 37 CFR 1.760 is an interim extension under 35 U.S.C. 156(e)(2). An extension issued pur-

suant to 37 CFR 1.790 is an interim extension under 35 U.S.C. 156(d)(5).

#### **REGULATORY REVIEW PERIOD**

37 CFR 1.720(d) restates the statutory requirement set forth in 35 U.S.C. 156(a)(4). The regulatory review period must have been a regulatory review period defined by the statute. A regulatory review period under section 510(k) of the Federal Food, Drug and Cosmetic Act is not a regulatory review period which gives rise to eligibility for patent term extension under 35 U.S.C. 156. *In re Nitinol Medical Technologies Inc.*, 17 USPQ2d 1492, 1492-1493 (Comm’r Pat. & Tm. 1990). See also *Baxter Diagnostics v. AVL Scientific Corp.* 798 F. Supp. 612, 619-620; 25 USPQ2d 1428, 1434 (CD CA 1992) (Congress intended only Class III medical devices to be eligible for patent term extension).

If the product is alleged to be a medical device, then regulatory review must have occurred under section 515, and not section 505, of the Federal Food, Drug and Cosmetic Act. Drug products are not reviewed under section 515.

If more than one application for patent term extension is filed based upon a single regulatory review period, election will be required of a single patent. See MPEP § 2761.

#### **FIRST PERMITTED MARKETING OR USE**

37 CFR 1.720(e) follows 35 U.S.C. 156(a)(5), and sets forth that the approval under the relevant provision of law must have been the first permitted marketing or use of the product under the provision of law, unless the product is for use in food producing animals as explained below. See *In re Patent Term Extension Application*, U.S. Patent No. 3,849,549, 226 USPQ 283, 284 (Pat. & Tm. Office 1985). If the product is a human drug product, then the approval of the active ingredient must be the first permitted commercial marketing or use of the active ingredient as a single entity or in combination with another active ingredient under the provision of law under which regulatory review occurred.

Where a product contains multiple active ingredients, if any one active ingredient has not been previously approved, it can form the basis of an extension of patent term provided the patent claims that ingredient. See *In re Alcon Laboratories Inc.*, 13 USPQ2d

1115, 1121 (Comm'r Pat. & Tm. 1989) for examples of products having different combinations of active ingredients. A different ratio of hormones is not a different active ingredient for purposes of 35 U.S.C. 156. Furthermore, an approved product having two active ingredients, which are not shown to have a synergistic effect or have pharmacological interaction, will not be considered to have a single active ingredient made of the two active ingredients.

As to 35 U.S.C. 156(a)(5)(C), which is addressed in 37 CFR 1.720(e)(3), the term of a patent directed to a new animal drug or veterinary biological product may be extended based on a second or subsequent approval of the active ingredient provided all the following conditions exist:

(A) the patent claims the drug or product;

(B) the drug or product is not covered by the claims in any other patent that has been extended;

(C) the patent term was not extended on the basis of the regulatory review period for use in non-food producing animals; and

(D) the second or subsequent approval was the first permitted commercial marketing or use of the drug or product for administration to a food-producing animal. In this case, the application must be filed within sixty days of the first approval for administration to a food-producing animal.

For animal drugs or products, prior approval for use in a non-food producing animal will not make a patent ineligible for patent term extension based upon a later approval of the drug or product for use in food producing animals, if the later approval is the first approval of the drug or product for use in food producing animals.

## 2752 Patent Term Extension Applicant

*35 U.S.C. 156. Extension of patent term*

\*\*\*\*\*

(d)(1) To obtain an extension of the term of a patent under this section, the owner of record of the patent or its agent shall submit an application to the Director. Except as provided in paragraph (5), such an application may only be submitted within the sixty-day period beginning on the date the product received permission under the provision of law under which the applicable regulatory review period occurred for commercial marketing or use. The application shall contain —

(A) the identity of the approved product and the Federal statute under which regulatory review occurred;

(B) the identity of the patent for which an extension is being sought and the identity of each claim of such patent;

(C) information to enable the Director to determine under subsections (a) and (b) the eligibility of a patent for extension and the rights that will be derived from the extension and information to enable the Director and the Secretary of Health and Human Services or the Secretary of Agriculture to determine the period of the extension under subsection (g);

(D) a brief description of the activities undertaken by the applicant during the applicable regulatory review period with respect to the approved product and the significant dates applicable to such activities; and

(E) such patent or other information as the Director may require.

\*\*\*\*\*

*37 CFR 1.730. Applicant for extension of patent term; signature requirements.*

(a) Any application for extension of a patent term must be submitted by the owner of record of the patent or its agent and must comply with the requirements of § 1.740.

(b) If the application is submitted by the patent owner, the application must be signed either by:

(1) The patent owner in compliance with § 3.73(b) of this chapter; or

(2) A registered practitioner on behalf of the patent owner.

(c) If the application is submitted on behalf of the patent owner by an agent of the patent owner (*e.g.*, a licensee of the patent owner), the application must be signed by a registered practitioner on behalf of the agent. The Office may require proof that the agent is authorized to act on behalf of the patent owner.

(d) If the application is signed by a registered practitioner, the Office may require proof that the practitioner is authorized to act on behalf of the patent owner or agent of the patent owner.

35 U.S.C. 156(d)(1) requires that the application for extension of the patent term must be submitted by the owner of record of the patent or its agent. If the application is filed by an assignee, the application papers should refer to the reel and frame number of the recorded assignment. A power of attorney from the patent owner to any patent attorney or agent submitting the patent term extension application papers should be filed, if the attorney or agent is not already of record in the patent (see 37 CFR 1.34(b)).

If the applicant for patent term extension was not the marketing applicant before the regulatory agency, then there must be an agency relationship between the patent owner and the marketing applicant during the regulatory review period. To show that such an applicant is authorized to rely upon the activities of the marketing applicant before the Food and Drug Administration or the Department of Agriculture, it is

advisable for the applicant for patent term extension to obtain a letter from the marketing applicant specifically authorizing such reliance.

## 2753 Application Contents [R-2]

37 CFR 1.740. *Formal requirements for application for extension of patent term; correction of informalities.*

\*\*>

(a) An application for extension of patent term must be made in writing to the Director. A formal application for the extension of patent term must include:<

(1) A complete identification of the approved product as by appropriate chemical and generic name, physical structure or characteristics;

(2) A complete identification of the Federal statute including the applicable provision of law under which the regulatory review occurred;

(3) An identification of the date on which the product received permission for commercial marketing or use under the provision of law under which the applicable regulatory review period occurred;

(4) In the case of a drug product, an identification of each active ingredient in the product and as to each active ingredient, a statement that it has not been previously approved for commercial marketing or use under the Federal Food, Drug, and Cosmetic Act, the Public Health Service Act, or the Virus-Serum-Toxin Act, or a statement of when the active ingredient was approved for commercial marketing or use (either alone or in combination with other active ingredients), the use for which it was approved, and the provision of law under which it was approved.

(5) A statement that the application is being submitted within the sixty day period permitted for submission pursuant to § 1.720(f) and an identification of the date of the last day on which the application could be submitted;

(6) A complete identification of the patent for which an extension is being sought by the name of the inventor, the patent number, the date of issue, and the date of expiration;

(7) A copy of the patent for which an extension is being sought, including the entire specification (including claims) and drawings;

(8) A copy of any disclaimer, certificate of correction, receipt of maintenance fee payment, or reexamination certificate issued in the patent;

(9) A statement that the patent claims the approved product, or a method of using or manufacturing the approved product, and a showing which lists each applicable patent claim and demonstrates the manner in which at least one such patent claim reads on:

(i) The approved product, if the listed claims include any claim to the approved product;

(ii) The method of using the approved product, if the listed claims include any claim to the method of using the approved product; and

(iii) The method of manufacturing the approved product, if the listed claims include any claim to the method of manufacturing the approved product;

(10) A statement beginning on a new page of the relevant dates and information pursuant to 35 U.S.C. 156(g) in order to enable the Secretary of Health and Human Services or the Secretary of Agriculture, as appropriate, to determine the applicable regulatory review period as follows:

(i) For a patent claiming a human drug, antibiotic, or human biological product:

(A) The effective date of the investigational new drug (IND) application and the IND number;

(B) The date on which a new drug application (NDA) or a Product License Application (PLA) was initially submitted and the NDA or PLA number; and

(C) The date on which the NDA was approved or the Product License issued;

(ii) For a patent claiming a new animal drug:

(A) The date a major health or environmental effects test on the drug was initiated, and any available substantiation of that date, or the date of an exemption under subsection (j) of Section 512 of the Federal Food, Drug, and Cosmetic Act became effective for such animal drug;

(B) The date on which a new animal drug application (NADA) was initially submitted and the NADA number; and

(C) The date on which the NADA was approved;

(iii) For a patent claiming a veterinary biological product:

(A) The date the authority to prepare an experimental biological product under the Virus-Serum-Toxin Act became effective;

(B) The date an application for a license was submitted under the Virus-Serum-Toxin Act; and

(C) The date the license issued;

(iv) For a patent claiming a food or color additive:

(A) The date a major health or environmental effects test on the additive was initiated and any available substantiation of that date;

(B) The date on which a petition for product approval under the Federal Food, Drug and Cosmetic Act was initially submitted and the petition number; and

(C) The date on which the FDA published a *Federal Register* notice listing the additive for use;

(v) For a patent claiming a medical device:

(A) The effective date of the investigational device exemption (IDE) and the IDE number, if applicable, or the date on which the applicant began the first clinical investigation involving the device, if no IDE was submitted, and any available substantiation of that date;

(B) The date on which the application for product approval or notice of completion of a product development protocol under Section 515 of the Federal Food, Drug and Cosmetic Act was initially submitted and the number of the application; and

(C) The date on which the application was approved or the protocol declared to be completed;

(11) A brief description beginning on a new page of the significant activities undertaken by the marketing applicant during the applicable regulatory review period with respect to the approved product and the significant dates applicable to such activities;

(12) A statement beginning on a new page that in the opinion of the applicant the patent is eligible for the extension and a statement as to the length of extension claimed, including how the length of extension was determined;

\*\*>

(13) A statement that applicant acknowledges a duty to disclose to the Director of the United States Patent and Trademark Office and the Secretary of Health and Human Services or the Secretary of Agriculture any information which is material to the determination of entitlement to the extension sought (*see* § 1.765);<

(14) The prescribed fee for receiving and acting upon the application for extension (*see* § 1.20(j)); and

(15) The name, address, and telephone number of the person to whom inquiries and correspondence relating to the application for patent term extension are to be directed.

(b) The application under this section must be accompanied by two additional copies of such application (for a total of three copies).

(c) If an application for extension of patent term is informal under this section, the Office will so notify the applicant. The applicant has two months from the mail date of the notice, or such time as is set in the notice, within which to correct the informality. Unless the notice indicates otherwise, this time period may be extended under the provisions of § 1.136.

37 CFR 1.740 sets forth the requirements for a formal application for extension of patent term. See MPEP § 2752 for a discussion of who may apply for a patent term extension. See 37 CFR 1.741 and MPEP § 2754 for a description of the information that must be submitted in the patent term extension application in order to be accorded a filing date.

37 CFR 1.740(a)(1) requires a complete identification of the approved product as by appropriate chemical and generic name, physical structure or characteristics so as to enable the \*>Director< to make a determination of whether the patent claims the approved product, or a method of using or manufacturing the approved product.

37 CFR 1.740(a)(2) requires a complete identification of the federal statute including the applicable provision of law under which the regulatory review occurred. When the regulatory review of the product took place under more than one Federal statute, each appropriate statute should be listed. This could apply to a situation where a human biological product is tested under an investigational new drug (IND) application pursuant to the Federal Food, Drug, and Cosmetic Act, but is approved under the Public Health Service Act; or to a situation where approval is sought for use of a particular medical device with a specific drug product which may require approval under more

than a single provision of law. The product that forms the basis of an application for patent term extension must be either a medical device or a drug product; it cannot be a combination of those separate products. See the file history of U.S. Patent No. 4,428,744 for an example of the application of this principle.

The date that a product receives permission for commercial marketing or use (which must be identified pursuant to 37 CFR 1.740(a)(3)) is generally the mailing date of the letter from the regulatory agency indicating regulatory approval. For a food additive, the approval date is generally the effective date stated in the regulation and the date the regulation is published.

37 CFR 1.740(a)(4) provides that for drug products, each active ingredient must be identified and there must be an indication of the use for which the product was approved. For each active ingredient, a statement must be made that either the active ingredient was not previously approved for commercial marketing or use under the Federal Food, Drug and Cosmetic Act, or that the active ingredient was approved for commercial marketing or use (either alone or in combination with other active ingredients) and the provision of law under which it was approved. The information is especially necessary for a determination of eligibility where, for example, the application is based on a second or subsequent approval of an active ingredient, but the first approval for administration to a food-producing animal.

In accordance with 37 CFR 1.740(a)(5), the application must be submitted within the sixty day period permitted for submission pursuant to 37 CFR 1.720(f). If the sixty day period ends on a Saturday, Sunday or Federal holiday, then the last day on which the application could be submitted will be considered to be the next business day following the Saturday, Sunday or Federal holiday. See 37 CFR 1.7. However, applicants are cautioned to avoid filing an application for patent term extension on the last day for filing to avoid the application being denied because the filing deadline was inadvertently missed.

The expiration date of the patent for which an extension is sought as identified pursuant to 37 CFR 1.740(a)(6) should be the expiration date according to the law (35 U.S.C. 154) at the time of filing of the application for patent term extension, and should

include any patent term adjustment under 35 U.S.C. 154(b).

Pursuant to 37 CFR 1.740(a)(9), the application for patent term extension need only explain how one product claim of the patent claims the approved product, if there is a claim to the product. In addition, the application need only explain how one method of use claim of the patent claims the method of use of the approved product, if there is a claim to the method of use of the product. Lastly, the application need only explain how one claim of the patent claims the method of manufacturing the approved product, if there is a claim to the method of manufacturing the approved product. At most, a showing explaining three claims is required. However, each claim that claims the approved product, the method of use of the approved product, or the method of manufacturing the approved product must be listed. See 35 U.S.C. 156(d)(1)(B).

The showing should clearly explain how each listed claim reads on the approved product. For example, where a generic chemical structure is used in the claim to define the claimed invention, a listing of variables and substituents which correspond to the approved product is appropriate. Where a claim uses the “means for” language permitted by 35 U.S.C. 112, paragraph 6, reference to the column and line number of the patent text and any drawing reference numbers, as well as a description of any relevant equivalents, is also appropriate.

Pursuant to 37 CFR 1.740(a)(10), the patent term extension applicant must provide a statement to enable the Secretary of Health and Human Services or the Secretary of Agriculture, as appropriate, to determine the applicable regulatory period. In cases where there is no regulatory event to reflect the commencement of the testing or approval phase of the regulatory review period, applicants should include in the application the dates that they claim initiate either the approval or the testing phases and an explanation of their reasonable bases for why they conclude that these dates are the relevant dates. For instance, when the clinical trials are conducted outside of the United States, the testing phase for a medical device begins on the date the clinical investigation involving the device began. An applicant should include an explanation as to why the date claimed is the date on which such clinical investigations had commenced. If the

applicant has any means of substantiating that date, that information should be included in the application.

37 CFR 1.740(a)(11) requires a brief description of the activities of the marketing applicant before the regulatory agency. This description should include an identification of significant communications of substance with the regulatory agency and the dates related to such communications. For example, these activities would include the dates of the submissions of new data to the FDA, communications between FDA and the applicant with respect to the appropriate protocols for testing the product, and communications between FDA and the applicant that are attempts to define the particular requirements for premarketing approval for this particular product. The applicant is not required to establish the existence of due diligence during the regulatory review period in order to have a complete application.

As stated above, the marketing applicant must have been an agent of the patent owner, if not the same entity as the patent owner. Accordingly, the Office will not assist the patent owner in obtaining information required in an application for patent term extension from the marketing applicant. It is sufficient that the description of the activities briefly identify those significant activities undertaken by the marketing applicant directed toward regulatory approval, and a submission of insignificant details or identification of non-substantive communications is not required.

37 CFR 1.740(a)(12) requires that the extension applicant state the length of extension claimed and show how the length of extension was calculated, including whether the 14-year limit of 35 U.S.C. 156(c)(3) or the two or three limit of 35 U.S.C. 156(g)(6)(C) applies.

37 CFR 1.740(a)(15) requires the patent term extension applicant to provide a correspondence address. A fax number should also be provided. Normally only communications regarding the application for patent term extension will be sent to the address specified in the patent term extension application. If the address is changed after filing the application for patent term extension, the change of address should be sent to \*>Mail Stop< Patent Extension, since changing the address for the patent file will not cause the address for the patent term extension application to also be changed.



In order to change the address of all correspondence, including maintenance fee reminders, a change of address should also be filed. A change of address must be signed by the patent applicant, the assignee of the entire interest, or an attorney or agent of record. 37 CFR 1.33(a). Accordingly, if the patent term extension application is signed by the marketing applicant, as an agent of the patent owner, a power of attorney from the patent owner to any attorney for the marketing applicant would be necessary for the attorney for the marketing applicant to be able to sign a change of address for the patent file.

Pursuant to 37 CFR 1.740(b), two additional copies of the application for patent term extension must be filed with the application. In addition, applicants are requested to file an additional two copies of the application, for a total of five copies. The original copy is placed into the patent application file after the Notice of Final Determination is mailed. Two copies of the application are forwarded to the regulatory agency, one copy is made available for public inspection in the Office of Patent Legal Administration, and the fifth copy is used by the Legal Advisor.

## 2754 Filing Date [R-2]

*37 CFR 1.741. Complete application given a filing date; petition procedure.*

(a) The filing date of an application for extension of a patent term is the date on which a complete application is received in the Office or filed pursuant to the procedures set forth in §1.8 or § 1.10. A complete application must include:

- (1) An identification of the approved product;
- (2) An identification of each Federal statute under which regulatory review occurred;
- (3) An identification of the patent for which an extension is being sought;
- (4) An identification of each claim of the patent which claims the approved product or a method of using or manufacturing the approved product;

\*\*>

(5) Sufficient information to enable the Director to determine under subsections (a) and (b) of 35 U.S.C. 156 the eligibility of a patent for extension, and the rights that will be derived from the extension, and information to enable the Director and the Secretary of Health and Human Services or the Secretary of Agriculture to determine the length of the regulatory review period; and

(6) A brief description of the activities undertaken by the marketing applicant during the applicable regulatory review period with respect to the approved product and the significant dates applicable to such activities.

(b) If an application for extension of patent term is incomplete under this section, the Office will so notify the applicant. If

applicant requests review of a notice that an application is incomplete, or review of the filing date accorded an application under this section, applicant must file a petition pursuant to this paragraph accompanied by the fee set forth in § 1.17(h) within two months of the mail date of the notice that the application is incomplete, or the notice according the filing date complained of. Unless the notice indicates otherwise, this time period may be extended under the provisions of § 1.136.

## FILING DATE ACCORDED

An application for patent term extension under 35 U.S.C. 156 may be filed by mail addressed to \*\*>Mail Stop Patent Ext., Commissioner for Patents, P.O. Box 1450, Alexandria, Virginia 22313-1450< or may be hand carried to the Office of Patent Legal Administration. Applicants are encouraged to use the post card receipt practice described in MPEP § 502.

As set forth in 37 CFR 1.741(a), the filing date of an application for patent term extension is the date on which a complete application is received in the USPTO or filed pursuant to the certificate of mailing provisions of 37 CFR 1.8 (see MPEP § 512 for suggested formats for a certificate of mailing) or the Express Mail provisions of 37 CFR 1.10. Patent term extension applications should not be filed by facsimile, however correspondence setting forth a change of address and other papers relating to a patent term extension may be sent by facsimile to the Office of Patent Legal Administration.

## COMPLETE APPLICATION

The term “complete application” is defined in 37 CFR 1.741(a) and is an application meeting the requirements set forth in 35 U.S.C. 156(d)(1). For the establishment of a filing date, the distinction between the requirements of 37 CFR 1.740 and the requirements of 37 CFR 1.741 are important. While the requirements of 37 CFR 1.740 may be satisfied outside the 60 day filing period, the requirements of 37 CFR 1.741 are mandated by 35 U.S.C. 156 and must be satisfied within the 60 day filing period for the establishment of the filing date. The Office will consider each of these statutory requirements to be satisfied in an application which provides sufficient information, directed to each requirement, to act on the application, even though further information may be desired by the USPTO or the regulatory agency before a final determination of eligibility and length of patent term extension is made.

## INFORMAL APPLICATION

37 CFR 1.740. *Formal requirements for application for extension of patent term; correction of informalities.*

\*\*\*\*\*

(c) If an application for extension of patent term is informal under this section, the Office will so notify the applicant. The applicant has two months from the mail date of the notice, or such time as is set in the notice, within which to correct the informality. Unless the notice indicates otherwise, this time period may be extended under the provisions of § 1.136.

\*\*\*\*\*

If the application does not meet all the formal requirements of 37 CFR 1.740(a) (see MPEP § 2753), the applicant will be notified of the informalities and may seek to have that holding reviewed under 37 CFR 1.740(c) or to correct the informality. The time periods set forth therein are subject to the provisions of 37 CFR 1.136, unless otherwise stated in the notice.

**Note that if the application satisfies the requirements of 37 CFR 1.741, the application filing date will have been established even if the application is held to be informal under 37 CFR 1.740.**

### 2754.01 Deadline for Filing an Application Under 35 U.S.C. 156(d)(1)

An application for patent term extension under 35 U.S.C. 156(d)(1) may only be filed within the sixty-day period beginning on the date the product received permission under the provision of law under which the applicable regulatory review period occurred for commercial marketing or use. The statutory time period is not extendable and cannot be waived or excused. See U.S. Patent No. 4,486,425 (application for patent term extension filed after the end of the 60-day period and was therefore denied). The sixty-day period begins on the regulatory agency approval date which marks the end of the regulatory review period. The statute takes into account only the regulatory review carried out by the Food and Drug Administration or the Department of Agriculture and no other government obstacles to marketing or use. See *Unimed, Inc. v. Quigg*, 888 F2d 826, 828; 12 USPQ2d 1644, 1646 (Fed. Cir. 1989). For drug products the approval date is the date of a letter by the Food and Drug Administration indicating that the application has been approved, even if the letter

requires further action before the drug can be marketed. *Mead Johnson Pharmaceutical Group v. Bowen*, 838 F2d 1332, 1336; 6 USPQ2d 1565, 1568 (D.C. Cir. 1988). For food or color additives, the relevant date is the effective date of the regulation or order, which is set forth in the regulation or order, and which is generally the date that the regulation or order is published, e.g., in the Federal Register. See 21 U.S.C. 348(e). This date will generally be later than the date the approval is communicated to the marketing applicant.

### 2754.02 Filing Window for an Application Under 35 U.S.C. 156(d)(5)

A first application for interim extension under 35 U.S.C. 156(d)(5) (to extend the patent term before product approval) must be filed within the period beginning six months and ending fifteen days before the patent is due to expire. Each subsequent application for interim extension must be filed during the period beginning sixty days before and ending thirty days before the expiration of the preceding interim extension. 35 U.S.C. 156(d)(5)(C). An interim extension granted under 35 U.S.C. 156(d)(5) terminates sixty days after permission for commercial marketing or use of the product is granted, except, if within the sixty-day period any additional information needed for an application for patent term extension under 35 U.S.C. 156(d)(1) is submitted, the patent may be further extended. 35 U.S.C. 156(d)(5)(E). The additional information required to be submitted includes the fee for an application for patent term extension under 35 U.S.C. 156(d)(1) and identification of the date the product received permission for commercial marketing or use and a statement that the application is being submitted within sixty days of such date and identification of the last date that the application could be submitted. See 37 CFR 1.740(a)(3) and (5). However, if the product is not approved within the period of interim extension, a new request for interim extension must be filed and another interim extension granted to keep the patent in force. An applicant is generally limited to four one-year interim extensions.

See MPEP § 2755.02 for additional information pertaining to the interim extension of patent term under 35 U.S.C. 156(d)(5).

### 2754.03 Filing of a Request for an Extension Under 35 U.S.C. 156(e)(2)

A request for an interim extension under 35 U.S.C. 156(e)(2) (to extend the patent term during the processing of the patent term extension application) should be made at least three months before the patent is due to expire. See MPEP § 2755.01 for information pertaining to the interim extension of patent term under 35 U.S.C. 156(e)(2).

### 2755 Eligibility Determination [R-2]

\*\*>

*37 CFR 1.750. Determination of eligibility for extension of patent term*

A determination as to whether a patent is eligible for extension may be made by the Director solely on the basis of the representations contained in the application for extension filed in compliance with § 1.740 or § 1.790. This determination may be delegated to appropriate Patent and Trademark Office officials and may be made at any time before the certificate of extension is issued. The Director or other appropriate officials may require from applicant further information or make such independent inquiries as desired before a final determination is made on whether a patent is eligible for extension. In an application for extension filed in compliance with § 1.740, a notice will be mailed to applicant containing the determination as to the eligibility of the patent for extension and the period of time of the extension, if any. This notice shall constitute the final determination as to the eligibility and any period of extension of the patent. A single request for reconsideration of a final determination may be made if filed by the applicant within such time as may be set in the notice of final determination or, if no time is set, within one month from the date of the final determination. The time periods set forth herein are subject to the provisions of § 1.136.<

The determination as to whether a patent is eligible for an extension will normally be made solely from the representations contained in the application for patent term extension. However, further information may be required or inquiry made of applicant before a final determination is made on whether a patent is eligible for extension. In circumstances where further information is required by the Office, the applicant will be given a time period within which to respond. The failure to provide a response within the time period provided may result in a final determination adverse to the granting of an extension of patent term unless the response period is extended. An extension of time to respond may be requested under the provisions of 37 CFR 1.136. Under appropriate circumstances, e.g., if time is of the essence for a particular

reason, a request for information may contain a statement that the provisions of 37 CFR 1.136(a) are not available. The intentional failure to provide the information requested may result in an adverse final determination.

A final determination may be made at any time after an application is filed. A single request for reconsideration of a final determination may be filed within one month or within such other time period set in the final determination. A notice will be mailed to applicant containing the determination as to eligibility of the patent for extension and the period of time of the extension of the term, if any. This notice shall constitute the final determination as to eligibility and any period of extension of the patent term. If no request for reconsideration is filed within the time period set in the notice of final determination, the certificate of patent term extension will be issued in due course. See MPEP § 2758.

### 2755.01 Interim Extension of Patent Term During the Processing of the Application [R-2]

*35 U.S.C. 156. Extension of patent term.*

\*\*\*\*\*

(e)(2) If the term of a patent for which an application has been submitted under subsection (d)(1) would expire before a certificate of extension is issued or denied under paragraph (1) respecting the application, the Director shall extend, until such determination is made, the term of the patent for periods of up to one year if he determines that the patent is eligible for extension.

\*\*\*\*\*

\*\*>

*37 CFR 1.760. Interim extension of patent term under 35 U.S.C. 156(e)(2).*

An applicant who has filed a formal application for extension in compliance with § 1.740 may request one or more interim extensions for periods of up to one year each pending a final determination on the application pursuant to § 1.750. Any such request should be filed at least three months prior to the expiration date of the patent. The Director may issue interim extensions, without a request by the applicant, for periods of up to one year each until a final determination is made. The patent owner or agent will be notified when an interim extension is granted and notice of the extension will be published in the *Official Gazette of the United States Patent and Trademark Office*. The notice will be recorded in the official file of the patent and will be considered as part of the original patent. In no event will the interim extensions

granted under this section be longer than the maximum period for extension to which the applicant would be eligible.<

If the original term of the patent for which extension is sought will expire before a final decision to issue a certificate of extension can be made, and a determination is made that the patent is eligible for extension, 35 U.S.C. 156 provides that the \*>Director< may issue an interim extension of the patent term for up to one year pending a final decision on the application for extension. Should additional time be necessary, additional interim extensions of up to one year may be granted by the \*>Director<. The length of any interim extension is discretionary with the \*>Director< so long as it is for one year or less. Its length should be set to provide time for completion of any outstanding requirements. See *In re Reckitt & Colman Products Ltd.*, 230 USPQ 369, 372 (Comm'r Pat. & Tm. 1986). The \*>Director< may issue an interim extension under 35 U.S.C. 156(e)(2) with or without a request from the applicant.

Where a determination is made that the patent is not eligible for patent term extension, an interim extension of the patent term is not warranted under 35 U.S.C. 156(e)(2). See *In re Alcon Laboratories Inc.*, 13 USPQ2d 1115, 1123 (Comm'r. Pat. & Tm. 1989).

Where an interim extension has been granted and it is subsequently determined that the patent is not eligible for patent term extension, the interim extension may be vacated *ab initio* as ineligible under 35 U.S.C. 156(e)(2). See *In re Reckitt*, 230 USPQ at 370.

While 37 CFR 1.760 provides that a request for an interim extension by the applicant "should" be filed three months prior to the expiration of the patent, this time frame is not mandatory. Any request filed within a shorter period of time will be considered, upon a proper showing, where it is not possible to make an earlier request. However, for an interim extension to be granted, the application for extension, in compliance with 37 CFR 1.741, must have been filed prior to the expiration date of the patent. In no event will an interim extension be granted for a period of patent term extension longer than the period of extension to which the patent would be eligible.

A notice of each interim extension granted will be issued to the applicant for patent term extension. The

notice will be recorded in the official file of the patent and will be considered as part of the original patent. Notification of the issuance of the interim extension will be published in the Official Gazette of the Patent and Trademark Office.

## 2755.02 Interim Extension of Patent Term Before Product Approval

35 U.S.C. 156. *Extension of patent term.*

\*\*\*\*\*

(d)(5)(A) If the owner of record of the patent or its agent reasonably expects that the applicable regulatory review period described in paragraphs (1)(B)(ii), (2)(B)(ii), (3)(B)(ii), (4)(B)(ii), or (5)(B)(ii) of subsection (g) that began for a product that is the subject of such patent may extend beyond the expiration of the patent term in effect, the owner or its agent may submit an application to the Director for an interim extension during the period beginning 6 months, and ending 15 days before such term is due to expire. The application shall contain—

(i) the identity of the product subject to regulating review and the Federal statute under which such review is occurring;

(ii) the identity of the patent for which interim extension is being sought and the identity of each claim of such patent which claims the product under regulatory review or a method of using or manufacturing the product;

(iii) information to enable the Director to determine under subsection (a)(1), (2), and (3) the eligibility of a patent for extension;

(iv) a brief description of the activities undertaken by the applicant during the applicable regulatory review period to date with respect to the product under review and the significant dates applicable to such activities; and

(v) such patent or other information as the Director may require.

(5)(B) If the Director determines that, except for permission to market or use the product commercially, the patent would be eligible for an extension of the patent term under this section, the Director shall publish in the Federal Register a notice of such determination, including the identity of the product under regulatory review, and shall issue to the applicant a certificate of interim extension for a period of not more than 1 year.

(C) The owner of record of a patent, or its agent, for which an interim extension has been granted under subparagraph (B), may apply for not more than 4 subsequent interim extensions under this paragraph, except that, in the case of a patent subject to subsection (g)(6)(C), the owner of record of the patent, or its agent, may apply for only 1 subsequent interim extension under this paragraph. Each such subsequent application shall be made during the period beginning 60 days before, and ending 30 days before, the expiration of the preceding interim extension.

(D) Each certificate of interim extension under this paragraph shall be recorded in the official file of the patent and shall be considered part of the original patent.

(E) Any interim extension granted under this paragraph shall terminate at the end of the 60-day period beginning on the day on which the product involved receives permission for commercial marketing or use, except that, if within that 60-day period, the applicant notifies the Director of such permission and submits any additional information under paragraph (1) of this subsection not previously contained in the application for interim extension, the patent shall be further extended, in accordance with the provisions of this section—

(i) for not to exceed 5 years from the date of expiration of the original patent term; or

(ii) if the patent is subject to subsection (g)(6)(C), from the date on which the product involved receives approval for commercial marketing or use.

(F) The rights derived from any patent the term of which is extended under this paragraph shall, during the period of interim extension—

(i) in the case of a patent which claims a product, be limited to any use then under regulatory review;

(ii) in the case of a patent which claims a method of using a product, be limited to any use claimed by the patent then under regulatory review; and

(iii) in the case of a patent which claims a method of manufacturing a product, be limited to the method of manufacturing as used to make the product then under regulatory review.

\*\*\*\*\*

*37 CFR 1.790. Interim extension of patent term under 35 U.S.C. 156(d)(5).*

(a) An owner of record of a patent or its agent who reasonably expects that the applicable regulatory review period described in paragraph (1)(B)(ii), (2)(B)(ii), (3)(B)(ii), (4)(B)(ii), or (5)(B)(ii) of subsection (g) that began for a product that is the subject of such patent may extend beyond the expiration of the patent term in effect may submit one or more applications for interim extensions for periods of up to one year each. The initial application for interim extension must be filed during the period beginning 6 months and ending 15 days before the patent term is due to expire. Each subsequent application for interim extension must be filed during the period beginning 60 days before and ending 30 days before the expiration of the preceding interim extension. In no event will the interim extensions granted under this section be longer than the maximum period of extension to which the applicant would be entitled under 35 U.S.C. 156(c).

(b) A complete application for interim extension under this section shall include all of the information required for a formal application under § 1.740 and a complete application under § 1.741. Sections (a)(1), (a)(2), (a)(4), and (a)(6) - (a)(17) of § 1.740 and § 1.741 shall be read in the context of a product currently undergoing regulatory review. Sections (a)(3) and (a)(5) of § 1.740 are not applicable to an application for interim extension under this section.

(c) The content of each subsequent interim extension application may be limited to a request for a subsequent interim extension

along with a statement that the regulatory review period has not been completed along with any materials or information required under §§ 1.740 and 1.741 that are not present in the preceding interim extension application.

*37 CFR 1.791. Termination of interim extension granted prior to regulatory approval of a product for commercial marketing or use.*

Any interim extension granted under 35 U.S.C. 156(d)(5) terminates at the end of the 60-day period beginning on the date on which the product involved receives permission for commercial marketing or use. If within that 60-day period the patent owner or its agent files an application for extension under §§ 1.740 and 1.741 including any additional information required under 35 U.S.C. 156(d)(1) not contained in the application for interim extension, the patent shall be further extended in accordance with the provisions of 35 U.S.C. 156.

If a patent that claims a product which is undergoing the approval phase of regulatory review as defined by 35 U.S.C. 156(g)(1)(B)(ii), (2)(B)(ii), (3)(B)(ii), (4)(B)(ii), and (5)(B)(ii) is expected to expire before approval is granted, interim patent term extension is available under 35 U.S.C. 156(d)(5). The application for patent term extension that must be submitted is generally the same as would be filed had the product been approved, except that the approval date is not required to be set forth. Once the product is approved, the application must be converted to an application for patent term extension under 35 U.S.C. 156(d)(1) to obtain patent term extension under that subsection.

Processing of an application for interim patent term extension under 35 U.S.C. 156(d)(5) is performed in the Office of Patent Legal Administration and is similar to other applications for patent term extension, except that the Office is not required to seek the advice of the relevant regulatory agency. The relevant agency, however, is normally consulted before an interim extension is granted or before the application is denied. The fee for an application for patent term extension under 35 U.S.C. 156(d)(5) is set forth in 37 CFR 1.20(j)(2), and the fee for a subsequent application is set forth in 37 CFR 1.20(j)(3). Copies of an application for interim extension are maintained in the same manner as applications for patent term extension. As required by 35 U.S.C. 156(d)(5)(B), a determination that a patent is eligible for extension under 35 U.S.C. 156, but for regulatory approval, is published in the Federal Register. A sample order granting a second interim extension follows:

**UNITED STATES PATENT AND TRADEMARK OFFICE  
BEFORE THE COMMISSIONER OF PATENTS AND  
TRADEMARKS**

In re \_\_\_\_

Request for Patent Term Extension      ORDER GRANTING  
U.S. Patent No. \_\_\_\_                      INTERIM EXTENSION

On \_\_\_, patent owner \_\_\_, filed an application under 35 U.S.C. 156(d)(5) for interim extension of the term of U.S. Patent No. \_\_\_. The patent claims the active ingredient \_\_\_ in the human drug product “\_\_\_.” The application indicates that the product is currently undergoing a regulatory review before the Food and Drug Administration for permission to market or use the product commercially. The original term of the patent expired on \_\_\_\_ On \_\_\_, the patent was granted an first interim extension under 35 U.S.C. 156(d)(5) for a period of one year.

Review of the application indicates that except for receipt of permission to market or use the product commercially, the subject patent would be eligible for an extension of the patent term under 35 U.S.C. 156. Since it is apparent that the regulatory review period may extend beyond the date of expiration of the patent, as extended by the first interim extension, a second interim extension of the patent term under 35 U.S.C. 156(d)(5) is appropriate.

An interim extension under 35 U.S.C. 156(d)(5) of the term of U.S. Patent No. \_\_\_ is granted for a period of one year from the extended expiration date of the patent.

As seen from the example given, a series of one-year interim extensions may be granted if requested in a timely manner (in the window of time between thirty and sixty days before the extended expiration date).

An interim extension granted under 35 U.S.C. 156(d)(5) terminates sixty days after permission for commercial marketing or use of the product is granted, except, if within the sixty day period any additional information needed for an application for patent term extension under 35 U.S.C. 156(d)(1) is submitted, the patent may be further extended. 35 U.S.C. 156(d)(5)(E).

**2756 Correspondence Between the  
USPTO and the Regulatory Agency  
[R-2]**

It is the \*>Director’s< responsibility to decide whether an applicant has satisfied the requirements of the statute and whether the patent qualifies for patent term extension. The regulatory agency possesses

expertise and records regarding some of the statutory requirements and has certain direct responsibilities under 35 U.S.C. 156 for determining the length of the regulatory review period. Consequently, to facilitate eligibility decisions and permit the regulatory agency and the Office to carry out their responsibilities under 35 U.S.C. 156, both the Food and Drug Administration and the Department of Agriculture have entered into an “agreement” of cooperation with the Office. *Memorandum of Understanding Between the Patent and Trademark Office and the Food and Drug Administration*, 52 Fed. Reg. 17830 (May 12, 1987); *Memorandum of Understanding Between the Patent and Trademark Office and the Animal and Plant Health Inspection Service*, 54 Fed. Reg. 26399 (June 23, 1989); 1104 OG 18 (July 11, 1989). The agreements establish the procedures whereby the regulatory agency assists the Office in determining a patent’s eligibility for patent term restoration under 35 U.S.C. 156. It also establishes procedures for exchanging information between the regulatory agency and the Office regarding regulatory review period determinations, due diligence petitions and informal regulatory agency hearings under the law. The patent term extension applicant receives a copy of all correspondence between the Office and the regulatory agency.

The Animal and Health Inspection Service of the Department of Agriculture is responsible for assisting the Office in determining the eligibility of patent claiming a veterinary biological product that has been subject to the Virus-Serum-Toxin Act (21 U.S.C. 151-59) and for determining the regulatory review period of the veterinary biological product. The Secretary of Health and Human Services of the Food and Drug Administration is responsible for assisting the Office in determining the eligibility of patents claiming any other product for which regulatory review gives rise to eligibility for patent term extension. 21 CFR 60.10.

**INFORMATION REGARDING ELIGIBILITY  
FOR EXTENSION**

If the Office has no clear reason to deny eligibility for patent term extension (even if there are questions concerning eligibility), or if the applicant has been notified of any informalities and it is anticipated that the informalities will be corrected or explained, a first letter is sent to the regulatory agency requesting infor-

mation regarding eligibility. The letter is accompanied by a copy of the patent term extension application. This letter does **not** request the determination of the applicable regulatory review period.

The regulatory agency reply is usually in the form of a written response:

(A) verifying whether the product has undergone a regulatory review period within the meaning of 35 U.S.C. 156(g) prior to commercial marketing or use;

(B) stating whether the marketing permission was for the first permitted commercial marketing or use of that product, or, in the case of recombinant DNA technology, whether such commercial marketing or use was the first permitted under the process claimed in the patent;

(C) informing the Office whether the patent term extension application was submitted within sixty days after the product was approved for marketing or use; and

(D) providing the Office with any other information relevant to the Office determination of whether a patent related to a product is eligible for patent term extension.

While the Office has primary responsibility for the eligibility determination, the regulatory agency often possesses information which is not readily available to the Office. The assistance on the part of the regulatory agency enables both the Office and the agency to process applications efficiently and to conserve resources.

### PRELIMINARY ELIGIBILITY DECISION

Upon receipt of a reply from the regulatory agency to the first letter from the Office requesting assistance on determining eligibility, a preliminary eligibility decision (not the final decision) is made as to whether the patent is eligible for an extension of its term. As noted above, the reply from the regulatory agency will usually inform the Office as to whether the permission for commercial marketing and use of the product on which the application for patent term extension is based is the first such approval for that product. Furthermore, the regulatory agency usually provides information regarding the date of product approval to permit a determination as to whether the application was filed within the sixty-day statutory period. The

information provided by the regulatory agency is then compared with the related information from the application. If no major discrepancies are found and the patent is determined to be eligible for patent term extension, a second letter requesting a determination of the length of the regulatory review period of the product is mailed to the regulatory agency not later than sixty (60) days after the Office receipt date of the reply from the regulatory agency. In the interest of efficiency, if the patent is determined to be ineligible for patent term extension, the Office will dismiss the application rather than request a determination of the regulatory review period. *In re Allen & Hansbury, Ltd.*, 227 USPQ 955, 960 n. 9 (Comm'r Pat. & Tm. 1985). A certified copy of the application for patent term extension is sent to the regulatory agency along with the second letter. The second letter states that, subject to final review, the patent is considered eligible for patent term extension and requests a determination of the applicable regulatory review period.

### 2757 Regulatory Agency Determination of the Length of the Regulatory Review Period

Under 35 U.S.C. 156, the regulatory agency is responsible for the determination of the length of the regulatory review period for the approved product on which the application for patent term extension is based. The determination by the regulatory agency is made based on the application as well as the official regulatory agency records for the approved product. See, e.g., 21 CFR Ch. 1, Subpart C. The determination of the length of the regulatory review period is solely the responsibility of the regulatory agency. *Aktiebo-laget Astra v. Lehman*, 71 F.3d 1578, 1580-81, 37 USPQ2d 1212, 1214-15 (Fed. Cir. 1995); U.S. Patent No. 4,215,113.

Once the determination has been made, the regulatory agency publishes the information in the Federal Register and forwards a letter to the Office with the same information. Included in both the Federal Register Notice and the letter to the Office are the total length of the regulatory review period and the relevant dates on which the determination is based. Both the letter to the Office and the Federal Register Notice separate the total regulatory period into the initial or testing phase and the final approval phase. This provides the Office with the information necessary to

determine the actual length of extension for which the patent may be eligible. The Federal Register Notice also sets a date, 180 days after publication of the notice, as a deadline for filing written comments concerning any of the information set forth in the notice or a petition for a determination regarding whether the marketing applicant has acted with due diligence during the regulatory review period. The letter to the Office makes clear that the determination does not take into account the issue date of the patent nor does it exclude one-half of the testing phase.

The regulatory review period determination is not final until due diligence petitions and informal hearings, if any, have been resolved. A certificate for extension of the term of a patent may not issue from the Office until the regulatory review period determination is final unless an interim extension appears warranted under 35 U.S.C. 156(d)(5) and (e)(2).

### 2757.01 Due Diligence Determination

If a due diligence petition is filed during the 180-day period following publication of the regulatory agency determination of the regulatory review period, the regulatory agency (e.g., FDA) makes the determination under 35 U.S.C. 156(d)(2)(B) whether the applicant for patent term extension acted with due diligence during the regulatory review proceedings. The term “due diligence” is defined in 35 U.S.C. 156(d)(3) as “that degree of attention, continuous directed effort, and timeliness as may reasonably be expected from, and are ordinarily exercised by, a person during a regulatory review period.” After affirming or revising the determination of the regulatory review period, the regulatory agency notifies the Office and publishes the results in the Federal Register. If no comment or petition is filed in the time period provided, the regulatory agency notifies the Office that the period for filing a due diligence petition pursuant to the notice has expired and that the regulatory agency therefore considers its determination of the regulatory review period for the product to be final. Following notification from the regulatory agency, the Office proceeds with the final eligibility determination. See 21 CFR Ch. 1, Subparts D and E.

## 2758 Notice of Final Determination - Calculation of Patent Term Extension [R-2]

35 U.S.C. 156. *Extension of patent term.*

\*\*\*\*\*

(c) The term of a patent eligible for extension under subsection (a) shall be extended by the time equal to the regulatory review period for the approved product which period occurs after the date the patent is issued, except that—

(1) each period of the regulatory review period shall be reduced by any period determined under subsection (d)(2)(B) during which the applicant for the patent extension did not act with due diligence during such period of the regulatory review period;

(2) after any reduction required by paragraph (1), the period of extension shall include only one-half of the time remaining in the periods described in paragraphs (1)(B)(i), (2)(B)(i), (3)(B)(i), (4)(B)(i), and (5)(B)(i) of subsection (g);

(3) if the period remaining in the term of a patent after the date of the approval of the approved product under the provision of law under which such regulatory review occurred when added to the regulatory review period as revised under paragraphs (1) and (2) exceeds fourteen years, the period of extension shall be reduced so that the total of both such periods does not exceed fourteen years, and

(4) in no event shall more than one patent be extended under subsection (e)(i) for the same regulatory review period for any product.

\*\*\*\*\*

(6) A period determined under any of the preceding paragraphs is subject to the following limitations:

(A) If the patent involved was issued after the date of the enactment of this section, the period of extension determined on the basis of the regulatory review period determined under any such paragraph may not exceed five years.

(B) If the patent involved was issued before the date of the enactment of this section and —

(i) no request for an exemption described in paragraph (1)(B) or (4)(B) was submitted and no request for the authority described in paragraph (5)(B) was submitted,

(ii) no major health or environment effects test described in paragraph (2)(B) or (4)(B) was initiated and no petition for a regulation or application for registration described in such paragraph was submitted, or

\*\*>

(iii) no clinical investigation described in paragraph (3) was begun or product development protocol described in such paragraph was submitted, before such date for the approved product the period of extension determined on the basis of the regulatory review period determined under any such paragraph may not exceed five years.<

(C) If the patent involved was issued before the date of the enactment of this section and if an action described in subparagraph (B) was taken before the date of enactment of this section



with respect to the approved product and the commercial marketing or use of the product has not been approved before such date, the period of extension determined on the basis of the regulatory review period determined under such paragraph may not exceed two years or in the case of an approved product which is a new animal drug or veterinary biological product (as those terms are used in the Federal Food, Drug, and Cosmetic Act or the Virus-Serum-Toxin Act), three years.

\*\*\*\*\*

After reviewing the information provided by the regulatory agency, if the Office determines the patent to be eligible for extension, the calculation is made of the length of extension for which the patent is eligible under the appropriate statutory provisions (35 U.S.C. 156(c); 37 CFR 1.750). The length of extension is subject to the limitations of 35 U.S.C. 156(c)(3) and 35 U.S.C. 156(g)(6). A Notice of Final Determination is mailed to applicant which states the length of extension for which the application has been determined to be eligible and the calculations used to determine the length of extension. Recently mailed Notices of Final Determination are posted in the Freedom of Information (FOIA) section of the USPTO web site ([www.uspto.gov](http://www.uspto.gov)) with other Decisions of the \*>Director<. The notice provides a period, usually one month, in which the applicant can request reconsideration of any aspect of the Office determination as to eligibility or the length of extension for which the application has been found eligible.

If the application has been determined to be ineligible for patent term extension, an appropriate Notice of Final Determination is mailed to applicant which denies the application and sets forth the basis for the denial. The applicant is given a period, usually one month, in which to seek reconsideration of the determination.

If the patent is found to be eligible for extension, the Notice of Final Determination may include text similar to the following:

A determination has been made that U.S. Patent No. \_\_\_\_, which claims the human drug \_\_\_\_, is eligible for patent term extension under 35 U.S.C. 156. The period of extension has been determined to be \_\_\_\_.

A single request for reconsideration of this final determination as to the length of extension of the term of the patent may be made if filed within one month of the date of this notice. Extensions of time under 37 CFR 1.136(a) are not applicable to this time period. In the absence of such request

for reconsideration, the \*>Director< will issue a certificate of extension, under seal, for a period of \_\_\_\_ days.

The period of extension has been calculated using the FDA determination of the length of the regulatory review period published in the Federal Register of \_\_\_\_\_. Under 35 U.S.C. 156(c).

Period of Extension = 1/2 (Testing Phase) + Approval Phase

$$= 1/2 (\text{---} - \text{---}) + \text{---}$$

$$= \text{---} \text{ days}$$

Since the regulatory review period began \_\_\_\_, before the patent issued \_\_\_\_, only that portion of the regulatory review period occurring after the date the patent issued has been considered in the above determination of the length of the extension period 35 U.S.C. 156(c). (From \_\_ to \_\_) is \_\_\_\_ days; this period is subtracted for the number of days occurring in the testing phase according to the FDA determination of the length of the regulatory review period.) No determination of a lack of due diligence under 35 U.S.C. 156(c)(1) was made.

The 14 year exception of 35 U.S.C. 156(c)(3) operates to limit the term of the extension in the present situation because it provides that the period remaining in the term of the patent measured from the date of approval of the approved product (\_\_\_\_) when added to the period of extension calculated above (\_\_\_\_ days) cannot exceed fourteen years. The period of extension is thus limited to \_\_\_\_, by operation of 35 U.S.C. 156(c)(3). Since the patent term (35 U.S.C. 154) would expire on \_\_\_\_, the period of extension is the number of days to extend the term of the patent from its expiration date to and including \_\_\_\_, or \_\_\_\_ days.

The limitations of 35 U.S.C. 156(g)(6) do not operate to further reduce the period of extension determined above.

See MPEP § 2759 for further information pertaining to the issuance of a certificate of extension.

A patent term extension generally extends the patent from its "original expiration date," as defined by 35 U.S.C. 154 to include extension under 35 U.S.C. 154(b). Patents "in force on June 8, 1995 only because of a Hatch-Waxman extension are not entitled to re-apply a restoration extension to a 20-year from filing term." *Merck & Co. v. Kessler*, 80 F.3d 1543, 1553, 38 USPQ2d 1347, 1354 (Fed. Cir. 1996). However, if the patent received an interim extension under 35 U.S.C. 156(d)(5) and the patent is eligible for either a two- or a three-year extension, the extension would run from the approval date of the product, not the original expiration date of the patent. See 35 U.S.C. 156(d)(5)(E)(ii).

No certificate or extension will be issued if the term of a patent cannot be extended, even though the patent is otherwise determined to be eligible for extension. In such situations the final determination would issue indicating that no certificate will issue.

### CALCULATION OF PATENT TERM EXTENSION

The procedure for calculating the length of the patent term extension is set forth for human drugs, antibiotic drugs, and human biological products in 37 FR 1.775; for food or color additives in 37 CFR 1.776; for medical devices in 37 CFR 1.777; for animal drug products in 37 CFR 1.778; and for veterinary biological products in 37 CFR 1.779. The length of patent term extension is the length of the regulatory review period as determined by the Secretary of Health and Human Services or the Secretary of Agriculture, but reduced, where appropriate, by the time periods provided in 37 CFR 1.775 - 1.779. The Office will rely on the Secretary's determination of the length of the regulatory review period when calculating the length of the extension period under 37 CFR 1.775 - 1.779.

Any part of the regulatory review period which occurs before the patent was granted will not be counted toward patent term extension. Any period in which the marketing applicant failed to exercise due diligence, thereby unnecessarily adding to the length of the regulatory review period after the patent issued, will not be considered in determining the length of the extension period. In making the calculation of the extension period, half days will be ignored and thus will not be subtracted from the regulatory review period.

For products other than animal drug or veterinary biological products, the calculated extension period cannot exceed any of the following statutory maximum periods of extension:

(A) If the period remaining in the term of the patent after the date of approval of the approved product when added to the calculated regulatory review period exceeds fourteen years, the period of extension shall be reduced so that the total of both such periods does not exceed fourteen years;

(B) If the patent involved was issued after September 24, 1984, (the date of enactment of the statute), the calculated period of extension may not exceed five years;

(C) If the patent involved was issued before September 24, 1984, (the date of enactment of the statute), and the regulatory review period proceeding started after this date, the calculated period of extension may not exceed five years; and

(D) If the patent involved was issued before September 24, 1984, (the date of enactment of the statute), and the regulatory review period proceeding started before this date, and the commercial marketing or use of the product has been approved after such date, the calculated period of extension may not exceed two years.

For animal drug or veterinary biological products, the calculated extension period cannot exceed any of the following statutory maximum periods of extension:

(A) If the period remaining in the term of the patent after the date of approval of the approved product when added to the calculated regulatory review period exceeds fourteen years, the period of extension shall be reduced so that the total of both such periods does not exceed fourteen years;

(B) If the patent involved was issued after November 16, 1988, the calculated period of extension may not exceed five years;

(C) If the patent involved was issued before November 16, 1988, and the regulatory review period proceeding started after this date, the calculated period of extension may not exceed five years; and

(D) If the patent involved was issued before November 16, 1988, and the regulatory review period proceeding started before this date, and the commercial marketing or use of the product has been approved after such date, the calculated period of extension may not exceed three years.

The patent term extension of a patent that issued before September 24, 1984, where the regulatory review period began and ended before September 24, 1984, would only be a function of the regulatory review period and the fourteen-year limit, and may be extended for more than five years. *Hoechst Aktiengesellschaft v. Quigg*, 916 F2d 522, 525, 16 USPQ2d 1549, 1551 (Fed. Cir. 1990).

## 2759 Certificate of Extension of Patent Term [R-2]

35 U.S.C. 156. *Extension of patent term.*

\*\*\*\*\*

(e)(1) A determination that a patent is eligible for extension may be made by the Director solely on the basis of the representations contained in the application for the extension. If the Director determines that a patent is eligible for extension under subsection (a) and that the requirements of paragraphs (1) through (4) of subsection (d) have been complied with, the Director shall issue to the applicant for the extension of the term of the patent a certificate of extension, under seal, for the period prescribed by subsection (c). Such certificate shall be recorded in the official file of the patent and shall be considered as part of the original patent.

\*\*\*\*\*

37 CFR 1.780. *Certificate or order of extension of patent term.*

If a determination is made pursuant to § 1.750 that a patent is eligible for extension and that the term of the patent is to be extended, a certificate of extension, under seal, or an order granting interim extension under 35 U.S.C. 156(d)(5), will be issued to the applicant for the extension of the patent term. Such certificate or order will be recorded in the official file of the patent and will be considered as part of the original patent. Notification of the issuance of the certificate or order of extension will be published in the *Official Gazette of the United States Patent and Trademark Office*. Notification of the issuance of the order granting an interim extension under 35 U.S.C. 156(d)(5), including the identity of the product currently under regulatory review, will be published in the *Official Gazette of the United States Patent and Trademark Office* and in the *Federal Register*. No certificate of, or order granting, an extension will be issued if the term of the patent cannot be extended, even though the patent is otherwise determined to be eligible for extension. In such situations, the final determination made pursuant to § 1.750 will indicate that no certificate or order will issue.

Once a determination is made pursuant to 37 CFR 1.750 that a patent is eligible for extension of its term, a certificate of extension, under seal, will be issued to the patent owner at the correspondence address specified in the application for patent term extension. Following the one-month period provided in the Notice of Final Determination, and where an extension is appropriate, the Certificate of Extension is signed by the \*>Director<. The original certificate is mailed or delivered to the applicant and a copy is sent to the regulatory agency. A copy of the certificate is placed in the two files (official file/patent file and public file) maintained for the patent term extension application.

Upon issuance of the certificate of extension, a notice is published in the *Official Gazette*. A sample *Official Gazette* Notice Follows:

### PATENT TERM EXTENDED UNDER 35 U.S.C. 156

A Certificate extending the term of the following patent was issued on \_\_\_.

U.S. Patent No.: \_\_ Granted: \_\_; Applicant: \_\_; Owner of Record: \_\_; Title: \_\_; Classification: \_\_ Product Trade Name: \_\_; Original Expiration Date: \_\_; Term Extended: \_\_\_\_; Extended Expiration Date: \_\_.

All original papers from the application for patent term extension in the official file are transferred to the official patent file of the subject patent and become a part of the permanent record. A copy of the certificate of extension of patent term is added to the patent electronic database as part of the patent record in the same manner as is a certificate of correction or a terminal disclaimer. The patent is also added to the list of patents extended under 35 U.S.C. 156, a copy of which is posted on the USPTO web site ([www.uspto.gov](http://www.uspto.gov)) and which is also available in the Reading Room of the Public Search Room and from the Office of Patent Legal Administration. The public file for the application for patent term extension is stored in the Office of Patent Legal Administration.

## 2760 Trade Secret, Confidential, and Protective Order Material

There is no provision in the statute or the rules for withholding from the public any information that is submitted to the Office or the regulatory agency relating to an application for patent term extension. While one submitting such materials to the Office in relation to a pending application for patent term extension must generally assume that such materials will be made of record in the file and be made public, the Office is not unmindful of the difficulties this sometimes imposes. Proprietary or trade secret information should be submitted generally in accordance with the procedures set forth in MPEP § 724.02. Identification of the propriety or trade secret material should be made by page, line, and word, as necessary. The Office will not in the first instance undertake the task of determining the precise material in the application which is proprietary or trade secret information. Only

the applicant is in a position to make this determination. See *In re Schering-Plough Corp.*, 1 USPQ2d 1926, 1926 (Comm'r Pat. & Tm. 1986).

The information will not be made public as part of the patent file before a certificate of patent extension is issued. Should the Office receive a Freedom of Information Act (FOIA) request for the material, the applicant will be provided notice and an opportunity to substantiate its claim that the material is proprietary before the Office determines whether disclosure of the material is required under the FOIA. If such information was material to a determination of eligibility or any other Office responsibility under 35 U.S.C. 156, it will be made public at the time the certificate of extension is issued. Otherwise, if a suitable petition to expunge is filed before the issuance of the certificate, the trade secret or confidential information will be expunged from the file and returned to the patent term extension applicant. If a petition to expunge is not filed prior to the issuance of the certificate, all of the information will be open to public inspection.

## **2761 Multiple Applications for Extension of Term of the Same Patent or of Different Patents for the Same Regulatory Review Period for a Product**

*35 U.S.C. 156. Extension of patent term.*

\*\*\*\*\*

(c)(4) in no event shall more than one patent be extended under subsection (e)(i) for the same regulatory review period for any product.

\*\*\*\*\*

*37 CFR 1.785. Multiple applications for extension of term of the same patent or of different patents for the same regulatory review period for a product.*

(a) Only one patent may be extended for a regulatory review period for any product § 1.720 (h). If more than one application for extension of the same patent is filed, the certificate of extension of patent term, if appropriate, will be issued based upon the first filed application for extension.

(b) If more than one application for extension is filed by a single applicant which seeks the extension of the term of two or more patents based upon the same regulatory review period, and the patents are otherwise eligible for extension pursuant to the requirements of this subpart, in the absence of an election by the applicant, the certificate of extension of patent term, if appropriate, will be issued upon the application for extension of the patent

term having the earliest date of issuance of those patents for which extension is sought.

(c) If an application for extension is filed which seeks the extension of the term of a patent based upon the same regulatory review period as that relied upon in one or more applications for extension pursuant to the requirements of this subpart, the certificate of extension of patent term will be issued on the application only if the patent owner or its agent is the holder of the regulatory approval granted with respect to the regulatory review period.

(d) An application for extension shall be considered complete and formal regardless of whether it contains the identification of the holder of the regulatory approval granted with respect to the regulatory review period. When an application contains such information, or is amended to contain such information, it will be considered in determining whether an application is eligible for an extension under this section. A request may be made of any applicant to supply such information within a non-extendable period of not less than one month whenever multiple applications for extension of more than one patent are received and rely upon the same regulatory review period. Failure to provide such information within the period for reply set shall be regarded as conclusively establishing that the applicant is not the holder of the regulatory approval.

(e) Determinations made under this section shall be included in the notice of final determination of eligibility for extension of the patent term pursuant to § 1.750 and shall be regarded as part of that determination.

Only one patent may be extended for a regulatory review period for any product. If more than one application for extension is filed for a single patent by different applicants, the certificate of extension of the term of the patent, if appropriate, would be issued based upon the first filed application for extension of patent term. If a single applicant files more than one application for patent term extension for a single patent based upon the regulatory review period of different products, then the final determination under 37 CFR 1.750 will provide a period of time (usually one month) for the patent owner to elect the product for which extension is desired. An express withdrawal of the applications for extension of the nonelected products should accompany the election. The final determination will indicate that if the patent owner fails to elect a single product within the set time period, the Office will issue a certificate of extension for the patent for a specified one of the products.

If more than one application for extension is filed by a single applicant for the extension of the terms of different patents based upon the same regulatory review period for a product, the certificate of extension will be issued on the application for extension of the patent having the earliest date of issuance of those

for which extension is sought unless all but one application for extension is voluntarily withdrawn by the applicant. When plural patents are found to be eligible for patent term extension based on the same regulatory review of a product, the final determination under 37 CFR 1.750 will provide a period of time (usually one month) for the patent owner to elect the patent for which extension is desired. An express withdrawal of the application(s) for extension of the nonelected patent(s) should accompany the election. A failure to elect within the set time period will result in issuance of a certificate of extension for the patent having the earliest date of issue.

If applications for extension are filed by different applicants for the extension of the terms of different patents based upon the same regulatory review period of a product, the certificate of extension will be issued on the application of the holder of the regulatory approval (marketing applicant). If the marketing applicant is not an applicant for extension, the certificate of extension will issue to the applicant for extension which holds an express authorization from the marketing applicant to rely upon the regulatory review period as the basis for the application for extension. See also 37 CFR 1.785(d).

## **2762 Duty of Disclosure in Patent Term Extension Proceedings [R-2]**

*37 CFR 1.765. Duty of disclosure in patent term extension proceedings.*

(a) A duty of candor and good faith toward the Patent and Trademark Office and the Secretary of Health and Human Services or the Secretary of Agriculture rests on the patent owner or its agent, on each attorney or agent who represents the patent owner and on every other individual who is substantively involved on behalf of the patent owner in a patent term extension proceeding. All such individuals who are aware, or become aware, of material information adverse to a determination of entitlement to the extension sought, which has not been previously made of record in the patent term extension proceeding must bring such information to the attention of the Office or the Secretary, as appropriate, in accordance with paragraph (b) of this section, as soon as it is practical to do so after the individual becomes aware of the information. Information is material where there is a substantial likelihood that the Office or the Secretary would consider it important in determinations to be made in the patent term extension proceeding.

(b) Disclosures pursuant to this section must be accompanied by a copy of each written document which is being disclosed. The disclosure must be made to the Office or the Secretary, as appropriate, unless the disclosure is material to determinations to

be made by both the Office and the Secretary, in which case duplicate copies, certified as such, must be filed in the Office and with the Secretary. Disclosures pursuant to this section may be made to the Office or the Secretary, as appropriate, through an attorney or agent having responsibility on behalf of the patent owner or its agent for the patent term extension proceeding or through a patent owner acting on his or her own behalf. Disclosure to such an attorney, agent or patent owner shall satisfy the duty of any other individual. Such an attorney, agent or patent owner has no duty to transmit information which is not material to the determination of entitlement to the extension sought.

(c) No patent will be determined eligible for extension and no extension will be issued if it is determined that fraud on the Office or the Secretary was practiced or attempted or the duty of disclosure was violated through bad faith or gross negligence in connection with the patent term extension proceeding. If it is established by clear and convincing evidence that any fraud was practiced or attempted on the Office or the Secretary in connection with the patent term extension proceeding or that there was any violation of the duty of disclosure through bad faith or gross negligence in connection with the patent term extension proceeding, a final determination will be made pursuant to § 1.750 that the patent is not eligible for extension.

\*\*\*\*\*

A duty of candor and good faith toward the USPTO, the Secretary of Health and Human Services, and the Secretary of Agriculture rests on the patent owner or its agent, on each attorney or agent who represents the patent owner, and on every other individual who is substantively involved on behalf of the patent owner in a patent term extension proceeding. All such individuals who are aware, or become aware, of material information adverse to a determination of entitlement to the extension sought, which has not been previously made of record in the patent term extension proceeding, must bring such information to the attention of the Office or the Secretary, as appropriate, as soon as it is practicable to do so after the individual becomes aware of the information. Information is "material" when there is a substantial likelihood that the Office or the Secretary would consider it important in determinations to be made in the patent term extension proceeding. Any such material information should be submitted to the **>Director of the United States Patent and Trademark Office<**, the Secretary of Health and Human Services, or the Secretary of Agriculture, as appropriate, accompanied by a copy of each written document being disclosed. The information may be submitted through a patent attorney or agent.

A determination of eligibility for an extension or the issuance of a certificate will not be made if clear and convincing evidence of fraud or attempted fraud on the Office or a Secretary is determined to be present, or the duty of disclosure is determined to have been violated through bad faith or gross negligence in connection with the patent term extension proceeding. Since the determination as to whether a patent is eligible for extension may be made solely on the basis of the representations made in the application for extension, a final determination to refuse a patent term extension because of fraud or a violation of the duty of disclosure is expected to be rare. See MPEP § 2010.

**2763 Limitation of Third Party Participation [R-2]**

*37 CFR 1.765. Duty of disclosure in patent term extension proceedings.*

\*\*\*\*\*

(d) The duty of disclosure pursuant to this section rests on the individuals identified in paragraph (a) of this section and no submission on behalf of third parties, in the form of protests or otherwise, will be considered by the Office. Any such submissions by third parties to the Office will be returned to the party making the submission, or otherwise disposed of, without consideration by the Office.

\*\*\*\*\*

Although the statute specifically provides for public input into the determination of the regulatory review period, i.e., the filing of a due diligence petition before the regulatory agency, no such provision was made for proceedings before the Office. Since applicant already has a duty of disclosure to both the Office and the regulatory agency, and Congress

expected that it would be an administratively simple proceeding, no input from third parties is permitted. Absent an invitation from the \*>Director<, any such submission would be inappropriate. Accordingly, 37 CFR 1.765(d) precludes submissions to the Office by or on behalf of third parties, thereby making patent term extension proceedings in the Office an *ex parte* matter between the patent owner or its agent and the Office. Submissions by third parties not requested by the Office will be returned, or otherwise disposed of, without consideration. See *In re Dubno*, 12 USPQ2d 1153, 1154 (Comm’r Pat. & Tm. 1989).

**2764 Express Withdrawal of Application for Extension of Patent Term**

*37 CFR 1.770. Express withdrawal of application for extension of patent term.*

An application for extension of patent term may be expressly withdrawn before a determination is made pursuant to § 1.750 by filing in the Office, in duplicate, a written declaration of withdrawal signed by the owner of record of the patent or its agent. An application may not be expressly withdrawn after the date permitted for reply to the final determination on the application. An express withdrawal pursuant to this section is effective when acknowledged in writing by the Office. The filing of an express withdrawal pursuant to this section and its acceptance by the Office does not entitle applicant to a refund of the filing fee (§ 1.20(j)) or any portion thereof.

Any request for withdrawal of an application for extension of patent term after a determination has been made pursuant to 37 CFR 1.750 must be submitted on or before the date permitted for reply to the final determination, and be accompanied by a petition under 37 CFR 1.182 with the appropriate petition filing fee.



MANUAL OF PATENT EXAMINING PROCEDURE

# Appendix I Partial List of Trademarks

The following is a partial list of trademarks which may appear from time to time in patent applications. Proper usage of trademarks requires that they be capitalized at all times. See MPEP § 608.01(v).

Any questions by the examiners as to whether an apparent trademark is in fact a registered trademark or to what particular goods a registered trademark applies should be referred to the Trademark Search Library (308-9800) for determination.

<i>Trademark</i>	<i>Particular goods on or in connection with which the trademark is used</i>	<i>Trademark</i>	<i>Particular goods on or in connection with which the trademark is used</i>
ACE.....	Elastic bandages, adhesive bandages, adherent compounds for attaching surgical dressings or bandages to the skin, and bandage fastening clips	BUSS .....	Electric fuses, fuse holders, fuse wire, and protectors for electric circuits that include fuse links and thermal cutouts and that respond to heavy overloads or short circuits to open the circuits
ACTIONWEAR .....	Men's, women's, children's, and infants' garments - namely coats, sweaters, blouses, shirts, underwear, and sleepwear	BUTTERFLY.....	Medical infusion sets for administration of fluids
ADRENALIN .....	Hemostatic, astringent, blood-pressure raising and stimulating preparations for medicinal or surgical purposes	CALGON.....	Water softening and water conditioning for industrial, laundry, and semi-industrial use
AEROJET .....	Thrust motors whose general purpose is to provide thrust by means of a combustion process, and includes all the component parts of such motors	CALROD .....	Electrical resistance heaters; electrical resistance heating elements for cooling devices
AEROSOL.....	Wetting agents for use in reducing the interfacial tension between liquids and solids or between two immiscible liquids	CARBORUNDUM ...	Electrical devices comprising detectors for radio apparatus, resistance rods, lightning arrestors, resistors, and resistor units
AIRVEYOR .....	Conveyors for conveying and handling materials	CARBORUNDUM ...	Crystalline substance used as an abradant and for other purposes
ANCHOR .....	Metallic fencing and related components	CAROUSEL.....	Photographic projectors
ARNEL .....	Yarns; textile fibers, including staple fibers and continuous filaments	CAT .....	Machinery for earth moving, earth conditioning, and material handling, namely, loaders and engines therefor, and parts for the foregoing; vehicles and internal combustion engines for earth and material hauling and handling, namely tractors and engines therefor, and parts for the foregoing
BARBIE .....	Doll; accessories for doll	CATERPILLAR.....	Tractors, engines, treads, etc.
BEEF STICK.....	Summer sausage	CHAP STICK.....	Medicinal preparation for chapped skin, sunburn, and hangnails
BIRKENSTOCK.....	Footwear-namely, sandals, shoes, and shoe insoles	CLOROX .....	Household cleanser compositions, laundry detergent
BLUSH .....	Wines		
BOOGIE .....	Surfboards		



MANUAL OF PATENT EXAMINING PROCEDURE

<i>Trademark</i>	<i>Particular goods on or in connection with which the trademark is used</i>	<i>Trademark</i>	<i>Particular goods on or in connection with which the trademark is used</i>
COCA-COLA . . . . .	Beverages and syrups for the manufacture of such beverages (carbonated soft drink)	FORMICA . . . . .	Laminates and solid surfacing materials in the form of slabs made predominantly of plastic for use in the manufacture of
COCOA-PUFFS . . . . .	Ready to eat breakfast cereal		countertops, vanity tops, tabletops, sinkbowls, bath tubs, wall paneling, flooring, and furniture
COKE . . . . .	Nonalcoholic, maltless beverages and the syrups for making such beverages	GLAD . . . . .	Plastic bag holders
COREX . . . . .	Thermosetting plastic in the nature of a paint converted by heat into an insoluble, unfusible film	GLAD LOCK . . . . .	Plastic bags for packaging, such as food storage and freezer bags
CRAWLER . . . . .	Children's play clothes, namely, overalls, shirts, rompers, and sunsuits	HACKY SACK . . . . .	Footbags used in a kicking game; conducting kicking game tournaments and kicking game instructional clinics
CYCLONE . . . . .	Seeders and planters	HI-LITER . . . . .	Marking pens
DACRON . . . . .	Yarns of synthetic fibers; synthetic polyester fibers for generalized use in the industrial arts	INTERNET . . . . .	Communication services, namely providing electronic data transmission services in the electronic banking field and retail marketing field
DORITOS . . . . .	Corn chips, potato chips, tortilla chips, pretzels, and nut meats	INTERNET . . . . .	Carpeting installation information exchange and consulting services rendered by computer
FEDEX . . . . .	Shipping containers in the nature of document envelopes, boxes and tubes; pick-up, transportation, storage, and delivery of documents, packages and freight by land and air	INTERNET TELEVISION . . . . .	Distribution and production of broadcast and nonbroadcast television programs, videotaped programs and audio tapes
FIBERGLAS . . . . .	Inorganic material in a fibrous condition or in the form of a loose mass of filaments or fibers	IRONCLAD . . . . .	Storage-battery plates
FLEXWOOD . . . . .	Fabric-backed wood veneer	JARLSBERG . . . . .	Cheese
FLYING SAUCER . . . . .	Toys, namely model airplanes and aerodynamic flying discs	JEEP . . . . .	Automobiles and structural parts thereof
FOAMICIDE . . . . .	Chemical composition for addition to foaming liquids present in bottle and container washing processes and in industrial chemistry processes, to prevent the formation of foam therein	JELL-O . . . . .	A compound used in the preparation of (jellies) desserts (pastries and ice-cream); gelatin dessert
FOOTLETS . . . . .	Anklets, knee-hi socks, hosiery, and footsocks	JELLO-LIGHT . . . . .	Pudding
		JET SKI . . . . .	Boats, recreational watercraft, floor mats, clothing, paint for machinery, tarpaulins, used to hold down boat covers; straps, namely boat covers and boat towing lines, motor oil, duffle bags

PARTIAL LIST OF TRADEMARKS

<i>Trademark</i>	<i>Particular goods on or in connection with which the trademark is used</i>	<i>Trademark</i>	<i>Particular goods on or in connection with which the trademark is used</i>
KARMELKORN . . . . .	Popcorn candy, seasoned popcorn, cheese-covered popcorn, and popcorn balls each of which is made from popped popcorn; and also unpopped popcorn, candy, candied apple, nuts, and ice cream	MONOTYPE . . . . .	Type casting and composing machines, including keyboards and casting-machines and repair parts and supplies therefor; paper ribbons or controllers for type casting and composing machines; photo typesetting machines utilizing cameras and laser beam, and structural parts thereof, typefaces, typefonts and type designs of alphanumeric characters and/or typographical symbols recorded as visible images in printer's type
KEVLAR . . . . .	Man-made fibers for generalized use in the industrial arts	MUSIC BY MUZAK . . . . .	Planned music service for transmitting specially programmed background music to stores, restaurants, homes, hotels, banks, railroads, airlines, boats, transportation terminals, factories and other industrial and commercial establishments throughout the U.S.
KITTY LITTER . . . . .	Ground clay used for litters for small animals, i.e., cats, rats, mice, hamsters	MYLAR . . . . .	Flexible film for packaging purposes; polyester film
KLEENEX . . . . .	Absorbent tissue suitable for cleaning, hygienic, and cosmetic purposes, and paper towels	OILGEAR . . . . .	Valves for use in and in connection with the hydraulic transmission of power
KOOSH . . . . .	Tossing balls	ORLON . . . . .	Synthetic fiber-forming polymers and copolymers of acrylic acid or its derivatives produced in the form of fibers for further use in the industrial arts
LIFE SAVERS . . . . .	Chewing-gum, candy, sweetmeats, and confections	PAMPERS . . . . .	Disposable diapers
LINOTYPE . . . . .	Typesetting machines and parts thereof; accessories and equipment for use with typeset machines and systems - namely, line printers, video terminals, keyboards, tape perforators, tape readers, graphic scanners, optical character readers and computer programs	PARA-SAIL . . . . .	Parachutes
LIQUID PAPER . . . . .	Office supply products, namely correction fluid, error correction tapes	PERF-A-TAPE . . . . .	Paper tape for sealing composition board joints
LISTSERV . . . . .	Computer software for managing electronic mailing lists	PERMALLOY . . . . .	Metal hardening agent sold as a component part of machine parts; namely, sheaves, drill steels, barrel rollers, and pins for mining machinery such as drag line conveyors and drills
LOAFERS . . . . .	Ladies', men's, and boys' shoes made of leather, rubber, fabric, and various combinations of such materials		
LUCITE . . . . .	Enamel and paint		
LYCRA . . . . .	Synthetic fibers and filaments for generalized use in the industrial arts		
MINI BAR . . . . .	Small-sized pry bars		

MANUAL OF PATENT EXAMINING PROCEDURE

<i>Trademark</i>	<i>Particular goods on or in connection with which the trademark is used</i>	<i>Trademark</i>	<i>Particular goods on or in connection with which the trademark is used</i>
PIZZA ROLLS . . . . .	Pasta snacks, namely hamburger flavor pasta snacks, cheeseburger flavor pasta snacks, pepperoni and cheese flavor pasta snacks, sausage, and cheese flavor pasta snacks, and shrimp and cheese flavor pasta snacks	SNOOZ-ALARM. . . . .	Electronic repeat alarm timer sold as a component of alarm clocks; clocks
POPSICLE. . . . .	Frozen confections on sticks and liquid flavoring concentrates for making said confections	SPEED NUT. . . . .	Nuts
POST-IT . . . . .	Stationary notes containing adhesive on one side for attachment to surfaces	SPERRY TOP-SIDER . . . . .	Boating coats, boating hats, boating suits, boating jackets, boating shirts and boating trousers, footwear
PYREX . . . . .	Beakers, flasks, test tubes, etc.; glass	STELLITE . . . . .	Metal alloys
QUICKEN. . . . .	Computer software programs and user documentation supplied therewith	STELLITE . . . . .	Rivet setting tools
Q-TIPS. . . . .	Absorbent swabs and balls for toiletry, medical, and cosmetic uses; swabs consisting of small sticks of wood or paper having wads of cotton twisted about one or both ends, intended for use primarily as a cosmetic aid	SWOOSH. . . . .	Footwear
RICE KRISPIES . . . . .	Cereal breakfast food	TABASCO . . . . .	Pepper sauce
RIPPLE . . . . .	Wines	TALON. . . . .	Thread
ROLLERBLADE . . . . .	Boots equipped with longitudinally aligned rollers used for skating and skiing	TEFLON. . . . .	Synthetic resinous fluorine-containing polymers in form of molding and extruding compositions, fabricated shapes—namely, sheets, [rods] tubes, tape and filaments [-solutions,] and emulsions; polytetrafluoroethylene coatings in the nature of paints and varnishes
ROQUEFORT. . . . .	Cheese	TELEMARKETING INC. . . . .	Telephone marketing consulting services; conducting telephone sales campaigns for business clients
SANKA . . . . .	Coffees and teas, coffee and tea extracts, both dry and liquid, and tea and coffee substitutes	TELETYPE . . . . .	Printing-telegraph apparatus
SCOTCH. . . . .	Masking tape, cellophane tape, acetate fiber tape and other pressure-sensitive adhesive tapes; liquid adhesive, adhesive sheet material, an adhesive coated sheet material in sheet or strip form; adhesive tape	TELEX. . . . .	Equipment and apparatus for electronic treatment of sound—namely, sound recorders-reproducers, phonographs, tape decks, tape recorders, tape cartridge players, tape duplicators, tapes for sound recording and reproduction, combination tape recorders and radios, and combination phonographs-tape decks, and components and parts for all of said equipment
SNAP-ON . . . . .	Sharpening stones, nail clipper; calibrated rulers, magnetic paper clips, magnetic tape holders, drill bit gauges, tape measurers; tools and machinery	THERMOS. . . . .	Temperature-retaining vessels; double-walled glass vessels with vacuum between the walls
		TOLL HOUSE . . . . .	Prepared edible chocolate

PARTIAL LIST OF TRADEMARKS

<i>Trademark</i>	<i>Particular goods on or in connection with which the trademark is used</i>	<i>Trademark</i>	<i>Particular goods on or in connection with which the trademark is used</i>
TOUCH-TONE . . . . .	Musical instruments, mainly timpani and other drums, mallets for playing drums, and other percussion instruments and parts thereof	WISE-GRIP . . . . .	Hand tools and instruments, namely pliers and workholding clamps with or without a cutting edge, wrenches, wrenches with a wire cutter and welding clamps, and sheet metal bending tool
TRAV-O-LATER . . . . .	Endless conveyors	VOTATOR . . . . .	Machinery for processing and handling materials in fluid, plastic, or particulate form including food products
TRIGGER . . . . .	Indicating tripping fuses	WEATHER-OMETER . . . . .	Apparatus for testing the effect of weather upon the surface of objects
TROUT CHOW . . . . .	Feed for fish	WEED EATER . . . . .	Machinery for edging and trimming vegetation; weed and grass cutting machinery for edging and trimming lawns
TWIST-LOCK . . . . .	Electrical wiring apparatus, namely electric flush receptacles, attachment plug, caps, cord-coupling, caps, couplings, connectors, motor couplings, attachment plugs, and motor plugs	WIFFLE . . . . .	Simulated or auxiliary pliable plastic baseballs and a game played therewith
TYVEK . . . . .	Fabrics of man-made fibers and filaments suitable for making into household furnishings and apparel and for industrial uses	WINDBREAKER . . . . .	Men's, young men's, boys', women's, misses' and girl's apparel for sportswear, dress wear, work wear, and uniforms; namely jackets, vests, trousers, suits, shirts, blouses
VASELINE . . . . .	Emollient and medicinal preparation for external and internal use; petroleum jelly, oil petrol, white mineral oil; moisturizing lotion and cream	WINDOWS . . . . .	Cartridges containing software for operating or enhancing the operation of laser printers, which cartridges are to be inserted into the printers, and accompanying software for installation in computers which communicate with the printers; computer programs and manuals sold as a unit; namely graphical operating environment programs for microcomputers
VELCRO . . . . .	Notion - namely, a synthetic material sold in ribbon, sheet, or piece goods form, said material having complementary parts which adhere to each other when pressed together and adapted for use as a closure fastener, or button for closing garments, curtains, or the like; separable fasteners-namely, hook and loop-type fasteners and components thereof	WINDSURFER . . . . .	Sailboats having a free sail system
VICTROLA . . . . .	Prerecorded audio cassettes; records for talking-machines	WITE-OUT . . . . .	Typing and drawing correction fluid (erasing liquid)
VIDEOFILE . . . . .	Document storage systems designed to automate the storage and retrieval of document images, and components thereof		
VIENNA BEEF . . . . .	Tongue, corned beef, frankfurters, wieners, knockwurst, polish sausage, pastrami, salami, and bologna		

MANUAL OF PATENT EXAMINING PROCEDURE

<i>Trademark</i>	<i>Particular goods on or in connection with which the trademark is used</i>
XEROX . . . . .	Electrophotographic copying machines (and equipment for recording x-ray images - namely, processors for electrostatically charging xeroradiographic plates and conditioners for producing positive or negative prints)
ZIPLOC . . . . .	Plastic bags

## Appendix II List of Decisions Cited

<p>A, Ex parte, 17 USPQ2d 1716 (Bd. Pat. App. &amp; Inter. 1990) . . . . . 716.02, 2131.02</p> <p>Abbott Laboratories v. Geneva Pharmaceuticals, Inc., 182 F.3d 1315, 51 USPQ2d 1307 (Fed. Cir. 1999) . . . 2112, 2133.03(c)</p> <p>Abbott Laboratories v. Young, 920 F.2d 984, 17 USPQ2d 1027 (D.C. Cir. 1990) . . . . . 2751</p> <p>Abele, In re, 684 F.2d 902, 214 USPQ 682 (CCPA 1982) . . . . . 2106, 2184</p> <p>Abseck, Ex parte, 133 USPQ 411 (P.O. Super. Exam. 1960) . . . . . 1208.03</p> <p>Ackermann, In re, 444 F.2d 1172, 170 USPQ 340 (CCPA 1971) . . . . . 706.03(w)</p> <p>ACTV, Inc. v. The Walt Disney Co., 346 F.3d 1082, 68 USPQ2d 1516 (Fed. Cir. 2003) . . . . . 2111.01</p> <p>Adidas Fabrique v. Andsmore Sportswear Corp., 578 F. Supp. 1568, 223 USPQ 1109 (S.D. N.Y. 1984) . . . . . 1504.06</p> <p>Adler v. Kluver, 159 USPQ 511 (Bd. Pat. Inter. 1968) . . . . . 715.05</p> <p>Aelony v. Arni, 547 F.2d 566, 192 USPQ 486 (CCPA 1977) . . . . . 2301.02, 2306</p> <p>AFG Industries, Inc. v. Cardinal IG Company, Inc., 239 F.3d 1239, 57 USPQ2d 1776 (Fed. Cir. 2001) . . . . . 2111.03</p> <p>A.F. Stoddard &amp; Co. v. Dann, 564 F.2d 556, 195 USPQ 97 (D.C. Cir. 1977) . . . . . 1412.04</p> <p>Affidavit Filed After Final Registration, In re, 152 USPQ 292, 1966 C.D. 53 (Comm'r Pat. 1966) . . . 710.02(e), 2265, 2665, 2675</p> <p>Ahlert, In re, 424 F.2d 1088, 165 USPQ 418 (CCPA 1970) . . . . . 2144.03</p> <p>Ahrens v. Grey, 1931 C.D. 9, 402 O.G. 261 (Bd. App. 1929) . . . . . 201.13</p> <p>Ajinomoto Co. v. Archer-Daniels-Midland Co., 228 F.3d 1338, 56 USPQ2d 1332 (Fed. Cir. 2000), cert. denied, 121 S.Ct 1957 (2001) . . . . . 2402</p> <p>AK Steel Corp. v. Sollac, 344 F.3d 1234, 68 USPQ2d 1280 (Fed. Cir. 2003) . . . . . 2111.03, 2163, 2164.08</p> <p>Akron Brass Co. v. Elkhart Brass Mfg. Co., 353 F.2d 704, 147 USPQ 301 (7th Cir. 1965) . . . . . 2133.03(e)(1)</p> <p>Aktiebolaget Astra v. Lehman, 71 F.3d 1578, 37 USPQ2d 1212 (Fed. Cir. 1995) . . . . . 2757</p>	<p>Akzo N.V. v. International Trade Comm'n, 808 F.2d 1471, 1 USPQ2d 1241 (Fed. Cir. 1986) . . . . . 2131.02</p> <p>Alappat, In re, 33 F.3d 1526, 31 USPQ2d 1545 (Fed. Cir. 1994) . . . . . 2106</p> <p>Albertson, In re, 332 F.2d 379, 141 USPQ 730 (CCPA 1964) . . . . . 2116.01</p> <p>Albrecht, In re, 514 F.2d 1389, 185 USPQ 585 (CCPA 1975) . . . . . 2144.08, 2144.09</p> <p>Alcon Laboratories Inc., In re, 13 USPQ2d 1115 (Comm'r Pat. &amp; Tm. 1989) . . . . . 2751, 2755.01</p> <p>Allen, Ex parte, 2 USPQ2d 1425 (Bd. Pat. App. &amp; Inter. 1987) . . . . . 2105</p> <p>Allen Eng'g Corp. v. Bartell Indus., Inc., 299 F.3d 1336, 63 USPQ2d 1769 (Fed. Cir. 2002) . . . . . 2133.03(e), 2133.03(e)(4)</p> <p>Allen &amp; Hansbury Ltd., 227 USPQ 955 (Comm'r Pat. &amp; Tm. 1985) . . . . . 2756</p> <p>Aller, In re, 220 F.2d 454, 105 USPQ 233 (CCPA 1955) . . . . . 2144.05</p> <p>Alpert v. Slatin, 305 F.2d 891, 134 USPQ 296 (CCPA 1962) . . . . . 2138.04</p> <p>Al-Site Corp. v. VSI International Inc., 174 F.3d 1308, 50 USPQ2d 1161 (Fed. Cir. 1999) . . . . . 2143.01, 2181, 2183, 2184</p> <p>Altiris Inc. v. Symantec Corp., 318 F.3d 1363, 65 USPQ2d 1865 (Fed. Cir. 2003) . . . . . 2111.01</p> <p>Alton, In re, 76 F.3d 1168, 37 USPQ2d 1578 (Fed. Cir. 1996) . . . . 2144.08, 2163, 2163.06, 2164.05</p> <p>Altoona Publix Theatres v. American Tri-Ergon Corp., 294 U.S. 477, 24 USPQ 308 (1935) . . . . . 1490</p> <p>Amazon.com v. Barnesandnoble.com, 73 F. Supp. 2d 1228, 53 USPQ2d 1115 (W.D. Wash. 1999) . . . . . 2128</p> <p>American Academy of Science Tech. Center, In re, _F.3d_, 2004 WL 1067528 (Fed. Cir. May 13, 2004) . . . . . 2111.01</p> <p>American Fruit Growers, Inc. v. Brogdex Co., 283 U.S. 1 (1931) . . . . . 2106</p> <p>American Infra-Red Radiant Co. v. Lambert Indus. Inc., 360 F.2d 977, 149 USPQ 722 (8th Cir. 1966) . . . . . 901.05, 2135.01</p> <p>American Hoist &amp; Derrick Co. v. Sowa &amp; Sons, Inc., 725 F.2d 1350, 220 USPQ 763 (Fed. Cir. 1984) . . . . . 410</p>
--	--

MANUAL OF PATENT EXAMINING PROCEDURE

Amgen, Inc. v. Chugai Pharmaceutical Co., 927 F.2d 1200, 18 USPQ2d 1016 (Fed. Cir. 1991) . . . . .	2138, 2138.04, 2143.02, 2163, 2163.02, 2164.08, 2165.04, 2173.05(b), 2411.01	Appeal, Decided 9/3/68, Ex parte, 866 O.G. 16 (Bd. App. 1968) . . . . .	1504.02
Amgen, Inc. v. Hoechst Marion Roussel, Inc., 126 F. Supp. 2d 69, 57 USPQ2d 1449 (D. Mass. 2001) . . . . .	706.04	Appeal No. 194-38, 152 USPQ 70, 1955 C.D. 31 (Bd. App. 1965) . . . . .	901.05(b)
Amos, In re, 953 F.2d 613, 21 USPQ2d 1271 (Fed. Cir. 1991) . . . . .	1412.01	Appeal No. 239-48, 151 USPQ 711, 1966 C.D. 22, 833 O.G. 10 (Bd. App. 1965) . . . . .	1504.02
Amp, In re, 212 USPQ 826 (Comm'r Pat. 1981) . . . . .	2225, 2625	Appeal No. 242-47, 196 USPQ 828 (Bd. App. 1976) . . . . .	901.05(b), 2135.01
Amphenol Corp. v. Gen'l Time Corp., 397 F.2d 431, 158 USPQ 113 (7th Cir. 1968) . . . . .	2133.03(e)(1)	Appeal No. 315-40, Ex Parte, 152 USPQ 71 (Bd. App. 1965) . . . . .	1504.05
Anchor Hocking Corp. v. Eyelet Specialty Co., 377 F. Supp 98, 183 USPQ 87 (D. Del. 1974) . . . . .	1504.06	Application Filed Nov. 16, 1945, In re, 89 USPQ 280, 1951 C.D. 1, 646 O.G. 5 (Comm'r Pat. 1951) . . . . .	904.01(a)
Anderson, Ex parte, 21 USPQ2d 1241 (Bd. Pat. App. & Inter. 1991) . . . . .	2173.05(b)	Application of Takao, 17 USPQ2d 1155 (Comm'r Pat. 1990) . . . . .	711.03(c)
Anderson, In re, 471 F.2d 1237, 176 USPQ 331 (CCPA 1973) . . . . .	601.01(d), 2163.07, 2181	Application Papers Filed Jan. 20, 1956, In re, 706 O.G. 4 (Comm'r Pat. 1956) . . . . .	714.07
Anderson's-Black Rock Inc. v. Pavement Salvage Co., 396 U.S. 57, 163 USPQ 673 (1969) . . . . .	716.01(a), 2141	Application Papers Filed Sept. 10, 1954, In re, 108 USPQ 340 (Comm'r Pat. 1955) . . . . .	409.03(c)
Anderson v. Crowther, 152 USPQ 504 (Bd. Pat. Inter. 1965) . . . . .	2138.06	Applied Materials Inc. v. Gemini Research Corp., 835 F.2d 279, 15 USPQ2d 1816 (Fed. Cir. 1988) . . . . .	2136.05, 2137.01
Andresen, Ex parte, 212 USPQ 100 (Bd. App. 1981) . . . . .	2004, 2137, 2141.01	Argoudelis, Ex parte, 157 USPQ 437 (Bd. App. 1967) . . . . .	1214.03
Andrew Corp. v. Gabriel Electronics, 847 F.2d 819, 6 USPQ2d 2010 (Fed. Cir. 1988) . . . . .	2173.05(b)	Argoudelis, In re, 434 F.2d 1390, 168 USPQ 99 (CCPA 1970) . . . . .	2164.06, 2164.06(a), 2402
Andrews v. Wickenden, 194 F.2d 729, 93 USPQ 27 (CCPA 1952) . . . . .	2307	Armbruster, In re, 512 F. 2d 676, 185 USPQ 152 (CCPA 1975) . . . . .	608.01(b), 2161, 2181
Angstadt, In re, 537 F.2d 498, 190 USPQ 214 (CCPA 1976) . . . . .	2164.01, 2164.06, 2164.08(b)	Armour & Co. v. Swift & Co., 466 F.2d 767, 175 USPQ 70 (7th Cir. 1972) . . . . .	2001.06(b)
Anthony, Ex parte, 230 USPQ 467 (Bd. App. 1982), aff'd 770 F.2d 182 (Fed. Cir. 1985) (table) . . . . .	1490	Armstrong, In re, 280 F.2d 132, 126 USPQ 281 (CCPA 1960) . . . . .	716.02(e)
Anthony, In re, 414 F. 2d 1383, 162 USPQ 594 (CCPA 1969) . . . . .	2107.01, 2107.03	Arnott, In re, 19 USPQ2d 1049 (Comm'r Pat. 1991) . . . . .	804.02, 1481
Antonie, In re, 559 F.2d 618, 195 USPQ 6 (CCPA 1977) . . . . .	2141.02, 2144.05	Arrhythmia Research Tech. v. Corazonix Corp., 958 F.2d 1053, 22 USPQ2d 1033 (Fed. Cir. 1992) . . . . .	2106
A&P Tea Co. v. Supermarket Corp., 340 U.S. 147 (1950) . . . . .	716.01(a)	Arzberger, In re, 112 F.2d 834, 46 USPQ 32 (CCPA 1940) . . . . .	1601
		Asahi/America Inc., In re, 68 F.3d 442, 37 USPQ2d 1204 (Fed. Cir. 1995) . . . . .	715.07
		Asano, Ex parte, 201 USPQ 315 (Bd. Pat. App. & Inter. 1978) . . . . .	1503.02

LIST OF DECISIONS CITED

Ashland Oil, Inc. v. Delta Resins & Refractories, Inc., 776 F.2d 281, 227 USPQ 657 (Fed. Cir. 1985). . . . 716.01(b), 716.01(c), 2144.08	Ball Corp. v. United States, 729 F.2d 1429, 221 USPQ 289 (Fed. Cir. 1984) . . . . 1412.02, 1490
Aslanian, In re, 590 F.2d 911, 200 USPQ 500 (CCPA 1979) . . . . . 2125	Balzarini, Ex parte, 21 USPQ2d 1892 (Bd. Pat. App. & Inter. 1991) . . . . . 2107.03
Atlantic Thermoplastics Co. v. Faytex Corp., 970 F.2d 834, 23 USPQ2d 1481 (Fed. Cir. 1992). . . . . 2133.03(b), 2133.03(c)	Bandel, In re, 348 F.2d 563, 146 USPQ 389 (CCPA 1965) . . . . . 715, 2305.01
Atlas Powder Co. v. E.I. duPont de Nemours & Co., 750 F.2d 1569, 224 USPQ 409 (Fed. Cir. 1984). . . . . 2111.03, 2164.01, 2164.08(b)	Barber, Ex parte, 187 USPQ 244 (Bd. App. 1974). . . . . 2173.05(j)
Atlas Powder Co. v. IRECO, Inc., 190 F.3d 1342, 51 USPQ2d 1943 (Fed. Cir. 1999) . . . . . 2112, 2131.01, 2131.05	Barber, In re, 81 F.2d 231, 28 USPQ 187 (CCPA 1936). . . . . 804
Atmel Corp. v. Information Storage Devices Inc., 198 F.3d 1374, 53 USPQ2d 1225 (Fed. Cir. 1999) . . . . . 2106, 2181	Barker, In re, 559 F.2d 588, 194 USPQ 470 (CCPA 1977) . . . . . 2106, 2161, 2163
AT&T Corp. v. Excel Communications, Inc., 172 F.3d 1352, 50 USPQ2d 1447 (Fed. Cir. 1999) . . . . . 2106	Barmag Barmer Maschinenfabrik AG v. Murata Mach., Ltd., 731 F.2d 831, 221 USPQ 561 (Fed. Cir. 1984). . . . . 2133.03(b)
Attig, Ex parte, 7 USPQ2d 1092 (Bd. Pat. App. & Inter. 1986) . . . . . 2173.05(b)	Barr, In re, 444 F.2d 588, 170 USPQ 330 (CCPA 1971). . . . . 2173.05(a), 2173.05(g), 2173.05(i)
Autogiro Co. of America v. United States, 384 F.2d 391, 155 USPQ 697 (Ct. Cl. 1967) . . . . . 2163	Bartfeld, Ex parte, 16 USPQ2d 1714 (Bd. Pat. App. & Inter. 1990) . . . . . 2136.01
Automatic Weighing Mach. Co. v. Pneumatic Scale Corp., 166 F.2d 288, 1909 C.D. 498, 139 O.G. 991 (1st Cir. 1909) . . . . . 715.07	Bartfeld, In re, 925 F.2d 1450, 17 USPQ2d 1885 (Fed. Cir. 1991). . . . . 706.02(f)(2), 706.02(i), 804, 804.03, 2136.01, 2136.05, 2141.01
Avia Group International, Inc. v. L.A. Gear California, Inc., 853 F.2d 1557, 7 USPQ2d 1548 (Fed. Cir. 1988). . . . . 1504.01(c), 1504.03	Bartlett, In re, 300 F.2d 942, 133 USPQ 204 (CCPA 1962) . . . . . 1504.02
Ayers, Ex parte, 108 USPQ 444 (Bd. App. 1955) . . . . . 608.04(a)	Bass, In re, 474 F.2d 1276, 177 USPQ 178 (CCPA 1973) . . . . . 715, 2004, 2138, 2138.03
Azar v. Burns, 188 USPQ 601 (Bd. Pat. Inter. 1975) . . . . . 2138.05, 2308.02	Bausch & Lomb v. Barnes-Hind/Hydrocurve, Inc., 796 F.2d 443, 230 USPQ 416 (Fed. Cir. 1986). . . . . 2141.02
Badger, Ex parte, 1901 C.D. 195, 97 O.G. 1596 (Comm'r Pat. 1901). . . . . 608.02(f)	Baxter Diagnostics v. AVL Scientific Corp., 798 F. Supp. 612, 25 USPQ2d 1428 (C.D., Cal. 1992) . . . . . 2751
Baird, In re, 16 F.3d 380, 29 USPQ2d 1550 (Fed. Cir. 1994) . . . . . 2144.05, 2144.08, 2163	Baxter, In re, 656 F.2d 679, 210 USPQ 795 (CCPA 1987) . . . . . 2111.03
Baker Hughes, Inc. v. Kirk, 921 F. Supp. 801, 38 USPQ2d 1885 (D.D.C. 1995) . . . . . 1412.04	Baxter Travenol Labs., In re, 952 F.2d 388, 21 USPQ2d 1281 (Fed. Cir. 1991) . . . . 2131.01, 2145
Ball Corp., In re, 925 F.2d 1480, 18 USPQ2d 1491 (Fed. Cir. 1991). . . . . 2145	Bayer, In re, 568 F.2d 1357, 196 USPQ 670 (CCPA 1978) . . . . . 2128.01
	B. Braun Medical, Inc. v. Abbott Labs, 124 F.3d 1419, 43 USPQ2d 1896 (Fed. Cir. 1997). . . . . 2106, 2163, 2181, 2182
	Beattie, In re, 974 F.2d 1309, 24 USPQ2d 1040 (Fed. Cir. 1992) . . . . . 716.01(c), 2144.08



MANUAL OF PATENT EXAMINING PROCEDURE

Beck, In re, 155 F.2d 398, 69 USPQ 520 (CCPA 1946) . . . . .	715.01(b)	Best Lock Corp v. Ilco Unican Corp., 94 F.3d 1563, 40 USPQ2d 1048 (Fed. Cir. 1996) . . . . .	1504.01(c)
Becker v. Patrick, 47 USPQ 314 (Comm'r Pat. 1939) . . . . .	2309.01	Bey v. Kollonitsch, 806 F.2d 1024, 231 USPQ 967 (Fed. Cir. 1986) . . . . .	2138.06
Beckman Instruments v. LKB Produkter AB, 892 F.2d 1547, 13 USPQ2d 1301 (Fed. Cir. 1989) . . . . .	2121.01	BIC Leisure Prods., Inc., v. Windsurfing Int'l, Inc., 1 F.3d 1214, 27 USPQ2d 1671 (Fed. Cir. 1993) . . . . .	1457
Beech Aircraft Corp. v. EDO Corp., 990 F.2d 1237, 26 USPQ2d 1572 (Fed. Cir. 1993) . . . . .	301	Biesecker, Ex parte, 144 USPQ 129 (Bd. App. 1964) . . . . .	715.02, 715.03
Belk, Ex parte, 161 USPQ 795 (Bd. Pat. App. 1968) . . . . .	901.05, 901.05(b), 2135.01	Bigham v. Godtfredsen, 857 F.2d 1415, 8 USPQ2d 1266 (Fed. Cir. 1988) . . . . .	2138.01, 2138.05
Bell Communications Research, Inc. v. Vitalink Communications Corp., 55 F.3d 615, 34 USPQ2d 1816 (Fed. Cir. 1995) . . . . .	2111.02, 2163	Billotet, Ex parte, 192 USPQ 413 (Bd. App. 1976) . . . . .	2137
Bell, In re, 991 F.2d 781, 26 USPQ2d 1529 (Fed. Cir. 1993) . . . . .	2144.08, 2144.09, 2163	Bindra v. Kelly, 206 USPQ 570 (Bd. Pat. Inter. 1979) . . . . .	2138.05
Benger Labs. Ltd. v. R.K. Laros Co., 209 F. Supp. 639, 135 USPQ 11 (E.D. Pa. 1966) . . . . .	2165	Bird Provision Co. v. Owens Country Sausage, Inc., 568 F.2d 369, 197 USPQ 134 (5th Cir. 1978) . . . . .	2133.03(a)
Benke, Ex parte, 1904 C.D. 63, 108 O.G. 1588 (Comm'r Pat. 1904) . . . . .	811.02	Black & Decker, Inc. v. Pittway Corp., 636 F.2d 1193, 231 USPQ 252 (N.D. Ill. 1986) . . . . .	1504.02
Bennage v. Phillippi, 1876 C.D. 135, 9 O.G. 1159 (Comm'r Pat. 1876) . . . . .	1504.01(d)	Blacklight Power, Inc. v. Rogan, 295 F.3d 1269, 63 USPQ2d 1534 (Fed. Cir. 2002) . . . . .	1134
Bennett, In re, 766 F.2d 524, 226 USPQ 413 (Fed. Cir. 1985) . . . . .	706.03(x), 1403, 1412.03	Blaisdell, In re, 242 F.2d 779, 113 USPQ 289 (CCPA 1957) . . . . .	2133.03(a), 2133.03(b), 2133.03(e)(3), 2133.03(e)(5)
Benno, In re, 768 F.2d 1340, 226 USPQ 683 (Fed. Cir. 1985) . . . . .	2163, 2163.06	Blake, In re, 358 F.2d 750, 149 USPQ 217 (CCPA 1966) . . . . .	715.07
Benson, In re, 122 USPQ 279, 1959 C.D. 5, 744 O.G. 353 (Comm'r Pat. 1959) . . . . .	608.01, 714.07	Blanc, Ex parte, 13 USPQ2d 1383 (Bd. Pat. App. & Inter. 1989) . . . . .	716.02(c), 2142, 2143.02
Berg, In re, 140 F.3d 1428, 46 USPQ2d 1226 (Fed. Cir. 1998) . . . . .	804	Bland, Ex parte, 3 USPQ2d 1103 (Bd. Pat App. & Inter. 1986) . . . . .	2141.01(a)
Bergstrom, In re, 427 F.2d 1394, 166 USPQ 256 (CCPA 1970) . . . . .	2144.04	Blattner, Ex parte, 2 USPQ2d 2047 (Bd. Pat. App. & Inter. 1987) . . . . .	2144.09
Berkman, In re, 642 F.2d 427, 209 USPQ 45 (CCPA 1981) . . . . .	1504.04, 1504.20	Blisscraft of Hollywood v. United Plastic Co., 189 F. Supp 333, 127 USPQ 452 (S.D.N.Y. 1960) . . . . .	1504.01(c)
Bernhart, In re, 417 F.2d 1395, 163 USPQ 611 (CCPA 1969) . . . . .	2106, 2173.05(j)	Blondel, In re, 499 F.2d 1311, 182 USPQ 294 (CCPA 1974) . . . . .	716.02(b)
Berry Sterling Corp. v. Pescor Plastics Inc., 122 F.3d 1452, 43 USPQ2d 1953 (Fed. Cir. 1997) . . . . .	1504.01(c)	Blonder-Tongue Labs., Inc. v. Univ. of Ill., Foundation, 402 U.S. 313, 169 USPQ 513 (1971) . . . . .	2012.01
Bertsch, In re, 132 F.2d 1014, 56 USPQ 379 (CCPA 1942) . . . . .	2111.03	Blout, In re, 333 F.2d 928, 142 USPQ 173 (CCPA 1964) . . . . .	715
Best, In re, 562 F.2d 1252, 195 USPQ 430 (CCPA 1977) . . . . .	2112, 2112.01, 2112.02		

LIST OF DECISIONS CITED

Blum, In re, 374 F.2d 904, 153 USPQ 177 (CCPA 1967) . . . . .	1503.01, 1503.02, 1503.03	Bowen, In re, 492 F.2d 859, 181 USPQ 48 (CCPA 1974) . . . . .	2164.04
Blumcraft of Pittsburgh v. Ladd, 238 F. Supp. 648, 144 USPQ 562 (D.D.C. 1965) . . . . .	1504.05, 1504.06	Bowers, In re, 359 F.2d 886, 149 USPQ 570 (CCPA 1966) . . . . .	706.02(1)(2), 804
Board of Education ex rel. Board of Trustees of Florida State Univ. v. American Bioscience Inc., 333 F.3d 1330, 67 USPQ2d 1252 (Fed. Cir. 2003) . . . . .	2137.01	Bowser Inc. v. United States, 388 F.2d 346, 156 USPQ 406 (Ct. Cl. 1967) . . . . .	2141
Boeing Co. v. Comm’r Pat., 853 F.2d 878, 7 USPQ2d 1487 (Fed. Cir. 1988) . . . . .	2279	Bowyer, Ex parte, 42 USPQ 526, 1939 C.D. 5, 505 O.G. 759 (Comm’r Pat. 1939) . . . . .	715.07(b)
Boesch, In re, 617 F.2d 272, 205 USPQ 215 (CCPA 1980) . . . . .	716.02(b), 2144.05	Boylan, In re, 392 F.2d 1017, 157 USPQ 370 (CCPA 1968) . . . . .	804
Bogese, In re, 303 F.3d 1362, 64 USPQ2d 1448 (Fed. Cir. 2002) . . . . .	2190	Braat, In re, 937 F.2d 589, 19 USPQ2d 1289 (Fed. Cir. 1991) . . . . .	804
Bogoslowsky v. Huse, 142 F.2d 75, 61 USPQ 349 (CCPA 1944) . . . . .	2138.03	Brader v. Schaeffer, 193 USPQ 627 (Bd. Pat. Inter. 1976) . . . . .	2137.01
Bolkcom v. Carborundum Co., 523 F.2d 492, 187 USPQ 446 (6th Cir. 1975) . . . . .	2003	Bradley, In re, 600 F.2d 807, 202 USPQ 480 (CCPA 1979) . . . . .	2106.02
Bond, In re, 910 F.2d 831, 15 USPQ2d 1566 (Fed. Cir. 1990) . . . . .	2131, 2183, 2184	Braithwaite, In re, 379 F.2d 594, 154 USPQ 29 (CCPA 1967) . . . . .	804, 804.02
Bondiou, Ex parte, 132 USPQ 356 (Bd. App. 1961) . . . . .	2163.07	Braithwaite, In re, 379 F.2d 606, 154 USPQ 38 (CCPA 1967) . . . . .	806.04(i)
Bonito Boats, Inc. v. Thunder Craft Boats, Inc., 489 U.S. 141, 9 USPQ2d 1847 (1989) . . . . .	2133.02	Brana, In re, 51 F.3d 1560, 34 USPQ2d 1436 (Fed. Cir. 1995) . . . . .	2107.01, 2107.02, 2107.03, 2164.01(c), 2164.02, 2164.04, 2164.07
Bonnie-B Co., Ex parte, 1923 C.D. 42, 313 O.G. 453 (Comm’r Pat. 1922) . . . . .	103, 104	Brandstadter, In re, 484 F.2d 1395, 179 USPQ 286 (CCPA 1973) . . . . .	716.01(c), 716.09, 2106, 2106.02, 2164.05
Borden, In re, 90 F.3d 1570, 39 USPQ2d 1524 (Fed. Cir. 1996) . . . . .	1504.03	Brasseler, U.S.A. I, L.P. v. Stryker Sales Corp., 267 F.3d 1370, 60 USPQ2d 1482 (Fed. Cir. 2001) . . . . .	2001.06
Borkowski, In re, 422 F.2d 904, 164 USPQ 642 (CCPA 1970) . . . . .	707.07(1), 2164.02, 2174	Brenner v. Ebbert, 398 F.2d 762, 157 USPQ 609 (D.C. Cir. 1968) . . . . .	711.03(c)
Borkowski, In re, 505 F.2d 713, 184 USPQ 29 (CCPA 1974) . . . . .	715.07, 2371	Brenner v. Manson, 383 U.S. 519, 148 USPQ 689 (1966) . . . . .	2106, 2107.01, 2107.02
Bose Corp., In re, 772 F.2d 866, 227 USPQ 1 (Fed. Cir. 1985) . . . . .	1203	Brenner v. State of Israel, 400 F.2d 789, 158 USPQ 584 (D.C. Cir. 1968) . . . . .	201.14, 201.16, 1402, 1417, 1444
Bose Corp. v. JBL, Inc., 274 F.3d 1354, 61 USPQ2d 1216 (Fed. Cir. 2001) . . . . .	2173.05	Breslow, In re, 616 F.2d 516, 205 USPQ 221 (CCPA 1980) . . . . .	2106, 2164.01(b)
Bosies v. Benedict, 27 F.3d 539, 30 USPQ2d 1862 (Fed. Cir. 1994) . . . . .	2138.04	Brian, Ex parte, 118 USPQ 242 (Bd. App. 1958) . . . . .	2173.05(t)
Bostwick, In re, 102 F.2d 886, 41 USPQ 279 (CCPA 1939) . . . . .	1449.02	Bridgford, In re, 357 F.2d 679, 149 USPQ 55 (CCPA 1966) . . . . .	806.05(f)
Bosy, In re, 360 F.2d 972, 149 USPQ 789 (CCPA 1966) . . . . .	2165.01	Bristol-Myers Squibb Co. v. Rhone Pou- lenc Rorer, Inc., 326 F.3d 1226, 66 USPQ2d 1481 (Fed. Cir. 2003) . . . . .	2001.04
Bourne v. Jones, 114 F. Supp 413, 98 USPQ 206 (S.D. Fla. 1951) . . . . .	2133.03(e)(7)		

MANUAL OF PATENT EXAMINING PROCEDURE

Brookhill-Wilk 1, LLC v. Intuitive Surgical, Inc., 334 F.3d 1294, 67 USPQ2d 1132 (Fed. Cir. 2003) . . . . .	2106, 2111.01	Burrowes, Ex parte, 1904 C.D. 155, 110 O.G. 599 (Comm'r Pat. 1904) . . . . .	1214.01, 2682
Brooktree Corp. v. Advanced Micro Devices, Inc., 977 F.2d 1555, 24 USPQ2d 1401 (Fed. Cir. 1992) . . . . .	2107.01	Busse, Ex parte, 1 USPQ2d 1908 (Bd. Pat. App. & Inter. 1986) . . . . .	2107.03
Broos v. Barton, 142 F.2d 690, 61 USPQ 447 (CCPA 1944) . . . . .	2138.06	Butera, In re, 1 F.3d 1252, 28 USPQ2d 1399 (Fed. Cir. 1993) . . . . .	2141.01(a)
Brouwer, In re, 77 F.3d 422, 37 USPQ2d 1663 (Fed. Cir. 1996) . . . . .	706.02(n), 2116.01, 2144.08	Buting, In re, 418 F.2d 540, 163 USPQ 689 (CCPA 1969) . . . . .	2107.03
Brower, In re, 433 F.2d 813, 167 USPQ 684 (CCPA 1970) . . . . .	2172	C, Ex parte, 27 USPQ2d 1492 (Bd. Pat. App. & Inter. 1992) . . . . .	716.02(b), 2133.03(a)
Brown, In re, 459 F.2d 531, 173 USPQ 685 (CCPA 1972) . . . . .	2113, 2183	Cable Electric Products, Inc. v. Genmark, Inc., 770 F.2d 1015, 226 USPQ 881 (Fed. Cir. 1985) . . . . .	716.03(b), 716.06, 1504.03
Brown, In re, 477 F.2d 946, 177 USPQ 691 (CCPA 1973) . . . . .	2106.02	Cady, Ex parte, 1916 C.D. 62, 232 O.G. 621 (Comm'r Pat. 1916) . . . . .	1502, 1504.04
Brown v. 3M, 265 F.3d 1349, 60 USPQ2d 1375 (Fed. Cir. 2001) . . . . .	2131	Caldwell, Ex parte, 1906 C.D. 58 (Comm'r Pat. 1906) . . . . .	2173.05(b)
Brummer, Ex parte, 12 USPQ2d 1653 (Bd. Pat. App. & Inter. 1989) . . . . .	2173.05(b)	California Research Corp. v. Ladd, 356 F.2d 813, 148 USPQ 404 (D.C. Cir. 1966) . . . . .	1216.02
Buchner, In re, 929 F.2d 660, 18 USPQ2d 1331 (Fed. Cir. 1991) . . . . .	716.09, 2107.02, 2164.01, 2164.05, 2164.05(a), 2164.08	Campbell, In re, 212 F.2d 606, 101 USPQ 406 (CCPA 1954) . . . . .	1504.20
Budde v. Harley-Davidson, Inc., 250 F.3d 1369, 58 USPQ2d 1801 (Fed. Cir. 2001) . . . . .	2181, 2182	Card, Ex parte, 1904 C.D. 383 (Comm'r Pat. 1904) . . . . .	2309.01
Budnick, In re, 537 F.2d 535, 190 USPQ 422 (CCPA 1976) . . . . .	2106.02, 2164.05(a)	Cardiac Pacemakers, Inc. v. St. Jude Med., Inc., 296 F.3d 1106, 63 USPQ2d 1725 (Fed. Cir. 2002) . . . . .	2181, 2182
Buildex v. Kason Indus., 849 F.2d 1461, 7 USPQ2d 1325 (Fed. Cir. 1988) . . . . .	2133.03(b)	Carella v. Starlight Archery, 804 F.2d 135, 231 USPQ 644 (Fed. Cir. 1986) . . . . .	2128, 2132
Bullier, Ex parte, 1899 C.D. 155, 88 O.G. 1161 (Comm'r Pat. 1899) . . . . .	709.01	Carl Zeiss Stiftung v. Renishaw PLC, 945 F.2d 1173, 20 USPQ2d 1094 (Fed. Cir. 1991) . . . . .	2107.01, 2107.02
Bundy, In re, 642 F.2d 430, 209 USPQ 48 (CCPA 1981) . . . . .	2107.02, 2164.04, 2164.06(b), 2164.07, 2165.04	Carletti, In re, 328 F.2d 1020, 140 USPQ 653 (CCPA 1964) . . . . .	1504.01(c)
Burckel, In re, 592 F.2d 1175, 201 USPQ 67 (CCPA 1979) . . . . .	716.02(e)	Carlson, In re, 79 F.2d 900, 27 USPQ 400 (CCPA 1935) . . . . .	715.04
Burhans, In re, 154 F.2d 690, 69 USPQ 330 (CCPA 1946) . . . . .	2144.04	Carlson, In re, 983 F.2d 1032, 25 USPQ2d 1207 (Fed. Cir. 1992) . . . . .	2126
Burlington Industries Inc. v. Quigg, 822 F.2d 1581, 3 USPQ2d 1436 (Fed. Cir. 1987) . . . . .	716.05	Carman Indus. Inc. v. Wahl, 724 F.2d 932, 220 USPQ 481 (Fed. Cir. 1983) . . . . .	804, 1504.06
Burr v. Duryee, 68 U.S. (1 Wall.) 531 (1863) . . . . .	2106	Carreira, In re, 532 F.2d 1356, 189 USPQ 461 (CCPA 1976) . . . . .	716.10, 2136.05
Burroughs Wellcome Co. v. Barr Labs., Inc., 40 F.3d 1223, 32 USPQ2d 1915 (Fed. Cir. 1994) . . . . .	2138.04, 2163	Carroll, In re, 601 F.2d 1184, 202 USPQ 571 (CCPA 1979) . . . . .	716.01(c)
		Carter, In re, 673 F.2d 1378, 213 USPQ 625 (CCPA 1982) . . . . .	1504.03

LIST OF DECISIONS CITED

Carter-Wallace, Inc. v. Riverton Labs., Inc., 433 F.2d 1034, 167 USPQ 656 (2d Cir. 1970) . . . . .	2165.01	Chemcast Corp. v. Acro Indus. Corp., 913 F.2d 923, 16 USPQ2d 1033 (Fed. Cir. 1990). . . . .	608.01(h), 2106.01, 2107.01, 2165.03, 2411.01
Case v. CPC Int'l Inc., 730 F.2d 745, 221 USPQ 196 (Fed. Cir. 1984). . . . .	2309.01	Chemithon Corp. v. Procter & Gamble Co., 287 F. Supp 291, 159 USPQ 139 (D. Md. 1968) . . . . .	2133.03(a)
Casey, In re, 370 F.2d 576, 152 USPQ 235 (CCPA 1967) . . . . .	707.07(f), 2115	Chevenard, In re, 139 F.2d 71, 60 USPQ 239 (CCPA 1943) . . . . .	2144.03
Catalina Mktg. Int'l v. Coolsavings.com, Inc., 289 F.3d 801, 62 USPQ2d 1781(Fed. Cir. 2002). . . . .	2111.02	Chicago Historical Antique Auto. Museum, Inc., In re, 197 USPQ 289 (Comm'r Pat. 1978) . . . . .	513
Cataphote Corp. v. Desoto Chem. Coat- ings, Inc., 356 F.2d 24, 148 USPQ 229 (9th Cir.) . . . . .	2133.03(e)(1)	Chicago Rawhide Mfg. Co., Ex parte, 223 USPQ 351 (Bd. Pat. App. & Inter. 1984) . . . . .	2144.04, 2258.01, 2642
Caterpillar Inc. v. Deere & Co., 224 F.3d 1374, 56 USPQ2d 1305 (Fed. Cir. 2000) . . . . .	2183, 2184	Chicopee Mfg. Corp. v. Columbus Fiber Mills Co., 165 F. Supp. 307, 118 USPQ 53 (M.D. Ga. 1958). . . . .	2133.03(e)(1)
Caterpillar Inc. v. Detroit Diesel Corp., 961 F. Supp. 1249, 41 USPQ2d 1876 (N.D. Ind. 1996) . . . . .	2181	Chiddix, In re, 209 USPQ 78 (Comm'r Pat. 1980) . . . . .	1206
Caterpillar Tractor Co. v. Comm'r Pat., 650 F. Supp. 218, 231 USPQ 590 (E.D. Va. 1986). . . . .	1850	Chilowski, In re, 229 F.2d 457, 108 USPQ 321 (CCPA 1956). . . . .	2107.01, 2107.02, 2107.03, 2164.02, 2164.07
Cavallito, In re, 282 F.2d 363, 127 USPQ 206 (CCPA 1960) . . . . .	2164.07	Chilowsky, In re, 306 F.2d 908, 134 USPQ 515 (CCPA 1962). . . . .	716.01(c)
Cavallito, In re, 306 F.2d 505, 134 USPQ 370 (CCPA 1962) . . . . .	2164.07	Chiron v. Corp. v. Genentech Inc., 363 F.3d 1247, 70 USPQ2d 1321 (Fed. Cir. 2004) . . . . .	2164.03, 2164.05(a)
Cavanagh, In re, 436 F.2d 491, 168 USPQ 466 (CCPA 1971). . . . .	716.04	Chiuminatta Concrete Concepts, Inc. v. Cardinal Indus. Inc., 145 F.3d 1303, 46 USPQ2d 1752 (Fed. Cir. 1998). . . . .	2183, 2184
Caveney, In re, 761 F.2d 671, 226 USPQ 1 (Fed. Cir. 1985) . . . . .	2133.03(b)	Chore-Time Equipment, Inc. v. Cumberland Corp., 713 F.2d 774, 218 USPQ 673 (Fed. Cir. 1983). . . . .	2141.03
Celeritas Technologies Ltd. v. Rockwell International Corp., 150 F.3d 1354, 47 USPQ2d 1516 (Fed. Cir. 1998) . . . . .	2123, 2131.05	Christensen, In re, 330 F.2d 652, 141 USPQ 295 (CCPA 1964). . . . .	804.03
Certain Limited-Charge Cell Culture Microcarriers, 221 USPQ 1165 (Int'l Trade Comm'n 1983), . . . . .	2164.01	Christie v. Seybold, 1893 C.D. 515, 64 O.G. 1650 (6th Cir. 1893) . . . . .	715.07(a)
CFMT, Inc. v. Yieldup Int'l Corp., 349 F.3d 1333, 68 USPQ2d 1940 (Fed. Cir. 2003). . . . .	2164	Chromalloy American Corp. v. Alloy Surfaces Co., 339 F.Supp 859, 173 USPQ 295 (D. Del. 1972). . . . .	201.11, 2004, 2012, 2016
Chandler, In re, 319 F.2d 211, 138 USPQ 138 (CCPA 1963) . . . . .	2173.05(n)	Chu, In re, 66 F.3d 292, 36 USPQ2d 1089 (Fed. Cir. 1995) . . . . .	201.11, 716.02(f), 1504.20, 2144.08,
Chapman, In re, 357 F.2d 418, 148 USPQ 711 (CCPA 1966) . . . . .	716.02(e)	Chupp, In re, 816 F.2d 643, 2 USPQ2d 1437 (Fed. Cir. 1987) . . . . .	716.01(d), 716.02(a), 2144.08
Chef America, Inc. v. Lamb-Weston, Inc., 358 F.3d 1371, 69 USPQ2d 1857 (Fed. Cir. 2004). . . . .	2111.01		

MANUAL OF PATENT EXAMINING PROCEDURE

Ciric v. Flanigen, 511 F.2d 1182, 185 USPQ 103 (CCPA 1975).....	2138.05	Colianni, In re, 561 F.2d 220, 195 USPQ 150 (CCPA 1977) .....	2164.06, 2164.06(b)
Citron, In re, 325 F.2d 248, 139 USPQ 516 (CCPA 1963) .....	2107.01, 2107.02, 2107.03	Collier, In re, 397 F.2d 1003, 158 USPQ 266 (CCPA 1968) .....	2163, 2163.05, 2172.01, 2173.05(k)
Clamp, In re, 151 USPQ 423 (Comm'r Pat. 1966) .....	201.13	Comstock, In re, 481 F.2d 905, 178 USPQ 616 (CCPA 1973).....	2106.02
Clapp, Ex parte, 227 USPQ 972 (Bd. Pat. App & Inter. 1985) .....	706.02(j), 2142, 2144	Comstock, Ex parte, 1923 C.D. 82, 317 O.G. 4 (Comm'r Pat. 1923).....	1214.01, 2682
Clark, Ex parte, 174 USPQ 40 (Bd. App. 1971) .....	2173.05(o)	Consolidated Aluminum Corp. v. Foseco Inc., 910 F.2d 804, 15 USPQ2d 1481 (Fed. Cir. 1990) .....	2165
Clark, In re, 522 F.2d 623, 187 USPQ 209 (CCPA 1975) .....	2012, 2012.01, 2016	Consolidated Edison Co. v. NLRB, 305 U.S. 197 (1938) .....	1216.01
Clark, In re, 457 F.2d 1004, 173 USPQ 359 (CCPA 1972) .....	715.05, 2308.01	Consolidated Fruit-Jar Co. v. Wright, 94 U.S. 92 (1876).....	2133.03(b)
Clarke, In re, 356 F.2d 987, 148 USPQ 665 (CCPA 1966) .....	715.03	Constant, In re, 827 F.2d 728, 3 USPQ2d 1479 (Fed. Cir. 1987) .....	1414
Clay, In re, 966 F.2d 656, 23 USPQ2d 1058 (Fed. Cir. 1992) .....	2141.01(a), 2144.08	Constant v. Advanced Micro-Devices, Inc., 848 F.2d 1560, 7 USPQ2d 1057 (Fed. Cir. 1988) .....	2128.02, 2145
Clemens, In re, 622 F.2d 1029, 206 USPQ 289 (CCPA 1980).....	716.02(d), 2144.08	Contico International, Inc. v. Rubbermaid Commercial Products, Inc., 506 F. Supp. 1072, 210 USPQ 649 (8th Cir. 1981) .....	1504.01(c)
Clement, In re, 131 F.3d 1464, 45 USPQ2d 1161 (Fed. Cir. 1997) .....	1412.02	Continental Can Co., Inc. v. Schuyler, 326 F. Supp 283, 168 USPQ 625 (D.D.C. 1970) .....	1216.01
Clifford, Ex parte, 49 USPQ 152 (Bd. App. 1940) .....	901.02	Continental Can Co. v. Monsanto Co., 948 F.2d 1264, 20 USPQ2d 1746 (Fed. Cir. 1991).....	2131.01
Clinical Products Ltd. v. Brenner, 255 F. Supp. 131, 149 USPQ 475 (D.D.C. 1966) .....	706.03(d), 2173.05(q)	Cook, In re, 439 F.2d 730, 169 USPQ 298 (CCPA 1971).....	2164.03, 2164.08(b)
Cloud v. Standard Packaging Corp., 376 F.2d 384, 153 USPQ 317 (7th Cir. 1967) .....	2133.03(e)(1)	Cooper v. Goldfarb, 154 F.3d 1321, 47 USPQ2d 1896 (Fed. Cir. 1998) .....	2163
Coca-Cola Co. v. Gemini Rising Inc., 346 F. Supp. 1183, 175 USPQ 56 (E.D.N.Y. 1972) .....	1512	Cooper v. Goldfarb, 240 F.3d 1378, 57 USPQ2d 1990 (Fed. Cir. 2001) .....	2138.05
Cochrane v. Deener, 94 U.S. 780 (1877).....	2106	Cooper, In re, 230 USPQ 638 (Dep. Assist. Comm'r Pat. 1986) .....	201.03
Cofer, In re, 354 F.2d 664, 148 USPQ 268 (CCPA 1966) .....	2144.04	Copenhaver, Ex parte, 109 USPQ 118 (Bd. App. 1955).....	2173.05(b)
Cogar v. Schuyler, 464 F.2d 747, 173 USPQ 389 (D.C. Cir. 1972) .....	409.03(i)	Corba, In re, 212 USPQ 825 (Comm'r Pat. 1981) .....	1504.20
Cohn, In re, 438 F.2d 984, 169 USPQ 95 (CCPA 1971).....	2173.03	Corbett v. Chisholm, 568 F.2d 759, 196 USPQ 337 (CCPA 1977).....	2307
Colbert v. Lofdahl, 21 USPQ2d 1068 (Bd. Pat. App. & Inter. 1991) .....	2138.02	Cordova, Ex parte, 10 USPQ2d 1949 (Bd. Pat. App. & Inter. 1989) .....	2173.05(h)
Cole, In re, 326 F.2d 769, 140 USPQ 230 (CCPA 1964).....	2106.02		
Cole v. Kimberly-Clark Corp., 102 F.3d 524, 41 USPQ2d 1001 (Fed. Cir. 1996) .....	2181		
Coleman v. Dines, 754 F.2d 353, 224 USPQ 857 (Fed. Cir. 1985).....	2138.04		

LIST OF DECISIONS CITED

Corkill, In re, 711 F.2d 1496, 226 USPQ 1005 (Fed. Cir. 1985) . . . . .	716.02(a), 2107.02	Curtis, In re, 354 F.3d 1347, 69 USPQ2d 1274 (Fed. Cir. 2004) . . . . .	2163, 2163.05
Cormany, In re, 476 F.2d 998, 177 USPQ 450 (CCPA 1973) . . . . .	2172	Cutter Co. v. Metropolitan Elec. Mfg. Co., 275 F. 158 (2d Cir. 1921). . . . .	603.01
Corneil, In re, 347 F.2d 563, 145 USPQ 702 (CCPA 1965) . . . . .	2124	Dailey, In re, 357 F.2d 669, 149 USPQ 47 (CCPA 1966). . . . .	2144.04
Corning Glass Works v. Sumitomo Elec. U.S.A., Inc., 868 F.2d 1251, 9 USPQ2d 1962 (Fed. Cir. 1989) . . . . .	2111.02, 2163	Dale Electronics Inc. v. R.C.L. Electron- ics, 488 F.2d 382, 180 USPQ 225 (1st Cir. 1973). . . . .	2004
Cornwall, In re, 230 F.2d 457, 109 USPQ 57 (CCPA 1956) . . . . .	1504.02, 1504.03	Dallas Cowboys Cheerleaders, Inc. v. Pussycat Cinema, Ltd., 604 F.2d 200, 203 USPQ 161 (2d Cir. 1979). . . . .	1512
Corona v. Dovon, 273 U.S. 692, 1928 C.D. 252 (1928) . . . . .	2138.05	Dana Corp. v. IPC Ltd. Partnership, 860 F.2d 415, 8 USPQ2d 1692 (Fed. Cir. 1988) . . . . .	608.01(h), 2165.04
Correge v. Murphy, 705 F.2d 1326, 217 USPQ 753 (Fed. Cir. 1983). . . . .	2138.03	Dance, In re, 160 F.3d 1339, 48 USPQ2d 1635 (Fed. Cir. 1998) . . . . .	2143.01
Cortright, In re, 165 F.3d 1353, 49 USPQ2d 1464 (Fed. Cir. 1999). . . . .	2111, 2164.04	Daniels, In re, 144 F.3d 1452, 46 USPQ2d 1788 (Fed. Cir. 1998). . . . .	1503.02, 1504.04
Costello, In re, 717 F.2d 1346, 219 USPQ 389 (Fed. Cir. 1983) . . . . .	716.10, 2136.05, 2137, 2138, 2138.04, 2138.05	Danly, In re, 263 F.2d 844, 120 USPQ 528 (CCPA 1959) . . . . .	2114
Craig, In re, 411 F.2d 1333, 162 USPQ 157 (CCPA 1969) . . . . .	706.03(w)	Dann v. Johnston, 425 U.S. 219, 189 USPQ 257 (1976) . . . . .	2106, 716.01(a)
Critikon, Inc. v. Becton Dickinson Vas- cular Access, Inc., 120 F.3d 1253, 43 USPQ2d 1666 (Fed. Cir. 1997). . . . .	2001.06(c)	Dart Indus. v. Banner, 636 F.2d 684, 207 USPQ 273 (C.A.D.C. 1980) . . . . .	201.06(c), 201.11
Crockett, In re, 279 F.2d 274, 126 USPQ 186 (CCPA 1960) . . . . .	2144.06	Dart Indus. v. E.I. du Pont de Nemours & Co., 489 F.2d 1359, 179 USPQ 392 (7th Cir. 1973). . . . .	2133.03, 2133.03(c)
Cronyn, In re, 890 F.2d 1158, 13 USPQ2d 1070 (Fed. Cir. 1989) . . . . .	2128.01	Data Line Corp. v. Micro Technologies, Inc., 813 F.2d 1196, 1 USPQ2d 2052 (Fed. Cir. 1987). . . . .	2183, 2184
Crosby, In re, 157 F.2d 198, 71 USPQ 73 (CCPA 1946). . . . .	716.07	Davis, Ex parte, 80 USPQ 448 (Bd. App. 1948) . . . . .	2111.03, 2163
Cross v. Iizuka, 753 F.2d 1040, 224 USPQ 739 (Fed. Cir. 1985). . . . .	2107.01, 2107.03, 2164.02	Davis, Ex parte, 56 USPQ2d 1434 (Bd. Pat. App. & Inter. 2000) . . . . .	804
Crossman, In re, 187 USPQ 367 (PTO Solicitor 1975) . . . . .	103	Davis Harvester Co., Inc. v. Long Mfg. Co., 252 F. Supp. 989, 149 USPQ 420 (E.D.N.C. 1966) . . . . .	2134
Cruciferous Sprout Litig., In re, 301 F.3d 1343, 64 USPQ2d 1202 (Fed. Cir. 2002) . . . . .	2111.02	Davis v. Carrier, 81 F.2d 250, 28 USPQ 227 (CCPA 1936) . . . . .	2137.01
Crystal Semiconductor Corp. v. TriTech Microelectronics Int'l Inc., 246 F.3d 1336, 57 USPQ2d 1953 (Fed. Cir. 2001) . . . . .	2111.03	Dayco Prod., Inc. v. Total Containment, Inc., 329 F.3d 1358, 66 USPQ2d 1801 (Fed. Cir. 2003). . . . .	2004
CTS Corp. v. Electro Materials Corp. of America, 469 F. Supp. 801, 202 USPQ 22 (S.D. N.Y. 1979) . . . . .	2133.03(b)	DeBaun, In re, 687 F.2d 459, 214 USPQ 933 (CCPA 1982) . . . . .	715.01(a), 716.10, 2136.05, 2137.01
CTS Corp. v. Piher Int'l Corp., 593 F.2d 777, 201 USPQ 649 (7th Cir. 1979) . . . . .	2133.03(d)	De Blauwe, In re, 736 F.2d 699, 222 USPQ 191 (Fed. Cir. 1984). . . . .	716.01(c), 2144.08

MANUAL OF PATENT EXAMINING PROCEDURE

DeCastelet, In re, 562 F.2d 1236, 195 USPQ 439 (CCPA 1977).....	2106	Diamond v. Diehr, 450 U.S. 175, 209 USPQ 1 (1981) .....	2106, 2107.01
Deckler, In re, 977 F.2d 1449, 24 USPQ2d 1448 (Fed. Cir. 1992).....	715, 2138.01	Dickinson v. Zurko, 527 U.S. 150, 50 USPQ2d 1930 (1999) .....	1216.01
Deep Welding, Inc. v. Sciaky Bros., 417 F.2d 1227, 163 USPQ 144 (7th Cir. 1969) .....	2128.01	Dien, In re, 680 F.2d 151, 214 USPQ 10 (CCPA 1982) .....	1449.02
Defano, In re, 392 F.2d 280, 157 USPQ 192 (CCPA 1968) .....	715.02, 715.03	Digital Magnetic Sys., Inc. v. Ansley, 213 USPQ 290 (W.D. Okla. 1982).....	2286, 2686.04
DeGeorge v. Bernier, 768 F.2d 1318, 226 USPQ 758 (Fed. Cir. 1985).....	2106	DiLeone, In re, 436 F.2d 1404 168 USPQ 592 (CCPA 1971) .....	2106
De Graffenried v. United States, 16 USPQ2d 1321 (Ct. Cl. 1990) .....	2133.02, 2181	Dillon, In re, 919 F.2d 688, 16 USPQ2d 1897 (Fed. Cir. 1990) .....	2144, 2144.08, 2144.09, 2145
De Lajarte, In re, 337 F.2d 870, 143 USPQ 256 (CCPA 1964).....	2111.03, 2163	Dilnot, In re, 319 F.2d 188, 138 USPQ 248 (CCPA 1963) .....	2144.04
Delavoye, Ex parte, 1906 C.D. 320, 124 O.G. 626 (Comm'r Pat. 1906).....	604.02	D.L. Auld Co. v. Chroma Graphics Corp., 714 F.2d 1144, 219 USPQ 13 (Fed. Cir. 1983) .....	2133.03(c)
Delgar Inc. v. Schuyler, 172 USPQ 513 (D.D.C. 1970) .....	711.03(c)	D.M.I., Inc. v. Deere & Co., 755 F.2d 1570, 225 USPQ 236 (Fed. Cir. 1985) .....	2184
Demaco Corp. v. Von Langsdorff Licens- ing Ltd., 851 F.2d 1387, 7 USPQ2d 1222 (Fed. Cir. 1988) .....	716.01(b), 716.01(d), 716.03, 716.03(a), 716.03(b)	Doll, In re, 419 F.2d 925, 164 USPQ 218 (CCPA 1970).....	1412.03
DeMarini Sports, Inc. v. Worth, Inc., 239 F.3d 1314, 57 USPQ2d 1889 (Fed. Cir. 2001) .....	2111.01	Donaldson, In re, 16 F.3d 1189, 29 USPQ2d 1845 (Fed. Cir. 1994).....	2106, 2111.01, 2114, 2181, 2182
Dembiczak, In re, 175 F.3d 994, 50 USPQ2d 1614 (Fed. Cir. 1999) .....	1504.06, 2106, 2144.04	Donaldson, Ex parte, 26 USPQ2d 1250 (Bd. Pat. App. & Inter. 1992) .....	1504.01
Deminski, In re, 796 F.2d 436, 230 USPQ 313 (Fed. Cir. 1986) .....	2141.01(a)	Donnell, Ex parte, 923 C.D. 54, 315 O.G. 398 (Comm'r Pat. 1923) .....	806.05(b), 820.01
De Seversky, In re, 474 F.2d 671, 177 USPQ 144 (CCPA 1973) .....	201.06(c), 608.01(p), 1504.05	Donohue, In re, 550 F.2d 1269, 193 USPQ 136 (CCPA 1977).....	2106, 2164.06, 2164.06(a)
DeSeversky v. Brenner, 424 F.2d 857, 164 USPQ 495 (D.C. Cir. 1970) .....	1216.02	Donohue, In re, 766 F.2d 531, 226 USPQ 619 (Fed. Cir. 1985) ...	2121.01, 2121.02, 2131.01
De Solms v. Schoenwald, 15 USPQ2d 1507 (Bd. Pat. App. & Inter. 1990).....	2138.05, 2138.06	Donovan, Ex parte, 1890 C.D. 109, 52 O.G. 309 (Comm'r Pat. 1890).....	715.07
DesOrmeaux, Ex parte, 25 USPQ2d 2040 (Bd. Pat. App. & Inter. 1992) .....	2136.04, 2137.01	Dossel, In re, 115 F.3d 942, 42 USPQ2d 1881 (Fed. Cir. 1997) .....	2106, 2181, 2185
Deters, In re, 515 F.2d 1152, 185 USPQ 644 (CCPA 1975) .....	715.09	Dotter, Ex parte, 12 USPQ 382 (Bd. App. 1931).....	2173.05(h)
Deuel, In re, 51 F.3d 1552, 34 USPQ2d 1210 (Fed. Cir. 1995) .....	2144.08, 2144.09, 2163	Dow Chem. Co., In re, 837 F.2d 469, 5 USPQ2d 1529 (Fed. Cir. 1988).....	716.05, 2144.08
Diamond v. Chakrabarty, 447 U.S. 303, 206 USPQ 193 (1980).....	2105, 2106, 2107.01	Dow Chem. Co. v. American Cyanamid Co., 816 F.2d 617, 2 USPQ2d 1350 (Fed. Cir. 1987) .....	716.06, 2144.08

LIST OF DECISIONS CITED

Dow Chem. Co. v. Astro-Valcour, Inc., 267 F.3d 1334, 60 USPQ2d 1519 (Fed. Cir. 2001) . . . . .	2138.04	Eaton v. Evans, 204 F.3d 1094, 53 USPQ2d 1696 (Fed. Cir. 2000) . . . . .	2138.05
Doyle, In re, 482 F.2d 1385, 179 USPQ 227 (CCPA 1973) . . . . .	1445, 2106.01	Ebata, Ex parte, 19 USPQ2d 1952 (Bd. Pat. App. & Inter. 1991) . . . . .	2136.03
Doyle, In re, 293 F.3d 1355, 63 USPQ2d 1161 (Fed. Cir. 2002) . . . . .	1412.01	Eckel, In re, 393 F.2d 848, 157 USPQ 415 (CCPA 1968) . . . . .	804.02
Dresser Indus. Inc. v. Ford Motor Co., 530 F. Supp. 303, 211 USPQ 1114 (N.D. Texas, 1981) . . . . .	2286, 2686.04	Edge, In re, 359 F.2d 896, 149 USPQ 556 (CCPA 1966). . . . .	2144.04
Driscoll v. Cebalo, 5 USPQ2d 1477 (Bd. Pat. Inter. 1982). . . . .	2137.01	Edgerton v. Kingsland, 168 F.2d 121, 75 USPQ 307 (D.C. Cir. 1947) . . . . .	706.03(w)
Druey, In re, 319 F.2d 237, 138 USPQ 39 (CCPA 1963). . . . .	2144.08	Edwards, In re, 568 F.2d 1349, 196 USPQ 465 (CCPA 1978) . . . . .	2138.05
DSL Dynamic Sciences, Ltd. v. Union Switch & Signal, Inc., 928 F.2d 1122, 18 USPQ2d 1152 (Fed. Cir. 1991) . . . . .	2138.05	Egbers, In re, 6 USPQ2d 1869 (Comm'r Pat. 1988) . . . . .	711.03(c)
Dubno, In re, 12 USPQ2d 1153 (Comm'r Pat. & Tm. 1989) . . . . .	2763	Egbert v. Lippmann, 104 U.S. 333 (1881) . . . . .	2133.03(a)
Dubost v. U.S. Patent and Trademark Office, 777 F.2d 1561, 227 USPQ 977 (Fed. Cir. 1985). . . . .	201.13	Eggan, Ex parte, 1911 C.D. 213, 172 O.G. 1091 (Comm'r Pat. 1911) . . . . .	403.01, 403.02
Dulberg, In re, 289 F.2d 522, 129 USPQ 348 (CCPA 1961) . . . . .	2144.04	Eggert, Ex parte, 67 USPQ2d 1716 (Bd. Pat. App. & Inter. 2003) . . . . .	1412.02
Dunki, Ex parte, 153 USPQ 678 (Bd. App. 1967) . . . . .	706.03(d), 2173.05(q)	Ehrreich, In re, 590 F.2d 902, 200 USPQ 504 (CCPA 1979) . . . . .	2129, 2172, 2411.01
Dunlop Holdings, Ltd. v. Ram Golf Corp., 524 F.2d 33, 188 USPQ 481 (7th Cir. 1975) . . . . .	2133.03(a)	E.I. du Pont de Nemours & Co. v. Berk- ley and Co., 620 F.2d 1247, 205 USPQ 1 (8th Cir. 1980) . . . . .	2107.01
Dunn, In re, 349 F.2d 433, 146 USPQ 479 (CCPA 1965) . . . . .	804.02	E.I. du Pont de Nemours & Co. v. Phillips Petroleum Co., 849 F.2d 1430, 7 USPQ2d 1129 (Fed. Cir. 1988). . . . .	2138
Dunn v. Ragin, 50 USPQ 472 (Bd. Pat. Inter. 1941) . . . . .	2138.02, 2138.04	Eickmeyer, In re, 602 F.2d 974, 202 USPQ 655 (CCPA 1979). . . . .	715.05, 715.07
Dunne, Ex parte, 20 USPQ2d 1479 (Bd. Pat. App. & Inter. 1991) . . . . .	2134	Eiselstein v. Frank, 52 F.3d 1035, 34 USPQ2d 1467 (Fed. Cir. 1995) . . . . .	1302.01
Durden, In re, 763 F.2d 1406, 226 USPQ 359 (Fed. Cir. 1985) . . . . .	2116.01	Ekenstam, In re, 256 F.2d 321, 118 USPQ 349 (CCPA 1958). . . . .	901.05, 901.05(b), 2126, 2126.01, 2132
Dybel, In re, 524 F.2d 1393, 187 USPQ 593 (CCPA 1975) . . . . .	2133.03(b), 2133.03(e)(3)	Elan Pharm., Inc. v. Mayo Foundation For Medical and Education Research, 346 F.3d 1051, 68 USPQ2d 1373 (Fed. Cir. 2003). . . . .	2121.01
E-Pass Techs., Inc. v. 3Com Corp., 343 F.3d 1364, 67 USPQ2d 1947(Fed. Cir. 2003). . . . .	2106, 2111.01	Electric Storage Battery Co. v. Shimadzu, 307 U.S. 5, 41 USPQ 155 (1938) . . . . .	2133.03(b)
East Chicago Machine Tool Corp. v. Stone Container Corp., 181 USPQ 744 (N.D. Ill. 1974) . . . . .	2012	Eli Lilly and Co. v. American Cyanamid Co., 82 F. 3d 1568, 38 USPQ2d 1705 (Fed. Cir. 1996) . . . . .	1412.03
Eastwood, Ex parte, 163 USPQ 316 (Bd. App. 1968) . . . . .	2173.05(b)	Eli Lilly & Co. v. Barr Laboratories, Inc., 251 F.3d 955, 58 USPQ2d 1865 (Fed. Cir. 2001) . . . . .	804, 2144.08, 2165, 2165.01



MANUAL OF PATENT EXAMINING PROCEDURE

Eli Lilly & Co. v. Medtronic, Inc., 496 US 661, 15 USPQ2d 1121 (1990) . . . . .	2750	Erlich, Ex parte, 3 USPQ2d 1011 (Bd. Pat. App. & Inter. 1986) . . . . .	2143.02, 2173.05(q)
Eli Lilly, In re, 902 F.2d 943, 14 USPQ2d 1741 (Fed. Cir. 1990) . . . . .	716.01(d), 716.02(b), 716.02(c), 2142, 2144, 2144.08, 2145	Erlich, Ex parte, 22 USPQ 1463 (Bd. Pat. App. & Inter. 1992) . . . . .	2124, 2141.03
Elliott, Ex parte, 1904 C.D.103, 109 O.G. 1337 (Comm'r Pat. 1904) . . . . .	608.02(g)	Ernsthausen v. Nakayama, 1 USPQ2d 1539 (Bd. Pat. App. & Inter. 1985) . . . . .	2165.01
Ellis, In re, 476 F.2d 1370, 177 USPQ 526 (CCPA 1973) . . . . .	2141.01(a)	Estee Lauder, Inc. v. L'Oreal S.A., 129 F.3d 588, 44 USPQ2d 1610 (Fed. Cir. 1997) . . . . .	2138.05, 2163
Elmwood Liquid Prod., Inc. v. Singleton Packing Corp., 328 F. Supp 974, 170 USPQ 398 (M.D. Fla. 1970) . . . . .	2004	Ethicon, Inc. v. United States Surgical Corp., 135 F.3d 1456, 45 USPQ2d 1545 (Fed. Cir. 1998) . . . . .	2137.01, 2181
Eltgroth, In re, 419 F.2d 918, 164 USPQ 221 (CCPA 1970) . . . . .	2107.01	Ethicon v. Quigg, 849 F.2d 1422, 7 USPQ2d 1152 (Fed. Cir. 1988) . . . . .	2242, 2286, 2642, 2686.04
Emerson Elec. Co. v. Davoil, Inc., 88 F.3d 1051, 39 USPQ 1474 (Fed. Cir. 1996) . . . . .	2254	Etter, In re, 756 F.2d 852, 225 USPQ 1 (Fed. Cir. 1985) . . . . .	2242, 2258, 2279, 2286, 2642, 2686.04
Emerson v. Beach, 215 F.2d 290, 103 USPQ 45 (CCPA 1954) . . . . .	2307	EWP Corp. v. Reliance Universal, Inc., 755 F.2d 898, 225 USPQ 20 (Fed. Cir. 1985) . . . . .	716.03(b)
Emert, In re, 124 F.3d 1458, 44 USPQ2d 1149 (Fed. Cir. 1997) . . . . .	804	Exxon Corp. v. Phillips Petroleum Co., 265 F.3d 1249, 60 USPQ2d 1368 (Fed. Cir. 2001) . . . . .	711.01, 714.01(e), 714.03
Emery v. Ronden, 188 USPQ 264 (Bd. Pat. Inter. 1974) . . . . .	2138.06	Eynde, In re, 480 F.2d 1364, 178 USPQ 470 (CCPA 1973) . . . . .	2144.03
Emm, Ex parte, 118 USPQ 180 (Bd. App. 1957) . . . . .	1208	EZ Dock v. Schafer Sys., Inc., 276 F.3d 1347, 61 USPQ2d 1289 (Fed. Cir. 2002) . . . . .	2133.03(e), 2133.03(e)(4)
Engelhardt v. Judd, 369 F.2d 408, 151 USPQ 732 (CCPA 1966) . . . . .	2138.03, 2138.05	Facius, In re, 408 F.2d 1396, 161 USPQ 294 (CCPA 1969) . . . . .	715.01(a), 715.01(c), 2132.01, 2136.04, 2136.05, 2137, 2137.01
Envirco Corp. v. Clestra Cleanroom, Inc., 209 F.3d 1360, 54 USPQ2d 1449 (Fed. Cir. 2000) . . . . .	2181	Farrenkopf, In re, 713 F.2d 714, 219 USPQ 1 (Fed. Cir. 1983) . . . . .	2145
Environ Prods., Inc. v. Total Contain- ment, Inc., 43 USPQ2d 1288 (E.D. Pa. 1997) . . . . .	2001.06(c)	Fassett, 1877 C.D. 32, 11 O.G. 420 (Comm'r Pat. 1877) . . . . .	1410.01
Environmental Designs, Ltd. v. Union Oil Co., 713 F.2d 693, 218 USPQ 865 (Fed. Cir. 1983) . . . . .	716.04, 716.05, 2141.03	Feldman v. Aunstrup, 517 F.2d 1351, 186 USPQ 108 (CCPA 1975) . . . . .	2406.01
Envirotech Corp. v. Westech Eng'g, Inc., 904 F.2d 1571, 15 USPQ2d 1230 (Fed. Cir. 1990) . . . . .	2133.03(b)	Ferag AG v. Quipp, Inc., 45 F.3d 1562, 33 USPQ2d 1512 (Fed. Cir. 1995) . . . . .	2133.03(b)
Enzo Biochem, Inc. v. Calgene, Inc., 188 F.3d 1362, 52 USPQ2d 1129 (Fed. Cir. 1999) . . . . .	2164.06(b)	Ferens, In re, 417 F.2d 1072, 163 USPQ 609 (CCPA 1969) . . . . .	2107.01
Enzo Biochem, Inc. v. Gen-Probe, Inc., 323 F.3d 956, 63 USPQ2d 1609 (Fed. Cir. 2002) . . . . .	2163	Ferguson, Ex parte, 117 USPQ 229 (Bd. App. 1957) . . . . .	2107.02, 2107.03, 2164.07
Epstein, In re, 32 F.3d 1559, 31 USPQ2d 1817 (Fed. Cir. 1994) . . . . .	716.07, 2128, 2133.03(b)	Ferguson Beauregard/Logic Controls v. Mega Systems, 350 F.3d 1327, 69 USPQ2d 1001 (Fed. Cir. 2003) . . . . .	2111.01

LIST OF DECISIONS CITED

Fessmann, In re, 489 F.2d 742, 180 USPQ 324 (CCPA 1974) . . . . .	2113	Fonar Corp. v. General Electric Co., 107 F.3d 1543, 41 USPQ2d 1801 (Fed. Cir. 1997) . . . . .	2106, 2106.01, 2163
Festo Corp. v. Shoketsu Kinzoku Kogyo Kabushiki Co., 535 U.S. 722, 122 S.Ct. 1831, 62 USPQ2d 1705 (2002) . .	1302.14, 2173.02	Fong, In re, 288 F.2d 932, 129 USPQ 264 (CCPA 1961) . . . . .	715.02, 715.03
Field v. Knowles, 183 F.2d 593, 86 USPQ 373 (CCPA 1950) . . . . .	2133.03(c)	Fong, In re, 378 F.2d 977, 154 USPQ 25 (CCPA 1967) . . . . .	804
Fielder, In re, 471 F.2d 640, 176 USPQ 300 (CCPA 1973) . . . . .	716.01(a), 716.03(b)	Forman, In re, 463 F.2d 1125, 175 USPQ 12 (CCPA 1972) . . . . .	2106.02
Fields v. Conover, 443 F.2d 1386, 170 USPQ 276 (CCPA 1970) . . . . .	2163, 2163.03	Fortel Corp. v. Phone-Mate, Inc., 825 F.2d 1577, 3 USPQ2d 1771 (Fed. Cir. 1987) . . . . .	2293
Fiers v. Revel, 984 F.2d 1164, 25 USPQ2d 1601 (Fed. Cir. 1993) . .	2137.01, 2138.04, 2163	Foster, Ex parte, 1903 C.D. 213, 105 O.G. 261 (Comm'r Pat. 1903) . . . . .	715.04
Fine, Ex parte, 217 USPQ 76 (Bd. App. 1981) . . . . .	2307.02	Foster, In re, 343 F.2d 980, 145 USPQ 166 (CCPA 1965) . . . . .	2132.01, 2133, 2133.02, 2133.03(c)
Fine, In re, 837 F.2d 1071, 5 USPQ2d 1596 (Fed. Cir. 1988) . . . . .	707.07(f), 2143.01, 2143.03, 2144	Foster, In re, 438 F.2d 1011, 169 USPQ 99 (CCPA 1971) . . . . .	2106
Finley, In re, 174 F.2d 130, 81 USPQ 383 (CCPA 1949) . . . . .	716.02(e)	Fotland, In re, 779 F.2d 31, 228 USPQ 193 (Fed. Cir. 1985) . . . . .	1403, 1412.03
Fischer, In re Application of, 6 USPQ2d 1573 (Comm'r Pat. 1988) . . . . .	711.03(c)	Fouche, In re, 439 F.2d 1237, 169 USPQ 429 (CCPA 1971) . . . . .	608.01(p), 716.02(b), 2107.01, 2164.07
Fischer & Porter Co. v. Corning Glass Works, 61 F.R.D. 321, 181 USPQ 329 (E.D. Pa. 1974) . . . . .	1701.01	Fout, In re, 675 F.2d 297, 213 USPQ 532 (CCPA 1982) . . . . .	2129, 2144.06
Fisher, In re, 427 F.2d 833, 166 USPQ 18 (CCPA 1970) . . . . .	706.03(w), 2164.01(b), 2164.03, 2164.08, 2173.05(a), 2173.05(t)	Fox, Ex parte, 128 USPQ 157, 1960 C.D. 28, 761 O.G. 906 (Bd. App. 1957) . . . . .	608.04(a)
Fisons Plc. v. Quigg, 876 F.2d 99, 10 USPQ2d 1491 (Fed. Cir. 1989) . . . . .	2751	Fox, In re, 471 F.2d 1405, 176 USPQ 340 (CCPA 1973) . . . . .	2144.03
Fitzgerald, In re, 619 F.2d 67, 205 USPQ 594 (CCPA 1980) . . . . .	706.02(m), 2112, 2183	Fredericksen, In re, 213 F.2d 547, 102 USPQ 35 (CCPA 1954) . . . . .	2173.05(c)
Fitzgerald v. Arbib, 268 F.2d 763, 122 USPQ 530 (CCPA 1959) . . . . .	2138.05, 2138.06	Fredkin v. Irasek, 397 F.2d 342, 158 USPQ 280 (CCPA 1968) . . . . .	2138.05
Flint, In re, 411 F.2d 1353, 162 USPQ 228 (CCPA 1969) . . . . .	2173.05(n)	Freeman, In re, 573 F.2d 1237, 197 USPQ 464 (CCPA 1978) . . . . .	2184
Floyd, In re, Appeal No. 94-1071, slip op. at page 4 (Fed. Cir. July 20, 1994) . . . . .	2144.07	Freeman, In re, 30 F.3d 1459, 31 USPQ2d 1444 (Fed. Cir. 1994) . . .	706.03(w), 2250, 2666.01
FMC Corp. v. Hennessy Indus., Inc., 836 F.2d 521, 5 USPQ2d 1272 (Fed. Cir. 1987) . . . . .	410	Fregeau v. Mossinghoff, 776 F.2d 1034, 227 USPQ 848 (Fed. Cir. 1985) . .	2107.01, 2107.02
FMC Corp. v. Manitowoc Co., 835 F.2d 1411, 5 USPQ2d 1112 (Fed. Cir. 1987) . .	410, 2010	Fressola, Ex parte, 27 USPQ2d 1608 (Bd. Pat. App. & Inter. 1993) . . .	2173.05(r), 2173.05(s)
Folkers, In re, 344 F.2d 970, 145 USPQ 390 (CCPA 1965) . . . . .	2107.02	Fressola v. Manbeck, 36 USPQ2d 1211 (D.D.C. 1995) . . . . .	608.01(m)
		Frey, In re, 182 F.2d 184, 86 USPQ 99 (CCPA 1950) . . . . .	2307

MANUAL OF PATENT EXAMINING PROCEDURE

Fried, In re, 312 F.2d 930, 136 USPQ 429 (CCPA 1963) . . . . .	706.03(w)	Gaubert, In re, 524 F.2d 1222, 187 USPQ 664 (CCPA 1975) . . . . .	2107.03
Fried, In re, 329 F.2d 323, 141 USPQ 27 (CCPA 1964) . . . . .	608.01(p)	Gaubert, In re, 530 F.2d 1402, 189 USPQ 432 (CCPA 1975) . . . . .	2107.02, 2107.03
Frilette, In re, 412 F.2d 164, 162 USPQ 163 (CCPA 1969) . . . . .	715.01(b)	Gay, In re, 309 F.2d 769, 135 USPQ 311 (CCPA 1962) . . . . .	608.01(h), 2106.01, 2165.01
Fritch, In re, 972 F.2d 1260, 23 USPQ2d 1780 (Fed. Cir. 1992) . . . . .	2143.01	Gazave, In re, 379 F.2d 973, 154 USPQ 92 (CCPA 1967) . . . . .	2164.07, 2107.01, 2107.02, 2107.03
Fritsch v. Lin, 21 USPQ2d 1731 (Bd. Pat. App. & Inter. 1991) . . . . .	2137.01, 2138.06	Gazda, In re, 219 F.2d 449, 104 USPQ 400 (CCPA 1955) . . . . .	2144.04
Fuge, In re, 272 F.2d 954, 124 USPQ 105 (CCPA 1959) . . . . .	901.05, 2126.02	Gearon v. United States, 121 F. Supp. 652, 101 USPQ 460 (Ct. Cl. 1954) . . . . .	601.01(e)
Fujikawa v. Wattanasin, 93 F.3d 1559, 39 USPQ2d 1895 (Fed. Cir. 1996) . . . . .	2163, 2163.05	Gebauer-Fuelnegg, In re, 121 F.2d 505, 50 USPQ 125 (CCPA 1941) . . . . .	608.01(v)
Fujishiro, Ex parte, 199 USPQ 36 (Bd. App. 1977) . . . . .	901.05, 2135.01	Geiger, In re, 815 F.2d 686, 2 USPQ2d 1276 (Fed. Cir. 1987) . . . . .	716.02(e), 2144.06
Funk Bros. Seed Co. v. Kalo Inoculant Co., 333 U.S. 127, 76 USPQ 280 (1948) . . . . .	2105, 2106	Geiger, In re, 425 F.2d 1276, 165 USPQ 572 (CCPA 1970) . . . . .	1504.06
Future's Technology Ltd. v. Quigg, 684 F. Supp. 430, 7 USPQ2d 1588 (E.D. Va. 1988) . . . . .	711.03(c)	Geisler, In re, 116 F.3d 1465, 43 USPQ2d 1362 (Fed. Cir. 1997) . . . . .	2144.05, 2145
G, In re Application of, 11 USPQ2d 1378 (Comm'r Pat. 1989) . . . . .	711.03(c)	Gellert v. Wanberg, 495 F.2d 779, 181 USPQ 648 (CCPA 1974) . . . . .	2138.05
Gallo, In re, 231 USPQ 496 (Comm'r Pat. 1986) . . . . .	103	Gelles, Ex parte, 22 USPQ2d 1318 (Bd. Pat. App. & Inter. 1992) . . . . .	716.02, 716.02(b)
Gambro Lundia AB v. Baxter Healthcare Corp., 110 F.3d 1573, 42 USPQ2d 1378 (Fed. Cir. 1997) . . . . .	2137	Gelnovatch, In re, 595 F.2d 32, 201 USPQ 136 (CCPA 1979) . . . . .	2106
Gandy v. Main Belting Co., 143 U.S. 587 (1892) . . . . .	2133.03(d)	Gemveto Jewelry Co. v. Lambert Bros., Inc., 542 F. Supp. 933, 216 USPQ 976 (S.D. N.Y. 1982) . . . . .	2001.06(a), 2004, 2016
Garbo, In re, 287 F.2d 192, 129 USPQ 72 (CCPA 1961) . . . . .	1504.03	Genentech, Inc. v. Chiron Corp., 112 F.3d 495, 42 USPQ2d 1608 (Fed. Cir. 1997) . . . . .	2111.03, 2138.05, 2163
Gardner, In re, 475 F.2d 1389, 177 USPQ 396 (CCPA 1973) . . . . .	2107.01, 2107.03, 2163	Genentech v. Wellcome Foundation, 29 F.3d 1555, 31 USPQ2d 1161 (Fed. Cir. 1994) . . . . .	2164.04
Gardner v. TEC Systems, Inc., 725 F.2d 1338, 220 USPQ 777 (Fed. Cir. 1984) . . . . .	2144.04	General Elec. v. Brenner, 407 F.2d 1258, 159 USPQ 335 (D.C. Cir. 1968) . . . . .	608.01(p)
Garfinkel, In re, 437 F.2d 1000, 168 USPQ 659 (CCPA 1971) . . . . .	715	General Elec. v. United States, 206 USPQ 260 (Ct. Cl. 1979) . . . . .	2133.03(e)(1)
Garnero, In re, 412 F.2d 276, 162 USPQ 221 (CCPA 1979) . . . . .	2113	General Electro Music Corp. v. Samick Music Corp., 19 F.3d 1405, 30 USPQ2d 1149 (Fed. Cir. 1994) . . . . .	410
Garret Corp. v. United States, 422 F.2d 874, 164 USPQ 521 (Ct. Cl. 1970) . . . . .	2128.01	General Foods Corp. v. Studiengesellschaft Kohle mbH, 972 F.2d 1272, 23 USPQ2d 1839 (Fed. Cir. 1992) . . . . .	804
Garrett v. Cox, 233 F.2d 343, 110 USPQ 52 (CCPA 1956) . . . . .	608.02(w), 1302.04		
Gartside, In re, 203 F.3d 1305, 53 USPQ2d 1769 (Fed. Cir. 2000) . . . . .	1216.01, 2144.03		

LIST OF DECISIONS CITED

General Motors Corp. v. Bendix Aviation Corp., 123 F. Supp 506, 102 USPQ 58 (N.D. Ind. 1954) . . . . .	2133.03(e)(6)	Golden Valley Microwave Food Inc. v. Weaver Popcorn Co., 837 F. Supp. 1444, 24 USPQ2d 1801 (N.D. Ind. 1992) . . . . .	410
Gentry Gallery, Inc. v. Berkline Corp., 134 F.3d 1473, 45 USPQ2d 1498 (Fed. Cir. 1998) . . . . .	2163, 2163.05	Goldstein, In re, 16 USPQ2d 1963 (Dep. Assist. Comm’r Pat. 1988) . . . . .	402.10
George, Ex parte, 21 USPQ2d 1058 (Bd. Pat. App. & Inter. 1991) . . . . .	716.01(c)	Golight Inc. v. Wal-Mart Stores Inc., 355 F.3d 1327, 69 USPQ2d 1481 (Fed. Cir. 2004) . . . . .	2182
George, In re, 2 USPQ2d 1880 (Bd. Pat. App. & Inter. 1987) . . . . .	2128.01	Golota v. Strom, 489 F.2d 1287, 180 USPQ 396 (CCPA 1974) . . . . .	2308.02
Gerber Garment Technology, Inc. v. Lectra Systems, Inc., 916 F.2d 683, 16 USPQ2d 1436 (Fed. Cir. 1990) . . . . .	804.01	Good, Ex parte, 1911 C.D. 43, 164 O.G. 789 (Comm’r Pat. 1911) . . . . .	608.02(d)
Gershon, In re, 372 F.2d 535, 152 USPQ 602 (CCPA 1967) . . . . .	716.02(c), 716.04	Goodman, In re, 11 F.3d 1046, 29 USPQ2d 2010 (Fed. Cir. 1993) . . . . .	804, 1504.06, 2164.06(b), 2164.08
Ghiron, In re, 442 F.2d 985, 169 USPQ 723 (CCPA 1971) . . . . .	2106, 2106.01, 2106.02, 2164.01(b), 2164.06, 2164.06(a), 2185	Goodyear Tire & Rubber Co., Ex parte, 230 USPQ 357 (Bd. Pat. App. & Inter. 1985) . . . . .	2141.01(a)
Gibbs, In re, 437 F.2d 486, 168 USPQ 578 (CCPA 1971) . . . . .	715, 2134	Gordon, In re, 733 F.2d 900, 221 USPQ 1125 (Fed. Cir. 1984) . . . . .	2143.01, 2144.08
Gibson, Ex parte, 20 USPQ 249 (Bd. App. 1933) . . . . .	1504.01(b)	Gorham Manufacturing Co. v. White, 81 U.S. (14 Wall.) 511 (1871) . . . . .	1504.01(d)
Gibson, In re, 39 F.2d 975, 5 USPQ 230 (CCPA 1930) . . . . .	2144.04	Gorman, In re, 933 F.2d 982, 18 USPQ2d 1885 (Fed. Cir. 1991) . . . . .	707.07(f), 2145
Gilderdale, Ex parte, 1990 Pat. App. LEXIS 25 (Bd. Pat. App. & Inter. Appeal no. 89-0352) . . . . .	2136.03	Gosteli, In re, 872 F.2d 1008, 10 USPQ2d 1614 (Fed. Cir. 1989) . . . . .	608.01(p), 715.03, 2131.02, 2136.05, 2163.02, 2163.03, 2163.05
Gillman v. Stern, 114 F.2d 28, 46 USPQ 430 (2d Cir. 1940) . . . . .	2133.03(a)	Gottlieb, In re, 328 F.2d 1016, 140 USPQ 665 (CCPA 1964) . . . . .	2107.02
Ginos v. Nedelec, 220 USPQ 831 (Bd. Pat. Inter. 1983) . . . . .	2138.05, 2138.06	Gottschalk v. Benson, 409 U.S. 63, 175 USPQ 673 (1972) . . . . .	2106
Glaser v. Strickland, 220 USPQ 446 (Bd. Pat. Inter. 1983) . . . . .	716.09	Gould v. Control Laser Corp., 705 F.2d 1340, 217 USPQ 985 (Fed. Cir. 1983) . . . . .	2286, 2686.04
Glass, In re, 492 F.2d 1228, 181 USPQ 31 (CCPA 1974) . . . . .	608.01(h), 608.01(p), 2124, 2165.02	Gould v. Quigg, 822 F.2d 1074, 3 USPQ2d 1302 (Fed. Cir. 1987) . . . . .	2164.02, 2164.05(a)
Glavas, In re, 230 F.2d 447, 109 USPQ 50 (CCPA 1956) . . . . .	1504.02, 1504.03	Gould v. Schawlow, 363 F.2d 908, 150 USPQ 634 (CCPA 1966) . . . . .	2138.06
Glaxo Inc. v. Novopharm Ltd., 52 F.3d 1043, 34 USPQ2d 1565 (Fed. Cir. 1995) . . . . .	2107.01	Gourtoff, Ex parte, 1924 C.D. 153, 329 O.G. 536 (Comm’r Pat. 1924) . . . . .	707.13, 710.06
Glaxo Operations UK Ltd. v. Quigg, 706 F. Supp. 1224, 10 USPQ2d 1100 (E.D. Va. 1989) . . . . .	2751	GPAC, In re, 57 F.3d 1573, 35 USPQ2d 1116 (Fed. Cir. 1995) . . . . .	716.03, 2144.08
Goffe, In re, 542 F.2d 564, 191 USPQ 429 (CCPA 1976) . . . . .	2164.08, 2164.08(c)	Gabiak, In re, 769 F.2d 729, 226 USPQ 871 (Fed. Cir. 1985) . . . . .	2144.08, 2144.09
		Grady, Ex parte, 59 USPQ2d 276 (Comm’r Pat. 1943) . . . . .	607.02

MANUAL OF PATENT EXAMINING PROCEDURE

Graff, In re, 111 F.3d 874, 42 USPQ2d 1471 (Fed. Cir. 1997) . . . . .	1403, 1412.02, 1412.03, 1451	Griswold, In re, 365 F.2d 834, 150 USPQ 804 (CCPA 1966) . . . . .	804.02
Graham v. John Deere, 383 U.S. 1, 148 USPQ 459 (1966) .706.02(j), 706.02(m), 716.01(a), 804, 1504.03, 2106, 2141, 2144.08, 2258		Grose, In re, 592 F.2d 1161, 201 USPQ 57 (CCPA 1979) . . . . .	2144.02, 2144.03, 2144.08
Grall, Ex parte, 202 USPQ 701 (Bd. App. 1978) . . . . .	2308.02	Group One, Ltd. v. Hallmark Cards, Inc., 254 F.3d 1041, 59 USPQ2d 1121 (Fed. Cir. 2001). . . . .	2133.03(b)
Gramme Elec. Co. v. Arnoux and Hochhausen Elec. Co., 17 F. 838, 1883 C.D.418 (S.D. N.Y. 1883). . . . .	901.05, 2135.01	Grunwell, In re, 609 F.2d 486, 203 USPQ 1055 (CCPA 1979) . . . . .	2107.02
Grasselli, Ex parte, 231 USPQ 393 (Bd. App. 1983) . . . . .	2143.03, 2173.05(i)	Gruschwitz, Ex parte, 138 USPQ 505, 1963 C.D. 859, 138 USPQ 505 (Bd. App. 1961). . . . .	901.05, 901.05(b)
Grasselli, In re, 713 F.2d 731, 218 USPQ 769 (Fed. Cir. 1983) . . . . .	716.02(d), 2112, 2145, 2144.08	Guastavino, In re, 83 F.2d 913, 29 USPQ 532 (CCPA 1936) . . . . .	1449.02
Graver Tank & Mfg. Co. v. Linde Air Products, 339 U.S. 605, 85 USPQ 328 (1950) . . . . .	2183, 2184, 2186	Gulack, In re, 703 F.2d 1381, 217 USPQ 401 (Fed. Cir. 1983) . . . . .	2106, 2112.01
Gray, Ex parte, 10 USPQ2d 1922 (Bd. Pat. App. & Inter. 1989) . . . . .	716.01(c), 716.02(g), 2113, 2144.04	Gulliksen v. Halberg, 75 USPQ 252 (Bd. App. 1937). . . . .	2128.01
Gray, In re, 115 USPQ 80 (Comm'r Pat. 1956) . . . . .	409.03(d), 409.03(f)	Gunn, In re, 537 F.2d 1123, 190 USPQ 402 (CCPA 1976) . . . . .	2106, 2106.02, 2164.05(a), 2164.06, 2164.06(a)
Gray, In re, 53 F.2d 520, 11 USPQ 255 (CCPA 1931). . . . .	2111.03	Gunn v. Bosch, 181 USPQ 758 (Bd. Pat. Inter. 1973) . . . . .	2138.06
Grayson, Ex parte, 51 USPQ 413 (Bd. App. 1941) . . . . .	706.03(a)	Gunter v. Stream, 573 F.2d 77, 197 USPQ 482 (CCPA 1978). . . . .	2138.04
Green v. The Rich Iron Co., 944 F.2d 852, 20 USPQ2d 1075 (Fed. Cir. 1991) . . . . .	1442.05	Gurley, In re, 27 F.3d 551, 31 USPQ2d 1130 (Fed. Cir. 1994). . . . .	2123, 2145
Greenberg v. Ethicon Endo-Surgery, Inc., 91 F.3d 1580, 39 USPQ2d 1783 (Fed. Cir. 1996) . . . . .	2181	Gustafson, In re, 331 F.2d 905, 141 USPQ 585 (CCPA 1964). . . . .	2173.05(k)
Greenewalt v. Stanley, 54 F.2d 195, 12 USPQ 122 (3d Cir. 1931) . . . . .	2133.03(e)(1)	Gustafson v. Strange, 227 USPQ 174 (Comm'r Pat. 1985). . . . .	513
Greenfield, In re, 40 F.2d 775, 5 USPQ 474 (CCPA 1930) . . . . .	1214.01, 2682	Gwinn, Ex parte, 112 USPQ 439 (Bd. App. 1955). . . . .	706.03(a)
Greenfield, In re, 571 F.2d 1185, 197 USPQ 227 (CCPA 1978). . . . .	2144.08	Haas, In re, 580 F.2d 461, 198 USPQ 334 (CCPA 1978). . . . .	803.02
Greenwood v. Seiko Instruments, 8 USPQ2d 1455 (D.D.C. 1988). . . . .	2273	Hack, In re, 245 F.2d 246, 114 USPQ 161 (CCPA 1957). . . . .	2112.02
Greer, In re, 484 F.2d 488, 179 USPQ 301 (CCPA 1973) . . . . .	1605	Hadco Products, Inc., v. Lighting Corp. of America, Inc., 312 F.Supp 1173, 165 USPQ 496 (E.D. Pa 1970) . . . . .	1503.02
Grier, Ex parte, 1923 C.D. 27, 309 O.G. 223 (Comm'r Pat. 1923). . . . .	706.04, 820	Hafner, In re, 410 F.2d 1403, 161 USPQ 783 (CCPA 1969) . . . . .	201.11
Griffith v. Kanamaru, 816 F.2d 624, 2 USPQ2d 1361 (Fed. Cir. 1987). . . . .	2138.06	Hageman, Ex parte, 179 USPQ 747 (Bd. App. 1971). . . . .	201.11
		Hahn v. Wong, 892 F.2d 1028, 13 USPQ2d 1313 (Fed. Cir. 1989). . . . .	2308.02

LIST OF DECISIONS CITED

Haines v. Quigg, 673 F. Supp 314, 5 USPQ2d 1130 (N.D. Ind. 1987) . . . . .	711.03(c)	Hartop, In re, 311 F.2d 249, 135 USPQ 419 (CCPA 1962) . . . . .	2107.01, 2107.03
Hale, Ex parte, 49 USPQ 209 (Bd. App. 1941) . . . . .	715.09	Harvey, In re, 12 F.3d 1061, 29 USPQ2d 1206 (Fed. Cir. 1993) . . . . .	1504.04
Hall, Ex parte, 83 USPQ 38 (Bd. App. 1949) . . . . .	706.03(d), 2173.05(d)	Harwood, In re, 390 F.2d 985, 156 USPQ 673 (CCPA 1968) . . . . .	2107.01
Hall, In re, 208 F.2d 370, 100 USPQ 46 (CCPA 1953) . . . . .	2173.05(j)	Harza, In re, 274 F.2d 669, 124 USPQ 378 (CCPA 1960) . . . . .	2144.04
Hall, In re, 781 F.2d 897, 228 USPQ 453 (Fed. Cir. 1986) . . . . .	2128, 2128.01, 2128.02	Hasche, Ex parte, 86 USPQ 481 (Bd. App. 1949) . . . . .	706.03(d), 2173.05(d)
Hall v. Macneale, 107 U.S. 90 (1882) . . . .	2133.03(a)	Haskell v. Colebourne, 671 F.2d 1362, 213 USPQ 192 (CCPA 1982) . . . . .	2138.06
Halleck, In re, 422 F.2d 911, 164 USPQ 647 (CCPA 1970) . . . . .	2173.05(c)	Hata, Ex parte, 6 USPQ2d 1652 (Bd Pat. App. & Int. 1987) . . . . .	2404.02
Haller, Ex parte, 103 USPQ 332 (Bd. App. 1953) . . . . .	901.05, 2127	Hawkins, In re, 179 USPQ 157, 486 F.2d 569 (CCPA 1973) . . . . .	608.01(p)
Hallmark Cards, Inc. v. Lehman, 959 F. Supp. 539, 42 USPQ2d 1134 (D.D.C. 1997) . . . . .	1480	Hawkins, In re, 179 USPQ 163, 486 F.2d 579 (CCPA 1973) . . . . .	608.01(p)
Hamilton, In re, 882 F.2d 1576, 11 USPQ2d 1890 (Fed. Cir. 1989) . . . . .	2133.03(c)	Hawkins, In re, 179 USPQ 167, 486 F.2d 577 (CCPA 1973) . . . . .	608.01(p)
Hammack, In re, 427 F.2d 1378, 166 USPQ 204 (CCPA 1970) . . . . .	2173.03	Hayes Microcomputer Products, Inc., In re, 982 F.2d 1527, 25 USPQ2d 1241 (Fed. Cir. 1992) . . . . .	1414.01, 2106, 2163
Hammack, In re, 427 F.2d 1384, 166 USPQ 209 (CCPA 1970) . . . . .	2173.05(e)	Hay, Ex parte, 1909 C.D. 18, 139 O.G. 197 (Comm'r Pat. 1909) . . . . .	706.04
Hammell, In re, 332 F.2d 796, 141 USPQ 832 (CCPA 1964) . . . . .	709.01	Hay, In re, 534 F.2d 917, 189 USPQ 790 (CCPA 1976) . . . . .	608.01(h), 2165.01, 2411.04
Hanback, Ex parte, 231 USPQ 739 (Bd. Pat. App. & Inter. 1986) . . . . .	1504.04	Hays v. Sony Corp. of Am., 847 F.2d 412, 7 USPQ2d 1043 (7th. Cir. 1988) . . . . .	410
Hardee, In re, 223 USPQ 1122 (Comm'r Pat. 1984) . . . . .	201.03, 803.02, 2137.01	Hazeltine Research Inc. v. Brenner, 382 U.S. 252, 147 USPQ 429 (1965) . . . . .	2136.02
Hargraves, In re, 53 F.2d 900, 11 USPQ 240 (CCPA 1931) . . . . .	804	Head, Ex parte, 214 USPQ 551 (Bd. App. 1981) . . . . .	2173.05(h)
Harito, In re, 847 F.2d 801, 6 USPQ2d 1930 (Fed. Cir. 1988) . . . . .	2010	Healy, Ex parte, 1898 C.D. 157, 84 O.G. 1281 (Comm'r Pat. 1898) . . . . .	806.04(b)
Harley v. Lehman, 981 F. Supp. 9, 44 USPQ2d 1699 (D.D.C. 1997) . . . . .	1308	Heany, In re, 1911 C.D. 138 (Comm'r Pat. 1911) . . . . .	2012, 2012.01
Harnish, In re, 631 F.2d 716, 206 USPQ 300 (CCPA 1980) . . . . .	803.02, 2173.05(h)	Heck, In re, 699 F.2d 1331, 216 USPQ 1038 (Fed. Cir. 1983) . . . . .	2123
Harrington Mfg. Co. v. Powell Mfg. Co., 815 F.2d 1478, 2 USPQ2d 1364 (Fed. Cir. 1986) . . . . .	2133.03(e)(2)	Heckman, Ex parte, 135 USPQ 229 (P.O. Super. Exam. 1960) . . . . .	1504.05
Harris, Ex parte, 79 USPQ 439 (Comm'r Pat. 1948) . . . . .	707.05(f)	Hedges, In re, 783 F.2d 1038, 228 USPQ 685 (Fed. Cir. 1986) . . . . .	2145
Harry, In re, 333 F.2d 920, 142 USPQ 164 (CCPA 1964) . . . . .	715.07, 2138.06	Hedgewick v. Akers, 497 F.2d 905, 182 USPQ 167 (CCPA 1974) . . . . .	2137
Hartley, Ex parte, 1908 C.D. 224 (Comm'r Pat. 1908) . . . . .	720.05	Heinl v. Godici, 143 F. Supp. 2d 593 (E.D. Va. 2001) . . . . .	2242, 2246, 2258.01, 2646

MANUAL OF PATENT EXAMINING PROCEDURE

Helifix Ltd. v. Blok-Lok Ltd., 208 F.3d 1339, 54 USPQ2d 1299 (Fed. Cir. 2000) . . . . .	2133.03(e)(1)	Hill, In re, 284 F.2d 955, 128 USPQ 197 (CCPA 1960) . . . . .	716.02(d)
Hellbaum, In re, 371 F.2d 1022, 152 USPQ 571 (CCPA 1967) . . . . .	706.03(w)	Hill-Rom Co. v. Kinetic Concepts, Inc., 209 F.3d 1337, 54 USPQ2d 1437 (Fed. Cir. 2000) . . . . .	1302.04, 2181
Hellsund, In re, 474 F.2d 1307, 177 USPQ 170 (CCPA 1973) . . . . .	715	Hilmer, In re, 359 F.2d 859, 149 USPQ 480 (CCPA 1966) . . . . .	706.02(f)(1), 715, 2136.03, 2308.01
Hengehold, In re, 440 F.2d 1395, 169 USPQ 473 (CCPA 1971) . . . . .	821	Hilton, Ex parte, 148 USPQ 356 (Bd. App. 1965) . . . . .	2144.04
Henrich, Ex parte, 1913 Dec. Comm'r Pat. 139 (Comm'r Pat. 1913) . . . . .	711.03(c)	Hiniker Co., In re, 150 F.3d 1362, 47 USPQ2d 1523 (Fed. Cir. 1998) . . . . .	2106, 2242, 2258, 2258.01, 2642
Henriksen, In re, 399 F.2d 253, 158 USPQ 224 (CCPA 1968) . . . . .	201.11	Hirao, In re, 535 F.2d 67, 190 USPQ 15 (CCPA 1976) . . . . .	707.07(f), 2141.02
Heritage, In re, 182 F.2d 639, 86 USPQ 160 (CCPA 1950) . . . . .	901.02	Hirschfield v. Banner, 462 F. Supp 135, 200 USPQ 276 (D.D.C. 1978) . . . . .	2106.02
Heritage Pat. No. 2,375,414, Ex parte, decided Jan. 26, 1944 . . . . .	819.01	Hirschler, Ex parte, 110 USPQ 384 (Bd. App. 1952) . . . . .	2132.01
Herman v. Huddleston, 459 U.S. 375 (1983) . . . . .	2107.02	Hitchings, In re, 342 F.2d 80, 144 USPQ 637 (CCPA 1965) . . . . .	2164.01(c)
Herman v. William Brooks Shoe Co., 39 USPQ2d 1773 (S.D.N.Y. 1996) . . . . .	410	Hitzeman v. Rutter, 243 F.3d 1345, 58 USPQ2d 1161 (Fed. Cir. 2001) . . . . .	2138.04
Herr, In re, 377 F.2d 610, 153 USPQ 548 (CCPA 1967) . . . . .	706.03(w)	Hiyamizu, Ex parte, 10 USPQ2d 1393 (Bd. Pat. App. & Inter. 1988) . . . . .	2141.03
Herrmann, In re, 261 F.2d 598, 120 USPQ 182 (CCPA 1949) . . . . .	707.07(f)	Hobbs v. United States, 451 F.2d 849, 171 USPQ 713 (5th Cir. 1971) . . . . .	2133.03, 2133.03(b)
Hershberger, Ex parte, 96 USPQ 54 (Bd. App. 1952) . . . . .	2128.01	Hoch, In re, 428 F.2d 1341, 166 USPQ 406 (CCPA 1970) . . . . .	706.02(j), 1208.01, 2144.08
Herschler, In re, 591 F.2d 693, 200 USPQ 711 (CCPA 1979) . . . . .	2106.01, 2163, 2163.05	Hockerson-Halberstadt, Inc. v. Avia Group Int'l, 222 F.3d 951, 55 USPQ2d 1487 (Fed. Cir. 2000) . . . . .	2125
Herz, In re, 537 F.2d 549, 190 USPQ 461 (CCPA 1976) . . . . .	2111.03	Hodge v. Rostker, 501 F. Supp 332 (D.D.C. 1980) . . . . .	1216.02
Hester Industries, Inc. v. Stein, Inc., 142 F.3d 1472, 46 USPQ2d 1641 (Fed. Cir. 1998) . . . . .	1412.02	Hodosh v. Block Drug Co., Inc., 786 F.2d 1136, 229 USPQ 182 (Fed. Cir. 1986) . . . . .	2141, 2144.08
Hewlett-Packard Co. v. Bausch & Lomb Inc., 909 F.2d 1464, 15 USPQ2d 1525 (Fed. Cir. 1990) . . . . .	2114	Hoechst Aktiengesellschaft v. Quigg, 916 F.2d 522, 16 USPQ2d 1549 (Fed. Cir. 1990) . . . . .	2758
Hiatt v. Ziegler, 179 USPQ 757 (Bd. Pat. Inter. 1973) . . . . .	2138.04	Hoechst-Roussel Pharmaceuticals Inc. v. Lehman, 109 F.3d 756, 42 USPQ2d 1220 (Fed. Cir. 1997) . . . . .	2751
Hibberd, Ex parte, 227 USPQ 443 (Bd. Pat. App. & Inter. 1985) . . . . .	1206, 1601, 2105	Hoeksema, In re, 399 F.2d 269, 158 USPQ 596 (CCPA 1968) . . . . .	2121.01, 2121.02, 2144.08, 2144.09
Hidy, In re, 303 F.2d 954, 133 USPQ 650 (CCPA 1962) . . . . .	715.05, 804.02, 2308.01	Hoeschele, In re, 406 F.2d 1403, 160 USPQ 809 (CCPA 1969) . . . . .	2144.05
Hilborn v. Dann, 546 F.2d 401, 192 USPQ 132 (CCPA 1976) . . . . .	2308.02		
Hildebrand, Ex parte, 15 USPQ2d 1662 (Bd. Pat. App. & Inter. 1990) . . . . .	2404.01, 2410.01		

LIST OF DECISIONS CITED

Hoffman, Ex parte, 12 USPQ2d 1061 (Bd. Pat. App. & Inter. 1989) . . . . .	2111.03	Howarth, In re, 654 F.2d 103, 210 USPQ 689 (CCPA 1981) . . . . .	716.09, 2164.01(b)
Hoffman v. Klaus, 9 USPQ2d 1657 (Bd. Pat. App. & Inter. 1988) . . . . .	2107.02	Hozumi, Ex parte, 3 USPQ2d 1059 (Bd. Pat. App. & Inter. 1984) . . . . .	803.02
Hoffman-La Roche, Inc. v. Promega Corp., 323 F.3d 1354, 66 USPQ2d 1385 (Fed. Cir. 2003) . . . . .	608.01(p), 2004	Hruby, In re, 373 F.2d 997, 153 USPQ 61 (CCPA 1967) . . . . .	1504.01(a)
Hogan, In re, 559 F.2d 595, 194 USPQ 527 (CCPA 1977) . . . . .	2124, 2164.05(a)	Huang, In re, 100 F.3d 135, 40 USPQ2d 1685 (Fed. Cir. 1996) . . . . .	716.03, 716.03(b), 2144.08
Holladay, In re, 584 F.2d 384, 199 USPQ 516 (CCPA 1978) . . . . .	716.02(e)	Huber, Ex parte, 148 USPQ 447 (Bd. Pat. App. 1965) . . . . .	2172.01
Hollingsworth, In re, 253 F.2d 238, 117 USPQ 182 (CCPA 1958) . . . . .	716.03(a)	Huelster v. Reiter, 168 F.2d 542, 78 USPQ 82 (CCPA 1948) . . . . .	2138.06
Holmes v. Kelly, 586 F.2d 234, 199 USPQ 778 (CCPA 1978) . . . . .	2371	Hull v. Bonis, 214 USPQ 731 (Bd. Pat. Inter. 1982) . . . . .	2138.05
Holmwood v. Cherpeck, 2 USPQ2d 1942 (Bd. Pat. App. & Inter. 1986) . . . . .	2138.03	Hull v. Davenport, 90 F.2d 103, 33 USPQ 506 (CCPA 1937) . . . . .	2138.01, 2138.06
Homan, Ex parte, 1905 C.D. 288 (Comm'r Pat. 1905) . . . . .	715.07	Humber, Ex parte, 217 USPQ 265 (Bd. App. 1961) . . . . .	716.02(e)
Honeywell v. Diamond, 499 F. Supp. 924, 208 USPQ 452 (D.D.C. 1980) . . . . .	2165.04	Humphreys, Ex parte, 24 USPQ2d 1255 (Bd. Pat. App. & Inter. 1992) . . . . .	2404.01, 2405
Honigsbaum v. Lehman, 903 F. Supp 8, 37 USPQ2d 1799 (D.D.C. 1995) . . . . .	513	Hunt Co. v. Mallinckrodt Chem. Works, 177 F.2d 583, 83 USPQ 277 (2d Cir. 1949) . . . . .	201.11, 1504.20
Honn, In re, 364 F.2d 454, 150 USPQ 652 (CCPA 1966) . . . . .	608.01(h), 2165.01	Hunter, Ex parte, 1889 C.D. 218, 49 O.G. 733 (Comm'r Pat. 1889) . . . . .	715.07(a)
Hoogendam, Ex parte, 1939 C.D. 3, 499 O.G. 3, 40 USPQ 389 (Comm'r Pat. 1939) . . . . .	706.07	Hunter v. Biessbarth, 15 USPQ2d 1343 (Comm'r Pat. 1990) . . . . .	2361
Hook, Ex parte, 102 USPQ 130 (Bd. App. 1953) . . . . .	715.07	Hupp v. Siroflex of America, Inc., 122 F.3d 1456, 43 USPQ2d 1887 (Fed. Cir. 1997) . . . . .	1504.02
Hoover Co., In re, 134 F.2d 624, 57 USPQ 111 (CCPA 1943) . . . . .	2363.02	Hyatt, In re, 211 F.3d 1367, 54 USPQ2d 1664 (Fed. Cir. 2000) . . . . .	2111
Hormone Research Foundation Inc. v. Genentech Inc., 904 F.2d 1558, 15 USPQ2d 1039 (Fed. Cir. 1990) . . . . .	2173.05(a)	Hyatt, In re, 708 F.2d 712, 218 USPQ 195 (Fed. Cir. 1983) . . . . .	2164.08(a), 2181
Horton, Ex parte, 226 USPQ 697 (Bd. Pat. App. & Inter. 1985) . . . . .	2258	Hyatt v. Boone, 146 F.3d 1348, 47 USPQ2d 1128 (Fed. Cir. 1998) . . . . .	2106, 2138.05, 2163, 2163.03
Horvitz v. Pritchard, 182 USPQ 505 (Bd. Pat. & Int. 1974) . . . . .	2308.02	Hybritech, Inc. v. Monoclonal Antibod- ies, Inc., 802 F.2d 1367, 231 USPQ 81 (Fed. Cir. 1986) 716.03(b), 2138.04, 2141, 2144.08, 2163, 2164.01, 2164.05(a), 2173.05(a), 2182, 2184	
Hostettler, In re, 356 F.2d 562, 148 USPQ 514 (CCPA 1966) . . . . .	715.03	Hycor Corp. v. The Schlueter Co., 740 F.2d 1529, 222 USPQ 553 (Fed. Cir. 1984) . . . . .	2004
Hough, In re, 108 USPQ 89, 703 O.G.200 (Comm'r Pat. 1955) . . . . .	409.03(i)	I.C.E. Corp. v. Armco Steel Corp., 250 F. Supp 738, 148 USPQ 537 (S.D.N.Y. 1966) . . . . .	2128
Houghton, In re, 433 F.2d 820, 167 USPQ 687 (CCPA 1970) . . . . .	2107.01		
Hovlid v. Asari, 305 F.2d 747, 134 USPQ 162 (9th Cir. 1962) . . . . .	201.06(d), 201.11		



MANUAL OF PATENT EXAMINING PROCEDURE

IMS Technology Inc. v. Haas Automation Inc., 206 F.3d 1422, 54 USPQ2d 1129 (Fed. Cir. 2000) . . . . .	2181, 2183, 2184	Janakirama-Rao, In re, 317 F.2d 951, 137 USPQ 893 (CCPA 1963) . . . . .	2111.03, 2163
Intel Corp. v. VIA Tech., Inc., 319 F.3d 1537, 65 USPQ2d 1934 (Fed. Cir. 2003) . . . . .	2181	Jansen v. Rexall Sundown, Inc., 342 F.3d 1329, 68 USPQ2d 1154 (Fed. Cir. 2003) . . . . .	2111.02
Intellicall, Inc. v. Phonometrics, Inc., 952 F.2d 1384, 21 USPQ2d 1383 (Fed. Cir. 1992) . . . . .	2111.01, 2181	Japikse, In re, 181 F.2d 1019, 86 USPQ 70 (CCPA 1950) . . . . .	2144.04
Intermountain Research and Eng'g Co. v. Hercules, Inc., 171 USPQ 577 (C.D. Cal. 1971) . . . . .	2012	J.E.M. Ag Supply, Inc. v. Pioneer Hi-Bred Int'l, Inc., 534 U.S. 124, 122 S.Ct. 593, 60 USPQ2d 1865 (2001) . . . . .	2105
International Glass Co. v. United States, 408 F.2d 395, 159 USPQ 434 (Ct. Cl. 1968) . . . . .	2138.03	Jennings, In re, 182 F.2d 207, 86 USPQ 68 (CCPA 1950) . . . . .	1504.03
International Rectifier Corp. v. IXYS Corp., 361 F.3d 1363, 70 USPQ2d 1209 (Fed. Cir. 2004) . . . . .	2111.01	Jentoft, In re, 392 F.2d 633, 157 USPQ 363 (CCPA 1968) . . . . .	804.02, 1490
Interroyal Corp. v. Simmons Co., 204 USPQ 562 (S.D. N.Y. 1979) . . . . .	2133.03(e)(1), 2133.03(e)(3)	Jessel v. Newland, 195 USPQ 678 (Comm'r Pat. 1977) . . . . .	1605
Invitrogen Corp. v. Biocrest Mfg., L.P., 327 F.3d 1364, 66 USPQ2d 1631 (Fed. Cir. 2003) . . . . .	2111.03	Jockmus v. Leviton, 28 F.2d 812 (2d Cir. 1928) . . . . .	2121.04, 2125
Ionescu, Ex parte, 222 USPQ 537 (Bd. App. 1984) . . . . .	2143.03, 2171, 2173.06	John O. Butler Co. v. Block Drug Co. Inc., 620 F. Supp. 771, 226 USPQ 855 (D. Ill. 1985) . . . . .	1504
Irish, In re, 433 F.2d 1342, 167 USPQ 764 (CCPA 1970) . . . . .	2136.01	Johns-Manville Corp. v. Guardian Industries Corp., 586 F. Supp 1034, 221 USPQ 319 (E.D. Mich. 1983) . . . . .	2165.01
Irons, In re, 340 F.2d 974, 144 USPQ 351 (CCPA 1965) . . . . .	2107.02, 2164.07	Johnson, In re, 282 F.2d 370, 127 USPQ 216 (CCPA 1960) . . . . .	2164.01(c)
Irwin, Ex parte, 1928 C.D. 13, 367 O.G. 701 (Comm'r Pat. 1928) . . . . .	604.02	Johnson, In re, 558 F.2d 1008, 194 USPQ 187 (CCPA 1977) . . . . .	2164.08, 2173.05(i)
Isaacs, In re, 347 F.2d 889, 146 USPQ 193 (CCPA 1963) . . . . .	2107.02, 2107.03	Johnson, In re, 589 F.2d 1070, 200 USPQ 199 (CCPA 1978) . . . . .	2106, 2184
Ishida Co. v. Taylor, 221 F.3d 1310, 55 USPQ2d 1449 (Fed. Cir. 2000) . . . . .	2184	Johnson, In re, 747 F.2d 1456, 223 USPQ 1260 (Fed. Cir. 1984) . . . . .	716.02(e)
Ishizaka, Ex parte, 24 USPQ2d 1621 (Bd. Pat. App. & Inter. 1992) . . . . .	716.02(b)	Johnson Worldwide Associates v. Zebco Corp., 175 F.3d 985, 993, 50 USPQ2d 1607, (Fed. Cir. 1999) . . . . .	2163, 2163.05
Iwahashi, In re, 888 F.2d 1370, 12 USPQ2d 1908 (Fed. Cir. 1989) . . . . .	2106	Jolles, In re, 628 F.2d 1322, 206 USPQ 885 (CCPA 1980) . . . . .	2107.01, 2107.02, 2107.03
Jackson, Ex parte, 217 USPQ 804 (Bd. Pat. App. & Inter. 1982) . . . . .	2164.06, 2164.06(a), 2404.02	Jolley, In re, 308 F.3d 1317, 64 USPQ2d 1901 (Fed. Cir. 2002) . . . . .	2138.04, 2138.06
Jaffe, Ex parte, 147 USPQ 45 (Bd. of App. 1964) . . . . .	1504	Joly, In re, 376 F.2d 906, 153 USPQ 45 (CCPA 1967) . . . . .	2107.02
J. A. La Porte, Inc. v. Norfolk Dredging Co., 787 F.2d 1577, 229 USPQ 435 (Fed. Cir. 1986) . . . . .	2133.03(b)	Jones, Ex parte, 62 USPQ2d 1206, 1208 (Bd. Pat. App. & Inter. 2001) . . . . .	706.02
		Jones, Ex parte, 1924 C.D. 59, 327 O.G. 681 (Comm'r Pat. 1924) . . . . .	709.01
		Jones, In re, 373 F.2d 1007, 153 USPQ 77 (CCPA 1967) . . . . .	706.03(a)

LIST OF DECISIONS CITED

Jones, In re, 958 F.2d 347, 21 USPQ2d 1941 (Fed. Cir. 1992) . . . 707.07(f), 2143.01, 2144, 2144.05, 2144.08	Kattwinkle, Ex parte, 12 USPQ 11 (Bd. App. 1931) . . . . . 608.01(v)
Jones v. Hardy, 727 F.2d 1524, 220 USPQ 1021 (Fed. Cir. 1984) . . . . 2141.02, 2144.08	Katz, In re, 467 F.2d 939, 167 USPQ 487 (CCPA 1970) . . . . . 706.03(w)
Jones v. Progress Ind., Inc., 163 F. Supp. 824, 119 USPQ 92 (D. R.I. 1958) . . . . . 1504.02, 1504.03	Katz, In re, 687 F.2d 450, 215 USPQ 14 (CCPA 1982) . . . . . 715.01(c), 716.10, 804, 2132, 2132.01, 2133, 2136.05, 2137, 2138.02
Josserand, In re, 188 F.2d 486, 89 USPQ 371 (CCPA 1951) . . . . . 2133.03(e)(1)	Kaufman Co. v. Lantech, Inc., 807 F.2d 970, 1 USPQ2d 1202 (Fed. Cir. 1986) . . . . . 2293
Jovanovics, Ex parte, 211 USPQ 907 (Bd. Pat. App. & Inter. 1981) . . . . . 2107.03	Kawai v. Metlesics, 480 F.2d 880, 178 USPQ 158 (CCPA 1973) . . . . . 2107.02, 2138, 2138.05, 2163.03
Joy Mfg. Co. v. National Mine Service Co., 810 F.2d 1127, 1 USPQ2d 1627 (Fed. Cir. 1987) . . . . . 2246, 2646	Keil, In re, 808 F.2d 830, 1 USPQ2d 1427 (Fed. Cir. 1987) . . . . . 1449.02
Joy Technologies Inc. v. Manbeck, 751 F. Supp 225, 17 USPQ2d 1257 (D.D.C. 1990) . . . . . 716.03(a)	Keizer v. Bradley, 270 F.2d 396, 123 USPQ 215 (CCPA 1959) . . . . . 2138.06
J. P. Stevens & Co. v. Lex Tex Ltd., 747 F.2d 1553, 223 USPQ 1089 (Fed. Cir. 1984) . . . . . 2016	Keller, In re, 642 F.2d 413, 208 USPQ 871 (CCPA 1981) . . . . . 707.07(f), 2145
Judin v. United States, 110 F.3d 780, 42 USPQ2d 1300 (Fed. Cir. 1997) . . . . . 410	Kellogg Switchboard & Supply Co., The, In re, 1906 C.D. 274 (Comm'r Pat. 1906) . . . . . 106
Justus v. Appenzeller, 177 USPQ 332 (Bd. Pat. Inter. 1971) . . . . . 2138.06	Kelly, In re, 200 USPQ 560 (Comm'r Pat. 1978) . . . . . 1504.05
Kaghan, In re, 387 F.2d 398, 156 USPQ 130 (CCPA 1967) . . . . . 706.03(w)	Kelly, In re, 305 F.2d 909, 134 USPQ 397 (CCPA 1962) . . . . . 2173.05(o)
Kahn, In re, 202 USPQ 772 (Comm'r Pat. 1979) . . . . . 2012.01	Kemco Sales Inc. v. Control Papers Co., 208 F.3d 1352, 54 USPQ2d 1308 (Fed. Cir. 2000) . . . . . 2106, 2183, 2184
Kaiser Industries Corp. v. Jones & Laughlin Steel Corp., 515 F.2d 964, 185 USPQ 343 (3d Cir. 1975) . . . . . 2012.01	Kemps, In re, 97 F.3d 1427, 40 USPQ2d 1309 (Fed. Cir. 1996) . . . . . 2144.08
KangaROOS U.S.A., Inc. v. Caldor, Inc., 778 F.2d. 1571, 228 USPQ 32 (Fed. Cir. 1985) . . . . . 1504.20, 2004	Kendall v. Searles, 173 F.2d 986, 81 USPQ 363 (CCPA 1949) . . . . . 2138.06
Kanter, In re, 399 F.2d 249, 158 USPQ 331 (CCPA 1968) . . . . . 2116.01	Kerkhoven, In re, 626 F.2d 846, 205 USPQ 1069 (CCPA 1980) . . . . . 2144.06
Kantor, Ex parte, 177 USPQ 455 (Bd. App. 1958) . . . . . 715.07(a)	Key Mfg. Group Inc. v. Microdot, Inc., 679 F. Supp. 648, 4 USPQ2d 1687 (E.D. Mich. 1987) . . . . . 2293
Kaplan, In re, 789 F.2d 1574, 229 USPQ 678 (Fed. Cir. 1986) . . . . . 804	Keyes, Ex parte, 214 USPQ 579 (Bd. App. 1982) . . . . . 716.01(c)
Kaslow, In re, 707 F.2d 1366, 217 USPQ 1089 (Fed. Cir. 1983) . . . . . 706.03(v), 2106.01, 2141.02, 2163.02	Keystone Driller Co. v. Gen'l Excavator Co., 290 U.S. 240, 19 USPQ 228 (1933) . . . . . 2012
Kathawala, In re, 9 F.3d 942, 28 USPQ2d 1785 (Fed. Cir. 1993) . . . . 2126, 2126.02, 2135.01	KeyStone Retaining Wall Systems Inc. v. Westrock Inc., 997 F.2d 1444, 27 USPQ2d 1297 (Fed. Cir. 1993) . . . . . 1504.05
Katrapat, In re, 6 USPQ2d 1863 (Comm'r Pat. 1988) . . . . . 711.03(c), 2268, 2668	Khoury, In re, 207 USPQ 942 (Comm'r Pat. 1980) . . . . . 1904
	Khusid, Ex parte, 174 USPQ 59 (Bd. App. 1971) . . . . . 2173.05(c)

MANUAL OF PATENT EXAMINING PROCEDURE

Kilbey v. Thiele, 199 USPQ 290 (Bd. Pat. Inter. 1978) . . . . .	2137	Kohler, Ex parte, 1905 C.D. 192., 116 O.G. 1185 (Comm'r Pat. 1905) . . .	1503.02, 1504.04
Killian v. Watson, 121 USPQ 507 (D.D.C. 1958) . . . . .	1216.02	Kollar, In re, 286 F.3d 1326, 62 USPQ2d 1425 (Fed. Cir. 2002) . . . . .	2133.03(b)
Kim v. Quigg, 718 F. Supp. 1280, 12 USPQ2d 1604 (E.D. Va. 1989) . . . . .	711.03(c)	Koller, In re, 613 F.2d 819, 204 USPQ 702 (CCPA 1980) . . . . .	2124, 2163
Kimbell, Ex parte, 226 USPQ 688 (Bd. App. 1985) . . . . .	2258	Kollman, In re, 595 F.2d 48, 201 USPQ 193 (CCPA 1979) . . . . .	716.02(d)
Kimberly-Clark v. Johnson & Johnson, 745 F.2d 1437, 223 USPQ 603 (Fed. Cir. 1984) . . . . .	2138	Kondo v. Martel, 220 USPQ 47 (Bd. Pat. Inter. 1983) . . . . .	2138.02
Kimberly-Clark Corp. v. Procter & Gamble Distrib. Co., 973 F.2d 911, 23 USPQ2d 1921 (Fed. Cir. 1992) . . . . .	605.07, 2137.01	Komenak, Ex parte, 45 USPQ 186, 1940 C.D. 1, 512 O.G. 739 (Comm'r Pat. 1940) . . . . .	201.09
King Instrument Corp. v. Otari Corp., 767 F.2d 853, 226 USPQ 402 (Fed. Cir. 1985) . . . . .	2133.03(a), 2138.05	Kotler, Ex parte, 1901 C.D. 62, 95 O.G. 2684 (Comm'r Pat. 1901) . . . . .	608.01(o)
King, In re, 801 F.2d 1324, 231 USPQ 136 (Fed. Cir.1986) . . . . .	1206, 2112.02, 2131.01	Kotzab, In re, 217 F.3d 1365, 55 USPQ2d 1313 (Fed. Cir. 2000) . . . . .	2143.01
Kirk, In re, 376 F.2d 936, 153 USPQ 48 (CCPA 1967) . . . . .	2107.01, 2107.02	Krahn v. Commissioner, 15 USPQ2d 1823 (E.D. Va. 1990) . . . . .	711.03(c)
Kirsch, In re, 498 F.2d 1389, 182 USPQ 286 (CCPA 1974) . . . . .	2173.05(c)	Krepelka, Ex parte, 231 USPQ 746 (Bd. Pat. App. & Inter. 1986) . . . . .	2107.03
Kistler v. Weber, 412 F.2d 280, 162 USPQ 214 (CCPA 1969) . . . . .	2308.02	Krimmel, In re, 292 F.2d 948, 130 USPQ 215 (CCPA 1961) . . . . .	2107.02, 2107.03
Klein, In re, 5 USPQ 259, 1930 C.D. 2, 393 O.G. 519 (Comm'r Pat. 1930) . . . . .	201.08	Kristensen, Ex parte, 10 USPQ2d 1701 (Bd. Pat. App. & Inter. 1989) . . . . .	2173.05(b), 2173.05(o)
Kluis, Ex parte, 70 USPQ 165 (Bd. App. 1945) . . . . .	1604	Kroekel, In re, 504 F.2d 1143, 183 USPQ 610 (CCPA 1974) . . . . .	2173.05(c)
Klumb, Ex parte, 159 USPQ 694 (Bd. App. 1967) . . . . .	706.03(d), 2181	Kroekel, In re, 803 F.2d 705, 231 USPQ 640 (Fed. Cir. 1986) . . . . .	715
Knapp v. Anderson, 477 F.2d 588, 177 USPQ 688 (CCPA 1973) . . . . .	2107.01	Kroger, Ex parte, 218 USPQ 370 (Bd. App. 1982) . . . . .	716.10, 2132.01
Knapp Monarch Co., In re, 296 F.2d 230, 132 USPQ 6 (CCPA 1961) . . . . .	2144.03	Kronig, In re, 539 F.2d 1300, 190 USPQ 425 (CCPA 1976) . . . . .	1208.01
Knell v. Muller, 174 USPQ 460 (Comm'r Pat. 1971) . . . . .	804.02	Kropa v. Robie, 187 F.2d 150, 88 USPQ 478 (CCPA 1951) . . . . .	707.07(f), 2111.02
Knight, In re, 217 USPQ 294 (Comm'r Pat. 1982) . . . . .	2225, 2258, 2625, 2658	Kuehl, In re, 425 F.2d 658, 177 USPQ 250 (CCPA 1973) . . . . .	2116.01
Knohl, In re, 386 F.2d 476, 155 USPQ 586 (CCPA 1967) . . . . .	804.02	Kuhle, In re, 526 F.2d 553, 188 USPQ 7 (CCPA 1975) . . . . .	2144.04
Knowlton, In re, 481 F.2d 1357, 178 USPQ 486 (CCPA 1973) . . . . .	2106, 2106.02, 2181, 2185	Kuklo, Ex parte, 25 USPQ2d 1387 (Bd. Pat. App. & Inter. 1992) . . . . .	2133.03(a)
Knowlton, In re, 500 F.2d 266, 183 USPQ 33 (CCPA 1974) . . . . .	2106.02	Kulling, In re, 897 F.2d 1147, 14 USPQ2d 1056 (Fed. Cir. 1990) . . .	2144.05, 2144.08
Kochan, Ex parte, 131 USPQ 204 (Bd. App. 1961) . . . . .	2173.05(n)	Kusko, Ex parte, 215 USPQ 972 (Bd. App. 1981) . . . . .	2137, 2138.01

LIST OF DECISIONS CITED

LaBounty Mfg. Inc. v. United States Int'l Trade Comm'n, 958 F.2d 1066, 22 USPQ2d 1025 (Fed. Cir. 1992) . . . . .	2004, 2133.03, 2133.03(e), 2133.03(e)(2)
Lafferty, Ex parte, 190 USPQ 202 (Bd. App. 1975) . . . . .	1403
L.A. Gear, Inc. v. Thom McAn Shoe Co., 988 F.2d 1117, 25 USPQ2d 1913 (Fed. Cir. 1993) . . . . .	1504.01(c)
Lalu, In re, 747 F.2d 703, 223 USPQ 1257 (Fed. Cir. 1984) . . . . .	2144.08, 2144.09
Lamb, In re, 286 F.2d 610, 128 USPQ 539 (CCPA 1961) . . . . .	1504.03
Lamberti, In re, 545 F.2d 747, 192 USPQ 278 (CCPA 1976) . . . . .	2144.01
Lambrech, In re, 202 USPQ 620 (Comm'r Pat. 1976) . . . . .	1481
Lampi Corp. v. American Power Products Inc., 228 F.3d 1365, 56 USPQ2d 1445 (Fed. Cir. 2000) . . . . .	2111.03
Lancaster, Ex parte, 151 USPQ 713, 1966 C.D. 20, 833 O.G. 8 (Bd. App. 1965) . . . . .	1504.02
Land, In re, 368 F.2d 866, 151 USPQ 621 (CCPA 1966) . . . . .	2136.04, 2136.05
Lander, Ex parte, 223 USPQ 687 (Bd. App. 1983) . . . . .	1504.02
Lange v. Comm'r, 352 F. Supp 166, 176 USPQ 162 (D. D.C. 1972) . . . . .	1701.01
Langer, In re, 465 F.2d 896, 175 USPQ 169 (CCPA 1972) . . . . .	2144.09
Langer, In re, 503 F.2d 1380, 183 USPQ 288 (CCPA 1974) . . . . .	2107.02, 2107.03, 2124
Langer v. Kaufman, 465 F.2d 915, 175 USPQ 172 (CCPA 1972) . . . . .	2138.04
Lanham, In re, 1 USPQ2d 1877 (Comm'r Pat. 1986) . . . . .	2258
Lantzke, Ex parte, 1910 C.D. 100, 156 O.G. 257 (Comm'r Pat. 1910) . . . . .	810.01
Lantech Inc. v. Kaufman Co. of Ohio, Inc., 878 F.2d 1446, 12 USPQ2d 1076 (Fed. Cir. 1989) . . . . .	2145
Lapworth, In re, 451 F.2d 1094, 172 USPQ 129 (CCPA 1971) . . . . .	1504
Larson, In re, 340 F.2d 965, 144 USPQ 347 (CCPA 1965) . . . . .	2144.04
Larson v. Classic Corp., 683 F. Supp. 1202, 7 USPQ2d 1747 (N.D. Ill. 1988) . . . . .	1504.01(c)
Lasscell, Ex parte, 1884 C.D. 66, 29 O.G. 861 (Comm'r Pat. 1884) . . . . .	711.01
Lawrence, Ex parte, 70 USPQ 326, 1946 C.D. 1 (Comm'r Pat. 1946) . . . . .	1457, 1509
Lee, Ex parte, 31 USPQ2d 1105 (Bd. Pat. App. & Inter. 1993) . . . . .	706.02(m), 2131.03
Lee Pharmaceutical v. Kreps, 577 F.2d 610, 198 USPQ 601 (9th Cir. 1978) . . . . .	2127
Lee v. Dayton-Hudson Corp., 838 F.2d 1186, 5 USPQ2d 1625 (Fed. Cir. 1988) . . . . .	1504
Lee, In re, 199 USPQ 108 (Comm'r Pat. 1978) . . . . .	803
Lee, In re, 277 F.3d 1338, 61 USPQ2d 1430 (Fed. Cir. 2002) . . . . .	2143.01, 2144.03
Leggett v. Avery, 101 U.S. 256 (1879) . . . . .	1490
LeGrice, In re, 301 F.2d 929, 133 USPQ 365 (CCPA 1962) . . . . .	2121.03
Lemelson, In re, 397 F.2d 1006, 158 USPQ 275 (CCPA 1968) . . . . .	2123
Lemieux, Ex parte, 115 USPQ 148, 1957 C.D. 47, 725 O.G. 4 (Bd. App. 1957) . . . . .	715.01(c)
Leonard, Ex parte, 187 USPQ 122 (Bd. App. 1974) . . . . .	2116
Le Roy v. Tatham, 55 U.S. (14 How.) 156 (1852) . . . . .	2106
Leshin, In re, 227 F.2d 197, 125 USPQ 416 (CCPA 1960) . . . . .	2144.07
Leslie, In re, 547 F.2d 116, 192 USPQ 427 (CCPA 1977) . . . . .	1503.01, 1504.03
Levengood, Ex parte, 28 USPQ2d 1300 (Bd. Pat. App. & Inter. 1993) . . . . .	2143.01, 2144
Levy, Ex parte, 17 USPQ2d 1461 (Bd. Pat. App. & Inter. 1990) . . . . .	2112
Liebel-Flarsheim Co. v. Medrad Inc., 358 F.3d 898, 69 USPQ2d 1801 (Fed. Cir. 2004) . . . . .	2111.01
Lincoln Engineering Co. v. Stewart-Warner Corp., 303 U.S. 545, 37 USPQ 1 (1938) . . . . .	2173.05(j)
Lindberg, In re, 194 F.2d 732, 93 USPQ 23 (CCPA 1952) . . . . .	2144.04
Lindell, In re, 385 F.2d 453, 155 USPQ 521 (CCPA 1967) . . . . .	716.01(c)
Lindemann Maschinenfabrik GMBH v. American Hoist & Derrick Co., 730 F.2d 1452, 221 USPQ 481 (Fed. Cir. 1984) . . . . .	716.03, 2164.01, 2164.05(a)

MANUAL OF PATENT EXAMINING PROCEDURE

Lindner, In re, 457 F.2d 506, 173 USPQ 356 (CCPA 1972) . . . 716.01(c), 716.02(d), 2144.08	Lund, In re, 376 F.2d 982, 153 USPQ 625 (CCPA 1967) . . . . . 901.01, 901.02, 2127, 2136.02, 2136.03
Linear Tech. Corp. v. Micrel, Inc., 275 F.3d 1040, 61 USPQ2d 1225 (Fed. Cir. 2001) . . . . . 2133.03(b)	Lundak, In re, 773 F.2d 1216, 227 USPQ 90 (Fed. Cir. 1985) . . . . 2163, 2164.06, 2164.06(a), 2406.01
Links, Ex parte, 184 USPQ 429 (Bd. App. 1974) . . . . . 901.05(b), 2135.01	Lutzker v. Plet, 843 F.2d 1364, 6 USPQ2d 1370 (Fed. Cir. 1988) . . . . . 2138.03
Lintner, In re, 458 F.2d 1013, 173 USPQ 560 (CCPA 1972) . . . . . 2142, 2143.01, 2144, 2144.08, 2145	Lyell, Ex parte, 17 USPQ2d 1548 (Bd. Pat. App. & Inter. 1990) . . . . . 2173.05(p)
Litchfield v. Eigen, 535 F.2d 72, 190 USPQ 113 (CCPA 1976) . . . . . 2138.06	Maas, Ex parte, 9 USPQ2d 1746 (Bd. Pat. App. & Inter. 1987) . . . . . 2107.03
Litton Systems, Inc. v. Whirlpool Corp., 728 F.2d 1423, 221 USPQ 97 (Fed. Cir. 1984) . . . . . 601.01(e), 716.03(b), 1504.03	Mackay Radio & Telegraph Co. v. Radio Corp. of America, 306 U.S. 86, 40 USPQ 199 (1939) . . . . . 2106
Ljungstrom, Ex parte, 1905 C.D. 541, 119 O.G. 2335 (Comm'r Pat. 1905) . . . . . 814	MacKay v. Quigg, 641 F. Supp 567, 231 USPQ 90 (D.D.C. 1986) . . . . . 1216.02
Lockheed Aircraft Corporation v. United States, 193 USPQ 449 (Ct. Cl. 1977) . . . 2183, 2184	MacMillan v. Moffett, 432 F.2d 1237, 167 USPQ 550 (CCPA 1970) . . . . . 2138.04
Lockwood v. American Airlines, Inc., 107 F.3d 1505, 41 USPQ2d 1961 (Fed. Cir. 1997) . . . . . 2133.03(a), 2163, 2163.02	Mageli, In re, 470 F.2d 1380, 176 USPQ 305 (CCPA 1973) . . . . . 716.03(b)
Loewenbach, Ex parte, 1904 C.D. 170, 110 O.G. 857 (Comm'r Pat. 1904) . . . . . 819	Magerlein, In re, 602 F.2d 366, 202 USPQ 473 (CCPA 1979) . . . . . 716.02(b)
Loffland Bros. Co. v. Mid-Western Energy Corp., 225 USPQ 886 (W.D. Okla. 1985) . . . . . 2286, 2686.04	Magnetics v. Arnold Eng'g Co., 438 F.2d 72, 168 USPQ 392 (7th Cir. 1971) . . . 2133.03(e)(7)
Lohman, Ex parte, 1912 C.D. 336, 184 O.G. 287 (Comm'r Pat. 1912) . . . . . 1503.02	Mahurkar v. C.R. Bard, Inc., 79 F.3d 1572, 38 USPQ2d 1288 (Fed. Cir. 1996) . . . . . 2163
Lonardo, In re, 119 F.3d 960, 43 USPQ2d 1262 (Fed. Cir. 1997) . . . . . 804, 2217, 2258, 2617	Malachowski, In re, 530 F.2d 1402, 189 USPQ 432 (CCPA 1976) . . . . . 2107.02, 2107.03
Longi, In re, 759 F.2d 887, 225 USPQ 645 (Fed. Cir. 1985) . . . . . 804	Maldague, In re, 10 USPQ2d 1477 (Comm'r Pat. 1988) . . . . . 711.03(c)
Lopresti, In re, 333 F.2d 932, 142 USPQ 177 (CCPA 1964) . . . . . 715	Mancy, In re, 499 F.2d 1289, 182 USPQ 303 (CCPA 1974) . . . . . 2116.01
Lorenz v. Finkl, 333 F.2d 885, 142 USPQ 26 (CCPA 1964) . . . . . 711.03(c)	Mann, In re, 861 F.2d 1581, 8 USPQ2d 2030 (Fed. Cir. 1988) . . . . . 1504.02, 1504.04, 2133.03(e)(6)
Lowry, In re, 32 F.3d 1579, 32 USPQ2d 1031 (Fed. Cir. 1994) . . . . . 2106	Mannesmann Demag Corp. v. Engi- neered Metal Products Co., 793 F.2d 1279, 230 USPQ 45 (Fed. Cir. 1986) . . . . . 2111.03
Luck, In re, 476 F.2d 650, 177 USPQ 523 (CCPA 1973) . . . . . 2173.05(o)	Mantell, In re, 454 F.2d 1398, 172 USPQ 530 (CCPA 1972) . . . . . 715.03
Ludtke, In re, 441 F.2d 660, 169 USPQ 563 (CCPA 1971) . . . . . 2112.01	Manville Sales Corp. v. Paramount Sys., Inc., 917 F.2d 544, 16 USPQ2d 1587 (Fed. Cir. 1990) . . . . . 2133.03, 2133.03(a)
Lukach, In re, 442 F.2d 967, 169 USPQ 795 (CCPA 1971) . . . . . 201.11, 2163, 2163.05	Margolis, In re, 785 F.2d 1029, 228 USPQ 940 (Fed. Cir. 1986) . . . . . 716.01(a)
Lumenyte Int'l Corp. v. Cable Lite Corp., 92 F.3d 1206 (Fed. Cir. 1996) (table) . . . . 711.03(c)	

LIST OF DECISIONS CITED

Margolis v. Banner, 599 F.2d 435, 202 USPQ 365 (CCPA 1979).....	804.03	May, In re, 574 F.2d 1082, 197 USPQ 601 (CCPA 1978) . . . .	716.02(c), 2112.02, 2144.08, 2144.09
Marinissen, Ex parte, 155 USPQ 528, 842 O.G. 528 (Bd. App. 1966).....	1504.02	Mayewsky, In re, 860 F.2d 430, 162 USPQ 86 (E.D. Va. 1969).....	1701.01
Markman v. Westview Instruments, 52 F.3d 967, 34 USPQ2d 1321 (Fed. Cir. 1995) . . . . .	2106	Mayhew, In re, 527 F.2d 1229, 188 USPQ 356 (CCPA 1976)2163, 2163.05, 2164.08(c), 2172.01, 2174	
Markush, Ex parte, 1925 C.D. 126, 340 O.G. 839 (Comm'r Pat. 1924).....	2173.05(h)	Mayne, In re, 104 F.3d 1339, 41 USPQ2d 1451 (Fed. Cir. 1977) . . . . .	2144.08, 2144.09
Marosi, In re, 710 F.2d 799, 218 USPQ 289 (Fed. Cir. 1983) . . . .	706.02(m), 2111.01, 2113, 2173.05(b)	Mazer v. Stein, 347 U.S. 201, 100 USPQ 325 (1954).....	1512
Marsh Eng'g Co., In re, 1913 C.D. 183 (Comm'r Pat. 1913) . . . . .	103	Maziere, Ex parte, 27 USPQ2d 1705 (Bd. Pat. App. & Inter. 1993) . . . . .	608.01(p)
Martin, In re, 154 F.2d 126, 69 USPQ 75 (CCPA 1946).....	1212	McCormick, Ex parte, 1904 C.D. 575 113 O.G. 2508 (Assist. Comm'r 1924).....	709.01
Martin v. Johnson, 454 F.2d 746, 172 USPQ 391 (CCPA 1972).....	2163, 2173.05(t)	McCulloch Gas Processing Co. v. Dept. of Energy, 650 F.2d 1216 (Temp. Emer. Ct. App. 1981).....	1701.01
Martin v. Mayer, 823 F.2d 500, 3 USPQ2d 1333 (Fed. Cir. 1987) . . . . .	2163	McCullough, Ex parte, 7 USPQ2d 1889 (Bd. Pat. App. & Inter. 1987) . . . . .	2145
Marzocchi, In re, 439 F.2d 220, 169 USPQ 367 (CCPA 1971).....	2107.01, 2107.02, 2124, 2163, 2163.04, 2164.03, 2164.04, 2164.08	McGaughey, Ex parte, 6 USPQ2d 1334 (Bd. Pat. App. & Inter. 1988) . . . .	2217, 2258, 2617
Masco Corp. v. United States, 303 F.3d 1316, 64 USPQ2d 1182 (Fed. Cir. 2002).....	2181	McGrady v. Aspenglas Corp., 487 F. Supp 859, 208 USPQ 242 (S.D. N.Y. 1981) . . . . .	1503.01, 1504.01(a)
Masham, Ex parte, 2 USPQ2d 1647 (Bd. Pat. App. & Inter. 1987) . . . . .	2114	McGrew, In re, 120 F.3d 1236, 43 USPQ2d 1632 (Fed. Cir. 1997).....	715.05, 2307
Mas-Hamilton Group v. LaGard, Inc., 156 F.3d 1206, 48 USPQ2d 1010 (Fed. Cir. 1998) . . . . .	2181	McKellin, In re, 529 F.2d 1342, 188 USPQ 428 (CCPA 1976).....	715
Massachusetts Institute of Technology v. A.B. Fortia, 774 F.2d 1104, 227 USPQ 428 (Fed. Cir. 1985) . . . . .	2128.01, 2164.01	McKenna, In re, 203 F.2d 717, 97 USPQ 348 (CCPA 1953) . . . . .	716.01(c)
Mathews, In re, 408 F.2d 1393, 161 USPQ 276 (CCPA 1969).....	715.01(c), 2136.04, 2136.05	McLaughlin, In re, 443 F.2d 1392, 170 USPQ 209 (CCPA 1971).....	707.07(f), 2145
Mattison, In re, 509 F.2d 563, 184 USPQ 484 (CCPA 1975) . . . . .	2173.05(c)	Mead, In re, 581 F.2d 251, 198 USPQ 412 (CCPA 1978) . . . . .	1412.01
Mattor v. Coolegem, 530 F.2d 1391, 189 USPQ 201 (CCPA 1976).....	2137.01	Mead Johnson & Co., Ex parte, 227 USPQ 78 (Bd. Pat. App. & Inter. 1985) ..	716.02(a)
Mattson, In re, 208 USPQ 168 (Comm'r Pat. 1980) . . . . .	601.01(e)	Mead Johnson Pharmaceutical Group v. Bowen, 838 F.2d 1332, 6 USPQ2d 1565 (DC Cir. 1988) . . . . .	2754.01
Mattullath, In re, 38 App. D.C. 497 (1912) . . . . .	711.03(c), 2734	Meden v. Curtis, 1905 C.D. 272, 117 O.G. 1795 (Comm'r Pat. 1905).....	819.01
Maucorps, In re, 609 F.2d 481, 203 USPQ 812 (CCPA 1979).....	2184	Medical Instrumentation and Diagnostics Corp. v. Elekta AB, 344 F.3d 1205, 68 USPQ2d 1263 (Fed. Cir. 2003).....	2181, 2182

MANUAL OF PATENT EXAMINING PROCEDURE

Medtronic, Inc. v. Cardiac Pacemakers, 721 F.2d 1563, 220 USPQ 97 (Fed. Cir. 1983) . . . . .	2141.01(a)	Milburn v. Davis-Bournonville Co., 270 U.S. 390, 46 S. Ct. 324, 1926 C.D. 303, 344 O.G. 817 (1926) . . . . .	2136.04
Meitzner v. Corte, 537 F.2d 524, 190 USPQ 407 (CCPA 1976). . . . .	2138.05	Miles Labs. Inc. v. Shandon Inc., 997 F.2d 870, 27 USPQ2d 1123 (Fed. Cir. 1993) . . . . .	716.01(a)
Mendenhall v. Cedarapids, Inc., 5 F.3d 1557, 28 USPQ2d 1081 (Fed. Cir. 1993) . . . . .	201.11	Miller, In re, 418 F.2d 1392, 164 USPQ 46 (CCPA 1969) . . . . .	706.03(a)
Mentor Corp. v. Coloplast, Inc., 998 F.2d 992, 27 USPQ2d 1521 (Fed. Cir. 1993) . . .	1412.02	Miller, In re, 441 F.2d 689, 169 USPQ 597 (CCPA 1971) . . . . .	2173.04
Merchant, In re, 575 F.2d 865, 197 USPQ 785 (CCPA 1978) . . . . .	716.02(e)	Miller v. Eagle Mfg. Co., 151 U.S. 186 (1894) . . . . .	.804
Merck & Co. v. Biocraft Laboratories, 874 F.2d 804, 10 USPQ2d 1843 (Fed. Cir. 1989) . . . . .	716.02(a), 2123, 2144.05, 2144.08	Mills, In re, 281 F.2d 218, 126 USPQ 513 (CCPA 1960). . . . .	2144.09
Merck & Co., Inc., In re, 800 F.2d 1091, 231 USPQ 375 (Fed. Cir. 1986) . . . . .	707.07(f), 716.02, 2143.02, 2144.08, 2144.09, 2145	Mills, In re, 916 F.2d 680, 16 USPQ2d 1430 (Fed. Cir. 1990) . . . . .	2143.01, 2144.08
Merck & Co., Inc. v. Chase Chem. Co., 273 F. Supp 68, 155 USPQ 139 (D.N.J. 1967) . . . . .	2402	Mills, In re, 12 USPQ2d 1847 (Comm'r Pat. 1989) . . . . .	711.03(c)
Merck & Co. v. Kessler, 80 F.3d 1543, 38 USPQ2d 1347 (Fed. Cir. 1996) . . . . .	2758	Milton, Ex parte, 63 USPQ 132 (P.O. Super. Exam. 1938). . . . .	710.04(a)
Mergenthaler v. Scudder, 11 App. D.C., 1897 C.D. 724, 81 O.G. 1417 (D.C. Cir. 1897) . . . . .	706.02(l)(2), 715, 715.07	Mineral Separation v. Hyde, 242 U.S. 261 (1916). . . . .	2164.01
Merz, Ex parte, 75 USPQ 296 (Bd. App. 1947) . . . . .	715, 715.07(a)	Minton v. National Ass'n. of Securities Dealers, 336 F.3d 1373, 67 USPQ2d 1614 (Fed. Cir. 2003) . . . . .	2133.03(c)
Messick, Ex parte, 7 USPQ 57, 1930 C.D. 6, 400 O.G. 3 (Comm'r Pat.1930) . .	710.01(a)	Mlot-Fijalkowski, In re, 676 F.2d 666, 213 USPQ 713 (CCPA 1982) . . . . .	2141.01(a)
Metcalf, In re, 410 F.2d 1378, 161 USPQ 789 (CCPA 1969). . . . .	608.01(v), 2404.01	Moba, B.V. v. Diamond Automation, Inc., 325 F.3d 1306, 66 USPQ2d 1429 (Fed. Cir. 2003) . . . . .	2163
Metropolitan Eng. Co. v. Coe, 78 F.2d 199, 25 USPQ 216 (D.C. Cir. 1935) . . . . .	716.07	Mochel, In re, 470 F.2d 638, 176 USPQ 194 (CCPA 1974) . . . . .	2173.05(c)
Metz, In re, 173 F.3d 433 (Fed. Cir. 1998) (table) . . . . .	1449.02	Mogen David Wine Corp., In re, 328 F.2d 925, 140 USPQ 575 (CCPA 1964) . . . . .	1512
Meyer, Ex parte, 6 USPQ2d 1966 (Bd. Pat. App. & Inter. 1988) . . . . .	2145	Moleculon Research Corp. v. CBS, Inc., 793 F.2d 1261, 229 USPQ 805 (Fed. Cir. 1986). . . . .	2111.03, 2133.03(a), 2133.03(b)
Meyer, In re, 599 F.2d 1026, 202 USPQ 175 (CCPA 1979) . . . . .	2131.02	Moler v. Purdy, 131 USPQ 276 (Bd. Pat. Inter. 1960) . . . . .	2137.01
Meyer, In re, 688 F.2d 789, 215 USPQ 193 (CCPA 1982) . . . . .	2184	Molins, In re, 368 F.2d 258, 151 USPQ 570 (CCPA 1996) . . . . .	1449.02
Michalek, In re, 162 F.2d 229, 74 USPQ 107 (CCPA 1947) . . . . .	716.07	Molins PLC v. Textron Inc., 48 F.3d 1172, 33 USPQ2d 1823 (Fed. Cir. 1995) . . . . .	2004
Micro Chemical, Inc. v. Great Plains Chemical Co., 103 F.3d 1538, 41 USPQ2d 1238 (Fed. Cir. 1997). . . . .	2133.03(b)	Monaco v. Watson, 270 F.2d 335, 122 USPQ 564 (D.C. Cir. 1959). . . . .	2358

LIST OF DECISIONS CITED

Monks, In re, 588 F.2d 308, 200 USPQ 129 (CCPA 1978) . . . . . 901.05, 901.05(b), 1504, 2126.01, 2135.01	Mulder, In re, 716 F.2d 1542, 219 USPQ 189 (Fed. Cir. 1983) . . . . . 2138.06, 2183, 2184
Monogram Mfg. v. F & H Mfg., 62 USPQ 409 (9th Cir. 1944). . . . . 2133.03(e)(1)	Multiform Desiccants Inc. v. Medzam Ltd., 133 F.3d 1473, 45 USPQ2d 1429 (Fed. Cir. 1998) . . . . . 2106, 2111.01
Monsanto Co. v. Kamp, 269 F. Supp 818, 154 USPQ 259 (D.D.C. 1967) . . . . 605.07, 1216.02	Multiple Litigation Involving Frost Patent, In re, 540 F.2d 601, 185 USPQ 729 (3d Cir. 1976) . . . . . 2016
Moore, In re, 439 F.2d 1232, 169 USPQ 236 (CCPA 1971) . . . . . 1504.04, 2164.08, 2172	Murphy v. Eiseman, 166 USPQ 149 (Bd. Pat. Int. 1970) . . . . . 2308.02
Moore, In re, 444 F.2d 572, 170 USPQ 260 (CCPA 1971) . . . . . 715.07	Murray, Ex parte, 1891 Dec. Comm'r Pat. 130 (1891) . . . . . 711.03(c)
Moore v. U.S., 194 USPQ 423 (Ct. Cl. 1977) . . . . . 2134	Musgrave, In re, 431 F.2d 882, 167 USPQ 280 (CCPA 1970) . . . . . 2106
Morehouse, In re, 545 F.2d 162, 192 USPQ 29 (CCPA 1976) . . . . . 2106.02	Myers v. Feigelman, 455 F.2d 596, 172 USPQ 580 (CCPA 1972) . . . . . 2344
Moreton, In re, 288 F.2d 708, 129 USPQ 227 (CCPA 1961) . . . . . 2121	Naber v. Cricchi, 567 F.2d 382, 196 USPQ 294 (CCPA 1977) . . . . . 2138.06
Morgan, In re, 990 F.2d 1230, 26 USPQ2d 1392 (Fed. Cir. 1993) . . . . 1415.01, 1443	Nalbandian, In re, 661 F.2d 1214, 211 USPQ 782 (CCPA 1981) . . . . . 1504.02, 1504.03
Morris, In re, 127 F.3d 1048, 44 USPQ2d 1023 (Fed. Cir. 1997) . . . 904.01, 2106, 2111, 2163, 2173.05(a), 2181	Napier, In re, 55 F.3d 610, 34 USPQ2d 1782 (Fed. Cir. 1995) . . . . . 2112
Morse v. Porter, 155 USPQ 280 (Bd. Pat. Inter. 1965) . . . . . 2137.01, 2138.04	Naquin, In re, 398 F.2d 863, 158 USPQ 317 (CCPA 1968) . . . . 2106, 2106.02, 2164.05(b)
Morton, Ex parte, 134 USPQ 407 (Bd. App. 1961) . . . . . 2173.05(t)	National Steel Car Ltd. v. Canadian Pacific Railway Ltd., 357 F.3d 1319, 69 USPQ2d 1641 (Fed. Cir. 2004) . . . . . 2145
Morton Int'l, Inc. v. Cardinal Chem. Co., 5 F.3d 1464, 28 USPQ2d 1190 (Fed. Cir. 1993) . . . . . 2173.02	Nehrenberg, In re, 280 F.2d 161, 126 USPQ 383 (CCPA 1960) . . . . . 2173.05(b)
Morway v. Bondi, 203 F.2d 742, 97 USPQ 318 (CCPA 1953) . . . . . 2138.06	Nelson, In re, 280 F.2d 172, 126 USPQ 242 (CCPA 1960) . . . . . 2165
Mosher, In re, 248 F.2d 956, 115 USPQ 140 (CCPA 1957) . . . . . 1216.01	Nelson, In re, 420 F.2d 1079, 164 USPQ 458 (CCPA 1970) . . . . . 715.07(a)
Mott, In re, 539 F.2d 1291, 190 USPQ 536 (CCPA 1976) . . . . . 804, 2181	Nelson v. Bowler, 212 USPQ 760 (Comm'r Pat. 1981) . . . . . 2361
Mowry, Ex parte, 91 USPQ 219 (Bd. App. 1950) . . . . . 2144.09	Nelson v. Bowler, 626 F.2d 853, 206 USPQ 881 (CCPA 1980) . . . . . 2107.01, 2107.02, 2107.03, 2138.05
Mowry v. Whitney, 81 U.S. (14 Wall.) 620 (1871) . . . . . 2164.07	New England Braiding Co. v. A.W. Chesterton Co., 970 F.2d 878, 23 USPQ2d 1622 (Fed. Cir. 1992) . . . . . 2137.01
Mraz, In re, 455 F.2d 1069, 173 USPQ 25 (CCPA 1972) . . . . . 2125	New Idea Farm Equip. Corp. v. Sperry Corp., 916 F.2d 1561, 16 USPQ2d 1424 (Fed. Cir. 1990) . . . . . 2138
MSM Investments Co. v. Carolwood Corp., 259 F.3d 1335, 59 USPQ2d 1856 (Fed. Cir. 2001) . . . . . 2111.01	New Railhead Mfg., L.L.C. v. Vermeer Mfg. Co., 298 F.3d 1290, 63 USPQ2d 1843 (Fed. Cir. 2002) . . . . . 201.11, 2163



MANUAL OF PATENT EXAMINING PROCEDURE

Newell Cos. v. Kenney Mfg. Co., 864 F.2d 757, 9 USPQ2d 1417 (Fed. Cir. 1988) . . . . .	716.01(d), 716.04	Northern Telecom, Inc. v. Datapoint Corp., 908 F.2d 931, 15 USPQ2d 1321 (Fed. Cir. 1990) . . . . .	2106, 2128.01
Newkirk v. Lulejian, 825 F.2d 1581, 3 USPQ2d 1793 (Fed. Cir. 1987) . . . . .	715.07	Northern Telecom Ltd. v. Samsung Electronics Co., 215 F.3d 1281, 55 USPQ2d 1065 (Fed. Cir. 2000) . . . . .	2165.01
Newman v. Quigg, 877 F.2d 1575, 11 USPQ2d 1340 (Fed. Cir. 1989) . . . . .	2107.01	Norton v. Curtiss, 433 F.2d 779, 167 USPQ 532 (CCPA 1970) . . . . .	2012
Newton, In re, 414 F.2d 1400, 163 USPQ 34 (CCPA 1969) . . . . .	2161, 2165.02	Novak, In re, 306 F.2d 924, 134 USPQ 335 (CCPA 1962) . . . . .	2107.02, 2107.03
Ngai, In re, <u>F.3d</u> , 2004 WL 1068957 (Fed. Cir. May 13, 2004) . . . . .	2106, 2112.01	Novitski, Ex parte, 26 USPQ2d 1389 (Bd. Pat. App. & Inter. 1993) . . . . .	2112.02
Nielson, In re, 816 F.2d 1567, 2 USPQ2d 1525 (Fed. Cir. 1987) . . . . .	1206	Noznick, In re, 478 F.2d 1260, 178 USPQ 43 (CCPA 1973) . . . . .	716.03(b)
Nievelt, In re, 482 F.2d 965, 179 USPQ 224 (CCPA 1973) . . . . .	2145	Obiaya, Ex parte, 227 USPQ 58 (Bd. Pat. App. & Inter. 1985) . . . . .	707.07(f), 2145, 2258
Nilssen, In re, 851 F.2d 1401, 7 USPQ2d 1500 (Fed. Cir. 1988) . . . . .	1701.01, 2144	Ochiai, In re, 71 F.3d 1565, 37 USPQ2d 1127 (Fed. Cir. 1995) . . . . .	706.02(n), 2116.01, 2144.08
Nitinol Medical Technologies Inc., In re, 17 USPQ2d 1492 (Comm'r Pat. & Tm. 1990) . . . . .	2751	Ockert, In re, 245 F.2d 467, 114 USPQ 330 (CCPA 1957) . . . . .	804
Nitto Chemical Indus. Co. v. Comer, 39 USPQ2d 1778 (D.D.C. 1994) . . . . .	513	Oda, In re, 443 F.2d 1200, 170 USPQ 268 (CCPA 1971) . . . . .	2163, 2163.07
Nitz v. Ehrenreich, 537 F.2d 539, 190 USPQ 413 (CCPA 1976) . . . . .	2309.01	OddzOn Products, Inc. v. Just Toys, Inc., 122 F.3d 1396, 43 USPQ2d 1641 (Fed. Cir. 1997) . . . . .	706.02(l), 2004
Noelle v. Lederman, 355 F.3d 1343, 69 USPQ2d 1508 (Fed. Cir. 2004) . . . . .	2163	Odetics Inc. v. Storage Tech. Corp., 185 F.3d 1259, 51 USPQ2d 1225 (Fed. Cir. 1999) . . . . .	2183, 2184
Nolan, In re, 553 F.2d 1261, 193 USPQ 641 (CCPA 1977) . . . . .	716.02(b), 716.02(c)	Oelrich, In re, 579 F.2d 86, 198 USPQ 210 (CCPA 1978) . . . . .	716.01(c), 2144.08
Nolden, Ex parte, 149 USPQ 378 (Bd. Pat. App. 1965) . . . . .	2172.01	Oelrich, In re, 666 F.2d 578, 212 USPQ 323 (CCPA 1981) . . . . .	2112
Noll, In re, 545 F.2d 141, 191 USPQ 721 (CCPA 1976) . . . . .	2163, 2181, 2182, 2184	Oetiker, Ex parte, 23 USPQ2d 1641 (Bd. Pat. App. & Inter. 1992) . . . . .	2173.05(b)
Nomiya, In re, 509 F.2d 566, 184 USPQ 607 (CCPA 1975) . . . . .	2129, 2258	Oetiker, In re, 977 F.2d 1443, 24 USPQ2d 1443 (Fed. Cir. 1992) . . . . .	707.07(f), 716.01(d), 1504.01(a), 2107.02, 2141, 2141.01(a), 2142, 2144.08, 2145, 2164.07
NOMOS Corp. v. BrainLAB USA Inc., 357 F.3d 1364, 69 USPQ2d 1853 (Fed. Cir. 2004) . . . . .	2184	O'Farrell, In re, 853 F.2d 894, 7 USPQ2d 1673 (Fed. Cir. 1988) . . . . .	2143.02, 2144.08, 2145
Norco Products, Inc. v. Mecca Development, Inc., 617 F. Supp 1079, 227 USPQ 724 (D. Conn. 1985) . . . . .	1504.01(c)	Oguie, In re, 517 F.2d 1382, 186 USPO 227 (CCPA 1975) . . . . .	706.03(u), 2305.01, 2306.01
Nordberg, Inc. v. Telsmith, Inc., 82 F.3d 394, 38 USPQ2d 1593 (Fed. Cir. 1996) . . . . .	410	Ohshiro, Ex parte, 14 USPQ2d 1750 (Bd. Pat. App. & Inter. 1989) . . . . .	2163.05
Norlund, Ex parte, 1913 C.D. 161, 192 O.G. 989 (Comm'r Pat. 1913) . . . . .	1213.01, 2681	Ohsumi, Ex parte, 21 USPQ2d 1020 (Bd. Pat. App. & Inter. 1991) . . . . .	1206
Northam Warren Corp. v. D. F. Newfield Co., 7 F. Supp 773, 22 USPQ 313 (E.D.N.Y. 1934) . . . . .	2112.01		

LIST OF DECISIONS CITED

O.I. Corp. v. Tekmar Corp., 115 F.3d 1576, 42 USPQ2d 1777 (Fed. Cir. 1997) . . . . .	2181	Panagrossi, In re, 277 F.2d 181, 125 USPQ 410 (CCPA 1960) . . . . .	2174
Oka v. Youssefyeh, 849 F.2d 581, 7 USPQ2d 1169 (Fed. Cir. 1988) . . . . .	2138.04	Pandrol USA, LP v. Airboss Railway Products, Inc., 320 F.3d 1654, 65 USPQ2d 1985, (Fed. Cir. 2003) . . . . .	1302.04
Okajima v. Bourdeau, 261 F.3d 1350, 59 USPQ2d 1795 (Fed. Cir. 2001) . . . . .	2141.03	Panduit Corp. v. Dennison Mfg. Co., 774 F.2d 1082, 227 USPQ 337 (Fed. Cir. 1985) . . . . .	716.06, 1504.03, 2134
Okuzawa, In re, 537 F.2d 545, 190 USPQ 464 (CCPA 1976) . . . . .	2111.01	Panduit Corp. v. Dennison Mfg. Co., 810 F.2d 1561, 1 USPQ2d 1593 (Fed. Cir. 1987) . . . . .	2141.01, 2141.02, 2144.08
Olah, Ex parte, 131 USPQ 41 (Bd. App. 1960) . . . . .	201.13, 706.02(a), 901.05, 2133, 2135.01	Pannu v. Storz Instruments Inc., 258 F.3d 1366, 59 USPQ2d 1597 (Fed. Cir. 2001) . . . . .	1412.02
Onda, In re, 229 USPQ 235 (Comm'r Pat. 1985) . . . . .	706.02(1)(2), 1449.01, 2285, 2686.03	Pantzer, Ex parte, 176 USPQ 141 (Bd. App. 1972) . . . . .	2173.05(o)
Opinion of Hon. Edward Bates, 10 Op. Atty. Gen. 137 (1861) . . . . .	605.04(a)	Paperless Accounting v. Bay Area Rapid Transit System, 804 F.2d 659, 231 USPQ 649 (Fed. Cir. 1986) . . . . .	2133.01
Oppenauer, In re, 143 F.2d 974, 62 USPQ 297 (CCPA 1944) . . . . .	716.09	Papesch, In re, 315 F.2d 381, 137 USPQ 43 (CCPA 1963) . . . . .	716.02(a), 2141.02, 2144.08, 2144.09
O'Reilly v. Morse, 56 U.S. (15 How.) 62 (1854) . . . . .	706.03(a), 2106	Pappas, Ex parte, 23 USPQ2d 1636 (Bd. Pat. App. & Inter. 1992) . . . . .	1503.01, 1504.04, 2141.01(a), 2173.05(b)
Orita, In re, 550 F.2d 1277, 193 USPQ 145 (CCPA 1977) . . . . .	1412.01, 1457	Papst-Motoren, In re, 1 USPQ2d 1655 (Bd. Pat. App. & Inter. 1986) . . . . .	2258
Orthokinetics, Inc. v. Safety Travel Chairs, Inc., 806 F.2d 1565, 1 USPQ2d 1081 (Fed. Cir. 1986) . . . . .	2173.02, 2173.05(b)	Paragon Podiatry Laboratory, Inc. v. KLM Labs., Inc., 984 F.2d 1182, 25 USPQ2d 1561 (Fed. Cir. 1993) . . . . .	410, 2133.03(e)(2)
Orthopedic Equip. Co., Inc. v. All Orthopedic Appliances, Inc., 707 F.2d 1376, 217 USPQ 1281 (Fed. Cir. 1983) . . . . .	716.04	Parker v. Flook, 437 U.S. 584, 198 USPQ 193 (1978) . . . . .	2106
Osmond, Ex parte, 191 USPQ 334 (Bd. App. 1973) . . . . .	711.06(a), 2136	Parker v. Frilette, 462 F.2d 544, 174 USPQ 321 (CCPA 1972) . . . . .	2138.05
Osmond, Ex parte, 191 USPQ 340 (Bd. App. 1976) . . . . .	711.06(a)	Parks v. Fine, 773 F.2d 1577, 227 USPQ 432 (Fed. Cir. 1985) . . . . .	2307
Ott v. Goodpasture, 40 USPQ2d 1831 (D. N.Tex. 1996) . . . . .	410	Parks, Ex parte, 30 USPQ2d 1234 (Bd. Pat. App. & Inter. 1993) . . . . .	2173.05(i)
Otto, In re, 312 F.2d 937, 136 USPQ 458 (CCPA 1963) . . . . .	707.07(f), 2111.02, 2115	Patent No. 4,409,763, In re, 7 USPQ2d 1798 (Comm'r Pat. 1988) . . . . .	2590
Ovist, Ex parte, 152 USPQ 709 (Bd. App. 1963) . . . . .	901.05, 2126.02	Patent Term Extension Application, US Patent No. 3,849,549, In re, 226 USPQ 283 (Pat. & Tm. Office 1985) . . . . .	2751
Ovshinsky, Ex parte, 10 USPQ2d 1075 (Bd. Pat. App. & Inter. 1989) . . . . .	715.07	Patlex Corp. v. Mossinghoff, 771 F.2d 480, 226 USPQ 985 (Fed. Cir. 1985) . . . . .	2225, 2240, 2244, 2249, 2625, 2640
Pac-Tec Inc. v. Amerace Corp., 903 F.2d 796, 14 USPQ2d 1871 (Fed. Cir. 1990) . . . . .	2111.02, 2163		
Paine, Webber, Jackson & Curtis, Inc. v. Merrill Lynch, Pierce, Fenner, & Smith, Inc., 564 F. Supp. 1358, 218 USPQ 212 (D. Del. 1983) . . . . .	2106		
Palmer, In re, 451 F.2d 1100, 172 USPQ 126 (CCPA 1971) . . . . .	716.01(a)		

MANUAL OF PATENT EXAMINING PROCEDURE

Patlex Corp. v. Mossinghoff, 758 F.2d 594, 225 USPQ 243 (Fed. Cir. 1985) . . .	2211, 2611	Phelan, In re, 205 F.2d 183, 98 USPQ 156 (CCPA 1953) . . . . .	804
Patlex Corp. v. Quigg, 6 USPQ2d 1296 (D. D.C. 1988). . . . .	2246, 2646	Philco Corp. v. Admiral Corp., 199 F. Supp. 797 131 USPQ 413 (D. Del. 1961) . . . . .	1503.02, 1504.04, 2133.03(e)(1)
Paulik v. Rizkalla, 760 F.2d 1270, 226 USPQ 224 (Fed. Cir. 1985). . . . .	2138.01, 2138.03	Phillips, In re, 608 F.2d 879, 203 USPQ 971 (CCPA 1979) . . . . .	2106
Paulsen, In re, 30 F.3d 1475, 31 USPQ2d 1671 (Fed. Cir. 1994) . . . . .	716.03, 2106, 2144.08	Piasecki, In re, 745 F.2d 1468, 223 USPQ 785 (Fed. Cir. 1984) . . . . .	716.01(d), 2107.02, 2142, 2144.08
Payne, Ex parte, 1904 C.D. 42, 108 O.G. 1049 (Comm'r Pat. 1903) . . . . .	707.07(g)	Pickles, Ex parte, 1904 C.D. 126, 109 O.G. 1888 (Comm'r Pat. 1904) . . . . .	810.02
Payne, In re, 606 F.2d 303, 203 USPQ 245 (CCPA 1979) . . . . .	716.02(a), 716.02(e), 2144.09	Pierce v. Allen B. DuMont Laboratories, Inc., 297 F.2d 323, 131 USPQ 340 (3d Cir. 1961). . . . .	804
Peeler v. Miller, 535 F.2d 647, 190 USPQ 117 (CCPA 1976) . . . . .	2138.03	Pierce v. Watson, 275 F.2d 890, 124 USPQ 356 (D.C. Cir. 1960). . . . .	715.01(b)
Peck, Ex parte, 1901 C.D. 136, 96 O.G. 2409 (Comm'r Pat. 1901) . . . . .	608.02(f)	Pilkington, In re, 411 F.2d 1345, 162 USPQ 145 (CCPA 1969). . . . .	2173.05(o)
Penn Yan Boats, Inc. v. Sea Lark Boats Inc., 354 F. Supp 948, 175 USPQ 260 (S.D. Fla. 1972). . . . .	2004	PIN/NIP, Inc. v. Platte Chem. Co., 304 F.3d 1235, 64 USPQ2d 1344 (Fed. Cir. 2002) . . . . .	2163
Pennwalt Corp. v. Akzona, Inc., 740 F.2d 1573, 222 USPQ 833 (Fed. Cir. 1984) . .	2133.03(e)	Pio, In re, 217 F.2d 956, 104 USPQ 177 (CCPA 1954). . . . .	716.07
Pennwalt Corp. v. Durand-Wayland, Inc., 833 F.2d 931, 4 USPQ2d 1737 (Fed. Cir. 1987) . . . . .	2184	Pitney Bowes, Inc. v. Hewlett-Packard Co., 182 F.3d 1298, 51 USPQ2d 1161 (Fed. Cir. 1999) . . . . .	2111.02
Pentec, Inc. v. Graphic Controls Corp., 776 F.2d 309, 227 USPQ 766 (Fed. Cir. 1985) . . . . .	716.03(b), 716.06, 2141.01(a)	Plant Genetic Sys., N.V. v. DeKalb Genetics Corp., 315 F.3d 1335, 65 USPQ2d 1452 (Fed. Cir. 2003) . . . . .	2164.08
Personalized Media Communications LLC v. ITC, 161 F.3d 696, 48 USPQ2d 1880 (Fed. Cir. 1998) . . . . .	2181	Plastic Contact Lens Co. v. Gottschalk, 484 F.2d 837, 179 USPQ 262 (D.C. Cir. 1973). . . . .	706.03(w)
Petering, In re, 301 F.2d 676, 133 USPQ 275 (CCPA 1962) . . . . .	2131.02, 2131.03, 2144.08	Platner, In re, 155 USPQ 222 (Comm'r Pat. 1967) . . . . .	1504.05
Peters, In re, 723 F.2d 891, 221 USPQ 952 (Fed. Cir. 1983) . . . . .	2163.05	Pleuddemann, In re, 910 F.2d 823, 15 USPQ2d 1738 (Fed. Cir. 1990). . . . .	2116.01
Petersen v. Fee Int'l Ltd., 381 F. Supp 1071, 182 USPQ 264 (W.D. Okla. 1974) . . . . .	2134	Plockinger, In re, 481 F.2d 1327, 179 USPQ 103 (CCPA 1973). . . . .	2317
Peterson, Ex parte, 49 USPQ 119, 1941 C.D. 8 (Comm'r Pat. 1941). . . . .	710.02(b), 2315, 2363	Plumb, In re, 470 F.2d 1403, 176 USPQ 323 (CCPA 1973) . . . . .	715.03
Peterson, Ex parte, 63 USPQ 99 (Bd. App. 1944) . . . . .	901.02	Polumbo v. Don-Joy Co., 762 F.2d 969, 226 USPQ 5 (Fed. Cir. 1985) . . . . .	2183, 2184
Peterson, In re, 315 F.3d 1325, 65 USPQ2d 1379 (Fed. Cir. 2003). . . . .	716.02(d), 2144.05	Popoff v. Orchin, 144 USPQ 762 (Bd. Pat. Int. 1963) . . . . .	2371
Pfaff v. Wells Elecs., Inc., 525 U.S. 55, 48 USPQ2d 1641 (1998). . . . .	706.02(l)(2), 2133.03(b), 2133.03(c), 2163, 2163.02	Porter, Ex parte, 25 USPQ2d 1144 (Bd. Pat. App. & Inter. 1992) . . . . .	608.01(n), 2173.05(e), 2173.05(f), 2173.05(q)

LIST OF DECISIONS CITED

Portola Packaging, Inc., In re, 110 F.3d 786, 42 USPQ2d 1295 (Fed. Cir. 1997) . . .	2258.01	Radio Steel and Mfg. Co. v. MTD Prod- ucts, Inc., 731 F.2d 840, 221 USPQ 657 (Fed. Cir. 1984) . . . . .	2173.05(j)
Potter v. Dann, 201 USPQ 574 (D.D.C. 1978) . . . . .	711.03(c)	Rainer, In re, 305 F.2d 505, 134 USPQ 343 (CCPA 1962) . . . . .	2124
Pottier, In re, 376 F.2d 328, 153 USPQ 407 (CCPA 1967) . . . . .	2107.02	Rainer, In re, 390 F.2d 771, 156 USPQ 334 (CCPA 1968) . . . . .	715.03
Powell, Ex parte, 37 USPQ 285, 1938 C.D. 15, 489 O.G. 231 (Bd. App. 1938) . .	715.01(c)	Ralston Purina Co. v. Far-Mar-Co., Inc., 772 F.2d 1570, 227 USPQ 177 (Fed. Cir. 1985) . . . . .	2163.02
Power Controls Corp., v. Hybrinetics, Inc., 806 F.2d 234, 231 USPQ 774 (Fed. Cir. 1986) . . . . .	1504.01(c)	Rapoport v. Dement, 254 F.3d 1053, 59 USPQ2d 1215 (Fed. Cir. 2001) . . . . .	2111.01
PPG Ind. v. Guardian Ind., 75 F.3d 1558, 37 USPQ2d 1618 (Fed. Cir. 1996) . . . . .	2164.06(b)	Rasmussen, In re, 650 F.2d 1212, 211 USPQ 323 (CCPA 1981) . . . . .	706.03(o), 1504.04, 2163, 2163.01, 2163.04, 2163.05, 2163.06
PPG Industries v. Guardian Industries, 156 F.3d 1351, 48 USPQ2d 1351 (Fed. Cir. 1998) . . . . .	2111.03, 2163	Ratny, In re, 24 USPQ2d 1713 (Comm'r Pat. 1992) . . . . .	323
Prater, In re, 415 F.2d 1393, 162 USPQ 541 (CCPA 1969) . . . . .	2106, 2111, 2172, 2173.05(a), 2173.05(q), 2411.01	Ratti, In re, 270 F.2d 810, 123 USPQ 349 (CCPA 1959) . . . . .	2143.01
Pratt, Ex parte, 1887 Dec. Comm'r Pat. 31 (Comm'r Pat. 1887) . . . . .	711.03(c), 2734	Ray v. Lehman, 55 F.3d 606, 34 USPQ2d 1786 (Fed. Cir. 1995) . . . . .	2590, 2734
Preda, In re, 401 F.2d 825, 159 USPQ 342 (CCPA 1968) . . . . .	2144.01	Raytek, Inc. v. Solfan Systems, Inc., 211 USPQ 405 (N.D. Cal., 1981) . . . . .	2286, 2686.04
Price v. Symsek, 988 F.2d 1187, 26 USPQ2d 1031 (Fed. Cir. 1993) . . . . .	2137, 2138.01	Raytheon v. Roper, 724 F.2d 951, 220 USPQ 592 (Fed. Cir. 1983) . . . . .	2107.02, 2164.08
Process Control Corp. v. HydReclaim Corp., 190 F.3d 1350, 52 USPQ2d 1029 (Fed. Cir. 1999) . . . . .	706.03(d), 2111.01, 2173.05(a)	RCA Corp. v. Data Gen. Corp., 887 F.2d 1056, 12 USPQ2d 1449 (Fed. Cir. 1989) . . . . .	2133.03, 2133.03(b), 2133.03(e)(3)
Protein Found., Inc. v. Brenner, 260 F. Supp 519, 151 USPQ 561 (D.D.C. 1966) . . . . .	706.02(a)	Reading & Bates Construction Co. v. Baker Energy, 748 F.2d 645, 223 USPQ 1168 (Fed. Cir. 1984) . . . . .	2129
Purdue Pharma L.P. v. Faulding, Inc., 230 F.3d 1320, 56 USPQ2d 1481 (Fed. Cir. 2000) . . . . .	2163, 2163.05	Rebstock v. Flouret, 191 USPQ 342 (Bd. Pat. Inter. 1975) . . . . .	2138.06
Quad Environmental Technologies Corp. v. Union Sanitary District, 946 F.2d 870, 20 USPQ2d 1392 (Fed. Cir. 1991) . . . .	804.02	Reckitt & Colman Products Ltd., In re, 230 USPQ 369 (Comm'r Pat. & Tm. 1986) . . . . .	2755.01
Quadranti, Ex parte, 25 USPQ2d 1071 (Bd. Pat. App. & Inter. 1992) . . . . .	2144.06	Recreative Technologies, In re, 83 F.3d 1394, 38 USPQ2d 1776 (Fed. Cir. 1996) . . . . .	2242, 2246, 2642, 2646
Quayle, Ex parte, 25 USPQ 74, 1935 C.D. 11, 453 O.G. 213 (Comm'r Pat. 1935) . . . . .	706.07(h), 710.02(b), 714.03, 714.14, 714.15, 2266.01, 2731	Red Cross Mfg. v. Toro Sales Co., 525 F.2d 1135, 188 USPQ 241 (7th Cir. 1975) . . . . .	2133.03(e)(1)
Rackham, Ex parte, 1923 C.D. 4 (Comm'r Pat. 1922) . . . . .	901.05	Reed v. Quigg, 110 F.R.D. 363, 230 USPQ 2 (D.D.C. 1986) . . . . .	2279
Radio Corp. of America v. Radio Eng'g Labs., Inc., 293 U.S. 1, 21 USPQ 353 (1934) . . . . .	2138.01	Reeves Bros., Inc. v. U.S. Laminating Corp., 282 F. Supp. 118, 157 USPQ 235 (E.D. N.Y. 1968) . . . . .	901.05

MANUAL OF PATENT EXAMINING PROCEDURE

Refac Int'l Ltd. v. Lotus Development Corp., 81 F.3d 1576, 38 USPQ2d 1665 (Fed. Cir. 1996) . . . . .	410	Rinehart, In re, 531 F.2d 1048, 189 USPQ 143 (CCPA 1976) . . . . .	2107.02, 2142, 2143.02, 2144.04
Regents of the University of California v. Eli Lilly & Co., 119 F.3d 1559, 43 USPQ2d 1398 (Fed. Cir. 1997) . . . . .	2106, 2111.03, 2163, 2163.02, 2163.03	Riverwood Int'l Corp. v. R.A. Jones & Co., 324 F.3d 1346, 66 USPQ2d 1331 (Fed. Cir. 2003) . . . . .	2129
Reid, In re, 179 F.2d 998, 84 USPQ 478 (CCPA 1950) . . . . .	716.07	Robbins Co. v. Lawrence Mfg. Co., 482 F.2d 426, 178 USPQ 577 (9th Cir. 1973) . . . . .	2133.03(d), 2133.03(e)(1), 2133.03(e)(4)
Rekers, In re, 203 USPQ 1034 (Comm'r Pat. 1979) . . . . .	804.03	Roberts, In re, 470 F.2d 1399, 176 USPQ 313 (CCPA 1973) . . . . .	2181
Remark, Ex parte, 15 USPQ2d 1498 (Bd. Pat. App. & Inter. 1990) . . . . .	716.03, 716.03(b), 2144.08	Robertson, In re, 169 F.3d 743, 49 USPQ2d 1949 (Fed. Cir. 1999) . . . . .	2112, 2114, 2163, 2163.07(a)
Remington, Ex parte, 1905 C.D. 28, 114 O.G. 694 (Comm'r Pat. 1904) . . . . .	1503.01	Robins, In re, 429 F.2d 452, 166 USPQ 552 (CCPA 1970) . . . . .	2163
Republic Indus., Inc. v. Schlage Lock Co. 593 F.2d 963, 200 USPQ 769 (7th Cir. 1979) . . . . .	2141	Robotic Vision Sys. v. View Eng'g, Inc., 112 F.3d 1163, 42 USPQ2d 1619 (Fed. Cir. 1997) . . . . .	2106
Reuge, Ex parte, 115 USPQ 51 (Bd. Pat. App. & Inter. 1957) . . . . .	901.05, 901.05(b)	Roche Products v. Bolar Pharmaceuticals, 733 F.2d 858, 221 USPQ 937 (Fed. Cir. 1984) . . . . .	2750
Reuter, In re, 651 F.2d 751, 210 USPQ 249 (CCPA 1981) . . . . .	1901.06	Rodime PLC v. Seagate Technology, Inc., 174 F.3d 1294, 50 USPQ2d 1429 (Fed. Cir. 1999) . . . . .	2181
Rexnord Corp. v. Laitram Corp., 274 F.3d 1336, 60 USPQ2d 1851 (Fed. Cir. 2001) . . . . .	2111.01	Rohm & Haas Co. v. Crystal Chem.Co., 722 F.2d 1556, 200 USPQ 289 (Fed. Cir. 1983) . . . . .	410
Rey-Bellet v. Engelhardt, 493 F.2d 1380, 181 USPQ 453 (CCPA 1974) . . . . .	2107.02, 2138.05	Rohm & Haas Co. v. Roberts Chem., Inc., 142 F. Supp. 499, 110 USPQ 93 (S.W. Va. 1956) . . . . .	1403
Reynolds, In re, 443 F.2d 384, 170 USPQ 94 (CCPA 1971) . . . . .	2163.07(a)	Rose, In re, 220 F.2d 459, 105 USPQ 237 (CCPA 1955) . . . . .	2144.04
Richardson, Ex Parte, 1906 Dec. Comm'r Pat. 83 (1905) . . . . .	711.03(c)	Rosen, In re, 673 F.2d 388, 213 USPQ 347 (CCPA 1982) . . . . .	1503.01, 1504.03, 2141.01(a)
Richardson v. Suzuki Motor Co., 868 F.2d 1226, 9 USPQ2d 1913 (Fed. Cir. 1989) . . . . .	2131	Rosenberg, Ex parte, 46 USPQ 393 (Bd. App. 1939) . . . . .	1610
Richardson-Vicks, Inc. v. The Upjohn Co., 122 F.3d 1476, 44 USPQ2d 1181 (Fed. Cir. 1997) . . . . .	716.01(d)	Rosenblum v. Hiroshima, 220 USPQ 383 (Comm'r Pat. 1983) . . . . .	1206
Richman, In re, 409 F.2d 269, 161 USPQ 359 (CCPA 1969) . . . . .	1412.02	Rothermel, In re, 276 F.2d 393, 125 USPQ 328 (CCPA 1960) . . . . .	716.01
Riegger v. Beierl, 1910 C.D. 12, 150 O.G. 826 (Comm'r Pat. 1910) . . . . .	604.06	Rouffet, In re, 149 F.3d 1350, 47 USPQ2d 1453 (Fed. Cir. 1998) . . . . .	1216.01, 2143.01
Rieser v. Williams, 225 F.2d 419, 118 USPQ 96 (CCPA 1958) . . . . .	2138.06, 2307	Rowand, In re, 526 F.2d 558, 187 USPQ 487 (CCPA 1975) . . . . .	1412.01
Rijckaert, In re, 9 F.3d 1531, 28 USPQ2d 1955 (Fed. Cir. 1993) . . . . .	2112, 2141.02, 2144.08	Rowe v. Dror, 112 F.3d 473, 42 USPQ2d 1550 (Fed. Cir. 1997) . . . . .	2111.02, 2303
Rinehart, Ex parte, 10 USPQ2d 1719 (Bd. Pat. App. & Inter. 1985) . . . . .	2404.01		

LIST OF DECISIONS CITED

Royka, In re, 490 F.2d 981, 180 USPQ 580 (CCPA 1974) . . . . .	2143.03	Salmon, In re, 705 F.2d 1579, 217 USPQ 981 (Fed. Cir. 1983) . . . . .	1504.04, 1504.20
Rubber-Tip Pencil Co. v. Howard, 87 U.S. (20 Wall.) 498 (1874) . . . . .	2106	Salsbury, Ex parte, 38 USPQ 149 (Comm'r Pat. 1938) . . . . .	1504.04
Rubin, Ex parte, 128 USPQ 440 (Bd. App. 1959) . . . . .	2144.04	Samour, In re, 571 F.2d 559, 197 USPQ 1 (CCPA 1978) . . . . .	2131.01
Rubinfeld, In re, 270 F.2d 391, 123 USPQ 210 (CCPA 1959) . . . . .	1504.05	Sampson v. Ampex Corp., 463 F.2d 1042, 174 USPQ 417 (2d Cir. 1972) . . . . .	201.06(d)
Ruff, In re, 256 F.2d 590, 118 USPQ 340 (CCPA 1958) . . . . .	2144.06	Sampson v. Comm'r Pat., 195 USPQ 136 (D.D.C. 1976) . . . . .	1402
Ruiz v. A.B. Chance Co., 357 F.3d 1270, 69 USPQ2d 1686 (Fed. Cir. 2004) . . . . .	2143.01, 2145	Sampson v. Dann, 466 F. Supp. 965, 201 USPQ 15 (D.D.C. 1978) . . . . .	1308
Ruscetta, In re, 255 F.2d 687, 118 USPQ 101 (CCPA 1958) . . . . .	201.11, 2004, 2217, 2218, 2258, 2617	Sanford, Ex parte, 1914 C.D. 69, 204 O.G. 1346 (Comm'r Pat. 1914) . . . . .	1504.05
Ruschig, In re, 343 F.2d 965, 145 USPQ 274 (CCPA 1965) . . . . .	2144.08	Sapp, In re, 324 F.2d 1021, 139 USPQ 552 (CCPA 1963) . . . . .	1504.03
Ruschig, In re, 379 F.2d 990, 154 USPQ 118 (CCPA 1967) . . . . .	2163, 2163.05	Sarett, In re, 327 F.2d 1005, 140 USPQ 474 (CCPA 1964) . . . . .	804
Ruskin, In re, 347 F.2d 843, 146 USPQ 211 (CCPA 1965) . . . . .	2114	Sarkar, In re, 575 F.2d 870, 197 USPQ 788 (CCPA 1978) . . . . .	724
Ruskin, In re, 354 F.2d 395, 148 USPQ 221 (CCPA 1966) . . . . .	2107.01	Sarkar, In re, 588 F.2d 1330, 200 USPQ 132 (CCPA 1978) . . . . .	2106
Russell, In re, 239 F.2d 387, 112 USPQ 58 (CCPA 1956) . . . . .	1504.05	Sasajima, Ex parte, 212 USPQ 103 (Bd. App. 1981) . . . . .	716.02(f)
Russell, In re, 439 F.2d 1228, 169 USPQ 426 (CCPA 1971) . . . . .	706.03(w)	Sasse, In re, 629 F.2d 675, 207 USPQ 107 (CCPA 1980) . . . . .	716.07, 2121, 2121.02
Rutan, In re, 231 USPQ 864 (Comm'r Pat. 1986) . . . . .	150	Saunders, Ex parte, 1883 C.D. 23, 23 O.G. 1224 (Comm'r Pat. 1883) . . . . .	715.07
Ryco, Inc. v. Ag-Bag Corp., 857 F.2d 1418, 8 USPQ2d 1323 (Fed. Cir. 1988) . . . . .	2144.07	Saunders, In re, 444 F.2d 599, 170 USPQ 213 (CCPA 1971) . . . . .	716.02(f), 2142, 2172
Rydeen v. Quigg, 748 F. Supp 900, 16 USPQ2d 1876 (D.D.C. 1990) . . . . .	2590	Scaltech, Inc. v. Retec/Tetra, L.L.C., 269 F.3d 1321, 60 USPQ2d 1687 (Fed. Cir. 2001) . . . . .	2133.03(c)
Ryko Manufacturing Co. v. Nu-Star, Inc., 950 F.2d 714, 21 USPQ2d 1053 (Fed. Cir. 1991) . . . . .	2141.03, 2144.08	Scarborough, In re, 500 F.2d 560, 182 USPQ 298 (CCPA 1974) . . . . .	608.01(p), 2106, 2106.01, 2106.02,, 2164.06, 2164.06(a)
S, In re Application of, 8 USPQ2d 1630 (Comm'r Pat. 1988) . . . . .	711.03(c)	Schaub, In re, 537 F.2d 509, 190 USPQ 324 (CCPA 1976) . . . . .	715.03
SAB Industri AB v. Bendix Corp., 199 USPQ 95 (E.D. Va. 1978) . . . . .	605.07	Schauman, In re, 572 F.2d 312, 197 USPQ 5 (CCPA 1978) . . . . .	706.02(m), 2131.02, 2144.08
Sachs v. Wadsworth, 48 F.2d 928, 9 USPQ 252 (CCPA 1931) . . . . .	715.07	Schechter, In re, 205 F.2d 185, 98 USPQ 144 (CCPA 1953) . . . . .	2144.08, 2144.09, 2173.05(i)
Sage Prods., Inc. v. Devon Indus., Inc., 126 F.3d 1420, 44 USPQ2d 1103 (Fed. Cir. 1997) . . . . .	2181	Scheiber, In re, 587 F.2d 59, 199 USPQ 782 (CCPA 1978) . . . . .	201.11, 2163.03
Sakraida v. Ag Pro, Inc., 425 U.S. 273, 189 USPQ 449 (1979) . . . . .	716.01(a), 2141	Schenck v. Nortron Corp., 713 F.2d 782, 218 USPQ 698 (Fed. Cir. 1983) . . . . .	2141.02, 2144.04

MANUAL OF PATENT EXAMINING PROCEDURE

Schendel v. Curtis, 83 F.3d 1399, 38 USPQ2d 1743 (Fed. Cir. 1996) . . . . .	2308.02	Scudder, Ex parte, 169 USPQ 814 (Bd. App. 1971) . . . . .	1402, 1412.04
Schering Corp. v. Amgen, Inc., 222 F.3d 1347, 55 USPQ2d 1650 (Fed. Cir. 2000) . . . . .	2163.07	Scully Signal Co. v. Electronics Corp. of America, 570 F.2d 355, 196 USPQ 657 (1st Cir. 1977) . . . . .	716.04
Schering Corp. v. Geneva Pharm. Inc., 339 F.3d 1373, 67 USPQ2d 1664 (Fed. Cir. 2003) . . . . .	2112	Seal-Flex, Inc. v. Athletic Track and Court Construction, 172 F.3d 836, 50 USPQ2d 1225 (Fed. Cir. 1999) . . . . .	2181
Schering-Plough Corp., In re, 1 USPQ2d 1926 (Comm'r Pat. & Tm. 1986) . . . . .	2760	Searles, In re, 422 F.2d 431, 164 USPQ 623 (CCPA 1970) . . . . .	602.03, 2132.01
Schier, Ex parte, 21 USPQ2d 1016 Bd. Pat. App. & Inter. 1991) . . . . .	1206	Seattle Box Co. v. Industrial Crating & Packing, Inc., 731 F.2d 818, 221 USPQ 568 (Fed. Cir. 1984) . . . . .	2173.05(b)
Schlittler, In re, 234 F.2d 882, 110 USPQ 304 (CCPA 1956) . . . . .	2128.02	Seebach, In re, 88 F.2d 722, 33 USPQ 149 (CCPA 1937) . . . . .	709.01
Schnell, In re, 46 F.2d 203, 8 USPQ 19 (CCPA 1931) . . . . .	1504.01	Seid, In re, 161 F.2d 229, 73 USPQ 431 (CCPA 1947) . . . . .	2144.04
Schneller, In re, 397 F.2d 350, 158 USPQ 210 (CCPA 1968) . . . . .	804, 1504.06	Seiko Epson Corp. v. Nu-Kote Int'l, Inc., 190 F.3d 1360, 52 USPQ2d 1011 (Fed. Cir. 1999) . . . . .	1504.01(c)
Schoenwald, In re, 964 F.2d 1122, 22 USPQ2d 1671 (Fed. Cir. 1992) . . . . .	2122	Seiko Koko Kabushiki Kaisha, Ex parte, 225 USPQ 1260 (Bd. App. 1984) . . . . .	2258
Schrader, In re, 22 F.3d 290, 30 USPQ2d 1445 (Fed. Cir. 1994) . . . . .	2106	Self, In re, 671 F.2d 1344, 213 USPQ 1 (CCPA 1982) . . . . .	1412.03, 2131.05
Schreiber, In re, 128 F.3d 1473, 44 USPQ2d 1429 (Fed. Cir. 1997) . . . . .	2111.02, 2112, 2114	Semiconductor Energy Laboratory Co. v. Samsung Electronics Co., 204 F.3d 1368, 54 USPQ2d 1001 (Fed. Cir. 2000) . . . . .	609, 2004
Schulze, In re, 346 F.2d 600, 145 USPQ 716 (CCPA 1965) . . . . .	716.01(c), 2106.02, 2145	Sernaker, In re, 702 F.2d 989, 217 USPQ 1 (Fed. Cir. 1983) . . . . .	1206, 2144
Schuurs, In re, 218 USPQ 443 (Comm'r Pat. 1983) . . . . .	1481	Shaffer Tool Works v. Joy Mfg. Co., 687 F. Supp 80, 167 USPQ 170 (S.D. Tex. 1970) . . . . .	1701.01
Schwab v. Pittman, 451 F.2d 637, 172 USPQ 69 (CCPA 1971) . . . . .	2308.02	Shaked v. Taniguchi, 21 USPQ2d 1289 (Bd. Pat. App. & Inter. 1991) . . . . .	2686.02
Schwarze, Ex parte, 151 USPQ 426 (Bd. App. 1966) . . . . .	608.01(p)	Sharp, Ex parte, Pat. No. 2,232,739 . . . . .	820
Scott, In re, 323 F.2d 1016, 139 USPQ 297 (CCPA 1963) . . . . .	2144.06	Shatterproof Glass Corp. v. Libbey- Owens Ford Co., 758 F.2d 613, 225 USPQ 634 (Fed. Cir. 1985) . . . . .	2133.03(b), 2173.05(a)
Scott v. Brandenburger, 216 USPQ 326 (Bd. App. 1982) . . . . .	2137	Shell Development Co. v. Watson, 149 F. Supp 279, 113 USPQ 265 (D. D.C. 1957) . . . . .	2106
Scott v. Finney, 34 F.3d 1058, 32 USPQ2d 1115 (Fed. Cir. 1994) . . . . .	2107.01, 2107.03, 2164.05	Shepherd, In re, 172 F.2d 560, 80 USPQ 495 (CCPA 1949) . . . . .	716.07
Scott v. Koyama, 281 F.3d 1243, 61 USPQ2d 1856 (Fed. Cir. 2002) . . . . .	2138.06	Sherwood, In re, 613 F.2d 809, 204 USPQ 537 (CCPA 1980) . . . . .	608.01(h), 2106.01, 2165.04
Scragg, In re, 215 USPQ 715 (Comm'r Pat. 1982) . . . . .	2285, 2686.03		
Scripps Clinic and Res. Found. v. Genen- tech, Inc., 927 F.2d 1565, 18 USPQ2d 1001 (Fed. Cir. 1991) . . . . .	2165.04, 2411.01		

LIST OF DECISIONS CITED

Shindelar v. Holdeman, 628 F.2d 1337, 207 USPQ 112 (CCPA 1980) . . . . .	2138.03	Smith, Ex parte, 1888 C.D. 131, 44 O.G. 1183 (Comm'r Pat. 1888) . . . . .	806.04(c)
Shohan, Ex parte, 1941 C.D. 1 (Comm'r Pat. 1940) . . . . .	2307.03	Smith, In re, 458 F.2d 1389, 173 USPQ 679 (CCPA 1972) . . . . .	2163, 2163.05
Shokal, In re, 242 F.2d 771, 113 USPQ 283 (CCPA 1957) . . . . .	715.03	Smith, In re, 714 F.2d 1127, 218 USPQ 976 (Fed. Cir. 1983) . . . . .	2133.03(a), 2133.03(e)
Sichert, In re, 566 F.2d 1154, 196 USPQ 209 (CCPA 1977) . . . . .	2107.01, 2107.02, 2107.03	Smith v. Diamond, 209 USPQ 1091 (D.D.C. 1981) . . . . .	711.03(c)
Signtech USA Ltd. v. Vutek, Inc., 174 F.3d 1352, 50 USPQ2d 1372 (Fed. Cir. 1999) . . . . .	2181	Smith v. Hayashi, 209 USPQ 754 (Bd. of Pat. Inter. 1980) . . . . .	2144.06
Silvestri v. Grant, 496 F.2d 593, 181 USPQ 706 (CCPA 1974) . . . . .	2138.04	Smith v. M & B Sales & Mfg., 13 USPQ2d 2002 (N.D. Cal. 1990) . . . . .	1504.01(c)
Simon, In re, 302 F.2d 737, 133 USPQ 524 (CCPA 1962) . . . . .	2174	Smith v. Mossinghoff, 671 F.2d 533, 213 USPQ 977 (D.C. Cir. 1982) . . . . .	711.03(c)
Simpson, Ex parte, 218 USPQ 1020 (Bd. App. 1982) . . . . .	706.03(d), 2173.05(u)	Smith Davis Mfg. Co. v. Mellon, 58 F. 705 (8th Cir. 1893) . . . . .	2133.03(e)(6)
Sinclair & Carroll Co. v. Interchemical Corp., 325 U.S. 327, 65 USPQ 297 (1945) . . . . .	2144.07	SmithKline Beecham Corp. v. Apotex Corp., _F.3d_, 2004 WL 868425 (Fed. Cir. Apr. 23, 2004) . . . . .	2133.03(e), 2133.03(e)(3), 2133.03(e)(6)
Sitz, In re, 331 F.2d 617, 141 USPQ 505 (CCPA 1964) . . . . .	2307	Smyth, In re, 189 F.2d 982, 90 USPQ 106 (CCPA 1951) . . . . .	716.09
Sivaramakrishnan, In re, 673 F.2d 1383, 213 USPQ 441 (CCPA 1982) . . . . .	2131.02	Smythe, In re, 480 F.2d 1376, 178 USPQ 279 (CCPA 1973) . . . . .	2163, 2163.05, 2163.07(a)
Sivertz, In re, 227 USPQ 255 (Comm'r Pat. 1985) . . . . .	711.03(c)	Sneed, In re, 710 F.2d 1544, 218 USPQ 385 (Fed. Cir. 1983) . . . . .	1445, 2145
Skil Corp. v. Lucerne Products Inc., 503 F.2d 745, 183 USPQ 396 (7 <sup>th</sup> Cir. 1974) . . . . .	2133.03(e)	Snyder, Ex parte, 1904 C.D. 242, 110 O.G. 2636 (Comm'r Pat. 1904) . . . . .	810.02
Skil Corp. v. Rockwell Manufacturing Co., 358 F. Supp. 1257, 178 USPQ 562 (N.D. Ill. 1973) . . . . .	2133.03(e)(3)	Sobin, Ex parte, 139 USPQ 528 (Bd. App. 1962) . . . . .	2173.05(t)
Skinner, Ex parte, 2 USPQ2d 1788 (Bd. Pat. App. & Inter. 1986) . . . . .	2142	Soli, In re, 317 F.2d 941, 137 USPQ 797 (CCPA 1963) . . . . .	2144.02, 2144.03
Skrivan, In re, 427 F.2d 801, 166 USPQ 85 (CCPA 1970) . . . . .	2164.08	Soll, In re, 97 F.2d 623, 38 USPQ 189 (CCPA 1938) . . . . .	2164.03
Skuballa, Ex parte, 12 USPQ2d 1570 (Bd. Pat. App. & Inter. 1989) . . . . .	2173.05(c)	Solomon v. Kimberly-Clark Corp., 216 F.3d 1372, 55 USPQ2d 1279 (Fed. Cir. 2000) . . . . .	2172
Sinex, In re, 309 F.2d 488, 135 USPQ 302 (CCPA 1962) . . . . .	2111.02	Soni, In re, 54 F.3d 746, 34 USPQ2d 1684 (Fed. Cir. 1995) . . . . .	707.07(f), 2144.08
Slayter, In re, 276 F.2d 408, 125 USPQ 345 (CCPA 1960) . . . . .	715.03, 2131.02	Southwest Software, Inc. v. Harlequin, Inc., 226 F.3d 1280, 56 USPQ2d 1161 (Fed. Cir. 2000) . . . . .	1480
Slip Track Systems, Inc. v. Metal Lite, Inc., 159 F.3d 1337, 48 USPQ2d 1055 (Fed. Cir. 1998) . . . . .	1449.02	Spada, In re, 911 F.2d 705, 15 USPQ2d 1655 (Fed. Cir. 1990) . . . . .	2112.01
Smernoff, Ex parte, 215 USPQ 545 (Bd. App. 1982) . . . . .	2137.01	Spectra-Physics, Inc. v. Coherent, Inc., 827 F.2d 1524, 3 USPQ2d 1737 (Fed. Cir.) . . . . .	608.01(h), 2164.01(b), 2165.02, 2165.04



MANUAL OF PATENT EXAMINING PROCEDURE

Spencer, In re, 273 F.2d 181, 124 USPQ 175 (CCPA 1959) . . . . .	1449.02	Stemniski, In re, 444 F.2d 581, 170 USPQ 343 (CCPA 1971) . . . . .	2144.08, 2144.09
Spiller, In re, 500 F.2d 1170, 182 USPQ 614 (CCPA 1974) . . . . .	715.02, 715.03	Stempel, In re, 241 F.2d 755, 113 USPQ 77 (CCPA 1957) . . . . .	715.03
Sponnoble, In re, 405 F.2d 578, 160 USPQ 237 (CCPA 1969) . . . . .	2141.02	Stencel, In re, 828 F.2d 751, 4 USPQ2d 1071 (Fed. Cir. 1987) . . . . .	2111.02
Staeger v. Commissioner, 189 USPQ 272 (D.D.C. 1976) . . . . .	409.03(b), 605.04(a)	Steppan, In re, 394 F.2d 1013, 156 USPQ 143 (CCPA 1967) . . . . .	2173.05(o)
Stahelin v. Secher, 24 USPQ2d 1513 (Bd. Pat. App. & Inter. 1992) . . . . .	2138.04	Stern, Ex parte, 13 USPQ2d 1379 (Bd. Pat. App. & Inter. 1987) . . . . .	2144.04
Stalego, Ex parte, 154 USPQ 52 (Bd. App. 1966) . . . . .	901.01, 2127, 2136.02	Stevens, Ex parte, 16 USPQ2d 1379 (Bd. Pat. App. & Inter. 1990) . . . . .	2107.03
Stalego v. Heymes, 263 F.2d 334, 120 USPQ 473 (CCPA 1959) . . . . .	2307	Stevens, In re, 173 F.2d 1015, 81 USPQ 362 (CCPA 1949) . . . . .	1504.01(c)
Standard Oil Co. v. Montedison, S.p.A., 494 F. Supp 370, 206 USPQ 676 (D.Del. 1980) . . . . .	2165.01	Stevens, In re, 212 F.2d 197, 101 USPQ 284 (CCPA 1954) . . . . .	2144.04
Standish, Ex parte, 10 USPQ2d 1454 (Bd. Pat. App. & Inter. 1988) . . . . .	716.03(a), 716.03(b), 2138.01	Stevenson v. International Trade Comm'n, 612 F.2d 546, 204 USPQ 276 (CCPA 1979) . . . . .	2141.01(a)
Stanley, Ex parte, 121 USPQ 621 (Bd. App. 1958) . . . . .	2181	Stewart Sys. v. Commissioner, 1 USPQ2d 1879 (E.D. Va. 1986) . . . . .	2258
Star Fruits S.N.C. v. United States, 280 F.Supp.2d 512 (E.D. Va 2003) . . . . .	704.10, 704.12(a), 2005	Sticker Indus. Supply Corp. v. Blaw-Knox Co., 405 F.2d 90, 160 USPQ 177 (7th Cir. 1968) . . . . .	201.06(d), 201.11
State Contracting & Eng'g Corp. v. Con- dotte, Inc., 346 F.3d 1057, 68 USPQ2d 1481 (Fed. Cir. 2003) . . . . .	2131.05, 2141.01(a)	Stoddard, In re, 213 USPQ 386 (Comm'r Pat. 1982) . . . . .	2285, 2686.03
State Street Bank & Trust Co. v. Signa- ture Financial Group Inc., 149 F.3d 1368, 47 USPQ2d 1596 (Fed. Cir. 1998) . . . . .	2106	Stratoflex, Inc. v. Aeroquip Corp., 713 F.2d 1530, 218 USPQ 871 (Fed. Cir. 1983) . . . . .	716.01(a), 2141, 2141.01(a), 2141.02, 2144.08
Steele, In re, 305 F.2d 859, 134 USPQ 292 (CCPA 1959) . . . . .	2143.03, 2173.06	Strijland, Ex parte, 26 USPQ2d 1259 (Bd. Pat. App. & Inter. 1992) . . . . .	1503.01, 1504.01(a), 1504.04
Steenbock, In re, 83 F.2d 912, 30 USPQ 45 (CCPA 1936) . . . . .	201.11	Striker, In re, 182 USPQ 507 (Comm'r Pat. 1973) . . . . .	409.03(b), 605.04(a)
Steierman v. Connelly, 192 USPQ 433 (Bd. Pat. Int. 1975) . . . . .	2004	Strong v. General Electric Co., 434 F.2d 1042, 168 USPQ 8 (5th Cir. 1970) . . . . .	2012, 2016, 2133.03(b)
Steierman v. Connelly, 192 USPQ 446 (Bd. Pat. Int. 1976) . . . . .	2004	Stryker, In re, 435 F.2d 1340, 168 USPQ 372 (CCPA 1971) . . . . .	715.02
Steierman v. Connelly, 197 USPQ 288 (Comm'r Pat. 1976) . . . . .	2138.03	Studiengesellschaft Kohle mbH v. Northern Petrochemical Co., 784 F.2d 351, 228 USPQ 837 (Fed. Cir. 1986) . . . . .	804.01
Steigerwald, Ex parte, 131 USPQ 74 (Bd. App. 1961) . . . . .	706.03(d), 2173.05(d)	Studiengesellschaft Kohle m.b.H. v. Shell Oil Co., 112 F.3d 1561, 42 USPQ2d 1674 (Fed. Cir. 1997) . . . . .	201.11, 605.07, 706.02(k)
Steinberg v. Seitz, 517 F.2d 1359, 186 USPQ 209 (CCPA 1975) . . . . .	2133.03(c)		

LIST OF DECISIONS CITED

STX LLC. v. Brine, 211 F.3d 588, 54 USPQ2d 1347 (Fed. Cir. 2000) . . . . .	2111.02, 2133.03(c)	Tallent v. Lemoine, 204 USPQ 1058 (Comm'r Pat. 1979) . . . . .	2361
Suh v. Hoefle, 23 USPQ2d 1321 (Bd. Pat. App. & Inter. 1992) . . . . .	2138.05	Tanczyn, In re, 347 F.2d 830, 146 USPQ 298 (CCPA 1965) . . . . .	715.02
Sun Studs v. ATA Equipment Leasing, Inc., 872 F.2d 978, 10 USPQ2d 1338 (Fed. Cir. 1989) . . . . .	2136.02, 2136.03	Taner, In re, 681 F.2d 787, 214 USPQ 678 (CCPA 1982) . . . . .	2106
Sunrace Roots Enter. Co. v. SRAM Corp., 336 F.3d 1298, 67 USPQ2d 1438 (Fed. Cir. 2003) . . . . .	2106, 2111.01	Tangsrud, In re, 184 USPQ 746 (Comm'r Pat. 1973) . . . . .	201.14(b)
Superguide Corp. v. DirecTV Enter- prises, Inc., 358 F.3d 870, 69 USPQ2d 1865 (Fed. Cir. 2004) . . . . .	2111.01	Tanke, In re, 213 F.2d 551, 102 USPQ 93 (CCPA 1954) . . . . .	2307
Sus, In re, 306 F.2d 494, 134 USPQ 301(CCPA 1962) . . . . .	2163, 2163.05	Tansel, In re, 253 F.2d 241, 117 USPQ 188 (CCPA 1958) . . . . .	706.02(l)(2)
Susi, In re, 440 F.2d 442, 169 USPQ 423 (CCPA 1971) . . . . .	2123, 2144.08	Tarczy-Hornoch, In re, 397 F.2d 856, 158 USPQ 141 (CCPA 1955) . . . . .	2173.05(v)
Suska, In re, 589 F.2d 527, 200 USPQ 497 (CCPA 1979) . . . . .	2138.03	Teague, In re, 254 F.2d 145, 117 USPQ 284 (CCPA 1958) . . . . .	715.05, 804.02
Swanberg, In re, 129 USPQ 364 (Comm'r Pat. 1960) . . . . .	608.01	Technicon Instruments Corp. v. Alpkem Corp., 664 F. Supp 1558, 2 USPQ2d 1729 (D. Ore 1986) . . . . .	2164.05(b)
Swartz, In re, 232 F.3d 862, 56 USPQ2d 1703 (Fed. Cir. 2000) . . . . .	2107.01, 2164.07	Tennant v. Hako Minuteman, 4 USPQ2d 1167 (N.D. Ill. 1987) . . . . .	2293
Sweet, In re, 136 F.2d 722, 58 USPQ 327 (CCPA 1943) . . . . .	1211.01	Tenney, In re, 254 F.2d 619, 117 USPQ 348 (CCPA 1958) . . . . .	2128.01
Swet, In re, 145 F.2d 631, 172 USPQ 72 (CCPA 1971) . . . . .	1504.06	Texas Digital Sys., Inc. v. Telegenix, Inc., 308 F.3d 1193, 64 USPQ2d 1812 (Fed. Cir. 2002) . . . . .	2111.01, 2173.05(a)
Swinehart, In re, 439 F.2d 210, 169 USPQ 226 (CCPA 1971) . . . . .	2114, 2173.01, 2173.05(g), 2183	Texas Instruments, Inc. v. Int'l Trade Comm'n, 988 F.2d 1165, 26 USPQ2d 1018 (Fed. Cir. 1993) . . . . .	716.04
Switzer, In re, 166 F.2d 827, 77 USPQ 156 (CCPA 1948) . . . . .	901.02	Theis, In re, 610 F.2d 786, 204 USPQ 188 (CCPA 1979) . . . . .	2133.03(b), 2133.03(e)(1), 2133.03(e)(3), 2133.03(e)(6)
Switzer v. Sockman, 333 F.2d 935, 142 USPQ 226 (CCPA 1964) . . . . .	1403, 1412.03, 2307	The Gentry Gallery, Inc. v. The Berkline Corp., 134 F.3d 1473, 45 USPQ2d 1498 (Fed. Cir. 1998) . . . . .	2163.05
Sylgab Steel & Wire Corp. v. Imoco- Gateway Corp., 357 F. Supp 657, 178 USPQ 22 (N.D. Ill. 1973) . . . . .	2165.01	The NutraSweet Co., Ex parte, 19 USPQ2d 1586 (Bd. Pat. App. & Inter. 1991) . . . . .	716.02(a)
Symbol Techs., Inc. v. Opticon, Inc., 935 F.2d 1569, 19 USPQ2d 1241 (Fed. Cir. 1991) . . . . .	804, 2121.01	Theodor Groz & Sohne & Ernst Beckert Nadelfabrik KG v. Quigg, 10 USPQ2d 1787 (D.D.C. 1988) . . . . .	711.03(c), 2265, 2272
Szwarc, In re, 319 F.2d 277, 138 USPQ 208 (CCPA 1963) . . . . .	706.03(w)	Thibault, Ex parte, 164 USPQ 666 (Bd. App. 1969) . . . . .	2115
Tabuchi v. Nubel, 559 F.2d 1183, 194 USPQ 521 (CCPA 1977) . . . . .	2404.02	Thomson, Ex parte, 24 USPQ2d 1618 (Bd. Pat. App. & Inter. 1992) . . . . .	2121.03
Talbott, In re, 443 F.2d 1397, 170 USPQ 281 (CCPA 1971) . . . . .	2135.01	Thompson v. Hamilton, 152 F.2d 994, 68 USPQ 161 (CCPA 1946) . . . . .	2307

MANUAL OF PATENT EXAMINING PROCEDURE

Thorington, In re, 418 F.2d 528, 163 USPQ 644 (CCPA 1969).....	804, 1504.06	Transco Products, Inc. v. Performance Contracting, Inc., 38 F.3d 551, 32 USPQ2d 1077 (Fed. Cir. 1994) . . .	201.11, 2107.01, 2165.01
Thorpe, In re, 777 F.2d 695, 227 USPQ 964 (Fed. Cir. 1985) . . . . .	706.02(m), 2113	Transmatic, Inc. v. Gulton Indus., Inc., 601 F.2d 904, 202 USPQ 559 (6th Cir. 1979) . . . . .	1504.06
Thumm, Ex parte, 132 USPQ 66 (Bd. App. 1961) . . . . .	716.02(a)	Trevette, Ex parte, 1901 C.D. 170, 97 O.G. 1173 (Comm'r Pat. 1901) . . . . .	820
Tiffin, In re, 443 F.2d 394, 170 USPQ 88 (CCPA 1971).....	716.04, 2142	Trimless Cabinets, In re, 128 USPQ 95 (Comm'r Pat. 1960).....	103
Tiffin, In re, 448 F.2d 791, 171 USPQ 294 (CCPA 1971) . . . . .	716.03(a)	Tronzo v. Biomet, Inc., 156 F.3d 1154, 47 USPQ2d 1829 (Fed. Cir. 1998) . . .	201.11, 2163, 2163.03, 2163.05
Tillotson Ltd. v. Walbro Corp., 831 F.2d 1033, 4 USPQ2d 1450 (Fed. Cir. 1987) . . .	1412.03,	Tucker, Ex parte, 1901 C.D. 140, 47 O.G. 187 (Comm'r Pat. 1901) . . . . .	1503.02
Titanium Metals Corp. of America v. Banner, 778 F.2d 775, 227 USPQ 773 (Fed. Cir. 1985) . . . . .	2112.01, 2131.01, 2131.03, 2144.05	Tucker v. Naito, 188 USPQ 260 (Bd. Pat. Inter. 1975) . . . . .	2137.01
Tol-O-Matic, Inc. v. Proma Produkt-Und Mktg. Gesellschaft m.b.H., 945 F.2d 1546, 20 USPQ2d 1332 (Fed. Cir. 1991) . . . . .	2107.02	Tucker v. Natta, 171 USPQ 494 (Bd. Pat. Inter. 1971) . . . . .	2138.06
Toma, In re, 575 F.2d 872, 197 USPQ 852 (CCPA 1978) . . . . .	2106	Tucker Aluminum Prods. v. Grossman, 312 F.2d 393, 136 USPQ 244 (9th Cir. 1963) . . . . .	2133.03(e)(1)
Tomlinson, In re, 363 F.2d 928, 150 USPQ 623 (CCPA 1966).....	2112.02	Twin Disc, Inc. v. United States, 231 USPQ 417 (Cl. Ct. 1986) . . . . .	2131.05
Tone Brothers, Inc. v. Sysco Corp., 28 F.3d 1192, 31 USPQ2d 1321 (Fed. Cir. 1994) . . . . .	1504.02, 2133.03(e)(6)	Tytgat, Ex parte, 225 USPQ 907 (Bd. App. 1985).....	2363.03
Toro Co. v. Deere & Co., 355 F.3d 1313, 69 USPQ2d 1584 (Fed. Cir. 2004) . . . . .	2112	UMC Elecs. Co. v. United States, 816 F.2d 647, 2 USPQ2d 1465 (Fed. Cir. 1987) . . . . .	804, 2133.03(b), 2133.03(c), 2163
Toro Co. v. L.R. Nelson Corp., 223 USPQ 636 (C.D. Ill. 1984) . . . . .	2286, 2686.04	Unidynamics Corp. v. Automatic Prod. Int'l, 157 F.3d 1311, 48 USPQ2d 1099 (Fed. Cir. 1998) . . . . .	2181
Toro Co. v. White Consol. Indus., Inc., 199 F.3d 1295, 53 USPQ2d 1065 (Fed. Cir. 1999) . . . . .	2106, 2111.01	Unimed, Inc. v. Quigg, 888 F.2d 826, 12 USPQ2d 1644 (Fed. Cir. 1989) . . . . .	2754.01
TorPharm., Inc. v. Ranbaxy Pharmaceuti- cals, 336 F.3d 1322, 67 USPQ2d 1511 (Fed. Cir. 2003) . . . . .	2116.01	Union Carbide Corp. v. Borg-Warner Corp., 550 F.2d 355, 193 USPQ 1 (6th Cir. 1977).....	2165
Touval v. Newcombe, 194 USPQ 509 (Comm'r Pat. 1976) . . . . .	2301.02	Union Oil of Cal. v. Atlantic Richfield Co., 208 F.3d 989, 54 USPQ2d 1227 (Fed. Cir. 2000) . . . . .	2163.05
Townsend, In re, 1913 C.D. 55 (Comm'r Pat. 1929) . . . . .	720.05	Union Pacific Resources Co. v. Chesa- peake Energy Corp., 236 F.3d 684, 57 USPQ2d 1293 (Fed. Cir. 2001) . . . . .	2164.06(a)
Townsend v. Smith, 36 F.2d 292, 4 USPQ 269 (CCPA 1929).....	2138.04	Uniroyal, Inc. v. Rudkin-Wiley Corp., 837 F.2d 1044, 5 USPQ2d 1434 (Fed. Cir. 1988).....	2144.08
TP Labs., Inc. v. Professional Positioners, Inc., 724 F.2d 965, 220 USPQ 577 (Fed. Cir. 1984) . . . . .	2133.03(a)		

LIST OF DECISIONS CITED

United States v. Adams, 383 U.S. 39, 148 USPQ 479 (1966) . . . . .	716.01(b), 716.05, 2145	Van Otteren v. Hafner, 278 F.2d 738, 126 USPQ 151 (CCPA 1960) . . . . .	2336
United States v. Morgan, 313 U.S. 409, 61 S. Ct. 999 (1941) . . . . .	1701.01	Varga, Ex Parte, 189 USPQ 209 (Bd. App. 1973). . . . .	2012.01
United States v. Telectronics, Inc., 857 F.2d 778, 8 USPQ2d 1217 (Fed. Cir. 1988) . . . . .	2164.01, 2164.06	Vas-Cath, Inc. v. Mahurkar, 935 F.2d 1555, 19 USPQ2d 1111 (Fed. Cir. 1991) . . . . .	1504.20, 2161, 2163, 2163.02, 2164, 2181
United States Indus. Chem., Inc. v. Car- bide and Carbon Chem. Corp., 315 U.S. 668, 53 USPQ 6 (1942). . . . .	1411.02	Venezia, In re, 530 F.2d 956, 189 USPQ 149 (CCPA 1976) . . . . .	2163, 2163.05, 2172.01, 2173.05(g)
University of Rochester v. G.D. Searle & Co., 358 F.3d 916, 69 USPQ2d 1886 (Fed. Cir. 2004) . . . . .	2163	Venner, In re, 262 F.2d 91, 120 USPQ 193 (CCPA 1958) . . . . .	2106, 2144.04
U.S. Industries v. Norton Co., 210 USPQ 94 (N.D. N.Y. 1980) . . . . .	2004	Verdegaal Bros. v. Union Oil Co. of Cali- fornia, 814 F.2d 628, 2 USPQ2d 1051 (Fed. Cir. 1987) . . . . .	2131
Ushakoff v. United States, 327 F.2d 669, 140 USPQ 341 (Ct. Cl. 1964). . . . .	2133.03(e)(1)	Vickers, In re, 141 F.2d 522, 61 USPQ 122 (CCPA 1944) . . . . .	2164.03
Utschig, Ex parte, 156 USPQ 156 (Bd. App. 1966) . . . . .	2137.01	Vincent v. Mossinghoff, 230 USPQ 621 (D.D.C. 1985) . . . . .	513, 711.03(c)
Vaeck, In re, 947 F.2d 448, 20 USPQ2d 1438 (Fed. Cir. 1991) . . . . .	706.02(j), 904.01(d), 2107.01, 2142, 2143, 2144.08, 2164.01, 2164.01(c), 2164.03, 2164.06(b), 2164.08	Vogel, In re, 422 F.2d 438, 164 USPQ 619 (CCPA 1970) . . . . .	804, 804.02, 1504.06, 2111.01
Valmont Industries, Inc. v. Reinke Manufacturing Co., 983 F.2d 1039, 25 USPQ2d 1451 (Fed. Cir. 1993). . . . .	2183, 2184, 2186	Von Brimer v. Whirlpool Corp., 536 F.2d 838, 190 USPQ 528 (9th Cir. 1976) . . . . .	1208.03
Vamco Machine and Tool, Inc., In re, 752 F.2d 1564, 224 USPQ 617 (Fed. Cir. 1985) . . . . .	716.03(b), 2286, 2686.04	Wadlinger, In re, 496 F.2d 1200, 181 USPQ 826 (CCPA 1974). . . . .	1412.02
Vandenberg v. Dairy Equipment Co., 740 F.2d 1560, 224 USPQ 195 (Fed. Cir. 1984) . . . . .	716.06	Wagenhorst, In re, 62 F.2d 831, 16 USPQ 126, 20 CCPA 829 (CCPA 1933) . . . . .	715.05
Vander Wal, Ex parte, 109 USPQ 119, 1956 C.D. 11, 705 O.G. 5 (Bd. Pat. App. 1955) . . . . .	608.04(a)	Wagner, In re, 371 F.2d 877, 152 USPQ 552 (CCPA 1967), . . . . .	716.02
Van Esdonk, In re, 187 USPQ 671 (Comm'r Pat. 1975) . . . . .	201.16, 1481	Wahl v. Rexnord, Inc., 624 F.2d 1169, 206 USPQ 865 (3rd Cir. 1980) . . . . .	1504.06
Van Geuns, In re, 988 F.2d 1181, 26 USPQ2d 1057 (Fed. Cir. 1993). . . . .	707.07(f), 2145	Wakefield, In re, 422 F.2d 897, 164 USPQ 636 (CCPA 1970). . . . .	715.02, 2173.05(i)
Van Langenhoven, In re, 458 F.2d 132, 173 USPQ 426 (CCPA 1972) . . . . .	201.11, 2004, 2135.01, 2217, 2258, 2617	Waldeck v. Lewis, 120 USPQ 88 (Comm'r Pat. 1955) . . . . .	2309.01
Vanmoor v. Wal-Mart Stores, Inc., 201 F.3d 1363, 53 USPQ2d 1377 (Fed. Cir. 2000) . . . . .	2133.03(c)	Waldemar Link, GmbH & Co. v. Osteon- ics Corp., 32 F.3d 556, 31 USPQ2d 1855 (Fed. Cir. 1994) . . . . .	706.03(o)
Van Ornum, In re, 686 F.2d 937, 214 USPQ 761 (CCPA 1982). . . . .	804, 804.02	Walsdorf v. Commissioner, 229 USPQ 559 (D.D.C. 1986) . . . . .	1216.02
		Walsh v. Sakai, 167 USPQ 465 (Comm'r Pat. 1970) . . . . .	2337
		Walter, In re, 618 F.2d 758, 205 USPQ 397 (CCPA 1980) . . . . .	2183, 2184
		Wands, In re, 858 F.2d 731, 8 USPQ2d 1400 (Fed. Cir. 1988) . . . . .	706.03(a), 706.03(b), 2164.01, 2164.01(a), 2164.06, 2164.06(b)

MANUAL OF PATENT EXAMINING PROCEDURE

Wang Labs., Inc. v. Toshiba Corp., 993 F.2d 858, 26 USPQ2d 1767 (Fed. Cir. 1993) . . . . .	2164.01, 2141.01(a), 2163, 2164.06, 2164.06(b)
Ward, In re, 236 F.2d 428, 111 USPQ 101 (CCPA 1956) . . . . .	715.05, 804.02
Warmerdam, In re, 33 F.3d 1354, 31 USPQ2d 1754 (Fed. Cir. 1994) . . . . .	2106
Warner, In re, 379 F.2d 1011, 154 USPQ 173 (CCPA 1967) . . . . .	2142
Warner-Jenkinsen Co. v. Hilton Davis Chemical Co., 520 U.S. 17, 41 USPQ2d 1865 (1997) . . . . .	2183, 2184, 2186
Water Technologies Corp. v. Calco Ltd., 850 F.2d 660, 7 USPQ2d 1097 (Fed. Cir. 1988) . . . . .	2111.03
Watkinson, In re, 900 F.2d 230, 14 USPQ2d 1407 (Fed. Cir. 1990) . . . . .	1201, 1412.01, 1457
Watson, In re, 517 F.2d 465, 186 USPQ 11 (CCPA 1975) . . . . .	2107.01, 2107.03
Watson v. Allen, 254 F.2d 342, 117 USPQ 68 (D.C. Cir. 1958) . . . . .	2133.03(e)(3), 2133.03(e)(7)
Watts v. XL Systems, Inc., 232 F.3d 877, 56 USPQ2d 1836 (Fed. Cir. 2000) . . . . .	2181
Waugh, In re, 135 F.2d 627, 57 USPQ 371 (CCPA 1943) . . . . .	819
Waymouth, In re, 499 F.2d 1273, 182 USPQ 290 (CCPA 1974) . . . . .	716.02
Weatherchem Corp. v. J.L. Clark, Inc., 163 F.3d 1326, 49 USPQ2d 1001 (Fed. Cir. 1998) . . . . .	2133.03(b), 2133.03(c)
Webb, Ex parte, 30 USPQ2d 1064 (Bd. Pat. App. & Inter. 1993) . . . . .	1504.01(c)
Webb, In re, 916 F.2d 1553, 16 USPQ2d 1433 (Fed. Cir. 1990) . . . . .	1504.01(c)
Weber, In re, 405 F.2d 1403, 160 USPQ 549 (CCPA 1969) . . . . .	716.07
Weber, In re, 580 F.2d 455, 198 USPQ 328 (CCPA 1978) . . . . .	803.02
Weiss, In re, 989 F.2d 1202, 26 USPQ2d 1885 (Fed. Cir. 1993) . . . . .	2111.01
Wells v. Fremont, 177 USPQ 22 (Bd. Pat. Inter. 1972) . . . . .	2138.05
Wende v. Horine, 225 F. 501 (7th Cir. 1915) . . . . .	2133.03(b)
Wertheim, In re, 541 F.2d 257, 191 USPQ 90 (CCPA 1976) . . . . .	706.03(o), 1302.01, 2144.05, 2163, 2163.03, 2163.04, 2163.05
Wertheim, In re, 646 F.2d 527, 209 USPQ 554 (CCPA 1981) . . . . .	2136.03
Western Elec. Co. v. Piezo Technology, Inc., 860 F.2d 428, 8 USPQ2d 1853 (Fed. Cir 1988) . . . . .	1701.01
Weston, Ex parte, 1911 C.D. 218, 173 O.G. 285 (Comm'r Pat. 1911) . . . . .	810.02
Wetmore v. Quick, 536 F.2d 937, 190 USPQ 223 (CCPA 1976) . . . . .	2138.05, 2308.02
Wetterau, In re, 356 F.2d 556, 148 USPQ 499 (CCPA 1966) . . . . .	804
White, Ex parte, 759 O.G. 783 (Bd. App. 1958) . . . . .	2173.05(o)
White, In re, 405 F.2d 904, 160 USPQ 417 (CCPA 1969) . . . . .	804
White Consol. Indus. v. Vega Servo-Control, Inc., 214 USPQ 796 (S.D. Mich. 1982) . . . . .	608.01(p), 2106.01, 2106.02
Whitelaw, Ex parte, 1915 C.D. 18, 219 O.G. 1237 (Comm'r Pat. 1914) . . . . .	2173.05(n)
Whittle, In re, 454 F.2d 1193, 172 USPQ 535 (CCPA 1972) . . . . .	2136.05
Wiechert, In re, 370 F.2d 927, 152 USPQ 247 (CCPA 1967) . . . . .	2144.09
Wiesner v. Weigert, 666 F.2d 582, 212 USPQ 721 (CCPA 1981) . . . . .	2138.05
Wiggins, In re, 488 F.2d 538, 179 USPQ 421 (CCPA 1973) . . . . .	2121.02, 2131.04, 2173.02, 2173.05(b)
Wikdahl, Ex parte, 10 USPQ2d 1546 (Bd. Pat. App. & Inter. 1989) . . . . .	1412.02, 1412.03,
Wilder, In re, 563 F.2d 457, 195 USPQ 426 (CCPA 1977) . . . . .	2144.08, 2144.09, 2163
Wilder, In re, 736 F.2d 1516, 222 USPQ 369 (Fed. Cir. 1984) . . . . .	1402, 1414, 2163.05
Wilkinson, In re, 304 F.2d 673, 134 USPQ 171 (CCPA 1962) . . . . .	715.07
Willien, In re, 74 F.2d 550, 24 USPQ 210 (CCPA 1935) . . . . .	715
Willingham, In re, 282 F.2d 353, 127 USPQ 211 (CCPA 1960) . . . . .	1302.04, 1412.02
Wilson, In re, 311 F.2d 266, 135 USPQ 442 (CCPA 1962) . . . . .	2124
Wilson, In re, 424 F.2d 1382, 165 USPQ 494, (CCPA 1970) . . . . .	2143.03, 2173.06

LIST OF DECISIONS CITED

Wilson v. Yakel, 1876 C.D. 245 (Comm'r Pat. 1876) . . . . .	2301.02	Yardley, In re, 493 F.2d 1389, 181 USPQ 331 (CCPA 1974) . . . . .	1504.03, 1512
Winkhaus, In re, 527 F.2d 637, 188 USPQ 129 (CCPA 1975). . . . .	2173.05(q)	Yarn Processing Patent Validity Litiga- tion, 183 USPQ 65 (5th Cir. 1974) . . . . .	2128.01
Winkler v. Ladd, 221 F. Supp. 550, 138 USPQ 666 (D.D.C. 1963). . . . .	711.03(c)	York Products, Inc. v. Central Tractor Farm & Family Center, 99 F.3d 1568, 40 USPQ2d 1619 (Fed. Cir. 1996) . . . . .	2181
Wise, In re, 340 F.2d 982, 144 USPQ 354 (CCPA 1965). . . . .	1504.01(d)	Yoshino, Ex parte, 227 USPQ 52 (Bd. Pat. App. & Inter. 1985) . . . . .	2141.01
Wiseman, In re, 596 F.2d 1019, 201 USPQ 658 (CCPA 1979). . . . .	2106.02, 2141.02, 2145	Young, Ex parte, 18 Gour. 24 . . . . .	1213.01
W.L. Gore & Assoc., Inc. v. Garlock, Inc., 721 F.2d 1540, 220 USPQ 303 (Fed. Cir. 1983). . . . .	2132, 2133.03(a), 2133.03(c), 2141.01, 2141.02, 2144.08, 2164.08, 2165.04, 2173.05(b)	Young, In re, 75 F.2d 996, 25 USPQ 69 (CCPA 1935). . . . .	2115
Wolfensperger, In re, 302 F.2d 950, 133 USPQ 537 (CCPA 1962) . . . . .	2163, 2181	Young, In re, 927 F.2d 588, 18 USPQ2d 1089 (Fed. Cir. 1991) . . . . .	1206, 2143.01
Woody, In re, 331 F.2d 636, 141 USPQ 518 (CCPA 1964) . . . . .	2107.03	Young v. Dworkin, 489 F.2d 1277, 180 USPQ 388 (CCPA 1974). . . . .	2138.03
Woodruff, In re, 919 F.2d 1575, 16 USPQ2d 1934 (Fed. Cir. 1990). . . . .	2144.05	Yuasa Battery v. Comm'r, 3 USPQ2d 1143 (D.D.C. 1987). . . . .	2279
Wright, 1876 C.D. 217, 10 O.G. 587 (Comm'r Pat. 1876) . . . . .	1410.01	Zahn, In re, 617 F.2d 261, 204 USPQ 988 (CCPA 1980). . . . .	1502, 1503.02, 1504.04
Wright, In re, 569 F.2d 1124, 193 USPQ 332 (CCPA 1977) . . . . .	707.07(f), 2125, 2145	Zechall, Ex parte, 194 USPQ 461 (Bd. App. 1973). . . . .	2106, 2164.05(b)
Wright, In re, 866 F.2d 422, 9 USPQ2d 1649 (Fed. Cir. 1989) . . . . .	2163, 2163.03	Zenith Labs., Inc. v. Bristol-Myers Squibb Co., 19 F.3d 1418, 30 USPQ2d 1285 (Fed. Cir. 1996) . . . . .	1302.14
Wright, In re, 999 F.2d 1557, 27 USPQ2d 1510 (Fed. Cir. 1993) . . . . .	2107.01, 2164.03, 2164.01(a), 2164.04, 2164.05(a), 2164.06(b), 2164.08	Zenitz, In re, 333 F.2d 924, 142 USPQ 158 (CCPA 1964) . . . . .	716.02(f)
Wu, Ex parte, 10 USPQ 2031 (Bd. Pat. App. & Inter. 1989). . . . .	706.03(d), 2144.04, 2173.05(h)	Zickendraht, In re, 319 F.2d 225, 138 USPQ 22 (CCPA 1963). . . . .	804, 804.03, 1504.06
Wu v. Jucker, 167 USPQ 467 (Bd. Pat. Inter. 1968) . . . . .	2138.05, 2138.06	Ziegler, In re, 443 F.2d 1211, 170 USPQ 129 (CCPA 1971) . . . . .	804.01
Wyer, In re, 655 F.2d 221, 210 USPQ 790 (CCPA 1981) . . . . .	901.05, 2127, 2128	Ziegler, In re, 992 F.2d 1197, 26 USPQ2d 1600 (Fed. Cir. 1993) . . . . .	2106, 2107.01, 2107.02, 2163, 2163.03
Yale, In re, 434 F.2d 66, 168 USPQ 46 (CCPA 1970). . . . .	716.07	Zimmerley, Ex parte, 153 USPQ 367 (Bd. App. 1966). . . . .	2181
Yamaguchi, Ex parte, 61 USPQ2d 1043 (Bd. Pat. App. & Inter. 2001). . . . .	1412.02	Zletz, In re, 893 F.2d 319, 13 USPQ2d 1320 (Fed. Cir. 1989) . . . . .	715, 2106, 2111.01, 2111.03, 2138, 2171, 2173.05(a), 2181, 2286, 2686.04
Yamamoto, In re, 740 F.2d 1569, 222 USPQ 934 (Fed. Cir. 1984). . . . .	2258	Zurko, In re, 258 F.3d 1379, 59 USPQ2d 1693 (Fed. Cir. 2001) . . . . .	2144.03

MANUAL OF PATENT EXAMINING PROCEDURE

# Appendix L Patent Laws

---

## United States Code Title 35 - Patents

### PART I — UNITED STATES PATENT AND TRADEMARK OFFICE

#### CHAPTER 1 — ESTABLISHMENT, OFFICERS AND EMPLOYEES, FUNCTIONS

Sec.

- 1 Establishment.
- 2 Powers and Duties.
- 3 Officers and employees.
- 4 Restrictions on officers and employees as to interest in patents.
- 5 Patent and Trademark Office Public Advisory Committees.
- 6 Board of Patent Appeals and Interferences.
- 7 Library.
- 8 Classification of patents.
- 9 Certified copies of records.
- 10 Publications.
- 11 Exchange of copies of patents and applications with foreign countries.
- 12 Copies of patents and applications for public libraries.
- 13 Annual report to Congress.

#### CHAPTER 2 — PROCEEDINGS IN THE PATENT AND TRADEMARK OFFICE

- 21 Filing date and day for taking action.
- 22 Printing of papers filed.
- 23 Testimony in Patent and Trademark Office cases.
- 24 Subpoenas, witnesses.
- 25 Declaration in lieu of oath.
- 26 Effect of defective execution.

#### CHAPTER 3 — PRACTICE BEFORE PATENT AND TRADEMARK OFFICE

- 31 [Repealed].
- 32 Suspension or exclusion from practice.
- 33 Unauthorized representation as practitioner.

#### CHAPTER 4 — PATENT FEES; FUNDING; SEARCH SYSTEMS

- 41 Patent fees; patent and trademark search systems.
- 42 Patent and Trademark Office funding.

### PART II — PATENTABILITY OF INVENTIONS AND GRANT OF PATENTS

#### CHAPTER 10 — PATENTABILITY OF INVENTIONS

- 100 Definitions.
- 101 Inventions patentable.
- 102 Conditions for patentability; novelty and loss of right to patent.
- 103 Conditions for patentability; non-obvious subject matter.
- 104 Invention made abroad.
- 105 Inventions in outer space.

#### CHAPTER 11 — APPLICATION FOR PATENT

- 111 Application.
- 112 Specification.
- 113 Drawings.
- 114 Models, specimens.
- 115 Oath of applicant.
- 116 Inventors.
- 117 Death or incapacity of inventor.
- 118 Filing by other than inventor.
- 119 Benefit of earlier filing date; right of priority.
- 120 Benefit of earlier filing date in the United States.
- 121 Divisional applications.
- 122 Confidential status of applications; publication of patent applications.

#### CHAPTER 12 — EXAMINATION OF APPLICATION

- 131 Examination of application.
- 132 Notice of rejection; reexamination.
- 133 Time for prosecuting application.
- 134 Appeal to the Board of Patent Appeals and Interferences.
- 135 Interferences.

#### CHAPTER 13 — REVIEW OF PATENT AND TRADEMARK OFFICE DECISION

- 141 Appeal to Court of Appeals for the Federal Circuit.
- 142 Notice of appeal.
- 143 Proceedings on appeal.
- 144 Decision on appeal.
- 145 Civil action to obtain patent.
- 146 Civil action in case of interference.



## MANUAL OF PATENT EXAMINING PROCEDURE

### CHAPTER 14 — ISSUE OF PATENT

- 151 Issue of patent.
- 152 Issue of patent to assignee.
- 153 How issued.
- 154 Contents and term of patent; provisional rights.
- 155 Patent term extension.
- 155A Patent term restoration.
- 156 Extension of patent term.
- 157 Statutory invention registration.

### CHAPTER 15 — PLANT PATENTS

- 161 Patents for plants.
- 162 Description, claim.
- 163 Grant.
- 164 Assistance of the Department of Agriculture.

### CHAPTER 16 — DESIGNS

- 171 Patents for designs.
- 172 Right of priority.
- 173 Term of design patent.

### CHAPTER 17 — SECRECY OF CERTAIN INVENTIONS AND FILING APPLICATIONS IN FOREIGN COUNTRIES

- 181 Secrecy of certain inventions and withholding of patent.
- 182 Abandonment of invention for unauthorized disclosure.
- 183 Right to compensation.
- 184 Filing of application in foreign country.
- 185 Patent barred for filing without license.
- 186 Penalty.
- 187 Nonapplicability to certain persons.
- 188 Rules and regulations, delegation of power.

### CHAPTER 18 — PATENT RIGHTS IN INVENTIONS MADE WITH FEDERAL ASSISTANCE

- 200 Policy and objective.
- 201 Definitions.
- 202 Disposition of rights.
- 203 March-in rights.

- 204 Preference for United States industry.
- 205 Confidentiality.
- 206 Uniform clauses and regulations.
- 207 Domestic and foreign protection of federally owned inventions.
- 208 Regulations governing Federal licensing.
- 209 Licensing federally owned inventions.
- 210 Precedence of chapter.
- 211 Relationship to antitrust laws.
- 212 Disposition of rights in educational awards.

## PART III — PATENTS AND PROTECTION OF PATENT RIGHTS

### CHAPTER 25 — AMENDMENT AND CORRECTION OF PATENTS

- 251 Reissue of defective patents.
- 252 Effect of reissue.
- 253 Disclaimer.
- 254 Certificate of correction of Patent and Trademark Office mistake.
- 255 Certificate of correction of applicant's mistake.
- 256 Correction of named inventor.

### CHAPTER 26 — OWNERSHIP AND ASSIGNMENT

- 261 Ownership; assignment.
- 262 Joint owners.

### CHAPTER 27 — GOVERNMENT INTERESTS IN PATENTS

- 266 [Repealed.]
- 267 Time for taking action in Government applications.

### CHAPTER 28 — INFRINGEMENT OF PATENTS

- 271 Infringement of patent.
- 272 Temporary presence in the United States.
- 273 Defense to infringement based on earlier inventor.

### CHAPTER 29 — REMEDIES FOR INFRINGEMENT OF PATENT, AND OTHER ACTIONS

- 281 Remedy for infringement of patent.
- 282 Presumption of validity; defenses.

## PATENT LAWS

- 283 Injunction.
- 284 Damages.
- 285 Attorney fees.
- 286 Time limitation on damages.
- 287 Limitation on damages and other remedies; marking and notice.
- 288 Action for infringement of a patent containing an invalid claim.
- 289 Additional remedy for infringement of design patent.
- 290 Notice of patent suits.
- 291 Interfering patents.
- 292 False marking.
- 293 Nonresident patentee; service and notice.
- 294 Voluntary arbitration.
- 295 Presumptions: Product made by patented process.
- 296 Liability of States, instrumentalities of States, and State officials for infringement of patents.
- 297 Improper and deceptive invention promotion.

### CHAPTER 30 — PRIOR ART CITATIONS TO OFFICE AND EX PARTE REEXAMINATION OF PATENTS

- 301 Citation of prior art.
- 302 Request for reexamination.
- 303 Determination of issue by Director.
- 304 Reexamination order by Director.
- 305 Conduct of reexamination proceedings.
- 306 Appeal.
- 307 Certificate of patentability, unpatentability, and claim cancellation.

### CHAPTER 31 — OPTIONAL INTER PARTES REEXAMINATION PROCEDURES

- 311 Request for inter partes reexamination.
- 312 Determination of issue by Director.
- 313 Inter partes reexamination order by Director.
- 314 Conduct of inter partes reexamination proceedings.
- 315 Appeal.
- 316 Certificate of patentability, unpatentability, and claim cancellation.
- 317 Inter partes reexamination prohibited.
- 318 Stay of litigation.

## PART IV — PATENT COOPERATION TREATY

### CHAPTER 35 — DEFINITIONS

- 351 Definitions.

### CHAPTER 36 — INTERNATIONAL STAGE

- 361 Receiving Office.
- 362 International Searching Authority and International Preliminary Examining Authority.
- 363 International application designating the United States: Effect.
- 364 International stage: Procedure.
- 365 Right of priority; benefit of the filing date of a prior application.
- 366 Withdrawn international application.
- 367 Actions of other authorities: Review.
- 368 Secrecy of certain inventions; filing international applications in foreign countries.

### CHAPTER 37 — NATIONAL STAGE

- 371 National stage: Commencement.
- 372 National stage: Requirements and procedure.
- 373 Improper applicant.
- 374 Publication of international application.
- 375 Patent issued on international application.
- 376 Fees.

## PART I — UNITED STATES PATENT AND TRADEMARK OFFICE

### CHAPTER 1 — ESTABLISHMENT, OFFICERS AND EMPLOYEES, FUNCTIONS

- Sec.
- 1 Establishment.
- 2 Powers and duties.
- 3 Officers and employees.
- 4 Restrictions on officers and employees as to interest in patents.
- 5 Patent and Trademark Office Public Advisory Committees.
- 6 Board of Patent and Appeals and Interferences.
- 7 Library.
- 8 Classification of patents.

- 9 Certified copies of records.
- 10 Publications.
- 11 Exchange of copies of patents and applications with foreign countries.
- 12 Copies of patents and applications for public libraries.
- 13 Annual report to Congress.

### 35 U.S.C. 1 Establishment.

(a) ESTABLISHMENT.— The United States Patent and Trademark Office is established as an agency of the United States, within the Department of Commerce. In carrying out its functions, the United States Patent and Trademark Office shall be subject to the policy direction of the Secretary of Commerce, but otherwise shall retain responsibility for decisions regarding the management and administration of its operations and shall exercise independent control of its budget allocations and expenditures, personnel decisions and processes, procurements, and other administrative and management functions in accordance with this title and applicable provisions of law. Those operations designed to grant and issue patents and those operations which are designed to facilitate the registration of trademarks shall be treated as separate operating units within the Office.

(b) OFFICES.— The United States Patent and Trademark Office shall maintain its principal office in the metropolitan Washington, D.C., area, for the service of process and papers and for the purpose of carrying out its functions. The United States Patent and Trademark Office shall be deemed, for purposes of venue in civil actions, to be a resident of the district in which its principal office is located, except where jurisdiction is otherwise provided by law. The United States Patent and Trademark Office may establish satellite offices in such other places in the United States as it considers necessary and appropriate in the conduct of its business.

(c) REFERENCE.— For purposes of this title, the United States Patent and Trademark Office shall also be referred to as the “Office” and the “Patent and Trademark Office”.

(Amended Jan. 2, 1975, Public Law 93-596, sec. 1, 88 Stat. 1949; amended Nov. 29, 1999, Public Law 106-113, sec. 1000(a)(9), 113 Stat. 1501A-572 (S. 1948 sec. 4711).)

### 35 U.S.C. 2 Powers and duties.

(a) IN GENERAL.— The United States Patent and Trademark Office, subject to the policy direction of the Secretary of Commerce—

(1) shall be responsible for the granting and issuing of patents and the registration of trademarks; and

(2) shall be responsible for disseminating to the public information with respect to patents and trademarks.

(b) SPECIFIC POWERS.— The Office—

(1) shall adopt and use a seal of the Office, which shall be judicially noticed and with which letters patent, certificates of trademark registrations, and papers issued by the Office shall be authenticated;

(2) may establish regulations, not inconsistent with law, which—

(A) shall govern the conduct of proceedings in the Office;

(B) shall be made in accordance with section 553 of title 5;

(C) shall facilitate and expedite the processing of patent applications, particularly those which can be filed, stored, processed, searched, and retrieved electronically, subject to the provisions of section 122 relating to the confidential status of applications;

(D) may govern the recognition and conduct of agents, attorneys, or other persons representing applicants or other parties before the Office, and may require them, before being recognized as representatives of applicants or other persons, to show that they are of good moral character and reputation and are possessed of the necessary qualifications to render to applicants or other persons valuable service, advice, and assistance in the presentation or prosecution of their applications or other business before the Office;

(E) shall recognize the public interest in continuing to safeguard broad access to the United States patent system through the reduced fee structure for small entities under section 41(h)(1) of this title; and

(F) provide for the development of a performance-based process that includes quantitative and qualitative measures and standards for evaluating cost-effectiveness and is consistent with the principles of impartiality and competitiveness;

(3) may acquire, construct, purchase, lease, hold, manage, operate, improve, alter, and renovate any real, personal, or mixed property, or any interest therein, as it considers necessary to carry out its functions;

(4)(A) may make such purchases, contracts for the construction, maintenance, or management and operation of facilities, and contracts for supplies or services, without regard to the provisions of the Federal Property and Administrative Services Act of 1949 (40 U.S.C. 471 et seq.), the Public Buildings Act (40 U.S.C. 601 et seq.), and the McKinney-Vento Homeless Assistance Act (42 U.S.C. 11301 et seq.); and

(B) may enter into and perform such purchases and contracts for printing services, including the process of composition, platemaking, presswork, silk screen processes, binding, microform, and the products of such processes, as it considers necessary to carry out the functions of the Office, without regard to sections 501 through 517 and 1101 through 1123 of title 44;

(5) may use, with their consent, services, equipment, personnel, and facilities of other departments, agencies, and instrumentalities of the Federal Government, on a reimbursable basis, and cooperate with such other departments, agencies, and instrumentalities in the establishment and use of services, equipment, and facilities of the Office;

(6) may, when the Director determines that it is practicable, efficient, and cost-effective to do so, use, with the consent of the United States and the agency, instrumentality, Patent and Trademark Office, or international organization concerned, the services, records, facilities, or personnel of any State or local government agency or instrumentality or foreign patent and trademark office or international organization to perform functions on its behalf;

(7) may retain and use all of its revenues and receipts, including revenues from the sale, lease, or disposal of any real, personal, or mixed property, or any interest therein, of the Office;

(8) shall advise the President, through the Secretary of Commerce, on national and certain international intellectual property policy issues;

(9) shall advise Federal departments and agencies on matters of intellectual property policy in

the United States and intellectual property protection in other countries;

(10) shall provide guidance, as appropriate, with respect to proposals by agencies to assist foreign governments and international intergovernmental organizations on matters of intellectual property protection;

(11) may conduct programs, studies, or exchanges of items or services regarding domestic and international intellectual property law and the effectiveness of intellectual property protection domestically and throughout the world;

(12)(A) shall advise the Secretary of Commerce on programs and studies relating to intellectual property policy that are conducted, or authorized to be conducted, cooperatively with foreign intellectual property offices and international intergovernmental organizations; and

(B) may conduct programs and studies described in subparagraph (A); and

(13)(A) in coordination with the Department of State, may conduct programs and studies cooperatively with foreign intellectual property offices and international intergovernmental organizations; and

(B) with the concurrence of the Secretary of State, may authorize the transfer of not to exceed \$100,000 in any year to the Department of State for the purpose of making special payments to international intergovernmental organizations for studies and programs for advancing international cooperation concerning patents, trademarks, and other matters.

(c) CLARIFICATION OF SPECIFIC POWERS.—

(1) The special payments under subsection (b)(13)(B) shall be in addition to any other payments or contributions to international organizations described in subsection (b)(13)(B) and shall not be subject to any limitations imposed by law on the amounts of such other payments or contributions by the United States Government.

(2) Nothing in subsection (b) shall derogate from the duties of the Secretary of State or from the duties of the United States Trade Representative as set forth in section 141 of the Trade Act of 1974 (19 U.S.C. 2171).

(3) Nothing in subsection (b) shall derogate from the duties and functions of the Register of Copyrights or otherwise alter current authorities relating to copyright matters.

(4) In exercising the Director's powers under paragraphs (3) and (4)(A) of subsection (b), the Director shall consult with the Administrator of General Services.

(5) In exercising the Director's powers and duties under this section, the Director shall consult with the Register of Copyrights on all copyright and related matters.

(d) CONSTRUCTION.— Nothing in this section shall be construed to nullify, void, cancel, or interrupt any pending request-for-proposal let or contract issued by the General Services Administration for the specific purpose of relocating or leasing space to the United States Patent and Trademark Office.

(Amended Jan. 2, 1975, Public Law 93-596, sec. 1, 88 Stat. 1949; amended Nov. 29, 1999, Public Law 106-113, sec. 1000(a)(9), 113 Stat. 1501A-572 (S. 1948 sec. 4712); subsection (b)(4)(A) amended Oct. 30, 2000, Public Law 106-400, sec. 2, 114 Stat. 1675; subsections (b)(2)(B) and (b)(4)(B) amended Nov. 2, 2002, Public Law 107-273, sec. 13206, 116 Stat. 1904.)

### **35 U.S.C. 3 Officers and employees.**

(a) UNDER SECRETARY AND DIRECTOR.—

(1) IN GENERAL.— The powers and duties of the United States Patent and Trademark Office shall be vested in an Under Secretary of Commerce for Intellectual Property and Director of the United States Patent and Trademark Office (in this title referred to as the "Director"), who shall be a citizen of the United States and who shall be appointed by the President, by and with the advice and consent of the Senate. The Director shall be a person who has a professional background and experience in patent or trademark law.

(2) DUTIES.—

(A) IN GENERAL.— The Director shall be responsible for providing policy direction and management supervision for the Office and for the issuance of patents and the registration of trademarks. The Director shall perform these duties in a fair, impartial, and equitable manner.

(B) CONSULTING WITH THE PUBLIC ADVISORY COMMITTEES.— The Director shall

consult with the Patent Public Advisory Committee established in section 5 on a regular basis on matters relating to the patent operations of the Office, shall consult with the Trademark Public Advisory Committee established in section 5 on a regular basis on matters relating to the trademark operations of the Office, and shall consult with the respective Public Advisory Committee before submitting budgetary proposals to the Office of Management and Budget or changing or proposing to change patent or trademark user fees or patent or trademark regulations which are subject to the requirement to provide notice and opportunity for public comment under section 553 of title 5, as the case may be.

(3) OATH.— The Director shall, before taking office, take an oath to discharge faithfully the duties of the Office.

(4) REMOVAL.— The Director may be removed from office by the President. The President shall provide notification of any such removal to both Houses of Congress.

(b) OFFICERS AND EMPLOYEES OF THE OFFICE.—

(1) DEPUTY UNDER SECRETARY AND DEPUTY DIRECTOR.— The Secretary of Commerce, upon nomination by the Director, shall appoint a Deputy Under Secretary of Commerce for Intellectual Property and Deputy Director of the United States Patent and Trademark Office who shall be vested with the authority to act in the capacity of the Director in the event of the absence or incapacity of the Director. The Deputy Director shall be a citizen of the United States who has a professional background and experience in patent or trademark law.

(2) COMMISSIONERS.—

(A) APPOINTMENT AND DUTIES.— The Secretary of Commerce shall appoint a Commissioner for Patents and a Commissioner for Trademarks, without regard to chapter 33, 51, or 53 of title 5. The Commissioner for Patents shall be a citizen of the United States with demonstrated management ability and professional background and experience in patent law and serve for a term of 5 years. The Commissioner for Trademarks shall be a citizen of the United States with demonstrated management ability and professional background and experience in trademark law and serve for a term of 5 years. The Commissioner for Patents and the Commissioner for

Trademarks shall serve as the chief operating officers for the operations of the Office relating to patents and trademarks, respectively, and shall be responsible for the management and direction of all aspects of the activities of the Office that affect the administration of patent and trademark operations, respectively. The Secretary may reappoint a Commissioner to subsequent terms of 5 years as long as the performance of the Commissioner as set forth in the performance agreement in subparagraph (B) is satisfactory.

(B) **SALARY AND PERFORMANCE AGREEMENT.**— The Commissioners shall be paid an annual rate of basic pay not to exceed the maximum rate of basic pay for the Senior Executive Service established under section 5382 of title 5, including any applicable locality-based comparability payment that may be authorized under section 5304(h)(2)(C) of title 5. The compensation of the Commissioners shall be considered, for purposes of section 207(c)(2)(A) of title 18, to be the equivalent of that described under clause (ii) of section 207(c)(2)(A) of title 18. In addition, the Commissioners may receive a bonus in an amount of up to, but not in excess of, 50 percent of the Commissioners' annual rate of basic pay, based upon an evaluation by the Secretary of Commerce, acting through the Director, of the Commissioners' performance as defined in an annual performance agreement between the Commissioners and the Secretary. The annual performance agreements shall incorporate measurable organization and individual goals in key operational areas as delineated in an annual performance plan agreed to by the Commissioners and the Secretary. Payment of a bonus under this subparagraph may be made to the Commissioners only to the extent that such payment does not cause the Commissioners' total aggregate compensation in a calendar year to equal or exceed the amount of the salary of the Vice President under section 104 of title 3.

(C) **REMOVAL.**— The Commissioners may be removed from office by the Secretary for misconduct or nonsatisfactory performance under the performance agreement described in subparagraph (B), without regard to the provisions of title 5. The Secretary shall provide notification of any such removal to both Houses of Congress.

(3) **OTHER OFFICERS AND EMPLOYEES.**— The Director shall—

(A) appoint such officers, employees (including attorneys), and agents of the Office as the Director considers necessary to carry out the functions of the Office; and

(B) define the title, authority, and duties of such officers and employees and delegate to them such of the powers vested in the Office as the Director may determine.

The Office shall not be subject to any administratively or statutorily imposed limitation on positions or personnel, and no positions or personnel of the Office shall be taken into account for purposes of applying any such limitation

(4) **TRAINING OF EXAMINERS.**— The Office shall submit to the Congress a proposal to provide an incentive program to retain as employees patent and trademark examiners of the primary examiner grade or higher who are eligible for retirement, for the sole purpose of training patent and trademark examiners.

(5) **NATIONAL SECURITY POSITIONS.**— The Director, in consultation with the Director of the Office of Personnel Management, shall maintain a program for identifying national security positions and providing for appropriate security clearances, in order to maintain the secrecy of certain inventions, as described in section 181, and to prevent disclosure of sensitive and strategic information in the interest of national security.

(c) **CONTINUED APPLICABILITY OF TITLE 5.**— Officers and employees of the Office shall be subject to the provisions of title 5, relating to Federal employees.

(d) **ADOPTION OF EXISTING LABOR AGREEMENTS.**— The Office shall adopt all labor agreements which are in effect, as of the day before the effective date of the Patent and Trademark Office Efficiency Act, with respect to such Office (as then in effect).

(e) **CARRYOVER OF PERSONNEL.**—

(1) **FROM PTO.**— Effective as of the effective date of the Patent and Trademark Office Efficiency Act, all officers and employees of the Patent and Trademark Office on the day before such effective date shall become officers and employees of the Office, without a break in service.

(2) **OTHER PERSONNEL.**— Any individual who, on the day before the effective date of the

Patent and Trademark Office Efficiency Act, is an officer or employee of the Department of Commerce (other than an officer or employee under paragraph (1)) shall be transferred to the Office, as necessary to carry out the purposes of this Act, if—

(A) such individual serves in a position for which a major function is the performance of work reimbursed by the Patent and Trademark Office, as determined by the Secretary of Commerce;

(B) such individual serves in a position that performed work in support of the Patent and Trademark Office during at least half of the incumbent's work time, as determined by the Secretary of Commerce; or

(C) such transfer would be in the interest of the Office, as determined by the Secretary of Commerce in consultation with the Director.

Any transfer under this paragraph shall be effective as of the same effective date as referred to in paragraph (1), and shall be made without a break in service.

(f) **TRANSITION PROVISIONS.—**

(1) **INTERIM APPOINTMENT OF DIRECTOR.—** On or after the effective date of the Patent and Trademark Office Efficiency Act, the President shall appoint an individual to serve as the Director until the date on which a Director qualifies under subsection (a). The President shall not make more than one such appointment under this subsection.

(2) **CONTINUATION IN OFFICE OF CERTAIN OFFICERS.—**

(A) The individual serving as the Assistant Commissioner for Patents on the day before the effective date of the Patent and Trademark Office Efficiency Act may serve as the Commissioner for Patents until the date on which a Commissioner for Patents is appointed under subsection (b).

(B) The individual serving as the Assistant Commissioner for Trademarks on the day before the effective date of the Patent and Trademark Office Efficiency Act may serve as the Commissioner for Trademarks until the date on which a Commissioner for Trademarks is appointed under subsection (b).

(Amended Sept. 6, 1958, Public Law 85-933, sec. 1, 72 Stat. 1793; Sept. 23, 1959, Public Law 86-370, sec. 1(a), 73 Stat. 650; Aug. 14, 1964, Public Law 88-426, sec. 305(26), 78 Stat. 425; Jan. 2, 1975, Public Law 93-596, sec. 1, 88 Stat. 1949; Jan. 2, 1975, Public Law 93-601, sec. 1,

88 Stat. 1956; Aug. 27, 1982, Public Law 97-247, sec. 4, 96 Stat. 319; Oct. 25, 1982, Public Law 97-366, sec. 4, 96 Stat. 1760; Nov. 8, 1984, Public Law 98-622, sec. 405, 98 Stat. 3392; Oct. 28, 1998, Public Law 105-304, sec. 401(a)(1), 112 Stat. 2887; Nov. 29, 1999, Public Law 106-113, sec. 1000(a)(9), 113 Stat. 1501A-575 (S. 1948 sec. 4713); subsections (a)(2)(B), (b)(2), and (c) amended Nov. 2, 2002, Public Law 107-273, sec. 13206, 116 Stat. 1904.)

**35 U.S.C. 4 Restrictions on officers and employees as to interest in patents.**

Officers and employees of the Patent and Trademark Office shall be incapable, during the period of their appointments and for one year thereafter, of applying for a patent and of acquiring, directly or indirectly, except by inheritance or bequest, any patent or any right or interest in any patent, issued or to be issued by the Office. In patents applied for thereafter they shall not be entitled to any priority date earlier than one year after the termination of their appointment.

(Amended Jan. 2, 1975, Public Law 93-596, sec. 1, 88 Stat. 1949.)

**35 U.S.C. 5 Patent and Trademark Office Public Advisory Committees.**

(a) **ESTABLISHMENT OF PUBLIC ADVISORY COMMITTEES.—**

(1) **APPOINTMENT.—** The United States Patent and Trademark Office shall have a Patent Public Advisory Committee and a Trademark Public Advisory Committee, each of which shall have nine voting members who shall be appointed by the Secretary of Commerce and serve at the pleasure of the Secretary of Commerce. Members of each Public Advisory Committee shall be appointed for a term of 3 years, except that of the members first appointed, three shall be appointed for a term of 1 year, and three shall be appointed for a term of 2 years. In making appointments to each Committee, the Secretary of Commerce shall consider the risk of loss of competitive advantage in international commerce or other harm to United States companies as a result of such appointments.

(2) **CHAIR.—** The Secretary shall designate a chair of each Advisory Committee, whose term as chair shall be for 3 years.

(3) **TIMING OF APPOINTMENTS.—** Initial appointments to each Advisory Committee shall be made within 3 months after the effective date of the

Patent and Trademark Office Efficiency Act. Vacancies shall be filled within 3 months after they occur.

(b) **BASIS FOR APPOINTMENTS.**— Members of each Advisory Committee—

(1) shall be citizens of the United States who shall be chosen so as to represent the interests of diverse users of the United States Patent and Trademark Office with respect to patents, in the case of the Patent Public Advisory Committee, and with respect to trademarks, in the case of the Trademark Public Advisory Committee;

(2) shall include members who represent small and large entity applicants located in the United States in proportion to the number of applications filed by such applicants, but in no case shall members who represent small entity patent applicants, including small business concerns, independent inventors, and nonprofit organizations, constitute less than 25 percent of the members of the Patent Public Advisory Committee, and such members shall include at least one independent inventor; and

(3) shall include individuals with substantial background and achievement in finance, management, labor relations, science, technology, and office automation. In addition to the voting members, each Advisory Committee shall include a representative of each labor organization recognized by the United States Patent and Trademark Office. Such representatives shall be nonvoting members of the Advisory Committee to which they are appointed.

(c) **MEETINGS.**— Each Advisory Committee shall meet at the call of the chair to consider an agenda set by the chair.

(d) **DUTIES.**— Each Advisory Committee shall—

(1) review the policies, goals, performance, budget, and user fees of the United States Patent and Trademark Office with respect to patents, in the case of the Patent Public Advisory Committee, and with respect to Trademarks, in the case of the Trademark Public Advisory Committee, and advise the Director on these matters;

(2) within 60 days after the end of each fiscal year—

(A) prepare an annual report on the matters referred to in paragraph (1);

(B) transmit the report to the Secretary of Commerce, the President, and the Committees on the

Judiciary of the Senate and the House of Representatives; and

(C) publish the report in the Official Gazette of the United States Patent and Trademark Office.

(e) **COMPENSATION.**— Each member of each Advisory Committee shall be compensated for each day (including travel time) during which such member is attending meetings or conferences of that Advisory Committee or otherwise engaged in the business of that Advisory Committee, at the rate which is the daily equivalent of the annual rate of basic pay in effect for level III of the Executive Schedule under section 5314 of title 5. While away from such member's home or regular place of business such member shall be allowed travel expenses, including per diem in lieu of subsistence, as authorized by section 5703 of title 5.

(f) **ACCESS TO INFORMATION.**— Members of each Advisory Committee shall be provided access to records and information in the United States Patent and Trademark Office, except for personnel or other privileged information and information concerning patent applications required to be kept in confidence by section 122.

(g) **APPLICABILITY OF CERTAIN ETHICS LAWS.**— Members of each Advisory Committee shall be special Government employees within the meaning of section 202 of title 18.

(h) **INAPPLICABILITY OF FEDERAL ADVISORY COMMITTEE ACT.**— The Federal Advisory Committee Act (5 U.S.C. App.) shall not apply to each Advisory Committee.

(i) **OPEN MEETINGS.**— The meetings of each Advisory Committee shall be open to the public, except that each Advisory Committee may by majority vote meet in executive session when considering personnel, privileged, or other confidential information.

(j) **INAPPLICABILITY OF PATENT PROHIBITION.**— Section 4 shall not apply to voting members of the Advisory Committees.

(Added Nov. 29, 1999, Public Law 106-113, sec. 1000(a)(9), 113 Stat. 1501A-578 (S. 1948 sec. 4714); subsections (e) and (g) amended Nov. 2, 2002, Public Law 107-273, sec. 13206, 116 Stat. 1904; subsection (i) amended and subsection (j) added Nov. 2, 2002, Public Law 107-273, sec. 13203, 116 Stat. 1902.)



### **35 U.S.C. 6 Board of Patent Appeals and Interferences.**

(a) ESTABLISHMENT AND COMPOSITION.— There shall be in the United States Patent and Trademark Office a Board of Patent Appeals and Interferences. The Director, the Deputy Commissioner, the Commissioner for Patents, the Commissioner for Trademarks, and the administrative patent judges shall constitute the Board. The administrative patent judges shall be persons of competent legal knowledge and scientific ability who are appointed by the Director.

(b) DUTIES.— The Board of Patent Appeals and Interferences shall, on written appeal of an applicant, review adverse decisions of examiners upon applications for patents and shall determine priority and patentability of invention in interferences declared under section 135(a). Each appeal and interference shall be heard by at least three members of the Board, who shall be designated by the Director. Only the Board of Patent Appeals and Interferences may grant rehearings.

(Repealed by Public Law 106-113, sec. 1000(a)(9), 113 Stat. 1501A-580 (S. 1948 sec. 4715(a).)

(Added Nov. 29, 1999, Public Law 106-113, sec. 1000(a)(9), 113 Stat. 1501A-580 (S. 1948 sec. 4717(2)).)

(Subsection (a) amended Nov. 2, 2002, Public Law 107-273, sec. 13203, 116 Stat. 1902.)

### **35 U.S.C. 7 Library.**

The Director shall maintain a library of scientific and other works and periodicals, both foreign and domestic, in the Patent and Trademark Office to aid the officers in the discharge of their duties.

(Repealed Nov. 29, 1999, Public Law 106-113, sec. 1000(a)(9), 113 Stat. 1501A-580 (S. 1948 sec. 4717(1)).)

(Transferred from 35 U.S.C. 8 Nov. 29, 1999, Public Law 106-113, sec. 1000(a)(9), 113 Stat. 1501A-580 (S. 1948 sec. 4717(1)); amended Jan. 2, 1975, Public Law 93-596, sec. 1, 88 Stat. 1949.)

(Amended Nov. 29, 1999, Public Law 106-113, sec. 1000(a)(9), 113 Stat. 1501A-582 (S. 1948 sec. 4732(a)(10)(A)).)

### **35 U.S.C. 8 Classification of patents.**

The Director may revise and maintain the classification by subject matter of United States letters patent, and such other patents and printed publications as may be necessary or practicable, for the purpose of determining with readiness and accuracy the novelty of inventions for which applications for patent are filed.

(Transferred to 35 U.S.C. 7 Nov. 29, 1999, Public Law 106-113, sec. 1000(a)(9), 113 Stat. 1501A-580 (S. 1948 sec. 4717(1)).)

(Transferred from 35 U.S.C. 9 Nov. 29, 1999, Public Law 106-113, sec. 1000(a)(9), 113 Stat. 1501A-580 (S. 1948 sec. 4717(1)).)

(Amended Nov. 29, 1999, Public Law 106-113, sec. 1000(a)(9), 113 Stat. 1501A-582 (S. 1948 sec. 4732(a)(10)(A)).)

### **35 U.S.C. 9 Certified copies of records.**

The Director may furnish certified copies of specifications and drawings of patents issued by the Patent and Trademark Office, and of other records available either to the public or to the person applying therefor.

(Transferred to 35 U.S.C. 8 Nov. 29, 1999, Public Law 106-113, sec. 1000(a)(9), 113 Stat. 1501A-580 (S. 1948 sec. 4717(1)).)

(Transferred from 35 U.S.C. 10 Nov. 29, 1999, Public Law 106-113, sec. 1000(a)(9), 113 Stat. 1501A-580 (S. 1948 sec. 4717(1)); amended Jan. 2, 1975, Public Law 93-596, sec. 1, 88 Stat. 1949.)

(Amended Nov. 29, 1999, Public Law 106-113, sec. 1000(a)(9), 113 Stat. 1501A-582 (S. 1948 sec. 4732(a)(10)(A)).)

### **35 U.S.C. 10 Publications.**

(a) The Director may publish in printed, typewritten, or electronic form, the following:

(1) Patents and published applications for patents, including specifications and drawings, together with copies of the same. The Patent and Trademark Office may print the headings of the drawings for patents for the purpose of photolithography.

(2) Certificates of trademark registrations, including statements and drawings, together with copies of the same.

(3) The Official Gazette of the United States Patent and Trademark Office.

(4) Annual indexes of patents and patentees, and of trademarks and registrants.

(5) Annual volumes of decisions in patent and trademark cases.

(6) Pamphlet copies of the patent laws and rules of practice, laws and rules relating to trademarks, and circulars or other publications relating to the business of the Office.

(b) The Director may exchange any of the publications specified in items 3, 4, 5, and 6 of subsection (a) of this section for publications desirable for the use of the Patent and Trademark Office.

(Transferred to 35 U.S.C. 9 Nov. 29, 1999, Public Law 106-113, sec. 1000(a)(9), 113 Stat. 1501A-580 (S. 1948 sec. 4717(1)).)

(Transferred from 35 U.S.C. 11 Nov. 29, 1999, Public Law 106-113, sec. 1000(a)(9), 113 Stat. 1501A-580 (S 1948 sec. 4717(1)); amended Jan. 2, 1975, Public Law 93-596, sec. 1, 88 Stat. 1949; Nov. 29, 1999, Public Law 106-113, sec. 1000(a)(9), 113 Stat. 1501A-589 (S. 1948 sec. 4804(b)).)

(Amended Nov. 29, 1999, Public Law 106-113, sec. 1000(a)(9), 113 Stat. 1501A-565, 582 (S. 1948 secs. 4507(1) and 4732(a)(10)(A)).)

### **35 U.S.C. 11 Exchange of copies of patents and applications with foreign countries.**

The Director may exchange copies of specifications and drawings of United States patents and published applications for patents for those of foreign countries.

The Director shall not enter into an agreement to provide such copies of specifications and drawings of United States patents and applications to a foreign country, other than a NAFTA country or a WTO member country, without the express authorization of the Secretary of Commerce. For purposes of this section, the terms “NAFTA country” and “WTO member country” have the meanings given those terms in section 104(b).

(Transferred to 35 U.S.C. 10 Nov. 29, 1999, Public Law 106-113, sec. 1000(a)(9), 113 Stat. 1501A-580 (S 1948 sec. 4717(1)).)

(Transferred from 35 U.S.C. 12 Nov. 29, 1999, Public Law 106-113, sec. 1000(a)(9), 113 Stat. 1501A-580 (S 1948 sec. 4717(1)); amended Nov. 29, 1999, Public Law

106-113, sec. 1000(a)(9), 113 Stat. 1501A-591 (S. 1948 sec. 4808).)

(Amended Nov. 29, 1999, Public Law 106-113, sec. 1000(a)(9), 113 Stat. 1501A-565, 582 (S. 1948 secs. 4507(2)(A), 4507(2)(B), and 4732(a)(10)(A)).)

### **35 U.S.C. 12 Copies of patents and applications for public libraries.**

The Director may supply copies of specifications and drawings of patents and published applications for patents in printed or electronic form to public libraries in the United States which shall maintain such copies for the use of the public, at the rate for each year’s issue established for this purpose in section 41(d) of this title.

(Transferred to 35 U.S.C. 11 Nov. 29, 1999, Public Law 106-113, sec. 1000(a)(9), 113 Stat. 1501A-580 (S. 1948 sec. 4717(1)).)

(Transferred from 35 U.S.C. 13 Nov. 29, 1999, Public Law 106-113, sec. 1000(a)(9), 113 Stat. 1501A-580 (S 1948 sec. 4717(1)); amended Aug. 27, 1982, Public Law 97-247, sec. 15, 96 Stat. 321; Nov. 29, 1999, Public Law 106-113, sec. 1000(a)(9), 113 Stat. 1501A-589 (S. 1948 sec. 4804(c)).)

(Amended Nov. 29, 1999, Public Law 106-113, sec. 1000(a)(9), 113 Stat. 1501A-565, 566, 582 (S. 1948 secs. 4507(3)(A), 4507(3)(B), 4507(4), and 4732(a)(10)(A)).)

### **35 U.S.C. 13 Annual report to Congress.**

The Director shall report to the Congress, not later than 180 days after the end of each fiscal year, the moneys received and expended by the Office, the purposes for which the moneys were spent, the quality and quantity of the work of the Office, the nature of training provided to examiners, the evaluation of the Commissioner of Patents and the Commissioner of Trademarks by the Secretary of Commerce, the compensation of the Commissioners, and other information relating to the Office.

(Transferred to 35 U.S.C. 12 Nov. 29, 1999, Public Law 106-113, sec. 1000(a)(9), 113 Stat. 1501A-580 (S 1948 sec. 4717(1)).)

(Transferred from 35 U.S.C. 14 Nov. 29, 1999, Public Law 106-113, sec. 1000(a)(9), 113 Stat. 1501A-580 (S 1948 sec. 4717(1)).)

(Amended Nov. 29, 1999, Public Law 106-113, sec. 1000(a)(9), 113 Stat. 1501A-565, 581 (S. 1948 secs. 4507(2), 4718).)

## CHAPTER 2 — PROCEEDINGS IN THE PATENT AND TRADEMARK OFFICE

Sec.

- 21 Filing date and day for taking action.
- 22 Printing of papers filed.
- 23 Testimony in Patent and Trademark Office cases.
- 24 Subpoenas, witnesses.
- 25 Declaration in lieu of oath.
- 26 Effect of defective execution.

### **35 U.S.C. 21 Filing date and day for taking action.**

(a) The Director may by rule prescribe that any paper or fee required to be filed in the Patent and Trademark Office will be considered filed in the Office on the date on which it was deposited with the United States Postal Service or would have been deposited with the United States Postal Service but for postal service interruptions or emergencies designated by the Director.

(b) When the day, or the last day, for taking any action or paying any fee in the United States Patent and Trademark Office falls on Saturday, Sunday, or a Federal holiday within the District of Columbia, the action may be taken, or fee paid, on the next succeeding secular or business day.

(Amended Jan. 2, 1975, Public Law 93-596, sec. 1, 88 Stat. 1949; Aug. 27, 1982, Public Law 97-247, sec. 12, 96 Stat. 321; Nov. 29, 1999, Public Law 106-113, sec. 1000(a)(9), 113 Stat. 1501A-582 (S. 1948 sec. 4732(a)(10)(A)).)

### **35 U.S.C. 22 Printing of papers filed.**

The Director may require papers filed in the Patent and Trademark Office to be printed, typewritten, or on an electronic medium.

(Amended Jan. 2, 1975, Public Law 93-596, sec. 1, 88 Stat. 1949; Nov. 29, 1999, Public Law 106-113, sec. 1000(a)(9), 113 Stat. 1501A-582, 589 (S. 1948 secs. 4732(a)(10)(A), 4804(a)).)

### **35 U.S.C. 23 Testimony in Patent and Trademark Office cases.**

The Director may establish rules for taking affidavits and depositions required in cases in the Patent

and Trademark Office. Any officer authorized by law to take depositions to be used in the courts of the United States, or of the State where he resides, may take such affidavits and depositions.

(Amended Jan. 2, 1975, Public Law 93-596, sec. 1, 88 Stat. 1949; Nov. 29, 1999, Public Law 106-113, sec. 1000(a)(9), 113 Stat. 1501A-582 (S. 1948 sec. 4732(a)(10)(A)).)

### **35 U.S.C. 24 Subpoenas, witnesses.**

The clerk of any United States court for the district wherein testimony is to be taken for use in any contested case in the Patent and Trademark Office, shall, upon the application of any party thereto, issue a subpoena for any witness residing or being within such district, commanding him to appear and testify before an officer in such district authorized to take depositions and affidavits, at the time and place stated in the subpoena. The provisions of the Federal Rules of Civil Procedure relating to the attendance of witnesses and to the production of documents and things shall apply to contested cases in the Patent and Trademark Office.

Every witness subpoenaed and in attendance shall be allowed the fees and traveling expenses allowed to witnesses attending the United States district courts.

A judge of a court whose clerk issued a subpoena may enforce obedience to the process or punish disobedience as in other like cases, on proof that a witness, served with such subpoena, neglected or refused to appear or to testify. No witness shall be deemed guilty of contempt for disobeying such subpoena unless his fees and traveling expenses in going to, and returning from, and one day's attendance at the place of examination, are paid or tendered him at the time of the service of the subpoena; nor for refusing to disclose any secret matter except upon appropriate order of the court which issued the subpoena.

(Amended Jan. 2, 1975, Public Law 93-596, sec. 1, 88 Stat. 1949.)

### **35 U.S.C. 25 Declaration in lieu of oath.**

(a) The Director may by rule prescribe that any document to be filed in the Patent and Trademark Office and which is required by any law, rule, or other regulation to be under oath may be subscribed to by a written declaration in such form as the Director may prescribe, such declaration to be in lieu of the oath otherwise required.

(b) Whenever such written declaration is used, the document must warn the declarant that willful false statements and the like are punishable by fine or imprisonment, or both (18 U.S.C. 1001).

(Added Mar. 26, 1964, Public Law 88-292, sec. 1, 78 Stat. 171; amended Jan. 2, 1975, Public Law 93-596, sec. 1, 88 Stat. 1949; Nov. 29, 1999, Public Law 106-113, sec. 1000(a)(9), 113 Stat. 1501A-582 (S. 1948 sec. 4732(a)(10)(A)).)

### **35 U.S.C. 26 Effect of defective execution.**

Any document to be filed in the Patent and Trademark Office and which is required by any law, rule, or other regulation to be executed in a specified manner may be provisionally accepted by the Director despite a defective execution, provided a properly executed document is submitted within such time as may be prescribed.

(Added Mar. 26, 1964, Public Law 88-292, sec. 1, 78 Stat. 171; amended Jan. 2, 1975, Public Law 93-596, sec. 1, 88 Stat. 1949; Nov. 29, 1999, Public Law 106-113, sec. 1000(a)(9), 113 Stat. 1501A-582 (S. 1948 sec. 4732(a)(10)(A)).)

## CHAPTER 3 — PRACTICE BEFORE PATENT AND TRADEMARK OFFICE

Sec.

31 [Repealed]

32 Suspension or exclusion from practice.

33 Unauthorized representation as practitioner.

### **35 U.S.C. 31 [Repealed].**

(Repealed Nov. 29, 1999, Public Law 106-113, sec. 1000(a)(9), 113 Stat. 1501A-580 (S. 1948 sec. 4715(b)).)

### **35 U.S.C. 32 Suspension or exclusion from practice.**

The Director may, after notice and opportunity for a hearing, suspend or exclude, either generally or in any particular case, from further practice before the Patent and Trademark Office, any person, agent, or attorney shown to be incompetent or disreputable, or guilty of gross misconduct, or who does not comply with the regulations established under section 2(b)(2)(D) of this title, or who shall, by word, circular, letter, or advertising, with intent to defraud in any manner, deceive, mislead, or threaten any applicant or prospective applicant, or other person having immediate or prospective business before the Office. The reasons

for any such suspension or exclusion shall be duly recorded. The Director shall have the discretion to designate any attorney who is an officer or employee of the United States Patent and Trademark Office to conduct the hearing required by this section. The United States District Court for the District of Columbia, under such conditions and upon such proceedings as it by its rules determines, may review the action of the Director upon the petition of the person so refused recognition or so suspended or excluded.

(Amended Jan. 2, 1975, Public Law 93-596, sec. 1, 88 Stat. 1949; Nov. 29, 1999, Public Law 106-113, sec. 1000(a)(9), 113 Stat. 1501A-580, 581, 582 (S. 1948 secs. 4715(c), 4719, 4732(a)(10)(A)).)

### **35 U.S.C. 33 Unauthorized representation as practitioner.**

Whoever, not being recognized to practice before the Patent and Trademark Office, holds himself out or permits himself to be held out as so recognized, or as being qualified to prepare or prosecute applications for patent, shall be fined not more than \$1,000 for each offense.

(Amended Jan. 2, 1975, Public Law 93-596, sec. 1, 88 Stat. 1949.)

## CHAPTER 4 — PATENT FEES; FUNDING; SEARCH SYSTEMS

Sec.

41 Patent fees; patent and trademark search systems.

42 Patent and Trademark Office funding.

### **35 U.S.C. 41 Patent fees; patent and trademark search systems.**

(a) The Director shall charge the following fees:

(1)(A) On filing each application for an original patent, except in design or plant cases, \$690.

(B) In addition, on filing or on presentation at any other time, \$78 for each claim in independent form which is in excess of 3, \$18 for each claim (whether independent or dependent) which is in excess of 20, and \$260 for each application containing a multiple dependent claim.

(C) On filing each provisional application for an original patent, \$150.

(2) For issuing each original or reissue patent, except in design or plant cases, \$1,210.

- (3) In design and plant cases-
- (A) on filing each design application, \$310;
  - (B) on filing each plant application, \$480;
  - (C) on issuing each design patent, \$430;

and

- (D) on issuing each plant patent, \$580.

(4)(A) On filing each application for the reissue of a patent, \$690.

(B) In addition, on filing or on presentation at any other time, \$78 for each claim in independent form which is in excess of the number of independent claims of the original patent, and \$18 for each claim (whether independent or dependent) which is in excess of 20 and also in excess of the number of claims of the original patent.

- (5) On filing each disclaimer, \$110.

(6)(A) On filing an appeal from the examiner to the Board of Patent Appeals and Interferences, \$300.

(B) In addition, on filing a brief in support of the appeal, \$300, and on requesting an oral hearing in the appeal before the Board of Patent Appeals and Interferences, \$260.

(7) On filing each petition for the revival of an unintentionally abandoned application for a patent, for the unintentionally delayed payment of the fee for issuing each patent, or for an unintentionally delayed response by the patent owner in any reexamination proceeding, \$1,210, unless the petition is filed under section 133 or 151 of this title, in which case the fee shall be \$110.

(8) For petitions for 1-month extensions of time to take actions required by the Director in an application-

- (A) on filing a first petition, \$110;
- (B) on filing a second petition, \$270; and
- (C) on filing a third or subsequent petition, \$490.

(9) Basic national fee for an international application where the Patent and Trademark Office was the International Preliminary Examining Authority and the International Searching Authority, \$670.

(10) Basic national fee for an international application where the Patent and Trademark Office was the International Searching Authority but not the International Preliminary Examining Authority, \$690.

(11) Basic national fee for an international application where the Patent and Trademark Office

was neither the International Searching Authority nor the International Preliminary Examining Authority, \$970.

(12) Basic national fee for an international application where the international preliminary examination has been paid to the Patent and Trademark Office, and the international preliminary examination report states that the provisions of Article 33 (2), (3), and (4) of the Patent Cooperation Treaty have been satisfied for all claims in the application entering the national stage, \$96.

(13) For filing or later presentation of each independent claim in the national stage of an international application in excess of 3, \$78.

(14) For filing or later presentation of each claim (whether independent or dependent) in a national stage of an international application in excess of 20, \$18.

(15) For each national stage of an international application containing a multiple dependent claim, \$260.

For the purpose of computing fees, a multiple dependent claim as referred to in section 112 of this title or any claim depending therefrom shall be considered as separate dependent claims in accordance with the number of claims to which reference is made. Errors in payment of the additional fees may be rectified in accordance with regulations of the Director.

(b) The Director shall charge the following fees for maintaining in force all patents based on applications filed on or after December 12, 1980:

- (1) 3 years and 6 months after grant, \$830.
- (2) 7 years and 6 months after grant, \$1,900.
- (3) 11 years and 6 months after grant, \$2,910.

Unless payment of the applicable maintenance fee is received in the Patent and Trademark Office on or before the date the fee is due or within a grace period of six months thereafter, the patent will expire as of the end of such grace period. The Director may require the payment of a surcharge as a condition of accepting within such 6-month grace period the payment of an applicable maintenance fee. No fee may be established for maintaining a design or plant patent in force.

(c)(1) The Director may accept the payment of any maintenance fee required by subsection (b) of this section which is made within twenty-four months after the six-month grace period if the delay is shown

to the satisfaction of the Director to have been unintentional, or at any time after the six-month grace period if the delay is shown to the satisfaction of the Director to have been unavoidable. The Director may require the payment of a surcharge as a condition of accepting payment of any maintenance fee after the six-month grace period. If the Director accepts payment of a maintenance fee after the six-month grace period, the patent shall be considered as not having expired at the end of the grace period.

(2) A patent, the term of which has been maintained as a result of the acceptance of a payment of a maintenance fee under this subsection, shall not abridge or affect the right of any person or that person's successors in business who made, purchased, offered to sell, or used anything protected by the patent within the United States, or imported anything protected by the patent into the United States after the 6-month grace period but prior to the acceptance of a maintenance fee under this subsection, to continue the use of, to offer for sale, or to sell to others to be used, offered for sale, or sold, the specific thing so made, purchased, offered for sale, used, or imported. The court before which such matter is in question may provide for the continued manufacture, use, offer for sale, or sale of the thing made, purchased, offered for sale, or used within the United States, or imported into the United States, as specified, or for the manufacture, use, offer for sale, or sale in the United States of which substantial preparation was made after the 6-month grace period but before the acceptance of a maintenance fee under this subsection, and the court may also provide for the continued practice of any process that is practiced, or for the practice of which substantial preparation was made, after the 6-month grace period but before the acceptance of a maintenance fee under this subsection, to the extent and under such terms as the court deems equitable for the protection of investments made or business commenced after the 6-month grace period but before the acceptance of a maintenance fee under this subsection.

(d) The Director shall establish fees for all other processing, services, or materials relating to patents not specified in this section to recover the estimated average cost to the Office of such processing, services, or materials, except that the Director shall charge the following fees for the following services:

(1) For recording a document affecting title, \$40 per property.

(2) For each photocopy, \$.25 per page.

(3) For each black and white copy of a patent, \$3.

The yearly fee for providing a library specified in section 13 of this title with uncertified printed copies of the specifications and drawings for all patents issued in that year shall be \$50.

(e) The Director may waive the payment of any fee for any service or material related to patents in connection with an occasional or incidental request made by a department or agency of the Government, or any officer thereof. The Director may provide any applicant issued a notice under section 132 of this title with a copy of the specifications and drawings for all patents referred to in that notice without charge.

(f) The fees established in subsections (a) and (b) of this section may be adjusted by the Director on October 1, 1992, and every year thereafter, to reflect any fluctuations occurring during the previous 12 months in the Consumer Price Index, as determined by the Secretary of Labor. Changes of less than 1 per centum may be ignored.

(g) No fee established by the Director under this section shall take effect until at least 30 days after notice of the fee has been published in the Federal Register and in the *Official Gazette* of the Patent and Trademark Office.

(h)(1) Fees charged under subsection (a) or (b) shall be reduced by 50 percent with respect to their application to any small business concern as defined under section 3 of the Small Business Act, and to any independent inventor or nonprofit organization as defined in regulations issued by the Director.

(2) With respect to its application to any entity described in paragraph (1), any surcharge or fee charged under subsection (c) or (d) shall not be higher than the surcharge or fee required of any other entity under the same or substantially similar circumstances.

(i)(1) The Director shall maintain, for use by the public, paper, microform or electronic collections of United States patents, foreign patent documents, and United States trademark registrations arranged to permit search for and retrieval of information. The Director may not impose fees directly for the use of such collections, or for the use of the public patent and trademark search rooms or libraries.

(2) The Director shall provide for the full deployment of the automated search systems of the Patent and Trademark Office so that such systems are available for use by the public, and shall assure full access by the public to, and dissemination of, patent and trademark information, using a variety of automated methods, including electronic bulletin boards and remote access by users to mass storage and retrieval systems.

(3) The Director may establish reasonable fees for access by the public to the automated search systems of the Patent and Trademark Office. If such fees are established, a limited amount of free access shall be made available to users of the systems for purposes of education and training. The Director may waive the payment by an individual of fees authorized by this subsection upon a showing of need or hardship, and if such waiver is in the public interest.

(4) The Director shall submit to the Congress an annual report on the automated search systems of the Patent and Trademark Office and the access by the public to such systems. The Director shall also publish such report in the Federal Register. The Director shall provide an opportunity for the submission of comments by interested persons on each such report.

(Amended July 24, 1965, Public Law 89-83, sec. 1, 2, 79 Stat. 259; Jan. 2, 1975, Public Law 93-596, sec. 1, Jan. 2, 1975, 88 Stat. 1949; Nov. 14, 1975, Public Law 94-131, sec. 3, 89 Stat. 690.)

(Subsection (g) amended Dec. 12, 1980, Public Law 96-517, sec. 2, 94 Stat. 3017; Aug. 27, 1982, Public Law 97-247, sec. 3(a)-(e), 96 Stat. 317.)

(Subsections (a)-(d) amended Sept. 8, 1982, Public Law 97-256, sec. 101, 96 Stat. 816.)

(Subsection (a)(6) amended Nov. 8, 1984, Public Law 98-622, sec. 204(a), 98 Stat. 3388.)

(Subsection (h) added Nov. 6, 1986, Public Law 99-607, sec. 1(b)(2), 100 Stat. 3470.)

(Subsections (a), (b), (d), (f), and (g) amended Dec. 10, 1991, Public Law 102-204, sec. 5, 105 Stat. 1637.)

(Subsections (a)(9) - (15) and (i) added Dec. 10, 1991, Public Law 102-204, sec. 5, 105 Stat. 1637.)

(Subsection (c)(1) amended Oct. 23, 1992, Public Law 102-444, sec. 1, 106 Stat. 2245.)

(Subsection (a)(1)(C) added Dec. 8, 1994, Public Law 103-465, sec. 532(b)(2), 108 Stat. 4986.)

(Subsection (c)(2) amended, Dec. 8, 1994, Public Law 103-465, sec. 533(b)(1), 108 Stat. 4988.)

(Subsections (a)-(b) revised Nov. 10, 1998, Public Law 105-358, sec. 3, 112 Stat. 3272.)

(Amended Nov. 29, 1999, Public Law 106-113, sec. 1000(a)(9), 113 Stat. 1501A-554, 570, 582, 589 (S. 1948 secs. 4202, 4605(a), 4732(a)(5), 4732(a)(10)(A)) and 4804(d).)

### **35 U.S.C. 42 Patent and Trademark Office funding.**

(a) All fees for services performed by or materials furnished by the Patent and Trademark Office will be payable to the Director.

(b) All fees paid to the Director and all appropriations for defraying the costs of the activities of the Patent and Trademark Office will be credited to the Patent and Trademark Office Appropriation Account in the Treasury of the United States.

(c) To the extent and in the amounts provided in advance in appropriations Acts, fees authorized in this title or any other Act to be charged or established by the Director shall be collected by and shall be available to the Director to carry out the activities of the Patent and Trademark Office. All fees available to the Director under section 31 of the Trademark Act of 1946 shall be used only for the processing of trademark registrations and for other activities, services and materials relating to trademarks and to cover a proportionate share of the administrative costs of the Patent and Trademark Office.

(d) The Director may refund any fee paid by mistake or any amount paid in excess of that required.

(e) The Secretary of Commerce shall, on the day each year on which the President submits the annual budget to the Congress, provide to the Committees on the Judiciary of the Senate and the House of Representatives:

(1) a list of patent and trademark fee collections by the Patent and Trademark Office during the preceding fiscal year;

(2) a list of activities of the Patent and Trademark Office during the preceding fiscal year which were supported by patent fee expenditures, trademark fee expenditures, and appropriations;

(3) budget plans for significant programs, projects, and activities of the Office, including out-year funding estimates;

(4) any proposed disposition of surplus fees by the Office; and

(5) such other information as the committees consider necessary.

(Amended Nov. 14, 1975, Public Law 94-131, sec. 4, 89 Stat. 690; Dec. 12, 1980, Public Law 96-517, sec. 3, 94 Stat. 3018; Aug. 27, 1982, Public Law 97-247, sec. 3(g), 96 Stat. 319; Sept. 13, 1982, Public Law 97-258, sec. 3(i), 96 Stat. 1065.)

(Subsection (c) amended Dec. 10, 1991, Public Law 102-204, sec. 5(e), 105 Stat. 1640.)

(Subsection (e) added Dec. 10, 1991, Public Law 102-204, sec. 4, 105 Stat. 1637.)

(Subsection (c) revised Nov. 10, 1998, Public Law 105-358, sec. 4, 112 Stat. 3274.)

(Amended Nov. 29, 1999, Public Law 106-113, sec. 1000(a)(9), 113 Stat. 1501A-555, 582 (S. 1948 secs. 4205 and 4732(a)(10)(A)).)

## PART II — PATENTABILITY OF INVENTIONS AND GRANT OF PATENTS

### CHAPTER 10 — PATENTABILITY OF INVENTIONS

Sec.

100 Definitions.

101 Inventions patentable.

102 Conditions for patentability; novelty and loss of right to patent.

103 Conditions for patentability; non-obvious subject matter.

104 Invention made abroad.

105 Inventions in outer space.

#### 35 U.S.C. 100 Definitions.

When used in this title unless the context otherwise indicates -

(a) The term “invention” means invention or discovery.

(b) The term “process” means process, art, or method, and includes a new use of a known process, machine, manufacture, composition of matter, or material.

(c) The terms “United States” and “this country” mean the United States of America, its territories and possessions.

(d) The word “patentee” includes not only the patentee to whom the patent was issued but also the successors in title to the patentee.

(e) The term “third-party requester” means a person requesting ex parte reexamination under section 302 or inter partes reexamination under section 311 who is not the patent owner.

(Subsection (e) added Nov. 29, 1999, Public Law 106-113, sec. 1000(a)(9), 113 Stat. 1501A-567 (S. 1948 sec. 4603).)

#### 35 U.S.C. 101 Inventions patentable.

Whoever invents or discovers any new and useful process, machine, manufacture, or composition of matter, or any new and useful improvement thereof, may obtain a patent therefor, subject to the conditions and requirements of this title.

#### 35 U.S.C. 102 Conditions for patentability; novelty and loss of right to patent.

A person shall be entitled to a patent unless —

(a) the invention was known or used by others in this country, or patented or described in a printed publication in this or a foreign country, before the invention thereof by the applicant for patent, or

(b) the invention was patented or described in a printed publication in this or a foreign country or in public use or on sale in this country, more than one year prior to the date of the application for patent in the United States, or

(c) he has abandoned the invention, or

(d) the invention was first patented or caused to be patented, or was the subject of an inventor’s certificate, by the applicant or his legal representatives or assigns in a foreign country prior to the date of the application for patent in this country on an application for patent or inventor’s certificate filed more than twelve months before the filing of the application in the United States, or

(e) the invention was described in — (1) an application for patent, published under section 122(b), by another filed in the United States before the invention by the applicant for patent or (2) a patent granted on an application for patent by another filed in the United States before the invention by the applicant for patent, except that an international application filed under the treaty defined in section 351(a) shall have the effects for the purposes of this subsection of an application filed in the United States only if the inter-



national application designated the United States and was published under Article 21(2) of such treaty in the English language; or

(f) he did not himself invent the subject matter sought to be patented, or

(g)(1) during the course of an interference conducted under section 135 or section 291, another inventor involved therein establishes, to the extent permitted in section 104, that before such person's invention thereof the invention was made by such other inventor and not abandoned, suppressed, or concealed, or (2) before such person's invention thereof, the invention was made in this country by another inventor who had not abandoned, suppressed, or concealed it. In determining priority of invention under this subsection, there shall be considered not only the respective dates of conception and reduction to practice of the invention, but also the reasonable diligence of one who was first to conceive and last to reduce to practice, from a time prior to conception by the other.

(Amended July 28, 1972, Public Law 92-358, sec. 2, 86 Stat. 501; Nov. 14, 1975, Public Law 94-131, sec. 5, 89 Stat. 691.)

(Subsection (e) amended Nov. 29, 1999, Public Law 106-113, sec. 1000(a)(9), 113 Stat. 1501A-565 (S. 1948 sec. 4505).)

(Subsection (g) amended Nov. 29, 1999, Public Law 106-113, sec. 1000(a)(9), 113 Stat. 1501A-590 (S. 1948 sec. 4806).)

(Subsection (e) amended Nov. 2, 2002, Public Law 107-273, sec. 13205, 116 Stat. 1903.)

### **35 U.S.C. 103 Conditions for patentability; non-obvious subject matter.**

(a) A patent may not be obtained though the invention is not identically disclosed or described as set forth in section 102 of this title, if the differences between the subject matter sought to be patented and the prior art are such that the subject matter as a whole would have been obvious at the time the invention was made to a person having ordinary skill in the art to which said subject matter pertains. Patentability shall not be negated by the manner in which the invention was made.

(b)(1) Notwithstanding subsection (a), and upon timely election by the applicant for patent to proceed under this subsection, a biotechnological process using or resulting in a composition of matter that is

novel under section 102 and nonobvious under subsection (a) of this section shall be considered nonobvious if-

(A) claims to the process and the composition of matter are contained in either the same application for patent or in separate applications having the same effective filing date; and

(B) the composition of matter, and the process at the time it was invented, were owned by the same person or subject to an obligation of assignment to the same person.

(2) A patent issued on a process under paragraph (1)-

(A) shall also contain the claims to the composition of matter used in or made by that process, or

(B) shall, if such composition of matter is claimed in another patent, be set to expire on the same date as such other patent, notwithstanding section 154.

(3) For purposes of paragraph (1), the term "biotechnological process" means-

(A) a process of genetically altering or otherwise inducing a single- or multi-celled organism to-

(i) express an exogenous nucleotide sequence,

(ii) inhibit, eliminate, augment, or alter expression of an endogenous nucleotide sequence, or

(iii) express a specific physiological characteristic not naturally associated with said organism;

(B) cell fusion procedures yielding a cell line that expresses a specific protein, such as a monoclonal antibody; and

(C) a method of using a product produced by a process defined by subparagraph (A) or (B), or a combination of subparagraphs (A) and (B).

(c) Subject matter developed by another person, which qualifies as prior art only under one or more of subsections (e), (f), and (g) of section 102 of this title, shall not preclude patentability under this section where the subject matter and the claimed invention were, at the time the invention was made, owned by the same person or subject to an obligation of assignment to the same person.

(Amended Nov. 8, 1984, Public Law 98-622, sec. 103, 98 Stat. 3384; Nov. 1, 1995, Public Law 104-41, sec.1, 109 Stat. 3511.)

(Subsection (c) amended Nov. 29, 1999, Public Law 106-113, sec. 1000(a)(9), 113 Stat. 1501A-591 (S. 1948 sec. 4807).)

### **35 U.S.C. 104 Invention made abroad.**

(a) IN GENERAL.—

(1) PROCEEDINGS.—In proceedings in the Patent and Trademark Office, in the courts, and before any other competent authority, an applicant for a patent, or a patentee, may not establish a date of invention by reference to knowledge or use thereof, or other activity with respect thereto, in a foreign country other than a NAFTA country or a WTO member country, except as provided in sections 119 and 365 of this title.

(2) RIGHTS.—If an invention was made by a person, civil or military—

(A) while domiciled in the United States, and serving in any other country in connection with operations by or on behalf of the United States,

(B) while domiciled in a NAFTA country and serving in another country in connection with operations by or on behalf of that NAFTA country, or

(C) while domiciled in a WTO member country and serving in another country in connection with operations by or on behalf of that WTO member country, that person shall be entitled to the same rights of priority in the United States with respect to such invention as if such invention had been made in the United States, that NAFTA country, or that WTO member country, as the case may be.

(3) USE OF INFORMATION.—To the extent that any information in a NAFTA country or a WTO member country concerning knowledge, use, or other activity relevant to proving or disproving a date of invention has not been made available for use in a proceeding in the Patent and Trademark Office, a court, or any other competent authority to the same extent as such information could be made available in the United States, the Director, court, or such other authority shall draw appropriate inferences, or take other action permitted by statute, rule, or regulation, in favor of the party that requested the information in the proceeding.

(b) DEFINITIONS.—As used in this section—

(1) The term “NAFTA country” has the meaning given that term in section 2(4) of the North American Free Trade Agreement Implementation Act; and

(2) The term “WTO member country” has the meaning given that term in section 2(10) of the Uruguay Round Agreements Act.

(Amended Jan. 2, 1975, Public Law 93-596, sec. 1, 88 Stat. 1949; Nov. 14, 1975, Public Law 94-131, sec. 6, 89 Stat. 691; Nov. 8, 1984, Public Law 98-622, sec. 403(a), 98 Stat. 3392; Dec. 8, 1993, Public Law 103-182, sec. 331, 107 Stat. 2113; Dec. 8, 1994, Public Law 103-465, sec. 531(a), 108 Stat. 4982; Nov. 29, 1999, Public Law 106-113, sec. 1000(a)(9), 113 Stat. 1501A-582 (S. 1948 sec. 4732(a)(10)(A)).)

### **35 U.S.C. 105 Inventions in outer space.**

(a) Any invention made, used, or sold in outer space on a space object or component thereof under the jurisdiction or control of the United States shall be considered to be made, used or sold within the United States for the purposes of this title, except with respect to any space object or component thereof that is specifically identified and otherwise provided for by an international agreement to which the United States is a party, or with respect to any space object or component thereof that is carried on the registry of a foreign state in accordance with the Convention on Registration of Objects Launched into Outer Space.

(b) Any invention made, used, or sold in outer space on a space object or component thereof that is carried on the registry of a foreign state in accordance with the Convention on Registration of Objects Launched into Outer Space, shall be considered to be made, used, or sold within the United States for the purposes of this title if specifically so agreed in an international agreement between the United States and the state of registry.

(Added Nov. 15, 1990, Public Law 101-580, sec. 1(a), 104 Stat. 2863.)

## **CHAPTER 11 — APPLICATION FOR PATENT**

Sec.	
111	Application.
112	Specification.
113	Drawings.
114	Models, specimens.
115	Oath of applicant.
116	Inventors.
117	Death or incapacity of inventor.
118	Filing by other than inventor.
119	Benefit of earlier filing date; right of priority.

- 120 Benefit of earlier filing date in the United States.
- 121 Divisional applications.
- 122 Confidential status of applications; publication of patent applications.

### 35 U.S.C. 111 Application.

#### (a) IN GENERAL.—

(1) WRITTEN APPLICATION.—An application for patent shall be made, or authorized to be made, by the inventor, except as otherwise provided in this title, in writing to the Director.

(2) CONTENTS.—Such application shall include—

(A) a specification as prescribed by section 112 of this title;

(B) a drawing as prescribed by section 113 of this title; and

(C) an oath by the applicant as prescribed by section 115 of this title.

(3) FEE AND OATH.—The application must be accompanied by the fee required by law. The fee and oath may be submitted after the specification and any required drawing are submitted, within such period and under such conditions, including the payment of a surcharge, as may be prescribed by the Director.

(4) FAILURE TO SUBMIT.—Upon failure to submit the fee and oath within such prescribed period, the application shall be regarded as abandoned, unless it is shown to the satisfaction of the Director that the delay in submitting the fee and oath was unavoidable or unintentional. The filing date of an application shall be the date on which the specification and any required drawing are received in the Patent and Trademark Office.

#### (b) PROVISIONAL APPLICATION.—

(1) AUTHORIZATION.—A provisional application for patent shall be made or authorized to be made by the inventor, except as otherwise provided in this title, in writing to the Director. Such application shall include—

(A) a specification as prescribed by the first paragraph of section 112 of this title; and

(B) a drawing as prescribed by section 113 of this title.

(2) CLAIM.—A claim, as required by the second through fifth paragraphs of section 112, shall not be required in a provisional application.

#### (3) FEE.—

(A) The application must be accompanied by the fee required by law.

(B) The fee may be submitted after the specification and any required drawing are submitted, within such period and under such conditions, including the payment of a surcharge, as may be prescribed by the Director.

(C) Upon failure to submit the fee within such prescribed period, the application shall be regarded as abandoned, unless it is shown to the satisfaction of the Director that the delay in submitting the fee was unavoidable or unintentional.

(4) FILING DATE.—The filing date of a provisional application shall be the date on which the specification and any required drawing are received in the Patent and Trademark Office.

(5) ABANDONMENT.—Notwithstanding the absence of a claim, upon timely request and as prescribed by the Director, a provisional application may be treated as an application filed under subsection (a). Subject to section 119(e)(3) of this title, if no such request is made, the provisional application shall be regarded as abandoned 12 months after the filing date of such application and shall not be subject to revival after such 12-month period.

(6) OTHER BASIS FOR PROVISIONAL APPLICATION.—Subject to all the conditions in this subsection and section 119(e) of this title, and as prescribed by the Director, an application for patent filed under subsection (a) may be treated as a provisional application for patent.

(7) NO RIGHT OF PRIORITY OR BENEFIT OF EARLIEST FILING DATE.—A provisional application shall not be entitled to the right of priority of any other application under section 119 or 365(a) of this title or to the benefit of an earlier filing date in the United States under section 120, 121, or 365(c) of this title.

(8) APPLICABLE PROVISIONS.—The provisions of this title relating to applications for patent shall apply to provisional applications for patent, except as otherwise provided, and except that provisional applications for patent shall not be subject to sections 115, 131, 135, and 157 of this title.

(Amended Aug. 27, 1982, Public Law 97-247, sec. 5, 96 Stat. 319; Dec. 8, 1994, Public Law 103-465, sec. 532(b)(3), 108 Stat. 4986; Nov. 29, 1999, Public Law 106-

113, sec. 1000(a)(9), 113 Stat. 1501A-582, 588 (S. 1948 secs. 4732(a)(10)(A), 4801(a)).

### **35 U.S.C. 112 Specification.**

The specification shall contain a written description of the invention, and of the manner and process of making and using it, in such full, clear, concise, and exact terms as to enable any person skilled in the art to which it pertains, or with which it is most nearly connected, to make and use the same, and shall set forth the best mode contemplated by the inventor of carrying out his invention.

The specification shall conclude with one or more claims particularly pointing out and distinctly claiming the subject matter which the applicant regards as his invention.

A claim may be written in independent or, if the nature of the case admits, in dependent or multiple dependent form.

Subject to the following paragraph, a claim in dependent form shall contain a reference to a claim previously set forth and then specify a further limitation of the subject matter claimed. A claim in dependent form shall be construed to incorporate by reference all the limitations of the claim to which it refers.

A claim in multiple dependent form shall contain a reference, in the alternative only, to more than one claim previously set forth and then specify a further limitation of the subject matter claimed. A multiple dependent claim shall not serve as a basis for any other multiple dependent claim. A multiple dependent claim shall be construed to incorporate by reference all the limitations of the particular claim in relation to which it is being considered.

An element in a claim for a combination may be expressed as a means or step for performing a specified function without the recital of structure, material, or acts in support thereof, and such claim shall be construed to cover the corresponding structure, material, or acts described in the specification and equivalents thereof.

(Amended July 24, 1965, Public Law 89-83, sec. 9, 79 Stat. 261; Nov. 14, 1975, Public Law 94-131, sec. 7, 89 Stat. 691.)

### **35 U.S.C. 113 Drawings.**

The applicant shall furnish a drawing where necessary for the understanding of the subject matter sought to be patented. When the nature of such subject matter admits of illustration by a drawing and the applicant has not furnished such a drawing, the Director may require its submission within a time period of not less than two months from the sending of a notice thereof. Drawings submitted after the filing date of the application may not be used (i) to overcome any insufficiency of the specification due to lack of an enabling disclosure or otherwise inadequate disclosure therein, or (ii) to supplement the original disclosure thereof for the purpose of interpretation of the scope of any claim.

(Amended Nov. 14, 1975, Public Law 94-131, sec. 8, 89 Stat. 691; Nov. 29, 1999, Public Law 106-113, sec. 1000(a)(9), 113 Stat. 1501A-582 (S. 1948 sec. 4732(a)(10)(A)).)

### **35 U.S.C. 114 Models, specimens.**

The Director may require the applicant to furnish a model of convenient size to exhibit advantageously the several parts of his invention.

When the invention relates to a composition of matter, the Director may require the applicant to furnish specimens or ingredients for the purpose of inspection or experiment.

(Amended Nov. 29, 1999, Public Law 106-113, sec. 1000(a)(9), 113 Stat. 1501A-582 (S. 1948 sec. 4732(a)(10)(A)).)

### **35 U.S.C. 115 Oath of applicant.**

The applicant shall make oath that he believes himself to be the original and first inventor of the process, machine, manufacture, or composition of matter, or improvement thereof, for which he solicits a patent; and shall state of what country he is a citizen. Such oath may be made before any person within the United States authorized by law to administer oaths, or, when made in a foreign country, before any diplomatic or consular officer of the United States authorized to administer oaths, or before any officer having an official seal and authorized to administer oaths in the foreign country in which the applicant may be, whose authority is proved by certificate of a diplomatic or consular officer of the United States, or apostille of an official designated by a foreign country which, by treaty or convention, accords like effect to

apostilles of designated officials in the United States. Such oath is valid if it complies with the laws of the state or country where made. When the application is made as provided in this title by a person other than the inventor, the oath may be so varied in form that it can be made by him. For purposes of this section, a consular officer shall include any United States citizen serving overseas, authorized to perform notarial functions pursuant to section 1750 of the Revised Statutes, as amended (22 U.S.C. 4221).

(Amended Aug. 27, 1982, Public Law 97-247, sec. 14(a), 96 Stat. 321; Oct. 21, 1998, Pub. L. 105-277, sec. 2222(d), 112 Stat. 2681-818.)

### **35 U.S.C. 116 Inventors.**

When an invention is made by two or more persons jointly, they shall apply for patent jointly and each make the required oath, except as otherwise provided in this title. Inventors may apply for a patent jointly even though (1) they did not physically work together or at the same time, (2) each did not make the same type or amount of contribution, or (3) each did not make a contribution to the subject matter of every claim of the patent.

If a joint inventor refuses to join in an application for patent or cannot be found or reached after diligent effort, the application may be made by the other inventor on behalf of himself and the omitted inventor. The Director, on proof of the pertinent facts and after such notice to the omitted inventor as he prescribes, may grant a patent to the inventor making the application, subject to the same rights which the omitted inventor would have had if he had been joined. The omitted inventor may subsequently join in the application.

Whenever through error a person is named in an application for patent as the inventor, or through an error an inventor is not named in an application, and such error arose without any deceptive intention on his part, the Director may permit the application to be amended accordingly, under such terms as he prescribes.

(Amended Aug. 27, 1982, Public Law 97-247, sec. 6(a), 96 Stat. 320; Nov. 8, 1984, Public Law 98-622, sec. 104(a), 98 Stat. 3384; Nov. 29, 1999, Public Law 106-113, sec. 1000(a)(9), 113 Stat. 1501A-582 (S. 1948 sec. 4732(a)(10)(A)).)

### **35 U.S.C. 117 Death or incapacity of inventor.**

Legal representatives of deceased inventors and of those under legal incapacity may make application for patent upon compliance with the requirements and on the same terms and conditions applicable to the inventor.

### **35 U.S.C. 118 Filing by other than inventor.**

Whenever an inventor refuses to execute an application for patent, or cannot be found or reached after diligent effort, a person to whom the inventor has assigned or agreed in writing to assign the invention or who otherwise shows sufficient proprietary interest in the matter justifying such action, may make application for patent on behalf of and as agent for the inventor on proof of the pertinent facts and a showing that such action is necessary to preserve the rights of the parties or to prevent irreparable damage; and the Director may grant a patent to such inventor upon such notice to him as the Director deems sufficient, and on compliance with such regulations as he prescribes.

(Amended Nov. 29, 1999, Public Law 106-113, sec. 1000(a)(9), 113 Stat. 1501A-582 (S. 1948 sec. 4732(a)(10)(A)).)

### **35 U.S.C. 119 Benefit of earlier filing date; right of priority.**

(a) An application for patent for an invention filed in this country by any person who has, or whose legal representatives or assigns have, previously regularly filed an application for a patent for the same invention in a foreign country which affords similar privileges in the case of applications filed in the United States or to citizens of the United States, or in a WTO member country, shall have the same effect as the same application would have if filed in this country on the date on which the application for patent for the same invention was first filed in such foreign country, if the application in this country is filed within twelve months from the earliest date on which such foreign application was filed; but no patent shall be granted on any application for patent for an invention which had been patented or described in a printed publication in any country more than one year before the date of the actual filing of the application in this country, or which had been in public use or on sale in this country more than one year prior to such filing.

(b)(1) No application for patent shall be entitled to this right of priority unless a claim is filed in the Patent and Trademark Office, identifying the foreign application by specifying the application number on that foreign application, the intellectual property authority or country in or for which the application was filed, and the date of filing the application, at such time during the pendency of the application as required by the Director.

(2) The Director may consider the failure of the applicant to file a timely claim for priority as a waiver of any such claim. The Director may establish procedures, including the payment of a surcharge, to accept an unintentionally delayed claim under this section.

(3) The Director may require a certified copy of the original foreign application, specification, and drawings upon which it is based, a translation if not in the English language, and such other information as the Director considers necessary. Any such certification shall be made by the foreign intellectual property authority in which the foreign application was filed and show the date of the application and of the filing of the specification and other papers.

(c) In like manner and subject to the same conditions and requirements, the right provided in this section may be based upon a subsequent regularly filed application in the same foreign country instead of the first filed foreign application, provided that any foreign application filed prior to such subsequent application has been withdrawn, abandoned, or otherwise disposed of, without having been laid open to public inspection and without leaving any rights outstanding, and has not served, nor thereafter shall serve, as a basis for claiming a right of priority.

(d) Applications for inventors' certificates filed in a foreign country in which applicants have a right to apply, at their discretion, either for a patent or for an inventor's certificate shall be treated in this country in the same manner and have the same effect for purpose of the right of priority under this section as applications for patents, subject to the same conditions and requirements of this section as apply to applications for patents, provided such applicants are entitled to the benefits of the Stockholm Revision of the Paris Convention at the time of such filing.

(e)(1) An application for patent filed under section 111(a) or section 363 of this title for an invention dis-

closed in the manner provided by the first paragraph of section 112 of this title in a provisional application filed under section 111(b) of this title, by an inventor or inventors named in the provisional application, shall have the same effect, as to such invention, as though filed on the date of the provisional application filed under section 111(b) of this title, if the application for patent filed under section 111(a) or section 363 of this title is filed not later than 12 months after the date on which the provisional application was filed and if it contains or is amended to contain a specific reference to the provisional application. No application shall be entitled to the benefit of an earlier filed provisional application under this subsection unless an amendment containing the specific reference to the earlier filed provisional application is submitted at such time during the pendency of the application as required by the Director. The Director may consider the failure to submit such an amendment within that time period as a waiver of any benefit under this subsection. The Director may establish procedures, including the payment of a surcharge, to accept an unintentionally delayed submission of an amendment under this subsection during the pendency of the application

(2) A provisional application filed under section 111(b) of this title may not be relied upon in any proceeding in the Patent and Trademark Office unless the fee set forth in subparagraph (A) or (C) of section 41(a)(1) of this title has been paid.

(3) If the day that is 12 months after the filing date of a provisional application falls on a Saturday, Sunday, or Federal holiday within the District of Columbia, the period of pendency of the provisional application shall be extended to the next succeeding secular or business day.

(f) Applications for plant breeder's rights filed in a WTO member country (or in a foreign UPOV Contracting Party) shall have the same effect for the purpose of the right of priority under subsections (a) through (c) of this section as applications for patents, subject to the same conditions and requirements of this section as apply to applications for patents.

(g) As used in this section—

(1) the term "WTO member country" has the same meaning as the term is defined in section 104(b)(2) of this title; and

(2) the term “UPOV Contracting Party” means a member of the International Convention for the Protection of New Varieties of Plants.

(Amended Oct. 3, 1961, Public Law 87-333, sec. 1, 75 Stat. 748; July 28, 1972, Public Law 92-358, sec. 1, 86 Stat. 501; Jan. 2, 1975, Public Law 93-596, sec. 1, 88 Stat. 1949; Dec. 8, 1994, Public Law 103-465, sec. 532(b)(1), 108 Stat. 4985.)

(Subsection (b) amended Nov. 29, 1999, Public Law 106-113, sec. 1000(a)(9), 113 Stat. 1501A-563 (S. 1948 sec.4503(a)).)

(Subsection (e) amended Nov. 29, 1999, Public Law 106-113, sec. 1000(a)(9), 113 Stat. 1501A-564, 588, 589 (S. 1948 secs. 4503(b)(2), 4801 and 4802).)

(Subsections (f) and (g) added Nov. 29, 1999, Public Law 106-113, sec. 1000(a)(9), 113 Stat. 1501A-589 (S. 1948 sec. 4802).)

### **35 U.S.C. 120 Benefit of earlier filing date in the United States.**

An application for patent for an invention disclosed in the manner provided by the first paragraph of section 112 of this title in an application previously filed in the United States, or as provided by section 363 of this title, which is filed by an inventor or inventors named in the previously filed application shall have the same effect, as to such invention, as though filed on the date of the prior application, if filed before the patenting or abandonment of or termination of proceedings on the first application or on an application similarly entitled to the benefit of the filing date of the first application and if it contains or is amended to contain a specific reference to the earlier filed application. No application shall be entitled to the benefit of an earlier filed application under this section unless an amendment containing the specific reference to the earlier filed application is submitted at such time during the pendency of the application as required by the Director. The Director may consider the failure to submit such an amendment within that time period as a waiver of any benefit under this section. The Director may establish procedures, including the payment of a surcharge, to accept an unintentionally delayed submission of an amendment under this section.

(Amended Nov. 14, 1975, Public Law 94-131, sec. 9, 89 Stat. 691; Nov. 8, 1984, Public Law 98-622, sec. 104(b), 98 Stat. 3385; Nov. 29, 1999, Public Law 106-113, sec.

1000(a)(9), 113 Stat. 1501A-563 (S. 1948 sec. 4503(b)(1)).)

### **35 U.S.C. 121 Divisional applications.**

If two or more independent and distinct inventions are claimed in one application, the Director may require the application to be restricted to one of the inventions. If the other invention is made the subject of a divisional application which complies with the requirements of section 120 of this title it shall be entitled to the benefit of the filing date of the original application. A patent issuing on an application with respect to which a requirement for restriction under this section has been made, or on an application filed as a result of such a requirement, shall not be used as a reference either in the Patent and Trademark Office or in the courts against a divisional application or against the original application or any patent issued on either of them, if the divisional application is filed before the issuance of the patent on the other application. If a divisional application is directed solely to subject matter described and claimed in the original application as filed, the Director may dispense with signing and execution by the inventor. The validity of a patent shall not be questioned for failure of the Director to require the application to be restricted to one invention.

(Amended Jan. 2, 1975, Public Law 93-596, sec. 1, 88 Stat. 1949; Nov. 29, 1999, Public Law 106-113, sec. 1000(a)(9), 113 Stat. 1501A-582 (S. 1948 sec. 4732(a)(10)(A)).)

### **35 U.S.C. 122 Confidential status of applications; publication of patent applications.**

(a) CONFIDENTIALITY.— Except as provided in subsection (b), applications for patents shall be kept in confidence by the Patent and Trademark Office and no information concerning the same given without authority of the applicant or owner unless necessary to carry out the provisions of an Act of Congress or in such special circumstances as may be determined by the Director.

(b) PUBLICATION.—

(1) IN GENERAL.—

(A) Subject to paragraph (2), each application for a patent shall be published, in accordance with procedures determined by the Director, promptly after the expiration of a period of 18 months from the earliest filing date for which a benefit is sought under

this title. At the request of the applicant, an application may be published earlier than the end of such 18-month period.

(B) No information concerning published patent applications shall be made available to the public except as the Director determines.

(C) Notwithstanding any other provision of law, a determination by the Director to release or not to release information concerning a published patent application shall be final and nonreviewable.

(2) EXCEPTIONS.—

(A) An application shall not be published if that application is—

- (i) no longer pending;
- (ii) subject to a secrecy order under section 181 of this title;
- (iii) a provisional application filed under section 111(b) of this title; or
- (iv) an application for a design patent filed under chapter 16 of this title.

(B)(i) If an applicant makes a request upon filing, certifying that the invention disclosed in the application has not and will not be the subject of an application filed in another country, or under a multilateral international agreement, that requires publication of applications 18 months after filing, the application shall not be published as provided in paragraph (1).

(ii) An applicant may rescind a request made under clause (i) at any time.

(iii) An applicant who has made a request under clause (i) but who subsequently files, in a foreign country or under a multilateral international agreement specified in clause (i), an application directed to the invention disclosed in the application filed in the Patent and Trademark Office, shall notify the Director of such filing not later than 45 days after the date of the filing of such foreign or international application. A failure of the applicant to provide such notice within the prescribed period shall result in the application being regarded as abandoned, unless it is shown to the satisfaction of the Director that the delay in submitting the notice was unintentional.

(iv) If an applicant rescinds a request made under clause (i) or notifies the Director that an application was filed in a foreign country or under a

multilateral international agreement specified in clause (i), the application shall be published in accordance with the provisions of paragraph (1) on or as soon as is practical after the date that is specified in clause (i).

(v) If an applicant has filed applications in one or more foreign countries, directly or through a multilateral international agreement, and such foreign filed applications corresponding to an application filed in the Patent and Trademark Office or the description of the invention in such foreign filed applications is less extensive than the application or description of the invention in the application filed in the Patent and Trademark Office, the applicant may submit a redacted copy of the application filed in the Patent and Trademark Office eliminating any part or description of the invention in such application that is not also contained in any of the corresponding applications filed in a foreign country. The Director may only publish the redacted copy of the application unless the redacted copy of the application is not received within 16 months after the earliest effective filing date for which a benefit is sought under this title. The provisions of section 154(d) shall not apply to a claim if the description of the invention published in the redacted application filed under this clause with respect to the claim does not enable a person skilled in the art to make and use the subject matter of the claim.

(c) PROTEST AND PRE-ISSUANCE OPPOSITION.— The Director shall establish appropriate procedures to ensure that no protest or other form of pre-issuance opposition to the grant of a patent on an application may be initiated after publication of the application without the express written consent of the applicant.

(d) NATIONAL SECURITY.— No application for patent shall be published under subsection (b)(1) if the publication or disclosure of such invention would be detrimental to the national security. The Director shall establish appropriate procedures to ensure that such applications are promptly identified and the secrecy of such inventions is maintained in accordance with chapter 17 of this title.

(Amended Jan. 2, 1975, Public Law 93-596, sec. 1, 88 Stat. 1949; Nov. 29, 1999, Public Law 106-113, sec.



1000(a)(9), 113 Stat. 1501A-563 (S. 1948 sec. 4503(b)(1)).)

## CHAPTER 12 — EXAMINATION OF APPLICATION

Sec.

- 131 Examination of application.
- 132 Notice of rejection; reexamination.
- 133 Time for prosecuting application.
- 134 Appeal to the Board of Patent Appeals and Interferences.
- 135 Interferences.

### 35 U.S.C. 131 Examination of application.

The Director shall cause an examination to be made of the application and the alleged new invention; and if on such examination it appears that the applicant is entitled to a patent under the law, the Director shall issue a patent therefor.

(Amended Nov. 29, 1999, Public Law 106-113, sec. 1000(a)(9), 113 Stat. 1501A-582 (S. 1948 sec. 4732(a)(10)(A)).)

### 35 U.S.C. 132 Notice of rejection; reexamination.

(a) Whenever, on examination, any claim for a patent is rejected, or any objection or requirement made, the Director shall notify the applicant thereof, stating the reasons for such rejection, or objection or requirement, together with such information and references as may be useful in judging of the propriety of continuing the prosecution of his application; and if after receiving such notice, the applicant persists in his claim for a patent, with or without amendment, the application shall be reexamined. No amendment shall introduce new matter into the disclosure of the invention.

(b) The Director shall prescribe regulations to provide for the continued examination of applications for patent at the request of the applicant. The Director may establish appropriate fees for such continued examination and shall provide a 50 percent reduction in such fees for small entities that qualify for reduced fees under section 41(h)(1) of this title.

(Amended Nov. 29, 1999, Public Law 106-113, sec. 1000(a)(9), 113 Stat. 1501A-560, 582 (S. 1948 secs. 4403 and 4732(a)(10)(A)).)

### 35 U.S.C. 133 Time for prosecuting application.

Upon failure of the applicant to prosecute the application within six months after any action therein, of which notice has been given or mailed to the applicant, or within such shorter time, not less than thirty days, as fixed by the Director in such action, the application shall be regarded as abandoned by the parties thereto, unless it be shown to the satisfaction of the Director that such delay was unavoidable.

(Amended Nov. 29, 1999, Public Law 106-113, sec. 1000(a)(9), 113 Stat. 1501A-582 (S. 1948 sec. 4732(a)(10)(A)).)

### 35 U.S.C. 134 Appeal to the Board of Patent Appeals and Interferences.

(a) PATENT APPLICANT.— An applicant for a patent, any of whose claims has been twice rejected, may appeal from the decision of the primary examiner to the Board of Patent Appeals and Interferences, having once paid the fee for such appeal.

(b) PATENT OWNER.— A patent owner in any reexamination proceeding may appeal from the final rejection of any claim by the primary examiner to the Board of Patent Appeals and Interferences, having once paid the fee for such appeal.

(c) THIRD-PARTY.— A third-party requester in an inter partes proceeding may appeal to the Board of Patent Appeals and Interferences from the final decision of the primary examiner favorable to the patentability of any original or proposed amended or new claim of a patent, having once paid the fee for such appeal.

(Amended Nov. 8, 1984, Public Law 98-622, sec. 204(b)(1), 98 Stat. 3388; Nov. 29, 1999, Public Law 106-113, sec. 1000(a)(9), 113 Stat. 1501A-570 (S. 1948 sec. 4605(b)); subsections (a)-(c) amended Nov. 2, 2002, Public Law 107-273, secs. 13106 and 13202, 116 Stat. 1901.)

### 35 U.S.C. 135 Interferences.

(a) Whenever an application is made for a patent which, in the opinion of the Director, would interfere with any pending application, or with any unexpired patent, an interference may be declared and the Director shall give notice of such declaration to the applicants, or applicant and patentee, as the case may be. The Board of Patent Appeals and Interferences shall determine questions of priority of the inventions and may determine questions of patentability. Any final decision, if adverse to the claim of an

applicant, shall constitute the final refusal by the Patent and Trademark Office of the claims involved, and the Director may issue a patent to the applicant who is adjudged the prior inventor. A final judgment adverse to a patentee from which no appeal or other review has been or can be taken or had shall constitute cancellation of the claims involved in the patent, and notice of such cancellation shall be endorsed on copies of the patent distributed after such cancellation by the Patent and Trademark Office.

(b)(1) A claim which is the same as, or for the same or substantially the same subject matter as, a claim of an issued patent may not be made in any application unless such a claim is made prior to one year from the date on which the patent was granted.

(2) A claim which is the same as, or for the same or substantially the same subject matter as, a claim of an application published under section 122(b) of this title may be made in an application filed after the application is published only if the claim is made before 1 year after the date on which the application is published.

(c) Any agreement or understanding between parties to an interference, including any collateral agreements referred to therein, made in connection with or in contemplation of the termination of the interference, shall be in writing and a true copy thereof filed in the Patent and Trademark Office before the termination of the interference as between the said parties to the agreement or understanding. If any party filing the same so requests, the copy shall be kept separate from the file of the interference, and made available only to Government agencies on written request, or to any person on a showing of good cause. Failure to file the copy of such agreement or understanding shall render permanently unenforceable such agreement or understanding and any patent of such parties involved in the interference or any patent subsequently issued on any application of such parties so involved. The Director may, however, on a showing of good cause for failure to file within the time prescribed, permit the filing of the agreement or understanding during the six-month period subsequent to the termination of the interference as between the parties to the agreement or understanding.

The Director shall give notice to the parties or their attorneys of record, a reasonable time prior to

said termination, of the filing requirement of this section. If the Director gives such notice at a later time, irrespective of the right to file such agreement or understanding within the six-month period on a showing of good cause, the parties may file such agreement or understanding within sixty days of the receipt of such notice.

Any discretionary action of the Director under this subsection shall be reviewable under section 10 of the Administrative Procedure Act.

(d) Parties to a patent interference, within such time as may be specified by the Director by regulation, may determine such contest or any aspect thereof by arbitration. Such arbitration shall be governed by the provisions of title 9 to the extent such title is not inconsistent with this section. The parties shall give notice of any arbitration award to the Director, and such award shall, as between the parties to the arbitration, be dispositive of the issues to which it relates. The arbitration award shall be unenforceable until such notice is given. Nothing in this subsection shall preclude the Director from determining patentability of the invention involved in the interference.

(Subsection (c) added Oct. 15, 1962, Public Law 87-831, 76 Stat. 958.)

(Subsections (a) and (c) amended, Jan. 2, 1975, Public Law 93-596, sec. 1, 88 Stat. 1949.)

(Subsection (a) amended Nov. 8, 1984, Public Law 98-622, sec. 202, 98 Stat. 3386.)

(Subsection (d) added Nov. 8, 1984, Public Law 98-622, sec. 105, 98 Stat. 3385.)

(Amended Nov. 29, 1999, Public Law 106-113, sec. 1000(a)(9), 113 Stat. 1501A-566, 582 (S. 1948 secs. 4507(11) and 4732(a)(10)(A)).)

## CHAPTER 13 — REVIEW OF PATENT AND TRADEMARK OFFICE DECISION

Sec.

- 141 Appeal to Court of Appeals for the Federal Circuit.
- 142 Notice of appeal.
- 143 Proceedings on appeal.
- 144 Decision on appeal.
- 145 Civil action to obtain patent.
- 146 Civil action in case of interference.

### **35 U.S.C. 141 Appeal to the Court of Appeals for the Federal Circuit.**

An applicant dissatisfied with the decision in an appeal to the Board of Patent Appeals and Interferences under section 134 of this title may appeal the decision to the United States Court of Appeals for the Federal Circuit. By filing such an appeal the applicant waives his or her right to proceed under section 145 of this title. A patent owner, or a third-party requester in an inter partes reexamination proceeding, who is in any reexamination proceeding dissatisfied with the final decision in an appeal to the Board of Patent Appeals and Interferences under section 134 may appeal the decision only to the United States Court of Appeals for the Federal Circuit. A party to an interference dissatisfied with the decision of the Board of Patent Appeals and Interferences on the interference may appeal the decision to the United States Court of Appeals for the Federal Circuit, but such appeal shall be dismissed if any adverse party to such interference, within twenty days after the appellant has filed notice of appeal in accordance with section 142 of this title, files notice with the Director that the party elects to have all further proceedings conducted as provided in section 146 of this title. If the appellant does not, within thirty days after filing of such notice by the adverse party, file a civil action under section 146, the decision appealed from shall govern the further proceedings in the case.

(Amended Apr. 2, 1982, Public Law 97-164, sec. 163(a)(7), (b)(2), 96 Stat. 49, 50; Nov. 8, 1984, Public Law 98-622, sec. 203(a), 98 Stat. 3387; Nov. 29, 1999, Public Law 106-113, sec. 1000(a)(9), 113 Stat. 1501A-571, 582 (S. 1948 secs. 4605(c) and 4732(a)(10)(A)); Nov. 2, 2002, Public Law 107-273, sec. 13106, 116 Stat. 1901.)

### **35 U.S.C. 142 Notice of appeal.**

When an appeal is taken to the United States Court of Appeals for the Federal Circuit, the appellant shall file in the Patent and Trademark Office a written notice of appeal directed to the Director, within such time after the date of the decision from which the appeal is taken as the Director prescribes, but in no case less than 60 days after that date.

(Amended Jan. 2, 1975, Public Law 93-596, sec. 1, 88 Stat. 1949; Apr. 2, 1982, Public Law 97-164, sec. 163(a)(7), 96 Stat. 49; Nov. 8, 1984, Public Law 98-620, sec. 414(a), 98 Stat. 3363; Nov. 29, 1999, Public Law 106-

113, sec. 1000(a)(9), 113 Stat. 1501A-582 (S. 1948 sec. 4732(a)(10)(A)).)

### **35 U.S.C. 143 Proceedings on appeal.**

With respect to an appeal described in section 142 of this title, the Director shall transmit to the United States Court of Appeals for the Federal Circuit a certified list of the documents comprising the record in the Patent and Trademark Office. The court may request that the Director forward the original or certified copies of such documents during the pendency of the appeal. In an ex parte case or any reexamination case, the Director shall submit to the court in writing the grounds for the decision of the Patent and Trademark Office, addressing all the issues involved in the appeal. The court shall, before hearing an appeal, give notice of the time and place of the hearing to the Director and the parties in the appeal.

(Amended Jan. 2, 1975, Public Law 93-596, sec. 1, 88 Stat. 1949; Apr. 2, 1982, Public Law 97-164, sec. 163(a)(7), 96 Stat. 49; Nov. 8, 1984, Public Law 98-620, sec. 414(a), 98 Stat. 3363; Nov. 29, 1999, Public Law 106-113, sec. 1000(a)(9), 113 Stat. 1501A-571, 582 (S. 1948 secs. 4605(d) and 4732(a)(10)(A)); Nov. 2, 2002, Public Law 107-273, sec. 13202, 116 Stat. 1901.)

### **35 U.S.C. 144 Decision on appeal.**

The United States Court of Appeals for the Federal Circuit shall review the decision from which an appeal is taken on the record before the Patent and Trademark Office. Upon its determination the court shall issue to the Director its mandate and opinion, which shall be entered of record in the Patent and Trademark Office and shall govern the further proceedings in the case.

(Amended Jan. 2, 1975, Public Law 93-596, sec. 1, 88 Stat. 1949; Apr. 2, 1982, Public Law 97-164, sec. 163(a)(7), 96 Stat. 49; Nov. 8, 1984, Public Law 98-620, sec. 414(a), 98 Stat. 3363; Nov. 29, 1999, Public Law 106-113, sec. 1000(a)(9), 113 Stat. 1501A-582 (S. 1948 sec. 4732(a)(10)(A)).)

### **35 U.S.C. 145 Civil action to obtain patent.**

An applicant dissatisfied with the decision of the Board of Patent Appeals and Interferences in an appeal under section 134(a) of this title may, unless appeal has been taken to the United States Court of Appeals for the Federal Circuit, have remedy by civil action against the Director in the United States District Court for the District of Columbia if commenced

within such time after such decision, not less than sixty days, as the Director appoints. The court may adjudge that such applicant is entitled to receive a patent for his invention, as specified in any of his claims involved in the decision of the Board of Patent Appeals and Interferences, as the facts in the case may appear, and such adjudication shall authorize the Director to issue such patent on compliance with the requirements of law. All the expenses of the proceedings shall be paid by the applicant.

(Amended Apr. 2, 1982, Public Law 97-164, sec. 163(a)(7), 96 Stat. 49; Nov. 8, 1984, Public Law 98-622, sec. 203(b), 98 Stat. 3387; Nov. 29, 1999, Public Law 106-113, sec. 1000(a)(9), 113 Stat. 1501A-571, 582 (S. 1948 secs. 4605(e) and 4732(a)(10)(A).)

### **35 U.S.C. 146 Civil action in case of interference.**

Any party to an interference dissatisfied with the decision of the Board of Patent Appeals and Interferences may have remedy by civil action, if commenced within such time after such decision, not less than sixty days, as the Director appoints or as provided in section 141 of this title, unless he has appealed to the United States Court of Appeals for the Federal Circuit, and such appeal is pending or has been decided. In such suits the record in the Patent and Trademark Office shall be admitted on motion of either party upon the terms and conditions as to costs, expenses, and the further cross-examination of the witnesses as the court imposes, without prejudice to the right of the parties to take further testimony. The testimony and exhibits of the record in the Patent and Trademark Office when admitted shall have the same effect as if originally taken and produced in the suit.

Such suit may be instituted against the party in interest as shown by the records of the Patent and Trademark Office at the time of the decision complained of, but any party in interest may become a party to the action. If there be adverse parties residing in a plurality of districts not embraced within the same state, or an adverse party residing in a foreign country, the United States District Court for the District of Columbia shall have jurisdiction and may issue summons against the adverse parties directed to the marshal of any district in which any adverse party resides. Summons against adverse parties residing in foreign countries may be served by publication or otherwise as the court directs. The Director shall not be a necessary party but he shall be notified of the filing of

the suit by the clerk of the court in which it is filed and shall have the right to intervene. Judgment of the court in favor of the right of an applicant to a patent shall authorize the Director to issue such patent on the filing in the Patent and Trademark Office of a certified copy of the judgment and on compliance with the requirements of law.

(Amended Jan. 2, 1975, Public Law 93-596, sec. 1, 88 Stat. 1949; Apr. 2, 1982, Public Law 97-164, sec. 163(a)(7), 96 Stat. 49; Nov. 8, 1984, Public Law 98-622, sec. 203(c), 98 Stat. 3387; Nov. 29, 1999, Public Law 106-113, sec. 1000(a)(9), 113 Stat. 1501A-582 (S. 1948 sec. 4732(a)(10)(A).)

## CHAPTER 14 — ISSUE OF PATENT

Sec.

- 151 Issue of patent.
- 152 Issue of patent to assignee.
- 153 How issued.
- 154 Contents and term of patent; provisional rights.
- 155 Patent term extension.
- 155A Patent term restoration.
- 156 Extension of patent term.
- 157 Statutory invention registration.

### **35 U.S.C. 151 Issue of patent.**

If it appears that applicant is entitled to a patent under the law, a written notice of allowance of the application shall be given or mailed to the applicant. The notice shall specify a sum, constituting the issue fee or a portion thereof, which shall be paid within three months thereafter.

Upon payment of this sum the patent shall issue, but if payment is not timely made, the application shall be regarded as abandoned.

Any remaining balance of the issue fee shall be paid within three months from the sending of a notice thereof, and, if not paid, the patent shall lapse at the termination of this three-month period. In calculating the amount of a remaining balance, charges for a page or less may be disregarded.

If any payment required by this section is not timely made, but is submitted with the fee for delayed payment and the delay in payment is shown to have been unavoidable, it may be accepted by the Director as though no abandonment or lapse had ever occurred.

(Amended July 24, 1965, Public Law 89-83, sec. 4, 79 Stat. 260; Jan. 2, 1975, Public Law 93-601, sec. 3, 88

Stat. 1956; Nov. 29, 1999, Public Law 106-113, sec. 1000(a)(9), 113 Stat. 1501A-582 (S. 1948 sec. 4732(a)(10)(A)); Nov. 29, 1999, Public Law 106-113, sec. 1000(a)(9), 113 Stat. 1501A-582 (S. 1948 sec. 4732(a)(10)(A)).

### 35 U.S.C. 152 Issue of patent to assignee.

Patents may be granted to the assignee of the inventor of record in the Patent and Trademark Office, upon the application made and the specification sworn to by the inventor, except as otherwise provided in this title.

(Amended Jan. 2, 1975, Public Law 93-596, sec. 1, 88 Stat. 1949.)

### 35 U.S.C. 153 How issued.

Patents shall be issued in the name of the United States of America, under the seal of the Patent and Trademark Office, and shall be signed by the Director or have his signature placed thereon and shall be recorded in the Patent and Trademark Office.

(Amended Jan. 2, 1975, Public Law 93-596, sec. 1, 88 Stat. 1949; Nov. 29, 1999, Public Law 106-113, sec. 1000(a)(9), 113 Stat. 1501A-582 (S. 1948 sec. 4732(a)(10)(A)); Nov. 2, 2002, Public Law 107-273, sec. 13203, 116 Stat. 1902.)

### 35 U.S.C. 154 Contents and term of patent; provisional rights.

#### (a) IN GENERAL.—

(1) CONTENTS.—Every patent shall contain a short title of the invention and a grant to the patentee, his heirs or assigns, of the right to exclude others from making, using, offering for sale, or selling the invention throughout the United States or importing the invention into the United States, and, if the invention is a process, of the right to exclude others from using, offering for sale or selling throughout the United States, or importing into the United States, products made by that process, referring to the specification for the particulars thereof.

(2) TERM.—Subject to the payment of fees under this title, such grant shall be for a term beginning on the date on which the patent issues and ending 20 years from the date on which the application for the patent was filed in the United States or, if the application contains a specific reference to an earlier filed application or applications under section 120,

121, or 365(c) of this title, from the date on which the earliest such application was filed.

(3) PRIORITY.—Priority under section 119, 365(a), or 365(b) of this title shall not be taken into account in determining the term of a patent.

(4) SPECIFICATION AND DRAWING.—A copy of the specification and drawing shall be annexed to the patent and be a part of such patent.

#### (b) ADJUSTMENT OF PATENT TERM.—

##### (1) PATENT TERM GUARANTEES.—

(A) GUARANTEE OF PROMPT PATENT AND TRADEMARK OFFICE RESPONSES.— Subject to the limitations under paragraph (2), if the issue of an original patent is delayed due to the failure of the Patent and Trademark Office to—

(i) provide at least one of the notifications under section 132 of this title or a notice of allowance under section 151 of this title not later than 14 months after—

(I) the date on which an application was filed under section 111(a) of this title; or

(II) the date on which an international application fulfilled the requirements of section 371 of this title;

(ii) respond to a reply under section 132, or to an appeal taken under section 134, within 4 months after the date on which the reply was filed or the appeal was taken;

(iii) act on an application within 4 months after the date of a decision by the Board of Patent Appeals and Interferences under section 134 or 135 or a decision by a Federal court under section 141, 145, or 146 in a case in which allowable claims remain in the application; or

(iv) issue a patent within 4 months after the date on which the issue fee was paid under section 151 and all outstanding requirements were satisfied, the term of the patent shall be extended 1 day for each day after the end of the period specified in clause (i), (ii), (iii), or (iv), as the case may be, until the action described in such clause is taken.

(B) GUARANTEE OF NO MORE THAN 3-YEAR APPLICATION PENDENCY.— Subject to the limitations under paragraph (2), if the issue of an original patent is delayed due to the failure of the United States Patent and Trademark Office to issue a patent within 3 years after the actual filing date of the application in the United States, not including—

(i) any time consumed by continued examination of the application requested by the applicant under section 132(b);

(ii) any time consumed by a proceeding under section 135(a), any time consumed by the imposition of an order under section 181, or any time consumed by appellate review by the Board of Patent Appeals and Interferences or by a Federal court; or

(iii) any delay in the processing of the application by the United States Patent and Trademark Office requested by the applicant except as permitted by paragraph (3)(C), the term of the patent shall be extended 1 day for each day after the end of that 3-year period until the patent is issued.

(C) **GUARANTEE OR ADJUSTMENTS FOR DELAYS DUE TO INTERFERENCES, SECRECY ORDERS, AND APPEALS.**— Subject to the limitations under paragraph (2), if the issue of an original patent is delayed due to—

(i) a proceeding under section 135(a);

(ii) the imposition of an order under section 181; or

(iii) appellate review by the Board of Patent Appeals and Interferences or by a Federal court in a case in which the patent was issued under a decision in the review reversing an adverse determination of patentability, the term of the patent shall be extended 1 day for each day of the pendency of the proceeding, order, or review, as the case may be.

(2) **LIMITATIONS.**—

(A) **IN GENERAL.**— To the extent that periods of delay attributable to grounds specified in paragraph (1) overlap, the period of any adjustment granted under this subsection shall not exceed the actual number of days the issuance of the patent was delayed.

(B) **DISCLAIMED TERM.**— No patent the term of which has been disclaimed beyond a specified date may be adjusted under this section beyond the expiration date specified in the disclaimer.

(C) **REDUCTION OF PERIOD OF ADJUSTMENT.**—

(i) The period of adjustment of the term of a patent under paragraph (1) shall be reduced by a period equal to the period of time during which the applicant failed to engage in reasonable efforts to conclude prosecution of the application.

(ii) With respect to adjustments to patent term made under the authority of paragraph (1)(B), an applicant shall be deemed to have failed to engage in reasonable efforts to conclude processing or examination of an application for the cumulative total of any periods of time in excess of 3 months that are taken to respond to a notice from the Office making any rejection, objection, argument, or other request, measuring such 3-month period from the date the notice was given or mailed to the applicant.

(iii) The Director shall prescribe regulations establishing the circumstances that constitute a failure of an applicant to engage in reasonable efforts to conclude processing or examination of an application.

(3) **PROCEDURES FOR PATENT TERM ADJUSTMENT DETERMINATION.**—

(A) The Director shall prescribe regulations establishing procedures for the application for and determination of patent term adjustments under this subsection.

(B) Under the procedures established under subparagraph (A), the Director shall—

(i) make a determination of the period of any patent term adjustment under this subsection, and shall transmit a notice of that determination with the written notice of allowance of the application under section 151; and

(ii) provide the applicant one opportunity to request reconsideration of any patent term adjustment determination made by the Director.

(C) The Director shall reinstate all or part of the cumulative period of time of an adjustment under paragraph (2)(C) if the applicant, prior to the issuance of the patent, makes a showing that, in spite of all due care, the applicant was unable to respond within the 3-month period, but in no case shall more than three additional months for each such response beyond the original 3-month period be reinstated.

(D) The Director shall proceed to grant the patent after completion of the Director's determination of a patent term adjustment under the procedures established under this subsection, notwithstanding any appeal taken by the applicant of such determination.

(4) APPEAL OF PATENT TERM ADJUSTMENT DETERMINATION.—

(A) An applicant dissatisfied with a determination made by the Director under paragraph (3) shall have remedy by a civil action against the Director filed in the United States District Court for the District of Columbia within 180 days after the grant of the patent. Chapter 7 of title 5 shall apply to such action. Any final judgment resulting in a change to the period of adjustment of the patent term shall be served on the Director, and the Director shall thereafter alter the term of the patent to reflect such change.

(B) The determination of a patent term adjustment under this subsection shall not be subject to appeal or challenge by a third party prior to the grant of the patent.

(c) CONTINUATION.—

(1) DETERMINATION.—The term of a patent that is in force on or that results from an application filed before the date that is 6 months after the date of the enactment of the Uruguay Round Agreements Act shall be the greater of the 20-year term as provided in subsection (a), or 17 years from grant, subject to any terminal disclaimers.

(2) REMEDIES.—The remedies of sections 283, 284, and 285 of this title shall not apply to acts which —

(A) were commenced or for which substantial investment was made before the date that is 6 months after the date of the enactment of the Uruguay Round Agreements Act; and

(B) became infringing by reason of paragraph (1).

(3) REMUNERATION.—The acts referred to in paragraph (2) may be continued only upon the payment of an equitable remuneration to the patentee that is determined in an action brought under chapter 28 and chapter 29 (other than those provisions excluded by paragraph (2)) of this title.

(d) PROVISIONAL RIGHTS.—

(1) IN GENERAL.— In addition to other rights provided by this section, a patent shall include the right to obtain a reasonable royalty from any person who, during the period beginning on the date of publication of the application for such patent under section 122(b), or in the case of an international application filed under the treaty defined in section 351(a)

designating the United States under Article 21(2)(a) of such treaty, the date of publication of the application, and ending on the date the patent is issued—

(A) (i) makes, uses, offers for sale, or sells in the United States the invention as claimed in the published patent application or imports such an invention into the United States; or

(ii) if the invention as claimed in the published patent application is a process, uses, offers for sale, or sells in the United States or imports into the United States products made by that process as claimed in the published patent application; and

(B) had actual notice of the published patent application and, in a case in which the right arising under this paragraph is based upon an international application designating the United States that is published in a language other than English, had a translation of the international application into the English language.

(2) RIGHT BASED ON SUBSTANTIALLY IDENTICAL INVENTIONS.— The right under paragraph (1) to obtain a reasonable royalty shall not be available under this subsection unless the invention as claimed in the patent is substantially identical to the invention as claimed in the published patent application.

(3) TIME LIMITATION ON OBTAINING A REASONABLE ROYALTY.— The right under paragraph (1) to obtain a reasonable royalty shall be available only in an action brought not later than 6 years after the patent is issued. The right under paragraph (1) to obtain a reasonable royalty shall not be affected by the duration of the period described in paragraph (1).

(4) REQUIREMENTS FOR INTERNATIONAL APPLICATIONS.—

(A) EFFECTIVE DATE.— The right under paragraph (1) to obtain a reasonable royalty based upon the publication under the treaty defined in section 351(a) of an international application designating the United States shall commence on the date of publication under the treaty of the international application, or, if the publication under the treaty of the international application is in a language other than English, on the date on which the Patent and Trademark Office receives a translation of the publication in the English language.

(B) COPIES.— The Director may require the applicant to provide a copy of the international application and a translation thereof.

(Amended July 24, 1965, Public Law 89-83, sec. 5, 79 Stat. 261; Dec. 12, 1980, Public Law 96-517, sec. 4, 94 Stat. 3018; Aug. 23, 1988, Public Law 100-418, sec. 9002, 102 Stat. 1563; Dec. 8, 1994, Public Law 103-465, sec. 532 (a)(1), 108 Stat. 4983; Oct. 11, 1996, Public Law 104-295, sec. 20(e)(1), 110 Stat. 3529.)

(Subsection (b) amended Nov. 29, 1999, Public Law 106-113, sec. 1000(a)(9), 113 Stat. 1501A-557 (S. 1948 sec. 4402(a)).)

(Subsection (d) added Nov. 29, 1999, Public Law 106-113, sec. 1000(a)(9), 113 Stat. 1501A-564 (S. 1948 sec. 4504).)

(Subsection (b)(4) amended Nov. 2, 2002, Public Law 107-273, sec. 13206, 116 Stat. 1904; subsection (d)(4)(A) amended Nov. 2, 2002, Public Law 107-273, sec. 13204, 116 Stat. 1902.)

### 35 U.S.C. 155 Patent term extension.

Notwithstanding the provisions of section 154, the term of a patent which encompasses within its scope a composition of matter or a process for using such composition shall be extended if such composition or process has been subjected to a regulatory review by the Federal Food and Drug Administration pursuant to the Federal Food, Drug and Cosmetic Act leading to the publication of regulation permitting the interstate distribution and sale of such composition or process and for which there has thereafter been a stay of regulation of approval imposed pursuant to section 409 of the Federal Food, Drug and Cosmetic Act, which stay was in effect on January 1, 1981, by a length of time to be measured from the date such stay of regulation of approval was imposed until such proceedings are finally resolved and commercial marketing permitted. The patentee, his heirs, successors, or assigns shall notify the Director within 90 days of the date of enactment of this section or the date the stay of regulation of approval has been removed, whichever is later, of the number of the patent to be extended and the date the stay was imposed and the date commercial marketing was permitted. On receipt of such notice, the Director shall promptly issue to the owner of record of the patent a certificate of extension, under seal, stating the fact and length of the extension and identifying the composition of matter or process for using such composition to which such extension is

applicable. Such certificate shall be recorded in the official file of each patent extended and such certificate shall be considered as part of the original patent, and an appropriate notice shall be published in the Official Gazette of the Patent and Trademark Office.

(Added Jan. 4, 1983, Public Law 97-414, sec. 11(a), 96 Stat. 2065; amended Nov. 29, 1999, Public Law 106-113, sec. 1000(a)(9), 113 Stat. 1501A-582 (S. 1948 secs. 4732(a)(6) and 4732(a)(10)(A)).)

### 35 U.S.C. 155A Patent term restoration.

(a) Notwithstanding section 154 of this title, the term of each of the following patents shall be extended in accordance with this section:

(1) Any patent which encompasses within its scope a composition of matter which is a new drug product, if during the regulatory review of the product by the Federal Food and Drug Administration —

(A) the Federal Food and Drug Administration notified the patentee, by letter dated February 20, 1976, that such product's new drug application was not approvable under section 505(b)(1) of the Federal Food, Drug and Cosmetic Act;

(B) in 1977 the patentee submitted to the Federal Food and Drug Administration the results of a health effects test to evaluate the carcinogenic potential of such product;

(C) the Federal Food and Drug Administration approved, by letter dated December 18, 1979, the new drug application for such application; and

(D) the Federal Food and Drug Administration approved, by letter dated May 26, 1981, a supplementary application covering the facility for the production of such product.

(2) Any patent which encompasses within its scope a process for using the composition described in paragraph (1).

(b) The term of any patent described in subsection (a) shall be extended for a period equal to the period beginning February 20, 1976, and ending May 26, 1981, and such patent shall have the effect as if originally issued with such extended term.

(c) The patentee of any patent described in subsection (a) of this section shall, within ninety days after the date of enactment of this section, notify the Director of the number of any patent so extended. On receipt of such notice, the Director shall confirm such extension by placing a notice thereof in the official file of such patent and publishing an appropriate



notice of such extension in the *Official Gazette* of the Patent and Trademark Office.

(Added Oct. 13, 1983, Public Law 98-127, sec. 4(a), 97 Stat. 832; amended Nov. 29, 1999, Public Law 106-113, sec. 1000(a)(9), 113 Stat. 1501A-582 (S. 1948 secs. 4732(a)(7) and 4732(a)(10)(A)).)

### 35 U.S.C. 156 Extension of patent term.

(a) The term of a patent which claims a product, a method of using a product, or a method of manufacturing a product shall be extended in accordance with this section from the original expiration date of the patent, which shall include any patent term adjustment granted under section 154(b) if —

(1) the term of the patent has not expired before an application is submitted under subsection (d)(1) for its extension;

(2) the term of the patent has never been extended under subsection (e)(1) of this section;

(3) an application for extension is submitted by the owner of record of the patent or its agent and in accordance with the requirements of paragraphs (1) through (4) of subsection (d);

(4) the product has been subject to a regulatory review period before its commercial marketing or use;

(5)(A) except as provided in subparagraph (B) or (C), the permission for the commercial marketing or use of the product after such regulatory review period is the first permitted commercial marketing or use of the product under the provision of law under which such regulatory review period occurred;

(B) in the case of a patent which claims a method of manufacturing the product which primarily uses recombinant DNA technology in the manufacture of the product, the permission for the commercial marketing or use of the product after such regulatory period is the first permitted commercial marketing or use of a product manufactured under the process claimed in the patent; or

(C) for purposes of subparagraph (A), in the case of a patent which —

(i) claims a new animal drug or a veterinary biological product which (I) is not covered by the claims in any other patent which has been extended, and (II) has received permission for the commercial marketing or use in non-food-producing animals and in food-producing animals, and

(ii) was not extended on the basis of the regulatory review period for use in non-food-producing animals, the permission for the commercial marketing or use of the drug or product after the regulatory review period for use in food-producing animals is the first permitted commercial marketing or use of the drug or product for administration to a food-producing animal.

The product referred to in paragraphs (4) and (5) is hereinafter in this section referred to as the “approved product.”

(b) Except as provided in subsection (d)(5)(F), the rights derived from any patent the term of which is extended under this section shall during the period during which the term of the patent is extended —

(1) in the case of a patent which claims a product, be limited to any use approved for the product —

(A) before the expiration of the term of the patent —

(i) under the provision of law under which the applicable regulatory review occurred, or

(ii) under the provision of law under which any regulatory review described in paragraph (1), (4), or (5) of subsection (g) occurred, and

(B) on or after the expiration of the regulatory review period upon which the extension of the patent was based;

(2) in the case of a patent which claims a method of using a product, be limited to any use claimed by the patent and approved for the product —

(A) before the expiration of the term of the patent —

(i) under any provision of law under which an applicable regulatory review occurred, and

(ii) under the provision of law under which any regulatory review described in paragraph (1), (4), or (5) of subsection (g) occurred, and

(B) on or after the expiration of the regulatory review period upon which the extension of the patent was based; and

(3) in the case of a patent which claims a method of manufacturing a product, be limited to the method of manufacturing as used to make —

(A) the approved product, or

(B) the product if it has been subject to a regulatory review period described in paragraph (1), (4), or (5) of subsection (g).

As used in this subsection, the term “product” includes an approved product.

(c) The term of a patent eligible for extension under subsection (a) shall be extended by the time equal to the regulatory review period for the approved product which period occurs after the date the patent is issued, except that—

(1) each period of the regulatory review period shall be reduced by any period determined under subsection (d)(2)(B) during which the applicant for the patent extension did not act with due diligence during such period of the regulatory review period;

(2) after any reduction required by paragraph (1), the period of extension shall include only one-half of the time remaining in the periods described in paragraphs (1)(B)(i), (2)(B)(i), (3)(B)(i), (4)(B)(i), and (5)(B)(i) of subsection (g);

(3) if the period remaining in the term of a patent after the date of the approval of the approved product under the provision of law under which such regulatory review occurred when added to the regulatory review period as revised under paragraphs (1) and (2) exceeds fourteen years, the period of extension shall be reduced so that the total of both such periods does not exceed fourteen years, and

(4) in no event shall more than one patent be extended under subsection (e)(i) for the same regulatory review period for any product.

(d)(1) To obtain an extension of the term of a patent under this section, the owner of record of the patent or its agent shall submit an application to the Director. Except as provided in paragraph (5), such an application may only be submitted within the sixty-day period beginning on the date the product received permission under the provision of law under which the applicable regulatory review period occurred for commercial marketing or use. The application shall contain —

(A) the identity of the approved product and the Federal statute under which regulatory review occurred;

(B) the identity of the patent for which an extension is being sought and the identity of each claim of such patent;

(C) information to enable the Director to determine under subsections (a) and (b) the eligibility of a patent for extension and the rights that will be derived from the extension and information to enable

the Director and the Secretary of Health and Human Services or the Secretary of Agriculture to determine the period of the extension under subsection (g);

(D) a brief description of the activities undertaken by the applicant during the applicable regulatory review period with respect to the approved product and the significant dates applicable to such activities; and

(E) such patent or other information as the Director may require.

(2)(A) Within 60 days of the submittal of an application for extension of the term of a patent under paragraph (1), the Director shall notify —

(i) the Secretary of Agriculture if the patent claims a drug product or a method of using or manufacturing a drug product and the drug product is subject to the Virus-Serum-Toxin Act, and

(ii) the Secretary of Health and Human Services if the patent claims any other drug product, a medical device, or a food additive or color additive or a method of using or manufacturing such a product, device, or additive and if the product, device, and additive are subject to the Federal Food, Drug and Cosmetic Act, of the extension application and shall submit to the Secretary who is so notified a copy of the application. Not later than 30 days after the receipt of an application from the Director, the Secretary reviewing the application shall review the dates contained in the application pursuant to paragraph (1)(C) and determine the applicable regulatory review period, shall notify the Director of the determination, and shall publish in the Federal Register a notice of such determination.

(B)(i) If a petition is submitted to the Secretary making the determination under subparagraph (A), not later than 180 days after the publication of the determination under subparagraph (A), upon which it may reasonably be determined that the applicant did not act with due diligence during the applicable regulatory review period, the Secretary making the determination shall, in accordance with regulations promulgated by the Secretary, determine if the applicant acted with due diligence during the applicable regulatory review period. The Secretary making the determination shall make such determination not later than 90 days after the receipt of such a petition. For a drug product, device, or additive subject to the Federal Food, Drug, and Cosmetic Act or the Public

Health Service Act, the Secretary may not delegate the authority to make the determination prescribed by this clause to an office below the Office of the Commissioner of Food and Drugs. For a product subject to the Virus-Serum-Toxin Act, the Secretary of Agriculture may not delegate the authority to make the determination prescribed by this clause to an office below the Office of the Assistant Secretary for Marketing and Inspection Services.

(ii) The Secretary making a determination under clause (i) shall notify the Director of the determination and shall publish in the Federal Register a notice of such determination together with the factual and legal basis for such determination. Any interested person may request, within the 60-day period beginning on the publication of a determination, the Secretary making the determination to hold an informal hearing on the determination. If such a request is made within such period, such Secretary shall hold such hearing not later than 30 days after the date of the request, or at the request of the person making the request, not later than 60 days after such date. The Secretary who is holding the hearing shall provide notice of the hearing to the owner of the patent involved and to any interested person and provide the owner and any interested person an opportunity to participate in the hearing. Within 30 days after the completion of the hearing, such Secretary shall affirm or revise the determination which was the subject of the hearing and notify the Director of any revision of the determination and shall publish any such revision in the Federal Register.

(3) For the purposes of paragraph (2)(B), the term “due diligence” means that degree of attention, continuous directed effort, and timeliness as may reasonably be expected from, and are ordinarily exercised by, a person during a regulatory review period.

(4) An application for the extension of the term of a patent is subject to the disclosure requirements prescribed by the Director.

(5)(A) If the owner of record of the patent or its agent reasonably expects that the applicable regulatory review period described in paragraphs (1)(B)(ii), (2)(B)(ii), (3)(B)(ii), (4)(B)(ii), or (5)(B)(ii) of subsection (g) that began for a product that is the subject of such patent may extend beyond the expiration of the patent term in effect, the owner or its agent may submit an application to the Director for an

interim extension during the period beginning 6 months, and ending 15 days before such term is due to expire. The application shall contain—

(i) the identity of the product subject to regulatory review and the Federal statute under which such review is occurring;

(ii) the identity of the patent for which interim extension is being sought and the identity of each claim of such patent which claims the product under regulatory review or a method of using or manufacturing the product;

(iii) information to enable the Director to determine under subsection (a)(1), (2), and (3) the eligibility of a patent for extension;

(iv) a brief description of the activities undertaken by the applicant during the applicable regulatory review period to date with respect to the product under review and the significant dates applicable to such activities; and

(v) such patent or other information as the Director may require.

(B) If the Director determines that, except for permission to market or use the product commercially, the patent would be eligible for an extension of the patent term under this section, the Director shall publish in the Federal Register a notice of such determination, including the identity of the product under regulatory review, and shall issue to the applicant a certificate of interim extension for a period of not more than 1 year.

(C) The owner of record of a patent, or its agent, for which an interim extension has been granted under subparagraph (B), may apply for not more than 4 subsequent interim extensions under this paragraph, except that, in the case of a patent subject to subsection (g)(6)(C), the owner of record of the patent, or its agent, may apply for only 1 subsequent interim extension under this paragraph. Each such subsequent application shall be made during the period beginning 60 days before, and ending 30 days before, the expiration of the preceding interim extension.

(D) Each certificate of interim extension under this paragraph shall be recorded in the official file of the patent and shall be considered part of the original patent.

(E) Any interim extension granted under this paragraph shall terminate at the end of the 60-day

period beginning on the day on which the product involved receives permission for commercial marketing or use, except that, if within that 60-day period, the applicant notifies the Director of such permission and submits any additional information under paragraph (1) of this subsection not previously contained in the application for interim extension, the patent shall be further extended, in accordance with the provisions of this section—

(i) for not to exceed 5 years from the date of expiration of the original patent term; or

(ii) if the patent is subject to subsection (g)(6)(C), from the date on which the product involved receives approval for commercial marketing or use.

(F) The rights derived from any patent the term of which is extended under this paragraph shall, during the period of interim extension—

(i) in the case of a patent which claims a product, be limited to any use then under regulatory review;

(ii) in the case of a patent which claims a method of using a product, be limited to any use claimed by the patent then under regulatory review; and

(iii) in the case of a patent which claims a method of manufacturing a product, be limited to the method of manufacturing as used to make the product then under regulatory review.

(e)(1) A determination that a patent is eligible for extension may be made by the Director solely on the basis of the representations contained in the application for the extension. If the Director determines that a patent is eligible for extension under subsection (a) and that the requirements of paragraphs (1) through (4) of subsection (d) have been complied with, the Director shall issue to the applicant for the extension of the term of the patent a certificate of extension, under seal, for the period prescribed by subsection (c). Such certificate shall be recorded in the official file of the patent and shall be considered as part of the original patent.

(2) If the term of a patent for which an application has been submitted under subsection (d)(1) would expire before a certificate of extension is issued or denied under paragraph (1) respecting the application, the Director shall extend, until such determination is made, the term of the patent for peri-

ods of up to one year if he determines that the patent is eligible for extension.

(f) For purposes of this section:

(1) The term “product” means:

(A) A drug product.

(B) Any medical device, food additive, or color additive subject to regulation under the Federal Food, Drug, and Cosmetic Act.

(2) The term “drug product” means the active ingredient of—

(A) a new drug, antibiotic drug, or human biological product (as those terms are used in the Federal Food, Drug, and Cosmetic Act and the Public Health Service Act) or

(B) a new animal drug or veterinary biological product (as those terms are used in the Federal Food, Drug, and Cosmetic Act and the Virus-Serum-Toxin Act) which is not primarily manufactured using recombinant DNA, recombinant RNA, hybridoma technology, or other processes involving site specific genetic manipulation techniques, including any salt or ester of the active ingredient, as a single entity or in combination with another active ingredient.

(3) The term “major health or environmental effects test” means a test which is reasonably related to the evaluation of the health or environmental effects of a product, which requires at least six months to conduct, and the data from which is submitted to receive permission for commercial marketing or use. Periods of analysis or evaluation of test results are not to be included in determining if the conduct of a test required at least six months.

(4)(A) Any reference to section 351 is a reference to section 351 of the Public Health Service Act.

(B) Any reference to section 503, 505, 512, or 515 is a reference to section 503, 505, 512, or 515 of the Federal Food, Drug and Cosmetic Act.

(C) Any reference to the Virus-Serum-Toxin Act is a reference to the Act of March 4, 1913 (21 U.S.C. 151 - 158).

(5) The term “informal hearing” has the meaning prescribed for such term by section 201(y) of the Federal Food, Drug and Cosmetic Act.

(6) The term “patent” means a patent issued by the United States Patent and Trademark Office.

(7) The term “date of enactment” as used in this section means September 24, 1984, for human

drug product, a medical device, food additive, or color additive.

(8) The term “date of enactment” as used in this section means the date of enactment of the Generic Animal Drug and Patent Term Restoration Act for an animal drug or a veterinary biological product.

(g) For purposes of this section, the term “regulatory review period” has the following meanings:

(1)(A) In the case of a product which is a new drug, antibiotic drug, or human biological product, the term means the period described in subparagraph (B) to which the limitation described in paragraph (6) applies.

(B) The regulatory review period for a new drug, antibiotic drug, or human biological product is the sum of —

(i) the period beginning on the date an exemption under subsection (i) of section 505 or subsection (d) of section 507 became effective for the approved product and ending on the date an application was initially submitted for such drug product under section 351, 505, or 507, and

(ii) the period beginning on the date the application was initially submitted for the approved product under section 351, subsection (b) of section 505, or section 507 and ending on the date such application was approved under such section.

(2)(A) In the case of a product which is a food additive or color additive, the term means the period described in subparagraph (B) to which the limitation described in paragraph (6) applies.

(B) The regulatory review period for a food or color additive is the sum of —

(i) the period beginning on the date a major health or environmental effects test on the additive was initiated and ending on the date a petition was initially submitted with respect to the product under the Federal Food, Drug, and Cosmetic Act requesting the issuance of a regulation for use of the product, and

(ii) the period beginning on the date a petition was initially submitted with respect to the product under the Federal Food, Drug, and Cosmetic Act requesting the issuance of a regulation for use of the product, and ending on the date such regulation became effective or, if objections were filed to such regulation, ending on the date such objections were

resolved and commercial marketing was permitted or, if commercial marketing was permitted and later revoked pending further proceedings as a result of such objections, ending on the date such proceedings were finally resolved and commercial marketing was permitted.

(3)(A) In the case of a product which is a medical device, the term means the period described in subparagraph (B) to which the limitation described in paragraph (6) applies.

(B) The regulatory review period for a medical device is the sum of —

(i) the period beginning on the date a clinical investigation on humans involving the device was begun and ending on the date an application was initially submitted with respect to the device under section 515, and

(ii) the period beginning on the date an application was initially submitted with respect to the device under section 515 and ending on the date such application was approved under such Act or the period beginning on the date a notice of completion of a product development protocol was initially submitted under section 515(f)(5) and ending on the date the protocol was declared completed under section 515(f)(6).

(4)(A) In the case of a product which is a new animal drug, the term means the period described in subparagraph (B) to which the limitation described in paragraph (6) applies.

(B) The regulatory review period for a new animal drug product is the sum of —

(i) the period beginning on the earlier of the date a major health or environmental effects test on the drug was initiated or the date an exemption under subsection (j) of section 512 became effective for the approved new animal drug product and ending on the date an application was initially submitted for such animal drug product under section 512, and

(ii) the period beginning on the date the application was initially submitted for the approved animal drug product under subsection (b) of section 512 and ending on the date such application was approved under such section.

(5)(A) In the case of a product which is a veterinary biological product, the term means the period described in subparagraph (B) to which the limitation described in paragraph (6) applies.

(B) The regulatory period for a veterinary biological product is the sum of —

(i) the period beginning on the date the authority to prepare an experimental biological product under the Virus- Serum-Toxin Act became effective and ending on the date an application for a license was submitted under the Virus-Serum-Toxin Act, and

(ii) the period beginning on the date an application for a license was initially submitted for approval under the Virus-Serum-Toxin Act and ending on the date such license was issued.

(6) A period determined under any of the preceding paragraphs is subject to the following limitations:

(A) If the patent involved was issued after the date of the enactment of this section, the period of extension determined on the basis of the regulatory review period determined under any such paragraph may not exceed five years.

(B) If the patent involved was issued before the date of the enactment of this section and —

(i) no request for an exemption described in paragraph (1)(B) or (4)(B) was submitted and no request for the authority described in paragraph (5)(B) was submitted,

(ii) no major health or environment effects test described in paragraph (2)(B) or (4)(B) was initiated and no petition for a regulation or application for registration described in such paragraph was submitted, or

(iii) no clinical investigation described in paragraph (3) was begun or product development protocol described in such paragraph was submitted, before such date for the approved product the period of extension determined on the basis of the regulatory review period determined under any such paragraph may not exceed five years.

(C) If the patent involved was issued before the date of the enactment of this section and if an action described in subparagraph (B) was taken before the date of enactment of this section with respect to the approved product and the commercial marketing or use of the product has not been approved before such date, the period of extension determined on the basis of the regulatory review period determined under such paragraph may not exceed two years or in the case of an approved product which is a new animal drug or veterinary biological product (as

those terms are used in the Federal Food, Drug, and Cosmetic Act or the Virus-Serum-Toxin Act), three years.

(h) The Director may establish such fees as the Director determines appropriate to cover the costs to the Office of receiving and acting upon applications under this section.

(Added Sept. 24, 1984, Public Law 98-417, sec. 201(a), 98 Stat. 1598; amended Nov. 16, 1988, Public Law 100-670, sec. 201(a)-(h), 102 Stat. 3984; Dec. 3, 1993, Public Law 103-179, secs. 5, 6, 107 Stat. 2040, 2042; Dec. 8, 1994, Public Law 103-465, sec. 532(c)(1), 108 Stat. 4987.)

(Subsection (f) amended Nov. 21, 1997, Public Law 105-115, sec. 125(b)(2)(P), 111 Stat. 2326.)

(Amended Nov. 29, 1999, Public Law 106-113, sec. 1000(a)(9), 113 Stat. 1501A-560, 582 (S. 1948 secs. 4404 and 4732(a)(10)(A)).)

(Subsections (b)(3)(B), (d)(2)(B)(i), and (g)(6)(B)(iii) amended Nov. 2, 2002, Public Law 107-273, sec. 13206, 116 Stat. 1904.)

### **35 U.S.C. 157 Statutory invention registration.**

(a) Notwithstanding any other provision of this title, the Director is authorized to publish a statutory invention registration containing the specification and drawings of a regularly filed application for a patent without examination if the applicant —

(1) meets the requirements of section 112 of this title;

(2) has complied with the requirements for printing, as set forth in regulations of the Director;

(3) waives the right to receive a patent on the invention within such period as may be prescribed by the Director; and

(4) pays application, publication, and other processing fees established by the Director.

If an interference is declared with respect to such an application, a statutory invention registration may not be published unless the issue of priority of invention is finally determined in favor of the applicant.

(b) The waiver under subsection (a)(3) of this section by an applicant shall take effect upon publication of the statutory invention registration.

(c) A statutory invention registration published pursuant to this section shall have all of the attributes specified for patents in this title except those specified

in section 183 and sections 271 through 289 of this title. A statutory invention registration shall not have any of the attributes specified for patents in any other provision of law other than this title. A statutory invention registration published pursuant to this section shall give appropriate notice to the public, pursuant to regulations which the Director shall issue, of the preceding provisions of this subsection. The invention with respect to which a statutory invention certificate is published is not a patented invention for purposes of section 292 of this title.

(d) The Director shall report to the Congress annually on the use of statutory invention registrations. Such report shall include an assessment of the degree to which agencies of the federal government are making use of the statutory invention registration system, the degree to which it aids the management of federally developed technology, and an assessment of the cost savings to the Federal Government of the uses of such procedures.

(Added Nov. 8, 1984, Public Law 98-622, sec. 102(a), 98 Stat. 3383; amended Nov. 29, 1999, Public Law 106-113, sec. 1000(a)(9), 113 Stat. 1501A-582, 583 (S. 1948 secs. 4732(a)(10)(A) and 4732(a)(11)).)

#### CHAPTER 15 — PLANT PATENTS

Sec.

- 161 Patents for plants.
- 162 Description, claim.
- 163 Grant.
- 164 Assistance of the Department of Agriculture.

#### **35 U.S.C. 161 Patents for plants.**

Whoever invents or discovers and asexually reproduces any distinct and new variety of plant, including cultivated sports, mutants, hybrids, and newly found seedlings, other than a tuber propagated plant or a plant found in an uncultivated state, may obtain a patent therefor, subject to the conditions and requirements of this title.

The provisions of this title relating to patents for inventions shall apply to patents for plants, except as otherwise provided.

(Amended Sept. 3, 1954, 68 Stat. 1190.)

#### **35 U.S.C. 162 Description, claim.**

No plant patent shall be declared invalid for non-compliance with section 112 of this title if the description is as complete as is reasonably possible.

The claim in the specification shall be in formal terms to the plant shown and described.

#### **35 U.S.C. 163 Grant.**

In the case of a plant patent, the grant shall include the right to exclude others from asexually reproducing the plant, and from using, offering for sale, or selling the plant so reproduced, or any of its parts, throughout the United States, or from importing the plant so reproduced, or any parts thereof, into the United States.

(Amended Oct. 27, 1998, Public Law 105-289, sec. 3, 112 Stat. 2781.)

#### **35 U.S.C. 164 Assistance of the Department of Agriculture.**

The President may by Executive order direct the Secretary of Agriculture, in accordance with the requests of the Director, for the purpose of carrying into effect the provisions of this title with respect to plants (1) to furnish available information of the Department of Agriculture, (2) to conduct through the appropriate bureau or division of the Department research upon special problems, or (3) to detail to the Director officers and employees of the Department.

(Amended Nov. 29, 1999, Public Law 106-113, sec. 1000(a)(9), 113 Stat. 1501A-582 (S. 1948 sec. 4732(a)(10)(A)).)

#### CHAPTER 16 — DESIGNS

Sec.

- 171 Patents for designs.
- 172 Right of priority.
- 173 Term of design patent.

#### **35 U.S.C. 171 Patents for designs.**

Whoever invents any new, original, and ornamental design for an article of manufacture may obtain a patent therefor, subject to the conditions and requirements of this title.

The provisions of this title relating to patents for inventions shall apply to patents for designs, except as otherwise provided.

#### **35 U.S.C. 172 Right of priority.**

The right of priority provided for by subsections (a) through (d) of section 119 of this title and the time specified in section 102(d) shall be six months in the

case of designs. The right of priority provided for by section 119(e) of this title shall not apply to designs.

(Amended Dec. 8, 1994, Public Law 103-465, sec. 532(c)(2), 108 Stat. 4987.)

### **35 U.S.C. 173 Term of design patent.**

Patents for designs shall be granted for the term of fourteen years from the date of grant.

(Amended Aug. 27, 1982, Public Law 97-247, sec. 16, 96 Stat. 321; Dec. 8, 1994, Public Law 103-465, sec. 532(c)(3), 108 Stat. 4987.)

## CHAPTER 17 — SECRECY OF CERTAIN INVENTIONS AND FILING APPLICATIONS IN FOREIGN COUNTRIES

Sec.

181 Secrecy of certain inventions and withholding of patent.

182 Abandonment of invention for unauthorized disclosure.

183 Right to compensation.

184 Filing of application in foreign country.

185 Patent barred for filing without license.

186 Penalty.

187 Nonapplicability to certain persons.

188 Rules and regulations, delegation of power.

### **35 U.S.C. 181 Secrecy of certain inventions and withholding of patent.**

Whenever publication or disclosure by the publication of an application or by the grant of a patent on an invention in which the Government has a property interest might, in the opinion of the head of the interested Government agency, be detrimental to the national security, the Commissioner of Patents upon being so notified shall order that the invention be kept secret and shall withhold the publication of an application or the grant of a patent therefor under the conditions set forth hereinafter.

Whenever the publication or disclosure of an invention by the publication of an application or by the granting of a patent, in which the Government does not have a property interest, might, in the opinion of the Commissioner of Patents, be detrimental to the national security, he shall make the application for patent in which such invention is disclosed available for inspection to the Atomic Energy Commission, the Secretary of Defense, and the chief officer of any other department or agency of the Government desig-

nated by the President as a defense agency of the United States.

Each individual to whom the application is disclosed shall sign a dated acknowledgment thereof, which acknowledgment shall be entered in the file of the application. If, in the opinion of the Atomic Energy Commission, the Secretary of a Defense Department, or the chief officer of another department or agency so designated, the publication or disclosure of the invention by the publication of an application or by the granting of a patent therefor would be detrimental to the national security, the Atomic Energy Commission, the Secretary of a Defense Department, or such other chief officer shall notify the Commissioner of Patents and the Commissioner of Patents shall order that the invention be kept secret and shall withhold the publication of the application or the grant of a patent for such period as the national interest requires, and notify the applicant thereof. Upon proper showing by the head of the department or agency who caused the secrecy order to be issued that the examination of the application might jeopardize the national interest, the Commissioner of Patents shall thereupon maintain the application in a sealed condition and notify the applicant thereof. The owner of an application which has been placed under a secrecy order shall have a right to appeal from the order to the Secretary of Commerce under rules prescribed by him.

An invention shall not be ordered kept secret and the publication of an application or the grant of a patent withheld for a period of more than one year. The Commissioner of Patents shall renew the order at the end thereof, or at the end of any renewal period, for additional periods of one year upon notification by the head of the department or the chief officer of the agency who caused the order to be issued that an affirmative determination has been made that the national interest continues to so require. An order in effect, or issued, during a time when the United States is at war, shall remain in effect for the duration of hostilities and one year following cessation of hostilities. An order in effect, or issued, during a national emergency declared by the President shall remain in effect for the duration of the national emergency and six months thereafter. The Commissioner of Patents may rescind any order upon notification by the heads of the departments and the chief officers of the agencies who



caused the order to be issued that the publication or disclosure of the invention is no longer deemed detrimental to the national security.

(Amended Nov. 29, 1999, Public Law 106-113, sec. 1000(a)(9), 113 Stat. 1501A-566, 582 (S. 1948 secs. 4507(7) and 4732(a)(10)(B)).)

### **35 U.S.C. 182 Abandonment of invention for unauthorized disclosure.**

The invention disclosed in an application for patent subject to an order made pursuant to section 181 of this title may be held abandoned upon its being established by the Commissioner of Patents that in violation of said order the invention has been published or disclosed or that an application for a patent therefor has been filed in a foreign country by the inventor, his successors, assigns, or legal representatives, or anyone in privity with him or them, without the consent of the Commissioner of Patents. The abandonment shall be held to have occurred as of the time of violation. The consent of the Commissioner of Patents shall not be given without the concurrence of the heads of the departments and the chief officers of the agencies who caused the order to be issued. A holding of abandonment shall constitute forfeiture by the applicant, his successors, assigns, or legal representatives, or anyone in privity with him or them, of all claims against the United States based upon such invention.

(Amended Nov. 29, 1999, Public Law 106-113, sec. 1000(a)(9), 113 Stat. 1501A-582 (S. 1948 sec. 4732(a)(10)(B)).)

### **35 U.S.C. 183 Right to compensation.**

An applicant, his successors, assigns, or legal representatives, whose patent is withheld as herein provided, shall have the right, beginning at the date the applicant is notified that, except for such order, his application is otherwise in condition for allowance, or February 1, 1952, whichever is later, and ending six years after a patent is issued thereon, to apply to the head of any department or agency who caused the order to be issued for compensation for the damage caused by the order of secrecy and/or for the use of the invention by the Government, resulting from his disclosure. The right to compensation for use shall begin on the date of the first use of the invention by the Government. The head of the department or agency is authorized, upon the presentation of a

claim, to enter into an agreement with the applicant, his successors, assigns, or legal representatives, in full settlement for the damage and/or use. This settlement agreement shall be conclusive for all purposes notwithstanding any other provision of law to the contrary. If full settlement of the claim cannot be effected, the head of the department or agency may award and pay to such applicant, his successors, assigns, or legal representatives, a sum not exceeding 75 per centum of the sum which the head of the department or agency considers just compensation for the damage and/or use. A claimant may bring suit against the United States in the United States Court of Federal Claims or in the District Court of the United States for the district in which such claimant is a resident for an amount which when added to the award shall constitute just compensation for the damage and/or use of the invention by the Government. The owner of any patent issued upon an application that was subject to a secrecy order issued pursuant to section 181 of this title, who did not apply for compensation as above provided, shall have the right, after the date of issuance of such patent, to bring suit in the United States Court of Federal Claims for just compensation for the damage caused by reason of the order of secrecy and/or use by the Government of the invention resulting from his disclosure. The right to compensation for use shall begin on the date of the first use of the invention by the Government. In a suit under the provisions of this section the United States may avail itself of all defenses it may plead in an action under section 1498 of title 28. This section shall not confer a right of action on anyone or his successors, assigns, or legal representatives who, while in the full-time employment or service of the United States, discovered, invented, or developed the invention on which the claim is based.

(Amended Apr. 2, 1982, Public Law 97-164, sec. 160(a)(12), 96 Stat. 48; Oct. 29, 1992, Public Law 102-572, sec. 902 (b)(1), 106 Stat. 4516.)

### **35 U.S.C. 184 Filing of application in foreign country.**

Except when authorized by a license obtained from the Commissioner of Patents a person shall not file or cause or authorize to be filed in any foreign country prior to six months after filing in the United States an application for patent or for the registration of a utility model, industrial design, or model in respect of an

invention made in this country. A license shall not be granted with respect to an invention subject to an order issued by the Commissioner of Patents pursuant to section 181 of this title without the concurrence of the head of the departments and the chief officers of the agencies who caused the order to be issued. The license may be granted retroactively where an application has been filed abroad through error and without deceptive intent and the application does not disclose an invention within the scope of section 181 of this title.

The term “application” when used in this chapter includes applications and any modifications, amendments, or supplements thereto, or divisions thereof.

The scope of a license shall permit subsequent modifications, amendments, and supplements containing additional subject matter if the application upon which the request for the license is based is not, or was not, required to be made available for inspection under section 181 of this title and if such modifications, amendments, and supplements do not change the general nature of the invention in a manner which would require such application to be made available for inspection under such section 181. In any case in which a license is not, or was not, required in order to file an application in any foreign country, such subsequent modifications, amendments, and supplements may be made, without a license, to the application filed in the foreign country if the United States application was not required to be made available for inspection under section 181 and if such modifications, amendments, and supplements do not, or did not, change the general nature of the invention in a manner which would require the United States application to have been made available for inspection under such section 181.

(Amended Aug. 23, 1988, Public Law 100-418, sec. 9101(b)(1), 102 Stat. 1567; Nov. 29, 1999, Public Law 106-113, sec. 1000(a)(9), 113 Stat. 1501A-582 (S. 1948 sec. 4732(a)(10)(B)).)

### **35 U.S.C. 185 Patent barred for filing without license.**

Notwithstanding any other provisions of law any person, and his successors, assigns, or legal representatives, shall not receive a United States patent for an invention if that person, or his successors, assigns, or legal representatives shall, without procuring the license prescribed in section 184 of this title, have

made, or consented to or assisted another’s making, application in a foreign country for a patent or for the registration of a utility model, industrial design, or model in respect of the invention. A United States patent issued to such person, his successors, assigns, or legal representatives shall be invalid, unless the failure to procure such license was through error and without deceptive intent, and the patent does not disclose subject matter within the scope of section 181 of this title.

(Amended Aug. 23, 1988, Public Law 100-418, sec. 9101(b)(2), 102 Stat. 1568; Nov. 2, 2002, Public Law 107-273, sec. 13206, 116 Stat. 1904.)

### **35 U.S.C. 186 Penalty.**

Whoever, during the period or periods of time an invention has been ordered to be kept secret and the grant of a patent thereon withheld pursuant to section 181 of this title, shall, with knowledge of such order and without due authorization, willfully publish or disclose or authorize or cause to be published or disclosed the invention, or material information with respect thereto, or whoever willfully, in violation of the provisions of section 184 of this title, shall file or cause or authorize to be filed in any foreign country an application for patent or for the registration of a utility model, industrial design, or model in respect of any invention made in the United States, shall, upon conviction, be fined not more than \$10,000 or imprisoned for not more than two years, or both.

(Amended Aug. 23, 1988, Public Law 100-418, sec. 9101(b)(3), 102 Stat. 1568.)

### **35 U.S.C. 187 Nonapplicability to certain persons.**

The prohibitions and penalties of this chapter shall not apply to any officer or agent of the United States acting within the scope of his authority, nor to any person acting upon his written instructions or permission.

### **35 U.S.C. 188 Rules and regulations, delegation of power.**

The Atomic Energy Commission, the Secretary of a defense department, the chief officer of any other department or agency of the Government designated by the President as a defense agency of the United States, and the Secretary of Commerce, may separately issue rules and regulations to enable the respective department or agency to carry out the provisions

of this chapter, and may delegate any power conferred by this chapter.

CHAPTER 18 — PATENT RIGHTS IN  
INVENTIONS MADE WITH FEDERAL  
ASSISTANCE

Sec.

- 200 Policy and objective.
- 201 Definitions.
- 202 Disposition of rights.
- 203 March-in rights.
- 204 Preference for United States industry.
- 205 Confidentiality.
- 206 Uniform clauses and regulations.
- 207 Domestic and foreign protection of federally owned inventions.
- 208 Regulations governing Federal licensing.
- 209 Restrictions on licensing of federally owned inventions.
- 210 Precedence of chapter.
- 211 Relationship to antitrust laws.
- 212 Disposition of rights in educational awards.

**35 U.S.C. 200 Policy and objective.**

It is the policy and objective of the Congress to use the patent system to promote the utilization of inventions arising from federally supported research or development; to encourage maximum participation of small business firms in federally supported research and development efforts; to promote collaboration between commercial concerns and nonprofit organizations, including universities; to ensure that inventions made by nonprofit organizations and small business firms are used in a manner to promote free competition and enterprise without unduly encumbering future research and discovery; to promote the commercialization and public availability of inventions made in the United States by United States industry and labor; to ensure that the Government obtains sufficient rights in federally supported inventions to meet the needs of the Government and protect the public against nonuse or unreasonable use of inventions; and to minimize the costs of administering policies in this area.

(Added Dec. 12, 1980, Public Law 96-517, sec. 6(a), 94 Stat. 3018; amended Nov. 1, 2000, Public Law 106-404, sec. 5, 114 Stat. 1745.)

**35 U.S.C. 201 Definitions.**

As used in this chapter —

(a) The term “Federal agency” means any executive agency as defined in section 105 of title 5, and the military departments as defined by section 102 of title 5.

(b) The term “funding agreement” means any contract, grant, or cooperative agreement entered into between any Federal agency, other than the Tennessee Valley Authority, and any contractor for the performance of experimental, developmental, or research work funded in whole or in part by the Federal Government. Such term includes any assignment, substitution of parties, or subcontract of any type entered into for the performance of experimental, developmental, or research work under a funding agreement as herein defined.

(c) The term “contractor” means any person, small business firm, or nonprofit organization that is a party to a funding agreement.

(d) The term “invention” means any invention or discovery which is or may be patentable or otherwise protectable under this title or any novel variety of plant which is or may be protectable under the Plant Variety Protection Act (7 U.S.C. 2321, et seq.).

(e) The term “subject invention” means any invention of the contractor conceived or first actually reduced to practice in the performance of work under a funding agreement: *Provided*, That in the case of a variety of plant, the date of determination (as defined in section 41(d) of the Plant Variety Protection Act (7 U.S.C. 2401(d)) must also occur during the period of contract performance.

(f) The term “practical application” means to manufacture in the case of a composition or product, to practice in the case of a process or method, or to operate in the case of a machine or system; and, in each case, under such conditions as to establish that the invention is being utilized and that its benefits are to the extent permitted by law or Government regulations available to the public on reasonable terms.

(g) The term “made” when used in relation to any invention means the conception or first actual reduction to practice of such invention.

(h) The term “small business firm” means a small business concern as defined at section 2 of Public Law 85-536 (15 U.S.C. 632) and implementing

regulations of the Administrator of the Small Business Administration.

(i) The term “nonprofit organization” means universities and other institutions of higher education or an organization of the type described in section 501(c)(3) of the Internal Revenue Code of 1986 (26 U.S.C. 501(c)) and exempt from taxation under section 501(a) of the Internal Revenue Code (26 U.S.C. 501(a)) or any nonprofit scientific or educational organization qualified under a State nonprofit organization statute.

(Added Dec. 12, 1980, Public Law 96-517, sec. 6(a), 94 Stat. 3019.)

(Subsection (d) amended Nov. 8, 1984, Public Law 98-620, sec. 501(1), 98 Stat. 3364.)

(Subsection (e) amended Nov. 8, 1984, Public Law 98-620, sec. 501(2), 98 Stat. 3364.)

(Subsection (i) amended Oct. 22, 1986, Public Law 99-514, sec. 2, 100 Stat. 2095.)

(Subsection (a) amended Nov. 2, 2002, Public Law 107-273, sec. 13206, 116 Stat. 1904.)

### **35 U.S.C. 202 Disposition of rights.**

(a) Each nonprofit organization or small business firm may, within a reasonable time after disclosure as required by paragraph (c)(1) of this section, elect to retain title to any subject invention: *Provided, however,* That a funding agreement may provide otherwise (i) when the contractor is not located in the United States or does not have a place of business located in the United States or is subject to the control of a foreign government, (ii) in exceptional circumstances when it is determined by the agency that restriction or elimination of the right to retain title to any subject invention will better promote the policy and objectives of this chapter, (iii) when it is determined by a Government authority which is authorized by statute or Executive order to conduct foreign intelligence or counterintelligence activities that the restriction or elimination of the right to retain title to any subject invention is necessary to protect the security of such activities, or (iv) when the funding agreement includes the operation of a Government-owned, contractor-operated facility of the Department of Energy primarily dedicated to that Department's naval nuclear propulsion or weapons related programs and all funding agreement limitations under this subparagraph on the contractor's right to elect title to a sub-

ject invention are limited to inventions occurring under the above two programs of the Department of Energy. The rights of the nonprofit organization or small business firm shall be subject to the provisions of paragraph (c) of this section and the other provisions of this chapter.

(b)(1) The rights of the Government under subsection (a) shall not be exercised by a Federal agency unless it first determines that at least one of the conditions identified in clauses (i) through (iii) of subsection (a) exists. Except in the case of subsection (a)(iii), the agency shall file with the Secretary of Commerce, within thirty days after the award of the applicable funding agreement, a copy of such determination. In the case of a determination under subsection (a)(ii), the statement shall include an analysis justifying the determination. In the case of determinations applicable to funding agreements with small business firms, copies shall also be sent to the Chief Counsel for Advocacy of the Small Business Administration. If the Secretary of Commerce believes that any individual determination or pattern of determinations is contrary to the policies and objectives of this chapter or otherwise not in conformance with this chapter, the Secretary shall so advise the head of the agency concerned and the Administrator of the Office of Federal Procurement Policy, and recommend corrective actions.

(2) Whenever the Administrator of the Office of Federal Procurement Policy has determined that one or more Federal agencies are utilizing the authority of clause (i) or (ii) of subsection (a) of this section in a manner that is contrary to the policies and objectives of this chapter the Administrator is authorized to issue regulations describing classes of situations in which agencies may not exercise the authorities of those clauses.

(3) At least once every 5 years, the Comptroller General shall transmit a report to the Committees on the Judiciary of the Senate and House of Representatives on the manner in which this chapter is being implemented by the agencies and on such other aspects of Government patent policies and practices with respect to federally funded inventions as the Comptroller General believes appropriate.

(4) If the contractor believes that a determination is contrary to the policies and objectives of this chapter or constitutes an abuse of discretion by the

agency, the determination shall be subject to the section 203(b).

(c) Each funding agreement with a small business firm or nonprofit organization shall contain appropriate provisions to effectuate the following:

(1) That the contractor disclose each subject invention to the Federal agency within a reasonable time after it becomes known to contractor personnel responsible for the administration of patent matters, and that the Federal Government may receive title to any subject invention not disclosed to it within such time.

(2) That the contractor make a written election within two years after disclosure to the Federal agency (or such additional time as may be approved by the Federal agency) whether the contractor will retain title to a subject invention: *Provided*, That in any case where publication, on sale, or public use, has initiated the one year statutory period in which valid patent protection can still be obtained in the United States, the period for election may be shortened by the Federal agency to a date that is not more than sixty days prior to the end of the statutory period: *And provided further*, That the Federal Government may receive title to any subject invention in which the contractor does not elect to retain rights or fails to elect rights within such times.

(3) That a contractor electing rights in a subject invention agrees to file a patent application prior to any statutory bar date that may occur under this title due to publication, on sale, or public use, and shall thereafter file corresponding patent applications in other countries in which it wishes to retain title within reasonable times, and that the Federal Government may receive title to any subject inventions in the United States or other countries in which the contractor has not filed patent applications on the subject invention within such times.

(4) With respect to any invention in which the contractor elects rights, the Federal agency shall have a nonexclusive, nontransferable, irrevocable, paid-up license to practice or have practiced for or on behalf of the United States any subject invention throughout the world: *Provided*, That the funding agreement may provide for such additional rights, including the right to assign or have assigned foreign patent rights in the subject invention, as are determined by the agency as necessary for meeting the

obligations of the United States under any treaty, international agreement, arrangement of cooperation, memorandum of understanding, or similar arrangement, including military agreements relating to weapons development and production.

(5) The right of the Federal agency to require periodic reporting on the utilization or efforts at obtaining utilization that are being made by the contractor or his licensees or assignees: *Provided*, That any such information, as well as any information on utilization or efforts at obtaining utilization obtained as part of a proceeding under section 203 of this chapter shall be treated by the Federal agency as commercial and financial information obtained from a person and privileged and confidential and not subject to disclosure under section 552 of title 5.

(6) An obligation on the part of the contractor, in the event a United States patent application is filed by or on its behalf or by any assignee of the contractor, to include within the specification of such application and any patent issuing thereon, a statement specifying that the invention was made with Government support and that the Government has certain rights in the invention.

(7) In the case of a nonprofit organization, (A) a prohibition upon the assignment of rights to a subject invention in the United States without the approval of the Federal agency, except where such assignment is made to an organization which has as one of its primary functions the management of inventions (provided that such assignee shall be subject to the same provisions as the contractor); (B) a requirement that the contractor share royalties with the inventor; (C) except with respect to a funding agreement for the operation of a Government-owned-contractor-operated facility, a requirement that the balance of any royalties or income earned by the contractor with respect to subject inventions, after payment of expenses (including payments to inventors) incidental to the administration of subject inventions, be utilized for the support of scientific research, or education; (D) a requirement that, except where it proves infeasible after a reasonable inquiry, in the licensing of subject inventions shall be given to small business firms; and (E) with respect to a funding agreement for the operation of a Government-owned-contractor-operator facility, requirements (i) that after payment of patenting costs, licensing costs, payments

to inventors, and other expenses incidental to the administration of subject inventions, 100 percent of the balance of any royalties or income earned and retained by the contractor during any fiscal year, up to an amount equal to 5 percent of the annual budget of the facility, shall be used by the contractor for scientific research, development, and education consistent with the research and development mission and objectives of the facility, including activities that increase the licensing potential of other inventions of the facility provided that if said balance exceeds 5 percent of the annual budget of the facility, that 75 percent of such excess shall be paid to the Treasury of the United States and the remaining 25 percent shall be used for the same purposes as described above in this clause (D); and (ii) that, to the extent it provides the most effective technology transfer, the licensing of subject inventions shall be administered by contractor employees on location at the facility.

(8) The requirements of sections 203 and 204 of this chapter.

(d) If a contractor does not elect to retain title to a subject invention in cases subject to this section, the Federal agency may consider and after consultation with the contractor grant requests for retention of rights by the inventor subject to the provisions of this Act and regulations promulgated hereunder.

(e) In any case when a Federal employee is a coinventor of any invention made with a nonprofit organization, a small business firm, or a non-Federal inventor, the Federal agency employing such coinventor may, for the purpose of consolidating rights in the invention and if it finds that it would expedite the development of the invention—

(1) license or assign whatever rights it may acquire in the subject invention to the nonprofit organization, small business firm, or non-Federal inventor in accordance with the provisions of this chapter; or

(2) acquire any rights in the subject invention from the nonprofit organization, small business firm, or non-Federal inventor, but only to the extent the party from whom the rights are acquired voluntarily enters into the transaction and no other transaction under this chapter is conditioned on such acquisition.

(f)(1) No funding agreement with a small business firm or nonprofit organization shall contain a provision allowing a Federal agency to require the licensing to third parties of inventions owned by the

contractor that are not subject inventions unless such provision has been approved by the head of the agency and a written justification has been signed by the head of the agency. Any such provision shall clearly state whether the licensing may be required in connection with the practice of a subject invention, a specifically identified work object, or both. The head of the agency may not delegate the authority to approve provisions or sign justifications required by this paragraph.

(2) A Federal agency shall not require the licensing of third parties under any such provision unless the head of the agency determines that the use of the invention by others is necessary for the practice of a subject invention or for the use of a work object of the funding agreement and that such action is necessary to achieve the practical application of the subject invention or work object. Any such determination shall be on the record after an opportunity for an agency hearing. Any action commenced for judicial review of such determination shall be brought within sixty days after notification of such determination.

(Added Dec. 12, 1980, Public Law 96-517, sec. 6(a), 94 Stat. 3020; subsection (b)(4) added and subsections (a), (b)(1), (b)(2), (c)(4), (c)(5), and (c)(7) amended Nov. 8, 1984, Public Law 98-620, sec. 501, 98 Stat. 3364; subsection (b)(3) amended Dec. 10, 1991, Public Law 102-204, sec. 10, 105 Stat. 1641; subsection (a) amended Nov. 29, 1999, Public Law 106-113, sec. 1000(a)(9), 113 Stat. 1501A-583 (S. 1948 sec. 4732(a)(12)); subsection (e) amended Nov. 1, 2000, Public Law 106-404, sec. 6(1), 114 Stat. 1745; subsections (b)(4), (c)(4), and (c)(5) amended Nov. 2, 2002, Public Law 107-273, sec. 13206, 116 Stat. 1905.)

### **35 U.S.C. 203 March-in rights.**

(a) With respect to any subject invention in which a small business firm or nonprofit organization has acquired title under this chapter, the Federal agency under whose funding agreement the subject invention was made shall have the right, in accordance with such procedures as are provided in regulations promulgated hereunder, to require the contractor, an assignee, or exclusive licensee of a subject invention to grant a nonexclusive, partially exclusive, or exclusive license in any field of use to a responsible applicant or applicants, upon terms that are reasonable under the circumstances, and if the contractor, assignee, or exclusive licensee refuses

such request, to grant such a license itself, if the Federal agency determines that such —

(1) action is necessary because the contractor or assignee has not taken, or is not expected to take within a reasonable time, effective steps to achieve practical application of the subject invention in such field of use;

(2) action is necessary to alleviate health or safety needs which are not reasonably satisfied by the contractor, assignee, or their licensees;

(3) action is necessary to meet requirements for public use specified by Federal regulations and such requirements are not reasonably satisfied by the contractor, assignee, or licensees; or

(4) action is necessary because the agreement required by section 204 has not been obtained or waived or because a licensee of the exclusive right to use or sell any subject invention in the United States is in breach of its agreement obtained pursuant to section 204.

(b) A determination pursuant to this section or section 202(b)(4) shall not be subject to the Contract Disputes Act (41 U.S.C. § 601 et seq.). An administrative appeals procedure shall be established by regulations promulgated in accordance with section 206. Additionally, any contractor, inventor, assignee, or exclusive licensee adversely affected by a determination under this section may, at any time within sixty days after the determination is issued, file a petition in the United States Court of Federal Claims, which shall have jurisdiction to determine the appeal on the record and to affirm, reverse, remand or modify, as appropriate, the determination of the Federal agency. In cases described in paragraphs (1) and (3) of subsection (a), the agency's determination shall be held in abeyance pending the exhaustion of appeals or petitions filed under the preceding sentence.

(Added Dec. 12, 1980, Public Law 96-517, sec. 6(a), 94 Stat. 3022; amended Nov. 8, 1984, Public Law 98-620, sec. 501(9), 98 Stat. 3367; Oct. 29, 1992, Public Law 102-572, sec. 902(b)(1), 106 Stat. 4516; amended Nov. 2, 2002, Public Law 107-273, sec. 13206, 116 Stat. 1905.)

### **35 U.S.C. 204 Preference for United States industry.**

Notwithstanding any other provision of this chapter, no small business firm or nonprofit organization

which receives title to any subject invention and no assignee of any such small business firm or nonprofit organization shall grant to any person the exclusive right to use or sell any subject invention in the United States unless such person agrees that any products embodying the subject invention or produced through the use of the subject invention will be manufactured substantially in the United States. However, in individual cases, the requirement for such an agreement may be waived by the Federal agency under whose funding agreement the invention was made upon a showing by the small business firm, nonprofit organization, or assignee that reasonable but unsuccessful efforts have been made to grant licenses on similar terms to potential licensees that would be likely to manufacture substantially in the United States or that under the circumstances domestic manufacture is not commercially feasible.

(Added Dec. 12, 1980, Public Law 96-517, sec. 6(a), 94 Stat. 3023.)

### **35 U.S.C. 205 Confidentiality.**

Federal agencies are authorized to withhold from disclosure to the public information disclosing any invention in which the Federal Government owns or may own a right, title, or interest (including a nonexclusive license) for a reasonable time in order for a patent application to be filed. Furthermore, Federal agencies shall not be required to release copies of any document which is part of an application for patent filed with the United States Patent and Trademark Office or with any foreign patent office.

(Added Dec. 12, 1980, Public Law 96-517, sec. 6(a), 94 Stat. 3023.)

### **35 U.S.C. 206 Uniform clauses and regulations.**

The Secretary of Commerce may issue regulations which may be made applicable to Federal agencies implementing the provisions of sections 202 through 204 of this chapter and shall establish standard funding agreement provisions required under this chapter. The regulations and the standard funding agreement shall be subject to public comment before their issuance.

(Added Dec. 12, 1980, Public Law 96-517, sec. 6(a), 94 Stat. 3023; amended Nov. 8, 1984, Public Law 98-620, sec. 501(10), 98 Stat. 3367.)

**35 U.S.C. 207 Domestic and foreign protection of federally owned inventions.**

(a) Each Federal agency is authorized to —

(1) apply for, obtain, and maintain patents or other forms of protection in the United States and in foreign countries on inventions in which the Federal Government owns a right, title, or interest;

(2) grant nonexclusive, exclusive, or partially exclusive licenses under federally owned inventions, royalty-free or for royalties or other consideration, and on such terms and conditions, including the grant to the licensee of the right of enforcement pursuant to the provisions of chapter 29 of this title as determined appropriate in the public interest;

(3) undertake all other suitable and necessary steps to protect and administer rights to federally owned inventions on behalf of the Federal Government either directly or through contract, including acquiring rights for and administering royalties to the Federal Government in any invention, but only to the extent the party from whom the rights are acquired voluntarily enters into the transaction, to facilitate the licensing of a federally owned invention; and

(4) transfer custody and administration, in whole or in part, to another Federal agency, of the right, title, or interest in any federally owned invention.

(b) For the purpose of assuring the effective management of Government-owned inventions, the Secretary of Commerce authorized to -

(1) assist Federal agency efforts to promote the licensing and utilization of Government-owned inventions;

(2) assist Federal agencies in seeking protection and maintaining inventions in foreign countries, including the payment of fees and costs connected therewith; and

(3) consult with and advise Federal agencies as to areas of science and technology research and development with potential for commercial utilization.

(Added Dec. 12, 1980, Public Law 96-517, sec. 6(a), 94 Stat. 3023; amended Nov. 8, 1984, Public Law 98-620, sec. 501(11), 98 Stat. 3367; subsections (a)(2) and (a)(3) amended Nov. 1, 2000, Public Law 106-404, sec. 6(2), 114 Stat. 1745.)

**35 U.S.C. 208 Regulations governing Federal licensing.**

The Secretary of Commerce is authorized to promulgate regulations specifying the terms and conditions upon which any federally owned invention, other than inventions owned by the Tennessee Valley Authority, may be licensed on a nonexclusive, partially exclusive, or exclusive basis.

(Added Dec. 12, 1980, Public Law 96-517, sec. 6(a), 94 Stat. 3024; amended Nov. 8, 1984, Public Law 98-620, sec. 501(12), 98 Stat. 3367.)

**35 U.S.C. 209 Licensing federally owned inventions.**

(a) **AUTHORITY.**—A Federal agency may grant an exclusive or partially exclusive license on a federally owned invention under section 207(a)(2) only if—

(1) granting the license is a reasonable and necessary incentive to—

(A) call forth the investment capital and expenditures needed to bring the invention to practical application; or

(B) otherwise promote the invention's utilization by the public;

(2) the Federal agency finds that the public will be served by the granting of the license, as indicated by the applicant's intentions, plans, and ability to bring the invention to practical application or otherwise promote the invention's utilization by the public, and that the proposed scope of exclusivity is not greater than reasonably necessary to provide the incentive for bringing the invention to practical application, as proposed by the applicant, or otherwise to promote the invention's utilization by the public;

(3) the applicant makes a commitment to achieve practical application of the invention within a reasonable time, which time may be extended by the agency upon the applicant's request and the applicant's demonstration that the refusal of such extension would be unreasonable;

(4) granting the license will not tend to substantially lessen competition or create or maintain a violation of the Federal antitrust laws; and

(5) in the case of an invention covered by a foreign patent application or patent, the interests of the Federal Government or United States industry in foreign commerce will be enhanced.



(b) **MANUFACTURE IN UNITED STATES.**—A Federal agency shall normally grant a license under section 207(a)(2) to use or sell any federally owned invention in the United States only to a licensee who agrees that any products embodying the invention or produced through the use of the invention will be manufactured substantially in the United States.

(c) **SMALL BUSINESS.**—First preference for the granting of any exclusive or partially exclusive licenses under section 207(a)(2) shall be given to small business firms having equal or greater likelihood as other applicants to bring the invention to practical application within a reasonable time.

(d) **TERMS AND CONDITIONS.**—Any licenses granted under section 207(a)(2) shall contain such terms and conditions as the granting agency considers appropriate, and shall include provisions—

(1) retaining a nontransferrable, irrevocable, paid-up license for any Federal agency to practice the invention or have the invention practiced throughout the world by or on behalf of the Government of the United States;

(2) requiring periodic reporting on utilization of the invention, and utilization efforts, by the licensee, but only to the extent necessary to enable the Federal agency to determine whether the terms of the license are being complied with, except that any such report shall be treated by the Federal agency as commercial and financial information obtained from a person and privileged and confidential and not subject to disclosure under section 552 of title 5; and

(3) empowering the Federal agency to terminate the license in whole or in part if the agency determines that—

(A) the licensee is not executing its commitment to achieve practical application of the invention, including commitments contained in any plan submitted in support of its request for a license, and the licensee cannot otherwise demonstrate to the satisfaction of the Federal agency that it has taken, or can be expected to take within a reasonable time, effective steps to achieve practical application of the invention;

(B) the licensee is in breach of an agreement described in subsection (b);

(C) termination is necessary to meet requirements for public use specified by Federal regulations issued after the date of the license, and such

requirements are not reasonably satisfied by the licensee; or

(D) the licensee has been found by a court of competent jurisdiction to have violated the Federal antitrust laws in connection with its performance under the license agreement.

(e) **PUBLIC NOTICE.**—No exclusive or partially exclusive license may be granted under section 207(a)(2) unless public notice of the intention to grant an exclusive or partially exclusive license on a federally owned invention has been provided in an appropriate manner at least 15 days before the license is granted, and the Federal agency has considered all comments received before the end of the comment period in response to that public notice. This subsection shall not apply to the licensing of inventions made under a cooperative research and development agreement entered into under section 12 of the Stevenson-Wydler Technology Innovation Act of 1980 (15 U.S.C. 3710a).

(f) **PLAN.**—No Federal agency shall grant any license under a patent or patent application on a federally owned invention unless the person requesting the license has supplied the agency with a plan for development or marketing of the invention, except that any such plan shall be treated by the Federal agency as commercial and financial information obtained from a person and privileged and confidential and not subject to disclosure under section 552 of title 5.

(Added Dec. 12, 1980, Public Law 96-517, sec. 6(a), 94 Stat. 3024; amended Nov. 1, 2000, Public Law 106-404, sec. 4, 114 Stat. 1743; subsections (d)(2) and (f) amended Nov. 2, 2002, Public Law 107-273, sec. 13206, 116 Stat. 1905.)

### **35 U.S.C. 210 Precedence of chapter.**

(a) This chapter shall take precedence over any other Act which would require a disposition of rights in subject inventions of small business firms or non-profit organizations contractors in a manner that is inconsistent with this chapter, including but not necessarily limited to the following:

(1) section 10(a) of the Act of June 29, 1935, as added by title I of the Act of August 14, 1946 (7 U.S.C. 427i(a); 60 Stat. 1085);

(2) section 205(a) of the Act of August 14, 1946 (7 U.S.C. 1624(a); 60 Stat. 1090);

(3) section 501(c) of the Federal Mine Safety and Health Act of 1977 (30 U.S.C. 951(c); 83 Stat. 742);

(4) section 30168(e) of title 49;

(5) section 12 of the National Science Foundation Act of 1950 (42 U.S.C. 1871(a); 82 Stat. 360);

(6) section 152 of the Atomic Energy Act of 1954 (42 U.S.C. 2182; 68 Stat. 943);

(7) section 305 of the National Aeronautics and Space Act of 1958 (42 U.S.C. 2457);

(8) section 6 of the Coal Research Development Act of 1960 (30 U.S.C. 666; 74 Stat. 337);

(9) section 4 of the Helium Act Amendments of 1960 (50 U.S.C. 167b; 74 Stat. 920);

(10) section 32 of the Arms Control and Disarmament Act of 1961 (22 U.S.C. 2572; 75 Stat. 634);

(11) section 9 of the Federal Nonnuclear Energy Research and Development Act of 1974 (42 U.S.C. 5908; 88 Stat. 1878);

(12) section 5(d) of the Consumer Product Safety Act (15 U.S.C. 2054(d); 86 Stat. 1211);

(13) section 3 of the Act of April 5, 1944 (30 U.S.C. 323; 58 Stat. 191);

(14) section 8001(c)(3) of the Solid Waste Disposal Act (42 U.S.C. 6981(c); 90 Stat. 2829);

(15) section 219 of the Foreign Assistance Act of 1961 (22 U.S.C. 2179; 83 Stat. 806);

(16) section 427(b) of the Federal Mine Health and Safety Act of 1977 (30 U.S.C. 937(b); 86 Stat. 155);

(17) section 306(d) of the Surface Mining and Reclamation Act of 1977 (30 U.S.C. 1226(d); 91 Stat. 455);

(18) section 21(d) of the Federal Fire Prevention and Control Act of 1974 (15 U.S.C. 2218(d); 88 Stat. 1548);

(19) section 6(b) of the Solar Photovoltaic Energy Research Development and Demonstration Act of 1978 (42 U.S.C. 5585(b); 92 Stat. 2516);

(20) section 12 of the Native Latex Commercialization and Economic Development Act of 1978 (7 U.S.C. 178j; 92 Stat. 2533); and

(21) section 408 of the Water Resources and Development Act of 1978 (42 U.S.C. 7879; 92 Stat. 1360).

The Act creating this chapter shall be construed to take precedence over any future Act unless

that Act specifically cites this Act and provides that it shall take precedence over this Act.

(b) Nothing in this chapter is intended to alter the effect of the laws cited in paragraph (a) of this section or any other laws with respect to the disposition of rights in inventions made in the performance of funding agreements with persons other than nonprofit organizations or small business firms.

(c) Nothing in this chapter is intended to limit the authority of agencies to agree to the disposition of rights in inventions made in the performance of work under funding agreements with persons other than nonprofit organizations or small business firms in accordance with the Statement of Government Patent Policy issued on February 18, 1983, agency regulations, or other applicable regulations or to otherwise limit the authority of agencies to allow such persons to retain ownership of inventions, except that all funding agreements, including those with other than small business firms and nonprofit organizations, shall include the requirements established in section 202(c)(4) and section 203 of this title. Any disposition of rights in inventions made in accordance with the Statement or implementing regulations, including any disposition occurring before enactment of this section, are hereby authorized.

(d) Nothing in this chapter shall be construed to require the disclosure of intelligence sources or methods or to otherwise affect the authority granted to the Director of Central Intelligence by statute or Executive order for the protection of intelligence sources or methods.

(e) The provisions of the Stevenson-Wydler Technology Innovation Act of 1980 shall take precedence over the provisions of this chapter to the extent that they permit or require a disposition of rights in subject inventions which is inconsistent with this chapter.

(Added Dec. 12, 1980, Public Law 96-517, sec. 6(a), 94 Stat. 3026.)

(Subsection (c) amended Nov. 8, 1984, Public Law 98-620, sec. 501(13), 98 Stat. 3367.)

(Subsection (e) added Oct. 20, 1986, Public Law 99-502, sec. 9(c), 100 Stat. 1796.)

(Subsection (a)(4) amended July 5, 1994, Public Law 103-272, sec. 5(j), 108 Stat. 1375.)

(Subsection (e) amended Mar. 7, 1996, Public Law 104-113, sec. 7, 110 Stat. 779.)

(Subsection (a) amended Nov. 13, 1998, Public Law 105-393, sec. 220(c)(2), 112 Stat. 3625.)

(Subsections (a)(11), (a)(20), and (c) amended Nov. 2, 2002, Public Law 107-273, sec. 13206, 116 Stat. 1905.)

### **35 U.S.C. 211 Relationship to antitrust laws.**

Nothing in this chapter shall be deemed to convey to any person immunity from civil or criminal liability, or to create any defenses to actions, under any antitrust law.

(Added Dec.12, 1980, Public Law 96-517, sec. 6(a), 94 Stat. 3027.)

### **35 U.S.C. 212 Disposition of rights in educational awards.**

No scholarship, fellowship, training grant, or other funding agreement made by a Federal agency primarily to an awardee for educational purposes will contain any provision giving the Federal agency any rights to inventions made by the awardee.

(Added Nov. 8, 1984, Public Law 98-620, sec. 501(14), 98 Stat. 3368.)

## **PART III — PATENTS AND PROTECTION OF PATENT RIGHTS**

### **CHAPTER 25 — AMENDMENT AND CORRECTION OF PATENTS**

Sec.

- 251 Reissue of defective patents.
- 252 Effect of reissue.
- 253 Disclaimer.
- 254 Certificate of correction of Patent and Trademark Office mistake.
- 255 Certificate of correction of applicant's mistake.
- 256 Correction of named inventor.

### **35 U.S.C. 251 Reissue of defective patents.**

Whenever any patent is, through error without any deceptive intention, deemed wholly or partly inoperative or invalid, by reason of a defective specification or drawing, or by reason of the patentee claiming more or less than he had a right to claim in the patent, the Director shall, on the surrender of such patent and the payment of the fee required by law, reissue the patent for the invention disclosed in the original

patent, and in accordance with a new and amended application, for the unexpired part of the term of the original patent. No new matter shall be introduced into the application for reissue.

The Director may issue several reissued patents for distinct and separate parts of the thing patented, upon demand of the applicant, and upon payment of the required fee for a reissue for each of such reissued patents.

The provisions of this title relating to applications for patent shall be applicable to applications for reissue of a patent, except that application for reissue may be made and sworn to by the assignee of the entire interest if the application does not seek to enlarge the scope of the claims of the original patent.

No reissued patent shall be granted enlarging the scope of the claims of the original patent unless applied for within two years from the grant of the original patent.

(Amended Nov. 29, 1999, Public Law 106-113, sec. 1000(a)(9), 113 Stat. 1501A-582 (S. 1948 sec. 4732(a)(10)(A)).)

### **35 U.S.C. 252 Effect of reissue.**

The surrender of the original patent shall take effect upon the issue of the reissued patent, and every reissued patent shall have the same effect and operation in law, on the trial of actions for causes thereafter arising, as if the same had been originally granted in such amended form, but in so far as the claims of the original and reissued patents are substantially identical, such surrender shall not affect any action then pending nor abate any cause of action then existing, and the reissued patent, to the extent that its claims are substantially identical with the original patent, shall constitute a continuation thereof and have effect continuously from the date of the original patent.

A reissued patent shall not abridge or affect the right of any person or that person's successors in business who, prior to the grant of a reissue, made, purchased, offered to sell, or used within the United States, or imported into the United States, anything patented by the reissued patent, to continue the use of, to offer to sell, or to sell to others to be used, offered for sale, or sold, the specific thing so made, purchased, offered for sale, used, or imported unless the making, using, offering for sale, or selling of such thing infringes a valid claim of the reissued patent which was in the original patent. The court before

which such matter is in question may provide for the continued manufacture, use, offer for sale, or sale of the thing made, purchased, offered for sale, used, or imported as specified, or for the manufacture, use, offer for sale, or sale in the United States of which substantial preparation was made before the grant of the reissue, and the court may also provide for the continued practice of any process patented by the reissue that is practiced, or for the practice of which substantial preparation was made, before the grant of the reissue, to the extent and under such terms as the court deems equitable for the protection of investments made or business commenced before the grant of the reissue.

(Amended Dec. 8, 1994, Public Law 103-465, sec. 533(b)(2), 108 Stat. 4989; Nov. 29, 1999, Public Law 106-113, sec. 1000(a)(9), 113 Stat. 1501A-566 (S. 1948 sec. 4507(8)).)

### **35 U.S.C. 253 Disclaimer.**

Whenever, without any deceptive intention, a claim of a patent is invalid the remaining claims shall not thereby be rendered invalid. A patentee, whether of the whole or any sectional interest therein, may, on payment of the fee required by law, make disclaimer of any complete claim, stating therein the extent of his interest in such patent. Such disclaimer shall be in writing and recorded in the Patent and Trademark Office, and it shall thereafter be considered as part of the original patent to the extent of the interest possessed by the disclaimant and by those claiming under him.

In like manner any patentee or applicant may disclaim or dedicate to the public the entire term, or any terminal part of the term, of the patent granted or to be granted.

(Amended Jan. 2, 1975, Public Law 93-596, sec. 1, 88 Stat. 1949.)

### **35 U.S.C. 254 Certificate of correction of Patent and Trademark Office mistake.**

Whenever a mistake in a patent, incurred through the fault of the Patent and Trademark Office, is clearly disclosed by the records of the Office, the Director may issue a certificate of correction stating the fact and nature of such mistake, under seal, without charge, to be recorded in the records of patents. A printed copy thereof shall be attached to each printed copy of the patent, and such certificate shall be con-

sidered as part of the original patent. Every such patent, together with such certificate, shall have the same effect and operation in law on the trial of actions for causes thereafter arising as if the same had been originally issued in such corrected form. The Director may issue a corrected patent without charge in lieu of and with like effect as a certificate of correction.

(Amended Jan. 2, 1975, Public Law 93-596, sec. 1, 88 Stat. 1949; Nov. 29, 1999, Public Law 106-113, sec. 1000(a)(9), 113 Stat. 1501A-582 (S. 1948 sec. 4732(a)(10)(A)).)

### **35 U.S.C. 255 Certificate of correction of applicant's mistake.**

Whenever a mistake of a clerical or typographical nature, or of minor character, which was not the fault of the Patent and Trademark Office, appears in a patent and a showing has been made that such mistake occurred in good faith, the Director may, upon payment of the required fee, issue a certificate of correction, if the correction does not involve such changes in the patent as would constitute new matter or would require reexamination. Such patent, together with the certificate, shall have the same effect and operation in law on the trial of actions for causes thereafter arising as if the same had been originally issued in such corrected form.

(Amended Jan. 2, 1975, Public Law 93-596, sec. 1, 88 Stat. 1949; Nov. 29, 1999, Public Law 106-113, sec. 1000(a)(9), 113 Stat. 1501A-582 (S. 1948 sec. 4732(a)(10)(A)).)

### **35 U.S.C. 256 Correction of named inventor.**

Whenever through error a person is named in an issued patent as the inventor, or through error an inventor is not named in an issued patent and such error arose without any deceptive intention on his part, the Director may, on application of all the parties and assignees, with proof of the facts and such other requirements as may be imposed, issue a certificate correcting such error.

The error of omitting inventors or naming persons who are not inventors shall not invalidate the patent in which such error occurred if it can be corrected as provided in this section. The court before which such matter is called in question may order correction of the patent on notice and hearing of all parties concerned and the Director shall issue a certificate accordingly.

(Amended Aug. 27, 1982, Public Law 97-247, sec. 6(b), 96 Stat. 320; Nov. 29, 1999, Public Law 106-113, sec. 1000(a)(9), 113 Stat. 1501A-582 (S. 1948 sec. 4732(a)(10)(A)).)

## CHAPTER 26 — OWNERSHIP AND ASSIGNMENT

Sec.

261 Ownership; assignment.

262 Joint owners.

### **35 U.S.C. 261 Ownership; assignment.**

Subject to the provisions of this title, patents shall have the attributes of personal property.

Applications for patent, patents, or any interest therein, shall be assignable in law by an instrument in writing. The applicant, patentee, or his assigns or legal representatives may in like manner grant and convey an exclusive right under his application for patent, or patents, to the whole or any specified part of the United States.

A certificate of acknowledgment under the hand and official seal of a person authorized to administer oaths within the United States, or, in a foreign country, of a diplomatic or consular officer of the United States or an officer authorized to administer oaths whose authority is proved by a certificate of a diplomatic or consular officer of the United States, or apostille of an official designated by a foreign country which, by treaty or convention, accords like effect to apostilles of designated officials in the United States, shall be *prima facie* evidence of the execution of an assignment, grant, or conveyance of a patent or application for patent.

An assignment, grant, or conveyance shall be void as against any subsequent purchaser or mortgagee for a valuable consideration, without notice, unless it is recorded in the Patent and Trademark Office within three months from its date or prior to the date of such subsequent purchase or mortgage.

(Amended Jan. 2, 1975, Public Law 93-596, sec. 1, 88 Stat. 1949; Aug. 27, 1982, Public Law 97-247, sec. 14(b), 96 Stat. 321.)

### **35 U.S.C. 262 Joint owners.**

In the absence of any agreement to the contrary, each of the joint owners of a patent may make, use, offer to sell, or sell the patented invention within the United States, or import the patented invention into

the United States, without the consent of and without accounting to the other owners.

(Amended Dec. 8, 1994, Public Law 103-465, sec. 533(b)(3), 108 Stat. 4989.)

## CHAPTER 27 — GOVERNMENT INTERESTS IN PATENTS

Sec.

266 [Repealed.]

267 Time for taking action in Government applications.

### **35 U.S.C. 266 [Repealed.]**

(Repealed July 24, 1965, Public Law 89-83, sec. 8, 79 Stat. 261.)

### **35 U.S.C. 267 Time for taking action in Government applications.**

Notwithstanding the provisions of sections 133 and 151 of this title, the Director may extend the time for taking any action to three years, when an application has become the property of the United States and the head of the appropriate department or agency of the Government has certified to the Director that the invention disclosed therein is important to the armament or defense of the United States.

(Amended Nov. 29, 1999, Public Law 106-113, sec. 1000(a)(9), 113 Stat. 1501A-582 (S. 1948 sec. 4732(a)(10)(A)).)

## CHAPTER 28 — INFRINGEMENT OF PATENTS

Sec.

271 Infringement of patent.

272 Temporary presence in the United States.

273 Defense to infringement based on earlier inventor.

### **35 U.S.C. 271 Infringement of patent.**

(a) Except as otherwise provided in this title, whoever without authority makes, uses, offers to sell, or sells any patented invention, within the United States, or imports into the United States any patented invention during the term of the patent therefor, infringes the patent.

(b) Whoever actively induces infringement of a patent shall be liable as an infringer.

(c) Whoever offers to sell or sells within the United States or imports into the United States a component of a patented machine, manufacture, combination, or composition, or a material or apparatus for use in practicing a patented process, constituting a material part of the invention, knowing the same to be especially made or especially adapted for use in an infringement of such patent, and not a staple article or commodity of commerce suitable for substantial non-infringing use, shall be liable as a contributory infringer.

(d) No patent owner otherwise entitled to relief for infringement or contributory infringement of a patent shall be denied relief or deemed guilty of misuse or illegal extension of the patent right by reason of his having done one or more of the following: (1) derived revenue from acts which if performed by another without his consent would constitute contributory infringement of the patent; (2) licensed or authorized another to perform acts which if performed without his consent would constitute contributory infringement of the patent; (3) sought to enforce his patent rights against infringement or contributory infringement; (4) refused to license or use any rights to the patent; or (5) conditioned the license of any rights to the patent or the sale of the patented product on the acquisition of a license to rights in another patent or purchase of a separate product, unless, in view of the circumstances, the patent owner has market power in the relevant market for the patent or patented product on which the license or sale is conditioned.

(e)(1) It shall not be an act of infringement to make, use, offer to sell, or sell within the United States or import into the United States a patented invention (other than a new animal drug or veterinary biological product (as those terms are used in the Federal Food, Drug, and Cosmetic Act and the Act of March 4, 1913) which is primarily manufactured using recombinant DNA, recombinant RNA, hybridoma technology, or other processes involving site specific genetic manipulation techniques) solely for uses reasonably related to the development and submission of information under a Federal law which regulates the manufacture, use, or sale of drugs or veterinary biological products.

(2) It shall be an act of infringement to submit —

(A) an application under section 505(j) of the Federal Food, Drug, and Cosmetic Act or described in section 505(b)(2) of such Act for a drug claimed in a patent or the use of which is claimed in a patent, or

(B) an application under section 512 of such Act or under the Act of March 4, 1913 (21 U.S.C. 151 - 158) for a drug or veterinary biological product which is not primarily manufactured using recombinant DNA, recombinant RNA, hybridoma technology, or other processes involving site specific genetic manipulation techniques and which is claimed in a patent or the use of which is claimed in a patent, if the purpose of such submission is to obtain approval under such Act to engage in the commercial manufacture, use, or sale of a drug or veterinary biological product claimed in a patent or the use of which is claimed in a patent before the expiration of such patent.

(3) In any action for patent infringement brought under this section, no injunctive or other relief may be granted which would prohibit the making, using, offering to sell, or selling within the United States or importing into the United States of a patented invention under paragraph (1).

(4) For an act of infringement described in paragraph (2)—

(A) the court shall order the effective date of any approval of the drug or veterinary biological product involved in the infringement to be a date which is not earlier than the date of the expiration of the patent which has been infringed,

(B) injunctive relief may be granted against an infringer to prevent the commercial manufacture, use, offer to sell, or sale within the United States or importation into the United States of an approved drug or veterinary biological product, and

(C) damages or other monetary relief may be awarded against an infringer only if there has been commercial manufacture, use, offer to sell, or sale within the United States or importation into the United States of an approved drug or veterinary biological product.

The remedies prescribed by subparagraphs (A), (B), and (C) are the only remedies which may be granted by a court for an act of infringement described in paragraph (2), except that a court may award attorney fees under section 285.

(f)(1) Whoever without authority supplies or causes to be supplied in or from the United States all or a substantial portion of the components of a patented invention, where such components are uncombined in whole or in part, in such manner as to actively induce the combination of such components outside of the United States in a manner that would infringe the patent if such combination occurred within the United States, shall be liable as an infringer.

(2) Whoever without authority supplies or causes to be supplied in or from the United States any component of a patented invention that is especially made or especially adapted for use in the invention and not a staple article or commodity of commerce suitable for substantial noninfringing use, where such component is uncombined in whole or in part, knowing that such component is so made or adapted and intending that such component will be combined outside of the United States in a manner that would infringe the patent if such combination occurred within the United States, shall be liable as an infringer.

(g) Whoever without authority imports into the United States or offers to sell, sells, or uses within the United States a product which is made by a process patented in the United States shall be liable as an infringer, if the importation, offer to sell, sale, or use of the product occurs during the term of such process patent. In an action for infringement of a process patent, no remedy may be granted for infringement on account of the noncommercial use or retail sale of a product unless there is no adequate remedy under this title for infringement on account of the importation or other use, offer to sell, or sale of that product. A product which is made by a patented process will, for purposes of this title, not be considered to be so made after —

(1) it is materially changed by subsequent processes; or

(2) it becomes a trivial and nonessential component of another product.

(h) As used in this section, the term “whoever” includes any State, any instrumentality of a State, any officer or employee of a State or instrumentality of a State acting in his official capacity. Any State, and any such instrumentality, officer, or employee, shall be subject to the provisions of this title in the same

manner and to the same extent as any nongovernmental entity.

(i) As used in this section, an “offer for sale” or an “offer to sell” by a person other than the patentee or any assignee of the patentee, is that in which the sale will occur before the expiration of the term of the patent.

(Subsection (e) added Sept. 24, 1984, Public Law 98-417, sec. 202, 98 Stat. 1603.)

(Subsection (f) added Nov. 8, 1984, Public Law 98-622, sec. 101(a), 98 Stat. 3383.)

(Subsection (g) added Aug. 23, 1988, Public Law 100-418, sec. 9003, 102 Stat. 1564.)

(Subsection (e) amended Nov. 16, 1988, Public Law 100-670, sec. 201(i), 102 Stat. 3988.)

(Subsection (d) amended Nov. 19, 1988, Public Law 100-703, sec. 201, 102 Stat. 4676.)

(Subsection (h) added Oct. 28, 1992, Public Law 102-560, sec. 2(a)(1), 106 Stat. 4230.)

(Subsections (a), (c), (e), and (g) amended Dec. 8, 1994, Public Law 103-465, sec. 533(a), 108 Stat. 4988.)

(Subsection (i) added Dec. 8, 1994, Public Law 103-465, sec. 533(a), 108 Stat. 4988.)

### **35 U.S.C. 272 Temporary presence in the United States.**

The use of any invention in any vessel, aircraft or vehicle of any country which affords similar privileges to vessels, aircraft, or vehicles of the United States, entering the United States temporarily or accidentally, shall not constitute infringement of any patent, if the invention is used exclusively for the needs of the vessel, aircraft, or vehicle and is not offered for sale or sold in or used for the manufacture of anything to be sold in or exported from the United States.

(Amended Dec. 8, 1994, Public Law 103-465, sec. 533(b)(4), 108 Stat. 4989.)

### **35 U.S.C. 273 Defense to infringement based on earlier inventor.**

(a) DEFINITIONS.— For purposes of this section—

(1) the terms “commercially used” and “commercial use” mean use of a method in the United States, so long as such use is in connection with an internal commercial use or an actual arm’s-length sale

or other arm's-length commercial transfer of a useful end result, whether or not the subject matter at issue is accessible to or otherwise known to the public, except that the subject matter for which commercial marketing or use is subject to a premarketing regulatory review period during which the safety or efficacy of the subject matter is established, including any period specified in section 156(g), shall be deemed "commercially used" and in "commercial use" during such regulatory review period;

(2) in the case of activities performed by a nonprofit research laboratory, or nonprofit entity such as a university, research center, or hospital, a use for which the public is the intended beneficiary shall be considered to be a use described in paragraph (1), except that the use—

(A) may be asserted as a defense under this section only for continued use by and in the laboratory or nonprofit entity; and

(B) may not be asserted as a defense with respect to any subsequent commercialization or use outside such laboratory or nonprofit entity;

(3) the term "method" means a method of doing or conducting business; and

(4) the "effective filing date" of a patent is the earlier of the actual filing date of the application for the patent or the filing date of any earlier United States, foreign, or international application to which the subject matter at issue is entitled under section 119, 120, or 365 of this title.

(b) DEFENSE TO INFRINGEMENT.—

(1) IN GENERAL.— It shall be a defense to an action for infringement under section 271 of this title with respect to any subject matter that would otherwise infringe one or more claims for a method in the patent being asserted against a person, if such person had, acting in good faith, actually reduced the subject matter to practice at least 1 year before the effective filing date of such patent, and commercially used the subject matter before the effective filing date of such patent.

(2) EXHAUSTION OF RIGHT.— The sale or other disposition of a useful end product produced by a patented method, by a person entitled to assert a defense under this section with respect to that useful end result shall exhaust the patent owner's rights under the patent to the extent such rights would have

been exhausted had such sale or other disposition been made by the patent owner.

(3) LIMITATIONS AND QUALIFICATIONS OF DEFENSE.— The defense to infringement under this section is subject to the following:

(A) PATENT.— A person may not assert the defense under this section unless the invention for which the defense is asserted is for a method.

(B) DERIVATION.— A person may not assert the defense under this section if the subject matter on which the defense is based was derived from the patentee or persons in privity with the patentee.

(C) NOT A GENERAL LICENSE.— The defense asserted by a person under this section is not a general license under all claims of the patent at issue, but extends only to the specific subject matter claimed in the patent with respect to which the person can assert a defense under this chapter, except that the defense shall also extend to variations in the quantity or volume of use of the claimed subject matter, and to improvements in the claimed subject matter that do not infringe additional specifically claimed subject matter of the patent.

(4) BURDEN OF PROOF.— A person asserting the defense under this section shall have the burden of establishing the defense by clear and convincing evidence.

(5) ABANDONMENT OF USE.— A person who has abandoned commercial use of subject matter may not rely on activities performed before the date of such abandonment in establishing a defense under this section with respect to actions taken after the date of such abandonment.

(6) PERSONAL DEFENSE.— The defense under this section may be asserted only by the person who performed the acts necessary to establish the defense and, except for any transfer to the patent owner, the right to assert the defense shall not be licensed or assigned or transferred to another person except as an ancillary and subordinate part of a good faith assignment or transfer for other reasons of the entire enterprise or line of business to which the defense relates.

(7) LIMITATION ON SITES.— A defense under this section, when acquired as part of a good faith assignment or transfer of an entire enterprise or line of business to which the defense relates, may only



be asserted for uses at sites where the subject matter that would otherwise infringe one or more of the claims is in use before the later of the effective filing date of the patent or the date of the assignment or transfer of such enterprise or line of business.

(8) **UNSUCCESSFUL ASSERTION OF DEFENSE.**— If the defense under this section is pleaded by a person who is found to infringe the patent and who subsequently fails to demonstrate a reasonable basis for asserting the defense, the court shall find the case exceptional for the purpose of awarding attorney fees under section 285 of this title.

(9) **INVALIDITY.**— A patent shall not be deemed to be invalid under section 102 or 103 of this title solely because a defense is raised or established under this section.

(Added Nov. 29, 1999, Public Law 106-113, sec. 1000(a)(9), 113 Stat. 1501A-555 (S. 1948 sec. 4302).)

#### CHAPTER 29 — REMEDIES FOR INFRINGEMENT OF PATENT, AND OTHER ACTIONS

Sec.

- 281 Remedy for infringement of patent.
- 282 Presumption of validity; defenses.
- 283 Injunction.
- 284 Damages.
- 285 Attorney fees.
- 286 Time limitation on damages.
- 287 Limitation on damages and other remedies; marking and notice.
- 288 Action for infringement of a patent containing an invalid claim.
- 289 Additional remedy for infringement of design patent.
- 290 Notice of patent suits.
- 291 Interfering patents.
- 292 False marking.
- 293 Nonresident patentee; service and notice.
- 294 Voluntary arbitration.
- 295 Presumptions: Product made by patented process.
- 296 Liability of States, instrumentalities of States, and State officials for infringement of patents.
- 297 Improper and deceptive invention promotion

#### **35 U.S.C. 281 Remedy for infringement of patent.**

A patentee shall have remedy by civil action for infringement of his patent.

#### **35 U.S.C. 282 Presumption of validity; defenses.**

A patent shall be presumed valid. Each claim of a patent (whether in independent, dependent, or multiple dependent form) shall be presumed valid independently of the validity of other claims; dependent or multiple dependent claims shall be presumed valid even though dependent upon an invalid claim. Notwithstanding the preceding sentence, if a claim to a composition of matter is held invalid and that claim was the basis of a determination of nonobviousness under section 103(b)(1), the process shall no longer be considered nonobvious solely on the basis of section 103(b)(1). The burden of establishing invalidity of a patent or any claim thereof shall rest on the party asserting such invalidity.

The following shall be defenses in any action involving the validity or infringement of a patent and shall be pleaded:

- (1) Noninfringement, absence of liability for infringement, or unenforceability,
- (2) Invalidity of the patent or any claim in suit on any ground specified in part II of this title as a condition for patentability,
- (3) Invalidity of the patent or any claim in suit for failure to comply with any requirement of sections 112 or 251 of this title,
- (4) Any other fact or act made a defense by this title.

In actions involving the validity or infringement of a patent the party asserting invalidity or noninfringement shall give notice in the pleadings or otherwise in writing to the adverse party at least thirty days before the trial, of the country, number, date, and name of the patentee of any patent, the title, date, and page numbers of any publication to be relied upon as anticipation of the patent in suit or, except in actions in the United States Court of Federal Claims, as showing the state of the art, and the name and address of any person who may be relied upon as the prior inventor or as having prior knowledge of or as having previously used or offered for sale the invention of the patent in suit. In the absence of such notice proof of the said matters may not be made at the trial except on such terms as the court requires.

Invalidity of the extension of a patent term or any portion thereof under section 154(b) or 156 of this title because of the material failure—

- (1) by the applicant for the extension, or
- (2) by the Director, to comply with the requirements of such section shall be a defense in any action involving the infringement of a patent during the period of the extension of its term and shall be pleaded. A due diligence determination under section 156(d)(2) is not subject to review in such an action.

(Amended July 24, 1965, Public Law 89-83, sec. 10, 79 Stat. 261; Nov. 14, 1975, Public Law 94-131, sec. 10, 89 Stat. 692; Apr. 2, 1982, Public Law 97-164, sec. 161(7), 96 Stat. 49; Sept. 24, 1984, Public Law 98-417, sec. 203, 98 Stat. 1603; Oct. 29, 1992, Public Law 102-572, sec. 902(b)(1), 106 Stat. 4516; Nov. 1, 1995, Public Law 104-41, sec. 2, 109 Stat. 352; Nov. 29, 1999, Public Law 106-113, sec. 1000(a)(9), 113 Stat. 1501A-560, 582 (S. 1948 secs. 4402(b)(1) and 4732(a)(10)(A)).)

### **35 U.S.C. 283 Injunction.**

The several courts having jurisdiction of cases under this title may grant injunctions in accordance with the principles of equity to prevent the violation of any right secured by patent, on such terms as the court deems reasonable.

### **35 U.S.C. 284 Damages.**

Upon finding for the claimant the court shall award the claimant damages adequate to compensate for the infringement but in no event less than a reasonable royalty for the use made of the invention by the infringer, together with interest and costs as fixed by the court.

When the damages are not found by a jury, the court shall assess them. In either event the court may increase the damages up to three times the amount found or assessed. Increased damages under this paragraph shall not apply to provisional rights under section 154(d) of this title.

The court may receive expert testimony as an aid to the determination of damages or of what royalty would be reasonable under the circumstances.

(Amended Nov. 29, 1999, Public Law 106-113, sec. 1000(a)(9), 113 Stat. 1501A-566 (S. 1948 sec. 4507(9)).)

### **35 U.S.C. 285 Attorney fees.**

The court in exceptional cases may award reasonable attorney fees to the prevailing party.

### **35 U.S.C. 286 Time limitation on damages.**

Except as otherwise provided by law, no recovery shall be had for any infringement committed more than six years prior to the filing of the complaint or counterclaim for infringement in the action.

In the case of claims against the United States Government for use of a patented invention, the period before bringing suit, up to six years, between the date of receipt of a written claim for compensation by the department or agency of the Government having authority to settle such claim, and the date of mailing by the Government of a notice to the claimant that his claim has been denied shall not be counted as a part of the period referred to in the preceding paragraph.

### **35 U.S.C. 287 Limitation on damages and other remedies; marking and notice.**

(a) Patentees, and persons making, offering for sale, or selling within the United States any patented article for or under them, or importing any patented article into the United States, may give notice to the public that the same is patented, either by fixing thereon the word “patent” or the abbreviation “pat.,” together with the number of the patent, or when, from the character of the article, this cannot be done, by fixing to it, or to the package wherein one or more of them is contained, a label containing a like notice. In the event of failure so to mark, no damages shall be recovered by the patentee in any action for infringement, except on proof that the infringer was notified of the infringement and continued to infringe thereafter, in which event damages may be recovered only for infringement occurring after such notice. Filing of an action for infringement shall constitute such notice.

(b)(1) An infringer under section 271(g) shall be subject to all the provisions of this title relating to damages and injunctions except to the extent those remedies are modified by this subsection or section 9006 of the Process Patent Amendments Act of 1988. The modifications of remedies provided in this subsection shall not be available to any person who —

- (A) practiced the patented process;
- (B) owns or controls, or is owned or controlled by, the person who practiced the patented process; or
- (C) had knowledge before the infringement that a patented process was used to make the product the importation, use, offer for sale, or sale of which constitutes the infringement.

(2) No remedies for infringement under section 271(g) of this title shall be available with respect to any product in the possession of, or in transit to, the person subject to liability under such section before that person had notice of infringement with respect to that product. The person subject to liability shall bear the burden of proving any such possession or transit.

(3)(A) In making a determination with respect to the remedy in an action brought for infringement under section 271(g), the court shall consider—

(i) the good faith demonstrated by the defendant with respect to a request for disclosure;

(ii) the good faith demonstrated by the plaintiff with respect to a request for disclosure, and

(iii) the need to restore the exclusive rights secured by the patent.

(B) For purposes of subparagraph (A), the following are evidence of good faith:

(i) a request for disclosure made by the defendant;

(ii) a response within a reasonable time by the person receiving the request for disclosure; and

(iii) the submission of the response by the defendant to the manufacturer, or if the manufacturer is not known, to the supplier, of the product to be purchased by the defendant, together with a request for a written statement that the process claimed in any patent disclosed in the response is not used to produce such product.

The failure to perform any acts described in the preceding sentence is evidence of absence of good faith unless there are mitigating circumstances. Mitigating circumstances include the case in which, due to the nature of the product, the number of sources for the product, or like commercial circumstances, a request for disclosure is not necessary or practicable to avoid infringement.

(4)(A) For purposes of this subsection, a “request for disclosure” means a written request made to a person then engaged in the manufacture of a product to identify all process patents owned by or licensed to that person, as of the time of the request, that the person then reasonably believes could be asserted to be infringed under section 271(g) if that product were imported into, or sold, offered for sale, or used in, the United States by an unauthorized person. A request for disclosure is further limited to a request —

(i) which is made by a person regularly engaged in the United States in the sale of the type of products as those manufactured by the person to whom the request is directed, or which includes facts showing that the person making the request plans to engage in the sale of such products in the United States;

(ii) which is made by such person before the person's first importation, use, offer for sale, or sale of units of the product produced by an infringing process and before the person had notice of infringement with respect to the product; and

(iii) which includes a representation by the person making the request that such person will promptly submit the patents identified pursuant to the request to the manufacturer, or if the manufacturer is not known, to the supplier, of the product to be purchased by the person making the request, and will request from that manufacturer or supplier a written statement that none of the processes claimed in those patents is used in the manufacture of the product.

(B) In the case of a request for disclosure received by a person to whom a patent is licensed, that person shall either identify the patent or promptly notify the licensor of the request for disclosure.

(C) A person who has marked, in the manner prescribed by subsection (a), the number of the process patent on all products made by the patented process which have been offered for sale or sold by that person in the United States, or imported by the person into the United States, before a request for disclosure is received is not required to respond to the request for disclosure. For purposes of the preceding sentence, the term “all products” does not include products made before the effective date of the Process Patent Amendments Act of 1988.

(5)(A) For purposes of this subsection, notice of infringement means actual knowledge, or receipt by a person of a written notification, or a combination thereof, of information sufficient to persuade a reasonable person that it is likely that a product was made by a process patented in the United States.

(B) A written notification from the patent holder charging a person with infringement shall specify the patented process alleged to have been used and the reasons for a good faith belief that such process was used. The patent holder shall include in the notification such information as is reasonably neces-

sary to explain fairly the patent holder's belief, except that the patent holder is not required to disclose any trade secret information.

(C) A person who receives a written notification described in subparagraph (B) or a written response to a request for disclosure described in paragraph (4) shall be deemed to have notice of infringement with respect to any patent referred to in such written notification or response unless that person, absent mitigating circumstances—

(i) promptly transmits the written notification or response to the manufacturer or, if the manufacturer is not known, to the supplier, of the product purchased or to be purchased by that person; and

(ii) receives a written statement from the manufacturer or supplier which on its face sets forth a well grounded factual basis for a belief that the identified patents are not infringed.

(D) For purposes of this subsection, a person who obtains a product made by a process patented in the United States in a quantity which is abnormally large in relation to the volume of business of such person or an efficient inventory level shall be rebuttably presumed to have actual knowledge that the product was made by such patented process.

(6) A person who receives a response to a request for disclosure under this subsection shall pay to the person to whom the request was made a reasonable fee to cover actual costs incurred in complying with the request, which may not exceed the cost of a commercially available automated patent search of the matter involved, but in no case more than \$500.

(c)(1) With respect to a medical practitioner's performance of a medical activity that constitutes an infringement under section 271(a) or (b) of this title, the provisions of sections 281, 283, 284, and 285 of this title shall not apply against the medical practitioner or against a related health care entity with respect to such medical activity.

(2) For the purposes of this subsection:

(A) the term "medical activity" means the performance of a medical or surgical procedure on a body, but shall not include (i) the use of a patented machine, manufacture, or composition of matter in violation of such patent, (ii) the practice of a patented use of a composition of matter in violation of such

patent, or (iii) the practice of a process in violation of a biotechnology patent.

(B) the term "medical practitioner" means any natural person who is licensed by a State to provide the medical activity described in subsection (c)(1) or who is acting under the direction of such person in the performance of the medical activity.

(C) the term "related health care entity" shall mean an entity with which a medical practitioner has a professional affiliation under which the medical practitioner performs the medical activity, including but not limited to a nursing home, hospital, university, medical school, health maintenance organization, group medical practice, or a medical clinic.

(D) the term "professional affiliation" shall mean staff privileges, medical staff membership, employment or contractual relationship, partnership or ownership interest, academic appointment, or other affiliation under which a medical practitioner provides the medical activity on behalf of, or in association with, the health care entity.

(E) the term "body" shall mean a human body, organ or cadaver, or a nonhuman animal used in medical research or instruction directly relating to the treatment of humans.

(F) the term "patented use of a composition of matter" does not include a claim for a method of performing a medical or surgical procedure on a body that recites the use of a composition of matter where the use of that composition of matter does not directly contribute to achievement of the objective of the claimed method.

(G) the term "State" shall mean any state or territory of the United States, the District of Columbia, and the Commonwealth of Puerto Rico.

(3) This subsection does not apply to the activities of any person, or employee or agent of such person (regardless of whether such person is a tax exempt organization under section 501(c) of the Internal Revenue Code), who is engaged in the commercial development, manufacture, sale, importation, or distribution of a machine, manufacture, or composition of matter or the provision of pharmacy or clinical laboratory services (other than clinical laboratory services provided in a physician's office), where such activities are:

(A) directly related to the commercial development, manufacture, sale, importation, or dis-

tribution of a machine, manufacture, or composition of matter or the provision of pharmacy or clinical laboratory services (other than clinical laboratory services provided in a physician's office), and

(B) regulated under the Federal Food, Drug, and Cosmetic Act, the Public Health Service Act, or the Clinical Laboratories Improvement Act.

(4) This subsection shall not apply to any patent issued based on an application the earliest effective filing date of which is prior to September 30, 1996.

(Amended Aug. 23, 1988, Public Law 100-418, sec. 9004(a), 102 Stat. 1564; Dec. 8, 1994, Public Law 103-465, sec. 533(b)(5), 108 Stat. 4989.)

(Subsection (c) added Sept. 30, 1996, Public Law 104-208, sec. 616, 110 Stat. 3009-67.)

(Amended Nov. 29, 1999, Public Law 106-113, sec. 1000(a)(9), 113 Stat. 1501A-589 (S. 1948 sec. 4803).)

### **35 U.S.C. 288 Action for infringement of a patent containing an invalid claim.**

Whenever, without deceptive intention, a claim of a patent is invalid, an action may be maintained for the infringement of a claim of the patent which may be valid. The patentee shall recover no costs unless a disclaimer of the invalid claim has been entered at the Patent and Trademark Office before the commencement of the suit.

(Amended Jan. 2, 1975, Public Law 93-596, sec. 1, 88 Stat. 1949.)

### **35 U.S.C. 289 Additional remedy for infringement of design patent.**

Whoever during the term of a patent for a design, without license of the owner, (1) applies the patented design, or any colorable imitation thereof, to any article of manufacture for the purpose of sale, or (2) sells or exposes for sale any article of manufacture to which such design or colorable imitation has been applied shall be liable to the owner to the extent of his total profit, but not less than \$250, recoverable in any United States district court having jurisdiction of the parties.

Nothing in this section shall prevent, lessen, or impeach any other remedy which an owner of an infringed patent has under the provisions of this title, but he shall not twice recover the profit made from the infringement.

### **35 U.S.C. 290 Notice of patent suits.**

The clerks of the courts of the United States, within one month after the filing of an action under this title, shall give notice thereof in writing to the Director, setting forth so far as known the names and addresses of the parties, name of the inventor, and the designating number of the patent upon which the action has been brought. If any other patent is subsequently included in the action he shall give like notice thereof. Within one month after the decision is rendered or a judgment issued the clerk of the court shall give notice thereof to the Director. The Director shall, on receipt of such notices, enter the same in the file of such patent.

(Amended Nov. 29, 1999, Public Law 106-113, sec. 1000(a)(9), 113 Stat. 1501A-582 (S. 1948 sec. 4732(a)(10)(A)).)

### **35 U.S.C. 291 Interfering patents.**

The owner of an interfering patent may have relief against the owner of another by civil action, and the court may adjudge the question of validity of any of the interfering patents, in whole or in part. The provisions of the second paragraph of section 146 of this title shall apply to actions brought under this section.

### **35 U.S.C. 292 False marking.**

(a) Whoever, without the consent of the patentee, marks upon, or affixes to, or uses in advertising in connection with anything made, used, offered for sale, or sold by same person within the United States, or imported by the person into the United States, the name or any imitation of the name of the patentee, the patent number, or the words "patent," "patentee," or the like, with the intent of counterfeiting or imitating the mark of the patentee, or of deceiving the public and inducing them to believe that the thing was made, offered for sale, sold, or imported into the United States by or with the consent of the patentee; or

Whoever marks upon, or affixes to, or uses in advertising in connection with any unpatented article the word "patent" or any word or number importing the same is patented, for the purpose of deceiving the public; or

Whoever marks upon, or affixes to, or uses in advertising in connection with any article the words "patent applied for," "patent pending," or any word importing that an application for patent has been made, when no application for patent has been made,

or if made, is not pending, for the purpose of deceiving the public —

Shall be fined not more than \$500 for every such offense.

(b) Any person may sue for the penalty, in which event one-half shall go to the person suing and the other to the use of the United States.

(Subsection (a) amended Dec. 8, 1994, Public Law 103-465, sec. 533(b)(6), 108 Stat. 4990.)

### **35 U.S.C. 293 Nonresident patentee; service and notice.**

Every patentee not residing in the United States may file in the Patent and Trademark Office a written designation stating the name and address of a person residing within the United States on whom may be served process or notice of proceedings affecting the patent or rights thereunder. If the person designated cannot be found at the address given in the last designation, or if no person has been designated, the United States District Court for the District of Columbia shall have jurisdiction and summons shall be served by publication or otherwise as the court directs. The court shall have the same jurisdiction to take any action respecting the patent or rights thereunder that it would have if the patentee were personally within the jurisdiction of the court.

(Amended Jan. 2, 1975, Public Law 93-596, sec. 1, 88 Stat. 1949.)

### **35 U.S.C. 294 Voluntary arbitration.**

(a) A contract involving a patent or any right under a patent may contain a provision requiring arbitration of any dispute relating to patent validity or infringement arising under the contract. In the absence of such a provision, the parties to an existing patent validity or infringement dispute may agree in writing to settle such dispute by arbitration. Any such provision or agreement shall be valid, irrevocable, and enforceable, except for any grounds that exist at law or in equity for revocation of a contract.

(b) Arbitration of such disputes, awards by arbitrators, and confirmation of awards shall be governed by title 9, to the extent such title is not inconsistent with this section. In any such arbitration proceeding, the defenses provided for under section 282 of this title shall be considered by the arbitrator if raised by any party to the proceeding.

(c) An award by an arbitrator shall be final and binding between the parties to the arbitration but shall have no force or effect on any other person. The parties to an arbitration may agree that in the event a patent which is the subject matter of an award is subsequently determined to be invalid or unenforceable in a judgment rendered by a court of competent jurisdiction from which no appeal can or has been taken, such award may be modified by any court of competent jurisdiction upon application by any party to the arbitration. Any such modification shall govern the rights and obligations between such parties from the date of such modification.

(d) When an award is made by an arbitrator, the patentee, his assignee or licensee shall give notice thereof in writing to the Director. There shall be a separate notice prepared for each patent involved in such proceeding. Such notice shall set forth the names and addresses of the parties, the name of the inventor, and the name of the patent owner, shall designate the number of the patent, and shall contain a copy of the award. If an award is modified by a court, the party requesting such modification shall give notice of such modification to the Director. The Director shall, upon receipt of either notice, enter the same in the record of the prosecution of such patent. If the required notice is not filed with the Director, any party to the proceeding may provide such notice to the Director.

(e) The award shall be unenforceable until the notice required by subsection (d) is received by the Director.

(Added Aug. 27, 1982, Public Law 97-247, sec. 17(b)(1), 96 Stat. 322; amended Nov. 29, 1999, Public Law 106-113, sec. 1000(a)(9), 113 Stat. 1501A-582 (S. 1948 sec. 4732(a)(10)(A)); subsections (b) and (c) amended Nov. 2, 2002, Public Law 107-273, sec. 13206, 116 Stat. 1905.)

### **35 U.S.C. 295 Presumption: Product made by patented process.**

In actions alleging infringement of a process patent based on the importation, sale, offered for sale, or use of a product which is made from a process patented in the United States, if the court finds—

(1) that a substantial likelihood exists that the product was made by the patented process, and

(2) that the plaintiff has made a reasonable effort to determine the process actually used in the production of the product and was unable so to determine, the product shall be presumed to have been so

made, and the burden of establishing that the product was not made by the process shall be on the party asserting that it was not so made.

(Added Aug. 23, 1988, Public Law 100-418, sec. 9005(a), 102 Stat. 1566; amended Dec. 8, 1994, Public Law 103-465, sec. 533(b)(7), 108 Stat. 4990.)

**35 U.S.C. 296 Liability of States, instrumentalities of States, and State officials for infringement of patents.**

(a) **IN GENERAL.** - Any State, any instrumentality of a State, and any officer or employee of a State or instrumentality of a State, acting in his official capacity, shall not be immune, under the eleventh amendment of the Constitution of the United States or under any other doctrine of sovereign immunity, from suit in Federal court by any person, including any governmental or nongovernmental entity, for infringement of a patent under section 271, or for any other violation under this title.

(b) **REMEDIES.** - In a suit described in subsection (a) for a violation described in that subsection, remedies (including remedies both at law and in equity) are available for the violation to the same extent as such remedies are available for such a violation in a suit against any private entity. Such remedies include damages, interest, costs, and treble damages under section 284, attorney fees under section 285, and the additional remedy for infringement of design patents under section 289.

(Added Oct. 28, 1992, Public Law 102-560, sec. 2(a)(2), 106 Stat. 4230.)

**35 U.S.C. 297 Improper and deceptive invention promotion.**

(a) **IN GENERAL.**— An invention promoter shall have a duty to disclose the following information to a customer in writing, prior to entering into a contract for invention promotion services:

(1) the total number of inventions evaluated by the invention promoter for commercial potential in the past 5 years, as well as the number of those inventions that received positive evaluations, and the number of those inventions that received negative evaluations;

(2) the total number of customers who have contracted with the invention promoter in the past 5 years, not including customers who have purchased trade show services, research, advertising, or other

nonmarketing services from the invention promoter, or who have defaulted in their payment to the invention promoter;

(3) the total number of customers known by the invention promoter to have received a net financial profit as a direct result of the invention promotion services provided by such invention promoter;

(4) the total number of customers known by the invention promoter to have received license agreements for their inventions as a direct result of the invention promotion services provided by such invention promoter; and

(5) the names and addresses of all previous invention promotion companies with which the invention promoter or its officers have collectively or individually been affiliated in the previous 10 years.

(b) **CIVIL ACTION.**—

(1) Any customer who enters into a contract with an invention promoter and who is found by a court to have been injured by any material false or fraudulent statement or representation, or any omission of material fact, by that invention promoter (or any agent, employee, director, officer, partner, or independent contractor of such invention promoter), or by the failure of that invention promoter to disclose such information as required under subsection (a), may recover in a civil action against the invention promoter (or the officers, directors, or partners of such invention promoter), in addition to reasonable costs and attorneys' fees--

(A) the amount of actual damages incurred by the customer; or

(B) at the election of the customer at any time before final judgment is rendered, statutory damages in a sum of not more than \$5,000, as the court considers just.

(2) Notwithstanding paragraph (1), in a case where the customer sustains the burden of proof, and the court finds, that the invention promoter intentionally misrepresented or omitted a material fact to such customer, or willfully failed to disclose such information as required under subsection (a), with the purpose of deceiving that customer, the court may increase damages to not more than three times the amount awarded, taking into account past complaints made against the invention promoter that resulted in regulatory sanctions or other corrective actions based on

those records compiled by the Commissioner of Patents under subsection (d).

(c) **DEFINITIONS.**— For purposes of this section—

(1) a “contract for invention promotion services” means a contract by which an invention promoter undertakes invention promotion services for a customer;

(2) a “customer” is any individual who enters into a contract with an invention promoter for invention promotion services;

(3) the term “invention promoter” means any person, firm, partnership, corporation, or other entity who offers to perform or performs invention promotion services for, or on behalf of, a customer, and who holds itself out through advertising in any mass media as providing such services, but does not include—

(A) any department or agency of the Federal Government or of a State or local government;

(B) any nonprofit, charitable, scientific, or educational organization, qualified under applicable State law or described under section 170(b)(1)(A) of the Internal Revenue Code of 1986;

(C) any person or entity involved in the evaluation to determine commercial potential of, or offering to license or sell, a utility patent or a previously filed nonprovisional utility patent application;

(D) any party participating in a transaction involving the sale of the stock or assets of a business; or

(E) any party who directly engages in the business of retail sales of products or the distribution of products; and

(4) the term “invention promotion services” means the procurement or attempted procurement for a customer of a firm, corporation, or other entity to develop and market products or services that include the invention of the customer.

(d) **RECORDS OF COMPLAINTS.**—

(1) **RELEASE OF COMPLAINTS.**— The Commissioner of Patents shall make all complaints received by the Patent and Trademark Office involving invention promoters publicly available, together with any response of the invention promoters. The Commissioner of Patents shall notify the invention promoter of a complaint and provide a reasonable opportunity to reply prior to making such complaint publicly available.

(2) **REQUEST FOR COMPLAINTS.**— The Commissioner of Patents may request complaints relating to invention promotion services from any Federal or State agency and include such complaints in the records maintained under paragraph (1), together with any response of the invention promoters.

(Added Nov. 29, 1999, Public Law 106-113, sec. 1000(a)(9), 113 Stat. 1501A-552 (S. 1948 sec. 4102(a)).)

#### CHAPTER 30 — PRIOR ART CITATIONS TO OFFICE AND EX PARTE REEXAMINATION OF PATENTS

Sec.

301 Citation of prior art.

302 Request for reexamination.

303 Determination of issue by Director.

304 Reexamination order by Director.

305 Conduct of reexamination proceedings.

306 Appeal.

307 Certificate of patentability, unpatentability, and claim cancellation.

#### **35 U.S.C. 301 Citation of prior art.**

Any person at any time may cite to the Office in writing prior art consisting of patents or printed publications which that person believes to have a bearing on the patentability of any claim of a particular patent. If the person explains in writing the pertinency and manner of applying such prior art to at least one claim of the patent, the citation of such prior art and the explanation thereof will become a part of the official file of the patent. At the written request of the person citing the prior art, his or her identity will be excluded from the patent file and kept confidential.

(Added Dec. 12, 1980, Public Law 96-517, sec. 1, 94 Stat. 3015.)

#### **35 U.S.C. 302 Request for reexamination.**

Any person at any time may file a request for reexamination by the Office of any claim of a patent on the basis of any prior art cited under the provisions of section 301 of this title. The request must be in writing and must be accompanied by payment of a reexamination fee established by the Director pursuant to the provisions of section 41 of this title. The request must set forth the pertinency and manner of applying cited prior art to every claim for which reexamination



is requested. Unless the requesting person is the owner of the patent, the Director promptly will send a copy of the request to the owner of record of the patent.

(Added Dec. 12, 1980, Public Law 96-517, sec. 1, 94 Stat. 3015; amended Nov. 29, 1999, Public Law 106-113, sec. 1000(a)(9), 113 Stat. 1501A-582 (S. 1948 secs. 4732(a)(8) and 4732(a)(10)(A)).)

### **35 U.S.C. 303 Determination of issue by Director.**

(a) Within three months following the filing of a request for reexamination under the provisions of section 302 of this title, the Director will determine whether a substantial new question of patentability affecting any claim of the patent concerned is raised by the request, with or without consideration of other patents or printed publications. On his own initiative, and any time, the Director may determine whether a substantial new question of patentability is raised by patents and publications discovered by him or cited under the provisions of section 301 of this title. The existence of a substantial new question of patentability is not precluded by the fact that a patent or printed publication was previously cited by or to the Office or considered by the Office.

(b) A record of the Director's determination under subsection (a) of this section will be placed in the official file of the patent, and a copy promptly will be given or mailed to the owner of record of the patent and to the person requesting reexamination, if any.

(c) A determination by the Director pursuant to subsection (a) of this section that no substantial new question of patentability has been raised will be final and nonappealable. Upon such a determination, the Director may refund a portion of the reexamination fee required under section 302 of this title.

(Added Dec. 12, 1980, Public Law 96-517, sec. 1, 94 Stat. 3015; amended Nov. 29, 1999, Public Law 106-113, sec. 1000(a)(9), 113 Stat. 1501A-581, 582 (S. 1948 secs. 4732(a)(9) and (4732(a)(10)(A))); subsection (a) amended Nov. 2, 2002, Public Law 107-273, sec. 13105, 116 Stat. 1900.)

### **35 U.S.C. 304 Reexamination order by Director.**

If, in a determination made under the provisions of subsection 303(a) of this title, the Director finds that a substantial new question of patentability affecting any claim of a patent is raised, the determination will include an order for reexamination of the patent for

resolution of the question. The patent owner will be given a reasonable period, not less than two months from the date a copy of the determination is given or mailed to him, within which he may file a statement on such question, including any amendment to his patent and new claim or claims he may wish to propose, for consideration in the reexamination. If the patent owner files such a statement, he promptly will serve a copy of it on the person who has requested reexamination under the provisions of section 302 of this title. Within a period of two months from the date of service, that person may file and have considered in the reexamination a reply to any statement filed by the patent owner. That person promptly will serve on the patent owner a copy of any reply filed.

(Added Dec. 12, 1980, Public Law 96-517, sec. 1, 94 Stat. 3016; amended Nov. 29, 1999, Public Law 106-113, sec. 1000(a)(9), 113 Stat. 1501A-582 (S. 1948 sec. 4732(a)(10)(A)).)

### **35 U.S.C. 305 Conduct of reexamination proceedings.**

After the times for filing the statement and reply provided for by section 304 of this title have expired, reexamination will be conducted according to the procedures established for initial examination under the provisions of sections 132 and 133 of this title. In any reexamination proceeding under this chapter, the patent owner will be permitted to propose any amendment to his patent and a new claim or claims thereto, in order to distinguish the invention as claimed from the prior art cited under the provisions of section 301 of this title, or in response to a decision adverse to the patentability of a claim of a patent. No proposed amended or new claim enlarging the scope of a claim of the patent will be permitted in a reexamination proceeding under this chapter. All reexamination proceedings under this section, including any appeal to the Board of Patent Appeals and Interferences, will be conducted with special dispatch within the Office.

(Added Dec. 12, 1980, Public Law 96-517, sec. 1, 94 Stat. 3016; amended Nov. 8, 1984, Public Law 98-622, sec. 204(c), 98 Stat. 3388.)

### **35 U.S.C. 306 Appeal.**

The patent owner involved in a reexamination proceeding under this chapter may appeal under the provisions of section 134 of this title, and may seek court review under the provisions of sections 141 to 145 of

this title, with respect to any decision adverse to the patentability of any original or proposed amended or new claim of the patent.

(Added Dec. 12, 1980, Public Law 96-517, sec. 1, 94 Stat. 3016.)

**35 U.S.C. 307 Certificate of patentability, unpatentability, and claim cancellation.**

(a) In a reexamination proceeding under this chapter, when the time for appeal has expired or any appeal proceeding has terminated, the Director will issue and publish a certificate canceling any claim of the patent finally determined to be unpatentable, confirming any claim of the patent determined to be patentable, and incorporating in the patent any proposed amended or new claim determined to be patentable.

(b) Any proposed amended or new claim determined to be patentable and incorporated into a patent following a reexamination proceeding will have the same effect as that specified in section 252 of this title for reissued patents on the right of any person who made, purchased, or used within the United States, or imported into the United States, anything patented by such proposed amended or new claim, or who made substantial preparation for the same, prior to issuance of a certificate under the provisions of subsection (a) of this section.

(Added Dec. 12, 1980, Public Law 96-517, sec. 1, 94 Stat. 3016; amended Dec. 8, 1994, Public Law 103-465, sec. 533(b)(8), 108 Stat. 4990; Nov. 29, 1999, Public Law 106-113, sec. 1000(a)(9), 113 Stat. 1501A-582 (S. 1948 sec. 4732(a)(10)(A)).)

**CHAPTER 31 — OPTIONAL INTER PARTES REEXAMINATION PROCEDURES**

Sec.

- 311 Request for inter partes reexamination.
- 312 Determination of issue by Director.
- 313 Inter partes reexamination order by Director.
- 314 Conduct of inter partes reexamination proceedings.
- 315 Appeal.
- 316 Certificate of patentability, unpatentability, and claim cancellation.
- 317 Inter partes reexamination prohibited.
- 318 Stay of litigation.

**35 U.S.C. 311 Request for inter partes reexamination**

(a) **IN GENERAL.**— Any third-party requester at any time may file a request for inter partes reexamination by the Office of a patent on the basis of any prior art cited under the provisions of section 301.

(b) **REQUIREMENTS.**— The request shall—

(1) be in writing, include the identity of the real party in interest, and be accompanied by payment of an inter partes reexamination fee established by the Director under section 41; and

(2) set forth the pertinency and manner of applying cited prior art to every claim for which reexamination is requested.

(c) **COPY.**— The Director promptly shall send a copy of the request to the owner of record of the patent.

(Added Nov. 29, 1999, Public Law 106-113, sec. 1000(a)(9), 113 Stat. 1501A-570 (S. 1948 sec. 4604(a)); subsections (a) and (c) amended Nov. 2, 2002, Public Law 107-273, sec. 13202, 116 Stat. 1901.)

**35 U.S.C. 312 Determination of issue by Director**

(a) **REEXAMINATION.**— Not later than 3 months after the filing of a request for inter partes reexamination under section 311, the Director shall determine whether a substantial new question of patentability affecting any claim of the patent concerned is raised by the request, with or without consideration of other patents or printed publications. The existence of a substantial new question of patentability is not precluded by the fact that a patent or printed publication was previously cited by or to the Office or considered by the Office.

(b) **RECORD.**— A record of the Director's determination under subsection (a) shall be placed in the official file of the patent, and a copy shall be promptly given or mailed to the owner of record of the patent and to the third-party requester.

(c) **FINAL DECISION.**— A determination by the Director under subsection (a) shall be final and non-appealable. Upon a determination that no substantial new question of patentability has been raised, the Director may refund a portion of the inter partes reexamination fee required under section 311.

(Added Nov. 29, 1999, Public Law 106-113, sec. 1000(a)(9), 113 Stat. 1501A-570 (S. 1948 sec. 4604(a)); subsections (a) and (b) amended Nov. 2, 2002, Public Law 107-273, secs. 13105 and 13202, 116 Stat. 1900-1901.)

### **35 U.S.C. 313 Inter partes reexamination order by Director**

If, in a determination made under section 312(a), the Director finds that a substantial new question of patentability affecting a claim of a patent is raised, the determination shall include an order for inter partes reexamination of the patent for resolution of the question. The order may be accompanied by the initial action of the Patent and Trademark Office on the merits of the inter partes reexamination conducted in accordance with section 314.

(Added Nov. 29, 1999, Public Law 106-113, sec. 1000(a)(9), 113 Stat. 1501A-570 (S. 1948 sec. 4604(a)).)

### **35 U.S.C. 314 Conduct of inter partes reexamination proceedings**

(a) **IN GENERAL.**— Except as otherwise provided in this section, reexamination shall be conducted according to the procedures established for initial examination under the provisions of sections 132 and 133. In any inter partes reexamination proceeding under this chapter, the patent owner shall be permitted to propose any amendment to the patent and a new claim or claims, except that no proposed amended or new claim enlarging the scope of the claims of the patent shall be permitted.

(b) **RESPONSE.**—

(1) With the exception of the inter partes reexamination request, any document filed by either the patent owner or the third-party requester shall be served on the other party. In addition, the Office shall send to the third-party requester a copy of any communication sent by the Office to the patent owner concerning the patent subject to the inter partes reexamination proceeding.

(2) Each time that the patent owner files a response to an action on the merits from the Patent and Trademark Office, the third-party requester shall have one opportunity to file written comments addressing issues raised by the action of the Office or the patent owner's response thereto, if those written comments are received by the Office within 30 days after the date of service of the patent owner's response.

(c) **SPECIAL DISPATCH.**— Unless otherwise provided by the Director for good cause, all inter partes reexamination proceedings under this section,

including any appeal to the Board of Patent Appeals and Interferences, shall be conducted with special dispatch within the Office.

(Added Nov. 29, 1999, Public Law 106-113, sec. 1000(a)(9), 113 Stat. 1501A-570 (S. 1948 sec. 4604(a)); subsection (b)(1) amended Nov. 2, 2002, Public Law 107-273, sec. 13202, 116 Stat. 1901.)

### **35 U.S.C. 315 Appeal**

(a) **PATENT OWNER.**— The patent owner involved in an inter partes reexamination proceeding under this chapter—

(1) may appeal under the provisions of section 134 and may appeal under the provisions of sections 141 through 144, with respect to any decision adverse to the patentability of any original or proposed amended or new claim of the patent; and

(2) may be a party to any appeal taken by a third-party requester under subsection (b).

(b) **THIRD-PARTY REQUESTER.**— A third-party requester—

(1) may appeal under the provisions of section 134, and may appeal under the provisions of sections 141 through 144, with respect to any final decision favorable to the patentability of any original or proposed amended or new claim of the patent; and

(2) may, subject to subsection (c), be a party to any appeal taken by the patent owner under the provisions of section 134 or sections 141 through 144.

(c) **CIVIL ACTION.**— A third-party requester whose request for an inter partes reexamination results in an order under section 313 is estopped from asserting at a later time, in any civil action arising in whole or in part under section 1338 of title 28, the invalidity of any claim finally determined to be valid and patentable on any ground which the third-party requester raised or could have raised during the inter partes reexamination proceedings. This subsection does not prevent the assertion of invalidity based on newly discovered prior art unavailable to the third-party requester and the Patent and Trademark Office at the time of the inter partes reexamination proceedings.

(Added Nov. 29, 1999, Public Law 106-113, sec. 1000(a)(9), 113 Stat. 1501A-570 (S. 1948 sec. 4604(a)); subsection (b) amended Nov. 2, 2002, Public Law 107-273, sec. 13106, 116 Stat. 1900; subsection (c) amended Nov. 2, 2002, Public Law 107-273, sec. 13202, 116 Stat. 1901.)

### **35 U.S.C. 316 Certificate of patentability, unpatentability and claim cancellation**

(a) **IN GENERAL.**— In an inter partes reexamination proceeding under this chapter, when the time for appeal has expired or any appeal proceeding has terminated, the Director shall issue and publish a certificate canceling any claim of the patent finally determined to be unpatentable, confirming any claim of the patent determined to be patentable, and incorporating in the patent any proposed amended or new claim determined to be patentable.

(b) **AMENDED OR NEW CLAIM.**— Any proposed amended or new claim determined to be patentable and incorporated into a patent following an inter partes reexamination proceeding shall have the same effect as that specified in section 252 of this title for reissued patents on the right of any person who made, purchased, or used within the United States, or imported into the United States, anything patented by such proposed amended or new claim, or who made substantial preparation therefor, prior to issuance of a certificate under the provisions of subsection (a) of this section.

(Added Nov. 29, 1999, Public Law 106-113, sec. 1000(a)(9), 113 Stat. 1501A-570 (S. 1948 sec. 4604(a)).)

### **35 U.S.C. 317 Inter partes reexamination prohibited**

(a) **ORDER FOR REEXAMINATION.**— Notwithstanding any provision of this chapter, once an order for inter partes reexamination of a patent has been issued under section 313, neither the third-party requester nor its privies may file a subsequent request for inter partes reexamination of the patent until an inter partes reexamination certificate is issued and published under section 316, unless authorized by the Director.

(b) **FINAL DECISION.**— Once a final decision has been entered against a party in a civil action arising in whole or in part under section 1338 of title 28, that the party has not sustained its burden of proving the invalidity of any patent claim in suit or if a final decision in an inter partes reexamination proceeding instituted by a third-party requester is favorable to the patentability of any original or proposed amended or new claim of the patent, then neither that party nor its privies may thereafter request an inter partes reexamination of any such patent claim on the basis of issues which that party or its privies raised or

could have raised in such civil action or inter partes reexamination proceeding, and an inter partes reexamination requested by that party or its privies on the basis of such issues may not thereafter be maintained by the Office, notwithstanding any other provision of this chapter. This subsection does not prevent the assertion of invalidity based on newly discovered prior art unavailable to the third-party requester and the Patent and Trademark Office at the time of the inter partes reexamination proceedings.

(Added Nov. 29, 1999, Public Law 106-113, sec. 1000(a)(9), 113 Stat. 1501A-570 (S. 1948 sec. 4604(a)); subsections (a) and (b) amended Nov. 2, 2002, Public Law 107-273, sec. 13202, 116 Stat. 1901.)

### **35 U.S.C. 318 Stay of litigation**

Once an order for inter partes reexamination of a patent has been issued under section 313, the patent owner may obtain a stay of any pending litigation which involves an issue of patentability of any claims of the patent which are the subject of the inter partes reexamination order, unless the court before which such litigation is pending determines that a stay would not serve the interests of justice.

(Added Nov. 29, 1999, Public Law 106-113, sec. 1000(a)(9), 113 Stat. 1501A-570 (S. 1948 sec. 4604(a)).)

## **PART IV — PATENT COOPERATION TREATY**

### **CHAPTER 35 — DEFINITIONS**

Sec.

351 Definitions.

#### **35 U.S.C. 351 Definitions.**

When used in this part unless the context otherwise indicates—

(a) The term “treaty” means the Patent Cooperation Treaty done at Washington, on June 19, 1970.

(b) The term “Regulations,” when capitalized, means the Regulations under the treaty, done at Washington on the same date as the treaty. The term “regulations,” when not capitalized, means the regulations established by the Director under this title.

(c) The term “international application” means an application filed under the treaty.

(d) The term “international application originating in the United States” means an international appli-

cation filed in the Patent and Trademark Office when it is acting as a Receiving Office under the treaty, irrespective of whether or not the United States has been designated in that international application.

(e) The term “international application designating the United States” means an international application specifying the United States as a country in which a patent is sought, regardless where such international application is filed.

(f) The term “Receiving Office” means a national patent office or intergovernmental organization which receives and processes international applications as prescribed by the treaty and the Regulations.

(g) The terms “International Searching Authority” and “International Preliminary Examining Authority” mean a national patent office or intergovernmental organization as appointed under the treaty which processes international applications as prescribed by the treaty and the Regulations.

(h) The term “International Bureau” means the international intergovernmental organization which is recognized as the coordinating body under the treaty and the Regulations.

(i) Terms and expressions not defined in this part are to be taken in the sense indicated by the treaty and the Regulations.

(Added Nov. 14, 1975, Public Law 94-131, sec. 1, 89 Stat. 685; amended Nov. 8, 1984, Public Law 98-622, sec. 403(a), 98 Stat. 3392; Nov. 6, 1986, Public Law 99-616, sec. 2 (a)-(c), 100 Stat. 3485; Nov. 29, 1999, Public Law 106-113, sec. 1000(a)(9), 113 Stat. 1501A-582 (S. 1948 sec. 4732(a)(10)(A)).)

## CHAPTER 36 — INTERNATIONAL STAGE

Sec.

- 361 Receiving Office.
- 362 International Searching Authority and International Preliminary Examining Authority.
- 363 International application designating the United States: Effect.
- 364 International stage: Procedure.
- 365 Right of priority; benefit of the filing date of a prior application.
- 366 Withdrawn international application.
- 367 Actions of other authorities: Review.
- 368 Secrecy of certain inventions; filing international applications in foreign countries.

### 35 U.S.C. 361 Receiving Office.

(a) The Patent and Trademark Office shall act as a Receiving Office for international applications filed by nationals or residents of the United States. In accordance with any agreement made between the United States and another country, the Patent and Trademark Office may also act as a Receiving Office for international applications filed by residents or nationals of such country who are entitled to file international applications.

(b) The Patent and Trademark Office shall perform all acts connected with the discharge of duties required of a Receiving Office, including the collection of international fees and their transmittal to the International Bureau.

(c) International applications filed in the Patent and Trademark Office shall be in the English language.

(d) The international fee, and the transmittal and search fees prescribed under section 376(a) of this part, shall either be paid on filing of an international application or within such later time as may be fixed by the Director.

(Added Nov. 14, 1975, Public Law 94-131, sec. 1, 89 Stat. 686; amended Nov. 8, 1984, Public Law 98-622, sec. 401(a), 403(a), 98 Stat. 3391-3392; Nov. 6, 1986, Public Law 99-616, sec. 2(d), 100 Stat. 3485; Nov. 29, 1999, Public Law 106-113, sec. 1000(a)(9), 113 Stat. 1501A-582 (S. 1948 sec. 4732(a)(10)(A)).)

### 35 U.S.C. 362 International Searching Authority and International Preliminary Examining Authority.

(a) The Patent and Trademark Office may act as an International Searching Authority and International Preliminary Examining Authority with respect to international applications in accordance with the terms and conditions of an agreement which may be concluded with the International Bureau, and may discharge all duties required of such Authorities, including the collection of handling fees and their transmittal to the International Bureau.

(b) The handling fee, preliminary examination fee, and any additional fees due for international preliminary examination shall be paid within such time as may be fixed by the Director.

(Added Nov. 14, 1975, Public Law 94-131, sec. 1, 89 Stat. 686; amended Nov. 8, 1984, Public Law 98-622, sec. 403 (a), 98 Stat. 3392; Nov. 6, 1986, Public Law 99-

616, sec. 4, 100 Stat. 3485; Nov. 29, 1999, Public Law 106-113, sec. 1000(a)(9), 113 Stat. 1501A-582 (S. 1948 sec. 4732(a)(10)(A)).)

**35 U.S.C. 363 International application designating the United States: Effect.**

An international application designating the United States shall have the effect, from its international filing date under article 11 of the treaty, of a national application for patent regularly filed in the Patent and Trademark Office except as otherwise provided in section 102(e) of this title.

(Added Nov. 14, 1975, Public Law 94-131, sec. 1, 89 Stat. 686; amended Nov. 8, 1984, Public Law 98-622, sec. 403(a), 98 Stat. 3392.)

**35 U.S.C. 364 International stage: Procedure.**

(a) International applications shall be processed by the Patent and Trademark Office when acting as a Receiving Office, International Searching Authority, or International Preliminary Examining Authority, in accordance with the applicable provisions of the treaty, the Regulations, and this title.

(b) An applicant's failure to act within prescribed time limits in connection with requirements pertaining to a pending international application may be excused upon a showing satisfactory to the Director of unavoidable delay, to the extent not precluded by the treaty and the Regulations, and provided the conditions imposed by the treaty and the Regulations regarding the excuse of such failure to act are complied with.

(Added Nov. 14, 1975, Public Law 94-131, sec. 1, 89 Stat. 686; amended Nov. 8, 1984, Public Law 98-622, sec. 403(a), 98 Stat. 3392.)

(Subsection (a) amended Nov. 6, 1986, Public Law 99-616, sec. 5, 100 Stat. 3485.)

(Amended Nov. 29, 1999, Public Law 106-113, sec. 1000(a)(9), 113 Stat. 1501A-582 (S. 1948 sec. 4732(a)(10)(A)).)

**35 U.S.C. 365 Right of priority; benefit of the filing date of a prior application.**

(a) In accordance with the conditions and requirements of subsections (a) through (d) of section 119 of this title, a national application shall be entitled to the right of priority based on a prior filed international application which designated at least one country other than the United States.

(b) In accordance with the conditions and requirements of section 119(a) of this title and the treaty and the Regulations, an international application designating the United States shall be entitled to the right of priority based on a prior foreign application, or a prior international application designating at least one country other than the United States.

(c) In accordance with the conditions and requirements of section 120 of this title, an international application designating the United States shall be entitled to the benefit of the filing date of a prior national application or a prior international application designating the United States, and a national application shall be entitled to the benefit of the filing date of a prior international application designating the United States. If any claim for the benefit of an earlier filing date is based on a prior international application which designated but did not originate in the United States, the Director may require the filing in the Patent and Trademark Office of a certified copy of such application together with a translation thereof into the English language, if it was filed in another language.

(Added Nov. 14, 1975, Public Law 94-131, sec. 1, 89 Stat. 686; amended Nov. 8, 1984, Public Law 98-622, sec. 403(a), 98 Stat. 3392; Dec. 8, 1994, Public Law 103-465, sec. 532(c)(4), 108 Stat. 4987; Nov. 29, 1999, Public Law 106-113, sec. 1000(a)(9), 113 Stat. 1501A-582 (S. 1948 sec. 4732(a)(10)(A)).)

**35 U.S.C. 366 Withdrawn international application.**

Subject to section 367 of this part, if an international application designating the United States is withdrawn or considered withdrawn, either generally or as to the United States, under the conditions of the treaty and the Regulations, before the applicant has complied with the applicable requirements prescribed by section 371(c) of this part, the designation of the United States shall have no effect after the date of withdrawal and shall be considered as not having been made, unless a claim for benefit of a prior filing date under section 365(c) of this section was made in a national application, or an international application designating the United States, filed before the date of such withdrawal. However, such withdrawn international application may serve as the basis for a claim of priority under section 365 (a) and (b) of this part, if it designated a country other than the United States.

(Added Nov. 14, 1975, Public Law 94-131, sec. 1, 89 Stat. 687; amended Nov. 8, 1984, Public Law 98-622, sec. 401(b), 98 Stat. 3391.)

**35 U.S.C. 367 Actions of other authorities: Review.**

(a) Where a Receiving Office other than the Patent and Trademark Office has refused to accord an international filing date to an international application designating the United States or where it has held such application to be withdrawn either generally or as to the United States, the applicant may request review of the matter by the Director, on compliance with the requirements of and within the time limits specified by the treaty and the Regulations. Such review may result in a determination that such application be considered as pending in the national stage.

(b) The review under subsection (a) of this section, subject to the same requirements and conditions, may also be requested in those instances where an international application designating the United States is considered withdrawn due to a finding by the International Bureau under article 12 (3) of the treaty.

(Added Nov. 14, 1975, Public Law 94-131, sec. 1, 89 Stat. 687; amended Nov. 8, 1984, Public Law 98-622, sec. 403(a), 98 Stat. 3392; Nov. 29, 1999, Public Law 106-113, sec. 1000(a)(9), 113 Stat. 1501A-582 (S. 1948 sec. 4732(a)(10)(A)).)

**35 U.S.C. 368 Secrecy of certain inventions; filing international applications in foreign countries.**

(a) International applications filed in the Patent and Trademark Office shall be subject to the provisions of chapter 17 of this title.

(b) In accordance with article 27 (8) of the treaty, the filing of an international application in a country other than the United States on the invention made in this country shall be considered to constitute the filing of an application in a foreign country within the meaning of chapter 17 of this title, whether or not the United States is designated in that international application.

(c) If a license to file in a foreign country is refused or if an international application is ordered to be kept secret and a permit refused, the Patent and Trademark Office when acting as a Receiving Office, International Searching Authority, or International

Preliminary Examining Authority, may not disclose the contents of such application to anyone not authorized to receive such disclosure.

(Added Nov. 14, 1975, Public Law 94-131, sec. 1, 89 Stat. 687; amended Nov. 8, 1984, Public Law 98-622, sec. 403(a), 98 Stat. 3392; Nov. 6, 1986, Public Law 99-616, sec. 6, 100 Stat. 3486.)

CHAPTER 37 — NATIONAL STAGE

Sec.

- 371 National stage: Commencement.
- 372 National stage: Requirements and procedure.
- 373 Improper applicant.
- 374 Publication of international application: Effect.
- 375 Patent issued on international application: Effect.
- 376 Fees.

**35 U.S.C. 371 National stage: Commencement.**

(a) Receipt from the International Bureau of copies of international applications with any amendments to the claims, international search reports, and international preliminary examination reports including any annexes thereto may be required in the case of international applications designating or electing the United States.

(b) Subject to subsection (f) of this section, the national stage shall commence with the expiration of the applicable time limit under article 22 (1) or (2), or under article 39 (1)(a) of the treaty.

(c) The applicant shall file in the Patent and Trademark Office —

- (1) the national fee provided in section 41(a) of this title;
- (2) a copy of the international application, unless not required under subsection (a) of this section or already communicated by the International Bureau, and a translation into the English language of the international application, if it was filed in another language;
- (3) amendments, if any, to the claims in the international application, made under article 19 of the treaty, unless such amendments have been communicated to the Patent and Trademark Office by the International Bureau, and a translation into the English language if such amendments were made in another language;

(4) an oath or declaration of the inventor (or other person authorized under chapter 11 of this title) complying with the requirements of section 115 of this title and with regulations prescribed for oaths or declarations of applicants;

(5) a translation into the English language of any annexes to the international preliminary examination report, if such annexes were made in another language.

(d) The requirement with respect to the national fee referred to in subsection (c)(1), the translation referred to in subsection (c)(2), and the oath or declaration referred to in subsection (c)(4) of this section shall be complied with by the date of the commencement of the national stage or by such later time as may be fixed by the Director. The copy of the international application referred to in subsection (c)(2) shall be submitted by the date of the commencement of the national stage. Failure to comply with these requirements shall be regarded as abandonment of the application by the parties thereof, unless it be shown to the satisfaction of the Director that such failure to comply was unavoidable. The payment of a surcharge may be required as a condition of accepting the national fee referred to in subsection (c)(1) or the oath or declaration referred to in subsection (c)(4) of this section if these requirements are not met by the date of the commencement of the national stage. The requirements of subsection (c)(3) of this section shall be complied with by the date of the commencement of the national stage, and failure to do so shall be regarded as a cancellation of the amendments to the claims in the international application made under article 19 of the treaty. The requirement of subsection (c)(5) shall be complied with at such time as may be fixed by the Director and failure to do so shall be regarded as cancellation of the amendments made under article 34 (2)(b) of the treaty.

(e) After an international application has entered the national stage, no patent may be granted or refused thereon before the expiration of the applicable time limit under article 28 or article 41 of the treaty, except with the express consent of the applicant. The applicant may present amendments to the specification, claims, and drawings of the application after the national stage has commenced.

(f) At the express request of the applicant, the national stage of processing may be commenced at any time at which the application is in order for such purpose and the applicable requirements of subsection (c) of this section have been complied with.

(Added Nov. 14, 1975, Public Law 94-131, sec. 1, 89 Stat. 688; amended Nov. 8, 1984, Public Law 98-622, sec. 402(a)-(d), 403(a), 98 Stat. 3391, 3392.)

(Subsections (a), (b), (c), (d), and (e) amended Nov. 6, 1986, Public Law, 99-616, sec. 7, 100 Stat. 3486.)

(Subsection (c)(1) amended Dec. 10, 1991, Public Law 102-204, sec. 5(g)(2), 105 Stat. 1641.)

(Amended Nov. 29, 1999, Public Law 106-113, sec. 1000(a)(9), 113 Stat. 1501A-582 (S. 1948 sec. 4732(a)(10)(A)).)

(Subsection (d) amended Nov. 2, 2002, Public Law 107-273, sec. 13206, 116 Stat. 1905.)

### **35 U.S.C. 372 National stage: Requirements and procedure.**

(a) All questions of substance and, within the scope of the requirements of the treaty and Regulations, procedure in an international application designating the United States shall be determined as in the case of national applications regularly filed in the Patent and Trademark Office.

(b) In case of international applications designating but not originating in, the United States -

(1) the Director may cause to be reexamined questions relating to form and contents of the application in accordance with the requirements of the treaty and the Regulations;

(2) the Director may cause the question of unity of invention to be reexamined under section 121 of this title, within the scope of the requirements of the treaty and the Regulations; and

(3) the Director may require a verification of the translation of the international application or any other document pertaining to the application if the application or other document was filed in a language other than English.

(Added Nov. 14, 1975, Public Law 94-131, sec. 1, 89 Stat. 689; amended Nov. 8, 1984, Public Law 98-622, sec. 402(e), (f), 403(a), 98 Stat. 3392; Nov. 29, 1999, Public Law 106-113, sec. 1000(a)(9), 113 Stat. 1501A-582 (S. 1948 sec. 4732(a)(10)(A)).)



**35 U.S.C. 373 Improper applicant.**

An international application designating the United States, shall not be accepted by the Patent and Trademark Office for the national stage if it was filed by anyone not qualified under chapter 11 of this title to be an applicant for the purpose of filing a national application in the United States. Such international applications shall not serve as the basis for the benefit of an earlier filing date under section 120 of this title in a subsequently filed application, but may serve as the basis for a claim of the right of priority under subsections (a) through (d) of section 119 of this title, if the United States was not the sole country designated in such international application.

(Added Nov. 14, 1975, Public Law 94-131, sec. 1, 89 Stat. 689; amended Nov. 8, 1984, Public Law 98-622, sec. 403(a), 98 Stat. 3392; Dec. 8, 1994, Public Law 103-465, sec. 532(c)(5), 108 Stat. 4987.)

**35 U.S.C. 374 Publication of international application.**

The publication under the treaty defined in section 351(a) of this title, of an international application designating the United States shall be deemed a publication under section 122(b), except as provided in sections 102(e) and 154(d) of this title.

(Added Nov. 14, 1975, Public Law 94-131, sec. 1, 89 Stat. 689; amended Nov. 29, 1999, Public Law 106-113, sec. 1000(a)(9), 113 Stat. 1501A-566 (S. 1948 sec. 4507(10)); amended Nov. 2, 2002, Public Law 107-273, sec. 13205, 116 Stat. 1903.)

**35 U.S.C. 375 Patent issued on international application: Effect.**

(a) A patent may be issued by the Director based on an international application designating the United States, in accordance with the provisions of this title. Subject to section 102(e) of this title, such patent shall have the force and effect of a patent issued on a national application filed under the provisions of chapter 11 of this title.

(b) Where due to an incorrect translation the scope of a patent granted on an international application designating the United States, which was not originally filed in the English language, exceeds the scope of the international application in its original language, a court of competent jurisdiction may retroactively limit the scope of the patent, by declaring it unenforceable to the extent that it exceeds the scope

of the international application in its original language.

(Added Nov. 14, 1975, Public Law 94-131, sec. 1, 89 Stat. 689; amended Nov. 29, 1999, Public Law 106-113, sec. 1000(a)(9), 113 Stat. 1501A-582 (S. 1948 sec. 4732(a)(10)(A)).)

**35 U.S.C. 376 Fees.**

(a) The required payment of the international fee and the handling fee, which amounts are specified in the Regulations, shall be paid in United States currency. The Patent and Trademark Office shall charge a national fee as provided in section 41(a), and may also charge the following fees:

- (1) A transmittal fee (see section 361(d)).
- (2) A search fee (see section 361(d)).
- (3) A supplemental search fee (to be paid when required).
- (4) A preliminary examination fee and any additional fees (see section 362(b)).
- (5) Such other fees as established by the Director.

(b) The amounts of fees specified in subsection (a) of this section, except the international fee and the handling fee, shall be prescribed by the Director. He may refund any sum paid by mistake or in excess of the fees so specified, or if required under the treaty and the Regulations. The Director may also refund any part of the search fee, the national fee, the preliminary examination fee and any additional fees, where he determines such refund to be warranted.

(Added Nov. 14, 1975, Public Law 94-131, sec. 1, 89 Stat. 690, amended Nov. 8, 1984, Public Law 98-622, sec. 402(g), 403(a), 98 Stat. 3392; Nov. 6, 1986, Public Law 99-616, sec. 8(a) & (b), 100 Stat. 3486; Dec. 10, 1991, Public Law 102-204, sec. 5(g)(1), 105 Stat. 1640; amended Nov. 29, 1999, Public Law 106-113, sec. 1000(a)(9), 113 Stat. 1501-582 (S. 1948 sec. 4732(a)(10)(A)); subsections (a)(1)-(a)(3) amended Nov. 2, 2002, Public Law 107-273, sec. 13206, 116 Stat. 1905.)

**LAWS NOT IN TITLE 35, UNITED STATES CODE****18 U.S.C. 1001 Statements or entries generally.**

(a) Except as otherwise provided in this section, whoever, in any matter within the jurisdiction of the executive, legislative, or judicial branch of the

Government of the United States, knowingly and willfully —

(1) falsifies, conceals, or covers up by any trick, scheme, or device a material fact;

(2) makes any materially false, fictitious, or fraudulent statement or representation; or

(3) makes or uses any false writing or document knowing the same to contain any materially false, fictitious, or fraudulent statement or entry; shall be fined under this title or imprisoned not more than 5 years, or both.

(b) Subsection (a) does not apply to a party to a judicial proceeding, or that party's counsel, for statements, representations, writings or documents submitted by such party or counsel to a judge or magistrate in that proceeding.

(c) With respect to any matter within the jurisdiction of the legislative branch, subsection (a) shall apply only to —

(1) administrative matters, including a claim for payment, a matter related to the procurement of property or services, personnel or employment practices, or support services, or a document required by law, rule, or regulation to be submitted to the Congress or any office or officer within the legislative branch; or

(2) any investigation or review, conducted pursuant to the authority of any committee, subcommittee, commission or office of the Congress, consistent with applicable rules of the House or Senate.

(Amended Sept. 13, 1994, Public Law 103-322, sec. 330016(1)(L), 108 Stat. 2147; Oct. 11, 1996, Public Law 104-292, Sec. 2, 110 Stat. 3459.)

**18 U.S.C. 2071 Concealment, removal, or mutilation generally.**

(a) Whoever willfully and unlawfully conceals, removes, mutilates, obliterates, or destroys, or attempts to do so, or, with intent to do so takes and carries away any record, proceeding, map, book, paper, document, or other thing, filed or deposited with any clerk or officer of any court of the United States, or in any public office, or with any judicial or public officer of the United States, shall be fined under this title or imprisoned not more than three years, or both.

(b) Whoever, having the custody of any such record, proceeding, map, book, document, paper, or other thing, willfully and unlawfully conceals, removes, mutilates, obliterates, falsifies, or destroys the same, shall be fined under this title or imprisoned not more than three years, or both; and shall forfeit his office and be disqualified from holding any office under the United States. As used in this subsection, the term "office" does not include the office held by any person as a retired officer of the Armed Forces of the United States.

(Amended Nov. 5, 1990, Public Law 101-510, sec. 552(a), 104 Stat. 1566; Sept. 13, 1994, Public Law 103-322, sec. 330016(1)(I), 108 Stat. 2147.)

MANUAL OF PATENT EXAMINING PROCEDURE

PATENT LAWS

INDEX OF PATENT LAWS

**A**

Abandoned applications, fee on petition to revive .41(a)7

Abandonment of application by failure to prosecute . . . . . 133, 371

Abandonment of invention:

    Bar to patent . . . . . 102

    By violation of secrecy . . . . . 182

Adjustment of patent term . . . . . 154

Administrative Patent Judges . . . . . 6

Administrator, executor, or guardian . . . . . 117

Affidavits and depositions in contested cases, rules for taking . . . . . 23

Agreement to terminate interference . . . . . 135

Agriculture, Secretary of, to furnish information, and detail employees to Director for plant patent . . 164

Allowance and issue of patents . . . . . 153

Allowance, notice of . . . . . 151

Amendment:

    Copying claim of issued patent . . . . . 135

    Time for . . . . . 133, 135

Annual indexes of patents . . . . . 10

Annual report of the Director . . . . . 13

Apostille on assignment . . . . . 261

Appeals to Board of Patent Appeals and Interferences . . . . . 134

    Fee . . . . . 41(a)6, 134

    Hearing of . . . . . 6

    Reexamination proceedings . . . . . 306

Appeals to Court of Appeals for the Federal Circuit . . . . . 141

    Certificate of decision of Court recorded in the United States Patent and Trademark Office . . . 144

    Determination of Appeal; revision of decision . . 144

    From Board of Patent Appeals and Interferences . . . . . 141

    Grounds of decision to be furnished court . . . . 143

    Notice of appeal . . . . . 142

    Proceedings on appeal . . . . . 143

Applicant for foreign patent, license required . . . . . 184

Applicant for international application . . . . . 373

Applicant, notified of interference . . . . . 135

Application:

    Abandonment of, by failure to prosecute . . . . . 133

    Assignment of . . . . . 261

    Confidential while pending . . . . . 122

    Continuing . . . . . 120

    Description; specification and claim . . . . . 112

    Divisional . . . . . 121

Drawings . . . . . 113

Effect of defective execution . . . . . 26

Effective as of date of earliest foreign application in certain cases . . . . . 119

Examination of invention . . . . . 131

Fee on filing . . . . . 41(a)1, 111

For deceased or insane inventors . . . . . 117

May be made by legal representative of deceased or incapacitated inventor . . . . . 117

Must be made within specified time after foreign application for right of priority . . . . . 119

Oath of applicant (See Oath in patent application)

    Owned by Government . . . . . 267

    Provisional . . . . . 111

    Publication . . . . . 102, 122, 181

    Reissue . . . . . 251

    Secrecy order . . . . . 181

    What to contain . . . . . 111

    When filed by other than inventor . . . . . 118, 121

Appointments, how made . . . . . 3

Arbitration of interferences . . . . . 135

Arbitration, voluntary . . . . . 294

Article patented marked with number of patent . . . . 287

Assignee:

    May file application in certain cases . . . . . 118

    May file divisional application . . . . . 121

    May file reissue application . . . . . 251

    Patent may be issued to . . . . . 152

Assignments, patent . . . . . 261

Establishing prima facie execution of . . . . . 261

    Fees for recording . . . . . 41(a)10

    Must be recorded in United States Patent and Trademark Office to issue patent to assignee . . . 152

    Patent may issue to assignee . . . . . 152

    Recording in Patent and Trademark Office . . . . 261

Attorney fees in infringement suit . . . . . 285

Attorneys and agents:

    May be refused recognition for misconduct . . . . . 32

    Petition to District Court, DC . . . . . 32

    Suspension or exclusion from practice . . . . . 32

    Unauthorized practitioners . . . . . 33

**B**

Bars to grant of a patent . . . . . 102, 103

Benefit of earlier filing date in foreign country . . . . 119

Benefit of earlier filing date in United States . . . . . 120

Best mode required . . . . . 112

Bill in equity (See Civil action)

MANUAL OF PATENT EXAMINING PROCEDURE

Board of Patent Appeals and Interferences, how constituted . . . . . 6

**C**

Certificate of correction:  
 Applicant's mistake . . . . . 255  
 Fee for applicant's mistake. . . . . 41(a)8  
 Office mistake . . . . . 254  
 Certified copies:  
 Fee for certification . . . . . 41(a)11  
 Of drawings and specifications of patents issued . . . . . 9  
 Of records, furnished to Court of Appeals for the Federal Circuit in appeals . . . . . 143  
 Citation of prior art in patent . . . . . 301  
 Citizenship required in oath. . . . . 115  
 Civil action:  
 Election of in case of interference . . . . . 141  
 Infringement. . . . . 291  
 In case of interference . . . . . 146  
 Jurisdiction, plurality of parties, foreign party . . . 146  
 To obtain patent . . . . . 145  
 Claim of patent:  
 Independent or dependent . . . . . 41, 112  
 Independent or dependent, validity . . . . . 282  
 Invalid, effect of. . . . . 253  
 Invalid, suits on patent with. . . . . 288  
 Notice of rejection . . . . . 132  
 Too extensive or narrow, remedy. . . . . 251  
 What to cover. . . . . 112  
 Classification of patents . . . . . 8  
 Clerk of United States Court may summon witness in  
 Interference cases. . . . . 24  
 Must notify Director of patent suits. . . . . 290  
 Commerce, Department of, United States Patent and Trademark Office in . . . . . 1  
 Commerce, Secretary of:  
 Appointments by . . . . . 3  
 Commissioner for Patents:  
 How appointed and duties . . . . . 3  
 Member of Board. . . . . 6  
 Commonly owned invention and reference subject matter . . . . . 103  
 Compensation, right to because of secrecy order . . . 183  
 Composition of matter:  
 Patentable. . . . . 101  
 Specimens of ingredients may be required . . . . . 114  
 Concealment of records . . . . . 18 U.S.C. 2071  
 Confidential status of application . . . . . 122, 205  
 Continuing application . . . . . 120  
 Contributory infringement. . . . . 271

Copies of records, fees . . . . . 41  
 Correction of inventors in patent . . . . . 256  
 Correction of letters patent . . . . . 254, 255

**D**

Damages for infringement . . . . . 284  
 Day of taking any action or paying any fee falling on Saturday, Sunday, or holiday . . . . . 21  
 Death or incapacity of inventor . . . . . 117  
 Decisions in patent cases, printing of . . . . . 10  
 Declaration in lieu of oath . . . . . 25  
 Dedication of term . . . . . 253  
 Defective execution of documents, effect of . . . . . 26  
 Defenses in action for infringement . . . . . 282  
 Definitions . . . . . 100, 351  
 Deposit with United States Postal Service . . . . . 21  
 Depositions, Director may establish rules for . . . . . 23  
 Deputy Commissioner . . . . . 6  
 Member of Board . . . . . 6  
 Description of invention. . . . . 112  
 Design patents:  
 Double recovery, not allowed . . . . . 289  
 Fees . . . . . 41(a)3  
 For what granted . . . . . 171  
 Liability for infringement of. . . . . 289  
 Penalty for unauthorized use of patented design . . . . . 289  
 Prior foreign applications . . . . . 172  
 Right of priority . . . . . 172  
 Subject to same provisions as other patents . . . . . 171  
 Term of . . . . . 173  
 Unauthorized use of . . . . . 289  
 Designated office . . . . . 363, 366, 367, 371, 372  
 Determination of patent term adjustment . . . . . 154  
 Director:  
 Annual report to Congress . . . . . 13  
 Consult with Patent Public Advisory Committee . . . . . 3  
 Duties of . . . . . 6  
 How appointed . . . . . 3  
 Intellectual Property Policy Issues, advises President, Federal Departments . . . . . 2  
 May disbar attorneys. . . . . 32  
 May establish charges . . . . . 41  
 May make rules for taking affidavits and depositions . . . . . 23  
 Member of Board . . . . . 6  
 Reexamination order. . . . . 304  
 Shall cause examination to be made. . . . . 131  
 To establish regulations . . . . . 3  
 To furnish court with grounds of decision, on appeal . . . . . 143

PATENT LAWS

To prescribe rules and regulations governing recognition of attorneys and agents . . . . . 2

To sign patents or have name printed thereon and attested . . . . . 153

To superintend grant of patents . . . . . 3

Disbarment of attorneys and agents . . . . . 32

Disclaimer:

    Fee . . . . . 41(a)5

    How filed and by whom . . . . . 253

    Must be filed before commencement of suit to recover costs . . . . . 288

    Nature of . . . . . 253

District Court for District of Columbia:

    Jurisdiction . . . . . 146

    Review of disbarment of attorneys and agents . . . . . 32

Division of application . . . . . 121

Division of patent on reissue . . . . . 251

Drawing:

    Attached to patent . . . . . 154

    Part of patent . . . . . 154

    Printing of . . . . . 10

    When necessary . . . . . 113

Duties of Director . . . . . 3

**E**

Elected office . . . . . 371, 372

Employees of United States Patent and Trademark Office . . . . . 3

    How appointed . . . . . 3

    Restrictions on as to interest in patents . . . . . 4

English language . . . . . 361

Entry into national phase in United States . . . . . 371

Error in naming inventors . . . . . 116

Establishment of date of invention by reference to knowledge or use in foreign country . . . . . 104

Establishment, United States Patent and Trademark Office . . . . . 1

Examination:

    Applicants shall be notified of rejection on . . . . . 132

    To be made of application and alleged invention . . . . . 131

Exchange of United States Patent and Trademark Office Publications for other publications . . . . . 10

Exchange of printed copies of patents and published application of patents with foreign countries . . . . . 11

Executors, administrators or guardians . . . . . 117

Extension of patent term . . . . . 155

Extension of time to reply fee . . . . . 41(a)8

**F**

Falsely making or labeling articles as patented . . . . . 292

Federal agency, defined . . . . . 200

Federal Assistance, inventions made with:

    Confidentiality . . . . . 205

    Definitions . . . . . 201

    Disposition of rights . . . . . 202

    Domestic and foreign protection of federally owned inventions . . . . . 207

    Educational awards . . . . . 212

    March-in rights . . . . . 203

    Policy and objective of . . . . . 200

    Precedence of chapter over other Acts . . . . . 210

    Preference for United States industry . . . . . 204

    Regulations governing Federal licensing . . . . . 208

    Relationship to antitrust laws . . . . . 211

    Restrictions on licensing of federally owned inventions . . . . . 209

    Uniform clauses and regulations . . . . . 206

Fees:

    Amount of . . . . . 41

    For attorney awarded by court . . . . . 285

    For records, publications, and services not specified in statute . . . . . 41

    How paid and refunded . . . . . 42

    Independent inventor, 50% reduction . . . . . 41(h)

    International . . . . . 361, 376

    Nonprofit organization, 50% reduction . . . . . 41(h)

    Payable to Director . . . . . 42(a)

    Small business, 50% reduction . . . . . 41(h)

    Small entity, 50% reduction . . . . . 41(h), 133

    To witness interference cases . . . . . 24

Filing application by other than inventor . . . . . 118

Filing date requirements . . . . . 111

Filing fee, Amount of . . . . . 41(a)1

Foreign applications:

    License to file required . . . . . 184

    Penalty for filing without license . . . . . 185, 186

Foreign countries, exchange of printed copies of patents and published application of patents with . . . . . 11

Foreign country, knowledge of use in, not used to establish date of invention . . . . . 102, 104

Foreign patentee:

    Jurisdiction . . . . . 293

    Service . . . . . 293

Foreign patents:

    Copies of, exchanged for United States patents and published application of patents . . . . . 11

## MANUAL OF PATENT EXAMINING PROCEDURE

Prior, effect on United States application for patent . . . . .	102
Foreign priority . . . . .	119(a)-(d), 365, 373
Fraudulent statements . . . . .	18 U.S.C. 1001
Funding agreement, defined . . . . .	200

### G

Government interests in patents . . . . .	267
---	-----

### H

Holiday, time for action expiring on . . . . .	21
--	----

### I

Importation of products made by a patented process . . . . .	295
Improvements, patents may be granted for . . . . .	101
Indexes of patents and patentees, printing of . . . . .	10
Infringement, patent: Action for . . . . .	281
Attorney fees . . . . .	285
By United States, time limitation in suit for . . . . .	286
Clerk of court to notify United States Patent and Trademark Office of suit . . . . .	290
Contributory . . . . .	271
Damages for . . . . .	284
Defenses in suit for . . . . .	273, 282
Defined . . . . .	271
Design patent . . . . .	289
Injunction . . . . .	283
Notice of, necessary to recovery of damages . . . . .	287
Pleading defense and special matters to be proved in suit . . . . .	282
Suit for, when a claim is invalid . . . . .	288
Temporary presence in United States . . . . .	272
Time limitation . . . . .	286
Injunctions may be granted by court having jurisdiction . . . . .	283
Insane persons, patent applications of . . . . .	117
Interference, patent:	
Agreements, between parties, relating to termination, to be filed in Patent and Trademark Office . . . . .	135
Appeal to court . . . . .	141
Arbitration . . . . .	135
Determination of priority . . . . .	102, 135
Parties to be notified of . . . . .	135
Review of decision by civil action . . . . .	145, 146
Rules for taking testimony . . . . .	23
International application . . . . .	351, 365, 366, 367, 375
Fees . . . . .	376
National phase in United States . . . . .	371
Priority rights . . . . .	365

Interfering patent:	
How set aside . . . . .	291
Jurisdiction, plurality of parties, foreign party . . . . .	146, 291
Relief against . . . . .	291
International Bureau . . . . .	351, 361, 362, 371
International Preliminary Examining Authority . . . . .	362, 364, 368
International Searching Authority . . . . .	351, 362, 364, 368
International studies . . . . .	2
Intervening rights on reissue . . . . .	252
Invalid patent claim disclaimer . . . . .	288
Invalidity of term extension . . . . .	282
Invention date as affected by activity abroad . . . . .	104
Invention, defined . . . . .	100
Invention made abroad . . . . .	104
Inventions promotion, improper and deceptive . . . . .	297
Inventions in outer space . . . . .	105
Inventions patentable . . . . .	101
Inventions previously patented abroad . . . . .	102
Inventive step . . . . .	103
Inventor:	
Correction of patent . . . . .	256
Death or incapacity . . . . .	117
May obtain patent . . . . .	101
Oath for joint . . . . .	116
Refuses to sign . . . . .	118
To make application . . . . .	111
Inventor's certificate as reference . . . . .	102
Inventor's certificate priority right . . . . .	119
Issue of patent . . . . .	151
Issue fee . . . . .	41
If not paid within three months, patent withheld . . . . .	151
Nonpayment . . . . .	41, 151
Payment of . . . . .	151

### J

Joint inventors . . . . .	116, 256
Joint owners . . . . .	262
Jurisdiction of District Court for District of Columbia . . . . .	32

### K

Knowledge or use in foreign country no bar to patent . . . . .	102
--	-----

### L

Legal representative of dead or incapacitated inventor . . . . .	117
Liability of States . . . . .	296

PATENT LAWS

Libraries, public, copies of patents and published applications for patents for. . . . . 12, 41  
 Library . . . . . 7  
 License for foreign filing. . . . . 184  
 Limitation on damages . . . . . 154, 286, 287

**M**

Machines patentable . . . . . 100  
 Maintenance fees. . . . . 41(b)  
     Late payment . . . . . 41(c)  
 Manufactures patentable . . . . . 101  
 Marking articles falsely as patented . . . . . 292  
 Marking articles patented . . . . . 287  
 Misjoinder of inventor. . . . . 116, 202, 256  
 Mistake in patent, certificate thereof issued . . . . . 254, 255  
 Model, shall be furnished if required . . . . . 114  
 Money:  
     Paid by mistake or in excess, refunded . . . . . 42  
     Received for fees, etc. to be paid into Treasury. . . . . 42  
 Multiple dependent claim . . . . . 112  
     Fee . . . . . 41  
 Mutilation of records. . . . . 18 U.S.C. 2071

**N**

National Security . . . . . 3, 122, 181  
 National stage of international application . 371, 372, 373  
 New matter inadmissible in reissue. . . . . 251  
 New matter, may not be introduced by amendment . . 132  
 Nonjoinder of inventor . . . . . 256  
 Nonobviousness. . . . . 103  
 Nonprofit organization, defined . . . . . 200  
 Nonresident patentee . . . . . 293  
 Notice as regards patents:  
     As to proof in infringement suits. . . . . 282  
     Of allowance of patent. . . . . 151  
     Of appeal to the Court of Appeals for the Federal Circuit. . . . . 142, 143  
     Of interference. . . . . 135  
     Of patent suit, decision to be given United States Patent and Trademark Office by clerk of court . . . . . 290  
     Of rejection of an application . . . . . 132  
     Of suit to be entered on file of patent . . . . . 290  
     To the public by Federal agency . . . . . 209  
     To the public that invention is patented. . . . . 287  
 Novelty . . . . . 102

**O**

Oath in patent application . . . . . 115, 152  
     Before whom taken in foreign countries . . . . . 25, 115  
     Before whom taken in the United States . . . . . 115

Declaration in lieu of . . . . . 25  
 Joint inventors. . . . . 116  
 Must be made by inventor, if living . . . . . 115  
 Requirements of . . . . . 115  
 To be made by legal representative if inventor is dead or incapacitated . . . . . 117  
 Obviousness . . . . . 103  
 Officer of United States Patent and Trademark Office may attest patents. . . . . 153  
 Officers and employees:  
     Of United States Patent and Trademark Office . . . . . 3  
     Of United States Patent and Trademark Office, restrictions on as to interests in patents . . . . . 4  
 Official Gazette:  
     Exchange for publications . . . . . 11  
     Printing and distribution of. . . . . 11  
     Public Advisory Committee Report . . . . . 5  
 Owners, joint . . . . . 262  
 Ownership assignment . . . . . 261

**P**

Paris Convention . . . . . 119  
 Patent and Trademark Office: See United States Patent and Trademark Office  
 Patent Cooperation Treaty:  
     Definitions . . . . . 351  
 Patent fees. . . . . 41  
     Disposition of . . . . . 42  
 Patent laws, printing of. . . . . 10  
 Patent pending, false marking as . . . . . 292  
 Patent Public Advisory Committee . . . . . 3, 5  
     Appointment, timing and basis. . . . . 5  
     Duties . . . . . 5  
     Consultation with Director . . . . . 3, 5  
 Patent term adjustment. . . . . 154  
 Patent term extension . . . . . 155  
 Patent term extension application. . . . . 156  
 Patent term restoration . . . . . 155A  
 Patentability, conditions for . . . . . 102, 103  
 Patentable inventions . . . . . 101  
 Patented article, marked as such. . . . . 287  
 Patentee:  
     Defined . . . . . 100  
     Notified of interference . . . . . 135  
 Patents:  
     Application for . . . . . 111  
     Assignment of. . . . . 261  
     Based on international application . . . . . 375  
     Certified copies of . . . . . 9  
     Classification of . . . . . 8  
     Contents and duration of. . . . . 154  
     Copies supplied to public libraries . . . . . 12, 41



MANUAL OF PATENT EXAMINING PROCEDURE

Copying claim of . . . . .	135	Photolithography, Headings of drawings printed . . . . .	10
Date, duration, and form . . . . .	154	Plant patents:	
Design (See Design patents)		Claim. . . . .	162, 164
Effect of adverse interference decision . . . . .	135	Description . . . . .	162, 163
Exchange of printed copies with foreign coun- tries . . . . .	11	Fees . . . . .	41
Fee on issuing . . . . .	41	Nature of right. . . . .	163
Filing application in foreign country . . . . .	184	Plants patentable . . . . .	161
For what granted . . . . .	101	Secretary of Agriculture to furnish information and detail employees . . . . .	164
Foreign knowledge or use no bar to grant of . . . . .	102	Pleading and proof in action for infringement . . . . .	282
How issued, attested, and recorded . . . . .	153	Postal Service deposit. . . . .	21
May be granted to assignee . . . . .	152	Practical application, defined . . . . .	200
May be withheld in certain cases. . . . .	181	Pre-issuance opposition, when prohibited . . . . .	122
Obtainable by civil action . . . . .	145	Presumption of product made by patented process . . . . .	295
Personal property . . . . .	261	Presumption of validity of patents . . . . .	282
Presumption of validity . . . . .	282	Printed publication bar to a patent . . . . .	102
Price of copies . . . . .	41(a)9	Printing:	
Printing of . . . . .	10	Decisions in patent cases . . . . .	10
Reissuing of, when defective. . . . .	251	Of papers filed . . . . .	22
Rights of invention made with federal assis- tance. . . . .	200 - 212	United States Patent and Trademark Office . . . . .	10
Restrictions on officers and employees of United States Patent and Trademark Office as to interest in. . . . .	4	Printing headings of drawings by United States Patent and Trademark Office . . . . .	10
Surrender of, to take effect on reissue . . . . .	251	Prior art, citation of. . . . .	301
Term . . . . .	154, 155, 166A, 156	Prior patenting or publication bar to patent . . . . .	102
Term adjustment . . . . .	154	Priority, foreign. . . . .	119, 365
Term extension. . . . .	155, 156	Priority of invention . . . . .	102
Term restoration. . . . .	155A	Priority of invention, determined by Board of Patent Appeals and Interferences . . . . .	135
Time of issue, payment of issue fee. . . . .	151	Priority, right of, under treaty or law . . . . .	119
To be authenticated by seal of United States Patent and Trademark Office. . . . .	2	For design applications . . . . .	172
When to issue. . . . .	151	Process defined. . . . .	100
Withheld for nonpayment of issue fee. . . . .	151	Process Patent Amendment Act of 1988 . . . . .	287
Patent rights in inventions made with Federal assistance . . . . .	200-212	Process patentable . . . . .	101
Confidentiality . . . . .	205	Product made by patent process. . . . .	295
Definitions . . . . .	201	Property of United States Patent and Trademark Office. . . . .	2
Disposition of rights. . . . .	202	Provisional applications . . . . .	111, 119
Domestic and foreign protection of federally owned inventions. . . . .	207	Provisional rights . . . . .	154
Educational awards . . . . .	212	Protest and pre-issuance opposition, when prohib- ited . . . . .	122
March-in rights . . . . .	203	Public use or sale . . . . .	102
Policy and objective of . . . . .	200	Of invention bar to a patent . . . . .	102
Precedence of chapter over other Acts . . . . .	210	Publication of international application, effect. . . . .	374
Preference for United States industry . . . . .	204	Publication of patent applications . . . . .	122, 181
Regulations governing federal licensing . . . . .	208	Publications regarding patents and trademarks . . . . .	10
Relationship to antitrust laws. . . . .	211		
Restrictions on licensing of federally owned inventions . . . . .	209	<b>R</b>	
Uniform clauses and regulations . . . . .	206	Receiving Office. . . . .	351, 361, 364, 367, 368
Period for response . . . . .	21, 133	Recording of assignments. . . . .	261
		Reexamination order by Director . . . . .	304, 313
		Reexamination procedure Appeal. . . . .	134, 141, 306, 315

## PATENT LAWS

Certificate of patentability, unpatentability, and claim cancellation . . . . .	307, 316
Conduct of reexamination proceedings . . . . .	305, 314
Determination of issue by Director . . . . .	303, 312
Determination of new question . . . . .	303, 312
Ex Parte . . . . .	302-307
Inter Partes . . . . .	311-318
When prohibited . . . . .	317
Request . . . . .	302, 311
Special dispatch . . . . .	305, 314
Stay of litigation . . . . .	318
Reexamination to be made after first rejection, if desired . . . . .	132
References, to be cited on examination . . . . .	132
Refund of money paid by mistake or in excess . . . . .	42
Reissue of patents:	
Application fee . . . . .	41(a)4
Application may be made by assignee in cer- tain cases . . . . .	251
By reason of defective claims . . . . .	251
Effect of . . . . .	252
For unexpired term of original patent . . . . .	251
Intervening rights . . . . .	252
Of defective patents . . . . .	251
To contain no new matter . . . . .	251
Rejection, applicant shall be notified of reasons for . . . . .	132
Remedy for infringement of patent . . . . .	281
Removal of records . . . . .	18 U.S.C. 2071
Report to Congress, annual . . . . .	13
Request for reexamination proceeding . . . . .	302, 311
Restoration of patent . . . . .	155A
Restrictions on officers and employees of United States Patent and Trademark Office as to inter- est in patents . . . . .	4
Retention of revenue . . . . .	2
Revival if delay unavoidable . . . . .	133
Right of foreign priority . . . . .	365
Right to compensation because of secrecy order . . . . .	183
Rules for taking testimony, Director to establish . . . . .	23
Rules of practice:	
Authority for . . . . .	2
Printing of . . . . .	10

### S

Saturday, time for action expiring on . . . . .	21
Seal of United States Patent and Trademark Office . . . . .	2
Secrecy of applications . . . . .	122
Secrecy of certain inventions . . . . .	181 - 188
Secrecy of international application . . . . .	368

Secrecy order . . . . .	181
Small business firm, defined . . . . .	200
Small entity status . . . . .	2, 41
Specification(s):	
Contents of . . . . .	112
If defective, reissue to correct . . . . .	251
Part of patent . . . . .	154
Printing of . . . . .	10, 41
Uncertified copies, price of . . . . .	41
Specimens, may be required . . . . .	114
Statutory invention registration . . . . .	157
Subpoenas to witnesses . . . . .	24
Suit against the United States . . . . .	286
Suit in equity (See Civil action)	
Sunday, time for action expiring on . . . . .	21
Surcharge for later filing of fee or oath . . . . .	111

### T

Term extension:	
For administrative delays . . . . .	154
For delays due to interference, secrecy orders, and/or appellate review . . . . .	154
Regulatory review . . . . .	156
Term of patent:	
Design . . . . .	173
Disclaimer of . . . . .	253
Extension . . . . .	155, 156
Period . . . . .	154
Restoration . . . . .	155A
Testimony, rules for taking . . . . .	23
Time:	
Expiring on Saturday, Sunday, or holiday . . . . .	21
For payment of issue fee . . . . .	151
For taking action in Government cases . . . . .	267
Limitation on damages . . . . .	286
Within which action must be taken . . . . .	133
Title of invention . . . . .	154
Trademark fees . . . . .	42(c)
Trademarks, reference to . . . . .	1, 2, 3, 10
Translation error in international application . . . . .	375

### U

Unauthorized disclosure . . . . .	182
Unauthorized person may not lawfully assist per- sons in transaction of business before the Office . . . . .	33
Under Secretary of Commerce for Intellectual Property . . . . .	6
United States as designated office . . . . .	363
United States, defined . . . . .	100

MANUAL OF PATENT EXAMINING PROCEDURE

United States Patent and Trademark Office:  
  In Department of Commerce . . . . . 1  
  Library . . . . . 7  
  Printing . . . . . 10  
  Rules, authority for . . . . . 2  
  Seal of . . . . . 2  
Unpatented article, penalty for deceptive marking . . . 292  
Use in foreign countries, no bar to grant of patent . . . 102

**V**

Verified translation requirement . . . . . 372

Voluntary arbitration . . . . . 294

**W**

Withdrawal of international application . . . . . 366  
Withholding of patent . . . . . 181

Witness:

  Failing to attend or refusing to testify . . . . . 24  
  Fees of, interference cases . . . . . 24  
  In interference summoned by clerk of United  
    States court . . . . . 24  
  When in contempt, punishment . . . . . 24

# Appendix R PATENT RULES

---

## Title 37 - Code of Federal Regulations Patents, Trademarks, and Copyrights

---

### CHAPTER I — UNITED STATES PATENT AND TRADEMARK OFFICE, DEPARTMENT OF COMMERCE

#### SUBCHAPTER A - GENERAL

##### *PATENTS*

###### *Part*

- 1 Rules of practice in patent cases
- 3 Assignment, recording and rights of assignee
- 4 Complaints regarding invention promoters
- 5 Secrecy of certain inventions and licenses to export and file applications in foreign countries

Index I - Rules pertaining to patents

##### *PRACTICE BEFORE THE PATENT AND TRADEMARK OFFICE*

- 10 Representation of others before the United States Patent and Trademark Office

Index II - Rules relating to practice before the United States Patent and Trademark Office

15 [Reserved]

15a [Reserved]

#### SUBCHAPTER B — ADMINISTRATION

100 [Reserved]

101 [Reserved]

102 Disclosure of government information

104 Legal processes

#### SUBCHAPTER C—PROTECTION OF FOREIGN MASK WORKS

150 Requests for Presidential proclamations pursuant to 17 U.S.C. 902(a)(2)

---

#### SUBCHAPTER A - GENERAL

##### **PART 1 - RULES OF PRACTICE IN PATENT CASES**

###### **Subpart A - General Provisions**

##### **GENERAL INFORMATION AND CORRESPONDENCE**

###### **Sec.**

- 1.1 Addresses for non-trademark correspondence with the United States Patent and Trademark Office.
- 1.2 Business to be transacted in writing.
- 1.3 Business to be conducted with decorum and courtesy.
- 1.4 Nature of correspondence and signature requirements.
- 1.5 Identification of patent, patent application, or patent-related proceeding.
- 1.6 Receipt of correspondence.
- 1.7 Times for taking action; Expiration on Saturday, Sunday, or Federal holiday.
- 1.8 Certificate of mailing or transmission.
- 1.9 Definitions.
- 1.10 Filing of papers and fees by "Express Mail."

##### **RECORDS AND FILES OF THE PATENT AND TRADEMARK OFFICE**

- 1.11 Files open to the public.
- 1.12 Assignment records open to public inspection.
- 1.13 Copies and certified copies.
- 1.14 Patent applications preserved in confidence.
- 1.15 [Reserved]

##### **FEEES AND PAYMENT OF MONEY**

- 1.16 National application filing fees.
- 1.17 Patent application and reexamination processing fees.
- 1.18 Patent post allowance (including issue) fees.
- 1.19 Document supply fees.

## MANUAL OF PATENT EXAMINING PROCEDURE

- 1.20 Post issuance fees.
- 1.21 Miscellaneous fees and charges.
- 1.22 Fees payable in advance.
- 1.23 Method of payment.
- 1.24 [Reserved]
- 1.25 Deposit accounts.
- 1.26 Refunds.
- 1.27 Definition of small entities and establishing status as a small entity to permit payment of small entity fees; when a determination of entitlement to small entity status and notification of loss of entitlement to small entity status are required; fraud on the Office.
- 1.28 Refunds when small entity status is later established; how errors in small entity status are excused.
- 1.52 Language, paper, writing, margins, compact disc specifications.
- 1.53 Application number, filing date, and completion of application.
- 1.54 Parts of application to be filed together; filing receipt.
- 1.55 Claim for foreign priority.
- 1.56 Duty to disclose information material to patentability.
- 1.57 [Reserved]
- 1.58 Chemical and mathematical formulae and tables.
- 1.59 Expungement of information or copy of papers in application file.
- 1.60 [Reserved]
- 1.61 [Reserved]
- 1.62 [Reserved]

### Subpart B - National Processing Provision

## PROSECUTION OF APPLICATION AND APPOINTMENT OF ATTORNEY OR AGENT

- 1.31 Applicants may be represented by a registered attorney or agent.
- 1.32 [Reserved]
- 1.33 Correspondence respecting patent applications, reexamination proceedings, and other proceedings.
- 1.34 Recognition for representation.
- 1.36 Revocation of power of attorney or authorization; withdrawal of attorney or agent.

## WHO MAY APPLY FOR A PATENT

- 1.41 Applicant for patent.
- 1.42 When the inventor is dead.
- 1.43 When the inventor is insane or legally incapacitated.
- 1.44 [Reserved]
- 1.45 Joint inventors.
- 1.46 Assigned inventions and patents.
- 1.47 Filing when an inventor refuses to sign or cannot be reached.
- 1.48 Correction of inventorship in a patent application, other than a reissue application, pursuant to 35 U.S.C. 116.

## THE APPLICATION

- 1.51 General requisites of an application.

## OATH OR DECLARATION

- 1.63 Oath or declaration.
- 1.64 Person making oath or declaration.
- 1.66 Officers authorized to administer oaths.
- 1.67 Supplemental oath or declaration.
- 1.68 Declaration in lieu of oath.
- 1.69 Foreign language oaths and declarations.
- 1.70 [Reserved]

## SPECIFICATION

- 1.71 Detailed description and specification of the invention.
- 1.72 Title and abstract.
- 1.73 Summary of the invention.
- 1.74 Reference to drawings.
- 1.75 Claim(s).
- 1.76 Application data sheet.
- 1.77 Arrangement of application elements.
- 1.78 Claiming benefit of earlier filing date and cross-references to other applications.
- 1.79 Reservation clauses not permitted.

## THE DRAWINGS

- 1.81 Drawings required in patent application.
- 1.83 Content of drawing.
- 1.84 Standards for drawings.
- 1.85 Corrections to drawings.

## PATENT RULES

1.88 [Reserved]

### MODELS, EXHIBITS, SPECIMENS

- 1.91 Models or exhibits not generally admitted as part of application or patent.
- 1.92 [Reserved]
- 1.93 Specimens.
- 1.94 Return of models, exhibits or specimens.
- 1.95 Copies of exhibits.
- 1.96 Submission of computer program listings.

### INFORMATION DISCLOSURE STATEMENT

- 1.97 Filing of information disclosure statement.
- 1.98 Content of information disclosure statement.
- 1.99 Third-party submission in published application.

### EXAMINATION OF APPLICATIONS

- 1.101 [Reserved]
- 1.102 Advancement of examination.
- 1.103 Suspension of action by the Office.
- 1.104 Nature of examination.
- 1.105 Requirements for information.
- 1.106 [Reserved]
- 1.107 [Reserved]
- 1.108 [Reserved]
- 1.109 [Reserved]
- 1.110 Inventorship and date of invention of the subject matter of individual claims.

### ACTION BY APPLICANT AND FURTHER CONSIDERATION

- 1.111 Reply by applicant or patent owner to a non-final Office action.
- 1.112 Reconsideration before final action.
- 1.113 Final rejection or action.
- 1.114 Request for continued examination.

## AMENDMENTS

- 1.115 Preliminary amendments.
- 1.116 Amendments after final action or appeal.
- 1.117 [Reserved]
- 1.118 [Reserved]
- 1.119 [Reserved]
- 1.121 Manner of making amendments in applications.
- 1.122 [Reserved]
- 1.123 [Reserved]
- 1.124 [Reserved]
- 1.125 Substitute specification.
- 1.126 Numbering of claims.
- 1.127 Petition from refusal to admit amendment.

### TRANSITIONAL PROVISIONS

- 1.129 Transitional procedures for limited examination after final rejection and restriction practice.

### AFFIDAVITS OVERCOMING REJECTIONS

- 1.130 Affidavit or declaration to disqualify commonly owned patent or published application as prior art.
- 1.131 Affidavit or declaration of prior invention.
- 1.132 Affidavits or declarations traversing rejections or objections.

### INTERVIEWS

- 1.133 Interviews.

### TIME FOR REPLY BY APPLICANT; ABANDONMENT OF APPLICATION

- 1.134 Time period for reply to an Office action.
- 1.135 Abandonment for failure to reply within time period.
- 1.136 Extensions of time.
- 1.137 Revival of abandoned application, terminated reexamination proceeding, or lapsed patent.
- 1.138 Express abandonment.
- 1.139 [Reserved]

## JOINDER OF INVENTIONS IN ONE APPLICATION; RESTRICTION

- 1.141 Different inventions in one national application.
- 1.142 Requirement for restriction.
- 1.143 Reconsideration of requirement.
- 1.144 Petition from requirement for restriction.
- 1.145 Subsequent presentation of claims for different invention.
- 1.146 Election of species.

## DESIGN PATENTS

- 1.151 Rules applicable.
- 1.152 Design drawings.
- 1.153 Title, description and claim, oath or declaration.
- 1.154 Arrangement of application elements in a design application.
- 1.155 Expedited examination of design applications.

## PLANT PATENTS

- 1.161 Rules applicable.
- 1.162 Applicant, oath or declaration.
- 1.163 Specification and arrangement of application elements in a plant application.
- 1.164 Claim.
- 1.165 Plant Drawings.
- 1.166 Specimens.
- 1.167 Examination.

## REISSUES

- 1.171 Application for reissue.
- 1.172 Applicants, assignees.
- 1.173 Reissue specification, drawings, and amendments.
- 1.174 [Reserved]
- 1.175 Reissue oath or declaration.
- 1.176 Examination of reissue.
- 1.177 Issuance of multiple reissue patents.
- 1.178 Original patent; continuing duty of applicant.
- 1.179 Notice of reissue application.

## PETITIONS AND ACTION BY THE DIRECTOR

- 1.181 Petition to the Director.
- 1.182 Questions not specifically provided for.
- 1.183 Suspension of rules.
- 1.184 [Reserved]

## APPEAL TO THE BOARD OF PATENT APPEALS AND INTERFERENCES

- 1.191 Appeal to Board of Patent Appeals and Interferences.
- 1.192 Appellant's brief.
- 1.193 Examiner's answer and reply brief.
- 1.194 Oral hearing.
- 1.195 Affidavits or declarations after appeal.
- 1.196 Decision by the Board of Patent Appeals and Interferences.
- 1.197 Action following decision.
- 1.198 Reopening after decision.

## PUBLICATION OF APPLICATIONS

- 1.211 Publication of applications.
- 1.213 Nonpublication request.
- 1.215 Patent application publication.
- 1.217 Publication of a redacted copy of an application.
- 1.219 Early publication.
- 1.221 Voluntary publication or republication of patent application publication.

## MISCELLANEOUS PROVISIONS

- 1.248 Service of papers; manner of service; proof of service in cases other than interferences.
- 1.251 Unlocatable file.

## PROTESTS AND PUBLIC USE PROCEEDINGS

- 1.291 Protests by the public against pending applications.
- 1.292 Public use proceedings.
- 1.293 Statutory invention registration.
- 1.294 Examination of request for publication of a statutory

## PATENT RULES

invention registration and patent application to which the request is directed.

- 1.295 Review of decision finally refusing to publish a statutory invention registration.
- 1.296 Withdrawal of request for publication of statutory invention registration.
- 1.297 Publication of statutory invention registration.

### REVIEW OF PATENT AND TRADEMARK OFFICE DECISIONS BY COURT

- 1.301 Appeal to U.S. Court of Appeals for the Federal Circuit.
- 1.302 Notice of appeal.
- 1.303 Civil action under 35 U.S.C. 145, 146, 306.
- 1.304 Time for appeal or civil action.

### ALLOWANCE AND ISSUE OF PATENT

- 1.311 Notice of Allowance.
- 1.312 Amendments after allowance.
- 1.313 Withdrawal from issue.
- 1.314 Issuance of patent.
- 1.315 Delivery of patent.
- 1.316 Application abandoned for failure to pay issue fee.
- 1.317 Lapsed patents; delayed payment of balance of issue fee.
- 1.318 [Reserved]

### DISCLAIMER

- 1.321 Statutory disclaimers, including terminal disclaimers.

### CORRECTION OF ERRORS IN PATENT

- 1.322 Certificate of correction of Office mistake.
- 1.323 Certificate of correction of applicant's mistake.
- 1.324 Correction of inventorship in patent, pursuant to 35 U.S.C. 256.

- 1.325 Other mistakes not corrected.

### ARBITRATION AWARDS

- 1.331 [Reserved]
- 1.332 [Reserved]
- 1.333 [Reserved]
- 1.334 [Reserved]
- 1.335 Filing of notice of arbitration awards

### AMENDMENT OF RULES

- 1.351 Amendments to rules will be published.
- 1.352 [Reserved]

### MAINTENANCE FEES

- 1.362 Time for payment of maintenance fees.
- 1.363 Fee address for maintenance fee purposes.
- 1.366 Submission of maintenance fees.
- 1.377 Review of decision refusing to accept and record payment of a maintenance fee filed prior to expiration of patent.
- 1.378 Acceptance of delayed payment of maintenance fee in expired patent to reinstate patent.

### Subpart C - International Processing Provisions

### GENERAL INFORMATION

- 1.401 Definitions of terms under the Patent Cooperation Treaty.
- 1.412 The United States Receiving Office.
- 1.413 The United States International Searching Authority.
- 1.414 The United States Patent and Trademark Office as a Designated Office or Elected Office.
- 1.415 The International Bureau.
- 1.416 The United States International Preliminary Examining Authority.
- 1.417 Submission of translation of international publication.
- 1.419 Display of currently valid control number under the Paperwork Reduction Act.



## WHO MAY FILE AN INTERNATIONAL APPLICATION

- 1.421 Applicant for international application.
- 1.422 When the inventor is dead.
- 1.423 When the inventor is insane or legally incapacitated.

## THE INTERNATIONAL APPLICATION

- 1.431 International application requirements.
- 1.432 Designation of States by filing an international application.
- 1.433 Physical requirements of international application.
- 1.434 The request.
- 1.435 The description.
- 1.436 The claims.
- 1.437 The drawings.
- 1.438 The abstract.

## FEES

- 1.445 International application filing, processing and search fees.
- 1.446 Refund of international application filing and processing fees.

## PRIORITY

- 1.451 The priority claim and priority document in an international application.

## REPRESENTATION

- 1.455 Representation in international applications.

## TRANSMITTAL OF RECORD COPY

- 1.461 Procedures for transmittal of record copy to the International Bureau.

## TIMING

- 1.465 Timing of application processing based on the priority date.

- 1.468 Delays in meeting time limits.

## AMENDMENTS

- 1.471 Corrections and amendments during international processing.
- 1.472 Changes in person, name, or address of applicants and inventors.

## UNITY OF INVENTION

- 1.475 Unity of invention before the International Searching Authority, the International Preliminary Examining Authority and during the national stage.
- 1.476 Determination of unity of invention before the International Searching Authority.
- 1.477 Protest to lack of unity of invention before the International Searching Authority.

## INTERNATIONAL PRELIMINARY EXAMINATION

- 1.480 Demand for international preliminary examination.
- 1.481 Payment of international preliminary examination fees.
- 1.482 International preliminary examination fees.
- 1.484 Conduct of international preliminary examination.
- 1.485 Amendments by applicant during international preliminary examination.
- 1.488 Determination of unity of invention before the International Preliminary Examining Authority.
- 1.489 Protest to lack of unity of invention before the International Preliminary Examining Authority.

## NATIONAL STAGE

- 1.491 National stage commencement and entry.
- 1.492 National stage fees.
- 1.494 [Reserved]
- 1.495 Entering the national stage in the United States of America.
- 1.496 Examination of international applications in the national stage.
- 1.497 Oath or declaration under 35 U.S.C. 371(c)(4).
- 1.499 Unity of invention during the national stage.

## PATENT RULES

### Subpart D - *Ex Parte* Reexamination of Patents

#### CITATION OF PRIOR ART

- 1.501 Citation of prior art in patent files.
- 1.502 Processing of prior art citations during an *ex parte* reexamination proceeding.

#### REQUEST FOR REEXAMINATION

- 1.510 Request for *ex parte* reexamination.
- 1.515 Determination of the request for *ex parte* reexamination.
- 1.520 *Ex parte* reexamination at the initiative of the Director.
- 1.525 Order for *ex parte* reexamination.
- 1.530 Statement by patent owner in *ex parte* reexamination; amendment by patent owner in *ex parte* or *inter partes* reexamination; inventorship change in *ex parte* or *inter partes* reexamination.
- 1.535 Reply by third party requester in *ex parte* reexamination.
- 1.540 Consideration of responses in *ex parte* reexamination.
- 1.550 Conduct of *ex parte* reexamination proceedings.
- 1.552 Scope of reexamination in *ex parte* reexamination proceedings.
- 1.555 Information material to patentability in *ex parte* reexamination and *inter partes* reexamination proceedings.
- 1.560 Interviews in *ex parte* reexamination proceedings.
- 1.565 Concurrent office proceedings which include an *ex parte* reexamination proceeding.
- 1.570 Issuance of *ex parte* reexamination certificate after *ex parte* reexamination proceedings.

### Subpart E - Interferences

- 1.601 Scope of rules, definitions.
- 1.602 Interest in applications and patents involved in an interference.
- 1.603 Interference between applications; subject matter of the interference.
- 1.604 Request for interference between applications by an applicant.
- 1.605 Suggestion of claim to applicant by examiner.
- 1.606 Interference between an application and a patent;

- subject matter of the interference.
- 1.607 Request by applicant for interference with patent.
- 1.608 Interference between an application and a patent; *prima facie* showing by applicant.
- 1.609 [Reserved]
- 1.610 Assignment of interference to administrative patent judge, time period for completing interference.
- 1.611 Declaration of interference.
- 1.612 Access to applications.
- 1.613 Lead attorney, same attorney representing different parties in an interference, withdrawal of attorney or agent.
- 1.614 Jurisdiction over interference.
- 1.615 Suspension of *ex parte* prosecution.
- 1.616 Sanctions for failure to comply with rules or order or for taking and maintaining a frivolous position.
- 1.617 Summary judgment against applicant.
- 1.618 Return of unauthorized papers.
- 1.621 Preliminary statement, time for filing, notice of filing.
- 1.622 Preliminary statement, who made invention, where invention made.
- 1.623 Preliminary statement; invention made in United States, a NAFTA country, or a WTO member country.
- 1.624 Preliminary statement; invention made in a place other than the United States, a NAFTA country, or a WTO member country.
- 1.625 Preliminary statement; derivation by an opponent
- 1.626 Preliminary statement; earlier application.
- 1.627 Preliminary statement; sealing before filing, opening of statement.
- 1.628 Preliminary statement; correction of error.
- 1.629 Effect of preliminary statement.
- 1.630 Reliance on earlier application.
- 1.631 Access to preliminary statement, service of preliminary statement.
- 1.632 Notice of intent to argue abandonment, suppression or concealment by opponent.
- 1.633 Preliminary motions.
- 1.634 Motion to correct inventorship.
- 1.635 Miscellaneous motions.
- 1.636 Motions, time for filing.
- 1.637 Content of motions.
- 1.638 Opposition and reply; time for filing opposition and reply.
- 1.639 Evidence in support of motion, opposition, or reply.
- 1.640 Motions, hearing and decision, redeclaration

## MANUAL OF PATENT EXAMINING PROCEDURE

of interference, order to show cause.

- 1.641 Unpatentability discovered by administrative patent judge.
- 1.642 Addition of application or patent to interference.
- 1.643 Prosecution of interference by assignee.
- 1.644 Petitions in interferences.
- 1.645 Extension of time, late papers, stay of proceedings.
- 1.646 Service of papers, proof of service.
- 1.647 Translation of document in foreign language.
- 1.651 Setting times for discovery and taking testimony, parties entitled to take testimony.
- 1.652 Judgment for failure to take testimony or file record.
- 1.653 Record and exhibits.
- 1.654 Final hearing.
- 1.655 Matters considered in rendering a final decision.
- 1.656 Briefs for final hearing.
- 1.657 Burden of proof as to date of invention.
- 1.658 Final decision.
- 1.659 Recommendation.
- 1.660 Notice of reexamination, reissue, protest, or litigation.
- 1.661 Termination of interference after judgment.
- 1.662 Request for entry of adverse judgment; reissue filed by patentee.
- 1.663 Status of claim of defeated applicant after interference.
- 1.664 Action after interference.
- 1.665 Second interference.
- 1.666 Filing of interference settlement agreements.
- 1.671 Evidence must comply with rules.
- 1.672 Manner of taking testimony.
- 1.673 Notice of examination of witness.
- 1.674 Persons before whom depositions may be taken.
- 1.675 Examination of witness, reading and signing transcript of deposition.
- 1.676 Certification and filing by officer, marking exhibits.
- 1.677 Form of an affidavit or a transcript of deposition.
- 1.678 Time for filing transcript of deposition.
- 1.679 Inspection of transcript.
- 1.682 [Reserved]
- 1.683 [Reserved]
- 1.684 [Reserved]
- 1.685 Errors and irregularities in depositions.
- 1.687 Additional discovery.
- 1.688 [Reserved]
- 1.690 Arbitration of interferences.

### **Subpart F - Adjustment and Extension of Patent Term**

#### **ADJUSTMENT OF PATENT TERM DUE TO EXAMINATION DELAY**

- 1.701 Extension of patent term due to examination delay under the Uruguay Round Agreements Act (original applications, other than designs, filed on or after June 8, 1995, and before May 29, 2000).
- 1.702 Grounds for adjustment of patent term due to examination delay under the Patent Term Guarantee Act of 1999 (original applications, other than designs, filed on or after May 29, 2000).
- 1.703 Period of adjustment of patent term due to examination delay.
- 1.704 Reduction of period of adjustment of patent term.
- 1.705 Patent term adjustment determination.

#### **EXTENSION OF PATENT TERM DUE TO REGULATORY REVIEW**

- 1.710 Patents subject to extension of the patent term.
- 1.720 Conditions for extension of patent term.
- 1.730 Applicant for extension of patent term; signature requirements.
- 1.740 Formal requirements for application for extension of patent term; correction of informalities.
- 1.741 Complete application given a filing date; petition procedure.
- 1.750 Determination of eligibility for extension of patent term.
- 1.760 Interim extension of patent term under 35 U.S.C. 156(e)(2).
- 1.765 Duty of disclosure in patent term extension proceedings.
- 1.770 Express withdrawal of application for extension of patent term.
- 1.775 Calculation of patent term extension for a human drug, antibiotic drug, or human biological product.
- 1.776 Calculation of patent term extension for a food additive or color additive.
- 1.777 Calculation of patent term extension for a medical device.
- 1.778 Calculation of patent term extension for an animal drug product.
- 1.779 Calculation of patent term extension for a veterinary

## PATENT RULES

biological product.

- 1.780 Certificate or order of extension of patent term.
- 1.785 Multiple applications for extension of term of the same patent or of different patents for the same regulatory review period for a product.
- 1.790 Interim extension of patent term under 35 U.S.C. 156(d)(5)
- 1.791 Termination of interim extension granted prior to regulatory approval of a product for commercial marketing or use.

### Subpart G - Biotechnology Invention Disclosures

#### DEPOSIT OF BIOLOGICAL MATERIAL

- 1.801 Biological material.
- 1.802 Need or opportunity to make a deposit.
- 1.803 Acceptable depository.
- 1.804 Time of making an original deposit.
- 1.805 Replacement or supplement of deposit.
- 1.806 Term of deposit.
- 1.807 Viability of deposit.
- 1.808 Furnishing of samples.
- 1.809 Examination procedures.

#### APPLICATION DISCLOSURES CONTAINING NUCLEOTIDE AND/OR AMINO ACID SEQUENCES

- 1.821 Nucleotide and/or amino acid sequence disclosures in patent applications.
- 1.822 Symbols and format to be used for nucleotide and/or amino acid sequence data.
- 1.823 Requirements for nucleotide and/or amino acid sequences as part of the application.
- 1.824 Form and format for nucleotide and/or amino acid sequence submissions in computer readable form.
- 1.825 Amendments to or replacement of sequence listing and computer readable copy thereof.

Appendix A - Sample Sequence Listing

### Subpart H - *Inter Partes* Reexamination of Patents that Issued From an Original Application Filed in the United States on or After November 29, 1999

#### PRIOR ART CITATIONS

- 1.902 Processing of prior art citations during an *inter partes* reexamination proceeding.

#### REQUIREMENTS FOR *INTER PARTES* REEXAMINATION PROCEEDINGS

- 1.903 Service of papers on parties in *inter partes* reexamination.
- 1.904 Notice of *inter partes* reexamination in *Official Gazette*.
- 1.905 Submission of papers by the public in *inter partes* reexamination.
- 1.906 Scope of reexamination in *inter partes* reexamination proceeding.
- 1.907 *Inter partes* reexamination prohibited.
- 1.913 Persons eligible to file request for *inter partes* reexamination.
- 1.915 Content of request for *inter partes* reexamination.
- 1.919 Filing date of request for *inter partes* reexamination.
- 1.923 Examiner's determination on the request for *inter partes* reexamination.
- 1.925 Partial refund if request for *inter partes* reexamination is not ordered.
- 1.927 Petition to review refusal to order *inter partes* reexamination.

#### *INTER PARTES* REEXAMINATION OF PATENTS

- 1.931 Order for *inter partes* reexamination.

#### INFORMATION DISCLOSURE IN *INTER PARTES* REEXAMINATION

- 1.933 Patent owner duty of disclosure in *inter partes* reexamination proceedings.

**OFFICE ACTIONS AND RESPONSES  
(BEFORE THE EXAMINER) IN *INTER  
PARTES* REEXAMINATION**

- 1.935 Initial Office action usually accompanies order for *inter partes* reexamination.
- 1.937 Conduct of *inter partes* reexamination.
- 1.939 Unauthorized papers in *inter partes* reexamination.
- 1.941 Amendments by patent owner in *inter partes* reexamination.
- 1.943 Requirements of responses, written comments, and briefs in *inter partes* reexamination.
- 1.945 Response to Office action by patent owner in *inter partes* reexamination.
- 1.947 Comments by third party requester to patent owner's response in *inter partes* reexamination.
- 1.948 Limitations on submission of prior art by third party requester following the order for *inter partes* reexamination.
- 1.949 Examiner's Office action closing prosecution in *inter partes* reexamination.
- 1.951 Options after Office action closing prosecution in *inter partes* reexamination.
- 1.953 Examiner's Right of Appeal Notice in *inter partes* reexamination.

**INTERVIEWS PROHIBITED IN *INTER  
PARTES* REEXAMINATION**

- 1.955 Interviews prohibited in *inter partes* reexamination proceedings.

**EXTENSIONS OF TIME, TERMINATION  
OF PROCEEDINGS, AND PETITIONS  
TO REVIVE IN *INTER PARTES*  
REEXAMINATION**

- 1.956 Patent owner extensions of time in *inter partes* reexamination.
- 1.957 Failure to file a timely, appropriate or complete response or comment in *inter partes* reexamination.
- 1.958 Petition to revive terminated *inter partes* reexamination or claims terminated for lack of patent owner response.

**APPEAL TO THE BOARD OF PATENT  
APPEALS AND INTERFERENCES IN  
*INTER PARTES* REEXAMINATION**

- 1.959 Notice of appeal and cross appeal to Board of Patent Appeals and Interferences in *inter partes* reexamination.
- 1.961 Jurisdiction over appeal in *inter partes* reexamination.
- 1.962 Appellant and respondent in *inter partes* reexamination defined.
- 1.963 Time for filing briefs in *inter partes* reexamination.
- 1.965 Appellant's brief in *inter partes* reexamination.
- 1.967 Respondent's brief in *inter partes* reexamination.
- 1.969 Examiner's answer in *inter partes* reexamination.
- 1.971 Rebuttal brief in *inter partes* reexamination.
- 1.973 Oral hearing in *inter partes* reexamination.
- 1.975 Affidavits or declarations after appeal in *inter partes* reexamination.
- 1.977 Decision by the Board of Patent Appeals and Interferences; remand to examiner in *inter partes* reexamination.
- 1.979 Action following decision by the Board of Patent Appeals and Interferences or dismissal of appeal in *inter partes* reexamination.
- 1.981 Reopening after decision by the Board of Patent Appeals and Interferences in *inter partes* reexamination.

**APPEAL TO THE  
UNITED STATES COURT OF APPEALS  
FOR THE FEDERAL CIRCUIT IN  
*INTER PARTES* REEXAMINATION**

- 1.983 Appeal to the United States Court of Appeals for the Federal Circuit in *inter partes* reexamination.

**CONCURRENT PROCEEDINGS  
INVOLVING SAME PATENT IN  
*INTER PARTES* REEXAMINATION**

- 1.985 Notification of prior or concurrent proceedings in *inter partes* reexamination.
- 1.987 Suspension of *inter partes* reexamination proceeding due to litigation.

- 1.989 Merger of concurrent reexamination proceedings.
- 1.991 Merger of concurrent reissue application and *inter partes* reexamination proceeding.
- 1.993 Suspension of concurrent interference and *inter partes* reexamination proceeding.
- 1.995 Third party requester's participation rights preserved in merged proceeding.

## REEXAMINATION CERTIFICATE IN *INTER PARTES* REEXAMINATION

- 1.997 Issuance of *inter partes* reexamination certificate.

### SUBCHAPTER A – GENERAL

## PART 1 — RULES OF PRACTICE IN PATENT CASES

### Subpart A — General Provisions

#### GENERAL INFORMATION AND CORRESPONDENCE

#### § 1.1 Addresses for non-trademark correspondence with the United States Patent and Trademark Office.

(a) *In general.* Except as provided in paragraphs (a)(3)(i), (a)(3)(ii) and (d)(1) of this section, all correspondence intended for the United States Patent and Trademark Office must be addressed to either “Director of the United States Patent and Trademark Office, P.O. Box 1450, Alexandria, Virginia 22313-1450” or to specific areas within the Office as set out in paragraphs (a)(1) and (a)(3)(iii) of this section. When appropriate, correspondence should also be marked for the attention of a particular office or individual.

##### (1) *Patent correspondence.*

(i) *In general.* All correspondence concerning patent matters processed by organizations reporting to the Commissioner for Patents should be addressed to: Commissioner for Patents, PO Box 1450, Alexandria, Virginia 22313-1450.

(ii) *Board of Patent Appeals and Interferences: Appeals.* All correspondence in an application involved in an appeal to the Board of Patent Appeals and Interferences during the period beginning when an appeal docketing notice is issued and

ending when a decision has been rendered by the Board of Patent Appeals and Interferences, as well as any request for rehearing of a decision by the Board of Patent Appeals and Interferences, should be mailed to: Board of Patent Appeals and Interferences, United States Patent and Trademark Office, PO Box 1450, Alexandria, Virginia 22313-1450. Notices of appeal, appeal briefs, reply briefs, requests for oral hearing, as well as all other correspondence in an application involved in an appeal to the Board of Patent Appeals and Interferences for which an address is not otherwise specified, should be addressed as set out in paragraph (a)(1)(i) of this section.

(iii) *Board of Patent Appeals and Interferences: Interferences.* Except as an administrative patent judge or the Board may otherwise direct, all correspondence relating to patent interferences, or relating to patent applications or patents involved in an interference, should be mailed to: Mail Stop INTERFERENCE, Board of Patent Appeals and Interferences, United States Patent and Trademark Office, PO Box 1450, Alexandria, Virginia 22313-1450.

(2) [Reserved]

(3) *Office of General Counsel correspondence.*—

(i) *Litigation and service.* Correspondence relating to pending litigation or otherwise within the scope of part 104 of this title shall be addressed as provided in § 104.2.

(ii) *Disciplinary proceedings.* Correspondence to counsel for the Director of the Office of Enrollment and Discipline relating to disciplinary proceedings pending before an Administrative Law Judge or the Director shall be mailed to: Office of the Solicitor, PO Box 16116, Arlington, Virginia 22215.

(iii) *Solicitor, in general.* Correspondence to the Office of the Solicitor not otherwise provided for shall be addressed to: Mail Stop 8, Director of the United States Patent and Trademark Office, PO Box 1450, Alexandria, Virginia 22313-1450.

(iv) *General Counsel.* Correspondence to the Office of the General Counsel not otherwise provided for, including correspondence to the General Counsel relating to disciplinary proceedings, shall be addressed to: General Counsel, United States Patent and Trademark Office, PO Box 1450, Alexandria, Virginia 22313-1450.

(v) *Improper correspondence.* Correspondence improperly addressed to a Post Office Box specified in paragraphs (a)(3)(i) and (a)(3)(ii) of this section will not be filed elsewhere in the United States Patent and Trademark Office, and may be returned.

(4) *Office of Public Records correspondence.*—

(i) *Assignments.* All patent-related documents to be recorded by the Assignment Services Division, except for documents filed together with a new application or under § 3.81 of this chapter, should be addressed to: Mail Stop Assignment Recordation Services, Director of the United States Patent and Trademark Office, P.O. Box 1450, Alexandria, Virginia 22313-1450. See § 3.27.

(ii) *Documents.* All requests for certified or uncertified copies of patent documents should be addressed to: Mail Stop Document Services, Director of the United States Patent and Trademark Office, P.O. Box 1450, Alexandria, Virginia 22313-1450.

(b) *Patent Cooperation Treaty.* Letters and other communications relating to international applications during the international stage and prior to the assignment of a national serial number should be additionally marked “Mail Stop PCT.”

(c) *For reexamination proceedings.*

(1) Requests for *ex parte* reexamination (original request papers only) should be additionally marked “Mail Stop *Ex parte* Reexam.”

(2) Requests for *inter partes* reexamination (original request papers) and all subsequent *inter partes* reexamination correspondence filed in the Office, other than correspondence to the Office of the General Counsel pursuant to § 1.1(a)(3) and § 1.302(c), should be additionally marked “Mail Stop *Inter partes* Reexam.”

(d) *Maintenance fee correspondence.*—

(1) *Payments.* Payments of maintenance fees in patents not submitted electronically should be mailed to: United States Patent and Trademark Office, P.O. Box 371611, Pittsburgh, Pennsylvania 15250-1611.

(2) *Other correspondence.* Correspondence related to maintenance fees other than payments of maintenance fees in patents is not to be mailed to P.O. Box 371611, Pittsburgh, Pennsylvania 15250-1611, but must be mailed to: Mail Stop M Correspondence, Director of the United States Patent and Trademark

Office, P.O. Box 1450, Alexandria, Virginia 22313-1450.

(e) *Patent term extension.* All applications for extension of patent term under 35 U.S.C. 156 and any communications relating thereto intended for the United States Patent and Trademark Office should be additionally marked “Mail Stop Patent Ext.” When appropriate, the communication should also be marked to the attention of a particular individual, as where a decision has been rendered.

(f) *Provisional applications.* The filing of all provisional applications and any communications relating thereto should be additionally marked “Mail Stop Provisional Patent Application.”

[46 FR 29181, May 29, 1981; para. (d) added, 49 FR 34724, Aug. 31, 1984, effective Nov. 1, 1984; para. (e), 49 FR 48416, Dec. 12, 1984, effective Feb. 11, 1985; para. (f) added, 52 FR 9394, Mar. 24, 1987; para. (g) added, 53 FR 16413, May 9, 1988; para. (h) added, 54 FR 37588, Sept. 11, 1989, effective Nov. 16, 1989; para. (i) added, 60 FR 20195, Apr. 25, 1995, effective June 8, 1995; para. (a) revised and para. (g) removed and reserved, 61 FR 56439, Nov. 1, 1996, effective Dec. 2, 1996; para. (b) revised, 64 FR 48900, Sept. 8, 1999, effective Oct. 30, 1999; paras. (a) and (d) revised, 66 FR 39447, July 31, 2001, effective Oct. 1, 2001; revised, 68 FR 14332, Mar. 25, 2003, effective May 1, 2003; para. (a)(2) corrected, 68 FR 19371, Apr. 21, 2003, effective May 1, 2003; section heading, para. (a) introductory text and para. (a)(4) revised, para. (a)(2) removed and reserved, and note following para. (f) removed, 68 FR 48286, Aug. 13, 2003, effective Sept. 12, 2003; para. (c) revised, 68 FR 70996, Dec. 22, 2003, effective Jan. 21, 2004]

### § 1.2 Business to be transacted in writing.

All business with the Patent and Trademark Office should be transacted in writing. The personal attendance of applicants or their attorneys or agents at the Patent and Trademark Office is unnecessary. The action of the Patent and Trademark Office will be based exclusively on the written record in the Office. No attention will be paid to any alleged oral promise, stipulation, or understanding in relation to which there is disagreement or doubt.

### § 1.3 Business to be conducted with decorum and courtesy.

Applicants and their attorneys or agents are required to conduct their business with the United

States Patent and Trademark Office with decorum and courtesy. Papers presented in violation of this requirement will be submitted to the Director and will not be entered. A notice of the non-entry of the paper will be provided. Complaints against examiners and other employees must be made in correspondence separate from other papers.

[Amended, 61 FR 56439, Nov. 1, 1996, effective Dec. 2, 1996; revised, 68 FR 14332, Mar. 25, 2003, effective May 1, 2003; revised, 68 FR 38611, June 30, 2003, effective July 30, 2003]

#### § 1.4 Nature of correspondence and signature requirements.

(a) Correspondence with the Patent and Trademark Office comprises:

(1) Correspondence relating to services and facilities of the Office, such as general inquiries, requests for publications supplied by the Office, orders for printed copies of patents, orders for copies of records, transmission of assignments for recording, and the like, and

(2) Correspondence in and relating to a particular application or other proceeding in the Office. See particularly the rules relating to the filing, processing, or other proceedings of national applications in subpart B, §§ 1.31 to 1.378; of international applications in subpart C, §§ 1.401 to 1.499; of *ex parte* reexaminations of patents in subpart D, §§ 1.501 to 1.570; of interferences in subpart E, §§ 1.601 to 1.690; of extension of patent term in subpart F, §§ 1.710 to 1.785; and of *inter partes* reexaminations of patents in subpart H, §§ 1.902 to 1.997.

(b) Since each file must be complete in itself, a separate copy of every paper to be filed in a patent, patent file, or other proceeding must be furnished for each file to which the paper pertains, even though the contents of the papers filed in two or more files may be identical. The filing of duplicate copies of correspondence in the file of an application, patent, or other proceeding should be avoided, except in situations in which the Office requires the filing of duplicate copies. The Office may dispose of duplicate copies of correspondence in the file of an application, patent, or other proceeding.

(c) Since different matters may be considered by different branches or sections of the United States Patent and Trademark Office, each distinct subject,

inquiry or order must be contained in a separate paper to avoid confusion and delay in answering papers dealing with different subjects.

(d)(1) Each piece of correspondence, except as provided in paragraphs (e) and (f) of this section, filed in an application, patent file, or other proceeding in the Office which requires a person's signature, must:

(i) Be an original, that is, have an original signature personally signed in permanent ink by that person; or

(ii) Be a direct or indirect copy, such as a photocopy or facsimile transmission (§ 1.6(d)), of an original. In the event that a copy of the original is filed, the original should be retained as evidence of authenticity. If a question of authenticity arises, the Office may require submission of the original.

(iii) [Reserved]

(2) The presentation to the Office (whether by signing, filing, submitting, or later advocating) of any paper by a party, whether a practitioner or non-practitioner, constitutes a certification under § 10.18(b) of this chapter. Violations of § 10.18(b)(2) of this chapter by a party, whether a practitioner or non-practitioner, may result in the imposition of sanctions under § 10.18(c) of this chapter. Any practitioner violating § 10.18(b) may also be subject to disciplinary action. See §§ 10.18(d) and 10.23(c)(15).

(e) Correspondence requiring person's signature and relating to registration practice before the Patent and Trademark Office in patent cases, enrollment and disciplinary investigations, or disciplinary proceedings must be submitted with an original signature personally signed in permanent ink by that person.

(f) When a document that is required by statute to be certified must be filed, a copy, including a photocopy or facsimile transmission, of the certification is not acceptable.

(g) An applicant who has not made of record a registered attorney or agent may be required to state whether assistance was received in the preparation or prosecution of the patent application, for which any compensation or consideration was given or charged, and if so, to disclose the name or names of the person or persons providing such assistance. Assistance includes the preparation for the applicant of the specification and amendments or other papers to be filed in the Patent and Trademark Office, as well as other



assistance in such matters, but does not include merely making drawings by draftsmen or stenographic services in typing papers.

[24 FR 10332, Dec. 22, 1959; 43 FR 20461, May 11, 1978; para. (a), 48 FR 2707, Jan. 20, 1983, effective Feb. 27, 1983; para. (a), 49 FR 48416, Dec. 12, 1984, effective Feb. 11, 1985; para. (a)(2), 53 FR 47807, Nov. 28, 1988, effective Jan. 1, 1989; paras. (d)-(f) added, 58 FR 54494, Oct. 22, 1993, effective Nov. 22, 1993; para. (d) revised & para. (g) added, 62 FR 53131, Oct. 10, 1997, effective Dec. 1, 1997; paras. (a)(2) and (d)(1) revised, 64 FR 48900, Sept. 8, 1999, effective Oct. 30, 1999; paras. (b) and (c) revised, 65 FR 54604, Sept. 8, 2000, effective Nov. 7, 2000; para. (a)(2) revised, 65 FR 76756, Dec. 7, 2000, effective Feb. 5, 2001; para. (d)(1)(iii)(A) amended, 67 FR 79520, Dec. 30, 2002, effective Dec. 30, 2002; para. (d)(1)(iii)(B) revised, 68 FR 14332, Mar. 25, 2003, effective May 1, 2003; para. (d)(1)(iii) removed and reserved, paras. (a)(1), (a)(2), (b), (d)(1), introductory text, and (d)(1)(ii) revised, 68 FR 48286, Aug. 13, 2003, effective Sept. 12, 2003]

### § 1.5 Identification of patent, patent application, or patent-related proceeding.

(a) No correspondence relating to an application should be filed prior to receipt of the application number from the Patent and Trademark Office. When a letter directed to the Patent and Trademark Office concerns a previously filed application for a patent, it must identify on the top page in a conspicuous location, the application number (consisting of the series code and the serial number; e.g., 07/123,456), or the serial number and filing date assigned to that application by the Patent and Trademark Office, or the international application number of the international application. Any correspondence not containing such identification will be returned to the sender where a return address is available. The returned correspondence will be accompanied with a cover letter which will indicate to the sender that if the returned correspondence is resubmitted to the Patent and Trademark Office within two weeks of the mail date on the cover letter, the original date of receipt of the correspondence will be considered by the Patent and Trademark Office as the date of receipt of the correspondence. Applicants may use either the Certificate of Mailing or Transmission procedure under § 1.8 or the Express Mail procedure under § 1.10 for resubmissions of returned correspondence if they desire to have the

benefit of the date of deposit in the United States Postal Service. If the returned correspondence is not resubmitted within the two-week period, the date of receipt of the resubmission will be considered to be the date of receipt of the correspondence. The two-week period to resubmit the returned correspondence will not be extended. In addition to the application number, all letters directed to the Patent and Trademark Office concerning applications for patent should also state the name of the applicant, the title of the invention, the date of filing the same, and, if known, the group art unit or other unit within the Patent and Trademark Office responsible for considering the letter and the name of the examiner or other person to which it has been assigned.

(b) When the letter concerns a patent other than for purposes of paying a maintenance fee, it should state the number and date of issue of the patent, the name of the patentee, and the title of the invention. For letters concerning payment of a maintenance fee in a patent, see the provisions of § 1.366(c).

(c) [Reserved]

(d) A letter relating to a reexamination proceeding should identify it as such by the number of the patent undergoing reexamination, the reexamination request control number assigned to such proceeding, and, if known, the group art unit and name of the examiner to which it been assigned.

(e) When a paper concerns an interference, it should state the names of the parties and the number of the interference. The name of the examiner-in-chief assigned to the interference (§ 1.610) and the name of the party filing the paper should appear conspicuously on the first page of the paper.

(f) When a paper concerns a provisional application, it should identify the application as such and include the application number.

[24 FR 10332, Dec. 22, 1959; 46 FR 29181, May 29, 1981; para. (a), 49 FR 552, Jan. 4, 1984, effective Apr. 1, 1984; para. (a), 49 FR 48416, Dec. 12, 1984, effective Feb. 11, 1985; paras. (a) & (b), 53 FR 47807, Nov. 28, 1988, effective Jan. 1, 1989; para. (a) revised, 58 FR 54494, Oct. 22, 1993, effective Nov. 22, 1993; para. (f) added, 61 FR 42790, Aug. 19, 1996, effective Sept. 23, 1996; para. (a) amended, 61 FR 56439, Nov. 1, 1996, effective Dec. 2, 1996; para. (c) revised, 64 FR 48900, Sept. 8, 1999, effective Oct. 30, 1999; section heading revised, para. (c) removed and reserved, 68 FR 48286, Aug. 13, 2003, effective Sept. 12, 2003]

### § 1.6 Receipt of correspondence.

(a) *Date of receipt and Express Mail date of deposit.* Correspondence received in the Patent and Trademark Office is stamped with the date of receipt except as follows:

(1) The Patent and Trademark Office is not open for the filing of correspondence on any day that is a Saturday, Sunday, or Federal holiday within the District of Columbia. Except for correspondence transmitted by facsimile under paragraph (a)(3) of this section, or filed electronically under paragraph (a)(4) of this section, no correspondence is received in the Office on Saturdays, Sundays, or Federal holidays within the District of Columbia.

(2) Correspondence filed in accordance with § 1.10 will be stamped with the date of deposit as “Express Mail” with the United States Postal Service.

(3) Correspondence transmitted by facsimile to the Patent and Trademark Office will be stamped with the date on which the complete transmission is received in the Patent and Trademark Office unless that date is a Saturday, Sunday, or Federal holiday within the District of Columbia, in which case the date stamped will be the next succeeding day which is not a Saturday, Sunday, or Federal holiday within the District of Columbia.

(4) [Reserved]

(b) [Reserved]

(c) *Correspondence delivered by hand.* In addition to being mailed, correspondence may be delivered by hand during hours the Office is open to receive correspondence.

(d) *Facsimile transmission.* Except in the cases enumerated below, correspondence, including authorizations to charge a deposit account, may be transmitted by facsimile. The receipt date accorded to the correspondence will be the date on which the complete transmission is received in the United States Patent and Trademark Office, unless that date is a Saturday, Sunday, or Federal holiday within the District of Columbia. See § 1.6(a)(3). To facilitate proper processing, each transmission session should be limited to correspondence to be filed in a single application or other proceeding before the United States Patent and Trademark Office. The application number of a patent application, the control number of a reexamination proceeding, the interference number of an interference proceeding, or the patent number of a patent

should be entered as a part of the sender’s identification on a facsimile cover sheet. Facsimile transmissions are not permitted and, if submitted, will not be accorded a date of receipt in the following situations:

(1) Correspondence as specified in § 1.4(e), requiring an original signature;

(2) Certified documents as specified in § 1.4(f);

(3) Correspondence which cannot receive the benefit of the certificate of mailing or transmission as specified in § 1.8(a)(2)(i)(A) through (D) and (F), and § 1.8(a)(2)(iii)(A), except that a continued prosecution application under § 1.53(d) may be transmitted to the Office by facsimile;

(4) Drawings submitted under §§ 1.81, 1.83 through 1.85, 1.152, 1.165, 1.174, or 1.437;

(5) A request for reexamination under § 1.510 or § 1.913;

(6) Correspondence to be filed in a patent application subject to a secrecy order under §§ 5.1 through 5.5 of this chapter and directly related to the secrecy order content of the application;

(7) [Reserved]

(8) [Reserved]

(9) Correspondence to be filed in an interference proceeding which consists of a preliminary statement under § 1.621; a transcript of a deposition under § 1.676 or of interrogatories, or cross-interrogatories; or an evidentiary record and exhibits under § 1.653.

(e) *Interruptions in U.S. Postal Service.* If interruptions or emergencies in the United States Postal Service which have been so designated by the Director occur, the Patent and Trademark Office will consider as filed on a particular date in the Office any correspondence which is:

(1) Promptly filed after the ending of the designated interruption or emergency; and

(2) Accompanied by a statement indicating that such correspondence would have been filed on that particular date if it were not for the designated interruption or emergency in the United States Postal Service.

(f) *Facsimile transmission of a patent application under § 1.53(d).* In the event that the Office has no evidence of receipt of an application under § 1.53(d) (a continued prosecution application) transmitted to the Office by facsimile transmission, the party who transmitted the application under § 1.53(d)

may petition the Director to accord the application under § 1.53(d) a filing date as of the date the application under § 1.53(d) is shown to have been transmitted to and received in the Office,

(1) Provided that the party who transmitted such application under § 1.53(d):

(i) Informs the Office of the previous transmission of the application under § 1.53(d) promptly after becoming aware that the Office has no evidence of receipt of the application under § 1.53(d);

(ii) Supplies an additional copy of the previously transmitted application under § 1.53(d); and

(iii) Includes a statement which attests on a personal knowledge basis or to the satisfaction of the Director to the previous transmission of the application under § 1.53(d) and is accompanied by a copy of the sending unit's report confirming transmission of the application under § 1.53(d) or evidence that came into being after the complete transmission and within one business day of the complete transmission of the application under § 1.53(d).

(2) The Office may require additional evidence to determine if the application under § 1.53(d) was transmitted to and received in the Office on the date in question.

[48 FR 2707, Jan. 20, 1983, effective Feb. 27, 1983; 48 FR 4285, Jan. 31, 1983; para. (a), 49 FR 552, Jan. 4, 1984, effective Apr. 1, 1984; revised, 58 FR 54494, Oct. 22, 1993, effective Nov. 22, 1993; para. (a) amended, 61 FR 56439, Nov. 1, 1996, effective Dec. 2, 1996; paras. (d)(3), (d)(6) & (e) amended, para. (f) added, 62 FR 53131, Oct. 10, 1997, effective Dec. 1, 1997; para (a)(1) revised and para. (a)(4) added, 64 FR 48900, Sept. 8, 1999, effective Oct. 30, 1999; para.(d)(9) revised, 65 FR 54604, Sept. 8, 2000, effective Nov. 7, 2000; para. (d)(5) revised, 65 FR 76756, Dec. 7, 2000, effective Feb. 5, 2001; para. (b) removed and reserved and paras. (e), (f) & (f)(1)(iii) revised, 68 FR 14332, Mar. 25, 2003, effective May 1, 2003; paras. (a)(4), (d)(7) and (d)(8) removed and reserved, and paras. (d), introductory text, (d)(3), and (d)(4) revised, 68 FR 48286, Aug. 13, 2003, effective Sept. 12, 2003]

### § 1.7 Times for taking action; Expiration on Saturday, Sunday or Federal holiday.

(a) Whenever periods of time are specified in this part in days, calendar days are intended. When the day, or the last day fixed by statute or by or under this part for taking any action or paying any fee in the United States Patent and Trademark Office falls on

Saturday, Sunday, or on a Federal holiday within the District of Columbia, the action may be taken, or the fee paid, on the next succeeding business day which is not a Saturday, Sunday, or a Federal holiday. See § 1.304 for time for appeal or for commencing civil action.

(b) If the day that is twelve months after the filing date of a provisional application under 35 U.S.C. 111(b) and § 1.53(c) falls on Saturday, Sunday, or on a Federal holiday within the District of Columbia, the period of pendency shall be extended to the next succeeding secular or business day which is not a Saturday, Sunday, or a Federal holiday.

[48 FR 2707, Jan. 20, 1983, effective Feb. 27, 1983; corrected 48 FR 4285, Jan. 31, 1983; revised, 65 FR 14865, Mar. 20, 2000, effective May 29, 2000 (adopted as final, 65 FR 50092, Aug. 16, 2000)]

### § 1.8 Certificate of mailing or transmission.

(a) Except in the cases enumerated in paragraph (a)(2) of this section, correspondence required to be filed in the Patent and Trademark Office within a set period of time will be considered as being timely filed if the procedure described in this section is followed. The actual date of receipt will be used for all other purposes.

(1) Correspondence will be considered as being timely filed if:

(i) The correspondence is mailed or transmitted prior to expiration of the set period of time by being:

(A) Addressed as set out in § 1.1(a) and deposited with the U.S. Postal Service with sufficient postage as first class mail; or

(B) Transmitted by facsimile to the Patent and Trademark Office in accordance with § 1.6(d); and

(ii) The correspondence includes a certificate for each piece of correspondence stating the date of deposit or transmission. The person signing the certificate should have reasonable basis to expect that the correspondence would be mailed or transmitted on or before the date indicated.

(2) The procedure described in paragraph (a)(1) of this section does not apply to, and no benefit will be given to a Certificate of Mailing or Transmission on, the following:

(i) *Relative to Patents and Patent Applications*—

(A) The filing of a national patent application specification and drawing or other correspondence for the purpose of obtaining an application filing date, including a request for a continued prosecution application under § 1.53(d);

(B) The filing of correspondence in an interference which an examiner-in-chief orders to be filed by hand or “Express Mail”;

(C) The filing of agreements between parties to an interference under 35 U.S.C. 135(c);

(D) The filing of an international application for patent;

(E) The filing of correspondence in an international application before the U.S. Receiving Office, the U.S. International Searching Authority, or the U.S. International Preliminary Examining Authority;

(F) The filing of a copy of the international application and the basic national fee necessary to enter the national stage, as specified in § 1.495(b).

(ii) [Reserved]

(iii) *Relative to Disciplinary Proceedings*—

(A) Correspondence filed in connection with a disciplinary proceeding under part 10 of this chapter.

(B) [Reserved]

(b) In the event that correspondence is considered timely filed by being mailed or transmitted in accordance with paragraph (a) of this section, but not received in the Patent and Trademark Office, and the application is held to be abandoned or the proceeding is dismissed, terminated, or decided with prejudice, the correspondence will be considered timely if the party who forwarded such correspondence:

(1) Informs the Office of the previous mailing or transmission of the correspondence promptly after becoming aware that the Office has no evidence of receipt of the correspondence;

(2) Supplies an additional copy of the previously mailed or transmitted correspondence and certificate; and

(3) Includes a statement which attests on a personal knowledge basis or to the satisfaction of the Director to the previous timely mailing or transmission. If the correspondence was sent by facsimile transmission, a copy of the sending unit’s report con-

firmed transmission may be used to support this statement.

(c) The Office may require additional evidence to determine if the correspondence was timely filed.

[41 FR 43721, Oct. 4, 1976; 43 FR 20461, May 11, 1978; para. (a). 47 FR 47381, Oct. 26, 1982, effective Oct. 26, 1982; para. (a), 48 FR 2708, Jan. 20, 1983; para. (a) 49 FR 48416, Dec. 12, 1984, effective Feb. 11, 1985; para. (a), 49 FR 5171, Feb. 6, 1985, effective Mar. 8, 1985; 52 FR 20046, May 28, 1987; subparas. (a)(2)(xiv)-(xvi), 54 FR 37588, Sept. 11, 1989, effective Nov. 16, 1989; revised, 58 FR 54494, Oct. 22, 1993, effective Nov. 22, 1993; para. (a) revised, 61 FR 56439, Nov. 1, 1996, effective Dec. 2, 1996; paras. (a)(2)(i)(A) & (b) revised; 62 FR 53131, Oct. 10, 1997, effective Dec. 1, 1997; para. (a)(2)(i)(F) revised, 67 FR 520, Jan. 4, 2002, effective Apr. 1, 2002; para. (b)(3) revised, 68 FR 14332, Mar. 25, 2003, effective May 1, 2003; para. (a)(2)(ii) removed and reserved, 68 FR 48286, Aug. 13, 2003, effective Sept. 12, 2003]

**§ 1.9 Definitions.**

(a)(1) A national application as used in this chapter means a U.S. application for patent which was either filed in the Office under 35 U.S.C. 111, or which entered the national stage from an international application after compliance with 35 U.S.C. 371.

(2) A provisional application as used in this chapter means a U.S. national application for patent filed in the Office under 35 U.S.C. 111(b).

(3) A nonprovisional application as used in this chapter means a U.S. national application for patent which was either filed in the Office under 35 U.S.C. 111(a), or which entered the national stage from an international application after compliance with 35 U.S.C. 371.

(b) An international application as used in this chapter means an international application for patent filed under the Patent Cooperation Treaty prior to entering national processing at the Designated Office stage.

(c) A published application as used in this chapter means an application for patent which has been published under 35 U.S.C. 122(b).

(d) [Reserved]

(e) [Reserved]

(f) [Reserved]

(g) For definitions in interferences see § 1.601.

(h) A Federal holiday within the District of Columbia as used in this chapter means any day, except Saturdays and Sundays, when the Patent and Trademark Office is officially closed for business for the entire day.

(i) National security classified as used in this chapter means specifically authorized under criteria established by an Act of Congress or Executive Order to be kept secret in the interest of national defense or foreign policy and, in fact, properly classified pursuant to such Act of Congress or Executive Order.

(j) Director as used in this chapter, except for part 10 of this section, means the Under Secretary of Commerce for Intellectual Property and Director of the United States Patent and Trademark Office.

(k) Paper as used in this chapter means a document that may exist in electronic form, or in physical form, and therefore does not necessarily imply physical sheets of paper.

[43 FR 20461, May 11, 1978; 47 FR 40139, Sept. 10, 1982, effective Oct. 1, 1982; 47 FR 43275, Sept. 30, 1982, effective Oct. 1, 1982; para. (d), 49 FR 34724, Aug. 31, 1984, effective Nov. 1, 1984; para. (g), 49 FR 48416, Dec. 12, 1984, effective Feb. 11, 1985; para. (d) revised, 58 FR 54504, Oct. 22, 1993, effective Jan. 3, 1994; para. (a) amended, 60 FR 20195, Apr. 25, 1995, effective June 8, 1995; para. (h) added, 61 FR 56439, Nov. 1, 1996, effective Dec. 2, 1996; paras. (d) & (f) revised, 62 FR 53131, Oct. 10, 1997, effective Dec. 1, 1997; paras. (c)-(f) removed and reserved and para. (i) added, 65 FR 54604, Sept. 8, 2000, effective Nov. 7, 2000; para. (c) revised, 65 FR 57024, Sept. 20, 2000, effective Nov. 29, 2000; para. (j) added, 68 FR 14332, Mar. 25, 2003, effective May 1, 2003; para. (k) added, 68 FR 38611, June 30, 2003, effective July 30, 2003]

### § 1.10 Filing of correspondence by “Express Mail.”

(a)(1) Any correspondence received by the U.S. Patent and Trademark Office (USPTO) that was delivered by the “Express Mail Post Office to Addressee” service of the United States Postal Service (USPS) will be considered filed with the USPTO on the date of deposit with the USPS.

(2) The date of deposit with USPS is shown by the “date in” on the “Express Mail” label or other official USPS notation. If the USPS deposit date cannot be determined, the correspondence will be

accorded the USPTO receipt date as the filing date. See § 1.6(a).

(b) Correspondence should be deposited directly with an employee of the USPS to ensure that the person depositing the correspondence receives a legible copy of the “Express Mail” mailing label with the “date-in” clearly marked. Persons dealing indirectly with the employees of the USPS (such as by deposit in an “Express Mail” drop box) do so at the risk of not receiving a copy of the “Express Mail” mailing label with the desired “date-in” clearly marked. The paper(s) or fee(s) that constitute the correspondence should also include the “Express Mail” mailing label number thereon. See paragraphs (c), (d) and (e) of this section.

(c) Any person filing correspondence under this section that was received by the Office and delivered by the “Express Mail Post Office to Addressee” service of the USPS, who can show that there is a discrepancy between the filing date accorded by the Office to the correspondence and the date of deposit as shown by the “date-in” on the “Express Mail” mailing label or other official USPS notation, may petition the Director to accord the correspondence a filing date as of the “date-in” on the “Express Mail” mailing label or other official USPS notation, provided that:

(1) The petition is filed promptly after the person becomes aware that the Office has accorded, or will accord, a filing date other than the USPS deposit date;

(2) The number of the “Express Mail” mailing label was placed on the paper(s) or fee(s) that constitute the correspondence prior to the original mailing by “Express Mail;” and

(3) The petition includes a true copy of the “Express Mail” mailing label showing the “date-in,” and of any other official notation by the USPS relied upon to show the date of deposit.

(d) Any person filing correspondence under this section that was received by the Office and delivered by the “Express Mail Post Office to Addressee” service of the USPS, who can show that the “date-in” on the “Express Mail” mailing label or other official notation entered by the USPS was incorrectly entered or omitted by the USPS, may petition the Director to accord the correspondence a filing date as of the date

the correspondence is shown to have been deposited with the USPS, provided that:

(1) The petition is filed promptly after the person becomes aware that the Office has accorded, or will accord, a filing date based upon an incorrect entry by the USPS;

(2) The number of the “Express Mail” mailing label was placed on the paper(s) or fee(s) that constitute the correspondence prior to the original mailing by “Express Mail”; and

(3) The petition includes a showing which establishes, to the satisfaction of the Director, that the requested filing date was the date the correspondence was deposited in the “Express Mail Post Office to Addressee” service prior to the last scheduled pickup for that day. Any showing pursuant to this paragraph must be corroborated by evidence from the USPS or that came into being after deposit and within one business day of the deposit of the correspondence in the “Express Mail Post Office to Addressee” service of the USPS.

(e) Any person mailing correspondence addressed as set out in § 1.1(a) to the Office with sufficient postage utilizing the “Express Mail Post Office to Addressee” service of the USPS but not received by the Office, may petition the Director to consider such correspondence filed in the Office on the USPS deposit date, provided that:

(1) The petition is filed promptly after the person becomes aware that the Office has no evidence of receipt of the correspondence;

(2) The number of the “Express Mail” mailing label was placed on the paper(s) or fee(s) that constitute the correspondence prior to the original mailing by “Express Mail”;

(3) The petition includes a copy of the originally deposited paper(s) or fee(s) that constitute the correspondence showing the number of the “Express Mail” mailing label thereon, a copy of any returned postcard receipt, a copy of the “Express Mail” mailing label showing the “date-in,” a copy of any other official notation by the USPS relied upon to show the date of deposit, and, if the requested filing date is a date other than the “date-in” on the “Express Mail” mailing label or other official notation entered by the USPS, a showing pursuant to paragraph (d)(3) of this section that the requested filing date was the date the correspondence was deposited in the “Express Mail

Post Office to Addressee” service prior to the last scheduled pickup for that day; and

(4) The petition includes a statement which establishes, to the satisfaction of the Director, the original deposit of the correspondence and that the copies of the correspondence, the copy of the “Express Mail” mailing label, the copy of any returned postcard receipt, and any official notation entered by the USPS are true copies of the originally mailed correspondence, original “Express Mail” mailing label, returned postcard receipt, and official notation entered by the USPS.

(f) The Office may require additional evidence to determine if the correspondence was deposited as “Express Mail” with the USPS on the date in question.

[48 FR 2708, Jan. 20, 1983, added effective Feb. 27, 1983; 48 FR 4285, Jan. 31, 1983, paras. (a) & (c), 49 FR 552, Jan. 4, 1984, effective Apr. 1, 1984; paras. (a)-(c) revised and paras. (d) - (f) added, 61 FR 56439, Nov. 1, 1996, effective Dec. 2, 1996; paras. (d) & (e) revised, 62 FR 53131, Oct. 10, 1997, effective Dec. 1, 1997; para. (a) revised, 67 FR 36099, May 23, 2002, effective June 24, 2002; paras. (c), (d), (d)(3), (e) & (e)(4) revised, 68 FR 14332, Mar. 25, 2003, effective May 1, 2003; para. (a)(1) revised, 68 FR 48286, Aug. 13, 2003, effective Sept. 12, 2003]

## RECORDS AND FILES OF THE PATENT AND TRADEMARK OFFICE

### § 1.11 Files open to the public.

(a) The specification, drawings, and all papers relating to the file of an abandoned published application, except if a redacted copy of the application was used for the patent application publication, a patent, or a statutory invention registration are open to inspection by the public, and copies may be obtained upon the payment of the fee set forth in § 1.19(b)(2). See § 2.27 for trademark files.

(b) All reissue applications, all applications in which the Office has accepted a request to open the complete application to inspection by the public, and related papers in the application file, are open to inspection by the public, and copies may be furnished upon paying the fee therefor. The filing of reissue applications, other than continued prosecution applications under § 1.53(d) of reissue applications, will be

announced in the *Official Gazette*. The announcement shall include at least the filing date, reissue application and original patent numbers, title, class and subclass, name of the inventor, name of the owner of record, name of the attorney or agent of record, and examining group to which the reissue application is assigned.

(c) All requests for reexamination for which the fee under § 1.20(c) has been paid, will be announced in the *Official Gazette*. Any reexaminations at the initiative of the Director pursuant to § 1.520 will also be announced in the *Official Gazette*. The announcement shall include at least the date of the request, if any, the reexamination request control number or the Director initiated order control number, patent number, title, class and subclass, name of the inventor, name of the patent owner of record, and the examining group to which the reexamination is assigned.

(d) All papers or copies thereof relating to a reexamination proceeding which have been entered of record in the patent or reexamination file are open to inspection by the general public, and copies may be furnished upon paying the fee therefor.

(e) The file of any interference involving a patent, a statutory invention registration, a reissue application, or an application on which a patent has been issued or which has been published as a statutory invention registration, is open to inspection by the public, and copies may be obtained upon paying the fee therefor, if:

- (1) The interference has terminated or
- (2) An award of priority or judgment has been entered as to all parties and all counts.

[42 FR 5593, Jan. 28, 1977; 43 FR 28477, June 30, 1978; 46 FR 29181, May 29, 1981, para. (c), 47 FR 41272, Sept. 17, 1982, effective Oct. 1, 1982; para. (a), 49 FR 48416, Dec. 12, 1984, effective Feb. 11, 1985; paras. (a), (b) and (e), 50 FR 9278, Mar. 7, 1985, effective May 8, 1985; para. (e) revised, 60 FR 14488, Mar. 17, 1995, effective Mar. 17, 1995; para. (b) revised, 62 FR 53131, Oct. 10, 1997, effective Dec. 1, 1997; para. (a) revised, 65 FR 57024, Sept. 20, 2000, effective Nov. 29, 2000; para. (c) revised, 68 FR 14332, Mar. 25, 2003, effective May 1, 2003]

### § 1.12 Assignment records open to public inspection.

(a)(1) Separate assignment records are maintained in the United States Patent and Trademark Office for patents and trademarks. The assignment records, relating to original or reissue patents, including digests and indexes (for assignments recorded on or after May 1, 1957), and published patent applications are open to public inspection at the United States Patent and Trademark Office, and copies of patent assignment records may be obtained upon request and payment of the fee set forth in § 1.19 of this chapter. See § 2.200 of this chapter regarding trademark assignment records.

(2) All records of assignments of patents recorded before May 1, 1957, are maintained by the National Archives and Records Administration (NARA). The records are open to public inspection. Certified and uncertified copies of those assignment records are provided by NARA upon request and payment of the fees required by NARA.

(b) Assignment records, digests, and indexes relating to any pending or abandoned patent application which has not been published under 35 U.S.C. 122(b) are not available to the public. Copies of any such assignment records and related information shall be obtainable only upon written authority of the applicant or applicant's assignee or attorney or agent or upon a showing that the person seeking such information is a bona fide prospective or actual purchaser, mortgagee, or licensee of such application, unless it shall be necessary to the proper conduct of business before the Office or as provided in this part.

(c) Any request by a member of the public seeking copies of any assignment records of any pending or abandoned patent application preserved in confidence under § 1.14, or any information with respect thereto, must:

- (1) Be in the form of a petition including the fee set forth in § 1.17 (h); or
- (2) Include written authority granting access to the member of the public to the particular assignment records from the applicant or applicant's assignee or attorney or agent of record.

(d) An order for a copy of an assignment or other document should identify the reel and frame number where the assignment or document is recorded. If a document is identified without specifying its correct reel and frame, an extra charge as set forth in § 1.21(j) will be made for the time consumed in making a search for such assignment.

[47 FR 41272, Sept. 17, 1982, effective Oct. 1, 1982; paras. (a) and (c), 54 FR 6893, Feb. 15, 1989, effective April 17, 1989; paras. (a) and (d), 56 FR 65142, Dec. 13, 1991, effective Dec. 16, 1991; paras. (a)(1) and (d), 57 FR 29641, July 6, 1992, effective Sept. 4, 1992; para. (a)(2) added, 57 FR 29641, July 6, 1992, effective Sept. 4, 1992; para. (c) amended, 60 FR 20195, Apr. 25, 1995, effective June 8, 1995; para. (c) amended, 61 FR 42790, Aug. 19, 1996, effective Sept. 23, 1996; para. (c)(1) amended, 65 FR 54604, Sept. 8, 2000, effective Nov. 7, 2000; paras. (a)(1) and (b) revised, 65 FR 57024, Sept. 20, 2000, effective Nov. 29, 2000; paras. (a)(1) and (a)(2) revised, 68 FR 48286, Aug. 13, 2003, effective Sept. 12, 2003]

### § 1.13 Copies and certified copies.

(a) Non-certified copies of patents, patent application publications, and of any records, books, papers, or drawings within the jurisdiction of the United States Patent and Trademark Office and open to the public, will be furnished by the United States Patent and Trademark Office to any person, and copies of other records or papers will be furnished to persons entitled thereto, upon payment of the appropriate fee. See § 2.201 of this chapter regarding copies of trademark records.

(b) Certified copies of patents, patent application publications, and trademark registrations and of any records, books, papers, or drawings within the jurisdiction of the United States Patent and Trademark Office and open to the public or persons entitled thereto will be authenticated by the seal of the United States Patent and Trademark Office and certified by the Director, or in his or her name, upon payment of the fee for the certified copy.

[Revised, 58 FR 54504, Oct. 22, 1993, effective Jan. 3, 1994; revised, 65 FR 57024, Sept. 20, 2000, effective Nov. 29, 2000; para. (b) revised, 68 FR 14332, Mar. 25, 2003, effective May 1, 2003; revised, 68 FR 48286, Aug. 13, 2003, effective Sept. 12, 2003; para. (b) revised, 68 FR 70996, Dec. 22, 2003, effective Jan. 21, 2004]

### § 1.14 Patent applications preserved in confidence.

(a) *Confidentiality of patent application information.* Patent applications that have not been published under 35 U.S.C. 122(b) are generally preserved in confidence pursuant to 35 U.S.C. 122(a). Information concerning the filing, pendency, or subject matter of an application for patent, including status information, and access to the application, will only be given to the public as set forth in § 1.11 or in this section.

(1) Records associated with patent applications (see paragraph (g) for international applications) may be available in the following situations:

(i) *Patented applications and statutory invention registrations.* The file of an application that has issued as a patent or published as a statutory invention registration is available to the public as set forth in § 1.11(a). A copy of the patent application-as-filed, the file contents of the application, or a specific document in the file of such an application may be provided upon request and payment of the appropriate fee set forth in § 1.19(b).

(ii) *Published abandoned applications.* The file of an abandoned application that has been published as a patent application publication is available to the public as set forth in § 1.11(a). A copy of the application-as-filed, the file contents of the published application, or a specific document in the file of the published application may be provided to any person upon request, and payment of the appropriate fee set forth in § 1.19(b).

(iii) *Published pending applications.* A copy of the application-as-filed, the file contents of the application, or a specific document in the file of a pending application that has been published as a patent application publication may be provided to any person upon request, and payment of the appropriate fee set forth in § 1.19(b). If a redacted copy of the application was used for the patent application publication, the copy of the specification, drawings, and papers may be limited to a redacted copy. The Office will not provide access to the paper file of a pending application that has been published, except as provided in paragraph (c) or (h) of this section.

(iv) *Unpublished abandoned applications (including provisional applications) that are identified or relied upon.* The file contents of an unpublished, abandoned application may be made available



to the public if the application is identified in a U.S. patent, a statutory invention registration, a U.S. patent application publication, or an international patent application publication of an international application that was published in accordance with PCT Article 21(2). An application is considered to have been identified in a document, such as a patent, when the application number or serial number and filing date, first named inventor, title and filing date or other application specific information are provided in the text of the patent, but not when the same identification is made in a paper in the file contents of the patent and is not included in the printed patent. Also, the file contents may be made available to the public, upon a written request, if benefit of the abandoned application is claimed under 35 U.S.C. 119(e), 120, 121, or 365 in an application that has issued as a U.S. patent, or has published as a statutory invention registration, a U.S. patent application publication, or an international patent application that was published in accordance with PCT Article 21(2). A copy of the application-as-filed, the file contents of the application, or a specific document in the file of the application may be provided to any person upon written request, and payment of the appropriate fee (§ 1.19(b)).

(v) *Unpublished pending applications (including provisional applications) whose benefit is claimed.* A copy of the file contents of an unpublished pending application may be provided to any person, upon written request and payment of the appropriate fee (§ 1.19(b)), if the benefit of the application is claimed under 35 U.S.C. 119(e), 120, 121, or 365 in an application that has issued as a U.S. patent, an application that has published as a statutory invention registration, a U.S. patent application publication, or an international patent application publication that was published in accordance with PCT Article 21(2). A copy of the application-as-filed, or a specific document in the file of the pending application may also be provided to any person upon written request, and payment of the appropriate fee (§ 1.19(b)). The Office will not provide access to the paper file of a pending application, except as provided in paragraph (c) or (h) of this section.

(vi) *Unpublished pending applications (including provisional applications) that are incorporated by reference or otherwise identified.* A copy of

the application as originally filed of an unpublished pending application may be provided to any person, upon written request and payment of the appropriate fee (§ 1.19(b)), if the application is incorporated by reference or otherwise identified in a U.S. patent, a statutory invention registration, a U.S. patent application publication, or an international patent application publication that was published in accordance with PCT Article 21(2). The Office will not provide access to the paper file of a pending application, except as provided in paragraph (c) or (h) of this section.

(vii) *When a petition for access or a power to inspect is required.* Applications that were not published or patented, that are not the subject of a benefit claim under 35 U.S.C. 119(e), 120, 121, or 365 in an application that has issued as a U.S. patent, an application that has published as a statutory invention registration, a U.S. patent application publication, or an international patent application publication that was published in accordance with PCT Article 21(2), or are not identified in a U.S. patent, a statutory invention registration, a U.S. patent application publication, or an international patent application that was published in accordance with PCT Article 21(2), are not available to the public. If an application is identified in the file contents of another application, but not the published patent application or patent itself, a granted petition for access (see paragraph (h)) or a power to inspect (see paragraph (c)) is necessary to obtain the application, or a copy of the application.

(2) Information concerning a patent application may be communicated to the public if the patent application is identified in paragraphs (a)(1)(i) through (a)(1)(vi) of this section. The information that may be communicated to the public (*i.e.*, status information) includes:

(i) Whether the application is pending, abandoned, or patented;

(ii) Whether the application has been published under 35 U.S.C. 122(b);

(iii) The application “numerical identifier” which may be:

(A) The eight-digit application number (the two-digit series code plus the six-digit serial number); or

(B) The six-digit serial number plus any one of the filing date of the national application, the

international filing date, or date of entry into the national stage; and

(iv) Whether another application claims the benefit of the application (*i.e.*, whether there are any applications that claim the benefit of the filing date under 35 U.S.C. 119(e), 120, 121 or 365 of the application), and if there are any such applications, the numerical identifier of the application, the specified relationship between the applications (*e.g.*, continuation), whether the application is pending, abandoned or patented, and whether the application has been published under 35 U.S.C. 122(b).

(b) *Electronic access to an application.* Where a copy of the application papers or access to the application may be made available pursuant to paragraphs (a)(1)(i) through (a)(1)(vi) of this section, the Office may at its discretion provide access to only an electronic copy of the specification, drawings, and file contents of the application.

(c) *Power to inspect a pending or abandoned application.* Access to an application may be provided to any person if the application file is available, and the application contains written authority (*e.g.*, a power to inspect) granting access to such person. The written authority must be signed by:

- (1) An applicant;
- (2) An attorney or agent of record;
- (3) An authorized official of an assignee of record (made of record pursuant to § 3.71 of this chapter); or
- (4) A registered attorney or agent named in the papers accompanying the application papers filed under § 1.53 or the national stage documents filed under § 1.495, if an executed oath or declaration pursuant to § 1.63 or § 1.497 has not been filed.

(d) *Applications reported to Department of Energy.* Applications for patents which appear to disclose, purport to disclose or do disclose inventions or discoveries relating to atomic energy are reported to the Department of Energy, which Department will be given access to the applications. Such reporting does not constitute a determination that the subject matter of each application so reported is in fact useful or is an invention or discovery, or that such application in fact discloses subject matter in categories specified by 42 U.S.C. 2181(c) and (d).

(e) *Decisions by the Director or the Board of Patent Appeals and Interferences.* Any decision by

the Director or the Board of Patent Appeals and Interferences which would not otherwise be open to public inspection may be published or made available for public inspection if:

(1) The Director believes the decision involves an interpretation of patent laws or regulations that would be of precedential value; and

(2) The applicant, or a party involved in an interference for which a decision was rendered, is given notice and an opportunity to object in writing within two months on the ground that the decision discloses a trade secret or other confidential information. Any objection must identify the deletions in the text of the decision considered necessary to protect the information, or explain why the entire decision must be withheld from the public to protect such information. An applicant or party will be given time, not less than twenty days, to request reconsideration and seek court review before any portions of a decision are made public under this paragraph over his or her objection.

(f) *Publication pursuant to § 1.47.* Information as to the filing of an application will be published in the *Official Gazette* in accordance with § 1.47(c).

(g) *International applications.* (1) Copies of international application files for international applications which designate the U.S. and which have been published in accordance with PCT Article 21(2), or copies of a document in such application files, will be furnished in accordance with PCT Articles 30 and 38 and PCT Rules 94.2 and 94.3, upon written request including a showing that the publication of the application has occurred and that the U.S. was designated, and upon payment of the appropriate fee (see § 1.19(b)), if:

(i) With respect to the Home Copy (the copy of the international application kept by the Office in its capacity as the Receiving Office, see PCT Article 12(1)), the international application was filed with the U.S. Receiving Office;

(ii) With respect to the Search Copy (the copy of an international application kept by the Office in its capacity as the International Searching Authority, see PCT Article 12(1)), the U.S. acted as the International Searching Authority, except for the written opinion of the International Searching Authority which shall not be available until the expiration of thirty months from the priority date; or

(iii) With respect to the Examination Copy (the copy of an international application kept by the Office in its capacity as the International Preliminary Examining Authority), the United States acted as the International Preliminary Examining Authority, an International Preliminary Examination Report has issued, and the United States was elected.

(2) A copy of an English language translation of a publication of an international application which has been filed in the United States Patent and Trademark Office pursuant to 35 U.S.C. 154(d)(4) will be furnished upon written request including a showing that the publication of the application in accordance with PCT Article 21(2) has occurred and that the U.S. was designated, and upon payment of the appropriate fee (§ 1.19(b)(4)).

(3) Access to international application files for international applications which designate the U.S. and which have been published in accordance with PCT Article 21(2), or copies of a document in such application files, will be permitted in accordance with PCT Articles 30 and 38 and PCT Rules 44<sup>ter</sup>.1, 94.2 and 94.3, upon written request including a showing that the publication of the application has occurred and that the U.S. was designated.

(4) In accordance with PCT Article 30, copies of an international application-as-filed under paragraph (a) of this section will not be provided prior to the international publication of the application pursuant to PCT Article 21(2).

(5) Access to international application files under paragraphs (a)(1)(i) through (a)(1)(vi) and (g)(3) of this section will not be permitted with respect to the Examination Copy in accordance with PCT Article 38.

(h) *Access or copies in other circumstances.* The Office, either *sua sponte* or on petition, may also provide access or copies of all or part of an application if necessary to carry out an Act of Congress or if warranted by other special circumstances. Any petition by a member of the public seeking access to, or copies of, all or part of any pending or abandoned application preserved in confidence pursuant to paragraph (a) of this section, or any related papers, must include:

(1) The fee set forth in § 1.17(h); and

(2) A showing that access to the application is necessary to carry out an Act of Congress or that

special circumstances exist which warrant petitioner being granted access to all or part of the application.

[42 FR 5593, Jan. 28, 1977; 43 FR 20462, May 11, 1978; para. (e) added, 47 FR 41273, Sept. 17, 1982, effective Oct. 1, 1982; para. (b), 49 FR 552, Jan. 4, 1984, effective Apr. 1, 1984; para. (d), 49 FR 48416, Dec. 12, 1984, effective Feb. 11, 1985; para. (b), 50 FR 9378, Mar. 7, 1985, effective May 8, 1985; 53 FR 23733, June 23, 1988; para. (e), 54 FR 6893, Feb. 15, 1989, effective April 17, 1989; para. (b) revised, 58 FR 54504, Oct. 22, 1993, effective Jan. 3, 1994; para. (e) amended, 60 FR 20195, Apr. 25, 1995, effective June 8, 1995; paras. (a), (b) and (e) amended, 61 FR 42790, Aug. 19, 1996, effective Sept. 23, 1996; para. (a) revised & para. (f) added, 62 FR 53131, Oct. 10, 1997, effective Dec. 1, 1997; para. (g) added, 63 FR 29614, June 1, 1998, effective July 1, 1998, (adopted as final, 63 FR 66040, Dec. 1, 1998); revised, 65 FR 54604, Sept. 8, 2000, effective Nov. 7, 2000; paras. (a), (b), (c), (e), (i) and (j) revised, 65 FR 57024, Sept. 20, 2000, effective Nov. 29, 2000; para (h) corrected, 65 FR 78958, Dec. 18, 2000; para.(i)(2) revised, 66 FR 67087, Dec. 28, 2001, effective Dec. 28, 2001; para. (d)(4) revised, 67 FR 520, Jan. 4, 2002, effective Apr. 1, 2002; paras. (g) & (g)(1) revised, 68 FR 14332, Mar. 25, 2003, effective May 1, 2003; revised, 68 FR 38611, June 30, 2003, effective July 30, 2003; paras. (g)(1)(ii) & (g)(3) revised, 68 FR 58991, Oct. 20, 2003, effective Jan. 1, 2004; para. (g)(1)(ii) corrected, 68 FR 67805, Dec. 4, 2003; para. (g)(5) revised, 68 FR 67805, Dec. 4, 2003, effective Jan. 1, 2004; para. (g)(2) revised, 68 FR 70996, Dec. 22, 2003, effective Jan. 21, 2004]

### § 1.15 [Removed and Reserved]

(Editor's note: substance supplanted by Part 102)

[32 FR 13812, Oct. 4, 1967; 34 FR 18857, Nov. 26, 1969; amended 53 FR 47685, Nov. 25, 1988, effective Dec. 30, 1988; removed and reserved, 68 FR 14332, Mar. 25, 2003, effective May 1, 2003]

## FEES AND PAYMENT OF MONEY

### § 1.16 National application filing fees.

(a) Basic fee for filing each application for an original patent, except provisional, design, or plant applications:

By a small entity (§ 1.27(a)). . . . \$385.00

By other than a small entity . . . . \$770.00

(b) In addition to the basic filing fee in an original application, except provisional applications, for

filing or later presentation of each independent claim in excess of 3:

By a small entity (§ 1.27(a)) . . . . \$43.00

By other than a small entity . . . . \$86.00

(c) In addition to the basic filing fee in an original application, except provisional applications, for filing or later presentation of each claim (whether independent or dependent) in excess of 20 (Note that § 1.75(c) indicates how multiple dependent claims are considered for fee calculation purposes.):

By a small entity (§ 1.27(a)) . . . . \$9.00

By other than a small entity . . . . \$18.00

(d) In addition to the basic filing fee in an original application, except provisional applications, if the application contains, or is amended to contain, a multiple dependent claim(s), per application:

By a small entity (§ 1.27(a)) . . . \$145.00

By other than a small entity . . . \$290.00

(e) Surcharge for filing the basic filing fee or oath or declaration on a date later than the filing date of the application, except provisional applications:

By a small entity (§ 1.27(a)) . . . \$65.00

By other than a small entity . . . \$130.00

(f) Basic fee for filing each design application:

By a small entity (§ 1.27(a)) . . . \$170.00

By other than a small entity . . . \$340.00

(g) Basic fee for filing each plant application, except provisional applications:

By a small entity (§ 1.27(a)) . . . \$265.00

By other than a small entity . . . \$530.00

(h) Basic fee for filing each reissue application:

By a small entity (§ 1.27(a)) . . . \$365.00

By other than a small entity . . . \$770.00

(i) In addition to the basic filing fee in a reissue application, for filing or later presentation of each independent claim which is in excess of the number of independent claims in the original patent:

By a small entity (§ 1.27(a)) . . . \$43.00

By other than a small entity . . . \$86.00

(j) In addition to the basic filing fee in a reissue application, for filing or later presentation of each claim (whether independent or dependent) in excess of 20 and also in excess of the number of claims in the original patent (Note that § 1.75(c) indicates how multiple dependent claims are considered for fee purposes.):

By a small entity (§ 1.27(a)) . . . . \$9.00

By other than a small entity . . . . \$18.00

(k) Basic fee for filing each provisional application:

By a small entity (§ 1.27(a)) . . . . \$80.00

By other than a small entity . . . \$160.00

(l) Surcharge for filing the basic filing fee or cover sheet (§ 1.51(c)(1)) on a date later than the filing date of the provisional application:

By a small entity (§ 1.27(a)) . . . \$25.00

By other than a small entity . . . \$50.00

(m) If the additional fees required by paragraphs (b), (c), (d), (i) and (j) of this section are not paid on filing or on later presentation of the claims for which the additional fees are due, they must be paid or the claims canceled by amendment, prior to the expiration of the time period set for reply by the Office in any notice of fee deficiency.

NOTE.—See §§ 1.445, 1.482 and 1.492 for international application filing and processing fees.

[Added, 47 FR 41273, Sept. 17, 1982, effective date Oct. 1, 1982; 50 FR 31824, Aug. 6, 1985, effective date Oct. 5, 1985; paras. (a), (b), (d) - (i), 54 FR 6893, Feb. 15, 1989, effective Apr. 17, 1989; paras. (a)-(j), 56 FR 65142, Dec. 13, 1991, effective Dec. 16, 1991; paras. (a)-(d) and (f)-(j), 57 FR 38190, Aug. 21, 1992, effective Oct. 1, 1992; paras. (a), (b), (d) and (f)-(i), 59 FR 43736, Aug. 25, 1994, effective Oct. 1, 1994; paras. (a)-(g) amended and paras. (k) and (l) added, 60 FR 20195, Apr. 25, 1995, effective June 8, 1995; paras. (a), (b), (d), & (f)-(i) amended, 60 FR 41018, Aug. 11, 1995, effective Oct. 1, 1995; paras. (a), (b), (d), and (f)-(i) amended and para. (m) added, 61 FR 39585, July 30, 1996, effective Oct. 1, 1996; paras. (a), (b), (d), and (f) - (i) amended, 62 FR 40450, July 29, 1997, effective Oct. 1, 1997; paras. (d) & (l) amended, 62 FR 53131, Oct. 10, 1997, effective Dec. 1, 1997; paras. (a)-(d) and (f)-(j) revised, 63 FR 6758, Dec. 8, 1998, effective Nov. 10, 1998; paras. (a) and (b) revised, 64 FR 67774, Dec. 3, 1999, effective Dec. 29, 1999; paras. (a), (b), (d), and (f)-(i) revised, 65 FR 49193, Aug. 11, 2000, effective Oct. 1, 2000; paras. (a)-(l) revised, 65 FR 78958, Dec. 18, 2000; paras. (a), (b), (d), (f)-(i) and (k) revised, 66 FR 39447, July 31, 2001, effective Oct. 1, 2001; paras. (a), (g), and (h) revised, 67 FR 70847, Nov. 27, 2002, effective Jan. 1, 2003; paras. (a), (b), (d), and (f) through (i) revised, 68 FR 41532, July 14, 2003, effective Oct. 1, 2003]

### § 1.17 Patent application and reexamination processing fees.

(a) Extension fees pursuant to § 1.136(a):

(1) For reply within first month:

- By a small entity (§ 1.27(a)) . . . . \$55.00
- By other than a small entity . . . . \$110.00
- (2) For reply within second month:
  - By a small entity (§ 1.27(a)) . . . \$210.00
  - By other than a small entity . . . . \$420.00
- (3) For reply within third month:
  - By a small entity (§ 1.27(a)) . . . \$475.00
  - By other than a small entity . . . . \$950.00
- (4) For reply within fourth month:
  - By a small entity (§ 1.27(a)) . . . \$740.00
  - By other than a small entity . . . \$1,480.00
- (5) For reply within fifth month:
  - By a small entity (§ 1.27(a)) . . \$1005.00
  - By other than a small entity . . . \$2010.00
- (b) For filing a notice of appeal from the examiner to the Board of Patent Appeals and Interferences:
  - By a small entity (§ 1.27(a)) . . . \$165.00
  - By other than a small entity . . . . \$330.00
- (c) In addition to the fee for filing a notice of appeal, for filing a brief in support of an appeal:
  - By a small entity (§ 1.27(a)) . . . \$165.00
  - By other than a small entity . . . . \$330.00
- (d) For filing a request for an oral hearing before the Board of Patent Appeals and Interferences in an appeal under 35 U.S.C. 134:
  - By a small entity (§ 1.27(a)) . . . \$145.00
  - By other than a small entity . . . . \$290.00
- (e) To request continued examination pursuant to § 1.114:
  - By a small entity (§1.27(a)) . . . . \$385.00
  - By other than a small entity . . . . \$770.00
- (f) [Reserved]
- (g) [Reserved]
- (h) For filing a petition under one of the following sections which refers to this paragraph . . \$130.00
  - § 1.12—for access to an assignment record.
  - § 1.14—for access to an application.
  - § 1.47—for filing by other than all the inventors or a person not the inventor.
  - § 1.53(e)—to accord a filing date.
  - § 1.59—for expungement of information.
  - § 1.84—for accepting color drawings or photographs.
  - § 1.91—for entry of a model or exhibit.
  - § 1.102—to make an application special.
  - § 1.103(a)—to suspend action in an application.
  - § 1.138(c)—to expressly abandon an application to avoid publication.

- § 1.182—for decision on a question not specifically provided for.
- § 1.183—to suspend the rules.
- § 1.295—for review of refusal to publish a statutory invention registration.
- § 1.313—to withdraw an application from issue.
- § 1.314—to defer issuance of a patent.
- § 1.377—for review of decision refusing to accept and record payment of a maintenance fee filed prior to expiration of a patent.
- § 1.378(e)—for reconsideration of decision on petition refusing to accept delayed payment of maintenance fee in an expired patent.
- § 1.644(e)—for petition in an interference.
- § 1.644(f)—for request for reconsideration of a decision on petition in an interference.
- § 1.666(b)—for access to an interference settlement agreement.
- § 1.666(c)—for late filing of interference settlement agreement.
- § 1.741(b)—to accord a filing date to an application under § 1.740 for extension of a patent term.
- § 5.12—for expedited handling of a foreign filing license.
- § 5.15—for changing the scope of a license.
- § 5.25—for retroactive license.
- § 104.3—for waiver of a rule in Part 104 of this title.
- (i) Processing fee for taking action under one of the following sections which refers to this paragraph . . . . . \$130.00
  - § 1.28(c)(3)—for processing a non-itemized fee deficiency based on an error in small entity status.
  - § 1.41—for supplying the name or names of the inventor or inventors after the filing date without an oath or declaration as prescribed by § 1.63, except in provisional applications.
  - § 1.48—for correcting inventorship, except in provisional applications.
  - § 1.52(d)—for processing a nonprovisional application filed with a specification in a language other than English.
  - § 1.53(b)(3)—to convert a provisional application filed under § 1.53(c) into a nonprovisional application under § 1.53(b).
  - § 1.55—for entry of late priority papers.

§ 1.99(e)—for processing a belated submission under § 1.99.

§ 1.103(b)—for requesting limited suspension of action, continued prosecution application (§ 1.53(d)).

§ 1.103(c)—for requesting limited suspension of action, request for continued examination (§ 1.114).

§ 1.103(d)—for requesting deferred examination of an application.

§ 1.217—for processing a redacted copy of a paper submitted in the file of an application in which a redacted copy was submitted for the patent application publication.

§ 1.221—for requesting voluntary publication or republication of an application.

§ 1.497(d)—for filing an oath or declaration pursuant to 35 U.S.C. 371(c)(4) naming an inventive entity different from the inventive entity set forth in the international stage.

§ 3.81—for a patent to issue to assignee, assignment submitted after payment of the issue fee.

(j) For filing a petition to institute a public use proceeding under § 1.292 . . . . \$1,510.00

(k) For filing a request for expedited examination under § 1.155(a) . . . . \$900.00

(l) For filing a petition for the revival of an unavoidably abandoned application under 35 U.S.C. 111, 133, 364, or 371 for the unavoidably delayed payment of the issue fee under 35 U.S.C. 151 or for the revival of an unavoidably terminated reexamination proceeding under 35 U.S.C. 133 (§ 1.137(a)):

By a small entity (§ 1.27(a)) . . . \$55.00

By other than a small entity . . . \$110.00

(m) For filing a petition for the revival of an unintentionally abandoned application, for the unintentionally delayed payment of the fee for issuing a patent, or for the revival of an unintentionally terminated reexamination proceeding under 35 U.S.C. 41(a)(7) (§ 1.137(b)):

By a small entity (§ 1.27(a)) . . . \$665.00

By other than a small entity . . . \$1,330.00

(n) For requesting publication of a statutory invention registration prior to the mailing of the first examiner’s action pursuant to § 1.104. . . . \$920.00 reduced by the amount of the application basic filing fee paid.

(o) For requesting publication of a statutory invention registration after the mailing of the first examiner’s action pursuant to § 1.104. . . . \$1,840.00 reduced by the amount of the application basic filing fee paid.

(p) For an information disclosure statement under § 1.97(c) or (d) or a submission under § 1.99 . . \$180.00

(q) Processing fee for taking action under one of the following sections which refers to this paragraph . . . . \$50.00

§ 1.41—to supply the name or names of the inventor or inventors after the filing date without a cover sheet as prescribed by § 1.51(c)(1) in a provisional application

§ 1.48—for correction of inventorship in a provisional application.

§ 1.53(c)(2) —to convert a nonprovisional application filed under § 1.53(b) to a provisional application under § 1.53(c).

(r) For entry of a submission after final rejection under § 1.129(a):

By a small entity (§ 1.27(a)) . . . \$385.00

By other than a small entity . . . \$770.00

(s) For each additional invention requested to be examined under § 1.129(b):

By a small entity (§ 1.27(a)) . . . \$375.00

By other than a small entity . . . \$750.00

(t) For the acceptance of an unintentionally delayed claim for priority under 35 U.S.C. 119, 120, 121, or 365(a) or (c) (§§ 1.55 and 1.78): . . \$1,330.00

[Added 47 FR 41273, Sept. 17, 1982, effective Oct. 1, 1982; para. (h), 48 FR 2708, Jan. 20, 1983, effective Feb. 27, 1983; para. (h), 49 FR 13461, Apr. 4, 1984, effective June 4, 1984; para. (h), 49 FR 34724, Aug. 31, 1984, effective Nov. 1, 1984; paras. (e), (g), (h) and (i), 49 FR 48416, Dec. 12, 1984, effective Feb. 11, 1985; paras. (h), (n) and (c), 50 FR 9379, Mar. 7, 1985, effective May 8, 1985; 50 FR 31824, Aug. 6, 1985, effective Oct. 5, 1985; paras. (a)-(m), 54 FR 6893, Feb. 15, 1989, 54 FR 9431, March 7, 1989, effective Apr. 17, 1989; para. (i)(1), 54 FR 47518, Nov. 15, 1989, effective Jan. 16, 1990; paras. (a)-(o), 56 FR 65142, Dec. 13, 1991, effective Dec. 16, 1991; para. (i)(1), 57 FR 2021, Jan. 17, 1992, effective March 16, 1992; para. (p) added, 57 FR 2021, Jan. 17, 1992, effective March 16, 1992; para. (i)(1), 57 FR 29642, July 6, 1992, effective Sept. 4, 1992; corrected 57 FR 32439, July 22, 1992; paras. (b)-(g), (j), and (m)-(o), 57 FR 38190, Aug. 21, 1992, effective Oct. 1, 1992; para. (h), 58 FR 38719, July 20, 1993,

effective Oct. 1, 1993; paras. (b)-(g), (j) and (m)-(p), 59 FR 43736, Aug. 25, 1994, effective Oct. 1, 1994; paras. (h) & (i) amended and paras. (q)-(s) added, 67 FR 20195, Apr. 25, 1995, effective June 8, 1995; paras. (b)-(g), (j), (m)-(p), (r) & (s) amended, 60 FR 41018, Aug. 11, 1995, effective Oct. 1, 1995; paras. (b) - (g), (j), (m)-(p), (r) and (s) amended, 61 FR 39585, July 30, 1996, effective Oct. 1, 1996; paras. (b) - (g), (j), (m) - (p), (r) & (s) amended, 62 FR 40450, July 29, 1997, effective Oct. 1, 1997; paras. (a) - (d), (h), (i) & (q) revised, paras. (e) - (g) reserved, 62 FR 53131, Oct. 10, 1997, effective Dec. 1, 1997; para. (q) corrected, 62 FR 61235, Nov. 17, 1997, effective Dec. 1, 1997; paras. (a)-(d), (l) and (m) revised, 63 FR 67578, Dec. 8, 1998, effective Nov. 10, 1998; paras. (r) and (s) revised, 63 FR 67578, Dec. 8, 1998, effective Dec. 8, 1998; paras. (r) and (s) revised, 64 FR 67774, Dec. 3, 1999, effective Jan. 10, 2000; para. (e) added and para. (i) revised, 65 FR 14865, Mar. 20, 2000, effective May 29, 2000 (adopted as final, 65 FR 50092, Aug. 16, 2000); paras. (a)-(e), (m), (r) and (s) revised, 65 FR 49193, August 11, 2000, effective October 1, 2000; paras. (h), (i), (k), (l), (m), (p), and (q) revised, 65 FR 54604, Sept. 8, 2000, effective Nov. 7, 2000; heading and paras. (h), (i), (l), (m) and (p) revised, 65 FR 57024, Sept. 20, 2000, effective Nov. 29, 2000; para. (t) added, 65 FR 57024, Sept. 20, 2000, effective Nov. 29, 2000; paras. (a)-(e), (r) and (s) revised, 65 FR 78958, Dec. 18, 2000; heading and para. (h) revised, 66 FR 47387, Sept. 12, 2001, effective Sept. 12, 2001; paras. (a)(2)-(a)(5), (b)-(e), (m) and (r)-(t) revised, 66 FR 39447, July 31, 2001, effective Oct. 1, 2001; paras. (a)(2) through (a)(5), (e), (m), and (r) through (t) revised, 67 FR 70847, Nov. 27, 2002, effective Jan. 1, 2003; para. (h) revised, 68 FR 38611, June 30, 2003, effective July 30, 2003; paras. (a)(2) through (a)(5), (b) through (e), (m), and (r) through (t) revised, 68 FR 41532, July 14, 2003, effective Oct. 1, 2003]

**§ 1.18 Patent post allowance (including issue) fees.**

- (a) Issue fee for issuing each original or reissue patent, except a design or plant patent:
  - By a small entity (§ 1.27(a)) . . . \$665.00
  - By other than a small entity . . . \$1,330.00
- (b) Issue fee for issuing a design patent:
  - By a small entity (§ 1.27(a)) . . . \$240.00
  - By other than a small entity . . . \$480.00
- (c) Issue fee for issuing a plant patent:
  - By a small entity (§ 1.27(a)) . . . \$320.00
  - By other than a small entity . . . \$640.00
- (d) Publication fee . . . . . \$300.00
- (e) For filing an application for patent term adjustment under § 1.705. . . . . \$200.00

- (f) For filing a request for reinstatement of all or part of the term reduced pursuant to § 1.704(b) in an application for patent term adjustment under § 1.705 . . . . . \$400.00

[Added, 47 FR 41273, Sept. 17, 1982, effective Oct. 1, 1982; 50 FR 31824, Aug. 6, 1985, effective Oct. 5, 1985; revised, 54 FR 6893, Feb. 15, 1989, effective Apr. 17, 1989; revised, 56 FR 65142, Dec. 13, 1991, effective Dec. 16, 1991; paras. (a)-(c), 57 FR 38190, Aug. 21, 1992, effective Oct. 1, 1992; revised, 59 FR 43736, Aug. 25, 1994, effective Oct. 1, 1994; amended, 60 FR 41018, Aug. 11, 1995, effective Oct. 1, 1995; amended, 61 FR 39585, July 30, 1996, effective Oct. 1, 1996; amended, 62 FR 40450, July 29, 1997, effective Oct. 1, 1997; amended, 63 FR 67578, Dec. 8, 1998, effective Nov. 10, 1998; revised, 65 FR 49193, Aug. 11, 2000, effective Oct. 1, 2000; heading revised and paras. (d)-(f) added, 65 FR 56366, Sept. 18, 2000, effective Nov. 17, 2000; para. (d) revised, 65 FR 57024, Sept. 20, 2000, effective Nov. 29, 2000; paras. (a)-(c) revised, 65 FR 78958, Dec. 18, 2000; paras. (a)-(c) revised, 66 FR 39447, July 31, 2001, effective Oct. 1, 2001; paras. (a) through (c) revised, 67 FR 70847, Nov. 27, 2002, effective Jan. 1, 2003; paras. (a) through (c) revised, 68 FR 41532, July 14, 2003, effective Oct. 1, 2003]

**§ 1.19 Document supply fees.**

The United States Patent and Trademark Office will supply copies of the following documents upon payment of the fees indicated. The copies will be in black and white unless the original document is in color, a color copy is requested and the fee for a color copy is paid.

- (a) Uncertified copies of patent application publications and patents:
  - (1) Printed copy of the paper portion of a patent application publication or patent, including a design patent, statutory invention registration, or defensive publication document. Service includes preparation of copies by the Office within two to three business days and delivery by United States Postal Service; and preparation of copies by the Office within one business day of receipt and delivery to an Office Box or by electronic means (e.g., facsimile, electronic mail) . . . . . \$3.00
  - (2) Printed copy of a plant patent in color: . . \$15.00
  - (3) Color copy of a patent (other than a plant patent) or statutory invention registration containing a color drawing . . . . . \$25.00

(b) Certified and uncertified copies of Office documents:

(1) Certified or uncertified copy of the paper portion of patent application as filed processed within seven calendar days . . . . . \$20.00

(2) Certified or uncertified copy of paper portion of patent-related file wrapper and contents:

(i) File wrapper and paper contents of 400 or fewer pages . . . . . \$200.00

(ii) Additional fee for each additional 100 pages or portion thereof. . . . . \$40.00

(iii) Additional fee for certification. \$25.00

(3) Certified or uncertified copy on compact disc of patent-related file-wrapper contents that were submitted on compact disc:

(i) First compact disc in a single order . . . \$55.00

(ii) Each additional compact disc in the single order of paragraph (b)(3)(i) of this section . . . \$15.00

(4) Certified or uncertified copy of Office records, per document except as otherwise provided in this section . . . . . \$25.00

(5) For assignment records, abstract of title and certification, per patent . . . . . \$25.00

(c) Library service (35 U.S.C. 13): For providing to libraries copies of all patents issued annually, per annum . . . . . \$50.00

(d) For list of all United States patents and statutory invention registrations in a subclass. . . . . \$3.00

(e) Uncertified statement as to status of the payment of maintenance fees due on a patent or expiration of a patent. . . . . \$10.00

(f) Uncertified copy of a non-United States patent document, per document. . . . . \$25.00

(g) [Reserved]

(h) [Reserved]

[Added 47 FR 41273, Sept. 17, 1982, effective date Oct. 1, 1982; para. (b), 49 FR 552, Jan. 4, 1984, effective date Apr. 1, 1984; paras. (f) and (g) added, 49 FR 34724, Aug. 31, 1984, effective date Nov. 1, 1984; paras. (a) and (c), 50 FR 9379, Mar. 7, 1985, effective date May 8, 1985; 50 FR 31825, Aug. 6, 1985, effective date Oct. 5, 1985; revised, 54 FR 6893, Feb. 15, 1989; 54 FR 9432, March 7, 1989, effective Apr. 17, 1989, revised 56 FR 65142, Dec. 13, 1991, effective Dec. 16, 1991; paras. (b)(4), (f) and (h), 57 FR 38190, Aug. 21, 1992, effective Oct. 1, 1992; para. (a)(3), 58 FR 38719, July 20, 1993, effective Oct. 1,

1993; paras. (a)(1)(ii), (a)(1)(iii), (b)(1)(i), & (b)(1)(ii) amended, 60 FR 41018, Aug. 11, 1995, effective Oct. 1, 1995; paras. (a)(2) and (a)(3) amended, 62 FR 40450, July 29, 1997, effective Oct. 1, 1997; paras. (a)(1)(i) through (a)(1)(iii) revised, 64 FR 67486, Dec. 2, 1999, effective Dec. 2, 1999; introductory text and paras. (a) and (b) revised, 65 FR 54604, Sept. 8, 2000, effective Nov. 7, 2000; paras. (g) and (h) removed and reserved, 65 FR 54604, Sept. 8, 2000, effective Nov. 7, 2000; para. (a) revised, 65 FR 57024, Sept. 20, 2000, effective Nov. 29, 2000; paras. (a)(1) and (b)(1) revised, 67 FR 70847, Nov. 27, 2002, effective Jan. 1, 2003]

**§ 1.20 Post issuance fees.**

(a) For providing a certificate of correction for applicant’s mistake (§ 1.323). . . . . \$100.00

(b) Processing fee for correcting inventorship in a patent (§ 1.324). . . . . \$130.00

(c) In reexamination proceedings

(1) For filing a request for *ex parte* reexamination (§ 1.510(a)). . . . . \$2,520.00

(2) For filing a request for *inter partes* reexamination (§ 1.915(a)). . . . . \$8,800.00

(d) For filing each statutory disclaimer (§ 1.321):

By a small entity (§ 1.27(a)) . . . . \$55.00

By other than a small entity . . . . \$110.00

(e) For maintaining an original or reissue patent, except a design or plant patent, based on an application filed on or after December 12, 1980, in force beyond four years; the fee is due by three years and six months after the original grant:

By small entity (§ 1.27(a)) . . . . \$455.00

By other than a small entity . . . . \$910.00

(f) For maintaining an original or reissue patent, except a design or plant patent, based on an application filed on or after December 12, 1980, in force beyond eight years; the fee is due by seven years and six months after the original grant:

By a small entity (§ 1.27(a)) . . \$1,045.00

By other than a small entity . . . \$2,090.00

(g) For maintaining an original or reissue patent, except a design or plant patent, based on an application filed on or after December 12, 1980, in force beyond twelve years; the fee is due by eleven years and six months after the original grant:

By a small entity (§ 1.27(a)) . . \$1,610.00

By other than a small entity . . . \$3,220.00



(h) Surcharge for paying a maintenance fee during the six-month grace period following the expiration of three years and six months, seven years and six months, and eleven years and six months after the date of the original grant of a patent based on an application filed on or after December 12, 1980:

By a small entity (§ 1.27(a)) . . . . \$65.00

By other than a small entity . . . . \$130.00

(i) Surcharge for accepting a maintenance fee after expiration of a patent for non-timely payment of a maintenance fee where the delay in payment is shown to the satisfaction of the Director to have been

—

(1) Unavoidable . . . . . \$700.00

(2) Unintentional . . . . . \$1,640.00

(j) For filing an application for extension of the term of a patent

(1) Application for extension under § 1.740 . \$1,120.00

(2) Initial application for interim extension under § 1.790 . . . . . \$420.00

(3) Subsequent application for interim extension under § 1.790 . . . . . \$220.00

[Added 47 FR 41273, Sept. 17, 1982, effective date Oct. 1, 1982; paras. (k), (l) and (m) added, 49 FR 34724, Aug. 31, 1984, effective date Nov. 1, 1984; paras. (c), (f), (g) and (m), 50 FR 9379, Mar. 7, 1985, effective date May 8, 1985; 50 FR 31825, Aug. 6, 1985, effective date Oct. 5, 1985; 51 FR 28057, Aug. 4, 1986; 52 FR 9394, Mar. 24, 1987; paras. (a)-(n), 54 FR 6893, Feb. 15, 1989, 54 FR 8053, Feb. 24, 1989, effective Apr. 17, 1989; revised 56 FR 65142, Dec. 13, 1991, effective Dec. 16, 1991; paras. (a), (c), (e)-(g) and (i), 57 FR 38190, Aug. 21, 1992, effective Oct. 1, 1992; para. (i), 58 FR 44277, Aug. 20, 1993, effective Sept. 20, 1993; paras. (c), (e)-(g), (i)(1) and (j), 59 FR 43736, Aug. 25, 1994, effective Oct. 1, 1994; para. (j) revised, 60 FR 25615, May 12, 1995, effective July 11, 1995; paras. (c), (e)-(g), (i)(2), & (j)(1) amended, 60 FR 41018, Aug. 11, 1995, effective Oct. 1, 1995; paras. (a), (e) - (g), (i)(1), (i)(2), and (j)(1) - (j)(3) amended, 61 FR 39585, July 30, 1996, effective Oct. 1, 1996; paras. (c), (e) - (g), (i)(1), (i)(2), and (j)(1) - (j)(3) amended, 62 FR 40450, July 29, 1997, effective Oct. 1, 1997; paras. (d)-(g) revised, 63 FR 67578, Dec. 8, 1998, effective Nov. 10, 1998; para. (e) revised, 64 FR 67774, Dec. 3, 1999, effective Dec. 29, 1999; paras. (e)-(g) revised, 65 FR 49193, Aug. 11, 2000, effective Oct. 1, 2000; paras. (b) and (d)-(h) revised, 65 FR 78958, Dec. 18, 2000; para. (b) corrected, 65 FR 80755, Dec. 22, 2000; para. (c) revised, 65 FR 76756, Dec. 7, 2000, effective Feb. 5, 2001; paras. (e)-(g) revised, 66 FR

39447, July 31, 2001, effective Oct. 1, 2001; paras. (e) through (g) revised, 67 FR 70847, Nov. 27, 2002, effective Jan. 1, 2003; para. (i) revised, 68 FR 14332, Mar. 25, 2003, effective May 1, 2003; paras. (e) through (g) revised, 68 FR 41532, July 14, 2003, effective Oct. 1, 2003]

**§ 1.21 Miscellaneous fees and charges.**

The Patent and Trademark Office has established the following fees for the services indicated:

(a) Registration of attorneys and agents:

(1) For admission to examination for registration to practice:

(i) Application Fee (non-refundable) . . . . \$40.00

(ii) Registration examination fee . \$310.00

(2) On registration to practice . . . . \$100.00

(3) For reinstatement to practice . . . . \$40.00

(4) For certificate of good standing as an attorney or agent . . . . . \$10.00

Suitable for framing . . . . . \$20.00

(5) For review of decision of the Director of Enrollment and Discipline under § 10.2(c) . . \$130.00

(6) For requesting regrading of an examination under § 10.7(c):

(i) Regrading of seven or fewer questions \$230.00

(ii) Regrading of eight or more questions . \$460.00

(b) Deposit accounts:

(1) For establishing a deposit account \$10.00

(2) Service charge for each month when the balance at the end of the month is below \$1,000. . . . \$25.00

(3) Service charge for each month when the balance at the end of the month is below \$300 for restricted subscription deposit accounts used exclusively for subscription order of patent copies as issued \$25.00

(c) Disclosure document: For filing a disclosure document . . . . . \$10.00

(d) Delivery box: Local delivery box rental, per annum . . . . . \$50.00

(e) International type search reports: For preparing an international type search report of an international type search made at the time of the first action on the merits in a national patent application . . \$40.00

(f) [Reserved]

- (g) Self-service copy charge, per page . . \$0.25
- (h) For recording each assignment, agreement, or other paper relating to the property in a patent or application, per property . . . . . \$40.00
- (i) Publication in *Official Gazette*: For publication in the *Official Gazette* of a notice of the availability of an application or a patent for licensing or sale:
  - Each application or patent . . . . . \$25.00
- (j) Labor charges for services, per hour or fraction thereof . . . . . \$40.00
- (k) For items and services that the Director finds may be supplied, for which fees are not specified by statute or by this part, such charges as may be determined by the Director with respect to each such item or service . . . . . Actual cost
- (l) For processing and retaining any application abandoned pursuant to § 1.53(f), unless the required basic filing fee (§ 1.16) has been paid . . . . . \$130.00
- (m) For processing each payment refused (including a check returned “unpaid”) or charged back by a financial institution . . . . . \$50.00
- (n) For handling an application in which proceedings are terminated pursuant to § 1.53(e) \$130.00
- (o) [Reserved]

[Added 47 FR 41274, Sept. 17, 1982, effective date Oct. 1, 1982; paras. (b) and (l), 49 FR 553, Jan. 4, 1984, effective date Apr. 1, 1984; paras. (a)(5) and (6) added, 50 FR 5171, Feb. 6, 1985, effective date Apr. 8, 1985; 50 FR 31825, Aug. 6, 1985, effective date Oct. 5, 1985; paras. (a), (b)(1), (d)-(j), (l)-(m), 54 FR 6893, Feb. 15, 1989; 54 FR 8053, Feb. 24, 1989; 54 FR 9432, March 7, 1989, effective Apr. 17, 1989; para. (n) added 54 FR 47518, Nov. 15, 1989, effective Jan. 16, 1990; paras. (o)-(q) added 54 FR 50942, Dec.11, 1989, effective Feb. 12, 1990; paras. (a)-(c), (e)-(h), (j)-(l) & (n) amended, 56 FR 65142, Dec. 13, 1991, effective Dec. 16, 1991; paras. (p) and (q) deleted, 56 FR 65142, Dec. 13, 1991, effective Dec. 16, 1991; paras. (a)(1), (a)(5), (a)(6), (b)(2), (b)(3), (e) and (i), 57 FR 38190, Aug. 21, 1992, effective Oct. 1, 1992; para. (p) added, 57 FR 38190, Aug. 21, 1992, effective Oct. 1, 1992; para. (p) deleted, 59 FR 43736, Aug.25, 1994, effective Oct. 1, 1994; para. (l) amended, 60 FR 20195, Apr. 25, 1995, effective June 8, 1995; para. (a)(1) amended, 60 FR 41018, Aug. 11, 1995, effective Oct. 1, 1995; paras. (a)(1), (a)(3) and (a)(6) revised, 61 FR 39585, July 30, 1996, effective Oct. 1, 1996; paras. (a)(1)(ii), (a)(6), and (j) amended, 62 FR 40450, July 29, 1997, effective Oct. 1, 1997; paras. (l) & (n) revised, 62 FR 53131, Oct. 10, 1997, effective Dec. 1, 1997; para. (a)(6)(ii) revised, 63 FR 67578, Dec. 8, 1998, effective Dec. 8, 1998; para (m)

revised, 65 FR 33455, May 24, 2000, effective July 24, 2000; para. (a)(6) revised, 65 FR 49193, Aug. 11, 2000, effective Oct. 1, 2000; para. (o) removed and reserved, 66 FR 39447, July 31, 2001, effective Oct. 1, 2001; para. (k) revised, 68 FR 14332, Mar. 25, 2003, effective May 1, 2003]

**§ 1.22 Fees payable in advance.**

(a) Patent fees and charges payable to the United States Patent and Trademark Office are required to be paid in advance; that is, at the time of requesting any action by the Office for which a fee or charge is payable with the exception that under § 1.53 applications for patent may be assigned a filing date without payment of the basic filing fee.

(b) All fees paid to the United States Patent and Trademark Office must be itemized in each individual application, patent, or other proceeding in such a manner that it is clear for which purpose the fees are paid. The Office may return fees that are not itemized as required by this paragraph. The provisions of § 1.5(a) do not apply to the resubmission of fees returned pursuant to this paragraph.

[48 FR 2708, Jan. 20, 1983, effective Feb. 27, 1983; para. (b) revised, 65 FR 54604, Sept. 8, 2000, effective Nov. 7, 2000; revised, 68 FR 48286, Aug. 13, 2003, effective Sept. 12, 2003]

**§ 1.23 Method of payment.**

(a) All payments of money required for United States Patent and Trademark Office fees, including fees for the processing of international applications (§ 1.445), shall be made in U.S. dollars and in the form of a cashier’s or certified check, Treasury note, national bank notes, or United States Postal Service money order. If sent in any other form, the Office may delay or cancel the credit until collection is made. Checks and money orders must be made payable to the Director of the United States Patent and Trademark Office. (Checks made payable to the Commissioner of Patents and Trademarks will continue to be accepted.) Payments from foreign countries must be payable and immediately negotiable in the United States for the full amount of the fee required. Money sent to the Office by mail will be at the risk of the sender, and letters containing money should be registered with the United States Postal Service.

(b) Payments of money required for United States Patent and Trademark Office fees may also be made by credit card. Payment of a fee by credit card must specify the amount to be charged to the credit card and such other information as is necessary to process the charge, and is subject to collection of the fee. The Office will not accept a general authorization to charge fees to a credit card. If credit card information is provided on a form or document other than a form provided by the Office for the payment of fees by credit card, the Office will not be liable if the credit card number becomes public knowledge.

[43 FR 20462, May 11, 1978; revised, 64 FR 48900, Sept. 8, 1999, effective Oct. 30, 1999; revised, 65 FR 33455, May 24, 2000, effective June 5, 2000]

#### § 1.24 [Reserved]

[47 FR 41274, Sept. 17, 1982, effective Oct. 1, 1982; 48 FR 2708, Jan. 20, 1983, effective date Feb. 27, 1983; 50 FR 31825, Aug. 6, 1985, effective Oct. 5, 1985; 51 FR 28057, Aug. 4, 1986; 56 FR 65142, Dec. 13, 1991, effective Dec. 16, 1991; para. (b) revised, 65 FR 54604, Sept. 8, 2000, effective Nov. 7, 2000; removed and reserved, 65 FR 57024, Sept. 20, 2000, effective Nov. 29, 2000]

#### § 1.25 Deposit accounts.

(a) For the convenience of attorneys, and the general public in paying any fees due, in ordering services offered by the Office, copies of records, etc., deposit accounts may be established in the Patent and Trademark Office upon payment of the fee for establishing a deposit account § 1.21(b)(1)). A minimum deposit of \$1,000 is required for paying any fee due or in ordering any services offered by the Office. However, a minimum deposit of \$300 may be paid to establish a restricted subscription deposit account used exclusively for subscription order of patent copies as issued. At the end of each month, a deposit account statement will be rendered. A remittance must be made promptly upon receipt of the statement to cover the value of items or services charged to the account and thus restore the account to its established normal deposit value. An amount sufficient to cover all fees, services, copies, etc., requested must always be on deposit. Charges to accounts with insufficient funds will not be accepted. A service charge (§ 1.21(b)(2)) will be assessed for each month that the

balance at the end of the month is below \$1,000. For restricted subscription deposit accounts, a service charge (§ 1.21(b)(3)) will be assessed for each month that the balance at the end of the month is below \$300.

(b) Filing, issue, appeal, international-type search report, international application processing, petition, and post-issuance fees may be charged against these accounts if sufficient funds are on deposit to cover such fees. A general authorization to charge all fees, or only certain fees, set forth in §§ 1.16 to 1.18 to a deposit account containing sufficient funds may be filed in an individual application, either for the entire pendency of the application or with a particular paper filed. An authorization to charge fees under § 1.16 in an international application entering the national stage under 35 U.S.C. 371 will be treated as an authorization to charge fees under § 1.492. An authorization to charge fees set forth in § 1.18 to a deposit account is subject to the provisions of § 1.311(b). An authorization to charge to a deposit account the fee for a request for reexamination pursuant to § 1.510 or § 1.913 and any other fees required in a reexamination proceeding in a patent may also be filed with the request for reexamination. An authorization to charge a fee to a deposit account will not be considered payment of the fee on the date the authorization to charge the fee is effective as to the particular fee to be charged unless sufficient funds are present in the account to cover the fee.

(c) A deposit account holder may replenish the deposit account by submitting a payment to the United States Patent and Trademark Office. A payment to replenish a deposit account must be submitted by one of the methods set forth in paragraphs (c)(1), (c)(2), (c)(3), or (c)(4) of this section.

(1) A payment to replenish a deposit account may be submitted by electronic funds transfer through the Federal Reserve Fedwire System, which requires that the following information be provided to the deposit account holder's bank or financial institution:

(i) Name of the Bank, which is Treas NYC (Treasury New York City);

(ii) Bank Routing Code, which is 021030004;

(iii) United States Patent and Trademark Office account number with the Department of the Treasury, which is 13100001; and

(iv) The deposit account holder's company name and deposit account number.

(2) A payment to replenish a deposit account may be submitted by credit card or electronic funds transfer over the Office's Internet Web site ([www.uspto.gov](http://www.uspto.gov)).

(3) A payment to replenish a deposit account may be submitted by mail with the USPS to: Director of the United States Patent and Trademark Office, P.O. Box 70541, Chicago, Illinois 60673.

(4) A payment to replenish a deposit account may be submitted by mail with a private delivery service or hand-carrying the payment to: Director of the United States Patent and Trademark Office, Deposit Accounts, One Crystal Park, 2011 Crystal Drive, Suite 307, Arlington, Virginia 22202.

[49 FR 553, Jan. 4, 1984, effective Apr. 1, 1984; 47 FR 41274, Sept. 17, 1982, effective Oct. 1, 1982; 50 FR 31826, Aug. 6, 1985, effective Oct. 5, 1985; para. (b) revised, 65 FR 54604, Sept. 8, 2000, effective Nov. 7, 2000; para (b) revised, 65 FR 76756, Dec. 7, 2000, effective Feb. 5, 2001; para. (b) revised, 67 FR 520, Jan. 4, 2002, effective Apr. 1, 2002; para. (c) added, 68 FR 14332, Mar. 25, 2003, effective May 1, 2003]

### § 1.26 Refunds.

(a) The Director may refund any fee paid by mistake or in excess of that required. A change of purpose after the payment of a fee, such as when a party desires to withdraw a patent filing for which the fee was paid, including an application, an appeal, or a request for an oral hearing, will not entitle a party to a refund of such fee. The Office will not refund amounts of twenty-five dollars or less unless a refund is specifically requested, and will not notify the payor of such amounts. If a party paying a fee or requesting a refund does not provide the banking information necessary for making refunds by electronic funds transfer (31 U.S.C. 3332 and 31 CFR part 208), or instruct the Office that refunds are to be credited to a deposit account, the Director may require such information, or use the banking information on the payment instrument to make a refund. Any refund of a fee paid by credit card will be by a credit to the credit card account to which the fee was charged.

(b) Any request for refund must be filed within two years from the date the fee was paid, except as otherwise provided in this paragraph or in § 1.28(a). If

the Office charges a deposit account by an amount other than an amount specifically indicated in an authorization (§ 1.25(b)), any request for refund based upon such charge must be filed within two years from the date of the deposit account statement indicating such charge, and include a copy of that deposit account statement. The time periods set forth in this paragraph are not extendable.

(c) If the Director decides not to institute a reexamination proceeding, for *ex parte* reexaminations filed under § 1.510, a refund of \$1,690 will be made to the reexamination requester. For *inter partes* reexaminations filed under § 1.913, a refund of \$7,970 will be made to the reexamination requester. The reexamination requester should indicate the form in which any refund should be made (*e.g.*, by check, electronic funds transfer, credit to a deposit account, etc.). Generally, reexamination refunds will be issued in the form that the original payment was provided.

[47 FR 41274, Sept. 17, 1982, effective Oct. 1, 1982; 50 FR 31826 Aug. 6, 1985, effective Oct. 5, 1985; para. (c), 54 FR 6893, Feb. 15, 1989, effective Apr. 17, 1989; para. (c), 56 FR 65142, Dec. 13, 1991, effective Dec. 16, 1991; paras. (a) and (c), 57 FR 38190, Aug. 21, 1992, effective Oct. 1, 1992; para. (a) revised, 62 FR 53131, Oct. 10, 1997, effective Dec. 1, 1997; para. (a) revised and para. (b) added, 65 FR 54604, Sept. 8, 2000, effective Nov. 7, 2000; para. (c) revised, 65 FR 76756, Dec. 7, 2000, effective Feb. 5, 2001; paras. (a) & (c) revised, 68 FR 14332, Mar. 25, 2003, effective May 1, 2003; para. (a) revised, 68 FR 48286, Aug. 13, 2003, effective Sept. 12, 2003]

### § 1.27 Definition of small entities and establishing status as a small entity to permit payment of small entity fees; when a determination of entitlement to small entity status and notification of loss of entitlement to small entity status are required; fraud on the Office.

(a) *Definition of small entities.* A small entity as used in this chapter means any party (person, small business concern, or nonprofit organization) under paragraphs (a)(1) through (a)(3) of this section.

(1) *Person.* A person, as used in paragraph (c) of this section, means any inventor or other individual (*e.g.*, an individual to whom an inventor has transferred some rights in the invention), who has not assigned, granted, conveyed, or licensed, and is under

no obligation under contract or law to assign, grant, convey, or license, any rights in the invention. An inventor or other individual who has transferred some rights, or is under an obligation to transfer some rights in the invention to one or more parties, can also qualify for small entity status if all the parties who have had rights in the invention transferred to them also qualify for small entity status either as a person, small business concern, or nonprofit organization under this section.

(2) *Small business concern.* A small business concern, as used in paragraph (c) of this section, means any business concern that:

(i) Has not assigned, granted, conveyed, or licensed, and is under no obligation under contract or law to assign, grant, convey, or license, any rights in the invention to any person, concern, or organization which would not qualify for small entity status as a person, small business concern, or nonprofit organization.

(ii) Meets the standards set forth in 13 CFR part 121 to be eligible for reduced patent fees. Questions related to standards for a small business concern may be directed to: Small Business Administration, Size Standards Staff, 409 Third Street, S.W., Washington, D.C. 20416.

(3) *Nonprofit Organization.* A nonprofit organization, as used in paragraph (c) of this section, means any nonprofit organization that:

(i) Has not assigned, granted, conveyed, or licensed, and is under no obligation under contract or law to assign, grant, convey, or license, any rights in the invention to any person, concern, or organization which would not qualify as a person, small business concern, or a nonprofit organization, and

(ii) Is either:

(A) A university or other institution of higher education located in any country;

(B) An organization of the type described in section 501(c)(3) of the Internal Revenue Code of 1986 (26 U.S.C. 501(c)(3)) and exempt from taxation under section 501(a) of the Internal Revenue Code (26 U.S.C. 501(a));

(C) Any nonprofit scientific or educational organization qualified under a nonprofit organization statute of a state of this country (35 U.S.C. 201(i)); or

(D) Any nonprofit organization located in a foreign country which would qualify as a nonprofit organization under paragraphs (a)(3)(ii)(B) of this section or (a)(3)(ii)(C) of this section if it were located in this country.

(4) *License to a Federal agency.* (i) For persons under paragraph (a)(1) of this section, a license to the Government resulting from a rights determination under Executive Order 10096 does not constitute a license so as to prohibit claiming small entity status.

(ii) For small business concerns and nonprofit organizations under paragraphs (a)(2) and (a)(3) of this section, a license to a Federal agency resulting from a funding agreement with that agency pursuant to 35 U.S.C. 202(c)(4) does not constitute a license for the purposes of paragraphs (a)(2)(i) and (a)(3)(i) of this section.

(b) *Establishment of small entity status permits payment of reduced fees.* A small entity, as defined in paragraph (a) of this section, who has properly asserted entitlement to small entity status pursuant to paragraph (c) of this section will be accorded small entity status by the Office in the particular application or patent in which entitlement to small entity status was asserted. Establishment of small entity status allows the payment of certain reduced patent fees pursuant to 35 U.S.C. 41(h).

(c) *Assertion of small entity status.* Any party (person, small business concern or nonprofit organization) should make a determination, pursuant to paragraph (f) of this section, of entitlement to be accorded small entity status based on the definitions set forth in paragraph (a) of this section, and must, in order to establish small entity status for the purpose of paying small entity fees, actually make an assertion of entitlement to small entity status, in the manner set forth in paragraphs (c)(1) or (c)(3) of this section, in the application or patent in which such small entity fees are to be paid.

(1) *Assertion by writing.* Small entity status may be established by a written assertion of entitlement to small entity status. A written assertion must:

(i) Be clearly identifiable;

(ii) Be signed (see paragraph (c)(2) of this section); and

(iii) Convey the concept of entitlement to small entity status, such as by stating that applicant is a small entity, or that small entity status is entitled to

be asserted for the application or patent. While no specific words or wording are required to assert small entity status, the intent to assert small entity status must be clearly indicated in order to comply with the assertion requirement.

(2) *Parties who can sign and file the written assertion.* The written assertion can be signed by:

(i) One of the parties identified in § 1.33(b) (e.g., an attorney or agent registered with the Office), § 3.73(b) of this chapter notwithstanding, who can also file the written assertion;

(ii) At least one of the individuals identified as an inventor (even though a § 1.63 executed oath or declaration has not been submitted), notwithstanding § 1.33(b)(4), who can also file the written assertion pursuant to the exception under § 1.33(b) of this part; or

(iii) An assignee of an undivided part interest, notwithstanding §§ 1.33(b)(3) and 3.73(b) of this chapter, but the partial assignee cannot file the assertion without resort to a party identified under § 1.33(b) of this part.

(3) *Assertion by payment of the small entity basic filing or basic national fee.* The payment, by any party, of the exact amount of one of the small entity basic filing fees set forth in §§ 1.16(a), (f), (g), (h), or (k), or one of the small entity basic national fees set forth in §§ 1.492(a)(1), (a)(2), (a)(3), (a)(4), or (a)(5), will be treated as a written assertion of entitlement to small entity status even if the type of basic filing or basic national fee is inadvertently selected in error.

(i) If the Office accords small entity status based on payment of a small entity basic filing or basic national fee under paragraph (c)(3) of this section that is not applicable to that application, any balance of the small entity fee that is applicable to that application will be due along with the appropriate surcharge set forth in § 1.16(e), or § 1.16(l).

(ii) The payment of any small entity fee other than those set forth in paragraph (c)(3) of this section (whether in the exact fee amount or not) will not be treated as a written assertion of entitlement to small entity status and will not be sufficient to establish small entity status in an application or a patent.

(4) *Assertion required in related, continuing, and reissue applications.* Status as a small entity must be specifically established by an assertion in each

related, continuing and reissue application in which status is appropriate and desired. Status as a small entity in one application or patent does not affect the status of any other application or patent, regardless of the relationship of the applications or patents. The refiling of an application under § 1.53 as a continuation, divisional, or continuation-in-part application (including a continued prosecution application under § 1.53(d)), or the filing of a reissue application, requires a new assertion as to continued entitlement to small entity status for the continuing or reissue application.

(d) *When small entity fees can be paid.* Any fee, other than the small entity basic filing fees and the small entity national fees of paragraph (c)(3) of this section, can be paid in the small entity amount only if it is submitted with, or subsequent to, the submission of a written assertion of entitlement to small entity status, except when refunds are permitted by § 1.28(a).

(e) *Only one assertion required.*

(1) An assertion of small entity status need only be filed once in an application or patent. Small entity status, once established, remains in effect until changed pursuant to paragraph (g)(1) of this section. Where an assignment of rights or an obligation to assign rights to other parties who are small entities occurs subsequent to an assertion of small entity status, a second assertion is not required.

(2) Once small entity status is withdrawn pursuant to paragraph (g)(2) of this section, a new written assertion is required to again obtain small entity status.

(f) *Assertion requires a determination of entitlement to pay small entity fees.* Prior to submitting an assertion of entitlement to small entity status in an application, including a related, continuing, or reissue application, a determination of such entitlement should be made pursuant to the requirements of paragraph (a) of this section. It should be determined that all parties holding rights in the invention qualify for small entity status. The Office will generally not question any assertion of small entity status that is made in accordance with the requirements of this section, but note paragraph (h) of this section.

(g)(1) *New determination of entitlement to small entity status is needed when issue and maintenance fees are due.* Once status as a small entity has been

established in an application or patent, fees as a small entity may thereafter be paid in that application or patent without regard to a change in status until the issue fee is due or any maintenance fee is due.

(2) *Notification of loss of entitlement to small entity status is required when issue and maintenance fees are due.* Notification of a loss of entitlement to small entity status must be filed in the application or patent prior to paying, or at the time of paying, the earliest of the issue fee or any maintenance fee due after the date on which status as a small entity as defined in paragraph (a) of this section is no longer appropriate. The notification that small entity status is no longer appropriate must be signed by a party identified in § 1.33(b). Payment of a fee in other than the small entity amount is not sufficient notification that small entity status is no longer appropriate.

(h) *Fraud attempted or practiced on the Office.*

(1) Any attempt to fraudulently establish status as a small entity, or pay fees as a small entity, shall be considered as a fraud practiced or attempted on the Office.

(2) Improperly, and with intent to deceive, establishing status as a small entity, or paying fees as a small entity, shall be considered as a fraud practiced or attempted on the Office.

[47 FR 40139, Sept. 10, 1982, added effective Oct. 1, 1982; para. (c) added, 47 FR 43276, Sept. 30, 1982; paras. (b), (c), and (d), 49 FR 553, Jan. 4, 1984, effective Apr. 1, 1984; revised, 62 FR 53131, Oct. 10, 1997, effective Dec. 1, 1997; revised, 65 FR 54604, Sept. 8, 2000, effective Sept. 8, 2000]

**§ 1.28 Refunds when small entity status is later established; how errors in small entity status are excused.**

(a) *Refunds based on later establishment of small entity status.* A refund pursuant to § 1.26, based on establishment of small entity status, of a portion of fees timely paid in full prior to establishing status as a small entity may only be obtained if an assertion under § 1.27(c) and a request for a refund of the excess amount are filed within three months of the date of the timely payment of the full fee. The three-month time period is not extendable under § 1.136. Status as a small entity is waived for any fee by the failure to establish the status prior to paying, at the

time of paying, or within three months of the date of payment of, the full fee.

(b) *Date of payment.*

(1) The three-month period for requesting a refund, pursuant to paragraph (a) of this section, starts on the date that a full fee has been paid;

(2) The date when a deficiency payment is paid in full determines the amount of deficiency that is due, pursuant to paragraph (c) of this section.

(c) *How errors in small entity status are excused.* If status as a small entity is established in good faith, and fees as a small entity are paid in good faith, in any application or patent, and it is later discovered that such status as a small entity was established in error, or that through error the Office was not notified of a loss of entitlement to small entity status as required by § 1.27(g)(2), the error will be excused upon: compliance with the separate submission and itemization requirements of paragraphs (c)(1) and (c)(2) of this section, and the deficiency payment requirement of paragraph (c)(2) of this section:

(1) *Separate submission required for each application or patent.* Any paper submitted under this paragraph must be limited to the deficiency payment (all fees paid in error), required by paragraph (c)(2) of this section, for one application or one patent. Where more than one application or patent is involved, separate submissions of deficiency payments (*e.g.*, checks) and itemizations are required for each application or patent. See § 1.4(b).

(2) *Payment of deficiency owed.* The deficiency owed, resulting from the previous erroneous payment of small entity fees, must be paid.

(i) *Calculation of the deficiency owed.* The deficiency owed for each previous fee erroneously paid as a small entity is the difference between the current fee amount (for other than a small entity) on the date the deficiency is paid in full and the amount of the previous erroneous (small entity) fee payment. The total deficiency payment owed is the sum of the individual deficiency owed amounts for each fee amount previously erroneously paid as a small entity. Where a fee paid in error as a small entity was subject to a fee decrease between the time the fee was paid in error and the time the deficiency is paid in full, the deficiency owed is equal to the amount (previously) paid in error;

(ii) *Itemization of the deficiency payment.*

An itemization of the total deficiency payment is required. The itemization must include the following information:

(A) Each particular type of fee that was erroneously paid as a small entity, (e.g., basic statutory filing fee, two-month extension of time fee) along with the current fee amount for a non-small entity;

(B) The small entity fee actually paid, and when. This will permit the Office to differentiate, for example, between two one-month extension of time fees erroneously paid as a small entity but on different dates;

(C) The deficiency owed amount (for each fee erroneously paid); and

(D) The total deficiency payment owed, which is the sum or total of the individual deficiency owed amounts set forth in paragraph (c)(2)(ii)(C) of this section.

(3) *Failure to comply with requirements.* If the requirements of paragraphs (c)(1) and (c)(2) of this section are not complied with, such failure will either: be treated as an authorization for the Office to process the deficiency payment and charge the processing fee set forth in § 1.17(i), or result in a requirement for compliance within a one-month non-extendable time period under § 1.136(a) to avoid the return of the fee deficiency paper, at the option of the Office.

(d) *Payment of deficiency operates as notification of loss of status.* Any deficiency payment (based on a previous erroneous payment of a small entity fee) submitted under paragraph (c) of this section will be treated under § 1.27(g)(2) as a notification of a loss of entitlement to small entity status.

[47 FR 40140, Sept. 10, 1982, added effective Oct. 1, 1982; para. (a), 49 FR 553, Jan. 4, 1984, effective Apr. 1, 1984; para. (d)(2), 57 FR 2021, Jan. 17, 1992, effective Mar. 16, 1992; para. (c) revised, 58 FR 54504, Oct. 22, 1993, effective Jan. 3, 1994; para. (a) revised, 60 FR 20195, Apr. 25, 1995, effective June 8, 1995; paras. (a) & (c) revised, 62 FR 53131, Oct. 10 1997, effective Dec. 1, 1997; revised, 65 FR 54604, Sept. 8, 2000, effective Nov. 7, 2000]

## Subpart B — National Processing Provisions

### PROSECUTION OF APPLICATION AND APPOINTMENT OF ATTORNEY OR AGENT

#### § 1.31 Applicants may be represented by a registered attorney or agent.

An applicant for patent may file and prosecute his or her own case, or he or she may be represented by a registered attorney, registered agent, or other individual authorized to practice before the Patent and Trademark Office in patent cases. See §§ 10.6 and 10.9 of this subchapter. The Patent and Trademark Office cannot aid in the selection of a registered attorney or agent.

[50 FR 5171, Feb. 6, 1985, effective Mar. 8, 1985]

#### § 1.32 [Reserved]

[Deleted 57 FR 29642, July 6, 1992, effective Sept. 4, 1992]

#### § 1.33 Correspondence respecting patent applications, reexamination proceedings, and other proceedings.

(a) *Correspondence address and daytime telephone number.* When filing an application, a correspondence address must be set forth in either an application data sheet (§ 1.76), or elsewhere, in a clearly identifiable manner, in any paper submitted with an application filing. If no correspondence address is specified, the Office may treat the mailing address of the first named inventor (if provided, see §§ 1.76(b)(1) and 1.63(c)(2)) as the correspondence address. The Office will direct all notices, official letters, and other communications relating to the application to the correspondence address. The Office will not engage in double correspondence with an applicant and a registered attorney or agent, or with more than one registered attorney or agent except as deemed necessary by the Director. If more than one correspondence address is specified, the Office will establish one as the correspondence address. For the party to whom correspondence is to be addressed, a daytime telephone number should be supplied in a clearly identifiable manner and may be changed by any party who may change the correspondence



address. The correspondence address may be changed as follows:

(1) *Prior to filing of § 1.63 oath or declaration by any of the inventors.* If a § 1.63 oath or declaration has not been filed by any of the inventors, the correspondence address may be changed by the party who filed the application. If the application was filed by a registered attorney or agent, any other registered practitioner named in the transmittal papers may also change the correspondence address. Thus, the inventor(s), any registered practitioner named in the transmittal papers accompanying the original application, or a party that will be the assignee who filed the application, may change the correspondence address in that application under this paragraph.

(2) *Where a § 1.63 oath or declaration has been filed by any of the inventors.* If a § 1.63 oath or declaration has been filed, or is filed concurrent with the filing of an application, by any of the inventors, the correspondence address may be changed by the parties set forth in paragraph (b) of this section, except for paragraph (b)(2).

(b) *Amendments and other papers.* Amendments and other papers, except for written assertions pursuant to § 1.27(c)(2)(ii) of this part, filed in the application must be signed by:

(1) A registered attorney or agent of record appointed in compliance with § 1.34(b);

(2) A registered attorney or agent not of record who acts in a representative capacity under the provisions of § 1.34(a);

(3) An assignee as provided for under § 3.71(b) of this chapter; or

(4) All of the applicants (§ 1.41(b)) for patent, unless there is an assignee of the entire interest and such assignee has taken action in the application in accordance with § 3.71 of this chapter.

(c) All notices, official letters, and other communications for the patent owner or owners in a reexamination proceeding will be directed to the attorney or agent of record (see § 1.34(b)) in the patent file at the address listed on the register of patent attorneys and agents maintained pursuant to §§ 10.5 and 10.11 or, if no attorney or agent is of record, to the patent owner or owners at the address or addresses of record. Amendments and other papers filed in a reexamination proceeding on behalf of the patent owner must be signed by the patent owner, or if there is more than

one owner by all the owners, or by an attorney or agent of record in the patent file, or by a registered attorney or agent not of record who acts in a representative capacity under the provisions of § 1.34(a). Double correspondence with the patent owner or owners and the patent owner's attorney or agent, or with more than one attorney or agent, will not be undertaken. If more than one attorney or agent is of record and a correspondence address has not been specified, correspondence will be held with the last attorney or agent made of record.

(d) A "correspondence address" or change thereto may be filed with the Patent and Trademark Office during the enforceable life of the patent. The "correspondence address" will be used in any correspondence relating to maintenance fees unless a separate "fee address" has been specified. See § 1.363 for "fee address" used solely for maintenance fee purposes.

[36 FR 12617, July 2, 1971; 46 FR 29181, May 29, 1981; para. (d) added, 49 FR 34724, Aug. 31, 1984, effective Nov. 1, 1984; para. (c), 50 FR 5171, Feb. 6, 1985, effective Mar. 8, 1985; paras. (a) & (b) revised, 62 FR 53131, Oct. 10 1997, effective Dec. 1, 1997; paras. (a) and (b) revised, 65 FR 54604, Sept. 8, 2000, effective Nov. 7, 2000; para. (a) revised, 68 FR 14332, Mar. 25, 2003, effective May 1, 2003]

### § 1.34 Recognition for representation.

(a) When a registered attorney or agent acting in a representative capacity, pursuant to § 1.31, appears in person or signs a paper in practice before the United States Patent and Trademark Office in a patent case, his or her personal appearance or signature shall constitute a representation to the United States Patent and Trademark Office that under the provisions of this subchapter and the law, he or she is authorized to represent the particular party in whose behalf he or she acts. In filing such a paper, the registered attorney or agent should specify his or her registration number with his or her signature. Further proof of authority to act in a representative capacity may be required.

(b) When a registered attorney or agent shall have filed his or her power of attorney, or authorization, duly executed by the person or persons entitled to prosecute an application or a patent involved in a reexamination proceeding, pursuant to § 1.31, he or

she is a principal registered attorney or agent of record in the case. A principal registered attorney or agent, so appointed, may appoint an associate registered attorney or agent who shall also then be of record.

[46 FR 29181, May 29, 1981; para. (a), 50 FR 5171, Feb. 6, 1985, effective Mar. 6, 1985; revised, 65 FR 54604, Sept. 8, 2000, effective Nov. 7, 2000]

### § 1.36 Revocation of power of attorney or authorization; withdrawal of attorney or agent.

A power of attorney or authorization of agent, pursuant to § 1.31, may be revoked at any stage in the proceedings of a case, and a registered attorney or agent may withdraw, upon application to and approval by the Director. A registered attorney or agent, except an associate registered attorney or agent whose address is the same as that of the principal registered attorney or agent, will be notified of the revocation of the power of attorney or authorization, and the applicant or patent owner will be notified of the withdrawal of the registered attorney or agent. An assignment will not of itself operate as a revocation of a power or authorization previously given, but the assignee of the entire interest may revoke previous powers and be represented by a registered attorney or agent of the assignee's own selection. See § 1.613(d) for withdrawal in an interference.

[49 FR 48416, Dec. 12, 1984, effective Feb. 11, 1985; revised, 65 FR 54604, Sept. 8, 2000, effective Nov. 7, 2000; revised, 68 FR 14332, Mar. 25, 2003, effective May 1, 2003]

## WHO MAY APPLY FOR A PATENT

### § 1.41 Applicant for patent.

(a) A patent is applied for in the name or names of the actual inventor or inventors.

(1) The inventorship of a nonprovisional application is that inventorship set forth in the oath or declaration as prescribed by § 1.63, except as provided for in §§ 1.53(d)(4) and 1.63(d). If an oath or declaration as prescribed by § 1.63 is not filed during the pendency of a nonprovisional application, the inventorship is that inventorship set forth in the application papers filed pursuant to § 1.53(b), unless appli-

cant files a paper, including the processing fee set forth in § 1.17(i), supplying or changing the name or names of the inventor or inventors.

(2) The inventorship of a provisional application is that inventorship set forth in the cover sheet as prescribed by § 1.51(c)(1). If a cover sheet as prescribed by § 1.51(c)(1) is not filed during the pendency of a provisional application, the inventorship is that inventorship set forth in the application papers filed pursuant to § 1.53(c), unless applicant files a paper including the processing fee set forth in § 1.17(q), supplying or changing the name or names of the inventor or inventors.

(3) In a nonprovisional application filed without an oath or declaration as prescribed by § 1.63 or a provisional application filed without a cover sheet as prescribed by § 1.51(c)(1), the name, residence, and citizenship of each person believed to be an actual inventor should be provided when the application papers pursuant to § 1.53(b) or § 1.53(c) are filed.

(4) The inventorship of an international application entering the national stage under 35 U.S.C. 371 is that inventorship set forth in the international application, which includes any change effected under PCT Rule 92bis. See § 1.497(d) and (f) for filing an oath or declaration naming an inventive entity different from the inventive entity named in the international application, or if a change to the inventive entity has been effected under PCT Rule 92bis subsequent to the execution of any declaration filed under PCT Rule 4.17(iv) (§ 1.48(f)(1) does not apply to an international application entering the national stage under 35 U.S.C. 371).

(b) Unless the contrary is indicated the word "applicant" when used in these sections refers to the inventor or joint inventors who are applying for a patent, or to the person mentioned in §§ 1.42, 1.43 or 1.47 who is applying for a patent in place of the inventor.

(c) Any person authorized by the applicant may physically or electronically deliver an application for patent to the Office on behalf of the inventor or inventors, but an oath or declaration for the application (§ 1.63) can only be made in accordance with § 1.64.

(d) A showing may be required from the person filing the application that the filing was authorized where such authorization comes into question.

[48 FR 2708, Jan. 20, 1983; 48 FR 4285, Jan. 31, 1983; para. (a) revised, 62 FR 53131, Oct. 10, 1997, effective Dec. 1, 1997; paras. (a) and (c) revised, 65 FR 54604, Sept. 8, 2000, effective Nov. 7, 2000; para. (a)(4) revised, 67 FR 520, Jan. 4, 2002, effective Apr. 1, 2002]

#### § 1.42 When the inventor is dead.

In case of the death of the inventor, the legal representative (executor, administrator, etc.) of the deceased inventor may make the necessary oath or declaration, and apply for and obtain the patent. Where the inventor dies during the time intervening between the filing of the application and the granting of a patent thereon, the letters patent may be issued to the legal representative upon proper intervention.

[48 FR 2709, Jan. 20, 1983, effective Feb. 27, 1983]

#### § 1.43 When the inventor is insane or legally incapacitated.

In case an inventor is insane or otherwise legally incapacitated, the legal representative (guardian, conservator, etc.) of such inventor may make the necessary oath or declaration, and apply for and obtain the patent.

[48 FR 2709, Jan. 20, 1983, effective Feb. 27, 1983]

#### § 1.44 [Reserved]

[Removed and reserved, 65 FR 54604, Sept. 8, 2000, effective Sept. 8, 2000]

#### § 1.45 Joint inventors.

(a) Joint inventors must apply for a patent jointly and each must make the required oath or declaration: neither of them alone, nor less than the entire number, can apply for a patent for an invention invented by them jointly, except as provided in § 1.47.

(b) Inventors may apply for a patent jointly even though

(1) They did not physically work together or at the same time,

(2) Each inventor did not make the same type or amount of contribution, or

(3) Each inventor did not make a contribution to the subject matter of every claim of the application.

(c) If multiple inventors are named in a nonprovisional application, each named inventor must have made a contribution, individually or jointly, to the subject matter of at least one claim of the application and the application will be considered to be a joint application under 35 U.S.C. 116. If multiple inventors are named in a provisional application, each named inventor must have made a contribution, individually or jointly, to the subject matter disclosed in the provisional application and the provisional application will be considered to be a joint application under 35 U.S.C. 116.

[paras. (b) and (c), 47 FR 41274, Sept. 17, 1982, effective Oct. 1, 1982; 48 FR 2709, Jan. 20, 1983, effective Feb. 27, 1983; 50 FR 9379, Mar. 7, 1985, effective May 8, 1985; para. (c) revised, 60 FR 20195, Apr. 25, 1995, effective June 8, 1995]

#### § 1.46 Assigned inventions and patents.

In case the whole or a part interest in the invention or in the patent to be issued is assigned, the application must still be made or authorized to be made, and an oath or declaration signed, by the inventor or one of the persons mentioned in §§ 1.42, 1.43, or 1.47. However, the patent may be issued to the assignee or jointly to the inventor and the assignee as provided in § 3.81.

[48 FR 2709, Jan. 20, 1983, effective Feb. 27, 1983; 57 FR 29642, July 6, 1992, effective Sept. 4, 1992]

#### § 1.47 Filing when an inventor refuses to sign or cannot be reached.

(a) If a joint inventor refuses to join in an application for patent or cannot be found or reached after diligent effort, the application may be made by the other inventor on behalf of himself or herself and the nonsigning inventor. The oath or declaration in such an application must be accompanied by a petition including proof of the pertinent facts, the fee set forth in § 1.17(h), and the last known address of the nonsigning inventor. The nonsigning inventor may subsequently join in the application by filing an oath or declaration complying with § 1.63.

(b) Whenever all of the inventors refuse to execute an application for patent, or cannot be found or reached after diligent effort, a person to whom an inventor has assigned or agreed in writing to assign

the invention, or who otherwise shows sufficient proprietary interest in the matter justifying such action, may make application for patent on behalf of and as agent for all the inventors. The oath or declaration in such an application must be accompanied by a petition including proof of the pertinent facts, a showing that such action is necessary to preserve the rights of the parties or to prevent irreparable damage, the fee set forth in § 1.17(h), and the last known address of all of the inventors. An inventor may subsequently join in the application by filing an oath or declaration complying with § 1.63.

(c) The Office will send notice of the filing of the application to all inventors who have not joined in the application at the address(es) provided in the petition under this section, and publish notice of the filing of the application in the *Official Gazette*. The Office may dispense with this notice provision in a continuation or divisional application, if notice regarding the filing of the prior application was given to the non-signing inventor(s).

[47 FR 41275, Sept. 17, 1982, effective Oct. 1, 1982; 48 FR 2709, Jan. 20, 1983, effective Feb. 27, 1983; revised, 62 FR 53131, Oct. 10, 1997, effective Dec. 1, 1997; revised, 65 FR 54604, Sept. 8, 2000, effective Nov. 7, 2000]

**§ 1.48 Correction of inventorship in a patent application, other than a reissue application, pursuant to 35 U.S.C. 116.**

(a) *Nonprovisional application after oath/declaration filed.* If the inventive entity is set forth in error in an executed § 1.63 oath or declaration in a nonprovisional application, and such error arose without any deceptive intention on the part of the person named as an inventor in error or on the part of the person who through error was not named as an inventor, the inventorship of the nonprovisional application may be amended to name only the actual inventor or inventors. If the nonprovisional application is involved in an interference, the amendment must comply with the requirements of this section and must be accompanied by a motion under § 1.634. Amendment of the inventorship requires:

- (1) A request to correct the inventorship that sets forth the desired inventorship change;
- (2) A statement from each person being added as an inventor and from each person being

deleted as an inventor that the error in inventorship occurred without deceptive intention on his or her part;

(3) An oath or declaration by the actual inventor or inventors as required by § 1.63 or as permitted by §§ 1.42, 1.43 or § 1.47;

(4) The processing fee set forth in § 1.17(i); and

(5) If an assignment has been executed by any of the original named inventors, the written consent of the assignee (see § 3.73(b) of this chapter).

(b) *Nonprovisional application—fewer inventors due to amendment or cancellation of claims.* If the correct inventors are named in a nonprovisional application, and the prosecution of the nonprovisional application results in the amendment or cancellation of claims so that fewer than all of the currently named inventors are the actual inventors of the invention being claimed in the nonprovisional application, an amendment must be filed requesting deletion of the name or names of the person or persons who are not inventors of the invention being claimed. If the application is involved in an interference, the amendment must comply with the requirements of this section and must be accompanied by a motion under § 1.634. Amendment of the inventorship requires:

(1) A request, signed by a party set forth in § 1.33(b), to correct the inventorship that identifies the named inventor or inventor's being deleted and acknowledges that the inventor's invention is no longer being claimed in the nonprovisional application; and

(2) The processing fee set forth in § 1.17(i).

(c) *Nonprovisional application—inventors added for claims to previously unclaimed subject matter.* If a nonprovisional application discloses unclaimed subject matter by an inventor or inventors not named in the application, the application may be amended to add claims to the subject matter and name the correct inventors for the application. If the application is involved in an interference, the amendment must comply with the requirements of this section and must be accompanied by a motion under § 1.634. Amendment of the inventorship requires:

(1) A request to correct the inventorship that sets forth the desired inventorship change;

(2) A statement from each person being added as an inventor that the addition is necessitated

by amendment of the claims and that the inventorship error occurred without deceptive intention on his or her part;

(3) An oath or declaration by the actual inventors as required by § 1.63 or as permitted by §§ 1.42, 1.43, or § 1.47;

(4) The processing fee set forth in § 1.17(i); and

(5) If an assignment has been executed by any of the original named inventors, the written consent of the assignee (see § 3.73(b) of this chapter).

(d) *Provisional application—adding omitted inventors.* If the name or names of an inventor or inventors were omitted in a provisional application through error without any deceptive intention on the part of the omitted inventor or inventors, the provisional application may be amended to add the name or names of the omitted inventor or inventors. Amendment of the inventorship requires:

(1) A request, signed by a party set forth in § 1.33(b), to correct the inventorship that identifies the inventor or inventors being added and states that the inventorship error occurred without deceptive intention on the part of the omitted inventor or inventors; and

(2) The processing fee set forth in § 1.17(q).

(e) *Provisional application—deleting the name or names of the inventor or inventors.* If a person or persons were named as an inventor or inventors in a provisional application through error without any deceptive intention on the part of such person or persons, an amendment may be filed in the provisional application deleting the name or names of the person or persons who were erroneously named. Amendment of the inventorship requires:

(1) A request to correct the inventorship that sets forth the desired inventorship change;

(2) A statement by the person or persons whose name or names are being deleted that the inventorship error occurred without deceptive intention on the part of such person or persons;

(3) The processing fee set forth in § 1.17(q); and

(4) If an assignment has been executed by any of the original named inventors, the written consent of the assignee (see § 3.73(b) of this chapter).

(f)(1) *Nonprovisional application—filing executed oath/declaration corrects inventorship.* If the

correct inventor or inventors are not named on filing a nonprovisional application under § 1.53(b) without an executed oath or declaration under § 1.63 by any of the inventors, the first submission of an executed oath or declaration under § 1.63 by any of the inventors during the pendency of the application will act to correct the earlier identification of inventorship. See §§ 1.41(a)(4) and 1.497(d) and (f) for submission of an executed oath or declaration to enter the national stage under 35 U.S.C. 371 naming an inventive entity different from the inventive entity set forth in the international stage.

(2) *Provisional application filing cover sheet corrects inventorship.* If the correct inventor or inventors are not named on filing a provisional application without a cover sheet under § 1.51(c)(1), the later submission of a cover sheet under § 1.51(c)(1) during the pendency of the application will act to correct the earlier identification of inventorship.

(g) *Additional information may be required.* The Office may require such other information as may be deemed appropriate under the particular circumstances surrounding the correction of inventorship.

(h) *Reissue applications not covered.* The provisions of this section do not apply to reissue applications. See §§ 1.171 and 1.175 for correction of inventorship in a patent via a reissue application.

(i) *Correction of inventorship in patent or interference.* See § 1.324 for correction of inventorship in a patent, and § 1.634 for correction of inventorship in an interference.

[48 FR 2709, Jan. 20, 1983, effective Feb. 27, 1983; 49 FR 48416, Dec. 12, 1984, effective Feb. 11, 1985; 50 FR 9379, Mar. 7, 1985, effective May 8, 1985; para. (a), 57 FR 56446, Nov. 30, 1992, effective Jan. 4, 1993; revised, 60 FR 20195, Apr. 25, 1995, effective June 8, 1995; revised, 62 FR 53131, Oct. 10, 1997, effective Dec. 1, 1997; revised, 65 FR 54604, Sept. 8, 2000, effective Nov. 7, 2000; para. (f)(1) revised, 67 FR 520, Jan. 4, 2002, effective Apr. 1, 2002]

## THE APPLICATION

### § 1.51 General requisites of an application.

(a) Applications for patents must be made to the Director of the United States Patent and Trademark Office.

(b) A complete application filed under § 1.53(b) or § 1.53(d) comprises:

(1) A specification as prescribed by 35 U.S.C. 112, including a claim or claims, see §§ 1.71 to 1.77;

(2) An oath or declaration, see §§ 1.63 and 1.68;

(3) Drawings, when necessary, see §§ 1.81 to 1.85; and

(4) The prescribed filing fee, see § 1.16.

(c) A complete provisional application filed under § 1.53(c) comprises:

(1) A cover sheet identifying:

(i) The application as a provisional application,

(ii) The name or names of the inventor or inventors, (see § 1.41(a)(2)),

(iii) The residence of each named inventor,

(iv) The title of the invention,

(v) The name and registration number of the attorney or agent (if applicable),

(vi) The docket number used by the person filing the application to identify the application (if applicable),

(vii) The correspondence address, and

(viii) The name of the U.S. Government agency and Government contract number (if the invention was made by an agency of the U.S. Government or under a contract with an agency of the U.S. Government);

(2) A specification as prescribed by the first paragraph of 35 U.S.C. 112, see § 1.71;

(3) Drawings, when necessary, see §§ 1.81 to 1.85; and

(4) The prescribed filing fee, see § 1.16.

(d) Applicants are encouraged to file an information disclosure statement in nonprovisional applications. See § 1.97 and § 1.98. No information disclosure statement may be filed in a provisional application.

[42 FR 5593, Jan. 28, 1977; paras. (a) and (c), 47 FR 41275, Sept. 17, 1982, effective Oct. 1, 1982; paras. (a) and (b), 48 FR 2709, Jan. 20, 1983, effective Feb. 27, 1983; para. (b), 57 FR 2021, Jan. 17, 1992, effective Mar. 16, 1992; paras. (a) & (b) revised, 60 FR 20195, Apr. 25, 1995, effective June 8, 1995; revised, 62 FR 53131, Oct. 10, 1997, effective Dec. 1, 1997; para. (b) revised, 65 FR 54604, Sept. 8, 2000, effective Nov. 7, 2000; para. (a)

revised, 68 FR 14332, Mar. 25, 2003, effective May 1, 2003]

### § 1.52 Language, paper, writing, margins, compact disc specifications.

(a) *Papers that are to become a part of the permanent United States Patent and Trademark Office records in the file of a patent application or a reexamination proceeding.*

(1) All papers, other than drawings, that are submitted on paper or by facsimile transmission, and are to become a part of the permanent United States Patent and Trademark Office records in the file of a patent application or reexamination proceeding, must be on sheets of paper that are the same size, not permanently bound together, and:

(i) Flexible, strong, smooth, non-shiny, durable, and white;

(ii) Either 21.0 cm by 29.7 cm (DIN size A4) or 21.6 cm by 27.9 cm (8 1/2 by 11 inches), with each sheet including a top margin of at least 2.0 cm (3/4 inch), a left side margin of at least 2.5 cm (1 inch), a right side margin of at least 2.0 cm (3/4 inch), and a bottom margin of at least 2.0 cm (3/4 inch);

(iii) Written on only one side in portrait orientation;

(iv) Plainly and legibly written either by a typewriter or machine printer in permanent dark ink or its equivalent; and

(v) Presented in a form having sufficient clarity and contrast between the paper and the writing thereon to permit the direct reproduction of readily legible copies in any number by use of photographic, electrostatic, photo-offset, and microfilming processes and electronic capture by use of digital imaging and optical character recognition.

(2) All papers that are submitted on paper or by facsimile transmission and are to become a part of the permanent records of the United States Patent and Trademark Office should have no holes in the sheets as submitted.

(3) The provisions of this paragraph and paragraph (b) of this section do not apply to the pre-printed information on paper forms provided by the Office, or to the copy of the patent submitted on paper in double column format as the specification in a reissue application or request for reexamination.

(4) See § 1.58 for chemical and mathematical formulae and tables, and § 1.84 for drawings.

(5) If papers that are submitted on paper or by facsimile transmission do not comply with paragraph (a)(1) of this section and are submitted as part of the permanent record, other than the drawings, applicant, or the patent owner, or the requester in a reexamination proceeding, will be notified and given a period of time within which to provide substitute papers that comply with paragraph (a)(1) of this section in order to avoid abandonment of the application in the case of an applicant for patent, termination of proceedings in the case of a patent owner in a reexamination proceeding, or refusal of consideration of the papers in the case of a third party requester in a reexamination proceeding.

(6) Papers that are submitted electronically to the Office must be formatted and transmitted in compliance with the Office's electronic filing system requirements.

(7) If the papers that are submitted electronically to the Office do not comply with paragraph (a)(6) of this section, the applicant, or the patent owner, or the requester in a reexamination proceeding, will be notified and given a period of time within which to provide substitute papers that comply with paragraph (a)(6) of this section in order to avoid abandonment of the application in the case of an applicant for patent, termination of proceedings in the case of a patent owner in a reexamination proceeding, or refusal of consideration of the papers in the case of a third party requester in a reexamination proceeding.

(b) *The application (specification, including the claims, drawings, and oath or declaration) or reexamination proceeding and any amendments or corrections to the application or reexamination proceeding.*

(1) The application or proceeding and any amendments or corrections to the application (including any translation submitted pursuant to paragraph (d) of this section) or proceeding, except as provided for in § 1.69 and paragraph (d) of this section, must:

(i) Comply with the requirements of paragraph (a) of this section; and

(ii) Be in the English language or be accompanied by a translation of the application and a translation of any corrections or amendments into the English language together with a statement that the translation is accurate.

(2) The specification (including the abstract and claims) for other than reissue applications and reexamination proceedings, and any amendments for applications (including reissue applications) and reexamination proceedings to the specification, except as provided for in §§ 1.821 through 1.825, must have:

(i) Lines that are 1 1/2 or double spaced;

(ii) Text written in a nonscript type font (*e.g.*, Arial, Times Roman, or Courier) lettering style having capital letters which are at least 0.21 cm (0.08 inch) high; and

(iii) Only a single column of text.

(3) The claim or claims must commence on a separate physical sheet or electronic page (§ 1.75(h)).

(4) The abstract must commence on a separate physical sheet or electronic page or be submitted as the first page of the patent in a reissue application or reexamination proceeding (§ 1.72(b)).

(5) Other than in a reissue application or reexamination proceeding, the pages of the specification including claims and abstract must be numbered consecutively, starting with 1, the numbers being centrally located above or preferably below, the text.

(6) Other than in a reissue application or reexamination proceeding, the paragraphs of the specification, other than in the claims or abstract, may be numbered at the time the application is filed, and should be individually and consecutively numbered using Arabic numerals, so as to unambiguously identify each paragraph. The number should consist of at least four numerals enclosed in square brackets, including leading zeros (*e.g.*, [0001]). The numbers and enclosing brackets should appear to the right of the left margin as the first item in each paragraph, before the first word of the paragraph, and should be highlighted in bold. A gap, equivalent to approximately four spaces, should follow the number. Nontext elements (*e.g.*, tables, mathematical or chemical formulae, chemical structures, and sequence data) are considered part of the numbered paragraph around or above the elements, and should not be independently numbered. If a nontext element extends to the left margin, it should not be numbered as a separate and independent paragraph. A list is also treated as part of the paragraph around or above the list, and should not be independently numbered. Paragraph or section headers (titles), whether abutting the left margin or

centered on the page, are not considered paragraphs and should not be numbered.

(7) If papers that do not comply with paragraphs (b)(1) through (b)(5) of this section are submitted as part of the application, the applicant, or patent owner, or requester in a reexamination proceeding, will be notified and given a period of time within which to provide substitute papers that comply with paragraphs (b)(1) through (b)(5) of this section in order to avoid abandonment of the application in the case of an applicant for patent, termination of proceedings in the case of a patent owner in a reexamination proceeding, or refusal of consideration of the papers in the case of a third party requester in a reexamination proceeding.

(c)(1) Any interlineation, erasure, cancellation or other alteration of the application papers filed must be made before the signing of any accompanying oath or declaration pursuant to § 1.63 referring to those application papers and should be dated and initialed or signed by the applicant on the same sheet of paper. Application papers containing alterations made after the signing of an oath or declaration referring to those application papers must be supported by a supplemental oath or declaration under § 1.67. In either situation, a substitute specification (§ 1.125) is required if the application papers do not comply with paragraphs (a) and (b) of this section.

(2) After the signing of the oath or declaration referring to the application papers, amendments may only be made in the manner provided by § 1.121.

(3) Notwithstanding the provisions of this paragraph, if an oath or declaration is a copy of the oath or declaration from a prior application, the application for which such copy is submitted may contain alterations that do not introduce matter that would have been new matter in the prior application.

(d) A nonprovisional or provisional application may be in a language other than English.

(1) *Nonprovisional application.* If a nonprovisional application is filed in a language other than English, an English language translation of the non-English language application, a statement that the translation is accurate, and the processing fee set forth in § 1.17(i) are required. If these items are not filed with the application, applicant will be notified and

given a period of time within which they must be filed in order to avoid abandonment.

(2) *Provisional application.* If a provisional application is filed in a language other than English, an English language translation of the non-English language provisional application will not be required in the provisional application. See § 1.78(a) for the requirements for claiming the benefit of such provisional application in a nonprovisional application.

(e) *Electronic documents that are to become part of the permanent United States Patent and Trademark Office records in the file of a patent application or reexamination proceeding.*

(1) The following documents may be submitted to the Office on a compact disc in compliance with this paragraph:

(i) A computer program listing (see § 1.96);

(ii) A “Sequence Listing” (submitted under § 1.821(c)); or

(iii) A table (see § 1.58) that has more than 50 pages of text.

(2) A compact disc as used in this part means a Compact Disc-Read Only Memory (CD-ROM) or a Compact Disc-Recordable (CD-R) in compliance with this paragraph. A CD-ROM is a “read-only” medium on which the data is pressed into the disc so that it cannot be changed or erased. A CD-R is a “write once” medium on which once the data is recorded, it is permanent and cannot be changed or erased.

(3)(i) Each compact disc must conform to the International Standards Organization (ISO) 9660 standard, and the contents of each compact disc must be in compliance with the American Standard Code for Information Interchange (ASCII).

(ii) Each compact disc must be enclosed in a hard compact disc case within an unsealed padded and protective mailing envelope and accompanied by a transmittal letter on paper in accordance with paragraph (a) of this section. The transmittal letter must list for each compact disc the machine format (*e.g.*, IBM-PC, Macintosh), the operating system compatibility (*e.g.*, MS-DOS, MS-Windows, Macintosh, Unix), a list of files contained on the compact disc including their names, sizes in bytes, and dates of creation, plus any other special information that is necessary to identify, maintain, and interpret the



information on the compact disc. Compact discs submitted to the Office will not be returned to the applicant.

(4) Any compact disc must be submitted in duplicate unless it contains only the “Sequence Listing” in computer readable form required by § 1.821(e). The compact disc and duplicate copy must be labeled “Copy 1” and “Copy 2,” respectively. The transmittal letter which accompanies the compact disc must include a statement that the two compact discs are identical. In the event that the two compact discs are not identical, the Office will use the compact disc labeled “Copy 1” for further processing. Any amendment to the information on a compact disc must be by way of a replacement compact disc in compliance with this paragraph containing the substitute information, and must be accompanied by a statement that the replacement compact disc contains no new matter. The compact disc and copy must be labeled “COPY 1 REPLACEMENT MM/DD/YYYY” (with the month, day and year of creation indicated), and “COPY 2 REPLACEMENT MM/DD/YYYY,” respectively.

(5) The specification must contain an incorporation-by-reference of the material on the compact disc in a separate paragraph (§ 1.77(b)(4)), identifying each compact disc by the names of the files contained on each of the compact discs, their date of creation and their sizes in bytes. The Office may require applicant to amend the specification to include in the paper portion any part of the specification previously submitted on compact disc.

(6) A compact disc must also be labeled with the following information:

- (i) The name of each inventor (if known);
- (ii) Title of the invention;
- (iii) The docket number, or application number if known, used by the person filing the application to identify the application; and
- (iv) A creation date of the compact disc.
- (v) If multiple compact discs are submitted, the label shall indicate their order (*e.g.* “1 of X”).
- (vi) An indication that the disk is “Copy 1” or “Copy 2” of the submission. See paragraph (b)(4) of this section.

(7) If a file is unreadable on both copies of the disc, the unreadable file will be treated as not having been submitted. A file is unreadable if, for exam-

ple, it is of a format that does not comply with the requirements of paragraph (e)(3) of this section, it is corrupted by a computer virus, or it is written onto a defective compact disc.

[43 FR 20462, May 11, 1978; paras. (a) and (d), 47 FR 41275, Sept. 17, 1982, effective Oct. 1, 1982; para. (c), 48 FR 2709, Jan. 20, 1983, effective Feb. 27, 1983; para. (d), 49 FR 554, Jan. 4, 1984, effective Apr. 1, 1984; para. (c), 57 FR 2021, Jan. 17, 1992, effective Mar. 16, 1992; paras. (a) and (b) amended, 61 FR 42790, Aug. 19, 1996, effective Sept. 23, 1996; paras. (a), (c) & (d) revised, 62 FR 53131, Oct. 10, 1997, effective Dec. 1, 1997; para. (e) added, 65 FR 54604, Sept. 8, 2000, effective Sept. 8, 2000 (effective date corrected, 65 FR 78958, Dec. 18, 2000); paras. (a), (b), and (c) revised, 65 FR 54604, Sept. 8, 2000, effective Nov. 7, 2000; para. (d) revised, 65 FR 57024, Sept. 20, 2000, effective Nov. 29, 2000; paras. (a) and (b) revised, 68 FR 38611, June 30, 2003, effective July 30, 2003]

### § 1.53 Application number, filing date, and completion of application.

(a) *Application number.* Any papers received in the Patent and Trademark Office which purport to be an application for a patent will be assigned an application number for identification purposes.

(b) *Application filing requirements - Nonprovisional application.* The filing date of an application for patent filed under this section, except for a provisional application under paragraph (c) of this section or a continued prosecution application under paragraph (d) of this section, is the date on which a specification as prescribed by 35 U.S.C. 112 containing a description pursuant to § 1.71 and at least one claim pursuant to § 1.75, and any drawing required by § 1.81(a) are filed in the Patent and Trademark Office. No new matter may be introduced into an application after its filing date. A continuing application, which may be a continuation, divisional, or continuation-in-part application, may be filed under the conditions specified in 35 U.S.C. 120, 121 or 365(c) and § 1.78(a).

(1) A continuation or divisional application that names as inventors the same or fewer than all of the inventors named in the prior application may be filed under this paragraph or paragraph (d) of this section.

(2) A continuation-in-part application (which may disclose and claim subject matter not disclosed in the prior application) or a continuation or divisional application naming an inventor not named in the prior application must be filed under this paragraph.

(c) *Application filing requirements - Provisional application.* The filing date of a provisional application is the date on which a specification as prescribed by the first paragraph of 35 U.S.C. 112, and any drawing required by § 1.81(a) are filed in the Patent and Trademark Office. No amendment, other than to make the provisional application comply with the patent statute and all applicable regulations, may be made to the provisional application after the filing date of the provisional application.

(1) A provisional application must also include the cover sheet required by § 1.51(c)(1), which may be an application data sheet (§ 1.76), or a cover letter identifying the application as a provisional application. Otherwise, the application will be treated as an application filed under paragraph (b) of this section.

(2) An application for patent filed under paragraph (b) of this section may be converted to a provisional application and be accorded the original filing date of the application filed under paragraph (b) of this section. The grant of such a request for conversion will not entitle applicant to a refund of the fees that were properly paid in the application filed under paragraph (b) of this section. Such a request for conversion must be accompanied by the processing fee set forth in § 1.17(q) and be filed prior to the earliest of:

(i) Abandonment of the application filed under paragraph (b) of this section;

(ii) Payment of the issue fee on the application filed under paragraph (b) of this section;

(iii) Expiration of twelve months after the filing date of the application filed under paragraph (b) of this section; or

(iv) The filing of a request for a statutory invention registration under § 1.293 in the application filed under paragraph (b) of this section.

(3) A provisional application filed under paragraph (c) of this section may be converted to a nonprovisional application filed under paragraph (b) of this section and accorded the original filing date of the provisional application. The conversion of a pro-

visional application to a nonprovisional application will not result in either the refund of any fee properly paid in the provisional application or the application of any such fee to the filing fee, or any other fee, for the nonprovisional application. Conversion of a provisional application to a nonprovisional application under this paragraph will result in the term of any patent to issue from the application being measured from at least the filing date of the provisional application for which conversion is requested. Thus, applicants should consider avoiding this adverse patent term impact by filing a nonprovisional application claiming the benefit of the provisional application under 35 U.S.C. 119(e) (rather than converting the provisional application into a nonprovisional application pursuant to this paragraph). A request to convert a provisional application to a nonprovisional application must be accompanied by the fee set forth in § 1.17(i) and an amendment including at least one claim as prescribed by the second paragraph of 35 U.S.C. 112, unless the provisional application under paragraph (c) of this section otherwise contains at least one claim as prescribed by the second paragraph of 35 U.S.C.112. The nonprovisional application resulting from conversion of a provisional application must also include the filing fee for a nonprovisional application, an oath or declaration by the applicant pursuant to §§ 1.63, 1.162, or 1.175, and the surcharge required by § 1.16(e) if either the basic filing fee for a nonprovisional application or the oath or declaration was not present on the filing date accorded the resulting nonprovisional application (*i.e.*, the filing date of the original provisional application). A request to convert a provisional application to a nonprovisional application must also be filed prior to the earliest of:

(i) Abandonment of the provisional application filed under paragraph (c) of this section; or

(ii) Expiration of twelve months after the filing date of the provisional application filed under this paragraph (c).

(4) A provisional application is not entitled to the right of priority under 35 U.S.C. 119 or 365(a) or § 1.55, or to the benefit of an earlier filing date under 35 U.S.C. 120, 121 or 365(c) or § 1.78 of any other application. No claim for priority under 35 U.S.C. 119(e) or § 1.78(a)(4) may be made in a design application based on a provisional application.

No request under § 1.293 for a statutory invention registration may be filed in a provisional application. The requirements of §§ 1.821 through 1.825 regarding application disclosures containing nucleotide and/or amino acid sequences are not mandatory for provisional applications.

(d) *Application filing requirements - Continued prosecution (nonprovisional) application.*

(1) A continuation or divisional application (but not a continuation-in-part) of a prior nonprovisional application may be filed as a continued prosecution application under this paragraph, provided that:

(i) The application is for a design patent;

(ii) The prior nonprovisional application is a design application that is complete as defined by § 1.51(b); and

(iii) The application under this paragraph is filed before the earliest of:

(A) Payment of the issue fee on the prior application, unless a petition under § 1.313(c) is granted in the prior application;

(B) Abandonment of the prior application; or

(C) Termination of proceedings on the prior application.

(2) The filing date of a continued prosecution application is the date on which a request on a separate paper for an application under this paragraph is filed. An application filed under this paragraph:

(i) Must identify the prior application;

(ii) Discloses and claims only subject matter disclosed in the prior application;

(iii) Names as inventors the same inventors named in the prior application on the date the application under this paragraph was filed, except as provided in paragraph (d)(4) of this section;

(iv) Includes the request for an application under this paragraph, will utilize the file jacket and contents of the prior application, including the specification, drawings and oath or declaration from the prior application, to constitute the new application, and will be assigned the application number of the prior application for identification purposes; and

(v) Is a request to expressly abandon the prior application as of the filing date of the request for an application under this paragraph.

(3) The filing fee for a continued prosecution application filed under this paragraph is the basic filing fee as set forth in § 1.16(f).

(4) An application filed under this paragraph may be filed by fewer than all the inventors named in the prior application, provided that the request for an application under this paragraph when filed is accompanied by a statement requesting deletion of the name or names of the person or persons who are not inventors of the invention being claimed in the new application. No person may be named as an inventor in an application filed under this paragraph who was not named as an inventor in the prior application on the date the application under this paragraph was filed, except by way of correction of inventorship under § 1.48.

(5) Any new change must be made in the form of an amendment to the prior application as it existed prior to the filing of an application under this paragraph. No amendment in an application under this paragraph (a continued prosecution application) may introduce new matter or matter that would have been new matter in the prior application. Any new specification filed with the request for an application under this paragraph will not be considered part of the original application papers, but will be treated as a substitute specification in accordance with § 1.125.

(6) The filing of a continued prosecution application under this paragraph will be construed to include a waiver of confidentiality by the applicant under 35 U.S.C. 122 to the extent that any member of the public, who is entitled under the provisions of § 1.14 to access to, copies of, or information concerning either the prior application or any continuing application filed under the provisions of this paragraph, may be given similar access to, copies of, or similar information concerning the other application or applications in the file jacket.

(7) A request for an application under this paragraph is the specific reference required by 35 U.S.C. 120 to every application assigned the application number identified in such request. No amendment in an application under this paragraph may delete this specific reference to any prior application.

(8) In addition to identifying the application number of the prior application, applicant should furnish in the request for an application under this paragraph the following information relating to the prior application to the best of his or her ability:

- (i) Title of invention;
- (ii) Name of applicant(s); and
- (iii) Correspondence address.

(9) Envelopes containing only requests and fees for filing an application under this paragraph should be marked "Mail Stop CPA." Requests for an application under this paragraph filed by facsimile transmission should be clearly marked "Mail Stop CPA."

(10) See § 1.103(b) for requesting a limited suspension of action in an application filed under this paragraph.

(e) *Failure to meet filing date requirements.*

(1) If an application deposited under paragraph (b), (c), or (d) of this section does not meet the requirements of such paragraph to be entitled to a filing date, applicant will be so notified, if a correspondence address has been provided, and given a period of time within which to correct the filing error. If, however, a request for an application under paragraph (d) of this section does not meet the requirements of that paragraph because the application in which the request was filed is not a design application, and if the application in which the request was filed was itself filed on or after June 8, 1995, the request for an application under paragraph (d) of this section will be treated as a request for continued examination under § 1.114.

(2) Any request for review of a notification pursuant to paragraph (e)(1) of this section, or a notification that the original application papers lack a portion of the specification or drawing(s), must be by way of a petition pursuant to this paragraph accompanied by the fee set forth in § 1.17(h). In the absence of a timely (§ 1.181(f)) petition pursuant to this paragraph, the filing date of an application in which the applicant was notified of a filing error pursuant to paragraph (e)(1) of this section will be the date the filing error is corrected.

(3) If an applicant is notified of a filing error pursuant to paragraph (e)(1) of this section, but fails to correct the filing error within the given time period or otherwise timely (§ 1.181(f)) take action pursuant

to this paragraph, proceedings in the application will be considered terminated. Where proceedings in an application are terminated pursuant to this paragraph, the application may be disposed of, and any filing fees, less the handling fee set forth in § 1.21(n), will be refunded.

(f) *Completion of application subsequent to filing—nonprovisional (including continued prosecution or reissue) application.*

(1) If an application which has been accorded a filing date pursuant to paragraph (b) or (d) of this section does not include the basic filing fee, or if an application which has been accorded a filing date pursuant to paragraph (b) of this section does not include an oath or declaration by the applicant pursuant to §§ 1.63, 1.162 or § 1.175, and applicant has provided a correspondence address (§ 1.33(a)), applicant will be notified and given a period of time within which to pay the filing fee, file an oath or declaration in an application under paragraph (b) of this section, and pay the surcharge required by § 1.16(e) to avoid abandonment.

(2) If an application which has been accorded a filing date pursuant to paragraph (b) of this section does not include the basic filing fee or an oath or declaration by the applicant pursuant to §§ 1.63, 1.162 or § 1.175, and applicant has not provided a correspondence address (§ 1.33(a)), applicant has two months from the filing date of the application within which to pay the basic filing fee, file an oath or declaration, and pay the surcharge required by § 1.16(e) to avoid abandonment.

(3) This paragraph applies to continuation or divisional applications under paragraphs (b) or (d) of this section and to continuation-in-part applications under paragraph (b) of this section.

(4) See § 1.63(d) concerning the submission of a copy of the oath or declaration from the prior application for a continuation or divisional application under paragraph (b) of this section.

(5) If applicant does not pay one of the basic filing or the processing and retention fees (§ 1.21(l)) during the pendency of the application, the Office may dispose of the application.

(g) *Completion of application subsequent to filing—provisional application.*

(1) If a provisional application which has been accorded a filing date pursuant to paragraph (c)

of this section does not include the cover sheet required by § 1.51(c)(1) or the basic filing fee (§ 1.16(k)), and applicant has provided a correspondence address (§ 1.33(a)), applicant will be notified and given a period of time within which to pay the basic filing fee, file a cover sheet (§ 1.51(c)(1)), and pay the surcharge required by § 1.16(l) to avoid abandonment.

(2) If a provisional application which has been accorded a filing date pursuant to paragraph (c) of this section does not include the cover sheet required by § 1.51(c)(1) or the basic filing fee (§ 1.16(k)), and applicant has not provided a correspondence address (§ 1.33(a)), applicant has two months from the filing date of the application within which to pay the basic filing fee, file a cover sheet (§ 1.51(c)(1)), and pay the surcharge required by § 1.16(l) to avoid abandonment.

(3) If applicant does not pay the basic filing fee during the pendency of the application, the Office may dispose of the application.

(h) *Subsequent treatment of application - Non-provisional (including continued prosecution) application.* An application for a patent filed under paragraphs (b) or (d) of this section will not be placed on the files for examination until all its required parts, complying with the rules relating thereto, are received, except that certain minor informalities may be waived subject to subsequent correction whenever required.

(i) *Subsequent treatment of application - Provisional application.* A provisional application for a patent filed under paragraph (c) of this section will not be placed on the files for examination and will become abandoned no later than twelve months after its filing date pursuant to 35 U.S.C. 111(b)(1).

(j) *Filing date of international application.* The filing date of an international application designating the United States of America is treated as the filing date in the United States of America under PCT Article 11(3), except as provided in 35 U.S.C. 102(e).

[48 FR 2709, Jan. 20, 1983, effective Feb. 27, 1983; paras. (b) and (d), 49 FR 554, Jan. 4, 1984, effective Apr. 1, 1984; para. (c), 50 FR 31826, Aug. 6, 1985, effective Oct. 5, 1985; paras. (c) and (d), 53 FR 47808, Nov. 28, 1988, effective Jan. 1, 1989; paras. (b) and (c), 54 FR 47518, Nov. 15, 1989, effective Jan. 16, 1990; paras. (a)-(e) revised, 60 FR 20195, Apr. 25, 1995, effective June 8, 1995; revised, 62 FR 53131, Oct. 10, 1997, effective Dec. 1, 1997; para. (d) revised, 63 FR 5734, Feb. 4, 1998, effective Feb. 4, 1998 (adopted as final, 63 FR 36184, Jul. 2, 1998); paras. (c)(3), (c)(4) and (d) revised, 65 FR 14865, Mar. 20, 2000, effective May 29, 2000 (paras. (c)(4) and (d) adopted as final, 65 FR 50092, Aug. 16, 2000); para. (c)(3) revised, 65 FR 50092, Aug. 16, 2000, effective Aug. 16, 2000; paras. (c)(1), (c)(2), (d)(4), (e)(2), (f), and (g) revised and para. (d)(10) added, 65 FR 54604, Sept. 8, 2000, effective Nov. 7, 2000; para. (c)(4) revised, 65 FR 78958, Dec. 18, 2000; para. (d)(9) revised, 68 FR 14332, Mar. 25, 2003, effective May 1, 2003; paras. (d)(1), (d)(3) and (e)(1) revised, 68 FR 32376, May 30, 2003, effective July 14, 2003]

of this section does not include the cover sheet required by § 1.51(c)(1) or the basic filing fee (§ 1.16(k)), and applicant has provided a correspondence address (§ 1.33(a)), applicant will be notified and given a period of time within which to pay the basic filing fee, file a cover sheet (§ 1.51(c)(1)), and pay the surcharge required by § 1.16(l) to avoid abandonment.

#### § 1.54 Parts of application to be filed together; filing receipt.

(a) It is desirable that all parts of the complete application be deposited in the Office together; otherwise, a letter must accompany each part, accurately and clearly connecting it with the other parts of the application. See § 1.53(f) and (g) with regard to completion of an application.

(b) Applicant will be informed of the application number and filing date by a filing receipt, unless the application is an application filed under § 1.53(d).

[48 FR 2710, Jan. 20, 1983, effective Feb. 27, 1983; para. (b) amended, 61 FR 42790, Aug. 19, 1996, effective Sept. 23, 1996; revised, 62 FR 53131, Oct. 10, 1997, effective Dec. 1, 1997]

#### § 1.55 Claim for foreign priority.

(a) An applicant in a nonprovisional application may claim the benefit of the filing date of one or more prior foreign applications under the conditions specified in 35 U.S.C. 119(a) through (d) and (f), 172, and 365(a) and (b).

(1)(i) In an original application filed under 35 U.S.C. 111(a), the claim for priority must be presented during the pendency of the application, and within the later of four months from the actual filing date of the application or sixteen months from the filing date of the prior foreign application. This time period is not extendable. The claim must identify the foreign application for which priority is claimed, as well as any foreign application for the same subject matter and having a filing date before that of the application for which priority is claimed, by specifying the application number, country (or intellectual property authority), day, month, and year of its filing.

The time periods in this paragraph do not apply in an application under 35 U.S.C. 111(a) if the application is:

- (A) A design application; or
- (B) An application filed before November 29, 2000.

(ii) In an application that entered the national stage from an international application after compliance with 35 U.S.C. 371, the claim for priority must be made during the pendency of the application and within the time limit set forth in the PCT and the Regulations under the PCT.

(2) The claim for priority and the certified copy of the foreign application specified in 35 U.S.C. 119(b) or PCT Rule 17 must, in any event, be filed before the patent is granted. If the claim for priority or the certified copy of the foreign application is filed after the date the issue fee is paid, it must be accompanied by the processing fee set forth in § 1.17(i), but the patent will not include the priority claim unless corrected by a certificate of correction under 35 U.S.C. 255 and § 1.323

(3) When the application becomes involved in an interference (§ 1.630), when necessary to overcome the date of a reference relied upon by the examiner, or when deemed necessary by the examiner, the Office may require that the claim for priority and the certified copy of the foreign application be filed earlier than provided in paragraphs (a)(1) or (a)(2) of this section.

(4) An English language translation of a non-English language foreign application is not required except when the application is involved in an interference (§ 1.630), when necessary to overcome the date of a reference relied upon by the examiner, or when specifically required by the examiner. If an English language translation is required, it must be filed together with a statement that the translation of the certified copy is accurate.

(b) An applicant in a nonprovisional application may under certain circumstances claim priority on the basis of one or more applications for an inventor's certificate in a country granting both inventor's certificates and patents. To claim the right of priority on the basis of an application for an inventor's certificate in such a country under 35 U.S.C. 119(d), the applicant when submitting a claim for such right as specified in paragraph (a) of this section, shall include an affidavit

or declaration. The affidavit or declaration must include a specific statement that, upon an investigation, he or she is satisfied that to the best of his or her knowledge, the applicant, when filing the application for the inventor's certificate, had the option to file an application for either a patent or an inventor's certificate as to the subject matter of the identified claim or claims forming the basis for the claim of priority.

(c) Unless such claim is accepted in accordance with the provisions of this paragraph, any claim for priority under 35 U.S.C. 119(a)-(d) or 365(a) not presented within the time period provided by paragraph (a) of this section is considered to have been waived. If a claim for priority under 35 U.S.C. 119(a)-(d) or 365(a) is presented after the time period provided by paragraph (a) of this section, the claim may be accepted if the claim identifying the prior foreign application by specifying its application number, country (or intellectual property authority), and the day, month, and year of its filing was unintentionally delayed. A petition to accept a delayed claim for priority under 35 U.S.C. 119(a)-(d) or 365(a) must be accompanied by:

(1) The claim under 35 U.S.C. 119(a)-(d) or 365(a) and this section to the prior foreign application, unless previously submitted;

(2) The surcharge set forth in § 1.17(t); and

(3) A statement that the entire delay between the date the claim was due under paragraph (a)(1) of this section and the date the claim was filed was unintentional. The Director may require additional information where there is a question whether the delay was unintentional.

[para. (b), 48 FR 41275, Sept. 17, 1982, effective Oct. 1 1982; 48 FR 2710, Jan. 20, 1983, effective Feb. 27, 1983; para. (b), 49 FR 554, Jan. 4, 1984, effective Apr. 1, 1984; para. (a), 49 FR 48416, Dec. 12, 1984, effective Feb. 11, 1985; para. (a), 54 FR 6893, Feb. 15, 1989, effective Apr. 17, 1989; para. (a) revised, 54 FR 9432, March 7, 1989, effective Apr. 17, 1989; para. (a), 54 FR 47518, Nov. 15, 1989, effective Jan. 16, 1990; para. (a) revised, 58 FR 54504, Oct. 22, 1993, effective Jan. 3, 1994; revised, 60 FR 20195, Apr.25, 1995, effective June 8, 1995; para. (a) revised, 62 FR 53131, Oct. 10, 1997, effective Dec. 1, 1997; para. (a) revised, 65 FR 54604, Sept. 8, 2000, effective Nov. 7, 2000; para. (a) revised and para. (c) added, 65 FR 57024, Sept. 20, 2000, effective Nov. 29, 2000; paras. (a) and (c) corrected, 65 FR 66502, Nov. 6, 2000, effective Nov. 29, 2000; paras.(a)(1) and (c) revised, 66 FR 67087,

Dec. 28, 2001, effective Dec. 28, 2001; para. (c)(3) revised, 68 FR 14332, Mar. 25, 2003, effective May 1, 2003]

**§ 1.56 Duty to disclose information material to patentability.**

(a) A patent by its very nature is affected with a public interest. The public interest is best served, and the most effective patent examination occurs when, at the time an application is being examined, the Office is aware of and evaluates the teachings of all information material to patentability. Each individual associated with the filing and prosecution of a patent application has a duty of candor and good faith in dealing with the Office, which includes a duty to disclose to the Office all information known to that individual to be material to patentability as defined in this section. The duty to disclose information exists with respect to each pending claim until the claim is cancelled or withdrawn from consideration, or the application becomes abandoned. Information material to the patentability of a claim that is cancelled or withdrawn from consideration need not be submitted if the information is not material to the patentability of any claim remaining under consideration in the application. There is no duty to submit information which is not material to the patentability of any existing claim. The duty to disclose all information known to be material to patentability is deemed to be satisfied if all information known to be material to patentability of any claim issued in a patent was cited by the Office or submitted to the Office in the manner prescribed by §§ 1.97(b)-(d) and 1.98. However, no patent will be granted on an application in connection with which fraud on the Office was practiced or attempted or the duty of disclosure was violated through bad faith or intentional misconduct. The Office encourages applicants to carefully examine:

(1) Prior art cited in search reports of a foreign patent office in a counterpart application, and

(2) The closest information over which individuals associated with the filing or prosecution of a patent application believe any pending claim patentably defines, to make sure that any material information contained therein is disclosed to the Office.

(b) Under this section, information is material to patentability when it is not cumulative to information already of record or being made of record in the application, and

(1) It establishes, by itself or in combination with other information, a *prima facie* case of unpatentability of a claim; or

(2) It refutes, or is inconsistent with, a position the applicant takes in:

(i) Opposing an argument of unpatentability relied on by the Office, or

(ii) Asserting an argument of patentability.

A *prima facie* case of unpatentability is established when the information compels a conclusion that a claim is unpatentable under the preponderance of evidence, burden-of-proof standard, giving each term in the claim its broadest reasonable construction consistent with the specification, and before any consideration is given to evidence which may be submitted in an attempt to establish a contrary conclusion of patentability.

(c) Individuals associated with the filing or prosecution of a patent application within the meaning of this section are:

(1) Each inventor named in the application;

(2) Each attorney or agent who prepares or prosecutes the application; and

(3) Every other person who is substantively involved in the preparation or prosecution of the application and who is associated with the inventor, with the assignee or with anyone to whom there is an obligation to assign the application.

(d) Individuals other than the attorney, agent or inventor may comply with this section by disclosing information to the attorney, agent, or inventor.

(e) In any continuation-in-part application, the duty under this section includes the duty to disclose to the Office all information known to the person to be material to patentability, as defined in paragraph (b) of this section, which became available between the filing date of the prior application and the national or PCT international filing date of the continuation-in-part application.

[42 FR 5593, Jan. 28, 1977; paras. (d) & (e) - (i), 47 FR 21751, May 19, 1982, effective July 1, 1982; para. (c), 48 FR 2710, Jan. 20, 1983, effective Feb. 27, 1983; paras. (b) and (j), 49 FR 554, Jan. 4, 1984, effective Apr. 1, 1984; paras. (d) and (h), 50 FR 5171, Feb. 6, 1985, effective Mar. 8, 1985; para. (e), 53 FR 47808, Nov. 28, 1988, effective Jan. 1, 1989; 57 FR 2021, Jan. 17, 1992, effective Mar. 16, 1992; para. (e) added, 65 FR 54604, Sept. 8, 2000, effective Nov. 7, 2000]

**§ 1.57 [Reserved]**

[48 FR 2710, Jan. 20, 1983, effective Feb. 27, 1983]

**§ 1.58 Chemical and mathematical formulae and tables.**

(a) The specification, including the claims, may contain chemical and mathematical formulas, but shall not contain drawings or flow diagrams. The description portion of the specification may contain tables; claims may contain tables either if necessary to conform to 35 U.S.C. 112 or if otherwise found to be desirable.

(b) Tables that are submitted in electronic form (§§ 1.96(c) and 1.821(c)) must maintain the spatial relationships (*e.g.*, columns and rows) of the table elements and preserve the information they convey. Chemical and mathematical formulae must be encoded to maintain the proper positioning of their characters when displayed in order to preserve their intended meaning.

(c) Chemical and mathematical formulae and tables must be presented in compliance with § 1.52(a) and (b), except that chemical and mathematical formulae or tables may be placed in a landscape orientation if they cannot be presented satisfactorily in a portrait orientation. Typewritten characters used in such formulae and tables must be chosen from a block (nonscript) type font or lettering style having capital letters which are at least 0.21 cm. (0.08 inch) high (*e.g.*, elite type). A space at least 0.64 cm. (1/4 inch) high should be provided between complex formulae and tables and the text. Tables should have the lines and columns of data closely spaced to conserve space, consistent with a high degree of legibility.

[43 FR 20463, May 11, 1978; para. (b) removed and reserved, para. (c) amended, 61 FR 42790, Aug. 19, 1996, effective Sept. 23, 1996; para. (b) added, 65 FR 54604, Sept. 8, 2000, effective Nov. 7, 2000]

**§ 1.59 Expungement of information or copy of papers in application file.**

(a)(1) Information in an application will not be expunged, except as provided in paragraph (b) of this section.

(2) Information forming part of the original disclosure (*i.e.*, written specification including the claims, drawings, and any preliminary amendment

specifically incorporated into an executed oath or declaration under §§ 1.63 and 1.175) will not be expunged from the application file.

(b) An applicant may request that the Office expunge information, other than what is excluded by paragraph (a)(2) of this section, by filing a petition under this paragraph. Any petition to expunge information from an application must include the fee set forth in § 1.17(h) and establish to the satisfaction of the Director that the expungement of the information is appropriate in which case a notice granting the petition for expungement will be provided.

(c) Upon request by an applicant and payment of the fee specified in § 1.19(b), the Office will furnish copies of an application, unless the application has been disposed of (*see* §§ 1.53(e), (f) and (g)). The Office cannot provide or certify copies of an application that has been disposed of.

[48 FR 2710, Jan. 20, 1983, effective Feb. 27, 1983; 49 FR 554, Jan. 4, 1984, effective Apr. 1, 1984; 49 FR 48416, Dec. 12, 1984, effective Feb. 11, 1985; 50 FR 23123, May 31, 1985, effective Feb. 11, 1985; revised, 60 FR 20195, Apr. 25, 1995, effective June 8, 1995; revised, 62 FR 53131, Oct. 10, 1997, effective Dec. 1, 1997; para. (b) revised, 65 FR 54604, Sept. 8, 2000, effective Nov. 7, 2000; para. (b) revised, 68 FR 14332, Mar. 25, 2003, effective May 1, 2003; revised, 68 FR 38611, June 30, 2003, effective July 30, 2003]

**§ 1.60 [Reserved]**

[48 FR 2710, Jan. 20, 1983, effective Feb. 27, 1983; 49 FR 554, Jan. 4, 1984, effective Apr. 1, 1984; 50 FR 9379, Mar. 7, 1985, effective May 8, 1985; paras. (a), (b) and (c), 54 FR 47519, Nov. 15, 1989, effective Jan. 16, 1990; paras. (b) and (c) revised, para. (d) added, 57 FR 56446, Nov. 30, 1992, effective Jan. 4, 1993; para. (b) revised, 60 FR 20195, Apr. 25, 1995, effective June 8, 1995; removed and reserved, 62 FR 53131, Oct. 10, 1997, effective Dec. 1, 1997]

**§ 1.61 [Reserved]**

(Editor's note: Substance is now in § 1.495)

**§ 1.62 [Reserved]**

[47 FR 47244, Oct. 25, 1982, added effective Feb. 27, 1983; 48 FR 2710, Jan. 20, 1983, effective date Feb. 27, 1983; paras. (a) and (d), 49 FR 555, Jan. 4, 1984, effective



Apr. 1, 1984; paras. (a), (c), and (h), 50 FR 9380, Mar. 7, 1985, effective May 8, 1985; paras. (e) and (j), 54 FR 47519, Nov. 15, 1989, effective Jan. 16, 1990; paras. (a) and (e) revised, 60 FR 20195, Apr. 25, 1995, effective June 8, 1995; para. (f) revised, 61 FR 42790, Aug. 19, 1996, effective Sept. 23, 1996; removed and reserved, 62 FR 53131, Oct. 10, 1997, effective Dec. 1, 1997]

## OATH OR DECLARATION

### § 1.63 Oath or declaration.

(a) An oath or declaration filed under § 1.51(b)(2) as a part of a nonprovisional application must:

(1) Be executed, *i.e.*, signed, in accordance with either § 1.66 or § 1.68. There is no minimum age for a person to be qualified to sign, but the person must be competent to sign, *i.e.*, understand the document that the person is signing;

(2) Identify each inventor by full name, including the family name, and at least one given name without abbreviation together with any other given name or initial;

(3) Identify the country of citizenship of each inventor; and

(4) State that the person making the oath or declaration believes the named inventor or inventors to be the original and first inventor or inventors of the subject matter which is claimed and for which a patent is sought.

(b) In addition to meeting the requirements of paragraph (a) of this section, the oath or declaration must also:

(1) Identify the application to which it is directed;

(2) State that the person making the oath or declaration has reviewed and understands the contents of the application, including the claims, as amended by any amendment specifically referred to in the oath or declaration; and

(3) State that the person making the oath or declaration acknowledges the duty to disclose to the Office all information known to the person to be material to patentability as defined in § 1.56.

(c) Unless such information is supplied on an application data sheet in accordance with § 1.76, the oath or declaration must also identify:

(1) The mailing address, and the residence if an inventor lives at a location which is different from where the inventor customarily receives mail, of each inventor; and

(2) Any foreign application for patent (or inventor's certificate) for which a claim for priority is made pursuant to § 1.55, and any foreign application having a filing date before that of the application on which priority is claimed, by specifying the application number, country, day, month, and year of its filing.

(d)(1) A newly executed oath or declaration is not required under § 1.51(b)(2) and § 1.53(f) in a continuation or divisional application, provided that:

(i) The prior nonprovisional application contained an oath or declaration as prescribed by paragraphs (a) through (c) of this section;

(ii) The continuation or divisional application was filed by all or by fewer than all of the inventors named in the prior application;

(iii) The specification and drawings filed in the continuation or divisional application contain no matter that would have been new matter in the prior application; and

(iv) A copy of the executed oath or declaration filed in the prior application, showing the signature or an indication thereon that it was signed, is submitted for the continuation or divisional application.

(2) The copy of the executed oath or declaration submitted under this paragraph for a continuation or divisional application must be accompanied by a statement requesting the deletion of the name or names of the person or persons who are not inventors in the continuation or divisional application.

(3) Where the executed oath or declaration of which a copy is submitted for a continuation or divisional application was originally filed in a prior application accorded status under § 1.47, the copy of the executed oath or declaration for such prior application must be accompanied by:

(i) A copy of the decision granting a petition to accord § 1.47 status to the prior application, unless all inventors or legal representatives have filed an oath or declaration to join in an application accorded status under § 1.47 of which the continuation or divisional application claims a benefit under 35 U.S.C. 120, 121, or 365(c); and

(ii) If one or more inventor(s) or legal representative(s) who refused to join in the prior application or could not be found or reached has subsequently joined in the prior application or another application of which the continuation or divisional application claims a benefit under 35 U.S.C. 120, 121, or 365(c), a copy of the subsequently executed oath(s) or declaration(s) filed by the inventor or legal representative to join in the application.

(4) Where the power of attorney (or authorization of agent) or correspondence address was changed during the prosecution of the prior application, the change in power of attorney (or authorization of agent) or correspondence address must be identified in the continuation or divisional application. Otherwise, the Office may not recognize in the continuation or divisional application the change of power of attorney (or authorization of agent) or correspondence address during the prosecution of the prior application.

(5) A newly executed oath or declaration must be filed in a continuation or divisional application naming an inventor not named in the prior application.

(e) A newly executed oath or declaration must be filed in any continuation-in-part application, which application may name all, more, or fewer than all of the inventors named in the prior application.

[48 FR 2711, Jan. 20, 1983, added effective Feb. 27, 1983; 48 FR 4285, Jan. 31, 1983; paras. (b)(3) and (d), 57 FR 2021, Jan. 17, 1992, effective Mar. 16, 1992; para. (a) revised, 60 FR 20195, Apr. 25, 1995, effective June 8, 1995; paras. (a) & (d) revised, para. (e) added, 62 FR 53131, Oct. 10, 1997, effective Dec. 1, 1997; paras. (a), (b), (c), and (e) revised, 65 FR 54604, Sept. 8, 2000, effective Nov. 7, 2000]

#### § 1.64 Person making oath or declaration.

(a) The oath or declaration (§ 1.63), including any supplemental oath or declaration (§ 1.67), must be made by all of the actual inventors except as provided for in §§ 1.42, 1.43, 1.47, or § 1.67.

(b) If the person making the oath or declaration or any supplemental oath or declaration is not the inventor (§§ 1.42, 1.43, 1.47, or § 1.67), the oath or declaration shall state the relationship of the person to the inventor, and, upon information and belief, the facts which the inventor is required to state. If the per-

son signing the oath or declaration is the legal representative of a deceased inventor, the oath or declaration shall also state that the person is a legal representative and the citizenship, residence, and mailing address of the legal representative.

[48 FR 2711, Jan. 20, 1983, added effective Feb. 27, 1983; revised, 65 FR 54604, Sept. 8, 2000, effective Nov. 7, 2000]

#### § 1.66 Officers authorized to administer oaths.

(a) The oath or affirmation may be made before any person within the United States authorized by law to administer oaths. An oath made in a foreign country may be made before any diplomatic or consular officer of the United States authorized to administer oaths, or before any officer having an official seal and authorized to administer oaths in the foreign country in which the applicant may be, whose authority shall be proved by a certificate of a diplomatic or consular officer of the United States, or by an apostille of an official designated by a foreign country which, by treaty or convention, accords like effect to apostilles of designated officials in the United States. The oath shall be attested in all cases in this and other countries, by the proper official seal of the officer before whom the oath or affirmation is made. Such oath or affirmation shall be valid as to execution if it complies with the laws of the State or country where made. When the person before whom the oath or affirmation is made in this country is not provided with a seal, his official character shall be established by competent evidence, as by a certificate from a clerk of a court of record or other proper officer having a seal.

(b) When the oath is taken before an officer in a country foreign to the United States, any accompanying application papers, except the drawings, must be attached together with the oath and a ribbon passed one or more times through all the sheets of the application, except the drawings, and the ends of said ribbon brought together under the seal before the latter is affixed and impressed, or each sheet must be impressed with the official seal of the officer before whom the oath is taken. If the papers as filed are not properly ribboned or each sheet impressed with the seal, the case will be accepted for examination, but before it is allowed, duplicate papers, prepared in compliance with the foregoing sentence, must be filed.

[47 FR 41275, Sept. 17, 1982, effective Oct. 1, 1982]

### § 1.67 Supplemental oath or declaration.

(a) The Office may require, or inventors and applicants may submit, a supplemental oath or declaration meeting the requirements of § 1.63 or § 1.162 to correct any deficiencies or inaccuracies present in the earlier filed oath or declaration.

(1) Deficiencies or inaccuracies relating to all the inventors or applicants (§§ 1.42, 1.43, or § 1.47) may be corrected with a supplemental oath or declaration signed by all the inventors or applicants.

(2) Deficiencies or inaccuracies relating to fewer than all of the inventor(s) or applicant(s) (§§ 1.42, 1.43 or § 1.47) may be corrected with a supplemental oath or declaration identifying the entire inventive entity but signed only by the inventor(s) or applicant(s) to whom the error or deficiency relates.

(3) Deficiencies or inaccuracies due to the failure to meet the requirements of § 1.63(c) (*e.g.*, to correct the omission of a mailing address of an inventor) in an oath or declaration may be corrected with an application data sheet in accordance with § 1.76.

(4) Submission of a supplemental oath or declaration or an application data sheet (§ 1.76), as opposed to who must sign the supplemental oath or declaration or an application data sheet, is governed by § 1.33(a)(2) and paragraph (b) of this section.

(b) A supplemental oath or declaration meeting the requirements of § 1.63 must be filed when a claim is presented for matter originally shown or described but not substantially embraced in the statement of invention or claims originally presented or when an oath or declaration submitted in accordance with § 1.53(f) after the filing of the specification and any required drawings specifically and improperly refers to an amendment which includes new matter. No new matter may be introduced into a nonprovisional application after its filing date even if a supplemental oath or declaration is filed. In proper situations, the oath or declaration here required may be made on information and belief by an applicant other than the inventor.

(c) [Reserved]

[48 FR 2711, Jan. 20, 1983, effective Feb. 27, 1983; para. (c) added, 57 FR 2021, Jan. 17, 1992, effective Mar. 16, 1992; para. (b) revised, 60 FR 20195, Apr. 25, 1995, effective June 8, 1995; para. (b) revised, 62 FR 53131, Oct. 10, 1997, effective Dec. 1, 1997; para. (a) revised and para. (c) removed and reserved, 65 FR 54604, Sept. 8, 2000, effective Nov. 7, 2000]

### § 1.68 Declaration in lieu of oath.

Any document to be filed in the Patent and Trademark Office and which is required by any law, rule, or other regulation to be under oath may be subscribed to by a written declaration. Such declaration may be used in lieu of the oath otherwise required, if, and only if, the declarant is on the same document, warned that willful false statements and the like are punishable by fine or imprisonment, or both (18 U.S.C. 1001) and may jeopardize the validity of the application or any patent issuing thereon. The declarant must set forth in the body of the declaration that all statements made of the declarant's own knowledge are true and that all statements made on information and belief are believed to be true.

[49 FR 48416, Dec. 12, 1984, effective Feb. 11, 1985]

### § 1.69 Foreign language oaths and declarations.

(a) Whenever an individual making an oath or declaration cannot understand English, the oath or declaration must be in a language that such individual can understand and shall state that such individual understands the content of any documents to which the oath or declaration relates.

(b) Unless the text of any oath or declaration in a language other than English is a form provided or approved by the Patent and Trademark Office, it must be accompanied by an English translation together with a statement that the translation is accurate, except that in the case of an oath or declaration filed under § 1.63, the translation may be filed in the Office no later than two months from the date applicant is notified to file the translation.

[42 FR 5594, Jan. 28, 1977; para. (b), 48 FR 2711, Jan. 20, 1983, effective Feb. 27, 1983; para. (b) revised, 62 FR 53131, Oct. 10, 1997, effective Dec. 1, 1997]

**§ 1.70 [Reserved]**

(Editor's note: Substance moved to § 1.497)

[52 FR 20046, May 28, 1987, effective July 1, 1987]

**SPECIFICATION****§ 1.71 Detailed description and specification of the invention.**

(a) The specification must include a written description of the invention or discovery and of the manner and process of making and using the same, and is required to be in such full, clear, concise, and exact terms as to enable any person skilled in the art or science to which the invention or discovery appertains, or with which it is most nearly connected, to make and use the same.

(b) The specification must set forth the precise invention for which a patent is solicited, in such manner as to distinguish it from other inventions and from what is old. It must describe completely a specific embodiment of the process, machine, manufacture, composition of matter or improvement invented, and must explain the mode of operation or principle whenever applicable. The best mode contemplated by the inventor of carrying out his invention must be set forth.

(c) In the case of an improvement, the specification must particularly point out the part or parts of the process, machine, manufacture, or composition of matter to which the improvement relates, and the description should be confined to the specific improvement and to such parts as necessarily cooperate with it or as may be necessary to a complete understanding or description of it.

(d) A copyright or mask work notice may be placed in a design or utility patent application adjacent to copyright and mask work material contained therein. The notice may appear at any appropriate portion of the patent application disclosure. For notices in drawings, see § 1.84(s). The content of the notice must be limited to only those elements provided for by law. For example, "©1983 John Doe" (17 U.S.C. 401) and "\*M\* John Doe" (17 U.S.C. 909) would be properly limited and, under current statutes, legally sufficient notices of copyright and mask work, respectively. Inclusion of a copyright or mask work notice will be permitted only if the authorization language

set forth in paragraph (e) of this section is included at the beginning (preferably as the first paragraph) of the specification.

(e) The authorization shall read as follows:

A portion of the disclosure of this patent document contains material which is subject to (copyright or mask work) protection. The (copyright or mask work) owner has no objection to the facsimile reproduction by anyone of the patent document or the patent disclosure, as it appears in the Patent and Trademark Office patent file or records, but otherwise reserves all (copyright or mask work) rights whatsoever.

(f) The specification must commence on a separate sheet. Each sheet including part of the specification may not include other parts of the application or other information. The claim(s), abstract and sequence listing (if any) should not be included on a sheet including any other part of the application.

[paras. (d) and (e), 53 FR 47808, Nov. 28, 1988, effective Jan. 1, 1989; para. (d), 58 FR 38719, July 20, 1993, effective Oct. 1, 1993; para. (f) added, 68 FR 38611, June 30, 2003, effective July 30, 2003]

**§ 1.72 Title and abstract.**

(a) The title of the invention may not exceed 500 characters in length and must be as short and specific as possible. Characters that cannot be captured and recorded in the Office's automated information systems may not be reflected in the Office's records in such systems or in documents created by the Office. Unless the title is supplied in an application data sheet (§ 1.76), the title of the invention should appear as a heading on the first page of the specification.

(b) A brief abstract of the technical disclosure in the specification must commence on a separate sheet, preferably following the claims, under the heading "Abstract" or "Abstract of the Disclosure." The sheet or sheets presenting the abstract may not include other parts of the application or other material. The abstract in an application filed under 35 U.S.C. 111 may not exceed 150 words in length. The purpose of the abstract is to enable the United States Patent and Trademark Office and the public generally to determine quickly from a cursory inspection the nature and gist of the technical disclosure.

[31 FR 12922, Oct. 4, 1966; 43 FR 20464, May 11, 1978; para. (b) amended, 61 FR 42790, Aug. 19, 1996, effective Sept. 23, 1996; revised, 65 FR 54604, Sept. 8, 2000, effective Nov. 7, 2000; para. (a) revised, 65 FR 57024, Sept. 20, 2000, effective Nov. 29, 2000; para. (b) revised, 68 FR 38611, June 30, 2003, effective July 30, 2003]

### § 1.73 Summary of the invention.

A brief summary of the invention indicating its nature and substance, which may include a statement of the object of the invention, should precede the detailed description. Such summary should, when set forth, be commensurate with the invention as claimed and any object recited should be that of the invention as claimed.

### § 1.74 Reference to drawings.

When there are drawings, there shall be a brief description of the several views of the drawings and the detailed description of the invention shall refer to the different views by specifying the numbers of the figures and to the different parts by use of reference letters or numerals (preferably the latter).

### § 1.75 Claim(s).

(a) The specification must conclude with a claim particularly pointing out and distinctly claiming the subject matter which the applicant regards as his invention or discovery.

(b) More than one claim may be presented provided they differ substantially from each other and are not unduly multiplied.

(c) One or more claims may be presented in dependent form, referring back to and further limiting another claim or claims in the same application. Any dependent claim which refers to more than one other claim ("multiple dependent claim") shall refer to such other claims in the alternative only. A multiple dependent claim shall not serve as a basis for any other multiple dependent claim. For fee calculation purposes under § 1.16, a multiple dependent claim will be considered to be that number of claims to which direct reference is made therein. For fee calculation purposes, also, any claim depending from a multiple dependent claim will be considered to be that number of claims to which direct reference is made in that multiple dependent claim. In addition to the other fil-

ing fees, any original application which is filed with, or is amended to include, multiple dependent claims must have paid therein the fee set forth in § 1.16(d). Claims in dependent form shall be construed to include all the limitations of the claim incorporated by reference into the dependent claim. A multiple dependent claim shall be construed to incorporate by reference all the limitations of each of the particular claims in relation to which it is being considered.

(d)(1) The claim or claims must conform to the invention as set forth in the remainder of the specification and the terms and phrases used in the claims must find clear support or antecedent basis in the description so that the meaning of the terms in the claims may be ascertainable by reference to the description. (See § 1.58(a)).

(2) See §§ 1.141 to 1.146 as to claiming different inventions in one application.

(e) Where the nature of the case admits, as in the case of an improvement, any independent claim should contain in the following order:

(1) A preamble comprising a general description of all the elements or steps of the claimed combination which are conventional or known,

(2) A phrase such as "wherein the improvement comprises," and

(3) Those elements, steps, and/or relationships which constitute that portion of the claimed combination which the applicant considers as the new or improved portion.

(f) If there are several claims, they shall be numbered consecutively in Arabic numerals.

(g) The least restrictive claim should be presented as claim number 1, and all dependent claims should be grouped together with the claim or claims to which they refer to the extent practicable.

(h) The claim or claims must commence on a separate physical sheet or electronic page. Any sheet including a claim or portion of a claim may not contain any other parts of the application or other material.

(i) Where a claim sets forth a plurality of elements or steps, each element or step of the claim should be separated by a line indentation.

[31 FR 12922, Oct. 4, 1966; 36 FR 12690, July 3, 1971; 37 FR 21995, Oct. 18, 1972; 43 FR 4015, Jan. 31, 1978; para. (c), 47 FR 41276, Sept. 17, 1982, effective Oct. 1, 1982; para. (g) amended, paras. (h) and (i) added, 61 FR

42790, Aug. 19, 1996, effective Sept. 23, 1996; para. (h) revised, 68 FR 38611, June 30, 2003, effective July 30, 2003; para. (h) revised, 68 FR 38611, June 30, 2003, effective July 30, 2003]

### § 1.76 Application data sheet.

(a) *Application data sheet.* An application data sheet is a sheet or sheets that may be voluntarily submitted in either provisional or nonprovisional applications, which contains bibliographic data, arranged in a format specified by the Office. If an application data sheet is provided, the application data sheet is part of the provisional or nonprovisional application for which it has been submitted.

(b) *Bibliographic data.* Bibliographic data as used in paragraph (a) of this section includes:

(1) *Applicant information.* This information includes the name, residence, mailing address, and citizenship of each applicant (§ 1.41(b)). The name of each applicant must include the family name, and at least one given name without abbreviation together with any other given name or initial. If the applicant is not an inventor, this information also includes the applicant's authority (§§ 1.42, 1.43, and 1.47) to apply for the patent on behalf of the inventor.

(2) *Correspondence information.* This information includes the correspondence address, which may be indicated by reference to a customer number, to which correspondence is to be directed (see § 1.33(a)).

(3) *Application information.* This information includes the title of the invention, a suggested classification, by class and subclass, the Technology Center to which the subject matter of the invention is assigned, the total number of drawing sheets, a suggested drawing figure for publication (in a nonprovisional application), any docket number assigned to the application, the type of application (*e.g.*, utility, plant, design, reissue, provisional), whether the application discloses any significant part of the subject matter of an application under a secrecy order pursuant to § 5.2 of this chapter (see § 5.2(c)), and, for plant applications, the Latin name of the genus and species of the plant claimed, as well as the variety denomination. The suggested classification and Technology Center information should be supplied for provisional applications whether or not claims are present. If claims

are not present in a provisional application, the suggested classification and Technology Center should be based upon the disclosure.

(4) *Representative information.* This information includes the registration number of each practitioner having a power of attorney or authorization of agent in the application (preferably by reference to a customer number). Providing this information in the application data sheet does not constitute a power of attorney or authorization of agent in the application (see § 1.34(b)).

(5) *Domestic priority information.* This information includes the application number, the filing date, the status (including patent number if available), and relationship of each application for which a benefit is claimed under 35 U.S.C. 119(e), 120, 121, or 365(c). Providing this information in the application data sheet constitutes the specific reference required by 35 U.S.C. 119(e) or 120, and § 1.78(a)(2) or § 1.78(a)(4), and need not otherwise be made part of the specification.

(6) *Foreign priority information.* This information includes the application number, country, and filing date of each foreign application for which priority is claimed, as well as any foreign application having a filing date before that of the application for which priority is claimed. Providing this information in the application data sheet constitutes the claim for priority as required by 35 U.S.C. 119(b) and § 1.55(a).

(7) *Assignee information.* This information includes the name (either person or juristic entity) and address of the assignee of the entire right, title, and interest in an application. Providing this information in the application data sheet does not substitute for compliance with any requirement of part 3 of this chapter to have an assignment recorded by the Office.

(c) *Supplemental application data sheets.* Supplemental application data sheets:

(1) May be subsequently supplied prior to payment of the issue fee either to correct or update information in a previously submitted application data sheet, or an oath or declaration under § 1.63 or § 1.67, except that inventorship changes are governed by § 1.48, correspondence changes are governed by § 1.33(a), and citizenship changes are governed by § 1.63 or § 1.67; and

(2) Should identify the information that is being changed (added, deleted, or modified) and therefore need not contain all the previously submitted information that has not changed.

(d) *Inconsistencies between application data sheet and oath or declaration.* For inconsistencies between information that is supplied by both an application data sheet under this section and by an oath or declaration under §§ 1.63 and 1.67:

(1) The latest submitted information will govern notwithstanding whether supplied by an application data sheet, or by a § 1.63 or § 1.67 oath or declaration, except as provided by paragraph (d)(3) of this section;

(2) The information in the application data sheet will govern when the inconsistent information is supplied at the same time by a § 1.63 or § 1.67 oath or declaration, except as provided by paragraph (d)(3) of this section;

(3) The oath or declaration under § 1.63 or § 1.67 governs inconsistencies with the application data sheet in the naming of inventors (§ 1.41(a)(1)) and setting forth their citizenship (35 U.S.C. 115);

(4) The Office will initially capture bibliographic information from the application data sheet (notwithstanding whether an oath or declaration governs the information). Thus, the Office shall generally not look to an oath or declaration under § 1.63 to see if the bibliographic information contained therein is consistent with the bibliographic information captured from an application data sheet (whether the oath or declaration is submitted prior to or subsequent to the application data sheet). Captured bibliographic information derived from an application data sheet containing errors may be recaptured by a request therefor and the submission of a supplemental application data sheet, an oath or declaration under § 1.63 or § 1.67, or a letter pursuant to § 1.33(b).

[Added, 65 FR 54604, Sept. 8, 2000, effective Nov. 7, 2000; para. (b)(7) added, 65 FR 57024, Sept. 20, 2000, effective Nov. 29, 2000]

### § 1.77 Arrangement of application elements.

(a) The elements of the application, if applicable, should appear in the following order:

- (1) Utility application transmittal form.
- (2) Fee transmittal form.
- (3) Application data sheet (see § 1.76).

(4) Specification.

(5) Drawings.

(6) Executed oath or declaration.

(b) The specification should include the following sections in order:

(1) Title of the invention, which may be accompanied by an introductory portion stating the name, citizenship, and residence of the applicant (unless included in the application data sheet).

(2) Cross-reference to related applications (unless included in the application data sheet).

(3) Statement regarding federally sponsored research or development.

(4) Reference to a “Sequence Listing,” a table, or a computer program listing appendix submitted on a compact disc and an incorporation-by-reference of the material on the compact disc (see § 1.52(e)(5)). The total number of compact discs including duplicates and the files on each compact disc shall be specified.

(5) Background of the invention.

(6) Brief summary of the invention.

(7) Brief description of the several views of the drawing.

(8) Detailed description of the invention.

(9) A claim or claims.

(10) Abstract of the disclosure.

(11) “Sequence Listing,” if on paper (see §§ 1.821 through 1.825).

(c) The text of the specification sections defined in paragraphs (b)(1) through (b)(11) of this section, if applicable, should be preceded by a section heading in uppercase and without underlining or bold type.

[43 FR 20464, May 11, 1978; 46 FR 2612, Jan. 12, 1981; paras. (h) and (i), 48 FR 2712, Jan. 20, 1983, effective Feb. 27, 1983; revised, 61 FR 42790, Aug. 19, 1996, effective Sept. 23, 1996; revised, 65 FR 54604, Sept. 8, 2000, effective Nov. 7, 2000]

### § 1.78 Claiming benefit of earlier filing date and cross-references to other applications.

(a)(1) A nonprovisional application or international application designating the United States of America may claim an invention disclosed in one or more prior-filed copending nonprovisional applications or international applications designating the United States of America. In order for an application

to claim the benefit of a prior-filed copending nonprovisional application or international application designating the United States of America, each prior-filed application must name as an inventor at least one inventor named in the later-filed application and disclose the named inventor's invention claimed in at least one claim of the later-filed application in the manner provided by the first paragraph of 35 U.S.C. 112. In addition, each prior-filed application must be:

(i) An international application entitled to a filing date in accordance with PCT Article 11 and designating the United States of America; or

(ii) Complete as set forth in § 1.51(b); or

(iii) Entitled to a filing date as set forth in § 1.53(b) or § 1.53(d) and include the basic filing fee set forth in § 1.16; or

(iv) Entitled to a filing date as set forth in § 1.53(b) and have paid therein the processing and retention fee set forth in § 1.21(l) within the time period set forth in § 1.53(f).

(2)(i) Except for a continued prosecution application filed under § 1.53(d), any nonprovisional application claiming the benefit of one or more prior-filed copending nonprovisional applications or international applications designating the United States of America must contain or be amended to contain a reference to each such prior-filed application, identifying it by application number (consisting of the series code and serial number) or international application number and international filing date and indicating the relationship of the applications. Cross references to other related applications may be made when appropriate (see § 1.14).

(ii) This reference must be submitted during the pendency of the later-filed application. If the later-filed application is an application filed under 35 U.S.C. 111(a), this reference must also be submitted within the later of four months from the actual filing date of the later-filed application or sixteen months from the filing date of the prior-filed application. If the later-filed application is a nonprovisional application which entered the national stage from an international application after compliance with 35 U.S.C. 371, this reference must also be submitted within the later of four months from the date on which the national stage commenced under 35 U.S.C. 371(b) or (f) in the later-filed international application or sixteen months from the filing date of the prior-filed

application. These time periods are not extendable. Except as provided in paragraph (a)(3) of this section, the failure to timely submit the reference required by 35 U.S.C. 120 and paragraph (a)(2)(i) of this section is considered a waiver of any benefit under 35 U.S.C. 120, 121, or 365(c) to such prior-filed application. The time periods in this paragraph do not apply if the later-filed application is:

(A) An application for a design patent;

(B) An application filed under 35 U.S.C. 111 (a) before November 29, 2000; or

(C) A nonprovisional application which entered the national stage after compliance with 35 U.S.C. 371 from an international application filed under 35 U.S.C. 363 before November 29, 2000.

(iii) If the later-filed application is a nonprovisional application, the reference required by this paragraph must be included in an application data sheet (§ 1.76), or the specification must contain or be amended to contain such reference in the first sentence following the title.

(iv) The request for a continued prosecution application under § 1.53(d) is the specific reference required by 35 U.S.C. 120 to the prior-filed application. The identification of an application by application number under this section is the identification of every application assigned that application number necessary for a specific reference required by 35 U.S.C. 120 to every such application assigned that application number.

(3) If the reference required by 35 U.S.C. 120 and paragraph (a)(2) of this section is presented after the time period provided by paragraph (a)(2)(ii) of this section, the claim under 35 U.S.C. 120, 121, or 365(c) for the benefit of a prior-filed copending nonprovisional application or international application designating the United States of America may be accepted if the reference identifying the prior-filed application by application number or international application number and international filing date was unintentionally delayed. A petition to accept an unintentionally delayed claim under 35 U.S.C. 120, 121, or 365(c) for the benefit of a prior-filed application must be accompanied by:

(i) The reference required by 35 U.S.C. 120 and paragraph (a)(2) of this section to the prior-filed application, unless previously submitted;



(ii) The surcharge set forth in § 1.17(t); and

(iii) A statement that the entire delay between the date the claim was due under paragraph (a)(2)(ii) of this section and the date the claim was filed was unintentional. The Director may require additional information where there is a question whether the delay was unintentional.

(4) A nonprovisional application, other than for a design patent, or an international application designating the United States of America may claim an invention disclosed in one or more prior-filed provisional applications. In order for an application to claim the benefit of one or more prior filed provisional applications, each prior-filed provisional application must name as an inventor at least one inventor named in the later-filed application and disclose the named inventor's invention claimed in at least one claim of the later-filed application in the manner provided by the first paragraph of 35 U.S.C. 112. In addition, each prior-filed provisional application must be entitled to a filing date as set forth in § 1.53(c), and the basic filing fee set forth in § 1.16(k) must be paid within the time period set forth in § 1.53(g).

(5)(i) Any nonprovisional application or international application designating the United States of America claiming the benefit of one or more prior-filed provisional applications must contain or be amended to contain a reference to each such prior-filed provisional application, identifying it by the provisional application number (consisting of series code and serial number).

(ii) This reference must be submitted during the pendency of the later-filed application. If the later-filed application is an application filed under 35 U.S.C. 111(a), this reference must also be submitted within the later of four months from the actual filing date of the later-filed application or sixteen months from the filing date of the prior-filed provisional application. If the later-filed application is a nonprovisional application which entered the national stage from an international application after compliance with 35 U.S.C. 371, this reference must also be submitted within the later of four months from the date on which the national stage commenced under 35 U.S.C. 371(b) or (f) in the later-filed international application or sixteen months from the filing date of the prior-filed provisional application. These time

periods are not extendable. Except as provided in paragraph(a)(6) of this section, the failure to timely submit the reference is considered a waiver of any benefit under 35 U.S.C. 119(e) to such prior-filed provisional application. The time periods in this paragraph do not apply if the later-filed application is:

(A) An application filed under 35 U.S.C. 111(a) before November 29, 2000; or

(B) A nonprovisional application which entered the national stage after compliance with 35 U.S.C. 371 from an international application filed under 35 U.S.C. 363 before November 29, 2000.

(iii) If the later-filed application is a nonprovisional application, the reference required by this paragraph must be included in an application data sheet (§ 1.76), or the specification must contain or be amended to contain such reference in the first sentence following the title.

(iv) If the prior-filed provisional application was filed in a language other than English and an English-language translation of the prior-filed provisional application and a statement that the translation is accurate were not previously filed in the prior-filed provisional application or the later-filed nonprovisional application, applicant will be notified and given a period of time within which to file an English-language translation of the non-English-language prior-filed provisional application and a statement that the translation is accurate. In a pending nonprovisional application, failure to timely reply to such a notice will result in abandonment of the application.

(6) If the reference required by 35 U.S.C. 119(e) and paragraph (a)(5) of this section is presented in a nonprovisional application after the time period provided by paragraph (a)(5)(ii) of this section, the claim under 35 U.S.C. 119(e) for the benefit of a prior filed provisional application may be accepted during the pendency of the later-filed application if the reference identifying the prior-filed application by provisional application number was unintentionally delayed. A petition to accept an unintentionally delayed claim under 35 U.S.C. 119(e) for the benefit of a prior filed provisional application must be accompanied by:

(i) The reference required by 35 U.S.C. 119(e) and paragraph (a)(5) of this section to the prior-filed provisional application, unless previously submitted;

(ii) The surcharge set forth in § 1.17(t);  
and

(iii) A statement that the entire delay between the date the claim was due under paragraph (a)(5)(ii) of this section and the date the claim was filed was unintentional. The Director may require additional information where there is a question whether the delay was unintentional.

(b) Where two or more applications filed by the same applicant contain conflicting claims, elimination of such claims from all but one application may be required in the absence of good and sufficient reason for their retention during pendency in more than one application.

(c) If an application or a patent under reexamination and at least one other application naming different inventors are owned by the same party and contain conflicting claims, and there is no statement of record indicating that the claimed inventions were commonly owned or subject to an obligation of assignment to the same person at the time the later invention was made, the Office may require the assignee to state whether the claimed inventions were commonly owned or subject to an obligation of assignment to the same person at the time the later invention was made, and, if not, indicate which named inventor is the prior inventor.

[36 FR 7312, Apr. 17, 1971; 49 FR 555, Jan. 4, 1984; paras. (a), (c) & (d), 50 FR 9380, Mar. 7, 1985, effective May 8, 1985; 50 FR 11366, Mar. 21, 1985; para. (a) revised 58 FR 54504, Oct. 22, 1993, effective Jan. 3, 1994; paras. (a)(1) and (a)(2) revised and paras. (a)(3) and (a)(4) added, 60 FR 20195, Apr. 25, 1995, effective June 8, 1995; para. (c) revised and para. (d) deleted, 61 FR 42790, Aug. 19, 1996, effective Sept. 23, 1996; para. (a) revised, 62 FR 53131, Oct. 10, 1997, effective Dec. 1, 1997; para. (a)(3) revised, 65 FR 14865, Mar. 20, 2000, effective May 29, 2000 (adopted as final, 65 FR 50092, Aug. 16, 2000); paras. (a)(2), (a)(4), and (c) revised, 65 FR 54604, Sept. 8, 2000, effective Sept. 8, 2000; paras. (a)(2), (a)(3), and (a)(4) revised and paras. (a)(5) and (a)(6) added, 65 FR 57024, Sept. 20, 2000, effective Nov. 29, 2000; para. (a) revised, 66 FR 67087, Dec. 28, 2001, effective Dec. 28, 2001; paras. (a)(3)(iii) & (a)(6)(iii) revised, 68 FR 14332, Mar. 25, 2003, effective May 1, 2003; para (a)(3) revised, 68 FR 70996, Dec. 22, 2003, effective Jan. 21, 2004]

### § 1.79 Reservation clauses not permitted.

A reservation for a future application of subject matter disclosed but not claimed in a pending application will not be permitted in the pending application, but an application disclosing unclaimed subject matter may contain a reference to a later filed application of the same applicant or owned by a common assignee disclosing and claiming that subject matter.

## THE DRAWINGS

### § 1.81 Drawings required in patent application.

(a) The applicant for a patent is required to furnish a drawing of his or her invention where necessary for the understanding of the subject matter sought to be patented; this drawing, or a high quality copy thereof, must be filed with the application. Since corrections are the responsibility of the applicant, the original drawing(s) should be retained by the applicant for any necessary future correction.

(b) Drawings may include illustrations which facilitate an understanding of the invention (for example, flowsheets in cases of processes, and diagrammatic views).

(c) Whenever the nature of the subject matter sought to be patented admits of illustration by a drawing without its being necessary for the understanding of the subject matter and the applicant has not furnished such a drawing, the examiner will require its submission within a time period of not less than two months from the date of the sending of a notice thereof.

(d) Drawings submitted after the filing date of the application may not be used to overcome any insufficiency of the specification due to lack of an enabling disclosure or otherwise inadequate disclosure therein, or to supplement the original disclosure thereof for the purpose of interpretation of the scope of any claim.

[43 FR 4015, Jan. 31, 1978; para. (a), 53 FR 47809, Nov. 28, 1988, effective Jan. 1, 1989]

### § 1.83 Content of drawing.

(a) The drawing in a nonprovisional application must show every feature of the invention specified in the claims. However, conventional features disclosed in the description and claims, where their detailed

illustration is not essential for a proper understanding of the invention, should be illustrated in the drawing in the form of a graphical drawing symbol or a labeled representation (e.g., a labeled rectangular box).

(b) When the invention consists of an improvement on an old machine the drawing must when possible exhibit, in one or more views, the improved portion itself, disconnected from the old structure, and also in another view, so much only of the old structure as will suffice to show the connection of the invention therewith.

(c) Where the drawings in a nonprovisional application do not comply with the requirements of paragraphs (a) and (b) of this section, the examiner shall require such additional illustration within a time period of not less than two months from the date of the sending of a notice thereof. Such corrections are subject to the requirements of § 1.81(d).

[31 FR 12923, Oct. 4, 1966; 43 FR 4015, Jan. 31, 1978; paras. (a) and (c) revised, 60 FR 20195, Apr. 25, 1995, effective June 8, 1995]

#### § 1.84 Standards for drawings.

(a) *Drawings.* There are two acceptable categories for presenting drawings in utility and design patent applications.

(1) *Black ink.* Black and white drawings are normally required. India ink, or its equivalent that secures solid black lines, must be used for drawings; or

(2) *Color.* On rare occasions, color drawings may be necessary as the only practical medium by which to disclose the subject matter sought to be patented in a utility or design patent application or the subject matter of a statutory invention registration. The color drawings must be of sufficient quality such that all details in the drawings are reproducible in black and white in the printed patent. Color drawings are not permitted in international applications (see PCT Rule 11.13), or in an application, or copy thereof, submitted under the Office electronic filing system. The Office will accept color drawings in utility or design patent applications and statutory invention registrations only after granting a petition filed under this paragraph explaining why the color drawings are necessary. Any such petition must include the following:

(i) The fee set forth in § 1.17(h);

(ii) Three (3) sets of color drawings;

(iii) A black and white photocopy that accurately depicts, to the extent possible, the subject matter shown in the color drawing; and

(iv) An amendment to the specification to insert (unless the specification contains or has been previously amended to contain) the following language as the first paragraph of the brief description of the drawings:

The patent or application file contains at least one drawing executed in color. Copies of this patent or patent application publication with color drawing(s) will be provided by the Office upon request and payment of the necessary fee.

(b) *Photographs.*—

(1) *Black and white.* Photographs, including photocopies of photographs, are not ordinarily permitted in utility and design patent applications. The Office will accept photographs in utility and design patent applications, however, if photographs are the only practicable medium for illustrating the claimed invention. For example, photographs or photomicrographs of: electrophoresis gels, blots (e.g., immunological, western, Southern, and northern), autoradiographs, cell cultures (stained and unstained), histological tissue cross sections (stained and unstained), animals, plants, in vivo imaging, thin layer chromatography plates, crystalline structures, and, in a design patent application, ornamental effects, are acceptable. If the subject matter of the application admits of illustration by a drawing, the examiner may require a drawing in place of the photograph. The photographs must be of sufficient quality so that all details in the photographs are reproducible in the printed patent.

(2) *Color photographs.* Color photographs will be accepted in utility and design patent applications if the conditions for accepting color drawings and black and white photographs have been satisfied. See paragraphs (a)(2) and (b)(1) of this section.

(c) *Identification of drawings.* Identifying indicia, if provided, should include the title of the invention, inventor's name, and application number, or docket number (if any) if an application number has not been assigned to the application. If this information is provided, it must be placed on the front of each sheet and centered within the top margin.

(d) *Graphic forms in drawings.* Chemical or mathematical formulae, tables, and waveforms may

be submitted as drawings and are subject to the same requirements as drawings. Each chemical or mathematical formula must be labeled as a separate figure, using brackets when necessary, to show that information is properly integrated. Each group of waveforms must be presented as a single figure, using a common vertical axis with time extending along the horizontal axis. Each individual waveform discussed in the specification must be identified with a separate letter designation adjacent to the vertical axis.

(e) *Type of paper.* Drawings submitted to the Office must be made on paper which is flexible, strong, white, smooth, non-shiny, and durable. All sheets must be reasonably free from cracks, creases, and folds. Only one side of the sheet may be used for the drawing. Each sheet must be reasonably free from erasures and must be free from alterations, overwritings, and interlineations. Photographs must be developed on paper meeting the sheet-size requirements of paragraph (f) of this section and the margin requirements of paragraph (g) of this section. See paragraph (b) of this section for other requirements for photographs.

(f) *Size of paper.* All drawing sheets in an application must be the same size. One of the shorter sides of the sheet is regarded as its top. The size of the sheets on which drawings are made must be:

- (1) 21.0 cm. by 29.7 cm. (DIN size A4), or
- (2) 21.6 cm. by 27.9 cm. (8 1/2 by 11 inches).

(g) *Margins.* The sheets must not contain frames around the sight (*i.e.*, the usable surface), but should have scan target points (*i.e.*, cross-hairs) printed on two cater-corner margin corners. Each sheet must include a top margin of at least 2.5 cm. (1 inch), a left side margin of at least 2.5 cm. (1 inch), a right side margin of at least 1.5 cm. (5/8 inch), and a bottom margin of at least 1.0 cm. (3/8 inch), thereby leaving a sight no greater than 17.0 cm. by 26.2 cm. on 21.0 cm. by 29.7 cm. (DIN size A4) drawing sheets, and a sight no greater than 17.6 cm. by 24.4 cm. (6 15/16 by 9 5/8 inches) on 21.6 cm. by 27.9 cm. (8 1/2 by 11 inch) drawing sheets.

(h) *Views.* The drawing must contain as many views as necessary to show the invention. The views may be plan, elevation, section, or perspective views. Detail views of portions of elements, on a larger scale if necessary, may also be used. All views of the drawing must be grouped together and arranged on the

sheet(s) without wasting space, preferably in an upright position, clearly separated from one another, and must not be included in the sheets containing the specifications, claims, or abstract. Views must not be connected by projection lines and must not contain center lines. Waveforms of electrical signals may be connected by dashed lines to show the relative timing of the waveforms.

(1) *Exploded views.* Exploded views, with the separated parts embraced by a bracket, to show the relationship or order of assembly of various parts are permissible. When an exploded view is shown in a figure which is on the same sheet as another figure, the exploded view should be placed in brackets.

(2) *Partial views.* When necessary, a view of a large machine or device in its entirety may be broken into partial views on a single sheet, or extended over several sheets if there is no loss in facility of understanding the view. Partial views drawn on separate sheets must always be capable of being linked edge to edge so that no partial view contains parts of another partial view. A smaller scale view should be included showing the whole formed by the partial views and indicating the positions of the parts shown. When a portion of a view is enlarged for magnification purposes, the view and the enlarged view must each be labeled as separate views.

(i) Where views on two or more sheets form, in effect, a single complete view, the views on the several sheets must be so arranged that the complete figure can be assembled without concealing any part of any of the views appearing on the various sheets.

(ii) A very long view may be divided into several parts placed one above the other on a single sheet. However, the relationship between the different parts must be clear and unambiguous.

(3) *Sectional views.* The plane upon which a sectional view is taken should be indicated on the view from which the section is cut by a broken line. The ends of the broken line should be designated by Arabic or Roman numerals corresponding to the view number of the sectional view, and should have arrows to indicate the direction of sight. Hatching must be used to indicate section portions of an object, and must be made by regularly spaced oblique parallel lines spaced sufficiently apart to enable the lines to be distinguished without difficulty. Hatching should not

impede the clear reading of the reference characters and lead lines. If it is not possible to place reference characters outside the hatched area, the hatching may be broken off wherever reference characters are inserted. Hatching must be at a substantial angle to the surrounding axes or principal lines, preferably 45°. A cross section must be set out and drawn to show all of the materials as they are shown in the view from which the cross section was taken. The parts in cross section must show proper material(s) by hatching with regularly spaced parallel oblique strokes, the space between strokes being chosen on the basis of the total area to be hatched. The various parts of a cross section of the same item should be hatched in the same manner and should accurately and graphically indicate the nature of the material(s) that is illustrated in cross section. The hatching of juxtaposed different elements must be angled in a different way. In the case of large areas, hatching may be confined to an edging drawn around the entire inside of the outline of the area to be hatched. Different types of hatching should have different conventional meanings as regards the nature of a material seen in cross section.

(4) *Alternate position.* A moved position may be shown by a broken line superimposed upon a suitable view if this can be done without crowding; otherwise, a separate view must be used for this purpose.

(5) *Modified forms.* Modified forms of construction must be shown in separate views.

(i) *Arrangement of views.* One view must not be placed upon another or within the outline of another. All views on the same sheet should stand in the same direction and, if possible, stand so that they can be read with the sheet held in an upright position. If views wider than the width of the sheet are necessary for the clearest illustration of the invention, the sheet may be turned on its side so that the top of the sheet, with the appropriate top margin to be used as the heading space, is on the right-hand side. Words must appear in a horizontal, left-to-right fashion when the page is either upright or turned so that the top becomes the right side, except for graphs utilizing standard scientific convention to denote the axis of abscissas (of X) and the axis of ordinates (of Y).

(j) *Front page view.* The drawing must contain as many views as necessary to show the invention. One of the views should be suitable for inclusion on

the front page of the patent application publication and patent as the illustration of the invention. Views must not be connected by projection lines and must not contain center lines. Applicant may suggest a single view (by figure number) for inclusion on the front page of the patent application publication and patent.

(k) *Scale.* The scale to which a drawing is made must be large enough to show the mechanism without crowding when the drawing is reduced in size to two-thirds in reproduction. Indications such as “actual size” or “scale 1/2” on the drawings are not permitted since these lose their meaning with reproduction in a different format.

(l) *Character of lines, numbers, and letters.* All drawings must be made by a process which will give them satisfactory reproduction characteristics. Every line, number, and letter must be durable, clean, black (except for color drawings), sufficiently dense and dark, and uniformly thick and well-defined. The weight of all lines and letters must be heavy enough to permit adequate reproduction. This requirement applies to all lines however fine, to shading, and to lines representing cut surfaces in sectional views. Lines and strokes of different thicknesses may be used in the same drawing where different thicknesses have a different meaning.

(m) *Shading.* The use of shading in views is encouraged if it aids in understanding the invention and if it does not reduce legibility. Shading is used to indicate the surface or shape of spherical, cylindrical, and conical elements of an object. Flat parts may also be lightly shaded. Such shading is preferred in the case of parts shown in perspective, but not for cross sections. See paragraph (h)(3) of this section. Spaced lines for shading are preferred. These lines must be thin, as few in number as practicable, and they must contrast with the rest of the drawings. As a substitute for shading, heavy lines on the shade side of objects can be used except where they superimpose on each other or obscure reference characters. Light should come from the upper left corner at an angle of 45°. Surface delineations should preferably be shown by proper shading. Solid black shading areas are not permitted, except when used to represent bar graphs or color.

(n) *Symbols.* Graphical drawing symbols may be used for conventional elements when appropriate. The elements for which such symbols and labeled

representations are used must be adequately identified in the specification. Known devices should be illustrated by symbols which have a universally recognized conventional meaning and are generally accepted in the art. Other symbols which are not universally recognized may be used, subject to approval by the Office, if they are not likely to be confused with existing conventional symbols, and if they are readily identifiable.

(o) *Legends.* Suitable descriptive legends may be used subject to approval by the Office, or may be required by the examiner where necessary for understanding of the drawing. They should contain as few words as possible.

(p) *Numbers, letters, and reference characters.*

(1) Reference characters (numerals are preferred), sheet numbers, and view numbers must be plain and legible, and must not be used in association with brackets or inverted commas, or enclosed within outlines, *e.g.*, encircled. They must be oriented in the same direction as the view so as to avoid having to rotate the sheet. Reference characters should be arranged to follow the profile of the object depicted.

(2) The English alphabet must be used for letters, except where another alphabet is customarily used, such as the Greek alphabet to indicate angles, wavelengths, and mathematical formulas.

(3) Numbers, letters, and reference characters must measure at least .32 cm. (1/8 inch) in height. They should not be placed in the drawing so as to interfere with its comprehension. Therefore, they should not cross or mingle with the lines. They should not be placed upon hatched or shaded surfaces. When necessary, such as indicating a surface or cross section, a reference character may be underlined and a blank space may be left in the hatching or shading where the character occurs so that it appears distinct.

(4) The same part of an invention appearing in more than one view of the drawing must always be designated by the same reference character, and the same reference character must never be used to designate different parts.

(5) Reference characters not mentioned in the description shall not appear in the drawings. Reference characters mentioned in the description must appear in the drawings.

(q) *Lead lines.* Lead lines are those lines between the reference characters and the details

referred to. Such lines may be straight or curved and should be as short as possible. They must originate in the immediate proximity of the reference character and extend to the feature indicated. Lead lines must not cross each other. Lead lines are required for each reference character except for those which indicate the surface or cross section on which they are placed. Such a reference character must be underlined to make it clear that a lead line has not been left out by mistake. Lead lines must be executed in the same way as lines in the drawing. See paragraph (l) of this section.

(r) *Arrows.* Arrows may be used at the ends of lines, provided that their meaning is clear, as follows:

(1) On a lead line, a freestanding arrow to indicate the entire section towards which it points;

(2) On a lead line, an arrow touching a line to indicate the surface shown by the line looking along the direction of the arrow; or

(3) To show the direction of movement.

(s) *Copyright or Mask Work Notice.* A copyright or mask work notice may appear in the drawing, but must be placed within the sight of the drawing immediately below the figure representing the copyright or mask work material and be limited to letters having a print size of 32 cm. to 64 cm. (1/8 to 1/4 inches) high. The content of the notice must be limited to only those elements provided for by law. For example, “©1983 John Doe” (17 U.S.C. 401) and “\*M\* John Doe” (17 U.S.C. 909) would be properly limited and, under current statutes, legally sufficient notices of copyright and mask work, respectively. Inclusion of a copyright or mask work notice will be permitted only if the authorization language set forth in § 1.71(e) is included at the beginning (preferably as the first paragraph) of the specification.

(t) *Numbering of sheets of drawings.* The sheets of drawings should be numbered in consecutive Arabic numerals, starting with 1, within the sight as defined in paragraph (g) of this section. These numbers, if present, must be placed in the middle of the top of the sheet, but not in the margin. The numbers can be placed on the right-hand side if the drawing extends too close to the middle of the top edge of the usable surface. The drawing sheet numbering must be clear and larger than the numbers used as reference characters to avoid confusion. The number of each sheet should be shown by two Arabic numerals

placed on either side of an oblique line, with the first being the sheet number and the second being the total number of sheets of drawings, with no other marking.

(u) *Numbering of views.*

(1) The different views must be numbered in consecutive Arabic numerals, starting with 1, independent of the numbering of the sheets and, if possible, in the order in which they appear on the drawing sheet(s). Partial views intended to form one complete view, on one or several sheets, must be identified by the same number followed by a capital letter. View numbers must be preceded by the abbreviation "FIG." Where only a single view is used in an application to illustrate the claimed invention, it must not be numbered and the abbreviation "FIG." must not appear.

(2) Numbers and letters identifying the views must be simple and clear and must not be used in association with brackets, circles, or inverted commas. The view numbers must be larger than the numbers used for reference characters.

(v) *Security markings.* Authorized security markings may be placed on the drawings provided they are outside the sight, preferably centered in the top margin.

(w) *Corrections.* Any corrections on drawings submitted to the Office must be durable and permanent.

(x) *Holes.* No holes should be made by applicant in the drawing sheets.

(y) *Types of drawings.* See § 1.152 for design drawings, § 1.165 for plant drawings, and § 1.174 for reissue drawings.

[24 FR 10332, Dec. 22, 1959; 31 FR 12923, Oct. 4, 1966; 36 FR 9775, May 28, 1971; 43 FR 20464, May 11, 1978; 45 FR 73657, Nov. 6, 1980; paras. (a), (b), (i), (j), and (l) amended, paras. (n), (o), and (p) added, 53 FR 47809, Nov. 28, 1988, effective Jan. 1, 1989; revised, 58 FR 38719, July 20, 1993, effective Oct. 1, 1993; paras. (c), (f), (g), and (x) revised, 61 FR 42790, Aug. 19, 1996, effective Sept. 23, 1996; paras. (a)(2)(i), (b), (c) & (g) revised, 62 FR 53131, Oct. 10, 1997, effective Dec. 1, 1997; paras. (a), (b), (c), (j), (k), (o), and (x) revised, and para. (y) added, 65 FR 54604, Sept. 8, 2000, effective Nov. 7, 2000; paras. (a)(2), (e), and (j) revised, 65 FR 57024, Sept. 20, 2000, effective Nov. 29, 2000]

**§ 1.85 Corrections to drawings.**

(a) A utility or plant application will not be placed on the files for examination until objections to the drawings have been corrected. Except as provided in § 1.215(c), any patent application publication will not include drawings filed after the application has been placed on the files for examination. Unless applicant is otherwise notified in an Office action, objections to the drawings in a utility or plant application will not be held in abeyance, and a request to hold objections to the drawings in abeyance will not be considered a *bona fide* attempt to advance the application to final action (§ 1.135(c)). If a drawing in a design application meets the requirements of § 1.84(e), (f), and (g) and is suitable for reproduction, but is not otherwise in compliance with § 1.84, the drawing may be admitted for examination.

(b) The Office will not release drawings for purposes of correction. If corrections are necessary, new corrected drawings must be submitted within the time set by the Office.

(c) If a corrected drawing is required or if a drawing does not comply with § 1.84 at the time an application is allowed, the Office may notify the applicant and set a three month period of time from the mail date of the notice of allowability within which the applicant must file a corrected or formal drawing in compliance with § 1.84 to avoid abandonment. This time period is not extendable under § 1.136(a) or § 1.136(b).

[47 FR 41276, Sept. 17, 1982, effective Oct. 1, 1982; 53 FR 47810, Nov. 28, 1988, effective Jan. 1, 1989; revised, 65 FR 54604, Sept. 8, 2000, effective Nov. 7, 2000; para. (a) revised, 65 FR 57024, Sept. 20, 2000, effective Nov. 29, 2000]

**§ 1.88 [Reserved]**

[Deleted, 58 FR 38719, July 20, 1993, effective Oct. 1, 1993]

**MODELS, EXHIBITS, SPECIMENS**

**§ 1.91 Models or exhibits not generally admitted as part of application or patent.**

(a) A model or exhibit will not be admitted as part of the record of an application unless it:

(1) Substantially conforms to the requirements of § 1.52 or § 1.84;

(2) Is specifically required by the Office; or

(3) Is filed with a petition under this section including:

(i) The fee set forth in § 1.17(h); and

(ii) An explanation of why entry of the model or exhibit in the file record is necessary to demonstrate patentability.

(b) Notwithstanding the provisions of paragraph (a) of this section, a model, working model, or other physical exhibit may be required by the Office if deemed necessary for any purpose in examination of the application.

[Revised, 62 FR 53131, Oct. 10, 1997, effective Dec. 1, 1997; para. (a)(3)(i) revised, 65 FR 54604, Sept. 8, 2000, effective Nov. 7, 2000]

### § 1.92 [Reserved]

[Removed and reserved, 62 FR 53131, Oct. 10, 1997, effective Dec. 1, 1997]

### § 1.93 Specimens.

When the invention relates to a composition of matter, the applicant may be required to furnish specimens of the composition, or of its ingredients or intermediates, for the purpose of inspection or experiment.

### § 1.94 Return of models, exhibits or specimens.

Models, exhibits, or specimens in applications which have become abandoned, and also in other applications on conclusion of the prosecution, may be returned to the applicant upon demand and at his expense, unless it is deemed necessary that they be preserved in the Office. Such physical exhibits in contested cases may be returned to the parties at their expense. If not claimed within a reasonable time, they may be disposed of at the discretion of the Director.

[Revised, 68 FR 14332, Mar. 25, 2003, effective May 1, 2003]

### § 1.95 Copies of exhibits.

Copies of models or other physical exhibits will not ordinarily be furnished by the Office, and any model or exhibit in an application or patent shall not be taken

from the Office except in the custody of an employee of the Office specially authorized by the Director.

[Revised, 68 FR 14332, Mar. 25, 2003, effective May 1, 2003]

### § 1.96 Submission of computer program listings.

(a) *General.* Descriptions of the operation and general content of computer program listings should appear in the description portion of the specification. A computer program listing for the purpose of this section is defined as a printout that lists in appropriate sequence the instructions, routines, and other contents of a program for a computer. The program listing may be either in machine or machine-independent (object or source) language which will cause a computer to perform a desired procedure or task such as solve a problem, regulate the flow of work in a computer, or control or monitor events. Computer program listings may be submitted in patent applications as set forth in paragraphs (b) and (c) of this section.

(b) *Material which will be printed in the patent* If the computer program listing is contained in 300 lines or fewer, with each line of 72 characters or fewer, it may be submitted either as drawings or as part of the specification.

(1) *Drawings.* If the listing is submitted as drawings, it must be submitted in the manner and complying with the requirements for drawings as provided in § 1.84. At least one figure numeral is required on each sheet of drawing.

(2) *Specification.*

(i) If the listing is submitted as part of the specification, it must be submitted in accordance with the provisions of § 1.52.

(ii) Any listing having more than 60 lines of code that is submitted as part of the specification must be positioned at the end of the description but before the claims. Any amendment must be made by way of submission of a substitute sheet.

(c) *As an appendix which will not be printed:* Any computer program listing may, and any computer program listing having over 300 lines (up to 72 characters per line) must, be submitted on a compact disc in compliance with § 1.52(e). A compact disc containing such a computer program listing is to be referred to as a “computer program listing appendix.” The “computer program listing appendix” will not be part



of the printed patent. The specification must include a reference to the “computer program listing appendix” at the location indicated in § 1.77(b)(4).

(1) Multiple computer program listings for a single application may be placed on a single compact disc. Multiple compact discs may be submitted for a single application if necessary. A separate compact disc is required for each application containing a computer program listing that must be submitted on a “computer program listing appendix.”

(2) The “computer program listing appendix” must be submitted on a compact disc that complies with § 1.52(e) and the following specifications (no other format shall be allowed):

(i) Computer Compatibility: IBM PC/XT/AT, or compatibles, or Apple Macintosh;

(ii) Operating System Compatibility: MS-DOS, MS-Windows, Unix, or Macintosh;

(iii) Line Terminator: ASCII Carriage Return plus ASCII Line Feed;

(iv) Control Codes: the data must not be dependent on control characters or codes which are not defined in the ASCII character set; and

(v) Compression: uncompressed data.

[46 FR 2612, Jan. 12, 1981; para. (b)(1), 54 FR 47519, Nov. 15, 1989, effective Jan. 16, 1990; revised, 61 FR 42790, Aug. 19, 1996, effective Sept. 23, 1996; paras. (b) and (c) revised, 65 FR 54604, Sept. 8, 2000, effective Sept. 8, 2000 (effective date corrected, 65 FR 78958, Dec. 18, 2000)]

## INFORMATION DISCLOSURE STATEMENT

### § 1.97 Filing of information disclosure statement.

(a) In order for an applicant for a patent or for a reissue of a patent to have an information disclosure statement in compliance with § 1.98 considered by the Office during the pendency of the application, the information disclosure statement must satisfy one of paragraphs (b), (c), or (d) of this section.

(b) An information disclosure statement shall be considered by the Office if filed by the applicant within any one of the following time periods:

(1) Within three months of the filing date of a national application other than a continued prosecution application under § 1.53(d);

(2) Within three months of the date of entry of the national stage as set forth in § 1.491 in an international application;

(3) Before the mailing of a first Office action on the merits; or

(4) Before the mailing of a first Office action after the filing of a request for continued examination under § 1.114.

(c) An information disclosure statement shall be considered by the Office if filed after the period specified in paragraph (b) of this section, provided that the information disclosure statement is filed before the mailing date of any of a final action under § 1.113, a notice of allowance under § 1.311, or an action that otherwise closes prosecution in the application, and it is accompanied by one of:

(1) The statement specified in paragraph (e) of this section; or

(2) The fee set forth in § 1.17(p).

(d) An information disclosure statement shall be considered by the Office if filed by the applicant after the period specified in paragraph (c) of this section, provided that the information disclosure statement is filed on or before payment of the issue fee and is accompanied by:

(1) The statement specified in paragraph (e) of this section; and

(2) The fee set forth in § 1.17(p).

(e) A statement under this section must state either:

(1) That each item of information contained in the information disclosure statement was first cited in any communication from a foreign patent office in a counterpart foreign application not more than three months prior to the filing of the information disclosure statement; or

(2) That no item of information contained in the information disclosure statement was cited in a communication from a foreign patent office in a counterpart foreign application, and, to the knowledge of the person signing the certification after making reasonable inquiry, no item of information contained in the information disclosure statement was known to any individual designated in § 1.56(c) more than three months prior to the filing of the information disclosure statement.

(f) No extensions of time for filing an information disclosure statement are permitted under § 1.136.

If a *bona fide* attempt is made to comply with § 1.98, but part of the required content is inadvertently omitted, additional time may be given to enable full compliance.

(g) An information disclosure statement filed in accordance with section shall not be construed as a representation that a search has been made.

(h) The filing of an information disclosure statement shall not be construed to be an admission that the information cited in the statement is, or is considered to be, material to patentability as defined in § 1.56(b).

(i) If an information disclosure statement does not comply with either this section or § 1.98, it will be placed in the file but will not be considered by the Office.

[48 FR 2712, Jan. 20, 1983, effective date Feb. 27, 1983; 57 FR 2021, Jan. 17, 1992, effective Mar. 16, 1992; para. (d) revised, 60 FR 20195, Apr. 25, 1995, effective June 8, 1995; paras. (a)-(d) revised, 61 FR 42790, Aug. 19, 1996, effective Sept. 23, 1996; paras. (c)-(e) revised, 62 FR 53131, Oct. 10, 1997, effective Dec. 1, 1997; para. (b) revised, 65 FR 14865, Mar. 20, 2000, effective May 29, 2000 (adopted as final, 65 FR 50092, Aug. 16, 2000); paras. (a) through (e) and (i) revised, 65 FR 54604, Sept. 8, 2000, effective Nov. 7, 2000]

### § 1.98 Content of information disclosure statement.

(a) Any information disclosure statement filed under § 1.97 shall include:

(1) A list of all patents, publications, applications, or other information submitted for consideration by the Office;

(2) A legible copy of:

(i) Each U.S. patent application publication and U.S. and foreign patent;

(ii) Each publication or that portion which caused it to be listed;

(iii) For each cited pending U.S. application, the application specification including the claims, and any drawing of the application, or that portion of the application which caused it to be listed including any claims directed to that portion; and

(iv) All other information or that portion which caused it to be listed; and

(3)(i) A concise explanation of the relevance, as it is presently understood by the individual designated in § 1.56(c) most knowledgeable about the content of the information, of each patent, publication, or other information listed that is not in the English language. The concise explanation may be either separate from applicant's specification or incorporated therein.

(ii) A copy of the translation if a written English-language translation of a non-English-language document, or portion thereof, is within the possession, custody, or control of, or is readily available to any individual designated in § 1.56(c).

(b)(1) Each U.S. patent listed in an information disclosure statement must be identified by inventor, patent number, and issue date.

(2) Each U.S. patent application publication listed in an information disclosure statement shall be identified by applicant, patent application publication number, and publication date.

(3) Each U.S. application listed in an information disclosure statement must be identified by the inventor, application number, and filing date.

(4) Each foreign patent or published foreign patent application listed in an information disclosure statement must be identified by the country or patent office which issued the patent or published the application, an appropriate document number, and the publication date indicated on the patent or published application.

(5) Each publication listed in an information disclosure statement must be identified by publisher, author (if any), title, relevant pages of the publication, date, and place of publication.

(c) When the disclosures of two or more patents or publications listed in an information disclosure statement are substantively cumulative, a copy of one of the patents or publications may be submitted without copies of the other patents or publications, provided that it is stated that these other patents or publications are cumulative.

(d) A copy of any patent, publication, pending U.S. application or other information, as specified in paragraph (a) of this section, listed in an information disclosure statement is required to be provided, even if the patent, publication, pending U.S. application or other information was previously submitted to, or cited by, the Office in an earlier application, unless:

(1) The earlier application is properly identified in the information disclosure statement and is relied on for an earlier effective filing date under 35 U.S.C. 120; and

(2) The information disclosure statement submitted in the earlier application complies with paragraphs (a) through (c) of this section.

(e) The requirement in paragraph (a)(2)(i) of this section for a copy of all listed U.S. patents and U.S. patent application publications does not apply to any information disclosure statement submitted in compliance with the Office's electronic filing system.

[42 FR 5594, Jan. 28, 1977; para. (a) 48 FR 2712, Jan. 20, 1983, effective date Feb. 27, 1983; 57 FR 2021, Jan. 17, 1992, effective Mar. 16, 1992; revised, 65 FR 54604, Sept. 8, 2000, effective Nov. 7, 2000; paras. (a)(2) and (b) revised, 65 FR 57024, Sept. 20, 2000, effective Nov. 29, 2000; para. (e) added, 68 FR 38611, June 30, 2003, effective July 30, 2003]

### § 1.99 Third-party submission in published application.

(a) A submission by a member of the public of patents or publications relevant to a pending published application may be entered in the application file if the submission complies with the requirements of this section and the application is still pending when the submission and application file are brought before the examiner.

(b) A submission under this section must identify the application to which it is directed by application number and include:

(1) The fee set forth in § 1.17(p);

(2) A list of the patents or publications submitted for consideration by the Office, including the date of publication of each patent or publication;

(3) A copy of each listed patent or publication in written form or at least the pertinent portions; and

(4) An English language translation of all the necessary and pertinent parts of any non-English language patent or publication in written form relied upon.

(c) The submission under this section must be served upon the applicant in accordance with § 1.248.

(d) A submission under this section shall not include any explanation of the patents or publications, or any other information. The Office will not enter

such explanation or information if included in a submission under this section. A submission under this section is also limited to ten total patents or publications.

(e) A submission under this section must be filed within two months from the date of publication of the application (§ 1.215(a)) or prior to the mailing of a notice of allowance (§ 1.311), whichever is earlier. Any submission under this section not filed within this period is permitted only when the patents or publications could not have been submitted to the Office earlier, and must also be accompanied by the processing fee set forth in § 1.17(i). A submission by a member of the public to a pending published application that does not comply with the requirements of this section will not be entered.

(f) A member of the public may include a self-addressed postcard with a submission to receive an acknowledgment by the Office that the submission has been received. A member of the public filing a submission under this section will not receive any communications from the Office relating to the submission other than the return of a self-addressed postcard. In the absence of a request by the Office, an applicant has no duty to, and need not, reply to a submission under this section.

[48 FR 2712, Jan. 20, 1983; effective Feb. 27, 1983; removed and reserved, 57 FR 2021, Jan. 17, 1992, effective Mar. 16, 1992; added, 65 FR 57024, Sept. 20, 2000, effective Nov. 29, 2000; para. (f) corrected, 65 FR 66502, Nov. 6, 2000, effective Nov. 29, 2000; paras. (d) and (e) revised, 68 FR 38611, June 30, 2003, effective July 30, 2003]

## EXAMINATION OF APPLICATIONS

### § 1.101 [Reserved]

[29 FR 13470, Sept. 30, 1964; para. (a), 48 FR 2712, Jan. 20, 1983, effective Feb. 27, 1983; para. (a), 50 FR 9381, Mar. 7, 1985, effective May 8, 1985; 52 FR 20046, May 28, 1987, effective July 1, 1987; para. (a) revised, 60 FR 20195, Apr. 25, 1995, effective June 8, 1995; removed and reserved, 62 FR 53131, Oct. 10, 1997, effective Dec. 1, 1997]

### § 1.102 Advancement of examination.

(a) Applications will not be advanced out of turn for examination or for further action except as provided by this part, or upon order of the Director to

expedite the business of the Office, or upon filing of a request under paragraph (b) of this section or upon filing a petition under paragraphs (c) or (d) of this section with a showing which, in the opinion of the Director, will justify so advancing it.

(b) Applications wherein the inventions are deemed of peculiar importance to some branch of the public service and the head of some department of the Government requests immediate action for that reason, may be advanced for examination.

(c) A petition to make an application special may be filed without a fee if the basis for the petition is the applicant's age or health or that the invention will materially enhance the quality of the environment or materially contribute to the development or conservation of energy resources.

(d) A petition to make an application special on grounds other than those referred to in paragraph (c) of this section must be accompanied by the fee set forth in § 1.17(h).

[24 FR 10332, Dec. 22, 1959; paras. (a), (c), and (d), 47 FR 41276, Sept. 17, 1982, effective Oct. 1, 1982; para. (d), 54 FR 6893, Feb. 15, 1989, effective Apr. 17, 1989; para. (d) revised, 60 FR 20195, Apr. 25, 1995, effective June 8, 1995; para. (a) revised, 62 FR 53131, Oct. 10, 1997, effective Dec. 1, 1997; para. (d) revised, 65 FR 54604, Sept. 8, 2000, effective Nov. 7, 2000; para. (a) revised, 68 FR 14332, Mar. 25, 2003, effective May 1, 2003]

### § 1.103 Suspension of action by the Office.

(a) *Suspension for cause.* On request of the applicant, the Office may grant a suspension of action by the Office under this paragraph for good and sufficient cause. The Office will not suspend action if a reply by applicant to an Office action is outstanding. Any petition for suspension of action under this paragraph must specify a period of suspension not exceeding six months. Any petition for suspension of action under this paragraph must also include:

(1) A showing of good and sufficient cause for suspension of action; and

(2) The fee set forth in § 1.17(h), unless such cause is the fault of the Office.

(b) *Limited suspension of action in a continued prosecution application (CPA) filed under § 1.53(d).* On request of the applicant, the Office may grant a suspension of action by the Office under this paragraph in a continued prosecution application filed

under § 1.53(d) for a period not exceeding three months. Any request for suspension of action under this paragraph must be filed with the request for an application filed under § 1.53(d), specify the period of suspension, and include the processing fee set forth in § 1.17(i).

(c) *Limited suspension of action after a request for continued application (RCE) under § 1.114.* On request of the applicant, the Office may grant a suspension of action by the Office under this paragraph after the filing of a request for continued examination in compliance with § 1.114 for a period not exceeding three months. Any request for suspension of action under this paragraph must be filed with the request for continued examination under § 1.114, specify the period of suspension, and include the processing fee set forth in § 1.17(i).

(d) *Deferral of examination.* On request of the applicant, the Office may grant a deferral of examination under the conditions specified in this paragraph for a period not extending beyond three years from the earliest filing date for which a benefit is claimed under title 35, United States Code. A request for deferral of examination under this paragraph must include the publication fee set forth in § 1.18(d) and the processing fee set forth in § 1.17(i). A request for deferral of examination under this paragraph will not be granted unless:

(1) The application is an original utility or plant application filed under § 1.53(b) or resulting from entry of an international application into the national stage after compliance with § 1.495;

(2) The applicant has not filed a nonpublication request under § 1.213(a), or has filed a request under § 1.213(b) to rescind a previously filed nonpublication request;

(3) The application is in condition for publication as provided in § 1.211(c); and

(4) The Office has not issued either an Office action under 35 U.S.C. 132 or a notice of allowance under 35 U.S.C. 151.

(e) *Notice of suspension on initiative of the Office.* The Office will notify applicant if the Office suspends action by the Office on an application on its own initiative.

(f) *Suspension of action for public safety or defense.* The Office may suspend action by the Office

by order of the Director if the following conditions are met:

- (1) The application is owned by the United States;
- (2) Publication of the invention may be detrimental to the public safety or defense; and
- (3) The appropriate department or agency requests such suspension.

(g) *Statutory invention registration.* The Office will suspend action by the Office for the entire pendency of an application if the Office has accepted a request to publish a statutory invention registration in the application, except for purposes relating to patent interference proceedings under Subpart E of this part.

[24 FR 10332, Dec. 22, 11959; 33 FR 5624, Apr. 11, 1968; paras. (a) and (b), 47 FR 41276, Sept. 17, 1982, effective Oct. 1, 1982; para. (d), 49 FR 48416, Dec. 12, 1984, effective Feb. 11, 1985; para. (d), 50 FR 9381, Mar. 7, 1985, effective May 8, 1985; para. (a), 54 FR 6893, Feb. 15, 1989, effective Apr. 17, 1989; para. (a) revised, 60 FR 20195, Apr. 25, 1995, effective June 8, 1995; para. (a) revised, 62 FR 53131, Oct. 10, 1997, effective Dec. 1, 1997; revised, 65 FR 50092, Aug. 16, 2000, effective Aug. 16, 2000; paras. (d) through (f) redesignated as (e) through (g) and para. (d) added, 65 FR 57024, Sept. 20, 2000, effective Nov. 29, 2000; para. (d)(1) revised, 67 FR 520, Jan. 4, 2002, effective Apr. 1, 2002; para. (f) revised, 68 FR 14332, Mar. 25, 2003, effective May 1, 2003]

### § 1.104 Nature of examination.

#### (a) *Examiner's action.*

(1) On taking up an application for examination or a patent in a reexamination proceeding, the examiner shall make a thorough study thereof and shall make a thorough investigation of the available prior art relating to the subject matter of the claimed invention. The examination shall be complete with respect both to compliance of the application or patent under reexamination with the applicable statutes and rules and to the patentability of the invention as claimed, as well as with respect to matters of form, unless otherwise indicated.

(2) The applicant, or in the case of a reexamination proceeding, both the patent owner and the requester, will be notified of the examiner's action. The reasons for any adverse action or any objection or requirement will be stated in an Office action and such information or references will be given as may be useful in aiding the applicant, or in the case of a

reexamination proceeding the patent owner, to judge the propriety of continuing the prosecution.

(3) An international-type search will be made in all national applications filed on and after June 1, 1978.

(4) Any national application may also have an international-type search report prepared thereon at the time of the national examination on the merits, upon specific written request therefor and payment of the international-type search report fee set forth in § 1.21(e). The Patent and Trademark Office does not require that a formal report of an international-type search be prepared in order to obtain a search fee refund in a later filed international application.

(b) *Completeness of examiner's action.* The examiner's action will be complete as to all matters, except that in appropriate circumstances, such as misjoinder of invention, fundamental defects in the application, and the like, the action of the examiner may be limited to such matters before further action is made. However, matters of form need not be raised by the examiner until a claim is found allowable.

#### (c) *Rejection of claims.*

(1) If the invention is not considered patentable, or not considered patentable as claimed, the claims, or those considered unpatentable will be rejected.

(2) In rejecting claims for want of novelty or for obviousness, the examiner must cite the best references at his or her command. When a reference is complex or shows or describes inventions other than that claimed by the applicant, the particular part relied on must be designated as nearly as practicable. The pertinence of each reference, if not apparent, must be clearly explained and each rejected claim specified.

(3) In rejecting claims the examiner may rely upon admissions by the applicant, or the patent owner in a reexamination proceeding, as to any matter affecting patentability and, insofar as rejections in applications are concerned, may also rely upon facts within his or her knowledge pursuant to paragraph (d)(2) of this section.

(4) Subject matter which is developed by another person which qualifies as prior art only under 35 U.S.C. 102(e), (f) or (g) may be used as prior art under 35 U.S.C. 103 against a claimed invention unless the entire rights to the subject matter and the claimed invention were commonly owned by the

same person or organization or subject to an obligation of assignment to the same person or organization at the time the claimed invention was made.

(5) The claims in any original application naming an inventor will be rejected as being precluded by a waiver in a published statutory invention registration naming that inventor if the same subject matter is claimed in the application and the statutory invention registration. The claims in any reissue application naming an inventor will be rejected as being precluded by a waiver in a published statutory invention registration naming that inventor if the reissue application seeks to claim subject matter:

(i) Which was not covered by claims issued in the patent prior to the date of publication of the statutory invention registration; and

(ii) Which was the same subject matter waived in the statutory invention registration.

(d) *Citation of references.*

(1) If domestic patents are cited by the examiner, their numbers and dates, and the names of the patentees will be stated. If domestic patent application publications are cited by the examiner, their publication number, publication date, and the names of the applicants will be stated. If foreign published applications or patents are cited, their nationality or country, numbers and dates, and the names of the patentees will be stated, and such other data will be furnished as may be necessary to enable the applicant, or in the case of a reexamination proceeding, the patent owner, to identify the published applications or patents cited. In citing foreign published applications or patents, in case only a part of the document is involved, the particular pages and sheets containing the parts relied upon will be identified. If printed publications are cited, the author (if any), title, date, pages or plates, and place of publication, or place where a copy can be found, will be given.

(2) When a rejection in an application is based on facts within the personal knowledge of an employee of the Office, the data shall be as specific as possible, and the reference must be supported, when called for by the applicant, by the affidavit of such employee, and such affidavit shall be subject to contradiction or explanation by the affidavits of the applicant and other persons.

(e) *Reasons for allowance.* If the examiner believes that the record of the prosecution as a whole

does not make clear his or her reasons for allowing a claim or claims, the examiner may set forth such reasoning. The reasons shall be incorporated into an Office action rejecting other claims of the application or patent under reexamination or be the subject of a separate communication to the applicant or patent owner. The applicant or patent owner may file a statement commenting on the reasons for allowance within such time as may be specified by the examiner. Failure by the examiner to respond to any statement commenting on reasons for allowance does not give rise to any implication.

[43 FR 20465, May 11, 1978; 46 FR 29182, May 29, 1981; para. (d), 47 FR 41276, Sept. 17, 1982, effective date Oct. 1, 1982; para. (e), 50 FR 9381, Mar. 7, 1985, effective May 8, 1985; para. (e), 57 FR 29642, July 6, 1992, effective Sept. 4, 1992; revised, 62 FR 53131, Oct. 10, 1997, effective Dec. 1, 1997; para. (c)(4) revised, 65 FR 14865, Mar. 20, 2000, effective May 29, 2000 (adopted as final, 65 FR 50092, Aug. 16, 2000); paras. (a)(2) and (e) revised, 65 FR 54604, Sept. 8, 2000, effective Nov. 7, 2000; para. (a)(5) removed and para. (d)(1) revised, 65 FR 57024, Sept. 20, 2000, effective Nov. 29, 2000]

### § 1.105 Requirements for information.

(a)(1) In the course of examining or treating a matter in a pending or abandoned application filed under 35 U.S.C. 111 or 371 (including a reissue application), in a patent, or in a reexamination proceeding, the examiner or other Office employee may require the submission, from individuals identified under § 1.56(c), or any assignee, of such information as may be reasonably necessary to properly examine or treat the matter, for example:

(i) *Commercial databases:* The existence of any particularly relevant commercial database known to any of the inventors that could be searched for a particular aspect of the invention.

(ii) *Search:* Whether a search of the prior art was made, and if so, what was searched.

(iii) *Related information:* A copy of any non-patent literature, published application, or patent (U.S. or foreign), by any of the inventors, that relates to the claimed invention.

(iv) *Information used to draft application:* A copy of any non-patent literature, published application, or patent (U.S. or foreign) that was used to draft the application.

(v) *Information used in invention process:* A copy of any non-patent literature, published application, or patent (U.S. or foreign) that was used in the invention process, such as by designing around or providing a solution to accomplish an invention result.

(vi) *Improvements:* Where the claimed invention is an improvement, identification of what is being improved.

(vii) *In Use:* Identification of any use of the claimed invention known to any of the inventors at the time the application was filed notwithstanding the date of the use.

(2) Where an assignee has asserted its right to prosecute pursuant to § 3.71(a) of this chapter, matters such as paragraphs (a)(1)(i), (iii), and (vii) of this section may also be applied to such assignee.

(3) Any reply that states that the information required to be submitted is unknown and/or is not readily available to the party or parties from which it was requested will be accepted as a complete reply.

(b) The requirement for information of paragraph (a)(1) of this section may be included in an Office action, or sent separately.

(c) A reply, or a failure to reply, to a requirement for information under this section will be governed by §§ 1.135 and 1.136.

[Removed and reserved, 62 FR 53131, Oct. 10, 1997, effective Dec. 1, 1997; added, 65 FR 54604, Sept. 8, 2000, effective Nov. 7, 2000]

### § 1.106 [Reserved]

[24 FR 10332, Dec. 22, 1959; 34 FR 18857, Nov. 26, 1969; para. (c) added, 47 FR 21752, May 19, 1982, effective July 1, 1982; paras. (d) and (e), 50 FR 9381, Mar. 7, 1985, effective May 8, 1985; removed and reserved, 62 FR 53131, Oct. 10, 1997, effective Dec. 1, 1997]

### § 1.107 [Reserved]

[46 FR 29182, May 29, 1981; para. (a) revised, 61 FR 42790, Aug. 19, 1996, effective Sept. 23, 1996; removed and reserved, 62 FR 53131, Oct. 10, 1997, effective Dec. 1, 1997]

### § 1.108 [Reserved]

[50 FR 9381, Mar. 7, 1985, effective May 8, 1985; removed and reserved, 62 FR 53131, Oct. 10, 1997, effective Dec. 1, 1997]

### § 1.109 [Reserved]

[46 FR 29182, May 29, 1981; removed and reserved, 62 FR 53131, Oct. 10, 1997, effective Dec. 1, 1997]

### § 1.110 Inventorship and date of invention of the subject matter of individual claims.

When more than one inventor is named in an application or patent, the Patent and Trademark Office, when necessary for purposes of an Office proceeding, may require an applicant, patentee, or owner to identify the inventive entity of the subject matter of each claim in the application or patent. Where appropriate, the invention dates of the subject matter of each claim and the ownership of the subject matter on the date of invention may be required of the applicant, patentee or owner. See also §§ 1.78(c) and 1.130.

[50 FR 9381, Mar. 7, 1985, effective date May 8, 1985; revised, 61 FR 42790, Aug. 19, 1996, effective Sept. 23, 1996]

## ACTION BY APPLICANT AND FURTHER CONSIDERATION

### § 1.111 Reply by applicant or patent owner to a non-final Office action.

(a)(1) If the Office action after the first examination (§ 1.104) is adverse in any respect, the applicant or patent owner, if he or she persists in his or her application for a patent or reexamination proceeding, must reply and request reconsideration or further examination, with or without amendment. See §§ 1.135 and 1.136 for time for reply to avoid abandonment.

(2) A second (or subsequent) supplemental reply will be entered unless disapproved by the Director. A second (or subsequent) supplemental reply may be disapproved if the second (or subsequent) supplemental reply unduly interferes with an Office action being prepared in response to the previous reply. Factors that will be considered in disapproving a second (or subsequent) supplemental reply include:

(i) The state of preparation of an Office action responsive to the previous reply as of the date of receipt (§ 1.6) of the second (or subsequent) supplemental reply by the Office; and

(ii) The nature of any changes to the specification or claims that would result from entry of the second (or subsequent) supplemental reply.

(b) In order to be entitled to reconsideration or further examination, the applicant or patent owner must reply to the Office action. The reply by the applicant or patent owner must be reduced to a writing which distinctly and specifically points out the supposed errors in the examiner's action and must reply to every ground of objection and rejection in the prior Office action. The reply must present arguments pointing out the specific distinctions believed to render the claims, including any newly presented claims, patentable over any applied references. If the reply is with respect to an application, a request may be made that objections or requirements as to form not necessary to further consideration of the claims be held in abeyance until allowable subject matter is indicated. The applicant's or patent owner's reply must appear throughout to be a *bona fide* attempt to advance the application or the reexamination proceeding to final action. A general allegation that the claims define a patentable invention without specifically pointing out how the language of the claims patentably distinguishes them from the references does not comply with the requirements of this section.

(c) In amending in reply to a rejection of claims in an application or patent under reexamination, the applicant or patent owner must clearly point out the patentable novelty which he or she thinks the claims present in view of the state of the art disclosed by the references cited or the objections made. The applicant or patent owner must also show how the amendments avoid such references or objections.

[46 FR 29182, May 29, 1981; para. (b) revised, 62 FR 53131, Oct. 10, 1997, effective Dec. 1, 1997; paras. (a) and (c) revised, 65 FR 54604, Sept. 8, 2000, effective Nov. 7, 2000; para. (a)(2) revised, 68 FR 14332, Mar. 25, 2003, effective May 1, 2003]

### § 1.112 Reconsideration before final action.

After reply by applicant or patent owner (§ 1.111 or § 1.945) to a non-final action and any comments by an *inter partes* reexamination requester (§ 1.947), the application or the patent under reexamination will be reconsidered and again examined. The applicant, or in the case of a reexamination proceeding the patent owner and any third party requester, will be notified if claims are rejected, objections or requirements made, or decisions favorable to patentability are made, in the same manner as after the first examination (§ 1.104). Applicant or patent owner may reply to such Office action in the same manner provided in § 1.111 or § 1.945, with or without amendment, unless such Office action indicates that it is made final (§ 1.113) or an appeal (§ 1.191) has been taken (§ 1.116), or in an *inter partes* reexamination, that it is an action closing prosecution (§ 1.949) or a right of appeal notice (§ 1.953).

[46 FR 29182, May 29, 1981; revised, 62 FR 53131, Oct. 10, 1997, effective Dec. 1, 1997; revised, 65 FR 54604, Sept. 8, 2000, effective Nov. 7, 2000; revised, 65 FR 76756, Dec. 7, 2000, effective Feb. 5, 2001]

### § 1.113 Final rejection or action.

(a) On the second or any subsequent examination or consideration by the examiner the rejection or other action may be made final, whereupon applicants, or for *ex parte* reexaminations filed under § 1.510, patent owner's reply is limited to appeal in the case of rejection of any claim (§ 1.191), or to amendment as specified in § 1.114 or § 1.116. Petition may be taken to the Director in the case of objections or requirements not involved in the rejection of any claim (§ 1.181). Reply to a final rejection or action must comply with § 1.114 or paragraph (c) of this section. For final actions in an *inter partes* reexamination filed under § 1.913, see § 1.953.

(b) In making such final rejection, the examiner shall repeat or state all grounds of rejection then considered applicable to the claims in the application, clearly stating the reasons in support thereof.

(c) Reply to a final rejection or action must include cancellation of, or appeal from the rejection of, each rejected claim. If any claim stands allowed, the reply to a final rejection or action must comply with any requirements or objections as to form.



[24 FR 10332, Dec. 22, 1959; 46 FR 29182, May 29, 1981; revised, 62 FR 53131, Oct. 10, 1997, effective Dec. 1, 1997; revised, 65 FR 14865, Mar. 20, 2000, effective May 29, 2000 (adopted as final, 65 FR 50092, Aug. 16, 2000); para. (a) revised, 65 FR 76756, Dec. 7, 2000, effective Feb. 5, 2001; para. (a) revised, 68 FR 14332, Mar. 25, 2003, effective May 1, 2003]

### § 1.114 Request for continued examination.

(a) If prosecution in an application is closed, an applicant may request continued examination of the application by filing a submission and the fee set forth in § 1.17(e) prior to the earliest of:

- (1) Payment of the issue fee, unless a petition under § 1.313 is granted;
- (2) Abandonment of the application; or
- (3) The filing of a notice of appeal to the U.S. Court of Appeals for the Federal Circuit under 35 U.S.C. 141, or the commencement of a civil action under 35 U.S.C. 145 or 146, unless the appeal or civil action is terminated.

(b) Prosecution in an application is closed as used in this section means that the application is under appeal, or that the last Office action is a final action (§ 1.113), a notice of allowance (§ 1.311), or an action that otherwise closes prosecution in the application.

(c) A submission as used in this section includes, but is not limited to, an information disclosure statement, an amendment to the written description, claims, or drawings, new arguments, or new evidence in support of patentability. If reply to an Office action under 35 U.S.C. 132 is outstanding, the submission must meet the reply requirements of § 1.111.

(d) If an applicant timely files a submission and fee set forth in § 1.17(e), the Office will withdraw the finality of any Office action and the submission will be entered and considered. If an applicant files a request for continued examination under this section after appeal, but prior to a decision on the appeal, it will be treated as a request to withdraw the appeal and to reopen prosecution of the application before the examiner. An appeal brief under § 1.192 or a reply brief under § 1.193(b), or related papers, will not be considered a submission under this section.

(e) The provisions of this section do not apply to:

- (1) A provisional application;
- (2) An application for a utility or plant patent filed under 35 U.S.C. 111(a) before June 8, 1995;
- (3) An international application filed under 35 U.S.C. 363 before June 8, 1995;
- (4) An application for a design patent; or
- (5) A patent under reexamination.

[Added 65 FR 14865, Mar. 20, 2000, effective May 29, 2000; revised 65 FR 50092, Aug. 16, 2000]

## AMENDMENTS

### § 1.115 Preliminary amendments.

(a) A preliminary amendment is an amendment that is received in the Office (§ 1.6) on or before the mail date of the first Office action under § 1.104.

(b)(1) A preliminary amendment will be entered unless disapproved by the Director. A preliminary amendment may be disapproved if the preliminary amendment unduly interferes with the preparation of a first Office action in an application. Factors that will be considered in disapproving a preliminary amendment include:

- (i) The state of preparation of a first Office action as of the date of receipt (§ 1.6) of the preliminary amendment by the Office; and
- (ii) The nature of any changes to the specification or claims that would result from entry of the preliminary amendment.

(2) A preliminary amendment will not be disapproved if it is filed no later than:

- (i) Three months from the filing date of an application under § 1.53(b);
- (ii) The filing date of a continued prosecution application under § 1.53(d); or
- (iii) Three months from the date the national stage is entered as set forth in § 1.491 in an international application.

(c) The time periods specified in paragraph (b)(2) of this section are not extendable.

[46 FR 29183, May 29, 1981; removed and reserved, 62 FR 53131, Oct. 10, 1997, effective Dec. 1, 1997; added, 65 FR 54604, Sept. 8, 2000, effective Nov. 7, 2000; para. (b)(1) revised, 68 FR 14332, Mar. 25, 2003, effective May 1, 2003]

**§ 1.116 Amendments after final action or appeal.**

(a) An amendment after final action or appeal must comply with § 1.114 or this section.

(b) After a final rejection or other final action (§ 1.113) in an application or in an *ex parte* reexamination filed under § 1.510, or an action closing prosecution (§ 1.949) in an *inter partes* reexamination filed under § 1.913, amendments may be made canceling claims or complying with any requirement of form expressly set forth in a previous Office action. Amendments presenting rejected claims in better form for consideration on appeal may be admitted. The admission of, or refusal to admit, any amendment after a final rejection, a final action, an action closing prosecution, or any related proceedings will not operate to relieve the application or patent under reexamination from its condition as subject to appeal or to save the application from abandonment under § 1.135, or the reexamination from termination. No amendment can be made in an *inter partes* reexamination proceeding after the right of appeal notice under § 1.953 except as provided for in paragraph (d) of this section.

(c) If amendments touching the merits of the application or patent under reexamination are presented after final rejection, or after appeal has been taken, or when such amendment might not otherwise be proper, they may be admitted upon a showing of good and sufficient reasons why they are necessary and were not earlier presented.

(d) No amendment can be made as a matter of right in appealed cases. After decision on appeal, amendments can only be made as provided in §§ 1.198 and 1.981, or to carry into effect a recommendation under § 1.196 or § 1.977.

[24 FR 10332, Dec. 22, 1959; 46 FR 29183, May 29, 1981; para. (a) revised, 62 FR 53131, Oct. 10, 1997, effective Dec. 1, 1997; revised, 65 FR 14865, Mar. 20, 2000, effective May 29, 2000 (adopted as final, 65 FR 50092, Aug. 16, 2000); paras. (b) and (d) revised, 65 FR 76756, Dec. 7, 2000, effective Feb. 5, 2001]

**§ 1.117 [Reserved]**

[Removed and reserved, 62 FR 53131, Oct. 10, 1997, effective Dec. 1, 1997]

**§ 1.118 [Reserved]**

[48 FR 2712, Jan. 20, 1983, effective Feb. 27, 1983; removed and reserved, 62 FR 53131, Oct. 10, 1997, effective Dec. 1, 1997]

**§ 1.119 [Reserved]**

[32 FR 13583, Sept. 28, 1967; removed and reserved, 62 FR 53131, Oct. 10, 1997, effective Dec. 1, 1997]

**§ 1.121 Manner of making amendments in applications.**

(a) *Amendments in applications, other than reissue applications.* Amendments in applications, other than reissue applications, are made by filing a paper, in compliance with § 1.52, directing that specified amendments be made.

(b) *Specification.* Amendments to the specification, other than the claims, computer listings (§ 1.96) and sequence listings (§ 1.825), must be made by adding, deleting or replacing a paragraph, by replacing a section, or by a substitute specification, in the manner specified in this section.

(1) *Amendment to delete, replace, or add a paragraph.* Amendments to the specification, including amendment to a section heading or the title of the invention which are considered for amendment purposes to be an amendment of a paragraph, must be made by submitting:

(i) An instruction, which unambiguously identifies the location, to delete one or more paragraphs of the specification, replace a paragraph with one or more replacement paragraphs, or add one or more paragraphs;

(ii) The full text of any replacement paragraph with markings to show all the changes relative to the previous version of the paragraph. The text of any added subject matter must be shown by underlining the added text. The text of any deleted matter must be shown by strike-through except that double brackets placed before and after the deleted characters may be used to show deletion of five or fewer consecutive characters. The text of any deleted subject matter must be shown by being placed within double brackets if strikethrough cannot be easily perceived;

(iii) The full text of any added paragraphs without any underlining; and;

(iv) The text of a paragraph to be deleted must not be presented with strike-through or placed within double brackets. The instruction to delete may identify a paragraph by its paragraph number or include a few words from the beginning, and end, of the paragraph, if needed for paragraph identification purposes.

(2) *Amendment by replacement section.* If the sections of the specification contain section headings as provided in § 1.77(b), § 1.154(b), or § 1.163(c), amendments to the specification, other than the claims, may be made by submitting:

(i) A reference to the section heading along with an instruction, which unambiguously identifies the location, to delete that section of the specification and to replace such deleted section with a replacement section; and;

(ii) A replacement section with markings to show all changes relative to the previous version of the section. The text of any added subject matter must be shown by underlining the added text. The text of any deleted matter must be shown by strike-through except that double brackets placed before and after the deleted characters may be used to show deletion of five or fewer consecutive characters. The text of any deleted subject matter must be shown by being placed within double brackets if strike-through cannot be easily perceived.

(3) *Amendment by substitute specification.* The specification, other than the claims, may also be amended by submitting::

(i) An instruction to replace the specification; and

(ii) A substitute specification in compliance with §§ 1.125(b) and (c).

(4) *Reinstatement of previously deleted paragraph or section.* A previously deleted paragraph or section may be reinstated only by a subsequent amendment adding the previously deleted paragraph or section.

(5) *Presentation in subsequent amendment document.* Once a paragraph or section is amended in a first amendment document, the paragraph or section shall not be represented in a subsequent amendment document unless it is amended again or a substitute specification is provided.

(c) *Claims.* Amendments to a claim must be made by rewriting the entire claim with all changes (e.g., additions and deletions) as indicated in this subsection, except when the claim is being canceled. Each amendment document that includes a change to an existing claim, cancellation of an existing claim or addition of a new claim, must include a complete listing of all claims ever presented, including the text of all pending and withdrawn claims, in the application. The claim listing, including the text of the claims, in the amendment document will serve to replace all prior versions of the claims, in the application. In the claim listing, the status of every claim must be indicated after its claim number by using one of the following identifiers in a parenthetical expression: (Original), (Currently amended), (Canceled), (Withdrawn), (Previously presented), (New), and (Not entered).

(1) *Claim listing.* All of the claims presented in a claim listing shall be presented in ascending numerical order. Consecutive claims having the same status of “canceled” or “not entered” may be aggregated into one statement (e.g., Claims 1–5 (canceled)). The claim listing shall commence on a separate sheet of the amendment document and the sheet(s) that contain the text of any part of the claims shall not contain any other part of the amendment.

(2) *When claim text with markings is required.* All claims being currently amended in an amendment paper shall be presented in the claim listing, indicate a status of “currently amended,” and be submitted with markings to indicate the changes that have been made relative to the immediate prior version of the claims. The text of any added subject matter must be shown by underlining the added text. The text of any deleted matter must be shown by strike-through except that double brackets placed before and after the deleted characters may be used to show deletion of five or fewer consecutive characters. The text of any deleted subject matter must be shown by being placed within double brackets if strike-through cannot be easily perceived. Only claims having the status of “currently amended,” or “withdrawn” if also being amended, shall include markings. If a withdrawn claim is currently amended, its status in the claim listing may be identified as “withdrawn— currently amended.”

(3) *When claim text in clean version is required.* The text of all pending claims not being currently amended shall be presented in the claim listing in clean version, *i.e.*, without any markings in the presentation of text. The presentation of a clean version of any claim having the status of “original,” “withdrawn” or “previously presented” will constitute an assertion that it has not been changed relative to the immediate prior version, except to omit markings that may have been present in the immediate prior version of the claims of the status of “withdrawn” or “previously presented.” Any claim added by amendment must be indicated with the status of “new” and presented in clean version, *i.e.*, without any underlining.

(4) *When claim text shall not be presented; canceling a claim.*

(i) No claim text shall be presented for any claim in the claim listing with the status of “canceled” or “not entered.”

(ii) Cancellation of a claim shall be effected by an instruction to cancel a particular claim number. Identifying the status of a claim in the claim listing as “canceled” will constitute an instruction to cancel the claim.

(5) *Reinstatement of previously canceled claim.* A claim which was previously canceled may be reinstated only by adding the claim as a “new” claim with a new claim number.

(d) *Drawings.* One or more application drawings shall be amended in the following manner: Any changes to an application drawing must be in compliance with § 1.84 and must be submitted on a replacement sheet of drawings which shall be an attachment to the amendment document and, in the header, labeled “Replacement Sheet.” Any replacement sheet of drawings shall include all of the figures appearing on the immediate prior version of the sheet, even if only one figure is amended. All changes to the drawing(s) shall be explained, in detail, in either the drawing amendment or remarks section of the amendment paper.

(1) A marked-up copy of any amended drawing figure, including annotations indicating the changes made, may be included. The marked-up copy

must be clearly labeled as “Annotated Marked-up Drawings” and must be presented in the amendment or remarks section that explains the change to the drawings.

(2) A marked-up copy of any amended drawing figure, including annotations indicating the changes made, must be provided when required by the examiner.

(e) *Disclosure consistency.* The disclosure must be amended, when required by the Office, to correct inaccuracies of description and definition, and to secure substantial correspondence between the claims, the remainder of the specification, and the drawings.

(f) *No new matter.* No amendment may introduce new matter into the disclosure of an application.

(g) *Exception for examiner’s amendments.* Changes to the specification, including the claims, of an application made by the Office in an examiner’s amendment may be made by specific instructions to insert or delete subject matter set forth in the examiner’s amendment by identifying the precise point in the specification or the claim(s) where the insertion or deletion is to be made. Compliance with paragraphs (b)(1), (b)(2), or (c) of this section is not required.

(h) *Amendment sections.* Each section of an amendment document (*e.g.*, amendment to the claims, amendment to the specification, replacement drawings, and remarks) must begin on a separate sheet.

(i) *Amendments in reissue applications.* Any amendment to the description and claims in reissue applications must be made in accordance with § 1.173.

(j) *Amendments in reexamination proceedings.* Any proposed amendment to the description and claims in patents involved in reexamination proceedings must be made in accordance with § 1.530.

(k) *Amendments in provisional applications.* Amendments in provisional applications are not usually made. If an amendment is made to a provisional application, however, it must comply with the provisions of this section. Any amendments to a provisional application shall be placed in the provisional application file but may not be entered.

[32 FR 13583, Sept. 28, 1967; 46 FR 29183, May 29, 1981; para. (e), 49 FR 555, Jan. 4, 1984, effective Apr. 1, 1984; revised, 62 FR 53131, Oct. 10, 1997, effective Dec. 1, 1997; revised, 65 FR 54604, Sept. 8, 2000, effective Nov. 7, 2000; para. (i) revised, 65 FR 76756, Dec. 7, 2000, effective Feb. 5, 2001; revised, 68 FR 38611, June 30, 2003, effective July 30, 2003]

### § 1.122 [Reserved]

[24 FR 10332, Dec. 22, 1959; para. (b), 49 FR 48416, Dec. 12, 1984, effective Feb. 11, 1985; removed and reserved, 62 FR 53131, Oct. 10, 1997, effective Dec. 1, 1997]

### § 1.123 [Reserved]

[48 FR 2712, Jan. 20, 1983, effective Feb. 27, 1983; 49 FR 555, Jan. 4, 1984, effective Apr. 1, 1984; amended, 58 FR 38719, July 20, 1993, effective Oct. 1, 1993; removed and reserved, 62 FR 53131, Oct. 10, 1997, effective Dec. 1, 1997]

### § 1.124 [Reserved]

[Removed and reserved, 62 FR 53131, Oct. 10, 1997, effective Dec. 1, 1997]

### § 1.125 Substitute specification.

(a) If the number or nature of the amendments or the legibility of the application papers renders it difficult to consider the application, or to arrange the papers for printing or copying, the Office may require the entire specification, including the claims, or any part thereof, be rewritten.

(b) Subject to § 1.312, a substitute specification, excluding the claims, may be filed at any point up to payment of the issue fee if it is accompanied by a statement that the substitute specification includes no new matter.

(c) A substitute specification submitted under this section must be submitted with markings showing all the changes relative to the immediate prior version of the specification of record. The text of any added subject matter must be shown by underlining the added text. The text of any deleted matter must be shown by strike-through except that double brackets placed before and after the deleted characters may be used to show deletion of five or fewer consecutive characters. The text of any deleted subject matter

must be shown by being placed within double brackets if strike-through cannot be easily perceived. An accompanying clean version (without markings) must also be supplied. Numbering the paragraphs of the specification of record is not considered a change that must be shown pursuant to this paragraph.

(d) A substitute specification under this section is not permitted in a reissue application or in a reexamination proceeding.

[48 FR 2712, Jan. 20, 1983, effective Feb. 27, 1983; revised, 62 FR 53131, Oct. 10, 1997, effective Dec. 1, 1997; paras. (b)(2) and (c) revised, 65 FR 54604, Sept. 8, 2000, effective Nov. 7, 2000; paras. (b) and (c) revised, 68 FR 38611, June 30, 2003, effective July 30, 2003]

### § 1.126 Numbering of claims.

The original numbering of the claims must be preserved throughout the prosecution. When claims are canceled the remaining claims must not be renumbered. When claims are added, they must be numbered by the applicant consecutively beginning with the number next following the highest numbered claim previously presented (whether entered or not). When the application is ready for allowance, the examiner, if necessary, will renumber the claims consecutively in the order in which they appear or in such order as may have been requested by applicant.

[32 FR 13583, Sept. 28, 1967; revised, 62 FR 53131, Oct. 10, 1997, effective Dec. 1, 1997]

### § 1.127 Petition from refusal to admit amendment.

From the refusal of the primary examiner to admit an amendment, in whole or in part, a petition will lie to the Director under § 1.181.

[Revised, 68 FR 14332, Mar. 25, 2003, effective May 1, 2003]

## TRANSITIONAL PROVISIONS

### § 1.129 Transitional procedures for limited examination after final rejection and restriction practice.

(a) An applicant in an application, other than for reissue or a design patent, that has been pending for at least two years as of June 8, 1995, taking into

account any reference made in such application to any earlier filed application under 35 U.S.C. 120, 121 and 365(c), is entitled to have a first submission entered and considered on the merits after final rejection under the following circumstances: The Office will consider such a submission, if the first submission and the fee set forth in § 1.17(r) are filed prior to the filing of an appeal brief and prior to abandonment of the application. The finality of the final rejection is automatically withdrawn upon the timely filing of the submission and payment of the fee set forth in § 1.17(r). If a subsequent final rejection is made in the application, applicant is entitled to have a second submission entered and considered on the merits after the subsequent final rejection under the following circumstances: The Office will consider such a submission, if the second submission and a second fee set forth in § 1.17(r) are filed prior to the filing of an appeal brief and prior to abandonment of the application. The finality of the subsequent final rejection is automatically withdrawn upon the timely filing of the submission and payment of the second fee set forth in § 1.17(r). Any submission filed after a final rejection made in an application subsequent to the fee set forth in § 1.17(r) having been twice paid will be treated as set forth in § 1.116. A submission as used in this paragraph includes, but is not limited to, an information disclosure statement, an amendment to the written description, claims or drawings and a new substantive argument or new evidence in support of patentability.

(b)(1) In an application, other than for reissue or a design patent, that has been pending for at least three years as of June 8, 1995, taking into account any reference made in the application to any earlier filed application under 35 U.S.C. 120, 121 and 365(c), no requirement for restriction or for the filing of divisional applications shall be made or maintained in the application after June 8, 1995, except where:

(i) The requirement was first made in the application or any earlier filed application under 35 U.S.C. 120, 121 and 365(c) prior to April 8, 1995;

(ii) The examiner has not made a requirement for restriction in the present or parent application prior to April 8, 1995, due to actions by the applicant; or

(iii) The required fee for examination of each additional invention was not paid.

(2) If the application contains more than one independent and distinct invention and a requirement for restriction or for the filing of divisional applications cannot be made or maintained pursuant to this paragraph, applicant will be so notified and given a time period to:

(i) Elect the invention or inventions to be searched and examined, if no election has been made prior to the notice, and pay the fee set forth in 1.17(s) for each independent and distinct invention claimed in the application in excess of one which applicant elects;

(ii) Confirm an election made prior to the notice and pay the fee set forth in § 1.17(s) for each independent and distinct invention claimed in the application in addition to the one invention which applicant previously elected; or

(iii) File a petition under this section traversing the requirement. If the required petition is filed in a timely manner, the original time period for electing and paying the fee set forth in § 1.17(s) will be deferred and any decision on the petition affirming or modifying the requirement will set a new time period to elect the invention or inventions to be searched and examined and to pay the fee set forth in § 1.17(s) for each independent and distinct invention claimed in the application in excess of one which applicant elects.

(3) The additional inventions for which the required fee has not been paid will be withdrawn from consideration under § 1.142(b). An applicant who desires examination of an invention so withdrawn from consideration can file a divisional application under 35 U.S.C. 121.

(c) The provisions of this section shall not be applicable to any application filed after June 8, 1995.

[Added, 60 FR 20195, Apr. 25, 1995, effective June 8, 1995]

## AFFIDAVITS OVERCOMING REJECTIONS

### § 1.130 Affidavit or declaration to disqualify commonly owned patent or published application as prior art.

(a) When any claim of an application or a patent under reexamination is rejected under 35 U.S.C. 103 on a U.S. patent or U.S. patent application publication which is not prior art under 35 U.S.C.

102(b), and the inventions defined by the claims in the application or patent under reexamination and by the claims in the patent or published application are not identical but are not patentably distinct, and the inventions are owned by the same party, the applicant or owner of the patent under reexamination may disqualify the patent or patent application publication as prior art. The patent or patent application publication can be disqualified as prior art by submission of:

(1) A terminal disclaimer in accordance with § 1.321(c); and

(2) An oath or declaration stating that the application or patent under reexamination and patent or published application are currently owned by the same party, and that the inventor named in the application or patent under reexamination is the prior inventor under 35 U.S.C. 104.

(b) When an application or a patent under reexamination claims an invention which is not patentably distinct from an invention claimed in a commonly owned patent with the same or a different inventive entity, a double patenting rejection will be made in the application or a patent under reexamination. A judicially created double patenting rejection may be obviated by filing a terminal disclaimer in accordance with § 1.321(c).

[Added, 61 FR 42790, Aug. 19, 1996, effective Sept. 23, 1996; heading and para. (a) revised, 65 FR 57024, Sept. 20, 2000, effective Nov. 29, 2000]

### § 1.131 Affidavit or declaration of prior invention.

(a) When any claim of an application or a patent under reexamination is rejected, the inventor of the subject matter of the rejected claim, the owner of the patent under reexamination, or the party qualified under §§ 1.42, 1.43, or 1.47, may submit an appropriate oath or declaration to establish invention of the subject matter of the rejected claim prior to the effective date of the reference or activity on which the rejection is based. The effective date of a U.S. patent, U.S. patent application publication, or international application publication under PCT Article 21(2) is the earlier of its publication date or date that it is effective as a reference under 35 U.S.C. 102(e). Prior invention may not be established under this section in any country other than the United States, a NAFTA country, or

a WTO member country. Prior invention may not be established under this section before December 8, 1993, in a NAFTA country other than the United States, or before January 1, 1996, in a WTO member country other than a NAFTA country. Prior invention may not be established under this section if either:

(1) The rejection is based upon a U.S. patent or U.S. patent application publication of a pending or patented application to another or others which claims the same patentable invention as defined in § 1.601(n); or

(2) The rejection is based upon a statutory bar.

(b) The showing of facts shall be such, in character and weight, as to establish reduction to practice prior to the effective date of the reference, or conception of the invention prior to the effective date of the reference coupled with due diligence from prior to said date to a subsequent reduction to practice or to the filing of the application. Original exhibits of drawings or records, or photocopies thereof, must accompany and form part of the affidavit or declaration or their absence satisfactorily explained.

[24 FR 10332, Dec. 22, 1959; 34 FR 18857, Nov. 26, 1969; para. (a), 48 FR 2713, Jan. 20, 1983, effective Feb. 27, 1983; para. (a), 50 FR 9381, Mar. 7, 1985, effective May 8, 1985; 50 FR 11366, Mar. 21, 1985; 53 FR 23733, June 23, 1988, effective Sept. 12, 1988; para. (a)(1) revised and para. (a)(2) added, 60 FR 21043, May 1, 1995, effective May 31, 1995; para. (a) revised, 61 FR 42790, Aug. 19, 1996, effective Sept. 23, 1996; heading and para. (a) revised, 65 FR 54604, Sept. 8, 2000, effective Sept. 8, 2000; para. (a) revised, 65 FR 57024, Sept. 20, 2000, effective Nov. 29, 2000]

### § 1.132 Affidavits or declarations traversing rejections or objections.

When any claim of an application or a patent under reexamination is rejected or objected to, any evidence submitted to traverse the rejection or objection on a basis not otherwise provided for must be by way of an oath or declaration under this section.

[48 FR 2713, Jan. 20, 1983, effective Feb. 27, 1983; revised, 61 FR 42790, Aug. 19, 1996, effective Sept. 23, 1996; revised, 65 FR 54604, Sept. 8, 2000, effective Sept. 8, 2000; revised 65 FR 57024, Sept. 20, 2000, effective Nov. 29, 2000]

## INTERVIEWS

**§ 1.133 Interviews.**

(a)(1) Interviews with examiners concerning applications and other matters pending before the Office must be conducted on Office premises and within Office hours, as the respective examiners may designate. Interviews will not be permitted at any other time or place without the authority of the Director.

(2) An interview for the discussion of the patentability of a pending application will not occur before the first Office action, unless the application is a continuing or substitute application.

(3) The examiner may require that an interview be scheduled in advance.

(b) In every instance where reconsideration is requested in view of an interview with an examiner, a complete written statement of the reasons presented at the interview as warranting favorable action must be filed by the applicant. An interview does not remove the necessity for reply to Office actions as specified in §§ 1.111 and 1.135.

[Para. (b) revised, 62 FR 53131, Oct. 10, 1997, effective Dec. 1, 1997; para. (a) revised, 65 FR 54604, Sept. 8, 2000, effective Nov. 7, 2000; para. (a)(1) revised, 68 FR 14332, Mar. 25, 2003, effective May 1, 2003]

TIME FOR REPLY BY APPLICANT;  
ABANDONMENT OF APPLICATION**§ 1.134 Time period for reply to an Office action.**

An Office action will notify the applicant of any non-statutory or shortened statutory time period set for reply to an Office action. Unless the applicant is notified in writing that a reply is required in less than six months, a maximum period of six months is allowed.

[47 FR 41276, Sept. 17, 1982, effective Oct. 1, 1982; revised, 62 FR 53131, Oct. 10, 1997, effective Dec. 1, 1997]

**§ 1.135 Abandonment for failure to reply within time period.**

(a) If an applicant of a patent application fails to reply within the time period provided under § 1.134

and § 1.136, the application will become abandoned unless an Office action indicates otherwise.

(b) Prosecution of an application to save it from abandonment pursuant to paragraph (a) of this section must include such complete and proper reply as the condition of the application may require. The admission of, or refusal to admit, any amendment after final rejection or any amendment not responsive to the last action, or any related proceedings, will not operate to save the application from abandonment.

(c) When reply by the applicant is a *bona fide* attempt to advance the application to final action, and is substantially a complete reply to the non-final Office action, but consideration of some matter or compliance with some requirement has been inadvertently omitted, applicant may be given a new time period for reply under § 1.134 to supply the omission.

[Paras. (a), (b), and (c), 47 FR 41276, Sept. 17, 1982, effective Oct. 1, 1982; para. (d) deleted, 49 FR 555, Jan. 4, 1984, effective Apr. 1, 1984; revised, 62 FR 53131, Oct. 10, 1997, effective Dec. 1, 1997]

**§ 1.136 Extensions of time.**

(a)(1) If an applicant is required to reply within a nonstatutory or shortened statutory time period, applicant may extend the time period for reply up to the earlier of the expiration of any maximum period set by statute or five months after the time period set for reply, if a petition for an extension of time and the fee set in § 1.17(a) are filed, unless:

(i) Applicant is notified otherwise in an Office action;

(ii) The reply is a reply brief submitted pursuant to § 1.193(b);

(iii) The reply is a request for an oral hearing submitted pursuant to § 1.194(b);

(iv) The reply is to a decision by the Board of Patent Appeals and Interferences pursuant to § 1.196, § 1.197 or § 1.304; or

(v) The application is involved in an interference declared pursuant to § 1.611.

(2) The date on which the petition and the fee have been filed is the date for purposes of determining the period of extension and the corresponding amount of the fee. The expiration of the time period is determined by the amount of the fee paid. A reply must be filed prior to the expiration of the period of extension to avoid abandonment of the application (§ 1.135),



but in no situation may an applicant reply later than the maximum time period set by statute, or be granted an extension of time under paragraph (b) of this section when the provisions of this paragraph are available. See § 1.136(b) for extensions of time relating to proceedings pursuant to §§ 1.193(b), 1.194, 1.196 or 1.197; § 1.304 for extensions of time to appeal to the U.S. Court of Appeals for the Federal Circuit or to commence a civil action; § 1.550(c) for extensions of time in *ex parte* reexamination proceedings, § 1.956 for extensions of time in *inter partes* reexamination proceedings; and § 1.645 for extensions of time in interference proceedings.

(3) A written request may be submitted in an application that is an authorization to treat any concurrent or future reply, requiring a petition for an extension of time under this paragraph for its timely submission, as incorporating a petition for extension of time for the appropriate length of time. An authorization to charge all required fees, fees under § 1.17, or all required extension of time fees will be treated as a constructive petition for an extension of time in any concurrent or future reply requiring a petition for an extension of time under this paragraph for its timely submission. Submission of the fee set forth in § 1.17(a) will also be treated as a constructive petition for an extension of time in any concurrent reply requiring a petition for an extension of time under this paragraph for its timely submission.

(b) When a reply cannot be filed within the time period set for such reply and the provisions of paragraph (a) of this section are not available, the period for reply will be extended only for sufficient cause and for a reasonable time specified. Any request for an extension of time under this paragraph must be filed on or before the day on which such reply is due, but the mere filing of such a request will not affect any extension under this paragraph. In no situation can any extension carry the date on which reply is due beyond the maximum time period set by statute. See § 1.304 for extensions of time to appeal to the U.S. Court of Appeals for the Federal Circuit or to commence a civil action; § 1.645 for extensions of time in interference proceedings; § 1.550(c) for extensions of time in *ex parte* reexamination proceedings; and

§ 1.956 for extensions of time in *inter partes* reexamination proceedings.

(c) If an applicant is notified in a “Notice of Allowability” that an application is otherwise in condition for allowance, the following time periods are not extendable if set in the “Notice of Allowability” or in an Office action having a mail date on or after the mail date of the “Notice of Allowability”:

(1) The period for submitting an oath or declaration in compliance with § 1.63;

(2) The period for submitting formal drawings set under § 1.85(c); and

(3) The period for making a deposit set under § 1.809(c).

[47 FR 41277, Sept. 17, 1982, effective Oct. 1, 1982; 49 FR 555, Jan. 4, 1984, effective Apr. 1, 1984; 49 FR 48416, Dec. 12, 1984, effective Feb. 11, 1985; 54 FR 29551, July 13, 1989, effective Aug. 20, 1989; para. (a) revised, 58 FR 54504, Oct. 22, 1993, effective Jan. 3, 1994; revised, 62 FR 53131, Oct. 10, 1997, effective Dec. 1, 1997; para. (c) added, 65 FR 54604, Sept. 8, 2000, effective Nov. 7, 2000; paras. (a)(2) and (b) revised, 65 FR 76756, Dec. 7, 2000, effective Feb. 5, 2001; para. (c) revised, 66 FR 21090, Apr. 27, 2001, effective May 29, 2001]

### § 1.137 Revival of abandoned application, terminated reexamination proceeding, or lapsed patent.

(a) *Unavoidable*. If the delay in reply by applicant or patent owner was unavoidable, a petition may be filed pursuant to this paragraph to revive an abandoned application, a reexamination proceeding terminated under §§ 1.550(d) or 1.957(b) or (c), or a lapsed patent. A grantable petition pursuant to this paragraph must be accompanied by:

(1) The reply required to the outstanding Office action or notice, unless previously filed;

(2) The petition fee as set forth in § 1.17(l);

(3) A showing to the satisfaction of the Director that the entire delay in filing the required reply from the due date for the reply until the filing of a grantable petition pursuant to this paragraph was unavoidable; and

(4) Any terminal disclaimer (and fee as set forth in § 1.20(d)) required pursuant to paragraph (d) of this section.

(b) *Unintentional.* If the delay in reply by applicant or patent owner was unintentional, a petition may be filed pursuant to this paragraph to revive an abandoned application, a reexamination proceeding terminated under §§ 1.550(d) or 1.957(b) or (c), or a lapsed patent. A grantable petition pursuant to this paragraph must be accompanied by:

(1) The reply required to the outstanding Office action or notice, unless previously filed;

(2) The petition fee as set forth in § 1.17(m);

(3) A statement that the entire delay in filing the required reply from the due date for the reply until the filing of a grantable petition pursuant to this paragraph was unintentional. The Director may require additional information where there is a question whether the delay was unintentional; and

(4) Any terminal disclaimer (and fee as set forth in § 1.20(d)) required pursuant to paragraph (d) of this section.

(c) *Reply.* In a nonprovisional application abandoned for failure to prosecute, the required reply may be met by the filing of a continuing application. In a nonprovisional utility or plant application filed on or after June 8, 1995, and abandoned for failure to prosecute, the required reply may also be met by the filing of a request for continued examination in compliance with § 1.114. In an application or patent, abandoned or lapsed for failure to pay the issue fee or any portion thereof, the required reply must include payment of the issue fee or any outstanding balance. In an application, abandoned for failure to pay the publication fee, the required reply must include payment of the publication fee.

(d) *Terminal disclaimer.*

(1) Any petition to revive pursuant to this section in a design application must be accompanied by a terminal disclaimer and fee as set forth in § 1.321 dedicating to the public a terminal part of the term of any patent granted thereon equivalent to the period of abandonment of the application. Any petition to revive pursuant to this section in either a utility or plant application filed before June 8, 1995, must be accompanied by a terminal disclaimer and fee as set forth in § 1.321 dedicating to the public a terminal part of the term of any patent granted thereon equivalent to the lesser of:

(i) The period of abandonment of the application; or

(ii) The period extending beyond twenty years from the date on which the application for the patent was filed in the United States or, if the application contains a specific reference to an earlier filed application(s) under 35 U.S.C. 120, 121, or 365(c), from the date on which the earliest such application was filed.

(2) Any terminal disclaimer pursuant to paragraph (d)(1) of this section must also apply to any patent granted on a continuing utility or plant application filed before June 8, 1995, or a continuing design application, that contains a specific reference under 35 U.S.C. 120, 121, or 365(c) to the application for which revival is sought.

(3) The provisions of paragraph (d)(1) of this section do not apply to applications for which revival is sought solely for purposes of copendency with a utility or plant application filed on or after June 8, 1995, to lapsed patents, or to reexamination proceedings.

(e) *Request for reconsideration.* Any request for reconsideration or review of a decision refusing to revive an abandoned application, a terminated reexamination proceeding, or lapsed patent upon petition filed pursuant to this section, to be considered timely, must be filed within two months of the decision refusing to revive or within such time as set in the decision. Unless a decision indicates otherwise, this time period may be extended under:

(1) The provisions of § 1.136 for an abandoned application or lapsed patent;

(2) The provisions of § 1.550(c) for a terminated *ex parte* reexamination proceeding filed under § 1.510; or

(3) The provisions of § 1.956 for a terminated *inter partes* reexamination proceeding filed under § 1.913.

(f) *Abandonment for failure to notify the Office of a foreign filing:* A nonprovisional application abandoned pursuant to 35 U.S.C. 122(b)(2)(B)(iii) for failure to timely notify the Office of the filing of an application in a foreign country or under a multinational treaty that requires publication of applications eighteen months after filing, may be revived only pursuant to paragraph (b) of this section. The reply requirement of paragraph (c) of this section is met by the notification of such filing in a foreign country or under a multinational treaty, but the filing of a petition

under this section will not operate to stay any period for reply that may be running against the application.

(g) *Provisional applications:* A provisional application, abandoned for failure to timely respond to an Office requirement, may be revived pursuant to this section. Subject to the provisions of 35 U.S.C. 119(e)(3) and § 1.7(b), a provisional application will not be regarded as pending after twelve months from its filing date under any circumstances.

[47 FR 41277, Sept. 17, 1982, effective Oct. 1, 1982; para. (b) 48 FR 2713, Jan. 20, 1983, effective Feb. 27, 1983; paras. (a) - (c), paras. (d) & (e) added, 58 FR 44277, Aug. 20, 1993, effective Sept. 20, 1993; para. (c) revised, 60 FR 20195, Apr. 25, 1995, effective June 8, 1995; revised, 62 FR 53131, Oct. 10, 1997, effective Dec. 1, 1997; para. (c) revised, 65 FR 54604, Sept. 8, 2000, effective Sept. 8, 2000; revised, 65 FR 57024, Sept. 20, 2000, effective Nov. 29, 2000; paras. (a)(3) & (b)(3) revised, 68 FR 14332, Mar. 25, 2003, effective May 1, 2003]

### § 1.138 Express abandonment.

(a) An application may be expressly abandoned by filing a written declaration of abandonment identifying the application in the United States Patent and Trademark Office. Express abandonment of the application may not be recognized by the Office before the date of issue or publication unless it is actually received by appropriate officials in time to act.

(b) A written declaration of abandonment must be signed by a party authorized under § 1.33(b)(1), (b)(3), or (b)(4) to sign a paper in the application, except as otherwise provided in this paragraph. A registered attorney or agent, not of record, who acts in a representative capacity under the provisions of § 1.34(a) when filing a continuing application, may expressly abandon the prior application as of the filing date granted to the continuing application.

(c) An applicant seeking to abandon an application to avoid publication of the application (see § 1.211(a)(1)) must submit a declaration of express abandonment by way of a petition under this section including the fee set forth in § 1.17(h) in sufficient time to permit the appropriate officials to recognize the abandonment and remove the application from the publication process. Applicant should expect that the petition will not be granted and the application will be published in regular course unless such declaration of express abandonment and petition are received by the

appropriate officials more than four weeks prior to the projected date of publication.

[47 FR 47244, Oct. 25, 1982, effective Feb. 27, 1983; 49 FR 48416, Dec. 12, 1984, effective Feb. 11, 1985; revised, 65 FR 54604, Sept. 8, 2000, effective Nov. 7, 2000; para. (a) revised and para. (c) added, 65 FR 57024, Sept. 20, 2000, effective Nov. 29, 2000]

### § 1.139 [Reserved]

[Added, 60 FR 20195, Apr. 25, 1995, effective June 8, 1995; removed and reserved, 62 FR 53131, Oct. 10, 1997, effective Dec. 1, 1997]

## JOINDER OF INVENTIONS IN ONE APPLICATION; RESTRICTION

### § 1.141 Different inventions in one national application.

(a) Two or more independent and distinct inventions may not be claimed in one national application, except that more than one species of an invention, not to exceed a reasonable number, may be specifically claimed in different claims in one national application, provided the application also includes an allowable claim generic to all the claimed species and all the claims to species in excess of one are written in dependent form (§ 1.75) or otherwise include all the limitations of the generic claim.

(b) Where claims to all three categories, product, process of making, and process of use, are included in a national application, a three way requirement for restriction can only be made where the process of making is distinct from the product. If the process of making and the product are not distinct, the process of using may be joined with the claims directed to the product and the process of making the product even though a showing of distinctness between the product and process of using the product can be made.

[52 FR 20046, May 28, 1987, effective July 1, 1987]

### § 1.142 Requirement for restriction.

(a) If two or more independent and distinct inventions are claimed in a single application, the examiner in an Office action will require the applicant in the reply to that action to elect an invention to

which the claims will be restricted, this official action being called a requirement for restriction (also known as a requirement for division). Such requirement will normally be made before any action on the merits; however, it may be made at any time before final action.

(b) Claims to the invention or inventions not elected, if not canceled, are nevertheless withdrawn from further consideration by the examiner by the election, subject however to reinstatement in the event the requirement for restriction is withdrawn or overruled.

[Para (a) revised, 62 FR 53131, Oct. 10, 1997, effective Dec. 1, 1997]

### § 1.143 Reconsideration of requirement.

If the applicant disagrees with the requirement for restriction, he may request reconsideration and withdrawal or modification of the requirement, giving the reasons therefor. (See § 1.111). In requesting reconsideration the applicant must indicate a provisional election of one invention for prosecution, which invention shall be the one elected in the event the requirement becomes final. The requirement for restriction will be reconsidered on such a request. If the requirement is repeated and made final, the examiner will at the same time act on the claims to the invention elected.

### § 1.144 Petition from requirement for restriction.

After a final requirement for restriction, the applicant, in addition to making any reply due on the remainder of the action, may petition the Director to review the requirement. Petition may be deferred until after final action on or allowance of claims to the invention elected, but must be filed not later than appeal. A petition will not be considered if reconsideration of the requirement was not requested (see § 1.181).

[Revised, 62 FR 53131, Oct. 10, 1997, effective Dec. 1, 1997; revised, 68 FR 14332, Mar. 25, 2003, effective May 1, 2003]

### § 1.145 Subsequent presentation of claims for different invention.

If, after an office action on an application, the applicant presents claims directed to an invention dis-

ting from and independent of the invention previously claimed, the applicant will be required to restrict the claims to the invention previously claimed if the amendment is entered, subject to reconsideration and review as provided in §§ 1.143 and 1.144.

### § 1.146 Election of species.

In the first action on an application containing a generic claim to a generic invention (genus) and claims to more than one patentably distinct species embraced thereby, the examiner may require the applicant in the reply to that action to elect a species of his or her invention to which his or her claim will be restricted if no claim to the genus is found to be allowable. However, if such application contains claims directed to more than a reasonable number of species, the examiner may require restriction of the claims to not more than a reasonable number of species before taking further action in the application.

[43 FR 20465, May 11, 1978; revised, 62 FR 53131, Oct. 10, 1997, effective Dec. 1, 1997]

## DESIGN PATENTS

### § 1.151 Rules applicable.

The rules relating to applications for patents for other inventions or discoveries are also applicable to applications for patents for designs except as otherwise provided.

### § 1.152 Design drawings.

The design must be represented by a drawing that complies with the requirements of § 1.84 and must contain a sufficient number of views to constitute a complete disclosure of the appearance of the design. Appropriate and adequate surface shading should be used to show the character or contour of the surfaces represented. Solid black surface shading is not permitted except when used to represent the color black as well as color contrast. Broken lines may be used to show visible environmental structure, but may not be used to show hidden planes and surfaces that cannot be seen through opaque materials. Alternate positions of a design component, illustrated by full and broken lines in the same view are not permitted in a design drawing. Photographs and ink drawings are not permitted to be combined as formal drawings in one

application. Photographs submitted in lieu of ink drawings in design patent applications must not disclose environmental structure but must be limited to the design claimed for the article.

[53 FR 47810, Nov. 28, 1988, effective Jan. 1, 1989; amended, 58 FR 38719, July 20, 1993, effective Oct. 1, 1993; revised, 62 FR 53131, Oct. 10, 1997, effective Dec. 1, 1997; revised, 65 FR 54604, Sept. 8, 2000, effective Sept. 8, 2000]

### § 1.153 Title, description and claim, oath or declaration.

(a) The title of the design must designate the particular article. No description, other than a reference to the drawing, is ordinarily required. The claim shall be in formal terms to the ornamental design for the article (specifying name) as shown, or as shown and described. More than one claim is neither required nor permitted.

(b) The oath or declaration required of the applicant must comply with § 1.63.

[24 FR 10332, Dec. 22, 1959; 29 FR 18503, Dec. 29, 1964; para. (b), 48 FR 2712, Jan. 20, 1983, effective Feb. 27, 1983]

### § 1.154 Arrangement of application elements in a design application.

(a) The elements of the design application, if applicable, should appear in the following order:

- (1) Design application transmittal form.
- (2) Fee transmittal form.
- (3) Application data sheet (see § 1.76).
- (4) Specification.
- (5) Drawings or photographs.

(6) Executed oath or declaration (see § 1.153(b)).

(b) The specification should include the following sections in order:

(1) Preamble, stating the name of the applicant, title of the design, and a brief description of the nature and intended use of the article in which the design is embodied.

(2) Cross-reference to related applications (unless included in the application data sheet).

(3) Statement regarding federally sponsored research or development.

(4) Description of the figure or figures of the drawing.

(5) Feature description.

(6) A single claim.

(c) The text of the specification sections defined in paragraph (b) of this section, if applicable, should be preceded by a section heading in uppercase letters without underlining or bold type.

[24 FR 10332, Dec. 22, 1959, para. (e), 48 FR 2713, Jan. 20, 1983, effective date Feb. 27, 1983; revised, 61 FR 42790, Aug. 19, 1996, effective Sept. 23, 1996; para. (a)(3) revised, 62 FR 53131, Oct. 10, 1997, effective Dec. 1, 1997; revised, 65 FR 54604, Sept. 8, 2000, effective Nov. 7, 2000]

### § 1.155 Expedited examination of design applications.

(a) The applicant may request that the Office expedite the examination of a design application. To qualify for expedited examination:

(1) The application must include drawings in compliance with § 1.84;

(2) The applicant must have conducted a pre-examination search; and

(3) The applicant must file a request for expedited examination including:

(i) The fee set forth in § 1.17(k); and

(ii) A statement that a preexamination search was conducted. The statement must also indicate the field of search and include an information disclosure statement in compliance with § 1.98.

(b) The Office will not examine an application that is not in condition for examination (*e.g.*, missing basic filing fee) even if the applicant files a request for expedited examination under this section.

[47 FR 41277, Sept. 17, 1982, effective date Oct. 1, 1982; paras. (b)-(d) amended, paras. (e) and (f) added, 58 FR 44277, Aug. 20, 1993, effective Sept. 20, 1993; revised, 62 FR 53131, Oct. 10, 1997, effective Dec. 1, 1997; revised, 65 FR 54604, Sept. 8, 2000, effective Sept. 8, 2000]

## PLANT PATENTS

**§ 1.161 Rules applicable.**

The rules relating to applications for patent for other inventions or discoveries are also applicable to applications for patents for plants except as otherwise provided.

**§ 1.162 Applicant, oath or declaration.**

The applicant for a plant patent must be the person who has invented or discovered and asexually reproduced the new and distinct variety of plant for which a patent is sought (or as provided in §§ 1.42, 1.43, and 1.47). The oath or declaration required of the applicant, in addition to the averments required by § 1.63, must state that he or she has asexually reproduced the plant. Where the plant is a newly found plant the oath or declaration must also state that it was found in a cultivated area.

[48 FR 2713, Jan. 20, 1983, effective Feb. 27, 1983]

**§ 1.163 Specification and arrangement of application elements in a plant application.**

(a) The specification must contain as full and complete a disclosure as possible of the plant and the characteristics thereof that distinguish the same over related known varieties, and its antecedents, and must particularly point out where and in what manner the variety of plant has been asexually reproduced. For a newly found plant, the specification must particularly point out the location and character of the area where the plant was discovered.

(b) The elements of the plant application, if applicable, should appear in the following order:

- (1) Plant application transmittal form.
- (2) Fee transmittal form.
- (3) Application data sheet (see § 1.76).
- (4) Specification.
- (5) Drawings (in duplicate).
- (6) Executed oath or declaration (§ 1.162).

(c) The specification should include the following sections in order:

(1) Title of the invention, which may include an introductory portion stating the name, citizenship, and residence of the applicant.

(2) Cross-reference to related applications (unless included in the application data sheet).

(3) Statement regarding federally sponsored research or development.

(4) Latin name of the genus and species of the plant claimed.

(5) Variety denomination.

(6) Background of the invention.

(7) Brief summary of the invention.

(8) Brief description of the drawing.

(9) Detailed botanical description.

(10) A single claim.

(11) Abstract of the disclosure.

(d) The text of the specification or sections defined in paragraph (c) of this section, if applicable, should be preceded by a section heading in upper case, without underlining or bold type.

[24 FR 10332, Dec. 22, 1959; para. (b), 48 FR 2713, Jan. 20, 1983, effective Feb. 27, 1983; paras. (c) and (d) added, 61 FR 42790, Aug. 19, 1996, effective Sept. 23, 1996; para. (b) revised, 62 FR 53131, Oct. 10, 1997, effective Dec. 1, 1997; revised, 65 FR 54604, Sept. 8, 2000, effective Nov. 7, 2000]

**§ 1.164 Claim.**

The claim shall be in formal terms to the new and distinct variety of the specified plant as described and illustrated, and may also recite the principal distinguishing characteristics. More than one claim is not permitted.

**§ 1.165 Plant Drawings.**

(a) Plant patent drawings should be artistically and competently executed and must comply with the requirements of § 1.84. View numbers and reference characters need not be employed unless required by the examiner. The drawing must disclose all the distinctive characteristics of the plant capable of visual representation.

(b) The drawings may be in color. The drawing must be in color if color is a distinguishing characteristic of the new variety. Two copies of color drawings or photographs and a black and white photocopy that accurately depicts, to the extent possible, the subject matter shown in the color drawing or photograph must be submitted.

[24 FR 10332, Dec. 22, 1959; para. (b), 47 FR 41277, Sept. 17, 1982, effective Oct. 1, 1982; paras. (a) and (b) amended, 58 FR 38719, July 20, 1993, effective Oct. 1,

1993; para. (b) revised, 65 FR 57024, Sept. 20, 2000, effective Nov. 29, 2000]

### § 1.166 Specimens.

The applicant may be required to furnish specimens of the plant, or its flower or fruit, in a quantity and at a time in its stage of growth as may be designated, for study and inspection. Such specimens, properly packed, must be forwarded in conformity with instructions furnished to the applicant. When it is not possible to forward such specimens, plants must be made available for official inspection where grown.

### § 1.167 Examination.

Applications may be submitted by the Patent and Trademark Office to the Department of Agriculture for study and report.

[24 FR 10332, Dec. 22, 1959; 34 FR 18857, Nov. 26, 1969; revised, 62 FR 53131, Oct. 10, 1997, effective Dec. 1, 1997]

## REISSUES

### § 1.171 Application for reissue.

An application for reissue must contain the same parts required for an application for an original patent, complying with all the rules relating thereto except as otherwise provided, and in addition, must comply with the requirements of the rules relating to reissue applications.

[47 FR 41278, Sept. 17, 1982, effective Oct. 1, 1982; revised, 54 FR 6893, Feb. 17, 1989, 54 FR 9432, March 7, 1989, effective Apr. 17, 1989; 56 FR 65142, Dec. 13, 1991, effective Dec. 16, 1991; revised, 62 FR 53131, Oct. 10, 1997, effective Dec. 1, 1997]

### § 1.172 Applicants, assignees.

(a) A reissue oath must be signed and sworn to or declaration made by the inventor or inventors except as otherwise provided (see §§ 1.42, 1.43, 1.47), and must be accompanied by the written consent of all assignees, if any, owning an undivided interest in the patent, but a reissue oath may be made and sworn to or declaration made by the assignee of the entire interest if the application does not seek to enlarge the scope of the claims of the original patent. All assignees consenting to the reissue must establish

their ownership interest in the patent by filing in the reissue application a submission in accordance with the provisions of § 3.73(b) of this chapter.

(b) A reissue will be granted to the original patentee, his legal representatives or assigns as the interest may appear.

[24 FR 10332, Dec. 22, 1959; para. (a), 48 FR 2713, Jan. 20, 1983, effective Feb. 27, 1983; para. (a) revised, 62 FR 53131, Oct. 10, 1997, effective Dec. 1, 1997]

### § 1.173 Reissue specification, drawings, and amendments.

(a) *Contents of a reissue application.* An application for reissue must contain the entire specification, including the claims, and the drawings of the patent. No new matter shall be introduced into the application. No reissue patent shall be granted enlarging the scope of the claims of the original patent unless applied for within two years from the grant of the original patent, pursuant to 35 U.S.C. 251.

(1) *Specification, including claims.* The entire specification, including the claims, of the patent for which reissue is requested must be furnished in the form of a copy of the printed patent, in double column format, each page on only one side of a single sheet of paper. If an amendment of the reissue application is to be included, it must be made pursuant to paragraph (b) of this section. The formal requirements for papers making up the reissue application other than those set forth in this section are set out in § 1.52. Additionally, a copy of any disclaimer (§ 1.321), certificate of correction (§§ 1.322 through 1.324), or reexamination certificate (§ 1.570) issued in the patent must be included. (See also § 1.178).

(2) *Drawings.* Applicant must submit a clean copy of each drawing sheet of the printed patent at the time the reissue application is filed. If such copy complies with § 1.84, no further drawings will be required. Where a drawing of the reissue application is to include any changes relative to the patent being reissued, the changes to the drawing must be made in accordance with paragraph (b)(3) of this section. The Office will not transfer the drawings from the patent file to the reissue application.

(b) *Making amendments in a reissue application.* An amendment in a reissue application is made either by physically incorporating the changes into the specification when the application is filed, or by a

separate amendment paper. If amendment is made by incorporation, markings pursuant to paragraph (d) of this section must be used. If amendment is made by an amendment paper, the paper must direct that specified changes be made.

(1) *Specification other than the claims.* Changes to the specification, other than to the claims, must be made by submission of the entire text of an added or rewritten paragraph, including markings pursuant to paragraph (d) of this section, except that an entire paragraph may be deleted by a statement deleting the paragraph without presentation of the text of the paragraph. The precise point in the specification must be identified where any added or rewritten paragraph is located. This paragraph applies whether the amendment is submitted on paper or compact disc (see §§ 1.52(e)(1) and 1.821(c), but not for discs submitted under § 1.821(e)).

(2) *Claims.* An amendment paper must include the entire text of each claim being changed by such amendment paper and of each claim being added by such amendment paper. For any claim changed by the amendment paper, a parenthetical expression “amended,” “twice amended,” *etc.*, should follow the claim number. Each changed patent claim and each added claim must include markings pursuant to paragraph (d) of this section, except that a patent claim or added claim should be canceled by a statement canceling the claim without presentation of the text of the claim.

(3) *Drawings.* One or more patent drawings shall be amended in the following manner: Any changes to a patent drawing must be submitted as a replacement sheet of drawings which shall be an attachment to the amendment document. Any replacement sheet of drawings must be in compliance with § 1.84 and shall include all of the figures appearing on the original version of the sheet, even if only one figure is amended. Amended figures must be identified as “Amended,” and any added figure must be identified as “New.” In the event that a figure is canceled, the figure must be surrounded by brackets and identified as “Canceled.” All changes to the drawing(s) shall be explained, in detail, beginning on a separate sheet accompanying the papers including the amendment to the drawings.

(i) A marked-up copy of any amended drawing figure, including annotations indicating the

changes made, may be included. The marked-up copy must be clearly labeled as “Annotated Marked-up Drawings” and must be presented in the amendment or remarks section that explains the change to the drawings.

(ii) A marked-up copy of any amended drawing figure, including annotations indicating the changes made, must be provided when required by the examiner.

(c) *Status of claims and support for claim changes.* Whenever there is an amendment to the claims pursuant to paragraph (b) of this section, there must also be supplied, on pages separate from the pages containing the changes, the status (*i.e.*, pending or canceled), as of the date of the amendment, of all patent claims and of all added claims, and an explanation of the support in the disclosure of the patent for the changes made to the claims.

(d) *Changes shown by markings.* Any changes relative to the patent being reissued which are made to the specification, including the claims, upon filing, or by an amendment paper in the reissue application, must include the following markings:

(1) The matter to be omitted by reissue must be enclosed in brackets; and

(2) The matter to be added by reissue must be underlined, except for amendments submitted on compact discs (§§ 1.96 and 1.821(c)). Matter added by reissue on compact discs must be preceded with “<U>” and end with “</U>” to properly identify the material being added.

(e) *Numbering of patent claims preserved.* Patent claims may not be renumbered. The numbering of any claim added in the reissue application must follow the number of the highest numbered patent claim.

(f) *Amendment of disclosure may be required.* The disclosure must be amended, when required by the Office, to correct inaccuracies of description and definition, and to secure substantial correspondence between the claims, the remainder of the specification, and the drawings.

(g) *Amendments made relative to the patent.* All amendments must be made relative to the patent specification, including the claims, and drawings, which are in effect as of the date of filing of the reissue application.



[Revised, 65 FR 54604, Sept. 8, 2000, effective Nov. 7, 2000; para. (b)(3) revised, 68 FR 38611, June 30, 2003, effective July 30, 2003]

### § 1.174 [Reserved.]

[24 FR 10332, Dec. 22, 1959; para. (a), 48 FR 2713, Jan. 20, 1983, effective Feb. 27, 1983; removed and reserved, 65 FR 54604, Sept. 8, 2000, effective Nov. 7, 2000]

### § 1.175 Reissue oath or declaration.

(a) The reissue oath or declaration in addition to complying with the requirements of § 1.63, must also state that:

(1) The applicant believes the original patent to be wholly or partly inoperative or invalid by reason of a defective specification or drawing, or by reason of the patentee claiming more or less than the patentee had the right to claim in the patent, stating at least one error being relied upon as the basis for reissue; and

(2) All errors being corrected in the reissue application up to the time of filing of the oath or declaration under this paragraph arose without any deceptive intention on the part of the applicant.

(b)(1) For any error corrected, which is not covered by the oath or declaration submitted under paragraph (a) of this section, applicant must submit a supplemental oath or declaration stating that every such error arose without any deceptive intention on the part of the applicant. Any supplemental oath or declaration required by this paragraph must be submitted before allowance and may be submitted:

(i) With any amendment prior to allowance; or

(ii) In order to overcome a rejection under 35 U.S.C. 251 made by the examiner where it is indicated that the submission of a supplemental oath or declaration as required by this paragraph will overcome the rejection.

(2) For any error sought to be corrected after allowance, a supplemental oath or declaration must accompany the requested correction stating that the error(s) to be corrected arose without any deceptive intention on the part of the applicant.

(c) Having once stated an error upon which the reissue is based, as set forth in paragraph (a)(1), unless all errors previously stated in the oath or declaration are no longer being corrected, a subsequent

oath or declaration under paragraph (b) of this section need not specifically identify any other error or errors being corrected.

(d) The oath or declaration required by paragraph (a) of this section may be submitted under the provisions of § 1.53(f).

[24 FR 10332, Dec. 22, 1959; 29 FR 18503, Dec. 29, 1964; 34 FR 18857, Nov. 26, 1969; para. (a), 47 FR 21752, May 19, 1982, effective July 1, 1982; para. (a), 48 FR 2713, Jan. 20, 1983, effective Feb. 27, 1983; para. (a)(7), 57 FR 2021, Jan. 17, 1992, effective Mar. 16, 1992; revised, 62 FR 53131, Oct. 10, 1997, effective Dec. 1, 1997]

### § 1.176 Examination of reissue.

(a) A reissue application will be examined in the same manner as a non-reissue, non-provisional application, and will be subject to all the requirements of the rules related to non-reissue applications. Applications for reissue will be acted on by the examiner in advance of other applications.

(b) Restriction between subject matter of the original patent claims and previously unclaimed subject matter may be required (restriction involving only subject matter of the original patent claims will not be required). If restriction is required, the subject matter of the original patent claims will be held to be constructively elected unless a disclaimer of all the patent claims is filed in the reissue application, which disclaimer cannot be withdrawn by applicant.

[42 FR 5595, Jan. 28, 1977; revised, 65 FR 54604, Sept. 8, 2000, effective Nov. 7, 2000]

### § 1.177 Issuance of multiple reissue patents.

(a) The Office may reissue a patent as multiple reissue patents. If applicant files more than one application for the reissue of a single patent, each such application must contain or be amended to contain in the first sentence of the specification a notice stating that more than one reissue application has been filed and identifying each of the reissue applications by relationship, application number and filing date. The Office may correct by certificate of correction under § 1.322 any reissue patent resulting from an application to which this paragraph applies that does not contain the required notice.

(b) If applicant files more than one application for the reissue of a single patent, each claim of the

patent being reissued must be presented in each of the reissue applications as an amended, unamended, or canceled (shown in brackets) claim, with each such claim bearing the same number as in the patent being reissued. The same claim of the patent being reissued may not be presented in its original unamended form for examination in more than one of such multiple reissue applications. The numbering of any added claims in any of the multiple reissue applications must follow the number of the highest numbered original patent claim.

(c) If any one of the several reissue applications by itself fails to correct an error in the original patent as required by 35 U.S.C. 251 but is otherwise in condition for allowance, the Office may suspend action in the allowable application until all issues are resolved as to at least one of the remaining reissue applications. The Office may also merge two or more of the multiple reissue applications into a single reissue application. No reissue application containing only unamended patent claims and not correcting an error in the original patent will be passed to issue by itself.

[47 FR 41278, Sept. 17, 1982, effective date Oct. 1, 1982; revised, 54 FR 6893, Feb. 15, 1989, 54 FR 9432, March 7, 1989, effective Apr. 17, 1989; revised, 60 FR 20195, Apr. 25, 1995, effective June 8, 1995; revised, 65 FR 54604, Sept. 8, 2000, effective Nov. 7, 2000]

### § 1.178 Original patent; continuing duty of applicant.

(a) The application for a reissue should be accompanied by either an offer to surrender the original patent, or the original patent itself, or if the original is lost or inaccessible, by a statement to that effect. The application may be accepted for examination in the absence of the original patent or the statement, but one or the other must be supplied before the application is allowed. If a reissue application is refused, the original patent, if surrendered, will be returned to applicant upon request.

(b) In any reissue application before the Office, the applicant must call to the attention of the Office any prior or concurrent proceedings in which the patent (for which reissue is requested) is or was involved, such as interferences, reissues, reexaminations, or litigations and the results of such proceedings (see also § 1.173(a)(1)).

[24 FR 10332, Dec. 22, 1959; 34 FR 18857, Nov. 26, 1969; revised, 65 FR 54604, Sept. 8, 2000, effective Nov. 7, 2000]

### § 1.179 Notice of reissue application.

When an application for a reissue is filed, there will be placed in the file of the original patent a notice stating that an application for reissue has been filed. When the reissue is granted or the reissue application is otherwise terminated, the fact will be added to the notice in the file of the original patent.

## PETITIONS AND ACTION BY THE DIRECTOR

### § 1.181 Petition to the Director.

(a) Petition may be taken to the Director:

(1) From any action or requirement of any examiner in the *ex parte* prosecution of an application, or in *ex parte* or *inter partes* prosecution of a reexamination proceeding which is not subject to appeal to the Board of Patent Appeals and Interferences or to the court;

(2) In cases in which a statute or the rules specify that the matter is to be determined directly by or reviewed by the Director; and

(3) To invoke the supervisory authority of the Director in appropriate circumstances. For petitions in interferences, see § 1.644.

(b) Any such petition must contain a statement of the facts involved and the point or points to be reviewed and the action requested. Briefs or memoranda, if any, in support thereof should accompany or be embodied in the petition; and where facts are to be proven, the proof in the form of affidavits or declarations (and exhibits, if any) must accompany the petition.

(c) When a petition is taken from an action or requirement of an examiner in the *ex parte* prosecution of an application, or in the *ex parte* or *inter partes* prosecution of a reexamination proceeding, it may be required that there have been a proper request for reconsideration (§ 1.111) and a repeated action by the examiner. The examiner may be directed by the Director to furnish a written statement, within a specified time, setting forth the reasons for his or her decision upon the matters averred in the petition, supplying a copy to the petitioner.

(d) Where a fee is required for a petition to the Director the appropriate section of this part will so indicate. If any required fee does not accompany the petition, the petition will be dismissed.

(e) Oral hearing will not be granted except when considered necessary by the Director.

(f) The mere filing of a petition will not stay any period for reply that may be running against the application, nor act as a stay of other proceedings. Any petition under this part not filed within two months of the mailing date of the action or notice from which relief is requested may be dismissed as untimely, except as otherwise provided. This two-month period is not extendable.

(g) The Director may delegate to appropriate Patent and Trademark Office officials the determination of petitions.

[24 FR 10332, Dec. 22, 1959; 34 FR 18857, Nov. 26, 1969; paras. (d) and (g), 47 FR 41278, Sept. 17, 1982, effective Oct. 1, 1982; para. (a), 49 FR 48416, Dec. 12, 1984, effective Feb. 11, 1985; para. (f) revised, 65 FR 54604, Sept. 8, 2000, effective Nov. 7, 2000; paras. (a) and (c) revised, 65 FR 76756, Dec. 7, 2000, effective Feb. 5, 2001; paras. (a), (a)(2)-(3), (c)-(e) & (g) revised, 68 FR 14332, Mar. 25, 2003, effective May 1, 2003]

### § 1.182 Questions not specifically provided for.

All situations not specifically provided for in the regulations of this part will be decided in accordance with the merits of each situation by or under the authority of the Director, subject to such other requirements as may be imposed, and such decision will be communicated to the interested parties in writing. Any petition seeking a decision under this section must be accompanied by the petition fee set forth in § 1.17(h).

[47 FR 41278, Sept. 17, 1982, effective date Oct. 1, 1982; revised, 62 FR 53131, Oct. 10, 1997, effective Dec. 1, 1997; revised, 68 FR 14332, Mar. 25, 2003, effective May 1, 2003]

### § 1.183 Suspension of rules.

In an extraordinary situation, when justice requires, any requirement of the regulations in this part which is not a requirement of the statutes may be suspended or waived by the Director or the Director's

designee, *sua sponte*, or on petition of the interested party, subject to such other requirements as may be imposed. Any petition under this section must be accompanied by the petition fee set forth in § 1.17(h).

[47 FR 41278, Sept. 17, 1982, effective Oct. 1, 1982; revised, 68 FR 14332, Mar. 25, 2003, effective May 1, 2003]

### § 1.184 [Reserved]

[Removed and reserved, 62 FR 53131, Oct. 10, 1997, effective Dec. 1, 1997]

## APPEAL TO THE BOARD OF PATENT APPEALS AND INTERFERENCES

### § 1.191 Appeal to Board of Patent Appeals and Interferences.

(a)(1) Every applicant for a patent or for reissue of a patent, and every owner of a patent involved in an *ex parte* reexamination proceeding filed under § 1.510 before November 29, 1999, any of whose claims has been twice or finally (§ 1.113) rejected, may appeal from the decision of the examiner to the Board of Patent Appeals and Interferences by filing a notice of appeal and the fee set forth in § 1.17(b) within the time period for reply provided under §§ 1.134 and 1.136 (for applications) or § 1.550(c) (for *ex parte* reexamination proceedings).

(2) Every owner of a patent involved in an *ex parte* reexamination proceeding filed under § 1.510 on or after November 29, 1999, any of whose claims has been finally (§ 1.113) rejected, may appeal from the decision of the examiner to the Board of Patent Appeals and Interferences by filing a notice of appeal and the fee set forth in § 1.17(b) within the time period for reply provided under §§ 1.134 and 1.550(c).

(3) Appeals to the Board of Patent Appeals and Interferences in *inter partes* reexamination proceedings filed under § 1.913 are controlled by §§ 1.959 through 1.981. Sections 1.191 through 1.198 are not applicable to appeals in *inter partes* reexamination proceedings filed under § 1.913.

(b) The signature requirement of § 1.33 does not apply to a notice of appeal filed under this section.

(c) An appeal when taken must be taken from the rejection of all claims under rejection which the applicant or patent owner proposes to contest. Questions relating to matters not affecting the merits of the invention may be required to be settled before an appeal can be considered.

(d) The time periods set forth in §§ 1.191 and 1.192 are subject to the provisions of § 1.136 for patent applications and § 1.550(c) for reexamination proceedings. The time periods set forth in §§ 1.193, 1.194, 1.196 and 1.197 are subject to the provisions of § 1.136(b) for patent applications or § 1.550(c) for reexamination proceedings. See § 1.304(a) for extensions of time for filing a notice of appeal to the U.S. Court of Appeals for the Federal Circuit or for commencing a civil action.

(e) Jurisdiction over the application or patent under reexamination passes to the Board of Patent Appeals and Interferences upon transmittal of the file, including all briefs and examiner's answers, to the Board. Prior to the entry of a decision on the appeal, the Director may *sua sponte* order the application remanded to the examiner.

[46 FR 29183, May 29, 1981; para. (a), 47 FR 41278, Sept. 17, 1982, effective Oct. 1, 1982; para. (d), 49 FR 555, Jan. 4, 1984, effective Apr. 1, 1984; 49 FR 48416, Dec. 12, 1984, effective Feb. 11, 1985; paras. (b) and (d) amended, para. (e) added, 54 FR 29553, July 13, 1989, effective Aug. 20, 1989; para. (d) revised, 58 FR 54504, Oct. 22, 1993, effective Jan. 3, 1994; paras. (a) and (b) revised, 62 FR 53131, Oct. 10, 1997, effective Dec. 1, 1997; para. (a) revised, 65 FR 76756, Dec. 7, 2000, effective Feb. 5, 2001; para. (e) revised, 68 FR 14332, Mar. 25, 2003, effective May 1, 2003; para. (a) revised, 68 FR 70996, Dec. 22, 2003, effective Jan. 21, 2004]

### § 1.192 Appellant's brief.

(a) Appellant must, within two months from the date of the notice of appeal under § 1.191 or within the time allowed for reply to the action from which the appeal was taken, if such time is later, file a brief in triplicate. The brief must be accompanied by the fee set forth in § 1.17(c) and must set forth the authorities and arguments on which appellant will rely to maintain the appeal. Any arguments or authorities not included in the brief will be refused consideration by the Board of Patent Appeals and Interferences, unless good cause is shown.

(b) On failure to file the brief, accompanied by the requisite fee, within the time allowed, the appeal shall stand dismissed.

(c) The brief shall contain the following items under appropriate headings and in the order indicated below unless the brief is filed by an applicant who is not represented by a registered practitioner:

(1) *Real party in interest.* A statement identifying the real party in interest, if the party named in the caption of the brief is not the real party in interest.

(2) *Related appeals and interferences.* A statement identifying by number and filing date all other appeals or interferences known to appellant, the appellant's legal representative, or assignee which will directly affect or be directly affected by or have a bearing on the Board's decision in the pending appeal.

(3) *Status of claims.* A statement of the status of all the claims, pending or cancelled, and identifying the claims appealed.

(4) *Status of amendments.* A statement of the status of any amendment filed subsequent to final rejection.

(5) *Summary of invention.* A concise explanation of the invention defined in the claims involved in the appeal, which shall refer to the specification by page and line number, and to the drawing, if any, by reference characters.

(6) *Issues.* A concise statement of the issues presented for review.

(7) *Grouping of claims.* For each ground of rejection which appellant contests and which applies to a group of two or more claims, the Board shall select a single claim from the group and shall decide the appeal as to the ground of rejection on the basis of that claim alone unless a statement is included that the claims of the group do not stand or fall together and, in the argument under paragraph (c)(8) of this section, appellant explains why the claims of the group are believed to be separately patentable. Merely pointing out differences in what the claims cover is not an argument as to why the claims are separately patentable.

(8) *Argument.* The contentions of appellant with respect to each of the issues presented for review in paragraph (c)(6) of this section, and the basis therefor, with citations of the authorities, statutes, and parts of the record relied on. Each issue should be treated under a separate heading.

(i) For each rejection under 35 U.S.C. 112, first paragraph, the argument shall specify the errors in the rejection and how the first paragraph of 35 U.S.C. 112 is complied with, including, as appropriate, how the specification and drawings, if any,

(A) Describe the subject matter defined by each of the rejected claims,

(B) Enable any person skilled in the art to make and use the subject matter defined by each of the rejected claims, and

(C) Set forth the best mode contemplated by the inventor of carrying out his or her invention.

(ii) For each rejection under 35 U.S.C. 112, second paragraph, the argument shall specify the errors in the rejection and how the claims particularly point out and distinctly claim the subject matter which applicant regards as the invention.

(iii) For each rejection under 35 U.S.C. 102, the argument shall specify the errors in the rejection and why the rejected claims are patentable under 35 U.S.C. 102, including any specific limitations in the rejected claims which are not described in the prior art relied upon in the rejection.

(iv) For each rejection under 35 U.S.C. 103, the argument shall specify the errors in the rejection and, if appropriate, the specific limitations in the rejected claims which are not described in the prior art relied on in the rejection, and shall explain how such limitations render the claimed subject matter unobvious over the prior art. If the rejection is based upon a combination of references, the argument shall explain why the references, taken as a whole, do not suggest the claimed subject matter, and shall include, as may be appropriate, an explanation of why features disclosed in one reference may not properly be combined with features disclosed in another reference. A general argument that all the limitations are not described in a single reference does not satisfy the requirements of this paragraph.

(v) For any rejection other than those referred to in paragraphs (c)(8)(i) to (iv) of this section, the argument shall specify the errors in the rejection and the specific limitations in the rejected claims, if appropriate, or other reasons, which cause the rejection to be in error.

(9) *Appendix.* An appendix containing a copy of the claims involved in the appeal.

(d) If a brief is filed which does not comply with all the requirements of paragraph (c) of this section, appellant will be notified of the reasons for non-compliance and provided with a period of one month within which to file an amended brief. If appellant does not file an amended brief during the one-month period, or files an amended brief which does not overcome all the reasons for non-compliance stated in the notification, the appeal will stand dismissed.

[36 FR 5850, Mar. 30, 1971; para. (a), 47 FR 41278, Sept. 17, 1982, effective Oct. 1, 1982; para. (a), 49 FR 556, Jan. 4, 1984, effective Apr. 1, 1984; 53 FR 23734, June 23, 1988, effective Sept. 12, 1988; para. (a), (c), and (d) revised, 58 FR 54504, Oct. 22, 1993, effective Jan. 3, 1994; paras. (a)-(c) revised, 60 FR 14488, Mar 17, 1995, effective Apr. 21, 1995; para. (a) revised, 62 FR 53131, Oct. 10, 1997, effective Dec. 1, 1997]

#### § 1.193 Examiner's answer and reply brief.

(a)(1) The primary examiner may, within such time as may be directed by the Director, furnish a written statement in answer to appellant's brief including such explanation of the invention claimed and of the references and grounds of rejection as may be necessary, supplying a copy to appellant. If the primary examiner finds that the appeal is not regular in form or does not relate to an appealable action, the primary examiner shall so state.

(2) An examiner's answer must not include a new ground of rejection, but if an amendment under § 1.116 proposes to add or amend one or more claims and appellant was advised that the amendment under § 1.116 would be entered for purposes of appeal and which individual rejection(s) set forth in the action from which the appeal was taken would be used to reject the added or amended claim(s), then the appeal brief must address the rejection(s) of the claim(s) added or amended by the amendment under § 1.116 as appellant was so advised and the examiner's answer may include the rejection(s) of the claim(s) added or amended by the amendment under § 1.116 as appellant was so advised. The filing of an amendment under § 1.116 which is entered for purposes of appeal represents appellant's consent that when so advised any appeal proceed on those claim(s) added or amended by the amendment under § 1.116 subject to any rejection set forth in the action from which the appeal was taken.

(b)(1) Appellant may file a reply brief to an examiner's answer or a supplemental examiner's answer within two months from the date of such examiner's answer or supplemental examiner's answer. See § 1.136(b) for extensions of time for filing a reply brief in a patent application and § 1.550(c) for extensions of time for filing a reply brief in a reexamination proceeding. The primary examiner must either acknowledge receipt and entry of the reply brief or withdraw the final rejection and reopen prosecution to respond to the reply brief. A supplemental examiner's answer is not permitted, unless the application has been remanded by the Board of Patent Appeals and Interferences for such purpose.

(2) Where prosecution is reopened by the primary examiner after an appeal or reply brief has been filed, appellant must exercise one of the following two options to avoid abandonment of the application:

(i) File a reply under § 1.111, if the Office action is not final, or a reply under § 1.113, if the Office action is final; or

(ii) Request reinstatement of the appeal. If reinstatement of the appeal is requested, such request must be accompanied by a supplemental appeal brief, but no new amendments, affidavits (§§ 1.130, 1.131 or 1.132) or other evidence are permitted.

[24 FR 10332, Dec. 22, 1959; 34 FR 18858, Nov. 26, 1969; para. (c), 47 FR 21752, May 19, 1982, added effective July 1, 1982; para. (b), 50 FR 9382, Mar. 7, 1985, effective May 8, 1985; 53 FR 23735, June 23, 1988, effective Sept. 12, 1988; para. (c) deleted, 57 FR 2021, Jan. 17, 1992, effective Mar. 16, 1992; para. (b) revised, 58 FR 54504, Oct. 22, 1993, effective Jan. 3, 1994; revised, 62 FR 53131, Oct. 10, 1997, effective Dec. 1, 1997; para. (b)(1) revised, 65 FR 54604, Sept. 8, 2000, effective Nov. 7, 2000; para. (a)(1) revised, 68 FR 14332, Mar. 25, 2003, effective May 1, 2003]

### § 1.194 Oral hearing.

(a) An oral hearing should be requested only in those circumstances in which appellant considers such a hearing necessary or desirable for a proper presentation of the appeal. An appeal decided without an oral hearing will receive the same consideration by the Board of Patent Appeals and Interferences as appeals decided after oral hearing.

(b) If appellant desires an oral hearing, appellant must file, in a separate paper, a written request for

such hearing accompanied by the fee set forth in § 1.17(d) within two months from the date of the examiner's answer. If appellant requests an oral hearing and submits therewith the fee set forth in § 1.17(d), an oral argument may be presented by, or on behalf of, the primary examiner if considered desirable by either the primary examiner or the Board. See § 1.136(b) for extensions of time for requesting an oral hearing in a patent application and § 1.550(c) for extensions of time for requesting an oral hearing in a reexamination proceeding.

(c) If no request and fee for oral hearing have been timely filed by appellant, the appeal will be assigned for consideration and decision. If appellant has requested an oral hearing and has submitted the fee set forth in § 1.17(d), a day of hearing will be set, and due notice thereof given to appellant and to the primary examiner. A hearing will be held as stated in the notice, and oral argument will be limited to twenty minutes for appellant and fifteen minutes for the primary examiner unless otherwise ordered before the hearing begins. If the Board decides that a hearing is not necessary, the Board will so notify appellant.

[42 FR 5595, Jan. 28, 1977; paras. (b) & (c), 47 FR 41278, Sept. 17, 1982, effective Oct. 1, 1982; para. (a), 49 FR 48416, Dec. 12, 1984, effective Feb. 11, 1985; para. (b) revised 53 FR 23735, June 23, 1988, effective Sept. 12, 1988; para. (b) revised, 58 FR 54504, Oct. 22, 1993, effective Jan. 3, 1994; revised, 62 FR 53131, Oct. 10, 1997, effective Dec. 1, 1997]

### § 1.195 Affidavits or declarations after appeal.

Affidavits, declarations, or exhibits submitted after the case has been appealed will not be admitted without a showing of good and sufficient reasons why they were not earlier presented.

[34 FR 18858, Nov. 26, 1969]

### § 1.196 Decision by the Board of Patent Appeals and Interferences.

(a) The Board of Patent Appeals and Interferences, in its decision, may affirm or reverse the decision of the examiner in whole or in part on the grounds and on the claims specified by the examiner or remand the application to the examiner for further consideration. The affirmance of the rejection of a claim on any of the grounds specified constitutes a

general affirmance of the decision of the examiner on that claim, except as to any ground specifically reversed.

(b) Should the Board of Patent Appeals and Interferences have knowledge of any grounds not involved in the appeal for rejecting any pending claim, it may include in the decision a statement to that effect with its reasons for so holding, which statement constitutes a new ground of rejection of the claim. A new ground of rejection shall not be considered final for purposes of judicial review. When the Board of Patent Appeals and Interferences makes a new ground of rejection, the appellant, within two months from the date of the decision, must exercise one of the following two options with respect to the new ground of rejection to avoid termination of proceedings (§ 1.197(c)) as to the rejected claims:

(1) Submit an appropriate amendment of the claims so rejected or a showing of facts relating to the claims so rejected, or both, and have the matter reconsidered by the examiner, in which event the application will be remanded to the examiner. The new ground of rejection is binding upon the examiner unless an amendment or showing of facts not previously of record be made which, in the opinion of the examiner, overcomes the new ground of rejection stated in the decision. Should the examiner reject the claims, appellant may again appeal pursuant to §§ 1.191 through 1.195 to the Board of Patent Appeals and Interferences.

(2) Request that the application be reheard under § 1.197(b) by the Board of Patent Appeals and Interferences upon the same record. The request for rehearing must address the new ground of rejection and state with particularity the points believed to have been misapprehended or overlooked in rendering the decision and also state all other grounds upon which rehearing is sought. Where request for such rehearing is made, the Board of Patent Appeals and Interferences shall rehear the new ground of rejection and, if necessary, render a new decision which shall include all grounds of rejection upon which a patent is refused. The decision on rehearing is deemed to incorporate the earlier decision for purposes of appeal, except for those portions specifically withdrawn on rehearing, and is final for the purpose of judicial review, except when noted otherwise in the decision.

(c) Should the decision of the Board of Patent Appeals and Interferences include an explicit statement that a claim may be allowed in amended form, appellant shall have the right to amend in conformity with such statement which shall be binding on the examiner in the absence of new references or grounds of rejection.

(d) The Board of Patent Appeals and Interferences may require appellant to address any matter that is deemed appropriate for a reasoned decision on the pending appeal. Appellant will be given a non-extendable time period within which to respond to such a requirement.

(e) Whenever a decision of the Board of Patent Appeals and Interferences includes or allows a remand, that decision shall not be considered a final decision. When appropriate, upon conclusion of proceedings on remand before the examiner, the Board of Patent Appeals and Interferences may enter an order otherwise making its decision final.

(f) See § 1.136(b) for extensions of time to take action under this section in a patent application and § 1.550(c) for extensions of time in a reexamination proceeding.

[24 FR 10332, Dec. 12, 1959; 49 FR 29183, May 29, 1981; 49 FR 48416, Dec. 12, 1984, effective Feb. 12, 1985; para. (b) revised, 53 FR 23735, June 23, 1988, effective Sept. 12, 1988; paras. (a), (b) & (d) amended, paras. (e) & (f) added, 54 FR 29552, July 13, 1989, effective Aug. 20, 1989; para. (f) revised, 58 FR 54504, Oct. 22, 1993, effective Jan. 3, 1994; paras. (b) & (d) revised, 62 FR 53131, Oct. 10, 1997, effective Dec. 1, 1997]

### § 1.197 Action following decision.

(a) After decision by the Board of Patent Appeals and Interferences, the application will be returned to the examiner, subject to appellant's right of appeal or other review, for such further action by appellant or by the examiner, as the condition of the application may require, to carry into effect the decision.

(b) Appellant may file a single request for rehearing within two months from the date of the original decision, unless the original decision is so modified by the decision on rehearing as to become, in effect, a new decision, and the Board of Patent Appeals and Interferences so states. The request for rehearing must state with particularity the points

believed to have been misapprehended or overlooked in rendering the decision and also state all other grounds upon which rehearing is sought. See § 1.136(b) for extensions of time for seeking rehearing in a patent application and § 1.550(c) for extensions of time for seeking rehearing in a reexamination proceeding.

(c) Termination of proceedings.

(1) Proceedings are considered terminated by the dismissal of an appeal or the failure to timely file an appeal to the court or a civil action (§ 1.304) except:

(i) Where claims stand allowed in an application; or

(ii) Where the nature of the decision requires further action by the examiner.

(2) The date of termination of proceedings is the date on which the appeal is dismissed or the date on which the time for appeal to the Court or review by civil action (§ 1.304) expires. If an appeal to the Court or a civil action has been filed, proceedings are considered terminated when the appeal or civil action is terminated. An appeal to the U.S. Court of Appeals for the Federal Circuit is terminated when the mandate is issued by the Court. A civil action is terminated when the time to appeal the judgment expires.

[46 FR 29184, May 29, 1981; para. (a), 47 FR 41278, Sept. 17, 1982, effective Oct. 1, 1982; 49 FR 556, Jan. 4, 1984, effective Apr. 1, 1984; paras. (a) and (b), 49 FR 48416, Dec. 12, 1984, effective Feb. 11, 1985; paras. (b) and (c), 54 FR 29552, July 13, 1989, effective Aug. 20, 1989; para. (b) revised, 58 FR 54504, Oct. 22, 1993, effective Jan. 3, 1994; paras. (a) & (b) revised, 62 FR 53131, Oct. 10, 1997, effective Dec. 1, 1997; para. (c) revised, 68 FR 70996, Dec. 22, 2003, effective Jan. 21, 2004]

**§ 1.198 Reopening after decision.**

Cases which have been decided by the Board of Patent Appeals and Interferences will not be reopened or reconsidered by the primary examiner except under the provisions of § 1.114 or § 1.196 without the written authority of the Director, and then only for the consideration of matters not already adjudicated, sufficient cause being shown.

[49 FR 48416, Dec. 12, 1984, effective date Feb. 11, 1985; revised, 65 FR 14865, Mar. 20, 2000, effective May 29, 2000 (adopted as final, 65 FR 50092, Aug. 16, 2000); revised, 68 FR 14332, Mar. 25, 2003, effective May 1, 2003]

**PUBLICATION OF APPLICATIONS**

**§ 1.211 Publication of applications.**

(a) Each U.S. national application for patent filed in the Office under 35 U.S.C. 111(a) and each international application in compliance with 35 U.S.C. 371 will be published promptly after the expiration of a period of eighteen months from the earliest filing date for which a benefit is sought under title 35, United States Code, unless:

(1) The application is recognized by the Office as no longer pending;

(2) The application is national security classified (see § 5.2(c)), subject to a secrecy order under 35 U.S.C. 181, or under national security review;

(3) The application has issued as a patent in sufficient time to be removed from the publication process; or

(4) The application was filed with a nonpublication request in compliance with § 1.213(a).

(b) Provisional applications under 35 U.S.C. 111(b) shall not be published, and design applications under 35 U.S.C. chapter 16 and reissue applications under 35 U.S.C. chapter 25 shall not be published under this section.

(c) An application filed under 35 U.S.C. 111(a) will not be published until it includes the basic filing fee (§ 1.16(a) or 1.16(g)), any English translation required by § 1.52(d), and an executed oath or declaration under § 1.63. The Office may delay publishing any application until it includes a specification having papers in compliance with § 1.52 and an abstract (§ 1.72(b)), drawings in compliance with § 1.84, and a sequence listing in compliance with §§ 1.821 through 1.825 (if applicable), and until any petition under § 1.47 is granted.

(d) The Office may refuse to publish an application, or to include a portion of an application in the patent application publication (§ 1.215), if publication of the application or portion thereof would violate Federal or state law, or if the application or portion thereof contains offensive or disparaging material.



(e) The publication fee set forth in § 1.18(d) must be paid in each application published under this section before the patent will be granted. If an application is subject to publication under this section, the sum specified in the notice of allowance under § 1.311 will also include the publication fee which must be paid within three months from the date of mailing of the notice of allowance to avoid abandonment of the application. This three-month period is not extendable. If the application is not published under this section, the publication fee (if paid) will be refunded.

[Added, 65 FR 57024, Sept. 20, 2000, effective Nov. 29, 2000]

### § 1.213 Nonpublication request.

(a) If the invention disclosed in an application has not been and will not be the subject of an application filed in another country, or under a multilateral international agreement, that requires publication of applications eighteen months after filing, the application will not be published under 35 U.S.C. 122(b) and § 1.211 provided:

(1) A request (nonpublication request) is submitted with the application upon filing;

(2) The request states in a conspicuous manner that the application is not to be published under 35 U.S.C. 122(b);

(3) The request contains a certification that the invention disclosed in the application has not been and will not be the subject of an application filed in another country, or under a multilateral international agreement, that requires publication at eighteen months after filing; and

(4) The request is signed in compliance with § 1.33(b).

(b) The applicant may rescind a nonpublication request at any time. A request to rescind a nonpublication request under paragraph (a) of this section must:

(1) Identify the application to which it is directed;

(2) State in a conspicuous manner that the request that the application is not to be published under 35 U.S.C. 122(b) is rescinded; and

(3) Be signed in compliance with § 1.33(b).

(c) If an applicant who has submitted a nonpublication request under paragraph (a) of this section subsequently files an application directed to the invention disclosed in the application in which the

nonpublication request was submitted in another country, or under a multilateral international agreement, that requires publication of applications eighteen months after filing, the applicant must notify the Office of such filing within forty-five days after the date of the filing of such foreign or international application. The failure to timely notify the Office of the filing of such foreign or international application shall result in abandonment of the application in which the nonpublication request was submitted (35 U.S.C. 122(b)(2)(B)(iii)).

[Added, 65 FR 57024, Sept. 20, 2000, effective Nov. 29, 2000]

### § 1.215 Patent application publication.

(a) The publication of an application under 35 U.S.C. 122(b) shall include a patent application publication. The date of publication shall be indicated on the patent application publication. The patent application publication will be based upon the application papers deposited on the filing date of the application, as well as the executed oath or declaration submitted to complete the application, and any application papers or drawings submitted in reply to a pre-examination notice requiring a title and abstract in compliance with § 1.72, application papers in compliance with § 1.52, drawings in compliance with § 1.84, or a sequence listing in compliance with §§ 1.821 through 1.825, except as otherwise provided in this section. The patent application publication will not include any amendments, including preliminary amendments, unless applicant supplies a copy of the application containing the amendment pursuant to paragraph (c) of this section.

(b) If applicant wants the patent application publication to include assignee information, the applicant must include the assignee information on the application transmittal sheet or the application data sheet (§ 1.76). Assignee information may not be included on the patent application publication unless this information is provided on the application transmittal sheet or application data sheet included with the application on filing. Providing this information on the application transmittal sheet or the application data sheet does not substitute for compliance with any requirement of part 3 of this chapter to have an assignment recorded by the Office.

(c) At applicant's option, the patent application publication will be based upon the copy of the application (specification, drawings, and oath or declaration) as amended during examination, provided that applicant supplies such a copy in compliance with the Office electronic filing system requirements within one month of the actual filing date of the application or fourteen months of the earliest filing date for which a benefit is sought under title 35, United States Code, whichever is later.

(d) If the copy of the application submitted pursuant to paragraph (c) of this section does not comply with the Office electronic filing system requirements, the Office will publish the application as provided in paragraph (a) of this section. If, however, the Office has not started the publication process, the Office may use an untimely filed copy of the application supplied by the applicant under paragraph (c) of this section in creating the patent application publication.

[Added, 65 FR 57024, Sept. 20, 2000, effective Nov. 29, 2000]

### § 1.217 Publication of a redacted copy of an application.

(a) If an applicant has filed applications in one or more foreign countries, directly or through a multilateral international agreement, and such foreign-filed applications or the description of the invention in such foreign-filed applications is less extensive than the application or description of the invention in the application filed in the Office, the applicant may submit a redacted copy of the application filed in the Office for publication, eliminating any part or description of the invention that is not also contained in any of the corresponding applications filed in a foreign country. The Office will publish the application as provided in § 1.215(a) unless the applicant files a redacted copy of the application in compliance with this section within sixteen months after the earliest filing date for which a benefit is sought under title 35, United States Code.

(b) The redacted copy of the application must be submitted in compliance with the Office electronic filing system requirements. The title of the invention in the redacted copy of the application must correspond to the title of the application at the time the redacted copy of the application is submitted to the Office. If the redacted copy of the application does

not comply with the Office electronic filing system requirements, the Office will publish the application as provided in § 1.215(a).

(c) The applicant must also concurrently submit in paper (§ 1.52(a)) to be filed in the application:

(1) A certified copy of each foreign-filed application that corresponds to the application for which a redacted copy is submitted;

(2) A translation of each such foreign-filed application that is in a language other than English, and a statement that the translation is accurate;

(3) A marked-up copy of the application showing the redactions in brackets; and

(4) A certification that the redacted copy of the application eliminates only the part or description of the invention that is not contained in any application filed in a foreign country, directly or through a multilateral international agreement, that corresponds to the application filed in the Office.

(d) The Office will provide a copy of the complete file wrapper and contents of an application for which a redacted copy was submitted under this section to any person upon written request pursuant to § 1.14(c)(2), unless applicant complies with the requirements of paragraphs (d)(1), (d)(2), and (d)(3) of this section.

(1) Applicant must accompany the submission required by paragraph (c) of this section with the following:

(i) A copy of any Office correspondence previously received by applicant including any desired redactions, and a second copy of all Office correspondence previously received by applicant showing the redacted material in brackets; and

(ii) A copy of each submission previously filed by the applicant including any desired redactions, and a second copy of each submission previously filed by the applicant showing the redacted material in brackets.

(2) In addition to providing the submission required by paragraphs (c) and (d)(1) of this section, applicant must:

(i) Within one month of the date of mailing of any correspondence from the Office, file a copy of such Office correspondence including any desired redactions, and a second copy of such Office correspondence showing the redacted material in brackets; and

(ii) With each submission by the applicant, include a copy of such submission including any desired redactions, and a second copy of such submission showing the redacted material in brackets.

(3) Each submission under paragraph (d)(1) or (d)(2) of this paragraph must also be accompanied by the processing fee set forth in § 1.17(i) and a certification that the redactions are limited to the elimination of material that is relevant only to the part or description of the invention that was not contained in the redacted copy of the application submitted for publication.

(e) The provisions of § 1.8 do not apply to the time periods set forth in this section.

[Added, 65 FR 57024, Sept. 20, 2000, effective Nov. 29, 2000]

### § 1.219 Early publication.

Applications that will be published under § 1.211 may be published earlier than as set forth in § 1.211(a) at the request of the applicant. Any request for early publication must be accompanied by the publication fee set forth in § 1.18(d). If the applicant does not submit a copy of the application in compliance with the Office electronic filing system requirements pursuant to § 1.215(c), the Office will publish the application as provided in § 1.215(a). No consideration will be given to requests for publication on a certain date, and such requests will be treated as a request for publication as soon as possible.

[Added, 65 FR 57024, Sept. 20, 2000, effective Nov. 29, 2000]

### § 1.221 Voluntary publication or republication of patent application publication.

(a) Any request for publication of an application filed before, but pending on, November 29, 2000, and any request for republication of an application previously published under § 1.211, must include a copy of the application in compliance with the Office electronic filing system requirements and be accompanied by the publication fee set forth in § 1.18(d) and the processing fee set forth in § 1.17(i). If the request does not comply with the requirements of this paragraph or the copy of the application does not comply with the Office electronic filing system requirements,

the Office will not publish the application and will refund the publication fee.

(b) The Office will grant a request for a corrected or revised patent application publication other than as provided in paragraph (a) of this section only when the Office makes a material mistake which is apparent from Office records. Any request for a corrected or revised patent application publication other than as provided in paragraph (a) of this section must be filed within two months from the date of the patent application publication. This period is not extendable.

[Added, 65 FR 57024, Sept. 20, 2000, effective Nov. 29, 2000]

## MISCELLANEOUS PROVISIONS

### § 1.248 Service of papers; manner of service; proof of service in cases other than interferences.

(a) Service of papers must be on the attorney or agent of the party if there be such or on the party if there is no attorney or agent, and may be made in any of the following ways:

(1) By delivering a copy of the paper to the person served;

(2) By leaving a copy at the usual place of business of the person served with someone in his employment;

(3) When the person served has no usual place of business, by leaving a copy at the person's residence, with some person of suitable age and discretion who resides there;

(4) Transmission by first class mail. When service is by mail the date of mailing will be regarded as the date of service;

(5) Whenever it shall be satisfactorily shown to the Director that none of the above modes of obtaining or serving the paper is practicable, service may be by notice published in the *Official Gazette*.

(b) Papers filed in the Patent and Trademark Office which are required to be served shall contain proof of service. Proof of service may appear on or be affixed to papers filed. Proof of service shall include the date and manner of service. In the case of personal service, proof of service shall also include the name of any person served, certified by the person who made service. Proof of service may be made by:

(1) An acknowledgement of service by or on behalf of the person served or

(2) A statement signed by the attorney or agent containing the information required by this section.

(c) See § 1.646 for service of papers in interferences.

[46 FR 29184, May 29, 1981; 49 FR 48416, Dec. 12, 1984, effective Feb. 11, 1985; para. (a)(5) revised, 68 FR 14332, Mar. 25, 2003, effective May 1, 2003]

### § 1.251 Unlocatable file.

(a) In the event that the Office cannot locate the file of an application, patent, or other patent-related proceeding after a reasonable search, the Office will notify the applicant or patentee and set a time period within which the applicant or patentee must comply with the notice in accordance with one of paragraphs (a)(1), (a)(2), or (a)(3) of this section.

(1) Applicant or patentee may comply with a notice under this section by providing:

(i) A copy of the applicant's or patentee's record (if any) of all of the correspondence between the Office and the applicant or patentee for such application, patent, or other proceeding (except for U.S. patent documents);

(ii) A list of such correspondence; and

(iii) A statement that the copy is a complete and accurate copy of the applicant's or patentee's record of all of the correspondence between the Office and the applicant or patentee for such application, patent, or other proceeding (except for U.S. patent documents), and whether applicant or patentee is aware of any correspondence between the Office and the applicant or patentee for such application, patent, or other proceeding that is not among applicant's or patentee's records.

(2) Applicant or patentee may comply with a notice under this section by:

(i) Producing the applicant's or patentee's record (if any) of all of the correspondence between the Office and the applicant or patentee for such application, patent, or other proceeding for the Office to copy (except for U.S. patent documents); and

(ii) Providing a statement that the papers produced by applicant or patentee are applicant's or patentee's complete record of all of the correspondence between the Office and the applicant or patentee for such application, patent, or other proceeding (except for U.S. patent documents), and whether applicant or patentee is aware of any correspondence between the Office and the applicant or patentee for such application, patent, or other proceeding that is not among applicant's or patentee's records.

(3) If applicant or patentee does not possess any record of the correspondence between the Office and the applicant or patentee for such application, patent, or other proceeding, applicant or patentee must comply with a notice under this section by providing a statement that applicant or patentee does not possess any record of the correspondence between the Office and the applicant or patentee for such application, patent, or other proceeding.

(b) With regard to a pending application, failure to comply with one of paragraphs (a)(1), (a)(2), or (a)(3) of this section within the time period set in the notice will result in abandonment of the application.

[Added, 65 FR 69446, Nov. 17, 2000, effective Nov. 17, 2000]

## PROTESTS AND PUBLIC USE PROCEEDINGS

### § 1.291 Protests by the public against pending applications.

(a) Protests by a member of the public against pending applications will be referred to the examiner having charge of the subject matter involved. A protest specifically identifying the application to which the protest is directed will be entered in the application file if:

(1) The protest is submitted prior to the date the application was published or the mailing of a notice of allowance under § 1.311, whichever occurs first; and

(2) The protest is either served upon the applicant in accordance with § 1.248, or filed with the Office in duplicate in the event service is not possible.

(b) Protests raising fraud or other inequitable conduct issues will be entered in the application file, generally without comment on those issues. Protests which do not adequately identify a pending patent

application will be returned to the protestor and will not be further considered by the Office. A protest submitted in accordance with the second sentence of paragraph (a) of this section will be considered by the Office if the application is still pending when the protest and application file are brought before the examiner and it includes:

(1) A listing of the patents, publications, or other information relied upon;

(2) A concise explanation of the relevance of each listed item;

(3) A copy of each listed patent or publication or other item of information in written form or at least the pertinent portions thereof; and

(4) An English language translation of all the necessary and pertinent parts of any non-English language patent, publication, or other item of information in written form relied upon.

(c) A member of the public filing a protest in an application under paragraph (a) of this section will not receive any communications from the Office relating to the protest, other than the return of a self-addressed postcard which the member of the public may include with the protest in order to receive an acknowledgment by the Office that the protest has been received. In the absence of a request by the Office, an applicant has no duty to, and need not, reply to a protest. The limited involvement of the member of the public filing a protest pursuant to paragraph (a) of this section ends with the filing of the protest, and no further submission on behalf of the protestor will be considered, except for additional prior art, or unless such submission raises new issues which could not have been earlier presented.

[47 FR 21752, May 19, 1982, effective July 1, 1982; paras. (a) and (c), 57 FR 2021, Jan. 17, 1992, effective Mar. 16, 1992; paras. (a) and (b) revised, 61 FR 42790, Aug. 19, 1996, effective Sept. 23, 1996; para. (c) revised, 62 FR 53131, Oct. 10, 1997, effective Dec. 1, 1997; para. (a)(1) revised, 65 FR 57024, Sept. 20, 2000, effective Nov. 29, 2000]

### § 1.292 Public use proceedings.

(a) When a petition for the institution of public use proceedings, supported by affidavits or declarations is found, on reference to the examiner, to make a *prima facie* showing that the invention claimed in an application believed to be on file had been in

public use or on sale more than one year before the filing of the application, a hearing may be had before the Director to determine whether a public use proceeding should be instituted. If instituted, the Director may designate an appropriate official to conduct the public use proceeding, including the setting of times for taking testimony, which shall be taken as provided by §§ 1.671 through 1.685. The petitioner will be heard in the proceedings but after decision therein will not be heard further in the prosecution of the application for patent.

(b) The petition and accompanying papers, or a notice that such a petition has been filed, shall be entered in the application file if:

(1) The petition is accompanied by the fee set forth in § 1.17(j);

(2) The petition is served on the applicant in accordance with § 1.248, or filed with the Office in duplicate in the event service is not possible; and

(3) The petition is submitted prior to the date the application was published or the mailing of a notice of allowance under § 1.311, whichever occurs first.

(c) A petition for institution of public use proceedings shall not be filed by a party to an interference as to an application involved in the interference. Public use and on sale issues in an interference shall be raised by a preliminary motion under § 1.633(a).

[42 FR 5595, Jan. 28, 1977; para. (a), 47 FR 41279, Sept. 17, 1982; paras. (a) and (c), 49 FR 48416, Dec. 12, 1984, effective Feb. 12, 1985; paras. (a) and (b) revised, 61 FR 42790, Aug. 19, 1996, effective Sept. 23, 1996; para. (b)(3) revised, 65 FR 57024, Sept. 20, 2000, effective Nov. 29, 2000; para. (a) revised, 68 FR 14332, Mar. 25, 2003, effective May 1, 2003]

### § 1.293 Statutory invention registration.

(a) An applicant for an original patent may request, at any time during the pendency of applicant's pending complete application, that the specification and drawings be published as a statutory invention registration. Any such request must be signed by (1) the applicant and any assignee of record or (2) an attorney or agent of record in the application.

(b) Any request for publication of a statutory invention registration must include the following parts:

(1) A waiver of the applicant's right to receive a patent on the invention claimed effective upon the date of publication of the statutory invention registration;

(2) The required fee for filing a request for publication of a statutory invention registration as provided for in § 1.17(n) or (o);

(3) A statement that, in the opinion of the requester, the application to which the request is directed meets the requirements of 35 U.S.C. 112; and

(4) A statement that, in the opinion of the requester, the application to which the request is directed complies with the formal requirements of this part for printing as a patent.

(c) A waiver filed with a request for a statutory invention registration will be effective, upon publication of the statutory invention registration, to waive the inventor's right to receive a patent on the invention claimed in the statutory invention registration, in any application for an original patent which is pending on, or filed after, the date of publication of the statutory invention registration. A waiver filed with a request for a statutory invention registration will not affect the rights of any other inventor even if the subject matter of the statutory invention registration and an application of another inventor are commonly owned. A waiver filed with a request for a statutory invention registration will not affect any rights in a patent to the inventor which issued prior to the date of publication of the statutory invention registration unless a reissue application is filed seeking to enlarge the scope of the claims of the patent. See also § 1.104(c)(5).

[50 FR 9382, Mar. 7, 1985, effective date May 8, 1985; para. (c) revised, 62 FR 53131, Oct. 10, 1997, effective Dec. 1, 1997]

**§ 1.294 Examination of request for publication of a statutory invention registration and patent application to which the request is directed.**

(a) Any request for a statutory invention registration will be examined to determine if the requirements of § 1.293 have been met. The application to which the request is directed will be examined to determine (1) if the subject matter of the application is appropriate for publication, (2) if the requirements for

publication are met, and (3) if the requirements of 35 U.S.C. 112 and § 1.293 of this part are met.

(b) Applicant will be notified of the results of the examination set forth in paragraph (a) of this section. If the requirements of § 1.293 and this section are not met by the request filed, the notification to applicant will set a period of time within which to comply with the requirements in order to avoid abandonment of the application. If the application does not meet the requirements of 35 U.S.C. 112, the notification to applicant will include a rejection under the appropriate provisions of 35 U.S.C. 112. The periods for reply established pursuant to this section are subject to the extension of time provisions of § 1.136. After reply by the applicant, the application will again be considered for publication of a statutory invention registration. If the requirements of § 1.293 and this section are not timely met, the refusal to publish will be made final. If the requirements of 35 U.S.C. 112 are not met, the rejection pursuant to 35 U.S.C. 112 will be made final.

(c) If the examination pursuant to this section results in approval of the request for a statutory invention registration the applicant will be notified of the intent to publish a statutory invention registration.

[50 FR 9382, Mar. 7, 1985, effective date May 8, 1985; para. (b) revised, 62 FR 53131, Oct. 10, 1997, effective Dec. 1, 1997]

**§ 1.295 Review of decision finally refusing to publish a statutory invention registration.**

(a) Any requester who is dissatisfied with the final refusal to publish a statutory invention registration for reasons other than compliance with 35 U.S.C. 112 may obtain review of the refusal to publish the statutory invention registration by filing a petition to the Director accompanied by the fee set forth in § 1.17(h) within one month or such other time as is set in the decision refusing publication. Any such petition should comply with the requirements of § 1.181(b). The petition may include a request that the petition fee be refunded if the final refusal to publish a statutory invention registration for reasons other than compliance with 35 U.S.C. 112 is determined to result from an error by the Patent and Trademark Office.

(b) Any requester who is dissatisfied with a decision finally rejecting claims pursuant to 35 U.S.C. 112 may obtain review of the decision by filing an

appeal to the Board of Patent Appeals and Interferences pursuant to § 1.191. If the decision rejecting claims pursuant to 35 U.S.C. 112 is reversed, the request for a statutory invention registration will be approved and the registration published if all of the other provisions of § 1.293 and this section are met.

[50 FR 9382, Mar. 7, 1985, effective May 8, 1985; para. (a) revised, 68 FR 14332, Mar. 25, 2003, effective May 1, 2003]

### § 1.296 **Withdrawal of request for publication of statutory invention registration.**

A request for a statutory invention registration, which has been filed, may be withdrawn prior to the date of the notice of the intent to publish a statutory invention registration issued pursuant to § 1.294(c) by filing a request to withdraw the request for publication of a statutory invention registration. The request to withdraw may also include a request for a refund of any amount paid in excess of the application filing fee and a handling fee of \$130.00 which will be retained. Any request to withdraw the request for publication of a statutory invention registration filed on or after the date of the notice of intent to publish issued pursuant to § 1.294(c) must be in the form of a petition pursuant to § 1.183 accompanied by the fee set forth in § 1.17(h).

[50 FR 9382, Mar. 7, 1985, effective date May 8, 1985; revised, 54 FR 6893, Feb. 15, 1989, effective Apr. 17, 1989; 56 FR 65142, Dec. 13, 1991, effective Dec. 16, 1991]

### § 1.297 **Publication of statutory invention registration.**

(a) If the request for a statutory invention registration is approved the statutory invention registration will be published. The statutory invention registration will be mailed to the requester at the correspondence address as provided for in § 1.33(a). A notice of the publication of each statutory invention registration will be published in the *Official Gazette*.

(b) Each statutory invention registration published will include a statement relating to the attributes of a statutory invention registration. The statement will read as follows:

A statutory invention registration is not a patent. It has the defensive attributes of a patent but

does not have the enforceable attributes of a patent. No article or advertisement or the like may use the term patent, or any term suggestive of a patent, when referring to a statutory invention registration. For more specific information on the rights associated with a statutory invention registration see 35 U.S.C. 157.

[50 FR 9382, Mar. 7, 1985, effective May 8, 1985; 50 FR 31826, Aug. 6, 1985, effective Oct. 5, 1985]

## REVIEW OF PATENT AND TRADEMARK OFFICE DECISIONS BY COURT

### § 1.301 **Appeal to U.S. Court of Appeals for the Federal Circuit.**

Any applicant, or any owner of a patent involved in any *ex parte* reexamination proceeding filed under § 1.510, dissatisfied with the decision of the Board of Patent Appeals and Interferences, and any party to an interference dissatisfied with the decision of the Board of Patent Appeals and Interferences, may appeal to the U.S. Court of Appeals for the Federal Circuit. The appellant must take the following steps in such an appeal: In the U. S. Patent and Trademark Office, file a written notice of appeal directed to the Director (§§ 1.302 and 1.304); and in the Court, file a copy of the notice of appeal and pay the fee for appeal as provided by the rules of the Court. For appeals by patent owners and third party requesters in *inter partes* reexamination proceedings filed under § 1.913, § 1.983 is controlling.

[47 FR 47381, Oct. 26, 1982, effective Oct. 26, 1982; 49 FR 48416, Dec. 12, 1984, effective Feb. 11, 1985; 50 FR 9383, Mar. 7, 1985, effective May 8, 1985; 54 FR 29552, July 13, 1989, effective Aug. 20, 1989; revised, 65 FR 76756, Dec. 7, 2000, effective Feb. 5, 2001; revised, 68 FR 14332, Mar. 25, 2003, effective May 1, 2003; revised, 68 FR 70996, Dec. 22, 2003, effective Jan. 21, 2004]

### § 1.302 **Notice of appeal.**

(a) When an appeal is taken to the U.S. Court of Appeals for the Federal Circuit, the appellant shall give notice thereof to the Director within the time specified in § 1.304.

(b) In interferences, the notice must be served as provided in § 1.646.

(c) In *ex parte* reexamination proceedings, the notice must be served as provided in § 1.550(f).

(d) In *inter partes* reexamination proceedings, the notice must be served as provided in § 1.903.

(e) Notices of appeal directed to the Director shall be mailed to or served by hand on the General Counsel as provided in § 104.2.

[24 FR 10332, Dec. 22, 1959; para. (a), 47 FR 47381, Oct. 26, 1982, effective Oct. 26, 1982; 49 FR 48416, Dec. 12, 1984, effective Feb. 11, 1985; 50 FR 9383, Mar. 7, 1985, effective May 8, 1985; para. (c) added, 53 FR 16414, May 8, 1988; paras. (a) & (c) revised, 68 FR 14332, Mar. 25, 2003, effective May 1, 2003; revised, 68 FR 70996, Dec. 22, 2003, effective Jan. 21, 2004]

### § 1.303 Civil action under 35 U.S.C. 145, 146, 306.

(a) Any applicant, or any owner of a patent involved in an *ex parte* reexamination proceeding filed before November 29, 1999, dissatisfied with the decision of the Board of Patent Appeals and Interferences, and any party to an interference dissatisfied with the decision of the Board of Patent Appeals and Interferences may, instead of appealing to the U.S. Court of Appeals for the Federal Circuit (§ 1.301), have remedy by civil action under 35 U.S.C. 145 or 146, as appropriate. Such civil action must be commenced within the time specified in § 1.304.

(b) If an applicant in an *ex parte* case, or an owner of a patent involved in an *ex parte* reexamination proceeding filed before November 29, 1999, has taken an appeal to the U.S. Court of Appeals for the Federal Circuit, he or she thereby waives his or her right to proceed under 35 U.S.C. 145.

(c) If any adverse party to an appeal taken to the U.S. Court of Appeals for the Federal Circuit by a defeated party in an interference proceeding files notice with the Director within twenty days after the filing of the defeated party's notice of appeal to the court (§ 1.302), that he or she elects to have all further proceedings conducted as provided in 35 U.S.C. 146, the notice of election must be served as provided in § 1.646.

(d) For an *ex parte* reexamination proceeding filed on or after November 29, 1999, and for any *inter partes* reexamination proceeding, no remedy by civil action under 35 U.S.C. 145 is available.

[47 FR 47381, Oct. 26, 1982, effective Oct. 26, 1982; 49 FR 48416, Dec. 12, 1984, effective Feb. 11, 1985; para. (c), 54 FR 29553, July 13, 1989, effective Aug. 20, 1989;

para. (a) revised, 65 FR 54604, Sept. 8, 2000, effective Nov. 7, 2000; paras. (a) and (b) revised and para. (d) added, 65 FR 76756, Dec. 7, 2000, effective Feb. 5, 2001; para. (c) revised, 68 FR 14332, Mar. 25, 2003, effective May 1, 2003; paras. (a), (b), & (d) revised, 68 FR 70996, Dec. 22, 2003, effective Jan. 21, 2004]

### § 1.304 Time for appeal or civil action.

(a)(1) The time for filing the notice of appeal to the U.S. Court of Appeals for the Federal Circuit (§ 1.302) or for commencing a civil action (§ 1.303) is two months from the date of the decision of the Board of Patent Appeals and Interferences. If a request for rehearing or reconsideration of the decision is filed within the time period provided under § 1.197(b) or § 1.658(b), the time for filing an appeal or commencing a civil action shall expire two months after action on the request. If a request for rehearing or reconsideration of the decision is filed within the time period provided under § 1.979(a), the time for filing an appeal shall expire two months after action on the last such request.

(i) In interferences, the time for filing a cross-appeal or cross-action expires:

(A) Fourteen days after service of the notice of appeal or the summons and complaint; or

(B) Two months after the date of decision of the Board of Patent Appeals and Interferences, whichever is later.

(ii) In *inter partes* reexaminations, the time for filing a cross-appeal expires:

(A) Fourteen days after service of the notice of appeal; or

(B) Two months after the date of decision of the Board of Patent Appeals and Interferences, whichever is later.

(2) The time periods set forth in this section are not subject to the provisions of § 1.136, § 1.550(c), § 1.956, or § 1.645(a) or (b).

(3) The Director may extend the time for filing an appeal or commencing a civil action:

(i) For good cause shown if requested in writing before the expiration of the period for filing an appeal or commencing a civil action, or

(ii) Upon written request after the expiration of the period for filing an appeal or commencing a civil action upon a showing that the failure to act was the result of excusable neglect.



(b) The times specified in this section in days are calendar days. The time specified herein in months are calendar months except that one day shall be added to any two-month period which includes February 28. If the last day of the time specified for appeal or commencing a civil action falls on a Saturday, Sunday or Federal holiday in the District of Columbia, the time is extended to the next day which is neither a Saturday, Sunday nor a Federal holiday.

(c) If a defeated party to an interference has taken an appeal to the U.S. Court of Appeals for the Federal Circuit and an adverse party has filed notice under 35 U.S.C. 141 electing to have all further proceedings conducted under 35 U.S.C. 146 (§ 1.303(c)), the time for filing a civil action thereafter is specified in 35 U.S.C. 141. The time for filing a cross-action expires 14 days after service of the summons and complaint.

[41 FR 758, Jan. 5, 1976; para. (a) and (c), 47 FR 47382, Oct. 26, 1982; para. (a), 49 FR 556, Jan. 4, 1984, effective Apr. 1, 1984; para. (a) 49 FR Dec. 12, 1984, effective Feb. 11, 1985; para. (a), 50 FR 9383, Mar. 7, 1985, effective May 8, 1985; 54 FR 29553, July 13, 1989, effective Aug. 20, 1989; paras. (a) and (c) revised 58 FR 54494, Oct. 22, 1993, effective Nov. 22, 1993; para. (a)(1) revised, 62 FR 53131, Oct. 10, 1997, effective Dec. 1, 1997; paras. (a)(1) and (a)(2) revised, 65 FR 76756, Dec. 7, 2000, effective Feb. 5, 2001; para. (a)(3) revised, 68 FR 14332, Mar. 25, 2003, effective May 1, 2003; para. (a)(1) revised, 68 FR 70996, Dec. 22, 2003, effective Jan. 21, 2004]

## ALLOWANCE AND ISSUE OF PATENT

### § 1.311 Notice of Allowance.

(a) If, on examination, it appears that the applicant is entitled to a patent under the law, a notice of allowance will be sent to the applicant at the correspondence address indicated in § 1.33. The notice of allowance shall specify a sum constituting the issue fee which must be paid within three months from the date of mailing of the notice of allowance to avoid abandonment of the application. The sum specified in the notice of allowance may also include the publication fee, in which case the issue fee and publication fee (§ 1.211(e)) must both be paid within three months from the date of mailing of the notice of allowance to avoid abandonment of the application. This three-month period is not extendable.

(b) An authorization to charge the issue fee or other post-allowance fees set forth in § 1.18 to a deposit account may be filed in an individual application only after mailing of the notice of allowance. The submission of either of the following after the mailing of a notice of allowance will operate as a request to charge the correct issue fee to any deposit account identified in a previously filed authorization to charge fees:

- (1) An incorrect issue fee; or
- (2) A completed Office-provided issue fee transmittal form (where no issue fee has been submitted).

[47 FR 41279, Sept. 17, 1982, effective Oct. 1, 1982; para. (b) revised, 65 FR 54604, Sept. 8, 2000, effective Nov. 7, 2000; revised, 65 FR 57024, Sept. 20, 2000, effective Nov. 29, 2000; para. (a) revised, 66 FR 67087, Dec. 28, 2001, effective Dec. 28, 2001]

### § 1.312 Amendments after allowance.

No amendment may be made as a matter of right in an application after the mailing of the notice of allowance. Any amendment filed pursuant to this section must be filed before or with the payment of the issue fee, and may be entered on the recommendation of the primary examiner, approved by the Director, without withdrawing the application from issue.

[Para. (b) revised, 58 FR 54504, Oct. 22, 1993, effective Jan. 3, 1994; para. (b) revised, 60 FR 20195, Apr. 25, 1995, effective June 8, 1995; para. (b) revised, 62 FR 53131, Oct. 10, 1997, effective Dec. 1, 1997; revised, 65 FR 14865, Mar. 20, 2000, effective May 29, 2000 (adopted as final, 65 FR 50092, Aug. 16, 2000); revised, 68 FR 14332, Mar. 25, 2003, effective May 1, 2003]

### § 1.313 Withdrawal from issue.

(a) Applications may be withdrawn from issue for further action at the initiative of the Office or upon petition by the applicant. To request that the Office withdraw an application from issue, applicant must file a petition under this section including the fee set forth in § 1.17(h) and a showing of good and sufficient reasons why withdrawal of the application from issue is necessary. A petition under this section is not required if a request for continued examination under § 1.114 is filed prior to payment of the issue fee. If the Office withdraws the application from issue, the

Office will issue a new notice of allowance if the Office again allows the application.

(b) Once the issue fee has been paid, the Office will not withdraw the application from issue at its own initiative for any reason except:

- (1) A mistake on the part of the Office;
- (2) A violation of § 1.56 or illegality in the application;
- (3) Unpatentability of one or more claims; or
- (4) For interference.

(c) Once the issue fee has been paid, the application will not be withdrawn from issue upon petition by the applicant for any reason except:

(1) Unpatentability of one of more claims, which petition must be accompanied by an unequivocal statement that one or more claims are unpatentable, an amendment to such claim or claims, and an explanation as to how the amendment causes such claim or claims to be patentable;

(2) Consideration of a request for continued examination in compliance with § 1.114; or

(3) Express abandonment of the application. Such express abandonment may be in favor of a continuing application.

(d) A petition under this section will not be effective to withdraw the application from issue unless it is actually received and granted by the appropriate officials before the date of issue. Withdrawal of an application from issue after payment of the issue fee may not be effective to avoid publication of application information.

[47 FR 41280, Sept. 17, 1982, effective Oct. 1, 1982; para. (a), 54 FR 6893, Feb. 15, 1989, 54 FR 9432, March 7, 1989, effective Apr. 17, 1989; para. (b), 57 FR 2021, Jan. 17, 1992, effective Mar. 16, 1992; para. (a) revised, 60 FR 20195, Apr. 25, 1995, effective June 8, 1995; revised, 65 FR 14865, Mar. 20, 2000, effective May 29, 2000 (paras. (b), (c)(1), (c)(3) and (d) adopted as final, 65 FR 50092, Aug. 16, 2000); paras. (a) and c(2) revised, 65 FR 50092, Aug. 16, 2000, effective Aug. 16, 2000)]

### § 1.314 Issuance of patent.

If applicant timely pays the issue fee, the Office will issue the patent in regular course unless the application is withdrawn from issue (§ 1.313) or the Office defers issuance of the patent. To request that the Office defer issuance of a patent, applicant must file a

petition under this section including the fee set forth in § 1.17(h) and a showing of good and sufficient reasons why it is necessary to defer issuance of the patent.

[47 FR 41280, Sept. 17, 1982, effective date Oct. 1, 1982; revised, 54 FR 6893, Feb. 15, 1989, effective Apr. 17, 1989; revised, 60 FR 20195, Apr. 25, 1995, effective June 8, 1995; revised, 65 FR 54604, Sept. 8, 2000, effective Nov. 7, 2000]

### § 1.315 Delivery of patent.

The patent will be delivered or mailed upon issuance to the correspondence address of record. See § 1.33(a).

[Revised, 61 FR 42790, Aug. 19, 1996, effective Sept. 23, 1996]

### § 1.316 Application abandoned for failure to pay issue fee.

If the issue fee is not paid within three months from the date of the notice of allowance, the application will be regarded as abandoned. Such an abandoned application will not be considered as pending before the Patent and Trademark Office.

[47 FR 41280, Sept. 17, 1982, effective date Oct. 1, 1982; paras. (b)-(d) amended, paras. (e) and (f) added, 58 FR 44277, Aug. 20, 1993, effective Sept. 20, 1993; para. (d) revised, 60 FR 20195, Apr. 25, 1995, effective June 8, 1995; revised, 62 FR 53131, Oct. 10, 1997, effective Dec. 1, 1997]

### § 1.317 Lapsed patents; delayed payment of balance of issue fee.

If the issue fee paid is the amount specified in the notice of allowance, but a higher amount is required at the time the issue fee is paid, any remaining balance of the issue fee is to be paid within three months from the date of notice thereof and, if not paid, the patent will lapse at the termination of the three-month period.

[47 FR 41280, Sept. 17, 1982, effective date Oct. 1, 1982; paras. (a)-(d) amended, paras. (e) & (f) added, 58 FR 44277, Aug. 20, 1993, effective Sept. 20, 1993; para. (d) amended, 60 FR 20195, Apr. 25, 1995, effective June 8, 1995; revised, 62 FR 53131, Oct. 10, 1997, effective Dec. 1, 1997]

**§ 1.318 [Reserved]**

[43 FR 20465, May 11, 1978; removed and reserved, 62 FR 53131, Oct. 10, 1997, effective Dec. 1, 1997]

**DISCLAIMER**

**§ 1.321 Statutory disclaimers, including terminal disclaimers.**

(a) A patentee owning the whole or any sectional interest in a patent may disclaim any complete claim or claims in a patent. In like manner any patentee may disclaim or dedicate to the public the entire term, or any terminal part of the term, of the patent granted. Such disclaimer is binding upon the grantee and its successors or assigns. A notice of the disclaimer is published in the *Official Gazette* and attached to the printed copies of the specification. The disclaimer, to be recorded in the Patent and Trademark Office, must:

- (1) Be signed by the patentee, or an attorney or agent of record;
- (2) Identify the patent and complete claim or claims, or term being disclaimed. A disclaimer which is not a disclaimer of a complete claim or claims, or term will be refused recordation;
- (3) State the present extent of patentee's ownership interest in the patent; and
- (4) Be accompanied by the fee set forth in § 1.20(d).

(b) An applicant or assignee may disclaim or dedicate to the public the entire term, or any terminal part of the term, of a patent to be granted. Such terminal disclaimer is binding upon the grantee and its successors or assigns. The terminal disclaimer, to be recorded in the Patent and Trademark Office, must:

- (1) Be signed:
  - (i) By the applicant, or
  - (ii) If there is an assignee of record of an undivided part interest, by the applicant and such assignee, or
  - (iii) If there is an assignee of record of the entire interest, by such assignee, or
  - (iv) By an attorney or agent of record;
- (2) Specify the portion of the term of the patent being disclaimed;

(3) State the present extent of applicant's or assignee's ownership interest in the patent to be granted; and

(4) Be accompanied by the fee set forth in § 1.20(d).

(c) A terminal disclaimer, when filed to obviate a judicially created double patenting rejection in a patent application or in a reexamination proceeding, must:

- (1) Comply with the provisions of paragraphs (b)(2) through (b)(4) of this section;
- (2) Be signed in accordance with paragraph (b)(1) of this section if filed in a patent application or in accordance with paragraph (a)(1) of this section if filed in a reexamination proceeding; and
- (3) Include a provision that any patent granted on that application or any patent subject to the reexamination proceeding shall be enforceable only for and during such period that said patent is commonly owned with the application or patent which formed the basis for the rejection.

[47 FR 41281, Sept. 17, 1982, effective Oct. 1, 1982; revised, 58 FR 54504, Oct. 22, 1993, effective Jan. 3, 1994; para. (c) revised, 61 FR 42790, Aug. 19, 1996, effective Sept. 23, 1996]

**CORRECTION OF ERRORS IN PATENT**

**§ 1.322 Certificate of correction of Office mistake.**

(a)(1) The Director may issue a certificate of correction pursuant to 35 U.S.C. 254 to correct a mistake in a patent, incurred through the fault of the Office, which mistake is clearly disclosed in the records of the Office:

- (i) At the request of the patentee or the patentee's assignee;
- (ii) Acting *sua sponte* for mistakes that the Office discovers; or
- (iii) Acting on information about a mistake supplied by a third party.

(2)(i) There is no obligation on the Office to act on or respond to a submission of information or request to issue a certificate of correction by a third party under paragraph (a)(1)(iii) of this section.

(ii) Papers submitted by a third party under this section will not be made of record in the file that they relate to nor be retained by the Office.

(3) If the request relates to a patent involved in an interference, the request must comply with the requirements of this section and be accompanied by a motion under § 1.635.

(4) The Office will not issue a certificate of correction under this section without first notifying the patentee (including any assignee of record) at the correspondence address of record as specified in § 1.33(a) and affording the patentee or an assignee an opportunity to be heard.

(b) If the nature of the mistake on the part of the Office is such that a certificate of correction is deemed inappropriate in form, the Director may issue a corrected patent in lieu thereof as a more appropriate form for certificate of correction, without expense to the patentee.

[24 FR 10332, Dec. 22, 1959; 34 FR 5550, Mar. 22, 1969; para. (a), 49 FR 48416, Dec. 12, 1984, effective Feb. 11, 1985; para. (a) revised, 65 FR 54604, Sept. 8, 2000, effective Nov. 7, 2000; paras. (a)(1) & (b) revised, 68 FR 14332, Mar. 25, 2003, effective May 1, 2003]

### § 1.323 Certificate of correction of applicant's mistake.

The Office may issue a certificate of correction under the conditions specified in 35 U.S.C. 255 at the request of the patentee or the patentee's assignee, upon payment of the fee set forth in § 1.20(a). If the request relates to a patent involved in an interference, the request must comply with the requirements of this section and be accompanied by a motion under § 1.635.

[34 FR 5550, Mar. 22, 1969; 49 FR 48416, Dec. 12, 1984, effective Feb. 11, 1985; revised, 65 FR 54604, Sept. 8, 2000, effective Nov. 7, 2000]

### § 1.324 Correction of inventorship in patent, pursuant to 35 U.S.C. 256.

(a) Whenever through error a person is named in an issued patent as the inventor, or through error an inventor is not named in an issued patent and such error arose without any deceptive intention on his or her part, the Director may, on petition, or on order of a court before which such matter is called in question,

issue a certificate naming only the actual inventor or inventors. A petition to correct inventorship of a patent involved in an interference must comply with the requirements of this section and must be accompanied by a motion under § 1.634.

(b) Any petition pursuant to paragraph (a) of this section must be accompanied by:

(1) Where one or more persons are being added, a statement from each person who is being added as an inventor that the inventorship error occurred without any deceptive intention on his or her part;

(2) A statement from the current named inventors who have not submitted a statement under paragraph (b)(1) of this section either agreeing to the change of inventorship or stating that they have no disagreement in regard to the requested change;

(3) A statement from all assignees of the parties submitting a statement under paragraphs (b)(1) and (b)(2) of this section agreeing to the change of inventorship in the patent, which statement must comply with the requirements of § 3.73(b) of this chapter; and

(4) The fee set forth in § 1.20(b).

(c) For correction of inventorship in an application see §§ 1.48 and 1.497, and in an interference see § 1.634.

[47 FR 41281, Sept. 17, 1982, effective Oct. 1, 1982; 48 FR 2713, Jan. 20, 1983, effective Feb. 27, 1983; 49 FR 48416, Dec. 12, 1984, 50 FR 23123, May 31, 1985, effective Feb. 11, 1985; revised, 62 FR 53131, Oct. 10, 1997, effective Dec. 1, 1997; heading and para. (b)(1) revised, 65 FR 54604, Sept. 8, 2000, effective Sept. 8, 2000; para. (c) added, 65 FR 54604, Sept. 8, 2000, effective Sept. 8, 2000; para. (a) revised, 68 FR 14332, Mar. 25, 2003, effective May 1, 2003]

### § 1.325 Other mistakes not corrected.

Mistakes other than those provided for in §§ 1.322, 1.323, 1.324, and not affording legal grounds for reissue or for reexamination, will not be corrected after the date of the patent.

[48 FR 2714, Jan. 20, 1983, effective date Feb. 27, 1983]

## ARBITRATION AWARDS

## § 1.331 [Reserved]

[24 FR 10332, Dec. 22, 1959; 43 FR 20465, May 11, 1978; 47 FR 41281, Sept. 17, 1982; deleted, 57 FR 29642, July 6, 1992, effective Sept. 4, 1992]

## § 1.332 [Reserved]

[47 FR 41281, Sept. 17, 1982; deleted, 57 FR 29642, July 6, 1992, effective Sept. 4, 1992]

## § 1.333 [Reserved]

[Deleted, 57 FR 29642, July 6, 1992, effective Sept. 4, 1992]

## § 1.334 [Reserved]

[47 FR 41281, Sept. 17, 1982, effective Oct. 1, 1982; para. (c), 54 FR 6893, Feb. 15, 1989, effective Apr. 17, 1989; deleted, 57 FR 29642, July 6, 1992, effective Sept. 4, 1992]

§ 1.335 **Filing of notice of arbitration awards.**

(a) Written notice of any award by an arbitrator pursuant to 35 U.S.C. 294 must be filed in the Patent and Trademark Office by the patentee or the patentee's assignee or licensee. If the award involves more than one patent a separate notice must be filed for placement in the file of each patent. The notice must set forth the patent number, the names of the inventor and patent owner, and the names and addresses of the parties to the arbitration. The notice must also include a copy of the award.

(b) If an award by an arbitrator pursuant to 35 U.S.C. 294 is modified by a court, the party requesting the modification must file in the Patent and Trademark Office, a notice of the modification for placement in the file of each patent to which the modification applies. The notice must set forth the patent number, the names of the inventor and patent owner, and the names and addresses of the parties to the arbitration. The notice must also include a copy of the court's order modifying the award.

(c) Any award by an arbitrator pursuant to 35 U.S.C. 294 shall be unenforceable until any notices required by paragraph (a) or (b) of this section are filed in the Patent and Trademark Office. If any

required notice is not filed by the party designated in paragraph (a) or (b) of this section, any party to the arbitration proceeding may file such a notice.

[48 FR 2718, Jan. 20, 1983, effective Feb. 8, 1983]

## AMENDMENT OF RULES

§ 1.351 **Amendments to rules will be published.**

All amendments to the regulations in this part will be published in the *Official Gazette* and in the *Federal Register*.

## § 1.352 [Reserved]

[Para. (a) amended, 58 FR 54504, Oct. 22, 1993, effective Jan. 3, 1994; removed and reserved, 62 FR 53131, Oct. 10, 1997, effective Dec. 1, 1997]

## MAINTENANCE FEES

§ 1.362 **Time for payment of maintenance fees.**

(a) Maintenance fees as set forth in §§ 1.20(e) through (g) are required to be paid in all patents based on applications filed on or after December 12, 1980, except as noted in paragraph (b) of this section, to maintain a patent in force beyond 4, 8 and 12 years after the date of grant.

(b) Maintenance fees are not required for any plant patents or for any design patents. Maintenance fees are not required for a reissue patent if the patent being reissued did not require maintenance fees.

(c) The application filing dates for purposes of payment of maintenance fees are as follows:

(1) For an application not claiming benefit of an earlier application, the actual United States filing date of the application.

(2) For an application claiming benefit of an earlier foreign application under 35 U.S.C. 119, the United States filing date of the application.

(3) For a continuing (continuation, division, continuation-in-part) application claiming the benefit of a prior patent application under 35 U.S.C. 120, the actual United States filing date of the continuing application.

(4) For a reissue application, including a continuing reissue application claiming the benefit of a reissue application under 35 U.S.C. 120, the United

States filing date of the original non-reissue application on which the patent reissued is based.

(5) For an international application which has entered the United States as a Designated Office under 35 U.S.C. 371, the international filing date granted under Article 11(1) of the Patent Cooperation Treaty which is considered to be the United States filing date under 35 U.S.C. 363.

(d) Maintenance fees may be paid in patents without surcharge during the periods extending respectively from:

(1) 3 years through 3 years and 6 months after grant for the first maintenance fee,

(2) 7 years through 7 years and 6 months after grant for the second maintenance fee, and

(3) 11 years through 11 years and 6 months after grant for the third maintenance fee.

(e) Maintenance fees may be paid with the surcharge set forth in § 1.20(h) during the respective grace periods after:

(1) 3 years and 6 months and through the day of the 4th anniversary of the grant for the first maintenance fee.

(2) 7 years and 6 months and through the day of the 8th anniversary of the grant for the second maintenance fee, and

(3) 11 years and 6 months and through the day of the 12th anniversary of the grant for the third maintenance fee.

(f) If the last day for paying a maintenance fee without surcharge set forth in paragraph (d) of this section, or the last day for paying a maintenance fee with surcharge set forth in paragraph (e) of this section, falls on a Saturday, Sunday, or a federal holiday within the District of Columbia, the maintenance fee and any necessary surcharge may be paid under paragraph (d) or paragraph (e) respectively on the next succeeding day which is not a Saturday, Sunday, or Federal holiday.

(g) Unless the maintenance fee and any applicable surcharge is paid within the time periods set forth in paragraphs (d), (e) or (f) of this section, the patent will expire as of the end of the grace period set forth in paragraph (e) of this section. A patent which expires for the failure to pay the maintenance fee will expire at the end of the same date (anniversary date) the patent was granted in the 4th, 8th, or 12th year after grant.

(h) The periods specified in §§1.362 (d) and (e) with respect to a reissue application, including a continuing reissue application thereof, are counted from the date of grant of the original non-reissue application on which the reissued patent is based.

[49 FR 34724, Aug. 31, 1984, added effective Nov. 1, 1984; paras. (a) and (e), 56 FR 65142, Dec. 13, 1991, effective Dec. 16, 1991; paras. (c)(4) and (e) revised and para. (h) added, 58 FR 54504, Oct. 22, 1993, effective Jan. 3, 1994]

### § 1.363 Fee address for maintenance fee purposes.

(a) All notices, receipts, refunds, and other communications relating to payment or refund of maintenance fees will be directed to the correspondence address used during prosecution of the application as indicated in § 1.33(a) unless:

(1) A fee address for purposes of payment of maintenance fees is set forth when submitting the issue fee, or

(2) A change in the correspondence address for all purposes is filed after payment of the issue fee, or

(3) A fee address or a change in the “fee address” is filed for purposes of receiving notices, receipts and other correspondence relating to the payment of maintenance fees after the payment of the issue fee, in which instance, the latest such address will be used.

(b) An assignment of a patent application or patent does not result in a change of the “correspondence address” or “fee address” for maintenance fee purposes.

[49 FR 34725, Aug. 31, 1984, added effective Nov. 1, 1984]

### § 1.366 Submission of maintenance fees.

(a) The patentee may pay maintenance fees and any necessary surcharges, or any person or organization may pay maintenance fees and any necessary surcharges on behalf of a patentee. Authorization by the patentee need not be filed in the Patent and Trademark Office to pay maintenance fees and any necessary surcharges on behalf of the patentee.

(b) A maintenance fee and any necessary surcharge submitted for a patent must be submitted in the amount due on the date the maintenance fee and any necessary surcharge are paid. A maintenance fee or surcharge may be paid in the manner set forth in § 1.23 or by an authorization to charge a deposit account established pursuant to § 1.25. Payment of a maintenance fee and any necessary surcharge or the authorization to charge a deposit account must be submitted within the periods set forth in § 1.362(d), (e), or (f). Any payment or authorization of maintenance fees and surcharges filed at any other time will not be accepted and will not serve as a payment of the maintenance fee except insofar as a delayed payment of the maintenance fee is accepted by the Director in an expired patent pursuant to a petition filed under § 1.378. Any authorization to charge a deposit account must authorize the immediate charging of the maintenance fee and any necessary surcharge to the deposit account. Payment of less than the required amount, payment in a manner other than that set forth § 1.23, or in the filing of an authorization to charge a deposit account having insufficient funds will not constitute payment of a maintenance fee or surcharge on a patent. The procedures set forth in § 1.8 or § 1.10 may be utilized in paying maintenance fees and any necessary surcharges.

(c) In submitting maintenance fees and any necessary surcharges, identification of the patents for which maintenance fees are being paid must include the patent number, and the application number of the United States application for the patent on which the maintenance fee is being paid. If the payment includes identification of only the patent number (*i.e.*, does not identify the application number of the United States application for the patent on which the maintenance fee is being paid), the Office may apply the payment to the patent identified by patent number in the payment or may return the payment.

(d) Payment of maintenance fees and any surcharges should identify the fee being paid for each patent as to whether it is the 3 1/2-, 7 1/2-, or 11 1/2-year fee, whether small entity status is being changed or claimed, the amount of the maintenance fee and any surcharge being paid, and any assigned customer number. If the maintenance fee and any necessary surcharge is being paid on a reissue patent, the payment must identify the reissue patent by reissue patent

number and reissue application number as required by paragraph (c) of this section and should also include the original patent number.

(e) Maintenance fee payments and surcharge payments relating thereto must be submitted separate from any other payments for fees or charges, whether submitted in the manner set forth in § 1.23 or by an authorization to charge a deposit account. If maintenance fee and surcharge payments for more than one patent are submitted together, they should be submitted on as few sheets as possible with the patent numbers listed in increasing patent number order. If the payment submitted is insufficient to cover the maintenance fees and surcharges for all the listed patents, the payment will be applied in the order the patents are listed, beginning at the top of the listing.

(f) Notification of any change in status resulting in loss of entitlement to small entity status must be filed in a patent prior to paying, or at the time of paying, the earliest maintenance fee due after the date on which status as a small entity is no longer appropriate. See § 1.27(g).

(g) Maintenance fees and surcharges relating thereto will not be refunded except in accordance with §§ 1.26 and 1.28(a).

[49 FR 34725, Aug. 31, 1984, added effective Nov. 1, 1984; para. (b) amended, 58 FR 54494, Oct. 22, 1993, effective Nov. 22, 1993; paras. (b) - (d) revised, 62 FR 53131, Oct. 10, 1997, effective Dec. 1, 1997; para. (c) revised, 65 FR 54604, Sept. 8, 2000, effective Sept. 8, 2000; para. (f) revised, 65 FR 78958, Dec. 18, 2000; para. (b) revised, 68 FR 14332, Mar. 25, 2003, effective May 1, 2003]

### § 1.377 **Review of decision refusing to accept and record payment of a maintenance fee filed prior to expiration of patent.**

(a) Any patentee who is dissatisfied with the refusal of the Patent and Trademark Office to accept and record a maintenance fee which was filed prior to the expiration of the patent may petition the Director to accept and record the maintenance fee.

(b) Any petition under this section must be filed within 2 months of the action complained of, or within such other time as may be set in the action complained of, and must be accompanied by the fee set forth in § 1.17(h). The petition may include a request that the petition fee be refunded if the refusal

to accept and record the maintenance fee is determined to result from an error by the Patent and Trademark Office.

(c) Any petition filed under this section must comply with the requirements of § 1.181(b) and must be signed by an attorney or agent registered to practice before the Patent and Trademark Office, or by the patentee, the assignee, or other party in interest.

[49 FR 34725, Aug. 31, 1984, added effective Nov. 1, 1984; para. (c) revised, 62 FR 53131, Oct. 10, 1997, effective Dec. 1, 1997; para. (a) revised, 68 FR 14332, Mar. 25, 2003, effective May 1, 2003]

**§ 1.378 Acceptance of delayed payment of maintenance fee in expired patent to reinstate patent.**

(a) The Director may accept the payment of any maintenance fee due on a patent after expiration of the patent if, upon petition, the delay in payment of the maintenance fee is shown to the satisfaction of the Director to have been unavoidable (paragraph (b) of this section) or unintentional (paragraph (c) of this section) and if the surcharge required by § 1.20(i) is paid as a condition of accepting payment of the maintenance fee. If the Director accepts payment of the maintenance fee upon petition, the patent shall be considered as not having expired, but will be subject to the conditions set forth in 35 U.S.C. 41(c)(2).

(b) Any petition to accept an unavoidably delayed payment of a maintenance fee filed under paragraph (a) of this section must include:

(1) The required maintenance fee set forth in § 1.20 (e) through (g);

(2) The surcharge set forth in § 1.20(i)(1); and

(3) A showing that the delay was unavoidable since reasonable care was taken to ensure that the maintenance fee would be paid timely and that the petition was filed promptly after the patentee was notified of, or otherwise became aware of, the expiration of the patent. The showing must enumerate the steps taken to ensure timely payment of the maintenance fee, the date and the manner in which patentee

became aware of the expiration of the patent, and the steps taken to file the petition promptly.

(c) Any petition to accept an unintentionally delayed payment of a maintenance fee filed under paragraph (a) of this section must be filed within twenty-four months after the six-month grace period provided in § 1.362(e) and must include:

(1) The required maintenance fee set forth in § 1.20 (e) through (g);

(2) The surcharge set forth in § 1.20(i)(2); and

(3) A statement that the delay in payment of the maintenance fee was unintentional.

(d) Any petition under this section must be signed by an attorney or agent registered to practice before the Patent and Trademark Office, or by the patentee, the assignee, or other party in interest.

(e) Reconsideration of a decision refusing to accept a maintenance fee upon petition filed pursuant to paragraph (a) of this section may be obtained by filing a petition for reconsideration within two months of, or such other time as set in, the decision refusing to accept the delayed payment of the maintenance fee. Any such petition for reconsideration must be accompanied by the petition fee set forth in § 1.17(h). After decision on the petition for reconsideration, no further reconsideration or review of the matter will be undertaken by the Director. If the delayed payment of the maintenance fee is not accepted, the maintenance fee and the surcharge set forth in § 1.20(i) will be refunded following the decision on the petition for reconsideration, or after the expiration of the time for filing such a petition for reconsideration, if none is filed. Any petition fee under this section will not be refunded unless the refusal to accept and record the maintenance fee is determined to result from an error by the Patent and Trademark Office.

[49 FR 34726, Aug. 31, 1984, added effective Nov. 1, 1984; para. (a), 50 FR 9383, Mar. 7, 1985, effective May 8, 1985; paras. (b) and (c), 53 FR 47810, Nov. 28, 1988, effective Jan. 1, 1989; paras. (a) - (c) and (e), 56 FR 65142, Dec. 13, 1991, effective Dec. 16, 1991; paras. (a) - (c) and (e), 58 FR 44277, Aug. 20, 1993, effective Sept. 20, 1993; para. (d) revised, 62 FR 53131, Oct. 10, 1997, effective Dec. 1, 1997; paras. (a) & (e) revised, 68 FR 14332, Mar. 25, 2003, effective May 1, 2003]



## Subpart C — International Processing Provisions

### GENERAL INFORMATION

#### § 1.401 Definitions of terms under the Patent Cooperation Treaty.

(a) The abbreviation *PCT* and the term *Treaty* mean the Patent Cooperation Treaty.

(b) *International Bureau* means the World Intellectual Property Organization located in Geneva, Switzerland.

(c) *Administrative Instructions* means that body of instructions for operating under the Patent Cooperation Treaty referred to in PCT Rule 89.

(d) *Request*, when capitalized, means that element of the international application described in PCT Rules 3 and 4.

(e) *International application*, as used in this subchapter is defined in § 1.9(b).

(f) *Priority date* for the purpose of computing time limits under the Patent Cooperation Treaty is defined in PCT Art. 2(xi). Note also § 1.465.

(g) *Demand*, when capitalized, means that document filed with the International Preliminary Examining Authority which requests an international preliminary examination.

(h) *Annexes* means amendments made to the claims, description or the drawings before the International Preliminary Examining Authority.

(i) Other terms and expressions in this subpart C not defined in this section are to be taken in the sense indicated in PCT Art. 2 and 35 U.S.C. 351.

[43 FR 20466, May 11, 1978; 52 FR 20047, May 28, 1987]

#### § 1.412 The United States Receiving Office.

(a) The United States Patent and Trademark Office is a Receiving Office only for applicants who are residents or nationals of the United States of America.

(b) The Patent and Trademark Office, when acting as a Receiving Office, will be identified by the full title “United States Receiving Office” or by the abbreviation “RO/US.”

(c) The major functions of the Receiving Office include:

(1) According of international filing dates to international applications meeting the requirements of PCT Art. 11(1) and PCT Rule 20;

(2) Assuring that international applications meet the standards for format and content of PCT Art. 14(1), PCT Rule 9, 26, 29.1, 37, 38, 91, and portions of PCT Rules 3 through 11;

(3) Collecting and, when required, transmitting fees due for processing international applications (PCT Rule 14, 15, 16);

(4) Transmitting the record and search copies to the International Bureau and International Searching Authority, respectively (PCT Rules 22 and 23); and

(5) Determining compliance with applicable requirements of part 5 of this chapter.

(6) Reviewing and, unless prescriptions concerning national security prevent the application from being so transmitted (PCT Rule 19.4), transmitting the international application to the International Bureau for processing in its capacity as a Receiving Office:

(i) Where the United States Receiving Office is not the competent Receiving Office under PCT Rule 19.1 or 19.2 and § 1.421(a); or

(ii) Where the international application is not in English but is in a language accepted under PCT Rule 12.1(a) by the International Bureau as a Receiving Office; or

(iii) Where there is agreement and authorization in accordance with PCT Rule 19.4(a)(iii).

[Para. (c)(6) added, 60 FR 21438, May 2, 1995, effective June 1, 1995; para. (c)(6) revised, 63 FR 29614, June 1, 1998, effective July 1, 1998 (adopted as final, 63 FR 66040, Dec. 1, 1998)]

#### § 1.413 The United States International Searching Authority.

(a) Pursuant to appointment by the Assembly, the United States Patent and Trademark Office will act as an International Searching Authority for international applications filed in the United States Receiving Office and in other Receiving Offices as may be agreed upon by the Director, in accordance with the agreement between the Patent and Trademark Office and the International Bureau (PCT Art. 16(3)(b)).

(b) The Patent and Trademark Office, when acting as an International Searching Authority, will be identified by the full title “United States International Searching Authority” or by the abbreviation “ISA/US.”

(c) The major functions of the International Searching Authority include:

(1) Approving or establishing the title and abstract;

(2) Considering the matter of unity of invention;

(3) Conducting international and international-type searches and preparing international and international-type search reports (PCT Art. 15, 17 and 18, and PCT Rules 25, 33 to 45 and 47), and issuing declarations that no international search report will be established (PCT Article 17(2)(a));

(4) Preparing written opinions of the International Searching Authority in accordance with PCT Rule 43<sup>bis</sup> (when necessary); and

(5) Transmitting the international search report and the written opinion of the International Searching Authority to the applicant and the International Bureau.

[Para. (a) revised, 68 FR 14332, Mar. 25, 2003, effective May 1, 2003; paras. (a) & (c) revised, 68 FR 58991, Oct. 20, 2003, effective Jan. 1, 2004]

**§ 1.414 The United States Patent and Trademark Office as a Designated Office or Elected Office.**

(a) The United States Patent and Trademark Office will act as a Designated Office or Elected Office for international applications in which the United States of America has been designated or elected as a State in which patent protection is desired.

(b) The United States Patent and Trademark Office, when acting as a Designated Office or Elected Office during international processing will be identified by the full title “United States Designated Office” or by the abbreviation “DO/US” or by the full title “United States Elected Office” or by the abbreviation “EO/US.”

(c) The major functions of the United States Designated Office or Elected Office in respect to

international applications in which the United States of America has been designated or elected, include:

(1) Receiving various notifications throughout the international stage and

(2) Accepting for national stage examination international applications which satisfy the requirements of 35 U.S.C. 371.

[52 FR 20047, May 28, 1987, effective July 1, 1987]

**§ 1.415 The International Bureau.**

(a) The International Bureau is the World Intellectual Property Organization located at Geneva, Switzerland. It is the international intergovernmental organization which acts as the coordinating body under the Treaty and the Regulations (PCT Art. 2 (xix) and 35 U.S.C. 351(h)).

(b) The major functions of the International Bureau include:

(1) Publishing of international applications and the International Gazette;

(2) Transmitting copies of international applications to Designated Offices;

(3) Storing and maintaining record copies; and

(4) Transmitting information to authorities pertinent to the processing of specific international applications.

**§ 1.416 The United States International Preliminary Examining Authority.**

(a) Pursuant to appointment by the Assembly, the United States Patent and Trademark Office will act as an International Preliminary Examining Authority for international applications filed in the United States Receiving Office and in other Receiving Offices as may be agreed upon by the Director, in accordance with agreement between the Patent and Trademark Office and the International Bureau.

(b) The United States Patent and Trademark Office, when acting as an International Preliminary Examining Authority, will be identified by the full title “United States International Preliminary Examining Authority” or by the abbreviation “IPEA/US.”

(c) The major functions of the International Preliminary Examining Authority include:

(1) Receiving and checking for defects in the Demand;

(2) Forwarding Demands in accordance with PCT Rule 59.3;

(3) Collecting the handling fee for the International Bureau and the preliminary examination fee for the United States International Preliminary Examining Authority;

(4) Informing applicant of receipt of the Demand;

(5) Considering the matter of unity of invention;

(6) Providing an international preliminary examination report which is a non-binding opinion on the questions of whether the claimed invention appears: to be novel, to involve an inventive step (to be nonobvious), and to be industrially applicable; and

(7) Transmitting the international preliminary examination report to applicant and the International Bureau.

[Added 52 FR 20047, May 28, 1987; para. (c) revised, 63 FR 29614, June 1, 1998, effective July 1998 (adopted as final, 63 FR 66040, Dec. 1, 1998); para. (a) revised, 68 FR 14332, Mar. 25, 2003, effective May 1, 2003]

### § 1.417 Submission of translation of international publication.

The submission of an English language translation of the publication of an international application pursuant to 35 U.S.C. 154(d)(4) must clearly identify the international application to which it pertains (§ 1.5(a)) and be clearly identified as a submission pursuant to 35 U.S.C. 154(d)(4). Otherwise, the submission will be treated as a filing under 35 U.S.C. 111(a). Such submissions should be marked "Mail Stop PCT."

[Added 65 FR 57024, Sept. 20, 2000, effective Nov. 29, 2000; revised 67 FR 520, Jan. 4, 2002, effective Apr. 1, 2002; revised, 68 FR 14332, Mar. 25, 2003, effective May 1, 2003; revised, 68 FR 70996, Dec. 22, 2003, effective Jan. 21, 2004]

### § 1.419 Display of currently valid control number under the Paperwork Reduction Act.

(a) Pursuant to the Paperwork Reduction Act of 1995 (44 U.S.C. 3501 *et seq.*), the collection of information in this subpart has been reviewed and approved by the Office of Management and Budget under control number 0651-0021.

(b) Notwithstanding any other provision of law, no person is required to respond to nor shall a person be subject to a penalty for failure to comply with a collection of information subject to the requirements of the Paperwork Reduction Act unless that collection of information displays a currently valid Office of Management and Budget control number. This section constitutes the display required by 44 U.S.C. 3512(a) and 5 CFR 1320.5(b)(2)(i) for the collection of information under Office of Management and Budget control number 0651-0021 (see 5 CFR 1320.5(b)(2)(ii)(D)).

[Added, 63 FR 29614, June 1, 1998, effective July 1, 1998 (adopted as final, 63 FR 66040, Dec. 1, 1998)]

## WHO MAY FILE AN INTERNATIONAL APPLICATION

### § 1.421 Applicant for international application.

(a) Only residents or nationals of the United States of America may file international applications in the United States Receiving Office. If an international application does not include an applicant who is indicated as being a resident or national of the United States of America, and at least one applicant:

(1) Has indicated a residence or nationality in a PCT Contracting State, or

(2) Has no residence or nationality indicated, applicant will be so notified and, if the international application includes a fee amount equivalent to that required by § 1.445(a)(4), the international application will be forwarded for processing to the International Bureau acting as a Receiving Office (see also § 1.412(c)(6)).

(b) Although the United States Receiving Office will accept international applications filed by any resident or national of the United States of America for international processing, for the purposes of the designation of the United States, an international application must be filed, and will be accepted by the Patent and Trademark Office for the national stage only if filed, by the inventor or as provided in §§ 1.422 or 1.423. Joint inventors must jointly apply for an international application.

(c) For the purposes of designations other than the United States, international applications may be filed by the assignee or owner.

(d) A registered attorney or agent of the applicant may sign the international application Request and file the international application for the applicant. A separate power of attorney from each applicant may be required.

(e) Any indication of different applicants for the purpose of different Designated Offices must be shown on the Request portion of the international application.

(f) Requests for changes in the indications concerning the applicant, agent, or common representative of an international application shall be made in accordance with PCT Rule 92<sup>bis</sup> and may be required to be signed by all applicants.

(g) Requests for withdrawals of the international application, designations, priority claims, the Demand, or elections shall be made in accordance with PCT Rule 90<sup>bis</sup> and must be signed by all applicants. A separate power of attorney from the applicants will be required for the purposes of any request for a withdrawal in accordance with PCT Rule 90<sup>bis</sup> which is not signed by all applicants. The submission of a separate power of attorney may be excused upon the request of another applicant where one or more inventors cannot be found or reached after diligent effort. Such a request must be accompanied by a statement explaining to the satisfaction of the Director the lack of the signature concerned:

[Paras. (f) and (g), 53 FR 47810, Nov. 28, 1988, effective Jan. 1, 1989; para. (a) amended, 60 FR 21438, May 2, 1995, effective June 1, 1995; paras. (b)-(g) revised, 68 FR 58991, Oct. 20, 2003, effective Jan. 1, 2004; para. (a)(2) revised, 68 FR 67805, Dec. 4, 2003, effective Jan. 1, 2004]

#### § 1.422 When the inventor is dead.

In case of the death of the inventor, the legal representative (executor, administrator, etc.) of the deceased inventor may file an international application which designates the United States of America.

#### § 1.423 When the inventor is insane or legally incapacitated.

In case an inventor is insane or otherwise legally incapacitated, the legal representative (guardian, conservator, etc.) of such inventor may file an international application which designates the United States of America.

#### § 1.424 [Reserved]

[Removed and reserved, 68 FR 58991, Oct. 20, 2003, effective Jan. 1, 2004]

#### § 1.425 [Reserved]

[[Removed and reserved, 68 FR 58991, Oct. 20, 2003, effective Jan. 1, 2004]

### THE INTERNATIONAL APPLICATION

#### § 1.431 International application requirements.

(a) An international application shall contain, as specified in the Treaty and the Regulations, a Request, a description, one or more claims, an abstract, and one or more drawings (where required). (PCT Art. 3(2) and Section 207 of the Administrative Instructions.)

(b) An international filing date will be accorded by the United States Receiving Office, at the time of receipt of the international application, provided that:

(1) At least one applicant is a United States resident or national and the papers filed at the time of receipt of the international application so indicate (35 U.S.C. 361(a), PCT Art. 11(1)(i)).

(2) The international application is in the English language (35 U.S.C. 361(c), PCT Art. 11(1)(ii)).

(3) The international application contains at least the following elements (PCT Art. 11(1)(iii)):

(i) An indication that it is intended as an international application (PCT Rule 4.2);

(ii) The designation of at least one Contracting State of the International Patent Cooperation Union (§ 1.432);

(iii) The name of the applicant, as prescribed (note §§ 1.421-1.423);

(iv) A part which on the face of it appears to be a description; and

(v) A part which on the face of it appears to be a claim.

(c) Payment of the international filing fee (PCT Rule 15.2) and the transmittal and search fees (§ 1.445) may be made in full at the time the international application papers required by paragraph (b) of this section are deposited or within one month thereafter. The international filing, transmittal, and search fee payable is the international filing, transmittal, and

search fee in effect on the receipt date of the international application.

(1) If the international filing, transmittal and search fees are not paid within one month from the date of receipt of the international application and prior to the sending of a notice of deficiency which imposes a late payment fee, applicant will be notified and given one month within which to pay the deficient fees plus the late payment fee. Subject to paragraph (c)(2) of this section, the late payment fee will be equal to the greater of:

(i) Fifty percent of the amount of the deficient fees; or

(ii) An amount equal to the transmittal fee.

(2) The late payment fee shall not exceed an amount equal to fifty percent of the international filing fee not taking into account any fee for each sheet of the international application in excess of thirty sheets (PCT Rule 16<sup>bis</sup>).

(3) The one-month time limit set pursuant to paragraph (c) of this section to pay deficient fees may not be extended.

(d) If the payment needed to cover the transmittal fee, the international filing fee, the search fee, and the late payment fee pursuant to paragraph (c) of this section is not timely made in accordance with PCT Rule 16<sup>bis</sup>.1(e), the Receiving Office will declare the international application withdrawn under PCT Article 14(3)(a).

[43 FR 20486, May 11, 1978; paras. (b), (c), (d) and (e), 50 FR 9383, Mar. 7, 1985, effective May 8, 1985; para. (d) amended, 52 FR 20047, May 28, 1987; paras. (b)(1), (b)(3)(ii), (c) and (d) amended, para. (e) deleted, 58 FR 4335, Jan. 14, 1993, effective May 1, 1993; paras. (c) and (d) revised, 63 FR 29614, June 1, 1998, effective July 1, 1998 (adopted as final, 63 FR 66040, Dec. 1, 1998); paras. (b)(3), (c) & (d) revised, 68 FR 58991, Oct. 20, 2003, effective Jan. 1, 2004; para. (c)(2) corrected, 68 FR 67805, Dec. 4, 2003]

### § 1.432 Designation of States by filing an international application.

The filing of an international application request shall constitute:

(a) The designation of all Contracting States that are bound by the Treaty on the international filing date;

(b) An indication that the international application is, in respect of each designated State to which PCT Article 43 or 44 applies, for the grant of every kind of protection which is available by way of the designation of that State; and.

(c) An indication that the international application is, in respect of each designated State to which PCT Article 45(1) applies, for the grant of a regional patent and also, unless PCT Article 45(2) applies, a national patent.

[43 FR 20486, May 11, 1978; para. (b) amended 52 FR 20047, May 28, 1987; paras. (a), (b) amended and para. (c) added, 58 FR 4335, Jan. 14, 1993, effective May 1, 1993; paras. (b) and (c) revised, para. (d) added, 63 FR 29614, June 1, 1998, effective July 1, 1998 (adopted as final, 63 FR 66040, Dec. 1, 1998); revised, 68 FR 58991, Oct. 20, 2003, effective Jan. 1, 2004]

### § 1.433 Physical requirements of international application.

(a) The international application and each of the documents that may be referred to in the check list of the Request (PCT Rule 3.3(a)(ii)) shall be filed in one copy only.

(b) All sheets of the international application must be on A4 size paper (21.0 x 29.7 cm.).

(c) Other physical requirements for international applications are set forth in PCT Rule 11 and sections 201-207 of the Administrative Instructions.

### § 1.434 The request.

(a) The request shall be made on a standardized form (PCT Rules 3 and 4). Copies of printed Request forms are available from the United States Patent and Trademark Office. Letters requesting printed forms should be marked "Mail Stop PCT."

(b) The Check List portion of the Request form should indicate each document accompanying the international application on filing.

(c) All information, for example, addresses, names of States and dates, shall be indicated in the Request as required by PCT Rule 4 and Administrative Instructions 110 and 201.

(d) For the purposes of the designation of the United States of America, an international application shall include:

(1) The name of the inventor; and

(2) A reference to any prior-filed national application or international application designating the United States of America, if the benefit of the filing date for the prior-filed application is to be claimed.

(e) An international application may also include in the Request a declaration of the inventors as provided for in PCT Rule 4.17(iv).

[Para. (a) amended, 58 FR 4335, Jan. 14, 1993, effective May 1, 1993; para. (d) revised, 66 FR 16004, Mar. 22, 2001, effective Mar. 1, 2001; para. (d)(2) revised, 66 FR 67087, Dec. 28, 2001, effective Dec. 28, 2001; paras. (a) & (d)(2) revised, 68 FR 14332, Mar. 25, 2003, effective May 1, 2003; para. (d) revised, para (e) added, 68 FR 58991, Oct. 20, 2003, effective Jan. 1, 2004]

**§ 1.435 The description.**

(a) The application must meet the requirements as to the content and form of the description set forth in PCT Rules 5, 9, 10, and 11 and sections 204 and 208 of the Administrative Instructions.

(b) In international applications designating the United States the description must contain upon filing an indication of the best mode contemplated by the inventor for carrying out the claimed invention.

[Para. (a) revised, 63 FR 29614, June 1, 1998, effective July 1, 1998 (adopted as final, 63 FR 66040, Dec. 1, 1998)]

**§ 1.436 The claims.**

The requirements as to the content and format of claims are set forth in PCT Art. 6 and PCT Rules 6, 9, 10 and 11 and shall be adhered to. The number of the claims shall be reasonable, considering the nature of the invention claimed.

**§ 1.437 The drawings.**

(a) Subject to paragraph (b) of this section, when drawings are necessary for the understanding of the invention, or are mentioned in the description, they must be part of an international application as originally filed in the United States Receiving Office in order to maintain the international filing date during the national stage (PCT Art. 7).

(b) Drawings missing from the application upon filing will be accepted if such drawings are received within 30 days of the date of first receipt of the incomplete papers. If the missing drawings are

received within the 30-day period, the international filing date shall be the date on which such drawings are received. If such drawings are not timely received, all references to drawings in the international application shall be considered non-existent (PCT Art. 14(2), Administrative Instruction 310).

(c) The physical requirements for drawings are set forth in PCT Rule 11 and shall be adhered to.

**§ 1.438 The abstract.**

(a) Requirements as to the content and form of the abstract are set forth in PCT Rule 8, and shall be adhered to.

(b) Lack of an abstract upon filing of an international application will not affect the granting of a filing date. However, failure to furnish an abstract within one month from the date of the notification by the Receiving Office will result in the international application being declared withdrawn.

**FEES**

**§ 1.445 International application filing, processing and search fees.**

(a) The following fees and charges for international applications are established by the Director under the authority of 35 U.S.C. 376:

(1) A transmittal fee (see 35 U.S.C. 361(d) and PCT Rule 14) . . . . . \$300.00

(2) A search fee (see 35 U.S.C. 361(d) and PCT Rule 16):

(i) If a corresponding prior United States National application filed under 35 U.S.C. 111(a) with the filing fee under § 1.16(a) has been filed and the corresponding prior United States National application is identified by application number, if known, or if the application number is not known by the filing date, title, and name of applicant (and preferably the application docket number), in the international application or accompanying papers at the time of filing the international application. . . . . \$300.00

(ii) For all situations not provided for in paragraph (a)(2)(i) of this section . . . . . \$1,000.00

(3) A supplemental search fee when required, per additional invention . . . . . \$1,000.00

(4) A fee equivalent to the transmittal fee in paragraph (a)(1) of this section for transmittal of an international application to the International Bureau

for processing in its capacity as a Receiving Office (PCT Rule 19.4).

(b) The international filing fee shall be as prescribed in PCT Rule 15.

[43 FR 20466, May 11, 1978; para. (a), 47 FR 41282, Sept. 17, 1982, effective Oct. 1, 1982; para. (a)(4) - (6), 50 FR 9384, Mar. 7, 1985, effective May 8, 1985; 50 FR 31826, Aug. 6, 1985, effective Oct. 5, 1985; para. (a) amended 52 FR 20047, May 28, 1987; paras. (a)(2) and (3), 54 FR 6893, Feb. 15, 1989, 54 FR 9432, March 7, 1989, effective Apr. 17, 1989; para. (a), 56 FR 65142, Dec. 13, 1991, effective Dec. 27, 1991; para. (a), 57 FR 38190, Aug. 21, 1992, effective Oct. 1, 1992; para. (a)(4) added, 58 FR 4335, Jan. 14, 1993, effective May 1, 1993; paras. (a)(1)-(3), 59 FR 43736, Aug. 25, 1994, effective Oct. 1, 1994; para. (a)(5) added, 60 FR 21438, May 2, 1995, effective June 1, 1995; para. (a) amended, 60 FR 41018, Aug. 11, 1995, effective Oct. 1, 1995; para. (a) amended, 61 FR 39585, July 30, 1996, effective Oct. 1, 1996; para. (a) amended, 62 FR 40450, July 29, 1997, effective Oct. 1, 1997; para. (a) revised, 63 FR 29614, June 1, 1998, effective July 1, 1998 (adopted as final, 63 FR 66040, Dec. 1, 1998); para. (a) revised, 68 FR 14332, Mar. 25, 2003, effective May 1, 2003; revised, 68 FR 58991, Oct. 20, 2003, effective Jan. 1, 2004]

#### § 1.446 Refund of international application filing and processing fees.

(a) Money paid for international application fees, where paid by actual mistake or in excess, such as a payment not required by law or treaty and its regulations, may be refunded. A mere change of purpose after the payment of a fee will not entitle a party to a refund of such fee. The Office will not refund amounts of twenty-five dollars or less unless a refund is specifically requested and will not notify the payor of such amounts. If the payor or party requesting a refund does not provide the banking information necessary for making refunds by electronic funds transfer, the Office may use the banking information provided on the payment instrument to make any refund by electronic funds transfer.

(b) Any request for refund under paragraph (a) of this section must be filed within two years from the date the fee was paid. If the Office charges a deposit account by an amount other than an amount specifically indicated in an authorization under § 1.25(b), any request for refund based upon such charge must be filed within two years from the date of the deposit

account statement indicating such charge and include a copy of that deposit account statement. The time periods set forth in this paragraph are not extendable.

(c) Refund of the supplemental search fees will be made if such refund is determined to be warranted by the Director or the Director's designee acting under PCT Rule 40.2(c).

(d) The international and search fees will be refunded if no international filing date is accorded or if the application is withdrawn before transmittal of the record copy to the International Bureau (PCT Rules 15.6 and 16.2). The search fee will be refunded if the application is withdrawn before transmittal of the search copy to the International Searching Authority. The transmittal fee will not be refunded.

(e) The handling fee (§ 1.482(b)) will be refunded (PCT Rule 57.6) only if:

(1) The Demand is withdrawn before the Demand has been sent by the International Preliminary Examining Authority to the International Bureau, or

(2) The Demand is considered not to have been submitted (PCT Rule 54.4(a)).

[43 FR 20466, May 11, 1978; para. (b), 47 FR 41282, Sept. 17, 1982, effective Oct. 1, 1982; para.(b), 50 FR 9384, Mar. 7, 1985, effective May 8, 1985; 50 FR 31826, Aug. 6, 1985, effective Oct. 5, 1985; para. (d) amended and para. (e) added, 58 FR 4335, Jan. 14, 1993, effective May 1, 1993; para (a) revised and para. (b) added, 65 FR 54604, Sept. 8, 2000, effective Nov. 7, 2000; para. (c) revised, 68 FR 14332, Mar. 25, 2003, effective May 1, 2003]

## PRIORITY

#### § 1.451 The priority claim and priority document in an international application.

(a) The claim for priority must, subject to paragraph (d) of this section, be made on the Request (PCT Rule 4.10) in a manner complying with sections 110 and 115 of the Administrative Instructions.

(b) Whenever the priority of an earlier United States national application or international application filed with the United States Receiving Office is claimed in an international application, the applicant may request in a letter of transmittal accompanying the international application upon filing with the United States Receiving Office or in a separate letter filed in the United States Receiving Office not later

than 16 months after the priority date, that the United States Patent and Trademark Office prepare a certified copy of the prior application for transmittal to the International Bureau (PCT Article 8 and PCT Rule 17). The fee for preparing a certified copy is set forth in § 1.19(b)(1).

(c) If a certified copy of the priority document is not submitted together with the international application on filing, or, if the priority application was filed in the United States and a request and appropriate payment for preparation of such a certified copy do not accompany the international application on filing or are not filed within 16 months of the priority date, the certified copy of the priority document must be furnished by the applicant to the International Bureau or to the United States Receiving Office within the time limit specified in PCT Rule 17.1(a).

(d) The applicant may correct or add a priority claim in accordance with PCT Rule 26<sup>bis</sup>.1.

[43 FR 20466, May 11, 1978; 47 FR 40140, Sept. 10, 1982, effective Oct. 1, 1982; para. (b), 47 FR 41282, Sept. 17, 1982, effective Oct. 1, 1982; paras. (b) & (c), 50 FR 9384, Mar. 7, 1985, effective May 8, 1985; para. (b), 54 FR 6893, Feb. 15, 1989, effective Apr. 17, 1989; para. (a) amended, 58 FR 4335, Jan. 14, 1993, effective May 1, 1993; para. (a) revised, para. (d) added, 63 FR 29614, June 1, 1998, effective July 1, 1998 (adopted as final, 63 FR 66040, Dec. 1, 1998); para. (b) revised, 66 FR 16004, Mar. 22, 2001, effective Mar. 1, 2001]

## REPRESENTATION

### § 1.455 Representation in international applications.

(a) Applicants of international applications may be represented by attorneys or agents registered to practice before the Patent and Trademark Office or by an applicant appointed as a common representative (PCT Art. 49, Rules 4, 8 and 90 and § 10.10). If applicants have not appointed an attorney or agent or one of the applicants to represent them, and there is more than one applicant, the applicant first named in the request and who is entitled to file in the U.S. Receiving Office shall be considered to be the common representative of all the applicants. An attorney or agent having the right to practice before a national office with which an international application is filed and for

which the United States is an International Searching Authority or International Preliminary Examining Authority may be appointed to represent the applicants in the international application before that authority. An attorney or agent may appoint an associate attorney or agent who shall also then be of record (PCT Rule 90.1(d)). The appointment of an attorney or agent, or of a common representative, revokes any earlier appointment unless otherwise indicated (PCT Rule 90.6(b) and (c)).

(b) Appointment of an agent, attorney or common representative (PCT Rule 4.8) must be effected either in the Request form, signed by applicant, in the Demand form, signed by applicant, or in a separate power of attorney submitted either to the United States Receiving Office or to the International Bureau.

(c) Powers of attorney and revocations thereof should be submitted to the United States Receiving Office until the issuance of the international search report.

(d) The addressee for correspondence will be as indicated in section 108 of the Administrative Instructions.

[43 FR 20466, May 11, 1978; 50 FR 5171, Feb. 6, 1985, effective Mar. 8, 1985; para. (a) amended, 58 FR 4335, Jan. 14, 1993, effective May 1, 1993; para. (b) revised, 68 FR 58991, Oct. 20, 2003, effective Jan. 1, 2004]

## TRANSMITTAL OF RECORD COPY

### § 1.461 Procedures for transmittal of record copy to the International Bureau.

(a) Transmittal of the record copy of the international application to the International Bureau shall be made by the United States Receiving Office or as provided by PCT Rule 19.4.

(b) [Reserved]

(c) No copy of an international application may be transmitted to the International Bureau, a foreign Designated Office, or other foreign authority by the United States Receiving Office or the applicant, unless the applicable requirements of part 5 of this chapter have been satisfied.

[43 FR 20466, May 11, 1978; paras. (a) and (b), 50 FR 9384, Mar. 7, 1985, effective May 8, 1985; para. (a) revised, 63 FR 29614, June 1, 1998, effective July 1, 1998 (adopted as final, 63 FR 66040, Dec. 1, 1998)]



## TIMING

**§ 1.465 Timing of application processing based on the priority date.**

(a) For the purpose of computing time limits under the Treaty, the priority date shall be defined as in PCT Art. 2(xi).

(b) When a claimed priority date is corrected or added under PCT Rule 26<sup>bis</sup>.1(a), or withdrawn under PCT Rule 90<sup>bis</sup>.3, or considered not to have been made under PCT Rule 26<sup>bis</sup>.2, the priority date for the purposes of computing any non-expired time limits will be the date of the earliest valid remaining priority claim of the international application, or if none, the international filing date.

(c) When corrections under PCT Art. 11(2), Art. 14(2) or PCT Rule 20.2(a) (i) or (iii) are timely submitted, and the date of receipt of such corrections falls later than one year from the claimed priority date or dates, the Receiving Office shall proceed under PCT Rule 26<sup>bis</sup>.2.

[Paras. (b) and (c) revised, 63 FR 29614, June 1, 1998, effective July 1, 1998 (adopted as final, 63 FR 66040, Dec. 1, 1998)]

**§ 1.468 Delays in meeting time limits.**

Delays in meeting time limits during international processing of international applications may only be excused as provided in PCT Rule 82. For delays in meeting time limits in a national application, see § 1.137.

## AMENDMENTS

**§ 1.471 Corrections and amendments during international processing.**

(a) Except as otherwise provided in this paragraph, all corrections submitted to the United States Receiving Office or United States International Searching Authority must be in English, in the form of replacement sheets in compliance with PCT Rules 10 and 11, and accompanied by a letter that draws attention to the differences between the replaced sheets and the replacement sheets. Replacement sheets are not required for the deletion of lines of text, the correction of simple typographical errors, and one

addition or change of not more than five words per sheet. These changes may be stated in a letter and, if appropriate, the United States Receiving Office will make the deletion or transfer the correction to the international application, provided that such corrections do not adversely affect the clarity and direct reproducibility of the application (PCT Rule 26.4). Amendments that do not comply with PCT Rules 10 and 11.1 to 11.13 may not be entered.

(b) Amendments of claims submitted to the International Bureau shall be as prescribed by PCT Rule 46.

(c) Corrections or additions to the Request of any declarations under PCT Rule 4.17 should be submitted to the International Bureau as prescribed by PCT Rule 26<sup>ter</sup>.

[Para. (a) revised, 63 FR 29614, June 1, 1998, effective July 1, 1998 (adopted as final, 63 FR 66040, Dec. 1, 1998); para. (c) added, 66 FR 16004, Mar. 22, 2001, effective Mar. 1, 2001]

**§ 1.472 Changes in person, name, or address of applicants and inventors.**

All requests for a change in person, name or address of applicants and inventor should be sent to the United States Receiving Office until the time of issuance of the international search report. Thereafter requests for such changes should be submitted to the International Bureau.

[43 FR 20466, May 11, 1978; redesignated at 52 FR 20047, May 28, 1987]

## UNITY OF INVENTION

**§ 1.475 Unity of invention before the International Searching Authority, the International Preliminary Examining Authority and during the national stage.**

(a) An international and a national stage application shall relate to one invention only or to a group of inventions so linked as to form a single general inventive concept (“requirement of unity of invention”). Where a group of inventions is claimed in an application, the requirement of unity of invention shall be fulfilled only when there is a technical relationship among those inventions involving one or more of the same or corresponding special technical

features. The expression “special technical features” shall mean those technical features that define a contribution which each of the claimed inventions, considered as a whole, makes over the prior art.

(b) An international or a national stage application containing claims to different categories of invention will be considered to have unity of invention if the claims are drawn only to one of the following combinations of categories:

(1) A product and a process specially adapted for the manufacture of said product; or

(2) A product and process of use of said product; or

(3) A product, a process specially adapted for the manufacture of the said product, and a use of the said product; or

(4) A process and an apparatus or means specifically designed for carrying out the said process; or

(5) A product, a process specially adapted for the manufacture of the said product, and an apparatus or means specifically designed for carrying out the said process.

(c) If an application contains claims to more or less than one of the combinations of categories of invention set forth in paragraph (b) of this section, unity of invention might not be present.

(d) If multiple products, processes of manufacture or uses are claimed, the first invention of the category first mentioned in the claims of the application and the first recited invention of each of the other categories related thereto will be considered as the main invention in the claims, see PCT Article 17(3)(a) and § 1.476(c).

(e) The determination whether a group of inventions is so linked as to form a single general inventive concept shall be made without regard to whether the inventions are claimed in separate claims or as alternatives within a single claim.

[Added 52 FR 20047, May 28, 1987, effective July 1, 1987; paras. (a) - (e) amended and para. (f) deleted, 58 FR 4335, Jan. 14, 1993, effective May 1, 1993]

#### **§ 1.476 Determination of unity of invention before the International Searching Authority.**

(a) Before establishing the international search report, the International Searching Authority will determine whether the international application com-

plies with the requirement of unity of invention as set forth in § 1.475.

(b) If the International Searching Authority considers that the international application does not comply with the requirement of unity of invention, it shall inform the applicant accordingly and invite the payment of additional fees (note § 1.445 and PCT Art. 17(3)(a) and PCT Rule 40). The applicant will be given a time period in accordance with PCT Rule 40.3 to pay the additional fees due.

(c) In the case of non-compliance with unity of invention and where no additional fees are paid, the international search will be performed on the invention first mentioned (“main invention”) in the claims.

(d) Lack of unity of invention may be directly evident before considering the claims in relation to any prior art, or after taking the prior art into consideration, as where a document discovered during the search shows the invention claimed in a generic or linking claim lacks novelty or is clearly obvious, leaving two or more claims joined thereby without a common inventive concept. In such a case the International Searching Authority may raise the objection of lack of unity of invention.

[43 FR 20466, May 11, 1978; redesignated and amended at 52 FR 20047, May 28, 1987; para. (a) amended, 58 FR 4335, Jan. 14, 1993, effective May 1, 1993]

#### **§ 1.477 Protest to lack of unity of invention before the International Searching Authority.**

(a) If the applicant disagrees with the holding of lack of unity of invention by the International Searching Authority, additional fees may be paid under protest, accompanied by a request for refund and a statement setting forth reasons for disagreement or why the required additional fees are considered excessive, or both (PCT Rule 40.2(c)).

(b) Protest under paragraph (a) of this section will be examined by the Director or the Director’s designee. In the event that the applicant’s protest is determined to be justified, the additional fees or a portion thereof will be refunded.

(c) An applicant who desires that a copy of the protest and the decision thereon accompany the international search report when forwarded to the Designated Offices may notify the International Searching

Authority to that effect any time prior to the issuance of the international search report. Thereafter, such notification should be directed to the International Bureau (PCT Rule 40.2(c)).

[43 FR 20466, May 11, 1978; redesignated and amended at 52 FR 20047, May 28, 1987; para. (b) revised, 68 FR 14332, Mar. 25, 2003, effective May 1, 2003]

INTERNATIONAL PRELIMINARY EXAMINATION

§ 1.480 Demand for international preliminary examination.

(a) On the filing of a proper Demand in an application for which the United States International Preliminary Examining Authority is competent and for which the fees have been paid, the international application shall be the subject of an international preliminary examination. The preliminary examination fee (§ 1.482(a)(1)) and the handling fee (§ 1.482(b)) shall be due within the applicable time limit set forth in PCT Rule 57.3.

(b) The Demand shall be made on a standardized form (PCT Rule 53). Copies of the printed Demand forms are available from the United States Patent and Trademark Office. Letters requesting printed Demand forms should be marked "Mail Stop PCT."

(c) Withdrawal of a proper Demand prior to the start of the international preliminary examination will entitle applicant to a refund of the preliminary examination fee minus the amount of the transmittal fee set forth in § 1.445(a)(1).

(d) The filing of a Demand shall constitute the election of all Contracting States which are designated and are bound by Chapter II of the Treaty on the international filing date (PCT Rule 53.7).

(e) Any Demand filed after the expiration of the applicable time limit set forth in PCT Rule 54<sup>bis</sup>.1(a) shall be considered as if it had not been submitted (PCT Rule 54<sup>bis</sup>.1(b)).

[52 FR 20048, May 28, 1987; para. (d), 53 FR 47810, Nov. 28, 1988, effective Jan. 1, 1989; para. (b) amended, 58 FR 4335, Jan. 14, 1993, effective May 1, 1993; para. (a) revised, 63 FR 29614, June 1, 1998, effective July 1, 1998 (adopted as final, 63 FR 66040, Dec. 1, 1998); para. (c) removed and para. (d) redesignated as para. (c), 67 FR 520,

Jan. 4, 2002, effective Apr. 1, 2002; para. (b) revised, 68 FR 14332, Mar. 25, 2003, effective May 1, 2003; para. (a) revised, paras. (d) & (e) added, 68 FR 58991, Oct. 20, 2003, effective Jan. 1, 2004]

§ 1.481 Payment of international preliminary examination fees.

(a) The handling and preliminary examination fees shall be paid within the time period set in PCT Rule 57.3. The handling fee or preliminary examination fee payable is the handling fee or preliminary examination fee in effect on the date of payment.

(1) If the handling and preliminary examination fees are not paid within the time period set in PCT Rule 57.3, applicant will be notified and given one month within which to pay the deficient fees plus a late payment fee equal to the greater of:

(i) Fifty percent of the amount of the deficient fees, but not exceeding an amount equal to double the handling fee; or

(ii) An amount equal to the handling fee (PCT Rule 58<sup>bis</sup>.2).

(2) The one-month time limit set in this paragraph to pay deficient fees may not be extended.

(b) If the payment needed to cover the handling and preliminary examination fees, pursuant to paragraph (a) of this section, is not timely made in accordance with PCT Rule 58<sup>bis</sup>.1(d), the United States International Preliminary Examination Authority will declare the Demand to be considered as if it had not been submitted.

[63 FR 29614, June 1, 1998, effective July 1, 1998 (adopted as final, 63 FR 66040, Dec. 1, 1998); para. (a) revised, 68 FR 58991, Oct. 20, 2003, effective Jan. 1, 2004]

§ 1.482 International preliminary examination fees.

(a) The following fees and charges for international preliminary examination are established by the Director under the authority of 35 U.S.C. 376:

(1) The following preliminary examination fee is due on filing the Demand:

(i) If an international search fee as set forth in § 1.445(a)(2) has been paid on the international application to the United States Patent and Trademark Office as an International Searching Authority . . . . . \$600.00

(ii) If the International Searching Authority for the international application was an authority other than the United States Patent and Trademark Office . . . . . \$750.00

(2) An additional preliminary examination fee when required, per additional invention . \$600.00

(b) The handling fee is due on filing the Demand and shall be as prescribed in PCT Rule 57.

[52 FR 20048, May 28, 1987; para. (a), 54 FR 6893, Feb. 15, 1989, effective Apr. 17, 1989; para. (a), 56 FR 65142, Dec. 13, 1991, effective Dec. 27, 1991; paras. (a)(1) and (a)(2)(ii), 57 FR 38190, Aug. 21, 1992, effective Oct. 1, 1992; paras. (a)(2)(i) and (b) amended, 58 FR 4335, Jan. 14, 1993, effective May 1, 1993; paras. (a)(1) and (a)(2)(ii), 59 FR 43736, Aug. 25, 1994, effective Oct. 1, 1994; paras. (a)(1)(i), (a)(1)(ii), & (a)(2)(ii) amended, 60 FR 41018, Aug. 11, 1995, effective Oct. 1, 1995; paras. (a)(1)(i), (a)(1)(ii), and (a)(2)(ii) amended, 61 FR 39585, July 30, 1996, effective Oct. 1, 1996; paras. (a)(1)(i), (a)(1)(ii), and (a)(2)(ii) amended, 62 FR 40450, July 29, 1997, effective Oct. 1, 1997; para. (a) revised, 68 FR 14332, Mar. 25, 2003, effective May 1, 2003; revised, 68 FR 58991, Oct. 20, 2003, effective Jan. 1, 2004; para. (b) & (e)-(g) revised, paras. (h) & (i) added, 68 FR 58991, Oct. 20, 2003, effective Jan. 1, 2004 ]

#### § 1.484 Conduct of international preliminary examination.

(a) An international preliminary examination will be conducted to formulate a non-binding opinion as to whether the claimed invention has novelty, involves an inventive step (is non-obvious) and is industrially applicable.

(b) International preliminary examination will begin in accordance with PCT Rule 69.1.

(c) No international preliminary examination will be conducted on inventions not previously searched by an International Searching Authority.

(d) The International Preliminary Examining Authority will establish a written opinion if any defect exists or if the claimed invention lacks novelty, inventive step or industrial applicability and will set a non-extendable time limit in the written opinion for the applicant to reply.

(e) The written opinion established by the International Searching Authority under PCT Rule 43<sup>bis</sup>.1 shall be considered to be a written opinion of the United States International Preliminary Examining

Authority for the purposes of paragraph (d) of this section.

(f) The International Preliminary Examining Authority may establish further written opinions under paragraph (d) of this section.

(g) If no written opinion under paragraph (d) of this section is necessary, or if no further written opinion under paragraph (f) of this section is to be established, or after any written opinion and the reply thereto or the expiration of the time limit for reply to such written opinion, an international preliminary examination report will be established by the International Preliminary Examining Authority. One copy will be submitted to the International Bureau and one copy will be submitted to the applicant.

(h) An applicant will be permitted a personal or telephone interview with the examiner, which may be requested after the filing of a Demand, and must be conducted during the period between the establishment of the written opinion and the establishment of the international preliminary examination report. Additional interviews may be conducted where the examiner determines that such additional interviews may be helpful to advancing the international preliminary examination procedure. A summary of any such personal or telephone interview must be filed by the applicant or, if not filed by applicant be made of record in the file by the examiner.

(i) If the application whose priority is claimed in the international application is in a language other than English, the United States International Preliminary Examining Authority may, where the validity of the priority claim is relevant for the formulation of the opinion referred to in Article 33(1), invite the applicant to furnish an English translation of the priority document within two months from the date of the invitation. If the translation is not furnished within that time limit, the international preliminary report may be established as if the priority had not been claimed.

[52 FR 20049, May 28, 1987; para. (b) amended, 58 FR 4335, Jan. 14, 1993, effective May 1, 1993; paras. (d)-(f) revised, 62 FR 53131, Oct. 10, 1997, effective Dec. 1, 1997; para. (b) revised, 63 FR 29614, June 1, 1998, effective July 1, 1998 (adopted as final, 63 FR 66040, Dec. 1, 1998); para. (g) added, 66 FR 16004, Mar. 22, 2001, effective Mar. 1, 2001; para. (b) & (e)-(g) revised, paras. (h) & (i) added, 68 FR 58991, Oct. 20, 2003, effective Jan. 1, 2004]

**§ 1.485 Amendments by applicant during international preliminary examination.**

(a) The applicant may make amendments at the time of filing the Demand. The applicant may also make amendments within the time limit set by the International Preliminary Examining Authority for reply to any notification under § 1.484(b) or to any written opinion. Any such amendments must:

(1) Be made by submitting a replacement sheet in compliance with PCT Rules 10 and 11.1 to 11.13 for every sheet of the application which differs from the sheet it replaces unless an entire sheet is cancelled; and

(2) Include a description of how the replacement sheet differs from the replaced sheet. Amendments that do not comply with PCT Rules 10 and 11.1 to 11.13 may not be entered.

(b) If an amendment cancels an entire sheet of the international application, that amendment shall be communicated in a letter.

[Added 52 FR 20049, May 28, 1987; amended, 58 FR 4335, Jan. 14, 1993, effective May 1, 1993; para. (a) revised, 62 FR 53131, Oct. 10, 1997, effective Dec. 1, 1997; para. (a) revised, 63 FR 29614, June 1, 1998, effective July 1, 1998 (adopted as final, 63 FR 66040, Dec. 1, 1998)]

**§ 1.488 Determination of unity of invention before the International Preliminary Examining Authority.**

(a) Before establishing any written opinion or the international preliminary examination report, the International Preliminary Examining Authority will determine whether the international application complies with the requirement of unity of invention as set forth in § 1.475.

(b) If the International Preliminary Examining Authority considers that the international application does not comply with the requirement of unity of invention, it may:

(1) Issue a written opinion and/or an international preliminary examination report, in respect of the entire international application and indicate that unity of invention is lacking and specify the reasons therefor without extending an invitation to restrict or pay additional fees. No international preliminary examination will be conducted on inventions not pre-

viously searched by an International Searching Authority.

(2) Invite the applicant to restrict the claims or pay additional fees, pointing out the categories of invention found, within a set time limit which will not be extended. No international preliminary examination will be conducted on inventions not previously searched by an International Searching Authority, or

(3) If applicant fails to restrict the claims or pay additional fees within the time limit set for reply, the International Preliminary Examining Authority will issue a written opinion and/or establish an international preliminary examination report on the main invention and shall indicate the relevant facts in the said report. In case of any doubt as to which invention is the main invention, the invention first mentioned in the claims and previously searched by an International Searching Authority shall be considered the main invention.

(c) Lack of unity of invention may be directly evident before considering the claims in relation to any prior art, or after taking the prior art into consideration, as where a document discovered during the search shows the invention claimed in a generic or linking claim lacks novelty or is clearly obvious, leaving two or more claims joined thereby without a common inventive concept. In such a case the International Preliminary Examining Authority may raise the objection of lack of unity of invention.

[52 FR 20049, May 28, 1987; para. (a) amended, 58 FR 4335, Jan. 14, 1993, effective May 1, 1993; para. (b)(3) revised, 62 FR 53131, Oct. 10, 1997, effective Dec. 1, 1997]

**§ 1.489 Protest to lack of unity of invention before the International Preliminary Examining Authority.**

(a) If the applicant disagrees with the holding of lack of unity of invention by the International Preliminary Examining Authority, additional fees may be paid under protest, accompanied by a request for refund and a statement setting forth reasons for disagreement or why the required additional fees are considered excessive, or both.

(b) Protest under paragraph (a) of this section will be examined by the Director or the Director's designee. In the event that the applicant's protest is

determined to be justified, the additional fees or a portion thereof will be refunded.

(c) An applicant who desires that a copy of the protest and the decision thereon accompany the international preliminary examination report when forwarded to the Elected Offices, may notify the International Preliminary Examining Authority to that effect any time prior to the issuance of the international preliminary examination report. Thereafter, such notification should be directed to the International Bureau.

[Added 52 FR 20050, May 28, 1987, effective July 1, 1987; para. (b) revised, 68 FR 14332, Mar. 25, 2003, effective May 1, 2003]

## NATIONAL STAGE

### § 1.491 National stage commencement and entry.

(a) Subject to 35 U.S.C. 371(f), the national stage shall commence with the expiration of the applicable time limit under PCT Article 22(1) or (2), or under PCT Article 39(1)(a).

(b) An international application enters the national stage when the applicant has filed the documents and fees required by 35 U.S.C. 371(c) within the period set in § 1.495.

[Added, 52 FR 20050, May 28, 1987; revised, 66 FR 45775, Aug. 30, 2001; revised, 67 FR 520, Jan. 4, 2002, effective Apr. 1, 2002]

### § 1.492 National stage fees.

The following fees and charges are established for international applications entering the national stage under 35 U.S.C. 371:

(a) The basic national fee:

(1) Where an international preliminary examination fee as set forth in § 1.482 has been paid on the international application to the United States Patent and Trademark Office:

By a small entity (§ 1.27(a)) . . . \$365.00

By other than a small entity . . . \$730.00

(2) Where no international preliminary examination fee as set forth in § 1.482 has been paid to the United States Patent and Trademark Office, but an international search fee as set forth in § 1.445(a)(2) has been paid on the international application to the

United States Patent and Trademark Office as an International Searching Authority:

By a small entity (§ 1.27(a)) . . . \$385.00

By other than a small entity . . . \$770.00

(3) Where no international preliminary examination fee as set forth in § 1.482 has been paid and no international search fee as set forth in § 1.445(a)(2) has been paid on the international application to the United States Patent and Trademark Office:

By a small entity (§ 1.27(a)) . . . \$540.00

By other than a small entity . . . \$1,080.00

(4) Where an international preliminary examination fee as set forth in § 1.482 has been paid to the United States Patent and Trademark Office and the international preliminary examination report states that the criteria of novelty, inventive step (non-obviousness), and industrial applicability, as defined in PCT Article 33(1) to (4) have been satisfied for all the claims presented in the application entering the national stage (see § 1.496(b)):

By a small entity (§ 1.27(a)) . . . \$50.00

By other than a small entity . . . \$100.00

(5) Where a search report on the international application has been prepared by the European Patent Office or the Japan Patent Office:

By a small entity (§ 1.27(a)) . . . \$460.00

By other than a small entity . . . \$920.00

(b) In addition to the basic national fee, for filing or later presentation of each independent claim in excess of 3:

By a small entity (§ 1.27(a)) . . . \$43.00

By other than a small entity . . . \$86.00

(c) In addition to the basic national fee, for filing or later presentation of each claim (whether independent or dependent) in excess of 20 (Note that § 1.75(c) indicates how multiple dependent claims are considered for fee calculation purposes.):

By a small entity (§ 1.27(a)) . . . \$9.00

By other than a small entity . . . \$18.00

(d) In addition to the basic national fee, if the application contains, or is amended to contain, a multiple dependent claim(s), per application:

By a small entity (§ 1.27(a)) . . . \$145.00

By other than a small entity . . . \$290.00

(e) Surcharge for filing the oath or declaration later than thirty months from the priority date pursuant to § 1.495(c):

By a small entity (§ 1.27(a)) . . . . \$65.00  
 By other than a small entity . . . . . 130.00

(f) For filing an English translation of an international application or of any annexes to an international preliminary examination report later than thirty months after the priority date (§ 1.495(c) and (e)) . . . . . \$130.00

(g) If the additional fees required by paragraphs (b), (c), and (d) of this section are not paid on presentation of the claims for which the additional fees are due, they must be paid or the claims cancelled by amendment, prior to the expiration of the time period set for reply by the Office in any notice of fee deficiency.

(35 U.S.C. 6, 376)

[52 FR 20050, May 28, 1987, effective July 1, 1987; paras. (a)(1) - (3), (b), (d)- (f), 54 FR 6893, Feb. 15, 1989, effective Apr. 17, 1989; para. (a)(5) added, 56 FR 65142, Dec. 13, 1991, effective Dec. 16, 1991; revised, 56 FR 65142, Dec. 13, 1991, effective Dec. 16, 1991; paras. (a)(1)-(a)(3), (a)(5) and (b)-(d), 57 FR 38190, Aug. 21, 1992, effective Oct. 1, 1992; para. (e) amended, 58 FR 4335, Jan. 14, 1993, effective May 1, 1993; paras. (a), (b) and (d), 59 FR 43736, Aug. 25, 1994, effective Oct. 1, 1994; paras. (a), (b), & (d) amended, 60 FR 41018, Aug. 11, 1995, effective, Oct. 1, 1995; paras. (a), (b), & (d) amended, 61 FR 39585, July 30, 1996, effective Oct. 1, 1996; paras. (a), (b), & (d) amended, 62 FR 40450, July 29, 1997, effective Oct. 1, 1997; para. (g) added, 62 FR 53131, Oct. 10, 1997, effective Dec. 1, 1997; paras. (a)-(d) revised, 63 FR 67578, Dec. 8, 1998, effective Nov. 10, 1998; para. (a)(2) revised, 64 FR 67774, Dec. 3, 1999, effective Dec. 29, 1999; paras. (a), (b) and (d) revised, 65 FR 49193, Aug. 11, 2000, effective Oct. 1, 2000; paras. (a)-(e) revised, 65 FR 78958, Dec. 18, 2000; paras. (a)(1)-(a)(3), (a)(5), (b) and (d) revised, 66 FR 39447, July 31, 2001, effective Oct. 1, 2001; paras. (e) and (f) revised, 67 FR 520, Jan. 4, 2002, effective Apr. 1, 2002; paras. (a)(1) through (a)(3), and (a)(5) revised, 67 FR 70847, Nov. 27, 2002, effective Jan. 1, 2003; paras. (a)(1) through (a)(3), (a)(5), (b), and (d) revised, 68 FR 41532, July 14, 2003, effective Oct. 1, 2003]

**§ 1.494 [Reserved]**

[Added 52 FR 20050, May 28, 1987; paras. (a) - (d) and (g) amended and para. (h) deleted, 58 FR 4335, Jan. 14, 1993, effective May 1, 1993; para. (c) revised, 62 FR 53131, Oct. 10, 1997, effective Dec. 1, 1997; para (c) revised, 63 FR 29614, June 1, 1998, effective, July 1, 1998

(adopted as final, 63 FR 66040, Dec. 1, 1998); para (f) revised, 65 FR 57024, Sept. 20, 2000, effective Nov. 29, 2000; para. (c)(2) revised, 66 FR 16004, Mar. 22, 2001, effective Mar. 1, 2000; para. (c)(2) corrected, 66 FR 28053, May 22, 2001, effective Mar. 22, 2001; removed and reserved, 67 FR 520, Jan. 4, 2002, effective Apr. 1, 2002]

**§ 1.495 Entering the national stage in the United States of America.**

(a) The applicant in an international application must fulfill the requirements of 35 U.S.C. 371 within the time periods set forth in paragraphs (b) and (c) of this section in order to prevent the abandonment of the international application as to the United States of America. The thirty-month time period set forth in paragraphs (b), (c), (d), (e) and (h) of this section may not be extended. International applications for which those requirements are timely fulfilled will enter the national stage and obtain an examination as to the patentability of the invention in the United States of America.

(b) To avoid abandonment of the application, the applicant shall furnish to the United States Patent and Trademark Office not later than the expiration of thirty months from the priority date:

(1) A copy of the international application, unless it has been previously communicated by the International Bureau or unless it was originally filed in the United States Patent and Trademark Office; and

(2) The basic national fee (see § 1.492(a)).

(c) If applicant complies with paragraph (b) of this section before expiration of thirty months from the priority date but omits either a translation of the international application, as filed, into the English language, if the international application was originally filed in another language and if any English language translation of the publication of the international application previously submitted under 35 U.S.C. 154(d) (§ 1.417) is not also a translation of the international application as filed (35 U.S.C. 371(c)(2)), or the oath or declaration of the inventor (35 U.S.C. 371(c)(4) and § 1.497), if a declaration of inventorship in compliance with § 1.497 has not been previously submitted in the international application under PCT Rule 4.17(iv) within the time limits provided for in PCT Rule 26<sup>ter</sup>.1, applicant will be so notified and given a period of time within which to file the translation and/or oath or declaration in order

to prevent abandonment of the application. The payment of the processing fee set forth in § 1.492(f) is required for acceptance of an English translation later than the expiration of thirty months after the priority date. The payment of the surcharge set forth in § 1.492(e) is required for acceptance of the oath or declaration of the inventor later than the expiration of thirty months after the priority date. A “Sequence Listing” need not be translated if the “Sequence Listing” complies with PCT Rule 12.1(d) and the description complies with PCT Rule 5.2(b).

(d) A copy of any amendments to the claims made under PCT Article 19, and a translation of those amendments into English, if they were made in another language, must be furnished not later than the expiration of thirty months from the priority date. Amendments under PCT Article 19 which are not received by the expiration of thirty months from the priority date will be considered to be canceled.

(e) A translation into English of any annexes to an international preliminary examination report (if applicable), if the annexes were made in another language, must be furnished not later than the expiration of thirty months from the priority date. Translations of the annexes which are not received by the expiration of thirty months from the priority date may be submitted within any period set pursuant to paragraph (c) of this section accompanied by the processing fee set forth in § 1.492(f). Annexes for which translations are not timely received will be considered canceled.

(f) Verification of the translation of the international application or any other document pertaining to an international application may be required where it is considered necessary, if the international application or other document was filed in a language other than English.

(g) The documents and fees submitted under paragraphs (b) and (c) of this section must be clearly identified as a submission to enter the national stage under 35 U.S.C. 371. Otherwise, the submission will be considered as being made under 35 U.S.C. 111(a).

(h) An international application becomes abandoned as to the United States thirty months from the priority date if the requirements of paragraph (b) of this section have not been complied with within thirty months from the priority date. If the requirements of paragraph (b) of this section are complied with within

thirty months from the priority date but either of any required translation of the international application as filed or the oath or declaration are not timely filed, an international application will become abandoned as to the United States upon expiration of the time period set pursuant to paragraph (c) of this section.

[Added 52 FR 20051, May 28, 1987, effective July 1, 1987; paras. (a) -(e) & (h) amended and para. (i) deleted, 58 FR 4335, Jan. 14, 1993, effective May 1, 1993; para. (c) revised, 62 FR 53131, Oct. 10, 1997, effective Dec. 1, 1997; para (c) revised, 63 FR 29614, June 1, 1998, effective July 1, 1998 (adopted as final, 63 FR 66040, Dec. 1, 1998), para. (g) revised, 65 FR 57024, Sept. 20, 2000, effective Nov. 29, 2000; para. (c)(2) revised, 66 FR 16004, Mar. 22, 2001, effective Mar. 1, 2001 para. (c)(2) corrected, 66 FR 28053, May 22, 2001, effective Mar. 22, 2001; heading and paras. (a)-(e) and (h) revised, 67 FR 520, Jan. 4, 2002, effective Apr. 1, 2002; paras. (c) & (g) revised, 68 FR 70996, Dec. 22, 2003, effective Jan. 21, 2004]

#### **§ 1.496 Examination of international applications in the national stage.**

(a) International applications which have complied with the requirements of 35 U.S.C. 371(c) will be taken up for action based on the date on which such requirements were met. However, unless an express request for early processing has been filed under 35 U.S.C. 371(f), no action may be taken prior to one month after entry into the national stage.

(b) A national stage application filed under 35 U.S.C. 371 may have paid therein the basic national fee as set forth in § 1.492(a)(4) if it contains, or is amended to contain, at the time of entry into the national stage, only claims which have been indicated in an international preliminary examination report prepared by the United States Patent and Trademark Office as satisfying the criteria of PCT Article 33(1)-(4) as to novelty, inventive step and industrial applicability. Such national stage applications in which the basic national fee as set forth in § 1.492(a)(4) has been paid may be amended subsequent to the date of entry into the national stage only to the extent necessary to eliminate objections as to form or to cancel rejected claims. Such national stage applications in which the basic national fee as set forth in § 1.492(a)(4) has been paid will be taken up out of order.



[Added 52 FR 20051, May 28, 1987, effective July 1, 1987]

**§ 1.497 Oath or declaration under 35 U.S.C. 371(c)(4).**

(a) When an applicant of an international application desires to enter the national stage under 35 U.S.C. 371 pursuant to § 1.495, and a declaration in compliance with this section has not been previously submitted in the international application under PCT Rule 4.17(iv) within the time limits provided for in PCT Rule 26<sup>ter</sup>.1, he or she must file an oath or declaration that:

(1) Is executed in accordance with either §§ 1.66 or 1.68;

(2) Identifies the specification to which it is directed;

(3) Identifies each inventor and the country of citizenship of each inventor; and

(4) States that the person making the oath or declaration believes the named inventor or inventors to be the original and first inventor or inventors of the subject matter which is claimed and for which a patent is sought.

(b)(1) The oath or declaration must be made by all of the actual inventors except as provided for in §§ 1.42, 1.43 or 1.47.

(2) If the person making the oath or declaration or any supplemental oath or declaration is not the inventor (§§ 1.42, 1.43, or § 1.47), the oath or declaration shall state the relationship of the person to the inventor, and, upon information and belief, the facts which the inventor would have been required to state. If the person signing the oath or declaration is the legal representative of a deceased inventor, the oath or declaration shall also state that the person is a legal representative and the citizenship, residence and mailing address of the legal representative.

(c) Subject to paragraph (f) of this section, if the oath or declaration meets the requirements of paragraphs (a) and (b) of this section, the oath or declaration will be accepted as complying with 35 U.S.C. 371(c)(4) and § 1.495(c). However, if the oath or declaration does not also meet the requirements of § 1.63, a supplemental oath or declaration in compliance with § 1.63 or an application data sheet will be required in accordance with § 1.67.

(d) If the oath or declaration filed pursuant to 35 U.S.C. 371(c)(4) and this section names an inventive entity different from the inventive entity set forth in the international application, or if a change to the inventive entity has been effected under PCT Rule 92<sup>bis</sup> subsequent to the execution of any oath or declaration which was filed in the application under PCT Rule 4.17(iv) or this section and the inventive entity thus changed is different from the inventive entity identified in any such oath or declaration, applicant must submit:

(1) A statement from each person being added as an inventor and from each person being deleted as an inventor that any error in inventorship in the international application occurred without deceptive intention on his or her part;

(2) The processing fee set forth in § 1.17(i); and

(3) If an assignment has been executed by any of the original named inventors, the written consent of the assignee (see § 3.73(b) of this chapter); and

(4) Any new oath or declaration required by paragraph (f) of this section.

(e) The Office may require such other information as may be deemed appropriate under the particular circumstances surrounding the correction of inventorship.

(f) A new oath or declaration in accordance with this section must be filed to satisfy 35 U.S.C. 371(c)(4) if the declaration was filed under PCT Rule 4.17(iv), and:

(1) There was a change in the international filing date pursuant to PCT Rule 20.2 after the declaration was executed; or

(2) A change in the inventive entity was effected under PCT Rule 92<sup>bis</sup> after the declaration was executed and no declaration which sets forth and is executed by the inventive entity as so changed has been filed in the application.

(g) If a priority claim has been corrected or added pursuant to PCT Rule 26<sup>bis</sup> during the international stage after the declaration of inventorship was executed in the international application under PCT Rule 4.17(iv), applicant will be required to submit either a new oath or declaration or an application data sheet as set forth in § 1.76 correctly identifying the application upon which priority is claimed.

[Added 52 FR 20052, May 28, 1987, effective July 1, 1987; paras. (a) and (b) revised and para. (c) added, 61 FR 42790, Aug. 19, 1996, effective Sept. 23, 1996; para. (b)(2) revised and paras. (d) and (e) added, 65 FR 54604, Sept. 8, 2000, effective Nov. 7, 2000; paras. (a), (c), and (d) revised and paras. (f) and (g) added, 66 FR 16004, Mar. 22, 2001, effective Mar. 1, 2001; para. (a)(1) corrected, 66 FR 28053, May 22, 2001, effective Mar. 22, 2001; paras. (a), (c), (d), and (f) revised, 67 FR 520, Jan. 4, 2002, effective Apr. 1, 2002; para. (c) corrected, 67 FR 6075, Feb. 8, 2002]

### § 1.499 Unity of invention during the national stage.

If the examiner finds that a national stage application lacks unity of invention under § 1.475, the examiner may in an Office action require the applicant in the response to that action to elect the invention to which the claims shall be restricted. Such requirement may be made before any action on the merits but may be made at any time before the final action at the discretion of the examiner. Review of any such requirement is provided under §§ 1.143 and 1.144.

[Added 52 FR 20052, May 28, 1987, effective July 1, 1987; amended, 58 FR 4335, Jan. 14, 1993, effective May 1, 1993]

## Subpart D — *Ex Parte* Reexamination of Patents

### CITATION OF PRIOR ART

#### § 1.501 Citation of prior art in patent files.

(a) At any time during the period of enforceability of a patent, any person may cite, to the Office in writing, prior art consisting of patents or printed publications which that person states to be pertinent and applicable to the patent and believes to have a bearing on the patentability of any claim of the patent. If the citation is made by the patent owner, the explanation of pertinency and applicability may include an explanation of how the claims differ from the prior art. Such citations shall be entered in the patent file except as set forth in §§ 1.502 and 1.902.

(b) If the person making the citation wishes his or her identity to be excluded from the patent file and kept confidential, the citation papers must be submit-

ted without any identification of the person making the submission.

(c) Citation of patents or printed publications by the public in patent files should either: (1) Reflect that a copy of the same has been mailed to the patent owner at the address as provided for in § 1.33(c); or in the event service is not possible (2) Be filed with the Office in duplicate.

[46 FR 29185, May 29, 1981, effective July 1, 1981; para. (a) revised, 65 FR 76756, Dec. 7, 2000, effective Feb. 5, 2001]

#### § 1.502 Processing of prior art citations during an *ex parte* reexamination proceeding.

Citations by the patent owner under § 1.555 and by an *ex parte* reexamination requester under either § 1.510 or § 1.535 will be entered in the reexamination file during a reexamination proceeding. The entry in the patent file of citations submitted after the date of an order to reexamine pursuant to § 1.525 by persons other than the patent owner, or an *ex parte* reexamination requester under either § 1.510 or § 1.535, will be delayed until the reexamination proceeding has been terminated. See § 1.902 for processing of prior art citations in patent and reexamination files during an *inter partes* reexamination proceeding filed under § 1.913.

[Added 65 FR 76756, Dec. 7, 2000, effective Feb. 5, 2001]

### REQUEST FOR *EX PARTE* REEXAMINATION

#### § 1.510 Request *forex parte* reexamination.

(a) Any person may, at any time during the period of enforceability of a patent, file a request for an *ex parte* reexamination by the Office of any claim of the patent on the basis of prior art patents or printed publications cited under § 1.501. The request must be accompanied by the fee for requesting reexamination set in § 1.20(c)(1).

(b) Any request for reexamination must include the following parts:

(1) A statement pointing out each substantial new question of patentability based on prior patents and printed publications.

(2) An identification of every claim for which reexamination is requested, and a detailed explanation of the pertinency and manner of applying the cited prior art to every claim for which reexamination is requested. If appropriate the party requesting reexamination may also point out how claims distinguish over cited prior art.

(3) A copy of every patent or printed publication relied upon or referred to in paragraph (b)(1) and (2) of this section accompanied by an English language translation of all the necessary and pertinent parts of any non-English language patent or printed publication.

(4) A copy of the entire patent including the front face, drawings, and specification/claims (in double column format) for which reexamination is requested, and a copy of any disclaimer, certificate of correction, or reexamination certificate issued in the patent. All copies must have each page plainly written on only one side of a sheet of paper.

(5) A certification that a copy of the request filed by a person other than the patent owner has been served in its entirety on the patent owner at the address as provided for in § 1.33(c). The name and address of the party served must be indicated. If service was not possible, a duplicate copy must be supplied to the Office.

(c) If the request does not include the fee for requesting reexamination or all of the parts required by paragraph (b) of this section, the person identified as requesting reexamination will be so notified and given an opportunity to complete the request within a specified time. If the fee for requesting reexamination has been paid but the defect in the request is not corrected within the specified time, the determination whether or not to institute reexamination will be made on the request as it then exists. If the fee for requesting reexamination has not been paid, no determination will be made and the request will be placed in the patent file as a citation if it complies with the requirements of § 1.501(a).

(d) The filing date of the request is:

(1) The date on which the request including the entire fee for requesting reexamination is received in the Patent and Trademark Office; or

(2) The date on which the last portion of the fee for requesting reexamination is received.

(e) A request filed by the patent owner may include a proposed amendment in accordance with § 1.530.

(f) If a request is filed by an attorney or agent identifying another party on whose behalf the request is being filed, the attorney or agent must have a power of attorney from that party or be acting in a representative capacity pursuant to § 1.34(a).

[46 FR 29185, May 29, 1981, effective July 1, 1981; para. (a), 47 FR 41282, Sept. 17, 1982, effective Oct. 1, 1982; para. (e) revised, 62 FR 53131, Oct. 10, 1997, effective Dec. 1, 1997; paras. (b)(4) and (e) revised, 65 FR 54604, Sept. 8, 2000, effective Nov. 7, 2000; heading and para. (a) revised, 65 FR 76756, Dec. 7, 2000, effective Feb. 5, 2001]

### § 1.515 Determination of the request for *ex parte* reexamination.

(a) Within three months following the filing date of a request for an *ex parte* reexamination, an examiner will consider the request and determine whether or not a substantial new question of patentability affecting any claim of the patent is raised by the request and the prior art cited therein, with or without consideration of other patents or printed publications. The examiner's determination will be based on the claims in effect at the time of the determination, will become a part of the official file of the patent, and will be mailed to the patent owner at the address as provided for in § 1.33(c) and to the person requesting reexamination.

(b) Where no substantial new question of patentability has been found, a refund of a portion of the fee for requesting *ex parte* reexamination will be made to the requester in accordance with § 1.26(c).

(c) The requester may seek review by a petition to the Director under § 1.181 within one month of the mailing date of the examiner's determination refusing *ex parte* reexamination. Any such petition must comply with § 1.181(b). If no petition is timely filed or if the decision on petition affirms that no substantial new question of patentability has been raised, the determination shall be final and nonappealable.

[46 FR 29185, May 29, 1981, effective July 1, 1981; revised, 65 FR 76756, Dec. 7, 2000, effective Feb. 5, 2001; para. (c) revised, 68 FR 14332, Mar. 25, 2003, effective May 1, 2003]

**§ 1.520 *Ex parte* reexamination at the initiative of the Director.**

The Director, at any time during the period of enforceability of a patent, may determine whether or not a substantial new question of patentability is raised by patents or printed publications which have been discovered by the Director or which have been brought to the Director's attention, even though no request for reexamination has been filed in accordance with § 1.510 or § 1.913. The Director may initiate *ex parte* reexamination without a request for reexamination pursuant to § 1.510 or § 1.913. Normally requests from outside the Office that the Director undertake reexamination on his own initiative will not be considered. Any determination to initiate *ex parte* reexamination under this section will become a part of the official file of the patent and will be mailed to the patent owner at the address as provided for in § 1.33(c).

[46 FR 29186, May 29, 1981, effective July 1, 1981; revised, 65 FR 76756, Dec. 7, 2000, effective Feb. 5, 2001; revised, 68 FR 14332, Mar. 25, 2003, effective May 1, 2003]

**EX PARTE REEXAMINATION****§ 1.525 Order for *ex parte* reexamination.**

(a) If a substantial new question of patentability is found pursuant to § 1.515 or § 1.520, the determination will include an order for *ex parte* reexamination of the patent for resolution of the question. If the order for *ex parte* reexamination resulted from a petition pursuant to § 1.515(c), the *ex parte* reexamination will ordinarily be conducted by an examiner other than the examiner responsible for the initial determination under § 1.515(a).

(b) The notice published in the *Official Gazette* under § 1.11(c) will be considered to be constructive notice and *ex parte* reexamination will proceed.

[46 FR 29186, May 29, 1981, effective July 1, 1981; heading and paras. (a) and (b) revised, 65 FR 76756, Dec. 7, 2000, effective Feb. 5, 2001]

**§ 1.530 Statement by patent owner in *ex parte* reexamination; amendment by patent owner in *ex parte* or *inter partes* reexamination; inventorship change in *ex parte* or *inter partes* reexamination.**

(a) Except as provided in § 1.510(e), no statement or other response by the patent owner in an *ex parte* reexamination proceeding shall be filed prior to the determinations made in accordance with § 1.515 or § 1.520. If a premature statement or other response is filed by the patent owner, it will not be acknowledged or considered in making the determination.

(b) The order for *ex parte* reexamination will set a period of not less than two months from the date of the order within which the patent owner may file a statement on the new question of patentability, including any proposed amendments the patent owner wishes to make.

(c) Any statement filed by the patent owner shall clearly point out why the subject matter as claimed is not anticipated or rendered obvious by the prior art patents or printed publications, either alone or in any reasonable combinations. Where the reexamination request was filed by a third party requester, any statement filed by the patent owner must be served upon the *ex parte* reexamination requester in accordance with § 1.248.

(d) *Making amendments in a reexamination proceeding.* A proposed amendment in an *ex parte* or an *inter partes* reexamination proceeding is made by filing a paper directing that proposed specified changes be made to the patent specification, including the claims, or to the drawings. An amendment paper directing that proposed specified changes be made in a reexamination proceeding may be submitted as an accompaniment to a request filed by the patent owner in accordance with § 1.510(e), as part of a patent owner statement in accordance with paragraph (b) of this section, or, where permitted, during the prosecution of the reexamination proceeding pursuant to § 1.550(a) or § 1.937.

(1) *Specification other than the claims.* Changes to the specification, other than to the claims, must be made by submission of the entire text of an added or rewritten paragraph including markings pursuant to paragraph (f) of this section, except that an entire paragraph may be deleted by a statement deleting the paragraph, without presentation of the text of

the paragraph. The precise point in the specification must be identified where any added or rewritten paragraph is located. This paragraph applies whether the amendment is submitted on paper or compact disc (see §§ 1.96 and 1.825).

(2) *Claims.* An amendment paper must include the entire text of each patent claim which is being proposed to be changed by such amendment paper and of each new claim being proposed to be added by such amendment paper. For any claim changed by the amendment paper, a parenthetical expression “amended,” “twice amended,” *etc.*, should follow the claim number. Each patent claim proposed to be changed and each proposed added claim must include markings pursuant to paragraph (f) of this section, except that a patent claim or proposed added claim should be canceled by a statement canceling the claim, without presentation of the text of the claim.

(3) *Drawings.* Any change to the patent drawings must be submitted as a sketch on a separate paper showing the proposed changes in red for approval by the examiner. Upon approval of the changes by the examiner, only new sheets of drawings including the changes and in compliance with § 1.84 must be filed. Amended figures must be identified as “Amended,” and any added figure must be identified as “New.” In the event a figure is canceled, the figure must be surrounded by brackets and identified as “Canceled.”

(4) The formal requirements for papers making up the reexamination proceeding other than those set forth in this section are set out in § 1.52.

(e) *Status of claims and support for claim changes.* Whenever there is an amendment to the claims pursuant to paragraph (d) of this section, there must also be supplied, on pages separate from the pages containing the changes, the status (*i.e.*, pending or canceled), as of the date of the amendment, of all patent claims and of all added claims, and an explanation of the support in the disclosure of the patent for the changes to the claims made by the amendment paper.

(f) *Changes shown by markings.* Any changes relative to the patent being reexamined which are made to the specification, including the claims, must include the following markings:

(1) The matter to be omitted by the reexamination proceeding must be enclosed in brackets; and

(2) The matter to be added by the reexamination proceeding must be underlined.

(g) *Numbering of patent claims p.* Patent claims may not be renumbered. The numbering of any claims added in the reexamination proceeding must follow the number of the highest numbered patent claim.

(h) *Amendment of disclosure may be required.* The disclosure must be amended, when required by the Office, to correct inaccuracies of description and definition, and to secure substantial correspondence between the claims, the remainder of the specification, and the drawings.

(i) *Amendments made relative to patent.* All amendments must be made relative to the patent specification, including the claims, and drawings, which are in effect as of the date of filing the request for reexamination.

(j) *No enlargement of claim scope.* No amendment may enlarge the scope of the claims of the patent or introduce new matter. No amendment may be proposed for entry in an expired patent. Moreover, no amendment, other than the cancellation of claims, will be incorporated into the patent by a certificate issued after the expiration of the patent.

(k) *Amendments not effective until certificate.* Although the Office actions will treat proposed amendments as though they have been entered, the proposed amendments will not be effective until the reexamination certificate is issued.

(l) *Correction of inventorship in an ex parte or inter partes reexamination proceeding.*

(1) When it appears in a patent being reexamined that the correct inventor or inventors were not named through error without deceptive intention on the part of the actual inventor or inventors, the Director may, on petition of all the parties set forth in § 1.324(b)(1)-(3), including the assignees, and satisfactory proof of the facts and payment of the fee set forth in § 1.20(b), or on order of a court before which such matter is called in question, include in the reexamination certificate to be issued under § 1.570 or § 1.977 an amendment naming only the actual inventor or inventors. The petition must be submitted as part of the reexamination proceeding and must satisfy the requirements of § 1.324.

(2) Notwithstanding the preceding paragraph (1)(1) of this section, if a petition to correct inventorship satisfying the requirements of § 1.324 is

filed in a reexamination proceeding, and the reexamination proceeding is terminated other than by a reexamination certificate under § 1.570 or § 1.977, a certificate of correction indicating the change of inventorship stated in the petition will be issued upon request by the patentee.

[46 FR 29186, May 29, 1981, effective July 1, 1981; para. (d) revised, para. (e) removed, 62 FR 53131, Oct. 10, 1997, effective Dec. 1, 1997; heading and para. (d) revised, 65 FR 54604, Sept. 8, 2000, effective Nov. 7, 2000; paras. (e) through (l) added, 65 FR 54604, Sept. 8, 2000, effective Nov. 7, 2000; heading, paras. (a)-(c), para. (d) introductory text and para. (l) revised, 65 FR 76756, Dec. 7, 2000, effective Feb. 5, 2001; para. (l)(1) revised, 68 FR 14332, Mar. 25, 2003, effective May 1, 2003]

**§ 1.535 Reply by third party requester *in ex parte* reexamination.**

A reply to the patent owner's statement under § 1.530 may be filed by the *ex parte* reexamination requester within two months from the date of service of the patent owner's statement. Any reply by the *ex parte* requester must be served upon the patent owner in accordance with § 1.248. If the patent owner does not file a statement under § 1.530, no reply or other submission from the *ex parte* reexamination requester will be considered.

[46 FR 29186, May 29, 1981, effective July 1, 1981; revised, 65 FR 76756, Dec. 7, 2000, effective Feb. 5, 2001]

**§ 1.540 Consideration of responses in *ex parte* reexamination.**

The failure to timely file or serve the documents set forth in § 1.530 or in § 1.535 may result in their being refused consideration. No submissions other than the statement pursuant to § 1.530 and the reply by the *ex parte* reexamination requester pursuant to § 1.535 will be considered prior to examination.

[46 FR 29186, May 29, 1981, effective July 1, 1981; revised, 65 FR 76756, Dec. 7, 2000, effective Feb. 5, 2001]

**§ 1.550 Conduct of *ex parte* reexamination proceedings.**

(a) All *ex parte* reexamination proceedings, including any appeals to the Board of Patent Appeals and Interferences, will be conducted with special dispatch within the Office. After issuance of the *ex parte*

reexamination order and expiration of the time for submitting any responses, the examination will be conducted in accordance with §§ 1.104 through 1.116 and will result in the issuance of an *ex parte* reexamination certificate under § 1.570.

(b) The patent owner in an *ex parte* reexamination proceeding will be given at least thirty days to respond to any Office action. In response to any rejection, such response may include further statements and/or proposed amendments or new claims to place the patent in a condition where all claims, if amended as proposed, would be patentable.

(c) The time for taking any action by a patent owner in an *ex parte* reexamination proceeding will be extended only for sufficient cause and for a reasonable time specified. Any request for such extension must be filed on or before the day on which action by the patent owner is due, but in no case will the mere filing of a request effect any extension. See § 1.304(a) for extensions of time for filing a notice of appeal to the U.S. Court of Appeals for the Federal Circuit or for commencing a civil action.

(d) If the patent owner fails to file a timely and appropriate response to any Office action or any written statement of an interview required under § 1.560(b), the *ex parte* reexamination proceeding will be terminated, and the Director will proceed to issue a certificate under § 1.570 in accordance with the last action of the Office.

(e) If a response by the patent owner is not timely filed in the Office,

(1) The delay in filing such response may be excused if it is shown to the satisfaction of the Director that the delay was unavoidable; a petition to accept an unavoidably delayed response must be filed in compliance with § 1.137(a); or

(2) The response may nevertheless be accepted if the delay was unintentional; a petition to accept an unintentionally delayed response must be filed in compliance with § 1.137(b).

(f) The reexamination requester will be sent copies of Office actions issued during the *ex parte* reexamination proceeding. After filing of a request for *ex parte* reexamination by a third party requester, any document filed by either the patent owner or the third party requester must be served on the other party in the reexamination proceeding in the manner provided

by § 1.248. The document must reflect service or the document may be refused consideration by the Office.

(g) The active participation of the *ex parte* reexamination requester ends with the reply pursuant to § 1.535, and no further submissions on behalf of the reexamination requester will be acknowledged or considered. Further, no submissions on behalf of any third parties will be acknowledged or considered unless such submissions are:

- (1) in accordance with § 1.510 or § 1.535; or
- (2) entered in the patent file prior to the date of the order for *ex parte* reexamination pursuant to § 1.525.

(h) Submissions by third parties, filed after the date of the order for *ex parte* reexamination pursuant to § 1.525, must meet the requirements of and will be treated in accordance with § 1.501(a).

[46 FR 29186, May 29, 1981, effective July 1, 1981; para. (c), 49 FR 556, Jan. 4, 1984, effective Apr. 1, 1984; para. (a), 49 FR 48416, Dec. 12, 1984, effective Feb. 11, 1985; para. (c), 54 FR 29553, July 13, 1989, effective Aug. 20, 1989; paras. (a), (b), & (e) revised, 62 FR 53131, Oct. 10, 1997, effective Dec. 1, 1997; paras. (a) and (b) revised, 65 FR 54604, Sept. 8, 2000, effective Nov. 7, 2000; revised, 65 FR 76756, Dec. 7, 2000, effective Feb. 5, 2001; paras. (d) & (e)(1) revised, 68 FR 14332, Mar. 25, 2003, effective May 1, 2003]

### § 1.552 Scope of reexamination in *ex parte* reexamination proceedings.

(a) Claims in an *ex parte* reexamination proceeding will be examined on the basis of patents or printed publications and, with respect to subject matter added or deleted in the reexamination proceeding, on the basis of the requirements of 35 U.S.C. 112.

(b) Claims in an *ex parte* reexamination proceeding will not be permitted to enlarge the scope of the claims of the patent.

(c) Issues other than those indicated in paragraphs (a) and (b) of this section will not be resolved in a reexamination proceeding. If such issues are raised by the patent owner or third party requester during a reexamination proceeding, the existence of such issues will be noted by the examiner in the next Office action, in which case the patent owner may consider the advisability of filing a reissue application to have such issues considered and resolved.

[46 FR 29186, May 29, 1981, effective July 1, 1981; revised, 65 FR 76756, Dec. 7, 2000, effective Feb. 5, 2001]

### § 1.555 Information material to patentability in *ex parte* reexamination and *inter partes* reexamination proceedings.

(a) A patent by its very nature is affected with a public interest. The public interest is best served, and the most effective reexamination occurs when, at the time a reexamination proceeding is being conducted, the Office is aware of and evaluates the teachings of all information material to patentability in a reexamination proceeding. Each individual associated with the patent owner in a reexamination proceeding has a duty of candor and good faith in dealing with the Office, which includes a duty to disclose to the Office all information known to that individual to be material to patentability in a reexamination proceeding. The individuals who have a duty to disclose to the Office all information known to them to be material to patentability in a reexamination proceeding are the patent owner, each attorney or agent who represents the patent owner, and every other individual who is substantively involved on behalf of the patent owner in a reexamination proceeding. The duty to disclose the information exists with respect to each claim pending in the reexamination proceeding until the claim is cancelled. Information material to the patentability of a cancelled claim need not be submitted if the information is not material to patentability of any claim remaining under consideration in the reexamination proceeding. The duty to disclose all information known to be material to patentability in a reexamination proceeding is deemed to be satisfied if all information known to be material to patentability of any claim in the patent after issuance of the reexamination certificate was cited by the Office or submitted to the Office in an information disclosure statement. However, the duties of candor, good faith, and disclosure have not been complied with if any fraud on the Office was practiced or attempted or the duty of disclosure was violated through bad faith or intentional misconduct by, or on behalf of, the patent owner in the reexamination proceeding. Any information disclosure statement must be filed with the items listed in § 1.98(a) as applied to individuals associated with the patent owner in a reexamination proceeding, and should be filed within two months of the date of

the order for reexamination, or as soon thereafter as possible.

(b) Under this section, information is material to patentability in a reexamination proceeding when it is not cumulative to information of record or being made of record in the reexamination proceeding, and

(1) It is a patent or printed publication that establishes, by itself or in combination with other patents or printed publications, a *prima facie* case of unpatentability of a claim; or

(2) It refutes, or is inconsistent with, a position the patent owner takes in:

(i) Opposing an argument of unpatentability relied on by the Office, or

(ii) Asserting an argument of patentability.

A *prima facie* case of unpatentability of a claim pending in a reexamination proceeding is established when the information compels a conclusion that a claim is unpatentable under the preponderance of evidence, burden-of-proof standard, giving each term in the claim its broadest reasonable construction consistent with the specification, and before any consideration is given to evidence which may be submitted in an attempt to establish a contrary conclusion of patentability.

(c) The responsibility for compliance with this section rests upon the individuals designated in paragraph (a) of this section and no evaluation will be made by the Office in the reexamination proceeding as to compliance with this section. If questions of compliance with this section are raised by the patent owner or the third party requester during a reexamination proceeding, they will be noted as unresolved questions in accordance with § 1.552(c).

[46 FR 29187, May 29, 1981, effective July 1, 1981; 47 FR 21752, May 19, 1982, effective July 1, 1982; paras. (a) and (b), 49 FR 556, Jan. 4, 1984, effective Apr. 1, 1984; revised 57 FR 2021, Jan. 17, 1992, effective Mar. 16, 1992; heading and para. (c) revised, 65 FR 76756, Dec. 7, 2000, effective Feb. 5, 2001]

#### § 1.560 Interviews *inex parte* reexamination proceedings.

(a) Interviews in *ex parte* reexamination proceedings pending before the Office between examiners and the owners of such patents or their attorneys or agents of record must be conducted in the Office at such times, within Office hours, as the respective

examiners may designate. Interviews will not be permitted at any other time or place without the authority of the Director. Interviews for the discussion of the patentability of claims in patents involved in *ex parte* reexamination proceedings will not be conducted prior to the first official action. Interviews should be arranged in advance. Requests that reexamination requesters participate in interviews with examiners will not be granted.

(b) In every instance of an interview with an examiner in an *ex parte* reexamination proceeding, a complete written statement of the reasons presented at the interview as warranting favorable action must be filed by the patent owner. An interview does not remove the necessity for response to Office actions as specified in § 1.111. Patent owner's response to an outstanding Office action after the interview does not remove the necessity for filing the written statement. The written statement must be filed as a separate part of a response to an Office action outstanding at the time of the interview, or as a separate paper within one month from the date of the interview, whichever is later.

[46 FR 29187, May 29, 1981, effective July 1, 1981; revised, 65 FR 76756, Dec. 7, 2000, effective Feb. 5, 2001; para. (a) revised, 68 FR 14332, Mar. 25, 2003, effective May 1, 2003]

#### § 1.565 Concurrent office proceedings which include an *ex parte* reexamination proceeding.

(a) In an *ex parte* reexamination proceeding before the Office, the patent owner must inform the Office of any prior or concurrent proceedings in which the patent is or was involved such as interferences, reissues, *ex parte* reexaminations, *inter partes* reexaminations, or litigation and the results of such proceedings. See § 1.985 for notification of prior or concurrent proceedings in an *inter partes* reexamination proceeding.

(b) If a patent in the process of *ex parte* reexamination is or becomes involved in litigation, the Director shall determine whether or not to suspend the reexamination. See § 1.987 for *inter partes* reexamination proceedings.

(c) If *ex parte* reexamination is ordered while a prior *ex parte* reexamination proceeding is pending and prosecution in the prior *ex parte* reexamination



proceeding has not been terminated, the *ex parte* reexamination proceedings will be consolidated and result in the issuance of a single certificate under § 1.570. For merger of *inter partes* reexamination proceedings, see § 1.989(a). For merger of *ex parte* reexamination and *inter partes* reexamination proceedings, see § 1.989(b).

(d) If a reissue application and an *ex parte* reexamination proceeding on which an order pursuant to § 1.525 has been mailed are pending concurrently on a patent, a decision will normally be made to merge the two proceedings or to suspend one of the two proceedings. Where merger of a reissue application and an *ex parte* reexamination proceeding is ordered, the merged examination will be conducted in accordance with §§ 1.171 through 1.179, and the patent owner will be required to place and maintain the same claims in the reissue application and the *ex parte* reexamination proceeding during the pendency of the merged proceeding. The examiner's actions and responses by the patent owner in a merged proceeding will apply to both the reissue application and the *ex parte* reexamination proceeding and be physically entered into both files. Any *ex parte* reexamination proceeding merged with a reissue application shall be terminated by the grant of the reissued patent. For merger of a reissue application and an *inter partes* reexamination, see § 1.991.

(e) If a patent in the process of *ex parte* reexamination is or becomes involved in an interference, the Director may suspend the reexamination or the interference. The Director will not consider a request to suspend an interference unless a motion (§ 1.635) to suspend the interference has been presented to, and denied by, an administrative patent judge, and the request is filed within ten (10) days of a decision by an administrative patent judge denying the motion for suspension or such other time as the administrative patent judge may set. For concurrent *inter partes* reexamination and interference of a patent, see § 1.993.

[46 FR 29187, May 29, 1981, effective July 1, 1981; paras. (b) and (d), 47 FR 21753, May 19, 1982, effective July 1, 1982; paras. (b) & (e), 49 FR 48416, Dec. 12, 1984, 50 FR 23123, May 31, 1985, effective Feb. 11, 1985; para (a) revised, 65 FR 54604, Sept. 8, 2000, effective Nov. 7, 2000; revised, 65 FR 76756, Dec. 7, 2000, effective Feb. 5,

2001; paras. (b) & (e) revised, 68 FR 14332, Mar. 25, 2003, effective May 1, 2003]

## CERTIFICATE

### § 1.570 Issuance of *ex parte* reexamination certificate after *ex parte* reexamination proceedings.

(a) Upon the conclusion of *ex parte* reexamination proceedings, the Director will issue an *ex parte* reexamination certificate in accordance with 35 U.S.C. 307 setting forth the results of the *ex parte* reexamination proceeding and the content of the patent following the *ex parte* reexamination proceeding.

(b) An *ex parte* reexamination certificate will be issued in each patent in which an *ex parte* reexamination proceeding has been ordered under § 1.525 and has not been merged with any *inter partes* reexamination proceeding pursuant to § 1.989(a). Any statutory disclaimer filed by the patent owner will be made part of the *ex parte* reexamination certificate.

(c) The *ex parte* reexamination certificate will be mailed on the day of its date to the patent owner at the address as provided for in § 1.33(c). A copy of the *ex parte* reexamination certificate will also be mailed to the requester of the *ex parte* reexamination proceeding.

(d) If an *ex parte* reexamination certificate has been issued which cancels all of the claims of the patent, no further Office proceedings will be conducted with that patent or any reissue applications or any reexamination requests relating thereto.

(e) If the *ex parte* reexamination proceeding is terminated by the grant of a reissued patent as provided in § 1.565(d), the reissued patent will constitute the *ex parte* reexamination certificate required by this section and 35 U.S.C. 307.

(f) A notice of the issuance of each *ex parte* reexamination certificate under this section will be published in the *Official Gazette* on its date of issuance.

[46 FR 29187, May 29, 1981, effective July 1, 1981; para. (e), 47 FR 21753, May 19, 1982, effective July 1, 1982; revised, 65 FR 76756, Dec. 7, 2000, effective Feb. 5, 2001; para. (a) revised, 68 FR 14332, Mar. 25, 2003, effective May 1, 2003]

## Subpart E — Interferences

### § 1.601 Scope of rules, definitions.

This subpart governs the procedure in patent interferences in the Patent and Trademark Office. This subpart shall be construed to secure the just, speedy, and inexpensive determination of every interference. For the meaning of terms in the Federal Rules of Evidence as applied to interferences, see § 1.671(c). Unless otherwise clear from the context, the following definitions apply to this subpart:

(a) *Additional discovery* is discovery to which a party may be entitled under § 1.687 in addition to discovery to which the party is entitled as a matter of right under § 1.673(a) and (b).

(b) *Affidavit* means affidavit, declaration under § 1.68, or statutory declaration under 28 U.S.C. § 1746. A transcript of an *ex parte* deposition may be used as an affidavit.

(c) *Board* means the Board of Patent Appeals and Interferences.

(d) *Case-in-chief* means that portion of a party's case where the party has the burden of going forward with evidence.

(e) *Case-in-rebuttal* means that portion of a party's case where the party presents evidence in rebuttal to the case-in-chief of another party.

(f) A *count* defines the interfering subject matter between two or more applications or between one or more applications and one or more patents. When there is more than one count, each count shall define a separate patentable invention. Any claim of an application or patent that is designated to correspond to a count is a claim involved in the interference within the meaning of 35 U.S.C. 135(a). A claim of a patent or application that is designated to correspond to a count and is identical to the count is said to correspond exactly to the count. A claim of a patent or application that is designated to correspond to a count but is not identical to the count is said to correspond substantially to the count. When a count is broader in scope than all claims which correspond to the count, the count is a phantom count.

(g) The *effective filing date* of an application is the filing date of an earlier application, benefit of which is accorded to the application under 35 U.S.C.

119, 120, 121, or 365 or, if no benefit is accorded, the filing date of the application. The effective filing date of a patent is the filing date of an earlier application, benefit of which is accorded to the patent under 35 U.S.C. 119, 120, 121, or 365 or, if no benefit is accorded, the filing date of the application which issued as the patent.

(h) In the case of an application, *filing date* means the filing date assigned to the application. In the case of a patent, "filing date" means the filing date assigned to the application which issued as the patent.

(i) An *interference* is a proceeding instituted in the Patent and Trademark Office before the Board to determine any question of patentability and priority of invention between two or more parties claiming the same patentable invention. An interference may be declared between two or more pending applications naming different inventors when, in the opinion of an examiner, the applications contain claims for the same patentable invention. An interference may be declared between one or more pending applications and one or more unexpired patents naming different inventors when, in the opinion of an examiner, any application and any unexpired patent contain claims for the same patentable invention.

(j) An *interference-in-fact* exists when at least one claim of a party that is designated to correspond to a count and at least one claim of an opponent that is designated to correspond to the count define the same patentable invention.

(k) A *lead* attorney or agent is a registered attorney or agent of record who is primarily responsible for prosecuting an interference on behalf of a party and is the attorney or agent whom an administrative patent judge may contact to set times and take other action in the interference.

(l) A *party* is an applicant or patentee involved in the interference or a legal representative or an assignee of record in the Patent and Trademark Office of an applicant or patentee involved in an interference. Where acts of a party are normally performed by an attorney or agent, "party" may be construed to mean the attorney or agent. An inventor is the individual named as inventor in an application involved in an interference or the individual named as inventor in a patent involved in an interference.

(m) A *senior party* is the party with the earliest effective filing date as to all counts or, if there is no party with the earliest effective filing date as to all counts, the party with the earliest filing date. A *junior party* is any other party.

(n) Invention “A” is the *same patentable invention* as an invention “B” when invention “A” is the same as (35 U.S.C. 102) or is obvious (35 U.S.C. 103) in view of invention “B” assuming invention “B” is prior art with respect to invention “A”. Invention “A” is a *separate patentable invention* with respect to invention “B” when invention “A” is new (35 U.S.C. 102) and non-obvious (35 U.S.C. 103) in view of invention “B” assuming invention “B” is prior art with respect to invention “A”.

(o) *Sworn* means sworn or affirmed.

(p) *United States* means the United States of America, its territories and possessions.

(q) A *final decision* is a decision awarding judgment as to all counts. An *interlocutory order* is any other action taken by an administrative patent judge or the Board in an interference, including the notice declaring an interference.

(r) *NAFTA country* means NAFTA country as defined in section 2(4) of the North American Free Trade Agreement Implementation Act, Pub. L. 103-182, 107 Stat. 2060 (19 U.S.C. 3301).

(s) *WTO member country* means WTO member country as defined in section 2(10) of the Uruguay Round Agreements Act, Pub. L. 103-465, 108 Stat. 4813 (19 U.S.C. 3501).

[49 FR 48416, Dec. 12, 1984, effective Feb. 11, 1985; 50 FR 23123, May 31, 1985; para. (q) added, 58 FR 49432, Sept. 23, 1993, effective Oct. 25, 1993; paras. (f), (g), (j)-(n), and (q) revised, paras. (r) and (s) added, 60 FR 14488, Mar. 17, 1995, effective Apr. 21, 1995; para. (f) revised, 65 FR 56792, Sept. 20, 2000, effective Oct. 20, 2000; (adopted as final, 65 FR 70489, Nov. 24, 2000)]

### § 1.602 Interest in applications and patents involved in an interference.

(a) Unless good cause is shown, an interference shall not be declared or continued between (1) applications owned by a single party or (2) applications and an unexpired patent owned by a single party.

(b) The parties, within 20 days after an interference is declared, shall notify the Board of any and all

right, title, and interest in any application or patent involved or relied upon in the interference unless the right, title, and interest is set forth in the notice declaring the interference.

(c) If a change of any right, title, and interest in any application or patent involved or relied upon in the interference occurs after notice is given declaring the interference and before the time expires for seeking judicial review of a final decision of the Board, the parties shall notify the Board of the change within 20 days after the change.

[49 FR 48416, Dec. 12, 1984, added effective Feb. 11, 1985; para. (c) revised, 60 FR 14488, Mar. 17, 1995, effective Apr. 21, 1995]

### § 1.603 Interference between applications; subject matter of the interference.

Before an interference is declared between two or more applications, the examiner must be of the opinion that there is interfering subject matter claimed in the applications which is patentable to each applicant subject to a judgment in the interference. The interfering subject matter shall be defined by one or more counts. Each application must contain, or be amended to contain, at least one claim that is patentable over the prior art and corresponds to each count. All claims in the applications which define the same patentable invention as a count shall be designated to correspond to the count.

[Added, 49 FR 48416, Dec. 12, 1984, effective Feb. 11, 1985; revised, 60 FR 14488, Mar. 17, 1995, effective Apr. 21, 1995]

### § 1.604 Request for interference between applications by an applicant.

(a) An applicant may seek to have an interference declared with an application of another by,

(1) Suggesting a proposed count and presenting at least one claim corresponding to the proposed count or identifying at least one claim in its application that corresponds to the proposed count,

(2) Identifying the other application and, if known, a claim in the other application which corresponds to the proposed count, and

(3) Explaining why an interference should be declared.

(b) When an applicant presents a claim known to the applicant to define the same patentable invention claimed in a pending application of another, the applicant shall identify that pending application, unless the claim is presented in response to a suggestion by the examiner. The examiner shall notify the Director of any instance where it appears an applicant may have failed to comply with the provisions of this paragraph.

[49 FR 48416, Dec. 12, 1984, added effective Feb. 11, 1985; para. (a)(1) revised, 60 FR 14488, Mar. 17, 1995, effective Apr. 21, 1995; para. (b) revised, 68 FR 14332, Mar. 25, 2003, effective May 1, 2003]

#### § 1.605 Suggestion of claim to applicant by examiner.

(a) If no claim in an application is drawn to the same patentable invention claimed in another application or patent, the examiner may suggest that an applicant present a claim drawn to an invention claimed in another application or patent for the purpose of an interference with another application or a patent. The applicant to whom the claim is suggested shall amend the application by presenting the suggested claim within a time specified by the examiner, not less than one month. Failure or refusal of an applicant to timely present the suggested claim shall be taken without further action as a disclaimer by the applicant of the invention defined by the suggested claim. At the time the suggested claim is presented, the applicant may also call the examiner's attention to other claims already in the application or presented with the suggested claim and explain why the other claims would be more appropriate to be designated to correspond to a count in any interference which may be declared.

(b) The suggestion of a claim by the examiner for the purpose of an interference will not stay the period for response to any outstanding Office action. When a suggested claim is timely presented, *ex parte* proceedings in the application will be stayed pending a determination of whether an interference will be declared.

[49 FR 48416, Dec. 12, 1984, added effective Feb. 11, 1985; para. (a) revised, 60 FR 14488, Mar. 17, 1995, effective Apr. 21, 1995]

#### § 1.606 Interference between an application and a patent; subject matter of the interference.

Before an interference is declared between an application and an unexpired patent, an examiner must determine that there is interfering subject matter claimed in the application and the patent which is patentable to the applicant subject to a judgment in the interference. The interfering subject matter will be defined by one or more counts. The application must contain, or be amended to contain, at least one claim that is patentable over the prior art and corresponds to each count. The claim in the application need not be, and most often will not be, identical to a claim in the patent. All claims in the application and patent which define the same patentable invention as a count shall be designated to correspond to the count.

[49 FR 48416, Dec. 12, 1984, added effective Feb. 11, 1985; revised, 60 FR 14488, Mar. 17, 1995, effective Apr. 21, 1995; revised, 65 FR 56792, Sept. 20, 2000, effective Oct. 20, 2000 (adopted as final, 65 FR 70489, Nov. 24, 2000)]

#### § 1.607 Request by applicant for interference with patent.

(a) An applicant may seek to have an interference declared between an application and an unexpired patent by,

- (1) Identifying the patent,
- (2) Presenting a proposed count,
- (3) Identifying at least one claim in the patent corresponding to the proposed count,
- (4) Presenting at least one claim corresponding to the proposed count or identifying at least one claim already pending in its application that corresponds to the proposed count, and, if any claim of the patent or application identified as corresponding to the proposed count does not correspond exactly to the proposed count, explaining why each such claim corresponds to the proposed count, and
- (5) Applying the terms of any application claim,
  - (i) Identified as corresponding to the count, and
  - (ii) Not previously in the application to the disclosure of the application.
- (6) Explaining how the requirements of 35 U.S.C. 135(b) are met, if the claim presented or

identified under paragraph (a)(4) of this section was not present in the application until more than one year after the issue date of the patent.

(b) When an applicant seeks an interference with a patent, examination of the application, including any appeal to the Board, shall be conducted with special dispatch within the Patent and Trademark Office. The examiner shall determine whether there is interfering subject matter claimed in the application and the patent which is patentable to the applicant subject to a judgment in an interference. If the examiner determines that there is any interfering subject matter, an interference will be declared. If the examiner determines that there is no interfering subject matter, the examiner shall state the reasons why an interference is not being declared and otherwise act on the application.

(c) When an applicant presents a claim which corresponds exactly or substantially to a claim of a patent, the applicant shall identify the patent and the number of the patent claim, unless the claim is presented in response to a suggestion by the examiner. The examiner shall notify the Director of any instance where an applicant fails to identify the patent.

(d) A notice that an applicant is seeking to provoke an interference with a patent will be placed in the file of the patent and a copy of the notice will be sent to the patentee. The identity of the applicant will not be disclosed unless an interference is declared. If a final decision is made not to declare an interference, a notice to that effect will be placed in the patent file and will be sent to the patentee.

[49 FR 48416, Dec. 12, 1984, added effective Feb. 11, 1985; para. (a) amended, 53 FR 23735, June 23, 1988, effective Sept. 12, 1988; para. (a)(5)(i) revised, 58 FR 54504, Oct. 22, 1993, effective Jan. 3, 1994; para. (a)(4) revised, para. (a)(6) added, 60 FR 14488, Mar. 17, 1995, effective Apr. 21, 1995; para. (c) revised, 68 FR 14332, Mar. 25, 2003, effective May 1, 2003]

**§ 1.608 Interference between an application and a patent; prima facie showing by applicant.**

(a) When the effective filing date of an application is three months or less after the effective filing date of a patent, before an interference will be

declared, either the applicant or the applicant's attorney or agent of record shall file a statement alleging that there is a basis upon which the applicant is entitled to a judgment relative to the patentee.

(b) When the effective filing date of an application is more than three months after the effective filing date of a patent, the applicant, before an interference will be declared, shall file evidence which may consist of patents or printed publications, other documents, and one or more affidavits which demonstrate that applicant is *prima facie* entitled to a judgment relative to the patentee and an explanation stating with particularity the basis upon which the applicant is *prima facie* entitled to the judgment. Where the basis upon which an applicant is entitled to judgment relative to a patentee is priority of invention, the evidence shall include affidavits by the applicant, if possible, and one or more corroborating witnesses, supported by documentary evidence, if available, each setting out a factual description of acts and circumstances performed or observed by the affiant, which collectively would *prima facie* entitle the applicant to judgment on priority with respect to the effective filing date of the patent. To facilitate preparation of a record (§ 1.653(g)) for final hearing, an applicant should file affidavits on paper which is 21.8 by 27.9 cm. (8 1/2 x 11 inches). The significance of any printed publication or other document which is self-authenticating within the meaning of Rule 902 of the Federal Rules of Evidence or § 1.671(d) and any patent shall be discussed in an affidavit or the explanation. Any printed publication or other document which is not self-authenticating shall be authenticated and discussed with particularity in an affidavit. Upon a showing of good cause, an affidavit may be based on information and belief. If an examiner finds an application to be in condition for declaration of an interference, the examiner will consider the evidence and explanation only to the extent of determining whether a basis upon which the application would be entitled to a judgment relative to the patentee is alleged and, if a basis is alleged, an interference may be declared.

[49 FR 48416, Dec. 12, 1984, added effective Feb. 11, 1985; revised, 60 FR 14488, Mar. 17, 1995, effective Apr. 21, 1995]

**§ 1.609 [Reserved]**

[49 FR 48416, Dec. 12, 1984, added effective Feb. 11, 1985; paras. (b)(1)-(b)(3) revised, 60 FR 14488, Mar. 17, 1995, effective Apr. 21, 1995; removed and reserved, 65 FR 56792, Sept. 20, 2000, effective Oct. 20, 2000]

**§ 1.610 Assignment of interference to administrative patent judge, time period for completing interference.**

(a) Each interference will be declared by an administrative patent judge who may enter all interlocutory orders in the interference, except that only the Board shall hear oral argument at final hearing, enter a decision under § 1.617, 1.640(e), 1.652, 1.656(i) or 1.658, or enter any other order which terminates the interference.

(b) As necessary, another administrative patent judge may act in place of the one who declared the interference. At the discretion of the administrative patent judge assigned to the interference, a panel consisting of two or more members of the Board may enter interlocutory orders.

(c) Unless otherwise provided in this subpart, times for taking action by a party in the interference will be set on a case-by-case basis by the administrative patent judge assigned to the interference. Times for taking action shall be set and the administrative patent judge shall exercise control over the interference such that the pendency of the interference before the Board does not normally exceed two years.

(d) An administrative patent judge may hold a conference with the parties to consider simplification of any issues, the necessity or desirability of amendments to counts, the possibility of obtaining admissions of fact and genuineness of documents which will avoid unnecessary proof, any limitations on the number of expert witnesses, the time and place for conducting a deposition (§ 1.673(g)), and any other matter as may aid in the disposition of the interference. After a conference, the administrative patent judge may enter any order which may be appropriate.

(e) The administrative patent judge may determine a proper course of conduct in an interference for any situation not specifically covered by this part.

[49 FR 48416, Dec. 12, 1984, added effective Feb. 11, 1985; revised, 60 FR 14488, Mar. 17, 1995, effective Apr. 21, 1995]

**§ 1.611 Declaration of interference.**

(a) Notice of declaration of an interference will be sent to each party.

(b) When a notice of declaration is returned to the Patent and Trademark Office undelivered, or in any other circumstance where appropriate, an administrative patent judge may send a copy of the notice to a patentee named in a patent involved in an interference or the patentee's assignee of record in the Patent and Trademark Office or order publication of an appropriate notice in the *Official Gazette*.

(c) The notice of declaration shall specify:

(1) The name and residence of each party involved in the interference;

(2) The name and address of record of any attorney or agent of record in any application or patent involved in the interference;

(3) The name of any assignee of record in the Patent and Trademark Office;

(4) The identity of any application or patent involved in the interference;

(5) Where a party is accorded the benefit of the filing date of an earlier application, the identity of the earlier application;

(6) The count or counts and, if there is more than one count, the examiner's explanation why the counts define different patentable inventions;

(7) The claim or claims of any application or any patent which correspond to each count;

(8) The examiner's explanation as to why each claim designated as corresponding to a count is directed to the same patentable invention as the count and why each claim designated as not corresponding to any count is not directed to the same patentable invention as any count; and

(9) The order of the parties.

(d) The notice of declaration may also specify the time for:

(1) Filing a preliminary statement as provided in § 1.621(a);

(2) Serving notice that a preliminary statement has been filed as provided in § 1.621(b); and

(3) Filing preliminary motions authorized by § 1.633.

(e) Notice may be given in the *Official Gazette* that an interference has been declared involving a patent.

[49 FR 48416, Dec. 12, 1984, effective Feb. 11, 1985; 50 FR 23123, May 31, 1985; paras. (b), (c)(6), (c)(7), (c)(8), (c)(9) & (d) revised, 60 FR 14488, Mar. 17, 1995, effective Apr. 21, 1995]

### § 1.612 Access to applications.

(a) After an interference is declared, each party shall have access to and may obtain copies of the files of any application set out in the notice declaring the interference, except for affidavits filed under § 1.131 and any evidence and explanation under § 1.608 filed separate from an amendment. A party seeking access to any abandoned or pending application referred to in the opponent's involved application or access to any pending application referred to in the opponent's patent must file a motion under § 1.635. See § 1.11(e) concerning public access to interference files.

(b) After preliminary motions under § 1.633 are decided (§ 1.640(b)), each party shall have access to and may obtain copies of any affidavit filed under § 1.131 and any evidence and explanation filed under § 1.608 in any application set out in the notice declaring the interference.

(c) Any evidence and explanation filed under § 1.608 in the file of any application identified in the notice declaring the interference shall be served when required by § 1.617(b).

(d) The parties at any time may agree to exchange copies of papers in the files of any application identified in the notice declaring the interference.

[49 FR 48416, Dec. 12, 1984, effective Feb. 11, 1985; 50 FR 23124, May 31, 1985; para. (a) amended, 53 FR 23735, June 23, 1988, effective Sept. 12, 1988; para. (a) revised, 60 FR 14488, Mar. 17, 1995, effective Apr. 21, 1995]

### § 1.613 Lead attorney, same attorney representing different parties in an interference, withdrawal of attorney or agent.

(a) Each party may be required to designate one attorney or agent of record as the lead attorney or agent.

(b) The same attorney or agent or members of the same firm of attorneys or agents may not represent two or more parties in an interference except as may be permitted under this chapter.

(c) An administrative patent judge may make necessary inquiry to determine whether an attorney or

agent should be disqualified from representing a party in an interference. If an administrative patent judge is of the opinion that an attorney or agent should be disqualified, the administrative patent judge shall refer the matter to the Director. The Director will make a final decision as to whether any attorney or agent should be disqualified.

(d) No attorney or agent of record in an interference may withdraw as attorney or agent of record except with the approval of an administrative patent judge and after reasonable notice to the party on whose behalf the attorney or agent has appeared. A request to withdraw as attorney or agent of record in an interference shall be made by motion (§ 1.635).

[49 FR 48416, Dec. 12, 1984, added effective Feb. 11, 1985; paras. (c) & (d) revised, 60 FR 14488, Mar. 17, 1995, effective Apr. 21, 1995; para. (c) revised, 68 FR 14332, Mar. 25, 2003, effective May 1, 2003]

### § 1.614 Jurisdiction over interference.

(a) The Board acquires jurisdiction over an interference when the interference is declared under § 1.611.

(b) When the interference is declared the interference is a contested case within the meaning of 35 U.S.C. 24.

(c) The examiner shall have jurisdiction over any pending application until the interference is declared. An administrative patent judge may for a limited purpose restore jurisdiction to the examiner over any application involved in the interference.

[49 FR 48416, Dec. 12, 1984, added effective Feb. 11, 1985; paras. (a) & (c) revised, 60 FR 14488, Mar. 17, 1995, effective Apr. 21, 1995]

### § 1.615 Suspension of *ex parte* prosecution.

(a) When an interference is declared, *ex parte* prosecution of an application involved in the interference is suspended. Amendments and other papers related to the application received during pendency of the interference will not be entered or considered in the interference without the consent of an administrative patent judge.

(b) *Ex parte* prosecution as to specified matters may be continued concurrently with the interference with the consent of the administrative patent judge.

[49 FR 48416, Dec. 12, 1984, added effective Feb. 11, 1985; 50 FR 23124, May 31, 1985; revised, 60 FR 14488, Mar. 17, 1995, effective Apr. 21, 1995]

**§ 1.616 Sanctions for failure to comply with rules or order or for taking and maintaining a frivolous position.**

(a) An administrative patent judge or the Board may impose an appropriate sanction against a party who fails to comply with the regulations of this part or any order entered by an administrative patent judge or the Board. An appropriate sanction may include among others entry of an order:

- (1) Holding certain facts to have been established in the interference;
- (2) Precluding a party from filing a paper;
- (3) Precluding a party from presenting or contesting a particular issue;
- (4) Precluding a party from requesting, obtaining, or opposing discovery;
- (5) Awarding compensatory expenses and/or compensatory attorney fees; or
- (6) Granting judgment in the interference.

(b) An administrative patent judge or the Board may impose a sanction, including a sanction in the form of compensatory expenses and/or compensatory attorney fees, against a party for taking and maintaining a frivolous position in papers filed in the interference.

(c) To the extent that an administrative patent judge or the Board has authorized a party to compel the taking of testimony or the production of documents or things from an individual or entity located in a NAFTA country or a WTO member country concerning knowledge, use, or other activity relevant to proving or disproving a date of invention (§ 1.671(h)), but the testimony, documents or things have not been produced for use in the interference to the same extent as such information could be made available in the United States, the administrative patent judge or the Board shall draw such adverse inferences as may be appropriate under the circumstances, or take such other action permitted by statute, rule, or regulation, in favor of the party that requested the information in the interference, including imposition of appropriate sanctions under paragraph (a) of this section.

(d) A party may file a motion (§ 1.635) for entry of an order imposing sanctions, the drawing of

adverse inferences or other action under paragraph (a), (b) or (c) of this section. Where an administrative patent judge or the Board on its own initiative determines that a sanction, adverse inference or other action against a party may be appropriate under paragraph (a), (b) or (c) of this section, the administrative patent judge or the Board shall enter an order for the party to show cause why the sanction, adverse inference or other action is not appropriate. The Board shall take action in accordance with the order unless, within 20 days after the date of the order, the party files a paper which shows good cause why the sanction, adverse inference or other action would not be appropriate.

[49 FR 48416, Dec. 12, 1984, added effective Feb. 11, 1985; 50 FR 23124, May 31, 1985; revised, 60 FR 14488, Mar. 17, 1995, effective Apr. 21, 1995]

**§ 1.617 Summary judgment against applicant.**

(a) An administrative patent judge shall review any evidence filed by an applicant under § 1.608(b) to determine if the applicant is *prima facie* entitled to a judgment relative to the patentee. If the administrative patent judge determines that the evidence shows the applicant is *prima facie* entitled to a judgment relative to the patentee, the interference shall proceed in the normal manner under the regulations of this part. If in the opinion of the administrative patent judge the evidence fails to show that the applicant is *prima facie* entitled to a judgment relative to the patentee, the administrative patent judge shall, concurrently with the notice declaring the interference, enter an order stating the reasons for the opinion and directing the applicant, within a time set in the order, to show cause why summary judgment should not be entered against the applicant.

(b) The applicant may file a response to the order, which may include an appropriate preliminary motion under § 1.633(c), (f) or (g), and state any reasons why summary judgment should not be entered. Any request by the applicant for a hearing before the Board shall be made in the response. Additional evidence shall not be presented by the applicant or considered by the Board unless the applicant shows good cause why any additional evidence was not initially presented with the evidence filed under § 1.608(b). At the time an applicant files a response, the applicant



shall serve a copy of any evidence filed under § 1.608(b) and this paragraph.

(c) If a response is not timely filed by the applicant, the Board shall enter a final decision granting summary judgment against the applicant.

(d) If a response is timely filed by the applicant, all opponents may file a statement and may oppose any preliminary motion filed under § 1.633(c), (f) or (g) by the applicant within a time set by the administrative patent judge. The statement may set forth views as to why summary judgment should be granted against the applicant, but the statement shall be limited to discussing why all the evidence presented by the applicant does not overcome the reasons given by the administrative patent judge for issuing the order to show cause. Except as required to oppose a motion under § 1.633(c), (f) or (g) by the applicant, evidence shall not be filed by any opponent. An opponent may not request a hearing.

(e) Within a time authorized by the administrative patent judge, an applicant may file a reply to any statement or opposition filed by any opponent.

(f) When more than two parties are involved in an interference, all parties may participate in summary judgment proceedings under this section.

(g) If a response by the applicant is timely filed, the administrative patent judge or the Board shall decide whether the evidence submitted under § 1.608(b) and any additional evidence properly submitted under paragraphs (b) and (e) of this section shows that the applicant is *prima facie* entitled to a judgment relative to the patentee. If the applicant is not *prima facie* entitled to a judgment relative to the patentee, the Board shall enter a final decision granting summary judgment against the applicant. Otherwise, an interlocutory order shall be entered authorizing the interference to proceed in the normal manner under the regulations of this subpart.

(h) Only an applicant who filed evidence under § 1.608(b) may request a hearing. If that applicant requests a hearing, the Board may hold a hearing prior to entry of a decision under paragraph (g) of this section. The administrative patent judge shall set a date and time for the hearing. Unless otherwise ordered by the administrative patent judge or the Board, the applicant and any opponent will each be entitled to no more than 30 minutes of oral argument at the hearing.

[49 FR 48416, Dec. 12, 1984, added effective Feb. 11, 1985; 50 FR 23124, May 31, 1985; paras. (a), (b), (d), (e), (g), & (h) revised, 60 FR 14488, Mar. 17, 1995, effective Apr. 21, 1995]

#### § 1.618 Return of unauthorized papers.

(a) An administrative patent judge or the Board shall return to a party any paper presented by the party when the filing of the paper is not authorized by, or is not in compliance with the requirements of, this subpart. Any paper returned will not thereafter be considered in the interference. A party may be permitted to file a corrected paper under such conditions as may be deemed appropriate by an administrative patent judge or the Board.

(b) When presenting a paper in an interference, a party shall not submit with the paper a copy of a paper previously filed in the interference.

[49 FR 48416, Dec. 12, 1984, added effective Feb. 11, 1985; amended, 60 FR 14488, Mar. 17, 1995, effective Apr. 21, 1995]

#### § 1.621 Preliminary statement, time for filing, notice of filing.

(a) Within the time set for filing preliminary motions under § 1.633, each party may file a preliminary statement. The preliminary statement may be signed by any individual having knowledge of the facts recited therein or by an attorney or agent of record.

(b) When a party files a preliminary statement, the party shall also simultaneously file and serve on all opponents in the interference a notice stating that a preliminary statement has been filed. A copy of the preliminary statement need not be served until ordered by the administrative patent judge.

[49 FR 48416, Dec. 12, 1984, added effective Feb. 11, 1985; 50 FR 23124, May 31, 1985; revised, 60 FR 14488, Mar. 17, 1995, effective Apr. 21, 1995]

#### § 1.622 Preliminary statement, who made invention, where invention made.

(a) A party's preliminary statement must identify the inventor who made the invention defined by each count and must state on behalf of the inventor the facts required by paragraph (a) of §§ 1.623, 1.624, and 1.625 as may be appropriate. When an inventor

identified in the preliminary statement is not an inventor named in the party's application or patent, the party shall file a motion under § 1.634 to correct inventorship.

(b) The preliminary statement shall state whether the invention was made in the United States, a NAFTA country (and, if so, which NAFTA country), a WTO member country (and, if so, which WTO member country), or in a place other than the United States, a NAFTA country, or a WTO member country. If made in a place other than the United States, a NAFTA country, or a WTO member country, the preliminary statement shall state whether the party is entitled to the benefit of 35 U.S.C. 104(a)(2).

[49 FR 48416, Dec. 12, 1984, added effective Feb. 11, 1985; para. (b) revised, 60 FR 14488, Mar. 17, 1995, effective Apr. 21, 1995]

**§ 1.623 Preliminary statement; invention made in United States, a NAFTA country, or a WTO member country.**

(a) When the invention was made in the United States, a NAFTA country, or a WTO member country, or a party is entitled to the benefit of 35 U.S.C. 104(a)(2), the preliminary statement must state the following facts as to the invention defined by each count:

- (1) The date on which the first drawing of the invention was made.
- (2) The date on which the first written description of the invention was made.
- (3) The date on which the invention was first disclosed by the inventor to another person.
- (4) The date on which the invention was first conceived by the inventor.
- (5) The date on which the invention was first actually reduced to practice. If the invention was not actually reduced to practice by or on behalf of the inventor prior to the party's filing date, the preliminary statement shall so state.
- (6) The date after the inventor's conception of the invention when active exercise of reasonable diligence toward reducing the invention to practice began.

(b) If a party intends to prove derivation, the preliminary statement must also comply with § 1.625.

(c) When a party alleges under paragraph (a)(1) of this section that a drawing was made, a copy of the

first drawing shall be filed with and identified in the preliminary statement. When a party alleges under paragraph (a)(2) of this section that a written description of the invention was made, a copy of the first written description shall be filed with and identified in the preliminary statement. See § 1.628(b) when a copy of the first drawing or written description cannot be filed with the preliminary statement.

[49 FR 48416, Dec. 12, 1984, added effective Feb. 11, 1985; para. (a) revised, 60 FR 14488, Mar. 17, 1995, effective Apr. 21, 1995]

**§ 1.624 Preliminary statement; invention made in a place other than the United States, a NAFTA country, or a WTO member country.**

(a) When the invention was made in a place other than the United States, a NAFTA country, or a WTO member country and a party intends to rely on introduction of the invention into the United States, a NAFTA country, or a WTO member country, the preliminary statement must state the following facts as to the invention defined by each count:

- (1) The date on which a drawing of the invention was first introduced into the United States, a NAFTA country, or a WTO member country.
- (2) The date on which a written description of the invention was first introduced into the United States, a NAFTA country, or a WTO member country.
- (3) The date on which the invention was first disclosed to another person in the United States, a NAFTA country, or a WTO member country.
- (4) The date on which the inventor's conception of the invention was first introduced into the United States, a NAFTA country, or a WTO member country.
- (5) The date on which an actual reduction to practice of the invention was first introduced into the United States, a NAFTA country, or a WTO member country. If an actual reduction to practice of the invention was not introduced into the United States, a NAFTA country, or a WTO member country, the preliminary amendment shall so state.

(6) The date after introduction of the inventor's conception into the United States, a NAFTA country, or a WTO member country when active exercise of reasonable diligence in the United States, a

NAFTA country, or a WTO member country toward reducing the invention to practice began.

(b) If a party intends to prove derivation, the preliminary statement must also comply with § 1.625.

(c) When a party alleges under paragraph (a)(1) of this section that a drawing was introduced into the United States, a NAFTA country, or a WTO member country, a copy of that drawing shall be filed with and identified in the preliminary statement. When a party alleges under paragraph (a)(2) of this section that a written description of the invention was introduced into the United States, a NAFTA country, or a WTO member country, a copy of that written description shall be filed with and identified in the preliminary statement. See § 1.628(b) when a copy of the first drawing or first written description introduced in the United States, a NAFTA country, or a WTO member country cannot be filed with the preliminary statement.

[49 FR 48416, Dec. 12, 1984, added effective Feb. 11, 1985; 50 FR 23124, May 31, 1985; para. (a) & (c) revised, 60 FR 14488, Mar. 17, 1995, effective Apr. 21, 1995]

### § 1.625 Preliminary statement; derivation by an opponent

(a) When a party intends to prove derivation by an opponent from the party, the preliminary statement must state the following as to the invention defined by each count:

- (1) The name of the opponent.
- (2) The date on which the first drawing of the invention was made.
- (3) The date on which the first written description of the invention was made.
- (4) The date on which the invention was first disclosed by the inventor to another person.
- (5) The date on which the invention was first conceived by the inventor.
- (6) The date on which the invention was first communicated to the opponent.

(b) If a party intends to prove priority, the preliminary statement must also comply with § 1.623 or § 1.624.

(c) When a party alleges under paragraph (a)(2) of this section that a drawing was made, a copy of the

first drawing shall be filed with and identified in the preliminary statement. When a party alleges under paragraph (a)(3) of this section that a written description of the invention was made, a copy of the first written description shall be filed with and identified in the preliminary statement. See § 1.628(b) when a first drawing or first written description cannot be filed with the preliminary statement.

[49 FR 48416, Dec. 12, 1984, added effective Feb. 11, 1985; para. (a) revised, 60 FR 14488, Mar. 17, 1995, effective Apr. 21, 1995]

### § 1.626 Preliminary statement; earlier application.

When a party does not intend to present evidence to prove a conception or an actual reduction to practice and the party intends to rely solely on the filing date of an earlier filed application to prove a constructive reduction to practice, the preliminary statement may so state and identify the earlier filed application with particularity.

[49 FR 48416, Dec. 12, 1984, added effective Feb. 11, 1985; revised, 60 FR 14488, Mar. 17, 1995, effective Apr. 21, 1995]

### § 1.627 Preliminary statement; sealing before filing, opening of statement.

(a) The preliminary statement and copies of any drawing or written description shall be filed in a sealed envelope bearing only the name of the party filing the statement and the style (*e.g.*, Jones v. Smith) and number of the interference. The sealed envelope should contain only the preliminary statement and copies of any drawing or written description. If the preliminary statement is filed through the mail, the sealed envelope should be enclosed in an outer envelope addressed in accordance with § 1.1(a)(1)(iii).

(b) A preliminary statement may be opened only at the direction of an administrative patent judge.

[49 FR 48416, Dec. 12, 1984, added effective Feb. 11, 1985; para. (b) revised, 60 FR 14488, Mar. 17, 1995, effective Apr. 21, 1995; para. (a) revised, 68 FR 14332, Mar. 25, 2003, effective May 1, 2003]

**§ 1.628 Preliminary statement; correction of error.**

(a) A material error arising through inadvertence or mistake in connection with a preliminary statement or drawings or a written description submitted therewith or omitted therefrom may be corrected by a motion (§ 1.635) for leave to file a corrected statement. The motion shall be supported by an affidavit stating the date the error was first discovered, shall be accompanied by the corrected statement and shall be filed as soon as practical after discovery of the error. If filed on or after the date set by the administrative patent judge for service of preliminary statements, the motion shall also show that correction of the error is essential to the interest of justice.

(b) When a party cannot attach a copy of a drawing or a written description to the party's preliminary statement as required by § 1.623(c), § 1.624(c) or § 1.625(c), the party shall show good cause and explain in the preliminary statement why a copy of the drawing or written description cannot be attached to the preliminary statement and shall attach to the preliminary statement the earliest drawing or written description made in or introduced into the United States, a NAFTA country, or a WTO member country which is available. The party shall file a motion (§ 1.635) to amend its preliminary statement promptly after the first drawing, first written description, or drawing or written description first introduced into the United States, a NAFTA country, or a WTO member country becomes available. A copy of the drawing or written description may be obtained, where appropriate, by a motion (§ 1.635) for additional discovery under § 1.687 or during a testimony period.

[49 FR 48416, Dec. 12, 1984, added effective Feb. 11, 1985; revised, 60 FR 14488, Mar. 17, 1995, effective Apr. 21, 1995]

**§ 1.629 Effect of preliminary statement.**

(a) A party shall be strictly held to any date alleged in the preliminary statement. Doubts as to definiteness or sufficiency of any allegation in a preliminary statement or compliance with formal requirements will be resolved against the party filing the statement by restricting the party to its effective

filing date or to the latest date of a period alleged in the preliminary statement, as may be appropriate. A party may not correct a preliminary statement except as provided by § 1.628.

(b) Evidence which shows that an act alleged in the preliminary statement occurred prior to the date alleged in the statement shall establish only that the act occurred as early as the date alleged in the statement.

(c) If a party does not file a preliminary statement, the party:

(1) Shall be restricted to the party's effective filing date and

(2) Will not be permitted to prove that:

(i) The party made the invention prior to the party's filing date or

(ii) Any opponent derived the invention from the party.

(d) If a party files a preliminary statement which contains an allegation of a date of first drawing or first written description and the party does not file a copy of the first drawing or written description with the preliminary statement as required by § 1.623(c), § 1.624(c), or § 1.625(c), the party will be restricted to the party's effective filing date as to that allegation unless the party complies with § 1.628(b). The content of any drawing or written description submitted with a preliminary statement will not normally be evaluated or considered by the Board.

(e) A preliminary statement shall not be used as evidence on behalf of the party filing the statement.

[49 FR 48416, Dec. 12, 1984, added effective Feb. 11, 1985; paras. (a), (c)(1) & (d) revised, 60 FR 14488, Mar. 17, 1995, effective Apr. 21, 1995]

**§ 1.630 Reliance on earlier application.**

A party shall not be entitled to rely on the filing date of an earlier filed application unless the earlier application is identified (§ 1.611(c)(5)) in the notice declaring the interference or the party files a preliminary motion under § 1.633 seeking the benefit of the filing date of the earlier application.

[49 FR 48416, Dec. 12, 1984, added effective Feb. 11, 1985; revised, 60 FR 14488, Mar. 17, 1995, effective Apr. 21, 1995]

**§ 1.631 Access to preliminary statement, service of preliminary statement.**

(a) Unless otherwise ordered by an administrative patent judge, concurrently with entry of a decision on preliminary motions filed under § 1.633 any preliminary statement filed under § 1.621(a) shall be opened to inspection by the senior party and any junior party who filed a preliminary statement. Within a time set by the administrative patent judge, a party shall serve a copy of its preliminary statement on each opponent who served a notice under § 1.621(b).

(b) A junior party who does not file a preliminary statement shall not have access to the preliminary statement of any other party.

(c) If an interference is terminated before the preliminary statements have been opened, the preliminary statements will remain sealed and will be returned to the respective parties who submitted the statements.

[49 FR 48416, Dec. 12, 1984, added effective Feb. 11, 1985; 50 FR 23124, May 31, 1985; revised, 60 FR 14488, Mar. 17, 1995, effective Apr. 21, 1995]

**§ 1.632 Notice of intent to argue abandonment, suppression or concealment by opponent.**

A notice shall be filed by a party who intends to argue that an opponent has abandoned, suppressed, or concealed an actual reduction to practice (35 U.S.C. 102(g)). A party will not be permitted to argue abandonment, suppression, or concealment by an opponent unless the notice is timely filed. Unless authorized otherwise by an administrative patent judge, a notice is timely when filed within ten (10) days after the close of the testimony-in-chief of the opponent.

[49 FR 48416, Dec. 12, 1984, added effective Feb. 11, 1985; revised, 60 FR 14488, Mar. 17, 1995, effective Apr. 21, 1995]

**§ 1.633 Preliminary motions.**

A party may file the following preliminary motions:

(a) A motion for judgment against an opponent's claim designated to correspond to a count on the ground that the claim is not patentable to the opponent. The motion shall separately address each claim alleged to be unpatentable. In deciding an issue raised in a motion filed under this paragraph (a), a

claim will be construed in light of the specification of the application or patent in which it appears. A motion under this paragraph shall not be based on:

(1) Priority of invention by the moving party as against any opponent or

(2) Derivation of the invention by an opponent from the moving party. See § 1.637(a).

(b) A motion for judgment on the ground that there is no interference-in-fact. A motion under this paragraph is proper only if the interference involves a design application or patent or a plant application or patent or no claim of a party which corresponds to a count is identical to any claim of an opponent which corresponds to that count. See § 1.637(a). When claims of different parties are presented in "means plus function" format, it may be possible for the claims of the different parties not to define the same patentable invention even though the claims contain the same literal wording.

(c) A motion to redefine the interfering subject matter by (1) adding or substituting a count, (2) amending an application claim corresponding to a count or adding a claim in the moving party's application to be designated to correspond to a count, (3) designating an application or patent claim to correspond to a count, (4) designating an application or patent claim as not corresponding to a count, or (5) requiring an opponent who is an applicant to add a claim and to designate the claim to correspond to a count. See § 1.637(a) and (c).

(d) A motion to substitute a different application owned by a party for an application involved in the interference. See § 1.637(a) and (d).

(e) A motion to declare an additional interference (1) between an additional application not involved in the interference and owned by a party and an opponent's application or patent involved in the interference or (2) when an interference involves three or more parties, between less than all applications and any patent involved in the interference. See § 1.637 (a) and (e).

(f) A motion to be accorded the benefit of the filing date of an earlier filed application. See § 1.637 (a) and (f).

(g) A motion to attack the benefit accorded an opponent in the notice declaring the interference of the filing date of an earlier filed application. See § 1.637 (a) and (g).

(h) When a patent is involved in an interference and the patentee has on file or files an application for reissue under § 1.171, a motion to add the application for reissue to the interference. See § 1.637(a) and (h).

(i) When a motion is filed under paragraph (a), (b), or (g) of this section, an opponent, in addition to opposing the motion, may file a motion to redefine the interfering subject matter under paragraph (c) of this section, a motion to substitute a different application under paragraph (d) of this section, or a motion to add a reissue application to the interference under paragraph (h) of this section.

(j) When a motion is filed under paragraph (c)(1) of this section an opponent, in addition to opposing the motion, may file a motion for benefit under paragraph (f) of this section as to the count to be added or substituted.

[49 FR 48416, Dec. 12, 1984, added effective Feb. 11, 1985; 50 FR 23124, May 31, 1985; paras. (a), (b), (f), (g), & (i) revised, 60 FR 14488, Mar. 17, 1995, effective Apr. 21, 1995]

#### § 1.634 Motion to correct inventorship.

A party may file a motion to (a) amend its application involved in an interference to correct inventorship as provided by § 1.48 or (b) correct inventorship of its patent involved in an interference as provided in § 1.324. See § 1.637(a).

[49 FR 48416, Dec. 12, 1984, added effective Feb. 11, 1985; revised, 60 FR 14488, Mar. 17, 1995, effective Apr. 21, 1995]

#### § 1.635 Miscellaneous motions.

A party seeking entry of an order relating to any matter other than a matter which may be raised under §§ 1.633 or 1.634 may file a motion requesting entry of the order. See § 1.637 (a) and (b).

[49 FR 48416, Dec. 12, 1984, added effective Feb. 11, 1985; revised, 60 FR 14488, Mar. 17, 1995, effective Apr. 21, 1995]

#### § 1.636 Motions, time for filing.

(a) A preliminary motion under § 1.633 (a) through (h) shall be filed within a time period set by an administrative patent judge.

(b) A preliminary motion under § 1.633 (i) or (j) shall be filed within 20 days of the service of the preliminary motion under § 1.633 (a), (b), (c)(1), or (g) unless otherwise ordered by an administrative patent judge.

(c) A motion under § 1.634 shall be diligently filed after an error is discovered in the inventorship of an application or patent involved in an interference unless otherwise ordered by an administrative patent judge.

(d) A motion under § 1.635 shall be filed as specified in this subpart or when appropriate unless otherwise ordered by an administrative patent judge.

[49 FR 48416, Dec. 12, 1984, added effective Feb. 11, 1985; 50 FR 23124, May 31, 1985; revised, 60 FR 14488, Mar. 17, 1995, effective Apr. 21, 1995]

#### § 1.637 Content of motions.

(a) A party filing a motion has the burden of proof to show that it is entitled to the relief sought in the motion. Each motion shall include a statement of the precise relief requested, a statement of the material facts in support of the motion, in numbered paragraphs, and a full statement of the reasons why the relief requested should be granted. If a party files a motion for judgment under § 1.633(a) against an opponent based on the ground of unpatentability over prior art, and the dates of the cited prior art are such that the prior art appears to be applicable to the party, it will be presumed, without regard to the dates alleged in the preliminary statement of the party, that the cited prior art is applicable to the party unless there is included with the motion an explanation, and evidence if appropriate, as to why the prior art does not apply to the party.

(b) Unless otherwise ordered by an administrative patent judge or the Board, a motion under § 1.635 shall contain a certificate by the moving party stating that the moving party has conferred with all opponents in an effort in good faith to resolve by agreement the issues raised by the motion. The certificate shall indicate whether any opponent plans to oppose the motion. The provisions of this paragraph do not apply to a motion to suppress evidence (§ 1.656(h)).

(c) A preliminary motion under § 1.633(c) shall explain why the interfering subject matter should be redefined.

(1) A preliminary motion seeking to add or substitute a count shall:

(i) Propose each count to be added or substituted.

(ii) When the moving party is an applicant, show the patentability to the applicant of all claims in, or proposed to be added to, the party's application which correspond to each proposed count and apply the terms of the claims to the disclosure of the party's application; when necessary a moving party applicant shall file with the motion an amendment adding any proposed claim to the application.

(iii) Identify all claims in an opponent's application which should be designated to correspond to each proposed count; if an opponent's application does not contain such a claim, the moving party shall propose a claim to be added to the opponent's application. The moving party shall show the patentability of any proposed claims to the opponent and apply the terms of the claims to the disclosure of the opponent's application.

(iv) Designate the claims of any patent involved in the interference which define the same patentable invention as each proposed count.

(v) Show that each proposed count defines a separate patentable invention from every other count proposed to remain in the interference.

(vi) Be accompanied by a motion under § 1.633(f) requesting the benefit of the filing date of any earlier filed application, if benefit of the earlier filed application is desired with respect to a proposed count.

(vii) If an opponent is accorded the benefit of the filing date of an earlier filed application in the notice of declaration of the interference, show why the opponent is not also entitled to benefit of the earlier filed application with respect to the proposed count. Otherwise, the opponent will be presumed to be entitled to the benefit of the earlier filed application with respect to the proposed count.

(2) A preliminary motion seeking to amend an application claim corresponding to a count or adding a claim to be designated to correspond to a count shall:

(i) Propose an amended or added claim.

(ii) Show that the claim proposed to be amended or added defines the same patentable invention as the count.

(iii) Show the patentability to the applicant of each claim proposed to be amended or added and apply the terms of the claim proposed to be amended or added to the disclosure of the application; when necessary a moving party applicant shall file with the motion a proposed amendment to the application amending the claim corresponding to the count or adding the proposed additional claim to the application.

(3) A preliminary motion seeking to designate an application or patent claim to correspond to a count shall:

(i) Identify the claim and the count.

(ii) Show the claim defines the same patentable invention as another claim whose designation as corresponding to the count the moving party does not dispute.

(4) A preliminary motion seeking to designate an application or patent claim as not corresponding to a count shall:

(i) Identify the claim and the count.

(ii) Show that the claim does not define the same patentable invention as any other claim whose designation in the notice declaring the interference as corresponding to the count the party does not dispute.

(5) A preliminary motion seeking to require an opponent who is an applicant to add a claim and designate the claim as corresponding to a count shall:

(i) Propose a claim to be added by the opponent.

(ii) Show the patentability to the opponent of the claim and apply the terms of the claim to the disclosure of the opponent's application.

(iii) Identify the count to which the claim shall be designated to correspond.

(iv) Show the claim defines the same patentable invention as the count to which it will be designated to correspond.

(d) A preliminary motion under § 1.633(d) to substitute a different application of the moving party shall:

(1) Identify the different application.

(2) Certify that a complete copy of the file of the different application, except for documents filed under § 1.131 or § 1.608, has been served on all opponents.

(3) Show the patentability to the applicant of all claims in, or proposed to be added to, the different

application which correspond to each count and apply the terms of the claims to the disclosure of the different application; when necessary the applicant shall file with the motion an amendment adding a claim to the different application.

(e) A preliminary motion to declare an additional interference under § 1.633(e) shall explain why an additional interference is necessary.

(1) When the preliminary motion seeks an additional interference under § 1.633(e)(1), the motion shall:

(i) Identify the additional application.

(ii) Certify that a complete copy of the file of the additional application, except for documents filed under § 1.131 or § 1.608, has been served on all opponents.

(iii) Propose a count for the additional interference.

(iv) Show the patentability to the applicant of all claims in, or proposed to be added to, the additional application which correspond to each proposed count for the additional interference and apply the terms of the claims to the disclosure of the additional application; when necessary the applicant shall file with the motion an amendment adding any claim to the additional application.

(v) When the opponent is an applicant, show the patentability to the opponent of any claims in, or proposed to be added to, the opponent's application which correspond to the proposed count and apply the terms of the claims to the disclosure of the opponent's application.

(vi) Identify all claims in the opponent's application or patent which should be designated to correspond to each proposed count; if the opponent's application does not contain any such claim, the motion shall propose a claim to be added to the opponent's application.

(vii) Show that each proposed count for the additional interference defines a separate patentable invention from all counts of the interference in which the motion is filed.

(viii) Be accompanied by a motion under § 1.633(f) requesting the benefit of the filing date of an earlier filed application, if benefit is desired with respect to a proposed count.

(ix) If an opponent is accorded the benefit of the filing date of an earlier filed application in the

notice of declaration of the interference, show why the opponent is not also entitled to benefit of the earlier filed application with respect to the proposed count. Otherwise, the opponent will be presumed to be entitled to the benefit of the earlier filed application with respect to the proposed count.

(2) When the preliminary motion seeks an additional interference under § 1.633(e)(2), the motion shall:

(i) Identify any application or patent to be involved in the additional interference.

(ii) Propose a count for the additional interference.

(iii) When the moving party is an applicant, show the patentability to the applicant of all claims in, or proposed to be added to, the party's application which correspond to each proposed count and apply the terms of the claims to the disclosure of the party's application; when necessary a moving party applicant shall file with the motion an amendment adding any proposed claim to the application.

(iv) Identify all claims in any opponent's application which should be designated to correspond to each proposed count; if an opponent's application does not contain such a claim, the moving party shall propose a claim to be added to the opponent's application. The moving party shall show the patentability of any proposed claim to the opponent and apply the terms of the claim to the disclosure of the opponent's application.

(v) Designate the claims of any patent involved in the interference which define the same patentable invention as each proposed count.

(vi) Show that each proposed count for the additional interference defines a separate patentable invention from all counts in the interference in which the motion is filed.

(vii) Be accompanied by a motion under § 1.633(f) requesting the benefit of the filing date of an earlier filed application, if benefit is desired with respect to a proposed count.

(viii) If an opponent is accorded the benefit of the filing date of an earlier filed application in the notice of declaration of the interference, show why the opponent is not also entitled to benefit of the earlier filed application with respect to the proposed count. Otherwise, the opponent will be presumed to



be entitled to the benefit of the earlier filed application with respect to the proposed count.

(f) A preliminary motion for benefit under § 1.633(f) shall:

(1) Identify the earlier application.

(2) When the earlier application is an application filed in the United States, certify that a complete copy of the file of the earlier application, except for documents filed under § 1.131 or § 1.608, has been served on all opponents. When the earlier application is an application filed in a foreign country, certify that a copy of the application has been served on all opponents. If the earlier filed application is not in English, the requirements of § 1.647 must also be met.

(3) Show that the earlier application constitutes a constructive reduction to practice of each count.

(g) A preliminary motion to attack benefit under § 1.633(g) shall explain, as to each count, why an opponent should not be accorded the benefit of the filing date of the earlier application.

(h) A preliminary motion to add an application for reissue under § 1.633(h) shall:

(1) Identify the application for reissue.

(2) Certify that a complete copy of the file of the application for reissue has been served on all opponents.

(3) Show the patentability of all claims in, or proposed to be added to, the application for reissue which correspond to each count and apply the terms of the claims to the disclosure of the application for reissue; when necessary a moving applicant for reissue shall file with the motion an amendment adding any proposed claim to the application for reissue.

(4) Be accompanied by a motion under § 1.633(f) requesting the benefit of the filing date of any earlier filed application, if benefit is desired.

[49 FR 48416, Dec. 12, 1984, added effective Feb. 11, 1985; 50 FR 23124, May 31, 1985; para. (e)(1)(vi) revised 53 FR 23735, June 23, 1988, effective Sept. 12, 1988; para. (a) revised, 58 FR 49432, Sept. 23, 1993, effective Oct. 25, 1993; paras. (a), (b), (c)(1)(v), (c)(1)(vi), (c)(20)(ii), (c)(2)(iii), (c)(3)(ii), (c)(4)(ii), (d), (e)(1)(viii), (e)(2)(vii), (f)(2), & (h)(4) revised, paras. (c)(2)(iv), (c)(3)(iii), & (d)(4) removed, paras. (c)(1)(vii), (e)(1)(ix), & (e)(2)(viii) added, 60 FR 14488, Mar. 17, 1995, effective Apr. 21, 1995]

### § 1.638 Opposition and reply; time for filing opposition and reply.

(a) Unless otherwise ordered by an administrative patent judge, any opposition to any motion shall be filed within 20 days after service of the motion. An opposition shall identify any material fact set forth in the motion which is in dispute and include an argument why the relief requested in the motion should be denied.

(b) Unless otherwise ordered by an administrative patent judge, any reply shall be filed within 15 days after service of the opposition. A reply shall be directed only to new points raised in the opposition.

[49 FR 48416, Dec. 12, 1984, added effective Feb. 11, 1985; revised, 60 FR 14488, Mar. 17, 1995, effective Apr. 21, 1995]

### § 1.639 Evidence in support of motion, opposition, or reply.

(a) Except as provided in paragraphs (c) through (g) of this section, proof of any material fact alleged in a motion, opposition, or reply must be filed and served with the motion, opposition, or reply unless the proof relied upon is part of the interference file or the file of any patent or application involved in the interference or any earlier application filed in the United States of which a party has been accorded or seeks to be accorded benefit.

(b) Proof may be in the form of patents, printed publications, and affidavits. The pages of any affidavits filed under this paragraph shall, to the extent possible, be given sequential numbers, which shall also serve as the record page numbers for the affidavits in the event they are included in the party's record (§ 1.653). Any patents and printed publications submitted under this paragraph and any exhibits identified in affidavits submitted under this paragraph shall, to the extent possible, be given sequential exhibit numbers, which shall also serve as the exhibit numbers in the event the patents, printed publications and exhibits are filed with the party's record (§ 1.653).

(c) If a party believes that additional evidence in the form of testimony that is unavailable to the party is necessary to support or oppose a preliminary motion under § 1.633 or a motion to correct inventorship under § 1.634, the party shall describe the nature of any proposed testimony as specified in paragraphs

(d) through (g) of this section. If the administrative patent judge finds that testimony is needed to decide the motion, the administrative patent judge may grant appropriate interlocutory relief and enter an order authorizing the taking of testimony and deferring a decision on the motion to final hearing.

(d) When additional evidence in the form of expert-witness testimony is needed in support of or opposition to a preliminary motion, the moving party or opponent should:

(1) Identify the person whom it expects to use as an expert;

(2) State the field in which the person is alleged to be an expert; and

(3) State:

(i) The subject matter on which the person is expected to testify;

(ii) The facts and opinions to which the person is expected to testify; and

(iii) A summary of the grounds and basis for each opinion.

(e) When additional evidence in the form of fact-witness testimony is necessary, state the facts to which the witness is expected to testify.

(f) If the opponent is to be called, or if evidence in the possession of the opponent is necessary, explain the evidence sought, what it will show, and why it is needed.

(g) When *inter partes* tests are to be performed, describe the tests stating what they will be expected to show.

[49 FR 48416, Dec. 12, 1984, added effective Feb. 11, 1985; para. (c) revised, 58 FR 49432, Sept. 23, 1993, effective Oct. 25, 1993; paras. (d)-(g) added, 58 FR 49432, Sept. 23, 1993, effective Oct. 25, 1993; paras. (a)-(d)(1) revised, 60 FR 14488, Mar. 17, 1995, effective Apr. 21, 1995]

### § 1.640 Motions, hearing and decision, redeclaration of interference, order to show cause.

(a) A hearing on a motion may be held in the discretion of the administrative patent judge. The administrative patent judge shall set the date and time for any hearing. The length of oral argument at a hearing on a motion is a matter within the discretion of the administrative patent judge. An administrative patent judge may direct that a hearing take place by telephone.

(b) Unless an administrative patent judge or the Board is of the opinion that an earlier decision on a preliminary motion would materially advance the resolution of the interference, decision on a preliminary motion shall be deferred to final hearing. Motions not deferred to final hearing will be decided by an administrative patent judge. An administrative patent judge may consult with an examiner in deciding motions. An administrative patent judge may take up motions for decisions in any order, may grant, deny, or dismiss any motion, and may take such other action which will secure the just, speedy, and inexpensive determination of the interference. A matter raised by a party in support of or in opposition to a motion that is deferred to final hearing will not be entitled to consideration at final hearing unless the matter is raised in the party's brief at final hearing. If the administrative patent judge determines that the interference shall proceed to final hearing on the issue of priority or derivation, a time shall be set for each party to file a paper identifying any decisions on motions or on matters raised *sua sponte* by the administrative patent judge that the party wishes to have reviewed at final hearing as well as identifying any deferred motions that the party wishes to have considered at final hearing. Any evidence that a party wishes to have considered with respect to the decisions and deferred motions identified by the party or by an opponent for consideration or review at final hearing shall be filed or, if appropriate, noticed under § 1.671(e) during the testimony-in-chief period of the party.

(1) When appropriate after the time expires for filing replies to oppositions to preliminary motions, the administrative patent judge will set a time for filing any amendment to an application involved in the interference and for filing a supplemental preliminary statement as to any new counts which may become involved in the interference if a preliminary motion to amend or substitute a count has been filed. Failure or refusal of a party to timely present an amendment required by an administrative patent judge shall be taken without further action as a disclaimer by that party of the invention involved. A supplemental preliminary statement shall meet the requirements specified in § 1.623, 1.624, 1.625, or 1.626, but need not be filed if a party states that it intends to rely on a preliminary statement previously filed under § 1.621(a). At an appropriate time in the

interference, and when necessary, an order will be entered redeclaring the interference.

(2) After the time expires for filing preliminary motions, a further preliminary motion under § 1.633 will not be considered except as provided by § 1.645(b).

(c) When a decision on any motion under §§ 1.633, 1.634, or 1.635 or on any matter raised *sua sponte* by an administrative patent judge is entered which does not result in the issuance of an order to show cause under paragraph (d) of this section, a party may file a request for reconsideration within 14 days after the date of the decision. The request for reconsideration shall be filed and served by hand or Express Mail. The filing of a request for reconsideration will not stay any time period set by the decision. The request for reconsideration shall specify with particularity the points believed to have been misapprehended or overlooked in rendering the decision. No opposition to a request for reconsideration shall be filed unless requested by an administrative patent judge or the Board. A decision ordinarily will not be modified unless an opposition has been requested by an administrative patent judge or the Board. The request for reconsideration normally will be acted on by the administrative patent judge or the panel of the Board which issued the decision.

(d) An administrative patent judge may issue an order to show cause why judgment should not be entered against a party when:

(1) A decision on a motion or on a matter raised *sua sponte* by an administrative patent judge is entered which is dispositive of the interference against the party as to any count;

(2) The party is a junior party who fails to file a preliminary statement; or

(3) The party is a junior party whose preliminary statement fails to overcome the effective filing date of another party.

(e) When an order to show cause is issued under paragraph (d) of this section, the Board shall enter judgment in accordance with the order unless, within 20 days after the date of the order, the party against whom the order issued files a paper which shows good cause why judgment should not be entered in accordance with the order.

(1) If the order was issued under paragraph (d)(1) of this section, the paper may:

(i) Request that final hearing be set to review any decision which is the basis for the order as well as any other decision of the administrative patent judge that the party wishes to have reviewed by the Board at final hearing or

(ii) Fully explain why judgment should not be entered.

(2) Any opponent may file a response to the paper within 20 days of the date of service of the paper. If the order was issued under paragraph (d)(1) of this section and the party's paper includes a request for final hearing, the opponent's response must identify every decision of the administrative patent judge that the opponent wishes to have reviewed by the Board at a final hearing. If the order was issued under paragraph (d)(1) of this section and the paper does not include a request for final hearing, the opponent's response may include a request for final hearing, which must identify every decision of the administrative patent judge that the opponent wishes to have reviewed by the Board at a final hearing. Where only the opponent's response includes a request for a final hearing, the party filing the paper shall, within 14 days from the date of service of the opponent's response, file a reply identifying any other decision of the administrative patent judge that the party wishes to have reviewed by the Board at a final hearing.

(3) The paper or the response should be accompanied by a motion (§ 1.635) requesting a testimony period if either party wishes to introduce any evidence to be considered at final hearing (§ 1.671). Any evidence that a party wishes to have considered with respect to the decisions and deferred motions identified for consideration or review at final hearing shall be filed or, if appropriate, noticed under § 1.671(e) during the testimony period of the party. A request for a testimony period shall be construed as including a request for final hearing.

(4) If the paper contains an explanation of why judgment should not be entered in accordance with the order, and if no party has requested a final hearing, the decision that is the basis for the order shall be reviewed based on the contents of the paper and the response. If the paper fails to show good cause, the Board shall enter judgment against the party against whom the order issued.

[49 FR 48416, Dec. 12, 1984, added effective Feb. 11, 1985; 50 FR 23124, May 31, 1985; paras. (a)-(e) revised, 60 FR 14488, Mar. 17, 1995, effective Apr. 21, 1995]

**§ 1.641 Unpatentability discovered by administrative patent judge.**

(a) During the pendency of an interference, if the administrative patent judge becomes aware of a reason why a claim designated to correspond to a count may not be patentable, the administrative patent judge may enter an order notifying the parties of the reason and set a time within which each party may present its views, including any argument and any supporting evidence, and, in the case of the party whose claim may be unpatentable, any appropriate preliminary motions under §§ 1.633(c), (d) and (h).

(b) If a party timely files a preliminary motion in response to the order of the administrative patent judge, any opponent may file an opposition (§ 1.638(a)). If an opponent files an opposition, the party may reply (§ 1.638(b)).

(c) After considering any timely filed views, including any timely filed preliminary motions under § 1.633, oppositions and replies, the administrative patent judge shall decide how the interference shall proceed.

[49 FR 48416, Dec. 12, 1984, added effective Feb. 11, 1985; revised, 60 FR 14488, Mar. 17, 1995, effective Apr. 21, 1995]

**§ 1.642 Addition of application or patent to interference.**

During the pendency of an interference, if the administrative patent judge becomes aware of an application or a patent not involved in the interference which claims the same patentable invention as a count in the interference, the administrative patent judge may add the application or patent to the interference on such terms as may be fair to all parties.

[49 FR 48416, Dec. 12, 1984, added effective Feb. 11, 1985; revised, 60 FR 14488, Mar. 17, 1995, effective Apr. 21, 1995]

**§ 1.643 Prosecution of interference by assignee.**

(a) An assignee of record in the Patent and Trademark Office of the entire interest in an application or patent involved in an interference is entitled to

conduct prosecution of the interference to the exclusion of the inventor.

(b) An assignee of a part interest in an application or patent involved in an interference may file a motion (§ 1.635) for entry of an order authorizing it to prosecute the interference. The motion shall show the inability or refusal of the inventor to prosecute the interference or other cause why it is in the interest of justice to permit the assignee of a part interest to prosecute the interference. The administrative patent judge may allow the assignee of a part interest to prosecute the interference upon such terms as may be appropriate.

[49 FR 48416, Dec. 12, 1984, added effective Feb. 11, 1985; para. (b) revised, 60 FR 14488, Mar. 17, 1995, effective Apr. 21, 1995]

**§ 1.644 Petitions in interferences.**

(a) There is no appeal to the Director in an interference from a decision of an administrative patent judge or the Board. The Director will not consider a petition in an interference unless:

(1) The petition is from a decision of an administrative patent judge or the Board and the administrative patent judge or the Board shall be of the opinion that the decision involves a controlling question of procedure or an interpretation of a rule as to which there is a substantial ground for a difference of opinion and that an immediate decision on petition by the Director may materially advance the ultimate termination of the interference;

(2) The petition seeks to invoke the supervisory authority of the Director and does not relate to the merits of priority of invention or patentability or the admissibility of evidence under the Federal Rules of Evidence; or

(3) The petition seeks relief under § 1.183.

(b) A petition under paragraph (a)(1) of this section filed more than 15 days after the date of the decision of the administrative patent judge or the Board may be dismissed as untimely. A petition under paragraph (a)(2) of this section shall not be filed prior to the party's brief for final hearing (see § 1.656). Any petition under paragraph (a)(3) of this section shall be timely if it is filed simultaneously with a proper motion under § 1.633, 1.634, or 1.635 when granting the motion would require waiver of a rule. Any opposition to a petition under paragraphs (a)(1) or (a)(2) of

this section shall be filed within 20 days of the date of service of the petition. Any opposition to a petition under paragraph (a)(3) of this section shall be filed within 20 days of the date of service of the petition or the date an opposition to the motion is due, whichever is earlier.

(c) The filing of a petition shall not stay the proceeding unless a stay is granted in the discretion of the administrative patent judge, the Board, or the Director.

(d) Any petition must contain a statement of the facts involved, in numbered paragraphs, and the point or points to be reviewed and the action requested. The petition will be decided on the basis of the record made before the administrative patent judge or the Board, and no new evidence will be considered by the Director in deciding the petition. Copies of documents already of record in the interference shall not be submitted with the petition or opposition.

(e) Any petition under paragraph (a) of this section shall be accompanied by the petition fee set forth in § 1.17(h).

(f) Any request for reconsideration of a decision by the Director shall be filed within 14 days of the decision of the Director and must be accompanied by the fee set forth in § 1.17(h). No opposition to a request for reconsideration shall be filed unless requested by the Director. The decision will not ordinarily be modified unless such an opposition has been requested by the Director.

(g) Where reasonably possible, service of any petition, opposition, or request for reconsideration shall be such that delivery is accomplished within one working day. Service by hand or Express Mail complies with this paragraph.

(h) An oral hearing on the petition will not be granted except when considered necessary by the Director.

(i) The Director may delegate to appropriate Patent and Trademark Office employees the determination of petitions under this section.

[49 FR 48416, Dec. 12, 1984, added effective Feb. 11, 1985; 50 FR 23124, May 31, 1985; paras. (a)-(a)(2), (b)-(g) revised, 60 FR 14488, Mar. 17, 1995, effective Apr. 21, 1995; paras. (a), (a)(1)-(2), (c), (d), (f) & (h) revised, 68 FR 14332, Mar. 25, 2003, effective May 1, 2003]

### § 1.645 Extension of time, late papers, stay of proceedings.

(a) Except to extend the time for filing a notice of appeal to the U.S. Court of Appeals for the Federal Circuit or for commencing a civil action, a party may file a motion (§ 1.635) seeking an extension of time to take action in an interference. See § 1.304(a) for extensions of time for filing a notice of appeal to the U.S. Court of Appeals for the Federal Circuit or for commencing a civil action. The motion shall be filed within sufficient time to actually reach the administrative patent judge before expiration of the time for taking action. A moving party should not assume that the motion will be granted even if there is no objection by any other party. The motion will be denied unless the moving party shows good cause why an extension should be granted. The press of other business arising after an administrative patent judge sets a time for taking action will not normally constitute good cause. A motion seeking additional time to take testimony because a party has not been able to procure the testimony of a witness shall set forth the name of the witness, any steps taken to procure the testimony of the witness, the dates on which the steps were taken, and the facts expected to be proved through the witness.

(b) Any paper belatedly filed will not be considered except upon motion (§ 1.635) which shows good cause why the paper was not timely filed, or where an administrative patent judge or the Board, *sua sponte*, is of the opinion that it would be in the interest of justice to consider the paper. See § 1.304(a) for exclusive procedures relating to belated filing of a notice of appeal to the U.S. Court of Appeals for the Federal Circuit or belated commencement of a civil action.

(c) The provisions of § 1.136 do not apply to time periods in interferences.

(d) An administrative patent judge may stay proceedings in an interference.

[49 FR 48416, Dec. 12, 1984, added effective Feb. 11, 1985; 50 FR 23124, May 31, 1985; paras. (a) and (b), 54 FR 29553, July 13, 1989, effective Aug. 20, 1989; paras. (a), (b), & (d) revised, 60 FR 14488, Mar. 17, 1995, effective Apr. 21, 1995]

**§ 1.646 Service of papers, proof of service.**

(a) A copy of every paper filed in the Patent and Trademark Office in an interference or an application or patent involved in the interference shall be served upon all other parties except:

(1) Preliminary statements when filed under § 1.621; preliminary statements shall be served when service is ordered by an administrative patent judge.

(2) Certified transcripts and exhibits which accompany the transcripts filed under § 1.676; copies of transcripts shall be served as part of a party's record under § 1.653(c).

(b) Service shall be on an attorney or agent for a party. If there is no attorney or agent for the party, service shall be on the party. An administrative patent judge may order additional service or waive service where appropriate.

(c) Unless otherwise ordered by an administrative patent judge, or except as otherwise provided by this subpart, service of a paper shall be made as follows:

(1) By handing a copy of the paper or causing a copy of the paper to be handed to the person served.

(2) By leaving a copy of the paper with someone employed by the person at the person's usual place of business.

(3) When the person served has no usual place of business, by leaving a copy of the paper at the person's residence with someone of suitable age and discretion then residing therein.

(4) By mailing a copy of the paper by first class mail; when service is by first class mail the date of mailing is regarded as the date of service.

(5) By mailing a copy of the paper by Express Mail; when service is by Express Mail the date of deposit with the U.S. Postal Service is regarded as the date of service.

(6) When it is shown to the satisfaction of an administrative patent judge that none of the above methods of obtaining or serving the copy of the paper was successful, the administrative patent judge may order service by publication of an appropriate notice in the *Official Gazette*.

(d) An administrative patent judge may order that a paper be served by hand or Express Mail.

(e) The due date for serving a paper is the same as the due date for filing the paper in the Patent and

Trademark Office. Proof of service must be made before a paper will be considered in an interference. Proof of service may appear on or be affixed to the paper. Proof of service shall include the date and manner of service. In the case of personal service under paragraphs (c)(1) through (c)(3) of this section, proof of service shall include the names of any person served and the person who made the service. Proof of service may be made by an acknowledgment of service by or on behalf of the person served or a statement signed by the party or the party's attorney or agent containing the information required by this section. A statement of an attorney or agent attached to, or appearing in, the paper stating the date and manner of service will be accepted as *prima facie* proof of service.

[49 FR 48416, Dec. 12, 1984, added effective Feb. 11, 1985; 50 FR 23124, May 31, 1985; paras. (a)(1)-(c)(1), (c)(4)-(c)(5) revised, para. (c)(6) added, 60 FR 14488, Mar. 17, 1995, effective Apr. 21, 1995]

**§ 1.647 Translation of document in foreign language.**

When a party relies on a document or is required to produce a document in a language other than English, a translation of the document into English and an affidavit attesting to the accuracy of the translation shall be filed with the document.

[49 FR 48416, Dec. 12, 1984, added effective Feb. 11, 1985; paras. (a) and (d), 56 FR 42528, Aug. 28, 1991, effective Sept. 27, 1991; 56 FR 46823, Sept. 16, 1991; revised, 60 FR 14488, Mar. 17, 1995, effective Apr. 21, 1995]

**§ 1.651 Setting times for discovery and taking testimony, parties entitled to take testimony.**

(a) At an appropriate stage in an interference, an administrative patent judge shall set a time for filing motions (§ 1.635) for additional discovery under § 1.687(c) and testimony periods for taking any necessary testimony.

(b) Where appropriate, testimony periods will be set to permit a party to:

(1) Present its case-in-chief and/or case-in-rebuttal and/or

(2) Cross-examine an opponent's case-in-chief and/or a case-in-rebuttal.

(c) A party is not entitled to take testimony to present a case-in-chief unless:

(1) The administrative patent judge orders the taking of testimony under § 1.639(c);

(2) The party alleges in its preliminary statement a date of invention prior to the effective filing date of the senior party;

(3) A testimony period has been set to permit an opponent to prove a date of invention prior to the effective filing date of the party and the party has filed a preliminary statement alleging a date of invention prior to that date; or

(4) A motion (§ 1.635) is filed showing good cause why a testimony period should be set.

(d) Testimony, including any testimony to be taken in a place outside the United States, shall be taken and completed during the testimony periods set under paragraph (a) of this section. A party seeking to extend the period for taking testimony must comply with §§ 1.635 and 1.645(a).

[49 FR 48416, Dec. 12, 1984, added effective Feb. 11, 1985; paras. (a) and (d), 56 FR 42528, Aug. 28, 1991, effective Sept. 27, 1991; 56 FR 46823, Sept. 16, 1991; paras. (a) (c)(1)-(c)(3) & (d) revised, 60 FR 14488, Mar. 17, 1995, effective Apr. 21, 1995]

### § 1.652 Judgment for failure to take testimony or file record.

If a junior party fails to timely take testimony authorized under § 1.651, or file a record under § 1.653(c), an administrative patent judge, with or without a motion (§ 1.635) by another party, may issue an order to show cause why judgment should not be entered against the junior party. When an order is issued under this section, the Board shall enter judgment in accordance with the order unless, within 15 days after the date of the order, the junior party files a paper which shows good cause why judgment should not be entered in accordance with the order. Any other party may file a response to the paper within 15 days of the date of service of the paper. If the party against whom the order was issued fails to show good cause, the Board shall enter judgment against the party.

[49 FR 48416, Dec. 12, 1984, added effective Feb. 11, 1985; revised, 60 FR 14488, Mar. 17, 1995, effective Apr. 21, 1995]

### § 1.653 Record and exhibits.

(a) Testimony shall consist of affidavits under §§ 1.672(b), (c) and (g), 1.682(c), 1.683(b) and 1.688(b), transcripts of depositions under §§ 1.671(g) and 1.672(a) when a deposition is authorized by an administrative patent judge, transcripts of depositions under §§ 1.672(d), 1.682(d), 1.683(c) and 1.688(c), agreed statements under § 1.672(h), transcripts of interrogatories, cross-interrogatories, and recorded answers and copies of written interrogatories and answers and written requests for admissions and answers under § 1.688(a).

(b) An affidavit shall be filed as set forth in § 1.677. A certified transcript of a deposition, including a deposition cross-examining an affiant, shall be filed as set forth in §§ 1.676, 1.677 and 1.678. An original agreed statement shall be filed as set forth in § 1.672(h).

(c) In addition to the items specified in paragraph (b) of this section and within a time set by an administrative patent judge, each party shall file three copies and serve one copy of a record consisting of:

(1) An index of the names of the witnesses for the party, giving the pages of the record where the direct testimony and cross-examination of each witness begins.

(2) An index of exhibits briefly describing the nature of each exhibit and giving the page of the record where each exhibit is first identified and offered into evidence.

(3) The count or counts.

(4) Each affidavit by a witness for the party, transcript, including transcripts of cross-examination of any affiant who testified for the party and transcripts of compelled deposition testimony by a witness for the party, agreed statement relied upon by the party, and transcript of interrogatories, cross-interrogatories and recorded answers.

(5) [Reserved]

(6) Any evidence from another interference, proceeding, or action relied upon by the party under § 1.683.

(7) Each request for an admission and the admission and each written interrogatory and the

answer upon which a party intends to rely under § 1.688.

(d) The pages of the record shall be consecutively numbered to the extent possible.

(e) The name of each witness shall appear at the top of each page of each affidavit or transcript.

(f) [Reserved]

(g) The record may be produced by standard typographical printing or by any other process capable of producing a clear black permanent image. All printed matter except on covers must appear in at least 11 point type on opaque, unglazed paper. Footnotes may not be printed in type smaller than 9 point. The page size shall be 21.8 by 27.9 cm. (8 1/2 by 11 inches) (letter size) with printed matter 16.5 by 24.1 cm. (6 1/2 by 9 1/2 inches). The record shall be bound with covers at their left edges in such manner as to lie flat when open to any page and in one or more volumes of convenient size (approximately 100 pages per volume is suggested). When there is more than one volume, the numbers of the pages contained in each volume shall appear at the top of the cover for each volume.

(h) [Reserved]

(i) Each party shall file its exhibits with the record specified in paragraph (c) of this section. Exhibits include documents and things identified in affidavits or on the record during the taking of oral depositions as well as official records and publications filed by the party under § 1.682(a). One copy of each documentary exhibit shall be served. Documentary exhibits shall be filed in an envelope or folder and shall not be bound as part of the record. Physical exhibits, if not filed by an officer under § 1.676(d), shall be filed with the record. Each exhibit shall contain a label which identifies the party submitting the exhibit and an exhibit number, the style of the interference (e.g., Jones v. Smith), and the interference number. Where possible, the label should appear at the bottom right-hand corner of each documentary exhibit. Upon termination of an interference, an administrative patent judge may return an exhibit to the party filing the exhibit. When any exhibit is returned, an order shall be entered indicating that the exhibit has been returned.

(j) Any testimony, record, or exhibit which does not comply with this section may be returned under § 1.618(a).

[49 FR 48466, Dec. 12, 1984, added effective Feb. 11, 1985; paras. (a), (b), (c), (c)(1), (c)(4), (d), (g), & (i) revised, paras. (c)(5) (f) & (h) removed, 60 FR 14488, Mar. 17, 1995, effective Apr. 21, 1995]

#### § 1.654 Final hearing.

(a) At an appropriate stage of the interference, the parties will be given an opportunity to appear before the Board to present oral argument at a final hearing. An administrative patent judge may set a date and time for final hearing. Unless otherwise ordered by an administrative patent judge or the Board, each party will be entitled to no more than 30 minutes of oral argument at final hearing. A party who does not file a brief for final hearing (§ 1.656(a)) shall not be entitled to appear at final hearing.

(b) The opening argument of a junior party shall include a fair statement of the junior party's case and the junior party's position with respect to the case presented on behalf of any other party. A junior party may reserve a portion of its time for rebuttal.

(c) A party shall not be entitled to argue that an opponent abandoned, suppressed, or concealed an actual reduction to practice unless a notice under § 1.632 was timely filed.

(d) After final hearing, the interference shall be taken under advisement by the Board. No further paper shall be filed except under § 1.658(b) or as authorized by an administrative patent judge or the Board. No additional oral argument shall be had unless ordered by the Board.

[49 FR 48466, Dec. 12, 1984, added effective Feb. 11, 1985; paras. (a) & (d) revised, 60 FR 14488, Mar. 17, 1995, effective April 21, 1995]

#### § 1.655 Matters considered in rendering a final decision.

(a) In rendering a final decision, the Board may consider any properly raised issue, including priority of invention, derivation by an opponent from a party who filed a preliminary statement under § 1.625, patentability of the invention, admissibility of evidence, any interlocutory matter deferred to final hearing, and any other matter necessary to resolve the interference. The Board may also consider whether an interlocutory order should be modified. The burden of showing that an interlocutory order should be modified shall be on



the party attacking the order. The abuse of discretion standard shall apply only to procedural matters.

(b) A party shall not be entitled to raise for consideration at final hearing any matter which properly could have been raised by a motion under § 1.633 or 1.634 unless the matter was properly raised in a motion that was timely filed by the party under § 1.633 or 1.634 and the motion was denied or deferred to final hearing, the matter was properly raised by the party in a timely filed opposition to a motion under § 1.633 or 1.634 and the motion was granted over the opposition or deferred to final hearing, or the party shows good cause why the issue was not properly raised by a timely filed motion or opposition. A party that fails to contest, by way of a timely filed preliminary motion under § 1.633(c), the designation of a claim as corresponding to a count, or fails to timely argue the separate patentability of a particular claim when the ground for unpatentability is first raised, may not subsequently argue to an administrative patent judge or the Board the separate patentability of claims designated to correspond to the count with respect to that ground.

(c) In the interest of justice, the Board may exercise its discretion to consider an issue even though it would not otherwise be entitled to consideration under this section.

[49 FR 48466, Dec. 12, 1984, added effective Feb. 11, 1985; para. (a) revised, 58 FR 49432, Sept. 23, 1993, effective Oct. 25, 1993; revised, 60 FR 14488, Mar. 17, 1995, effective Apr. 21, 1995; para. (a) revised, 64 FR 12900, Mar. 16, 1999, effective Mar. 16, 1999]

### § 1.656 Briefs for final hearing.

(a) Each party shall be entitled to file briefs for final hearing. The administrative patent judge shall determine the briefs needed and shall set the time and order for filing briefs.

(b) The opening brief of a junior party shall contain under appropriate headings and in the order indicated:

(1) A statement of interest indicating the full name of every party represented by the attorney in the interference and the name of the real party in interest if the party named in the caption is not the real party in interest.

(2) A statement of related cases indicating whether the interference was previously before the Board for final hearing and the name and number of any related appeal or interference which is pending before, or which has been decided by, the Board, or which is pending before, or which has been decided by, the U.S. Court of Appeals for the Federal Circuit or a district court in a proceeding under 35 U.S.C. 146. A related appeal or interference is one which will directly affect or be directly affected by or have a bearing on the Board's decision in the pending interference.

(3) A table of contents, with page references, and a table of cases (alphabetically arranged), statutes, and other authorities cited, with references to the pages of the brief where they are cited.

(4) A statement of the issues presented for decision in the interference.

(5) A statement of the facts, in numbered paragraphs, relevant to the issues presented for decision with appropriate references to the record.

(6) An argument, which may be preceded by a summary, which shall contain the contentions of the party with respect to the issues it is raising for consideration at final hearing, and the reasons therefor, with citations to the cases, statutes, other authorities, and parts of the record relied on.

(7) A short conclusion stating the precise relief requested.

(8) An appendix containing a copy of the counts.

(c) The opening brief of the senior party shall conform to the requirements of paragraph (b) of this section except:

(1) A statement of the issues and of the facts need not be made unless the party is dissatisfied with the statement in the opening brief of the junior party and

(2) An appendix containing a copy of the counts need not be included if the copy of the counts in the opening brief of the junior party is correct.

(d) Unless ordered otherwise by an administrative patent judge, briefs shall be double-spaced (except for footnotes, which may be single-spaced) and shall comply with the requirements of § 1.653(g) for records except the requirement for binding.

(e) An original and four copies of each brief must be filed.

(f) Any brief which does not comply with the requirements of this section may be returned under § 1.618(a).

(g) Any party, separate from its opening brief, but filed concurrently therewith, may file an original and four copies of concise proposed findings of fact and conclusions of law. Any proposed findings of fact shall be in numbered paragraphs and shall be supported by specific references to the record. Any proposed conclusions of law shall be in numbered paragraphs and shall be supported by citation of cases, statutes, or other authority. Any opponent, separate from its opening or reply brief, but filed concurrently therewith, may file a paper accepting or objecting to any proposed findings of fact or conclusions of law; when objecting, a reason must be given. The Board may adopt the proposed findings of fact and conclusions of law in whole or in part.

(h) If a party wants the Board in rendering its final decision to rule on the admissibility of any evidence, the party shall file with its opening brief an original and four copies of a motion (§ 1.635) to suppress the evidence. The provisions of § 1.637(b) do not apply to a motion to suppress under this paragraph. Any objection previously made to the admissibility of the evidence of an opponent is waived unless the motion required by this paragraph is filed. A party that failed to challenge the admissibility of the evidence of an opponent on a ground that could have been raised in a timely objection under § 1.672(c), 1.682(c), 1.683(b) or 1.688(b) may not move under this paragraph to suppress the evidence on that ground at final hearing. An original and four copies of an opposition to the motion may be filed with an opponent's opening brief or reply brief as may be appropriate.

(i) When a junior party fails to timely file an opening brief, an order may issue requiring the junior party to show cause why the Board should not treat failure to file the brief as a concession of priority. If the junior party fails to show good cause within a time period set in the order, judgment may be entered against the junior party.

[49 FR 48466, Dec. 12, 1984, added effective Feb. 11, 1985; paras. (a), (b)(1)-(b)(8), (d), (e), (g), (h), & (i) revised, 60 FR 14488, Mar. 17, 1995, effective Apr. 21, 1995]

### § 1.657 Burden of proof as to date of invention.

(a) A rebuttable presumption shall exist that, as to each count, the inventors made their invention in the chronological order of their effective filing dates. The burden of proof shall be upon a party who contends otherwise.

(b) In an interference involving copending applications or involving a patent and an application having an effective filing date on or before the date the patent issued, a junior party shall have the burden of establishing priority by a preponderance of the evidence.

(c) In an interference involving an application and a patent and where the effective filing date of the application is after the date the patent issued, a junior party shall have the burden of establishing priority by clear and convincing evidence.

[49 FR 48466, Dec. 12, 1984, added effective Feb. 11, 1985; revised, 60 FR 14488, Mar. 17, 1995, effective Apr. 21, 1995]

### § 1.658 Final decision.

(a) After final hearing, the Board shall enter a decision resolving the issues raised at final hearing. The decision may enter judgment, in whole or in part, remand the interference to an administrative patent judge for further proceedings, or take further action not inconsistent with law. A judgment as to a count shall state whether or not each party is entitled to a patent containing the claims in the party's patent or application which correspond to the count. When the Board enters a decision awarding judgment as to all counts, the decision shall be regarded as a final decision for the purpose of judicial review (35 U.S.C. 141-144, 146) unless a request for reconsideration under paragraph (b) of this section is timely filed.

(b) Any request for reconsideration of a decision under paragraph (a) of this section shall be filed within one month after the date of the decision. The request for reconsideration shall specify with particularity the points believed to have been misapprehended or overlooked in rendering the decision. Any opposition to a request for reconsideration shall be filed within 14 days of the date of service of the request for reconsideration. Service of the request for reconsideration shall be by hand or Express Mail. The Board shall enter a decision on the request for reconsideration. If the Board shall be of the opinion that the

decision on the request for reconsideration significantly modifies its original decision under paragraph (a) of this section, the Board may designate the decision on the request for reconsideration as a new decision. A decision on reconsideration is a final decision for the purpose of judicial review (35 U.S.C. 141-144, 146).

(c) A judgment in an interference settles all issues which (1) were raised and decided in the interference, (2) could have been properly raised and decided in the interference by a motion under § 1.633 (a) through (d) and (f) through (j) or § 1.634, and (3) could have been properly raised and decided in an additional interference with a motion under § 1.633(e). A losing party who could have properly moved, but failed to move, under § 1.633 or 1.634, shall be estopped to take *ex parte* or *inter partes* action in the Patent and Trademark Office after the interference which is inconsistent with that party's failure to properly move, except that a losing party shall not be estopped with respect to any claims which correspond, or properly could have corresponded, to a count as to which that party was awarded a favorable judgment.

[49 FR 48467, Dec. 12, 1984, added effective Feb. 11, 1985; para. (b), 54 FR 29553, July 13, 1989, effective Aug. 20, 1989; paras. (a) & (b) revised, 60 FR 14488, Mar. 17, 1995, effective Apr. 21, 1995]

### § 1.659 Recommendation.

(a) Should the Board have knowledge of any ground for rejecting any application claim not involved in the judgment of the interference, it may include in its decision a recommended rejection of the claim. Upon resumption of *ex parte* prosecution of the application, the examiner shall be bound by the recommendation and shall enter and maintain the recommended rejection unless an amendment or showing of facts not previously of record is filed which, in the opinion of the examiner, overcomes the recommended rejection.

(b) Should the Board have knowledge of any ground for reexamination of a patent involved in the interference as to a patent claim not involved in the judgment of the interference, it may include in its decision a recommendation to the Director that the patent be reexamined. The Director will determine whether reexamination will be ordered.

(c) The Board may make any other recommendation to the examiner or the Director as may be appropriate.

[49 FR 48467, Dec. 12, 1984, added effective Feb. 11, 1985; paras. (b) & (c) revised, 68 FR 14332, Mar. 25, 2003, effective May 1, 2003]

### § 1.660 Notice of reexamination, reissue, protest, or litigation.

(a) When a request for reexamination of a patent involved in an interference is filed, the patent owner shall notify the Board within 10 days of receiving notice that the request was filed.

(b) When an application for reissue is filed by a patentee involved in an interference, the patentee shall notify the Board within 10 days of the day the application for reissue is filed.

(c) When a protest under § 1.291 is filed against an application involved in an interference, the applicant shall notify the Board within 10 days of receiving notice that the protest was filed.

(d) A party in an interference shall notify the Board promptly of any litigation related to any patent or application involved in an interference, including any civil action commenced under 35 U.S.C. 146.

(e) The notice required by this section is designed to assist the administrative patent judge and the Board in efficiently handling interference cases. Failure of a party to comply with the provisions of this section may result in sanctions under § 1.616. Knowledge by, or notice to, an employee of the Office other than an employee of the Board, of the existence of the reexamination, application for reissue, protest, or litigation shall not be sufficient. The notice contemplated by this section is notice addressed to the administrative patent judge in charge of the interference in which the application or patent is involved.

[49 FR 48467, Dec. 12, 1984, added effective Feb. 11, 1985; para. (e) added, 60 FR 14488, Mar. 17, 1995, effective Apr. 21, 1995]

### § 1.661 Termination of interference after judgment.

After a final decision is entered by the Board, an interference is considered terminated when no appeal (35 U.S.C. 141) or other review (35 U.S.C. 146) has been or can be taken or had.

[49 FR 48467, Dec. 12, 1984, added effective Feb. 11, 1985]

**§ 1.662 Request for entry of adverse judgment; reissue filed by patentee.**

(a) A party may, at any time during an interference, request and agree to entry of an adverse judgment. The filing by a party of a written disclaimer of the invention defined by a count, concession of priority or unpatentability of the subject matter of a count, abandonment of the invention defined by a count, or abandonment of the contest as to a count will be treated as a request for entry of an adverse judgment against the applicant or patentee as to all claims which correspond to the count. Abandonment of an application, other than an application for reissue having a claim of the patent sought to be reissued involved in the interference, will be treated as a request for entry of an adverse judgment against the applicant as to all claims corresponding to all counts. Upon the filing by a party of a request for entry of an adverse judgment, the Board may enter judgment against the party.

(b) If a patentee involved in an interference files an application for reissue during the interference and the reissue application does not include a claim that corresponds to a count, judgment may be entered against the patentee. A patentee who files an application for reissue which includes a claim that corresponds to a count shall, in addition to complying with the provisions of § 1.660(b), timely file a preliminary motion under § 1.633(h) or show good cause why the motion could not have been timely filed or would not be appropriate.

(c) The filing of a statutory disclaimer under 35 U.S.C. 253 by a patentee will delete any statutorily disclaimed claims from being involved in the interference. A statutory disclaimer will not be treated as a request for entry of an adverse judgment against the patentee unless it results in the deletion of all patent claims corresponding to a count.

[49 FR 48467, Dec. 12, 1984, added effective Feb. 11, 1985; para. (b) amended, 53 FR 23735, June 23, 1988, effective Sept. 12, 1988; paras. (a) & (e) revised, 60 FR 14488, Mar. 17, 1995, effective Apr. 21, 1995]

**§ 1.663 Status of claim of defeated applicant after interference.**

Whenever an adverse judgment is entered as to a count against an applicant from which no appeal (35 U.S.C. 141) or other review (35 U.S.C. 146) has been or can be taken or had, the claims of the application corresponding to the count stand finally disposed of without further action by the examiner. Such claims are not open to further *ex parte* prosecution.

[49 FR 48467, Dec. 12, 1984, added effective Feb. 11, 1985]

**§ 1.664 Action after interference.**

(a) After termination of an interference, the examiner will promptly take such action in any application previously involved in the interference as may be necessary. Unless entered by order of an administrative patent judge, amendments presented during the interference shall not be entered, but may be subsequently presented by the applicant subject to the provisions of this subpart provided prosecution of the application is not otherwise closed.

(b) After judgment, the application of any party may be held subject to further examination, including an interference with another application.

[49 FR 48467, Dec. 12, 1984; 50 FR 23124, May 31, 1985, added effective Feb. 11, 1985; revised, 60 FR 14488, Mar. 17, 1995, effective Apr. 21, 1995]

**§ 1.665 Second interference.**

A second interference between the same parties will not be declared upon an application not involved in an earlier interference for an invention defined by a count of the earlier interference. See § 1.658(c).

[49 FR 48468, Dec. 12, 1984, added effective Feb. 11, 1985]

**§ 1.666 Filing of interference settlement agreements.**

(a) Any agreement or understanding between parties to an interference, including any collateral agreements referred to therein, made in connection with or in contemplation of the termination of the interference, must be in writing and a true copy thereof must be filed before the termination of the

interference (§ 1.661) as between the parties to the agreement or understanding.

(b) If any party filing the agreement or understanding under paragraph (a) of this section so requests, the copy will be kept separate from the file of the interference, and made available only to Government agencies on written request, or to any person upon petition accompanied by the fee set forth in § 1.17(h) and on a showing of good cause.

(c) Failure to file the copy of the agreement or understanding under paragraph (a) of this section will render permanently unenforceable such agreement or understanding and any patent of the parties involved in the interference or any patent subsequently issued on any application of the parties so involved. The Director may, however, upon petition accompanied by the fee set forth in § 1.17(h) and on a showing of good cause for failure to file within the time prescribed, permit the filing of the agreement or understanding during the six month period subsequent to the termination of the interference as between the parties to the agreement or understanding.

[49 FR 48468, Dec. 12, 1984, added effective Feb. 11, 1985; 50 FR 23124, May 31, 1985; para. (b), 54 FR 6893, Feb. 15, 1989, effective Apr. 17, 1989; amended 60 FR 14488, Mar. 17, 1995, effective Apr. 21, 1995; paras. (a) & (b) amended, 60 FR 20195, Apr. 25, 1995, effective June 8, 1995; para (b) revised, 65 FR 54604, Sept. 8, 2000, effective Nov. 7, 2000; para. (c) revised, 68 FR 14332, Mar. 25, 2003, effective May 1, 2003]

### § 1.671 Evidence must comply with rules.

(a) Evidence consists of affidavits, transcripts of depositions, documents and things.

(b) Except as otherwise provided in this subpart, the Federal Rules of Evidence shall apply to interference proceedings. Those portions of the Federal Rules of Evidence relating to criminal actions, juries, and other matters not relevant to interferences shall not apply.

(c) Unless the context is otherwise clear, the following terms of the Federal Rules of Evidence shall be construed as follows:

- (1) *Courts of the United States, U.S. Magistrate, court, trial court, or trier of fact* means administrative patent judge or Board as may be appropriate.
- (2) *Judge* means administrative patent judge.
- (3) *Judicial notice* means official notice.

(4) *Civil action, civil proceeding, action, or trial* mean interference.

(5) *Appellate court* means United States Court of Appeals for the Federal Circuit or a United States district court when judicial review is under 35 U.S.C. 146.

(6) *Before the hearing* in Rule 703 of the Federal Rules of Evidence means before giving testimony by affidavit or oral deposition.

(7) *The trial or hearing* in Rules 803(24) and 804(5) of the Federal Rules of Evidence means the taking of testimony by affidavit or oral deposition.

(d) Certification is not necessary as a condition to admissibility when the record is a record of the Patent and Trademark Office to which all parties have access.

(e) A party may not rely on an affidavit (including exhibits), patent, or printed publication previously submitted by the party under § 1.639(b) unless a copy of the affidavit, patent, or printed publication has been served and a written notice is filed prior to the close of the party's relevant testimony period stating that the party intends to rely on the affidavit, patent, or printed publication. When proper notice is given under this paragraph, the affidavit, patent, or printed publication shall be deemed as filed under § 1.640(b), § 1.640(e)(3), or § 1.672, as appropriate.

(f) The significance of documentary and other exhibits identified by a witness in an affidavit or during oral deposition shall be discussed with particularity by a witness.

(g) A party must file a motion (§ 1.635) seeking permission from an administrative patent judge prior to compelling testimony or production of documents or things under 35 U.S.C. 24 or from an opposing party. The motion shall describe the general nature and the relevance of the testimony, document, or thing. If permission is granted, the party shall notice a deposition under § 1.673 and may proceed to take testimony.

(h) A party must file a motion (§ 1.635) seeking permission from an administrative patent judge prior to compelling testimony or production of documents or things in a foreign country.

- (1) In the case of testimony, the motion shall:
  - (i) Describe the general nature and relevance of the testimony;
  - (ii) Identify the witness by name or title;

(iii) Identify the foreign country and explain why the party believes the witness can be compelled to testify in the foreign country, including a description of the procedures that will be used to compel the testimony in the foreign country and an estimate of the time it is expected to take to obtain the testimony; and

(iv) Demonstrate that the party has made reasonable efforts to secure the agreement of the witness to testify in the United States but has been unsuccessful in obtaining the agreement, even though the party has offered to pay the expenses of the witness to travel to and testify in the United States.

(2) In the case of production of a document or thing, the motion shall:

(i) Describe the general nature and relevance of the document or thing;

(ii) Identify the foreign country and explain why the party believes production of the document or thing can be compelled in the foreign country, including a description of the procedures that will be used to compel production of the document or thing in the foreign country and an estimate of the time it is expected to take to obtain production of the document or thing; and

(iii) Demonstrate that the party has made reasonable efforts to obtain the agreement of the individual or entity having possession, custody, or control of the document to produce the document or thing in the United States but has been unsuccessful in obtaining that agreement, even though the party has offered to pay the expenses of producing the document or thing in the United States.

(i) Evidence which is not taken or sought and filed in accordance with this subpart shall not be admissible.

(j) The weight to be given deposition testimony taken in a foreign country will be determined in view of all the circumstances, including the laws of the foreign country governing the testimony. Little, if any, weight may be given to deposition testimony taken in a foreign country unless the party taking the testimony proves by clear and convincing evidence, as a matter of fact, that knowingly giving false testimony in that country in connection with an interference proceeding in the United States Patent and Trademark Office is punishable under the laws of that country and that the punishment in that country for such false

testimony is comparable to or greater than the punishment for perjury committed in the United States. The administrative patent judge and the Board, in determining foreign law, may consider any relevant material or source, including testimony, whether or not submitted by a party or admissible under the Federal Rules of Evidence.

[49 FR 48468, Dec. 12, 1984, added effective Feb. 11, 1985; 50 FR 23124, May 31, 1985; paras. (a), (c)(1), (c)(2), (c)(6), (c)(7), (e)-(j) revised, 60 FR 14488, Mar. 17, 1995, effective Apr. 21, 1995; para. (a) revised, 65 FR 56972, Sept. 20, 2000, effective Oct. 20, 2000 (adopted as final, 65 FR 70489, Nov. 24, 2000); para. (e) revised, 65 FR 70489, Nov. 24, 2000, effective Dec. 26, 2000]

### § 1.672 Manner of taking testimony.

(a) Unless testimony must be compelled under 35 U.S.C. 24, compelled from a party, or compelled in a foreign country, testimony of a witness shall be taken by affidavit in accordance with this subpart. Testimony which must be compelled under 35 U.S.C. 24, compelled from a party, or compelled in a foreign country shall be taken by oral deposition.

(b) A party presenting testimony of a witness by affidavit shall, within the time set by the administrative patent judge for serving affidavits, file a copy of the affidavit or, if appropriate, notice under § 1.671(e). If the affidavit relates to a party's case-in-chief, it shall be filed or noticed no later than the date set by an administrative patent judge for the party to file affidavits for its case-in-chief. If the affidavit relates to a party's case-in-rebuttal, it shall be filed or noticed no later than the date set by an administrative patent judge for the party to file affidavits for its case-in-rebuttal. A party shall not be entitled to rely on any document referred to in the affidavit unless a copy of the document is filed with the affidavit. A party shall not be entitled to rely on any thing mentioned in the affidavit unless the opponent is given reasonable access to the thing. A thing is something other than a document. The pages of affidavits filed under this paragraph and of any other testimony filed therewith under §§ 1.683(a) and 1.688(a) shall, to the extent possible, be given sequential numbers which shall also serve as the record page numbers for the affidavits and other testimony in the party's record to be filed under § 1.653. Exhibits identified in the affidavits or in any other testimony filed under §§ 1.683(a)

and 1.688(a) and any official records and printed publications filed under § 1.682(a) shall, to the extent possible, be given sequential exhibit numbers, which shall also serve as the exhibit numbers when the exhibits are filed with the party's record. The affidavits, testimony filed under §§ 1.683(a) and 1.688(a) and exhibits shall be accompanied by an index of the names of the witnesses, giving the number of the page where the testimony of each witness begins, and by an index of the exhibits briefly describing the nature of each exhibit and giving the number of the page where each exhibit is first identified and offered into evidence.

(c) If an opponent objects to the admissibility of any evidence contained in or submitted with an affidavit filed under paragraph (b) of this section, the opponent must, no later than the date set by the administrative patent judge for filing objections under this paragraph, file objections stating with particularity the nature of each objection. An opponent that fails to object to the admissibility of the evidence contained in or submitted with an affidavit on a ground that could have been raised in a timely objection under this paragraph will not be entitled to move under § 1.656(h) to suppress the evidence on that ground. If an opponent timely files objections, the party may, within 20 days of the due date for filing objections, file one or more supplemental affidavits, official records or printed publications to overcome the objections. No objection to the admissibility of the supplemental evidence shall be made, except as provided by § 1.656(h). The pages of supplemental affidavits filed under this paragraph shall, to the extent possible, be sequentially numbered beginning with the number following the last page number of the party's testimony submitted under paragraph (b) of this section. The page numbers assigned to the supplemental affidavits shall also serve as the record page numbers for the supplemental affidavits in the party's record filed under § 1.653. Additional exhibits identified in supplemental affidavits and any supplemental official records and printed publications shall, to the extent possible, be given sequential numbers beginning with the number following the last number of the exhibits submitted under paragraph (b) of this section. The exhibit numbers shall also serve as the exhibit numbers when the exhibits are filed with the party's record. The supplemental affidavits shall be accompa-

nied by an index of the names of the witnesses and an index of exhibits of the type specified in paragraph (b) of this section.

(d) After the time expires for filing objections and supplemental affidavits, or earlier when appropriate, the administrative patent judge shall set a time within which any opponent may file a request to cross-examine an affiant on oral deposition. If any opponent requests cross-examination of an affiant, the party shall notice a deposition at a reasonable location within the United States under § 1.673(e) for the purpose of cross-examination by any opponent. Any redirect and recross shall take place at the deposition. At any deposition for the purpose of cross-examination of a witness, the party shall not be entitled to rely on any document or thing not mentioned in one or more of the affidavits filed under paragraphs (b) and (c) of this section, except to the extent necessary to conduct proper redirect. The party who gives notice of a deposition shall be responsible for providing a translator if the witness does not testify in English, for obtaining a court reporter, and for filing a certified transcript of the deposition as required by § 1.676. Within 45 days of the close of the period for taking cross-examination, the party shall serve (but not file) a copy of each transcript on each opponent together with copies of any additional documentary exhibits identified by the witness during the deposition. The pages of the transcripts served under this paragraph shall, to the extent possible, be sequentially numbered beginning with the number following the last page number of the party's supplemental affidavits submitted under paragraph (c) of this section. The numbers assigned to the transcript pages shall also serve as the record page numbers for the transcripts in the party's record filed under § 1.653. Additional exhibits identified in the transcripts, shall, to the extent possible, be given sequential numbers beginning with the number following the last number of the exhibits submitted under paragraphs (b) and (c) of this section. The exhibit numbers assigned to the additional exhibits shall also serve as the exhibit numbers when those exhibits are filed with the party's record. The deposition transcripts shall be accompanied by an index of the names of the witnesses, giving the number of the page where cross-examination, redirect and recross of each witness begins, and an index of exhibits of the type specified in paragraph (b) of this section.

(e) [Reserved]

(f) When a deposition is authorized to be taken within the United States under this subpart and if the parties agree in writing, the deposition may be taken in any place within the United States, before any person authorized to administer oaths, upon any notice, and in any manner, and when so taken may be used like other depositions.

(g) If the parties agree in writing, the affidavit testimony of any witness may be submitted without opportunity for cross-examination.

(h) If the parties agree in writing, testimony may be submitted in the form of an agreed statement setting forth how a particular witness would testify, if called, or the facts in the case of one or more of the parties. The agreed statement shall be filed in the Patent and Trademark Office. See § 1.653(a).

(i) In an unusual circumstance and upon a showing that testimony cannot be taken in accordance with the provisions of this subpart, an administrative patent judge upon motion (§ 1.635) may authorize testimony to be taken in another manner.

[49 FR 48468, Dec. 12, 1984, added effective Feb. 11, 1985; 50 FR 23124, May 31, 1985; revised, 60 FR 14488, Mar. 17, 1995, effective Apr. 21, 1995]

### § 1.673 Notice of examination of witness.

(a) A party authorized to take testimony of a witness by deposition shall, after complying with paragraphs (b) and (g) of this section, file and serve a single notice of deposition stating the time and place of each deposition to be taken. Depositions to be taken in the United States may be noticed for a reasonable time and place in the United States. A deposition may not be noticed for any other place without approval of an administrative patent judge. The notice shall specify the name and address of each witness and the general nature of the testimony to be given by the witness. If the name of a witness is not known, a general description sufficient to identify the witness or a particular class or group to which the witness belongs may be given instead.

(b) Unless the parties agree or an administrative patent judge or the Board determine otherwise, a party shall serve, but not file, at least three working days prior to the conference required by paragraph (g) of this section, if service is made by hand or Express

Mail, or at least 14 days prior to the conference if service is made by any other means, the following:

(1) A list and copy of each document in the party's possession, custody, or control and upon which the party intends to rely at any deposition and

(2) A list of and a proffer of reasonable access to things in the party's possession, custody, or control and upon which the party intends to rely at any deposition.

(c) A party shall not be permitted to rely on any witness not listed in the notice, or any document not served or any thing not listed as required by paragraph (b) of this section:

(1) Unless all opponents agree in writing or on the record to permit the party to rely on the witness, document or thing, or

(2) Except upon a motion (§ 1.635) promptly filed which is accompanied by any proposed notice, additional documents, or lists and which shows good cause why the notice, documents, or lists were not served in accordance with this section.

(d) Each opponent shall have a full opportunity to attend a deposition and cross-examine.

(e) A party who has presented testimony by affidavit and is required to notice depositions for the purpose of cross-examination under § 1.672(b), shall, after complying with paragraph (g) of this section, file and serve a single notice of deposition stating the time and place of each cross-examination deposition to be taken.

(f) The parties shall not take depositions in more than one place at the same time or so nearly at the same time that reasonable opportunity to travel from one place of deposition to another cannot be had.

(g) Before serving a notice of deposition and after complying with paragraph (b) of this section, a party shall have an oral conference with all opponents to attempt to agree on a mutually acceptable time and place for conducting the deposition. A certificate shall appear in the notice stating that the oral conference took place or explaining why the conference could not be had. If the parties cannot agree to a mutually acceptable place and time for conducting the deposition at the conference, the parties shall contact an administrative patent judge who shall then designate the time and place for conducting the deposition.



(h) A copy of the notice of deposition shall be attached to the certified transcript of the deposition filed under § 1.676(a).

[49 FR 48469, Dec. 12, 1984, added effective Feb. 11, 1985; paras. (a)-(e) & (g) revised, 60 FR 14488, Mar. 17, 1995, effective Apr. 21, 1995]

**§ 1.674 Persons before whom depositions may be taken.**

(a) A deposition shall be taken before an officer authorized to administer oaths by the laws of the United States or of the place where the examination is held.

(b) Unless the parties agree in writing, the following persons shall not be competent to serve as an officer:

- (1) a relative or employee of a party,
- (2) a relative or employee of an attorney or agent of a party, or
- (3) a person interested, directly or indirectly, in the interference either as counsel, attorney, agent, or otherwise.

[49 FR 48469, Dec. 12, 1984, added effective Feb. 11, 1985; para. (a) revised, 60 FR 14488, Mar. 17, 1995, effective Apr. 21, 1995]

**§ 1.675 Examination of witness, reading and signing transcript of deposition.**

(a) Each witness before giving an oral deposition shall be duly sworn according to law by the officer before whom the deposition is to be taken.

(b) The testimony shall be taken in answer to interrogatories with any questions and answers recorded in their regular order by the officer or by some other person, who shall be subject to the provisions of § 1.674(b), in the presence of the officer unless the presence of the officer is waived on the record by agreement of all parties.

(c) All objections made at the time of the deposition to the qualifications of the officer taking the deposition, the manner of taking it, the evidence presented, the conduct of any party, and any other objection to the proceeding shall be noted on the record by the officer. Evidence objected to shall be taken subject to any objection.

(d) Unless the parties agree in writing or waive reading and signature by the witness on the record at

the deposition, when the testimony has been transcribed a transcript of the deposition shall, unless the witness refuses to read and/or sign the transcript of the deposition, be read by the witness and then signed by the witness in the form of:

- (1) An affidavit in the presence of any notary or
- (2) A declaration.

[49 FR 48469, Dec. 12, 1984, added effective Feb. 11, 1985; para. (d) revised, 60 FR 14488, Mar. 17, 1995, effective Apr. 21, 1995]

**§ 1.676 Certification and filing by officer, marking exhibits.**

(a) The officer shall prepare a certified transcript of the deposition by attaching to a transcript of the deposition a copy of the notice of deposition, any exhibits to be annexed to the certified transcript, and a certificate signed and sealed by the officer and showing:

- (1) The witness was duly sworn by the officer before commencement of testimony by the witness.
- (2) The transcript is a true record of the testimony given by the witness.
- (3) The name of the person by whom the testimony was recorded and, if not recorded by the officer, whether the testimony was recorded in the presence of the officer.
- (4) The presence or absence of any opponent.
- (5) The place where the deposition was taken and the day and hour when the deposition began and ended.
- (6) The officer is not disqualified under § 1.674.

(b) If the parties waived any of the requirements of paragraph (a) of this section, the certificate shall so state.

(c) The officer shall note on the certificate the circumstances under which a witness refuses to sign a transcript.

(d) Unless the parties agree otherwise in writing or on the record at the deposition, the officer shall securely seal the certified transcript in an envelope endorsed with the style of the interference (*e.g.*, Smith v. Jones), the interference number, the name of the witness, and the date of sealing and shall promptly forward the envelope to the address set out in

§ 1.1(a)(1)(iii). Documents and things produced for inspection during the examination of a witness, shall, upon request of a party, be marked for identification and annexed to the certified transcript, and may be inspected and copied by any party, except that if the person producing the documents and things desires to retain them, the person may:

(1) Offer copies to be marked for identification and annexed to the certified transcript and to serve thereafter as originals if the person affords to all parties fair opportunity to verify the copies by comparison with the originals or

(2) Offer the originals to be marked for identification, after giving each party an opportunity to inspect and copy them, in which event the documents and things may be used in the same manner as if annexed to the certified transcript. The exhibits shall then be filed as specified in § 1.653(i).

If the weight or bulk of a document or thing shall reasonably prevent the document or thing from being annexed to the certified transcript, it shall, unless waived on the record at the deposition of all parties, be authenticated by the officer and forwarded to the Director in a separate package marked and addressed as provided in this paragraph

[49 FR 48469, Dec. 12, 1984, added effective Feb. 11, 1985; 50 FR 23124, May 31, 1985; para. (a)(4) revised, 60 FR 14488, Mar. 17, 1995, effective Apr. 21, 1995; introductory text of para. (d) revised, 68 FR 14332, Mar. 25, 2003, effective May 1, 2003]

### § 1.677 Form of an affidavit or a transcript of deposition.

(a) An affidavit or a transcript of a deposition must be on opaque, unglazed, durable paper approximately 21.8 by 27.9 cm. (8 1/2 by 11 inches) in size (letter size). The printed matter shall be double-spaced on one side of the paper in not smaller than 11 point type with a margin of 3.8 cm. (1 1/2 inches) on the left-hand side of the page. The pages of each transcript must be consecutively numbered and the name of the witness shall appear at the top of each page (§ 1.653(e)). In transcripts of depositions, the questions propounded to each witness must be consecutively numbered unless paper with numbered lines is used and each question must be followed by its answer.

(b) Exhibits must be numbered consecutively to the extent possible and each must be marked as required by § 1.653(i).

[49 FR 48470, Dec. 12, 1984, added effective Feb. 11, 1985; revised, 60 FR 14488, Mar. 17, 1995, effective Apr. 21, 1995]

### § 1.678 Time for filing transcript of deposition.

Unless otherwise ordered by an administrative patent judge, a certified transcript of a deposition must be filed in the Patent and Trademark Office within one month after the date of deposition. If a party refuses to file a certified transcript, the administrative patent judge or the Board may take appropriate action under § 1.616. If a party refuses to file a certified transcript, any opponent may move for leave to file the certified transcript and include a copy of the transcript as part of the opponent's record.

[49 FR 48470, Dec. 12, 1984, added effective Feb. 11, 1985; revised, 60 FR 14488, Mar. 17, 1995, effective Apr. 21, 1995]

### § 1.679 Inspection of transcript.

A certified transcript of a deposition filed in the Patent and Trademark Office may be inspected by any party. The certified transcript may not be removed from the Patent and Trademark Office unless authorized by an administrative patent judge upon such terms as may be appropriate.

[49 FR 48470, Dec. 12, 1984, added effective Feb. 11, 1985; revised, 60 FR 14488, Mar. 17, 1995, effective Apr. 21, 1995]

### § 1.682 [Reserved]

[49 FR 48470, Dec. 12, 1984, added effective Feb. 11, 1985; revised, 60 FR 14488, Mar. 17, 1995, effective Apr. 21, 1995; removed and reserved, 65 FR 56792, Sept. 20, 2000, effective Oct. 20, 2000]

### § 1.683 [Reserved]

[49 FR 48470, Dec. 12, 1984, added effective Feb. 11, 1985; revised, 60 FR 14488, Mar. 17, 1995, effective Apr. 21, 1995; removed and reserved, 65 FR 56792, Sept. 20, 2000, effective Oct. 20, 2000]

**§ 1.684 [Reserved]****§ 1.685 Errors and irregularities in depositions.**

(a) An error in a notice for taking a deposition is waived unless a motion (§ 1.635) to quash the notice is filed as soon as the error is, or could have been, discovered.

(b) An objection to a qualification of an officer taking a deposition is waived unless:

(1) The objection is made on the record of the deposition before a witness begins to testify.

(2) If discovered after the deposition, a motion (§ 1.635) to suppress the deposition is filed as soon as the objection is, or could have been, discovered.

(c) An error or irregularity in the manner in which testimony is transcribed, a certified transcript is signed by a witness, or a certified transcript is prepared, signed, certified, sealed, endorsed, forwarded, filed, or otherwise handled by the officer is waived unless a motion (§ 1.635) to suppress the deposition is filed as soon as the error of irregularity is, or could have been, discovered.

(d) An objection to the deposition on any grounds, such as the competency of a witness, admissibility of evidence, manner of taking the deposition, the form of questions and answers, any oath or affirmation, or conduct of any party at the deposition, is waived unless an objection is made on the record at the deposition stating the specific ground of objection. Any objection which a party wishes considered by the Board at final hearing shall be included in a motion to suppress under § 1.656(h).

(e) Nothing in this section precludes taking notice of plain errors affecting substantial rights although they were not brought to the attention of an administrative patent judge or the Board.

[49 FR 48471, Dec. 12, 1984, added effective Feb. 11, 1985; 50 FR 23124, May 31, 1985; amended, 60 FR 14488, Mar. 17, 1995, effective Apr. 21, 1995]

**§ 1.687 Additional discovery.**

(a) A party is not entitled to discovery except as authorized in this subpart.

(b) Where appropriate, a party may obtain production of documents and things during cross-exami-

nation of an opponent's witness or during the testimony period of the party's case-in-rebuttal.

(c) Upon a motion (§ 1.635) brought by a party within the time set by an administrative patent judge under § 1.651 or thereafter as authorized by § 1.645 and upon a showing that the interest of justice so requires, an administrative patent judge may order additional discovery, as to matters under the control of a party within the scope of the Federal Rules of Civil Procedure, specifying the terms and conditions of such additional discovery. See § 1.647 concerning translations of documents in a foreign language.

(d) The parties may agree to discovery among themselves at any time. In the absence of an agreement, a motion for additional discovery shall not be filed except as authorized by this subpart.

[49 FR 48471, Dec. 12, 1984, added effective Feb. 11, 1985; paras. (d) & (e) revised, 60 FR 14488, Mar. 17, 1995, effective Apr. 21, 1995]

**§ 1.688 [Reserved]**

[49 FR 48471, Dec. 12, 1984, added effective Feb. 11, 1985; revised, 60 FR 14488, Mar. 17, 1995, effective Apr. 21, 1995; removed and reserved, 65 FR 56792, Sept. 20, 2000, effective Oct. 20, 2000]

**§ 1.690 Arbitration of interferences.**

(a) Parties to a patent interference may determine the interference or any aspect thereof by arbitration. Such arbitration shall be governed by the provisions of Title 9, United States Code. The parties must notify the Board in writing of their intention to arbitrate. An agreement to arbitrate must be in writing, specify the issues to be arbitrated, the name of the arbitrator or a date not more than thirty (30) days after the execution of the agreement for the selection of the arbitrator, and provide that the arbitrator's award shall be binding on the parties and that judgment thereon can be entered by the Board. A copy of the agreement must be filed within twenty (20) days after its execution. The parties shall be solely responsible for the selection of the arbitrator and the rules for conducting proceedings before the arbitrator. Issues not disposed of by the arbitration will be resolved in accordance with the procedures established in this subpart, as determined by the administrative patent judge.

(b) An arbitration proceeding under this section shall be conducted within such time as may be authorized on a case-by-case basis by an administrative patent judge.

(c) An arbitration award will be given no consideration unless it is binding on the parties, is in writing and states in a clear and definite manner the issue or issues arbitrated and the disposition of each issue. The award may include a statement of the grounds and reasoning in support thereof. Unless otherwise ordered by an administrative patent judge, the parties shall give notice to the Board of an arbitration award by filing within twenty (20) days from the date of the award a copy of the award signed by the arbitrator or arbitrators. When an award is timely filed, the award shall, as to the parties to the arbitration, be dispositive of the issue or issues to which it relates.

(d) An arbitration award shall not preclude the Office from determining patentability of any invention involved in the interference.

[Added, 52 FR 13838, Apr. 27, 1987; paras. (a)-(c) revised, 60 FR 14488, Mar. 17, 1995, effective Apr. 21, 1995]

## Subpart F — Adjustment and Extension of Patent Term

### ADJUSTMENT OF PATENT TERM DUE TO EXAMINATION DELAY

#### § 1.701 Extension of patent term due to examination delay under the Uruguay Round Agreements Act (original applications, other than designs, filed on or after June 8, 1995, and before May 29, 2000).

(a) A patent, other than for designs, issued on an application filed on or after June 8, 1995, is entitled to extension of the patent term if the issuance of the patent was delayed due to:

(1) Interference proceedings under 35 U.S.C. 135(a); and/or

(2) The application being placed under a secrecy order under 35 U.S.C. 181; and/or

(3) Appellate review by the Board of Patent Appeals and Interferences or by a Federal court under 35 U.S.C. 141 or 145, if the patent was issued pursuant to a decision in the review reversing an adverse

determination of patentability and if the patent is not subject to a terminal disclaimer due to the issuance of another patent claiming subject matter that is not patentably distinct from that under appellate review. If an application is remanded by a panel of the Board of Patent Appeals and Interferences and the remand is the last action by a panel of the Board of Patent Appeals and Interferences prior to the mailing of a notice of allowance under 35 U.S.C. 151 in the application, the remand shall be considered a decision in the review reversing an adverse determination of patentability as that phrase is used in 35 U.S.C. 154(b)(2) as amended by section 532(a) of the Uruguay Round Agreements Act, Public Law 103-465, 108 Stat. 4809, 4983-85 (1994), and a final decision in favor of the applicant under paragraph (c)(3) of this section. A remand by a panel of the Board of Patent Appeals and Interferences shall not be considered a decision in the review reversing an adverse determination of patentability as provided in this paragraph if there is filed a request for continued examination under 35 U.S.C. 132(b) that was not first preceded by the mailing, after such remand, of at least one of an action under 35 U.S.C. 132 or a notice of allowance under 35 U.S.C. 151.

(b) The term of a patent entitled to extension under paragraph (a) of this section shall be extended for the sum of the periods of delay calculated under paragraphs (c)(1), (c)(2), (c)(3) and (d) of this section, to the extent that these periods are not overlapping, up to a maximum of five years. The extension will run from the expiration date of the patent.

(c)(1) The period of delay under paragraph (a)(1) of this section for an application is the sum of the following periods, to the extent that the periods are not overlapping:

(i) With respect to each interference in which the application was involved, the number of days, if any, in the period beginning on the date the interference was declared or redeclared to involve the application in the interference and ending on the date that the interference was terminated with respect to the application; and

(ii) The number of days, if any, in the period beginning on the date prosecution in the application was suspended by the Patent and Trademark Office due to interference proceedings under 35 U.S.C. 135(a) not involving the application and

ending on the date of the termination of the suspension.

(2) The period of delay under paragraph (a)(2) of this section for an application is the sum of the following periods, to the extent that the periods are not overlapping:

(i) The number of days, if any, the application was maintained in a sealed condition under 35 U.S.C. 181;

(ii) The number of days, if any, in the period beginning on the date of mailing of an examiner's answer under § 1.193 in the application under secrecy order and ending on the date the secrecy order and any renewal thereof was removed;

(iii) The number of days, if any, in the period beginning on the date applicant was notified that an interference would be declared but for the secrecy order and ending on the date the secrecy order and any renewal thereof was removed; and

(iv) The number of days, if any, in the period beginning on the date of notification under § 5.3(c) and ending on the date of mailing of the notice of allowance under § 1.311.

(3) The period of delay under paragraph (a)(3) of this section is the sum of the number of days, if any, in the period beginning on the date on which an appeal to the Board of Patent Appeals and Interferences was filed under 35 U.S.C. 134 and ending on the date of a final decision in favor of the applicant by the Board of Patent Appeals and Interferences or by a Federal court in an appeal under 35 U.S.C. 141 or a civil action under 35 U.S.C. 145.

(d) The period of delay set forth in paragraph (c)(3) shall be reduced by:

(1) Any time during the period of appellate review that occurred before three years from the filing of the first national application for patent presented for examination; and

(2) Any time during the period of appellate review, as determined by the Director, during which the applicant for patent did not act with due diligence. In determining the due diligence of an applicant, the Director may examine the facts and circumstances of the applicant's actions during the period of appellate review to determine whether the applicant exhibited that degree of timeliness as may reasonably be expected from, and which is ordinarily exercised by, a person during a period of appellate review.

(e) The provisions of this section apply only to original patents, except for design patents, issued on applications filed on or after June 8, 1995, and before May 29, 2000.

[Added, 60 FR 20195, Apr. 25, 1995, effective June 8, 1995; para. (e) added, 65 FR 56366, Sept. 18, 2000, effective Oct. 18, 2000; para. (d)(2) revised, 68 FR 14332, Mar. 25, 2003, effective May 1, 2003; para. (a)(3) revised, 69 FR 21704, Apr. 22, 2004, effective May 24, 2004]

**§ 1.702 Grounds for adjustment of patent term due to examination delay under the Patent Term Guarantee Act of 1999 (original applications, other than designs, filed on or after May 29, 2000).**

(a) *Failure to take certain actions within specified time frames.* Subject to the provisions of 35 U.S.C. 154(b) and this subpart, the term of an original patent shall be adjusted if the issuance of the patent was delayed due to the failure of the Office to:

(1) Mail at least one of a notification under 35 U.S.C. 132 or a notice of allowance under 35 U.S.C. 151 not later than fourteen months after the date on which the application was filed under 35 U.S.C. 111(a) or fulfilled the requirements of 35 U.S.C. 371 in an international application;

(2) Respond to a reply under 35 U.S.C. 132 or to an appeal taken under 35 U.S.C. 134 not later than four months after the date on which the reply was filed or the appeal was taken;

(3) Act on an application not later than four months after the date of a decision by the Board of Patent Appeals and Interferences under 35 U.S.C. 134 or 135 or a decision by a Federal court under 35 U.S.C. 141, 145, or 146 where at least one allowable claim remains in the application; or

(4) Issue a patent not later than four months after the date on which the issue fee was paid under 35 U.S.C. 151 and all outstanding requirements were satisfied.

(b) *Failure to issue a patent within three years of the actual filing date of the application.* Subject to the provisions of 35 U.S.C. 154(b) and this subpart, the term of an original patent shall be adjusted if the issuance of the patent was delayed due to the failure of the Office to issue a patent within three years after the date on which the application was filed under 35 U.S.C. 111(a) or the national stage commenced

under 35 U.S.C. 371(b) or (f) in an international application, but not including:

(1) Any time consumed by continued examination of the application under 35 U.S.C. 132(b);

(2) Any time consumed by an interference proceeding under 35 U.S.C. 135(a);

(3) Any time consumed by the imposition of a secrecy order under 35 U.S.C. 181;

(4) Any time consumed by review by the Board of Patent Appeals and Interferences or a Federal court; or

(5) Any delay in the processing of the application by the Office that was requested by the applicant.

(c) *Delays caused by interference proceedings.* Subject to the provisions of 35 U.S.C. 154(b) and this subpart, the term of an original patent shall be adjusted if the issuance of the patent was delayed due to interference proceedings under 35 U.S.C. 135(a).

(d) *Delays caused by secrecy order.* Subject to the provisions of 35 U.S.C. 154(b) and this subpart, the term of an original patent shall be adjusted if the issuance of the patent was delayed due to the application being placed under a secrecy order under 35 U.S.C. 181.

(e) *Delays caused by successful appellate review.* Subject to the provisions of 35 U.S.C. 154(b) and this subpart, the term of an original patent shall be adjusted if the issuance of the patent was delayed due to review by the Board of Patent Appeals and Interferences under 35 U.S.C. 134 or by a Federal court under 35 U.S.C. 141 or 145, if the patent was issued under a decision in the review reversing an adverse determination of patentability. If an application is remanded by a panel of the Board of Patent Appeals and Interferences and the remand is the last action by a panel of the Board of Patent Appeals and Interferences prior to the mailing of a notice of allowance under 35 U.S.C. 151 in the application, the remand shall be considered a decision by the Board of Patent Appeals and Interferences as that phrase is used in 35 U.S.C. 154(b)(1)(A)(iii), a decision in the review reversing an adverse determination of patentability as that phrase is used in 35 U.S.C. 154(b)(1)(C)(iii), and a final decision in favor of the applicant under § 1.703(e). A remand by a panel of the Board of Patent Appeals and Interferences shall not be considered a decision in the review reversing an adverse determi-

nation of patentability as provided in this paragraph if there is filed a request for continued examination under 35 U.S.C. 132(b) that was not first preceded by the mailing, after such remand, of at least one of an action under 35 U.S.C. 132 or a notice of allowance under 35 U.S.C. 151.

(f) The provisions of this section and §§1.703 through 1.705 apply only to original applications, except applications for a design patent, filed on or after May 29, 2000, and patents issued on such applications.

[Added, 65 FR 56366, Sept. 18, 2000, effective Oct. 18, 2000; para. (e) revised, 69 FR 21704, Apr. 22, 2004, effective May 24, 2004]

### § 1.703 Period of adjustment of patent term due to examination delay.

(a) The period of adjustment under § 1.702(a) is the sum of the following periods:

(1) The number of days, if any, in the period beginning on the day after the date that is fourteen months after the date on which the application was filed under 35 U.S.C. 111(a) or fulfilled the requirements of 35 U.S.C. 371 and ending on the date of mailing of either an action under 35 U.S.C. 132, or a notice of allowance under 35 U.S.C. 151, whichever occurs first;

(2) The number of days, if any, in the period beginning on the day after the date that is four months after the date a reply under § 1.111 was filed and ending on the date of mailing of either an action under 35 U.S.C. 132, or a notice of allowance under 35 U.S.C. 151, whichever occurs first;

(3) The number of days, if any, in the period beginning on the day after the date that is four months after the date a reply in compliance with § 1.113(c) was filed and ending on the date of mailing of either an action under 35 U.S.C. 132, or a notice of allowance under 35 U.S.C. 151, whichever occurs first;

(4) The number of days, if any, in the period beginning on the day after the date that is four months after the date an appeal brief in compliance with § 1.192 was filed and ending on the date of mailing of any of an examiner's answer under § 1.193, an action under 35 U.S.C. 132, or a notice of allowance under 35 U.S.C. 151, whichever occurs first;

(5) The number of days, if any, in the period beginning on the day after the date that is four months

after the date of a final decision by the Board of Patent Appeals and Interferences or by a Federal court in an appeal under 35 U.S.C. 141 or a civil action under 35 U.S.C. 145 or 146 where at least one allowable claim remains in the application and ending on the date of mailing of either an action under 35 U.S.C. 132 or a notice of allowance under 35 U.S.C. 151, whichever occurs first; and

(6) The number of days, if any, in the period beginning on the day after the date that is four months after the date the issue fee was paid and all outstanding requirements were satisfied and ending on the date a patent was issued.

(b) The period of adjustment under § 1.702(b) is the number of days, if any, in the period beginning on the day after the date that is three years after the date on which the application was filed under 35 U.S.C. 111(a) or the national stage commenced under 35 U.S.C. 371(b) or (f) in an international application and ending on the date a patent was issued, but not including the sum of the following periods:

(1) The number of days, if any, in the period beginning on the date on which a request for continued examination of the application under 35 U.S.C. 132(b) was filed and ending on the date the patent was issued;

(2)(i) The number of days, if any, in the period beginning on the date an interference was declared or redeclared to involve the application in the interference and ending on the date that the interference was terminated with respect to the application; and

(ii) The number of days, if any, in the period beginning on the date prosecution in the application was suspended by the Office due to interference proceedings under 35 U.S.C. 135(a) not involving the application and ending on the date of the termination of the suspension;

(3)(i) The number of days, if any, the application was maintained in a sealed condition under 35 U.S.C. 181;

(ii) The number of days, if any, in the period beginning on the date of mailing of an examiner's answer under § 1.193 in the application under secrecy order and ending on the date the secrecy order was removed;

(iii) The number of days, if any, in the period beginning on the date applicant was notified that an interference would be declared but for the secrecy order and ending on the date the secrecy order was removed; and

(iv) The number of days, if any, in the period beginning on the date of notification under § 5.3(c) of this chapter and ending on the date of mailing of the notice of allowance under 35 U.S.C. 151; and,

(4) The number of days, if any, in the period beginning on the date on which a notice of appeal to the Board of Patent Appeals and Interferences was filed under 35 U.S.C. 134 and § 1.191 and ending on the date of the last decision by the Board of Patent Appeals and Interferences or by a Federal court in an appeal under 35 U.S.C. 141 or a civil action under 35 U.S.C. 145, or on the date of mailing of either an action under 35 U.S.C. 132, or a notice of allowance under 35 U.S.C. 151, whichever occurs first, if the appeal did not result in a decision by the Board of Patent Appeals and Interferences.

(c) The period of adjustment under § 1.702(c) is the sum of the following periods, to the extent that the periods are not overlapping:

(1) The number of days, if any, in the period beginning on the date an interference was declared or redeclared to involve the application in the interference and ending on the date that the interference was terminated with respect to the application; and

(2) The number of days, if any, in the period beginning on the date prosecution in the application was suspended by the Office due to interference proceedings under 35 U.S.C. 135(a) not involving the application and ending on the date of the termination of the suspension.

(d) The period of adjustment under § 1.702(d) is the sum of the following periods, to the extent that the periods are not overlapping:

(1) The number of days, if any, the application was maintained in a sealed condition under 35 U.S.C. 181;

(2) The number of days, if any, in the period beginning on the date of mailing of an examiner's answer under § 1.193 in the application under secrecy order and ending on the date the secrecy order was removed;

(3) The number of days, if any, in the period beginning on the date applicant was notified that an interference would be declared but for the secrecy order and ending on the date the secrecy order was removed; and

(4) The number of days, if any, in the period beginning on the date of notification under § 5.3(c) of this chapter and ending on the date of mailing of the notice of allowance under 35 U.S.C. 151.

(e) The period of adjustment under § 1.702(e) is the sum of the number of days, if any, in the period beginning on the date on which a notice of appeal to the Board of Patent Appeals and Interferences was filed under 35 U.S.C. 134 and § 1.191 and ending on the date of a final decision in favor of the applicant by the Board of Patent Appeals and Interferences or by a Federal court in an appeal under 35 U.S.C. 141 or a civil action under 35 U.S.C. 145.

(f) The adjustment will run from the expiration date of the patent as set forth in 35 U.S.C. 154(a)(2). To the extent that periods of delay attributable to the grounds specified in § 1.702 overlap, the period of adjustment granted under this section shall not exceed the actual number of days the issuance of the patent was delayed. The term of a patent entitled to adjustment under § 1.702 and this section shall be adjusted for the sum of the periods calculated under paragraphs (a) through (e) of this section, to the extent that such periods are not overlapping, less the sum of the periods calculated under § 1.704. The date indicated on any certificate of mailing or transmission under § 1.8 shall not be taken into account in this calculation.

(g) No patent, the term of which has been disclaimed beyond a specified date, shall be adjusted under § 1.702 and this section beyond the expiration date specified in the disclaimer.

[Added, 65 FR 56366, Sept. 18, 2000, effective Oct. 18, 2000; para. (f) revised, 69 FR 21704, Apr. 22, 2004, effective May 24, 2004]

#### **§ 1.704 Reduction of period of adjustment of patent term.**

(a) The period of adjustment of the term of a patent under § 1.703(a) through (e) shall be reduced

by a period equal to the period of time during which the applicant failed to engage in reasonable efforts to conclude prosecution (processing or examination) of the application.

(b) With respect to the grounds for adjustment set forth in §§ 1.702(a) through (e), and in particular the ground of adjustment set forth in § 1.702(b), an applicant shall be deemed to have failed to engage in reasonable efforts to conclude processing or examination of an application for the cumulative total of any periods of time in excess of three months that are taken to reply to any notice or action by the Office making any rejection, objection, argument, or other request, measuring such three-month period from the date the notice or action was mailed or given to the applicant, in which case the period of adjustment set forth in § 1.703 shall be reduced by the number of days, if any, beginning on the day after the date that is three months after the date of mailing or transmission of the Office communication notifying the applicant of the rejection, objection, argument, or other request and ending on the date the reply was filed. The period, or shortened statutory period, for reply that is set in the Office action or notice has no effect on the three-month period set forth in this paragraph.

(c) Circumstances that constitute a failure of the applicant to engage in reasonable efforts to conclude processing or examination of an application also include the following circumstances, which will result in the following reduction of the period of adjustment set forth in § 1.703 to the extent that the periods are not overlapping:

(1) Suspension of action under § 1.103 at the applicant's request, in which case the period of adjustment set forth in § 1.703 shall be reduced by the number of days, if any, beginning on the date a request for suspension of action under § 1.103 was filed and ending on the date of the termination of the suspension;

(2) Deferral of issuance of a patent under § 1.314, in which case the period of adjustment set forth in § 1.703 shall be reduced by the number of days, if any, beginning on the date a request for deferral of issuance of a patent under § 1.314 was filed and ending on the date the patent was issued;



(3) Abandonment of the application or late payment of the issue fee, in which case the period of adjustment set forth in § 1.703 shall be reduced by the number of days, if any, beginning on the date of abandonment or the date after the date the issue fee was due and ending on the earlier of:

(i) The date of mailing of the decision reviving the application or accepting late payment of the issue fee; or

(ii) The date that is four months after the date the grantable petition to revive the application or accept late payment of the issue fee was filed;

(4) Failure to file a petition to withdraw the holding of abandonment or to revive an application within two months from the mailing date of a notice of abandonment, in which case the period of adjustment set forth in § 1.703 shall be reduced by the number of days, if any, beginning on the day after the date two months from the mailing date of a notice of abandonment and ending on the date a petition to withdraw the holding of abandonment or to revive the application was filed;

(5) Conversion of a provisional application under 35 U.S.C. 111(b) to a nonprovisional application under 35 U.S.C. 111(a) pursuant to 35 U.S.C. 111(b)(5), in which case the period of adjustment set forth in § 1.703 shall be reduced by the number of days, if any, beginning on the date the application was filed under 35 U.S.C. 111(b) and ending on the date a request in compliance with § 1.53(c)(3) to convert the provisional application into a nonprovisional application was filed;

(6) Submission of a preliminary amendment or other preliminary paper less than one month before the mailing of an Office action under 35 U.S.C. 132 or notice of allowance under 35 U.S.C. 151 that requires the mailing of a supplemental Office action or notice of allowance, in which case the period of adjustment set forth in § 1.703 shall be reduced by the lesser of:

(i) The number of days, if any, beginning on the day after the mailing date of the original Office action or notice of allowance and ending on the date of mailing of the supplemental Office action or notice of allowance; or

(ii) Four months;

(7) Submission of a reply having an omission (§ 1.135(c)), in which case the period of adjustment set forth in § 1.703 shall be reduced by the number of days, if any, beginning on the day after the date the reply having an omission was filed and ending on the date that the reply or other paper correcting the omission was filed;

(8) Submission of a supplemental reply or other paper, other than a supplemental reply or other paper expressly requested by the examiner, after a reply has been filed, in which case the period of adjustment set forth in § 1.703 shall be reduced by the number of days, if any, beginning on the day after the date the initial reply was filed and ending on the date that the supplemental reply or other such paper was filed;

(9) Submission of an amendment or other paper after a decision by the Board of Patent Appeals and Interferences, other than a decision designated as containing a new ground of rejection under § 1.196(b) or statement under § 1.196(c), or a decision by a Federal court, less than one month before the mailing of an Office action under 35 U.S.C. 132 or notice of allowance under 35 U.S.C. 151 that requires the mailing of a supplemental Office action or supplemental notice of allowance, in which case the period of adjustment set forth in § 1.703 shall be reduced by the lesser of:

(i) The number of days, if any, beginning on the day after the mailing date of the original Office action or notice of allowance and ending on the mailing date of the supplemental Office action or notice of allowance; or

(ii) Four months;

(10) Submission of an amendment under § 1.312 or other paper after a notice of allowance has been given or mailed, in which case the period of adjustment set forth in § 1.703 shall be reduced by the lesser of:

(i) The number of days, if any, beginning on the date the amendment under § 1.312 or other paper was filed and ending on the mailing date of the Office action or notice in response to the amendment under § 1.312 or such other paper; or

(ii) Four months; and

(11) Further prosecution via a continuing application, in which case the period of adjustment set forth in § 1.703 shall not include any period that is prior to the actual filing date of the application that resulted in the patent.

(d) A paper containing only an information disclosure statement in compliance with §§ 1.97 and 1.98 will not be considered a failure to engage in reasonable efforts to conclude prosecution (processing or examination) of the application under paragraphs (c)(6), (c)(8), (c)(9), or (c)(10) of this section if it is accompanied by a statement that each item of information contained in the information disclosure statement was first cited in any communication from a foreign patent office in a counterpart application and that this communication was not received by any individual designated in § 1.56(c) more than thirty days prior to the filing of the information disclosure statement. This thirty-day period is not extendable.

(e) Submission of an application for patent term adjustment under § 1.705(b) (with or without request under § 1.705(c) for reinstatement of reduced patent term adjustment) will not be considered a failure to engage in reasonable efforts to conclude prosecution (processing or examination) of the application under paragraph (c)(10) of this section.

[Added, 65 FR 56366, Sept. 18, 2000, effective Oct. 18, 2000; para. (d) revised, 69 FR 21704, Apr. 22, 2004, effective May 24, 2004]

### § 1.705 Patent term adjustment determination.

(a) The notice of allowance will include notification of any patent term adjustment under 35 U.S.C. 154(b).

(b) Any request for reconsideration of the patent term adjustment indicated in the notice of allowance, except as provided in paragraph (d) of this section, and any request for reinstatement of all or part of the term reduced pursuant to § 1.704(b) must be by way of an application for patent term adjustment. An application for patent term adjustment under this section must be filed no later than the payment of the issue fee but may not be filed earlier than the date of mailing of the notice of allowance. An application for patent term adjustment under this section must be accompanied by:

- (1) The fee set forth in § 1.18(e); and

(2) A statement of the facts involved, specifying:

- (i) The correct patent term adjustment and the basis or bases under § 1.702 for the adjustment;

- (ii) The relevant dates as specified in §§ 1.703(a) through (e) for which an adjustment is sought and the adjustment as specified in § 1.703(f) to which the patent is entitled;

- (iii) Whether the patent is subject to a terminal disclaimer and any expiration date specified in the terminal disclaimer; and

- (iv)(A) Any circumstances during the prosecution of the application resulting in the patent that constitute a failure to engage in reasonable efforts to conclude processing or examination of such application as set forth in § 1.704; or

- (B) That there were no circumstances constituting a failure to engage in reasonable efforts to conclude processing or examination of such application as set forth in § 1.704.

(c) Any application for patent term adjustment under this section that requests reinstatement of all or part of the period of adjustment reduced pursuant to § 1.704(b) for failing to reply to a rejection, objection, argument, or other request within three months of the date of mailing of the Office communication notifying the applicant of the rejection, objection, argument, or other request must also be accompanied by:

- (1) The fee set forth in § 1.18(f); and

- (2) A showing to the satisfaction of the Director that, in spite of all due care, the applicant was unable to reply to the rejection, objection, argument, or other request within three months of the date of mailing of the Office communication notifying the applicant of the rejection, objection, argument, or other request. The Office shall not grant any request for reinstatement for more than three additional months for each reply beyond three months from the date of mailing of the Office communication notifying the applicant of the rejection, objection, argument, or other request.

(d) If there is a revision to the patent term adjustment indicated in the notice of allowance, the patent will indicate the revised patent term adjustment. If the patent indicates or should have indicated a revised patent term adjustment, any request for reconsideration of the patent term adjustment indicated in the patent must be filed within two months of

the date the patent issued and must comply with the requirements of paragraphs (b)(1) and (b)(2) of this section. Any request for reconsideration under this section that raises issues that were raised, or could have been raised, in an application for patent term adjustment under paragraph (b) of this section shall be dismissed as untimely as to those issues.

(e) The periods set forth in this section are not extendable.

(f) No submission or petition on behalf of a third party concerning patent term adjustment under 35 U.S.C. 154(b) will be considered by the Office. Any such submission or petition will be returned to the third party, or otherwise disposed of, at the convenience of the Office.

[Added, 65 FR 56366, Sept. 18, 2000, effective Oct. 18, 2000; para. (c)(2) revised, 68 FR 14332, Mar. 25, 2003, effective May 1, 2003; para. (d) revised, 69 FR 21704, Apr. 22, 2004, effective May 24, 2004]

## EXTENSION OF PATENT TERM DUE TO REGULATORY REVIEW

### § 1.710 Patents subject to extension of the patent term.

(a) A patent is eligible for extension of the patent term if the patent claims a product as defined in paragraph (b) of this section, either alone or in combination with other ingredients that read on a composition that received permission for commercial marketing or use, or a method of using such a product, or a method of manufacturing such a product, and meets all other conditions and requirements of this subpart.

(b) The term *product* referred to in paragraph (a) of this section means —

(1) The active ingredient of a new human drug, antibiotic drug, or human biological product (as those terms are used in the Federal Food, Drug, and Cosmetic Act and the Public Health Service Act) including any salt or ester of the active ingredient, as a single entity or in combination with another active ingredient; or

(2) The active ingredient of a new animal drug or veterinary biological product (as those terms are used in the Federal Food, Drug, and Cosmetic Act and the Virus-Serum-Toxin Act) that is not primarily manufactured using recombinant DNA, recombinant

RNA, hybridoma technology, or other processes including site specific genetic manipulation techniques, including any salt or ester of the active ingredient, as a single entity or in combination with another active ingredient; or

(3) Any medical device, food additive, or color additive subject to regulation under the Federal Food, Drug, and Cosmetic Act.

[Added 52 FR 9394, Mar. 24, 1987, effective May 26, 1987; amended, 54 FR 30375, July 20, 1989, effective Aug. 22, 1989]

### § 1.720 Conditions for extension of patent term.

The term of a patent may be extended if:

(a) The patent claims a product or a method of using or manufacturing a product as defined in § 1.710;

(b) The term of the patent has never been previously extended, except for extensions issued pursuant to §§ 1.701, 1.760, or 1.790;

(c) An application for extension is submitted in compliance with § 1.740;

(d) The product has been subject to a regulatory review period as defined in 35 U.S.C. 156(g) before its commercial marketing or use;

(e) The product has received permission for commercial marketing or use and —

(1) The permission for the commercial marketing or use of the product is the first received permission for commercial marketing or use under the provision of law under which the applicable regulatory review occurred, or

(2) In the case of a patent other than one directed to subject matter within § 1.710(b)(2) claiming a method of manufacturing the product that primarily uses recombinant DNA technology in the manufacture of the product, the permission for the commercial marketing or use is the first received permission for the commercial marketing or use of a product manufactured under the process claimed in the patent, or

(3) In the case of a patent claiming a new animal drug or a veterinary biological product that is not covered by the claims in any other patent that has been extended, and has received permission for the commercial marketing or use in non-food-producing animals and in food-producing animals, and was not extended on the basis of the regulatory review period

for use in non-food-producing animals, the permission for the commercial marketing or use of the drug or product after the regulatory review period for use in food-producing animals is the first permitted commercial marketing or use of the drug or product for administration to a food-producing animal.

(f) The application is submitted within the sixty-day period beginning on the date the product first received permission for commercial marketing or use under the provisions of law under which the applicable regulatory review period occurred; or in the case of a patent claiming a method of manufacturing the product which primarily uses recombinant DNA technology in the manufacture of the product, the application for extension is submitted within the sixty-day period beginning on the date of the first permitted commercial marketing or use of a product manufactured under the process claimed in the patent; or in the case of a patent that claims a new animal drug or a veterinary biological product that is not covered by the claims in any other patent that has been extended, and said drug or product has received permission for the commercial marketing or use in non-food-producing animals, the application for extension is submitted within the sixty-day period beginning on the date of the first permitted commercial marketing or use of the drug or product for administration to a food-producing animal;

(g) The term of the patent, including any interim extension issued pursuant to § 1.790, has not expired before the submission of an application in compliance with § 1.741; and

(h) No other patent term has been extended for the same regulatory review period for the product.

[Added 52 FR 9395, Mar. 24, 1987, effective May 26, 1987; paras. (e) & (f) amended, 54 FR 30375, July 20, 1989, effective Aug. 22, 1989; paras. (b) and (g) revised, 65 FR 54604, Sept. 8, 2000, effective Nov. 7, 2000]

**§ 1.730 Applicant for extension of patent term; signature requirements.**

(a) Any application for extension of a patent term must be submitted by the owner of record of the patent or its agent and must comply with the requirements of § 1.740.

(b) If the application is submitted by the patent owner, the application must be signed either by:

(1) The patent owner in compliance with § 3.73(b) of this chapter; or

(2) A registered practitioner on behalf of the patent owner.

(c) If the application is submitted on behalf of the patent owner by an agent of the patent owner (*e.g.*, a licensee of the patent owner), the application must be signed by a registered practitioner on behalf of the agent. The Office may require proof that the agent is authorized to act on behalf of the patent owner.

(d) If the application is signed by a registered practitioner, the Office may require proof that the practitioner is authorized to act on behalf of the patent owner or agent of the patent owner.

[Added 52 FR 9395, Mar. 24, 1987, effective May 26, 1987; revised, 65 FR 54604, Sept. 8, 2000, effective Nov. 7, 2000]

**§ 1.740 Formal requirements for application for extension of patent term; correction of informalities.**

(a) An application for extension of patent term must be made in writing to the Director. A formal application for the extension of patent term must include:

(1) A complete identification of the approved product as by appropriate chemical and generic name, physical structure or characteristics;

(2) A complete identification of the Federal statute including the applicable provision of law under which the regulatory review occurred;

(3) An identification of the date on which the product received permission for commercial marketing or use under the provision of law under which the applicable regulatory review period occurred;

(4) In the case of a drug product, an identification of each active ingredient in the product and as to each active ingredient, a statement that it has not been previously approved for commercial marketing or use under the Federal Food, Drug, and Cosmetic Act, the Public Health Service Act, or the Virus-Serum-Toxin Act, or a statement of when the active ingredient was approved for commercial marketing or use (either alone or in combination with other active ingredients), the use for which it was approved, and the provision of law under which it was approved.

(5) A statement that the application is being submitted within the sixty day period permitted for submission pursuant to § 1.720(f) and an identification of the date of the last day on which the application could be submitted;

(6) A complete identification of the patent for which an extension is being sought by the name of the inventor, the patent number, the date of issue, and the date of expiration;

(7) A copy of the patent for which an extension is being sought, including the entire specification (including claims) and drawings;

(8) A copy of any disclaimer, certificate of correction, receipt of maintenance fee payment, or reexamination certificate issued in the patent;

(9) A statement that the patent claims the approved product, or a method of using or manufacturing the approved product, and a showing which lists each applicable patent claim and demonstrates the manner in which at least one such patent claim reads on:

(i) The approved product, if the listed claims include any claim to the approved product;

(ii) The method of using the approved product, if the listed claims include any claim to the method of using the approved product; and

(iii) The method of manufacturing the approved product, if the listed claims include any claim to the method of manufacturing the approved product;

(10) A statement beginning on a new page of the relevant dates and information pursuant to 35 U.S.C. 156(g) in order to enable the Secretary of Health and Human Services or the Secretary of Agriculture, as appropriate, to determine the applicable regulatory review period as follows:

(i) For a patent claiming a human drug, antibiotic, or human biological product:

(A) The effective date of the investigational new drug (IND) application and the IND number;

(B) The date on which a new drug application (NDA) or a Product License Application (PLA)

was initially submitted and the NDA or PLA number; and

(C) The date on which the NDA was approved or the Product License issued;

(ii) For a patent claiming a new animal drug:

(A) The date a major health or environmental effects test on the drug was initiated, and any available substantiation of that date, or the date of an exemption under subsection (j) of Section 512 of the Federal Food, Drug, and Cosmetic Act became effective for such animal drug;

(B) The date on which a new animal drug application (NADA) was initially submitted and the NADA number; and

(C) The date on which the NADA was approved;

(iii) For a patent claiming a veterinary biological product:

(A) The date the authority to prepare an experimental biological product under the Virus-Serum-Toxin Act became effective;

(B) The date an application for a license was submitted under the Virus-Serum-Toxin Act; and

(C) The date the license issued;

(iv) For a patent claiming a food or color additive:

(A) The date a major health or environmental effects test on the additive was initiated and any available substantiation of that date;

(B) The date on which a petition for product approval under the Federal Food, Drug and Cosmetic Act was initially submitted and the petition number; and

(C) The date on which the FDA published a *Federal Register* notice listing the additive for use;

(v) For a patent claiming a medical device:

(A) The effective date of the investigational device exemption (IDE) and the IDE number, if applicable, or the date on which the applicant began the first clinical investigation involving the device, if no IDE was submitted, and any available substantiation of that date;

(B) The date on which the application for product approval or notice of completion of a product development protocol under Section 515 of the Federal Food, Drug and Cosmetic Act was initially submitted and the number of the application; and

(C) The date on which the application was approved or the protocol declared to be completed;

(11) A brief description beginning on a new page of the significant activities undertaken by the marketing applicant during the applicable regulatory review period with respect to the approved product and the significant dates applicable to such activities;

(12) A statement beginning on a new page that in the opinion of the applicant the patent is eligible for the extension and a statement as to the length of extension claimed, including how the length of extension was determined;

(13) A statement that applicant acknowledges a duty to disclose to the Director of the United States Patent and Trademark Office and the Secretary of Health and Human Services or the Secretary of Agriculture any information which is material to the determination of entitlement to the extension sought (*see* § 1.765);

(14) The prescribed fee for receiving and acting upon the application for extension (*see* § 1.20(j)); and

(15) The name, address, and telephone number of the person to whom inquiries and correspondence relating to the application for patent term extension are to be directed.

(b) The application under this section must be accompanied by two additional copies of such application (for a total of three copies).

(c) If an application for extension of patent term is informal under this section, the Office will so notify the applicant. The applicant has two months from the mail date of the notice, or such time as is set in the notice, within which to correct the informality. Unless the notice indicates otherwise, this time period may be extended under the provisions of § 1.136.

[Added 52 FR 9395, Mar. 24, 1987, effective May 26, 1987; para. (a) amended, 54 FR 30375, July 20, 1989, effective Aug. 22, 1989; para. (a)(14), 56 FR 65142, Dec. 13, 1991, effective Dec. 16, 1991; heading, introductory text of paragraph (a), and paras. (a)(9), (a)(10), (a)(14),

(a)(15), (b) and (c) revised, 65 FR 54604, Sept. 8, 2000, effective Sept. 8, 2000; paras. (a)(16) and (a)(17) removed, 65 FR 54604, Sept. 8, 2000, effective Sept. 8, 2000; paras. (a) & (a)(13) revised, 68 FR 14332, Mar. 25, 2003, effective May 1, 2003]

**§ 1.741 Complete application given a filing date; petition procedure.**

(a) The filing date of an application for extension of a patent term is the date on which a complete application is received in the Office or filed pursuant to the procedures set forth in §1.8 or § 1.10. A complete application must include:

(1) An identification of the approved product;

(2) An identification of each Federal statute under which regulatory review occurred;

(3) An identification of the patent for which an extension is being sought;

(4) An identification of each claim of the patent which claims the approved product or a method of using or manufacturing the approved product;

(5) Sufficient information to enable the Director to determine under subsections (a) and (b) of 35 U.S.C. 156 the eligibility of a patent for extension, and the rights that will be derived from the extension, and information to enable the Director and the Secretary of Health and Human Services or the Secretary of Agriculture to determine the length of the regulatory review period; and

(6) A brief description of the activities undertaken by the marketing applicant during the applicable regulatory review period with respect to the approved product and the significant dates applicable to such activities.

(b) If an application for extension of patent term is incomplete under this section, the Office will so notify the applicant. If applicant requests review of a notice that an application is incomplete, or review of the filing date accorded an application under this section, applicant must file a petition pursuant to this paragraph accompanied by the fee set forth in § 1.17(h) within two months of the mail date of the notice that the application is incomplete, or the notice according the filing date complained of. Unless the notice indicates otherwise, this time period may be extended under the provisions of § 1.136.

[Added 52 FR 9396, Mar. 24, 1987, effective May 26, 1987; para. (a) amended, 54 FR 30375, July 20, 1989, effective Aug. 22, 1989; para. (a) amended, 58 FR 54494, Oct. 22, 1993, effective Nov. 22, 1993; para. (a) correcting amendment, 61 FR 64027, Dec. 3, 1996; heading, introductory text of paragraph (a), and paras. (a)(5) and (b) revised, 65 FR 54604, Sept. 8, 2000, effective Nov. 7, 2000; para. (a)(5) revised, 68 FR 14332, Mar. 25, 2003, effective May 1, 2003]

### § 1.750 Determination of eligibility for extension of patent term.

A determination as to whether a patent is eligible for extension may be made by the Director solely on the basis of the representations contained in the application for extension filed in compliance with § 1.740 or § 1.790. This determination may be delegated to appropriate Patent and Trademark Office officials and may be made at any time before the certificate of extension is issued. The Director or other appropriate officials may require from applicant further information or make such independent inquiries as desired before a final determination is made on whether a patent is eligible for extension. In an application for extension filed in compliance with § 1.740, a notice will be mailed to applicant containing the determination as to the eligibility of the patent for extension and the period of time of the extension, if any. This notice shall constitute the final determination as to the eligibility and any period of extension of the patent. A single request for reconsideration of a final determination may be made if filed by the applicant within such time as may be set in the notice of final determination or, if no time is set, within one month from the date of the final determination. The time periods set forth herein are subject to the provisions of § 1.136.

[Added 52 FR 9396, Mar. 24, 1987, effective May 26, 1987; revised, 60 FR 25615, May 12, 1995, effective July 11, 1995; revised, 68 FR 14332, Mar. 25, 2003, effective May 1, 2003]

### § 1.760 Interim extension of patent term under 35 U.S.C. 156(e)(2).

An applicant who has filed a formal application for extension in compliance with § 1.740 may request one or more interim extensions for periods of up to one year each pending a final determination on the appli-

cation pursuant to § 1.750. Any such request should be filed at least three months prior to the expiration date of the patent. The Director may issue interim extensions, without a request by the applicant, for periods of up to one year each until a final determination is made. The patent owner or agent will be notified when an interim extension is granted and notice of the extension will be published in the *Official Gazette of the United States Patent and Trademark Office*. The notice will be recorded in the official file of the patent and will be considered as part of the original patent. In no event will the interim extensions granted under this section be longer than the maximum period for extension to which the applicant would be eligible.

[Added, 52 FR 9396, Mar. 24, 1987, effective May 26, 1987; heading revised, 60 FR 25615, May 12, 1995, effective July 11, 1995; revised, 65 FR 54604, Sept. 8, 2000, effective Sept. 8, 2000; revised, 68 FR 14332, Mar. 25, 2003, effective May 1, 2003]

### § 1.765 Duty of disclosure in patent term extension proceedings.

(a) A duty of candor and good faith toward the Patent and Trademark Office and the Secretary of Health and Human Services or the Secretary of Agriculture rests on the patent owner or its agent, on each attorney or agent who represents the patent owner and on every other individual who is substantively involved on behalf of the patent owner in a patent term extension proceeding. All such individuals who are aware, or become aware, of material information adverse to a determination of entitlement to the extension sought, which has not been previously made of record in the patent term extension proceeding must bring such information to the attention of the Office or the Secretary, as appropriate, in accordance with paragraph (b) of this section, as soon as it is practical to do so after the individual becomes aware of the information. Information is material where there is a substantial likelihood that the Office or the Secretary would consider it important in determinations to be made in the patent term extension proceeding.

(b) Disclosures pursuant to this section must be accompanied by a copy of each written document which is being disclosed. The disclosure must be made to the Office or the Secretary, as appropriate, unless the disclosure is material to determinations to

be made by both the Office and the Secretary, in which case duplicate copies, certified as such, must be filed in the Office and with the Secretary. Disclosures pursuant to this section may be made to the Office or the Secretary, as appropriate, through an attorney or agent having responsibility on behalf of the patent owner or its agent for the patent term extension proceeding or through a patent owner acting on his or her own behalf. Disclosure to such an attorney, agent or patent owner shall satisfy the duty of any other individual. Such an attorney, agent or patent owner has no duty to transmit information which is not material to the determination of entitlement to the extension sought.

(c) No patent will be determined eligible for extension and no extension will be issued if it is determined that fraud on the Office or the Secretary was practiced or attempted or the duty of disclosure was violated through bad faith or gross negligence in connection with the patent term extension proceeding. If it is established by clear and convincing evidence that any fraud was practiced or attempted on the Office or the Secretary in connection with the patent term extension proceeding or that there was any violation of the duty of disclosure through bad faith or gross negligence in connection with the patent term extension proceeding, a final determination will be made pursuant to § 1.750 that the patent is not eligible for extension.

(d) The duty of disclosure pursuant to this section rests on the individuals identified in paragraph (a) of this section and no submission on behalf of third parties, in the form of protests or otherwise, will be considered by the Office. Any such submissions by third parties to the Office will be returned to the party making the submission, or otherwise disposed of, without consideration by the Office.

[Added, 52 FR 9396, Mar. 24 1987, effective May 26, 1987, para. (a) amended, 54 FR 30375, July 20, 1989, effective Aug. 22, 1989; para. (a) revised, 60 FR 25615, May 12, 1995, effective July 11, 1995]

#### **§ 1.770 Express withdrawal of application for extension of patent term.**

An application for extension of patent term may be expressly withdrawn before a determination is made pursuant to § 1.750 by filing in the Office, in duplicate, a written declaration of withdrawal signed by the

owner of record of the patent or its agent. An application may not be expressly withdrawn after the date permitted for reply to the final determination on the application. An express withdrawal pursuant to this section is effective when acknowledged in writing by the Office. The filing of an express withdrawal pursuant to this section and its acceptance by the Office does not entitle applicant to a refund of the filing fee (§ 1.20(j)) or any portion thereof.

[Added 52 FR 9397, Mar. 24 1987, effective May 26, 1987; 56 FR 65142, Dec. 13, 1991, effective Dec. 16, 1991; revised, 62 FR 53131, Oct. 10, 1997, effective Dec. 1, 1997]

#### **§ 1.775 Calculation of patent term extension for a human drug, antibiotic drug, or human biological product.**

(a) If a determination is made pursuant to § 1.750 that a patent for a human drug, antibiotic drug, or human biological product is eligible for extension, the term shall be extended by the time as calculated in days in the manner indicated by this section. The patent term extension will run from the original expiration date of the patent or any earlier date set by terminal disclaimer (§ 1.321).

(b) The term of the patent for a human drug, antibiotic drug or human biological product will be extended by the length of the regulatory review period for the product as determined by the Secretary of Health and Human Services, reduced as appropriate pursuant to paragraphs (d)(1) through (d)(6) of this section.

(c) The length of the regulatory review period for a human drug, antibiotic drug or human biological product will be determined by the Secretary of Health and Human Services. Under 35 U.S.C. 156(g)(1)(B), it is the sum of —

(1) The number of days in the period beginning on the date an exemption under subsection (i) of section 505 or subsection (d) of section 507 of the Federal Food, Drug, and Cosmetic Act became effective for the approved product and ending on the date an application was initially submitted for such product under those sections or under section 351 of the Public Health Service Act; and

(2) The number of days in the period beginning on the date the application was initially submitted for the approved product under section 351 of the



Public Health Service Act, subsection (b) of section 505 or section 507 of the Federal Food, Drug, and Cosmetic Act and ending on the date such application was approved under such section.

(d) The term of the patent as extended for a human drug, antibiotic drug or human biological product will be determined by—

(1) Subtracting from the number of days determined by the Secretary of Health and Human Services to be in the regulatory review period:

(i) The number of days in the periods of paragraphs (c)(1) and (c)(2) of this section which were on and before the date on which the patent issued;

(ii) The number of days in the periods of paragraphs (c)(1) and (c)(2) of this section during which it is determined under 35 U.S.C. 156(d)(2)(B) by the Secretary of Health and Human Services that applicant did not act with due diligence;

(iii) One-half the number of days remaining in the period defined by paragraph (c)(1) of this section after that period is reduced in accordance with paragraphs (d)(1)(i) and (ii) of this section; half days will be ignored for purposes of subtraction;

(2) By adding the number of days determined in paragraph (d)(1) of this section to the original term of the patent as shortened by any terminal disclaimer;

(3) By adding 14 years to the date of approval of the application under section 351 of the Public Health Service Act, or subsection (b) of section 505 or section 507 of the Federal Food, Drug, and Cosmetic Act;

(4) By comparing the dates for the ends of the periods obtained pursuant to paragraphs (d)(2) and (d)(3) of this section with each other and selecting the earlier date;

(5) If the original patent was issued after September 24, 1984,

(i) By adding 5 years to the original expiration date of the patent or any earlier date set by terminal disclaimer; and

(ii) By comparing the dates obtained pursuant to paragraphs (d)(4) and (d)(5)(i) of this section with each other and selecting the earlier date;

(6) If the original patent was issued before September 24, 1984, and

(i) If no request was submitted for an exemption under subsection (i) of section 505 or sub-

section (d) of section 507 of the Federal Food, Drug, and Cosmetic Act before September 24, 1984, by—

(A) Adding 5 years to the original expiration date of the patent or earlier date set by terminal disclaimer; and

(B) By comparing the dates obtained pursuant to paragraphs (d)(4) and (d)(6)(i)(A) of this section with each other and selecting the earlier date; or

(ii) If a request was submitted for an exemption under subsection (i) of section 505 or subsection (d) of section 507 of the Federal Food, Drug, or Cosmetic Act before September 24, 1984 and the commercial marketing or use of the product was not approved before September 24, 1984, by -

(A) Adding 2 years to the original expiration date of the patent or earlier date set by terminal disclaimer; and

(B) By comparing the dates obtained pursuant to paragraphs (d)(4) and (d)(6)(ii)(A) of this section with each other and selecting the earlier filing date.

[Added, 52 FR 9397, Mar. 24 1987, effective May 26, 1987]

### § 1.776 Calculation of patent term extension for a food additive or color additive.

(a) If a determination is made pursuant to § 1.750 that a patent for a food additive or color additive is eligible for extension, the term shall be extended by the time as calculated in days in the manner indicated by this section. The patent term extension will run from the original expiration date of the patent or earlier date set by terminal disclaimer (§ 1.321).

(b) The term of the patent for a food additive or color additive will be extended by the length of the regulatory review period for the product as determined by the Secretary of Health and Human Services, reduced as appropriate pursuant to paragraphs (d)(1) through (d)(6) of this section.

(c) The length of the regulatory review period for a food additive or color additive will be determined by the Secretary of Health and Human Services. Under 35 U.S.C. 156(g)(2)(B), it is the sum of -

(1) The number of days in the period beginning on the date a major health or environmental effects test on the additive was initiated and ending on

the date a petition was initially submitted with respect to the approved product under the Federal Food, Drug, and Cosmetic Act requesting the issuance of a regulation for use of the product; and

(2) The number of days in the period beginning on the date a petition was initially submitted with respect to the approved product under the Federal Food, Drug and Cosmetic Act requesting the issuance of a regulation for use of the product, and ending on the date such regulation became effective or, if objections were filed to such regulation, ending on the date such objections were resolved and commercial marketing was permitted or, if commercial marketing was permitted and later revoked pending further proceedings as a result of such objections, ending on the date such proceedings were finally resolved and commercial marketing was permitted.

(d) The term of the patent as extended for a food additive or color additive will be determined by

(1) Subtracting from the number of days determined by the Secretary of Health and Human Services to be in the regulatory review period:

(i) The number of days in the periods of paragraphs (c)(1) and (c)(2) of this section which were on and before the date on which the patent issued;

(ii) The number of days in the periods of paragraphs (c)(1) and (c)(2) of this section during which it is determined under 35 U.S.C. 156(d)(2)(B) by the Secretary of Health and Human Services that applicant did not act with due diligence;

(iii) The number of days equal to one-half the number of days remaining in the period defined by paragraph (c)(1) of this section after that period is reduced in accordance with paragraphs (d)(1) (i) and (ii) of this section; half days will be ignored for purposes of subtraction;

(2) By adding the number of days determined in paragraph (d)(1) of this section to the original term of the patent as shortened by any terminal disclaimer;

(3) By adding 14 years to the date a regulation for use of the product became effective or, if objections were filed to such regulation, to the date such objections were resolved and commercial marketing was permitted or, if commercial marketing was permitted and later revoked pending further proceedings as a result of such objections, to the date such

proceedings were finally resolved and commercial marketing was permitted;

(4) By comparing the dates for the ends of the periods obtained pursuant to paragraphs (d)(2) and (d)(3) of this section with each other and selecting the earlier date;

(5) If the original patent was issued after September 24, 1984,

(i) By adding 5 years to the original expiration date of the patent or earlier date set by terminal disclaimer; and

(ii) By comparing the dates obtained pursuant to paragraphs (d)(4) and (d)(5)(i) of this section with each other and selecting the earlier date;

(6) If the original patent was issued before September 24, 1984, and

(i) If no major health or environmental effects test was initiated and no petition for a regulation or application for registration was submitted before September 24, 1984, by

(A) Adding 5 years to the original expiration date of the patent or earlier date set by terminal disclaimer, and

(B) By comparing the dates obtained pursuant to paragraphs (d)(4) and (d)(6)(i)(A) of this section with each other and selecting the earlier date; or

(ii) If a major health or environmental effects test was initiated or a petition for a regulation or application for registration was submitted by September 24, 1984, and the commercial marketing or use of the product was not approved before September 24, 1984, by —

(A) Adding 2 years to the original expiration date of the patent or earlier date set by terminal disclaimer, and

(B) By comparing the dates obtained pursuant to paragraphs (d)(4) and (d)(6)(ii)(A) of this section with each other and selecting the earlier date.

[Added, 52 FR 9397, Mar. 24, 1987, effective May 26, 1987]

### § 1.777 Calculation of patent term extension for a medical device.

(a) If a determination is made pursuant to § 1.750 that a patent for a medical device is eligible for extension, the term shall be extended by the time as calculated in days in the manner indicated by this

section. The patent term extension will run from the original expiration date of the patent or earlier date as set by terminal disclaimer (§ 1.321).

(b) The term of the patent for a medical device will be extended by the length of the regulatory review period for the product as determined by the Secretary of Health and Human Services, reduced as appropriate pursuant to paragraphs (d)(1) through (d)(6) of this section.

(c) The length of the regulatory review period for a medical device will be determined by the Secretary of Health and Human Services. Under 35 U.S.C. 156(g)(3)(B), it is the sum of

(1) The number of days in the period beginning on the date a clinical investigation on humans involving the device was begun and ending on the date an application was initially submitted with respect to the device under section 515 of the Federal Food, Drug, and Cosmetic Act; and

(2) The number of days in the period beginning on the date the application was initially submitted with respect to the device under section 515 of the Federal Food, Drug, and Cosmetic Act, and ending on the date such application was approved under such Act or the period beginning on the date a notice of completion of a product development protocol was initially submitted under section 515(f)(5) of the Act and ending on the date the protocol was declared completed under section 515(f)(6) of the Act.

(d) The term of the patent as extended for a medical device will be determined by —

(1) Subtracting from the number of days determined by the Secretary of Health and Human Services to be in the regulatory review period pursuant to paragraph (c) of this section:

(i) The number of days in the periods of paragraphs (c)(1) and (c)(2) of this section which were on and before the date on which the patent issued;

(ii) The number of days in the periods of paragraphs (c)(1) and (c)(2) of this section during which it is determined under 35 U.S.C. 156(d)(2)(B) by the Secretary of Health and Human Services that applicant did not act with due diligence;

(iii) One-half the number of days remaining in the period defined by paragraph (c)(1) of this section after that period is reduced in accordance with

paragraphs (d)(1) (i) and (ii) of this section; half days will be ignored for purposes of subtraction;

(2) By adding the number of days determined in paragraph (d)(1) of this section to the original term of the patent as shortened by any terminal disclaimer;

(3) By adding 14 years to the date of approval of the application under section 515 of the Federal Food, Drug, and Cosmetic Act or the date a product development protocol was declared completed under section 515(f)(6) of the Act;

(4) By comparing the dates for the ends of the periods obtained pursuant to paragraphs (d)(2) and (d)(3) of this section with each other and selecting the earlier date;

(5) If the original patent was issued after September 24, 1984,

(i) By adding 5 years to the original expiration date of the patent or earlier date set by terminal disclaimer; and

(ii) By comparing the dates obtained pursuant to paragraphs (d)(4) and (d)(5)(i) of this section with each other and selecting the earlier date;

(6) If the original patent was issued before September 24, 1984, and

(i) If no clinical investigation on humans involving the device was begun or no product development protocol was submitted under section 515(f)(5) of the Federal Food, Drug, and Cosmetic Act before September 24, 1984, by —

(A) Adding 5 years to the original expiration date of the patent or earlier date set by terminal disclaimer and

(B) By comparing the dates obtained pursuant to paragraphs (d)(4) and (d)(6)(i)(A) of this section with each other and selecting the earlier date; or

(ii) If a clinical investigation on humans involving the device was begun or a product development protocol was submitted under section 515(f)(5) of the Federal Food, Drug, and Cosmetic Act before September 24, 1984 and the commercial marketing or use of the product was not approved before September 24, 1984, by

(A) Adding 2 years to the original expiration date of the patent or earlier date set by terminal disclaimer, and

(B) By comparing the dates obtained pursuant to paragraphs (d)(4) and (d)(6)(ii)(A) of this section with each other and selecting the earlier date.

[Added, 52 FR 9398, Mar. 24 1987, effective May 26, 1987]

**§ 1.778 Calculation of patent term extension for an animal drug product.**

(a) If a determination is made pursuant to § 1.750 that a patent for an animal drug is eligible for extension, the term shall be extended by the time as calculated in days in the manner indicated by this section. The patent term extension will run from the original expiration date of the patent or any earlier date set by terminal disclaimer (§ 1.321).

(b) The term of the patent for an animal drug will be extended by the length of the regulatory review period for the drug as determined by the Secretary of Health and Human Services, reduced as appropriate pursuant to paragraphs (d)(1) through (d)(6) of this section.

(c) The length of the regulatory review period for an animal drug will be determined by the Secretary of Health and Human Services. Under 35 U.S.C. 156(g)(4)(B), it is the sum of —

(1) The number of days in the period beginning on the earlier of the date a major health or environmental effects test on the drug was initiated or the date an exemption under subsection (j) of section 512 of the Federal Food, Drug, and Cosmetic Act became effective for the approved animal drug and ending on the date an application was initially submitted for such animal drug under section 512 of the Federal Food, Drug, and Cosmetic Act; and

(2) The number of days in the period beginning on the date the application was initially submitted for the approved animal drug under subsection (b) of section 512 of the Federal Food, Drug, and Cosmetic Act and ending on the date such application was approved under such section.

(d) The term of the patent as extended for an animal drug will be determined by —

(1) Subtracting from the number of days determined by the Secretary of Health and Human Services to be in the regulatory review period:

(i) The number of days in the periods of paragraphs (c)(1) and (c)(2) of this section that were on and before the date on which the patent issued;

(ii) The number of days in the periods of paragraphs (c)(1) and (c)(2) of this section during which it is determined under 35 U.S.C. 156(d)(2)(B) by the Secretary of Health and Human Services that applicant did not act with due diligence;

(iii) One-half the number of days remaining in the period defined by paragraph (c)(1) of this section after that period is reduced in accordance with paragraphs (d)(1)(i) and (ii) of this section; half days will be ignored for purposes of subtraction;

(2) By adding the number of days determined in paragraph (d)(1) of this section to the original term of the patent as shortened by any terminal disclaimer;

(3) By adding 14 years to the date of approval of the application under section 512 of the Federal Food, Drug, and Cosmetic Act;

(4) By comparing the dates for the ends of the periods obtained pursuant to paragraphs (d)(2) and (d)(3) of this section with each other and selecting the earlier date;

(5) If the original patent was issued after November 16, 1988, by —

(i) Adding 5 years to the original expiration date of the patent or any earlier date set by terminal disclaimer; and

(ii) Comparing the dates obtained pursuant to paragraphs (d)(4) and (d)(5)(i) of this section with each other and selecting the earlier date;

(6) If the original patent was issued before November 16, 1988, and

(i) If no major health or environmental effects test on the drug was initiated and no request was submitted for an exemption under subsection (j) of section 512 of the Federal Food, Drug, and Cosmetic Act before November 16, 1988, by —

(A) Adding 5 years to the original expiration date of the patent or earlier date set by terminal disclaimer; and

(B) Comparing the dates obtained pursuant to paragraphs (d)(4) and (d)(6)(i)(A) of this section with each other and selecting the earlier date; or

(ii) If a major health or environmental effects test was initiated or a request for an exemption under subsection (j) of section 512 of the Federal Food, Drug, and Cosmetic Act was submitted before November 16, 1988, and the application for commercial marketing or use of the animal drug was not approved before November 16, 1988, by —

(A) Adding 3 years to the original expiration date of the patent or earlier date set by terminal disclaimer, and

(B) Comparing the dates obtained pursuant to paragraphs (d)(4) and (d)(6)(ii)(A) of this section with each other and selecting the earlier date.

[Added, 54 FR 30375, July 20, 1989, effective Aug. 22, 1989]

**§ 1.779 Calculation of patent term extension for a veterinary biological product.**

(a) If a determination is made pursuant to § 1.750 that a patent for a veterinary biological product is eligible for extension, the term shall be extended by the time as calculated in days in the manner indicated by this section. The patent term extension will run from the original expiration date of the patent or any earlier date set by terminal disclaimer (§ 1.321).

(b) The term of the patent for a veterinary biological product will be extended by the length of the regulatory review period for the product as determined by the Secretary of Agriculture, reduced as appropriate pursuant to paragraphs (d)(1) through (d)(6) of this section.

(c) The length of the regulatory review period for a veterinary biological product will be determined by the Secretary of Agriculture. Under 35 U.S.C. 156(g)(5)(B), it is the sum of —

(1) The number of days in the period beginning on the date the authority to prepare an experimental biological product under the Virus-Serum-Toxin Act became effective and ending on the date an application for a license was submitted under the Virus-Serum-Toxin Act; and

(2) The number of days in the period beginning on the date an application for a license was initially submitted for approval under the Virus-Serum-Toxin Act and ending on the date such license was issued.

(d) The term of the patent as extended for a veterinary biological product will be determined by —

(1) Subtracting from the number of days determined by the Secretary of Agriculture to be in the regulatory review period:

(i) The number of days in the periods of paragraphs (c)(1) and (c)(2) of this section that were on and before the date on which the patent issued;

(ii) The number of days in the periods of paragraphs (c)(1) and (c)(2) of this section during which it is determined under 35 U.S.C. 156(d)(2)(B) by the Secretary of Agriculture that applicant did not act with due diligence;

(iii) One-half the number of days remaining in the period defined by paragraph (c)(1) of this section after that period is reduced in accordance with paragraphs (d)(1)(i) and (ii) of this section; half days will be ignored for purposes of subtraction;

(2) By adding the number of days determined in paragraph (d)(1) of this section to the original term of the patent as shortened by any terminal disclaimer;

(3) By adding 14 years to the date of the issuance of a license under the Virus-Serum-Toxin Act;

(4) By comparing the dates for the ends of the periods obtained pursuant to paragraphs (d)(2) and (d)(3) of this section with each other and selecting the earlier date;

(5) If the original patent was issued after November 16, 1988, by —

(i) Adding 5 years to the original expiration date of the patent or any earlier date set by terminal disclaimer; and

(ii) Comparing the dates obtained pursuant to paragraphs (d)(4) and (d)(5)(i) of this section with each other and selecting the earlier date;

(6) If the original patent was issued before November 16, 1988, and

(i) If no request for the authority to prepare an experimental biological product under the Virus-Serum-Toxin Act was submitted before November 16, 1988, by —

(A) Adding 5 years to the original expiration date of the patent or earlier date set by terminal disclaimer; and

(B) Comparing the dates obtained pursuant to paragraphs (d)(4) and (d)(6)(i)(A) of this section with each other and selecting the earlier date; or

(ii) If a request for the authority to prepare an experimental biological product under the Virus-Serum-Toxin Act was submitted before November 16, 1988, and the commercial marketing or use of the product was not approved before November 16, 1988, by —

(A) Adding 3 years to the original expiration date of the patent or earlier date set by terminal disclaimer; and

(B) Comparing the dates obtained pursuant to paragraphs (d)(4) and (d)(6)(ii)(A) of this section with each other and selecting the earlier date.

[Added, 54 FR 30375, July 20, 1989, effective Aug. 22, 1989]

**§ 1.780 Certificate or order of extension of patent term.**

If a determination is made pursuant to § 1.750 that a patent is eligible for extension and that the term of the patent is to be extended, a certificate of extension, under seal, or an order granting interim extension under 35 U.S.C. 156(d)(5), will be issued to the applicant for the extension of the patent term. Such certificate or order will be recorded in the official file of the patent and will be considered as part of the original patent. Notification of the issuance of the certificate or order of extension will be published in the *Official Gazette of the United States Patent and Trademark Office*. Notification of the issuance of the order granting an interim extension under 35 U.S.C. 156(d)(5), including the identity of the product currently under regulatory review, will be published in the *Official Gazette of the United States Patent and Trademark Office* and in the *Federal Register*. No certificate of, or order granting, an extension will be issued if the term of the patent cannot be extended, even though the patent is otherwise determined to be eligible for extension. In such situations, the final determination made pursuant to § 1.750 will indicate that no certificate or order will issue.

[Added, 52 FR 9399, Mar. 24 1987, effective May 26, 1987; para. (a) revised, 60 FR 25615, May 12, 1995, effective July 11, 1995; revised, 65 FR 54604, Sept. 8, 2000, effective Nov. 7, 2000]

**§ 1.785 Multiple applications for extension of term of the same patent or of different patents for the same regulatory review period for a product.**

(a) Only one patent may be extended for a regulatory review period for any product § 1.720 (h). If more than one application for extension of the same patent is filed, the certificate of extension of patent term, if appropriate, will be issued based upon the first filed application for extension.

(b) If more than one application for extension is filed by a single applicant which seeks the extension of the term of two or more patents based upon the same regulatory review period, and the patents are otherwise eligible for extension pursuant to the requirements of this subpart, in the absence of an election by the applicant, the certificate of extension of patent term, if appropriate, will be issued upon the application for extension of the patent term having the earliest date of issuance of those patents for which extension is sought.

(c) If an application for extension is filed which seeks the extension of the term of a patent based upon the same regulatory review period as that relied upon in one or more applications for extension pursuant to the requirements of this subpart, the certificate of extension of patent term will be issued on the application only if the patent owner or its agent is the holder of the regulatory approval granted with respect to the regulatory review period.

(d) An application for extension shall be considered complete and formal regardless of whether it contains the identification of the holder of the regulatory approval granted with respect to the regulatory review period. When an application contains such information, or is amended to contain such information, it will be considered in determining whether an application is eligible for an extension under this section. A request may be made of any applicant to supply such information within a non-extendable period of not less than one month whenever multiple applications for extension of more than one patent are received and rely upon the same regulatory review period. Failure to provide such information within the period for reply set shall be regarded as conclusively establishing that the applicant is not the holder of the regulatory approval.

(e) Determinations made under this section shall be included in the notice of final determination of eligibility for extension of the patent term pursuant to § 1.750 and shall be regarded as part of that determination.

[Added, 52 FR 9399, Mar. 24 1987, effective May 26, 1987; para. (b) amended, 54 FR 30375, July 20, 1989, effective Aug. 22, 1989; revised, 60 FR 25615, May 12, 1995, effective July 11, 1995; para. (d) revised, 62 FR 53131, Oct. 10, 1997, effective Dec. 1, 1997]

**§ 1.790 Interim extension of patent term under 35 U.S.C. 156(d)(5)**

(a) An owner of record of a patent or its agent who reasonably expects that the applicable regulatory review period described in paragraph (1)(B)(ii), (2)(B)(ii), (3)(B)(ii), (4)(B)(ii), or (5)(B)(ii) of subsection (g) that began for a product that is the subject of such patent may extend beyond the expiration of the patent term in effect may submit one or more applications for interim extensions for periods of up to one year each. The initial application for interim extension must be filed during the period beginning 6 months and ending 15 days before the patent term is due to expire. Each subsequent application for interim extension must be filed during the period beginning 60 days before and ending 30 days before the expiration of the preceding interim extension. In no event will the interim extensions granted under this section be longer than the maximum period of extension to which the applicant would be entitled under 35 U.S.C. 156(c).

(b) A complete application for interim extension under this section shall include all of the information required for a formal application under § 1.740 and a complete application under § 1.741. Sections (a)(1), (a)(2), (a)(4), and (a)(6) - (a)(17) of § 1.740 and § 1.741 shall be read in the context of a product currently undergoing regulatory review. Sections (a)(3) and (a)(5) of § 1.740 are not applicable to an application for interim extension under this section.

(c) The content of each subsequent interim extension application may be limited to a request for a subsequent interim extension along with a statement that the regulatory review period has not been completed along with any materials or information required under §§ 1.740 and 1.741 that are not present in the preceding interim extension application.

[Added, 60 FR 25615, May 12, 1995, effective July 11, 1995]

**§ 1.791 Termination of interim extension granted prior to regulatory approval of a product for commercial marketing or use.**

Any interim extension granted under 35 U.S.C. 156(d)(5) terminates at the end of the 60-day period beginning on the date on which the product involved receives permission for commercial marketing or use.

If within that 60-day period the patent owner or its agent files an application for extension under §§ 1.740 and 1.741 including any additional information required under 35 U.S.C. 156(d)(1) not contained in the application for interim extension, the patent shall be further extended in accordance with the provisions of 35 U.S.C. 156.

[Added, 60 FR 25615, May 12, 1995, effective July 11, 1995]

**Subpart G — Biotechnology Invention Disclosures****DEPOSIT OF BIOLOGICAL MATERIAL****§ 1.801 Biological material.**

For the purposes of these regulations pertaining to the deposit of biological material for purposes of patents for inventions under 35 U.S.C. 101, the term biological material shall include material that is capable of self-replication either directly or indirectly. Representative examples include bacteria, fungi including yeast, algae, protozoa, eukaryotic cells, cell lines, hybridomas, plasmids, viruses, plant tissue cells, lichens and seeds. Viruses, vectors, cell organelles and other non-living material existing in and reproducible from a living cell may be deposited by deposit of the host cell capable of reproducing the non-living material.

[Added, 54 FR 34880, Aug. 22, 1989, effective Jan. 1, 1990]

**§ 1.802 Need or opportunity to make a deposit.**

(a) Where an invention is, or relies on, a biological material, the disclosure may include reference to a deposit of such biological material.

(b) Biological material need not be deposited unless access to such material is necessary for the satisfaction of the statutory requirements for patentability under 35 U.S.C. 112. If a deposit is necessary, it shall be acceptable if made in accordance with these regulations. Biological material need not be deposited, *inter alia*, if it is known and readily available to the public or can be made or isolated without undue experimentation. Once deposited in a depository complying with these regulations, a biological material will be considered to be readily available even though

some requirement of law or regulation of the United States or of the country in which the depository institution is located permits access to the material only under conditions imposed for safety, public health or similar reasons.

(c) The reference to a biological material in a specification disclosure or the actual deposit of such material by an applicant or patent owner does not create any presumption that such material is necessary to satisfy 35 U.S.C. 112 or that deposit in accordance with these regulations is or was required.

[Added, 54 FR 34880, Aug. 22, 1989, effective Jan. 1, 1990]

### § 1.803 Acceptable depository.

(a) A deposit shall be recognized for the purposes of these regulations if made in

(1) Any International Depository Authority (IDA) as established under the Budapest Treaty on the International Recognition of the Deposit of Microorganisms for the Purposes of Patent Procedure, or

(2) Any other depository recognized to be suitable by the Office. Suitability will be determined by the Director on the basis of the administrative and technical competence, and agreement of the depository to comply with the terms and conditions applicable to deposits for patent purposes. The Director may seek the advice of impartial consultants on the suitability of a depository. The depository must:

- (i) Have a continuous existence;
- (ii) Exist independent of the control of the depository;

(iii) Possess the staff and facilities sufficient to examine the viability of a deposit and store the deposit in a manner which ensures that it is kept viable and uncontaminated;

(iv) Provide for sufficient safety measures to minimize the risk of losing biological material deposited with it;

(v) Be impartial and objective;

(vi) Furnish samples of the deposited material in an expeditious and proper manner; and

(vii) Promptly notify depositors of its inability to furnish samples, and the reasons why.

(b) A depository seeking status under paragraph (a)(2) of this section must direct a communication to the Director which shall:

(1) Indicate the name and address of the depository to which the communication relates;

(2) Contain detailed information as to the capacity of the depository to comply with the requirements of paragraph (a)(2) of this section, including information on its legal status, scientific standing, staff, and facilities;

(3) Indicate that the depository intends to be available, for the purposes of deposit, to any depositor under these same conditions;

(4) Where the depository intends to accept for deposit only certain kinds of biological material, specify such kinds;

(5) Indicate the amount of any fees that the depository will, upon acquiring the status of suitable depository under paragraph (a)(2) of this section, charge for storage, viability statements and furnishings of samples of the deposit.

(c) A depository having status under paragraph (a)(2) of this section limited to certain kinds of biological material may extend such status to additional kinds of biological material by directing a communication to the Director in accordance with paragraph (b) of this section. If a previous communication under paragraph (b) of this section is of record, items in common with the previous communication may be incorporated by reference.

(d) Once a depository is recognized to be suitable by the Director or has defaulted or discontinued its performance under this section, notice thereof will be published in the *Official Gazette* of the Patent and Trademark Office.

[Added, 54 FR 34881, Aug. 22, 1989, effective Jan. 1, 1999; paras. (a)(2) & (b)-(d) revised, 68 FR 14332, Mar. 25, 2003, effective May 1, 2003]

### § 1.804 Time of making an original deposit.

(a) Whenever a biological material is specifically identified in an application for patent as filed, an original deposit thereof may be made at any time before filing the application for patent or, subject to § 1.809, during pendency of the application for patent.

(b) When the original deposit is made after the effective filing date of an application for patent, the applicant must promptly submit a statement from a person in a position to corroborate the fact, stating that the biological material which is deposited is a



biological material specifically identified in the application as filed.

[Added, 54 FR 34881, Aug. 22, 1989, effective Jan. 1, 1990; para. (b) revised, 62 FR 53131, Oct. 10, 1997, effective Dec. 1, 1997]

**§ 1.805 Replacement or supplement of deposit.**

(a) A depositor, after receiving notice during the pendency of an application for patent, application for reissue patent or reexamination proceeding, that the depository possessing a deposit either cannot furnish samples thereof or can furnish samples thereof but the deposit has become contaminated or has lost its capability to function as described in the specification, shall notify the Office in writing, in each application for patent or patent affected. In such a case, or where the Office otherwise learns, during the pendency of an application for patent, application for reissue patent or reexamination proceeding, that the depository possessing a deposit either cannot furnish samples thereof or can furnish samples thereof but the deposit has become contaminated or has lost its capability to function as described in the specification, the need for making a replacement or supplemental deposit will be governed by the same considerations governing the need for making an original deposit under the provisions set forth in § 1.802(b). A replacement or supplemental deposit made during the pendency of an application for patent shall not be accepted unless it meets the requirements for making an original deposit under these regulations, including the requirement set forth under § 1.804(b). A replacement or supplemental deposit made in connection with a patent, whether or not made during the pendency of an application for reissue patent or a reexamination proceeding or both, shall not be accepted unless a certificate of correction under § 1.323 is requested by the patent owner which meets the terms of paragraphs (b) and (c) of this section.

(b) A request for certificate of correction under this section shall not be granted unless the certificate identifies:

- (1) The accession number for the replacement or supplemental deposit;
- (2) The date of the deposit; and
- (3) The name and address of the depository.

(c) A request for a certificate of correction under this section shall not be granted unless the

request is made promptly after the replacement or supplemental deposit has been made and the request:

(1) Includes a statement of the reason for making the replacement or supplemental deposit;

(2) Includes a statement from a person in a position to corroborate the fact, and stating that the replacement or supplemental deposit is of a biological material which is identical to that originally deposited;

(3) Includes a showing that the patent owner acted diligently —

(i) In the case of a replacement deposit, in making the deposit after receiving notice that samples could no longer be furnished from an earlier deposit; or

(ii) In the case of a supplemental deposit, in making the deposit after receiving notice that the earlier deposit had become contaminated or had lost its capability to function as described in the specification;

(4) Includes a statement that the term of the replacement or supplemental deposit expires no earlier than the term of the deposit being replaced or supplemented; and

(5) Otherwise establishes compliance with these regulations.

(d) A depositor's failure to replace a deposit, or in the case of a patent, to diligently replace a deposit and promptly thereafter request a certificate of correction which meets the terms of paragraphs (b) and (c) of this section, after being notified that the depository possessing the deposit cannot furnish samples thereof, shall cause the application or patent involved to be treated in any Office proceeding as if no deposit were made.

(e) In the event a deposit is replaced according to these regulations, the Office will apply a rebuttable presumption of identity between the original and the replacement deposit where a patent making reference to the deposit is relied upon during any Office proceeding.

(f) A replacement or supplemental deposit made during the pendency of an application for patent may be made for any reason.

(g) In no case is a replacement or supplemental deposit of a biological material necessary where the biological material, in accordance with § 1.802(b), need not be deposited.

(h) No replacement deposit of a biological material is necessary where a depository can furnish samples thereof but the depository for national security, health or environmental safety reasons is unable to provide samples to requesters outside of the jurisdiction where the depository is located.

(i) The Office will not recognize in any Office proceeding a replacement deposit of a biological material made by a patent owner where the depository could furnish samples of the deposit being replaced.

[Added, 54 FR 34881, Aug. 22, 1989, effective Jan. 1, 1990; para. (c) revised, 62 FR 53131, Oct. 10, 1997, effective Dec. 1, 1997]

### § 1.806 Term of deposit.

A deposit made before or during pendency of an application for patent shall be made for a term of at least thirty (30) years and at least five (5) years after the most recent request for the furnishing of a sample of the deposit was received by the depository. In any case, samples must be stored under agreements that would make them available beyond the enforceable life of the patent for which the deposit was made.

[Added, 54 FR 34882, Aug. 22, 1989, effective Jan. 1, 1990]

### § 1.807 Viability of deposit.

(a) A deposit of biological material that is capable of self-replication either directly or indirectly must be viable at the time of deposit and during the term of deposit. Viability may be tested by the depository. The test must conclude only that the deposited material is capable of reproduction. No evidence is necessarily required regarding the ability of the deposited material to perform any function described in the patent application.

(b) A viability statement for each deposit of a biological material defined in paragraph (a) of this section not made under the Budapest Treaty on the International Recognition of the Deposit of Microorganisms for the Purposes of Patent Procedure must be filed in the application and must contain:

- (1) The name and address of the depository;
- (2) The name and address of the depositor;
- (3) The date of deposit;
- (4) The identity of the deposit and the accession number given by the depository;

- (5) The date of the viability test;
- (6) The procedures used to obtain a sample if the test is not done by the depository; and

(7) A statement that the deposit is capable of reproduction.

(c) If a viability test indicates that the deposit is not viable upon receipt, or the examiner cannot, for scientific or other valid reasons, accept the statement of viability received from the applicant, the examiner shall proceed as if no deposit has been made. The examiner will accept the conclusion set forth in a viability statement issued by a depository recognized under § 1.803(a).

[Added, 54 FR 34882, Aug. 22, 1989, effective Jan. 1, 1990]

### § 1.808 Furnishing of samples.

(a) A deposit must be made under conditions that assure that:

(1) Access to the deposit will be available during pendency of the patent application making reference to the deposit to one determined by the Director to be entitled thereto under § 1.14 and 35 U.S.C. 122, and

(2) Subject to paragraph (b) of this section, all restrictions imposed by the depositor on the availability to the public of the deposited material will be irrevocably removed upon the granting of the patent.

(b) The depositor may contract with the depository to require that samples of a deposited biological material shall be furnished only if a request for a sample, during the term of the patent:

(1) Is in writing or other tangible form and dated;

(2) Contains the name and address of the requesting party and the accession number of the deposit; and

(3) Is communicated in writing by the depository to the depositor along with the date on which the sample was furnished and the name and address of the party to whom the sample was furnished.

(c) Upon request made to the Office, the Office will certify whether a deposit has been stated to have been made under conditions which make it available to the public as of the issue date of the patent grant provided the request contains:

- (1) The name and address of the depository;

(2) The accession number given to the deposit;

(3) The patent number and issue date of the patent referring to the deposit; and

(4) The name and address of the requesting party.

[Added, 54 FR 34882, Aug. 22, 1989, effective Jan. 1, 1990; para. (a)(1) revised, 68 FR 14332, Mar. 25, 2003, effective May 1, 2003]

### § 1.809 Examination procedures.

(a) The examiner shall determine pursuant to § 1.104 in each application for patent, application for reissue patent or reexamination proceeding if a deposit is needed, and if needed, if a deposit actually made is acceptable for patent purposes. If a deposit is needed and has not been made or replaced or supplemented in accordance with these regulations, the examiner, where appropriate, shall reject the affected claims under the appropriate provision of 35 U.S.C. 112, explaining why a deposit is needed and/or why a deposit actually made cannot be accepted.

(b) The applicant for patent or patent owner shall reply to a rejection under paragraph (a) of this section by—

(1) In the case of an applicant for patent, either making an acceptable original, replacement, or supplemental deposit, or assuring the Office in writing that an acceptable deposit will be made; or, in the case of a patent owner, requesting a certificate of correction of the patent which meets the terms of paragraphs (b) and (c) of § 1.805, or

(2) Arguing why a deposit is not needed under the circumstances of the application or patent considered and/or why a deposit actually made should be accepted. Other replies to the examiner's action shall be considered nonresponsive. The rejection will be repeated until either paragraph (b)(1) of this section is satisfied or the examiner is convinced that a deposit is not needed.

(c) If an application for patent is otherwise in condition for allowance except for a needed deposit and the Office has received a written assurance that an acceptable deposit will be made, applicant will be notified and given a period of time within which the deposit must be made in order to avoid abandonment. This time period is not extendable under § 1.136(a) or (b) if set forth in a "Notice of Allowability" or in an

Office action having a mail date on or after the mail date of a "Notice of Allowability" (see § 1.136(c)).

(d) For each deposit made pursuant to these regulations, the specification shall contain:

(1) The accession number for the deposit;

(2) The date of the deposit;

(3) A description of the deposited biological material sufficient to specifically identify it and to permit examination; and

(4) The name and address of the depository.

(e) Any amendment required by paragraphs (d)(1), (d)(2) or (d)(4) of this section must be filed before or with the payment of the issue fee (see § 1.312).

[Added, 54 FR 34882, Aug. 22, 1989, effective Jan. 1, 1990; paras. (b) and (c) revised and para. (e) added, 66 FR 21092, Apr. 27, 2001, effective May 29, 2001]

## APPLICATION DISCLOSURES CONTAINING NUCLEOTIDE AND/OR AMINO ACID SEQUENCES

### § 1.821 Nucleotide and/or amino acid sequence disclosures in patent applications.

(a) Nucleotide and/or amino acid sequences as used in §§ 1.821 through 1.825 are interpreted to mean an unbranched sequence of four or more amino acids or an unbranched sequence of ten or more nucleotides. Branched sequences are specifically excluded from this definition. Sequences with fewer than four specifically defined nucleotides or amino acids are specifically excluded from this section. "Specifically defined" means those amino acids other than "Xaa" and those nucleotide bases other than "n" defined in accordance with the World Intellectual Property Organization (WIPO) Handbook on Industrial Property Information and Documentation, Standard ST.25: Standard for the Presentation of Nucleotide and Amino Acid Sequence Listings in Patent Applications (1998), including Tables 1 through 6 in Appendix 2, herein incorporated by reference. (Hereinafter "WIPO Standard ST.25 (1998)"). This incorporation by reference was approved by the Director of the Federal Register in accordance with 5 U.S.C. 552(a) and 1 CFR part 51. Copies of WIPO Standard ST.25 (1998) may be obtained from the World Intellectual Property Organization; 34 chemin des Colombettes; 1211 Geneva 20

Switzerland. Copies of ST.25 may be inspected at the Patent Search Room; Crystal Plaza 3, Lobby Level; 2021 South Clark Place; Arlington, VA 22202. Copies may also be inspected at the Office of the Federal Register, 800 North Capitol Street, NW, Suite 700, Washington, DC. Nucleotides and amino acids are further defined as follows:

(1) *Nucleotides*: Nucleotides are intended to embrace only those nucleotides that can be represented using the symbols set forth in WIPO Standard ST.25 (1998), Appendix 2, Table 1. Modifications, *e.g.*, methylated bases, may be described as set forth in WIPO Standard ST.25 (1998), Appendix 2, Table 2, but shall not be shown explicitly in the nucleotide sequence.

(2) *Amino acids*: Amino acids are those L-amino acids commonly found in naturally occurring proteins and are listed in WIPO Standard ST.25 (1998), Appendix 2, Table 3. Those amino acid sequences containing D-amino acids are not intended to be embraced by this definition. Any amino acid sequence that contains post-translationally modified amino acids may be described as the amino acid sequence that is initially translated using the symbols shown in WIPO Standard ST.25 (1998), Appendix 2, Table 3 with the modified positions; *e.g.*, hydroxylations or glycosylations, being described as set forth in WIPO Standard ST.25 (1998), Appendix 2, Table 4, but these modifications shall not be shown explicitly in the amino acid sequence. Any peptide or protein that can be expressed as a sequence using the symbols in WIPO Standard ST.25 (1998), Appendix 2, Table 3 in conjunction with a description in the Feature section to describe, for example, modified linkages, cross links and end caps, non-peptidyl bonds, etc., is embraced by this definition.

(b) Patent applications which contain disclosures of nucleotide and/or amino acid sequences, in accordance with the definition in paragraph (a) of this section, shall, with regard to the manner in which the nucleotide and/or amino acid sequences are presented and described, conform exclusively to the requirements of §§ 1.821 through 1.825.

(c) Patent applications which contain disclosures of nucleotide and/or amino acid sequences must contain, as a separate part of the disclosure, a paper or compact disc copy (*see* § 1.52(e)) disclosing the nucleotide and/or amino acid sequences and associ-

ated information using the symbols and format in accordance with the requirements of §§ 1.822 and 1.823. This paper or compact disc copy is referred to elsewhere in this subpart as the “Sequence Listing.” Each sequence disclosed must appear separately in the “Sequence Listing.” Each sequence set forth in the “Sequence Listing” must be assigned a separate sequence identifier. The sequence identifiers must begin with 1 and increase sequentially by integers. If no sequence is present for a sequence identifier, the code “000” must be used in place of the sequence. The response for the numeric identifier <160> must include the total number of SEQ ID NOs, whether followed by a sequence or by the code “000.”

(d) Where the description or claims of a patent application discuss a sequence that is set forth in the “Sequence Listing” in accordance with paragraph (c) of this section, reference must be made to the sequence by use of the sequence identifier, preceded by “SEQ ID NO:” in the text of the description or claims, even if the sequence is also embedded in the text of the description or claims of the patent application.

(e) A copy of the “Sequence Listing” referred to in paragraph (c) of this section must also be submitted in computer readable form (CRF) in accordance with the requirements of § 1.824. The computer readable form must be a copy of the “Sequence Listing” and may not be retained as a part of the patent application file. If the computer readable form of a new application is to be identical with the computer readable form of another application of the applicant on file in the Office, reference may be made to the other application and computer readable form in lieu of filing a duplicate computer readable form in the new application if the computer readable form in the other application was compliant with all of the requirements of this subpart. The new application must be accompanied by a letter making such reference to the other application and computer readable form, both of which shall be completely identified. In the new application, applicant must also request the use of the compliant computer readable “Sequence Listing” that is already on file for the other application and must state that the paper or compact disc copy of the “Sequence Listing” in the new application is identical to the computer readable copy filed for the other application.

(f) In addition to the paper or compact disc copy required by paragraph (c) of this section and the computer readable form required by paragraph (e) of this section, a statement that the “Sequence Listing” content of the paper or compact disc copy and the computer readable copy are the same must be submitted with the computer readable form, *e.g.*, a statement that “the sequence listing information recorded in computer readable form is identical to the written (on paper or compact disc) sequence listing.”

(g) If any of the requirements of paragraphs (b) through (f) of this section are not satisfied at the time of filing under 35 U.S.C. 111(a) or at the time of entering the national stage under 35 U.S.C. 371, applicant will be notified and given a period of time within which to comply with such requirements in order to prevent abandonment of the application. Any submission in reply to a requirement under this paragraph must be accompanied by a statement that the submission includes no new matter.

(h) If any of the requirements of paragraphs (b) through (f) of this section are not satisfied at the time of filing an international application under the Patent Cooperation Treaty (PCT), which application is to be searched by the United States International Searching Authority or examined by the United States International Preliminary Examining Authority, applicant will be sent a notice necessitating compliance with the requirements within a prescribed time period. Any submission in reply to a requirement under this paragraph must be accompanied by a statement that the submission does not include matter which goes beyond the disclosure in the international application as filed. If applicant fails to timely provide the required computer readable form, the United States International Searching Authority shall search only to the extent that a meaningful search can be performed without the computer readable form and the United States International Preliminary Examining Authority shall examine only to the extent that a meaningful examination can be performed without the computer readable form.

[Added, 55 FR 18230, May 1, 1990, effective Oct. 1, 1990; para. (h) amended, 58 FR 9335, Jan. 14, 1993, effective May 1, 1993; revised, 63 FR 29620, June 1, 1998, effective July 1, 1998; paras. (c), (e), and (f) revised, 65 FR 54604, Sept. 8, 2000, effective Sept. 8, 2000 (effective date corrected, 65 FR 78958, Dec. 18, 2000)]

### § 1.822 Symbols and format to be used for nucleotide and/or amino acid sequence data.

(a) The symbols and format to be used for nucleotide and/or amino acid sequence data shall conform to the requirements of paragraphs (b) through (e) of this section.

(b) The code for representing the nucleotide and/or amino acid sequence characters shall conform to the code set forth in the tables in WIPO Standard ST.25 (1998), Appendix 2, Tables 1 and 3. This incorporation by reference was approved by the Director of the Federal Register in accordance with 5 U.S.C. 552(a) and 1 CFR part 51. Copies of ST.25 may be obtained from the World Intellectual Property Organization; 34 chemin des Colombettes; 1211 Geneva 20 Switzerland. Copies of ST.25 may be inspected at the Patent Search Room; Crystal Plaza 3, Lobby Level; 2021 South Clark Place; Arlington, VA 22202. Copies may also be inspected at the Office of the Federal Register, 800 North Capitol Street, NW, Suite 700, Washington, DC. No code other than that specified in these sections shall be used in nucleotide and amino acid sequences. A modified base or modified or unusual amino acid may be presented in a given sequence as the corresponding unmodified base or amino acid if the modified base or modified or unusual amino acid is one of those listed in WIPO Standard ST.25 (1998), Appendix 2, Tables 2 and 4, and the modification is also set forth in the Feature section. Otherwise, each occurrence of a base or amino acid not appearing in WIPO Standard ST.25 (1998), Appendix 2, Tables 1 and 3, shall be listed in a given sequence as “n” or “Xaa,” respectively, with further information, as appropriate, given in the Feature section, preferably by including one or more feature keys listed in WIPO Standard ST.25 (1998), Appendix 2, Tables 5 and 6.

(c) *Format representation of nucleotides.* (1) A nucleotide sequence shall be listed using the lower-case letter for representing the one-letter code for the nucleotide bases set forth in WIPO Standard ST.25 (1998), Appendix 2, Table 1.

(2) The bases in a nucleotide sequence (including introns) shall be listed in groups of 10 bases except in the coding parts of the sequence. Left-over bases, fewer than 10 in number, at the end of noncoding parts of a sequence shall be grouped

together and separated from adjacent groups of 10 or 3 bases by a space.

(3) The bases in the coding parts of a nucleotide sequence shall be listed as triplets (codons). The amino acids corresponding to the codons in the coding parts of a nucleotide sequence shall be typed immediately below the corresponding codons. Where a codon spans an intron, the amino acid symbol shall be typed below the portion of the codon containing two nucleotides.

(4) A nucleotide sequence shall be listed with a maximum of 16 codons or 60 bases per line, with a space provided between each codon or group of 10 bases.

(5) A nucleotide sequence shall be presented, only by a single strand, in the 5 to 3 direction, from left to right.

(6) The enumeration of nucleotide bases shall start at the first base of the sequence with number 1. The enumeration shall be continuous through the whole sequence in the direction 5 to 3. The enumeration shall be marked in the right margin, next to the line containing the one-letter codes for the bases, and giving the number of the last base of that line.

(7) For those nucleotide sequences that are circular in configuration, the enumeration method set forth in paragraph (c)(6) of this section remains applicable with the exception that the designation of the first base of the nucleotide sequence may be made at the option of the applicant.

(d) *Representation of amino acids.* (1) The amino acids in a protein or peptide sequence shall be listed using the three-letter abbreviation with the first letter as an upper case character, as in WIPO Standard ST.25 (1998), Appendix 2, Table 3.

(2) A protein or peptide sequence shall be listed with a maximum of 16 amino acids per line, with a space provided between each amino acid.

(3) An amino acid sequence shall be presented in the amino to carboxy direction, from left to right, and the amino and carboxy groups shall not be presented in the sequence.

(4) The enumeration of amino acids may start at the first amino acid of the first mature protein, with the number 1. When presented, the amino acids preceding the mature protein, *e.g.*, pre-sequences, pro-sequences, pre-pro-sequences and signal sequences, shall have negative numbers, counting

backwards starting with the amino acid next to number 1. Otherwise, the enumeration of amino acids shall start at the first amino acid at the amino terminal as number 1. It shall be marked below the sequence every 5 amino acids. The enumeration method for amino acid sequences that is set forth in this section remains applicable for amino acid sequences that are circular in configuration, with the exception that the designation of the first amino acid of the sequence may be made at the option of the applicant.

(5) An amino acid sequence that contains internal terminator symbols (*e.g.*, “Ter”, “\*”, or “.”, etc.) may not be represented as a single amino acid sequence, but shall be presented as separate amino acid sequences.

(e) A sequence with a gap or gaps shall be presented as a plurality of separate sequences, with separate sequence identifiers, with the number of separate sequences being equal in number to the number of continuous strings of sequence data. A sequence that is made up of one or more noncontiguous segments of a larger sequence or segments from different sequences shall be presented as a separate sequence.

[Added, 55 FR 18230, May 1, 1990, effective Oct. 1, 1990; revised, 63 FR 29620, June 1, 1998, effective, July 1, 1998]

### § 1.823 Requirements for nucleotide and/or amino acid sequences as part of the application.

(a)(1) If the “Sequence Listing” required by § 1.821(c) is submitted on paper: The “Sequence Listing,” setting forth the nucleotide and/or amino acid sequence and associated information in accordance with paragraph (b) of this section, must begin on a new page and must be titled “Sequence Listing.” The pages of the “Sequence Listing” preferably should be numbered independently of the numbering of the remainder of the application. Each page of the “Sequence Listing” shall contain no more than 66 lines and each line shall contain no more than 72 characters. The sheet or sheets presenting a sequence listing may not include material other than part of the sequence listing. A fixed-width font should be used exclusively throughout the “Sequence Listing.”

(2) If the “Sequence Listing” required by § 1.821(c) is submitted on compact disc: The “Sequence Listing” must be submitted on a compact

disc in compliance with § 1.52(e). The compact disc may also contain table information if the application contains table information that may be submitted on a compact disc (§ 1.52(e)(1)(iii)). The specification must contain an incorporation-by-reference of the Sequence Listing as required by § 1.52(e)(5). The presentation of the “Sequence Listing” and other materials on compact disc under § 1.821(c) does not substitute for the Computer Readable Form that must be submitted on disk, compact disc, or tape in accordance with § 1.824.

(b) The “Sequence Listing” shall, except as otherwise indicated, include the actual nucleotide and/or amino acid sequence, the numeric identifiers and their accompanying information as shown in the following

table. The numeric identifier shall be used only in the “Sequence Listing.” The order and presentation of the items of information in the “Sequence Listing” shall conform to the arrangement given below. Each item of information shall begin on a new line and shall begin with the numeric identifier enclosed in angle brackets as shown. The submission of those items of information designated with an “M” is mandatory. The submission of those items of information designated with an “O” is optional. Numeric identifiers <110> through <170> shall only be set forth at the beginning of the “Sequence Listing.” The following table illustrates the numeric identifiers.

Numeric Identifier	Definition	Comments and format	Mandatory (M) or Optional (O)
<110>	Applicant.....	Preferably max. of 10 names; one name per line; preferable format: Surname, Other Names and/or Initials.	M.
<120>	Title of Invention.....	.....	M.
<130>	File Reference.....	Personal file reference.....	M when filed prior to assignment or appl. number
<140>	Current Application Number.	Specify as: US 07/999,999 or PCT/US96/99999.	M, if available.
<141>	Current Filing Date.....	Specify as: yyyy-mm-dd.....	M, if available.
<150>	Prior Application Number.	Specify as: US 07/999,999 or PCT/US96/99999.	M, if applicable include priority documents under 35 U.S.C. 119 and 120
<151>	Prior Application Filing Date.	Specify as: yyyy-mm-dd .....	M, if applicable
<160>	Number of SEQ ID NOs.	Count includes total number of SEQ ID NOs.....	M.
<170>	Software.....	Name of software used to create the Sequence Listing.	O.
<210>	SEQ ID NO:#:.....	Response shall be an integer representing the SEQ ID NO shown.	M.
<211>	Length.....	Respond with an integer expressing the number of bases or amino acid residues.	M.

Numeric Identifier	Definition	Comments and format	Mandatory (M) or Optional (O)
<212>	Type.....	Whether presented sequence molecule is DNA, RNA, or PRT (protein). If a nucleotide sequence contains both DNA and RNA fragments, the type shall be "DNA." In addition, the combined DNA/ RNA molecule shall be further described in the <220> to <223> feature section.	M.
<213>	Organism.....	Scientific name, i.e. Genus/ species, Unknown or Artificial Sequence. In addition, the "Unknown" or "Artificial Sequence" organisms shall be further described in the <220> to <223> feature section.	M.
<220>	Feature.....	Leave blank after <220>. <221-223> provide for a description of points of biological significance in the sequence.	M, under the following conditions: if "n," "Xaa," or a modified or unusual L-amino acid or modified base was used in a sequence; if ORGANISM is "Artificial Sequence" or "Unknown"; if molecule is combined DNA/RNA.
<221>	Name/Key.....	Provide appropriate identifier for feature, preferably from WIPO Standard ST.25 (1998), Appendix 2, Tables 5 and 6.	M, under the following conditions: if "n," "Xaa," or a modified or unusual L-amino acid or modified base was used in a sequence.
Numeric Identifier	Definition	Comments and format	Mandatory (M) or Optional (O)
<222>	Location.....	Specify location within sequence; where appropriate state number of first and last bases/amino acids in feature.	M, under the following conditions: if "n," "Xaa," or a modified or unusual L-amino acid or modified base was used in a sequence.
<223>	Other Information.....	Other relevant information; four lines maximum.....	M, under the following conditions: if "n," "Xaa," or a modified or unusual L-amino acid or modified base was used in a sequence; if ORGANISM is "Artificial Sequence" or "Unknown"; if molecule is combined DNA/RNA.
<300>	Publication Information	Leave blank after <300>	O.
<301>	Authors.....	Preferably max. of ten named authors of publication; specify one name per line; preferable format: Surname, Other Names and/or Initials.	O.
<302>	Title.....	.....	O.



Numeric Identifier	Definition	Comments and format	Mandatory (M) or Optional (O)
<303>	Journal.....	.....	O.
<304>	Volume .....	.....	O.
<305>	Issue .....	.....	O.
<306>	Pages .....	.....	O.
<307>	Date.....	Journal date on which data published; specify as yyyy- mm-dd, MMM-yyyy or Season- yyyy.	O.
<308>	Database Accession Number.	Accession number assigned by database including database name.	O.
<309>	Database Entry Date.....	Date of entry in database; specify as yyyy-mm-dd or MMM-yyyy.	O.
<310>	Patent Document Number.	Document number; for patent-type citations only. Specify as, for example, US 07/ 999,999.	O.
<311>	Patent Filing Date.....	Document filing date, for patent-type citations only; specify as yyyy-mm-dd.	O.
<312>	Publication Date.....	Document publication date, for patent-type citations only; specify as yyyy-mm-dd.	O.
<313>	Relevant Residues.....	FROM (position) TO (position).....	O.
<400>	Sequence.....	SEQ ID NO should follow the numeric identifier and should appear on the line preceding the actual sequence.	M.

[Added, 55 FR 18230, May 1, 1990, effective Oct. 1, 1990; revised, 63 FR 29620, June 1, 1998, effective July 1, 1998; heading and para. (a) revised, 65 FR 54604, Sept. 8, 2000, effective Sept. 8, 2000 (effective date corrected, 65 FR 78958, Dec. 18, 2000); para. (a)(1) revised, 68 FR 38611, June 30, 2003, effective July 30, 2003]

**§ 1.824 Form and format for nucleotide and/or amino acid sequence submissions in computer readable form.**

(a) The computer readable form required by § 1.821(e) shall meet the following requirements:

(1) The computer readable form shall contain a single “Sequence Listing” as either a diskette, series of diskettes, or other permissible media outlined in paragraph (c) of this section.

(2) The “Sequence Listing” in paragraph (a)(1) of this section shall be submitted in American Standard Code for Information Interchange (ASCII) text. No other formats shall be allowed.

(3) The computer readable form may be created by any means, such as word processors, nucleotide/amino acid sequence editors’ or other custom computer programs; however, it shall conform to all requirements detailed in this section.

(4) File compression is acceptable when using diskette media, so long as the compressed file is in a self-extracting format that will decompress on one of the systems described in paragraph (b) of this section.

(5) Page numbering must not appear within the computer readable form version of the “Sequence Listing” file.

(6) All computer readable forms must have a label permanently affixed thereto on which has been hand-printed or typed: the name of the applicant, the title of the invention, the date on which the data were recorded on the computer readable form, the operating system used, a reference number, and an application number and filing date, if known. If multiple diskettes are submitted, the diskette labels must indicate their order (*e.g.*, “1 of X”).

(b) Computer readable form submissions must meet these format requirements:

(1) Computer Compatibility: IBM PC/XT/AT or Apple Macintosh;

(2) Operating System Compatibility: MS-DOS, MS-Windows, Unix or Macintosh;

(3) Line Terminator: ASCII Carriage Return plus ASCII Line Feed; and

(4) Pagination: Continuous file (no “hard page break” codes permitted).

(c) Computer readable form files submitted may be in any of the following media:

(1) Diskette: 3.50 inch, 1.44 Mb storage; 3.50 inch, 720 Kb storage; 5.25 inch, 1.2 Mb storage; 5.25 inch, 360 Kb storage.

(2) Magnetic tape: 0.5 inch, up to 24000 feet; Density: 1600 or 6250 bits per inch, 9 track; Format: Unix tar command; specify blocking factor (not “block size”); Line Terminator: ASCII Carriage Return plus ASCII Line Feed.

(3) 8mm Data Cartridge: Format: Unix tar command; specify blocking factor (not “block size”); Line Terminator: ASCII Carriage Return plus ASCII Line Feed.

(4) Compact disc: Format: ISO 9660 or High Sierra Format.

(5) Magneto Optical Disk: Size/Storage Specifications: 5.25 inch, 640 Mb.

(d) Computer readable forms that are submitted to the Office will not be returned to the applicant.

[Added, 55 FR 18230, May 1, 1990, effective Oct. 1, 1990; revised, 63 FR 29620, June 1, 1998, effective July 1, 1998; revised, 65 FR 54604, Sept. 8, 2000, effective Sept. 8, 2000 (effective date corrected, 65 FR 78958, Dec. 18, 2000)]

### § 1.825 Amendments to or replacement of sequence listing and computer readable copy thereof.

(a) Any amendment to a paper copy of the “Sequence Listing” (§ 1.821(c)) must be made by the submission of substitute sheets and include a statement that the substitute sheets include no new matter. Any amendment to a compact disc copy of the “Sequence Listing” (§ 1.821(c)) must be made by the submission of a replacement compact disc (2 copies) in compliance with § 1.52(e). Amendments must also be accompanied by a statement that indicates support for the amendment in the application, as filed, and a statement that the replacement compact disc includes no new matter.

(b) Any amendment to the paper copy of the “Sequence Listing,” in accordance with paragraph (a) of this section, must be accompanied by a substitute copy of the computer readable form (§ 1.821(e)) including all previously submitted data with the amendment incorporated therein, accompanied by a statement that the copy in computer readable form is the same as the substitute copy of the “Sequence Listing.”

(c) Any appropriate amendments to the “Sequence Listing” in a patent; *e.g.*, by reason of reissue or certificate of correction, must comply with the requirements of paragraphs (a) and (b) of this section.

(d) If, upon receipt, the computer readable form is found to be damaged or unreadable, applicant must provide, within such time as set by the Director, a substitute copy of the data in computer readable form accompanied by a statement that the substitute data is identical to that originally filed.

[Added 55 FR 18230, May 1, 1990, effective Oct. 1, 1990; revised, 63 FR 29620, June 1, 1998, effective July 1, 1998; paras. (a) and (b) revised, 65 FR 54604, Sept. 8, 2000, effective Sept. 8, 2000 (effective date corrected, 65 FR 78958, Dec. 18, 2000); para. (d) revised, 68 FR 14332, Mar. 25, 2003, effective May 1, 2003]

**APPENDIX A TO SUBPART G TO PART 1 —  
SAMPLE SEQUENCE LISTING**

```

<110> Smith, John
      Smith, Jane

<120> Example of a Sequence Listing

<130> 01-00001

<140> US 08/999,999

<141> 1998-02-28

<150> EP 91000000
<151> 1997-12-31

<160> 2

<170> PatentIn ver. 2.0

<210> 1
<211> 403
<212> DNA
<213> Paramecium aurelia

<220>
<221> CDS
<222> 341..394

<300>
<301> Doe, Richard
<302> Isolation and Characterization of a Gene Encoding a
      Protease from Paramecium sp.
<303> Journal of Fictional Genes
<304> 1
<305> 4
<306> 1 - 7
<307> 1988-06-20

<400> 1
ctactctact ctactctcat ctactatctt ctttggatct ctgagctctgc ctgagtggtta      60
ctcttgagtc ctggagatct ctctctcac atgtgatcgt cgagactgac cgatagatcg      120
ctgactgact ctgagatagt cgagcccgta cgagaccogt cgaggggtgac agagagtggg      180
cgcggtgcgc cagagcgcgc cgccggtgcg cgcgcgagtg cgcggtgggc cgcgcgaggg      240
ctttcgcggc agcggggcg ctttcggcg cgcgcccgtc cgcccctaga cctgagaggt      300
cttctcttcc ctctcttca ctagagaggt ctatatatac atg gtt tca atg ttc      355
                                     Met Val Ser Met Phe
                                     1           5

```

agc ttg tct ttc aaa tgg cct gga ttt tgt ttg ttt gtt tgtttgctc 403  
Ser Leu Ser Phe Lys Trp Pro Gly Phe Cys Leu Phe Val  
10 15

<210> 2

<211> 18

<212> PRT

<213> Paramecium aurelia

<400> 2

Met Val Ser Met Phe Ser Leu Ser Phe Lys Trp Pro Gly Phe Cys Leu  
1 5 10 15

Phe Val

## Subpart H — *Inter Partes* Reexamination of Patents That Issued From an Original Application Filed in the United States on or After November 29, 1999

### PRIOR ART CITATIONS

#### § 1.902 Processing of prior art citations during an *inter partes* reexamination proceeding.

Citations by the patent owner in accordance with § 1.933 and by an *inter partes* reexamination third party requester under § 1.915 or § 1.948 will be entered in the *inter partes* reexamination file. The entry in the patent file of other citations submitted after the date of an order for reexamination pursuant to § 1.931 by persons other than the patent owner, or the third party requester under either § 1.915 or § 1.948, will be delayed until the *inter partes* reexamination proceeding has been terminated. See § 1.502 for processing of prior art citations in patent and reexamination files during an *ex parte* reexamination proceeding filed under § 1.510.

[Added, 65 FR 76756, Dec. 7, 2000, effective Feb. 5, 2001]

### REQUIREMENTS FOR *INTER PARTES* REEXAMINATION PROCEEDINGS

#### § 1.903 Service of papers on parties in *inter partes* reexamination.

The patent owner and the third party requester will be sent copies of Office actions issued during the *inter partes* reexamination proceeding. After filing of a request for *inter partes* reexamination by a third party requester, any document filed by either the patent owner or the third party requester must be served on every other party in the reexamination proceeding in the manner provided in § 1.248. Any document must reflect service or the document may be refused consideration by the Office. The failure of the patent owner or the third party requester to serve documents may result in their being refused consideration.

[Added, 65 FR 76756, Dec. 7, 2000, effective Feb. 5, 2001]

#### § 1.904 Notice of *inter partes* reexamination in *Official Gazette*.

A notice of the filing of an *inter partes* reexamination request will be published in the *Official Gazette*. The notice published in the *Official Gazette* under § 1.11(c) will be considered to be constructive notice of the *inter partes* reexamination proceeding and *inter partes* reexamination will proceed.

[Added, 65 FR 76756, Dec. 7, 2000, effective Feb. 5, 2001]

#### § 1.905 Submission of papers by the public in *inter partes* reexamination.

Unless specifically provided for, no submissions on behalf of any third parties other than third party requesters as defined in 35 U.S.C. 100(e) will be considered unless such submissions are in accordance with § 1.915 or entered in the patent file prior to the date of the order for reexamination pursuant to § 1.931. Submissions by third parties, other than third party requesters, filed after the date of the order for reexamination pursuant to § 1.931, must meet the requirements of § 1.501 and will be treated in accordance with § 1.902. Submissions which do not meet the requirements of § 1.501 will be returned.

[Added, 65 FR 76756, Dec. 7, 2000, effective Feb. 5, 2001]

#### § 1.906 Scope of reexamination in *inter partes* reexamination proceeding.

(a) Claims in an *inter partes* reexamination proceeding will be examined on the basis of patents or printed publications and, with respect to subject matter added or deleted in the reexamination proceeding, on the basis of the requirements of 35 U.S.C. 112.

(b) Claims in an *inter partes* reexamination proceeding will not be permitted to enlarge the scope of the claims of the patent.

(c) Issues other than those indicated in paragraphs (a) and (b) of this section will not be resolved in an *inter partes* reexamination proceeding. If such issues are raised by the patent owner or the third party requester during a reexamination proceeding, the existence of such issues will be noted by the examiner in the next Office action, in which case the patent owner may desire to consider the advisability of filing

a reissue application to have such issues considered and resolved.

[Added, 65 FR 76756, Dec. 7, 2000, effective Feb. 5, 2001]

**§ 1.907 *Inter partes* reexamination prohibited.**

(a) Once an order to reexamine has been issued under § 1.931, neither the third party requester, nor its privies, may file a subsequent request for *inter partes* reexamination of the patent until an *inter partes* reexamination certificate is issued under § 1.997, unless authorized by the Director.

(b) Once a final decision has been entered against a party in a civil action arising in whole or in part under 28 U.S.C. 1338 that the party has not sustained its burden of proving invalidity of any patent claim-in-suit, then neither that party nor its privies may thereafter request *inter partes* reexamination of any such patent claim on the basis of issues which that party, or its privies, raised or could have raised in such civil action, and an *inter partes* reexamination requested by that party, or its privies, on the basis of such issues may not thereafter be maintained by the Office.

(c) If a final decision in an *inter partes* reexamination proceeding instituted by a third party requester is favorable to patentability of any original, proposed amended, or new claims of the patent, then neither that party nor its privies may thereafter request *inter partes* reexamination of any such patent claims on the basis of issues which that party, or its privies, raised or could have raised in such *inter partes* reexamination proceeding.

[Added, 65 FR 76756, Dec. 7, 2000, effective Feb. 5, 2001; para. (a) revised, 68 FR 14332, Mar. 25, 2003, effective May 1, 2003]

**§ 1.913 Persons eligible to file request for *inter partes* reexamination.**

Except as provided for in § 1.907, any person other than the patent owner or its privies may, at any time during the period of enforceability of a patent which issued from an original application filed in the United States on or after November 29, 1999, file a request for *inter partes* reexamination by the Office of any claim of the patent on the basis of prior art patents or printed publications cited under § 1.501.

[Added, 65 FR 76756, Dec. 7, 2000, effective Feb. 5, 2001; revised, 68 FR 70996, Dec. 22, 2003, effective Jan. 21, 2004]

**§ 1.915 Content of request for *inter partes* reexamination.**

(a) The request must be accompanied by the fee for requesting *inter partes* reexamination set forth in § 1.20(c)(2).

(b) A request for *inter partes* reexamination must include the following parts:

(1) An identification of the patent by patent number and every claim for which reexamination is requested.

(2) A citation of the patents and printed publications which are presented to provide a substantial new question of patentability.

(3) A statement pointing out each substantial new question of patentability based on the cited patents and printed publications, and a detailed explanation of the pertinency and manner of applying the patents and printed publications to every claim for which reexamination is requested.

(4) A copy of every patent or printed publication relied upon or referred to in paragraphs (b)(1) through (3) of this section, accompanied by an English language translation of all the necessary and pertinent parts of any non-English language document.

(5) A copy of the entire patent including the front face, drawings, and specification/claims (in double column format) for which reexamination is requested, and a copy of any disclaimer, certificate of correction, or reexamination certificate issued in the patent. All copies must have each page plainly written on only one side of a sheet of paper.

(6) A certification by the third party requester that a copy of the request has been served in its entirety on the patent owner at the address provided for in § 1.33(c). The name and address of the party served must be indicated. If service was not possible, a duplicate copy of the request must be supplied to the Office.

(7) A certification by the third party requester that the estoppel provisions of § 1.907 do not prohibit the *inter partes* reexamination.

(8) A statement identifying the real party in interest to the extent necessary for a subsequent

person filing an *inter partes* reexamination request to determine whether that person is a privy.

(c) If an *inter partes* request is filed by an attorney or agent identifying another party on whose behalf the request is being filed, the attorney or agent must have a power of attorney from that party or be acting in a representative capacity pursuant to § 1.34(a).

(d) If the *inter partes* request does not meet all the requirements of subsection 1.915(b), the person identified as requesting *inter partes* reexamination may be so notified and given an opportunity to complete the formal requirements of the request within a specified time. Failure to comply with the notice may result in the *inter partes* reexamination proceeding being vacated.

[Added, 65 FR 76756, Dec. 7, 2000, effective Feb. 5, 2001]

#### § 1.919 Filing date of request for *inter partes* reexamination.

(a) The filing date of a request for *inter partes* reexamination is the date on which the request satisfies the fee requirement of § 1.915(a).

(b) If the request is not granted a filing date, the request will be placed in the patent file as a citation of prior art if it complies with the requirements of § 1.501.

[Added, 65 FR 76756, Dec. 7, 2000, effective Feb. 5, 2001]

#### § 1.923 Examiner's determination on the request for *inter partes* reexamination.

Within three months following the filing date of a request for *inter partes* reexamination under § 1.919, the examiner will consider the request and determine whether or not a substantial new question of patentability affecting any claim of the patent is raised by the request and the prior art citation. The examiner's determination will be based on the claims in effect at the time of the determination, will become a part of the official file of the patent, and will be mailed to the patent owner at the address as provided for in § 1.33(c) and to the third party requester. If the examiner determines that no substantial new question of

patentability is present, the examiner shall refuse the request and shall not order *inter partes* reexamination.

[Added, 65 FR 76756, Dec. 7, 2000, effective Feb. 5, 2001]

#### § 1.925 Partial refund if request for *inter partes* reexamination is not ordered.

Where *inter partes* reexamination is not ordered, a refund of a portion of the fee for requesting *inter partes* reexamination will be made to the requester in accordance with § 1.26(c).

[Added, 65 FR 76756, Dec. 7, 2000, effective Feb. 5, 2001]

#### § 1.927 Petition to review refusal to order *inter partes* reexamination.

The third party requester may seek review by a petition to the Director under § 1.181 within one month of the mailing date of the examiner's determination refusing to order *inter partes* reexamination. Any such petition must comply with § 1.181(b). If no petition is timely filed or if the decision on petition affirms that no substantial new question of patentability has been raised, the determination shall be final and nonappealable.

[Added, 65 FR 76756, Dec. 7, 2000, effective Feb. 5, 2001; revised, 68 FR 14332, Mar. 25, 2003, effective May 1, 2003]

### INTER PARTES REEXAMINATION OF PATENTS

#### § 1.931 Order for *inter partes* reexamination.

(a) If a substantial new question of patentability is found, the determination will include an order for *inter partes* reexamination of the patent for resolution of the question.

(b) If the order for *inter partes* reexamination resulted from a petition pursuant to § 1.927, the *inter partes* reexamination will ordinarily be conducted by an examiner other than the examiner responsible for the initial determination under § 1.923.

[Added, 65 FR 76756, Dec. 7, 2000, effective Feb. 5, 2001]

## INFORMATION DISCLOSURE IN *INTER PARTES* REEXAMINATION

### § 1.933 Patent owner duty of disclosure in *inter partes* reexamination proceedings.

(a) Each individual associated with the patent owner in an *inter partes* reexamination proceeding has a duty of candor and good faith in dealing with the Office, which includes a duty to disclose to the Office all information known to that individual to be material to patentability in a reexamination proceeding as set forth in § 1.555(a) and (b). The duty to disclose all information known to be material to patentability in an *inter partes* reexamination proceeding is deemed to be satisfied by filing a paper in compliance with the requirements set forth in § 1.555(a) and (b).

(b) The responsibility for compliance with this section rests upon the individuals designated in paragraph (a) of this section, and no evaluation will be made by the Office in the reexamination proceeding as to compliance with this section. If questions of compliance with this section are raised by the patent owner or the third party requester during a reexamination proceeding, they will be noted as unresolved questions in accordance with § 1.906(c).

[Added, 65 FR 76756, Dec. 7, 2000, effective Feb. 5, 2001]

## OFFICE ACTIONS AND RESPONSES (BEFORE THE EXAMINER) IN *INTER PARTES* REEXAMINATION

### § 1.935 Initial Office action usually accompanies order for *inter partes* reexamination.

The order for *inter partes* reexamination will usually be accompanied by the initial Office action on the merits of the reexamination.

[Added, 65 FR 76756, Dec. 7, 2000, effective Feb. 5, 2001]

### § 1.937 Conduct of *inter partes* reexamination.

(a) All *inter partes* reexamination proceedings, including any appeals to the Board of Patent Appeals and Interferences, will be conducted with special dispatch within the Office, unless the Director makes a determination that there is good cause for suspending the reexamination proceeding.

(b) The *inter partes* reexamination proceeding will be conducted in accordance with §§ 1.104 through 1.116, the sections governing the application examination process, and will result in the issuance of an *inter partes* reexamination certificate under § 1.997, except as otherwise provided.

(c) All communications between the Office and the parties to the *inter partes* reexamination which are directed to the merits of the proceeding must be in writing and filed with the Office for entry into the record of the proceeding.

[Added, 65 FR 76756, Dec. 7, 2000, effective Feb. 5, 2001; para. (a) revised, 68 FR 14332, Mar. 25, 2003, effective May 1, 2003]

### § 1.939 Unauthorized papers in *inter partes* reexamination

(a) If an unauthorized paper is filed by any party at any time during the *inter partes* reexamination proceeding it will not be considered and may be returned.

(b) Unless otherwise authorized, no paper shall be filed prior to the initial Office action on the merits of the *inter partes* reexamination.

[Added, 65 FR 76756, Dec. 7, 2000, effective Feb. 5, 2001]

### § 1.941 Amendments by patent owner in *inter partes* reexamination.

Amendments by patent owner in *inter partes* reexamination proceedings are made by filing a paper in compliance with §§ 1.530(d)-(k) and 1.943.

[Added, 65 FR 76756, Dec. 7, 2000, effective Feb. 5, 2001]

### § 1.943 Requirements of responses, written comments, and briefs in *inter partes* reexamination.

(a) The form of responses, written comments, briefs, appendices, and other papers must be in accordance with the requirements of § 1.52.

(b) Responses by the patent owner and written comments by the third party requester shall not exceed 50 pages in length, excluding amendments, appendices of claims, and reference materials such as prior art references.



(c) Appellant's briefs filed by the patent owner and the third party requester shall not exceed thirty pages or 14,000 words in length, excluding appendices of claims and reference materials such as prior art references. All other briefs filed by any party shall not exceed fifteen pages in length or 7,000 words. If the page limit for any brief is exceeded, a certificate is required stating the number of words contained in the brief.

[Added, 65 FR 76756, Dec. 7, 2000, effective Feb. 5, 2001]

**§ 1.945 Response to Office action by patent owner in *inter partes* reexamination.**

The patent owner will be given at least thirty days to file a response to any Office action on the merits of the *inter partes* reexamination.

[Added, 65 FR 76756, Dec. 7, 2000, effective Feb. 5, 2001]

**§ 1.947 Comments by third party requester to patent owner's response in *inter partes* reexamination.**

Each time the patent owner files a response to an Office action on the merits pursuant to § 1.945, a third party requester may once file written comments within a period of 30 days from the date of service of the patent owner's response. These comments shall be limited to issues raised by the Office action or the patent owner's response. The time for submitting comments by the third party requester may not be extended. For the purpose of filing the written comments by the third party requester, the comments will be considered as having been received in the Office as of the date of deposit specified in the certificate under § 1.8.

[Added, 65 FR 76756, Dec. 7, 2000, effective Feb. 5, 2001]

**§ 1.948 Limitations on submission of prior art by third party requester following the order for *inter partes* reexamination.**

(a) After the *inter partes* reexamination order, the third party requester may only cite additional prior art as defined under § 1.501 if it is filed as part of a

comments submission under § 1.947 or § 1.951(b) and is limited to prior art:

(1) which is necessary to rebut a finding of fact by the examiner;

(2) which is necessary to rebut a response of the patent owner; or

(3) which for the first time became known or available to the third party requester after the filing of the request for *inter partes* reexamination proceeding. Prior art submitted under paragraph (a)(3) of this section must be accompanied by a statement as to when the prior art first became known or available to the third party requester and must include a discussion of the pertinency of each reference to the patentability of at least one claim.

(b) [Reserved].

[Added, 65 FR 76756, Dec. 7, 2000, effective Feb. 5, 2001]

**§ 1.949 Examiner's Office action closing prosecution in *inter partes* reexamination.**

Upon consideration of the issues a second or subsequent time, or upon a determination of patentability of all claims, the examiner shall issue an Office action treating all claims present in the *inter partes* reexamination, which may be an action closing prosecution. The Office action shall set forth all rejections and determinations not to make a proposed rejection, and the grounds therefor. An Office action will not usually close prosecution if it includes a new ground of rejection which was not previously addressed by the patent owner, unless the new ground was necessitated by an amendment.

[Added, 65 FR 76756, Dec. 7, 2000, effective Feb. 5, 2001]

**§ 1.951 Options after Office action closing prosecution in *inter partes* reexamination.**

(a) After an Office action closing prosecution in an *inter partes* reexamination, the patent owner may once file comments limited to the issues raised in the Office action closing prosecution. The comments can include a proposed amendment to the claims, which amendment will be subject to the criteria of § 1.116 as to whether or not it shall be admitted. The comments must be filed within the time set for response in the Office action closing prosecution.

(b) When the patent owner does file comments, a third party requester may once file comments responsive to the patent owner's comments within 30 days from the date of service of patent owner's comments on the third party requester.

[Added, 65 FR 76756, Dec. 7, 2000, effective Feb. 5, 2001]

**§ 1.953 Examiner's Right of Appeal Notice in *inter partes* reexamination.**

(a) Upon considering the comments of the patent owner and the third party requester subsequent to the Office action closing prosecution in an *inter partes* reexamination, or upon expiration of the time for submitting such comments, the examiner shall issue a Right of Appeal Notice, unless the examiner reopens prosecution and issues another Office action on the merits.

(b) Expedited Right of Appeal Notice: At any time after the patent owner's response to the initial Office action on the merits in an *inter partes* reexamination, the patent owner and all third party requesters may stipulate that the issues are appropriate for a final action, which would include a final rejection and/or a final determination favorable to patentability, and may request the issuance of a Right of Appeal Notice. The request must have the concurrence of the patent owner and all third party requesters present in the proceeding and must identify all the appealable issues and the positions of the patent owner and all third party requesters on those issues. If the examiner determines that no other issues are present or should be raised, a Right of Appeal Notice limited to the identified issues shall be issued. Any appeal by the parties shall be conducted in accordance with §§ 1.959-1.983.

(c) The Right of Appeal Notice shall be a final action, which comprises a final rejection setting forth each ground of rejection and/or final decision favorable to patentability including each determination not to make a proposed rejection, an identification of the status of each claim, and the reasons for decisions favorable to patentability and/or the grounds of rejec-

tion for each claim. No amendment can be made in response to the Right of Appeal Notice. The Right of Appeal Notice shall set a one-month time period for either party to appeal. If no notice of appeal is filed, the *inter partes* reexamination proceeding will be terminated, and the Director will proceed to issue a certificate under § 1.997 in accordance with the Right of Appeal Notice.

[Added, 65 FR 76756, Dec. 7, 2000, effective Feb. 5, 2001; para. (c) revised, 68 FR 14332, Mar. 25, 2003, effective May 1, 2003]

**INTERVIEWS PROHIBITED IN *INTER PARTES* REEXAMINATION**

**§ 1.955 Interviews prohibited in *inter partes* reexamination proceedings.**

There will be no interviews in an *inter partes* reexamination proceeding which discuss the merits of the proceeding.

[Added, 65 FR 76756, Dec. 7, 2000, effective Feb. 5, 2001]

**EXTENSIONS OF TIME, TERMINATION OF PROCEEDINGS, AND PETITIONS TO REVIVE IN *INTER PARTES* REEXAMINATION**

**§ 1.956 Patent owner extensions of time in *inter partes* reexamination.**

The time for taking any action by a patent owner in an *inter partes* reexamination proceeding will be extended only for sufficient cause and for a reasonable time specified. Any request for such extension must be filed on or before the day on which action by the patent owner is due, but in no case will the mere filing of a request effect any extension. See § 1.304(a) for extensions of time for filing a notice of appeal to the U.S. Court of Appeals for the Federal Circuit.

[Added, 65 FR 76756, Dec. 7, 2000, effective Feb. 5, 2001]

**§ 1.957 Failure to file a timely, appropriate or complete response or comment in *inter partes* reexamination.**

(a) If the third party requester files an untimely or inappropriate comment, notice of appeal or brief in an *inter partes* reexamination, the paper will be refused consideration.

(b) If no claims are found patentable, and the patent owner fails to file a timely and appropriate response in an *inter partes* reexamination proceeding, the reexamination proceeding will be terminated and the Director will proceed to issue a certificate under § 1.997 in accordance with the last action of the Office.

(c) If claims are found patentable and the patent owner fails to file a timely and appropriate response to any Office action in an *inter partes* reexamination proceeding, further prosecution will be limited to the claims found patentable at the time of the failure to respond, and to any claims added thereafter which do not expand the scope of the claims which were found patentable at that time.

(d) When action by the patent owner is a *bona fide* attempt to respond and to advance the prosecution and is substantially a complete response to the Office action, but consideration of some matter or compliance with some requirement has been inadvertently omitted, an opportunity to explain and supply the omission may be given.

[Added, 65 FR 76756, Dec. 7, 2000, effective Feb. 5, 2001; para. (b) revised, 68 FR 14332, Mar. 25, 2003, effective May 1, 2003]

**§ 1.958 Petition to revive terminated *inter partes* reexamination or claims terminated for lack of patent owner response.**

(a) If a response by the patent owner is not timely filed in the Office, the delay in filing such response may be excused if it is shown to the satisfaction of the Director that the delay was unavoidable. A grantable petition to accept an unavoidably delayed response must be filed in compliance with § 1.137(a).

(b) Any response by the patent owner not timely filed in the Office may be accepted if the delay was unintentional. A grantable petition to accept an unintentionally delayed response must be filed in compliance with § 1.137(b).

[Added, 65 FR 76756, Dec. 7, 2000, effective Feb. 5, 2001; para. (a) revised, 68 FR 14332, Mar. 25, 2003, effective May 1, 2003]

**APPEAL TO THE BOARD OF PATENT APPEALS AND INTERFERENCES IN *INTER PARTES* REEXAMINATION**

**§ 1.959 Notice of appeal and cross appeal to Board of Patent Appeals and Interferences in *inter partes* reexamination.**

(a)(1) Upon the issuance of a Right of Appeal Notice under § 1.953, the patent owner involved in an *inter partes* reexamination proceeding may appeal to the Board of Patent Appeals and Interferences with respect to the final rejection of any claim of the patent by filing a notice of appeal within the time provided in the Right of Appeal Notice and paying the fee set forth in § 1.17(b).

(2) Upon the issuance of a Right of Appeal Notice under § 1.953, a third party requester involved in an *inter partes* reexamination proceeding may appeal to the Board of Patent Appeals and Interferences with respect to any final decision favorable to the patentability, including any final determination not to make a proposed rejection, of any original, proposed amended, or new claim of the patent by filing a notice of appeal within the time provided in the Right of Appeal Notice and paying the fee set forth in § 1.17(b).

(b)(1) Within fourteen days of service of a third party requester's notice of appeal under paragraph (a)(2) of this section and upon payment of the fee set forth in § 1.17(b), a patent owner who has not filed a notice of appeal may file a notice of cross appeal with respect to the final rejection of any claim of the patent.

(2) Within fourteen days of service of a patent owner's notice of appeal under paragraph (a)(1) of this section and upon payment of the fee set forth in § 1.17(b), a third party requester who has not filed a notice of appeal may file a notice of cross appeal with respect to any final decision favorable to the patentability, including any final determination not to make a proposed rejection, of any original, proposed amended, or new claim of the patent.

(c) The notice of appeal or cross appeal in an *inter partes* reexamination proceeding must identify

the appealed claim(s) and must be signed by the patent owner, the third party requester, or their duly authorized attorney or agent.

(d) An appeal or cross appeal, when taken, must be taken from all the rejections of the claims in a Right of Appeal Notice which the patent owner proposes to contest or from all the determinations favorable to patentability, including any final determination not to make a proposed rejection, in a Right of Appeal Notice which a third party requester proposes to contest. Questions relating to matters not affecting the merits of the invention may be required to be settled before an appeal is decided.

(e) The times for filing a notice of appeal or cross appeal may not be extended.

(f) If a notice of appeal or cross appeal is timely filed but does not comply with any requirement of this section, appellant will be notified of the reasons for non-compliance and provided with a non-extendable period of one month within which to file an amended notice of appeal or cross appeal. If the appellant does not then file an amended notice of appeal or cross appeal within the one-month period, or files a notice which does not overcome all the reasons for non-compliance stated in the notification of the reasons for non-compliance, that appellant's appeal or cross appeal will stand dismissed.

[Added, 65 FR 76756, Dec. 7, 2000, effective Feb. 5, 2001; para (f) added, 68 FR 70996, Dec. 22, 2003, effective Jan. 21, 2004]

#### § 1.961 Jurisdiction over appeal in *inter partes* reexamination.

Jurisdiction over the *inter partes* reexamination proceeding passes to the Board of Patent Appeals and Interferences upon transmittal of the file, including all briefs and examiner's answers, to the Board of Patent Appeals and Interferences. Prior to the entry of a decision on the appeal, the Director may *sua sponte* order the *inter partes* reexamination proceeding remanded to the examiner for action consistent with the Director's order.

[Added, 65 FR 76756, Dec. 7, 2000, effective Feb. 5, 2001; revised, 68 FR 14332, Mar. 25, 2003, effective May 1, 2003]

#### § 1.962 Appellant and respondent in *inter partes* reexamination defined.

For the purposes of *inter partes* reexamination, appellant is any party, whether the patent owner or a third party requester, filing a notice of appeal or cross appeal. If more than one party appeals or cross appeals, each appealing or cross appealing party is an appellant with respect to the claims to which his or her appeal or cross appeal is directed. A respondent is any third party requester responding under § 1.967 to the appellant's brief of the patent owner, or the patent owner responding under § 1.967 to the appellant's brief of any third party requester. No third party requester may be a respondent to the appellant brief of any other third party requester.

[Added, 65 FR 76756, Dec. 7, 2000, effective Feb. 5, 2001]

#### § 1.963 Time for filing briefs in *inter partes* reexamination.

(a) An appellant's brief in an *inter partes* reexamination must be filed no later than two months from the latest filing date of the last-filed notice of appeal or cross appeal or, if any party to the *inter partes* reexamination is entitled to file an appeal or cross appeal but fails to timely do so, the expiration of time for filing (by the last party entitled to do so) such notice of appeal or cross appeal. The time for filing an appellant's brief may not be extended.

(b) Once an appellant's brief has been properly filed, any brief must be filed by respondent within one month from the date of service of the appellant's brief. The time for filing a respondent's brief may not be extended.

(c) The examiner will consider both the appellant's and respondent's briefs and may prepare an examiner's answer under § 1.969.

(d) Any appellant may file a rebuttal brief under § 1.971 within one month of the date of the examiner's answer. The time for filing a rebuttal brief may not be extended.

(e) No further submission will be considered and any such submission will be treated in accordance with § 1.939.

[Added, 65 FR 76756, Dec. 7, 2000, effective Feb. 5, 2001]

**§ 1.965 Appellant's brief in *inter partes* reexamination.**

(a) Appellant(s) may once, within time limits for filing set forth in § 1.963, file a brief in triplicate and serve the brief on all other parties to the *inter partes* reexamination proceeding in accordance with § 1.903. The brief must be signed by the appellant, or the appellant's duly authorized attorney or agent and must be accompanied by the requisite fee set forth in § 1.17(c). The brief must set forth the authorities and arguments on which appellant will rely to maintain the appeal. Any arguments or authorities not included in the brief will be refused consideration by the Board of Patent Appeals and Interferences, unless good cause is shown.

(b) A party's appeal shall stand dismissed upon failure of that party to file an appellant's brief, accompanied by the requisite fee, within the time allowed.

(c) The appellant's brief shall contain the following items under appropriate headings and in the order indicated below, unless the brief is filed by a party who is not represented by a registered practitioner. The brief may include an appendix containing only those portions of the record on which reliance has been made.

(1) *Real Party in Interest.* A statement identifying the real party in interest.

(2) *Related Appeals and Interferences.* A statement identifying by number and filing date all other appeals or interferences known to the appellant, the appellant's legal representative, or assignee which will directly affect or be directly affected by or have a bearing on the decision of the Board of Patent Appeals and Interferences in the pending appeal.

(3) *Status of Claims.* A statement of the status of all the claims, pending or canceled. If the appellant is the patent owner, the appellant must also identify the rejected claims whose rejection is being appealed. If the appellant is a third party requester, the appellant must identify the claims that the examiner has made a determination favorable to patentability, which determination is being appealed.

(4) *Status of Amendments.* A statement of the status of any amendment filed subsequent to the close of prosecution.

(5) *Summary of Invention.* A concise explanation of the invention or subject matter defined in the claims involved in the appeal, which shall refer to the

specification by column and line number, and to the drawing(s), if any, by reference characters.

(6) *Issues.* A concise statement of the issues presented for review. No new ground of rejection can be proposed by a third party requester appellant.

(7) *Grouping of Claims.* If the appellant is the patent owner, for each ground of rejection in the Right of Appeal Notice which appellant contests and which applies to a group of two or more claims, the Board of Patent Appeals and Interferences shall select a single claim from the group and shall decide the appeal as to the ground of rejection on the basis of that claim alone unless a statement is included that the claims of the group do not stand or fall together; and, in the argument under paragraph (c)(8) of this section, appellant explains why the claims of this group are believed to be separately patentable. Merely pointing out differences in what the claims cover is not an argument as to why the claims are separately patentable.

(8) *Argument.* The contentions of appellant with respect to each of the issues presented for review in paragraph (c)(6) of this section, and the bases therefor, with citations of the authorities, statutes, and parts of the record relied on. Each issue should be treated under a separate, numbered heading.

(i) For each rejection under 35 U.S.C. 112, first paragraph, or for each determination favorable to patentability, including a determination not to make a proposed rejection under 35 U.S.C. 112, first paragraph, which appellant contests, the argument shall specify the errors in the rejection or the determination and how the first paragraph of 35 U.S.C. 112 is complied with, if the appellant is the patent owner, or is not complied with, if the appellant is a third party requester, including, as appropriate, how the specification and drawing(s), if any,

(A) Describe, if the appellant is the patent owner, or fail to describe, if the appellant is a third party requester, the subject matter defined by each of the appealed claims; and

(B) Enable, if the appellant is the patent owner, or fail to enable, if the appellant is a third party requester, any person skilled in the art to make and use the subject matter defined by each of the appealed claims.

(ii) For each rejection under 35 U.S.C. 112, second paragraph, or for each determination

favorable to patentability including a determination not to make a proposed rejection under 35 U.S.C. 112, second paragraph, which appellant contests, the argument shall specify the errors in the rejection, if the appellant is the patent owner, or the determination, if the appellant is a third party requester, and how the claims do, if the appellant is the patent owner, or do not, if the appellant is a third party requester, particularly point out and distinctly claim the subject matter which the inventor regards as the invention.

(iii) For each rejection under 35 U.S.C. 102 or for each determination favorable to patentability including a determination not to make a proposed rejection under 35 U.S.C. 102 which appellant contests, the argument shall specify the errors in the rejection, if the appellant is the patent owner, or determination, if the appellant is a third party requester, and why the appealed claims are, if the appellant is the patent owner, or are not, if the appellant is a third party requester, patentable under 35 U.S.C. 102, including any specific limitations in the appealed claims which are or are not described in the prior art.

(iv) For each rejection under 35 U.S.C. 103 or for each determination favorable to patentability, including a determination not to make a proposed rejection under 35 U.S.C. 103 which appellant contests, the argument shall specify the errors in the rejection, if the appellant is the patent owner, or determination, if the appellant is a third party requester. If appropriate, also state the specific limitations in the appealed claims which are or are not described in the prior art and explain how such limitations render the claimed subject matter obvious, if the appellant is a third party requester, or unobvious, if the appellant is the patent owner, over the prior art. If the rejection or determination is based upon a combination of references, the argument shall explain why the references, taken as a whole, do or do not suggest the claimed subject matter. The argument should include, as may be appropriate, an explanation of why features disclosed in one reference may or may not properly be combined with features disclosed in another reference. A general argument that all the limitations are or are not described in a single reference does not satisfy the requirements of this paragraph.

(v) For any rejection other than those referred to in paragraphs (c)(8)(i) to (iv) of this section or for each determination favorable to patentabil-

ity, including any determination not to make a proposed rejection other than those referred to in paragraphs (c)(8)(i) to (iv) of this section which appellant contests, the argument shall specify the errors in the rejection, if the appellant is the patent owner, or determination, if the appellant is a third party requester, and the specific limitations in the appealed claims, if appropriate, or other reasons, which cause the rejection or determination to be in error.

(9) *Appendix*. An appendix containing a copy of the claims appealed by the appellant.

(10) *Certificate of Service*. A certification that a copy of the brief has been served in its entirety on all other parties to the reexamination proceeding. The names and addresses of the parties served must be indicated.

(d) If a brief is filed which does not comply with all the requirements of paragraphs (a) and (c) of this section, appellant will be notified of the reasons for non-compliance and provided with a non-extendable period of one month within which to file an amended brief. If the appellant does not file an amended brief during the one-month period, or files an amended brief which does not overcome all the reasons for non-compliance stated in the notification, that appellant's appeal will stand dismissed.

[Added, 65 FR 76756, Dec. 7, 2000, effective Feb. 5, 2001; para. (d) revised, 68 FR 70996, Dec. 22, 2003, effective Jan. 21, 2004]

### § 1.967 Respondent's brief in *inter partes* reexamination

(a) Respondent(s) in an *inter partes* reexamination appeal may once, within the time limit for filing set forth in § 1.963, file a respondent brief in triplicate and serve the brief on all parties in accordance with § 1.903. The brief must be signed by the party, or the party's duly authorized attorney or agent, and must be accompanied by the requisite fee set forth in § 1.17(c). The brief must state the authorities and arguments on which respondent will rely. Any arguments or authorities not included in the brief will be refused consideration by the Board of Patent Appeals and Interferences, unless good cause is shown. The respondent brief shall be limited to issues raised in the appellant brief to which the respondent brief is

directed. A third party respondent brief may not address any brief of any other third party.

(b) The respondent brief shall contain the following items under appropriate headings and in the order here indicated, and may include an appendix containing only those portions of the record on which reliance has been made.

(1) *Real Party in Interest.* A statement identifying the real party in interest.

(2) *Related Appeals and Interferences.* A statement identifying by number and filing date all other appeals or interferences known to the respondent, the respondent's legal representative, or assignee (if any) which will directly affect or be directly affected by or have a bearing on the decision of the Board of Patent Appeals and Interferences in the pending appeal.

(3) *Status of claims.* A statement accepting or disputing appellant's statement of the status of claims. If appellant's statement of the status of claims is disputed, the errors in appellant's statement must be specified with particularity.

(4) *Status of amendments.* A statement accepting or disputing appellant's statement of the status of amendments. If appellant's statement of the status of amendments is disputed, the errors in appellant's statement must be specified with particularity.

(5) *Summary of invention.* A statement accepting or disputing appellant's summary of the invention or subject matter defined in the claims involved in the appeal. If appellant's summary of the invention or subject matter defined in the claims involved in the appeal is disputed, the errors in appellant's summary must be specified.

(6) *Issues.* A statement accepting or disputing appellant's statement of the issues presented for review. If appellant's statement of the issues presented for review is disputed, the errors in appellant's statement must be specified. A counter statement of the issues for review may be made. No new ground of rejection can be proposed by a third party requester respondent.

(7) *Argument.* A statement accepting or disputing the contentions of the appellant with each of the issues. If a contention of the appellant is disputed, the errors in appellant's argument must be specified, stating the basis therefor, with citations of the authorities, statutes, and parts of the record relied on. Each

issue should be treated under a separate heading. An argument may be made with each of the issues stated in the counter statement of the issues, with each counter-stated issue being treated under a separate heading. The provisions of § 1.965 (c)(8)(iii) and (iv) of these regulations shall apply to any argument raised under 35 U.S.C. 102 or § 103.

(8) *Certificate of Service.* A certification that a copy of the respondent brief has been served in its entirety on all other parties to the reexamination proceeding. The names and addresses of the parties served must be indicated.

(c) If a respondent's brief is filed which does not comply with all the requirements of paragraphs (a) and (b) of this section, respondent will be notified of the reasons for non-compliance and provided with a non-extendable period of one month within which to file an amended brief. If the respondent does not file an amended brief during the one-month period, or files an amended brief which does not overcome all the reasons for non-compliance stated in the notification, the respondent brief will not be considered.

[Added, 65 FR 76756, Dec. 7, 2000, effective Feb. 5, 2001; para. (c) revised, 68 FR 70996, Dec. 22, 2003, effective Jan. 21, 2004]

### § 1.969 Examiner's answer in *inter partes* reexamination

(a) The primary examiner in an *inter partes* reexamination appeal may, within such time as directed by the Director, furnish a written statement in answer to the patent owner's and/or third party requester's appellant brief or respondent brief including, as may be necessary, such explanation of the invention claimed and of the references, the grounds of rejection, and the reasons for patentability, including grounds for not adopting a proposed rejection. A copy of the answer shall be supplied to all parties to the reexamination proceeding. If the primary examiner finds that the appeal is not regular in form or does not relate to an appealable action, he or she shall so state.

(b) An examiner's answer may not include a new ground of rejection.

(c) An examiner's answer may not include a new determination not to make a proposed rejection of a claim.

(d) Any new ground of rejection, or any new determination not to make a proposed rejection, must be made in an Office action reopening prosecution.

[Added, 65 FR 76756, Dec. 7, 2000, effective Feb. 5, 2001; para. (a) revised, 68 FR 14332, Mar. 25, 2003, effective May 1, 2003]

**§ 1.971 Rebuttal brief in *inter partes* reexamination.**

(a) Within one month of the examiner's answer in an *inter partes* reexamination appeal, any appellant may once file a rebuttal brief in triplicate. The rebuttal brief of the patent owner may be directed to the examiner's answer and/or any respondent brief. The rebuttal brief of any third party requester may be directed to the examiner's answer and/or the respondent brief of the patent owner. The rebuttal brief of a third party requester may not be directed to the respondent brief of any other third party requester. No new ground of rejection may be proposed by a third party requester. The time for filing a rebuttal brief may not be extended. The rebuttal brief must include a certification that a copy of the rebuttal brief has been served in its entirety on all other parties to the reexamination proceeding. The names and addresses of the parties served must be indicated.

(b) If a rebuttal brief is filed which does not comply with all the requirements of paragraph (a) of this section, appellant will be notified of the reasons for non-compliance and provided with a non-extendable period of one month within which to file an amended rebuttal brief. If the appellant does not file an amended rebuttal brief during the one-month period, or files an amended rebuttal brief which does not overcome all the reasons for non-compliance stated in the notification, that appellant's rebuttal brief will not be considered.

[Added, 65 FR 76756, Dec. 7, 2000, effective Feb. 5, 2001; revised, 68 FR 70996, Dec. 22, 2003, effective Jan. 21, 2004]

**§ 1.973 Oral hearing in *inter partes* reexamination.**

(a) An oral hearing in an *inter partes* reexamination appeal should be requested only in those circumstances in which an appellant or a respondent

considers such a hearing necessary or desirable for a proper presentation of the appeal. An appeal decided without an oral hearing will receive the same consideration by the Board of Patent Appeals and Interferences as an appeal decided after oral hearing.

(b) If an appellant or a respondent desires an oral hearing, he or she must file a written request for such hearing accompanied by the fee set forth in § 1.17(d) within two months after the date of the examiner's answer. The time for requesting an oral hearing may not be extended.

(c) An oral argument may be presented at oral hearing by, or on behalf of, the primary examiner if considered desirable by either the primary examiner or the Board of Patent Appeals and Interferences.

(d) If an appellant or a respondent has requested an oral hearing and has submitted the fee set forth in § 1.17(d), a hearing date will be set, and notice given to all parties to the reexamination proceeding, as well as the primary examiner. The notice shall set a non-extendable period within which all requests for oral hearing shall be submitted by any other party to the appeal desiring to participate in the oral hearing. A hearing will be held as stated in the notice, and oral argument will be limited to thirty minutes for each appellant and respondent who has requested an oral hearing, and twenty minutes for the primary examiner unless otherwise ordered before the hearing begins. No appellant or respondent will be permitted to participate in an oral hearing unless he or she has requested an oral hearing and submitted the fee set forth in § 1.17(d).

(e) If no request and fee for oral hearing have been timely filed by an appellant or a respondent, the appeal will be assigned for consideration and decision on the written record.

[Added, 65 FR 76756, Dec. 7, 2000, effective Feb. 5, 2001]

**§ 1.975 Affidavits or declarations after appeal in *inter partes* reexamination.**

Affidavits, declarations, or exhibits submitted after the *inter partes* reexamination has been appealed will not be admitted without a showing of good and sufficient reasons why they were not earlier presented.

[Added, 65 FR 76756, Dec. 7, 2000, effective Feb. 5, 2001]



**§ 1.977 Decision by the Board of Patent Appeals and Interferences; remand to examiner in *inter partes* reexamination.**

(a) The Board of Patent Appeals and Interferences, in its decision, may affirm or reverse each decision of the examiner on all issues raised on each appealed claim, or remand the reexamination proceeding to the examiner for further consideration. The reversal of the examiner's determination not to make a rejection proposed by the third party requester constitutes a decision adverse to the patentability of the claims which are subject to that proposed rejection which will be set forth in the decision of the Board of Patent Appeals and Interferences as a new ground of rejection under paragraph (b) of this section. The affirmance of the rejection of a claim on any of the grounds specified constitutes a general affirmance of the decision of the examiner on that claim, except as to any ground specifically reversed.

(b) Should the Board of Patent Appeals and Interferences have knowledge of any grounds not raised in the appeal for rejecting any pending claim, it may include in the decision a statement to that effect with its reasons for so holding, which statement shall constitute a new ground of rejection of the claim. A decision which includes a new ground of rejection shall not be considered final for purposes of judicial review. When the Board of Patent Appeals and Interferences makes a new ground of rejection, the patent owner, within one month from the date of the decision, must exercise one of the following two options with respect to the new ground of rejection to avoid termination of the appeal proceeding as to the rejected claim:

(1) The patent owner may submit an appropriate amendment of the claim so rejected or a showing of facts relating to the claim, or both.

(2) The patent owner may file a request for rehearing of the decision of the Board of Patent Appeals and Interferences under § 1.979(a).

(c) Where the patent owner has responded under paragraph (b)(1) of this section, any third party requester, within one month of the date of service of the patent owner response, may once file comments on the response. Such written comments must be limited to the issues raised by the decision of the Board of Patent Appeals and Interferences and the patent owner's response. Any third party requester that had

not previously filed an appeal or cross appeal and is seeking under this subsection to file comments or a reply to the comments is subject to the appeal and brief fees under § 1.17(b) and (c), respectively, which must accompany the comments or reply.

(d) Following any response by the patent owner under paragraph (b)(1) of this section and any written comments from a third party requester under paragraph (c) of this section, the reexamination proceeding will be remanded to the examiner. The statement of the Board of Patent Appeals and Interferences shall be binding upon the examiner unless an amendment or showing of facts not previously of record be made which, in the opinion of the examiner, overcomes the new ground of rejection. The examiner will consider any response under paragraph (b)(1) of this section and any written comments by a third party requester under paragraph (c) of this section and issue a determination that the rejection should be maintained or has been overcome.

(e) Within one month of the examiner's determination pursuant to paragraph (d) of this section, the patent owner or any third party requester may once submit comments in response to the examiner's determination. Within one month of the date of service of comments in response to the examiner's determination, any party may file a reply to the comments. No third party requester reply may address the comments of any other third party requester reply. Any third party requester that had not previously filed an appeal or cross appeal and is seeking under this subsection to file comments or a reply to the comments is subject to the appeal and brief fees under § 1.17(b) and (c), respectively, which must accompany the comments or reply.

(f) After submission of any comments and any reply pursuant to paragraph (e) of this section, or after time has expired, the reexamination proceeding will be returned to the Board of Patent Appeals and Interferences which shall reconsider the matter and issue a new decision. The new decision will incorporate the earlier decision, except for those portions specifically withdrawn.

(g) The time period set forth in paragraph (b) of this section is subject to the extension of time provisions of § 1.956, when the patent owner is responding under paragraph (b)(1) of this section. The time period set forth in paragraph (b) of this section may

not be extended when the patent owner is responding under paragraph (b)(2) of this section. The time periods set forth in paragraphs (c) and (e) of this section may not be extended.

[Added, 65 FR 76756, Dec. 7, 2000, effective Feb. 5, 2001; para. (g) revised, 68 FR 70996, Dec. 22, 2003, effective Jan. 21, 2004]

**§ 1.979 Action following decision by the Board of Patent Appeals and Interferences or dismissal of appeal in *inter partes* reexamination.**

(a) Parties to the appeal may file a request for rehearing of the decision within one month of the date of:

- (1) The original decision of the Board of Patent Appeals and Interferences under § 1.977(a),
- (2) The original § 1.977(b) decision under the provisions of § 1.977(b)(2),
- (3) The expiration of the time for the patent owner to take action under § 1.977(b)(2), or
- (4) The new decision of the Board of Patent Appeals and Interferences under § 1.977(f).

(b) Within one month of the date of service of any request for rehearing under paragraph (a) of this section, or any further request for rehearing under paragraph (c) of this section, any party to the appeal may once file comments in opposition to the request for rehearing or the further request for rehearing. The comments in opposition must be limited to the issues raised in the request for rehearing or the further request for rehearing.

(c) If a party to an appeal files a request for rehearing under paragraph (a) of this section, or a further request for rehearing under this section, the Board of Patent Appeals and Interferences will issue a decision on rehearing. This decision is deemed to incorporate the earlier decision, except for those portions specifically withdrawn. If the decision on rehearing becomes, in effect, a new decision, and the Board of Patent Appeals and Interferences so states, then any party to the appeal may, within one month of the new decision, file a further request for rehearing of the new decision under this subsection.

(d) Any request for rehearing shall state the points believed to have been misapprehended or overlooked in rendering the decision and also state all other grounds upon which rehearing is sought.

(e) The parties to an appeal to the Board of Patent Appeals and Interferences may not appeal to the U.S. Court of Appeals for the Federal Circuit under § 1.983 until all parties rights to request rehearing have been exhausted, at which time the decision of the Board of Patent Appeals and Interferences is final and appealable by any party to an appeal to the Board of Patent Appeals and Interferences who is dissatisfied with the final decision of the Board of Patent Appeals and Interferences.

(f) An appeal to the Board of Patent Appeals and Interferences by a party is considered terminated by the dismissal of that party's appeal, the failure of the party to timely request rehearing under § 1.979(a) or (c), or the failure of the party to timely file an appeal to the U.S. Court of Appeals for the Federal Circuit under § 1.983. The date of such termination is the date on which the appeal is dismissed, the date on which the time for rehearing expires, or the date on which the time for the appeal to the U.S. Court of Appeals for the Federal Circuit expires. If an appeal to the U.S. Court of Appeals for the Federal Circuit has been filed, the appeal is considered terminated when the mandate is issued by the U.S. Court of Appeals for the Federal Circuit. Upon termination of an appeal, if no other appeal is present, the reexamination proceeding will be terminated and the Director will issue a certificate under § 1.997.

(g) The times for requesting rehearing under paragraph (a) of this section, for requesting further rehearing under paragraph (c) of this section, and for submitting comments under paragraph (b) of this section may not be extended.

[Added, 65 FR 76756, Dec. 7, 2000, effective Feb. 5, 2001; para. (f) revised, 68 FR 14332, Mar. 25, 2003, effective May 1, 2003; paras. (e) & (f) revised, 68 FR 70996, Dec. 22, 2003, effective Jan. 21, 2004]

**§ 1.981 Reopening after decision by the Board of Patent Appeals and Interferences in *inter partes* reexamination.**

Cases which have been decided by the Board of Patent Appeals and Interferences will not be reopened or reconsidered by the primary examiner except under the provisions of § 1.977 without the written authority of the Director, and then only for the consideration of matters not already adjudicated, sufficient cause being shown.

[Added, 65 FR 76756, Dec. 7, 2000, effective Feb. 5, 2001; revised, 68 FR 14332, Mar. 25, 2003, effective May 1, 2003]

### APPEAL TO THE UNITED STATES COURT OF APPEALS FOR THE FEDERAL CIRCUIT IN INTER PARTES REEXAMINATION

#### § 1.983 Appeal to the United States Court of Appeals for the Federal Circuit in inter partes reexamination.

(a) The patent owner or third party requester in an inter partes reexamination proceeding who is a party to an appeal to the Board of Patent Appeals and Interferences and who is dissatisfied with the decision of the Board of Patent Appeals and Interferences may, subject to § 1.979(e), appeal to the U.S. Court of Appeals for the Federal Circuit and may be a party to any appeal thereto taken from a reexamination decision of the Board of Patent Appeals and Interferences.

(b) The appellant must take the following steps in such an appeal:

(1) In the U.S. Patent and Trademark Office, timely file a written notice of appeal directed to the Director in accordance with §§ 1.302 and 1.304;

(2) In the U.S. Court of Appeals for the Federal Circuit, file a copy of the notice of appeal and pay the fee, as provided for in the rules of the U.S. Court of Appeals for the Federal Circuit; and

(3) Serve a copy of the notice of appeal on every other party in the reexamination proceeding in the manner provided in § 1.248.

(c) If the patent owner has filed a notice of appeal to the U.S. Court of Appeals for the Federal Circuit, the third party requester may cross appeal to the U.S. Court of Appeals for the Federal Circuit if also dissatisfied with the decision of the Board of Patent Appeals and Interferences.

(d) If the third party requester has filed a notice of appeal to the U.S. Court of Appeals for the Federal Circuit, the patent owner may cross appeal to the U.S. Court of Appeals for the Federal Circuit if also dissatisfied with the decision of the Board of Patent Appeals and Interferences.

(e) A party electing to participate in an appellant's appeal must, within fourteen days of service of the appellant's notice of appeal under paragraph (b) of this section, or notice of cross appeal under para-

graphs (c) or (d) of this section, take the following steps:

(1) In the U.S. Patent and Trademark Office, timely file a written notice directed to the Director electing to participate in the appellant's appeal to the U.S. Court of Appeals for the Federal Circuit by mail to, or hand service on, the General Counsel as provided in § 104.2;

(2) In the U.S. Court of Appeals for the Federal Circuit, file a copy of the notice electing to participate in accordance with the rules of the U.S. Court of Appeals for the Federal Circuit; and

(3) Serve a copy of the notice electing to participate on every other party in the reexamination proceeding in the manner provided in § 1.248.

(f) Notwithstanding any provision of the rules, in any reexamination proceeding commenced prior to November 2, 2002, the third party requester is precluded from appealing and cross appealing any decision of the Board of Patent Appeals and Interferences to the U.S. Court of Appeals for the Federal Circuit, and the third party requester is precluded from participating in any appeal taken by the patent owner to the U.S. Court of Appeals for the Federal Circuit.

[Added, 65 FR 76756, Dec. 7, 2000, effective Feb. 5, 2001; para. (a)(1) revised, 68 FR 14332, Mar. 25, 2003, effective May 1, 2003; revised, 68 FR 70996, Dec. 22, 2003, effective Jan. 21, 2004]

### CONCURRENT PROCEEDINGS INVOLVING SAME PATENT IN *INTER PARTES* REEXAMINATION

#### § 1.985 Notification of prior or concurrent proceedings in *inter partes* reexamination.

(a) In any *inter partes* reexamination proceeding, the patent owner shall call the attention of the Office to any prior or concurrent proceedings in which the patent is or was involved, including but not limited to interference, reissue, reexamination, or litigation and the results of such proceedings.

(b) Notwithstanding any provision of the rules, any person at any time may file a paper in an *inter partes* reexamination proceeding notifying the Office of a prior or concurrent proceedings in which the same patent is or was involved, including but not limited to interference, reissue, reexamination, or litigation and the results of such proceedings. Such

paper must be limited to merely providing notice of the other proceeding without discussion of issues of the current *inter partes* reexamination proceeding. Any paper not so limited will be returned to the sender.

[Added, 65 FR 76756, Dec. 7, 2000, effective Feb. 5, 2001]

**§ 1.987 Suspension of *inter partes* reexamination proceeding due to litigation.**

If a patent in the process of *inter partes* reexamination is or becomes involved in litigation, the Director shall determine whether or not to suspend the *inter partes* reexamination proceeding.

[Added, 65 FR 76756, Dec. 7, 2000, effective Feb. 5, 2001; revised, 68 FR 14332, Mar. 25, 2003, effective May 1, 2003]

**§ 1.989 Merger of concurrent reexamination proceedings.**

(a) If any reexamination is ordered while a prior *inter partes* reexamination proceeding is pending for the same patent and prosecution in the prior *inter partes* reexamination proceeding has not been terminated, a decision may be made to merge the two proceedings or to suspend one of the two proceedings. Where merger is ordered, the merged examination will normally result in the issuance of a single reexamination certificate under § 1.997.

(b) An *inter partes* reexamination proceeding filed under § 1.913 which is merged with an *ex parte* reexamination proceeding filed under § 1.510 will result in the merged proceeding being governed by §§ 1.902 through 1.997, except that the rights of any third party requester of the *ex parte* reexamination shall be governed by §§ 1.510 through 1.560.

[Added, 65 FR 76756, Dec. 7, 2000, effective Feb. 5, 2001]

**§ 1.991 Merger of concurrent reissue application and *inter partes* reexamination proceeding.**

If a reissue application and an *inter partes* reexamination proceeding on which an order pursuant to § 1.931 has been mailed are pending concurrently on a patent, a decision may be made to merge the two

proceedings or to suspend one of the two proceedings. Where merger of a reissue application and an *inter partes* reexamination proceeding is ordered, the merged proceeding will be conducted in accordance with §§ 1.171 through 1.179, and the patent owner will be required to place and maintain the same claims in the reissue application and the *inter partes* reexamination proceeding during the pendency of the merged proceeding. In a merged proceeding the third party requester may participate to the extent provided under §§ 1.902 through 1.997, except that such participation shall be limited to issues within the scope of *inter partes* reexamination. The examiner's actions and any responses by the patent owner or third party requester in a merged proceeding will apply to both the reissue application and the *inter partes* reexamination proceeding and be physically entered into both files. Any *inter partes* reexamination proceeding merged with a reissue application shall be terminated by the grant of the reissued patent.

[Added, 65 FR 76756, Dec. 7, 2000, effective Feb. 5, 2001]

**§ 1.993 Suspension of concurrent interference and *inter partes* reexamination proceeding.**

If a patent in the process of *inter partes* reexamination is or becomes involved in an interference, the Director may suspend the *inter partes* reexamination or the interference. The Director will not consider a request to suspend an interference unless a motion under § 1.635 to suspend the interference has been presented to, and denied by, an administrative patent judge and the request is filed within ten (10) days of a decision by an administrative patent judge denying the motion for suspension or such other time as the administrative patent judge may set.

[Added, 65 FR 76756, Dec. 7, 2000, effective Feb. 5, 2001; revised, 68 FR 14332, Mar. 25, 2003, effective May 1, 2003]

**§ 1.995 Third party requester's participation rights preserved in merged proceeding.**

When a third party requester is involved in one or more proceedings, including an *inter partes* reexamination proceeding, the merger of such proceedings will be accomplished so as to preserve the third party

requester's right to participate to the extent specifically provided for in these regulations. In merged proceedings involving different requesters, any paper filed by one party in the merged proceeding shall be served on all other parties of the merged proceeding.

[Added, 65 FR 76756, Dec. 7, 2000, effective Feb. 5, 2001]

### REEXAMINATION CERTIFICATE IN *INTER PARTES* REEXAMINATION

#### § 1.997 Issuance of *inter partes* reexamination certificate.

(a) Upon the conclusion of an *inter partes* reexamination proceeding, the Director will issue a certificate in accordance with 35 U.S.C. 316 setting forth the results of the *inter partes* reexamination proceeding and the content of the patent following the *inter partes* reexamination proceeding.

(b) A certificate will be issued in each patent in which an *inter partes* reexamination proceeding has been ordered under § 1.931. Any statutory disclaimer filed by the patent owner will be made part of the certificate.

(c) The certificate will be sent to the patent owner at the address as provided for in § 1.33(c). A copy of the certificate will also be sent to the third party requester of the *inter partes* reexamination proceeding.

(d) If a certificate has been issued which cancels all of the claims of the patent, no further Office proceedings will be conducted with that patent or any reissue applications or any reexamination requests relating thereto.

(e) If the *inter partes* reexamination proceeding is terminated by the grant of a reissued patent as provided in § 1.991, the reissued patent will constitute the reexamination certificate required by this section and 35 U.S.C. 316.

(f) A notice of the issuance of each certificate under this section will be published in the *Official Gazette*.

[Added, 65 FR 76756, Dec. 7, 2000, effective Feb. 5, 2001; para. (a) revised, 68 FR 14332, Mar. 25, 2003, effective May 1, 2003]

## PART 3 — ASSIGNMENT, RECORDING AND RIGHTS OF ASSIGNEE

Sec.

3.1 Definitions.

### DOCUMENTS ELIGIBLE FOR RECORDING

- 3.11 Documents which will be recorded.
- 3.16 Assignability of trademarks prior to filing an allegation of use.

### REQUIREMENTS FOR RECORDING

- 3.21 Identification of patents and patent applications.
- 3.24 Requirements for documents and cover sheets relating to patents and patent applications.
- 3.25 Recording requirements for trademark applications and registrations.
- 3.26 English language requirement.
- 3.27 Mailing address for submitting documents to be recorded.
- 3.28 Requests for recording.

### COVER SHEET REQUIREMENTS

- 3.31 Cover sheet content.
- 3.34 Correction of cover sheet errors.

### FEES

- 3.41 Recording fees.

### DATE AND EFFECT OF RECORDING

- 3.51 Recording date.
- 3.54 Effect of recording.
- 3.56 Conditional assignments.
- 3.58 Governmental registers.

### DOMESTIC REPRESENTATIVE

- 3.61 Domestic representative.

## ACTION TAKEN BY ASSIGNEE

- 3.71 Prosecution by assignee.  
 3.73 Establishing right of assignee to take action.

## ISSUANCE TO ASSIGNEE

- 3.81 Issue of patent to assignee.  
 3.85 Issue of registration to assignee.

**§ 3.1 Definitions.**

For purposes of this part, the following definitions shall apply:

*Application* means a national application for patent, an international application that designates the United States of America, or an application to register a trademark unless otherwise indicated.

*Assignment* means a transfer by a party of all or part of its right, title and interest in a patent or patent application, or a transfer of its entire right, title and interest in a registered mark or a mark for which an application to register has been filed.

*Document* means a document which a party requests to be recorded in the Office pursuant to § 3.11 and which affects some interest in an application, patent, or registration.

*Office* means the Patent and Trademark Office.

*Recorded document* means a document which has been recorded in the Office pursuant to § 3.11.

*Registration* means a trademark registration issued by the Office.

[Added, 57 FR 29634, July 6, 1992, effective Sept. 4, 1992]

## DOCUMENTS ELIGIBLE FOR RECORDING

**§ 3.11 Documents which will be recorded.**

(a) Assignments of applications, patents, and registrations, accompanied by completed cover sheets as specified in §§ 3.28 and 3.31, will be recorded in the Office. Other documents, accompanied by completed cover sheets as specified in §§ 3.28 and 3.31, affecting title to applications, patents, or registrations, will be recorded as provided in this part or at the discretion of the Director.

(b) Executive Order 9424 of February 18, 1944 (9 FR 1959, 3 CFR 1943-1948 Comp., p. 303) requires the several departments and other executive

agencies of the Government, including Government-owned or Government-controlled corporations, to forward promptly to the Director for recording all licenses, assignments, or other interests of the Government in or under patents or patent applications. Assignments and other documents affecting title to patents or patent applications and documents not affecting title to patents or patent applications required by Executive Order 9424 to be filed will be recorded as provided in this part.

[Added, 57 FR 29634, July 6, 1992, effective Sept. 4, 1992; revised, 62 FR 53131, Oct. 10, 1997, effective Dec. 1, 1997; revised, 68 FR 14332, Mar. 25, 2003, effective May 1, 2003]

**§ 3.16 Assignability of trademarks prior to filing an allegation of use.**

Before an allegation of use under either 15 U.S.C. 1051(c) or 15 U.S.C. 1051(d) is filed, an applicant may only assign an application to register a mark under 15 U.S.C. 1051(b) to a successor to the applicant's business, or portion of the business to which the mark pertains, if that business is ongoing and existing.

[Added, 57 FR 29634, July 6, 1992, effective Sept. 4, 1992; revised, 64 FR 48900, Sept. 8, 1999, effective Oct. 30, 1999]

## REQUIREMENTS FOR RECORDING

**§ 3.21 Identification of patents and patent applications.**

An assignment relating to a patent must identify the patent by the patent number. An assignment relating to a national patent application must identify the national patent application by the application number (consisting of the series code and the serial number, *e.g.*, 07/123,456). An assignment relating to an international patent application which designates the United States of America must identify the international application by the international application number (*e.g.*, PCT/US90/01234). If an assignment of a patent application filed under § 1.53(b) is executed concurrently with, or subsequent to, the execution of the patent application, but before the patent application is filed, it must identify the patent application by its date of execution, name of each inventor, and title of the invention so that there can be no mistake as to

the patent application intended. If an assignment of a provisional application under § 1.53(c) is executed before the provisional application is filed, it must identify the provisional application by name of each inventor and title of the invention so that there can be no mistake as to the provisional application intended.

[Added, 57 FR 29634, July 6, 1992, effective Sept. 4, 1992; amended, 60 FR 20195, Apr. 25, 1995, effective June 8, 1995; revised, 62 FR 53131, Oct. 10, 1997, effective Dec. 1, 1997]

### § 3.24 Requirements for documents and cover sheets relating to patents and patent applications.

The document and cover sheet must be legible. Either the original document or a true copy of the original document, may be submitted for recording. Only one side of each page shall be used. The paper used should be flexible, strong white, non-shiny, durable, and preferably no larger than 21.6 x 33.1 cm. (8 1/2 x 14 inches) with a 2.5 cm. (one-inch) margin on all sides.

[Added, 57 FR 29634, July 6, 1992, effective Sept. 4, 1992; heading revised, 64 FR 48900, Sept. 8, 1999, effective Oct. 30, 1999]

### § 3.25 Recording requirements for trademark applications and registrations.

(a) Documents affecting title. To record documents affecting title to a trademark application or registration, a legible cover sheet (see § 3.31) and one of the following must be submitted:

- (1) The original document;
- (2) A copy of the document;
- (3) A copy of an extract from the document evidencing the effect on title; or
- (4) A statement signed by both the party conveying the interest and the party receiving the interest explaining how the conveyance affects title.

(b) Name changes. Only a legible cover sheet is required (See § 3.31).

(c) All documents. All documents submitted to the Office should be on white and non-shiny paper that is no larger than 8 1/2 x 14 inches (21.6 x 33.1 cm.) with a one-inch (2.5 cm) margin on all sides. Only one side of each page should be used.

[Added, 64 FR 48900, Sept. 8, 1999, effective Oct. 30, 1999]

### § 3.26 English language requirement.

The Office will accept and record non-English language documents only if accompanied by an English translation signed by the individual making the translation.

[Added, 57 FR 29634, July 6, 1992, effective Sept. 4, 1992; revised, 62 FR 53131, Oct. 10, 1997, effective Dec. 1, 1997]

### § 3.27 Mailing address for submitting documents to be recorded.

Documents and cover sheets to be recorded should be addressed to Mail Stop Assignment Recordation Services, Director of the United States Patent and Trademark Office, P.O. Box 1450, Alexandria, Virginia 22313-1450, unless they are filed together with new applications or with a request under § 3.81.

[Added, 57 FR 29634, July 6, 1992, effective Sept. 4, 1992; revised, 62 FR 53131, Oct. 10, 1997, effective Dec. 1, 1997; revised, 65 FR 54604, Sept. 8, 2000, effective Nov. 7, 2000; revised, 68 FR 14332, Mar. 25, 2003, effective May 1, 2003]

### § 3.28 Requests for recording.

Each document submitted to the Office for recording must include at least one cover sheet as specified in § 3.31 referring either to those patent applications and patents, or to those trademark applications and registrations, against which the document is to be recorded. If a document to be recorded includes interests in, or transactions involving, both patents and trademarks, separate patent and trademark cover sheets should be submitted. Only one set of documents and cover sheets to be recorded should be filed. If a document to be recorded is not accompanied by a completed cover sheet, the document and the incomplete cover sheet will be returned pursuant to § 3.51 for proper completion. The document and a completed cover sheet should be resubmitted.

[Added, 57 FR 29634, July 6, 1992, effective Sept. 4, 1992; revised, 64 FR 48900, Sept. 8, 1999, effective Oct. 30, 1999]

## COVER SHEET REQUIREMENTS

**§ 3.31 Cover sheet content.**

(a) Each patent or trademark cover sheet required by § 3.28 must contain:

(1) The name of the party conveying the interest;

(2) The name and address of the party receiving the interest;

(3) A description of the interest conveyed or transaction to be recorded;

(4) Identification of the interests involved:

(i) For trademark assignments and trademark name changes: Each trademark registration number and each trademark application number, if known, against which the Office is to record the document. If the trademark application number is not known, a copy of the application or a reproduction of the trademark must be submitted, along with an estimate of the date that the Office received the application; or

(ii) For any other document affecting title to a trademark or patent application, registration or patent: Each trademark or patent application number or each trademark registration number or patent against which the document is to be recorded, or an indication that the document is filed together with a patent application;

(5) The name and address of the party to whom correspondence concerning the request to record the document should be mailed;

(6) The date the document was executed;

(7) The signature of the party submitting the document.

(b) A cover sheet should not refer to both patents and trademarks, since any information, including information about pending patent applications, submitted with a request for recordation of a document against a trademark application or trademark registration will become public record upon recordation.

(c) Each patent cover sheet required by § 3.28 seeking to record a governmental interest as provided by § 3.11(b) must:

(1) Indicate that the document is to be recorded on the Governmental Register, and, if applicable, that the document is to be recorded on the Secret Register (see § 3.58); and

(2) Indicate, if applicable, that the document to be recorded is not a document affecting title (see § 3.41(b)).

(d) Each trademark cover sheet required by § 3.28 seeking to record a document against a trademark application or registration should include, in addition to the serial number or registration number of the trademark, identification of the trademark or a description of the trademark, against which the Office is to record the document.

(e) Each patent or trademark cover sheet required by § 3.28 should contain the number of applications, patents or registrations identified in the cover sheet and the total fee.

[Added, 57 FR 29634, July 6, 1992, effective Sept. 4, 1992; para. (c) added, 62 FR 53131, Oct. 10, 1997, effective Dec. 1, 1997; paras. (a)-(b) revised, paras. (d)-(e) added, 64 FR 48900, Sept. 8, 1999, effective Oct. 30, 1999; para. (a)(7) deleted and para. (a)(8) redesignated as para. (a)(7), 67 FR 79520, Dec. 30, 2002, effective Dec. 30, 2002]

**§ 3.34 Correction of cover sheet errors.**

(a) An error in a cover sheet recorded pursuant to § 3.11 will be corrected only if:

(1) The error is apparent when the cover sheet is compared with the recorded document to which it pertains and

(2) A corrected cover sheet is filed for recordation.

(b) The corrected cover sheet must be accompanied by the originally recorded document or a copy of the originally recorded document and by the recording fee as set forth in § 3.41.

[Added, 57 FR 29634, July 6, 1992, effective Sept. 4, 1992]

## FEES

**§ 3.41 Recording fees.**

(a) All requests to record documents must be accompanied by the appropriate fee. Except as provided in paragraph (b) of this section, a fee is required for each application, patent and registration against which the document is recorded as identified in the cover sheet. The recording fee is set in § 1.21(h) of



this chapter for patents and in § 2.6(b)(6) of this chapter for trademarks.

(b) No fee is required for each patent application and patent against which a document required by Executive Order 9424 is to be filed if:

- (1) The document does not affect title and is so identified in the cover sheet (see § 3.31(c)(2)); and
- (2) The document and cover sheet are mailed to the Office in compliance with § 3.27(b).

[Added, 57 FR 29634, July 6, 1992, effective Sept. 4, 1992; revised, 62 FR 53131, Oct. 10, 1997, effective Dec. 1, 1997; para. (a) amended, 63 FR 48081, Sept. 9, 1998, effective October 9, 1998; para. (a) corrected, 63 FR 52158, Sept. 10, 1998]

## DATE AND EFFECT OF RECORDING

### § 3.51 Recording date.

The date of recording of a document is the date the document meeting the requirements for recording set forth in this part is filed in the Office. A document which does not comply with the identification requirements of § 3.21 will not be recorded. Documents not meeting the other requirements for recording, for example, a document submitted without a completed cover sheet or without the required fee, will be returned for correction to the sender where a correspondence address is available. The returned papers, stamped with the original date of receipt by the Office, will be accompanied by a letter which will indicate that if the returned papers are corrected and resubmitted to the Office within the time specified in the letter, the Office will consider the original date of filing of the papers as the date of recording of the document. The procedure set forth in § 1.8 or § 1.10 of this chapter may be used for resubmissions of returned papers to have the benefit of the date of deposit in the United States Postal Service. If the returned papers are not corrected and resubmitted within the specified period, the date of filing of the corrected papers will be considered to be the date of recording of the document. The specified period to resubmit the returned papers will not be extended.

[Added, 57 FR 29634, July 6, 1992, effective Sept. 4, 1992; revised, 62 FR 53131, Oct. 10, 1997, effective Dec. 1, 1997]

### § 3.54 Effect of recording.

The recording of a document pursuant to § 3.11 is not a determination by the Office of the validity of the document or the effect that document has on the title to an application, a patent, or a registration. When necessary, the Office will determine what effect a document has, including whether a party has the authority to take an action in a matter pending before the Office.

[Added, 57 FR 29634, July 6, 1992, effective Sept. 4, 1992]

### § 3.56 Conditional assignments.

Assignments which are made conditional on the performance of certain acts or events, such as the payment of money or other condition subsequent, if recorded in the Office, are regarded as absolute assignments for Office purposes until cancelled with the written consent of all parties or by the decree of a court of competent jurisdiction. The Office does not determine whether such conditions have been fulfilled.

[Added, 57 FR 29634, July 6, 1992, effective Sept. 4, 1992]

### § 3.58 Governmental registers.

(a) The Office will maintain a Departmental Register to record governmental interests required to be recorded by Executive Order 9424. This Departmental Register will not be open to public inspection but will be available for examination and inspection by duly authorized representatives of the Government. Governmental interests recorded on the Departmental Register will be available for public inspection as provided in § 1.12.

(b) The Office will maintain a Secret Register to record governmental interests required to be recorded by Executive Order 9424. Any instrument to be recorded will be placed on this Secret Register at the request of the department or agency submitting the same. No information will be given concerning any instrument in such record or register, and no examination or inspection thereof or of the index thereto will be permitted, except on the written authority of the head of the department or agency which submitted the instrument and requested secrecy, and the approval of such authority by the

Director. No instrument or record other than the one specified may be examined, and the examination must take place in the presence of a designated official of the Patent and Trademark Office. When the department or agency which submitted an instrument no longer requires secrecy with respect to that instrument, it must be recorded anew in the Departmental Register.

[Added, 62 FR 53131, Oct. 10, 1997, effective Dec. 1, 1997; para. (b) revised, 68 FR 14332, Mar. 25, 2003, effective May 1, 2003]

## DOMESTIC REPRESENTATIVE

### § 3.61 Domestic representative.

If the assignee of a patent, patent application, trademark application or trademark registration is not domiciled in the United States, the assignee may designate a domestic representative in a document filed in the United States Patent and Trademark Office. The designation should state the name and address of a person residing within the United States on whom may be served process or notice of proceedings affecting the application, patent or registration or rights thereunder.

[Added, 57 FR 29634, July 6, 1992, effective Sept. 4, 1992; revised, 67 FR 79520, Dec. 30, 2002, effective Dec. 30, 2002]

## ACTION TAKEN BY ASSIGNEE

### § 3.71 Prosecution by assignee.

(a) *Patents — conducting of prosecution.* One or more assignees as defined in paragraph (b) of this section may, after becoming of record pursuant to paragraph (c) of this section, conduct prosecution of a national patent application or a reexamination proceeding to the exclusion of either the inventive entity, or the assignee(s) previously entitled to conduct prosecution.

(b) *Patents — assignee(s) who can prosecute.* The assignee(s) who may conduct either the prosecution of a national application for patent or a reexamination proceeding are:

(1) *A single assignee.* An assignee of the entire right, title and interest in the application or patent being reexamined who is of record, or

(2) *Partial assignee(s) together or with inventor(s).* All partial assignees, or all partial assignees and inventors who have not assigned their right, title and interest in the application or patent being reexamined, who together own the entire right, title and interest in the application or patent being reexamined. A partial assignee is any assignee of record having less than the entire right, title and interest in the application or patent being reexamined.

(c) *Patents — Becoming of record.* An assignee becomes of record either in a national patent application or a reexamination proceeding by filing a statement in compliance with § 3.73(b) that is signed by a party who is authorized to act on behalf of the assignee.

(d) *Trademarks.* The assignee of a trademark application or registration may prosecute a trademark application, submit documents to maintain a trademark registration, or file papers against a third party in reliance on the assignee's trademark application or registration, to the exclusion of the original applicant or previous assignee. The assignee must establish ownership in compliance with § 3.73(b).

[Added, 57 FR 29634, July 6, 1992, effective Sept. 4, 1992; revised, 65 FR 54604, Sept. 8, 2000, effective Nov. 7, 2000]

### § 3.73 Establishing right of assignee to take action.

(a) The inventor is presumed to be the owner of a patent application, and any patent that may issue therefrom, unless there is an assignment. The original applicant is presumed to be the owner of a trademark application or registration, unless there is an assignment.

(b)(1) In order to request or take action in a patent or trademark matter, the assignee must establish its ownership of the patent or trademark property of paragraph (a) of this section to the satisfaction of the Director. The establishment of ownership by the assignee may be combined with the paper that requests or takes the action. Ownership is established by submitting to the Office a signed statement identifying the assignee, accompanied by either:

(i) Documentary evidence of a chain of title from the original owner to the assignee (*e.g.*, copy of an executed assignment). The documents submitted to establish ownership may be required to be

recorded pursuant to § 3.11 in the assignment records of the Office as a condition to permitting the assignee to take action in a matter pending before the Office; or

(ii) A statement specifying where documentary evidence of a chain of title from the original owner to the assignee is recorded in the assignment records of the Office (*e.g.*, reel and frame number).

(2) The submission establishing ownership must show that the person signing the submission is a person authorized to act on behalf of the assignee by:

(i) Including a statement that the person signing the submission is authorized to act on behalf of the assignee; or

(ii) Being signed by a person having apparent authority to sign on behalf of the assignee, *e.g.*, an officer of the assignee.

(c) For patent matters only:

(1) Establishment of ownership by the assignee must be submitted prior to, or at the same time as, the paper requesting or taking action is submitted.

(2) If the submission under this section is by an assignee of less than the entire right, title and interest, such assignee must indicate the extent (by percentage) of its ownership interest, or the Office may refuse to accept the submission as an establishment of ownership.

[Added, 57 FR 29634, July 6, 1992, effective Sept. 4, 1992; para. (b) revised, 62 FR 53131, Oct. 10, 1997, effective Dec. 1, 1997; revised, 65 FR 54604, Sept. 8, 2000, effective Nov. 7, 2000; para. (b)(1) revised, 68 FR 14332, Mar. 25, 2003, effective May 1, 2003]

## ISSUANCE TO ASSIGNEE

### § 3.81 Issue of patent to assignee.

(a) *With payment of the issue fee:* An application may issue in the name(s) of the assignee(s) consistent with the application's assignment where a request for such issuance is submitted with payment of the issue fee, provided the assignment has been previously recorded in the Office. If the assignment has not been previously recorded, the request should be accompanied by the assignment and either a direction to record the assignment in the Office pursuant to § 3.28, or a statement under § 3.73(b).

(b) *After payment of the issue fee:* An application may issue in the name(s) of the assignee(s) con-

sistent with the application's assignment where a request for such issuance along with the processing fee set forth in § 1.17(i) of this chapter is submitted after the date of payment of the issue fee, but prior to issuance of the patent, provided the assignment has been previously recorded in the Office. If the assignment has not been previously recorded, the request should be accompanied by the assignment and either a direction to record the assignment in the Office pursuant to § 3.28, or a statement under § 3.73(b).

(c) *Partial assignees.*

(1) If one or more assignee(s) together with one or more inventor(s) hold the entire right, title, and interest in the application, the patent may issue in the names of the assignee(s) and the inventor(s).

(2) If multiple assignees hold the entire right, title, and interest to the exclusion of all the inventors, the patent may issue in the names of the multiple assignees.

[Added, 57 FR 29634, July 6, 1992, effective Sept. 4, 1992; amended, 60 FR 20195, Apr. 25, 1995, effective June 8, 1995; revised, 65 FR 54604, Sept. 8, 2000, effective Nov. 7, 2000]

### § 3.85 Issue of registration to assignee.

The certificate of registration may be issued to the assignee of the applicant, or in a new name of the applicant, provided that the party files a written request in the trademark application by the time the application is being prepared for issuance of the certificate of registration, and the appropriate document is recorded in the Office. If the assignment or name change document has not been recorded in the Office, then the written request must state that the document has been filed for recordation. The address of the assignee must be made of record in the application file.

[Added, 57 FR 29634, July 6, 1992, effective Sept. 4, 1992]

## PART 4 — COMPLAINTS REGARDING INVENTION PROMOTERS

Sec.

4.1 Complaints Regarding Invention Promoters.

4.2 Definitions.

4.3 Submitting Complaints

- 4.4 Invention Promoter Reply.
- 4.5 Notice by Publication.
- 4.6 Attorneys and Agents

#### § 4.1 Complaints Regarding Invention Promoters.

These regulations govern the Patent and Trademark Office's (Office) responsibilities under the Inventors' Rights Act of 1999, which can be found in the U.S. Code at 35 U.S.C. 297. The Act requires the Office to provide a forum for the publication of complaints concerning invention promoters. The Office will not conduct any independent investigation of the invention promoter. Although the Act provides additional civil remedies for persons injured by invention promoters, those remedies must be pursued by the injured party without the involvement of the Office.

[Added, 65 FR 3127, Jan. 20, 2000, effective Jan. 28, 2000]

#### § 4.2 Definitions.

(a) *Invention Promoter* means any person, firm, partnership, corporation, or other entity who offers to perform or performs invention promotion services for, or on behalf of, a customer, and who holds itself out through advertising in any mass media as providing such services, but does not include—

- (1) Any department or agency of the Federal Government or of a State or local government;
- (2) Any nonprofit, charitable, scientific, or educational organization qualified under applicable State law or described under section 170(b)(1)(A) of the Internal Revenue Code of 1986;
- (3) Any person or entity involved in the evaluation to determine commercial potential of, or offering to license or sell, a utility patent or a previously filed nonprovisional utility patent application;
- (4) Any party participating in a transaction involving the sale of the stock or assets of a business; or
- (5) Any party who directly engages in the business of retail sales of products or the distribution of products.

(b) *Customer* means any individual who enters into a contract with an invention promoter for invention promotion services.

(c) *Contract for Invention Promotion Services* means a contract by which an invention promoter

undertakes invention promotion services for a customer.

(d) *Invention Promotion Services* means the procurement or attempted procurement for a customer of a firm, corporation, or other entity to develop and market products or services that include the invention of the customer.

[Added, 65 FR 3127, Jan. 20, 2000, effective Jan. 28, 2000]

#### § 4.3 Submitting Complaints.

(a) A person may submit a complaint concerning an invention promoter with the Office. A person submitting a complaint should understand that the complaint may be forwarded to the invention promoter and may become publicly available. The Office will not accept any complaint that requests that it be kept confidential.

(b) A complaint must be clearly marked, or otherwise identified, as a complaint under these rules. The complaint must include:

- (1) The name and address of the complainant;
- (2) The name and address of the invention promoter;
- (3) The name of the customer;
- (4) The invention promotion services offered or performed by the invention promoter;
- (5) The name of the mass media in which the invention promoter advertised providing such services;
- (6) An explanation of the relationship between the customer and the invention promoter, and
- (7) A signature of the complainant.

(c) The complaint should fairly summarize the action of the invention promoter about which the person complains. Additionally, the complaint should include names and addresses of persons believed to be associated with the invention promoter. Complaints, and any replies, must be addressed to: Mail Stop 24, Commissioner for Patents, P.O. Box 1450, Alexandria, Virginia 22313-1450.

(d) Complaints that do not provide the information requested in paragraphs (b) and (c) of this section will be returned. If complainant's address is not provided, the complaint will be destroyed.

(e) No originals of documents should be included with the complaint.

(f) A complaint can be withdrawn by the complainant or the named customer at any time prior to its publication.

[Para. (c) revised, 68 FR 14332, Mar. 25, 2003, effective May 1, 2003]

**§ 4.4 Invention Promoter Reply.**

(a) If a submission appears to meet the requirements of a complaint, the invention promoter named in the complaint will be notified of the complaint and given 30 days to respond. The invention promoter’s response will be made available to the public along with the complaint. If the invention promoter fails to reply within the 30-day time period set by the Office, the complaint will be made available to the public. Replies sent after the complaint is made available to the public will also be published.

(b) A response must be clearly marked, or otherwise identified, as a response by an invention promoter. The response must contain:

- (1) The name and address of the invention promoter;
- (2) A reference to a complaint forwarded to the invention promoter or a complaint previously published;
- (3) The name of the individual signing the response; and
- (4) The title or authority of the individual signing the response.

[Added, 65 FR 3127, Jan. 20, 2000, effective Jan. 28, 2000]

**§ 4.5 Notice by Publication.**

If the copy of the complaint that is mailed to the invention promoter is returned undelivered, then the Office will publish a Notice of Complaint Received in the *Official Gazette*, the Federal Register, or on the Office’s Internet home page. The invention promoter will be given 30 days from such notice to submit a reply to the complaint. If the Office does not receive a reply from the invention promoter within 30 days, the complaint alone will become publicly available.

[Added, 65 FR 3127, Jan. 20, 2000, effective Jan. 28, 2000]

**§ 4.6 Attorneys and Agents.**

Complaints against registered patent attorneys and agents will not be treated under this section, unless a complaint fairly demonstrates that invention promotion services are involved. Persons having complaints about registered patent attorneys or agents should contact the Office of Enrollment and Discipline at Mail Stop OED, Director of the United States Patent and Trademark Office, PO Box 1450, Alexandria, Virginia 22313-1450, and the attorney discipline section of the attorney’s state licensing bar if an attorney is involved.

[Added, 65 FR 3127, Jan. 20, 2000, effective Jan. 28, 2000; revised, 68 FR 14332, Mar. 25, 2003, effective May 1, 2003]

**PART 5 — SECRECY OF CERTAIN INVENTIONS AND LICENSES TO EXPORT AND FILE APPLICATIONS IN FOREIGN COUNTRIES**

**SECRECY**

- Sec.
- 5.1 Applications and correspondence involving national security.
- 5.2 Secrecy order.
- 5.3 Prosecution of application under secrecy orders; withholding patent.
- 5.4 Petition for rescission of secrecy order.
- 5.5 Permit to disclose or modification of secrecy order.
- 5.6 [Reserved]
- 5.7 [Reserved]
- 5.8 [Reserved]

**LICENSES FOR FOREIGN EXPORTING AND FILING**

- 5.11 License for filing in a foreign country an application on an invention made in the United States or for transmitting international application.
- 5.12 Petition for license.
- 5.13 Petition for license; no corresponding application.
- 5.14 Petition for license; corresponding U.S. application.
- 5.15 Scope of license.
- 5.16 [Reserved]
- 5.17 [Reserved]

- 5.18 Arms, ammunition, and implements of war.
- 5.19 Export of technical data.
- 5.20 Export of technical data relating to sensitive nuclear technology.
- 5.25 Petition for retroactive license.

#### GENERAL

- 5.31 [Reserved]
- 5.32 Reserved]
- 5.33 [Reserved]

#### SECURITY

### § 5.1 Applications and correspondence involving national security.

(a) All correspondence in connection with this part, including petitions, should be addressed to: Commissioner for Patents (Attention Licensing and Review), P.O. Box 1450, Alexandria, Virginia 22313-1450.

(b) Application as used in this part includes provisional applications filed under 35 U.S.C. 111(b) (§ 1.9(a)(2) of this chapter), nonprovisional applications filed under 35 U.S.C. 111(a) or entering the national stage from an international application after compliance with 35 U.S.C. 371 (§ 1.9(a)(3)), or international applications filed under the Patent Cooperation Treaty prior to entering the national stage of processing (§ 1.9(b)).

(c) Patent applications and documents relating thereto that are national security classified (see § 1.9(i) of this chapter) and contain authorized national security markings (*e.g.*, “Confidential,” “Secret” or “Top Secret”) are accepted by the Office. National security classified documents filed in the Office must be either hand-carried to Licensing and Review or mailed to the Office in compliance with paragraph (a) of this section.

(d) The applicant in a national security classified patent application must obtain a secrecy order pursuant to § 5.2(a). If a national security classified patent application is filed without a notification pursuant to § 5.2(a), the Office will set a time period within which either the application must be declassified, or the application must be placed under a secrecy order pursuant to § 5.2(a), or the applicant must submit evidence of a good faith effort to obtain a secrecy order pursuant to § 5.2(a) from the relevant depart-

ment or agency in order to prevent abandonment of the application. If evidence of a good faith effort to obtain a secrecy order pursuant to § 5.2(a) from the relevant department or agency is submitted by the applicant within the time period set by the Office, but the application has not been declassified or placed under a secrecy order pursuant to § 5.2(a), the Office will again set a time period within which either the application must be declassified, or the application must be placed under a secrecy order pursuant to § 5.2(a), or the applicant must submit evidence of a good faith effort to again obtain a secrecy order pursuant to § 5.2(a) from the relevant department or agency in order to prevent abandonment of the application.

(e) An application will not be published under § 1.211 of this chapter or allowed under § 1.311 of this chapter if publication or disclosure of the application would be detrimental to national security. An application under national security review will not be published at least until six months from its filing date or three months from the date the application was referred to a defense agency, whichever is later. A national security classified patent application will not be published under § 1.211 of this chapter or allowed under § 1.311 of this chapter until the application is declassified and any secrecy order under § 5.2(a) has been rescinded.

(f) Applications on inventions made outside the United States and on inventions in which a U.S. Government defense agency has a property interest will not be made available to defense agencies.

[43 FR 20470, May 11, 1978; revised, 62 FR 53131, Oct. 10, 1997, effective Dec. 1, 1997; revised, 65 FR 54604, Sept. 8, 2000, effective Nov. 7, 2000; para. (e) revised, 65 FR 57024, Sept. 20, 2000, effective Nov. 29, 2000; para. (a) revised, 68 FR 14332, Mar. 25, 2003, effective May 1, 2003]

### § 5.2 Secrecy order.

(a) When notified by the chief officer of a defense agency that publication or disclosure of the invention by the granting of a patent would be detrimental to the national security, an order that the invention be kept secret will be issued by the Commissioner for Patents.

(b) Any request for compensation as provided in 35 U.S.C. 183 must not be made to the Patent and

Trademark Office, but directly to the department or agency which caused the secrecy order to be issued.

(c) An application disclosing any significant part of the subject matter of an application under a secrecy order pursuant to paragraph (a) of this section also falls within the scope of such secrecy order. Any such application that is pending before the Office must be promptly brought to the attention of Licensing and Review, unless such application is itself under a secrecy order pursuant to paragraph (a) of this section. Any subsequently filed application containing any significant part of the subject matter of an application under a secrecy order pursuant to paragraph (a) of this section must either be hand-carried to Licensing and Review or mailed to the Office in compliance with § 5.1(a).

[24 FR 10381, Dec. 22, 1959; para. (b) revised, paras. (c) and (d) removed, 62 FR 53131, Oct. 10, 1997, effective Dec. 1, 1997; para. (c) added, 65 FR 54604, Sept. 8, 2000, effective Nov. 7, 2000; para. (a) revised, 68 FR 14332, Mar. 25, 2003, effective May 1, 2003]

### § 5.3 Prosecution of application under secrecy orders; withholding patent.

Unless specifically ordered otherwise, action on the application by the Office and prosecution by the applicant will proceed during the time an application is under secrecy order to the point indicated in this section:

(a) National applications under secrecy order which come to a final rejection must be appealed or otherwise prosecuted to avoid abandonment. Appeals in such cases must be completed by the applicant but unless otherwise specifically ordered by the Commissioner for Patents will not be set for hearing until the secrecy order is removed.

(b) An interference will not be declared involving national applications under secrecy order. However, if an applicant whose application is under secrecy order seeks to provoke an interference with an issued patent, a notice of that fact will be placed in the file wrapper of the patent. (See § 1.607(d)).

(c) When the national application is found to be in condition for allowance except for the secrecy order the applicant and the agency which caused the secrecy order to be issued will be notified. This notice (which is not a notice of allowance under § 1.311 of

this chapter) does not require reply by the applicant and places the national application in a condition of suspension until the secrecy order is removed. When the secrecy order is removed the Patent and Trademark Office will issue a notice of allowance under § 1.311 of this chapter, or take such other action as may then be warranted.

(d) International applications under secrecy order will not be mailed, delivered, or otherwise transmitted to the international authorities or the applicant. International applications under secrecy order will be processed up to the point where, if it were not for the secrecy order, record and search copies would be transmitted to the international authorities or the applicant.

[43 FR 20470, May 11, 1978; amended 43 FR 28479, June 30, 1978; para. (b) amended 53 FR 23736, June 23, 1988, effective Sept. 12, 1988; para. (c) revised, 62 FR 53131, Oct. 10, 1997, effective Dec. 1, 1997; para. (a) revised, 68 FR 14332, Mar. 25, 2003, effective May 1, 2003]

### § 5.4 Petition for rescission of secrecy order.

(a) A petition for rescission or removal of a secrecy order may be filed by, or on behalf of, any principal affected thereby. Such petition may be in letter form, and it must be in duplicate.

(b) The petition must recite any and all facts that purport to render the order ineffectual or futile if this is the basis of the petition. When prior publications or patents are alleged the petition must give complete data as to such publications or patents and should be accompanied by copies thereof.

(c) The petition must identify any contract between the Government and any of the principals under which the subject matter of the application or any significant part thereof was developed or to which the subject matter is otherwise related. If there is no such contract, the petition must so state.

(d) Appeal to the Secretary of Commerce, as provided by 35 U.S.C. 181, from a secrecy order cannot be taken until after a petition for rescission of the secrecy order has been made and denied. Appeal must be taken within sixty days from the date of the denial, and the party appealing, as well as the department or agency which caused the order to be issued, will be notified of the time and place of hearing.

[24 FR 10381, Dec. 22, 1959; paras. (a) and (d) revised, 62 FR 53131, Oct. 10, 1997, effective Dec. 1, 1997]

### § 5.5 Permit to disclose or modification of secrecy order.

(a) Consent to disclosure, or to the filing of an application abroad, as provided in 35 U.S.C. 182, shall be made by a “permit” or “modification” of the secrecy order.

(b) Petitions for a permit or modification must fully recite the reason or purpose for the proposed disclosure. Where any proposed disclosure is known to be cleared by a defense agency to receive classified information, adequate explanation of such clearance should be made in the petition including the name of the agency or department granting the clearance and the date and degree thereof. The petition must be filed in duplicate.

(c) In a petition for modification of a secrecy order to permit filing abroad, all countries in which it is proposed to file must be made known, as well as all attorneys, agents and others to whom the material will be consigned prior to being lodged in the foreign patent office. The petition should include a statement vouching for the loyalty and integrity of the proposed disclosees and where their clearance status in this or the foreign country is known all details should be given.

(d) Consent to the disclosure of subject matter from one application under secrecy order may be deemed to be consent to the disclosure of common subject matter in other applications under secrecy order so long as the subject matter is not taken out of context in a manner disclosing material beyond the modification granted in the first application.

(e) Organizations requiring consent for disclosure of applications under secrecy order to persons or organizations in connection with repeated routine operation may petition for such consent in the form of a general permit. To be successful such petitions must ordinarily recite the security clearance status of the disclosees as sufficient for the highest classification of material that may be involved.

[24 FR 10381, Dec. 22, 1959; paras. (b) and (e) revised, 62 FR 53131, Oct. 10, 1997, effective Dec. 1, 1997]

### § 5.6 [Reserved]

[Removed and reserved, 62 FR 53131, Oct. 10, 1997, effective Dec. 1, 1997]

### § 5.7 [Reserved]

[Removed and reserved, 62 FR 53131, Oct. 10, 1997, effective Dec. 1, 1997]

### § 5.8 [Reserved]

[Removed and reserved, 62 FR 53131, Oct. 10, 1997, effective Dec. 1, 1997]

## LICENSES FOR FOREIGN EXPORTING AND FILING

### § 5.11 License for filing in a foreign country an application on an invention made in the United States or for transmitting international application.

(a) A license from the Commissioner for Patents under 35 U.S.C. 184 is required before filing any application for patent including any modifications, amendments, or supplements thereto or divisions thereof or for the registration of a utility model, industrial design, or model, in a foreign patent office or any foreign patent agency or any international agency other than the United States Receiving Office, if the invention was made in the United States and:

(1) An application on the invention has been filed in the United States less than six months prior to the date on which the application is to be filed, or

(2) No application on the invention has been filed in the United States.

(b) The license from the Commissioner for Patents referred to in paragraph (a) would also authorize the export of technical data abroad for purposes relating to the preparation, filing or possible filing and prosecution of a foreign patent application without separately complying with the regulations contained in 22 CFR parts 121 through 130 (International Traffic in Arms Regulations of the Department of State), 15 CFR part 779 (Regulations of the Office of Export Administration, International Trade Administration, Department of Commerce) and 10 CFR part 810 (Foreign Atomic Energy Programs of the Department of Energy).



(c) Where technical data in the form of a patent application, or in any form, is being exported for purposes related to the preparation, filing or possible filing and prosecution of a foreign patent application, without the license from the Commissioner for Patents referred to in paragraphs (a) or (b) of this section, or on an invention not made in the United States, the export regulations contained in 22 CFR parts 120 through 130 (International Traffic in Arms Regulations of the Department of State), 15 CFR parts 768-799 (Export Administration Regulations of the Department of Commerce) and 10 CFR part 810 (Assistance to Foreign Atomic Energy Activities Regulations of the Department of Energy) must be complied with unless a license is not required because a United States application was on file at the time of export for at least six months without a secrecy order under § 5.2 being placed thereon. The term “exported” means export as it is defined in 22 CFR part 120, 15 CFR part 779 and activities covered by 10 CFR part 810.

(d) If a secrecy order has been issued under § 5.2, an application cannot be exported to, or filed in, a foreign country (including an international agency in a foreign country), except in accordance with § 5.5.

(e) No license pursuant to paragraph (a) of this section is required:

(1) If the invention was not made in the United States, or

(2) If the corresponding United States application is not subject to a secrecy order under § 5.2, and was filed at least six months prior to the date on which the application is filed in a foreign country, or

(3) For subsequent modifications, amendments and supplements containing additional subject matter to, or divisions of, a foreign patent application if:

(i) A license is not, or was not, required under paragraph (e)(2) of this section for the foreign patent application;

(ii) The corresponding United States application was not required to be made available for inspection under 35 U.S.C. 181; and

(iii) Such modifications, amendments, and supplements do not, or did not, change the general nature of the invention in a manner which would require any corresponding United States application

to be or have been available for inspection under 35 U.S.C. 181.

(f) A license pursuant to paragraph (a) of this section can be revoked at any time upon written notification by the Patent and Trademark Office. An authorization to file a foreign patent application resulting from the passage of six months from the date of filing of a United States patent application may be revoked by the imposition of a secrecy order.

[49 FR 13461, Apr. 4, 1984; paras. (a) and (e), 56 FR 1924, Jan. 18, 1991, effective Feb. 19, 1991; paras. (b), (c), and (e)(3) revised, 62 FR 53131, Oct. 10, 1997, effective Dec. 1, 1997; paras. (a)-(c) revised, 68 FR 14332, Mar. 25, 2003, effective May 1, 2003]

### § 5.12 Petition for license.

(a) Filing of an application for patent for inventions made in the United States will be considered to include a petition for license under 35 U.S.C. 184 for the subject matter of the application. The filing receipt will indicate if a license is granted. If the initial automatic petition is not granted, a subsequent petition may be filed under paragraph (b) of this section.

(b) A petition for license must include the fee set forth in § 1.17(h) of this chapter, the petitioner’s address, and full instructions for delivery of the requested license when it is to be delivered to other than the petitioner. The petition should be presented in letter form.

[48 FR 2714, Jan. 20, 1983; amended 49 FR 13462, Apr. 4, 1984; para. (b) revised, 62 FR 53131, Oct. 10, 1997, effective Dec. 1, 1997; para. (b) revised, 65 FR 54604, Sept. 8, 2000, effective Nov. 7, 2000]

### § 5.13 Petition for license; no corresponding application.

If no corresponding national or international application has been filed in the United States, the petition for license under § 5.12(b) must also be accompanied by a legible copy of the material upon which a license is desired. This copy will be retained as a measure of the license granted.

[43 FR 20471, May 11, 1978; 49 FR 13462, Apr. 4, 1984; revised, 62 FR 53131, Oct. 10, 1997, effective Dec. 1, 1997]

**§ 5.14 Petition for license; corresponding U.S. application.**

(a) When there is a corresponding United States application on file, a petition for license under § 5.12(b) must also identify this application by application number, filing date, inventor, and title, but a copy of the material upon which the license is desired is not required. The subject matter licensed will be measured by the disclosure of the United States application.

(b) Two or more United States applications should not be referred to in the same petition for license unless they are to be combined in the foreign or international application, in which event the petition should so state and the identification of each United States application should be in separate paragraphs.

(c) Where the application to be filed or exported abroad contains matter not disclosed in the United States application or applications, including the case where the combining of two or more United States applications introduces subject matter not disclosed in any of them, a copy of the application as it is to be filed in the foreign country or international application which is to be transmitted to a foreign international or national agency for filing in the Receiving Office, must be furnished with the petition. If however, all new matter in the foreign or international application to be filed is readily identifiable, the new matter may be submitted in detail and the remainder by reference to the pertinent United States application or applications.

[43 FR 20471, May 11, 1978; 49 FR 13462, Apr. 4, 1984; para. (a) revised, 62 FR 53131, Oct. 10, 1997, effective Dec. 1, 1997]

**§ 5.15 Scope of license.**

(a) Applications or other materials reviewed pursuant to §§ 5.12 through 5.14, which were not required to be made available for inspection by defense agencies under 35 U.S.C. 181, will be eligible for a license of the scope provided in this paragraph. This license permits subsequent modifications, amendments, and supplements containing additional subject matter to, or divisions of, a foreign patent application, if such changes to the application do not alter the general nature of the invention in a manner which would require the United States application to

have been made available for inspection under 35 U.S.C. 181. Grant of this license authorizing the export and filing of an application in a foreign country or the transmitting of an international application to any foreign patent agency or international patent agency when the subject matter of the foreign or international application corresponds to that of the domestic application. This license includes authority:

(1) To export and file all duplicate and formal application papers in foreign countries or with international agencies;

(2) To make amendments, modifications, and supplements, including divisions, changes or supporting matter consisting of the illustration, exemplification, comparison, or explanation of subject matter disclosed in the application; and

(3) To take any action in the prosecution of the foreign or international application provided that the adding of subject matter or taking of any action under paragraphs (a)(1) or (2) of this section does not change the general nature of the invention disclosed in the application in a manner which would require such application to have been made available for inspection under 35 U.S.C. 181 by including technical data pertaining to:

(i) Defense services or articles designated in the United States Munitions List applicable at the time of foreign filing, the unlicensed exportation of which is prohibited pursuant to the Arms Export Control Act, as amended, and 22 CFR parts 121 through 130; or

(ii) Restricted Data, sensitive nuclear technology or technology useful in the production or utilization of special nuclear material or atomic energy, dissemination of which is subject to restrictions of the Atomic Energy Act of 1954, as amended, and the Nuclear Non-Proliferation Act of 1978, as implemented by the regulations for Unclassified Activities in Foreign Atomic Energy Programs, 10 CFR part 810, in effect at the time of foreign filing.

(b) Applications or other materials which were required to be made available for inspection under 35 U.S.C. 181 will be eligible for a license of the scope provided in this paragraph. Grant of this license authorizes the export and filing of an application in a foreign country or the transmitting of an international application to any foreign patent agency or international patent agency. Further, this license includes

authority to export and file all duplicate and formal papers in foreign countries or with foreign and international patent agencies and to make amendments, modifications, and supplements to, file divisions of, and take any action in the prosecution of the foreign or international application, provided subject matter additional to that covered by the license is not involved.

(c) A license granted under § 5.12(b) pursuant to § 5.13 or § 5.14 shall have the scope indicated in paragraph (a) of this section, if it is so specified in the license. A petition, accompanied by the required fee (§ 1.17(h)), may also be filed to change a license having the scope indicated in paragraph (b) of this section to a license having the scope indicated in paragraph (a) of this section. No such petition will be granted if the copy of the material filed pursuant to § 5.13 or any corresponding United States application was required to be made available for inspection under 35 U.S.C. 181. The change in the scope of a license will be effective as of the date of the grant of the petition.

(d) In those cases in which no license is required to file the foreign application or transmit the international application, no license is required to file papers in connection with the prosecution of the foreign or international application not involving the disclosure of additional subject matter.

(e) Any paper filed abroad or transmitted to an international patent agency following the filing of a foreign or international application which changes the general nature of the subject matter disclosed at the time of filing in a manner which would require such application to have been made available for inspection under 35 U.S.C. 181 or which involves the disclosure of subject matter listed in paragraphs (a)(3)(i) or (ii) of this section must be separately licensed in the same manner as a foreign or international application. Further, if no license has been granted under § 5.12(a) on filing the corresponding United States application, any paper filed abroad or with an international patent agency which involves the disclosure of additional subject matter must be licensed in the same manner as a foreign or international application.

(f) Licenses separately granted in connection with two or more United States applications may be exercised by combining or dividing the disclosures, as desired, provided:

(1) Subject matter which changes the general nature of the subject matter disclosed at the time of filing or which involves subject matter listed in paragraphs (a)(3) (i) or (ii) of this section is not introduced and,

(2) In the case where at least one of the licenses was obtained under § 5.12(b), additional subject matter is not introduced.

(g) A license does not apply to acts done before the license was granted. See § 5.25 for petitions for retroactive licenses.

[49 FR 13462, Apr. 4, 1984; paras. (a) - (c), (e) and (f), 56 FR 1924, Jan. 18, 1991, effective Feb. 19, 1991; paras. (a)-(c) and (e) revised, 62 FR 53131, Oct. 10, 1997, effective Dec. 1, 1997]

#### § 5.16 [Reserved]

[Removed and reserved, 62 FR 53131, Oct. 10, 1997, effective Dec. 1, 1997]

#### § 5.17 [Reserved]

[49 FR 13463, Apr. 4, 1984; removed and reserved, 62 FR 53131, Oct. 10, 1997, effective Dec. 1, 1997]

#### § 5.18 Arms, ammunition, and implements of war.

(a) The exportation of technical data relating to arms, ammunition, and implements of war generally is subject to the International Traffic in Arms Regulations of the Department of State (22 CFR parts 120 through 130); the articles designated as arms, ammunitions, and implements of war are enumerated in the U.S. Munitions List (22 CFR part 121). However, if a patent applicant complies with regulations issued by the Commissioner for Patents under 35 U.S.C. 184, no separate approval from the Department of State is required unless the applicant seeks to export technical data exceeding that used to support a patent application in a foreign country. This exemption from Department of State regulations is applicable regardless of whether a license from the Commissioner for Patents is required by the provisions of §§ 5.11 and 5.12 (22 CFR part 125).

(b) When a patent application containing subject matter on the Munitions List (22 CFR part 121) is subject to a secrecy order under § 5.2 and a petition is

made under § 5.5 for a modification of the secrecy order to permit filing abroad, a separate request to the Department of State for authority to export classified information is not required (22 CFR part 125).

[35 FR 6430., Apr. 22, 1970; revised, 62 FR 53131, Oct. 10, 1997, effective Dec. 1, 1997; para. (a) revised, 68 FR 14332, Mar. 25, 2003, effective May 1, 2003]

### § 5.19 Export of technical data.

(a) Under regulations (15 CFR 770.10(j)) established by the Department of Commerce, a license is not required in any case to file a patent application or part thereof in a foreign country if the foreign filing is in accordance with the regulations (§§ 5.11 through 5.25) of the Patent and Trademark Office.

(b) An export license is not required for data contained in a patent application prepared wholly from foreign-origin technical data where such application is being sent to the foreign inventor to be executed and returned to the United States for subsequent filing in the U.S. Patent and Trademark Office (15 CFR 779A.3(e)).

[45 FR 72654, Nov. 3, 1980; para. (a) revised, 58 FR 54504, Oct. 22, 1993, effective Jan. 3, 1994; revised, 62 FR 53131, Oct. 10, 1997, effective Dec. 1, 1997]

### § 5.20 Export of technical data relating to sensitive nuclear technology.

Under regulations (10 CFR 810.7) established by the United States Department of Energy, an application filed in accordance with the regulations (§§ 5.11 through 5.25) of the Patent and Trademark Office and eligible for foreign filing under 35 U.S.C. 184, is considered to be information available to the public in published form and a generally authorized activity for the purposes of the Department of Energy regulations.

[49 FR 13463, Apr. 4, 1984; revised, 62 FR 53131, Oct. 10, 1997, effective Dec. 1, 1997]

### § 5.25 Petition for retroactive license.

(a) A petition for retroactive license under 35 U.S.C. 184 shall be presented in accordance with § 5.13 or § 5.14(a), and shall include:

- (1) A listing of each of the foreign countries in which the unlicensed patent application material was filed,
- (2) The dates on which the material was filed in each country,
- (3) A verified statement (oath or declaration) containing:
  - (i) An averment that the subject matter in question was not under a secrecy order at the time it was filed abroad, and that it is not currently under a secrecy order,
  - (ii) A showing that the license has been diligently sought after discovery of the proscribed foreign filing, and
  - (iii) An explanation of why the material was filed abroad through error and without deceptive intent without the required license under § 5.11 first having been obtained, and
- (4) The required fee (§ 1.17(h)).

The above explanation must include a showing of facts rather than a mere allegation of action through error and without deceptive intent. The showing of facts as to the nature of the error should include statements by those persons having personal knowledge of the acts regarding filing in a foreign country and should be accompanied by copies of any necessary supporting documents such as letters of transmittal or instructions for filing. The acts which are alleged to constitute error without deceptive intent should cover the period leading up to and including each of the proscribed foreign filings.

(b) If a petition for a retroactive license is denied, a time period of not less than thirty days shall be set, during which the petition may be renewed. Failure to renew the petition within the set time period will result in a final denial of the petition. A final denial of a petition stands unless a petition is filed under § 1.181 within two months of the date of the denial. If the petition for a retroactive license is denied with respect to the invention of a pending application and no petition under § 1.181 has been filed, a final rejection of the application under 35 U.S.C. 185 will be made.

[49 FR 13463, Apr. 4, 1984; para. (a), 56 FR 1924, Jan. 18, 1991, effective Feb. 19, 1991; para. (c) removed, 62 FR 53131, Oct. 10, 1997, effective Dec. 1, 1997]

§ 5.31

MANUAL OF PATENT EXAMINING PROCEDURE

GENERAL

[24 FR 10381, Dec. 22, 1959; Redesignated at 49 FR 13463, Apr. 4, 1984; removed and reserved, 62 FR 53131, Oct. 10, 1997, effective Dec. 1, 1997]

§ 5.31 [Reserved]

[24 FR 10381, Dec. 22, 1959; Redesignated at 49 FR 13463, Apr. 4, 1984; removed and reserved, 62 FR 53131, Oct. 10, 1997, effective Dec. 1, 1997]

§ 5.32 [Reserved]

§ 5.33 [Reserved]

[49 FR 13463, Apr. 4, 1984; amended, 61 FR 56439, Nov. 1, 1996, effective Dec. 2, 1996; removed and reserved, 62 FR 53131, Oct. 10, 1997, effective Dec. 1, 1997]

**Index I – RULES RELATING TO PATENTS**

**A**

Abandoned applications:

- Abandonment by failure to reply . . . . . 1.135
- Abandonment during interference . . . . . 1.662(a)
- Abandonment for failure to pay issue fee . . . . . 1.316
- Express abandonment . . . . . 1.138
- Processing and retention fee . . . . . 1.21(1)
- Referred to in issued patents . . . . . 1.14
- Revival of . . . . . 1.137
- When open to public inspection . . . . . 1.14

Abandonment of application. (See Abandoned applications.)

- Abstract of the disclosure . . . . . 1.72, 1.77, 1.163
- Access to pending applications (limited) . . . . . 1.14
- Action by applicant . . . . . 1.111 - 1.138

Addresses for correspondence with the

- United States Patent and Trademark Office . . . . . 1.1
- Board of Patent Appeals and Interferences . . 1.1(a)(1)
- Deposit account replenishment . . . . . 1.25(c)(3), 1.25(c)(4)

Director of the United States Patent and

- Trademark Office . . . . . 1.1(a)
- FOIA Officer . . . . . 102.1(b), 102.4(a)
- Generally . . . . . 1.1(a)
- Licensing and Review . . . . . 5.1(a)
- Office of the General Counsel . . . . . 1.1(a)(3), 102.10(b), 102.29(b)

Office of the Solicitor . . . . . 1.1(a)(3),

Mail Stops

- Mail Stop 4 . . . . . 150.6
- Mail Stop 8 . . . . . 1.1(a)(3)
- Mail Stop 24 . . . . . 4.3(c)
- Mail Stop Assignment Recordation Services . . . . . 1.1(a)(4), 3.27
- Mail Stop CPA . . . . . 1.53(d)(9)
- Mail Stop Document Services . . . . . 1.1(a)(4)
- Mail Stop *Ex parte* Reexam . . . . . 1.1(c)(1)
- Mail Stop *Inter partes* Reexam . . . . . 1.1(c)(2)
- Mail Stop Interference . . . . . 1.1(a)
- Mail Stop M Correspondence . . . . . 1.1(d)(2)
- Mail Stop OED . . . . . 4.6
- Mail Stop Patent Ext . . . . . 1.1(e)
- Mail Stop PCT . . . 1.1(b), 1.417, 1.434(a), 1.480(b)
- Mail Stop Provisional Patent Application . . . 1.1(f)

- Maintenance fee payments . . . . . 1.1(d)(1)
- Patent correspondence . . . . . 1.1(a)(1)
- Privacy Officer . . . . . 102.23(a), 102.24(a)
- Trademark correspondence . . . . . 2.190

Adjustment of patent term. (see Patent term adjustment.)

Administrator or executor, may make application and receive patent. . . . . 1.42, 1.64

Admission to practice. (See Attorneys and agents.)

Affidavit (See also Oath in patent application):

- After appeal . . . . . 1.195
- To disqualify commonly owned patent or published application as prior art . . . . . 1.130
- Traversing rejections or objections . . . . . 1.132

Agents. (See Attorneys and agents.)

Allowance and issue of patent:

- Amendment after allowance . . . . . 1.312
- Application abandoned for nonpayment of issue fee . . . . . 1.316
- Deferral of issuance . . . . . 1.314
- Delayed payment of issue fee . . . . . 1.137
- Delivery of patent . . . . . 1.315
- Issuance of patent . . . . . 1.314
- Notice of allowance . . . . . 1.311
- Patent to issue upon payment of issue fee . 1.311, 1.314
- Patent to lapse if issue fee is not paid in full . . . 1.317
- Reasons for . . . . . 1.104
- Withdrawal from issue . . . . . 1.313

Allowed claims, rejection of by Board of

- Patent Appeals and Interferences . . . . . 1.196

Amendment:

- Adding or substituting claims . . . . . 1.121
- After appeal . . . . . 1.116
- After decision on appeal, based on new rejection of Board of Patent Appeals and Interferences . . . . . 1.196
- After final action . . . . . 1.116
- After final action (transitional procedures) . . . . 1.129
- After notice of allowance . . . . . 1.312
- Copying claim of another application for interference . . . . . 1.603
- Copying claim of issued patent . . . . . 1.606, 1.607
- Deletions and insertions . . . . . 1.121
- Drawings . . . . . 1.121
- Manner of making . . . . . 1.121
- Not covered by original oath . . . . . 1.67
- Numbering of claims . . . . . 1.126
- Of amendments . . . . . 1.121
- Of claims . . . . . 1.121
- Of disclosure . . . . . 1.121
- Of drawing . . . . . 1.121
- Of specification . . . . . 1.121
- Paper and writing . . . . . 1.52
- Petition from refusal to admit . . . . . 1.127
- Preliminary . . . . . 1.115
- Proposed during interference . . . . . 1.615
- Provisional application . . . . . 1.53(c)

Reexamination proceedings . . .	1.121(j), 1.530, 1.941	Correspondence address . . . . .	1.33
Reissue . . . . .	1.121(i), 1.173	Daytime telephone number . . . . .	1.33
Requisites of . . . . .	1.33, 1.111, 1.116, 1.121, 1.125	Deceased or insane inventor . . . . .	1.42, 1.43
Right to amend . . . . .	1.111, 1.116, 1.127	Executor or administrator . . . . .	1.42
Signature to . . . . .	1.33	In a continued prosecution application . . .	1.53(b)(1), 1.53(d)(4)
Substitute specification . . . . .	1.125	In an international application . . . . .	1.421-1.425
Time for . . . . .	1.134	Informed of application number . . . . .	1.54
To accompany motion to amend interference . .	1.633	Inventorship in a provisional application .	1.41(a)(2)
To applications in interference . . . . .	1.633	Mailing address and residence of inventors may be provided in oath/declaration or in application data sheet . . . . .	1.63, 1.76
To correct inaccuracies . . . . .	1.121	May be represented by an attorney or agent . . . .	1.31
To correspond to original drawing or specifica- tion . . . . .	1.121	Person making oath or declaration . . . . .	1.64
To preliminary statement in interference . . . . .	1.628	Personal attendance unnecessary . . . . .	1.2
To reissues . . . . .	1.173	Required to conduct business with decorum and courtesy . . . . .	1.3
To save from abandonment . . . . .	1.135	Required to report assistance received . . . . .	1.4
Amino acid sequences. (See Nucleotide and/or amino acid sequences.)		Who may apply for a patent . . . . .	1.41-1.48
Appeals:		Application Data sheet . . . . .	1.76
Civil Actions under 35 U.S.C. 145, 146, 306 . .	1.303, 1.304	Application for patent (See also Abandoned appli- cations, Claims, Drawing, Examination of application, Provisional applications, Publica- tion of application, Published application, Reis- sues, Specification):	
To the Board of Patent Appeals and Interfer- ences:		Access to . . . . .	1.14
Action following decision . . . . .	1.197	Acknowledgment of filing . . . . .	1.54
Affidavits after appeal . . . . .	1.195	Alteration after execution . . . . .	1.52
Brief . . . . .	1.192	Alteration before execution . . . . .	1.52
Clarification of the record . . . . .	1.196	Application number and filing date . . . . .	1.54
Decision by Board . . . . .	1.196	Arrangement . . . . .	1.77
Examiner's answer . . . . .	1.193	Compact disc submissions (see Electronic documents)	
Fees . . . . .	1.17	Confidentiality of applications . . . . .	1.14
Hearing of . . . . .	1.194	Continuation or division, reexecution not required . . . . .	1.63
New grounds for refusing a patent . . . . .	1.196	Continued prosecution application . . . . .	1.53(d)
Notice of appeal . . . . .	1.191	Filed by facsimile . . . . .	1.6, 1.8
Public inspection or publication of decisions . .	1.14	Copies of, furnished to applicants . . . . .	1.59
Rehearing . . . . .	1.196, 1.197	Cross-references to related applications . . . . .	1.78
Reinstatement of appeal . . . . .	1.193	Deceased or insane inventor . . . . .	1.42, 1.43
Rejection by Board . . . . .	1.196	Declaration . . . . .	1.68
Reopening after decision . . . . .	1.198	Duty of disclosure . . . . .	1.56
Reopening of prosecution after appeal . . . . .	1.193	Examined only when complete . . . . .	1.53
Reply brief . . . . .	1.193	Filed by other than inventor . . . . .	1.42, 1.43, 1.47, 1.64, 1.421(b)
What may be appealed . . . . .	1.191	Filing date . . . . .	1.53
Who may appeal . . . . .	1.191	Filing requirements . . . . .	1.53
To Court of Appeals for the Federal Circuit:		Foreign language oath or declaration . . . . .	1.69
Fee provided by rules of court . . . . .	1.301	Formulas and tables . . . . .	1.58
From Board of Patent Appeals and Interfer- ences . . . . .	1.301	General requisites . . . . .	1.51
Notice and reasons of appeal . . . . .	1.302	Identification required in letters concerning . . . . .	1.5
Time for filing notice of appeal . . . . .	1.302, 1.304		
Applicant for patent:			
Actual inventor or inventors to make applica- tion for patent . . . . .	1.41, 1.45		
Assignee . . . . .	1.47(b)		
Change of (see Correction of inventorship)			

- Incomplete papers not filed for examination . . . . 1.53
- Interlineations, etc., to be indicated . . . . . 1.52
- Involving national security . . . . . 5.1
- Language, paper, writing, margin . . . . . 1.52
- Later filing of oath and filing fee . . . . . 1.53
- Missing pages when application filed . . . . . 1.53(e)
- Must be made by actual inventor, with excep-  
tions . . . . . 1.41, 1.46, 1.47
- Naming of inventors:
- Application data sheet . . . . . 1.76(b)(1)
- In a continued prosecution application . . . . . 1.53(d)(4)
- In a provisional application . . . . . 1.41(a)(2), 1.51(c)(1),  
    1.53(c)(1)
- In an international application . . . . . 1.421
- National stage . . . . . 1.497
- Inconsistencies between application data  
    sheet and oath or declaration . . . . . 1.76(d)
- Joint inventors . . . . . 1.45
- Oath/declaration . . . . . 1.63(a)(2)
- Non-English language . . . . . 1.52
- Nonpublication request . . . . . 1.213
- Numbering of claims . . . . . 1.126
- Numbering of paragraphs . . . . . 1.52, 1.125
- Original disclosure not expunged . . . . . 1.59(a)(2)
- Parts filed separately . . . . . 1.54
- Parts of application desirably filed together . . . . . 1.54
- Parts of complete application . . . . . 1.51
- Processing fees . . . . . 1.17
- Provisional application . . . . . 1.9, 1.51, 1.53
- Publication of . . . . . 1.211, 1.219
- Published . . . . . 1.9, 1.215
- Relating to atomic energy . . . . . 1.14
- Reservation for future application not permit-  
ted . . . . . 1.79
- Retention fee . . . . . 1.53(f)
- Secrecy order . . . . . 5.1-5.5
- Status information . . . . . 1.14
- Tables and formulas . . . . . 1.58
- To contain but one invention unless connected. . . . . 1.141
- To whom made . . . . . 1.51
- Two or more by same party with conflicting  
claims. . . . . 1.78
- Application number . . . . . 1.5(a), 1.53, 1.54
- Arbitration award filing . . . . . 1.335
- Arbitration in interference . . . . . 1.690
- Assignee:
- Correspondence held with assignee(s) of entire  
    interest . . . . . 3.71, 3.73
- Establishing ownership . . . . . 3.73(b)
- May conduct prosecution of application . . . . . 3.71, 3.73
- May make application on behalf of inven-  
    tor(s) . . . . . 1.47(b)
- May take action in interference . . . . . 1.643
- Must consent to application for reissue of  
    patent . . . . . 1.171, 1.172
- Partial assignee(s) . . . . . 1.46, 3.71, 3.73, 3.81
- Assignments and recording:
- Abstracts of title, fee for . . . . . 1.19(b)
- Conditional assignments . . . . . 3.56
- Cover sheet required . . . . . 3.28, 3.31
- Corrections . . . . . 3.34
- Date of receipt is date of record . . . . . 3.51
- Definitions . . . . . 1.332
- Effect of recording . . . . . 3.54
- Fees . . . . . 1.21(h)
- Formal requirements . . . . . 3.21-3.28
- If recorded before payment of issue fee, patent  
    may issue to assignee . . . . . 3.81
- Mailing address for submitting  
    documents . . . . . 1.1(a)(4), 3.27
- Must be recorded in Patent and Trademark  
    Office to issue patent to assignee . . . . . 3.81
- Must identify patent or application . . . . . 3.21
- Orders for copies of . . . . . 1.12
- Patent may issue to assignee . . . . . 3.81
- Recording of assignments . . . . . 3.11
- Records open to public inspection . . . . . 1.12
- Requirements for recording . . . . . 3.21-3.41
- What will be accepted for recording . . . . . 3.11
- Atomic energy applications reported to Depart-  
ment of Energy . . . . . 1.14
- Attorneys and agents:
- Acting in representative capacity . . . . . 1.33, 1.34
- Assignment will not operate as a revocation of  
    power . . . . . 1.36
- Associate . . . . . 1.34
- Certificate of good standing . . . . . 1.21(a)
- Complaints . . . . . 4.6
- Fee on admission . . . . . 1.21(a)
- Office cannot aid in selection of . . . . . 1.31
- Personal interviews with examiners . . . . . 1.133
- Power of attorney or authorization of agent . . . . . 1.34
- Power to inspect . . . . . 1.14
- Representative capacity . . . . . 1.33, 1.34
- Representing conflicting parties . . . . . 1.613
- Required to conduct business with decorum  
    and courtesy . . . . . 1.3
- Revocation of power . . . . . 1.36
- Signature and certificate of attorney . . . . . 1.4, 10.18
- Withdrawal of . . . . . 1.36, 1.613(d)
- Authorization of agents. (See Attorneys and  
agents.)
- Award in arbitration . . . . . 1.335



**B**

Balance in deposit account . . . . . 1.25  
 Basic filing fee. . . . . 1.16  
 Benefit of earlier application. . . . . 1.78  
 Bill in equity. (See Civil action.)  
 Biological material. (See Deposit of biological material.)  
 Board of Patent Appeals and Interferences. (See Appeal to Board of Patent Appeals and Interferences.)  
 Briefs:  
     At final hearing in interference . . . . . 1.656  
     In petitions to Director. . . . . 1.181  
     On appeal to Board . . . . . 1.192  
 Business to be conducted with decorum and courtesy . . . . . 1.3  
 Business to be transacted in writing . . . . . 1.2

**C**

Certificate of correction. . . . . 1.322, 1.323  
     Fees . . . . . 1.20  
     Mistakes not corrected. . . . . 1.325  
 Certificate of mailing (First Class) or transmission . . 1.8  
 Certification effect of signature. . . . . 1.4(d), 10.18  
 Certified copies of records, papers, etc. . . . . 1.4(f), 1.13  
     Fee for certification . . . . . 1.19(b)  
 Chemical and mathematical formulae and tables . . 1.58  
 Citation of prior art in patented file. . . . . 1.501  
 Citation of references. . . . . 1.104  
 Civil action . . . . . 1.303, 1.304  
 Claims (See also Examination of applications):  
     Amendment of . . . . . 1.121  
     Commence on separate sheet or electronic page . . . . . 1.52(b)  
     Conflicting, same applicant or owner . . . . . 1.78  
     Date of invention of. . . . . 1.110  
     Dependent . . . . . 1.75  
     Design patent . . . . . 1.153  
     May be in dependent form. . . . . 1.75  
     More than one permitted . . . . . 1.75  
     Multiple dependent . . . . . 1.75  
     Must conform to invention and specification . . 1.75  
     Notice of rejection of. . . . . 1.104  
     Numbering of. . . . . 1.126  
     Part of complete application . . . . . 1.51  
     Plant patent. . . . . 1.164  
     Rejection of . . . . . 1.104  
     Required. . . . . 1.75  
     Separate from other parts of application . . . . 1.75(h)  
     Twice or finally rejected before appeal . . . . . 1.191  
 Color drawing . . . . . 1.84(a)(2)

Commissioner of Patents and Trademarks (See Director of the USPTO.)  
 Common ownership, statement by assignee may be required. . . . . 1.78(c)  
 Compact disc submissions. (See Electronic documents.)  
 Complaints against examiners, how presented. . . . . 1.3  
 Complaints regarding invention promoters (See Invention promoters.)  
 Composition of matter, specimens of ingredients may be required. . . . . 1.93  
 Computer program listing appendix . . . . . 1.96  
 Concurrent office proceedings . . . . . 1.565  
 Conflicting claims, same applicant or owner in two or more applications. . . . . 1.78  
 Continued examination, request for . . . . . 1.114  
     Fee. . . . . 1.17  
     Suspension of action after . . . . . 1.103  
 Continued prosecution application . . . . . 1.53(d)  
     Suspension of action in . . . . . 1.103  
 Continuing application for invention disclosed and claimed in prior application . . . . . 1.53, 1.63  
 Control number, display of. . . . . 1.419  
 Copies of patents, published applications, records, etc. . . . . 1.11, 1.12, 1.13  
 Copies of records, fees . . . . . 1.19(b), 1.59  
 Copyright notice in specification . . . . . 1.71(d)  
 Copyright notice on drawings . . . . . 1.84(s)  
 Correction, certificate of. . . . . 1.322, 1.323  
 Correction of inventorship:  
     In a nonprovisional application . . . . . 1.48  
         Before filing oath/declaration . . 1.41(a)(1), 1.76(c)  
         By filing oath/declaration . . . . . 1.76(d)(3)  
         When filing a continuation or divisional application . . . . . 1.63(d)  
         When filing a continued prosecution application . . . . . 1.53(d)(4)  
     In a provisional application . . . . . 1.48  
         By filing a cover sheet . . . . . 1.48(f)(2)  
         Without filing a cover sheet . . . . . 1.41(a)(2)  
     In a reexamination proceeding . . . . . 1.530  
     In an international application . . . . . 1.472  
         When entering the national stage . . . . . 1.497  
     In an issued patent . . . . . 1.324  
     In other than a reissue application . . . . . 1.48  
 Inconsistencies between application data sheet and oath or declaration . . . . . 1.76(d)  
 Motion to correct inventorship in an interference . . . . . 1.634  
 Supplemental application data sheet(s) . . . . . 1.76(c)

Correspondence:  
 Address:  
     Change of correspondence address . . . . . 1.33(a)  
     Established by the office if more than one is  
     specified . . . . . 1.33(a)  
     Of the U.S. Patent and Trademark Office . . . . . 1.1  
 Business with the Office to be transacted by . . . . . 1.2  
 Discourteous communications not entered . . . . . 1.3  
 Double, with different parties in interest not  
 allowed . . . . . 1.33  
 Duplicate copies of . . . . . 1.4  
 Facsimile transmission . . . . . 1.6(d)  
 Held with attorney or agent . . . . . 1.33  
 Identification of application or patent in letter  
 relating to . . . . . 1.5  
 Involving national security . . . . . 5.1  
 May be held exclusively with assignee(s) of  
 entire interest . . . . . 3.71  
 Nature of . . . . . 1.4  
 Patent owners in reexamination . . . . . 1.33(c)  
 Receipt of letters and papers . . . . . 1.6  
 Rules for conducting in general . . . . . 1.1-1.8  
 Separate letter for each subject of inquiry . . . . . 1.4  
 Signature requirement . . . . . 1.4(d)  
 When no attorney or agent . . . . . 1.33  
 With attorney or agent after power or authori-  
 zation is filed . . . . . 1.33  
 Court of Appeals for the Federal Circuit, appeal  
 to. (See Appeal to Court of Appeals for the Fed-  
 eral Circuit.)  
 Credit card payment . . . . . 1.23  
 Cross-reference to related applications . . . . . 1.76-1.78

**D**

Date of invention of subject matter of individual  
 claims . . . . . 1.110  
 Day for taking any action or paying any fee falling  
 on Saturday, Sunday, or Federal holiday . . . . . 1.7  
 Death or insanity of inventor . . . . . 1.42, 1.43  
     In an international application . . . . . 1.422, 1.423  
 Decision by the Board of Patent Appeals and  
 Interferences . . . . . 1.196  
     Action following decision . . . . . 1.197  
 Declaration (See also Oath in patent application):  
     Foreign language . . . . . 1.69  
     In lieu of oath . . . . . 1.68  
     In patent application . . . . . 1.68  
 Deferral of examination . . . . . 1.103  
 Definitions:  
     Federal holiday within the District of  
     Columbia . . . . . 1.9  
     National and international applications . . . . . 1.9

National security classified . . . . . 1.9  
 Nonprofit organization . . . . . 1.27  
 Person (for small entity purposes) . . . . . 1.27  
 Published application . . . . . 1.9  
 Service of process . . . . . 15 CFR Part 15  
 Small business concern . . . . . 1.27  
 Small entity . . . . . 1.27  
 Terms under Patent Cooperation Treaty . . . . . 1.401  
 Testimony by employees . . . . . 15 CFR Part 15a  
 Delivery of patent . . . . . 1.315  
 Deposit accounts . . . . . 1.25  
     Fees . . . . . 1.21(b)  
 Deposit of biological material:  
     Acceptable depository . . . . . 1.803  
     Biological material . . . . . 1.801  
     Examination procedures . . . . . 1.809  
     Furnishing of samples . . . . . 1.808  
     Need or opportunity to make a deposit . . . . . 1.802  
     Replacement or supplemental deposit . . . . . 1.805  
     Term of deposit . . . . . 1.806  
     Time of making original deposit . . . . . 1.804  
     Viability of deposit . . . . . 1.807  
 Deposit of computer program listings . . . . . 1.52(e), 1.96  
 Depositions (See also Testimony in interferences):  
     Certificate of officer to accompany . . . . . 1.676  
     Formalities to be observed in preparing . . . . . 1.677  
     Person before whom taken . . . . . 1.674  
     To be sealed up, addressed, and forwarded to  
     the Office . . . . . 1.676  
     When transcript must be filed . . . . . 1.678  
 Description of invention. (See Specification.)  
 Design Patent Applications:  
     Arrangement of application elements . . . . . 1.154  
     Claim . . . . . 1.153  
     Drawing . . . . . 1.152  
     Expedited examination . . . . . 1.155  
     Filing fee . . . . . 1.16(f)  
     Issue fee . . . . . 1.18(b)  
     Oath . . . . . 1.153  
     Rules applicable . . . . . 1.151  
     Title, description and claim . . . . . 1.153  
 Determination of request for *ex parte*  
 reexamination . . . . . 1.515  
 Director of the USPTO (See also Petition to the  
 Director):  
     Address of . . . . . 1.1  
     Availability of decisions by . . . . . 1.14  
     Cases decided by Board reopened only by . . . . . 1.198  
     Initiates *ex parte* reexamination . . . . . 1.520  
 Disclaimer, statutory:  
     During interference . . . . . 1.662(a)  
     Fee . . . . . 1.20(d)

Requirements of . . . . . 1.321  
 Terminal . . . . . 1.321  
 Disclosure, amendments to add new matter not permitted . . . . . 1.121  
 Disclosure document fee . . . . . 1.21(c)  
 Discovery in interferences . . . . 1.672-1.679, 1.685, 1.687  
 Division. (See Restriction of application.)  
 Document supply fees . . . . . 1.19  
 Drawing:  
   Amendment of . . . . . 1.121  
   Arrangement of views . . . . . 1.84(i)  
   Arrows . . . . . 1.84(r)  
   Character of lines . . . . . 1.84(l)  
   Color . . . . . 1.84(a)(2), 1.165(b)  
   Content of drawing . . . . . 1.83  
   Copyright notice . . . . . 1.84(s)  
   Correction . . . . . 1.84(w), 1.85(c), 1.121  
   Cost of copies of . . . . . 1.19  
   Design application . . . . . 1.152  
   Figure for front page . . . . . 1.76, 1.84(j)  
   Filed with application . . . . . 1.81  
   Graphics . . . . . 1.84(d)  
   Hatching and shading . . . . . 1.84(m)  
   Holes . . . . . 1.84(x)  
   Identification . . . . . 1.84(c)  
   If of an improvement, must show connection with old structure . . . . . 1.83  
   Informal drawings . . . . . 1.85  
   Ink . . . . . 1.84(a)(1)  
   Lead lines . . . . . 1.84(q)  
   Legends . . . . . 1.84(o)  
   Letters . . . . . 1.84(p)  
   Location of names . . . . . 1.84(c)  
   Mask work notice . . . . . 1.84(s)  
   Must be described in and referred to specification . . . . . 1.74  
   Must show every feature of the invention . . . . . 1.83  
   No return or release . . . . . 1.85(b)  
   Numbering of sheets . . . . . 1.84(t)  
   Numbering of views . . . . . 1.84(u)  
   Numbers . . . . . 1.84(p)  
   Original should be retained by applicant . . . . 1.81(a)  
   Paper . . . . . 1.84(e)  
   Part of application papers . . . . . 1.52  
   Photographs . . . . . 1.84(b)  
   Plant patent application . . . . . 1.81, 1.165  
   Reference characters . . . . . 1.74, 1.84(p)  
   Reissue . . . . . 1.173  
   Release not permitted . . . . . 1.85(b)  
   Required by law when necessary for understanding . . . . . 1.81  
   Scale . . . . . 1.84(k)

Security markings . . . . . 1.84(v)  
 Shading . . . . . 1.84(m)  
 Size of sheet and margins . . . . . 1.84(f),(g)  
 Standards for drawings . . . . . 1.84  
 Symbols . . . . . 1.84(n)  
 Views . . . . . 1.84(h)  
   When necessary, part of complete application . . 1.51  
 Duty of disclosure . . . . . 1.56, 1.555  
   Patent term extension . . . . . 1.765

**E**

Election of species . . . . . 1.146  
 Electronic documents:  
   Compact disc submissions:  
     Amino acid sequences . . . . . 1.821, 1.823, 1.825  
     Computer program listings . . . . . 1.96  
     Incorporation by reference in specification . . 1.52  
     Nucleic acid sequences . . . . . 1.821, 1.823, 1.825  
     Requirements . . . . . 1.52  
     Submitted as part of permanent record . . . 1.52, 1.58, 1.96, 1.821, 1.823, 1.825  
     Tables . . . . . 1.58  
   Employee testimony. (See Testimony by Office employees.)  
   Establishing small entity status . . . . . 1.27, 1.28  
   Evidence. (See Testimony in interferences.)  
   *Ex parte* reexamination. (See Reexamination.)  
   Examination of applications:  
     Advancement of examination . . . . . 1.102  
     As to form . . . . . 1.104  
     Citation of references . . . . . 1.104  
     Completeness of examiner's action . . . . . 1.104  
     Deferral of . . . . . 1.103  
     Examiner's action . . . . . 1.104  
     International-type search . . . . . 1.104  
     Nature of examination . . . . . 1.104  
     Reasons for allowance . . . . . 1.104  
     Reconsideration after rejection if requested . . 1.111  
     Reissue . . . . . 1.176  
     Rejection of claims . . . . . 1.104  
     Request for continued examination . . . . . 1.114  
     Requirements for information by examiner . . 1.105  
     Suspension of . . . . . 1.103  
   Examiners:  
     Answers on appeal . . . . . 1.193  
     Complaints against . . . . . 1.3  
     Interviews with . . . . . 1.133  
   Executors . . . . . 1.42  
   Exhibits. (See Models and exhibits.)  
   Export of technical data . . . . . 5.19, 5.20  
   Express abandonment . . . . . 1.138  
   "Express Mail" . . . . . 1.6, 1.10

Date of receipt of . . . . .	1.6
Petition in regard to . . . . .	1.10
Expungement. . . . .	1.59
Extension of patent term (See also Patent term adjustment):	
Due to examination delay under the URAA (35 U.S.C. 154) . . . . .	1.701
Due to regulatory review period (35 U.S.C. 156):	
Applicant for . . . . .	1.730
Application for . . . . .	1.740
Calculation of term:	
Animal drug product. . . . .	1.778
Food or color additive. . . . .	1.776
Human drug product. . . . .	1.775
Medical device . . . . .	1.777
Veterinary biological product . . . . .	1.779
Certificate of extension . . . . .	1.780
Conditions for. . . . .	1.720
Correction of informalities . . . . .	1.740
Determination of eligibility . . . . .	1.750
Duty of disclosure . . . . .	1.765
Filing date of application . . . . .	1.741
Formal requirements . . . . .	1.740
Incomplete application . . . . .	1.741
Interim extension under 35 U.S.C. 156(d)(5) . . . . .	1.790
Interim extension under 35 U.S.C. 156(e)(2). . . . .	1.760
Multiple applications . . . . .	1.785
Order granting interim extension . . . . .	1.780
Patents subject to . . . . .	1.710
Signature requirements for application . . . . .	1.730
Termination of interim extension granted under 35 U.S.C. 156(d)(5) . . . . .	1.791
Withdrawal of application . . . . .	1.770
Extension of time. . . . .	1.136
Fees . . . . .	1.17
Interference proceedings . . . . .	1.645

**F**

Facsimile transmission . . . . .	1.6(d), 1.8
Federal holiday within the District of Columbia. . . . .	1.9(h)
Federal Register, publication of rules in . . . . .	1.351
Fees and payment of money:	
Credit card . . . . .	1.23
Deposit accounts . . . . .	1.25
Document supply fees . . . . .	1.19
Extension of time. . . . .	1.17
Fee on appeal to the Court of Appeals for the Federal Circuit provided by rules of court . . . . .	1.301
Fees payable in advance . . . . .	1.22
Foreign filing license petition . . . . .	1.17(h)
For international-type search report . . . . .	1.21(e)
Itemization required . . . . .	1.22
Method of payment. . . . .	1.23
Money by mail at risk of sender . . . . .	1.23
Money paid by mistake. . . . .	1.26
Petition fees . . . . .	1.17, 1.181
Post allowance . . . . .	1.18
Processing fees . . . . .	1.17
Reexamination request . . . . .	1.20(c)
Refunds. . . . .	1.26
Relating to international applications . . . . .	1.25(b), 1.445, 1.481, 1.482, 1.492
Schedule of fees and charges . . . . .	1.16-1.21
Files open to the public . . . . .	1.11
Filing date of application . . . . .	1.53
Filing fee part of complete application. . . . .	1.51
Filing fees. . . . .	1.16
Filing in Post Office . . . . .	1.10
Filing of interference settlement agreements . . . . .	1.666
Final rejection:	
Appeal from . . . . .	1.191
Response to. . . . .	1.113, 1.116
When and how given . . . . .	1.113
First Class Mail (includes Priority Mail and Express Mail) . . . . .	1.8
Foreign application. . . . .	1.55
License to file . . . . .	5.11-5.25
Foreign country:	
Taking oath in . . . . .	1.66
Taking testimony in . . . . .	1.671
Foreign mask work protection . . . . .	Part 150
Evaluation of request . . . . .	150.4
Definition . . . . .	150.1
Duration of proclamation . . . . .	150.5
Initiation of evaluation . . . . .	150.2
Mailing address. . . . .	150.6
Submission of requests . . . . .	150.3
Foreign patent rights acquired by government . . . . .	101.1-101.11
Licensing . . . . .	102.1-102.6
Formulas and tables in patent applications. . . . .	1.58
Fraud practiced or attempted on Office . . . . .	1.56
Freedom of Information Act (FOIA) . . . . .	Part 102
Appeals from initial determinations or untimely delays . . . . .	102.10
Business information . . . . .	102.9
Correspondence address . . . . .	102.1, 102.4
Expedited processing . . . . .	102.6
Fees . . . . .	102.11
Public reference facilities . . . . .	102.2
Records . . . . .	102.3

Responses to requests . . . . . 102.7  
 Responsibility for responding . . . . . 102.5  
 Time limits . . . . . 102.6  
 Requirements for making requests . . . . . 102.4

**G**

*Gazette.* (See *Official Gazette.*)  
 General authorization to charge deposit account 1.25, 1.136  
 General information and correspondence . . . . . 1.1-1.8  
 Government acquisition of foreign patent rights. Part 501  
 Government employee invention . . . . . Part 501  
 Government interest in patent, recording of . 3.11, 3.31, 3.41, 3.58  
 Governmental registers . . . . . 3.58  
 Guardian of insane person may apply for patent. . . . 1.43

**H**

Hearings:  
 Before the Board of Patents Appeals and Interferences . . . . . 1.194  
 Fee for appeal hearing . . . . . 1.17  
 In disciplinary proceedings . . . . . 10.144  
 Of motions in interferences . . . . . 1.640  
 Holiday, time for action expiring on . . . . . 1.6, 1.7

**I**

Identification of application, patent or registration . . . 1.5  
 Inconsistencies between application data sheet and oath or declaration . . . . . 1.76(d)  
 Information disclosure statement:  
 At time of filing application. . . . . 1.51  
 Content of . . . . . 1.98  
 Electronic filing of. . . . . 1.98(e)  
 Not permitted in provisional applications . . . . . 1.51  
 Reexamination . . . . . 1.555, 1.902  
 Suspension of action to provide time for consideration of an IDS in a CPA . . . . . 1.103(b)  
 Third party submission of . . . . . 1.99  
 To comply with duty of disclosure . . . . . 1.97  
 Information, Public . . . . . Part 102  
 Insane inventor, application by guardian of . . . . . 1.43  
*Inter partes* reexamination. (See Reexamination.)  
 Interferences (See also Depositions, Motions in interferences, Notice, Preliminary statement in interferences, Testimony in interferences):  
 Abandonment of the contest . . . . . 1.662  
 Access to applications . . . . . 1.612  
 Access to preliminary statement . . . . . 1.631  
 Action by examiner after interference . . . . . 1.664  
 Action if statutory bar appears. . . . . 1.641, 1.659

Addition of new party by administrative patent judge. . . . . 1.642  
 Amendment during . . . . . 1.615, 1.633, 1.634, 1.637  
 Appeal to the Court of Appeals for the Federal Circuit. . . . . 1.301, 1.302  
 Applicant requests . . . . . 1.604  
 Arbitration. . . . . 1.690  
 Briefs at final hearing . . . . . 1.656  
 Burden of proof. . . . . 1.657  
 Civil action . . . . . 1.303  
 Claims copied from patent . . . . . 1.606, 1.607  
 Claims of defeated parties stand finally disposed of . . . . . 1.633  
 Concession of priority. . . . . 1.662  
 Conflicting parties having same attorney . . . . . 1.613  
 Copying claims from patent . . . . . 1.606, 1.607  
 Correspondence . . . . . 1.5(e)  
 Declaration of interference . . . . . 1.611  
 Definition . . . . . 1.601  
 Disclaimer to avoid interference. . . . . 1.662(a)  
 Discovery . . . . . 1.671  
 Dissolution of . . . . . 1.633  
 Dissolution on motion of judge . . . . . 1.641  
 Extension of time . . . . . 1.645  
 Failure of junior party to take testimony . . . . . 1.652  
 Failure to prepare for . . . . . 1.603-1.606  
 Final decision . . . . . 1.658  
 Final hearing . . . . . 1.654  
 Final hearing briefs. . . . . 1.656  
 Identifying claim from patent . . . . . 1.607(a)(3), 1.637(e)(1)(vi)  
 In what cases declared . . . . . 1.601, 1.602  
 Inspection of cases of opposing parties . . . . . 1.612  
 Interference with a patent . . . . . 1.606-1.608  
 Junior party fails to overcome filing date of senior party . . . . . 1.640  
 Jurisdiction of interference . . . . . 1.614  
 Manner of service of papers . . . . . 1.646  
 Matters considered in rendering final decision. . 1.655  
 Motions . . . . . 1.633-1.638  
 NAFTA Country . . . . . 1.601(r)  
 Nonpatentability argued at final hearing . . . . . 1.655  
 Notice and access to applications of opposing parties . . . . . 1.612  
 Notice of intent to argue abandonment. . . . . 1.632  
 Notice of reexamination, reissue, protest, or litigation . . . . . 1.660  
 Notice to file civil action . . . . . 1.303  
 Notices and statements . . . . . 1.611  
 Order to show cause, judgment on the record . . 1.640  
 Ownership of applications or patents involved . . . . . 1.602

Petitions . . . . . 1.644  
 Preliminary statement . . . . . 1.621-1.631  
 Preparation for . . . . . 1.603-1.608  
 Presumption as to order of invention . . . . . 1.657  
 Prosecution by assignee . . . . . 1.643  
 Recommendation by Board of Patent Appeals  
 and Interferences . . . . . 1.659  
 Records and exhibits . . . . . 1.653  
 Records of, when open to public . . . . . 1.11  
 Reissue filed by patentee during . . . . . 1.662  
 Requests by applicants . . . . . 1.604  
 Requests for findings of fact and conclusions  
 of law . . . . . 1.656  
 Return of unauthorized papers . . . . . 1.618  
 Review of decision by civil action . . . . . 1.303  
 Same party . . . . . 1.602  
 Sanctions for failure to comply with rules of  
 order . . . . . 1.616  
 Sanctions for taking and maintaining a frivo-  
 lous position . . . . . 1.616  
 Second interference between same parties . . . . 1.665  
 Secrecy order cases . . . . . 5.3(b)  
 Service of papers . . . . . 1.646  
 Status of claims of defeated applicant after  
 interference . . . . . 1.663  
 Statutory disclaimer by patentee during . . . . . 1.662  
 Suggestion of claims for interference . . . . . 1.605  
 Summary judgment . . . . . 1.617  
 Suspension of ex parte prosecution . . . . . 1.615  
 Termination of interference . . . . . 1.661  
 Testimony copies . . . . . 1.653  
 Time period for completion . . . . . 1.610  
 Times for discovery and taking testimony . . . . 1.651  
 Translation of document in foreign language . . 1.647  
 International application. (See Patent Cooperation  
 Treaty.)  
 International Preliminary Examining Authority . . . 1.416  
 Interview summary . . . . . 1.133  
 Interviews with examiner . . . . . 1.133, 1.560  
 Invention promoters:  
     Complaints regarding . . . . . 4.1-4.6  
         Publication of . . . . . 4.1, 4.3, 4.5  
         Reply to . . . . . 4.4  
         Submission of . . . . . 4.3  
         Withdrawal of . . . . . 4.3  
     Definition . . . . . 4.2  
     Reply to complaint . . . . . 4.4  
 Inventor (See also Applicant for patent, Applica-  
 tion for patent):  
     Death or insanity of inventor . . . . . 1.42, 1.43  
     In an international application . . . . . 1.422, 1.423

Refuses to sign application . . . . . 1.47  
 To make application . . . . . 1.41, 1.45  
 Unavailable . . . . . 1.47  
 Inventor's certificate priority benefit . . . . . 1.55  
 Inventorship and date of invention of the subject  
 matter of individual claims . . . . . 1.110  
 Issue fee . . . . . 1.18  
 Issue of patent. (See Allowance and issue of  
 patent.)

**J**

Joinder of inventions in one application . . . . . 1.141  
 Joint inventors . . . . . 1.45, 1.47, 1.324  
 Joint patent to inventor and assignee . . . . . 1.46, 3.81  
 Jurisdiction:  
     After decision by Board of Patent Appeals  
     and Interferences . . . . . 1.197, 1.198  
     After notice of allowance . . . . . 1.312  
     Of contested case . . . . . 1.614

**L**

Lapsed patents . . . . . 1.317  
 Legal representative of deceased or incapacitated  
 inventor . . . . . 1.42-1.43, 1.64  
 Legibility of papers . . . . . 1.52  
 Letters to the Office. (See Correspondence.)  
 Library service fee . . . . . 1.19(c)  
 License and assignment of government interest in  
 patent . . . . . 3.11, 3.31, 3.41  
 License for foreign filing . . . . . 5.11-5.15  
 List of U.S. patents classified in a subclass, cost of . 1.19(d)  
 Local delivery box rental . . . . . 1.21(d)  
 Lost files . . . . . 1.251

**M**

Mail Stops  
     Mail Stop 4 . . . . . 150.6  
     Mail Stop 8 . . . . . 1.1(a)(3)  
     Mail Stop 24 . . . . . 4.3(c)  
     Mail Stop Assignment Recordation  
         Services . . . . . 1.1(a)(4), 3.27  
     Mail Stop CPA . . . . . 1.53(d)(9)  
     Mail Stop Document Services . . . . . 1.1(a)(4)  
     Mail Stop *Ex parte* Reexam . . . . . 1.1(c)(1)  
     Mail Stop *Inter partes* Reexam . . . . . 1.1(c)(2)  
     Mail Stop Interference . . . . . 1.1(a)  
     Mail Stop M Correspondence . . . . . 1.1(d)(2)  
     Mail Stop OED . . . . . 4.6  
     Mail Stop Patent Ext . . . . . 1.1(e)  
     Mail Stop PCT . . . . . 1.1(b), 1.417, 1.434(a), 1.480(b)  
     Mail Stop Provisional Patent Application . . . . 1.1(f)

Maintenance fees . . . . . 1.20  
 Acceptance of delayed payment of . . . . . 1.378  
 Address for payments . . . . . 1.1(d)(1)  
 Address for correspondence (at PTO) . . . . . 1.1(d)(2)  
 Address for correspondence (applicant's) . . . . . 1.363  
 Review of decision refusing to accept . . . . . 1.377  
 Submission of . . . . . 1.366  
 Time for payment of . . . . . 1.362  
 Mask work notice in specification . . . . . 1.71(s)  
 Mask work notice on drawing . . . . . 1.84(s)  
 Mask work protection, foreign . . . . . Part 150  
 Microorganisms. (See Deposit of biological material.)  
 Minimum balance in deposit accounts . . . . . 1.25  
 Misjoinder of inventor . . . . . 1.48, 1.324, 1.497  
 Missing pages when application filed . . . . . 1.53(e)  
 Mistake in patent, certificate thereof issued . 1.322, 1.323  
 Models and exhibits:  
     Copies of . . . . . 1.95  
     If not claimed within reasonable time, may be disposed of by Director . . . . . 1.94  
     If on examination model found necessary request therefor will be made . . . . . 1.91  
     In contested cases. . . . . 1.676  
     May be required. . . . . 1.91  
     Model not generally admitted in application or patent . . . . . 1.91  
     Not to be taken from the Office except in custody of sworn employee . . . . . 1.95  
     Return of . . . . . 1.94  
     Working model may be required . . . . . 1.91  
 Money. (See Fees and payment of money.)  
 Motions in interference . . . . . 1.633-1.637  
     To take testimony in foreign country . . . . . 1.671

**N**

Name of Applicant or Inventor (see Applicant for patent, Application for patent, Inventor)  
 New matter inadmissible in application . . . . . 1.121  
 New matter inadmissible in reissue . . . . . 1.173  
 Non-English language specification fee . . . . . 1.17(i)  
 Nonprofit organization:  
     Definition . . . . . 1.27  
     Small entity status . . . . . 1.27  
 Notice:  
     Of allowance of application . . . . . 1.311  
     Of appeal to the Court of Appeals for the Federal Circuit . . . . . 1.301, 1.302  
     Of arbitration award . . . . . 1.335  
     Of defective *ex parte* reexamination request . 1.510(c)  
     Of interference . . . . . 1.611

Of oral hearings before the Board of Patent  
     Appeals and Interferences . . . . . 1.194  
 Of rejection of an application . . . . . 1.104  
 Of taking testimony . . . . . 1.673  
 To conflicting parties with same attorney or agent . . . . . 1.613  
 To parties in interference cases . . . . . 1.611  
 Nucleotide and/or amino acid sequences:  
     Amendments to . . . . . 1.825  
     Disclosure in patent applications . . . . . 1.821  
     Form and format for computer readable form . . 1.824  
     Format for sequence data . . . . . 1.822  
     Replacement of . . . . . 1.825  
     Requirements . . . . . 1.823  
     Submission on compact disc . . . . . 1.52, 1.821, 1.823  
     Symbols . . . . . 1.822

**O**

Oath in patent application. (See also Declaration):  
     Apostilles . . . . . 1.66  
     Before whom taken in foreign countries . . . . . 1.66  
     Before whom taken in United States . . . . . 1.66  
     By administrator or executor . . . . . 1.42, 1.63, 1.64  
     By guardian of insane person . . . . . 1.43, 1.63, 1.64  
     Certificate of Officer administering . . . . . 1.66  
     Continuation-in-part . . . . . 1.63(e)  
     Declaration . . . . . 1.68  
     Foreign language . . . . . 1.69  
     International application . . . . . 1.497  
     Inventor's Certificate . . . . . 1.63  
     Made by inventor . . . . . 1.41, 1.63  
     Made by someone other than inventor . . . . . 1.64(b)  
     Officers authorized to administer oaths . . . . . 1.66  
     Part of complete application . . . . . 1.51  
     Person making . . . . . 1.64  
     Plant patent application . . . . . 1.162  
     Requirements of . . . . . 1.63  
     Ribbed to other papers . . . . . 1.66  
     Sealed . . . . . 1.66  
     Signature to . . . . . 1.63, 1.64, 1.67  
     Supplemental . . . . . 1.67  
     To acknowledge duty of disclosure . . . . . 1.63  
     When taken abroad to seal all papers . . . . . 1.66  
 Oath or declaration in reissue application . . . . . 1.175  
 Oath or declaration  
     Plant patent application . . . . . 1.162  
     When international application enters national stage . . . . . 1.497  
 Object of the invention . . . . . 1.73  
 Office action time for reply . . . . . 1.134  
 Office fees. (See Fees and payment of money.)

Official action, based exclusively upon the written record . . . . . 1.2  
 Official business, should be transacted in writing . . . . . 1.2  
*Official Gazette:*  
 Amendments to rules published in . . . . . 1.351  
 Announces request for reexamination . . . 1.11(c), 1.904  
 Notice of filing application to nonsigning inventor . . . . . 1.47  
 Notice of issuance of *ex parte* reexamination certificate . . . . . 1.570(f)  
 Notice of issuance of *inter partes* reexamination certificate . . . . . 1.997  
 Service of notices in . . . . . 1.646  
 Oral statements . . . . . 1.2

### P

Payment of fees, Method . . . . . 1.23  
 Paper, definition of . . . . . 1.9  
 Papers (requirements to become part of Office permanent records) . . . . . 1.52  
 Papers not received on Saturday, Sunday, or holidays . . . . . 1.6  
 Patent application. (See Application for patent and Provisional patent applications.)  
 Patent application publication. (See Published application.)  
 Patent attorneys and agents. (See Attorneys and agents.)  
 Patent Cooperation Treaty:  
 Access to international application files . . . . . 1.14(g)  
 Amendments and corrections during international processing . . . . . 1.471  
 Amendments during international preliminary examination . . . . . 1.485  
 Applicant for international application . . . . . 1.421  
 Changes in person, name or address, where filed . . . . . 1.421(f), 1.472  
 Conduct of international preliminary examination . . . . . 1.484  
 Copies of international application files . . . . . 1.14(g)  
 Definition of terms . . . . . 1.401  
 Delays in meeting time limits . . . . . 1.468  
 Demand for international preliminary examination . . . . . 1.480  
 Designation of States . . . . . 1.432  
 Entry into national stage . . . . . 1.491, 1.495  
 Examination at national stage . . . . . 1.496  
 Fees:  
 Authorization to charge fees under 37 CFR 1.16 . . . . . 1.25(b)  
 Due on filing of international application . . 1.431(c)  
 Failure to pay results in withdrawal of application . . . . . 1.431(d), 1.432  
 Filing, processing and search fees . . . . . 1.445  
 International Filing Fee . . . . . 1.431(c), 1.445(b)  
 International preliminary examination . . . . . 1.481, 1.482  
 National stage . . . . . 1.25(b), 1.492  
 Refunds . . . . . 1.446  
 Filing by other than inventor . . . . . 1.421(b)  
 International application requirements . . . . . 1.431  
 Abstract . . . . . 1.438  
 Claims . . . . . 1.436  
 Description . . . . . 1.435  
 Drawings . . . . . 1.437  
 Physical requirements . . . . . 1.433  
 Request . . . . . 1.434  
 International Bureau . . . . . 1.415  
 International Preliminary Examining Authority . . . . . 1.416  
 Inventor deceased . . . . . 1.422  
 Inventor insane or legally incapacitated . . . . . 1.423  
 Inventors, joint . . . . . 1.421(b), 1.497  
 National stage in the United States:  
 Commencement . . . . . 1.491  
 Entry . . . . . 1.491, 1.495  
 Examination . . . . . 1.496  
 Fees . . . . . 1.25(b); 1.492  
 Oath or declaration at national stage . . . . . 1.497  
 Priority, claim for . . . . . 1.55, 1.451  
 Record copy to International Bureau, transmittal procedures . . . . . 1.461  
 Representation by attorney or agent . . . . . 1.455  
 Time limits for processing applications . . 1.465, 1.468  
 United States as:  
 Designated or Elected Office . . . . . 1.414  
 International Searching Authority . . . . . 1.413  
 Receiving Office . . . . . 1.412  
 Unity of invention:  
 Before International Searching Authority . . 1.475, 1.476  
 Before International Preliminary Examining Authority . . . . . 1.487, 1.488  
 National stage . . . . . 1.475, 1.499  
 Protest to lack of . . . . . 1.477, 1.489  
 Patent policy, government . . . . . 100.1-100.11  
 Patent term adjustment due to examination delay . 1.702-1.705  
 Application for . . . . . 1.705  
 Determination . . . . . 1.705  
 Grounds for . . . . . 1.702  
 Period of adjustment . . . . . 1.703  
 Reduction of period of adjustment . . . . . 1.704



Patent term extension due to examination delay . . .	1.701	Drawings . . . . .	1.165
Patent term extension due to regulatory review period. (See Extension of patent term due to regulatory review period (35 U.S.C. 156).)		Examination . . . . .	1.167
Patentee notified of interference . . . . .	1.602	Fee for copies . . . . .	1.19
Patents (See also Allowance and issue of patent):		Filing fee . . . . .	1.16(g)
Available for license or sale, publication of notice . . . . .	1.21(i)	Issue fee . . . . .	1.18(c)
Certified copies of . . . . .	1.13	Oath . . . . .	1.162
Copying claims of . . . . .	1.606, 1.607	Rules applicable . . . . .	1.161
Correction of errors in . . . . .	1.171, 1.322, 1.323, 1.324	Specification and arrangement of application elements . . . . .	1.163
Delivery of . . . . .	1.315	Specimens . . . . .	1.166
Disclaimer . . . . .	1.321	Post issuance and reexamination fees . . . . .	1.20
Identification required in letters concerning . . . . .	1.5	Post Office receipt as filing date . . . . .	1.10
Lapsed, for nonpayment of issue fee . . . . .	1.317	Postal emergency or interruption . . . . .	1.6(e)
Obtainable by civil action . . . . .	1.303	Power of attorney. (See Attorneys or agents.)	
Price of copies . . . . .	1.19	Power to inspect . . . . .	1.14(c)
Records of, open to public . . . . .	1.11, 1.12	Preliminary amendments . . . . .	1.115
Reissuing of, when defective . . . . .	1.171-1.179	Preliminary Examining Authority, International . . . . .	1.416
Payment of fees . . . . .	1.23	Preliminary statement in interferences:	
Personal attendance unnecessary . . . . .	1.2	Access to . . . . .	1.631
Petition for reissue . . . . .	1.171, 1.172	Contents to . . . . .	1.622-1.627
Petition to the Director:		Contents of, invention made in other than United States, a NAFTA country, or a WTO member country . . . . .	1.624
Fees . . . . .	1.17	Correction of statement on motion . . . . .	1.628
For delayed payment of issue fee . . . . .	1.137	Effect of statement . . . . .	1.629
For expungement of papers . . . . .	1.59	Failure to file . . . . .	1.639, 1.640
For extension of time . . . . .	1.136	In case of motion to amend interference . . . . .	1.633
For license for foreign filing . . . . .	5.12	May be amended if defective . . . . .	1.628
For the revival of an abandoned application . . . . .	1.137	Reliance on prior application . . . . .	1.626, 1.630
From formal objections or requirements . . . . .	1.113, 1.181	Requirement for . . . . .	1.621
From requirement for restriction . . . . .	1.129, 1.144	Sealed before filing . . . . .	1.627
General requirements . . . . .	1.181	Service on opposing parties . . . . .	1.621
In interferences . . . . .	1.644	Subsequent testimony alleging prior dates excluded . . . . .	1.629
In reexamination . . . . .	1.181	When opened to inspection . . . . .	1.631
If examiner refused the <i>ex parte</i> request . . . . .	1.515(c)	Preserved in confidence, applications . . . . .	1.12, 1.14
On refusal of examiner to admit amendment . . . . .	1.127	Exceptions (status, access or copies available) . . . . .	1.14
Questions not specifically provided for . . . . .	1.182	Printing testimony . . . . .	1.653
Suspension of rules . . . . .	1.183	Prior art citation in patented files . . . . .	1.501
Petition to accept an unintentionally delayed claim for domestic priority . . . . .	1.78(a)(3), 1.78(a)(6)	Prior art statement:	
Petition to accept an unintentionally delayed claim for foreign priority . . . . .	1.55(c)	Content of . . . . .	1.98
To exercise supervisory authority . . . . .	1.181	To comply with duty of disclosure . . . . .	1.97
To make special . . . . .	1.102	Prior invention, affidavit or declaration of to overcome rejection . . . . .	1.130, 1.131
Untimely unless filed within two months . . . . .	1.181	Priority, right of, under treaty or law:	
Photographs . . . . .	1.84(b), 1.152	Domestic benefit claim:	
Plant patent applications:		Cross-reference to related a pplication(s) . . . . .	1.76-1.78
Applicant . . . . .	1.162	Filing fee must be paid in provisional a ppli- cation . . . . .	1.78
Claim . . . . .	1.164	Indication of whether international applica- tion was published in English . . . . .	1.78(a)(2)
Declaration . . . . .	1.162		
Description . . . . .	1.162		

- May be in first sentence of application or on application data sheet . . . . . 1.78
  - Petition to accept, unintentionally delayed . . . 1.78
  - Translation of non-English language
    - provisional application required . . . . . 1.78
    - Waived if not timely . . . . . 1.78
  - Foreign priority claim:
    - Filed after issue fee has been paid . . . . . 1.55
    - May be on application data sheet or in oath/declaration . . . . . 1.63(c)
    - Petition to accept, unintentionally delayed . . 1.55
    - Priority document . . . . . 1.55
      - Translation . . . . . 1.55, 1.647
    - Time for claiming . . . . . 1.55
  - Privacy Act . . . . . Part 102
    - Denial of access to records . . . . . 102.25
    - Definitions . . . . . 102.22
    - Disclosure of records . . . . . 102.25, 102.30
    - Exemptions . . . . . 102.33, 102.34
    - Fees . . . . . 102.31
    - Grant of access to records . . . . . 102.25
    - Inquiries . . . . . 102.23
    - Medical records . . . . . 102.26
    - Penalties . . . . . 102.32
    - Requests for records . . . . . 102.24
    - Requests for correction or amendment . . . . . 102.27
      - Appeal of initial adverse determination . . . 102.29
      - Review of requests . . . . . 102.28
  - Processing and retention fee . . . . . 1.21(l), 1.53(f)
  - Proclamation as to protection of foreign mask works . . . . . Part 150
  - Protests to grants of patent . . . . . 1.291
  - Provisional patent applications:
    - Claiming the benefit of . . . . . 1.78
    - Converting a nonprovisional to a provisional . 1.53(c)
    - Converting a provisional to a nonprovisional 1.53(c)
    - Cover sheet required by § 1.51(c)(1) may be a § 1.76 application data sheet . . . . . 1.53(c)(1)
    - Filing date . . . . . 1.53(c)
    - Filing fee . . . . . 1.16(k)
    - General requisites . . . . . 1.51(c)
    - Later filing of fee and cover sheet . . . . . 1.53(g)
    - Names of inventor(s) . . . . . 1.41(a)(2)
      - Application data sheet . . . . . 1.53(c)(1), 1.76
      - Correction of . . . . . 1.48
      - Cover sheet . . . . . 1.51(c)(1), 1.53(c)(1)
      - Joint inventors . . . . . 1.45
    - No right of priority . . . . . 1.53(c)
    - No examination . . . . . 1.53(i)
    - Papers concerning, should identify provisional application as such, by application number. . . 1.5(f)
    - Parts of complete provisional application . . . 1.51(c)
    - Processing fees . . . . . 1.17
    - Revival of . . . . . 1.137
      - When abandoned . . . . . 1.53(i)
    - Provisional rights
      - Submission of international publication or English translation thereof pursuant to 35 U.S.C. 154(d)(4) . . . . . 1.417
    - Public Information . . . . . Part 102
    - Public use proceedings . . . . . 1.292
      - Fee . . . . . 1.17(j)
    - Publication of application . . . . . 1.211
      - Early publication . . . . . 1.219
      - Express abandonment to avoid publication . . 1.138
      - Fee . . . . . 1.18
      - Nonpublication request . . . . . 1.213
      - Publication of redacted copy . . . . . 1.217
      - Republication . . . . . 1.221
      - Voluntary publication . . . . . 1.221
    - Published application
      - Access to . . . . . 1.11, 1.14
      - Certified copies of . . . . . 1.13
      - Contents . . . . . 1.215
      - Definition . . . . . 1.9
      - Records of, open to public . . . . . 1.11, 1.12
      - Republication of . . . . . 1.221
      - Third party submission in . . . . . 1.99
- R**
- Reasons for allowance . . . . . 1.104
  - Reconsideration of Office action . . . . . 1.112
  - Reconstruction of lost files . . . . . 1.251
  - Recording of assignments. (See Assignments and recording.)
  - Records of the Patent and Trademark Office . . 1.11-1.15
  - Reexamination:
    - Announcement in O.G. . . . . 1.11(c)
    - Correction of inventorship . . . . . 1.530
    - Correspondence address . . . . . 1.33(c)
    - Ex parte* proceedings:
      - Amendments, manner of making . . 1.121(j), 1.530
      - Appeal to Board . . . . . 1.191
      - Appeal to C.A.F.C. . . . . 1.301
      - Civil action under 35 U.S.C. 145 . . . . . 1.303
      - Concurrent with interference, reissue, other reexamination, litigation, or office proceeding(s) . . . . . 1.565
      - Conduct of. . . . . 1.550
      - Duty of disclosure in . . . . . 1.555
      - Examiner's determination to grant or refuse request for . . . . . 1.515
      - Extensions of time in. . . . . 1.550(c)
      - Initiated by the Director . . . . . 1.520

Interviews in . . . . .	1.560	International applications . . . . .	1.446
Issuance of certificate at conclusion of . . . . .	1.570	Later establishment of small entity status . . . . .	1.28
Order for reexamination by examiner . . . . .	1.525	Time period for requesting . . . . .	1.26
Patent owner’s statement . . . . .	1.530, 1.540	Register of Government interest in patents . . . . .	3.58
Processing of prior art citations during . . . . .	1.502	Rehearing:	
Reply to patent owner’s statement to third party requester . . . . .	1.535, 1.540	On appeal to Board . . . . .	1.197
Request for . . . . .	1.510	Request for, time for appeal after action on . . . . .	1.304
Scope of . . . . .	1.552	Reissues:	
Service of papers . . . . .	1.248	Amendments . . . . .	1.173
Examiner’s action . . . . .	1.104	Applicants, assignees . . . . .	1.172
Fee . . . . .	1.20(c)	Application for reissue . . . . .	1.171
Fees may be charged to deposit account . . . . .	1.25	Application made and sworn to by inventor, if living . . . . .	1.172
Identification in letter . . . . .	1.5(d)	Continuing duty of applicant . . . . .	1.178
<i>Inter partes</i> proceedings . . . . .	1.902-1.997	Declaration . . . . .	1.175
Amendments, manner of making . . . . .	1.121(j), 1.530, 1.941	Drawings . . . . .	1.173
Appeal to Board . . . . .	1.959-1.981	Examination of reissue . . . . .	1.176
Appeal to C.A.F.C. . . . .	1.983	Filed during interference . . . . .	1.662(b)
Civil action under 35 U.S.C. 145 not available . . . . .	1.303(d)	Filed during <i>ex parte</i> reexamination . . . . .	1.565
Concurrent with interference, reissue, other reexamination, litigation, or office proceeding(s) . . . . .	1.565, 1.985	Filed during <i>inter partes</i> reexamination . . . . .	1.985
Conduct of . . . . .	1.937	Filing fee . . . . .	1.16
Duty of disclosure in . . . . .	1.555, 1.923	Filing of announcement in <i>Official Gazette</i> . . . . .	1.11
Examiner’s determination to grant or refuse request for . . . . .	1.923-1.927	Grounds for and requirements . . . . .	1.171-1.179
Extensions of time in . . . . .	1.956	Issue fee . . . . .	1.18(a)
Filing date of request for . . . . .	1.919	Loss of original patent . . . . .	1.178
Issuance of certificate at conclusion of . . . . .	1.997	Multiple applications for reissue of a single patent . . . . .	1.177
Merged with concurrent reexamination proceedings . . . . .	1.989	Notice of reissue application . . . . .	1.179
Merged with reissue application . . . . .	1.991	Oath . . . . .	1.175
Notice of, in the <i>Official Gazette</i> . . . . .	1.904	Open to public . . . . .	1.11
Persons eligible to file request for . . . . .	1.903	Original patent surrendered . . . . .	1.178
Processing of prior art citations during . . . . .	1.902	Restriction . . . . .	1.176
Scope of . . . . .	1.906	Specification . . . . .	1.173
Service of papers . . . . .	1.248, 1.903	Take precedence in order of examination . . . . .	1.176
Submission of papers by the public . . . . .	1.905	To contain no new matter . . . . .	1.173
Subsequent requests for . . . . .	1.907	What must accompany application . . . . .	1.171, 1.172
Suspension due to concurrent interference . . . . .	1.993	When in interference . . . . .	1.660
Suspension due to litigation . . . . .	1.987	Rejection:	
Information Disclosure Statements . . . . .	1.98, 1.555	After two rejections appeal may be taken from examiner to Board . . . . .	1.191
Open to public . . . . .	1.11(d)	Applicant will be notified of rejection with reasons and references . . . . .	1.104
Reconsideration before final action . . . . .	1.112	Based on commonly owned prior art, how overcome . . . . .	1.130
Refund of fee . . . . .	1.26	Examiner may rely on admissions by applicant or patent owner, or facts within examiner’s knowledge . . . . .	1.104
Reply to action . . . . .	1.111	Final . . . . .	1.113
Revival of terminated proceeding . . . . .	1.137	Formal objections . . . . .	1.104
Reference characters in drawings . . . . .	1.74, 1.84(p)	On account of invention shown by others but not claimed, how overcome . . . . .	1.131
References cited on examination . . . . .	1.104		
Refund of money paid by mistake . . . . .	1.26		

References will be cited. . . . .	1.104
Requisites of notice of. . . . .	1.104
Reply brief. . . . .	1.193
Reply to Office action:	
Abandonment for failure to . . . . .	1.135
By applicant or patent owner. . . . .	1.111
Substantially complete. . . . .	1.135
Supplemental. . . . .	1.111
Time for. . . . .	1.134
Representative capacity. . . . .	1.34(a)
Request for continued examination. . . . .	1.114
Fee. . . . .	1.17
Suspension of action after. . . . .	1.103
Request for reconsideration. . . . .	1.112
Request for <i>ex parte</i> reexamination. . . . .	1.510
Request for <i>inter partes</i> reexamination. . . . .	1.913-1.927
Requirement for submission of information. . . . .	1.105
Reservation clauses not permitted. . . . .	1.79
Restriction of application. . . . .	1.141-1.146, 1.176
Claims to nonelected invention withdrawn. . . . .	1.142
Constructive election. . . . .	1.145
Petition from requirements for. . . . .	1.129, 1.144
Provisional election. . . . .	1.143
Reconsideration of requirement. . . . .	1.143
Requirement for. . . . .	1.142
Subsequent presentation of claims for different invention. . . . .	1.145
Retention fee. . . . .	1.21(l), 1.53(f)
Return of correspondence. . . . .	1.5(a)
Revival of abandoned application, terminated reexamination proceeding, or lapsed patent. . . . .	1.137
Unavoidable abandonment fee. . . . .	1.17(l)
Unintentional abandonment fee. . . . .	1.17(m)
Revocation of power of attorney or authorization of agent. . . . .	1.36
Rules of Practice:	
Amendments to rules will be published. . . . .	1.351

## S

Saturday, when last day falls on. . . . .	1.7
Secrecy order. . . . .	5.1-5.5
Sequences:	
Amendments to sequence listing and computer readable copy. . . . .	1.825
Disclosure requirements. . . . .	1.821, 1.823
Sequence data, symbols and format. . . . .	1.822
Submissions in computer readable form. . . . .	1.824
Submissions on compact disc in lieu of paper. . . . .	1.52, 1.821, 1.823
Serial number of application. . . . .	1.5
Service of notices:	
For taking testimony. . . . .	1.673
In interference cases. . . . .	1.611
Of appeal to the U.S. Court of Appeals for the Federal Circuit. . . . .	1.301
Service of papers. . . . .	1.248
Service of process. . . . .	15 CFR Part 15
Shortened period for reply. . . . .	1.134
Signature:	
Implicit certifications. . . . .	1.4(d), 10.18
Of attorney or agent. . . . .	10.18
To a written assertion of small entity status . . . . .	1.27(c)(2)
To amendments and other papers. . . . .	1.33(b)
To an application for extension of patent term. . . . .	1.730
To express abandonment. . . . .	1.138
To oath. . . . .	1.63
To reissue oath or declaration. . . . .	1.172
When copy is acceptable. . . . .	1.4
Small business concern:	
Definition. . . . .	1.27
Small entity status. . . . .	1.27
Small entity:	
Definition. . . . .	1.27
Errors in status excused. . . . .	1.28
Fraud on the office. . . . .	1.27
License to Federal agency. . . . .	1.27
Statement. . . . .	1.27
Statement in parent application. . . . .	1.27
Status establishment. . . . .	1.27, 1.28
Status update. . . . .	1.27, 1.28
Solicitor's address. . . . .	1.1(a)(3), 1.302(c)
Species of invention claimed. . . . .	1.141, 1.146
Specification (See also Application for patent, Claims):	
Abstract. . . . .	1.72
Amendments to. . . . .	1.121, 1.125
Arrangement of. . . . .	1.77, 1.154, 1.163
Best mode. . . . .	1.71
Claim. . . . .	1.75
Commence on separate sheet. . . . .	1.71(f)
Contents of. . . . .	1.71-1.75
Copyright notice. . . . .	1.71(d)
Cross-references to other applications. . . . .	1.78
Description of the invention. . . . .	1.71
If defective, reissue to correct. . . . .	1.171-1.179
Mask work notice. . . . .	1.71(d)
Must conclude with specific and distinct claim. . . . .	1.75
Must point out new improvements specifically. . . . .	1.71
Must refer by figures to drawings. . . . .	1.74
Must set forth the precise invention. . . . .	1.71
Object of the invention. . . . .	1.73
Order of arrangement in framing. . . . .	1.77

Paper, writing, margins . . . . . 1.52  
 Paragraph numbering . . . . . 1.52  
 Part of complete application . . . . . 1.51  
 Reference to drawings . . . . . 1.74  
 Requirements of . . . . . 1.71-1.75  
 Reservation clauses not permitted . . . . . 1.79  
 Separate from other parts of application . . . . . 1.71(f)  
 Substitute . . . . . 1.125  
 Summary of the invention . . . . . 1.73  
 Title of the invention . . . . . 1.72  
 To be rewritten, if necessary . . . . . 1.125  
 Specimens. (See Models and exhibits.)  
 Specimens of composition of matter to be furnished when required . . . . . 1.93  
 Specimens of plants . . . . . 1.166  
 Statement of status as small entity . . . . . 1.27  
 Status information . . . . . 1.14  
 Statutory disclaimer fee . . . . . 1.20(d)  
 Statutory invention registrations . . . . . 1.293  
     Examination. . . . . 1.294  
     Publication of . . . . . 1.297  
     Review of decision finally refusing to publish . 1.295  
     Withdrawal of request for publication of . . . . . 1.296  
 Submission of international publication or English translation thereof pursuant to 35 U.S.C. 154(d)(4) . . . . . 1.417  
 Sufficient funds in deposit account . . . . . 1.25  
 Suit in equity. (See Civil action.)  
 Summary of invention . . . . . 1.73  
 Sunday, when last day falls on . . . . . 1.7  
 Supervisory authority, petition to  
     Director to exercise . . . . . 1.181  
 Supplemental oath /declaration . . . . . 1.67  
 Surcharge for oath or basic filing fee filed after filing date . . . . . 1.16(e), 1.53(f)  
 Suspension of action . . . . . 1.103  
 Suspension of ex parte prosecution during interference . . . . . 1.615  
 Suspension of rules . . . . . 1.183  
 Symbols for drawings . . . . . 1.84(n)  
 Symbols for nucleotide and/or amino acid sequence data . . . . . 1.822

**T**

Tables in patent applications . . . . . 1.58  
 Terminal disclaimer . . . . . 1.321  
 Testimony by Office employees . . . . . 15 CFR Part 15a  
 Testimony in interferences:  
     Additional time for taking . . . . . 1.645  
     Assignment of times for taking . . . . . 1.651  
     Certification and filing by officer . . . . . 1.676  
     Copies of . . . . . 1.653

Depositions must be filed . . . . . 1.678  
 Discovery . . . . . 1.687  
 Effect of errors and irregularities  
     in deposition . . . . . 1.685  
 Evidence must comply with rules . . . . . 1.671  
 Examination of witnesses . . . . . 1.675  
 Failure to take . . . . . 1.652  
 Form of deposition . . . . . 1.677  
 Formal objections to . . . . . 1.685  
 Formalities in preparing depositions . . . . . 1.674-1.677  
 In foreign countries . . . . . 1.671  
 Inspection of testimony . . . . . 1.679  
 Manner of taking testimony of witnesses . . . . . 1.672  
 Motion to extend time for taking . . . . . 1.645  
 Not considered if not taken and filed in  
     compliance with rules . . . . . 1.671  
 Notice of examination of witnesses . . . . . 1.673  
 Notice of intent to use records . . . . . 1.671(e)  
 Objections noted in depositions . . . . . 1.675  
 Objections to formal matters . . . . . 1.685  
 Officer’s certificate . . . . . 1.676  
 Persons before whom depositions may be taken . . . . . 1.674  
 Printing of . . . . . 1.653  
 Service of notice . . . . . 1.673  
 Stipulations or agreements concerning . . . . . 1.672  
 Taken by depositions . . . . . 1.672  
 Time for taking . . . . . 1.651  
 To be inspected by parties to the case only . . . . . 1.679  
 Weight of deposition testimony taken in a foreign country . . . . . 1.671(j)  
 Third party submission in published application . . . . . 1.99  
 Time expiring on Saturday, Sunday, or holiday . . . . . 1.7  
 Time for claiming benefit of prior (domestic) application . . . . . 1.78  
 Time for claiming foreign priority . . . . . 1.55  
 Time for filing preliminary amendment to ensure entry thereof . . . . . 1.115  
 Time for payment of issue fee . . . . . 1.311  
 Time for payment of publication fee . . . . . 1.311  
 Time for reply by applicant . . . . . 1.134, 1.135, 1.136  
 Time for reply to Office action . . . . . 1.134, 1.136  
 Time for requesting a refund . . . . . 1.26  
 Time, periods of . . . . . 1.7  
 Timely filing of correspondence . . . . . 1.8, 1.10  
 Title of invention . . . . . 1.72  
 Title reports, fee for . . . . . 1.19(b)  
 Transitional procedures . . . . . 1.129

**U**

Unavoidable abandonment . . . . . 1.137  
 Unintentional abandonment . . . . . 1.137

PATENT RULES

RULES INDEX

United States as  
    Designated Office . . . . . 1.414  
    Elected Office . . . . . 1.414  
International Preliminary Examining  
    Authority . . . . . 1.416  
    International Searching Authority . . . . . 1.413  
    Receiving Office . . . . . 1.412  
Unlocatable files . . . . . 1.251

Unsigned continuation or divisional application 1.53, 1.63  
Use of file of parent application . . . . . 1.53(d)

**W**

Waiver of confidentiality . . . . . 1.53(d)(6)  
Withdrawal from issue . . . . . 1.313  
Withdrawal of attorney or agent . . . . . 1.36  
Withdrawal of request for statutory invention

MANUAL OF PATENT EXAMINING PROCEDURE

*PRACTICE BEFORE THE PATENT AND  
TRADEMARK OFFICE*

**PART 10 — REPRESENTATION OF  
OTHERS BEFORE THE UNITED  
STATES PATENT AND TRADEMARK  
OFFICE**

Sec.

- 10.1 Definitions.
- 10.2 Director of Enrollment and Discipline.
- 10.3 Committee on Enrollment.
- 10.4 Committee on Discipline.

**INDIVIDUALS ENTITLED TO  
PRACTICE BEFORE THE PATENT  
AND TRADEMARK OFFICE**

- 10.5 Register of attorneys and agents in patent cases.
- 10.6 Registration of attorneys and agents.
- 10.7 Requirements for registration.
- 10.8 Oath and registration fee.
- 10.9 Limited recognition in patent cases.
- 10.10 Restrictions on practice in patent cases.
- 10.11 Removing names from the register.
- 10.12 - 10.13 [Reserved]
- 10.14 Individuals who may practice before the Office in trademark and other non-patent cases.
- 10.15 Refusal to recognize a practitioner.
- 10.16 - 10.17 [Reserved]
- 10.18 Signature and certificate for correspondence filed in the Patent and Trademark Office.
- 10.19 [Reserved]

**PATENT AND TRADEMARK OFFICE CODE  
OF PROFESSIONAL RESPONSIBILITY**

- 10.20 Canons and Disciplinary Rules.
- 10.21 Canon 1.
- 10.22 Maintaining integrity and competence of the legal profession.
- 10.23 Misconduct.
- 10.24 Disclosure of information to authorities.
- 10.25 - 10.29 [Reserved]
- 10.30 Canon 2.
- 10.31 Communications concerning a practitioner's services.
- 10.32 Advertising.

- 10.33 Direct contact with prospective clients.
- 10.34 Communication of fields of practice.
- 10.35 Firm names and letterheads.
- 10.36 Fees for legal services.
- 10.37 Division of fees among practitioners.
- 10.38 Agreements restricting the practice of a practitioner.
- 10.39 Acceptance of employment.
- 10.40 Withdrawal from employment.
- 10.41 - 10.45 [Reserved]
- 10.46 Canon 3.
- 10.47 Aiding unauthorized practice of law.
- 10.48 Sharing legal fees.
- 10.49 Forming a partnership with a non-practitioner.
- 10.50 - 10.55 [Reserved]
- 10.56 Canon 4.
- 10.57 Preservation of confidences and secrets of a client.
- 10.58 - 10.60 [Reserved]
- 10.61 Canon 5.
- 10.62 Refusing employment when the interest of the practitioner may impair the practitioner's independent professional judgment.
- 10.63 Withdrawal when the practitioner becomes a witness.
- 10.64 Avoiding acquisition of interest in litigation or proceeding before the Office.
- 10.65 Limiting business relations with a client.
- 10.66 Refusing to accept or continue employment if the interests of another client may impair the independent professional judgment of the practitioner.
- 10.67 Settling similar claims of clients.
- 10.68 Avoiding influence by others than the client.
- 10.69 - 10.75 [Reserved]
- 10.76 Canon 6.
- 10.77 Failing to act competently.
- 10.78 Limiting liability to client.
- 10.79 - 10.82 [Reserved]
- 10.83 Canon 7.
- 10.84 Representing a client zealously.
- 10.85 Representing a client within the bounds of the law.
- 10.86 [Reserved]
- 10.87 Communicating with one of adverse interest.
- 10.88 Threatening criminal prosecution.
- 10.89 Conduct in proceedings.
- 10.90 - 10.91 [Reserved]
- 10.92 Contact with witnesses.
- 10.93 Contact with officials.



- 10.94 - 10.99 [Reserved]
- 10.100 Canon 8.
- 10.101 Action as a public official.
- 10.102 Statements concerning officials.
- 10.103 Practitioner candidate for judicial office.
- 10.104 - 10.109 [Reserved]
- 10.110 Canon 9.
- 10.111 Avoiding even the appearance of impropriety.
- 10.112 Preserving identity of funds and property of client.
- 10.113 - 10.129 [Reserved]

INVESTIGATIONS AND DISCIPLINARY  
PROCEEDINGS

- 10.130 Reprimand, suspension or exclusion.
- 10.131 Investigations.
- 10.132 Initiating a disciplinary proceeding; reference to an administrative law judge.
- 10.133 Conference between Director and practitioner; resignation.
- 10.134 Complaint.
- 10.135 Service of complaint.
- 10.136 Answer to complaint.
- 10.137 Supplemental complaint.
- 10.138 Contested case.
- 10.139 Administrative law judge; appointment; responsibilities; review of interlocutory orders; stays.
- 10.140 Representative for Director or respondent.
- 10.141 Filing of papers.
- 10.142 Service of papers.
- 10.143 Motions.
- 10.144 Hearings.
- 10.145 Proof; variance; amendment of pleadings.
- 10.146 - 10.148 [Reserved]
- 10.149 Burden of proof.
- 10.150 Evidence.
- 10.151 Depositions.
- 10.152 Discovery.
- 10.153 Proposed findings and conclusions; post-hearing memorandum.
- 10.154 Initial decision of administrative law judge.
- 10.155 Appeal to the Commissioner.
- 10.156 Decision of the Commissioner.
- 10.157 Review of Commissioner’s final decision.
- 10.158 Suspended or excluded practitioner.
- 10.159 Notice of suspension or exclusion.

- 10.160 Petitioner for reinstatement.
- 10.161 Savings clause.
- 10.162 - 10.169 [Reserved]
- 10.170 Suspension of rules.

**§ 10.1 Definitions.**

This part governs solely the practice of patent, trademark, and other law before the Patent and Trademark Office. Nothing in this part shall be construed to preempt the authority of each State to regulate the practice of law, except to the extent necessary for the Patent and Trademark Office to accomplish its federal objectives. Unless otherwise clear from the context, the following definitions apply to this part:

- (a) *Affidavit* means affidavit, declaration under 35 U.S.C. 25 (see § 1.68 and § 2.20 of this subchapter), or statutory declaration under 28 U.S.C. 1746.
- (b) *Application* includes an application for a design, plant, or utility patent, an application to reissue any patent, and an application to register a trademark.
- (c) *Attorney* or *lawyer* means an individual who is a member in good standing of the bar of any United States court or the highest court of any State. A “non-lawyer” is a person who is not an attorney or lawyer.
- (d) *Canon* is defined in § 10.20(a).
- (e) *Confidence* is defined in § 10.57(a).
- (f) *Differing interests* include every interest that may adversely affect either the judgment or the loyalty of a practitioner to a client, whether it be a conflicting, inconsistent, diverse, or other interest.
- (g) *Director* means the Director of Enrollment and Discipline.
- (h) *Disciplinary Rule* is defined in § 10.20(b).
- (i) *Employee of a tribunal* includes all employees of courts, the Office, and other adjudicatory bodies.
- (j) *Giving information* within the meaning of § 10.23(c) (2) includes making (1) a written statement or representation or (2) an oral statement or representation.
- (k) *Law firm* includes a professional legal corporation or a partnership.
- (l) *Legal counsel* means practitioner.
- (m) *Legal profession* includes the individuals who are lawfully engaged in practice of patent, trademark, and other law before the Office.

(n) *Legal service* means any legal service which may lawfully be performed by a practitioner before the Office.

(o) *Legal System* includes the Office and courts and adjudicatory bodies which review matters on which the Office has acted.

(p) *Office* means Patent and Trademark Office.

(q) *Person* includes a corporation, an association, a trust, a partnership, and any other organization or legal entity.

(r) *Practitioner* means (1) an attorney or agent registered to practice before the Office in patent cases or (2) an individual authorized under 5 U.S.C. 500(b) or otherwise as provided by this subchapter, to practice before the Office in trademark cases or other non-patent cases. A “suspended or excluded practitioner” is a practitioner who is suspended or excluded under § 10.156. A “non-practitioner” is an individual who is not a practitioner.

(s) *A proceeding before the Office* includes an application, a reexamination, a protest, a public use proceeding, a patent interference, an *inter partes* trademark proceeding, or any other proceeding which is pending before the Office.

(t) *Professional legal corporation* means a corporation authorized by law to practice law for profit.

(u) *Registration* means registration to practice before the Office in patent cases.

(v) *Respondent* is defined in § 10.134(a)(1).

(w) *Secret* is defined in § 10.57(a).

(x) *Solicit* is defined in § 10.33.

(y) *State* includes the District of Columbia, Puerto Rico, and other federal territories and possessions.

(z) *Tribunal* includes courts, the Office, and other adjudicatory bodies.

(aa) *United States* means the United States of America, its territories and possessions.

[Added 50 FR 5172, Feb. 6, 1985, effective Mar. 8, 1985]

## § 10.2 Director of Enrollment and Discipline.

(a) *Appointment.* The Commissioner shall appoint a Director of Enrollment and Discipline. In the event of the absence of the Director or a vacancy in the Office of the Director, the Commissioner may designate an employee of the Office to serve as acting Director of Enrollment and Discipline. The Director

and any acting Director shall be an active member in good standing of the bar of a State.

(b) *Duties.* The Director shall:

(1) Receive and act upon applications for registration, prepare and grade the examination provided for in § 10.7(b), maintain the register provided for in § 10.5, and perform such other duties in connection with enrollment and recognition of attorneys and agents as may be necessary.

(2) Conduct investigations into possible violations by practitioners of Disciplinary Rules, with the consent of the Committee on Discipline initiate disciplinary proceedings under § 10.132(b), and perform such other duties in connection with investigations and disciplinary proceedings as may be necessary.

(c) *Review of Director’s decision.* Any final decision of the Director refusing to register an individual under § 10.6, recognize an individual under § 10.9 or § 10.14(c), or reinstate a suspended or excluded petitioner under § 10.160, may be reviewed by petition to the Commissioner upon payment of the fee set forth in § 1.21(a)(5). A petition filed more than 30 days after the date of the decision of the Director may be dismissed as untimely. Any petition shall contain (1) a statement of the facts involved and the points to be reviewed and (2) the action requested. Briefs or memoranda, if any, in support of the petition shall accompany or be embodied therein. The petition will be decided on the basis of the record made before the Director and no new evidence will be considered by the Commissioner in deciding the petition. Copies of documents already of record before the Director shall not be submitted with the petition. An oral hearing on the petition will not be granted except when considered necessary by the Commissioner.

[Added 50 FR 5173, Feb. 6, 1985, effective Mar. 8, 1985]

## § 10.3 Committee on Enrollment.

(a) The Commissioner may establish a Committee on Enrollment composed of one or more employees of the Office.

(b) The Committee on Enrollment shall, as necessary, advise the Director in connection with the Director’s duties under § 10.2(b)(1).

[Added 50 FR 5173, Feb. 6, 1985, effective Mar. 8, 1985]

**§ 10.4 Committee on Discipline.**

(a) The Commissioner shall appoint a Committee on Discipline. The Committee on Discipline shall consist of at least three employees of the Office, none of whom reports directly or indirectly to the Director or the Solicitor. Each member of the Committee on Discipline shall be a member in good standing of the bar of a State.

(b) The Committee on Discipline shall meet at the request of the Director and after reviewing evidence presented by the Director shall, by majority vote, determine whether there is probable cause to bring charges under § 10.132 against a practitioner. When charges are brought against a practitioner, no member of the Committee on Discipline, employee under the direction of the Director, or associate solicitor or assistant solicitor in the Office of Solicitor shall participate in rendering a decision on the charges.

(c) No discovery shall be authorized of, and no member of the Committee on Discipline shall be required to testify about, deliberations of the Committee on Discipline.

[Added 50 FR 5173, Feb. 6, 1985, effective Mar. 8, 1985]

## INDIVIDUALS ENTITLED TO PRACTICE BEFORE THE PATENT AND TRADEMARK OFFICE

**§ 10.5 Register of attorneys and agents in patent cases.**

A register of attorneys and agents is kept in the Office on which are entered the names of all individuals recognized as entitled to represent applicants before the Office in the preparation and prosecution of applications for patent. Registration in the Office under the provisions of this part shall only entitle the individuals registered to practice before the Office in patent cases.

[Added 50 FR 5173, Feb. 6, 1985, effective Mar. 8, 1985]

**§ 10.6 Registration of attorneys and agents.**

(a) *Attorneys.* Any citizen of the United States who is an attorney and who fulfills the requirements of this part may be registered as a patent attorney to practice before the Office. When appropriate, any

alien who is an attorney, who lawfully resides in the United States, and who fulfills the requirements of this part may be registered as a patent attorney to practice before the Office, *provided:* Registration is not inconsistent with the terms upon which the alien was admitted to, and resides in, the United States and *further provided:* The alien may remain registered only (1) if the alien continues to lawfully reside in the United States and registration does not become inconsistent with the terms upon which the alien continues to lawfully reside in the United States or (2) if the alien ceases to reside in the United States, the alien is qualified to be registered under paragraph (c) of this section. See also § 10.9(b).

(b) *Agents.* Any citizen of the United States who is not an attorney and who fulfills the requirements of this part may be registered as a patent agent to practice before the Office. When appropriate, any alien who is not an attorney, who lawfully resides in the United States, and who fulfills the requirements of this part may be registered as a patent agent to practice before the Office, *provided:* Registration is not inconsistent with the terms upon which the alien was admitted to, and resides in, the United States, and *further provided:* The alien may remain registered only (1) if the alien continues to lawfully reside in the United States and registration does not become inconsistent with the terms upon which the alien continues to lawfully reside in the United States or (2) if the alien ceases to reside in the United States, the alien is qualified to be registered under paragraph (c) of this section. See also § 10.9(b).

NOTE.—All individuals registered prior to November 15, 1938, were registered as attorneys, whether they were attorneys or not, and such registrations have not been changed.

(c) *Foreigners.* Any foreigner not a resident of the United States who shall file proof to the satisfaction of the Director that he or she is registered and in good standing before the patent office of the country in which he or she resides and practices and who is possessed of the qualifications stated in § 10.7, may be registered as a patent agent to practice before the Office for the limited purpose of presenting and prosecuting patent applications of applicants located in such country, *provided:* The patent office of such country allows substantially reciprocal privileges to those admitted to practice before the United States

Patent and Trademark Office. Registration as a patent agent under this paragraph shall continue only during the period that the conditions specified in this paragraph obtain.

[Added 50 FR 5173, Feb. 6, 1985, effective Mar. 8, 1985; paras. (d) & (e) removed 53 FR 38948, Oct. 4, 1988, effective Nov. 4, 1988]

### § 10.7 Requirements for registration.

(a) No individual will be registered to practice before the Office unless he or she shall:

(1) Apply to the Commissioner in writing on a form supplied by the Director and furnish all requested information and material and

(2) Establish to the satisfaction of the Director that he or she is:

(i) Of good moral character and repute;

(ii) Possessed of the legal, scientific, and technical qualifications necessary to enable him or her to render applicants valuable service; and

(iii) Is otherwise competent to advise and assist applicants for patents in the presentation and prosecution of their applications before the Office.

(b) In order that the Director may determine whether an individual seeking to have his or her name placed upon the register has the qualifications specified in paragraph (a) of this section, satisfactory proof of good moral character and repute and of sufficient basic training in scientific and technical matters must be submitted to the Director. Except as provided in this paragraph, each applicant for registration must take and pass an examination which is held from time to time. Each application for admission to take the examination for registration must be accompanied by the fee set forth in § 1.21(a)(1) of this subchapter. The taking of an examination may be waived in the case of any individual who has actively served for at least four years in the patent examining corps of the Office. The examination will not be administered as a mere academic exercise.

(c) Within two months from the date an applicant is notified that he or she failed an examination, the applicant may request regrading of the examination upon payment of the fee set forth in § 1.21(a)(6). Any applicant requesting regrading shall particularly point out the errors which the applicant believed occurred in the grading of his or her examination.

[Added 50 FR 5174, Feb. 6, 1985, effective Mar. 8, 1985]

### § 10.8 Oath and registration fee.

Before an individual may have his or her name entered on the register of attorneys and agents, the individual must, after his or her application is approved, subscribe and swear to an oath or make a declaration prescribed by the Commissioner and pay the registration fee set forth in § 1.21(a)(2) of this subchapter.

[Added 50 FR 5174, Feb. 6, 1985, effective Mar. 8, 1985]

### § 10.9 Limited recognition in patent cases.

(a) Any individual not registered under § 10.6 may, upon a showing of circumstances which render it necessary or justifiable, be given limited recognition by the Director to prosecute as attorney or agent a specified application or specified applications, but limited recognition under this paragraph shall not extend further than the application or applications specified.

(b) When registration of a resident alien under paragraphs (a) or (b) of § 10.6 is not appropriate, the resident alien may be given limited recognition as may be appropriate under paragraph (a) of this section.

(c) An individual not registered under § 10.6 may, if appointed by applicant to do so, prosecute an international application only before the U.S. International Searching Authority and the U.S. International Preliminary Examining Authority, provided: The individual has the right to practice before the national office with which the international application is filed (PCT Art. 49, Rule 90 and § 1.455) or before the International Bureau when acting as Receiving Office pursuant to PCT Rules 83.1<sup>bis</sup> and 90.1.

[Added 50 FR 5174, Feb. 6, 1985, effective Mar. 8, 1985; para. (c) added, 58 FR 4335, Jan. 14, 1993, effective May 1, 1993; para. (c) amended, 60 FR 21438, May 2, 1995, effective June 1, 1995]

### § 10.10 Restrictions on practice in patent cases.

(a) Only practitioners who are registered under § 10.6 or individuals given limited recognition under

§ 10.9 will be permitted to prosecute patent applications of others before the Office.

(b) No individual who has served in the patent examining corps of the Office may practice before the Office after termination of his or her service, unless he or she signs a written undertaking,

(1) Not to prosecute or aid in any manner in the prosecution of any patent application pending in any patent examining group during his or her period of service therein and

(2) Not to prepare or prosecute or to assist in any manner in the preparation or prosecution of any patent application of another (i) assigned to such group for examination and (ii) filed within two years after the date he or she left such group, without written authorization of the Director. Associated and related classes in other patent examining groups may be required to be included in the undertaking or designated classes may be excluded from the undertaking. When an application for registration is made after resignation from the Office, the applicant will not be registered if he or she has prepared or prosecuted or assisted in the preparation or prosecution of any patent application as indicated in the paragraph. Knowingly preparing or prosecuting or providing assistance in the preparation or prosecution of any patent application contrary to the provisions of this paragraph shall constitute misconduct under § 10.23(c)(13) of this part.

(c) A practitioner who is an employee of the Office cannot prosecute or aid in any manner in the prosecution of any patent application before the Office.

(d) Practice before the Office by Government employees is subject to any applicable conflict of interest laws, regulations or codes of professional responsibility.

[Added 50 FR 5175, Feb. 6, 1985, effective Mar. 8, 1985; revised 53 FR 38950, Oct. 4, 1988, effective Nov. 4, 1988; corrected 53 FR 41278, Oct. 20, 1988]

### § 10.11 Removing names from the register.

(a) Registered attorneys and agents shall notify the Director of any change of address. Any notification to the Director of any change of address shall be separate from any notice of change of address filed in individual applications.

(b) A letter may be addressed to any individual on the register, at the address of which separate notice was last received by the Director, for the purpose of ascertaining whether such individual desires to remain on the register. The name of any individual failing to reply and give any information requested by the Director within a time limit specified will be removed from the register and the names of individuals so removed will be published in the *Official Gazette*. The name of any individual so removed may be reinstated on the register as may be appropriate and upon payment of the fee set forth in § 1.21(a)(3) of this subchapter.

[Added 50 FR 5175, Feb. 6, 1985, effective Mar. 8, 1985]

### § 10.12 - 10.13 [Reserved]

### § 10.14 Individuals who may practice before the Office in trademark and other non-patent cases.

(a) *Attorneys*. Any individual who is an attorney may represent others before the Office in trademark and other non-patent cases. An attorney is not required to apply for registration or recognition to practice before the Office in trademark and other non-patent cases.

(b) *Non-lawyers*. Individuals who are not attorneys are not recognized to practice before the Office in trademark and other non-patent cases, except that individuals not attorneys who were recognized to practice before the Office in trademark cases under this chapter prior to January 1, 1957, will be recognized as agents to continue practice before the Office in trademark cases.

(c) *Foreigners*. Any foreign attorney or agent not a resident of the United States who shall prove to the satisfaction of the Director that he or she is registered or in good standing before the patent or trademark office of the country in which he or she resides and practices, may be recognized for the limited purpose of representing parties located in such country before the Office in the presentation and prosecution of trademark cases, *provided*: The patent or trademark office of such country allows substantially reciprocal privileges to those permitted to practice in trademark cases before the United States Patent and Trademark

Office. Recognition under this paragraph shall continue only during the period that the conditions specified in this paragraph obtain.

(d) Recognition of any individual under this section shall not be construed as sanctioning or authorizing the performance of any act regarded in the jurisdiction where performed as the unauthorized practice of law.

(e) No individual other than those specified in paragraphs (a), (b), and (c) of this section will be permitted to practice before the Office in trademark cases. Any individual may appear in a trademark or other non-patent case in his or her own behalf. Any individual may appear in a trademark case for (1) a firm of which he or she is a member or (2) a corporation or association of which he or she is an officer and which he or she is authorized to represent, if such firm, corporation, or association is a party to a trademark proceeding pending before the Office.

[Added 50 FR 5175, Feb. 6, 1985, effective Mar. 8, 1985]

#### § 10.15 Refusal to recognize a practitioner.

Any practitioner authorized to appear before the Office may be suspended or excluded in accordance with the provisions of this part. Any practitioner who is suspended or excluded under this subpart or removed under § 10.11(b) shall not be entitled to practice before the Office.

[Added 50 FR 5175, Feb. 6, 1985, effective Mar. 8, 1985]

#### § 10.16 - 10.17 [Reserved]

#### § 10.18 Signature and certificate for correspondence filed in the Patent and Trademark Office.

(a) For all documents filed in the Office in patent, trademark, and other non-patent matters, except for correspondence that is required to be signed by the applicant or party, each piece of correspondence filed by a practitioner in the Patent and Trademark Office must bear a signature, personally signed by such practitioner, in compliance with § 1.4(d)(1) of this chapter.

(b) By presenting to the Office (whether by signing, filing, submitting, or later advocating) any paper, the party presenting such paper, whether a practitioner or non-practitioner, is certifying that—

(1) All statements made therein of the party's own knowledge are true, all statements made therein on information and belief are believed to be true, and all statements made therein are made with the knowledge that whoever, in any matter within the jurisdiction of the Patent and Trademark Office, knowingly and willfully falsifies, conceals, or covers up by any trick, scheme, or device a material fact, or makes any false, fictitious or fraudulent statements or representations, or makes or uses any false writing or document knowing the same to contain any false, fictitious or fraudulent statement or entry, shall be subject to the penalties set forth under 18 U.S.C. 1001, and that violations of this paragraph may jeopardize the validity of the application or document, or the validity or enforceability of any patent, trademark registration, or certificate resulting therefrom; and

(2) To the best of the party's knowledge, information and belief, formed after an inquiry reasonable under the circumstances, that —

(i) The paper is not being presented for any improper purpose, such as to harass someone or to cause unnecessary delay or needless increase in the cost of prosecution before the Office;

(ii) The claims and other legal contentions therein are warranted by existing law or by a nonfrivolous argument for the extension, modification, or reversal of existing law or the establishment of new law;

(iii) The allegations and other factual contentions have evidentiary support or, if specifically so identified, are likely to have evidentiary support after a reasonable opportunity for further investigation or discovery; and

(iv) The denials of factual contentions are warranted on the evidence, or if specifically so identified, are reasonably based on a lack of information or belief.

(c) Violations of paragraph (b)(1) of this section by a practitioner or non-practitioner may jeopardize the validity of the application or document, or the validity or enforceability of any patent, trademark registration, or certificate resulting therefrom. Violations of any of paragraphs (b)(2)(i) through (iv) of this

section are, after notice and reasonable opportunity to respond, subject to such sanctions as deemed appropriate by the Commissioner, or the Commissioner's designee, which may include, but are not limited to, any combination of —

- (1) Holding certain facts to have been established;
- (2) Returning papers;
- (3) Precluding a party from filing a paper, or presenting or contesting an issue;
- (4) Imposing a monetary sanction;
- (5) Requiring a terminal disclaimer for the period of the delay; or
- (6) Terminating the proceedings in the Patent and Trademark Office.

(d) Any practitioner violating the provisions of this section may also be subject to disciplinary action. See § 10.23(c)(15).

[Added 50 FR 5175, Feb. 6, 1985, effective Mar. 8, 1985; para. (a) revised, 58 FR 54494, Oct. 22, 1993, effective Nov. 22, 1993; paras. (a) & (b) revised, paras. (c) & (d) added, 62 FR 53131, Oct. 10, 1997, effective Dec. 1, 1997]

### § 10.19 [Reserved]

## PATENT AND TRADEMARK OFFICE CODE OF PROFESSIONAL RESPONSIBILITY

### § 10.20 Canons and Disciplinary Rules.

(a) Canons are set out in §§ 10.21, 10.30, 10.46, 10.56, 10.61, 10.76, 10.83, 10.100, and 10.110. Canons are statements of axiomatic norms, expressing in general terms the standards of professional conduct expected of practitioners in their relationships with the public, with the legal system, and with the legal profession.

(b) Disciplinary Rules are set out in §§ 10.22-10.24, 10.31-10.40, 10.47-10.57, 10.62-10.68, 10.77, 10.78, 10.84, 10.85, 10.87-10.89, 10.92, 10.93, 10.101-10.103, 10.111, and 10.112. Disciplinary Rules are mandatory in character and state the minimum level of conduct below which no practitioner can fall without being subjected to disciplinary action.

[Added 50 FR 5175, Feb. 6, 1985, effective Mar. 8, 1985]

### § 10.21 Canon 1.

A practitioner should assist in maintaining the integrity and competence of the legal profession.

[Added 50 FR 5175, Feb. 6, 1985, effective Mar. 8, 1985]

### § 10.22 Maintaining integrity and competence of the legal profession.

(a) A practitioner is subject to discipline if the practitioner has made a materially false statement in, or if the practitioner has deliberately failed to disclose a material fact requested in connection with, the practitioner's application for registration or membership in the bar of any United States court or any State court or his or her authority to otherwise practice before the Office in trademark and other non-patent cases.

(b) A practitioner shall not further the application for registration or membership in the bar of any United States court, State court, or administrative agency of another person known by the practitioner to be unqualified in respect to character, education, or other relevant attribute.

[Added 50 FR 5175, Feb. 6, 1985, effective Mar. 8, 1985]

### § 10.23 Misconduct.

(a) A practitioner shall not engage in disreputable or gross misconduct.

(b) A practitioner shall not:

- (1) Violate a Disciplinary Rule.
- (2) Circumvent a Disciplinary Rule through actions of another.
- (3) Engage in illegal conduct involving moral turpitude.
- (4) Engage in conduct involving dishonesty, fraud, deceit, or misrepresentation.
- (5) Engage in conduct that is prejudicial to the administration of justice.
- (6) Engage in any other conduct that adversely reflects on the practitioner's fitness to practice before the Office.

(c) Conduct which constitutes a violation of paragraphs (a) and (b) of this section includes, but is not limited to:

- (1) Conviction of a criminal offense involving moral turpitude, dishonesty, or breach of trust.

(2) Knowingly giving false or misleading information or knowingly participating in a material way in giving false or misleading information, to:

(i) A client in connection with any immediate, prospective, or pending business before the Office.

(ii) The Office or any employee of the Office.

(3) Misappropriation of, or failure to properly or timely remit, funds received by a practitioner or the practitioner's firm from a client to pay a fee which the client is required by law to pay to the Office.

(4) Directly or indirectly improperly influencing, attempting to improperly influence, offering or agreeing to improperly influence, or attempting to offer or agree to improperly influence an official action of any employee of the Office by:

(i) Use of threats, false accusations, duress, or coercion,

(ii) An offer of any special inducement or promise of advantage, or

(iii) Improperly bestowing of any gift, favor, or thing of value.

(5) Suspension or disbarment from practice as an attorney or agent on ethical grounds by any duly constituted authority of a State or the United States or, in the case of a practitioner who resides in a foreign country or is registered under § 10.6(c), by any duly constituted authority of:

(i) A State,

(ii) The United States, or

(iii) The country in which the practitioner resides.

(6) Knowingly aiding or abetting a practitioner suspended or excluded from practice before the Office in engaging in unauthorized practice before the Office under § 10.158.

(7) Knowingly withholding from the Office information identifying a patent or patent application of another from which one or more claims have been copied. See §§ 1.604(b) and 1.607(c) of this subchapter.

(8) Failing to inform a client or former client or failing to timely notify the Office of an inability to notify a client or former client of correspondence received from the Office or the client's or former client's opponent in an *inter partes* proceeding before

the Office when the correspondence (i) could have a significant effect on a matter pending before the Office, (ii) is received by the practitioner on behalf of a client or former client and (iii) is correspondence of which a reasonable practitioner would believe under the circumstances the client or former client should be notified.

(9) Knowingly misusing a "Certificate of Mailing or Transmission" under § 1.8 of this chapter.

(10) Knowingly violating or causing to be violated the requirements of § 1.56 or § 1.555 of this subchapter.

(11) Except as permitted by § 1.52(c) of this chapter, knowingly filing or causing to be filed an application containing any material alteration made in the application papers after the signing of the accompanying oath or declaration without identifying the alteration at the time of filing the application papers.

(12) Knowingly filing, or causing to be filed, a frivolous complaint alleging a violation by a practitioner of the Patent and Trademark Office Code of Professional Responsibility.

(13) Knowingly preparing or prosecuting or providing assistance in the preparation or prosecution of a patent application in violation of an undertaking signed under § 10.10(b).

(14) Knowingly failing to advise the Director in writing of any change which would preclude continued registration under § 10.6.

(15) Signing a paper filed in the Office in violation of the provisions of § 10.18 or making a scandalous or indecent statement in a paper filed in the Office.

(16) Willfully refusing to reveal or report knowledge or evidence to the Director contrary to § 10.24 or paragraph (b) of § 10.131.

(17) Representing before the Office in a patent case either a joint venture comprising an inventor and an invention developer or an inventor referred to the registered practitioner by an invention developer when (i) the registered practitioner knows, or has been advised by the Office, that a formal complaint filed by a Federal or State agency, based on any violation of any law relating to securities, unfair methods of competition, unfair or deceptive acts or practices, mail fraud, or other civil or criminal conduct, is pending before a Federal or State court or Federal or State agency, or has been resolved unfavorably by such



court or agency, against the invention developer in connection with invention development services and (ii) the registered practitioner fails to fully advise the inventor of the existence of the pending complaint or unfavorable resolution thereof prior to undertaking or continuing representation of the joint venture or inventor. “Invention developer” means any person, and any agent, employee, officer, partner, or independent contractor thereof, who is not a registered practitioner and who advertises invention development services in media of general circulation or who enters into contracts for invention development services with customers as a result of such advertisement. “Invention development services” means acts of invention development required or promised to be performed, or actually performed, or both, by an invention developer for a customer. “Invention development” means the evaluation, perfection, marketing, brokering, or promotion of an invention on behalf of a customer by an invention developer, including a patent search, preparation of a patent application, or any other act done by an invention developer for consideration toward the end of procuring or attempting to procure a license, buyer, or patent for an invention. “Customer” means any individual who has made an invention and who enters into a contract for invention development services with an invention developer with respect to the invention by which the inventor becomes obligated to pay the invention developer less than \$5,000 (not to include any additional sums which the invention developer is to receive as a result of successful development of the invention). “Contract for invention development services” means a contract for invention development services with an invention developer with respect to an invention made by a customer by which the inventor becomes obligated to pay the invention developer less than \$5,000 (not to include any additional sums which the invention developer is to receive as a result of successful development of the invention).

(18) In the absence of information sufficient to establish a reasonable belief that fraud or inequitable conduct has occurred, alleging before a tribunal that anyone has committed a fraud on the Office or engaged in inequitable conduct in a proceeding before the Office.

(19) Action by an employee of the Office contrary to the provisions set forth in § 10.10(c).

(20) Knowing practice by a Government employee contrary to applicable Federal conflict of interest laws, or regulations of the Department, agency, or commission employing said individual.

(d) A practitioner who acts with reckless indifference to whether a representation is true or false is chargeable with knowledge of its falsity. Deceitful statements of half-truths or concealment of material facts shall be deemed actual fraud within the meaning of this part.

[Added 50 FR 5175, Feb. 6, 1985, effective Mar. 8, 1985; amended 50 FR 25073, June 17, 1985; 50 FR 25980, June 24, 1985; paras. (c)(13), (19) & (20), 53 FR 38950, Oct. 4, 1988, effective Nov. 4, 1988; corrected 53 FR 41278, Oct. 20, 1988; paras. (c)(10) & (c)(11), 57 FR 2021, Jan. 17, 1992, effective Mar. 16, 1992; para. (c)(9) amended, 58 FR 54494, Oct. 22, 1993, effective Nov. 22, 1993; para. (c)(9) amended, 61 FR 56439, Nov. 1, 1996, effective Dec. 2, 1996; para. (c)(15) amended, 62 FR 53131, Oct. 10, 1997, effective Dec. 1, 1997; para. (c)(11) revised, 65 FR 54604, Sept. 8, 2000, effective Nov. 7, 2000]

#### § 10.24 Disclosure of information to authorities.

(a) A practitioner possessing unprivileged knowledge of a violation of a Disciplinary Rule shall report such knowledge to the Director.

(b) A practitioner possessing unprivileged knowledge or evidence concerning another practitioner, employee of the Office, or a judge shall reveal fully such knowledge or evidence upon proper request of a tribunal or other authority empowered to investigate or act upon the conduct of practitioners, employees of the Office, or judges.

[Added 50 FR 5176, Feb. 6, 1985, effective Mar. 8, 1985]

#### § 10.25 - 10.29 [Reserved]

#### § 10.30 Canon 2.

A practitioner should assist the legal profession in fulfilling its duty to make legal counsel available.

[Added 50 FR 5177, Feb. 6, 1985, effective Mar. 8, 1985]

**§ 10.31 Communications concerning a practitioner's services.**

(a) No practitioner shall with respect to any prospective business before the Office, by word, circular, letter, or advertising, with intent to defraud in any manner, deceive, mislead, or threaten any prospective applicant or other person having immediate or prospective business before the Office.

(b) A practitioner may not use the name of a Member of either House of Congress or of an individual in the service of the United States in advertising the practitioner's practice before the Office.

(c) Unless authorized under § 10.14(b), a non-lawyer practitioner shall not hold himself or herself out as authorized to practice before the Office in trademark cases.

(d) Unless a practitioner is an attorney, the practitioner shall not hold himself or herself out:

(1) To be an attorney or lawyer or

(2) As authorized to practice before the Office in non-patent and trademark cases.

[Added 50 FR 5177, Feb. 6, 1985, effective Mar. 8, 1985]

**§ 10.32 Advertising.**

(a) Subject to § 10.31, a practitioner may advertise services through public media, including a telephone directory, legal directory, newspaper, or other periodical, radio, or television, or through written communications not involving solicitation as defined by § 10.33.

(b) A practitioner shall not give anything of value to a person for recommending the practitioner's services, except that a practitioner may pay the reasonable cost of advertising or written communication permitted by this section and may pay the usual charges of a not-for-profit lawyer referral service or other legal service organization.

(c) Any communication made pursuant to this section shall include the name of at least one practitioner responsible for its content.

[Added 50 FR 5177, Feb. 6, 1985, effective Mar. 8, 1985]

**§ 10.33 Direct contact with prospective clients.**

A practitioner may not solicit professional employment from a prospective client with whom the practi-

tioner has no family or prior professional relationship, by mail, in-person, or otherwise, when a significant motive for the practitioner's doing so is the practitioner's pecuniary gain under circumstances evidencing undue influence, intimidation, or overreaching. The term "solicit" includes contact in person, by telephone or telegraph, by letter or other writing, or by other communication directed to a specific recipient, but does not include letters addressed or advertising circulars distributed generally to persons not specifically known to need legal services of the kind provided by the practitioner in a particular matter, but who are so situated that they might in general find such services useful.

[Added 50 FR 5177, Feb.6, 1985, effective Mar. 8, 1985]

**§ 10.34 Communication of fields of practice.**

A registered practitioner may state or imply that the practitioner is a specialist as follows:

(a) A registered practitioner who is an attorney may use the designation "Patents," "Patent Attorney," "Patent Lawyer," "Registered Patent Attorney," or a substantially similar designation.

(b) A registered practitioner who is not an attorney may use the designation "Patents," "Patent Agent," "Registered Patent Agent," or a substantially similar designation, except that any practitioner who was registered prior to November 15, 1938, may refer to himself or herself as a "patent attorney."

[Added 50 FR 5177, Feb. 6, 1985, effective Mar. 8, 1985]

**§ 10.35 Firm names and letterheads.**

(a) A practitioner shall not use a firm name, letterhead, or other professional designation that violates § 10.31. A trade name may be used by a practitioner in private practice if it does not imply a current connection with a government agency or with a public or charitable legal services organization and is not otherwise in violation of § 10.31.

(b) Practitioners may state or imply that they practice in a partnership or other organization only when that is the fact.

[Added 50 FR 5177, Feb. 6, 1985, effective Mar. 8, 1985]

**§ 10.36 Fees for legal services.**

(a) A practitioner shall not enter into an agreement for, charge, or collect an illegal or clearly excessive fee.

(b) A fee is clearly excessive when, after a review of the facts, a practitioner of ordinary prudence would be left with a definite and firm conviction that the fee is in excess of a reasonable fee. Factors to be considered as guides in determining the reasonableness of a fee include the following:

(1) The time and labor required, the novelty and difficulty of the questions involved, and the skill requisite to perform the legal service properly.

(2) The likelihood, if apparent to the client, that the acceptance of the particular employment will preclude other employment by the practitioner.

(3) The fee customarily charged for similar legal services.

(4) The amount involved and the results obtained.

(5) The time limitations imposed by the client or by the circumstances.

(6) The nature and length of the professional relationship with the client.

(7) The experience, reputation, and ability of the practitioner or practitioners performing the services.

(8) Whether the fee is fixed or contingent.

[Added 50 FR 5177, Feb. 6, 1985, effective Mar. 8, 1985]

**§ 10.37 Division of fees among practitioners.**

(a) A practitioner shall not divide a fee for legal services with another practitioner who is not a partner in or associate of the practitioner's law firm or law office, unless:

(1) The client consents to employment of the other practitioner after a full disclosure that a division of fees will be made.

(2) The division is made in proportion to the services performed and responsibility assumed by each.

(3) The total fee of the practitioners does not clearly exceed reasonable compensation for all legal services rendered to the client.

(b) This section does not prohibit payment to a former partner or associate pursuant to a separation or retirement agreement.

[Added 50 FR 5177, Feb. 6, 1985, effective Mar. 8, 1985]

**§ 10.38 Agreements restricting the practice of a practitioner.**

(a) A practitioner shall not be a party to or participate in a partnership or employment agreement with another practitioner that restricts the right of a practitioner to practice before the Office after the termination of a relationship created by the agreement, except as a condition to payment of retirement benefits.

(b) In connection with the settlement of a controversy or suit, a practitioner shall not enter into an agreement that restricts the practitioner's right to practice before the Office.

[Added 50 FR 5177, Feb. 6, 1985, effective Mar. 8, 1985]

**§ 10.39 Acceptance of employment.**

A practitioner shall not accept employment on behalf of a person if the practitioner knows or it is obvious that such person wishes to:

(a) Bring a legal action, commence a proceeding before the Office, conduct a defense, assert a position in any proceeding pending before the Office, or otherwise have steps taken for the person, merely for the purpose of harassing or maliciously injuring any other person.

(b) Present a claim or defense in litigation or any proceeding before the Office that it is not warranted under existing law, unless it can be supported by good faith argument for an extension, modification, or reversal of existing law.

[Added 50 FR 5177, Feb. 6, 1985, effective Mar. 8, 1985]

**§ 10.40 Withdrawal from employment.**

(a) A practitioner shall not withdraw from employment in a proceeding before the Office without permission from the Office (see §§ 1.36 and 2.19 of this subchapter). In any event, a practitioner shall not withdraw from employment until the practitioner has taken reasonable steps to avoid foreseeable prejudice to the rights of the client, including giving due notice to his or her client, allowing time for employment of another practitioner, delivering to the client all papers

and property to which the client is entitled, and complying with applicable laws and rules. A practitioner who withdraws from employment shall refund promptly any part of a fee paid in advance that has not been earned.

(b) *Mandatory withdrawal.* A practitioner representing a client before the Office shall withdraw from employment if:

(1) The practitioner knows or it is obvious that the client is bringing a legal action, commencing a proceeding before the Office, conducting a defense, or asserting a position in litigation or any proceeding pending before the Office, or is otherwise having steps taken for the client, merely for the purpose of harassing or maliciously injuring any person;

(2) The practitioner knows or it is obvious that the practitioner's continued employment will result in violation of a Disciplinary Rule;

(3) The practitioner's mental or physical condition renders it unreasonably difficult for the practitioner to carry out the employment effectively; or

(4) The practitioner is discharged by the client.

(c) *Permissive withdrawal.* If paragraph (b) of this section is not applicable, a practitioner may not request permission to withdraw in matters pending before the Office unless such request or such withdrawal is because:

(1) The petitioner's client:

(i) Insists upon presenting a claim or defense that is not warranted under existing law and cannot be supported by good faith argument for an extension, modification, or reversal of existing law;

(ii) Personally seeks to pursue an illegal course of conduct;

(iii) Insists that the practitioner pursue a course of conduct that is illegal or that is prohibited under a Disciplinary Rule;

(iv) By other conduct renders it unreasonably difficult for the practitioner to carry out the employment effectively;

(v) Insists, in a matter not pending before a tribunal, that the practitioner engage in conduct that is contrary to the judgment and advice of the practitioner but not prohibited under the Disciplinary Rule; or

(vi) Has failed to pay one or more bills rendered by the practitioner for an unreasonable period of time or has failed to honor an agreement to pay a

retainer in advance of the performance of legal services.

(2) The practitioner's continued employment is likely to result in a violation of a Disciplinary Rule;

(3) The practitioner's inability to work with co-counsel indicates that the best interests of the client likely will be served by withdrawal;

(4) The practitioner's mental or physical condition renders it difficult for the practitioner to carry out the employment effectively;

(5) The practitioner's client knowingly and freely assents to termination of the employment; or

(6) The practitioner believes in good faith, in a proceeding pending before the Office, that the Office will find the existence of other good cause for withdrawal.

[Added 50 FR 5178, Feb. 6, 1985, effective Mar. 8, 1985]

#### § 10.41 - 10.45 [Reserved]

#### § 10.46 Canon 3.

A practitioner should assist in preventing the unauthorized practice of law.

[Added 50 FR 5178, Feb. 6, 1985, effective Mar. 8, 1985]

#### § 10.47 Aiding unauthorized practice of law.

(a) A practitioner shall not aid a non-practitioner in the unauthorized practice of law before the Office.

(b) A practitioner shall not aid a suspended or excluded practitioner in the practice of law before the Office.

(c) A practitioner shall not aid a non-lawyer in the unauthorized practice of law.

[Added 50 FR 5178, Feb. 6, 1985, effective Mar. 8, 1985]

#### § 10.48 Sharing legal fees.

A practitioner or a firm of practitioners shall not share legal fees with a non-practitioner except that:

(a) An agreement by a practitioner with the practitioner's firm, partner, or associate may provide for the payment of money, over a reasonable period of

time after the practitioner's death, to the practitioner's estate or to one or more specified persons.

(b) A practitioner who undertakes to complete unfinished legal business of a deceased practitioner may pay to the estate of the deceased practitioner that proportion of the total compensation which fairly represents the services rendered by the deceased practitioner.

(c) A practitioner or firm of practitioners may include non-practitioner employees in a compensation or retirement plan, even though the plan is based in whole or in part on a profit-sharing arrangement, providing such plan does not circumvent another Disciplinary Rule.

[Added 50 FR 5178, Feb. 6, 1985, effective Mar. 8, 1985; para. (b) revised, 58 FR 54511, Oct. 22, 1993, effective June 3, 1994]

#### § 10.49 Forming a partnership with a non-practitioner.

A practitioner shall not form a partnership with a nonpractitioner if any of the activities of the partnership consist of the practice of patent, trademark, or other law before the Office.

[Added 50 FR 5178, Feb. 6, 1985, effective Mar. 8, 1985]

#### § 10.50 - 10.55 [Reserved]

#### § 10.56 Canon 4.

A practitioner should preserve the confidences and secrets of a client.

[Added 50 FR 5178, Feb. 6, 1985, effective Mar. 8, 1985]

#### § 10.57 Preservation of confidences and secrets of a client.

(a) "Confidence" refers to information protected by the attorney-client or agent-client privilege under applicable law. "Secret" refers to other information gained in the professional relationship that the client has requested be held inviolate or the disclosure of which would be embarrassing or would be likely to be detrimental to the client.

(b) Except when permitted under paragraph (c) of this section, a practitioner shall not knowingly:

- (1) Reveal a confidence or secret of a client.
- (2) Use a confidence or secret of a client to the disadvantage of the client.
- (3) Use a confidence or secret of a client for the advantage of the practitioner or of a third person, unless the client consents after full disclosure.
- (c) A practitioner may reveal:

(1) Confidences or secrets with the consent of the client affected but only after a full disclosure to the client.

(2) Confidences or secrets when permitted under Disciplinary Rules or required by law or court order.

(3) The intention of a client to commit a crime and the information necessary to prevent the crime.

(4) Confidences or secrets necessary to establish or collect the practitioner's fee or to defend the practitioner or the practitioner's employees or associates against an accusation of wrongful conduct.

(d) A practitioner shall exercise reasonable care to prevent the practitioner's employees, associates, and others whose services are utilized by the practitioner from disclosing or using confidences or secrets of a client, except that a practitioner may reveal the information allowed by paragraph (c) of this section through an employee.

[Added 50 FR 5178, Feb. 6, 1985, effective Mar. 8, 1985]

#### § 10.58 - 10.60 [Reserved]

#### § 10.61 Canon 5.

A practitioner should exercise independent professional judgment on behalf of a client.

[Added 50 FR 5179, Feb. 6, 1985, effective Mar. 8, 1985]

#### § 10.62 Refusing employment when the interest of the practitioner may impair the practitioner's independent professional judgment.

(a) Except with the consent of a client after full disclosure, a practitioner shall not accept employment if the exercise of the practitioner's professional judgment on behalf of the client will be or reasonably may

be affected by the practitioner's own financial, business, property, or personal interests.

(b) A practitioner shall not accept employment in a proceeding before the Office if the practitioner knows or it is obvious that the practitioner or another practitioner in the practitioner's firm ought to sign an affidavit to be filed in the Office or be called as a witness, except that the practitioner may undertake the employment and the practitioner or another practitioner in the practitioner's firm may testify:

(1) If the testimony will relate solely to an uncontested matter.

(2) If the testimony will relate solely to a matter of formality and there is no reason to believe that substantial evidence will be offered in opposition to the testimony.

(3) If the testimony will relate solely to the nature and value of legal services rendered in the case by the practitioner or the practitioner's firm to the client.

(4) As to any matter, if refusal would work a substantial hardship on the client because of the distinctive value of the practitioner or the practitioner's firm as counsel in the particular case.

[Added 50 FR 5179, Feb. 6, 1985, effective Mar. 8, 1985]

#### **§ 10.63 Withdrawal when the practitioner becomes a witness.**

(a) If, after undertaking employment in a proceeding in the Office, a practitioner learns or it is obvious that the practitioner or another practitioner in the practitioner's firm ought to sign an affidavit to be filed in the Office or be called as a witness on behalf of a practitioner's client, the practitioner shall withdraw from the conduct of the proceeding and the practitioner's firm, if any, shall not continue representation in the proceeding, except that the practitioner may continue the representation and the practitioner or another practitioner in the practitioner's firm may testify in the circumstances enumerated in paragraphs (1) through (4) of § 10.62(b).

(b) If, after undertaking employment in a proceeding before the Office, a practitioner learns or it is obvious that the practitioner or another practitioner in the practitioner's firm may be asked to sign an affidavit to be filed in the Office or be called as a witness other than on behalf of the practitioner's client, the

practitioner may continue the representation until it is apparent that the practitioner's affidavit or testimony is or may be prejudicial to the practitioner's client.

[Added 50 FR 5179, Feb. 6, 1985, effective Mar. 8, 1985]

#### **§ 10.64 Avoiding acquisition of interest in litigation or proceeding before the Office.**

(a) A practitioner shall not acquire a proprietary interest in the subject matter of a proceeding before the Office which the practitioner is conducting for a client, except that the practitioner may:

(1) Acquire a lien granted by law to secure the practitioner's fee or expenses; or

(2) Contract with a client for a reasonable contingent fee; or

(3) In a patent case, take an interest in the patent as part or all of his or her fee.

(b) While representing a client in connection with a contemplated or pending proceeding before the Office, a practitioner shall not advance or guarantee financial assistance to a client, except that a practitioner may advance or guarantee the expenses of going forward in a proceeding before the Office including fees required by law to be paid to the Office, expenses of investigation, expenses of medical examination, and costs of obtaining and presenting evidence, provided the client remains ultimately liable for such expenses. A practitioner may, however, advance any fee required to prevent or remedy an abandonment of a client's application by reason of an act or omission attributable to the practitioner and not to the client, whether or not the client is ultimately liable for such fee.

[Added 50 FR 5179, Feb. 6, 1985, effective Mar. 8, 1985]

#### **§ 10.65 Limiting business relations with a client.**

A practitioner shall not enter into a business transaction with a client if they have differing interests therein and if the client expects the practitioner to exercise professional judgment therein for the protection of the client, unless the client has consented after full disclosure.

[Added 50 FR 5179, Feb. 6, 1985, effective Mar. 8, 1985]

**§ 10.66 Refusing to accept or continue employment if the interests of another client may impair the independent professional judgment of the practitioner.**

(a) A practitioner shall decline proffered employment if the exercise of the practitioner's independent professional judgment in behalf of a client will be or is likely to be adversely affected by the acceptance of the proffered employment, or if it would be likely to involve the practitioner in representing differing interests, except to the extent permitted under paragraph (c) of this section.

(b) A practitioner shall not continue multiple employment if the exercise of the practitioner's independent professional judgment in behalf of a client will be or is likely to be adversely affected by the practitioner's representation of another client, or if it would be likely to involve the practitioner in representing differing interests, except to the extent permitted under paragraph (c) of this section.

(c) In the situations covered by paragraphs (a) and (b) of this section, a practitioner may represent multiple clients if it is obvious that the practitioner can adequately represent the interest of each and if each consents to the representation after full disclosure of the possible effect of such representation on the exercise of the practitioner's independent professional judgment on behalf of each.

(d) If a practitioner is required to decline employment or to withdraw from employment under a Disciplinary Rule, no partner, or associate, or any other practitioner affiliated with the practitioner or the practitioner's firm, may accept or continue such employment unless otherwise ordered by the Director or Commissioner.

[Added 50 FR 5179, Feb. 6, 1985, effective Mar. 8, 1985]

**§ 10.67 Settling similar claims of clients.**

A practitioner who represents two or more clients shall not make or participate in the making of an aggregate settlement of the claims of or against the practitioner's clients, unless each client has consented to the settlement after being advised of the existence and nature of all the claims involved in the proposed settlement, of the total amount of the settlement, and of the participation of each person in the settlement.

[Added 50 FR 5179, Feb. 6, 1985, effective Mar. 8, 1985]

**§ 10.68 Avoiding influence by others than the client.**

(a) Except with the consent of the practitioner's client after full disclosure, a practitioner shall not:

(1) Accept compensation from one other than the practitioner's client for the practitioner's legal services to or for the client.

(2) Accept from one other than the practitioner's client any thing of value related to the practitioner's representation of or the practitioner's employment by the client.

(b) A practitioner shall not permit a person who recommends, employs, or pays the practitioner to render legal services for another, to direct or regulate the practitioner's professional judgment in rendering such legal services.

(c) A practitioner shall not practice with or in the form of a professional corporation or association authorized to practice law for a profit, if a non-practitioner has the right to direct or control the professional judgment of a practitioner.

[Added 50 FR 5180, Feb. 6, 1985, effective Mar. 8, 1985]

**§ 10.69 - 10.75 [Reserved]**

**§ 10.76 Canon 6.**

A practitioner should represent a client competently.

[Added 50 FR 5180, Feb. 6, 1985, effective Mar. 8, 1985]

**§ 10.77 Failing to act competently.**

A practitioner shall not:

(a) Handle a legal matter which the practitioner knows or should know that the practitioner is not competent to handle, without associating with the practitioner another practitioner who is competent to handle it.

(b) Handle a legal matter without preparation adequate in the circumstances.

(c) Neglect a legal matter entrusted to the practitioner.

[Added 50 FR 5180, Feb. 6, 1985, effective Mar. 8, 1985]

**§ 10.78 Limiting liability to client.**

A practitioner shall not attempt to exonerate himself or herself from, or limit his or her liability to, a client for his or her personal malpractice.

[Added 50 FR 5180, Feb. 6, 1985, effective Mar. 8, 1985]

**§ 10.79 - 10.82 [Reserved]**

**§ 10.83 Canon 7.**

A practitioner should represent a client zealously within the bounds of the law.

[Added 50 FR 5180, Feb. 6, 1985, effective Mar. 8, 1985]

**§ 10.84 Representing a client zealously.**

(a) A practitioner shall not intentionally:

(1) Fail to seek the lawful objectives of a client through reasonable available means permitted by law and the Disciplinary Rules, except as provided by paragraph (b) of this section. A practitioner does not violate the provisions of this section, however, by acceding to reasonable requests of opposing counsel which do not prejudice the rights of the client, by being punctual in fulfilling all professional commitments, by avoiding offensive tactics, or by treating with courtesy and consideration all persons involved in the legal process.

(2) Fail to carry out a contract of employment entered into with a client for professional services, but a practitioner may withdraw as permitted under §§ 10.40, 10.63, and 10.66.

(3) Prejudice or damage a client during the course of a professional relationship, except as required under this part.

(b) In representation of a client, a practitioner may:

(1) Where permissible, exercise professional judgment to waive or fail to assert a right or position of the client.

(2) Refuse to aid or participate in conduct that the practitioner believes to be unlawful, even

though there is some support for an argument that the conduct is legal.

[Added 50 FR 5180, Feb. 6, 1985, effective Mar. 8, 1985]

**§ 10.85 Representing a client within the bounds of the law.**

(a) In representation of a client, a practitioner shall not:

(1) Initiate or defend any proceeding before the Office, assert a position, conduct a defense, delay a trial or proceeding before the Office, or take other action on behalf of the practitioner's client when the practitioner knows or when it is obvious that such action would serve merely to harass or maliciously injure another.

(2) Knowingly advance a claim or defense that is unwarranted under existing law, except that a practitioner may advance such claim or defense if it can be supported by good faith argument for an extension, modification, or reversal of existing law.

(3) Conceal or knowingly fail to disclose that which the practitioner is required by law to reveal.

(4) Knowingly use perjured testimony or false evidence.

(5) Knowingly make a false statement of law or fact.

(6) Participate in the creation or preservation of evidence when the practitioner knows or it is obvious that the evidence is false.

(7) Counsel or assist a client in conduct that the practitioner knows to be illegal or fraudulent.

(8) Knowingly engage in other illegal conduct or conduct contrary to a Disciplinary Rule.

(b) A practitioner who receives information clearly establishing that:

(1) A client has, in the course of the representation, perpetrated a fraud upon a person or tribunal shall promptly call upon the client to rectify the same, and if the client refuses or is unable to do so the practitioner shall reveal the fraud to the affected person or tribunal.

(2) A person other than a client has perpetrated a fraud upon a tribunal shall promptly reveal the fraud to the tribunal.

[Added 50 FR 5180, Feb. 6, 1985, effective Mar. 8, 1985]



## § 10.86 [Reserved]

§ 10.87 **Communicating with one of adverse interest.**

During the course of representation of a client, a practitioner shall not:

(a) Communicate or cause another to communicate on the subject of the representation with a party the practitioner knows to be represented by another practitioner in that matter unless the practitioner has the prior consent of the other practitioner representing such other party or is authorized by law to do so. It is not improper, however, for a practitioner to encourage a client to meet with an opposing party for settlement discussions.

(b) Give advice to a person who is not represented by a practitioner other than the advice to secure counsel, if the interests of such person are or have a reasonable possibility of being in conflict with the interests of the practitioner's client.

[Added 50 FR 5180, Feb. 6, 1985, effective Mar. 8, 1985]

§ 10.88 **Threatening criminal prosecution.**

A practitioner shall not present, participate in presenting, or threaten to present criminal charges solely to obtain an advantage in any prospective or pending proceeding before the Office.

[Added 50 FR 5180, Feb. 6, 1985, effective Mar. 8, 1985]

§ 10.89 **Conduct in proceedings.**

(a) A practitioner shall not disregard or advise a client to disregard any provision of this Subchapter or a decision of the Office made in the course of a proceeding before the Office, but the practitioner may take appropriate steps in good faith to test the validity of such provision or decision.

(b) In presenting a matter to the Office, a practitioner shall disclose:

(1) Controlling legal authority known to the practitioner to be directly adverse to the position of the client and which is not disclosed by opposing counsel or an employee of the Office.

(2) Unless privileged or irrelevant, the identities of the client the practitioner represents and of the persons who employed the practitioner.

(c) In appearing in a professional capacity before a tribunal, a practitioner shall not:

(1) State or allude to any matter that the practitioner has no reasonable basis to believe is relevant to the case or that will not be supported by admissible evidence.

(2) Ask any question that the practitioner has no reasonable basis to believe is relevant to the case and that is intended to degrade a witness or other person.

(3) Assert the practitioner's personal knowledge of the facts in issue, except when testifying as a witness.

(4) Assert the practitioner's personal opinion as to the justness of a cause, as to the credibility of a witness, as to the culpability of a civil litigant, or as to the guilt or innocence of an accused; but the practitioner may argue, on the practitioner's analysis of the evidence, for any position or conclusion with respect to the matters stated herein.

(5) Engage in undignified or discourteous conduct before the Office (see § 1.3 of the subchapter).

(6) Intentionally or habitually violate any provision of this subchapter or established rule of evidence.

[Added 50 FR 5180, Feb. 6, 1985, effective Mar. 8, 1985]

## § 10.90 - 10.91 [Reserved]

§ 10.92 **Contact with witnesses.**

(a) A practitioner shall not suppress any evidence that the practitioner or the practitioner's client has a legal obligation to reveal or produce.

(b) A practitioner shall not advise or cause a person to be sequestered or to leave the jurisdiction of a tribunal for the purpose of making the person unavailable as a witness therein.

(c) A practitioner shall not pay, offer to pay, or acquiesce in payment of compensation to a witness contingent upon the content of the witness' affidavit, testimony or the outcome of the case. But a

practitioner may advance, guarantee, or acquiesce in the payment of:

- (1) Expenses reasonably incurred by a witness in attending, testifying, or making an affidavit.
- (2) Reasonable compensation to a witness for the witness' loss of time in attending, testifying, or making an affidavit.
- (3) A reasonable fee for the professional services of an expert witness.

[Added 50 FR 5181, Feb. 6, 1985, effective Mar. 8, 1985]

### § 10.93 Contact with officials.

(a) A practitioner shall not give or lend anything of value to a judge, official, or employee of a tribunal under circumstances which might give the appearance that the gift or loan is made to influence official action.

(b) In an adversary proceeding, including any *inter partes* proceeding before the Office, a practitioner shall not communicate, or cause another to communicate, as to the merits of the cause with a judge, official, or Office employee before whom the proceeding is pending, except:

- (1) In the course of official proceedings in the cause.
- (2) In writing if the practitioner promptly delivers a copy of the writing to opposing counsel or to the adverse party if the adverse party is not represented by a practitioner.
- (3) Orally upon adequate notice to opposing counsel or to the adverse party if the adverse party is not represented by a practitioner.
- (4) As otherwise authorized by law.

[Added 50 FR 5181, Feb. 6, 1985, effective Mar. 8, 1985]

### § 10.94 - 10.99 [Reserved]

### § 10.100 Canon 8.

A practitioner should assist in improving the legal system.

[Added 50 FR 5181, Feb. 6, 1985, effective Mar. 8, 1985]

### § 10.101 Action as a public official.

(a) A practitioner who holds public office shall not:

(1) Use the practitioner's public position to obtain, or attempt to obtain, a special advantage in legislative matters for the practitioner or for a client under circumstances where the practitioner knows or it is obvious that such action is not in the public interest.

(2) Use the practitioner's public position to influence, or attempt to influence, a tribunal to act in favor of the practitioner or of a client.

(3) Accept any thing of value from any person when the practitioner knows or it is obvious that the offer is for the purpose of influencing the practitioner's action as a public official.

(b) A practitioner who is an officer or employee of the United States shall not practice before the Office in patent cases except as provided in § 10.10(c) and (d).

[Added 50 FR 5181, Feb. 6, 1985, effective Mar. 8, 1985; para. (b) amended, 54 FR 6520, Feb. 13, 1989]

### § 10.102 Statements concerning officials.

(a) A practitioner shall not knowingly make false statements of fact concerning the qualifications of a candidate for election or appointment to a judicial office or to a position in the Office.

(b) A practitioner shall not knowingly make false accusations against a judge, other adjudicatory officer, or employee of the Office.

[Added 50 FR 5181, Feb. 6, 1985, effective Mar. 8, 1985]

### § 10.103 Practitioner candidate for judicial office.

A practitioner who is a candidate for judicial office shall comply with applicable provisions of law.

[Added 50 FR 5181, Feb. 6, 1985, effective Mar. 8, 1985]

### § 10.104 - 10.109 [Reserved]

### § 10.110 Canon 9.

A practitioner should avoid even the appearance of professional impropriety.

[Added 50 FR 5181, Feb. 6, 1985, effective Mar. 8, 1985]

**§ 10.111 Avoiding even the appearance of impropriety.**

(a) A practitioner shall not accept private employment in a matter upon the merits of which he or she has acted in a judicial capacity.

(b) A practitioner shall not accept private employment in a matter in which he or she had personal responsibility while a public employee.

(c) A practitioner shall not state or imply that the practitioner is able to influence improperly or upon irrelevant grounds any tribunal, legislative body, or public official.

[Added 50 FR 5181, Feb. 6, 1985, effective Mar. 8, 1985]

**§ 10.112 Preserving identity of funds and property of client.**

(a) All funds of clients paid to a practitioner or a practitioner's firm, other than advances for costs and expenses, shall be deposited in one or more identifiable bank accounts maintained in the United States or, in the case of a practitioner having an office in a foreign country or registered under § 10.6(c), in the United States or the foreign country.

(b) No funds belonging to the practitioner or the practitioner's firm shall be deposited in the bank accounts required by paragraph (a) of this section except as follows:

(1) Funds reasonably sufficient to pay bank charges may be deposited therein.

(2) Funds belonging in part to a client and in part presently or potentially to the practitioner or the practitioner's firm must be deposited therein, but the portion belonging to the practitioner or the practitioner's firm may be withdrawn when due unless the right of the practitioner or the practitioner's firm to receive it is disputed by the client, in which event the disputed portion shall not be withdrawn until the dispute is finally resolved.

(c) A practitioner shall:

(1) Promptly notify a client of the receipt of the client's funds, securities, or other properties.

(2) Identify and label securities and properties of a client promptly upon receipt and place them

in a safe deposit box or other place of safekeeping as soon as practicable.

(3) Maintain complete records of all funds, securities, and other properties of a client coming into the possession of the practitioner and render appropriate accounts to the client regarding the funds, securities, or other properties.

(4) Promptly pay or deliver to the client as requested by a client the funds, securities, or other properties in the possession of the practitioner which the client is entitled to receive.

[Added 50 FR 5181, Feb. 6, 1985, effective Mar. 8, 1985]

**§ 10.113 - 10.129 [Reserved]**

**INVESTIGATIONS AND DISCIPLINARY PROCEEDINGS**

**§ 10.130 Reprimand, suspension or exclusion.**

(a) The Commissioner may, after notice and opportunity for a hearing, (1) reprimand or (2) suspend or exclude, either generally or in any particular case, any individual, attorney, or agent shown to be incompetent or disreputable, who is guilty of gross misconduct, or who violates a Disciplinary Rule.

(b) Petitions to disqualify a practitioner in *ex parte* or *inter partes* cases in the Office are not governed by §§ 10.130 through 10.170 and will be handled on a case-by-case basis under such conditions as the Commissioner deems appropriate.

[Added 50 FR 5181, Feb. 6, 1985, effective Mar. 8, 1985]

**§ 10.131 Investigations.**

(a) The Director is authorized to investigate possible violations of Disciplinary Rules by practitioners. See § 10.2(b)(2).

(b) Practitioners shall report and reveal to the Director any knowledge or evidence required by § 10.24. A practitioner shall cooperate with the Director in connection with any investigation under paragraph (a) of this section and with officials of the Office in connection with any disciplinary proceeding instituted under § 10.132(b).

(c) Any nonpractitioner possessing knowledge or information concerning a violation of a Disciplinary Rule by a practitioner may report the violation to the Director. The Director may require that the report be presented in the form of an affidavit.

[Added 50 FR 5181, Feb. 6, 1985, effective Mar. 8, 1985]

**§ 10.132 Initiating a disciplinary proceeding; reference to an administrative law judge.**

(a) If after conducting an investigation under § 10.131(a) the Director is of the opinion that a practitioner has violated a Disciplinary Rule, the Director shall, after complying where necessary with the provisions of 5 U.S.C. 558(c), call a meeting of the Committee on Discipline. The Committee on Discipline shall then determine as specified in § 10.4(b) whether a disciplinary proceeding shall be instituted under paragraph (b) of this section.

(b) If the Committee on Discipline determines that probable cause exists to believe that a practitioner has violated a Disciplinary Rule, the Director shall institute a disciplinary proceeding by filing a complaint under § 10.134. The complaint shall be filed in the Office of the Director. A disciplinary proceeding may result in:

(1) A reprimand, or

(2) Suspension or exclusion of a practitioner from practice before the Office.

(c) Upon the filing of a complaint under § 10.134, the Commissioner will refer the disciplinary proceeding to an administrative law judge.

[Added 50 FR 5181, Feb. 6, 1985, effective Mar. 8, 1985]

**§ 10.133 Conference between Director and practitioner; resignation.**

(a) *General.* The Director may confer with a practitioner concerning possible violations by the practitioner of a Disciplinary Rule whether or not a disciplinary proceeding has been instituted.

(b) *Resignation.* Any practitioner who is the subject of an investigation under § 10.131 or against whom a complaint has been filed under § 10.134 may resign from practice before the Office only by submitting with the Director an affidavit stating his or her desire to resign.

(c) If filed prior to the date set by the administrative law judge for a hearing, the affidavit shall state that:

(1) The resignation is freely and voluntarily proffered;

(2) The practitioner is not acting under duress or coercion from the Office;

(3) The practitioner is fully aware of the implications of filing the resignation;

(4) The practitioner is aware (i) of a pending investigation or (ii) of charges arising from the complaint alleging that he or she is guilty of a violation of the Patent and Trademark Office Code of Professional Responsibility, the nature of which shall be set forth by the practitioner to the satisfaction of the Director;

(5) The practitioner acknowledges that, if and when he or she applies for reinstatement under § 10.160, the Director will conclusively presume, for the limited purpose of determining the application for reinstatement, that:

(i) The facts upon which the complaint is based are true and

(ii) The practitioner could not have successfully defended himself or herself against (A) charges predicated on the violation under investigation or (B) charges set out in the complaint filed against the practitioner.

(d) If filed on or after the date set by the administrative law judge for a hearing, the affidavit shall make the statements required by paragraphs (b) (1) through (4) of this section and shall state that:

(1) The practitioner acknowledges the facts upon which the complaint is based are true; and

(2) The resignation is being submitted because the practitioner could not successfully defend himself or herself against (i) charges predicated on the violation under investigation or (ii) charges set out in the complaint.

(e) When an affidavit under paragraphs (b) or (c) of this section is received while an investigation is pending, the Commissioner shall enter an order excluding the practitioner "on consent." When an affidavit under paragraphs (b) or (c) of this section is received after a complaint under § 10.134 has been filed, the Director shall notify the administrative law judge. The administrative law judge shall enter an order transferring the disciplinary proceeding to the

Commissioner and the Commissioner shall enter an order excluding the practitioner “on consent.”

(f) Any practitioner who resigns from practice before the Office under this section and who intends to reapply for admission to practice before the Office must comply with the provisions of § 10.158.

(g) *Settlement.* Before or after a complaint is filed under § 10.134, a settlement conference may occur between the Director and a practitioner for the purpose of settling any disciplinary matter. If an offer of settlement is made by the Director or the practitioner and is not accepted by the other, no reference to the offer of settlement or its refusal shall be admissible in evidence in the disciplinary proceeding unless both the Director and the practitioner agree in writing.

[Added 50 FR 5181, Feb. 6, 1985, effective Mar. 8, 1985]

### § 10.134 Complaint.

(a) A complaint instituting a disciplinary proceeding shall:

(1) Name the practitioner, who may then be referred to as the “respondent.”

(2) Give a plain and concise description of the alleged violations of the Disciplinary Rules by the practitioner.

(3) State the place and time for filing an answer by the respondent.

(4) State that a decision by default may be entered against the respondent if an answer is not timely filed.

(5) Be signed by the Director.

(b) A complaint will be deemed sufficient if it fairly informs the respondent of any violation of the Disciplinary Rules which form the basis for the disciplinary proceeding so that the respondent is able to adequately prepare a defense.

[Added 50 FR 5182, Feb. 6, 1985, effective Mar. 8, 1985]

### § 10.135 Service of complaint.

(a) A complaint may be served on a respondent in any of the following methods:

(1) By handing a copy of the complaint personally to the respondent, in which case the individual handing the complaint to the respondent shall file an

affidavit with the Director indicating the time and place the complaint was handed to the respondent.

(2) By mailing a copy of the complaint by “Express Mail” or first-class mail to:

(i) A registered practitioner at the address for which separate notice was last received by the Director or

(ii) A nonregistered practitioner at the last address for the respondent known to the Director.

(3) By any method mutually agreeable to the Director and the respondent.

(b) If a complaint served by mail under paragraph (a)(2) of this section is returned by the U.S. Postal Service, the Director shall mail a second copy of the complaint to the respondent. If the second copy of the complaint is also returned by the U.S. Postal Service, the Director shall serve the respondent by publishing an appropriate notice in the *Official Gazette* for four consecutive weeks, in which case the time for answer shall be at least thirty days from the fourth publication of the notice.

(c) If a respondent is a registered practitioner, the Director may serve simultaneously with the complaint a letter under § 10.11(b). The Director may require the respondent to answer the § 10.11(b) letter within a period of not less than 15 days. An answer to the § 10.11(b) letter shall constitute proof of service. If the respondent fails to answer the § 10.11(b) letter, his or her name will be removed from the register as provided by § 10.11(b).

(d) If the respondent is represented by an attorney under § 10.140(a), a copy of the complaint shall also be served on the attorney.

[Added 50 FR 5183, Feb. 6, 1985, effective Mar. 8, 1985]

### § 10.136 Answer to complaint.

(a) *Time for answer.* An answer to a complaint shall be filed within a time set in the complaint which shall be not less than thirty days.

(b) *With whom filed.* The answer shall be filed in writing with the administrative law judge. The time for filing an answer may be extended once for a period of no more than thirty days by the administrative law judge upon a showing of good cause provided a motion requesting an extension of time is filed within thirty days after the date the complaint is filed

by the Director. A copy of the answer shall be served on the Director.

(c) *Content.* The respondent shall include in the answer a statement of the facts which constitute the grounds of defense and shall specifically admit or deny each allegation set forth in the complaint. The respondent shall not deny a material allegation in the complaint which the respondent knows to be true or state that respondent is without sufficient information to form a belief as to the truth of an allegation when in fact the respondent possesses that information. The respondent shall also state affirmatively special matters of defense.

(d) *Failure to deny allegations in complaint.* Every allegation in the complaint which is not denied by a respondent in the answer is deemed to be admitted and may be considered proven. No further evidence in respect of that allegation need be received by the administrative law judge at any hearing. Failure to timely file an answer will constitute an admission of the allegations in the complaint.

(e) *Reply by the Director.* No reply to an answer is required by the Director and any affirmative defense in the answer shall be deemed to be denied. The Director may, however, file a reply if he or she chooses or if ordered by the administrative law judge.

[Added 50 FR 5183, Feb. 6, 1985, effective Mar. 8, 1985; amended 50 FR 25073, June 17, 1985]

### § 10.137 Supplemental complaint.

False statements in an answer may be made the basis of a supplemental complaint.

[Added 50 FR 5183, Feb. 6, 1985, effective Mar. 8, 1985]

### § 10.138 Contested case.

Upon the filing of an answer by the respondent, a disciplinary proceeding shall be regarded as a contested case within the meaning of 35 U.S.C. 24. Evidence obtained by a subpoena issued under 35 U.S.C. 24 shall not be admitted into the record or considered unless leave to proceed under 35 U.S.C. 24 was previously authorized by the administrative law judge.

[Added 50 FR 5183, Feb. 6, 1985, effective Mar. 8, 1985]

### § 10.139 Administrative law judge; appointment; responsibilities; review of interlocutory orders; stays.

(a) *Appointment.* An administrative law judge, appointed under 5 U.S.C. 3105, shall conduct disciplinary proceedings as provided by this part.

(b) *Responsibilities.* The administrative law judge shall have authority to:

- (1) Administer oaths and affirmations;
- (2) Make rulings upon motions and other requests;
- (3) Rule upon offers of proof, receive relevant evidence, and examine witnesses;
- (4) Authorize the taking of a deposition of a witness in lieu of personal appearance of the witness before the administrative law judge;
- (5) Determine the time and place of any hearing and regulate its course and conduct;
- (6) Hold or provide for the holding of conferences to settle or simplify the issues;
- (7) Receive and consider oral or written arguments on facts or law;
- (8) Adopt procedures and modify procedures from time to time as occasion requires for the orderly disposition of proceedings;
- (9) Make initial decisions under § 10.154; and
- (10) Perform acts and take measures as necessary to promote the efficient and timely conduct of any disciplinary proceeding.

(c) *Time for making initial decision.* The administrative law judge shall set times and exercise control over a disciplinary proceeding such that an initial decision under § 10.154 is normally issued within six months of the date a complaint is filed. The administrative law judge may, however, issue an initial decision more than six months after a complaint is filed if in his or her opinion there exist unusual circumstances which preclude issuance of an initial decision within six months of the filing of the complaint.

(d) *Review of interlocutory orders.* An interlocutory order of an administrative law judge will not be reviewed by the Commissioner except:

- (1) When the administrative law judge shall be of the opinion (i) that the interlocutory order involves a controlling question of procedure or law as to which there is a substantial ground for a difference of opinion and (ii) that an immediate decision by the

Commissioner may materially advance the ultimate termination of the disciplinary proceeding or

(2) In an extraordinary situation where justice requires review.

(e) *Stays pending review of interlocutory order.* If the Director or a respondent seeks review of an interlocutory order of an administrative law judge under paragraph (b)(2) of this section, any time period set for taking action by the administrative law judge shall not be stayed unless ordered by the Commissioner or the administrative law judge.

[Added 50 FR 5183, Feb. 6, 1985, effective Mar. 8, 1985; amended 50 FR 25073, June 17, 1985]

#### § 10.140 Representative for Director or respondent.

(a) A respondent may be represented before the Office in connection with an investigation or disciplinary proceeding by an attorney. The attorney shall file a written declaration that he or she is an attorney within the meaning of § 10.1(c) and shall state:

(1) The address to which the attorney wants correspondence related to the investigation or disciplinary proceeding sent and

(2) A telephone number where the attorney may be reached during normal business hours.

(b) The Commissioner shall designate at least two associate solicitors in the Office of the Solicitor to act as representatives for the Director in disciplinary proceedings. In prosecuting disciplinary proceedings, the designated associate solicitors shall not involve the Solicitor or the Deputy Solicitor. The Solicitor and the Deputy Solicitor shall remain insulated from the investigation and prosecution of all disciplinary proceedings in order that they shall be available as counsel to the Commissioner in deciding disciplinary proceedings.

[Added 50 FR 5183, Feb. 6, 1985, effective Mar. 8, 1985]

#### § 10.141 Filing of papers.

(a) The provisions of § 1.8 of this subchapter do not apply to disciplinary proceedings.

(b) All papers filed after the complaint and prior to entry of an initial decision by the administrative law judge shall be filed with the administrative law judge at an address or place designated by the

administrative law judge. All papers filed after entry of an initial decision by the administrative law judge shall be filed with the Director. The Director shall promptly forward to the Commissioner any paper which requires action under this part by the Commissioner.

(c) The administrative law judge or the Director may provide for filing papers and other matters by hand or by "Express Mail."

[Added 50 FR 5184, Feb. 6, 1985, effective Mar. 8, 1985]

#### § 10.142 Service of papers.

(a) All papers other than a complaint shall be served on a respondent represented by an attorney by:

(1) Delivering a copy of the paper to the office of the attorney; or

(2) Mailing a copy of the paper by first-class mail or "Express Mail" to the attorney at the address provided by the attorney under § 10.140(a)(1); or

(3) Any other method mutually agreeable to the attorney and a representative for the Director.

(b) All papers other than a complaint shall be served on a respondent who is not represented by an attorney by:

(1) Delivering a copy of the paper to the respondent; or

(2) Mailing a copy of the paper by first-class mail or "Express Mail" to the respondent at the address to which a complaint may be served or such other address as may be designated in writing by the respondent; or

(3) Any other method mutually agreeable to the respondent and a representative of the Director.

(c) A respondent shall serve on the representative for the Director one copy of each paper filed with the administrative law judge or the Director. A paper may be served on the representative for the Director by:

(1) Delivering a copy of the paper to the representative; or

(2) Mailing a copy of the paper by first-class mail or "Express Mail" to an address designated in writing by the representative; or

(3) Any other method mutually agreeable to the respondent and the representative.

(d) Each paper filed in a disciplinary proceeding shall contain therein a certificate of service indicating:

- (1) The date of which service was made and
- (2) The method by which service was made.

(e) The administrative law judge or the Commissioner may require that a paper be served by hand or by “Express Mail.”

(f) Service by mail is completed when the paper mailed in the United States is placed into the custody of the U.S. Postal Service.

[Added 50 FR 5184, Feb. 6, 1985, effective Mar. 8, 1985]

### § 10.143 Motions.

Motions may be filed with the administrative law judge. The administrative law judge will determine on a case-by-case basis the time period for response to a motion and whether replies to responses will be authorized. No motion shall be filed with the administrative law judge unless such motion is supported by a written statement by the moving party that the moving party or attorney for the moving party has conferred with the opposing party or attorney for the opposing party in an effort in good faith to resolve by agreement the issues raised by the motion and has been unable to reach agreement. If issues raised by a motion are resolved by the parties prior to a decision on the motion by the administrative law judge, the parties shall promptly notify the administrative law judge.

[Added 50 FR 5184, Feb. 6, 1985, effective Mar. 8, 1985]

### § 10.144 Hearings.

(a) The administrative law judge shall preside at hearings in disciplinary proceedings. Hearings will be stenographically recorded and transcribed and the testimony of witnesses will be received under oath or affirmation. The administrative law judge shall conduct hearings in accordance with 5 U.S.C. 556. A copy of the transcript of the hearing shall become part of the record. A copy of the transcript shall be provided to the Director and the respondent at the expense of the Office.

(b) If the respondent to a disciplinary proceeding fails to appear at the hearing after a notice of hear-

ing has been given by the administrative law judge, the administrative law judge may deem the respondent to have waived the right to a hearing and may proceed with the hearing in the absence of the respondent.

(c) A hearing under this section will not be open to the public except that the Director may grant a request by a respondent to open his or her hearing to the public and make the record of the disciplinary proceeding available for public inspection, *provided*, Agreement is reached in advance to exclude from public disclosure information which is privileged or confidential under applicable laws or regulations. If a disciplinary proceeding results in disciplinary action against a practitioner, and subject to § 10.159(c), the record of the entire disciplinary proceeding, including any settlement agreement, will be available for public inspection.

[Added 50 FR 5184, Feb. 6, 1985, effective Mar. 8, 1985]

### § 10.145 Proof; variance; amendment of pleadings.

In case of a variance between the evidence and the allegations in a complaint, answer, or reply, if any, the administrative law judge may order or authorize amendment of the complaint, answer, or reply to conform to the evidence. Any party who would otherwise be prejudiced by the amendment will be given reasonable opportunity to meet the allegations in the complaint, answer, or reply, as amended, and the administrative law judge shall make findings on any issue presented by the complaint, answer, or reply as amended.

[Added 50 FR 5184, Feb. 6, 1985, effective Mar. 8, 1985]

### § 10.146 - 10.148 [Reserved]

### § 10.149 Burden of proof.

In a disciplinary proceeding, the Director shall have the burden of proving his or her case by clear and convincing evidence and a respondent shall have the burden of proving any affirmative defense by clear and convincing evidence.



[Added 50 FR 5184, Feb. 6, 1985, effective Mar. 8, 1985]

### § 10.150 Evidence.

(a) *Rules of evidence.* The rules of evidence prevailing in courts of law and equity are not controlling in hearings in disciplinary proceedings. However, the administrative law judge shall exclude evidence which is irrelevant, immaterial, or unduly repetitious.

(b) *Depositions.* Depositions of witnesses taken pursuant to § 10.151 may be admitted as evidence.

(c) *Government documents.* Official documents, records, and papers of the Office are admissible without extrinsic evidence of authenticity. These documents, records, and papers may be evidenced by a copy certified as correct by an employee of the Office.

(d) *Exhibits.* If any document, record, or other paper is introduced in evidence as an exhibit, the administrative law judge may authorize the withdrawal of the exhibit subject to any conditions the administrative law judge deems appropriate.

(e) *Objections.* Objections to evidence will be in short form, stating the grounds of objection. Objections and rulings on objections will be a part of the record. No exception to the ruling is necessary to preserve the rights of the parties.

[Added 50 FR 5184, Feb. 6, 1985, effective Mar. 8, 1985]

### § 10.151 Depositions.

(a) Depositions for use at the hearing in lieu of personal appearance of a witness before the administrative law judge may be taken by respondent or the Director upon a showing of good cause and with the approval of, and under such conditions as may be deemed appropriate by, the administrative law judge. Depositions may be taken upon oral or written questions, upon not less than ten days written notice to the other party, before any officer authorized to administer an oath or affirmation in the place where the deposition is to be taken. The requirement of ten days notice may be waived by the parties and depositions may then be taken of a witness at a time and place mutually agreed to by the parties. When a deposition is taken upon written questions, copies of the written questions will be served upon the other party with the

notice and copies of any written cross-questions will be served by hand or "Express Mail" not less than five days before the date of the taking of the deposition unless the parties mutually agree otherwise. A party on whose behalf a deposition is taken shall file a copy of a transcript of the deposition signed by a court reporter with the administrative law judge and shall serve one copy upon the opposing party. Expenses for a court reporter and preparing, serving, and filing depositions shall be borne by the party at whose instance the deposition is taken.

(b) When the Director and the respondent agree in writing, a deposition of any witness who will appear voluntarily may be taken under such terms and conditions as may be mutually agreeable to the Director and the respondent. The deposition shall not be filed with the administrative law judge and may not be admitted in evidence before the administrative law judge unless he or she orders the deposition admitted in evidence. The admissibility of the deposition shall lie within the discretion of the administrative law judge who may reject the deposition on any reasonable basis including the fact that demeanor is involved and that the witness should have been called to appear personally before the administrative law judge.

[Added 50 FR 5185, Feb. 6, 1985, effective Mar. 8, 1985]

### § 10.152 Discovery.

Discovery shall not be authorized except as follows:

(a) After an answer is filed under § 10.136 and when a party establishes in a clear and convincing manner that discovery is necessary and relevant, the administrative law judge, under such conditions as he or she deems appropriate, may order an opposing party to:

- (1) Answer a reasonable number of written requests for admission or interrogatories;
- (2) Produce for inspection and copying a reasonable number of documents; and
- (3) Produce for inspection a reasonable number of things other than documents.

(b) Discovery shall not be authorized under paragraph (a) of this section of any matter which:

- (1) Will be used by another party solely for impeachment or cross-examination;

(2) Is not available to the party under 35 U.S.C. § 122;

(3) Relates to any disciplinary proceeding commenced in the Patent and Trademark Office prior to March 8, 1985;

(4) Relates to experts except as the administrative law judge may require under paragraph (e) of this section.

(5) Is privileged; or

(6) Relates to mental impressions, conclusions, opinions, or legal theories of any attorney or other representative of a party.

(c) The administrative law judge may deny discovery requested under paragraph (a) of this section if the discovery sought:

(1) Will unduly delay the disciplinary proceeding;

(2) Will place an undue burden on the party required to produce the discovery sought; or

(3) Is available (i) generally to the public, (ii) equally to the parties; or (iii) to the party seeking the discovery through another source.

(d) Prior to authorizing discovery under paragraph (a) of this section, the administrative law judge shall require the party seeking discovery to file a motion (§ 10.143) and explain in detail for each request made how the discovery sought is necessary and relevant to an issue actually raised in the complaint or the answer.

(e) The administrative law judge may require parties to file and serve, prior to any hearing, a pre-hearing statement which contains:

(1) A list (together with a copy) of all proposed exhibits to be used in connection with a party's case-in-chief,

(2) A list of proposed witnesses,

(3) As to each proposed expert witness:

(i) An identification of the field in which the individual will be qualified as an expert;

(ii) A statement as to the subject matter on which the expert is expected to testify; and

(iii) A statement of the substance of the facts and opinions to which the expert is expected to testify,

(4) The identity of government employees who have investigated the case, and

(5) Copies of memoranda reflecting respondent's own statements to administrative representatives.

(f) After a witness testifies for a party, if the opposing party requests, the party may be required to produce, prior to cross-examination, any written statement made by the witness.

[Added 50 FR 5185, Feb. 6, 1985, effective Mar. 8, 1985]

#### § 10.153 Proposed findings and conclusions; post-hearing memorandum.

Except in cases when the respondent has failed to answer the complaint, the administrative law judge, prior to making an initial decision, shall afford the parties a reasonable opportunity to submit proposed findings and conclusions and a post-hearing memorandum in support of the proposed findings and conclusions.

[Added 50 FR 5185, Feb. 6, 1985, effective Mar. 8, 1985]

#### § 10.154 Initial decision of administrative law judge.

(a) The administrative law judge shall make an initial decision in the case. The decision will include (1) a statement of findings and conclusions, as well as the reasons or basis therefor with appropriate references to the record, upon all the material issues of fact, law, or discretion presented on the record, and (2) an order of suspension or exclusion from practice, an order of reprimand, or an order dismissing the complaint. The administrative law judge shall file the decision with the Director and shall transmit a copy to the representative of the Director and to the respondent. In the absence of an appeal to the Commissioner, the decision of the administrative law judge will, without further proceedings, become the decision of the Commissioner of Patents and Trademarks thirty (30) days from the date of the decision of the administrative law judge.

(b) The initial decision of the administrative law judge shall explain the reason for any penalty or reprimand, suspension or exclusion. In determining any penalty, the following should normally be considered:

- (1) The public interest;
- (2) The seriousness of the violation of the Disciplinary Rule;
- (3) The deterrent effects deemed necessary;
- (4) The integrity of the legal profession; and
- (5) Any extenuating circumstances.

[Added 50 FR 5185, Feb. 6, 1985, effective Mar. 8, 1985; amended 50 FR 25073, June 17, 1985]

### § 10.155 Appeal to the Commissioner.

(a) Within thirty (30) days from the date of the initial decision of the administrative law judge under § 10.154, either party may appeal to the Commissioner. If an appeal is taken, the time for filing a cross-appeal expires 14 days after the date of service of the appeal pursuant to § 10.142 or 30 days after the date of the initial decision of the administrative law judge, whichever is later. An appeal or cross-appeal by the respondent will be filed and served with the Director in duplicate and will include exceptions to the decisions of the administrative law judge and supporting reasons for those exceptions. If the Director files the appeal or cross-appeal, the Director shall serve on the other party a copy of the appeal or cross-appeal. The other party to an appeal or cross-appeal may file a reply brief. A respondent's reply brief shall be filed and served in duplicate with the Director. The time for filing any reply brief expires thirty (30) days after the date of service pursuant to § 10.142 of an appeal, cross-appeal or copy thereof. If the Director files a reply brief, the Director shall serve on the other party a copy of the reply brief. Upon the filing of an appeal, cross-appeal, if any, and reply briefs, if any, the Director shall transmit the entire record to the Commissioner.

(b) The appeal will be decided by the Commissioner on the record made before the administrative law judge.

(c) The Commissioner may order reopening of a disciplinary proceeding in accordance with the principles which govern the granting of new trials. Any request to reopen a disciplinary proceeding on the basis of newly discovered evidence must demonstrate that the newly discovered evidence could not have been discovered by due diligence.

(d) In the absence of an appeal by the Director, failure by the respondent to appeal under the provisions of this section shall be deemed to be both accep-

tance by the respondent of the initial decision and waiver by the respondent of the right to further administrative or judicial review.

[Added 50 FR 5185, Feb. 6, 1985, effective Mar. 8, 1985; para. (d) added, 54 FR 26026, June 21, 1989, effective Aug. 1, 1989; para. (a) amended, 60 FR 64125, Dec. 14, 1995, effective Jan. 16, 1996]

### § 10.156 Decision of the Commissioner.

(a) An appeal from an initial decision of the administrative law judge shall be decided by the Commissioner. The Commissioner may affirm, reverse, or modify the initial decision or remand the matter to the administrative law judge for such further proceedings as the Commissioner may deem appropriate. Subject to paragraph (c) of this section, a decision by the Commissioner does not become a final agency action in a disciplinary proceeding until 20 days after it is entered. In making a final decision, the Commissioner shall review the record or those portions of the record as may be cited by the parties in order to limit the issues. The Commissioner shall transmit a copy of the final decision to the Director and to the respondent.

(b) A final decision of the Commissioner may dismiss a disciplinary proceeding, reprimand a practitioner, or may suspend or exclude the practitioner from practice before the Office.

(c) A single request for reconsideration or modification of the Commissioner's decision may be made by the respondent or the Director if filed within 20 days from the date of entry of the decision. Such a request shall have the effect of staying the effective date of the decision. The decision by the Commissioner on the request is a final agency action in a disciplinary proceeding and is effective on its date of entry.

[Added 50 FR 5186, Feb. 6, 1985, effective Mar. 8, 1985; para. (a) amended and para. (c) added, 54 FR 6660, Feb. 14, 1989]

### § 10.157 Review of Commissioner's final decision.

(a) Review of the Commissioner's final decision in a disciplinary case may be had, subject to § 10.155(d), by a petition filed in the United States District Court for the District of Columbia. See

35 U.S.C. 32 and Local Rule 213 of the United States District Court for the District of Columbia.

(b) The Commissioner may stay a final decision pending review of the Commissioner's final decision.

[Added 50 FR 5186, Feb. 6, 1985, effective Mar. 8, 1985; amended 53 FR 13120, Apr. 21, 1988; para. (a) amended, 54 FR 26026, June 21, 1989, effective Aug. 1, 1989]

### § 10.158 Suspended or excluded practitioner.

(a) A practitioner who is suspended or excluded from practice before the Office under § 10.156(b) shall not engage in unauthorized practice of patent, trademark and other non patent law before the Office.

(b) Unless otherwise ordered by the Commissioner, any practitioner who is suspended or excluded from practice before the Office under § 10.156(b) shall:

(1) Within 30 days of entry of the order of suspension or exclusion, notify all bars of which he or she is a member and all clients of the practitioner for whom he or she is handling matters before the Office in separate written communications of the suspension or exclusion and shall file a copy of each written communication with the Director.

(2) Within 30 days of entry of the order of suspension or exclusion, surrender a client's active Office case files to (i) the client or (ii) another practitioner designated by the client.

(3) Not hold himself or herself out as authorized to practice law before the Office.

(4) Promptly take any necessary and appropriate steps to remove from any telephone, legal, or other directory any advertisement, statement, or representation which would reasonably suggest that the practitioner is authorized to practice patent, trademark, or other non-patent law before the Office, and within 30 days of taking those steps, file with the Director an affidavit describing the precise nature of the steps taken.

(5) Not advertise the practitioner's availability or ability to perform or render legal services for any person having immediate, prospective, or pending business before the Office.

(6) Not render legal advice or services to any person having immediate, prospective, or pending business before the Office as to that business.

(7) Promptly take steps to change any sign identifying a practitioner's or the practitioner's firm's office and the practitioner's or the practitioner's firm's stationery to delete therefrom any advertisement, statement, or representation which would reasonably suggest that the practitioner is authorized to practice law before the Office.

(8) Within 30 days, return to any client any unearned funds, including any unearned retainer fee, and any securities and property of the client.

(c) A practitioner who is suspended or excluded from practice before the Office and who aids another practitioner in any way in the other practitioner's practice of law before the Office, may, under the direct supervision of the other practitioner, act as a paralegal for the other practitioner or perform other services for the other practitioner which are normally performed by lay-persons, *provided*:

(1) The practitioner who is suspended or excluded is:

(i) A salaried employee of:

(A) The other practitioner;

(B) The other practitioner's law firm; or

(C) A client-employer who employs the other practitioner as a salaried employee;

(2) The other practitioner assumes full professional responsibility to any client and the Office for any work performed by the suspended or excluded practitioner for the other practitioner;

(3) The suspended or excluded practitioner, in connection with any immediate, prospective, or pending business before the Office, does not:

(i) Communicate directly in writing, orally, or otherwise with a client of the other practitioner;

(ii) Render any legal advice or any legal services to a client of the other practitioner; or

(iii) Meet in person or in the presence of the other practitioner with:

(A) Any Office official in connection with the prosecution of any patent, trademark, or other case;

(B) Any client of the other practitioner, the other practitioner's law firm, or the client-employer of the other practitioner;

(C) Any witness or potential witness which the other practitioner, the other practitioner's law firm, or the other practitioner's client-employer

may or intends to call as a witness in any proceeding before the Office. The term “witness” includes individuals who will testify orally in a proceeding before, or sign an affidavit or any other document to be filed in, the Office.

(d) When a suspended or excluded practitioner acts as a paralegal or performs services under paragraph (c) of this section, the suspended or excluded practitioner shall not thereafter be reinstated to practice before the Office unless:

(1) The suspended or excluded practitioner shall have filed with the Director an affidavit which (i) explains in detail the precise nature of all paralegal or other services performed by the suspended or excluded practitioner and (ii) shows by clear and convincing evidence that the suspended or excluded practitioner has complied with the provisions of this section and all Disciplinary Rules, and

(2) The other practitioner shall have filed with the Director a written statement which (i) shows that the other practitioner has read the affidavit required by subparagraph (d)(1) of this section and that the other practitioner believes every statement in the affidavit to be true and (ii) states why the other practitioner believes that the suspended or excluded practitioner has complied with paragraph (c) of this section.

[Added 50 FR 5186, Feb. 6, 1985, effective Mar. 8, 1985]

#### § 10.159 Notice of suspension or exclusion.

(a) Upon issuance of a final decision reprimanding a practitioner or suspending or excluding a practitioner from practice before the Office, the Director shall give notice of the final decision to appropriate employees of the Office and to interested departments, agencies, and courts of the United States. The Director shall also give notice to appropriate authorities of any State in which a practitioner is known to be a member of the bar and any appropriate bar association.

(b) The Director shall cause to be published in the *Official Gazette* the name of any practitioner suspended or excluded from practice. Unless otherwise ordered by the Commissioner, the Director shall publish in the *Official Gazette* the name of any practitioner reprimanded by the Commissioner.

(c) The Director shall maintain records, which shall be available for public inspection, of every disciplinary proceeding where practitioner is reprimanded, suspended, or excluded unless the Commissioner orders that the proceeding be kept confidential.

[Added 50 FR 5186, Feb. 6, 1985, effective Mar. 8, 1985]

#### § 10.160 Petitioner for reinstatement.

(a) A petition for reinstatement of a practitioner suspended for a period of less than five years will not be considered until the period of suspension has passed.

(b) A petition for reinstatement of a practitioner excluded from practice will not be considered until five years after the effective date of the exclusion.

(c) An individual who has resigned under § 10.133 or who has been suspended or excluded may file a petition for reinstatement. The Director may grant a petition for reinstatement when the individual makes a clear and convincing showing that the individual will conduct himself or herself in accordance with the regulations of this part and that granting a petition for reinstatement is not contrary to the public interest. As a condition to reinstatement, the Director may require the individual to:

(1) Meet the requirements of § 10.7, including taking and passing an examination under § 10.7(b) and

(2) Pay all or a portion of the costs and expenses, not to exceed \$1,500, of the disciplinary proceeding which led to suspension or exclusion.

(d) Any suspended or excluded practitioner who has violated the provisions of § 10.158 during his or her period of suspension or exclusion shall not be entitled to reinstatement until such time as the Director is satisfied that a period of suspension equal in time to that ordered by the Commissioner or exclusion for five years has passed during which the suspended or excluded practitioner has complied with the provisions of § 10.158.

(e) Proceedings on any petition for reinstatement shall be open to the public. Before reinstating any suspended or excluded practitioner, the Director shall publish in the *Official Gazette* a notice of the suspended or excluded practitioner's petition for reinstatement and shall permit the public a reasonable

opportunity to comment or submit evidence with respect to the petition for reinstatement.

[Added 50 FR 5186, Feb. 6, 1985, effective Mar. 8, 1985]

**§ 10.161 Savings clause.**

(a) A disciplinary proceeding based on conduct engaged in prior to the effective date of these regulations may be instituted subsequent to such effective date, if such conduct would continue to justify suspension or exclusion under the provisions of this part.

(b) No practitioner shall be subject to a disciplinary proceeding under this part based on conduct engaged in before the effective date hereof if such conduct would not have been subject to disciplinary action before such effective date.

[Added 50 FR 5186, Feb. 6, 1985, effective Mar. 8, 1985]

**§ 10.162 - 10.169 [Reserved]**

**§ 10.170 Suspension of rules.**

(a) In an extraordinary situation, when justice requires, any requirement of the regulations of this part which is not a requirement of the statutes may be suspended or waived by the Commissioner or the Commissioner's designee, *sua sponte*, or on petition of any party, including the Director or the Director's representative, subject to such other requirements as may be imposed.

(b) Any petition under this section will not stay a disciplinary proceeding unless ordered by the Commissioner or an administrative law judge.

[Added 50 FR 5186, Feb. 6, 1985, effective Mar. 8, 1985]

MANUAL OF PATENT EXAMINING PROCEDURE

**Index II – RULES RELATING TO PRACTICE  
BEFORE THE UNITED STATES PATENT AND  
TRADEMARK OFFICE**

**A**

Address change . . . . .	10.11
Advertising . . . . .	10.31, 10.32
Agents, registration of . . . . .	10.6
Agreements restricting practice . . . . .	10.38
Aliens . . . . .	10.6, 10.9
Applicant for patent, representation of . . . . .	1.31, 10.10
Applicant for trademark, representation of . . . . .	2.11
Attorneys, recognition of to practice in trademark cases . . . . .	10.14
Attorneys, registration of to practice in patent cases . . . . .	10.6, 10.7

**B**

Breach of trust . . . . .	10.23
Business transactions or relations with client . . . . .	10.65

**C**

Candidate for judicial office . . . . .	10.103
Canons and disciplinary rules . . . . .	10.20 - 10.112
Certificate of mailing . . . . .	1.8, 10.23, 10.141
Certification effect of signature . . . . .	10.18
Circumventing a disciplinary rule, amendment . . . . .	10.23
Code of Professional Responsibility . . . . .	10.20 - 10.112
Coercion, Use of . . . . .	10.23
Committee on Discipline . . . . .	10.4
Committee on Enrollment . . . . .	10.3
Communicating with person having adverse interest . . . . .	10.67
Communications concerning practitioner's service . . . . .	10.31
Compensation for legal services . . . . .	10.68
Competence . . . . .	10.76, 10.77
Complaint instituting disciplinary proceedings . . . . .	10.134
Concealment of material information . . . . .	10.23
Conduct in proceeding before Office . . . . .	10.89
Conduct prejudicial to the administration of justice . . . . .	10.23
Conflict of interest . . . . .	10.66
Conviction of criminal offense . . . . .	10.23

**D**

Deceit . . . . .	10.23
Decisions of the Commissioner . . . . .	10.156, 10.157
Definitions:	
Affidavit . . . . .	10.1
Agent . . . . .	10.6

Application . . . . .	10.1
Canon . . . . .	10.20
Confidence . . . . .	10.57
Differing interests . . . . .	10.1
Director of Enrollment and Discipline . . . . .	10.1
Disciplinary rule . . . . .	10.20
Employee of a tribunal . . . . .	10.1
Excessive legal fees . . . . .	10.36
Excluded practitioner . . . . .	10.1
Giving information . . . . .	10.1
Invention development services . . . . .	10.23
Law firm . . . . .	10.1
Lawyer . . . . .	10.1
Legal counsel . . . . .	10.1
Legal profession . . . . .	10.1
Legal service . . . . .	10.1
Legal system . . . . .	10.1
Non-practitioner . . . . .	10.1
Office . . . . .	10.1
Person . . . . .	10.1
Practitioner . . . . .	10.1
Proceeding before the Office . . . . .	10.1
Professional legal corporation . . . . .	10.1
Registration . . . . .	10.1
Respondent . . . . .	10.134
Secret . . . . .	10.33, 10.57
State . . . . .	10.1
Suspended practitioner . . . . .	10.1
Tribunal . . . . .	10.1
United States . . . . .	10.1
Designation as registered attorney or agent . . . . .	10.34
Direct contact with prospective clients . . . . .	10.33
Director of Enrollment and Discipline:	
Appointment . . . . .	10.2
Duties . . . . .	10.2
Review of decisions of the Director . . . . .	10.2
Disbarment from practice on ethical grounds . . . . .	10.130
Discharge of attorney or agent by client . . . . .	10.40
Disciplinary proceedings and investigations:	
Administrative Law Judge . . . . .	10.139
Administrative Procedures Act . . . . .	10.132, 10.144
Review of interlocutory orders by	
Administrative Law Judge . . . . .	10.139
Amendment of complaint . . . . .	10.145
Amendment of pleadings . . . . .	10.145
Answer to complaint . . . . .	10.136
Appeal of initial decision of Administrative Law Judge . . . . .	10.155
Burden of proof . . . . .	10.149
Certificate of mailing . . . . .	1.8, 10.141
Complaint . . . . .	10.134
Contested case . . . . .	10.138



Deliberations of Committee on Discipline . . . . .	10.4
Discovery (see also Discovery in Disciplinary Proceedings) . . . . .	10.152
Exception to ruling . . . . .	10.150
Filing papers after complaint filed . . . . .	10.141
Hearings before Administrative Law Judge . . . . .	10.144
Initial decision of Administrative Law Judge . . . . .	10.139, 10.154
Initiating disciplinary proceeding . . . . .	10.132
Investigations of violations of disciplinary rules . . . . .	10.131
Notice of suspension or exclusion of practitioner . . . . .	10.159
Objections to evidence . . . . .	10.150
Post hearing memorandum . . . . .	10.153
Pre-hearing statement . . . . .	10.153
Reinstatement of suspended or excluded practitioner . . . . .	10.160
Reprimand of registered attorney or agent . . . . .	10.130, 10.132
Resignation of practitioner . . . . .	10.133
Review of Commissioner's final decision . . . . .	10.157
Review of decision denying reinstatement of practitioner . . . . .	10.2
Savings clause . . . . .	10.161
Service of complaint . . . . .	10.135
Settlement of complaint . . . . .	10.133
Stay pending review of interlocutory order . . . . .	10.139
Supplemental complaint . . . . .	10.137
Disciplinary rule violation	
Disclosure of . . . . .	10.23, 10.24, 10.84, 10.85, 10.131
Discourteous conduct . . . . .	10.89
Discovery in disciplinary proceedings:	
Copying of documents . . . . .	10.152
Cross-examination . . . . .	10.152
Deliberations of committee on enrollment . . . . .	10.4
Depositions . . . . .	10.151
Evidence . . . . .	10.150, 10.152
Impeachment . . . . .	10.152
Inspection of documents . . . . .	10.152
Interrogatories . . . . .	10.152
Motions filed with Administrative Law Judge . . . . .	10.143, 10.152
Privileged information . . . . .	10.152
Undue delay in proceedings . . . . .	10.152
Division of legal fees . . . . .	10.37
Duress, use of . . . . .	10.23
Duty to make counsel available . . . . .	10.30

**E**

Employment:	
Acceptance . . . . .	10.39

Failure to carry out contract . . . . .	10.84
Refusing employment . . . . .	10.62, 10.63, 10.66
Withdrawal from employment . . . . .	10.40, 10.63, 10.66
Exception to ruling . . . . .	10.151
Excessive legal fees . . . . .	10.36
Exclusion of practitioner . . . . .	10.130, 10.132, 10.158

**F**

Failure to disclose material fact with regard to registration . . . . .	10.22
Failure to notify client . . . . .	10.23
False accusations . . . . .	10.23
False statements concerning officials . . . . .	10.102
Favors, improperly bestowing . . . . .	10.23
Fees:	
In general . . . . .	1.21
Petition to review decision of Director of Enrollment and Discipline . . . . .	10.2
Registration . . . . .	10.8
Registration examination . . . . .	10.7
Reinstatement . . . . .	10.11
Request regrade of examination . . . . .	10.6
Fees for legal services . . . . .	10.36
Firm name, use of . . . . .	10.35
Fitness to practice before the Office . . . . .	10.23
Foreigners . . . . .	10.6, 10.9, 10.14
Former Patent and Trademark Office employees . . . . .	10.7, 10.10, 10.23
Fraud or inequitable conduct . . . . .	10.23, 10.85
Frivolous complaint . . . . .	10.23
Funds of client, preserving identity of . . . . .	10.112

**G**

Gift, improperly bestowing . . . . .	10.23
Government employees, registration of to practice in patent cases . . . . .	10.10

**I**

Illegal conduct involving moral turpitude . . . . .	10.23
Illegal fees for services . . . . .	10.36
Improper alteration of patent application . . . . .	10.23
Improper execution of oath or declaration . . . . .	10.23
Improper influence . . . . .	10.23
Improper signature . . . . .	10.18, 10.23
Improperly bestowing thing of value . . . . .	10.23
Incompetence . . . . .	10.77, 10.78
Indecent statement, making of . . . . .	10.23
Independent professional judgment, exercise of . . . . .	10.61, 10.62, 10.66, 10.68
Individual unqualified in respect to character, education, etc. . . . .	10.7, 10.22

Influence by others than client . . . . . 10.68  
 Information precluding registration, failure to disclose . . . . . 10.22  
 Initial decision of Administrative Law Judge . . . 10.139, 10.154  
 Integrity and competence of the legal profession, maintaining of . . . . . 10.22  
 Interest in litigation or proceeding before Office, acquiring of . . . . . 10.64  
 Investigation of violations of disciplinary rules . . 10.131

**J**

Joint venture . . . . . 10.23  
 Judicial office, candidate for . . . . . 10.103

**L**

Legal fees:  
     Division of . . . . . 10.37  
     Failure to pay . . . . . 10.40  
     Sharing of . . . . . 10.48  
 Legal system, assistance in improving the . . . . . 10.100  
 Letterheads, use of . . . . . 10.35  
 Limited recognition to practice in patent cases . . . . 10.9

**M**

Malpractice, limiting client’s liability . . . . . 10.78  
 Materially false statements in application for registration . . . . . 10.22  
 Misappropriation of funds . . . . . 10.23  
 Misconduct . . . . . 10.23  
 Misrepresentations . . . . . 10.22, 10.23  
 Multiple employment . . . . . 10.66

**N**

Neglecting legal matters . . . . . 10.77  
 Non-practitioner, formation of partnership with . . . 10.49  
 Notice of suspension or exclusion . . . . . 10.159

**O**

Oath requirement . . . . . 10.8  
 Officials, contact with . . . . . 10.93

**P**

Petitions:  
     Fees in general . . . . . 1.21  
     Regrade of examination . . . . . 10.7(c)  
     Reinstatement . . . . . 10.160  
     Review decision of Commissioner . . . . . 10.157

Review decision of Director of Enrollment and Discipline . . . . . 10.2  
 Suspension of rules . . . . . 10.170  
 Preserve secrets and confidence of client . . . 10.56, 10.57  
*Pro se* applicant . . . . . 1.31, 2.11  
 Professional impropriety, avoiding appearance of . . . . . 10.110, 10.111  
 Promise of advantage, offer of . . . . . 10.23  
 Property of client . . . . . 10.112  
 Proprietary interest in subject matter . . . . . 10.64  
 Publication in *Official Gazette* . . . . 10.11, 10.159, 10.160

**R**

Recognition to practice before the Patent and Trademark Office:  
     Agents . . . . . 10.6, 10.7, 10.14  
     Aliens . . . . . 10.6, 10.7, 10.14  
     Attorneys . . . . . 10.6, 10.7, 10.14  
     Change of address, requirement to notify Director . . . . . 10.11  
     Contents of petition for reinstatement of:  
         person not suspended or excluded . . . . . 10.2  
         suspended or excluded practitioner . . . . . 10.160  
     Examination of registration in patent cases . . . . 10.7  
     Examination fee . . . . . 10.7  
     Foreigners . . . . . 10.6, 10.9, 10.14  
     Former Patent and Trademark Office employees . . . . . 10.7, 10.10, 10.23  
     Government employees . . . . . 10.10, 10.23  
     Limited recognition in patent cases . . . . . 10.9  
     Non-lawyers, recognition in trademark cases . . . 10.10  
     Patent cases . . . . . 10.6 - 10.10  
     Recognition for representation . . . . 1.34, 2.17, 10.14  
     Recognition to practice . . . . . 10.6 - 10.18  
     Refusal to recognize practitioner . . . . . 10.15  
     Register of attorneys and agents in patent cases . . . . . 10.5  
     Registration fee . . . . . 10.8  
     Registration number . . . . . 1.34  
     Removal of attorneys and agents from the register . . . . . 10.11  
     Representation by registered attorney or agent in patent cases . . . . . 1.31  
     Request for regrade of examination . . . . . 10.6  
     Requirements for registration . . . . . 10.7  
     Review of Director’s decision refusing registration . . . . . 10.2  
     Trademark cases . . . . . 10.14  
     Unauthorized representation by an agent . . . . . 10.10, 10.31  
 Records, property and funds of client, maintaining of . . . . . 10.112

Reinstatement after removal from the  
 register . . . . . 10.2, 10.11  
 Reinstatement of suspended or excluded  
 non-practitioner . . . . . 10.160  
 Representing client within bounds of the law . . . . 10.85  
 Reprimand of registered attorney  
 or agent. . . . . 10.130, 10.132  
 Resignation . . . . . 10.133  
 Revocation of power of attorney in  
 trademark case . . . . . 2.19

**S**

Scandalous statements, making of. . . . . 10.23  
 Secrets and confidence, preservation of clients. . . 10.56,  
 10.57  
 Settlement of claims of clients . . . . . 10.67  
 Sharing legal fees . . . . . 10.48  
 Signature and certificate of practitioner . . . . . 10.18  
 Solicitation. . . . . 10.32, 10.33  
 Statement concerning officials, making  
 false . . . . . 10.102  
 Suspension of  
 practitioner . . . . . 10.23, 10.130, 10.132, 10.158  
 Suspension of rules . . . . . 10.170

**T**

Threats of criminal prosecution . . . . . 10.88  
 Threats, use of . . . . . 10.23

**U**

Unauthorized practice. . 10.14, 10.23, 10.31, 10.46, 10.47  
 Undignified conduct . . . . . 10.89

**V**

Violating duty of candor and good faith. . . . . 10.23  
 Violation of disciplinary rule, misconduct . . . . . 10.23

**W**

Withdrawal from employment . . . . . 10.40  
 Withdrawal material information . . . . . 10.22, 10.23  
 Witnesses . . . . . 10.63, 10.92

**Z**

Zealously representing the client . . . . . 10.83, 10.84

**PART 15 — [Reserved]**

[Part 15 removed and reserved, 61 FR 42807, Aug. 19, 1996]

**PART 15a — [Reserved]**

[Part 15a removed and reserved, 61 FR 42807, Aug. 19, 1996]

**SUBCHAPTER B – ADMINISTRATION****PART 102 — DISCLOSURE OF GOVERNMENT INFORMATION****Subpart A - Freedom of Information Act**

Sec.

- 102.1 General.
  - 102.2 Public reference facilities.
  - 102.3 Records under FOIA.
  - 102.4 Requirements for making requests.
  - 102.5 Responsibility for responding to requests.
  - 102.6 Time limits and expedited processing.
  - 102.7 Responses to requests.
  - 102.9 Business Information.
  - 102.10 Appeals from initial determinations or untimely delays.
  - 102.11 Fees.
- Subpart B - Privacy Act**
- 102.21 Purpose and scope.
  - 102.22 Definitions.
  - 102.23 Procedures for making inquiries.
  - 102.24 Procedures for making requests for records.
  - 102.25 Disclosure of requested records to individuals.
  - 102.26 Special procedures: Medical records.
  - 102.27 Procedures for making requests for correction or amendment.
  - 102.28 Review of requests for correction or amendment.
  - 102.29 Appeal of initial adverse determination on correction or amendment.
  - 102.30 Disclosure of record to person other than the individual to whom it pertains.
  - 102.31 Fees.
  - 102.32 Penalties.
  - 102.33 General exemptions.
  - 102.34 Specific exemptions.

Appendix to Part 102— Systems of Records Noticed by Other Federal Agencies and Applicable to USPTO Records, and Applicability of this Part Thereto

**Subpart A — Freedom of Information Act****§ 102.1 General.**

(a) The information in this part is furnished for the guidance of the public and in compliance with the requirements of the Freedom of Information Act (FOIA), as amended (5 U.S.C. 552). This part sets forth the procedures the United States Patent and Trademark Office (USPTO) follows to make publicly available the materials and indices specified in 5 U.S.C. 552(a)(2) and records requested under 5 U.S.C. 552(a)(3). Information routinely provided to the public as part of a regular USPTO activity (for example, press releases issued by the Office of Public Affairs) may be provided to the public without following this part. USPTO's policy is to make discretionary disclosures of records or information exempt from disclosure under FOIA whenever disclosure would not foreseeably harm an interest protected by a FOIA exemption, but this policy does not create any right enforceable in court.

(b) As used in this subpart, *FOIA Officer* means the USPTO employee designated to administer FOIA for USPTO. To ensure prompt processing of a request, correspondence should be addressed to the FOIA Officer, United States Patent and Trademark Office, PO Box 1450, Alexandria, Virginia 22313-1450, or delivered by hand to Two Crystal Park, 2121 Crystal Drive, Suite 905, Arlington, Virginia.

[Added, 65 FR 52916, Aug. 31, 2000, effective Oct. 2, 2000; para. (b) revised, 68 FR 14332, Mar. 25, 2003, effective May 1, 2003]

**§ 102.2 Public reference facilities.**

(a) USPTO maintains a public reference facility that contains the records FOIA requires to be made regularly available for public inspection and copying; furnishes information and otherwise assists the public concerning USPTO operations under FOIA; and receives and processes requests for records under FOIA. The FOIA Officer is responsible for determining which of USPTO's records are required to be made available for public inspection and copying, and for making those records available in USPTO's

reference and records inspection facility. The FOIA Officer shall maintain and make available for public inspection and copying a current subject-matter index of USPTO's public inspection facility records. Each index shall be updated regularly, at least quarterly, with respect to newly included records. In accordance with 5 U.S.C. 552(a)(2), USPTO has determined that it is unnecessary and impracticable to publish quarterly, or more frequently, and distribute copies of the index and supplements thereto. The public reference facility is located in the Public Search Room, Crystal Plaza Three, 2021 South Clark Place, Room 1A01, Arlington, Virginia.

(b) The FOIA Officer shall also make public inspection facility records created by USPTO on or after November 1, 1996, available electronically through USPTO's World Wide Web site (<http://www.uspto.gov>). Information available at the site shall include:

(1) The FOIA Officer's index of the public inspection facility records, which indicates which records are available electronically; and

(2) The general index referred to in paragraph (c)(3) of this section.

(c) USPTO maintains and makes available for public inspection and copying:

(1) A current index providing identifying information for the public as to any matter that is issued, adopted, or promulgated after July 4, 1967, and that is retained as a record and is required to be made available or published. Copies of the index are available upon request after payment of the direct cost of duplication;

(2) Copies of records that have been released and that the FOIA Officer determines, because of their subject matter, have become or are likely to become the subject of subsequent requests for substantially the same records;

(3) A general index of the records described in paragraph (c)(2) of this section;

(4) Final opinions and orders, including concurring and dissenting opinions made in the adjudication of cases;

(5) Those statements of policy and interpretations that have been adopted by USPTO and are not published in the *Federal Register*; and

(6) Administrative staff manuals and instructions to staff that affect a member of the public.

[Added, 65 FR 52916, Aug. 31, 2000, effective Oct. 2, 2000]

### § 102.3 Records under FOIA.

(a) Records under FOIA include all Government records, regardless of format, medium or physical characteristics, and include electronic records and information, audiotapes, videotapes, and photographs.

(b) There is no obligation to create, compile, or obtain from outside USPTO a record to satisfy a FOIA request. With regard to electronic data, the issue of whether records are created or merely extracted from an existing database is not always apparent. When responding to FOIA requests for electronic data where creation of a record or programming becomes an issue, USPTO shall undertake reasonable efforts to search for the information in electronic format.

(c) USPTO officials may, upon request, create and provide new information pursuant to user fee statutes, such as the first paragraph of 15 U.S.C. 1525, or in accordance with authority otherwise provided by law. This is outside the scope of FOIA.

(d) The FOIA Officer shall preserve all correspondence pertaining to the requests received under this subpart, as well as copies of all requested records, until disposition or destruction is authorized by Title 44 of the United States Code or a National Archives and Records Administration's General Records Schedule. The FOIA Officer shall not dispose of records while they are the subject of a pending request, appeal, or lawsuit under FOIA.

[Added, 65 FR 52916, Aug. 31, 2000, effective Oct. 2, 2000]

### § 102.4 Requirements for making requests.

(a) A request for USPTO records that are not customarily made available to the public as part of USPTO's regular informational services must be in writing, and shall be processed under FOIA, regardless of whether FOIA is mentioned in the request. Requests should be sent to the USPTO FOIA Officer, United States Patent and Trademark Office, P.O. Box 1450, Alexandria, Virginia 22313-1450 (records FOIA requires to be made regularly available

for public inspection and copying are addressed in § 102.2(c)). For the quickest handling, the request letter and envelope should be marked “Freedom of Information Act Request.” For requests for records about oneself, § 102.24 contains additional requirements. For requests for records about another individual, either a written authorization signed by that individual permitting disclosure of those records to the requester or proof that individual is deceased (for example, a copy of a death certificate or an obituary) facilitates processing the request.

(b) The records requested must be described in enough detail to enable USPTO personnel to locate them with a reasonable amount of effort. Whenever possible, a request should include specific information about each record sought, such as the date, title or name, author, recipient, and subject matter of the record, and the name and location of the office where the record is located. Also, if records about a court case are sought, the title of the case, the court in which the case was filed, and the nature of the case should be included. If known, any file designations or descriptions for the requested records should be included. In general, the more specifically the request describes the records sought, the greater the likelihood that USPTO will locate those records. If the FOIA Officer determines that a request does not reasonably describe records, the FOIA Officer will inform the requester what additional information is needed or why the request is otherwise insufficient. The FOIA Officer also may give the requester an opportunity to discuss the request so that it may be modified to meet the requirements of this section.

[Added, 65 FR 52916, Aug. 31, 2000, effective Oct. 2, 2000; para. (a) revised, 68 FR 14332, Mar. 25, 2003, effective May 1, 2003]

### § 102.5 Responsibility for responding to requests.

(a) *In general.* Except as stated in paragraph (b) of this section, the USPTO will process FOIA requests directed to USPTO. In determining records responsive to a request, the FOIA Officer shall include only those records within USPTO’s possession and control as of the date the FOIA Officer receives the request.

(b) *Consultations and referrals.* If the FOIA Officer receives a request for a record in USPTO’s possession in which another Federal agency subject to

FOIA has the primary interest, the FOIA Officer shall refer the record to that agency for direct response to the requester. The FOIA Officer shall consult with another Federal agency before responding to a requester if the FOIA Officer receives a request for a record in which another Federal agency subject to FOIA has a significant interest, but not the primary interest; or another Federal agency not subject to FOIA has the primary interest or a significant interest. Ordinarily, the agency that originated a record will be presumed to have the primary interest in it.

(c) *Notice of referral.* Whenever a FOIA Officer refers a document to another Federal agency for direct response to the requester, the FOIA Officer will ordinarily notify the requester in writing of the referral and inform the requester of the name of the agency to which the document was referred.

(d) *Timing of responses to consultations and referrals.* All consultations and referrals shall be handled according to the date the FOIA request was received by the first Federal agency.

(e) *Agreements regarding consultations and referrals.* The FOIA Officer may make agreements with other Federal agencies to eliminate the need for consultations or referrals for particular types of records.

[Added, 65 FR 52916, Aug. 31, 2000, effective Oct. 2, 2000]

### § 102.6 Time limits and expedited processing.

(a) *In general.* The FOIA Officer ordinarily shall respond to requests according to their order of receipt.

(b) *Initial response and appeal.* Subject to paragraph (c)(1) of this section, an initial response shall be made within 20 working days (*i.e.*, excluding Saturdays, Sundays, and legal public holidays) of the receipt of a request for a record under this part by the proper FOIA Officer identified in accordance with § 102.5(a), and an appeal shall be decided within 20 working days of its receipt by the Office of the General Counsel.

(c) *Unusual circumstances.*

(1) In unusual circumstances as specified in paragraph (c)(2) of this section, the FOIA Officer may extend the time limits in paragraph (b) of this section by notifying the requester in writing as soon as practicable of the unusual circumstances and of the date by

which processing of the request is expected to be completed. Extensions of time for the initial determination and extensions on appeal may not exceed a total of ten working days, unless the requester agrees to a longer extension, or the FOIA Officer provides the requester with an opportunity either to limit the scope of the request so that it may be processed within the applicable time limit, or to arrange an alternative time frame for processing the request or a modified request.

(2) As used in this section, *unusual circumstances*, means, but only to the extent reasonably necessary to properly process the particular request:

(i) The need to search for and collect the requested records from field facilities or other establishments separate from the office processing the request;

(ii) The need to search for, collect, and appropriately examine a voluminous amount of separate and distinct records that are the subject of a single request; or

(iii) The need for consultation, which shall be conducted with all practicable speed, with another Federal agency having a substantial interest in the determination of the request.

(3) Unusual circumstances do not include a delay that results from a predictable workload of requests, unless USPTO demonstrates reasonable progress in reducing its backlog of pending requests. Refusal to reasonably modify the scope of a request or arrange an alternate time frame may affect a requester's ability to obtain judicial review.

(4) If the FOIA Officer reasonably believes that multiple requests submitted by a requester, or by a group of requesters acting in concert, constitute a single request that would otherwise involve unusual circumstances, and the requests involve clearly related matters, the FOIA Officer may aggregate them. Multiple requests involving unrelated matters will not be aggregated.

(d) *Multitrack processing.*

(1) The FOIA Officer may use two or more processing tracks by distinguishing between simple and more complex requests based on the number of pages involved, or some other measure of the amount of work and/or time needed to process the request, and whether the request qualifies for expedited processing as described in paragraph (e) of this section.

(2) The FOIA Officer may provide requesters in a slower track with an opportunity to limit the scope of their requests in order to qualify for faster processing. The FOIA Officer may contact the requester by telephone or by letter, whichever is most efficient in each case.

(e) *Expedited processing.*

(1) Requests and appeals shall be taken out of order and given expedited treatment whenever it is determined they involve:

(i) Circumstances in which the lack of expedited treatment could reasonably be expected to pose an imminent threat to the life or physical safety of an individual;

(ii) The loss of substantial due process rights;

(iii) A matter of widespread and exceptional media interest in which there exist questions about the Government's integrity that affect public confidence; or

(iv) An urgency to inform the public about an actual or alleged Federal Government activity, if made by a person primarily engaged in disseminating information.

(2) A request for expedited processing may be made at the time of the initial request for records or at any later time. For a prompt determination, a request for expedited processing should be sent to the FOIA Officer.

(3) A requester who seeks expedited processing must submit a statement, certified to be true and correct to the best of that person's knowledge and belief, explaining in detail the basis for requesting expedited processing. For example, a requester within the category described in paragraph (e)(1)(iv) of this section, if not a full-time member of the news media, must establish that he or she is a person whose main professional activity or occupation is information dissemination, though it need not be his or her sole occupation. A requester within the category described in paragraph (e)(1)(iv) of this section must also establish a particular urgency to inform the public about the Government activity involved in the request, beyond the public's right to know about Government activity generally. The formality of certification may be waived as a matter of administrative discretion.

(4) Within ten calendar days of receipt of a request for expedited processing, the FOIA Officer

will decide whether to grant it and shall notify the requester of the decision. If a request for expedited treatment is granted, the request shall be given priority and processed as soon as practicable. If a request for expedited processing is denied, any appeal of that decision shall be acted on expeditiously.

[Added, 65 FR 52916, Aug. 31, 2000, effective Oct. 2, 2000]

### § 102.7 Responses to requests.

(a) *Grants of requests.* If the FOIA Officer makes a determination to grant a request in whole or in part, the FOIA Officer will notify the requester in writing. The FOIA Officer will inform the requester in the notice of any fee charged under § 102.11 and disclose records to the requester promptly upon payment of any applicable fee. Records disclosed in part shall be marked or annotated to show each applicable FOIA exemption and the amount of information deleted, unless doing so would harm an interest protected by an applicable exemption. The location of the information deleted shall also be indicated on the record, if feasible.

(b) *Adverse determinations of requests.* If the FOIA Officer makes an adverse determination regarding a request, the FOIA Officer will notify the requester of that determination in writing. An adverse determination is a denial of a request in any respect, namely: A determination to withhold any requested record in whole or in part; a determination that a requested record does not exist or cannot be located; a determination that a record is not readily reproducible in the form or format sought by the requester; a determination that what has been requested is not a record subject to FOIA (except that a determination under § 102.11(j) that records are to be made available under a fee statute other than FOIA is not an adverse determination); a determination against the requester on any disputed fee matter, including a denial of a request for a fee waiver; or a denial of a request for expedited treatment. Each denial letter shall be signed by the FOIA Officer and shall include:

- (1) The name and title or position of the denying official;
- (2) A brief statement of the reason(s) for the denial, including applicable FOIA exemption(s);
- (3) An estimate of the volume of records or information withheld, in number of pages or some

other reasonable form of estimation. This estimate need not be provided if the volume is otherwise indicated through deletions on records disclosed in part, or if providing an estimate would harm an interest protected by an applicable FOIA exemption; and

(4) A statement that the denial may be appealed, and a list of the requirements for filing an appeal under § 102.10(b).

[Added, 65 FR 52916, Aug. 31, 2000, effective Oct. 2, 2000]

### § 102.9 Business Information.

(a) *In general.* Business information obtained by USPTO from a submitter will be disclosed under FOIA only under this section.

(b) *Definitions.* For the purposes of this section:

(1) *Business information* means commercial or financial information, obtained by USPTO from a submitter, which may be protected from disclosure under FOIA exemption 4 (5 U.S.C. 552(b)(4)).

(2) *Submitter* means any person or entity outside the Federal Government from whom USPTO obtains business information, directly or indirectly. The term includes corporations; state, local and tribal governments; and foreign governments.

(c) *Designation of business information.* A submitter of business information should designate by appropriate markings, either at the time of submission or at a reasonable time thereafter, any portions of its submission that it considers to be protected from disclosure under FOIA exemption 4. These designations will expire ten years after the date of the submission unless the submitter requests, and provides justification for, a longer designation period.

(d) *Notice to submitters.* The FOIA Officer shall provide a submitter with prompt written notice of a FOIA request or administrative appeal that seeks its business information whenever required under paragraph (e) of this section, except as provided in paragraph (h) of this section, in order to give the submitter an opportunity under paragraph (f) of this section to object to disclosure of any specified portion of that information. Such written notice shall be sent via certified mail, return receipt requested, or similar means. The notice shall either describe the business information requested or include copies of the requested records containing the information. When notification of a large number of submitters is



required, notification may be made by posting or publishing the notice in a place reasonably likely to accomplish notification.

(e) *When notice is required.* Notice shall be given to the submitter whenever:

(1) The information has been designated in good faith by the submitter as protected from disclosure under FOIA exemption 4; or

(2) The FOIA Officer has reason to believe that the information may be protected from disclosure under FOIA exemption 4.

(f) *Opportunity to object to disclosure.* The FOIA Officer shall allow a submitter seven working days (*i.e.*, excluding Saturdays, Sundays, and legal public holidays) from the date of receipt of the written notice described in paragraph (d) of this section to provide the FOIA Officer with a detailed statement of any objection to disclosure. The statement must specify all grounds for withholding any portion of the information under any exemption of FOIA and, in the case of exemption 4, it must show why the information is a trade secret or commercial or financial information that is privileged or confidential. If a submitter fails to respond to the notice within the time specified, the submitter will be considered to have no objection to disclosure of the information. Information a submitter provides under this paragraph may itself be subject to disclosure under FOIA.

(g) *Notice of intent to disclose.* The FOIA Officer shall consider a submitter's objections and specific grounds under FOIA for nondisclosure in deciding whether to disclose business information. If the FOIA Officer decides to disclose business information over the objection of a submitter, the FOIA Officer shall give the submitter written notice via certified mail, return receipt requested, or similar means, which shall include:

(1) A statement of reason(s) why the submitter's objections to disclosure were not sustained;

(2) A description of the business information to be disclosed; and

(3) A statement that the FOIA Officer intends to disclose the information seven working days from the date the submitter receives the notice.

(h) *Exceptions to notice requirements.* The notice requirements of paragraphs (d) and (g) of this section shall not apply if:

(1) The FOIA Officer determines that the information should not be disclosed;

(2) The information has been lawfully published or has been officially made available to the public;

(3) Disclosure of the information is required by statute (other than FOIA) or by a regulation issued in accordance with Executive Order 12600; or

(4) The designation made by the submitter under paragraph (c) of this section appears obviously frivolous, in which case the FOIA Officer shall provide the submitter written notice of any final decision to disclose the information seven working days from the date the submitter receives the notice.

(i) *Notice of FOIA lawsuit.* Whenever a requester files a lawsuit seeking to compel the disclosure of business information, the FOIA Officer shall promptly notify the submitter.

(j) *Corresponding notice to requesters.* Whenever a FOIA Officer provides a submitter with notice and an opportunity to object to disclosure under paragraph (d) of this section, the FOIA Officer shall also notify the requester(s). Whenever a submitter files a lawsuit seeking to prevent the disclosure of business information, the FOIA Officer shall notify the requester(s).

[Added, 65 FR 52916, Aug. 31, 2000, effective Oct. 2, 2000]

### § 102.10 Appeals from initial determinations or untimely delays.

(a) If a request for records is initially denied in whole or in part, or has not been timely determined, or if a requester receives an adverse initial determination regarding any other matter under this subpart (as described in § 102.7(b)), the requester may file a written appeal, which must be received by the Office of General Counsel within thirty calendar days of the date of the written denial or, if there has been no determination, may be submitted anytime after the due date, including the last extension under § 102.6(c), of the determination.

(b) Appeals shall be decided by a Deputy General Counsel. Appeals should be addressed to the General Counsel, United States Patent and Trademark

Office, PO Box 1450, Alexandria, Virginia 22313-1450. Both the letter and the appeal envelope should be clearly marked “Freedom of Information Appeal”. The appeal must include a copy of the original request and the initial denial, if any, and may include a statement of the reasons why the records requested should be made available and why the initial denial, if any, was in error. No opportunity for personal appearance, oral argument or hearing on appeal is provided.

(c) If an appeal is granted, the person making the appeal shall be immediately notified and copies of the releasable documents shall be made available promptly thereafter upon receipt of appropriate fees determined in accordance with § 102.11.

(d) If no determination of an appeal has been sent to the requester within the twenty-working-day period specified in § 102.6(b) or the last extension thereof, the requester is deemed to have exhausted his administrative remedies with respect to the request, giving rise to a right of judicial review under 5 U.S.C. 552(a)(6)(C). If the person making a request initiates a civil action against USPTO based on the provision in this paragraph, the administrative appeal process may continue.

(e) A determination on appeal shall be in writing and, when it denies records in whole or in part, the letter to the requester shall include:

(1) A brief explanation of the basis for the denial, including a list of applicable FOIA exemptions and a description of how the exemptions apply;

(2) A statement that the decision is final;

(3) Notification that judicial review of the denial is available in the United States district court for the district in which the requester resides or has its principal place of business, the United States District Court for the Eastern District of Virginia, or the District of Columbia; and

(4) The name and title or position of the official responsible for denying the appeal.

[Added, 65 FR 52916, Aug. 31, 2000, effective Oct. 2, 2000; para. (b) revised, 68 FR 14332, Mar. 25, 2003, effective May 1, 2003]

### § 102.11 Fees.

(a) *In general.* USPTO shall charge for processing requests under FOIA in accordance with paragraph (c) of this section, except when fees are limited under paragraph (d) of this section or when a waiver

or reduction of fees is granted under paragraph (k) of this section. USPTO shall collect all applicable fees before sending copies of requested records to a requester. Requesters must pay fees by check or money order made payable to the Treasury of the United States.

(b) *Definitions.* For purposes of this section:

(1) *Commercial use request* means a request from or on behalf of a person who seeks information for a use or purpose that furthers his or her commercial, trade, or profit interests, which can include furthering those interests through litigation. The FOIA Officer shall determine, whenever reasonably possible, the use to which a requester will put the requested records. When it appears that the requester will put the records to a commercial use, either because of the nature of the request itself or because the FOIA Officer has reasonable cause to doubt a requester’s stated use, the FOIA Officer shall provide the requester a reasonable opportunity to submit further clarification.

(2) *Direct costs* means those expenses USPTO incurs in searching for and duplicating (and, in the case of commercial use requests, reviewing) records to respond to a FOIA request. Direct costs include, for example, the labor costs of the employee performing the work (the basic rate of pay for the employee, plus 16 percent of that rate to cover benefits). Not included in direct costs are overhead expenses such as the costs of space and heating or lighting of the facility in which the records are kept.

(3) *Duplication* means the making of a copy of a record, or of the information contained in it, necessary to respond to a FOIA request. Copies may take the form of paper, microform, audiovisual materials, or electronic records (for example, magnetic tape or disk), among others. The FOIA Officer shall honor a requester’s specified preference of form or format of disclosure if the record is readily reproducible with reasonable efforts in the requested form or format.

(4) *Educational institution* means a pre-school, a public or private elementary or secondary school, an institution of undergraduate higher education, an institution of graduate higher education, an institution of professional education, or an institution of vocational education, that operates a program of scholarly research. To be in this category, a requester must show that the request is authorized by and is

made under the auspices of a qualifying institution, and that the records are sought to further scholarly research rather than for a commercial use.

(5) *Noncommercial scientific institution* means an institution that is not operated on a “commercial” basis, as that term is defined in paragraph (b)(1) of this section, and that is operated solely for the purpose of conducting scientific research, the results of which are not intended to promote any particular product or industry. To be in this category, a requester must show that the request is authorized by and is made under the auspices of a qualifying institution and that the records are sought to further scientific research rather than for a commercial use.

(6) *Representative of the news media, or news media requester* means any person actively gathering news for an entity that is organized and operated to publish or broadcast news to the public. The term “news” means information that is about current events or that would be of current interest to the public. Examples of news media entities include television or radio stations broadcasting to the public at large and publishers of periodicals (but only if they can qualify as disseminators of “news”) that make their products available for purchase or subscription by the general public. For “freelance” journalists to be regarded as working for a news organization, they must demonstrate a solid basis for expecting publication through that organization. A publication contract would be the clearest proof, but the FOIA Officer shall also look to the past publication record of a requester in making this determination. To be in this category, a requester must not be seeking the requested records for a commercial use. However, a request for records supporting the news-dissemination function of the requester shall not be considered to be for a commercial use.

(7) *Review* means the examination of a record located in response to a request in order to determine whether any portion of it is exempt from disclosure. It also includes processing any record for disclosure—for example, doing all that is necessary to redact it and prepare it for disclosure. Review costs are recoverable even if a record ultimately is not disclosed. Review time does not include time spent resolving general legal or policy issues regarding the application of exemptions.

(8) *Search* means the process of looking for and retrieving records or information responsive to a request. It includes page-by-page or line-by-line identification of information within records and also includes reasonable efforts to locate and retrieve information from records maintained in electronic form or format. The FOIA Officer shall ensure that searches are done in the most efficient and least expensive manner reasonably possible.

(c) *Fees.* In responding to FOIA requests, the FOIA Officer shall charge the fees summarized in chart form in paragraphs (c)(1) and (c)(2) of this section and explained in paragraphs (c)(3) through (c)(5) of this section, unless a waiver or reduction of fees has been granted under paragraph (k) of this section.

(1) The four categories and chargeable fees are:

Category	Chargeable fees
(i) Commercial Use Requesters	Search, Review, and Duplication.
(ii) Educational and Non-commercial Scientific Institution Requesters	Duplication (excluding the cost of the first 100 pages).
(iii) Representatives of the News Media	Duplication (excluding the cost of the first 100 pages).
(iv) All Other Requesters	Search and Duplication (excluding the cost of the first 2 hours of search and 100 pages).

(2) *Uniform fee schedule.*

Service	Rate
(i) Manual search	Actual salary rate of employee involved, plus 16 percent of salary rate.
(ii) Computerized search	Actual direct cost, including operator time.

Service	Rate
(iii) Duplication of records: (A) Paper copy reproduction (B) Other reproduction ( <i>e.g.</i> , computer disk or print-out, microfilm, microfiche, or microform)	\$.15 per page Actual direct cost, including operator time
(iv) Review of records (includes preparation for release, <i>i.e.</i> excising)	Actual salary rate of employee conducting review, plus 16 percent of salary rate.

(3) *Search.*

(i) Search fees shall be charged for all requests—other than requests made by educational institutions, noncommercial scientific institutions, or representatives of the news media—subject to the limitations of paragraph (d) of this section. The FOIA Officer will charge for time spent searching even if no responsive records are located or if located records are entirely exempt from disclosure. Search fees shall be the direct costs of conducting the search by the involved employees

(ii) For computer searches of records, requesters will be charged the direct costs of conducting the search, although certain requesters (as provided in paragraph (d)(1) of this section) will be charged no search fee and certain other requesters (as provided in paragraph (d)(3) of this section) are entitled to the cost equivalent of two hours of manual search time without charge. These direct costs include the costs, attributable to the search, of operating a central processing unit and operator/programmer salary.

(4) *Duplication.* Duplication fees will be charged to all requesters, subject to the limitations of paragraph (d) of this section. For a paper photocopy of a record (no more than one copy of which need be supplied), the fee shall be \$.15 cents per page. For copies produced by computer, such as tapes or print-outs, the FOIA Officer shall charge the direct costs, including operator time, of producing the copy. For other forms of duplication, the FOIA Officer will charge the direct costs of that duplication.

(5) *Review.* Review fees shall be charged to requesters who make a commercial use request.

Review fees shall be charged only for the initial record review—the review done when the FOIA Officer determines whether an exemption applies to a particular record at the initial request level. No charge will be made for review at the administrative appeal level for an exemption already applied. However, records withheld under an exemption that is subsequently determined not to apply may be reviewed again to determine whether any other exemption not previously considered applies, and the costs of that review are chargeable. Review fees shall be the direct costs of conducting the review by the involved employees.

(d) *Limitations on charging fees.*

(1) No search fee will be charged for requests by educational institutions, noncommercial scientific institutions, or representatives of the news media.

(2) No search fee or review fee will be charged for a quarter-hour period unless more than half of that period is required for search or review.

(3) Except for requesters seeking records for a commercial use, the FOIA Officer will provide without charge:

(i) The first 100 pages of duplication (or the cost equivalent); and

(ii) The first two hours of search (or the cost equivalent).

(4) Whenever a total fee calculated under paragraph (c) of this section is \$20.00 or less for any request, no fee will be charged.

(5) The provisions of paragraphs (d) (3) and (4) of this section work together. This means that for requesters other than those seeking records for a commercial use, no fee will be charged unless the cost of the search in excess of two hours plus the cost of duplication in excess of 100 pages totals more than \$20.00.

(e) *Notice of anticipated fees over \$20.00.* When the FOIA Officer determines or estimates that the fees to be charged under this section will be more than \$20.00, the FOIA Officer shall notify the requester of the actual or estimated fees, unless the requester has indicated a willingness to pay fees as high as those anticipated. If only a portion of the fee can be estimated readily, the FOIA Officer shall advise the requester that the estimated fee may be only a portion of the total fee. If the FOIA Officer has notified a requester that actual or estimated fees are

more than \$20.00, the FOIA Officer shall not consider the request received or process it further until the requester agrees to pay the anticipated total fee. Any such agreement should be in writing. A notice under this paragraph shall offer the requester an opportunity to discuss the matter with USPTO personnel in order to reformulate the request to meet the requester's needs at a lower cost.

(f) *Charges for other services.* Apart from the other provisions of this section, the FOIA Officer shall ordinarily charge the direct cost of special services. Such special services could include certifying that records are true copies or sending records by other than ordinary mail.

(g) *Charging interest.* The FOIA Officer shall charge interest on any unpaid bill starting on the 31st calendar day following the date of billing the requester. Interest charges shall be assessed at the rate provided in 31 U.S.C. 3717 and accrue from the date of the billing until payment is received by the FOIA Officer. The FOIA Officer shall follow the provisions of the Debt Collection Improvement Act of 1996 (Pub. L. 104-134), as amended, and its administrative procedures, including the use of consumer reporting agencies, collection agencies, and offset.

(h) *Aggregating requests.* If a FOIA Officer reasonably believes that a requester or a group of requesters acting together is attempting to divide a request into a series of requests for the purpose of avoiding fees, the FOIA Officer may aggregate those requests and charge accordingly. The FOIA Officer may presume that multiple requests of this type made within a 30-calendar-day period have been made in order to avoid fees. If requests are separated by a longer period, the FOIA Officer shall aggregate them only if a solid basis exists for determining that aggregation is warranted under all the circumstances involved. Multiple requests involving unrelated matters shall not be aggregated.

(i) *Advance payments.*

(1) For requests other than those described in paragraphs (i)(2) and (3) of this section, the FOIA

Officer shall not require the requester to make an advance payment: a payment made before work is begun or continued on a request. Payment owed for work already completed (*i.e.*, a payment before copies are sent to a requester) is not an advance payment.

(2) If the FOIA Officer determines or estimates that a total fee to be charged under this section will be more than \$250.00, the requester must pay the entire anticipated fee before beginning to process the request, unless the FOIA Officer receives a satisfactory assurance of full payment from a requester who has a history of prompt payment.

(3) If a requester has previously failed to pay a properly charged FOIA fee to USPTO or another responsible Federal agency within 30 calendar days of the date of billing, the FOIA Officer shall require the requester to pay the full amount due, plus any applicable interest, and to make an advance payment of the full amount of any anticipated fee, before the FOIA Officer begins to process a new request or continues to process a pending request from that requester.

(4) In cases in which the FOIA Officer requires payment under paragraphs (i)(2) or (3) of this section, the request shall not be considered received and further work will not be done on it until the required payment is received.

(5) Upon the completion of processing of a request, when a specific fee is determined to be payable and appropriate notice has been given to the requester, the FOIA Officer shall make records available to the requester only upon receipt of full payment of the fee.

(j) *Other statutes specifically providing for fees.* The fee schedule of this section does not apply to fees charged under any statute (except for FOIA) that specifically requires USPTO or another responsible Federal agency to set and collect fees for particular types of records. If records responsive to requests are maintained for distribution by agencies operating such statutorily based fee schedule programs, the FOIA Officer shall inform requesters of how to obtain records from those sources.

(k) *Requirements for waiver or reduction of fees.*

(1) Records responsive to a request will be furnished without charge or at a charge reduced below that established under paragraph (c) of this section if the FOIA Officer determines, based on all available information, that the requester has demonstrated that:

(i) Disclosure of the requested information is in the public interest because it is likely to contribute significantly to public understanding of the operations or activities of the Government; and

(ii) Disclosure of the information is not primarily in the commercial interest of the requester.

(2) To determine whether the first fee waiver requirement is met, the FOIA Officer shall consider the following factors:

(i) *The subject of the request:* whether the subject of the requested records concerns the operations or activities of the Government. The subject of the requested records must concern identifiable operations or activities of the Federal Government, with a connection that is direct and clear, not remote or attenuated.

(ii) *The informative value of the information to be disclosed:* whether the disclosure is “likely to contribute” to an understanding of Government operations or activities. The disclosable portions of the requested records must be meaningfully informative about Government operations or activities in order to be “likely to contribute” to an increased public understanding of those operations or activities. The disclosure of information that already is in the public domain, in either a duplicative or a substantially identical form, would not be likely to contribute to such understanding.

(iii) *The contribution to an understanding of the subject by the public likely to result from disclosure:* whether disclosure of the requested information will contribute to the understanding of a reasonably broad audience of persons interested in the subject, as opposed to the individual understanding of the requester. A requester’s expertise in the subject area and ability and intention to effectively convey information to the public shall be considered. It shall be presumed that a representative of the news media satisfies this consideration. It shall be presumed that a

requester who merely provides information to media sources does not satisfy this consideration.

(iv) *The significance of the contribution to public understanding:* whether the disclosure is likely to contribute “significantly” to public understanding of Government operations or activities. The public’s understanding of the subject in question prior to the disclosure must be significantly enhanced by the disclosure.

(3) To determine whether the second fee waiver requirement is met, the FOIA Officer shall consider the following factors:

(i) *The existence and magnitude of a commercial interest:* whether the requester has a commercial interest that would be furthered by the requested disclosure. The FOIA Officer shall consider any commercial interest of the requester (with reference to the definition of “commercial use request” in paragraph (b)(1) of this section), or of any person on whose behalf the requester may be acting, that would be furthered by the requested disclosure. Requesters shall be given an opportunity to provide explanatory information regarding this consideration.

(ii) *The primary interest in disclosure:* whether any identified commercial interest of the requester is sufficiently large, in comparison with the public interest in disclosure, that disclosure is “primarily in the commercial interest of the requester.” A fee waiver or reduction is justified if the public interest standard (paragraph (k)(1)(i) of this section) is satisfied and the public interest is greater than any identified commercial interest in disclosure. The FOIA Officer ordinarily shall presume that if a news media requester has satisfied the public interest standard, the public interest is the primary interest served by disclosure to that requester. Disclosure to data brokers or others who merely compile and market Government information for direct economic return shall not be presumed to primarily serve the public interest.

(4) If only some of the records to be released satisfy the requirements for a fee waiver, a waiver shall be granted for those records.

(5) Requests for the waiver or reduction of fees should address the factors listed in paragraphs (k)(2) and (3) of this section, insofar as they apply to each request.

[Added, 65 FR 52916, Aug. 31, 2000, effective Oct. 2, 2000]

## Subpart B — Privacy Act

### § 102.21 Purpose and scope.

(a) The purpose of this subpart is to establish policies and procedures for implementing the Privacy Act of 1974, as amended (5 U.S.C. 552a) (the Act). The main objectives are to facilitate full exercise of rights conferred on individuals under the Act and to ensure the protection of privacy as to individuals on whom USPTO maintains records in systems of records under the Act. USPTO accepts the responsibility to act promptly and in accordance with the Act upon receipt of any inquiry, request or appeal from a citizen of the United States or an alien lawfully admitted for permanent residence into the United States, regardless of the age of the individual. Further, USPTO accepts the obligations to maintain only such information on individuals as is relevant and necessary to the performance of its lawful functions, to maintain that information with such accuracy, relevancy, timeliness, and completeness as is reasonably necessary to assure fairness in determinations made by USPTO about the individual, to obtain information from the individual to the extent practicable, and to take every reasonable step to protect that information from unwarranted disclosure. USPTO will maintain no record describing how an individual exercises rights guaranteed by the First Amendment unless expressly authorized by statute or by the individual about whom the record is maintained or unless pertinent to and within the scope of an authorized law enforcement activity. An individual's name and address will not be sold or rented by USPTO unless such action is specifically authorized by law; however, this provision shall not be construed to require the withholding of names and addresses otherwise permitted to be made public.

(b) This subpart is administered by the Privacy Officer of USPTO.

(c) Matters outside the scope of this subpart include the following:

(1) Requests for records which do not pertain to the individual making the request, or to the individual about whom the request is made if the requester is the parent or guardian of the individual;

(2) Requests involving information pertaining to an individual which is in a record or file but not within the scope of a system of records notice published in the *Federal Register*;

(3) Requests to correct a record where a grievance procedure is available to the individual either by regulation or by provision in a collective bargaining agreement with USPTO, and the individual has initiated, or has expressed in writing the intention of initiating, such grievance procedure. An individual selecting the grievance procedure waives the use of the procedures in this subpart to correct or amend a record; and,

(4) Requests for employee-employer services and counseling which were routinely granted prior to enactment of the Act, including, but not limited to, test calculations of retirement benefits, explanations of health and life insurance programs, and explanations of tax withholding options.

(d) Any request for records which pertains to the individual making the request, or to the individual about whom the request is made if the requester is the parent or guardian of the individual, shall be processed under the Act and this subpart and under the Freedom of Information Act and USPTO's implementing regulations at Subpart A of this part, regardless whether the Act or the Freedom of Information Act is mentioned in the request.

[Added, 65 FR 52916, Aug. 31, 2000, effective Oct. 2, 2000]

### § 102.22 Definitions.

(a) All terms used in this subpart which are defined in 5 U.S.C. 552a shall have the same meaning herein.

(b) As used in this subpart:

(1) *Act* means the "Privacy Act of 1974, as amended (5 U.S.C. 552a)".

(2) *Appeal* means a request by an individual to review and reverse an initial denial of a request by that individual for correction or amendment.

(3) *USPTO* means the United States Patent and Trademark Office.

(4) *Inquiry* means either a request for general information regarding the Act and this subpart or a request by an individual (or that individual's parent or guardian) that USPTO determine whether it has any

record in a system of records which pertains to that individual.

(5) *Person* means any human being and also shall include but not be limited to, corporations, associations, partnerships, trustees, receivers, personal representatives, and public or private organizations.

(6) *Privacy Officer* means a USPTO employee designated to administer this subpart.

(7) *Request for access* means a request by an individual or an individual's parent or guardian to see a record which is in a particular system of records and which pertains to that individual.

(8) *Request for correction or amendment* means the request by an individual or an individual's parent or guardian that USPTO change (either by correction, amendment, addition or deletion) a particular record in a system of records which pertains to that individual.

[Added, 65 FR 52916, Aug. 31, 2000, effective Oct. 2, 2000]

### § 102.23 Procedures for making inquiries.

(a) Any individual, regardless of age, who is a citizen of the United States or an alien lawfully admitted for permanent residence into the United States may submit an inquiry to USPTO. The inquiry should be made either in person at Two Crystal Park, 2121 Crystal Drive, Suite 905, Arlington, Virginia, or by mail addressed to the Privacy Officer, United States Patent and Trademark Office, PO Box 1450, Alexandria, Virginia 22313-1450, or to the official identified in the notification procedures paragraph of the systems of records notice published in the Federal Register. If an individual believes USPTO maintains a record pertaining to that individual but does not know which system of records might contain such a record, the USPTO Privacy Officer will provide assistance in person or by mail.

(b) Inquiries submitted by mail should include the words "PRIVACY ACT INQUIRY" in capital letters at the top of the letter and on the face of the envelope. If the inquiry is for general information regarding the Act and this subpart, no particular information is required. USPTO reserves the right to require compliance with the identification procedures appearing at § 102.24(d) where circumstances warrant. If the inquiry is a request that USPTO determine whether it has, in a given system of records, a record

which pertains to the individual, the following information should be submitted:

(1) Name of individual whose record is sought;

(2) Individual whose record is sought is either a U.S. citizen or an alien lawfully admitted for permanent residence;

(3) Identifying data that will help locate the record (for example, maiden name, occupational license number, period or place of employment, etc.);

(4) Record sought, by description and by record system name, if known;

(5) Action requested (that is, sending information on how to exercise rights under the Act; determining whether requested record exists; gaining access to requested record; or obtaining copy of requested record);

(6) Copy of court guardianship order or minor's birth certificate, as provided in § 102.24(f)(3), but only if requester is guardian or parent of individual whose record is sought;

(7) Requester's name (printed), signature, address, and telephone number (optional);

(8) Date; and,

(9) Certification of request by notary or other official, but only if

(i) Request is for notification that requested record exists, for access to requested record or for copy of requested record;

(ii) Record is not available to any person under 5 U.S.C. 552; and

(iii) Requester does not appear before an employee of USPTO for verification of identity.

(c) Any inquiry which is not addressed as specified in paragraph (a) of this section or which is not marked as specified in paragraph (b) of this section will be so addressed and marked by USPTO personnel and forwarded immediately to the Privacy Officer. An inquiry which is not properly addressed by the individual will not be deemed to have been "received" for purposes of measuring the time period for response until actual receipt by the Privacy Officer. In each instance when an inquiry so forwarded is received, the Privacy Officer shall notify the individual that his or her inquiry was improperly addressed and the date the inquiry was received at the proper address.



(d)(1) Each inquiry received shall be acted upon promptly by the Privacy Officer. Every effort will be made to respond within ten working days (*i.e.*, excluding Saturdays, Sundays and legal public holidays) of the date of receipt. If a response cannot be made within ten working days, the Privacy Officer shall send an acknowledgment during that period providing information on the status of the inquiry and asking for such further information as may be necessary to process the inquiry. The first correspondence sent by the Privacy Officer to the requester shall contain USPTO's control number assigned to the request, as well as a note that the requester should use that number in all future contacts in order to facilitate processing. USPTO shall use that control number in all subsequent correspondence.

(2) If the Privacy Officer fails to send an acknowledgment within ten working days, as provided above, the requester may ask the General Counsel to take corrective action. No failure of the Privacy Officer to send an acknowledgment shall confer administrative finality for purposes of judicial review.

(e) An individual shall not be required to state a reason or otherwise justify his or her inquiry.

(f) Special note should be taken of the fact that certain agencies are responsible for publishing notices of systems of records having Government-wide application to other agencies, including USPTO. The agencies known to be publishing these general notices and the types of records covered therein appear in an appendix to this part. The provisions of this section, and particularly paragraph (a) of this section, should be followed in making inquiries with respect to such records. Such records in USPTO are subject to the provisions of this part to the extent indicated in the appendix to this part. The exemptions, if any, determined by an agency publishing a general notice shall be invoked and applied by USPTO after consultation, as necessary, with that other agency.

[Added, 65 FR 52916, Aug. 31, 2000, effective Oct. 2, 2000; para. (a) revised, 68 FR 14332, Mar. 25, 2003, effective May 1, 2003]

#### § 102.24 Procedures for making requests for records.

(a) Any individual, regardless of age, who is a citizen of the United States or an alien lawfully admit-

ted for permanent residence into the United States may submit a request for access to records to USPTO. The request should be made either in person at Two Crystal Park, 2121 Crystal Drive, Suite 905, Arlington, Virginia, or by mail addressed to the Privacy Officer, United States Patent and Trademark Office, PO Box 1450, Alexandria, Virginia 22313-1450.

(b) Requests submitted by mail should include the words "PRIVACY ACT REQUEST" in capital letters at the top of the letter and on the face of the envelope. Any request which is not addressed as specified in paragraph (a) of this section or which is not marked as specified in this paragraph will be so addressed and marked by USPTO personnel and forwarded immediately to the Privacy Officer. A request which is not properly addressed by the individual will not be deemed to have been "received" for purposes of measuring time periods for response until actual receipt by the Privacy Officer. In each instance when a request so forwarded is received, the Privacy Officer shall notify the individual that his or her request was improperly addressed and the date when the request was received at the proper address.

(c) If the request follows an inquiry under § 102.23 in connection with which the individual's identity was established by USPTO, the individual need only indicate the record to which access is sought, provide the USPTO control number assigned to the request, and sign and date the request. If the request is not preceded by an inquiry under § 102.23, the procedures of this section should be followed.

(d) The requirements for identification of individuals seeking access to records are as follows:

(1) *In person.* Each individual making a request in person shall be required to present satisfactory proof of identity. The means of proof, in the order of preference and priority, are:

(i) A document bearing the individual's photograph (for example, driver's license, passport or military or civilian identification card);

(ii) A document, preferably issued for participation in a federally sponsored program, bearing the individual's signature (for example, unemployment insurance book, employer's identification card, national credit card, and professional, craft or union membership card); and

(iii) A document bearing neither the photograph nor the signature of the individual, preferably issued for participation in a federally sponsored program (for example, Medicaid card). In the event the individual can provide no suitable documentation of identity, USPTO will require a signed statement asserting the individual’s identity and stipulating that the individual understands the penalty provision of 5 U.S.C. 552a(i)(3) recited in § 102.32(a). In order to avoid any unwarranted disclosure of an individual’s records, USPTO reserves the right to determine the adequacy of proof of identity offered by any individual, particularly when the request involves a sensitive record.

(2) *Not in person.* If the individual making a request does not appear in person before the Privacy Officer or other employee authorized to determine identity, a certification of a notary public or equivalent officer empowered to administer oaths must accompany the request under the circumstances prescribed in § 102.23(b)(9). The certification in or attached to the letter must be substantially in accordance with the following text:

City of \_\_\_\_\_

County of \_\_\_\_\_:ss

(Name of individual), who affixed (his) (her) signature below in my presence, came before me, a (title), in and for the aforesaid County and State, this \_\_\_\_\_ day of \_\_\_\_\_, 20\_\_\_\_, and established (his) (her) identity to my satisfaction.

My commission expires \_\_\_\_\_.

(Signature)

(3) *Parents of minors and legal guardians.* An individual acting as the parent of a minor or the legal guardian of the individual to whom a record pertains shall establish his or her personal identity in the same manner prescribed in either paragraph (d)(1) or (d)(2) of this section. In addition, such other individual shall establish his or her identity in the representative capacity of parent or legal guardian. In the case of the parent of a minor, the proof of identity shall be a certified or authenticated copy of the minor’s birth certificate. In the case of a legal guardian of an individual who has been declared incompetent due to physical or mental incapacity or age by a court of competent jurisdiction, the proof of identity shall be a certified or authenticated copy of the court’s order. For purposes of the Act, a parent or legal guardian

may represent only a living individual, not a decedent. A parent or legal guardian may be accompanied during personal access to a record by another individual, provided the provisions of § 102.25(f) are satisfied.

(e) When the provisions of this subpart are alleged to impede an individual in exercising his or her right to access, USPTO will consider, from an individual making a request, alternative suggestions regarding proof of identity and access to records.

(f) An individual shall not be required to state a reason or otherwise justify his or her request for access to a record.

[Added, 65 FR 52916, Aug. 31, 2000, effective Oct. 2, 2000; para. (a) revised, 68 FR 14332, Mar. 25, 2003, effective May 1, 2003]

**§ 102.25 Disclosure of requested records to individuals.**

(a)(1) The Privacy Officer shall act promptly upon each request. Every effort will be made to respond within ten working days (*i.e.*, excluding Saturdays, Sundays, and legal public holidays) of the date of receipt. If a response cannot be made within ten working days due to unusual circumstances, the Privacy Officer shall send an acknowledgment during that period providing information on the status of the request and asking for any further information that may be necessary to process the request. “Unusual circumstances” shall include circumstances in which

(i) A search for and collection of requested records from inactive storage, field facilities or other establishments is required;

(ii) A voluminous amount of data is involved;

(iii) Information on other individuals must be separated or expunged from the particular record; or

(iv) Consultations with other agencies having a substantial interest in the determination of the request are necessary.

(2) If the Privacy Officer fails to send an acknowledgment within ten working days, as provided above in paragraph (a) of this section, the requester may ask the General Counsel to take corrective action. No failure of the Privacy Officer to send an acknowledgment shall confer administrative finality for purposes of judicial review.

(b) *Grant of access*—

(1) *Notification.* An individual shall be granted access to a record pertaining to him or her, except where the provisions of paragraph (g)(1) of this section apply. The Privacy Officer will notify the individual of a determination to grant access, and provide the following information:

(i) The methods of access, as set forth in paragraph (b)(2) of this section;

(ii) The place at which the record may be inspected;

(iii) The earliest date on which the record may be inspected and the period of time that the records will remain available for inspection. In no event shall the earliest date be later than thirty calendar days from the date of notification;

(iv) The estimated date by which a copy of the record could be mailed and the estimate of fees pursuant to § 102.31. In no event shall the estimated date be later than thirty calendar days from the date of notification;

(v) The fact that the individual, if he or she wishes, may be accompanied by another individual during personal access, subject to the procedures set forth in paragraph (f) of this section; and,

(vi) Any additional requirements needed to grant access to a specific record.

(2) *Methods of access.* The following methods of access to records by an individual may be available depending on the circumstances of a given situation:

(i) Inspection in person may be had in a location specified by the Privacy Officer during business hours;

(ii) Transfer of records to a Federal facility more convenient to the individual may be arranged, but only if the Privacy Officer determines that a suitable facility is available, that the individual's access can be properly supervised at that facility, and that transmittal of the records to that facility will not unduly interfere with operations of USPTO or involve unreasonable costs, in terms of both money and manpower; and

(iii) Copies may be mailed at the request of the individual, subject to payment of the fees prescribed in § 102.31. USPTO, on its own initiative, may elect to provide a copy by mail, in which case no fee will be charged the individual.

(c) Access to medical records is governed by the provisions of § 102.26.

(d) USPTO will supply such other information and assistance at the time of access as to make the record intelligible to the individual.

(e) USPTO reserves the right to limit access to copies and abstracts of original records, rather than the original records. This election would be appropriate, for example, when the record is in an automated data media such as tape or diskette, when the record contains information on other individuals, and when deletion of information is permissible under exemptions (for example, 5 U.S.C. 552a(k)(2)). In no event shall original records of USPTO be made available to the individual except under the immediate supervision of the Privacy Officer or the Privacy Officer's designee.

(f) Any individual who requests access to a record pertaining to that individual may be accompanied by another individual of his or her choice. "Accompanied" includes discussion of the record in the presence of the other individual. The individual to whom the record pertains shall authorize the presence of the other individual in writing. The authorization shall include the name of the other individual, a specific description of the record to which access is sought, the USPTO control number assigned to the request, the date, and the signature of the individual to whom the record pertains. The other individual shall sign the authorization in the presence of the Privacy Officer. An individual shall not be required to state a reason or otherwise justify his or her decision to be accompanied by another individual during personal access to a record.

(g) *Initial denial of access*—

(1) *Grounds.* Access by an individual to a record which pertains to that individual will be denied only upon a determination by the Privacy Officer that:

(i) The record is exempt under § 102.33 or § 102.34, or exempt by determination of another agency publishing notice of the system of records, as described in § 102.23(f);

(ii) The record is information compiled in reasonable anticipation of a civil action or proceeding;

(iii) The provisions of § 102.26 pertaining to medical records temporarily have been invoked; or

(iv) The individual has unreasonably failed to comply with the procedural requirements of this part.

(2) *Notification.* The Privacy Officer shall give notice of denial of access to records to the individual in writing and shall include the following information:

(i) The Privacy Officer's name and title or position;

(ii) The date of the denial;

(iii) The reasons for the denial, including citation to the appropriate section of the Act and this part;

(iv) The individual's opportunities, if any, for further administrative consideration, including the identity and address of the responsible official. If no further administrative consideration within USPTO is available, the notice shall state that the denial is administratively final; and

(v) If stated to be administratively final within USPTO, the individual's right to judicial review provided under 5 U.S.C. 552a(g)(1), as limited by 5 U.S.C. 552a(g)(5).

(3) *Administrative review.* When an initial denial of a request is issued by the Privacy Officer, the individual's opportunities for further consideration shall be as follows:

(i) As to denial under paragraph (g)(1)(i) of this section, two opportunities for further consideration are available in the alternative:

(A) If the individual contests the application of the exemption to the records, review procedures in § 102.25(g)(3)(ii) shall apply; or

(B) If the individual challenges the exemption itself, the procedure is a petition for the issuance, amendment, or repeal of a rule under 5 U.S.C. 553(e). If the exemption was determined by USPTO, such petition shall be filed with the General Counsel. If the exemption was determined by another agency (as described in § 102.23(f)), USPTO will provide the individual with the name and address of the other agency and any relief sought by the individual shall be that provided by the regulations of the other agency. Within USPTO, no such denial is administratively final until such a petition has been filed by the individual and disposed of on the merits by the General Counsel.

(ii) As to denial under paragraphs (g)(1)(ii) of this section, (g)(1)(iv) of this section or (to the limited extent provided in paragraph (g)(3)(i)(A) of this section) paragraph (g)(1)(i) of this section, the individual may file for review with the General Counsel, as indicated in the Privacy Officer's initial denial notification. The procedures appearing in § 102.28 shall be followed by both the individual and USPTO to the maximum extent practicable.

(iii) As to denial under paragraph (g)(1)(iii) of this section, no further administrative consideration within USPTO is available because the denial is not administratively final until expiration of the time period indicated in § 102.26(a).

(h) If a request is partially granted and partially denied, the Privacy Officer shall follow the appropriate procedures of this section as to the records within the grant and the records within the denial.

[Added, 65 FR 52916, Aug. 31, 2000, effective Oct. 2, 2000]

#### § 102.26 Special procedures: Medical records.

(a) No response to any request for access to medical records by an individual will be issued by the Privacy Officer for a period of seven working days (*i.e.*, excluding Saturdays, Sundays, and legal public holidays) from the date of receipt.

(b) USPTO has published as a routine use, for all systems of records containing medical records, consultations with an individual's physician or psychologist if, in the sole judgment of USPTO, disclosure could have an adverse effect upon the individual. The mandatory waiting period set forth in paragraph (a) of this section will permit exercise of this routine use in appropriate cases. USPTO will pay no cost of any such consultation.

(c) In every case of a request by an individual for access to medical records, the Privacy Officer shall:

(1) Inform the individual of the waiting period prescribed in paragraph (a) of this section;

(2) Obtain the name and address of the individual's physician and/or psychologist, if the individual consents to give them;

(3) Obtain specific, written consent for USPTO to consult the individual's physician and/or psychologist in the event that USPTO believes such

consultation is advisable, if the individual consents to give such authorization;

(4) Obtain specific, written consent for USPTO to provide the medical records to the individual's physician or psychologist in the event that USPTO believes access to the record by the individual is best effected under the guidance of the individual's physician or psychologist, if the individual consents to give such authorization; and

(5) Forward the individual's medical record to USPTO's medical expert for review and a determination on whether consultation with or transmittal of the medical records to the individual's physician or psychologist is warranted. If the consultation with or transmittal of such records to the individual's physician or psychologist is determined to be warranted, USPTO's medical expert shall so consult or transmit. Whether or not such a consultation or transmittal occurs, USPTO's medical officer shall provide instruction to the Privacy Officer regarding the conditions of access by the individual to his or her medical records.

(d) If an individual refuses in writing to give the names and consents set forth in paragraphs (c)(2) through (c)(4) of this section and USPTO has determined that disclosure could have an adverse effect upon the individual, USPTO shall give the individual access to said records by means of a copy, provided without cost to the requester, sent registered mail return receipt requested.

[Added, 65 FR 52916, Aug. 31, 2000, effective Oct. 2, 2000]

### § 102.27 Procedures for making requests for correction or amendment.

(a) Any individual, regardless of age, who is a citizen of the United States or an alien lawfully admitted for permanent residence into the United States may submit a request for correction or amendment to USPTO. The request should be made either in person or by mail addressed to the Privacy Officer who processed the individual's request for access to the record, and to whom is delegated authority to make initial determinations on requests for correction or amendment. The office of the Privacy Officer is open to the public between the hours of 9 a.m. and 4 p.m., Monday through Friday (excluding legal public holidays).

(b) Requests submitted by mail should include the words "PRIVACY ACT REQUEST" in capital letters at the top of the letter and on the face of the envelope. Any request which is not addressed as specified in paragraph (a) of this section or which is not marked as specified in this paragraph will be so addressed and marked by USPTO personnel and forwarded immediately to the Privacy Officer. A request which is not properly addressed by the individual will not be deemed to have been "received" for purposes of measuring the time period for response until actual receipt by the Privacy Officer. In each instance when a request so forwarded is received, the Privacy Officer shall notify the individual that his or her request was improperly addressed and the date the request was received at the proper address.

(c) Since the request, in all cases, will follow a request for access under § 102.25, the individual's identity will be established by his or her signature on the request and use of the USPTO control number assigned to the request.

(d) A request for correction or amendment should include the following:

(1) Specific identification of the record sought to be corrected or amended (for example, description, title, date, paragraph, sentence, line and words);

(2) The specific wording to be deleted, if any;

(3) The specific wording to be inserted or added, if any, and the exact place at which to be inserted or added; and

(4) A statement of the basis for the requested correction or amendment, with all available supporting documents and materials which substantiate the statement. The statement should identify the criterion of the Act being invoked, that is, whether the information in the record is unnecessary, inaccurate, irrelevant, untimely or incomplete.

[Added, 65 FR 52916, Aug. 31, 2000, effective Oct. 2, 2000]

### § 102.28 Review of requests for correction or amendment.

(a)(1)(i) Not later than ten working days (*i.e.*, excluding Saturdays, Sundays and legal public holidays) after receipt of a request to correct or amend a record, the Privacy Officer shall send an

acknowledgment providing an estimate of time within which action will be taken on the request and asking for such further information as may be necessary to process the request. The estimate of time may take into account unusual circumstances as described in § 102.25(a). No acknowledgment will be sent if the request can be reviewed, processed, and the individual notified of the results of review (either compliance or denial) within the ten working days. Requests filed in person will be acknowledged in writing at the time submitted.

(ii) If the Privacy Officer fails to send the acknowledgment within ten working days, as provided in paragraph (a)(1)(i) of this section, the requester may ask the General Counsel to take corrective action. No failure of the Privacy Officer to send an acknowledgment shall confer administrative finality for purposes of judicial review.

(2) Promptly after acknowledging receipt of a request, or after receiving such further information as might have been requested, or after arriving at a decision within the ten working days, the Privacy Officer shall either:

(i) Make the requested correction or amendment and advise the individual in writing of such action, providing either a copy of the corrected or amended record or a statement as to the means whereby the correction or amendment was effected in cases where a copy cannot be provided (for example, erasure of information from a record maintained only in magnetically recorded computer files); or

(ii) Inform the individual in writing that his or her request is denied and provide the following information:

(A) The Privacy Officer's name and title or position;

(B) The date of the denial;

(C) The reasons for the denial, including citation to the appropriate sections of the Act and this subpart; and

(D) The procedures for appeal of the denial as set forth in § 102.29, including the address of the General Counsel.

(3) The term *promptly* in this section means within thirty working days (*i.e.*, excluding Saturdays, Sundays, and legal public holidays). If the Privacy Officer cannot make the determination within thirty working days, the individual will be advised in writ-

ing of the reason therefor and of the estimated date by which the determination will be made.

(b) Whenever an individual's record is corrected or amended pursuant to a request by that individual, the Privacy Officer shall be responsible for notifying all persons and agencies to which the corrected or amended portion of the record had been disclosed prior to its correction or amendment, if an accounting of such disclosure required by the Act was made. The notification shall require a recipient agency maintaining the record to acknowledge receipt of the notification, to correct or amend the record, and to apprise any agency or person to which it had disclosed the record of the substance of the correction or amendment.

(c) The following criteria will be considered by the Privacy Officer in reviewing a request for correction or amendment:

(1) The sufficiency of the evidence submitted by the individual;

(2) The factual accuracy of the information;

(3) The relevance and necessity of the information in terms of purpose for which it was collected;

(4) The timeliness and currency of the information in light of the purpose for which it was collected;

(5) The completeness of the information in terms of the purpose for which it was collected;

(6) The degree of risk that denial of the request could unfairly result in determinations adverse to the individual;

(7) The character of the record sought to be corrected or amended; and

(8) The propriety and feasibility of complying with the specific means of correction or amendment requested by the individual.

(d) USPTO will not undertake to gather evidence for the individual, but does reserve the right to verify the evidence which the individual submits.

(e) Correction or amendment of a record requested by an individual will be denied only upon a determination by the Privacy Officer that:

(1) The individual has failed to establish, by a preponderance of the evidence, the propriety of the correction or amendment in light of the criteria set forth in paragraph (c) of this section;

(2) The record sought to be corrected or amended is part of the official record in a terminated

judicial, quasi-judicial, or quasi-legislative proceeding to which the individual was a party or participant;

(3) The information in the record sought to be corrected or amended, or the record sought to be corrected or amended, is the subject of a pending judicial, quasi-judicial, or quasi-legislative proceeding to which the individual is a party or participant;

(4) The correction or amendment would violate a duly enacted statute or promulgated regulation; or

(5) The individual has unreasonably failed to comply with the procedural requirements of this part.

(f) If a request is partially granted and partially denied, the Privacy Officer shall follow the appropriate procedures of this section as to the records within the grant and the records within the denial.

[Added, 65 FR 52916, Aug. 31, 2000, effective Oct. 2, 2000]

#### § 102.29 Appeal of initial adverse determination on correction or amendment.

(a) When a request for correction or amendment has been denied initially under § 102.28, the individual may submit a written appeal within thirty working days (*i.e.*, excluding Saturdays, Sundays and legal public holidays) after the date of the initial denial. When an appeal is submitted by mail, the postmark is conclusive as to timeliness.

(b) An appeal should be addressed to the General Counsel, United States Patent and Trademark Office, PO Box 1450, Alexandria, Virginia 22313-1450. An appeal should include the words "PRIVACY APPEAL" in capital letters at the top of the letter and on the face of the envelope. An appeal not addressed and marked as provided herein will be so marked by USPTO personnel when it is so identified and will be forwarded immediately to the General Counsel. An appeal which is not properly addressed by the individual will not be deemed to have been "received" for purposes of measuring the time periods in this section until actual receipt by the General Counsel. In each instance when an appeal so forwarded is received, the General Counsel shall notify the individual that his or her appeal was improperly addressed and the date when the appeal was received at the proper address.

(c) The individual's appeal shall include a statement of the reasons why the initial denial is believed

to be in error and USPTO's control number assigned to the request. The appeal shall be signed by the individual. The record which the individual requests be corrected or amended and all correspondence between the Privacy Officer and the requester will be furnished by the Privacy Officer who issued the initial denial. Although the foregoing normally will comprise the entire record on appeal, the General Counsel may seek additional information necessary to assure that the final determination is fair and equitable and, in such instances, disclose the additional information to the individual to the greatest extent possible, and provide an opportunity for comment thereon.

(d) No personal appearance or hearing on appeal will be allowed.

(e) The General Counsel shall act upon the appeal and issue a final determination in writing not later than thirty working days (*i.e.*, excluding Saturdays, Sundays and legal public holidays) from the date on which the appeal is received, except that the General Counsel may extend the thirty days upon deciding that a fair and equitable review cannot be made within that period, but only if the individual is advised in writing of the reason for the extension and the estimated date by which a final determination will issue. The estimated date should not be later than the sixtieth working day after receipt of the appeal unless unusual circumstances, as described in § 102.25(a), are met.

(f) If the appeal is determined in favor of the individual, the final determination shall include the specific corrections or amendments to be made and a copy thereof shall be transmitted promptly both to the individual and to the Privacy Officer who issued the initial denial. Upon receipt of such final determination, the Privacy Officer promptly shall take the actions set forth in § 102.28(a)(2)(i) and (b).

(g) If the appeal is denied, the final determination shall be transmitted promptly to the individual and state the reasons for the denial. The notice of final determination also shall inform the individual of the following:

(1) The right of the individual under the Act to file a concise statement of reasons for disagreeing with the final determination. The statement ordinarily should not exceed one page and USPTO reserves the right to reject a statement of excessive length. Such a statement shall be filed with the General Counsel. It

should provide the USPTO control number assigned to the request, indicate the date of the final determination and be signed by the individual. The General Counsel shall acknowledge receipt of such statement and inform the individual of the date on which it was received.

(2) The facts that any such disagreement statement filed by the individual will be noted in the disputed record, that the purposes and uses to which the statement will be put are those applicable to the record in which it is noted, and that a copy of the statement will be provided to persons and agencies to which the record is disclosed subsequent to the date of receipt of such statement;

(3) The fact that USPTO will append to any such disagreement statement filed by the individual, a copy of the final determination or summary thereof which also will be provided to persons and agencies to which the disagreement statement is disclosed; and,

(4) The right of the individual to judicial review of the final determination under 5 U.S.C. 552a(g)(1)(A), as limited by 5 U.S.C. 552a(g)(5).

(h) In making the final determination, the General Counsel shall employ the criteria set forth in § 102.28(c) and shall deny an appeal only on the grounds set forth in § 102.28(e).

(i) If an appeal is partially granted and partially denied, the General Counsel shall follow the appropriate procedures of this section as to the records within the grant and the records within the denial.

(j) Although a copy of the final determination or a summary thereof will be treated as part of the individual's record for purposes of disclosure in instances where the individual has filed a disagreement statement, it will not be subject to correction or amendment by the individual.

(k) The provisions of paragraphs (g)(1) through (g)(3) of this section satisfy the requirements of 5 U.S.C. 552a(e)(3).

[Added, 65 FR 52916, Aug. 31, 2000, effective Oct. 2, 2000; para. (b) revised, 68 FR 14332, Mar. 25, 2003, effective May 1, 2003]

### § 102.30 Disclosure of record to person other than the individual to whom it pertains.

(a) USPTO may disclose a record pertaining to an individual to a person other than the individual to whom it pertains only in the following instances:

(1) Upon written request by the individual, including authorization under § 102.25(f);

(2) With the prior written consent of the individual;

(3) To a parent or legal guardian under 5 U.S.C. 552a(h);

(4) When required by the Act and not covered explicitly by the provisions of 5 U.S.C. 552a(b); and

(5) When permitted under 5 U.S.C. 552a(b)(1) through (12), which read as follows:<sup>1</sup>

---

<sup>1</sup> 5 U.S.C. 552a(b)(4) has no application within USPTO.

---

(i) To those officers and employees of the agency which maintains the record who have a need for the record in the performance of their duties;

(ii) Required under 5 U.S.C. 552;

(iii) For a routine use as defined in 5 U.S.C. 552a(a)(7) and described under 5 U.S.C. 552a(e)(4)(D);

(iv) To the Bureau of the Census for purposes of planning or carrying out a census or survey or related activity pursuant to the provisions of Title 13;

(v) To a recipient who has provided the agency with advance adequate written assurance that the record will be used solely as a statistical research or reporting record, and the record is to be transferred in a form that is not individually identifiable;

(vi) To the National Archives and Records Administration as a record which has sufficient historical or other value to warrant its continued preservation by the United States Government, or for evaluation by the Archivist of the United States or the designee of the Archivist to determine whether the record has such value;

(vii) To another agency or to an instrumentality of any governmental jurisdiction within or under the control of the United States for a civil or criminal law enforcement activity if the activity is authorized by law, and if the head of the agency or instrumentality has made a written request to the agency which maintains the record specifying the particular portion desired and the law enforcement activity for which the record is sought;



(viii) To a person pursuant to a showing of compelling circumstances affecting the health or safety of an individual if upon such disclosure notification is transmitted to the last known address of such individual;

(ix) To either House of Congress, or, to the extent of matter within its jurisdiction, any committee or subcommittee thereof, any joint committee of Congress or subcommittee of any such joint committee;

(x) To the Comptroller General, or any of his authorized representatives, in the course of the performance of the duties of the General Accounting Office;

(xi) Pursuant to the order of a court of competent jurisdiction; or

(xii) To a consumer reporting agency in accordance with section 3711(e) of Title 31.

(b) The situations referred to in paragraph (a)(4) of this section include the following:

(1) 5 U.S.C. 552a(c)(4) requires dissemination of a corrected or amended record or notation of a disagreement statement by USPTO in certain circumstances;

(2) 5 U.S.C. 552a(d) requires disclosure of records to the individual to whom they pertain, upon request; and

(3) 5 U.S.C. 552a(g) authorizes civil action by an individual and requires disclosure by USPTO to the court.

(c) The Privacy Officer shall make an accounting of each disclosure by him of any record contained in a system of records in accordance with 5 U.S.C. 552a(c) (1) and (2). Except for a disclosure made under 5 U.S.C. 552a(b)(7), the Privacy Officer shall make such accounting available to any individual, insofar as it pertains to that individual, on request submitted in accordance with § 102.24. The Privacy Officer shall make reasonable efforts to notify any individual when any record in a system of records is disclosed to any person under compulsory legal process, promptly upon being informed that such process has become a matter of public record.

[Added, 65 FR 52916, Aug. 31, 2000, effective Oct. 2, 2000]

### § 102.31 Fees.

The only fees to be charged to or collected from an individual under the provisions of this part are for

duplication of records at the request of the individual. The Privacy Officer shall charge fees for duplication of records under the Act in the same way in which they charge duplication fees under § 102.11, except as provided in this section.

(a) No fees shall be charged or collected for the following: Search for and retrieval of the records; review of the records; copying at the initiative of USPTO without a request from the individual; transportation of records and personnel; and first-class postage.

(b) It is the policy of USPTO to provide an individual with one copy of each record corrected or amended pursuant to his or her request without charge as evidence of the correction or amendment.

(c) As required by the United States Office of Personnel Management in its published regulations implementing the Act, USPTO will charge no fee for a single copy of a personnel record covered by that agency's Government-wide published notice of systems of records.

[Added, 65 FR 52916, Aug. 31, 2000, effective Oct. 2, 2000]

### § 102.32 Penalties.

(a) The Act provides, in pertinent part:

Any person who knowingly and willfully requests or obtains any record concerning an individual from an agency under false pretenses shall be guilty of a misdemeanor and fined not more than \$5,000. (5 U.S.C. 552a(i)(3)).

(b) A person who falsely or fraudulently attempts to obtain records under the Act also may be subject to prosecution under such other criminal statutes as 18 U.S.C. 494, 495 and 1001.

[Added, 65 FR 52916, Aug. 31, 2000, effective Oct. 2, 2000]

### § 102.33 General exemptions.

(a) Individuals may not have access to records maintained by USPTO but which were provided by another agency which has determined by regulation that such information is subject to general exemption under 5 U.S.C. 552a(j). If such exempt records are within a request for access, USPTO will advise the individual of their existence and of the name and

address of the source agency. For any further information concerning the record and the exemption, the individual must contact that source agency.

(b) The general exemption determined to be necessary and proper with respect to systems of records maintained by USPTO, including the parts of each system to be exempted, the provisions of the Act from which they are exempted, and the justification for the exemption, is as follows: *Investigative Records—Contract and Grant Frauds and Employee Criminal Misconduct—COMMERCE/DEPT.—12*. Pursuant to 5 U.S.C. 552a(j)(2), these records are hereby determined to be exempt from all provisions of the Act, except 5 U.S.C. 552a (b), (c) (1) and (2), (e)(4) (A) through (F), (e) (6), (7), (9), (10), and (11), and (i). These exemptions are necessary to ensure the proper functions of the law enforcement activity, to protect confidential sources of information, to fulfill promises of confidentiality, to prevent interference with law enforcement proceedings, to avoid the disclosure of investigative techniques, to avoid the endangering of law enforcement personnel, to avoid premature disclosure of the knowledge of criminal activity and the evidentiary bases of possible enforcement actions, and to maintain the integrity of the law enforcement process.

[Added, 65 FR 52916, Aug. 31, 2000, effective Oct. 2, 2000]

### § 102.34 Specific exemptions.

(a)(1) Some systems of records under the Act which are maintained by USPTO contain, from time-to-time, material subject to the exemption appearing at 5 U.S.C. 552a(k)(1), relating to national defense and foreign policy materials. The systems of records published in the *Federal Register* by USPTO which are within this exemption are: COMMERCE/PAT-TM-6, COMMERCE/PAT-TM-7, COMMERCE/PAT-TM-8, COMMERCE/PAT-TM-9.

(2) USPTO hereby asserts a claim to exemption of such materials wherever they might appear in such systems of records, or any systems of records, at present or in the future. The materials would be exempt from 5 U.S.C. 552a (c)(3), (d), (e)(1), (e)(4) (G), (H), and (I), and (f) to protect materials required by Executive order to be kept secret in the interest of the national defense and foreign policy.

(b) The specific exemptions determined to be necessary and proper with respect to systems of records maintained by USPTO, including the parts of each system to be exempted, the provisions of the Act from which they are exempted, and the justification for the exemption, are as follows:

(1)(i) Exempt under 5 U.S.C. 552a(k)(2). The systems of records exempt (some only conditionally), the sections of the Act from which exempted, and the reasons therefor are as follows:

(A) Investigative Records—Contract and Grant Frauds and Employee Criminal Misconduct—COMMERCE/DEPT—12, but only on condition that the general exemption claimed in § 102.33(b)(3) is held to be invalid;

(B) Investigative Records—Persons Within the Investigative Jurisdiction of USPTO—COMMERCE/DEPT-13;

(C) Litigation, Claims and Administrative Proceeding Records—COMMERCE/DEPT-14;

(D) Attorneys and Agents Registered to Practice Before the Office—COMMERCE/PAT-TM-1;

(E) Complaints, Investigations and Disciplinary Proceedings Relating to Registered Patent Attorneys and Agents—COMMERCE/PAT-TM-2; and

(F) Non-Registered Persons Rendering Assistance to Patent Applicants—COMMERCE/PAT-TM-5.

(ii) The foregoing are exempted from 5 U.S.C. 552a (c)(3), (d), (e)(1), (e)(4)(G), (H), and (I), and (f). The reasons for asserting the exemption are to prevent subjects of investigation from frustrating the investigatory process, to insure the proper functioning and integrity of law enforcement activities, to prevent disclosure of investigative techniques, to maintain the ability to obtain necessary information, to fulfill commitments made to sources to protect their identities and the confidentiality of information and to avoid endangering these sources and law enforcement personnel. Special note is taken of the fact that the proviso clause in this exemption imports due process and procedural protections for the individual. The existence and general character of the information exempted will be made known to the individual to whom it pertains.

(2)(i) Exempt under 5 U.S.C. 552a(k)(5). The systems of records exempt (some only conditionally), the sections of the act from which exempted, and the reasons therefor are as follows:

(A) Investigative Records—Contract and Grant Frauds and Employee Criminal Misconduct—COMMERCE/DEPT-12, but only on condition that the general exemption claimed in § 102.33(b)(3) is held to be invalid;

(B) Investigative Records—Persons Within the Investigative Jurisdiction of USPTO—COMMERCE/DEPT-13; and

(C) Litigation, Claims, and Administrative Proceeding Records—COMMERCE/DEPT-14.

(ii) The foregoing are exempted from 5 U.S.C. 552a (c)(3), (d), (e)(1), (e)(4)(G), (H), and (I), and (f). The reasons for asserting the exemption are to maintain the ability to obtain candid and necessary information, to fulfill commitments made to sources to protect the confidentiality of information, to avoid endangering these sources and, ultimately, to facilitate proper selection or continuance of the best applicants or persons for a given position or contract. Special note is made of the limitation on the extent to which this exemption may be asserted. The existence and general character of the information exempted will be made known to the individual to whom it pertains.

(c) At the present time, USPTO claims no exemption under 5 U.S.C. 552a(k)(3), (4), (6) and (7).

[Added, 65 FR 52916, Aug. 31, 2000, effective Oct. 2, 2000]

**Appendix to Part 102 - Systems of Records Noticed by Other Federal Agencies<sup>1</sup> and Applicable to USPTO Records and Applicability of this Part Thereto**

Category of records	Other federal agency
Federal Personnel Records	Office of Personnel Management. <sup>2</sup>
Federal Employee Compensation Act Program	Department of Labor. <sup>3</sup>

Category of records	Other federal agency
Equal Employment Opportunity Appeal Complaints	Equal Employment Opportunity Commission. <sup>4</sup>
Formal Complaints/ Appeals of Adverse Personnel Actions	Merit Systems Protection Board. <sup>5</sup>
<sup>1</sup> Other than systems of records noticed by the Department of Commerce. Where the system of records applies only to USPTO, these regulations apply. Where the system of records applies generally to components of the Department of Commerce, the regulations of that department attach at the point of any denial for access or for correction or amendment.	
<sup>2</sup> The provisions of this part do not apply to these records covered by notices of systems of records published by the Office of Personnel Management for all agencies. The regulations of OPM alone apply.	
<sup>3</sup> The provisions of this part apply only initially to these records covered by notices of systems of records published by the U.S. Department of Labor for all agencies. The regulations of that department attach at the point of any denial for access or for correction or amendment.	
<sup>4</sup> The provisions of this part do not apply to these records covered by notices of systems of records published by the Equal Employment Opportunity Commission for all agencies. The regulations of the Commission alone apply.	
<sup>5</sup> The provisions of this part do not apply to these records covered by notices of systems of records published by the Merit Systems Protection Board for all agencies. The regulations of the Board alone apply.	

[Added, 65 FR 52916, Aug. 31, 2000, effective Oct. 2, 2000]

**PART 104 — LEGAL PROCESSES**

**Subpart A — General Provisions**

Sec.

104.1 Definitions.

104.2 Address for mail and service; telephone number.

- 104.3 Waiver of rules.  
 104.4 Relationship of this Part to the Federal Rules of Civil and Criminal Procedure.

### **Subpart B — Service of Process**

- 104.11 Scope and purpose.  
 104.12 Acceptance of service of process.

### **Subpart C — Employee Testimony and Production of Documents in Legal Proceedings**

- 104.21 Scope and purpose.  
 104.22 Demand for testimony or production of documents.  
 104.23 Expert or opinion testimony.  
 104.24 Demands or requests in legal proceedings for records protected by confidentiality statutes.

### **Subpart D — Employee Indemnification**

- 104.31 Scope.  
 104.32 Procedure for requesting indemnification.

### **Subpart E — Tort Claims**

- 104.41 Procedure for filing claims.  
 104.42 Finality of settlement or denial of claims.

## **Subpart A — General Provisions**

### **§ 104.1 Definitions.**

*Demand* means a request, order, or subpoena for testimony or documents for use in a legal proceeding.

*Director* means the Under Secretary of Commerce for Intellectual Property and Director of the United States Patent and Trademark Office (*see* § 1.9(j)).

*Document* means any record, paper, and other property held by the Office, including without limitation, official letters, telegrams, memoranda, reports, studies, calendar and diary entries, maps, graphs, pamphlets, notes, charts, tabulations, analyses, statistical or informational accumulations, any kind of summaries of meetings and conversations, film impressions, magnetic tapes, and sound or mechanical reproductions.

*Employee* means any current or former officer or employee of the Office.

*Legal proceeding* means any pretrial, trial, and posttrial stages of existing or reasonably anticipated judicial or administrative actions, hearings, investigations, or similar proceedings before courts, commissions, boards or other tribunals, foreign or domestic. This phrase includes all phases of discovery as well as responses to formal or informal requests by attorneys or others involved in legal proceedings.

*Office* means the United States Patent and Trademark Office, including any operating unit in the United States Patent and Trademark Office, and its predecessors, the Patent Office and the Patent and Trademark Office.

*Official business* means the authorized business of the Office.

*General Counsel* means the General Counsel of the Office.

*Testimony* means a statement in any form, including personal appearances before a court or other legal tribunal, interviews, depositions, telephonic, televised, or videotaped statements or any responses given during discovery or similar proceedings, which response would involve more than the production of documents, including a declaration under 35 U.S.C. 25 or 28 U.S.C. 1746.

*United States* means the Federal Government, its departments and agencies, individuals acting on behalf of the Federal Government, and parties to the extent they are represented by the United States.

[Added, 66 FR 47387, Sept. 12, 2001, effective Sept. 12, 2001; second sentence revised, 68 FR 14332, Mar. 25, 2003, effective May 1, 2003]

### **§ 104.2 Address for mail and service; telephone number.**

(a) Mail under this part should be addressed to:  
 General Counsel, United States Patent and Trademark Office

P.O. Box 15667

Arlington, VA 22215.

(b) Service by hand should be made during business hours to the:

Office of the General Counsel

Crystal Park Two Suite 905

2121 Crystal Drive

Arlington, Virginia.

(c) The Office of the General Counsel may be reached by telephone at 703–308–2000 during business hours.

[Added, 66 FR 47387, Sept. 12, 2001, effective Sept. 12, 2001]

### § 104.3 Waiver of rules.

In extraordinary situations, when the interest of justice requires, the General Counsel may waive or suspend the rules of this part, sua sponte or on petition of an interested party to the Director, subject to such requirements as the General Counsel may impose. Any petition must be accompanied by the petition fee set forth in § 1.17(h) of this title

[Added, 66 FR 47387, Sept. 12, 2001, effective Sept. 12, 2001]

### § 104.4 Relationship of this Part to the Federal Rules of Civil or Criminal Procedure.

Nothing in this part waives or limits any requirement under the Federal Rules of Civil or Criminal Procedure.

[Added, 66 FR 47387, Sept. 12, 2001, effective Sept. 12, 2001]

## Subpart B — Service of Process

### § 104.11 Scope and purpose.

(a) This subpart sets forth the procedures to be followed when a summons and complaint is served on the Office or on the Director or an employee in his or her official capacity.

(b) This subpart is intended, and should be construed, to ensure the efficient administration of the Office and not to impede any legal proceeding.

(c) This subpart does not apply to subpoenas, the procedures for which are set out in subpart C.

(d) This subpart does not apply to service of process made on an employee personally on matters not related to official business of the Office or to the official responsibilities of the employee.

[Added, 66 FR 47387, Sept. 12, 2001, effective Sept. 12, 2001]

### § 104.12 Acceptance of service of process.

(a) Any summons and complaint to be served in person or by registered or certified mail or as otherwise authorized by law on the Office, on the Director, or on an employee in his or her official capacity, shall be served as indicated in § 104.2.

(b) Any employee of the Office served with a summons and complaint shall immediately notify, and shall deliver the summons and complaint to, the Office of the General Counsel.

(c) Any employee receiving a summons and complaint shall note on the summons and complaint the date, hour, and place of service and whether service was by hand or by mail.

(d) When a legal proceeding is brought to hold an employee personally liable in connection with an action taken in the conduct of official business, rather than liable in an official capacity, the employee by law is to be served personally with process. *See Fed. R. Civ. P.* 4(e). An employee sued personally for an action taken in the conduct of official business shall immediately notify and deliver a copy of the summons and complaint to the General Counsel.

(e) An employee sued personally in connection with official business may be represented by the Department of Justice at its discretion (28 CFR 50.15 and 50.16).

(f) The Office will only accept service of process for an employee in the employee's official capacity.

[Added, 66 FR 47387, Sept. 12, 2001, effective Sept. 12, 2001]

## Subpart C — Employee Testimony and Production of Documents in Legal Proceedings

### § 104.21 Scope and purpose.

(a) This subpart sets forth the policies and procedures of the Office regarding the testimony of employees as witnesses in legal proceedings and the production or disclosure of information contained in Office documents for use in legal proceedings pursuant to a demand.

(b) *Exceptions.* This subpart does not apply to any legal proceeding in which:

(1) An employee is to testify regarding facts or events that are unrelated to official business; or

(2) A former employee is to testify as an expert in connection with a particular matter in which the former employee did not participate personally while at the Office.

[Added, 66 FR 47387, Sept. 12, 2001, effective Sept. 12, 2001]

#### § 104.22 Demand for testimony or production of documents.

(a) Whenever a demand for testimony or for the production of documents is made upon an employee, the employee shall immediately notify the Office of the General Counsel at the telephone number or addresses in §104.2 and make arrangements to send the subpoena to the General Counsel promptly.

(b) An employee may not give testimony, produce documents, or answer inquiries from a person not employed by the Office regarding testimony or documents subject to a demand or a potential demand under the provisions of this subpart without the approval of the General Counsel. The General Counsel may authorize the provision of certified copies not otherwise available under Part 1 of this title subject to payment of applicable fees under §1.19.

(c)(1) *Demand for testimony or documents.* A demand for the testimony of an employee under this subpart shall be addressed to the General Counsel as indicated in § 104.2.

(2) *Subpoenas.* A subpoena for employee testimony or for a document shall be served in accordance with the Federal Rules of Civil or Criminal Procedure or applicable state procedure, and a copy of the subpoena shall be sent to the General Counsel as indicated in § 104.2.

(3) *Affidavits.* Except when the United States is a party, every demand shall be accompanied by an affidavit or declaration under 28 U.S.C. 1746 or 35 U.S.C. 25(b) setting forth the title of the legal proceeding, the forum, the requesting party's interest in the legal proceeding, the reason for the demand, a showing that the desired testimony or document is not reasonably available from any other source, and, if testimony is requested, the intended use of the testimony, a general summary of the desired testimony, and a showing that no document could be provided and used in lieu of testimony.

(d) Failure of the attorney to cooperate in good faith to enable the General Counsel to make an informed determination under this subpart may serve as a basis for a determination not to comply with the demand.

(e) A determination under this subpart to comply or not to comply with a demand is not a waiver or an assertion of any other ground for noncompliance, including privilege, lack of relevance, or technical deficiency.

(f) *Noncompliance.* If the General Counsel makes a determination not to comply, he or she will seek Department of Justice representation for the employee and will attempt to have the subpoena modified or quashed. If Department of Justice representation cannot be arranged, the employee should appear at the time and place set forth in the subpoena. In such a case, the employee should produce a copy of these rules and state that the General Counsel has advised the employee not to provide the requested testimony nor to produce the requested document. If a legal tribunal rules that the demand in the subpoena must be complied with, the employee shall respectfully decline to comply with the demand, citing *United States ex rel. Touhy v. Ragen*, 340 U.S. 462 (1951).

[Added, 66 FR 47387, Sept. 12, 2001, effective Sept. 12, 2001]

#### § 104.23 Expert or opinion testimony.

(a)(1) If the General Counsel authorizes an employee to give testimony in a legal proceeding not involving the United States, the testimony, if otherwise proper, shall be limited to facts within the personal knowledge of the employee. Employees, with or without compensation, shall not provide expert testimony in any legal proceedings regarding Office information, subjects, or activities except on behalf of the United States or a party represented by the United States Department of Justice.

(2) The General Counsel may authorize an employee to appear and give the expert or opinion testimony upon the requester showing, pursuant to §104.3 of this part, that exceptional circumstances warrant such testimony and that the anticipated testimony will not be adverse to the interest of the Office or the United States.

(b)(1) If, while testifying in any legal proceeding, an employee is asked for expert or opinion testimony

regarding Office information, subjects, or activities, which testimony has not been approved in advance in writing in accordance with the regulations in this subpart, the witness shall:

(i) Respectfully decline to answer on the grounds that such expert or opinion testimony is forbidden by this subpart;

(ii) Request an opportunity to consult with the General Counsel before giving such testimony; and

(iii) Explain that upon such consultation, approval for such testimony may be provided.

(2) If the tribunal conducting the proceeding then orders the employee to provide expert or opinion testimony regarding Office information, subjects, or activities without the opportunity to consult with the General Counsel, the employee shall respectfully refuse to provide such testimony, citing *United States ex rel. Touhy v. Ragen*, 340 U.S. 462 (1951).

(c) If an employee is unaware of the regulations in this subpart and provides expert or opinion testimony regarding Office information, subjects, or activities in a legal proceeding without the aforementioned consultation, the employee shall, as soon after testifying as possible, inform the General Counsel that such testimony was given and provide a written summary of the expert or opinion testimony provided.

(d) *Proceeding where the United States is a party.* In a proceeding in which the United States is a party or is representing a party, an employee may not testify as an expert or opinion witness for any party other than the United States.

[Added, 66 FR 47387, Sept. 12, 2001, effective Sept. 12, 2001]

#### **§ 104.24 Demands or requests in legal proceedings for records protected by confidentiality statutes.**

Demands in legal proceedings for the production of records, or for the testimony of employees regarding information protected by the confidentiality provisions of the Patent Act (35 U.S.C. 122), the Privacy Act (5 U.S.C. 552a), the Trade Secrets Act (18 U.S.C. 1905), or any other confidentiality statute, must satisfy the requirements for disclosure set forth in those statutes and associated rules before the records may be provided or testimony given.

[Added, 66 FR 47387, Sept. 12, 2001, effective Sept. 12, 2001]

### **Subpart D — Employee Indemnification**

#### **§ 104.31 Scope.**

The procedure in this subpart shall be followed if a civil action or proceeding is brought, in any court, against an employee (including the employee's estate) for personal injury, loss of property, or death, resulting from the employee's activities while acting within the scope of the employee's office or employment. When the employee is incapacitated or deceased, actions required of an employee should be performed by the employee's executor, administrator, or comparable legal representative.

[Added, 66 FR 47387, Sept. 12, 2001, effective Sept. 12, 2001]

#### **§ 104.32 Procedure for requesting indemnification.**

(a) After being served with process or pleadings in such an action or proceeding, the employee shall within five (5) calendar days of receipt, deliver to the General Counsel all such process and pleadings or an attested true copy thereof, together with a fully detailed report of the circumstances of the incident giving rise to the court action or proceeding.

(b)(1) An employee may request indemnification to satisfy a verdict, judgment, or award entered against that employee only if the employee has timely satisfied the requirements of paragraph (a) of this section.

(2) No request for indemnification will be considered unless the employee has submitted a written request through the employee's supervisory chain to the General Counsel with:

(i) Appropriate documentation, including copies of the verdict, judgment, appeal bond, award, or settlement proposal;

(ii) The employee's explanation of how the employee was acting within the scope of the employee's employment; and

(iii) The employee's statement of whether the employee has insurance or any other source of indemnification.

[Added, 66 FR 47387, Sept. 12, 2001, effective Sept. 12, 2001]

## Subpart E — Tort Claims

### § 104.41 Procedure for filing claims.

Administrative claims against the Office filed pursuant to the administrative claims provision of the Federal Tort Claims Act (28 U.S.C. 2672) and the corresponding Department of Justice regulations (28 CFR Part 14) shall be filed with the General Counsel as indicated in §104.2.

[Added, 66 FR 47387, Sept. 12, 2001, effective Sept. 12, 2001]

### § 104.42 Finality of settlement or denial of claims.

Only a decision of the Director or the General Counsel regarding settlement or denial of any claim under this subpart may be considered final for the purpose of judicial review.

[Added, 66 FR 47387, Sept. 12, 2001, effective Sept. 12, 2001]

## SUBCHAPTER C – PROTECTION OF FOREIGN MASK WORKS

### PART 150 — REQUESTS FOR PRESIDENTIAL PROCLAMATIONS PURSUANT TO 17 U.S.C. 902(a)(2)

Sec.

150.1 Definitions.

150.2 Initiation of evaluation.

150.3 Submission of requests.

150.4 Evaluation.

150.5 Duration of proclamation.

150.6 Mailing Address.

#### § 150.1 Definitions.

(a) *Director* means the Under Secretary of Commerce for Intellectual Property and Director of the United States Patent and Trademark Office (*see* § 1.9(j)).

(b) *Foreign government* means the duly-constituted executive of a foreign nation, or an international or regional intergovernmental organization which has been empowered by its member states to request issuance of Presidential proclamations on their behalf under this part.

(c) *Interim order* means an order issued by the Secretary of Commerce under 17 U.S.C. 914.

(d) *Mask work* means a series of related images, however fixed or encoded —

(1) Having or representing the predetermined, three-dimensional pattern of metallic, insulating, or semiconductor material present or removed from the layers of a semiconductor chip product; and

(2) In which series the relation of the images to one another is that each image has the pattern of the surface of one form of the semiconductor chip product.

(e) *Presidential proclamation* means an action by the President extending to foreign nationals, domiciliaries and sovereign authorities the privilege of applying for registrations for mask works pursuant to 17 U.S.C. 902.

(f) *Request* means a request by a foreign government for the issuance of a Presidential proclamation.

(g) *Proceeding* means a proceeding to issue an interim order extending protection to foreign nationals, domiciliaries and sovereign authorities under 17 U.S.C. Chapter 9.

(h) *Secretary* means the Secretary of Commerce.

[Added, 53 FR 24447, June 29, 1988, effective August 1, 1988; para. (a) revised, 68 FR 14332, Mar. 25, 2003, effective May 1, 2003]

#### § 150.2 Initiation of evaluation.

(a) The Director independently or as directed by the Secretary, may initiate an evaluation of the propriety of recommending the issuance, revision, suspension or revocation of a section 902 proclamation.

(b) The Director shall initiate an evaluation of the propriety of recommending the issuance of a section 902 proclamation upon receipt of a request from a foreign government.



[Added, 53 FR 24447, June 29, 1988, effective August 1, 1988; revised, 68 FR 14332, Mar. 25, 2003, effective May 1, 2003]

### § 150.3 Submission of requests.

(a) Requests for the issuance of a section 902 proclamation shall be submitted by foreign governments for review by the Director.

(b) Requests for issuance of a proclamation shall include:

(1) A copy of the foreign law or legal rulings that provide protection for U.S. mask works which provide a basis for the request.

(2) A copy of any regulations or administrative orders implementing the protection.

(3) A copy of any laws, regulations, or administrative orders establishing or regulating the registration (if any) of mask works.

(4) Any other relevant laws, regulations, or administrative orders.

(5) All copies of laws, legal rulings, regulations, or administrative orders submitted must be in unedited, full-text form, and if possible, must be reproduced from the original document.

(6) All material submitted must be in the original language, and if not in English, must be accompanied by a certified English translation.

[Added, 53 FR 24447, June 29, 1988, effective August 1, 1988; para. (a) revised, 68 FR 14332, Mar. 25, 2003, effective May 1, 2003]

### § 150.4 Evaluation.

(a) Upon submission of a request by a foreign government for the issuance of a section 902 proclamation, if an interim order under section 914 has not been issued, the Director may initiate a section 914 proceeding if additional information is required.

(b) If an interim order under section 914 has been issued, the information obtained during the section 914 proceeding will be used in evaluating the request for a section 902 proclamation.

(c) After the Director receives the request of a foreign government for a section 902 proclamation, or after a determination is made by the Director to initiate independently an evaluation pursuant to § 150.2(a) of this part, a notice will be published in the *Federal Register* to request relevant and material comments on the adequacy and effectiveness of the

protection afforded U.S. mask works under the system of law described in the notice. Comments should include detailed explanations of any alleged deficiencies in the foreign law or any alleged deficiencies in its implementation. If the alleged deficiencies include problems in administration such as registration, the respondent should include as specifically as possible full detailed explanations, including dates for and the nature of any alleged problems. Comments shall be submitted to the Director within sixty (60) days of the publication of the *Federal Register* notice.

(d) The Director shall notify the Register of Copyrights and the Committee on the Judiciary of the Senate and the House of Representatives of the initiation of an evaluation under these regulations.

(e) If the written comments submitted by any party present relevant and material reasons why a proclamation should not issue, the Director will:

(1) Contact the party raising the issue for verification and any needed additional information;

(2) Contact the requesting foreign government to determine if the issues raised by the party can be resolved; and,

(i) If the issues are resolved, continue with the evaluation; or,

(ii) If the issues cannot be resolved on this basis, hold a public hearing to gather additional information.

(f) The comments, the section 902 request, information obtained from a section 914 proceeding, if any, and information obtained in a hearing held pursuant to paragraph (e)(ii) of this section, if any, will be evaluated by the Director.

(g) The Director will forward the information to the Secretary, together with an evaluation and a draft recommendation.

(h) The Secretary will forward a recommendation regarding the issuance of a section 902 proclamation to the President.

[Added, 53 FR 24448, June 29, 1988, effective August 1, 1988; paras. (a) & (c)-(f) revised, 68 FR 14332, Mar. 25, 2003, effective May 1, 2003]

### § 150.5 Duration of proclamation.

(a) The recommendation for the issuance of a proclamation may include terms and conditions regarding the duration of the proclamation.

(b) Requests for the revision, suspension or revocation of a proclamation may be submitted by any interested party. Requests for revision, suspension or revocation of a proclamation will be considered in substantially the same manner as requests for the issuance of a section 902 proclamation.

[Added 53 FR 24448, June 29, 1988, effective August 1, 1988]

**§ 150.6 Mailing address.**

Requests and all correspondence pursuant to these guidelines shall be addressed to: Mail Stop 4, Director of the United States Patent and Trademark Office, PO Box 1450, Alexandria, Virginia 22313-1450.

[Added 53 FR 24448, June 29, 1988, effective Aug. 1, 1988; revised, 68 FR 14332, Mar. 25, 2003, effective May 1, 2003]

MANUAL OF PATENT EXAMINING PROCEDURE

# Appendix T Patent Cooperation Treaty

---

**Patent Cooperation Treaty**  
**Done at Washington on June 19, 1970, amended on**  
**September 28, 1979, modified on February 3, 1984,**  
**and October 3, 2001**  
(as in force from April 1, 2002)

## TABLE OF CONTENTS<sup>1</sup>

### *Preamble*

### *Introductory Provisions*

Article 1	Establishment of a Union
Article 2	Definitions

### *Chapter I: International Application and International Search*

Article 3	The International Application
Article 4	The Request
Article 5	The Description
Article 6	The Claims
Article 7	The Drawings
Article 8	Claiming Priority
Article 9	The Applicant
Article 10	The Receiving Office
Article 11	Filing Date and Effects of the International Application
Article 12	Transmittal of the International Application to the International Bureau and the International Searching Authority
Article 13	Availability of Copy of the International Application to the Designated Offices
Article 14	Certain Defects in the International Application
Article 15	The International Search
Article 16	The International Searching Authority
Article 17	Procedure Before the International Searching Authority
Article 18	The International Search Report
Article 19	Amendment of the Claims Before the International Bureau
Article 20	Communication to Designated Offices
Article 21	International Publication
Article 22	Copy, Translation, and Fee, to Designated Offices

Article 23	Delaying of National Procedure
Article 24	Possible Loss of Effect in Designated States
Article 25	Review by Designated Offices
Article 26	Opportunity to Correct Before Designated Offices
Article 27	National Requirements
Article 28	Amendment of the Claims, the Description, and the Drawings, Before Designated Offices
Article 29	Effects of the International Publication
Article 30	Confidential Nature of the International Application

### *Chapter II: International Preliminary Examination*

Article 31	Demand for International Preliminary Examination
Article 32	The International Preliminary Examining Authority
Article 33	The International Preliminary Examination
Article 34	Procedure Before the International Preliminary Examining Authority
Article 35	The International Preliminary Examination Report
Article 36	Transmittal, Translation, and Communication of the International Preliminary Examination Report
Article 37	Withdrawal of Demand or Election
Article 38	Confidential Nature of the International Preliminary Examination
Article 39	Copy, Translation, and Fee, to Elected Offices
Article 40	Delaying of National Examination and Other Processing
Article 41	Amendment of the Claims, the Description, and the Drawings, before Elected Offices
Article 42	Results of National Examination in Elected Offices

### *Chapter III: Common Provisions*

Article 43	Seeking Certain Kinds of Protection
Article 44	Seeking Two Kinds of Protection
Article 45	Regional Patent Treaties
Article 46	Incorrect Translation of the International Application
Article 47	Time Limits

<sup>1</sup> This Table of Contents is added for the convenience of the reader. It does not appear in the signed text of the Treaty.

## MANUAL OF PATENT EXAMINING PROCEDURE

Article 48	Delay in Meeting Certain Time Limits
Article 49	Right to Practice Before International Authorities

### *Chapter IV: Technical Services*

Article 50	Patent Information Service
Article 51	Technical Assistance
Article 52	Relations with Other Provisions of the Treaty

### *Chapter V: Administrative Positions*

Article 53	Assembly
Article 54	Executive Committee
Article 55	International Bureau
Article 56	Committee for Technical Cooperation
Article 57	Finances
Article 58	Regulations

### *Chapter VI: Disputes*

Article 59	Disputes
------------	----------

### *Chapter VII: Revision and Amendment*

Article 60	Revision of the Treaty
Article 61	Amendment of Certain Provisions of the Treaty

### *Chapter VIII: Final Provisions*

Article 62	Becoming Party to the Treaty
Article 63	Entry into Force of the Treaty
Article 64	Reservations
Article 65	Gradual Application
Article 66	Denunciation
Article 67	Signature and Languages
Article 68	Depositary Functions
Article 69	Notifications

---

The Contracting States,

Desiring to make a contribution to the progress of science and technology,

Desiring to perfect the legal protection of inventions,

Desiring to simplify and render more economical the obtaining of protection for inventions where protection is sought in several countries,

Desiring to facilitate and accelerate access by the public to the technical information contained in documents describing new inventions,

Desiring to foster and accelerate the economic development of developing countries through the adoption of measures designed to increase the effi-

ciency of their legal systems, whether national or regional, instituted for the protection of inventions by providing easily accessible information on the availability of technological solutions applicable to their special needs and by facilitating access to the ever expanding volume of modern technology,

Convinced that cooperation among nations will greatly facilitate the attainment of these aims,

Have concluded the present Treaty.

## **Introductory Provisions**

### **Article 1**

#### **Establishment of a Union**

(1) The States party to this Treaty (hereinafter called “the Contracting States”) constitute a Union for cooperation in the filing, searching, and examination, of applications for the protection of inventions, and for rendering special technical services. The Union shall be known as the International Patent Cooperation Union.

(2) No provision of this Treaty shall be interpreted as diminishing the rights under the Paris Convention for the Protection of Industrial Property of any national or resident of any country party to that Convention.

### **Article 2**

#### **Definitions**

For the purposes of this Treaty and the Regulations and unless expressly stated otherwise:

(i) “application” means an application for the protection of an invention; references to an “application” shall be construed as references to applications for patents for inventions, inventors’ certificates, utility certificates, utility models, patents or certificates of addition, inventors’ certificates of addition, and utility certificates of addition;

(ii) references to a “patent” shall be construed as references to patents for inventions, inventors’ certificates, utility certificates, utility models, patents or certificates of addition, inventors’ certificates of addition, and utility certificates of addition;

(iii) “national patent” means a patent granted by a national authority;

(iv) “regional patent” means a patent granted by a national or an intergovernmental authority having

## PATENT COOPERATION TREATY

the power to grant patents effective in more than one State;

(v) “regional application” means an application for a regional patent;

(vi) references to a “national application” shall be construed as references to applications for national patents and regional patents, other than applications filed under this Treaty;

(vii) “international application” means an application filed under this Treaty;

(viii) references to an “application” shall be construed as references to international applications and national applications;

(ix) references to a “patent” shall be construed as references to national patents and regional patents;

(x) references to “national law” shall be construed as references to the national law of a Contracting State or, where a regional application or a regional patent is involved, to the treaty providing for the filing of regional applications or the granting of regional patents;

(xi) “priority date,” for the purpose of computing time limits, means:

(a) where the international application contains a priority claim under Article 8, the filing date of the application whose priority is so claimed;

(b) where the international application contains several priority claims under Article 8, the filing date of the earliest application whose priority is so claimed;

(c) where the international application does not contain any priority claim under Article 8, the international filing date of such application;

(xii) “national Office” means the government authority of a Contracting State entrusted with the granting of patents; references to a “national Office” shall be construed as referring also to any intergovernmental authority which several States have entrusted with the task of granting regional patents, provided that at least one of those States is a Contracting State, and provided that the said States have authorized that authority to assume the obligations and exercise the powers which this Treaty and the Regulations provide for in respect of national Offices;

(xiii) “designated Office” means the national Office of or acting for the State designated by the applicant under Chapter I of this Treaty;

(xiv) “elected Office” means the national Office of or acting for the State elected by the applicant under Chapter II of this Treaty;

(xv) “receiving Office” means the national Office or the intergovernmental organization with which the international application has been filed;

(xvi) “Union” means the International Patent Cooperation Union;

(xvii) “Assembly” means the Assembly of the Union;

(xviii) “Organization” means the World Intellectual Property Organization;

(xix) “International Bureau” means the International Bureau of the Organization and, as long as it subsists, the United International Bureaux for the Protection of Intellectual Property (BIRPI);

(xx) “Director General” means the Director General of the Organization and, as long as BIRPI subsists, the Director of BIRPI.

## Chapter I

### International Application and International Search

#### Article 3

#### The International Application

(1) Applications for the protection of inventions in any of the Contracting States may be filed as international applications under this Treaty.

(2) An international application shall contain, as specified in this Treaty and the Regulations, a request, a description, one or more claims, one or more drawings (where required), and an abstract.

(3) The abstract merely serves the purpose of technical information and cannot be taken into account for any other purpose, particularly not for the purpose of interpreting the scope of the protection sought.

(4) The international application shall:

(i) be in a prescribed language;

(ii) comply with the prescribed physical requirements;

(iii) comply with the prescribed requirement of unity of invention;

(iv) be subject to the payment of the prescribed fees.

## **Article 4**

### **The Request**

(1) The request shall contain:

(i) a petition to the effect that the international application be processed according to this Treaty;

(ii) the designation of the Contracting State or States in which protection for the invention is desired on the basis of the international application (“designated States”); if for any designated State a regional patent is available and the applicant wishes to obtain a regional patent rather than a national patent, the request shall so indicate; if, under a treaty concerning a regional patent, the applicant cannot limit his application to certain of the States party to that treaty, designation of one of those States and the indication of the wish to obtain the regional patent shall be treated as designation of all the States party to that treaty; if, under the national law of the designated State, the designation of that State has the effect of an application for a regional patent, the designation of the said State shall be treated as an indication of the wish to obtain the regional patent;

(iii) the name of and other prescribed data concerning the applicant and the agent (if any);

(iv) the title of the invention;

(v) the name of and other prescribed data concerning the inventor where the national law of at least one of the designated States requires that these indications be furnished at the time of filing a national application. Otherwise, the said indications may be furnished either in the request or in separate notices addressed to each designated Office whose national law requires the furnishing of the said indications but allows that they be furnished at a time later than that of the filing of a national application.

(2) Every designation shall be subject to the payment of the prescribed fee within the prescribed time limit.

(3) Unless the applicant asks for any of the other kinds of protection referred to in Article 43, designation shall mean that the desired protection consists of the grant of a patent by or for the designated State. For the purposes of this paragraph, Article 2(ii) shall not apply.

(4) Failure to indicate in the request the name and other prescribed data concerning the inventor

shall have no consequence in any designated State whose national law requires the furnishing of the said indications but allows that they be furnished at a time later than that of the filing of a national application. Failure to furnish the said indications in a separate notice shall have no consequence in any designated State whose national law does not require the furnishing of the said indications.

## **Article 5**

### **The Description**

The description shall disclose the invention in a manner sufficiently clear and complete for the invention to be carried out by a person skilled in the art.

## **Article 6**

### **The Claims**

The claim or claims shall define the matter for which protection is sought. Claims shall be clear and concise. They shall be fully supported by the description.

## **Article 7**

### **The Drawings**

(1) Subject to the provisions of paragraph (2)(ii), drawings shall be required when they are necessary for the understanding of the invention.

(2) Where, without being necessary for the understanding of the invention, the nature of the invention admits of illustration by drawings:

(i) the applicant may include such drawings in the international application when filed,

(ii) any designated Office may require that the applicant file such drawings with it within the prescribed time limit.

## **Article 8**

### **Claiming Priority**

(1) The international application may contain a declaration, as prescribed in the Regulations, claiming the priority of one or more earlier applications filed in or for any country party to the Paris Convention for the Protection of Industrial Property.

(2)(a) Subject to the provisions of subparagraph (b), the conditions for, and the effect of, any priority claim declared under paragraph (1) shall be as

provided in Article 4 of the Stockholm Act of the Paris Convention for the Protection of Industrial Property.

(b) The international application for which the priority of one or more earlier applications filed in or for a Contracting State is claimed may contain the designation of that State. Where, in the international application, the priority of one or more national applications filed in or for a designated State is claimed, or where the priority of an international application having designated only one State is claimed, the conditions for, and the effect of, the priority claim in that State shall be governed by the national law of that State.

### **Article 9**

#### **The Applicant**

(1) Any resident or national of a Contracting State may file an international application.

(2) The Assembly may decide to allow the residents and the nationals of any country party to the Paris Convention for the Protection of Industrial Property which is not party to this Treaty to file international applications.

(3) The concepts of residence and nationality, and the application of those concepts in cases where there are several applicants or where the applicants are not the same for all the designated States, are defined in the Regulations.

*[NOTE: The PCT Assembly has not as yet allowed residents or nationals of non-PCT member countries to file PCT international applications.]*

### **Article 10**

#### **The Receiving Office**

The international application shall be filed with the prescribed receiving Office, which will check and process it as provided in this Treaty and the Regulations.

### **Article 11**

#### **Filing Date and Effects of the International Application**

(1) The receiving Office shall accord as the international filing date the date of receipt of the inter-

national application, provided that Office has found that, at the time of receipt:

(i) the applicant does not obviously lack, for reasons of residence or nationality, the right to file an international application with the receiving Office,

(ii) the international application is in the prescribed language,

(iii) the international application contains at least the following elements:

(a) an indication that it is intended as an international application,

(b) the designation of at least one Contracting State,

(c) the name of the applicant, as prescribed,

(d) a part which on the face of it appears to be a description,

(e) a part which on the face of it appears to be a claim or claims.

(2)(a) If the receiving Office finds that the international application did not, at the time of receipt, fulfill the requirements listed in paragraph (1), it shall, as provided in the Regulations, invite the applicant to file the required correction.

(b) If the applicant complies with the invitation, as provided in the Regulations, the receiving Office shall accord as the international filing date the date of receipt of the required correction.

(3) Subject to Article 64(4), any international application fulfilling the requirement listed in items (i) to (iii) of paragraph (1) and accorded an international filing date shall have the effect of a regular national application in each designated State as of the international filing date, which date shall be considered to be the actual filing date in each designated State.

(4) Any international application fulfilling the requirements listed in items (i) to (iii) of paragraph (1) shall be equivalent to a regular national filing within the meaning of the Paris Convention for the Protection of Industrial Property.

### **Article 12**

#### **Transmittal of the International Application to the International Bureau and the International Searching Authority**

(1) One copy of the international application shall be kept by the receiving Office (“home copy”),



one copy (“record copy”) shall be transmitted to the International Bureau, and another copy (“search copy”) shall be transmitted to the competent International Searching Authority referred to in Article 16, as provided in the Regulations.

(2) The record copy shall be considered the true copy of the international application.

(3) The international application shall be considered withdrawn if the record copy has not been received by the International Bureau within the prescribed time limit.

### **Article 13**

#### **Availability of Copy of the International Application to the Designated Offices**

(1) Any designated Office may ask the International Bureau to transmit to it a copy of the international application prior to the communication provided for in Article 20, and the International Bureau shall transmit such copy to the designated Office as soon as possible after the expiration of one year from the priority date.

(2)(a) The applicant may, at any time, transmit a copy of his international application to any designated Office.

(b) The applicant may, at any time, ask the International Bureau to transmit a copy of his international application to any designated Office, and the International Bureau shall transmit such copy to the designated Office as soon as possible.

(c) Any national Office may notify the International Bureau that it does not wish to receive copies as provided for in subparagraph (b), in which case that subparagraph shall not be applicable in respect of that Office.

### **Article 14**

#### **Certain Defects in the International Application**

(1)(a) The receiving Office shall check whether the international application contains any of the following defects, that is to say:

- (i) it is not signed as provided in the Regulations;
- (ii) it does not contain the prescribed indications concerning the applicant;
- (iii) it does not contain a title;
- (iv) it does not contain an abstract;

(v) it does not comply to the extent provided in the Regulations with the prescribed physical requirements.

(b) If the receiving Office finds any of the said defects, it shall invite the applicant to correct the international application within the prescribed time limit, failing which that application shall be considered withdrawn and the receiving Office shall so declare.

(2) If the international application refers to drawings which, in fact, are not included in that application, the receiving Office shall notify the applicant accordingly and he may furnish them within the prescribed time limit and, if he does, the international filing date shall be the date on which the drawings are received by the receiving Office. Otherwise, any reference to the said drawings shall be considered non-existent

(3)(a) If the receiving Office finds that, within the prescribed time limits, the fees prescribed under Article 3(4)(iv) have not been paid, or no fee prescribed under Article 4(2) has been paid in respect of any of the designated States, the international application shall be considered withdrawn and the receiving Office shall so declare.

(b) If the receiving Office finds that the fee prescribed under Article 4(2) has been paid in respect of one or more (but less than all) designated States within the prescribed time limit, the designation of those States in respect of which it has not been paid within the prescribed time limit shall be considered withdrawn and the receiving Office shall so declare.

(4) If, after having accorded an international filing date to the international application, the receiving Office finds, within the prescribed time limit, that any of the requirements listed in items (i) to (iii) of Article 11(1) was not complied with at that date, the said application shall be considered withdrawn and the receiving Office shall so declare.

### **Article 15**

#### **The International Search**

(1) Each international application shall be the subject of international search.

(2) The objective of the international search is to discover relevant prior art.

## PATENT COOPERATION TREATY

(3) International search shall be made on the basis of the claims, with due regard to the description and the drawings (if any).

(4) The International Searching Authority referred to in Article 16 shall endeavor to discover as much of the relevant prior art as its facilities permit, and shall, in any case, consult the documentation specified in the Regulations.

(5)(a) If the national law of the Contracting State so permits, the applicant who files a national application with the national Office of or acting for such State may, subject to the conditions provided for in such law, request that a search similar to an international search (international-type search) be carried out on such application.

(b) If the national law of the Contracting State so permits, the national Office of or acting for such State may subject any national application filed with it to an international-type search.

(c) The international-type search shall be carried out by the International Searching Authority referred to in Article 16 which would be competent for an international search if the national application were an international application and were filed with the Office referred to in subparagraphs (a) and (b). If the national application is in a language which the International Searching Authority considers it is not equipped to handle, the international-type search shall be carried out on a translation prepared by the applicant in a language prescribed for international applications and which the International Searching Authority has undertaken to accept for international applications. The national application and the translation, when required, shall be presented in the form prescribed for international applications.

### **Article 16**

#### **The International Searching Authority**

(1) International search shall be carried out by an International Searching Authority, which may be either a national Office or an intergovernmental organization, such as the International Patent Institute, whose tasks include the establishing of documentary search reports on prior art with respect to inventions which are the subject of applications.

(2) If, pending the establishment of a single International Searching Authority, there are several International Searching Authorities, each receiving

Office shall, in accordance with the provisions of the applicable agreement referred to in paragraph(3)(b), specify the International Searching Authority or Authorities competent for the searching of international applications filed with such Office.

(3)(a) International Searching Authorities shall be appointed by the Assembly. Any national Office and any intergovernmental organization satisfying the requirements referred to in subparagraph (c) may be appointed as International Searching Authority.

(b) Appointment shall be conditional on the consent of the national Office or intergovernmental organization to be appointed and the conclusion of an agreement, subject to approval by the Assembly, between such Office or organization and the International Bureau. The agreement shall specify the rights and obligations of the parties, in particular, the formal undertaking by the said Office or organization to apply and observe all the common rules of international search.

(c) The Regulations prescribe the minimum requirements, particularly as to manpower and documentation, which any Office or organization must satisfy before it can be appointed and must continue to satisfy while it remains appointed.

(d) Appointment shall be for a fixed period of time and may be extended for further periods.

(e) Before the Assembly makes a decision on the appointment of any national Office or intergovernmental organization, or on the extension of its appointment, or before it allows any such appointment to lapse, the Assembly shall hear the interested Office or organization and seek the advice of the Committee for Technical Cooperation referred to in Article 56 once that Committee has been established.

### **Article 17**

#### **Procedure Before the International Searching Authority**

(1) Procedure before the International Searching Authority shall be governed by the provisions of this Treaty, the Regulations, and the agreement which the International Bureau shall conclude, subject to this Treaty and the Regulations, with the said Authority.

(2)(a) If the International Searching Authority considers:

(i) that the international application relates to a subject matter which the International

Searching Authority is not required, under the Regulations, to search, and in the particular case decides not to search, or

(ii) that the description, the claims, or the drawings, fail to comply with the prescribed requirements to such an extent that a meaningful search could not be carried out, the said Authority shall so declare and shall notify the applicant and the International Bureau that no international search report will be established.

(b) If any of the situations referred to in subparagraph (a) is found to exist in connection with certain claims only, the international search report shall so indicate in respect of such claims, whereas, for the other claims, the said report shall be established as provided in Article 18.

(3)(a) If the International Searching Authority considers that the international application does not comply with the requirement of unity of invention as set forth in the Regulations, it shall invite the applicant to pay additional fees. The International Searching Authority shall establish the international search report on those parts of the international application which relate to the invention first mentioned in the claims (“main invention”) and, provided the required additional fees have been paid within the prescribed time limit, on those parts of the international application which relate to inventions in respect of which the said fees were paid.

(b) The national law of any designated State may provide that, where the national Office of the State finds the invitation, referred to in subparagraph (a), of the International Searching Authority justified and where the applicant has not paid all additional fees, those parts of the international application which consequently have not been searched shall, as far as effects in the State are concerned, be considered withdrawn unless a special fee is paid by the applicant to the national Office of that State.

### **Article 18**

#### **The International Search Report**

(1) The international search report shall be established within the prescribed time limit and in the prescribed form.

(2) The international search report shall, as soon as it has been established, be transmitted by the

International Searching Authority to the applicant and the International Bureau.

(3) The international search report or the declaration referred to in Article 17(2)(a) shall be translated as provided in the Regulations. The translations shall be prepared by or under the responsibility of the International Bureau.

### **Article 19**

#### **Amendment of the Claims Before the International Bureau**

(1) The applicant shall, after having received the international search report, be entitled to one opportunity to amend the claims of the international application by filing amendments with the International Bureau within the prescribed time limit. He may, at the same time, file a brief statement, as provided in the Regulations, explaining the amendments and indicating any impact that such amendments might have on the description and the drawings.

(2) The amendments shall not go beyond the disclosure in the international application as filed.

(3) If the national law of any designated State permits amendments to go beyond the said disclosure, failure to comply with paragraph (2) shall have no consequence in that State.

### **Article 20**

#### **Communication to Designated Offices**

(1)(a) The international application, together with the international search report (including any indication referred to in Article 17(2)(b)) or the declaration referred to in Article 17(2)(a), shall be communicated to each designated Office, as provided in the Regulations, unless the designated Office waives such requirement in its entirety or in part.

(b) The communication shall include the translation (as prescribed) of the said report or declaration.

(2) If the claims have been amended by virtue of Article 19(1), the communication shall either contain the full text of the claims both as filed and as amended or shall contain the full text of the claims as filed and specify the amendments, and shall include the statement, if any, referred to in Article 19(1).

(3) At the request of the designated Office or the applicant, the International Searching Authority

shall send to the said Office or the applicant, respectively, copies of the documents cited in the international search report, as provided in the Regulations.

### **Article 21**

#### **International Publication**

(1) The International Bureau shall publish international applications.

(2)(a) Subject to the exceptions provided for in subparagraph (b) and in Article 64(3), the international publication of the international application shall be effected promptly after the expiration of 18 months from the priority date of that application.

(b) The applicant may ask the International Bureau to publish his international application any time before the expiration of the time limit referred to in subparagraph (a). The International Bureau shall proceed accordingly, as provided in the Regulations.

(3) The international search report or the declaration referred to in Article 17(2)(a) shall be published as prescribed in the Regulations.

(4) The language and form of the international publication and other details are governed by the Regulations.

(5) There shall be no international publication if the international application is withdrawn or is considered withdrawn before the technical preparations for publication have been completed.

(6) If the international application contains expressions or drawings which, in the opinion of the International Bureau, are contrary to morality or public order, or if, in its opinion, the international application contains disparaging statements as defined in the Regulations, it may omit such expressions drawings, and statements, from its publications, indicating the place and number of words or drawings omitted, and furnishing, upon request, individual copies of the passages omitted.

### **Article 22**

#### **Copy, Translation, and Fee to Designated Offices**

(1) The applicant shall furnish a copy of the international application (unless the communication provided for in Article 20 has already taken place) and a translation thereof (as prescribed), and pay the national fee (if any), to each designated Office not later than at the expiration of 30 months from the pri-

ority date. Where the national law of the designated State requires the indication of the name of and other prescribed data concerning the inventor but allows that these indications be furnished at a time later than that of the filing of a national application, the applicant shall, unless they were contained in the request, furnish the said indications to the national Office of or acting for the State not later than at the expiration of 30 months from the priority date.

(2) Where the International Searching Authority makes a declaration, under Article 17(2)(a), that no international search report will be established, the time limit for performing the acts referred to in paragraph (1) of this Article shall be the same as that provided for in paragraph (1).

(3) Any national law may, for performing the acts referred to in paragraphs (1) or (2), fix time limits which expire later than the time limit provided for in those paragraphs.

### **Article 23**

#### **Delaying of National Procedure**

(1) No designated Office shall process or examine the international application prior to the expiration of the applicable time limit under Article 22.

(2) Notwithstanding the provisions of paragraph (1), any designated Office may, on the express request of the applicant, process or examine the international application at any time.

### **Article 24**

#### **Possible Loss of Effect in Designated States**

(1) Subject, in case (ii) below, to the provisions of Article 25, the effect of the international application provided for in Article 11(3) shall cease in any designated State with the same consequences as the withdrawal of any national application in that State:

(i) if the applicant withdraws his international application or the designation of that State;

(ii) if the international application is considered withdrawn by virtue of Articles 12(3), 14(1)(b), 14(3)(a), or 14(4), or if the designation of that State is considered withdrawn by virtue of Article 14(3)(b);

(iii) if the applicant fails to perform the acts referred to in Article 22 within the applicable time limit.

(2) Notwithstanding the provisions of paragraph (1), any designated Office may maintain the effect provided for in Article 11(3) even where such effect is not required to be maintained by virtue of Article 25(2).

## Article 25

### Review by Designated Offices

(1)(a) Where the receiving Office has refused to accord an international filing date or has declared that the international application is considered withdrawn, or where the International Bureau has made a finding under Article 12(3), the International Bureau shall promptly send, at the request of the applicant, copies of any document in the file to any of the designated Offices named by the applicant.

(b) Where the receiving Office has declared that the designation of any given State is considered withdrawn, the International Bureau shall promptly send, at the request of the applicant, copies of any document in the file to the national Office of such State.

(c) The request under subparagraphs (a) or (b) shall be presented within the prescribed time limit.

(2)(a) Subject to the provisions of subparagraph (b), each designated Office shall, provided that the national fee (if any) has been paid and the appropriate translation (as prescribed) has been furnished within the prescribed time limit, decide whether the refusal, declaration, or finding, referred to in paragraph (1) was justified under the provisions of this Treaty and the Regulations, and, if it finds that the refusal or declaration was the result of an error or omission on the part of the receiving Office or that the finding was the result of an error or omission on the part of the International Bureau, it shall, as far as effects in the State of the designated Office are concerned, treat the international application as if such error or omission had not occurred.

(b) Where the record copy has reached the International Bureau after the expiration of the time limit prescribed under Article 12(3) on account of any error or omission on the part of the applicant, the provisions of subparagraph (a) shall apply only under the circumstances referred to in Article 48(2).

## Article 26

### Opportunity to Correct Before Designated Offices

No designated Office shall reject an international application on the grounds of noncompliance with the requirements of this Treaty and the Regulations without first giving the applicant the opportunity to correct the said application to the extent and according to the procedure provided by the national law for the same or comparable situations in respect of national applications.

## Article 27

### National Requirements

(1) No national law shall require compliance with requirements relating to the form or contents of the international application different from or additional to those which are provided for in this Treaty and the Regulations.

(2) The provisions of paragraph (1) neither affect the application of the provisions of Article 7(2) nor preclude any national law from requiring, once the processing of the international application has started in the designated Office, the furnishing:

(i) when the applicant is a legal entity, of the name of an officer entitled to represent such legal entity.

(ii) of documents not part of the international application but which constitute proof of allegations or statements made in that application, including the confirmation of the international application by the signature of the applicant when that application, as filed, was signed by his representative or agent.

(3) Where the applicant, for the purposes of any designated State, is not qualified according to the national law of that State to file a national application because he is not the inventor, the international application may be rejected by the designated Office.

(4) Where the national law provides, in respect of the form or contents of national applications, for requirements which, from the viewpoint of applicants, are more favorable than the requirements provided for by this Treaty and the Regulations in respect of international applications, the national Office, the courts and any other competent organs of or acting for the designated State may apply the former requirements, instead of the latter requirements, to international applications, except where the applicant insists that

the requirements provided for by this Treaty and the Regulations be applied to his international application.

(5) Nothing in this Treaty and the Regulations is intended to be construed as prescribing anything that would limit the freedom of each Contracting State to prescribe such substantive conditions of patentability as it desires. In particular, any provision in this Treaty and the Regulations concerning the definition of prior art is exclusively for the purposes of the international procedure and, consequently, any Contracting State is free to apply, when determining the patentability of an invention claimed in an international application, the criteria of its national law in respect of prior art and other conditions of patentability not constituting requirements as to the form and contents of applications.

(6) The national law may require that the applicant furnish evidence in respect of any substantive condition of patentability prescribed by such law.

(7) Any receiving Office or, once the processing of the international application has started in the designated Office, that Office may apply the national law as far as it relates to any requirement that the applicant be represented by an agent having the right to represent applicants before the said Office and/or that the applicant have an address in the designated State for the purpose of receiving notifications.

(8) Nothing in this Treaty and the Regulations is intended to be construed as limiting the freedom of any Contracting State to apply measures deemed necessary for the preservation of its national security or to limit, for the protection of the general economic interests of that State, the right of its own residents or nationals to file international applications.

### **Article 28**

#### **Amendment of the Claims, the Description, and the Drawings, Before Designated Offices**

(1) The applicant shall be given the opportunity to amend the claims, the description, and the drawings, before each designated Office within the prescribed time limit. No designated Office shall grant a patent, or refuse the grant of a patent, before such time limit has expired except with the express consent of the applicant.

(2) The amendments shall not go beyond the disclosure in the international application as filed

unless the national law of the designated State permits them to go beyond the said disclosure.

(3) The amendments shall be in accordance with the national law of the designated State in all respects not provided for in this Treaty and the Regulations.

(4) Where the designated Office requires a translation of the international application, the amendments shall be in the language of the translation.

### **Article 29**

#### **Effects of the International Publication**

(1) As far as the protection of any rights of the applicant in a designated State is concerned, the effects, in that State, of the international publication of an international application shall, subject to the provisions of paragraphs (2) to (4), be the same as those which the national law of the designated State provides for the compulsory national publication of unexamined national applications as such.

(2) If the language in which the international publication has been effected is different from the language in which publications under the national law are effected in the designated State, the said national law may provide that the effects provided for in paragraph (1) shall be applicable only from such time as:

(i) a translation into the latter language has been published as provided by the national law, or

(ii) a translation into the latter language has been made available to the public, by laying open for public inspection as provided by the national law, or

(iii) a translation into the latter language has been transmitted by the applicant to the actual or prospective unauthorized user of the invention claimed in the international application, or

(iv) both the acts described in (i) and (iii), or both the acts described in (ii) and (iii), have taken place.

(3) The national law of any designated State may provide that, where the international publication has been effected, on the request of the applicant, before the expiration of 18 months from the priority date, the effects provided for in paragraph (1) shall be applicable only from the expiration of 18 months from the priority date.

(4) The national law of any designated State may provide that the effects provided for in paragraph (1) shall be applicable only from the date on which a

copy of the international application as published under Article 21 has been received in the national Office of or acting for such State. The said Office shall publish the date of receipt in its gazette as soon as possible.

### **Article 30**

#### **Confidential Nature of the International Application**

(1)(a) Subject to the provisions of subparagraph (b), the International Bureau and the International Searching Authorities shall not allow access by any person or authority to the international application before the international publication of that application, unless requested or authorized by the applicant.

(b) The provisions of subparagraph (a) shall not apply to any transmittal to the competent International Searching Authority, to transmittals provided for under Article 13, and to communications provided for under Article 20.

(2)(a) No national Office shall allow access to the international application by third parties unless requested or authorized by the applicant, before the earliest of the following dates:

- (i) date of the international publication of the international application,
- (ii) date of receipt of the communication of the international application under Article 20,
- (iii) date of receipt of a copy of the international application under Article 22.

(b) The provisions of subparagraph (a) shall not prevent any national Office from informing third parties that it has been designated, or from publishing that fact. Such information or publication may, however, contain only the following data: identification of the receiving Office, name of the applicant, international filing date, international application number, and title of the invention.

(c) The provisions of subparagraph (a) shall not prevent any designated Office from allowing access to the international application for the purposes of the judicial authorities.

(3) The provisions of paragraph (2)(a) shall apply to any receiving Office except as so far as transmittals provided for under Article 12(1) are concerned.

(4) For the purposes of this Article, the term “access” covers any means by which third parties may

acquire cognizance, including individual communication and general publication, provided, however, that no national Office shall generally publish an international application or its translation before the international publication or, if international publication has not taken place by the expiration of 20 months from the priority date, before the expiration of 20 months from the said priority date.

## **Chapter II**

### **International Preliminary Examination**

#### **Article 31**

##### **Demand for International Preliminary Examination**

(1) On the demand of the applicant, his international application shall be the subject of an international preliminary examination as provided in the following provisions and the Regulations.

(2)(a) Any applicant who is a resident or national, as defined in the Regulations, of a Contracting State bound by Chapter II, and whose international application has been filed with the receiving Office of or acting for such State, may make a demand for international preliminary examination.

(b) The Assembly may decide to allow persons entitled to file international applications to make a demand for international preliminary examination even if they are residents or nationals of a State not party to this Treaty or not bound by Chapter II.

(3) The demand for international preliminary examination shall be made separately from the international application. The demand shall contain the prescribed particulars and shall be in the prescribed language and form.

(4)(a) The demand shall indicate the Contracting State or States in which the applicant intends to use the results of the international preliminary examination (“elected States”). Additional Contracting States may be elected later. Election may relate only to Contracting States already designated under Article 4.

(b) Applicants referred to in paragraph (2)(a) may elect any Contracting State bound by Chapter II. Applicants referred to in paragraph (2)(b) may elect only such Contracting States bound by Chapter II as

have declared that they are prepared to be elected by such applicants.

(5) The demand shall be subject to the payment of the prescribed fees within the prescribed time limit.

(6)(a) The demand shall be submitted to the competent International Preliminary Examining Authority referred to in Article 32.

(b) Any later election shall be submitted to the International Bureau.

(7) Each elected Office shall be notified of its election.

### **Article 32**

#### **The International Preliminary Examining Authority**

(1) International preliminary examination shall be carried out by the International Preliminary Examining Authority.

(2) In the case of demands referred to in Article 31(2)(a), the receiving Office, and, in the case of demands referred to in Article 31(2)(b), the Assembly, shall, in accordance with the applicable agreement between the interested International Preliminary Examining Authority or Authorities and the International Bureau, specify the International Preliminary Examining Authority or Authorities competent for the preliminary examination.

(3) The provisions of Article 16(3) shall apply, *mutatis mutandis*, in respect of the International Preliminary Examining Authorities.

### **Article 33**

#### **The International Preliminary Examination**

(1) The objective of the international preliminary examination is to formulate a preliminary and non-binding opinion on the questions whether the claimed inventions appears to be novel, to involve inventive step (to be non-obvious), and to be industrially applicable.

(2) For the purposes of the international preliminary examination, a claimed invention shall be considered novel if it is not anticipated by the prior art as defined in the Regulations.

(3) For purposes of the international preliminary examination, a claimed invention shall be considered to involve an inventive step if, having regard to the prior art as defined in the Regulations, it is not,

at the prescribed relevant date, obvious to a person skilled in the art.

(4) For the purposes of the international preliminary examination, a claimed invention shall be considered industrially applicable if, according to its nature, it can be made or used (in the technological sense) in any kind of industry. "Industry" shall be understood in its broadest sense, as in the Paris Convention for the Protection of Industrial Property.

(5) The criteria described above merely serve the purposes of international preliminary examination. Any Contracting State may apply additional or different criteria for the purpose of deciding whether, in that State, the claimed invention is patentable or not.

(6) The international preliminary examination shall take into consideration all the documents cited in the international search report. It may take into consideration any additional documents considered to be relevant in the particular case.

### **Article 34**

#### **Procedure Before the International Preliminary Examining Authority**

(1) Procedure before the International Preliminary Examining Authority shall be governed by the provisions of this Treaty, the Regulations, and the agreement which the International Bureau shall conclude, subject to this Treaty and the Regulations, with the said Authority.

(2)(a) The applicant shall have a right to communicate orally and in writing with the International Preliminary Examining Authority.

(b) The applicant shall have a right to amend the claims, the description, and the drawings, in the prescribed manner and within the prescribed time limit, before the international preliminary examination report is established. The amendment shall not go beyond the disclosure in the international application as filed.

(c) The applicant shall receive at least one written opinion from the International Preliminary Examining Authority unless such Authority considers that all of the following conditions are fulfilled:

(i) the invention satisfies the criteria set forth in Article 33(1),



(ii) the international application complies with the requirements of this Treaty and the Regulations in so far as checked by that Authority,

(iii) no observations are intended to be made under Article 35(2), last sentence.

(d) The applicant may respond to the written opinion.

(3)(a) If the International Preliminary Examining Authority considers that the international application does not comply with the requirement of unity of invention as set forth in the Regulations, it may invite the applicant, at his option, to restrict the claims so as to comply with the requirement or to pay additional fees.

(b) The national law of any elected State may provide that, where the applicant chooses to restrict the claims under subparagraph (a), those parts of the international application which, as a consequence of the restriction, are not to be the subject of international preliminary examination shall, as far as effects in that State are concerned, be considered withdrawn unless a special fee is paid by the applicant to the national Office of that State.

(c) If the applicant does not comply with the invitation referred to in subparagraph (a) within the prescribed time limit, the International Preliminary Examining Authority shall establish an international preliminary examination report on those parts of the international application which relate to what appears to be the main invention and shall indicate the relevant facts in the said report. The national law of any elected State may provide that, where its national Office finds the invitation of the International Preliminary Examining Authority justified, those parts of the international application which do not relate to the main invention shall, as far as effects in that State are concerned, be considered withdrawn unless a special fee is paid by the applicant to that Office.

(4)(a) If the International Preliminary Examining Authority considers

(i) that the international application relates to a subject matter on which the International Preliminary Examining Authority is not required, under the Regulations, to carry out an international preliminary examination, and an international preliminary examination, and in the particular case decides not to carry out such examination, or

(ii) that the description, the claims, or the drawings, are so unclear, or the claims are so inadequately supported by the description, that no meaningful opinion can be formed on the novelty, inventive step (non-obviousness), or industrial applicability, of the claimed invention, the said authority shall not go into the questions referred to in Article 33(1) and shall inform the applicant of this opinion and the reasons therefor.

(b) If any of the situations referred to in subparagraph (a) is found to exist in, or in connection with, certain claims only, the provisions of that subparagraph shall apply only to the said claims.

### **Article 35**

#### **The International Preliminary Examination Report**

(1) The international preliminary examination report shall be established within the prescribed time limit and in the prescribed form.

(2) The international preliminary examination report shall not contain any statement on the question whether the claimed invention is or seems to be patentable or unpatentable according to any national law. It shall state, subject to the provisions of paragraph (3), in relation to each claim, whether the claim appears to satisfy the criteria of novelty, inventive step (non-obviousness), and industrial applicability, as defined for the purposes of the international preliminary examination in Article 33(1) to (4). The statement shall be accompanied by the citation of the documents believed to support the stated conclusion with such explanations as the circumstances of the case may require. The statement shall also be accompanied by such other observation as the Regulations provide for.

(3)(a) If, at the time of establishing the international preliminary examination report, the International Preliminary Examining Authority considers that any of the situations referred to in Article 34(4)(a) exists, that report shall state this opinion and the reasons therefor. It shall not contain any statement as provided in paragraph (2).

(b) If a situation under Article 34(4)(b) is found to exist, the international preliminary examination report shall, in relation to the claims in question, contain the statement as provided in subparagraph (a),

whereas, in relation to the other claims, it shall contain the statement as provided in paragraph (2).

### Article 36

#### **Transmittal, Translation, and Communication of the International Preliminary Examination Report**

(1) The international preliminary examination report, together with the prescribed annexes, shall be transmitted to the applicant and to the International Bureau.

(2)(a) The international preliminary examination report and its annexes shall be translated into the prescribed languages.

(b) Any translation of the said report shall be prepared by or under the responsibility of the International Bureau, whereas any translation of the said annexes shall be prepared by the applicant.

(3)(a) The international preliminary examination report, together with its translation (as prescribed) and its annexes (in the original language), shall be communicated by the International Bureau to each elected Office.

(b) The prescribed translation of the annexes shall be transmitted within the prescribed time limit by the applicant to the elected Office.

(4) The provisions of Article 20(3) shall apply, *mutatis mutandis*, to copies of any document which is cited in the international preliminary examination report and which was not cited in the international search report.

### Article 37

#### **Withdrawal of Demand or Election**

(1) The applicant may withdraw any or all elections.

(2) If the election of all elected States is withdrawn, the demand shall be considered withdrawn.

(3)(a) Any withdrawal shall be notified to the International Bureau.

(b) The elected Office concerned and the International Preliminary Examining Authority concerned shall be notified accordingly by the International Bureau.

(4)(a) Subject to the provisions of subparagraph (b), withdrawal of the demand or of the election of a Contracting State shall, unless the national law of that State provides otherwise, be considered to be with-

drawal of the international application as far as that State is concerned.

(b) Withdrawal of the demand or of the election shall not be considered to be withdrawal of the international application if such withdrawal is effected prior to the expiration of the applicable time limit under Article 22; however, any Contracting State may provide in its national law that the aforesaid shall apply only if its national Office has received, within the said time limit, a copy of the international application, together with a translation (as prescribed), and the national fee.

### Article 38

#### **Confidential Nature of the International Preliminary Examination**

(1) Neither the International Bureau nor the International Preliminary Examining Authority shall, unless requested or authorized by the applicant, allow access within the meaning, and with the proviso, of Article 30(4) to the file of the international preliminary examination by any person or authority at any time, except by the elected Offices once the international preliminary examination report has been established.

(2) Subject to the provisions of paragraph (1) and Articles 36(1) and (3) and 37(3)(b), neither the International Bureau nor the International Preliminary Examining Authority shall, unless requested or authorized by the applicant, give information on the issuance or non-issuance of an international preliminary examination report and on the withdrawal or non-withdrawal of the demand or of any election.

### Article 39

#### **Copy, Translation, and Fee, to Elected Offices**

(1)(a) If the election of any Contracting State has been effected prior to the expiration of the 19th month from the priority date, the provisions of Article 22 shall not apply to such State and the applicant shall furnish a copy of the international application (unless the communication under Article 20 has already taken place) and a translation thereof (as prescribed), and pay the national fee (if any), to each elected Office not later than at the expiration of 30 months from the priority date.

(b) Any national law may, for performing the acts referred to in subparagraph (a), fix time limits which expire later than the time limit provided for in that subparagraph.

(2) The effect provided for in Article 11(3) shall cease in the elected State with the same consequences as the withdrawal of any national application in that State if the applicant fails to perform the acts referred to in paragraph (1)(a) within the time limit applicable under paragraph (1)(a) or (b).

(3) Any elected Office may maintain the effect provided for in Article 11(3) even where the applicant does not comply with the requirements provided for in paragraph (1)(a) or (b).

#### **Article 40**

##### **Delaying of National Examination and Other Processing**

(1) If the election of any Contracting State has been effected prior to the expiration of the 19th month from the priority date, the provisions of Article 23 shall not apply to such State and the national Office of or acting for that State shall not proceed, subject to the provisions of paragraph (2), to the examination and other processing of the international application prior to the expiration of the applicable time limit under Article 39.

(2) Notwithstanding the provisions of paragraph (1), any elected Office may, on the express request of the applicant, proceed to the examination and other processing of the international application at any time.

#### **Article 41**

##### **Amendment of the Claims, the Description, and the Drawings, before Elected Offices**

(1) The applicant shall be given the opportunity to amend the claims, the description, and the drawings, before each elected Office within the prescribed time limit. No elected Office shall grant a patent, or refuse the grant of a patent, before such time limit has expired, except with the express consent of the applicant.

(2) The amendments shall not go beyond the disclosure in the international application as filed, unless the national law of the elected State permits them to go beyond the said disclosure.

(3) The amendments shall be in accordance with the national law of the elected State in all respects not provided for in this Treaty and the Regulations.

(4) Where an elected Office requires a translation of the international application, the amendments shall be in the language of the translation.

#### **Article 42**

##### **Results of National Examination in Elected Offices**

No elected Office receiving the international preliminary examination report may require that the applicant furnish copies, or information on the contents, of any papers connected with the examination relating to the same international application in any other elected Office.

### **Chapter III**

#### **Common Provisions**

#### **Article 43**

##### **Seeking Certain Kinds of Protection**

In respect of any designated or elected State whose law provides for the grant of inventors' certificates, utility certificates, utility models, patents or certificates of addition, inventors' certificates of addition, or utility certificates of addition, the applicant may indicate, as prescribed in the Regulations, that his international application is for the grant, as far as that State is concerned, of an inventor's certificate, a utility certificate, or a utility model, rather than a patent, or that it is for the grant of a patent or certificate of addition, an inventor's certificate of addition, or a utility certificate of addition, and the ensuing effect shall be governed by the applicant's choice. For the purposes of this Article and any Rule thereunder, Article 2(ii) shall not apply.

#### **Article 44**

##### **Seeking Two Kinds of Protection**

In respect of any designated or elected State whose law permits an application, while being for the grant of a patent or one of the other kinds of protection referred to in Article 43, to be also for the grant of another of the said kinds of protection, the applicant may indicate, as prescribed in the Regulations, the

two kinds of protection he is seeking, and the ensuing effect shall be governed by the applicant's indications. For the purposes of this Article, Article 2(ii) shall not apply.

#### **Article 45**

##### **Regional Patent Treaties**

(1) Any treaty providing for the grant of regional patents ("regional patent treaty"), and giving to all persons who, according to Article 9, are entitled to file international applications the right to file applications for such patents, may provide that international applications designating or electing a State party to both the regional patent treaty and the present Treaty may be filed as applications for such patents.

(2) The national law of the said designated or elected State may provide that any designation or election of such State in the international application shall have the effect of an indication of the wish to obtain a regional patent under the regional patent treaty.

#### **Article 46**

##### **Incorrect Translation of the International Application**

If, because of an incorrect translation of the international application, the scope of any patent granted on that application exceeds the scope of the international application in its original language, the competent authorities of the Contracting State concerned may accordingly and retroactively limit the scope of the patent, and declare it null and void to the extent that its scope has exceeded the scope of the international application in its original language.

#### **Article 47**

##### **Time Limits**

(1) The details for computing time limits referred to in this Treaty are governed by the Regulations.

(2)(a) All time limits fixed in Chapters I and II of this Treaty may, outside any revision under Article 60, be modified by a decision of the Contracting States.

(b) Such decisions shall be made in the Assembly or through voting by correspondence and must be unanimous.

(c) The details of the procedure are governed by the Regulations.

#### **Article 48**

##### **Delay in Meeting Certain Time Limits**

(1) Where any time limit fixed in this Treaty or the Regulations is not met because of interruption in the mail service or unavoidable loss or delay in the mail, the time limit shall be deemed to be met in the cases and subject to the proof and other conditions prescribed in the Regulations.

(2)(a) Any Contracting State shall, as far as that State is concerned, excuse, for reasons admitted under its national law, any delay in meeting any time limit.

(b) Any Contracting State may, as far as that State is concerned, excuse, for reasons other than those referred to in subparagraph (a), any delay in meeting any time limit.

#### **Article 49**

##### **Right to Practice Before International Authorities**

Any attorney, patent agent, or other person, having the right to practice before the national Office with which the international application was filed, shall be entitled to practice before the International Bureau and the competent International Searching Authority and competent International Preliminary Examining Authority in respect of that application.

### **Chapter IV**

#### **Technical Services**

#### **Article 50**

##### **Patent Information Service**

(1) The International Bureau may furnish services by providing technical and any other pertinent information available to it on the basis of published documents, primarily patents and published applications (referred to in this Article as "the information services").

(2) The International Bureau may provide these information services either directly or through one or more International Searching Authorities or other national or international specialized institutions, with which the International Bureau may reach agreement.

(3) The information services shall be operated in a way particularly facilitating the acquisition by Contracting States which are developing countries of technical knowledge and technology, including available published know-how.

(4) The information services shall be available to Governments of Contracting States and their nationals and residents. The Assembly may decide to make these services available also to others.

(5)(a) Any service to Governments of Contracting States shall be furnished at cost, provided that, when the Government is that of a Contracting State which is a developing country, the service shall be furnished below cost if the difference can be covered from profit made on services furnished to others than Governments of Contracting States or from the sources referred to in Article 51(4).

(b) The cost referred to in subparagraph (a) is to be understood as cost over and above costs normally incident to the performance of the services of a national Office or the obligations of an International Searching Authority.

(6) The details concerning the implementation of the provisions of this Article shall be governed by decisions of the Assembly and, within the limits to be fixed by the Assembly, such working groups as the Assembly may set up for that purpose.

(7) The Assembly shall, when it considers it necessary, recommend methods of providing financing supplementary to those referred to in paragraph (5).

### **Article 51**

#### **Technical Assistance**

(1) The Assembly shall establish a Committee for Technical Assistance (referred to in this Article as “the Committee”).

(2)(a) The members of the Committee shall be elected among the Contracting States, with due regard to the representation of developing countries.

(b) The Director General shall, on his own initiative or at the request of the Committee, invite representatives of intergovernmental organizations concerned with technical assistance to developing countries to participate in the work of the Committee.

(3)(a) The task of the Committee shall be to organize and supervise technical assistance for Contracting States which are developing countries in

developing their patent systems individually or on a regional basis.

(b) The technical assistance shall comprise, among other things, the training of specialists, the loaning of experts, and the supply of equipment both for demonstration and for operational purposes.

(4) The International Bureau shall seek to enter into agreements, on the one hand, with international financing organizations and intergovernmental organizations, particularly the United Nations, the agencies of the United Nations, and the Specialized Agencies connected with the United Nations concerned with technical assistance, and, on the other hand, with the Governments of the States receiving the technical assistance, for the financing of projects pursuant to this Article.

(5) The details concerning the implementation of the provisions of this Article shall be governed by decisions of the Assembly and, within the limits to be fixed by the Assembly, such working groups as the Assembly may set up for that purpose.

### **Article 52**

#### **Relations with Other Provisions of the Treaty**

Nothing in this Chapter shall affect the financial provisions contained in any other Chapter of this Treaty. Such provisions are not applicable to the present Chapter or to its implementation.

## **Chapter V**

### **Administrative Provisions**

#### **Article 53**

##### **Assembly**

(1)(a) The Assembly shall, subject to Article 57(8), consist of the Contracting States.

(b) The Government of each Contracting State shall be represented by one delegate, who may be assisted by alternate delegates, advisors, and experts.

(2)(a) The Assembly shall:

(i) deal with matters concerning the maintenance and development of the Union and the implementation of this Treaty;

(ii) perform such tasks as are specifically assigned to it under other provisions of this Treaty;

## PATENT COOPERATION TREATY

(iii) give directions to the International Bureau concerning the preparation for revision conferences;

(iv) review and approve the reports and activities of the Director General concerning the Union, and give him all necessary instructions concerning matters within the competence of the Union;

(v) review and approve the reports and activities of the Executive Committee established under paragraph (9), and give instructions to such Committee;

(vi) determine the program and adopt the triennial<sup>2</sup> budget of the Union, and approve its final accounts;

(vii) adopt the financial regulations of the Union;

(viii) establish such committees and working groups as it deems appropriate to achieve the objectives of the Union;

(ix) determine which States other than the Contracting States and, subject to the provisions of paragraph (8), which intergovernmental and international nongovernmental organizations shall be admitted to its meetings as observers;

(x) take any other appropriate action designed to further the objectives of the Union and perform such other functions as are appropriate under the Treaty.

(b) With respect to matters which are of interest also to other Unions administered by the Organization, the Assembly shall make its decisions after having heard the advice of the Coordination Committee of the Organization.

(3) A delegate may represent, and vote in the name of, one State only.

(4) Each Contracting State shall have one vote.

(5)(a) One-half of the Contracting States shall constitute a quorum.

(b) In the absence of a quorum, the Assembly may make decisions but, with the exception of decisions concerning its own procedure, all such decisions shall take effect only if the quorum and the required majority are attained through voting by correspondence as provided in the Regulations.

(6)(a) Subject to the provisions of Articles 47(2)(b), 58(2)(b), 58(3) and 61(2)(b), the decisions of the Assembly shall require two-thirds of the votes cast.

(b) Abstentions shall not be considered as votes.

(7) In connection with matters of exclusive interest to States bound by Chapter II, any reference to Contracting States in paragraphs (4), (5), and (6), shall be considered as applying only to States bound by Chapter II.

(8) Any intergovernmental organization appointed as International Searching or Preliminary Examining Authority shall be admitted as observer to the Assembly.

(9) When the number of Contracting States exceeds forty, the Assembly shall establish an Executive Committee. Any reference to the Executive Committee in this Treaty and the Regulations shall be considered as references to such Committee once it has been established,

(10) Until the Executive Committee has been established, the Assembly shall approve, within the limits of the program and triennial<sup>3</sup> budget, the annual programs and budgets prepared by the Director General.

(11)(a) The Assembly shall meet in every second calendar year in ordinary session upon convocation by the Director General and, in the absence of exceptional circumstances, during the same period and at the same place as the General Assembly of the Organization.

(b) The Assembly shall meet in extraordinary session upon convocation by the Director General, at the request of the Executive Committee, or at the request of one-fourth of the Contracting States.

(12) The Assembly shall adopt its own rules of procedure.

### Article 54

#### Executive Committee

(1) When the Assembly has established an Executive Committee, that Committee shall be subject to the provisions set forth hereinafter.

<sup>2</sup> *Editor's Note:* Since 1980, the budget of the Union has been biennial.

<sup>3</sup> *Editor's Note:* Since 1980, the budget of the Union has been biennial.

## MANUAL OF PATENT EXAMINING PROCEDURE

(2)(a) The Executive Committee shall, subject to Article 57(8), consist of States elected by the Assembly from among States members of the Assembly.

(b) The Government of each State member of the Executive Committee shall be represented by one delegate, who may be assisted by alternate delegates, advisors, and experts.

(3) The number of States members of the Executive Committee shall correspond to one-fourth of the number of States members of the Assembly. In establishing the number of seats to be filled, remainders after division by four shall be disregarded.

(4) In electing the members of the Executive Committee, the Assembly shall have due regard to an equitable geographical distribution.

(5)(a) Each member of the Executive Committee shall serve from the close of the session of the Assembly which elected it to the close of the next ordinary session of the Assembly.

(b) Members of the Executive Committee may be re-elected but only up to a maximum of two-thirds of such members.

(c) The Assembly shall establish the details of the rules governing the election and possible re-election of the members of the Executive Committee.

(6)(a) The Executive Committee shall:

(i) prepare the draft agenda of the Assembly:

(ii) submit proposals to the Assembly in respect of the draft program and biennial budget of the Union prepared by the Director General:

(iii) *[deleted]*

(iv) submit, with appropriate comments, to the Assembly the periodical reports of the Director General and the yearly audit reports on the accounts:

(v) take all necessary measures to ensure the execution of the program of the Union by the Director General, in accordance with the decisions of the Assembly and having regard to circumstances arising between two ordinary sessions of the Assembly:

(vi) perform such other functions as are allocated to it under this Treaty.

(b) With respect to matters which are of interest also to other Unions administered by the Organization, the Executive Committee shall make its decisions after having heard the advice of the Coordinating Committee of the Organization.

(7)(a) The Executive Committee shall meet once a year in ordinary session upon convocation by the Director General, preferably during the same period and at the same place as the Coordination Committee of the Organization.

(b) The Executive Committee shall meet in extraordinary session upon convocation by the Director General, either on his own initiative or at the request of its Chairman or one-fourth of its members.

(8)(a) Each State member of the Executive Committee shall have one vote.

(b) One-half of the members of the Executive Committee shall constitute a quorum.

(c) Decisions shall be made by a simple majority of the votes cast.

(d) Abstentions shall not be considered as votes.

(e) A delegate may represent, and vote in the name of, one State only.

(9) Contracting States not members of the Executive Committee shall be admitted to its meetings as observers, as well as any intergovernmental organization appointed as International Searching or Preliminary Examining Authority.

(10) The Executive Committee shall adopt its own rules of procedure.

### Article 55

#### International Bureau

(1) Administrative tasks concerning the Union shall be performed by the International Bureau.

(2) The International Bureau shall provide the secretariat of the various organs of the Union.

(3) The Director General shall be the chief executive of the Union and shall represent the Union.

(4) The International Bureau shall publish a Gazette and other publications provided for by the Regulations or required by the Assembly.

(5) The Regulations shall specify the various services that national Offices shall perform in order to assist the International Bureau and the International Searching and Preliminary Examining Authorities in carrying out their tasks under the Treaty.

(6) The Director General and any staff member designated by him shall participate, without the right to vote, in all meetings of the Assembly, the Executive Committee and any other committee or working group established under this Treaty or the

## PATENT COOPERATION TREATY

Regulations. The Director General, or a staff member designated by him, shall be *ex officio* secretary of these bodies.

(7)(a) The International Bureau shall, in accordance with the directions of the Assembly and in cooperation with the Executive Committee, make the preparations for the revision conferences.

(b) The International Bureau may consult with intergovernmental and international non-governmental organizations concerning preparations for revision conferences.

(c) The Director General and persons designated by him shall take part, without the right to vote, in the discussions at revision conferences.

(8) The International Bureau shall carry out any other tasks assigned to it.

### Article 56

#### Committee for Technical Cooperation

(1) The Assembly shall establish a Committee for Technical Cooperation (referred to in this Article as “the Committee”).

(2)(a) The Assembly shall determine the composition of the Committee and appoint its members, with due regard to an equitable representation of developing countries.

(b) The International Searching and Preliminary Examining Authorities shall be *ex officio* members of the Committee. In the case where such an Authority is the national Office of a Contracting State, that State shall not be additionally represented on the Committee.

(c) If the number of Contracting States so allows, the total number of members of the Committee shall be more than double the number of *ex officio* members.

(d) The Director General shall, on his own initiative or at the request of the Committee, invite representatives of interested organizations to participate in discussions of interest to them.

(3) The aim of the Committee shall be to contribute, by advice and recommendations:

(i) to the constant improvement of the services provided for under the Treaty,

(ii) to the securing, so long as there are several International Searching Authorities and several International Preliminary Examining Authorities, of the maximum degree of uniformity in their docu-

mentation and working methods and the maximum degree of uniformly high quality in their reports, and

(iii) on the initiative of the Assembly or the Executive Committee, to the solution of the technical problems specifically involved in the establishment of a single International Searching Authority.

(4) Any Contracting State and any interested international organization may approach the Committee in writing on questions which fall within the competence of the Committee.

(5) The Committee may address its advice and recommendations to the Director General or, through him, to the Assembly, the Executive Committee, all or some of the International Searching and Preliminary Examining Authorities, and all or some of the receiving Offices.

(6)(a) In any case, the Director General shall transmit to the Executive Committee the texts of all the advice and recommendations of the Committee. He may comment on such texts.

(b) The Executive Committee may express its views on any advice, recommendation, or other activity of the Committee, and may invite the Committee to study and report on questions falling within its competence. The Executive Committee may submit to the Assembly, with appropriate comments, the advice, recommendations and report of the Committee.

(7) Until the Executive Committee has been established, references in paragraph (6) to the Executive Committee shall be construed as references to the Assembly.

(8) The details of the procedure of the Committee shall be governed by the decisions of the Assembly.

### Article 57

#### Finances

(1)(a) The Union shall have a budget.

(b) The budget of the Union shall include the income and expenses proper to the Union and its contribution to the budget of expenses common to the Unions administered by the Organization.

(c) Expenses not attributable exclusively to the Union but also to one or more other Unions administered by the Organization shall be considered as expenses common to the Unions. The share of the



## MANUAL OF PATENT EXAMINING PROCEDURE

Union in such common expenses shall be in proportion to the interest the Union has in them.

(2) The budget of the Union shall be established with due regard to the requirements of coordination with the budgets of the other Unions administered by the Organization.

(3) Subject to the provisions of paragraph (5), the budget of the Union shall be financed from the following sources:

(i) fees and charges due for services rendered by the International Bureau in relation to the Union;

(ii) sale of, or royalties on, the publications of the International Bureau concerning the Union;

(iii) gifts, bequests, and subventions;

(iv) rents, interests, and other miscellaneous income.

(4) The amounts of fees and charges due to the International Bureau and the prices of its publications shall be fixed that they should, under normal circumstances, be sufficient to cover all the expenses of the International Bureau connected with the administration of this Treaty.

(5)(a) Should any financial year close with a deficit, the Contracting States shall, subject to the provisions of subparagraphs (b) and (c), pay contributions to cover such deficit.

(b) The amount of the contribution of each Contracting State shall be decided by the Assembly with due regard to the number of international applications which has emanated from each of them in the relevant year.

(c) If other means of provisionally covering any deficit or any part thereof are secured, the Assembly may decide that such deficit be carried forward and that the Contracting States should not be asked to pay contributions.

(d) If the financial situation of the Union so permits, the Assembly may decide that any contributions paid under subparagraph (a) be reimbursed to the Contracting States which have paid them.

(e) A Contracting State which has not paid, within two years of the due date as established by the Assembly, its contribution under subparagraph (b) may not exercise its right to vote in any of the organs of the Union. However, any organ of the Union may allow such a State to continue to exercise its right to

vote in that organ as long as it is satisfied that the delay in payment is due to exceptional and unavoidable circumstances.

(6) If the budget is not adopted before the beginning of a new financial period, it shall be at the same level as the budget of the previous year, as provided in the financial regulations.

(7)(a) The Union shall have a working capital fund which shall be constituted by a single payment made by each Contracting State. If the fund becomes insufficient, the Assembly shall arrange to increase it. If part of the fund is no longer needed, it shall be reimbursed.

(b) The amount of the initial payment of each Contracting State to said fund or its participation in the increase thereof shall be decided by the Assembly on the basis of principles similar to those provided for under paragraph (5)(b).

(c) The terms of payment shall be fixed by the Assembly on the proposal of the Director General and after it has heard the advice of the Coordinating Committee of the Organization.

(d) Any reimbursement shall be proportionate to the amounts paid by each Contracting State, taking into account the dates at which they were paid.

(8)(a) In the headquarters agreement concluded with the State on the territory of which the Organization has its headquarters, it shall be provided that, whenever the working capital fund is insufficient, such State shall grant advances. The amount of these advances and the conditions on which they are granted shall be the subject of separate agreements, in each case, between such State and the Organization. As long as it remains under the obligation to grant advances, such State shall have an *ex officio* seat in the Assembly and on the Executive Committee.

(b) The State referred to in subparagraph (a) and the Organization shall each have the right to denounce the obligation to grant advances, by written notification. Denunciation shall take effect three years after the end of the year in which it has been notified.

(9) The auditing of the accounts shall be effected by one or more of the Contracting States or by external auditors, as provided in the financial regulations. They shall be designated, with their agreement, by the Assembly.

## **Article 58**

### **Regulations**

(1) The Regulations annexed to this Treaty provide Rules:

(i) concerning matters in respect of which this Treaty expressly refers to the Regulations or expressly provides that they are or shall be prescribed.

(ii) concerning any administrative requirements, matters, or procedures,

(iii) concerning any details useful in the implementation of the provisions of this Treaty.

(2)(a) The Assembly may amend the Regulations.

(b) Subject to the provisions of paragraph (3), amendments shall require three-fourths of the votes cast.

(3)(a) The Regulations specify the Rules which may be amended

(i) only by unanimous consent, or

(ii) only if none of the Contracting States whose national Office acts as an International Searching or Preliminary Examining Authority dissents, and, where such Authority is an intergovernmental organization, if the Contracting State member of the organization authorized for that purpose by the other member States within the competent body of such organization does not dissent.

(b) Exclusion, for the future, of any such Rules from the applicable requirement shall require the fulfillment of the conditions referred to in subparagraph (a)(i) or (a)(ii), respectively.

(c) Inclusion, for the future, of any Rule in one or the other of the requirements referred to in subparagraph (a) shall require unanimous consent.

(4) The Regulations provide for the establishment, under the control of the Assembly, of Administrative Instructions by the Director General.

(5) In the case of conflict between the provisions of the Treaty and those of the Regulations, the provisions of the Treaty shall prevail.

## **Chapter VI**

### **Disputes**

#### **Article 59**

##### **Disputes**

Subject to Article 64(5), any dispute between two or more Contracting States concerning the interpretation or application of this Treaty or the Regulations, not settled by negotiation, may, by any one of the States concerned, be brought before the International Court of Justice by application in conformity with the Statute of the Court, unless the States concerned agree on some other method of settlement. The Contracting State bringing the dispute before the Court shall inform the International Bureau; the International Bureau shall bring the matter to the attention of the other Contracting States.

## **Chapter VII**

### **Revision and Amendments**

#### **Article 60**

##### **Revision of the Treaty**

(1) This Treaty may be revised from time to time by a special conference of the Contracting States.

(2) The convocation of any revision conference shall be decided by the Assembly.

(3) Any intergovernmental organization appointed as International Searching or Preliminary Examining Authority shall be admitted as observer to any revision conference.

(4) Articles 53(5), (9) and (11), 54, 55(4) to (8), 56, and 57, may be amended either by a revision conference or according to the provisions of Article 61.

#### **Article 61**

##### **Amendment of Certain Provisions of the Treaty**

(1)(a) Proposals for the amendment of Articles 53(5), (9) and (11), 54, 55(4) to (8), 56, and 57, may be initiated by any State member of the Assembly, by the Executive Committee, or by the Director General.

(b) Such proposals shall be communicated by the Director General to the Contracting States at least

six months in advance of their consideration by the Assembly.

(2)(a) Amendments to the Articles referred to in paragraph (1) shall be adopted by the Assembly.

(b) Adoption shall require three-fourths of the votes cast.

(3)(a) Any amendment to the Articles referred to in paragraph (1) shall enter into force one month after written notifications of acceptance, effected in accordance with their respective constitutional processes, have been received by the Director General from three-fourths of the States of the Assembly at the time it adopted the amendment.

(b) Any amendment to the said Articles thus accepted shall bind all the States which are members of the Assembly at the time the amendment enters into force, provided that any amendment increasing the financial obligations of the Contracting States shall bind only those States which have notified their acceptance of such amendment.

(c) Any amendment accepted in accordance with the provisions of subparagraph (a) shall bind all States which become members of the Assembly after the date on which the amendment entered into force in accordance with the provisions of subparagraph (a).

## Chapter VIII

### Final Provisions

#### Article 62

##### Becoming Party to the Treaty

(1) Any State member of the International Union for the Protection of Industrial Property may become party to this Treaty by:

(i) signature followed by the deposit of an instrument of ratification, or

(ii) deposit of an instrument of accession.

(2) Instruments of ratification or accession shall be deposited with the Director General.

(3) The provisions of Article 24 of the Stockholm Act of the Paris Convention for the Protection of Industrial Property shall apply to this Treaty.

(4) Paragraph (3) shall in no way be understood as implying the recognition or tacit acceptance by a

Contracting State of the factual situation concerning a territory to which this Treaty is made applicable by another Contracting State by virtue of the said paragraph.

#### Article 63

##### Entry into Force of the Treaty

(1)(a) Subject to the provisions of paragraph (3), this Treaty shall enter into force three months after eight States have deposited their instruments of ratification or accession, provided that at least four of those States each fulfill any of the following conditions:

(i) the number of applications filed in the State has exceeded 40,000 according to the most recent annual statistics published by the International Bureau.

(ii) the nationals or residents of the State have filed at least 1,000 applications in one foreign country according to the most recent annual statistics published by the International Bureau.

(iii) the national Office of the State has received at least 10,000 applications from nationals or residents of foreign countries according to the most recent annual statistics published by the International Bureau.

(b) For the purposes of this paragraph, the term “applications” does not include applications for utility models.

(2) Subject to the provisions of paragraph (3), any State which does not become party to this Treaty upon entry into force under paragraph (1) shall be bound by this Treaty three months after the date on which such State has deposited its instrument of ratification or accession.

(3) The provisions of Chapter II and the corresponding provisions of the Regulations annexed to this Treaty shall become applicable, however, only on the date on which three States each of which fulfill at least one of the three requirements specified in paragraph (1) have become party to this Treaty without declaring, as provided in Article 64(1), that they do not intend to be bound by the provisions of Chapter II. That date shall not, however, be prior to that of the initial entry into force under paragraph (1).

**Article 64**

**Reservations**

(1)(a) Any State may declare that it shall not be bound by the provisions of Chapter II.

(b) States making a declaration under subparagraph (a) shall not be bound by the provisions of Chapter II and the corresponding provisions of the Regulations.

(2)(a) Any State not having made a declaration under paragraph(1)(a) may declare that:

(i) it shall not be bound by the provisions of Article 39(1) with respect to the furnishing of a copy of the international application and a translation thereof (as prescribed),

(ii) the obligation to delay national processing, as provided for under Article 40, shall not prevent publication, by or through its national Office, of the international application or a translation thereof, it being understood, however, that it is not exempted from the limitations provided for in Articles 30 and 38.

(b) States making such a declaration shall be bound accordingly.

(3)(a) Any State may declare that, as far as it is concerned, international publication of international applications is not required.

(b) Where, at the expiration of 18 months from the priority date, the international application contains the designation only of such States as have made declarations under subparagraph (a), the international application shall not be published by virtue of Article 21(2).

(c) Where the provisions of subparagraph (b) apply, the international application shall nevertheless be published by the International Bureau:

(i) at the request of the applicant, as provided in the Regulations,

(ii) when a national application or a patent based on the international application is published by or on behalf of the national Office of any designated State having made a declaration under subparagraph (a), promptly after such publication but not before the expiration of 18 months from the priority date.

(4)(a) Any State whose national law provides for prior art effect of its patents as from a date before publication, but does not equate for prior art purposes the priority date claimed under the Paris Convention

for the Protection of Industrial Property to the actual filing date in that State, may declare that the filing outside that State of an international application designating that State is not equated to an actual filing in that State for prior art purposes.

(b) Any State making a declaration under subparagraph (a) shall to that extent not be bound by the provisions of Article 11(3).

(c) Any State making a declaration under subparagraph (a) shall, at the same time, state in writing the date from which, and the conditions under which, the prior art effect of any international application designating that State becomes effective in that State. This statement may be modified at any time by notification addressed to the Director General.

(5) Each State may declare that it does not consider itself bound by Article 59. With regard to any dispute between any Contracting State having made such a declaration and any other Contracting State, the provisions of Article 59 shall not apply.

(6)(a) Any declaration made under this Article shall be made in writing. It may be made at the time of signing this Treaty, at the time of depositing the instrument of ratification or accession, or, except in the case referred to in paragraph (5), at any later time by notification addressed to the Director General. In the case of the said notification, the declaration shall take effect six months after the day on which the Director General has received the notification, and shall not affect international applications filed prior to the expiration of the said six-month period.

(b) Any declaration made under this Article may be withdrawn at any time by notification addressed to the Director General. Such withdrawal shall take effect three months after the day on which the Director General has received the notification and, in the case of the withdrawal of a declaration made under paragraph (3), shall not affect international applications filed prior to the expiration of the said three-month period.

(7) No reservations to this Treaty other than the reservations under paragraphs (1) to (5) are permitted.

**Article 65**

**Gradual Application**

(1) If the agreement with any International Searching or Preliminary Examining Authority provides, transitionally, for limits on the number or kinds

of international applications that such Authority undertakes to process, the Assembly shall adopt the measures necessary for the gradual application of this Treaty and the Regulations in respect of given categories of international applications. This provision shall also apply to requests for an international-type search under Article 15(5).

(2) The Assembly shall fix the dates from which, subject to the provision of paragraph (1), international applications may be filed and demands for international preliminary examination may be submitted. Such dates shall not be later than six months after this Treaty has entered into force according to the provisions of Article 63(1), or after Chapter II has become applicable under Article 63(3), respectively.

### **Article 66**

#### **Denunciation**

(1) Any Contracting State may denounce this Treaty by notification addressed to the Director General.

(2) Denunciation shall take effect six months after receipt of said notification by the Director General. It shall not affect the effects of the international application in the denouncing State if the international application was filed, and, where the denouncing State has been elected, the election was made, prior to the expiration of the said six-month period.

### **Article 67**

#### **Signature and Languages**

(1)(a) This Treaty shall be signed in a single original in the English and French languages, both texts being equally authentic.

(b) Official texts shall be established by the Director General after consultation with the interested Governments, in the German, Japanese, Portuguese, Russian and Spanish languages, and such other languages as the Assembly may designate.

(2) This Treaty shall remain open for signature at Washington until December 31, 1970.

### **Article 68**

#### **Depositary Functions**

(1) The original of this Treaty, when no longer open for signature, shall be deposited with the Director General.

(2) The Director General shall transmit two copies, certified by him, of this Treaty and the Regulations annexed hereto to the Government of all States party to the Paris Convention for the Protection of Industrial Property and, on request, to the Government of any other State.

(3) The Director General shall register this Treaty with the Secretariat of the United Nations.

(4) The Director General shall transmit two copies, certified by him, of any amendment to this Treaty and the Regulations to the Government of all Contracting States and, on request, to the Government of any other State.

### **Article 69**

#### **Notifications**

The Director General shall notify the government of all States party to the Paris Convention for the Protection of Industrial Property of:

- (i) signatures under Article 62,
- (ii) deposits of instruments of ratification or accession under Article 62,
- (iii) the date of entry into force of this Treaty and the date from which Chapter II is applicable in accordance with Article 63(3),
- (iv) any declarations made under Article 64(1) to (5),
- (v) withdrawals of any declarations made under Article 64(6)(b),
- (vi) denunciations received under Article 66, and
- (vii) any declarations made under Article 31(4).



## Regulations Under the Patent Cooperation Treaty

(as in force from January 1, 2004)

Adopted on June 19, 1970, and amended on April 14, 1978, October 3, 1978, May 1, 1979, June 16, 1980, September 26, 1980, July 3, 1981, September 10, 1982, October 4, 1983, February 3, 1984, September 28, 1984, October 1, 1985, July 12, 1991, October 2, 1991, September 29, 1992, September 29, 1993, October 3, 1995, October 1, 1997, September 15, 1998, September 29, 1999, March 17, 2000, October 3, 2000, October 3, 2001, October 1, 2002, and October 1, 2003.

### TABLE OF CONTENTS<sup>4</sup>

#### Part A: Introductory Rules

Rule 1	Abbreviated Expressions
1.1	Meaning of Abbreviated Expressions
Rule 2	Interpretation of Certain Words
2.1	“Applicant”
2.2	“Agent”
2.2 <sup>bis</sup>	“Common Representative”
2.3	“Signature”

#### Part B: Rules Concerning Chapter I of the Treaty

Rule 3	The Request (Form)
3.1	Form of Request
3.2	Availability of Forms
3.3	Check List
3.4	Particulars
Rule 4	The Request (Contents)
4.1	Mandatory and Optional Contents; Signature
4.2	The Petition
4.3	Title of the Invention
4.4	Names and Addresses
4.5	The Applicant
4.6	The Inventor

4.7	The Agent
4.8	Common Representative
4.9	Designation of States; Kinds of Protection; National and Regional Patents
4.10	Priority Claim
4.11	Reference to Earlier Search, Continuation or Continuation-in-Part, or Parent Application or Grant
4.12	[Deleted]
4.13	[Deleted]
4.14	[Deleted]
4.14 <sup>bis</sup>	Choice of International Searching Authority
4.15	Signature
4.16	Transliteration or Translation of Certain Words
4.17	Declarations Relating to National Requirements Referred to in Rule 5 1bis. 1(a)(i) to (v)
4.18	Additional Matter

Rule 5	The Description
5.1	Manner of the Description
5.2	Nucleotide and/or Amino Acid Sequence Disclosure
Rule 6	The Claims
6.1	Number and Numbering of Claims
6.2	References to Other Parts of the International Application
6.3	Manner of Claiming
6.4	Dependent Claims
6.5	Utility Models
Rule 7	The Drawings
7.1	Flow Sheets and Diagrams
7.2	Time Limit
Rule 8	The Abstract
8.1	Contents and Form of the Abstract
8.2	Figure
8.3	Guiding Principles in Drafting

<sup>4</sup> Table of Contents is added for the convenience of the reader; it does not appear in the original.

MANUAL OF PATENT EXAMINING PROCEDURE

Rule 9	Expressions, Etc., Not To Be Used	13.3	Determination of Unity of Invention Not Affected Manner of Claiming
	9.1 Definition		
	9.2 Noting of Lack of Compliance	13.4	Dependent Claims
	9.3 Reference to Article 21(6) 5	13.5	Utility Models
Rule 10	Terminology and Signs	Rule 13 <sup>bis</sup>	Inventions Relating to Biological Material
	10.1 Terminology and Signs		
	10.2 Consistency	13 <sup>bis</sup> .1	Definition
Rule 11	Physical Requirements of the International Application	13 <sup>bis</sup> .2	References (General)
	11.1 Number of Copies	13 <sup>bis</sup> .3	References: Contents; Failure to Include Reference or Indication
	11.2 Fitness for Reproduction	13 <sup>bis</sup> .4	References: Time Limit for Furnishing Indications
	11.3 Material to Be Used	13 <sup>bis</sup> .5	References and Indications for the Purposes of One or More Designated States; Different Deposits for Different Designated States; Deposits with Depository Institutions Other Than Those Notified
	11.4 Separate Sheets, Etc.		
	11.5 Size of Sheets		
	11.6 Margins		
	11.7 Numbering of Sheets		
	11.8 Numbering of Lines	13 <sup>bis</sup> .6	Furnishing of Samples
	11.9 Writing of Text Matter	13 <sup>bis</sup> .7	National Requirements: Notification and Publication
	11.10 Drawings, Formulae, and Tables, in Text Matter		
	11.11 Words in Drawings		
	11.12 Alterations, Etc.		
	11.13 Special Requirements for Drawings	Rule 13ter	Nucleotide and/or Amino Acid Sequence Listings
	11.14 Later Documents		
Rule 12	Language of the International Application and Translation for the Purposes of International Search and International Publication	13 <sup>ter</sup> .1	Sequence Listing for International Authorities
	12.1 Languages Accepted for the Filing of International Applications	13 <sup>ter</sup> .2	Sequence Listing for Designated Office
	12.2 Language of Changes in the International Application		
	12.3 Translation for the Purposes of International Search	Rule 14	The Transmittal Fee
	12.4 Translation for the Purposes of International Publication	14.1	The Transmittal Fee
Rule 13	Unity of Invention	Rule 15	The International Filing Fee
	13.1 Requirement	15.1	The International Filing Fee
	13.2 Circumstances in Which the Requirement of Unity of Invention Is to Be Considered Fulfilled	15.2	Amount
		15.3	[Deleted]
		15.4	Time Limit for Payment; Amount Payable
		15.5	[Deleted]
		15.6	Refund
		Rule 16	The Search Fee
		16.1	Right to Ask for a Fee

PATENT COOPERATION TREATY

	16.2 Refund	Rule 21	Preparation of Copies
	16.3 Partial Refund		
Rule 16bis	Extension of Time Limits for Payment of Fees		21.1 Responsibility of the Receiving Office
	16 <sup>bis</sup> .1 Invitation by the Receiving Office	Rule 22	Transmittal of the Record Copy and Translation
	16 <sup>bis</sup> .2 Late Payment Fee		22.1 Procedure
Rule 17	The Priority Document		22.2 <i>[Deleted]</i>
	17.1 Obligation to Submit Copy of Earlier National or International Application		22.3 Time Limit Under Article 12(3)
	17.2 Availability of Copies	Rule 23	Transmittal of the Search Copy, Translation and Sequence Listing
Rule 18	The Applicant		23.1 Procedure
	18.1 Residence and Nationality	Rule 24	Receipt of the Record Copy by the International Bureau
	18.2 <i>[Deleted]</i>		
	18.3 Two or More Applicants		24.1 <i>[Deleted]</i>
	18.4 Information on Requirements Under National Law as to Applicants		24.2 Notification of Receipt of the Record Copy
Rule 19	The Competent Receiving Office	Rule 25	Receipt of the Search Copy by the International Searching Authority
	19.1 Where to File )		25.1( Notification of Receipt of the Search Copy
	19.2 Two or More Applicants )		
	19.3 Publication of Fact of) Delegation of Duties of Receiving Office )	Rule 26(	Checking by, and Correcting Before, the Receiving Office of Certain Elements of the International Application
	19.4 Transmittal to the International ) Bureau as Receiving Office )		
Rule 20(	Receipt of the International Application		26.1 Time Limit for Check
	20.1 Date and Number		26.2 Time Limit for Correction
	20.2 Receipt on Different Days		26.2 <sup>bis</sup> Checking of Requirements Under Article 14(1)(a)(i) and (ii)
	20.3 Corrected International Application		26.3 Checking of Physical Requirements Under Article 14(1)(a)(v)
	20.3 <sup>bis</sup> <i>[Deleted]</i>		26.3 <sup>bis</sup> Invitation Under Article 14(1)(b) to Correct Defects Under Rule 11
	20.4 Determination Under Article 11(1)		26.3 <sup>ter</sup> Invitation to Correct Defects Under Article 3(4)(i)
	20.5 Positive Determination )		
	20.6 Invitation to Correct )		26.4 Procedure
	20.7 Negative Determination )		26.5 Decision of the Receiving Office
	20.8 Error by the Receiving Office )		26.6 Missing Drawings
	20.9 Certified Copy for the Applicant		



MANUAL OF PATENT EXAMINING PROCEDURE

Rule 26bis	Correction or Addition of Priority Claim	Rule 33	Relevant Prior Art for the International Search
	26 <sup>bis</sup> .1 Correction or Addition of Priority Claim	33.1	Relevant Prior Art for the International Search
	26 <sup>bis</sup> .2 Invitation to Correct Defects in Priority Claims	33.2	Fields to Be Covered by the International Search
Rule 26ter	Correction or Addition of Declarations Under Rule 4.17	33.3	Orientation of the International Search
	26 <sup>ter</sup> .1 Correction or Addition of Declarations	Rule 34	Minimum Documentation
	26 <sup>ter</sup> .2 Processing of Declarations	34.1	Definition
Rule 27	Lack of Payment of Fees	Rule 35	The Competent International Searching Authority
	27.1 Fees	35.1	When Only One International Searching Authority Is Competent
Rule 28	Defects Noted by the International Bureau	35.2	When Several International Searching Authorities Are Competent
	28.1 Note on Certain Defects	35.3	When the International Bureau Is Receiving Office Under Rule 19.1(a)(iii)
Rule 29	International Applications Considered Withdrawn	Rule 36	Minimum Requirements for International Searching Authorities
	29.1 Finding by Receiving Office	36.1	Definition of Minimum Requirements
	29.2 <i>[Deleted]</i>	Rule 37	Missing or Defective Title
	29.3 Calling Certain Facts to the Attention of the Receiving Office	37.1	Lack of Title
	29.4 Notification of Intent to Make Declaration Under Article 14(4)	37.2	Establishment of Title
Rule 30	Time Limit Under Article 14(4)	Rule 38	Missing or Defective Abstract
	30.1 Time Limit	38.1	Lack of Abstract
Rule 31	Copies Required Under Article 13	38.2	Establishment of Abstract
	31.1 Request for Copies	Rule 39	Subject Matter Under Article 17(2)(a)(i)
	31.2 Preparation of Copies	39.1	Definition
Rule 32	Extension of Effects of International Application to Certain Successor States	Rule 40	Lack of Unity of Invention (International Search)
	32.1 Extension of International Application to Successor State	40.1	Invitation to Pay
	32.2 Effects of Extension to Successor State	40.2	Additional Fees
Rule 32bis	<i>[Deleted]</i>	40.3	Time Limit

PATENT COOPERATION TREATY

<p>Rule 41</p> <p>Earlier Search Other Than International Search</p> <p>41.1 Obligation to Use Results; Refund of Fee</p>	<p>Rule 44<sup>ter</sup></p> <p>Confidential Nature of Written Opinion, Report, Translation and Observations</p> <p>44<sup>ter</sup>.1 Confidential Nature</p>
<p>Rule 42</p> <p>Time Limit for International Search</p> <p>42.1( Time Limit for International Search )</p>	<p>Rule 45</p> <p>Translation of the International Search Report</p> <p>45.1( Languages</p>
<p>Rule 43</p> <p>The International Search Report</p> <p>43.1 Identifications (</p> <p>43.2 Dates</p> <p>43.3 Classification</p> <p>43.4 Language</p> <p>43.5 Citations )</p> <p>43.6 Fields Searched )</p> <p>43.7 Remarks Concerning Unity of Invention</p> <p>43.8 Authorized Officer</p> <p>43.9( Additional Matter</p> <p>43.10 Form</p>	<p>Rule 46(</p> <p>Amendment of Claims Before the International Bureau</p> <p>46.1 Time Limit</p> <p>46.2 Where to File</p> <p>46.3 Language of Amendments</p> <p>46.4 Statement</p> <p>46.5 Form of Amendments</p> <p>Rule 47</p> <p>Communication to Designated Offices</p> <p>47.1 Procedure</p> <p>47.2 Copies</p> <p>47.3 Languages</p> <p>47.4 Express Request Under Article 23(2) Prior to International Publication</p>
<p>Rule 43<sup>bis</sup></p> <p>Written Opinion of the International Searching Authority</p> <p>43<sup>bis</sup>.1 Written Opinion</p>	<p>Rule 48(</p> <p>International Publication</p> <p>48.1 Form</p> <p>48.2 Contents</p> <p>48.3 Languages of Publication</p> <p>48.4 Earlier Publication on the Applicant's Request</p> <p>48.5 Notification of National Publication</p> <p>48.6 Announcing of Certain Facts</p>
<p>Rule 44</p> <p>Transmittal of the International Search Report, Written Opinion, Etc.</p> <p>44.1 Copies of Report or Declaration and Written Opinion</p> <p>44.2 Title or Abstract</p> <p>44.3 Copies of Cited Documents (</p>	<p>Rule 49(</p> <p>Copy, Translation and Fee Under Article 22</p> <p>49.1( Notification</p> <p>49.2 Languages</p> <p>49.3 Statements Under Article 19; Indications Under Rule 13bis.4 Use of National Form</p> <p>49.4 Use of National Form</p> <p>49.5 Contents of and Physical Requirements for the Translation</p>
<p>Rule 44bis(</p> <p>International Preliminary Report on Patentability by the International Searching Authority</p> <p>44<sup>bis</sup>.1( Issuance of Report; Transmittal to the Applicant(</p> <p>44<sup>bis</sup>.2( Communication to Designated Offices</p> <p>44<sup>bis</sup>.3 Translation for Designated Offices</p> <p>44<sup>bis</sup>.4 Observations on the Translation</p>	<p>Rule 49(</p> <p>Copy, Translation and Fee Under Article 22</p> <p>49.1( Notification</p> <p>49.2 Languages</p> <p>49.3 Statements Under Article 19; Indications Under Rule 13bis.4 Use of National Form</p> <p>49.4 Use of National Form</p> <p>49.5 Contents of and Physical Requirements for the Translation</p>

MANUAL OF PATENT EXAMINING PROCEDURE

49.6	Reinstatement of Rights After Failure to Perform the Acts Referred to in Article 22	53.8	Signature
		53.9	Statement Concerning Amendments
Rule 49 <sup>bis</sup>	Indications as to Protection Sought for Purposes of National Processing	Rule 54	The Applicant Entitled to Make a Demand
49 <sup>bis</sup> .1	Choice of Certain Kinds of Protection	54.1	Residence and Nationality
49 <sup>bis</sup> .2	Time of Furnishing Indications	54.2	Right to Make a Demand
Rule 50	Faculty Under Article 22(3)	54.3	International Applications Filed with the International Bureau as Receiving Office
50.1	Exercise of Faculty	54.4	Applicant Not Entitled To Make a Demand
Rule 51	Review by Designated Offices	Rule 54bis	Time Limit for Making a Demand
51.1	Time Limit for Presenting the Request to Send Copies	54 <sup>bis</sup> .1	Time Limit for Making a Demand
51.2	Copy of the Notice	Rule 55	Languages (International Preliminary Examination)
51.3	Time Limit for Paying National Fee and Furnishing Translation	55.1	Language of Demand
Rule 51bis	Certain National Requirements Allowed Under Article 27(1), (2), (6) and (7)	55.2	Translation of International Application
51 <sup>bis</sup> .1	Certain National Requirements Allowed 66	55.3	Translation of Amendments
51 <sup>bis</sup> .2	Certain Circumstances in Which Documents or Evidence May Not Be Required	Rule 56	<i>[Deleted]</i>
51 <sup>bis</sup> .3	Opportunity to Comply with National Requirements	Rule 57	The Handling Fee
Rule 52	Amendment of the Claims, the Description, and the Drawings, Before Designated Offices	57.1	Requirement to Pay
52.1	Time Limit	57.2	Amount
		57.3	Time Limit for Payment; Amount Payable
		57.4	<i>[Deleted]</i>
		57.5	<i>[Deleted]</i>
		57.6	Refund
<b>Part C: Rules Concerning Chapter II of the Treaty</b>		Rule 58	The Preliminary Examination Fee
Rule 53	The Demand	58.1	Right to Ask for a Fee
53.1	Form	58.2	<i>[Deleted]</i>
53.2	Contents	58.3	Refund
53.3	The Petition	Rule 58bis	Extension of Time Limits for Payment of Fees
53.4	The Applicant	58 <sup>bis</sup> .1	Invitation by the International Preliminary Examining Authority
53.5	Agent or Common Representative	58 <sup>bis</sup> .2	Late Payment Fee
53.6	Identification of the International Application		
53.7	Election of States		

PATENT COOPERATION TREATY

Rule 59	The Competent International Preliminary Examining Authority	Rule 63	Minimum Requirements for International Preliminary Examining Authorities
59.1	Demands Under Article 31(2)(a)	63.1(	Definition of Minimum Requirements
59.2	Demands Under Article 31(2)(b)	Rule 64(	Prior Art for International Preliminary Examination
59.3	Transmittal of Demand to the Competent International Preliminary Examining Authority	64.1	Prior Art
		64.2	Non-Written Disclosures
		64.3	Certain Published Documents
Rule 60	Certain Defects in the Demand	Rule 65(	Inventive Step or Non-Obviousness
60.1	Defects in the Demand	65.1	Approach to Prior Art
60.2	<i>[Deleted]</i>	65.2	Relevant Date
Rule 61	Notification of the Demand and Elections	Rule 66(	Procedure Before the International Preliminary Examining Authority
61.1	Notification to the International Bureau and the Applicant	66.1	Basis of the International Preliminary Examination
61.2	Notification to the Elected Offices	66.1 <sup>bis</sup>	Written Opinion of the International Searching Authority
61.3	Information for the Applicant	66.2(	Written Opinion of the International Preliminary Examining Authority
61.4	Publication in the Gazette	66.3	Formal Response to the International Preliminary Examining Authority
Rule 62	Copy of the Written Opinion by the International Searching Authority and of Amendments Under Article 19 for the International Preliminary Examining Authority	66.4(	Additional Opportunity for Submitting Amendments or Arguments
62.1	Copy of Written Opinion by International Searching Authority and of Amendments Made Before the Demand Is Filed	66.4 <sup>bis</sup>	Consideration of Amendments and Arguments
62.2	Amendments Made After the Demand Is Filed	66.5	Amendment
		66.6	Informal Communications with the Applicant
		66.7 (	Copy and Translation of Earlier Application Whose Priority is Claimed
		66.8	Form of Amendments
		66.9	Language of Amendments
Rule 62 <sup>bis</sup>	Translation for the International Preliminary Examining Authority of the Written Opinion of the International Searching Authority	Rule 67(	Subject Matter Under Article 34(4)(a)(i)
62 <sup>bis</sup> .1	Translation and Observations	67.1(	Definition
		Rule 68(	Lack of Unity of Invention (International Preliminary Examination)

MANUAL OF PATENT EXAMINING PROCEDURE

	68.1	No Invitation to Restrict or Pay	Rule 72	Translation of the International Preliminary Examination Report and of the Written Opinion of the International Searching Authority
	68.2	Invitation to Restrict or Pay		
	68.3	Additional Fees		
	68.4(	Procedure in the Case of) Insufficient Restriction of) the Claims		72.1( Languages
	68.5(	Main Invention		72.2( Copy of Translation for the Applicant
Rule 69(		Start of and Time Limit for International Preliminary Examination		72.2 <sup>bis</sup> Translation of the Written Opinion of the International Searching Authority Established Under Rule 43 <sup>bis</sup> .1
	69.1(	Start of International Preliminary Examination		72.3 Observations on the Translation
	69.2	Time Limit for International Preliminary Examination	Rule 73	Communication of the International Preliminary Examination Report or the Written Opinion of the International Searching Authority
Rule 70		International Preliminary Report on Patentability by the International Preliminary Examining Authority (International Preliminary Examination Report)		73.1 Preparation of Copies
	70.1	Definition )		73.2( Communication to Elected Offices
	70.2	Basis of the Report )	Rule 74)	Translations of Annexes of the International Preliminary Examination Report and Transmittal Thereof
	70.3	Identifications		
	70.4(	Dates		74.1 Contents of Translation and Time Limit for Transmittal Thereof
	70.5	Classification	Rule 75	<i>[Deleted]</i>
	70.6	Statement Under Article 35(2)	Rule 76(	Copy, Translation and Fee Under Article 39(1); Translation of Priority Document
	70.7	Citations Under Article 35(2)		
	70.8	Explanations Under Article 35(2)		76.1, 76.2 and 76.3 <i>[Deleted]</i>
	70.9	Non-Written Disclosures )		76.4 Time Limit for Translation of Priority Document
	70.10	Certain Published Documents )		76.5 Application of Rules 22.1(g), 47.1, 49, 49 <sup>bis</sup> and 51 <sup>bis</sup>
	70.11	Mention of Amendments )		76.6 <i>[Deleted]</i>
	70.12	Mention of Certain Defects and ) Other Matters )	Rule 77(	Faculty Under Article 39(1)(b)
	70.13	Remarks Concerning Unity of ) Invention )		
	70.14	Authorized Officer )		77.1( Exercise of Faculty
	70.15	Form; Title )	Rule 78(	Amendment of the Claims, the Description, and the Drawings, Before Elected Offices
	70.16	Annexes to the Report		
	70.17(	Languages of the Report and ) the Annexes )		
Rule 71(		Transmittal of the International Preliminary Examination Report		
	71.1	Recipients )		
	71.2	Copies of Cited Documents )		

PATENT COOPERATION TREATY

- 78.1 Time Limit (
- 78.2 *[Deleted]*
- 78.3 Utility Models

- 83.1 Proof of Right
- 83.1<sup>bis</sup> Where the International Bureau Is the Receiving Office
- 83.2 Information

**Part D: Rules Concerning Chapter III of the Treaty**

- Rule 79 Calendar )
  - 79.1 Expressing Dates)
- Rule 80 Computation of Time Limits
  - 80.1( Periods Expressed in Years
  - 80.2 Periods Expressed in Months
  - 80.3 Periods Expressed in Days
  - 80.4( Local Dates
  - 80.5( Expiration on a Non-Working ) Day or Official Holiday )
  - 80.6( Date of Documents
  - 80.7( End of Working Day
- Rule 81 Modification of Time Limits Fixed in the Treaty
  - 81.1( Proposal
  - 81.2 Decision by the Assembly
  - 81.3 Voting by Correspondence
- Rule 82 Irregularities in the Mail Service
  - 82.1 Delay or Loss in Mail
  - 82.2 Interruption in the Mail Service
- Rule 82bis Excuse by the Designated or Elected State of Delays in Meeting Certain Time Limits (
  - 82<sup>bis</sup>.1( Meaning of "Time Limit" in Article 48(2)
  - 82<sup>bis</sup>.2( Reinstatement of Rights and Other Provisions to Which Article 48(2) Applies
- Rule 82ter Rectification of Errors Made by the Receiving Office or by the International Bureau
  - 82<sup>ter</sup>.1( Errors Concerning the International Filing Date and the Priority Claim
- Rule 83 Right to Practice Before International ) Authorities )

**Part E: Rules Concerning Chapter V of the Treaty**

- Rule 84 Expenses of Delegations )
  - 84.1 Expenses Borne by) Governments )
- Rule 85 Absence of Quorum in the Assembly
  - 85.1 Voting by Correspondence
- Rule 86 The Gazette
  - 86.1( Contents and Form
  - 86.2( Languages; Access to the Gazette
  - 86.3 Frequency
  - 86.4( Sale
  - 86.5 Title
  - 86.6 Further Details
- Rule 87 Copies of Publications
  - 87.1( International Searching and Preliminary Examining Authorities
  - 87.2 National Offices
- Rule 88 Amendment of the Regulations
  - 88.1 Requirement of Unanimity
  - 88.2 *[Deleted]*
  - 88.3 Requirement of Absence of Opposition by Certain States
  - 88.4 Procedure
- Rule 89 Administrative Instructions 0
  - 89.1 Scope
  - 89.2 Source
  - 89.3 Publication and Entry into Force

**Part F: Rules Concerning Several Chapters of the Treaty**

- Rule 89<sup>bis</sup> Filing, Processing and Communication of International Applications and Other Documents in Electronic Form or by Electronic Means

MANUAL OF PATENT EXAMINING PROCEDURE

	89 <sup>bis</sup> .1 International Applications		92.3 Mailings by National Offices and Intergovernmental Organizations
	89 <sup>bis</sup> .2( Other Documents		
	89 <sup>bis</sup> .3 Communication Between Offices		92.4 Reproductions
Rule 89 <sup>ter</sup>	Copies in Electronic Form of Documents Filed on Paper	Rule 92bis	Recording of Changes in Certain Indications in the Request or the Demand
	89 <sup>ter</sup> .1( Copies in Electronic for of Documents Filed on Paper		92 <sup>bis</sup> .1 Recording of Changes by the International Bureau
Rule 90	Agents and Common Representatives	Rule 93	Keeping of Records and Files
	90.1 Appointment as Agent		93.1 The Receiving Office
	90.2 Common Representative		93.2 The International Bureau
	90.3 Effects of Acts by or in Relation to Agents and Common Representatives		93.3 The International Searching and Preliminary Examining Authorities
	90.4 Manner of Appointment of Agent or Common Representative		93.4 Reproductions
	90.5 General Power of Attorney	Rule 93 <sup>bis</sup>	Manner of Communication of Documents
	90.6 Revocation and Renunciation		93 <sup>bis</sup> .1 Communication on Request; Communication via Digital Library
Rule 90bis	Withdrawals		
	90 <sup>bis</sup> .1 Withdrawal of the International Application	Rule 94	Access to Files
	90 <sup>bis</sup> .2 Withdrawal of Designations		94.1 Access to the File Held by the International Bureau
	90 <sup>bis</sup> .3 Withdrawal of Priority Claims		94.2 Access to the File Held by the International Preliminary Examining Authority
	90 <sup>bis</sup> .4 Withdrawal of the Demand, or of Elections		94.3 Access to the File Held by the Elected Office
	90 <sup>bis</sup> .5 Signature		
	90 <sup>bis</sup> .6 Effect of Withdrawal	Rule 95	Availability of Translations
	90 <sup>bis</sup> .7 Faculty Under Article 37(4)(b)		95.1 Furnishing of Copies of Translations
Rule 91	Obvious Errors in Documents		
	91.1 Rectification	Rule 96	The Schedule of Fees
Rule 92	Correspondence		96.1 Schedule of Fees Annexed to Regulations
	92.1 Need for Letter and for Signature		
	92.2 Languages		<i>Schedule of Fees</i>

**PART A****Introductory Rules****Rule 1****Abbreviated Expressions**1.1 *Meaning of Abbreviated Expressions*

(a) In these Regulations, the word “Treaty” means the Patent Cooperation Treaty.

(b) In these Regulations, the words “Chapter” and “Article” refer to the specified Chapter or Article of the Treaty.

**Rule 2****Interpretation of Certain Words**2.1 *“Applicant”*

Whenever the word “applicant” is used, it shall be construed as meaning also the agent or other representative of the applicant, except where the contrary clearly follows from the wording or the nature of the provision, or the context in which the word is used, such as, in particular, where the provision refers to the residence or nationality of the applicant.

2.2 *“Agent”*

Whenever the word “agent” is used, it shall be construed as meaning an agent appointed under Rule 90.1, unless the contrary clearly follows from the wording or the nature of the provision, or the context in which the word is used.

2.2<sup>bis</sup> *“Common Representative”*

Whenever the expression “common representative” is used, it shall be construed as meaning an applicant appointed as, or considered to be, the common representative under Rule 90.2.

2.3 *“Signature”*

Whenever the word “signature” is used, it shall be understood that, if the national law applied by the receiving Office or the competent International Searching or Preliminary Examining Authority requires the use of a seal instead of a signature, the word, for the purposes of that Office or Authority, shall mean seal.

**PART B****Rules Concerning Chapter I of the Treaty****Rule 3****The Request (Form)**3.1 *Form of Request*

The request shall be made on a printed form or be presented as a computer print-out.

3.2 *Availability of Forms*

Copies of the printed form shall be furnished free of charge to the applicants by the receiving Office, or, if the receiving Office so desires, by the International Bureau.

3.3 *Check List*

(a) The request shall contain a list indicating:

(i) the total number of sheets constituting the international application and the number of the sheets of each element of the international application: request, description (separately indicating the number of sheets of any sequence listing part of the description), claims, drawings, abstract;

(ii) where applicable, that the international application as filed is accompanied by a power of attorney (i.e., a document appointing an agent or a common representative), a copy of a general power of attorney, a priority document, a sequence listing in computer readable form, a document relating to the payment of fees, or any other document (to be specified in the check list);

(iii) the number of that figure of the drawings which the applicant suggests should accompany the abstract when the abstract is published; in exceptional cases, the applicant may suggest more than one figure.

(b) The list shall be completed by the applicant, failing which the receiving Office shall make the necessary indications, except that the number referred to in paragraph (a)(iii) shall not be indicated by the receiving Office.

3.4 *Particulars*

Subject to Rule 3.3, particulars of the printed request form and of a request presented as a computer printout shall be prescribed by the Administrative Instructions.



**Rule 4**

**The Request (Contents)**

4.1 *Mandatory and Optional Contents; Signature*

(a) The request shall contain:

- (i) a petition,
- (ii) the title of the invention,

(iii) indications concerning the applicant and the agent, if there is an agent,

(iv) indications concerning the inventor where the national law of at least one of the designated States requires that the name of the inventor be furnished at the time of filing a national application.

(b) The request shall, where applicable, contain:

- (i) a priority claim,
- (ii) a reference to any earlier international, international-type or other search,
- (iii) a reference to a parent application or parent patent,
- (iv) an indication of the applicant's choice of competent International Searching Authority.

(c) The request may contain:

(i) indications concerning the inventor where the national law of none of the designated States requires that the name of the inventor be furnished at the time of filing a national application,

(ii) a request to the receiving Office to prepare and transmit the priority document to the International Bureau where the application whose priority is claimed was filed with the national Office or intergovernmental authority which is the receiving Office,

(iii) declarations as provided in Rule 4.17.

(d) The request shall be signed.

4.2 *The Petition*

The petition shall be to the following effect and shall preferably be worded as follows: "The undersigned requests that the present international application be processed according to the Patent Cooperation Treaty."

4.3 *Title of the Invention*

The title of the invention shall be short (preferably from two to seven words when in English or translated into English) and precise.

4.4 *Names and Addresses*

(a) Names of natural persons shall be indicated by the person's family name and given name(s), the family name being indicated before the given name(s).

(b) Names of legal entities shall be indicated by their full, official designations.

(c) Addresses shall be indicated in such a way as to satisfy the customary requirements for prompt postal delivery at the indicated address and, in any case, shall consist of all the relevant administrative units up to, and including, the house number, if any. Where the national law of the designated State does not require the indication of the house number, failure to indicate such number shall have no effect in that State. In order to allow rapid communication with the applicant, it is recommended to indicate any teleprinter address, telephone and facsimile machine numbers, or corresponding data for other like means of communication, of the applicant or, where applicable, the agent or the common representative.

(d) For each applicant, inventor, or agent, only one address may be indicated, except that, if no agent has been appointed to represent the applicant, or all of them if more than one, the applicant or, if there is more than one applicant, the common representative, may indicate, in addition to any other address given in the request, an address to which notifications shall be sent.

4.5 *The Applicant*

(a) The request shall indicate:

- (i) the name,
- (ii) the address, and
- (iii) the nationality and residence

of the applicant or, if there are several applicants, of each of them.

(b) The applicant's nationality shall be indicated by the name of the State of which he is a national.

(c) The applicant's residence shall be indicated by the name of the State of which he is a resident.

(d) The request may, for different designated States, indicate different applicants. In such a case, the

request shall indicate the applicant or applicants for each designated State or group of designated States.

(e) Where the applicant is registered with the national Office that is acting as receiving Office, the request may indicate the number or other indication under which the applicant is so registered.

#### 4.6 *The Inventor*

(a) Where Rule 4.1(a)(v) or (c)(i) applies, the request shall indicate the name and address of the inventor or, if there are several inventors, of each of them.

(b) If the applicant is the inventor, the request, in lieu of the indication under paragraph (a), shall contain a statement to that effect.

(c) The request may, for different designated States, indicate different persons as inventors where, in this respect, the requirements of the national laws of the designated States are not the same. In such a case, the request shall contain a separate statement for each designated State or group of States in which a particular person, or the same person, is to be considered the inventor, or in which particular persons, or the same persons, are to be considered the inventors.

#### 4.7 *The Agent*

(a) If an agent is appointed, the request shall so indicate, and shall state the agent's name and address.

(b) Where the agent is registered with national Office that is acting as receiving Office, the request may indicate the number or other indication under which the agent is so registered.

#### 4.8 *Common Representative*

If a common representative is appointed, the request shall so indicate.

#### 4.9 *Designation of States; Kinds of Protection; National and Regional Patents*

(a) The filing of a request shall constitute:

(i) the designation of all Contracting States that are bound by the Treaty on the international filing date;

(ii) an indication that the international application is, in respect of each designated State to which Article 43 or 44 applies, for the grant of every kind of protection which is available by way of the designation of that State;

(iii) an indication that the international application is, in respect of each designated State to which

Article 45(1) applies, for the grant of a regional patent and also, unless Article 45(2) applies, a national patent.

(b) Notwithstanding paragraph (a)(i), if, on October 1, 2002, the national law of a Contracting State provides that the filing of an international application which contains the designation of that State and claims the priority of an earlier national application having effect in that State shall have the result that the earlier national application ceases to have effect with the same consequences as the withdrawal of the earlier national application, any request may, for as long as that national law continues to so provide, contain an indication that the designation of that State is not made, provided that the designated Office informs the International Bureau by January 1, 2003, that this paragraph shall apply in respect of designations of that State. The information received shall be promptly published by the International Bureau in the Gazette.

(c) *[Deleted]*

#### 4.10 *Priority Claim*

(a) Any declaration referred to in Article 8(1) ("priority claim") may claim the priority of one or more earlier applications filed either in or for any country party to the Paris Convention for the Protection of Industrial Property or in or for any Member of the World Trade Organization that is not party to that Convention. Any priority claim shall, subject to Rule 26<sup>bis</sup>.1, be made in the request; it shall consist of a statement to the effect that the priority of an earlier application is claimed and shall indicate:

(i) the date on which the earlier application was filed, being a date falling within the period of 12 months preceding the international filing date;

(ii) the number of the earlier application;

(iii) where the earlier application is a national application, the country party to the Paris Convention for the Protection of Industrial Property or the Member of the World Trade Organization that is not party to that Convention in which it was filed;

(iv) where the earlier application is a regional application, the authority entrusted with the granting of regional patents under the applicable regional patent treaty;

(v) where the earlier application is an international application, the receiving Office with which it was filed.

(b) In addition to any indication required under paragraph (a)(iv) or (v):

(i) where the earlier application is a regional application or an international application, the priority claim may indicate one or more countries party to the Paris Convention for the Protection of Industrial Property for which that earlier application was filed;

(ii) where the earlier application is a regional application and at least one of the countries party to the regional patent treaty is neither party to the Paris Convention for the Protection of Industrial Property nor a Member of the World Trade Organization, the priority claim shall indicate at least one country party to that Convention or one Member of the Organization for which that earlier application was filed.

(c) For the purposes of paragraphs (a) and (b), Article 2(vi) shall not apply.

(d) If, on September 29, 1999, paragraphs (a) and (b) as amended with effect from January 1, 2000, are not compatible with the national law applied by a designated Office, those paragraphs as in force until December 31, 1999, shall continue to apply after that date in respect of that designated Office for as long as the said paragraphs as amended continue not to be compatible with that law, provided that the said Office informs the International Bureau accordingly by October 31, 1999. The information received shall be promptly published by the International Bureau in the Gazette.

#### 4.11 *Reference to Earlier Search, Continuation or Continuation-in-Part, or Parent Application or Grant*

(a) If:

(i) an international or international-type search has been requested on an application under Article 15(5);

(ii) the applicant wishes the International Searching Authority to base the international search report wholly or in part on the results of a search, other than an international or international-type search, made by the national Office or intergovernmental organization which is the International Searching Authority competent for the international application;

(iii) the applicant intends to make an indication under Rule 49<sup>bis</sup>.1(a) or (b) of the wish that the international application be treated, in any designated State, as an application for a patent of addition, certificate of addition, inventor's certificate of addition or utility certificate of addition; or

(iv) the applicant intends to make an indication under Rule 49<sup>bis</sup>.1(d) of the wish that the international application be treated, in any designated State, as an application for a continuation or a continuation-in-part of an earlier application;

the request shall so indicate and shall, as the case may be, identify the application in respect of which the earlier search was made or otherwise identify the search, or indicate the relevant parent application or parent patent or other parent grant.

(b) The inclusion in the request of an indication under paragraph (a)(iii) or (iv) shall have no effect on the operation of Rule 4.9.

4.12 *[Deleted]*

4.13 *[Deleted]*

4.14 *[Deleted]*

#### 4.14<sup>bis</sup> *Choice of International Searching Authority*

If two or more International Searching Authorities are competent for the searching of the international application, the applicant shall indicate his choice of International Searching Authority in the request.

#### 4.15 *Signature*

(a) Subject to paragraph (b), the request shall be signed by the applicant or, if there is more than one applicant, by all of them.

(b) Where two or more applicants file an international application which designates a State whose national law requires that national applications be filed by the inventor and where an applicant for that designated State who is an inventor refused to sign the request or could not be found or reached after diligent effort, the request need not be signed by that applicant if it is signed by at least one applicant and a statement is furnished explaining, to the satisfaction of the receiving Office, the lack of the signature concerned.

#### 4.16 *Transliteration or Translation of Certain Words*

(a) Where any name or address is written in characters other than those of the Latin alphabet, the same shall also be indicated in characters of the Latin alphabet either as a mere transliteration or through translation into English. The applicant shall decide which words will be merely transliterated and which words will be so translated.

(b) The name of any country written in characters other than those of the Latin alphabet shall also be indicated in English.

#### 4.17 *Declarations Relating to National Requirements Referred to in Rule 51<sup>bis</sup>.1(a)(i) to (v)*

The request may, for the purposes of the national law applicable in one or more designated States, contain one or more of the following declarations, worded as prescribed by the Administrative Instructions:

(i) a declaration as to the identity of the inventor, as referred to in Rule 51<sup>bis</sup>.1(a)(i);

(ii) a declaration as to the applicant's entitlement, as at the international filing date, to apply for and be granted a patent, as referred to in Rule 51<sup>bis</sup>.1(a)(ii);

(iii) a declaration as to the applicant's entitlement, as at the international filing date, to claim priority of the earlier application, as referred to in Rule 51<sup>bis</sup>.1(a)(iii);

(iv) a declaration of inventorship, as referred to in Rule 51<sup>bis</sup>.1(a)(iv), which shall be signed as prescribed by the Administrative Instructions;

(v) a declaration as to non-prejudicial disclosures or exceptions to lack of novelty, as referred to in Rule 51<sup>bis</sup>.1(a)(v).

#### 4.18 *Additional Matter*

(a) The request shall contain no matter other than that specified in Rules 4.1 to 4.17, provided that the Administrative Instructions may permit, but cannot make mandatory, the inclusion in the request of any additional matter specified in the Administrative Instructions.

(b) If the request contains matter other than that specified in Rules 4.1 to 4.17 or permitted under paragraph (a) by the Administrative Instructions, the receiving Office shall *ex officio* delete the additional matter.

## Rule 5

### The Description

#### 5.1 *Manner of the Description*

(a) The description shall first state the title of the invention as appearing in the request and shall:

(i) specify the technical field to which the invention relates;

(ii) indicate the background art which, as far as known to the applicant, can be regarded as useful for the understanding, searching and examination of the invention, and, preferably, cite the documents reflecting such art;

(iii) disclose the invention, as claimed, in such terms that the technical problem (even if not expressly stated as such) and its solution can be understood, and state the advantageous effects, if any, of the invention with reference to the background art;

(iv) briefly describe the figures in the drawings, if any;

(v) set forth at least the best mode contemplated by the applicant for carrying out the invention claimed; this shall be done in terms of examples, where appropriate, and with reference to the drawings, if any; where the national law of the designated State does not require the description of the best mode but is satisfied with the description of any mode (whether it is the best contemplated or not), failure to describe the best mode contemplated shall have no effect in that State;

(vi) indicate explicitly, when it is not obvious from the description or nature of the invention, the way in which the invention is capable of exploitation in industry and the way in which it can be made and used, or, if it can only be used, the way in which it can be used; the term "industry" is to be understood in its broadest sense as in the Paris Convention for the Protection of Industrial Property.

(b) The manner and order specified in paragraph (a) shall be followed except when, because of the nature of the invention, a different manner or a different order would result in a better understanding and a more economic presentation.

(c) Subject to the provisions of paragraph (b), each of the parts referred to in paragraph (a) shall preferably be preceded by an appropriate heading as suggested in the Administrative Instructions.

5.2 *Nucleotide and/or Amino Acid Sequence Disclosure*

(a) Where the international application contains disclosure of one or more nucleotide and/or amino acid sequences, the description shall contain a sequence listing complying with the standard provided for in the Administrative Instructions and presented as a separate part of the description in accordance with that standard.

(b) Where the sequence listing part of the description contains any free text as defined in the standard provided for in the Administrative Instructions, that free text shall also appear in the main part of the description in the language thereof.

**Rule 6**

**The Claims**

6.1 *Number and Numbering of Claims*

(a) The number of the claims shall be reasonable in consideration of the nature of the invention claimed.

(b) If there are several claims, they shall be numbered consecutively in Arabic numerals.

(c) The method of numbering in the case of the amendment of claims shall be governed by the Administrative Instructions.

6.2 *References to Other Parts of the International Application*

(a) Claims shall not, except where absolutely necessary, rely, in respect of the technical features of the invention, on references to the description or drawings. In particular, they shall not rely on such references as: “as described in part ... of the description,” or “as illustrated in figure ... of the drawings.”

(b) Where the international application contains drawings, the technical features mentioned in the claims shall preferably be followed by the reference signs relating to such features. When used, the reference signs shall preferably be placed between parentheses. If inclusion of reference signs does not particularly facilitate quicker understanding of a claim, it should not be made. Reference signs may be removed by a designated Office for the purposes of publication by such Office.

6.3 *Manner of Claiming*

(a) The definition of the matter for which protection is sought shall be in terms of the technical features of the invention.

(b) Whenever appropriate, claims shall contain:

(i) a statement indicating those technical features of the invention which are necessary for the definition of the claimed subject matter but which, in combination, are part of the prior art,

(ii) a characterizing portion — preceded by the words “characterized in that,” “characterized by,” “wherein the improvement comprises,” or any other words to the same effect — stating concisely the technical features which, in combination with the features stated under (i), it is desired to protect.

(c) Where the national law of the designated State does not require the manner of claiming provided for in paragraph (b), failure to use that manner of claiming shall have no effect in that State provided the manner of claiming actually used satisfies the national law of that State.

6.4 *Dependent Claims*

(a) Any claim which includes all the features of one or more other claims (claim in dependent form, hereinafter referred to as “dependent claim”) shall do so by a reference, if possible at the beginning, to the other claim or claims and shall then state the additional features claimed. Any dependent claim which refers to more than one other claim (“multiple dependent claim”) shall refer to such claims in the alternative only. Multiple dependent claims shall not serve as a basis for any other multiple dependent claim. Where the national law of the national Office acting as International Searching Authority does not allow multiple dependent claims to be drafted in a manner different from that provided for in the preceding two sentences, failure to use that manner of claiming may result in an indication under Article 17(2)(b) in the international search report. Failure to use the said manner of claiming shall have no effect in a designated State if the manner of claiming actually used satisfies the national law of that State.

(b) Any dependent claim shall be construed as including all the limitations contained in the claim to which it refers or, if the dependent claim is a multiple dependent claim, all the limitations contained in the particular claim in relation to which it is considered.

(c) All dependent claims referring back to a single previous claim, and all dependent claims referring back to several previous claims, shall be grouped together to the extent and in the most practical way possible.

#### 6.5 *Utility Models*

Any designated State in which the grant of a utility model is sought on the basis of an international application may, instead of Rules 6.1 to 6.4, apply in respect of the matters regulated in those Rules the provisions of its national law concerning utility models once the processing of the international application has started in that State, provided that the applicant shall be allowed at least two months from the expiration of the time limit applicable under Article 22 to adapt his application to the requirements of the said provisions of the national law.

### **Rule 7**

#### **The Drawings**

##### 7.1 *Flow Sheets and Diagrams*

Flowsheets and diagrams are considered drawings.

##### 7.2 *Time Limit*

The time limit referred to in Article 7(2)(ii) shall be reasonable under the circumstances of the case and shall, in no case, be shorter than two months from the date of the written invitation requiring the filing of drawings or additional drawings under the said provision.

### **Rule 8**

#### **The Abstract**

##### 8.1 *Contents and Form of the Abstract*

(a) The abstract shall consist of the following:

(i) a summary of the disclosure as contained in the description, the claims, and any drawings; the summary shall indicate the technical field to which the invention pertains and shall be drafted in a way which allows the clear understanding of the technical problem, the gist of the solution of that problem through the invention, and the principal use or uses of the invention;

(ii) where applicable, the chemical formula which, among all the formulae contained in the international application, best characterizes the invention.

(b) The abstract shall be as concise as the disclosure permits (preferably 50 to 150 words if it is in English or when translated into English).

(c) The abstract shall not contain statements on the alleged merits or value of the claimed invention or on its speculative application.

(d) Each main technical feature mentioned in the abstract and illustrated by a drawing in the international application shall be followed by a reference sign, placed between parentheses.

#### 8.2 *Figure*

(a) If the applicant fails to make the indication referred to in Rule 3.3(a)(iii), or if the International Searching Authority finds that a figure or figures other than that figure or those figures suggested by the applicant would, among all the figures of all the drawings, better characterize the invention, it shall, subject to paragraph (b), indicate the figure or figures which should accompany the abstract when the latter is published by the International Bureau. In such case, the abstract shall be accompanied by the figure or figures so indicated by the International Searching Authority. Otherwise, the abstract shall, subject to paragraph (b), be accompanied by the figure or figures suggested by the applicant.

(b) If the International Searching Authority finds that none of the figures of the drawings is useful for the understanding of the abstract, it shall notify the International Bureau accordingly. In such case, the abstract, when published by the International Bureau, shall not be accompanied by any figure of the drawings even where the applicant has made a suggestion under Rule 3.3(a)(iii).

#### 8.3 *Guiding Principles in Drafting*

The abstract shall be so drafted that it can efficiently serve as a scanning tool for purposes of searching in the particular art, especially by assisting the scientist, engineer or researcher in formulating an opinion on whether there is a need for consulting the international application itself.

### **Rule 9**

#### **Expressions, Etc., Not To Be Used**

##### 9.1 *Definition*

The international application shall not contain:

- (i) expressions or drawings contrary to morality;
- (ii) expressions or drawings contrary to public order;
- (iii) statements disparaging the products or processes of any particular person other than the applicant, or the merits or validity of applications or patents of any such person (mere comparisons with the prior art shall not be considered disparaging, *per se*);
- (iv) any statement or other matter obviously irrelevant or unnecessary under the circumstances.

### 9.2 *Noting of Lack of Compliance*

The receiving Office and the International Searching Authority may note lack of compliance with the prescriptions of Rule 9.1 and may suggest to the applicant that he voluntarily correct his international application accordingly. If the lack of compliance was noted by the receiving Office, that Office shall inform the competent International Searching Authority and the International Bureau; if the lack of compliance was noted by the International Searching Authority, that Authority shall inform the receiving Office and the International Bureau.

### 9.3 *Reference to Article 21(6)*

“Disparaging statements,” referred to in Article 21(6), shall have the meaning as defined in Rule 9.1(iii).

## **Rule 10**

### **Terminology and Signs**

#### 10.1 *Terminology and Signs*

- (a) Units of weights and measures shall be expressed in terms of the metric system, or also expressed in such terms if first expressed in terms of a different system.
- (b) Temperatures shall be expressed in degrees Celsius, or also expressed in degrees Celsius, if first expressed in a different manner.
- (c) *[Deleted]*
- (d) For indications of heat, energy, light, sound, and magnetism, as well as for mathematical formulae and electrical units, the rules of international practice shall be observed; for chemical formulae, the symbols, atomic weights, and molecular formulae, in general use, shall be employed.

(e) In general, only such technical terms, signs, and symbols should be used as are generally accepted in the art.

(f) When the international application or its translation is in Chinese, English, or Japanese, the beginning of any decimal shall be marked by a period, whereas, when the international application or its translation is in a language other than Chinese, English, or Japanese, it shall be marked by a comma.

### 10.2 *Consistency*

The terminology and the signs shall be consistent throughout the international application.

## **Rule 11**

### **Physical Requirements of the International Application**

#### 11.1 *Number of Copies*

(a) Subject to the provisions of paragraph (b), the international application and each of the documents referred to in the check list (Rule 3.3(a)(ii)) shall be filed in one copy.

(b) Any receiving Office may require that the international application and any of the documents referred to in the check list (Rule 3.3(a)(ii)), except the receipt for the fees paid or the check for the payment of the fees, be filed in two or three copies. In that case, the receiving Office shall be responsible for verifying the identity of the second and the third copies with the record copy.

#### 11.2 *Fitness for Reproduction*

(a) All elements of the international application (i.e., the request, the description, the claims, the drawings, and the abstract) shall be so presented as to admit of direct reproduction by photography, electrostatic processes, photo offset, and microfilming, in any number of copies.

(b) All sheets shall be free from creases and cracks; they shall not be folded.

(c) Only one side of each sheet shall be used.

(d) Subject to Rule 11.10(d) and Rule 11.13(j), each sheet shall be used in an upright position (i.e., the short sides at the top and bottom).

#### 11.3 *Material to Be Used*

All elements of the international application shall be on paper which shall be flexible, strong, white, smooth, non-shiny, and durable.

#### 11.4 *Separate Sheets, Etc.*

(a) Each element (request, description, claims, drawings, abstract) of the international application shall commence on a new sheet.

(b) All sheets of the international application shall be so connected that they can be easily turned when consulted, and easily separated and joined again if they have been separated for reproduction purposes.

#### 11.5 *Size of Sheets*

The size of the sheets shall be A4 (29.7 cm x 21 cm). However, any receiving Office may accept international applications on sheets of other sizes provided that the record copy, as transmitted to the International Bureau, and, if the competent International Searching Authority so desires, the search copy, shall be of A4 size.

#### 11.6 *Margins*

(a) The minimum margins of the sheets containing the description, the claims, and the abstract, shall be as follows:

- top: 2 cm
- left side: 2.5 cm
- right side: 2 cm
- bottom: 2 cm

(b) The recommended maximum, for the margins provided for in paragraph (a), is as follows:

- top: 4 cm
- left side: 4 cm
- right side: 3 cm
- bottom: 3 cm

(c) On sheets containing drawings, the surface usable shall not exceed 26.2 cm x 17.0 cm. The sheets shall not contain frames around the usable or used surface. The minimum margins shall be as follows:

- top: 2.5 cm
- left side: 2.5 cm
- right side: 1.5 cm
- bottom: 1.0 cm

(d) The margins referred to in paragraphs (a) to (c) apply to A4-size sheets, so that, even if the receiving Office accepts other sizes, the A4-size record copy and, when so required, the A4-size search copy shall leave the aforesaid margins.

(e) Subject to paragraph (f) and to Rule 11.8(b), the margins of the international application, when submitted, must be completely blank.

(f) The top margin may contain in the left-hand corner an indication of the applicant's file reference, provided that the reference appears within 1.5 cm from the top of the sheet. The number of characters in the applicant's file reference shall not exceed the maximum fixed by the Administrative Instructions.

#### 11.7 *Numbering of Sheets*

(a) All the sheets contained in the international application shall be numbered in consecutive Arabic numerals.

(b) The numbers shall be centered at the top or bottom of the sheet, but shall not be placed in the margin.

#### 11.8 *Numbering of Lines*

(a) It is strongly recommended to number every fifth line of each sheet of the description, and of each sheet of claims.

(b) The numbers should appear in the right half of the left margin.

#### 11.9 *Writing of Text Matter*

(a) The request, the description, the claims and the abstract shall be typed or printed.

(b) Only graphic symbols and characters, chemical or mathematical formulae, and certain characters in the Chinese or Japanese languages may, when necessary, be written by hand or drawn.

(c) The typing shall be 1 1/2-spaced.

(d) All text matter shall be in characters the capital letters of which are not less than 0.21 cm high, and shall be in a dark, indelible color, satisfying the requirements specified in Rule 11.2.

(e) As far as the spacing of the typing and the size of the characters are concerned, paragraphs (c) and (d) shall not apply to texts in the Chinese or Japanese languages.

#### 11.10 *Drawings, Formulae, and Tables, in Text Matter*

(a) The request, the description, the claims and the abstract shall not contain drawings.

(b) The description, the claims and the abstract may contain chemical or mathematical formulae.

(c) The description and the abstract may contain tables; any claim may contain tables only if the subject matter of the claim makes the use of tables desirable.



(d) Tables and chemical or mathematical formulae may be placed sideways on the sheet if they cannot be presented satisfactorily in an upright position thereon; sheets on which tables or chemical or mathematical formulae are presented sideways shall be so presented that the tops of the tables or formulae are at the left side of the sheet.

#### 11.11 *Words in Drawings*

(a) The drawings shall not contain text matter, except a single word or words, when absolutely indispensable, such as “water,” “steam,” “open,” “closed,” “section on AB,” and, in the case of electric circuits and block schematic or flow sheet diagrams, a few short catchwords indispensable for understanding.

(b) Any words used shall be so placed that, if translated, they may be pasted over without interfering with any lines of the drawings.

#### 11.12 *Alterations, Etc.*

Each sheet shall be reasonably free from erasures and shall be free from alterations, overwritings, and interlineations. Non-compliance with this Rule may be authorized if the authenticity of the content is not in question and the requirements for good reproduction are not in jeopardy.

#### 11.13 *Special Requirements for Drawings*

(a) Drawings shall be executed in durable, black, sufficiently dense and dark, uniformly thick and well-defined, lines and strokes without colorings.

(b) Cross-sections shall be indicated by oblique hatching which should not impede the clear reading of the reference signs and leading lines.

(c) The scale of the drawings and the distinctness of their graphical execution shall be such that a photographic reproduction with a linear reduction in size to two-thirds would enable all details to be distinguished without difficulty.

(d) When, in exceptional cases, the scale is given on a drawing, it shall be represented graphically.

(e) All numbers, letters and reference lines, appearing on the drawings, shall be simple and clear. Brackets, circles or inverted commas shall not be used in association with numbers and letters.

(f) All lines in the drawings shall, ordinarily, be drawn with the aid of drafting instruments.

(g) Each element of each figure shall be in proper proportion to each of the other elements in the

figure, except where the use of a different proportion is indispensable for the clarity of the figure.

(h) The height of the numbers and letters shall not be less than 0.32 cm. For the lettering of drawings, the Latin and, where customary, the Greek alphabets shall be used.

(i) The same sheet of drawings may contain several figures. Where figures on two or more sheets form in effect a single complete figure, the figures on the several sheets shall be so arranged that the complete figure can be assembled without concealing any part of any of the figures appearing on the various sheets.

(j) The different figures shall be arranged on a sheet or sheets without wasting space, preferably in an upright position, clearly separated from one another. Where the figures are not arranged in an upright position, they shall be presented sideways with the top of the figures at the left side of the sheet.

(k) The different figures shall be numbered in Arabic numerals consecutively and independently of the numbering of the sheets.

(l) Reference signs not mentioned in the description shall not appear in the drawings, and vice versa.

(m) The same features, when denoted by reference signs, shall, throughout the international application, be denoted by the same signs.

(n) If the drawings contain a large number of reference signs, it is strongly recommended to attach a separate sheet listing all reference signs and the features denoted by them.

#### 11.14 *Later Documents*

Rules 10, and 11.1 to 11.13, also apply to any document - for example, corrected pages, amended claims, translations - submitted after the filing of the international application.

## Rule 12

### **Language of the International Application and Translation for the Purposes of International Search and International Publication**

#### 12.1 *Languages Accepted for the Filing of International Applications*

(a) An international application shall be filed in any language which the receiving Office accepts for that purpose.

(b) Each receiving Office shall, for the filing of international applications, accept at least one language which is both:

(i) a language accepted by the International Searching Authority, or, if applicable, by at least one of the International Searching Authorities, competent for the international searching of international applications filed with that receiving Office, and

(ii) a language of publication.

(iii) *[Deleted]*

(c) Notwithstanding paragraph (a), the request shall be filed in any language of publication which the receiving Office accepts for the purposes of this paragraph.

(d) Notwithstanding paragraph (a), any text matter contained in the sequence listing part of the description referred to in Rule 5.2(a) shall be presented in accordance with the standard provided for in the Administrative Instructions.

#### 12.2 *Language of Changes in the International Application*

(a) Any amendment of the international application shall, subject to Rules 46.3, 55.3 and 66.9, be in the language in which the application is filed.

(b) Any rectification under Rule 91.1 of an obvious error in the international application shall be in the language in which the application is filed, provided that:

(i) where a translation of the international application is required under Rule 12.3(a), 12.4(a) or 55.2(a), rectifications referred to in Rule 91.1(e)(ii) and (iii) shall be filed in both the language of the application and the language of that translation;

(ii) where a translation of the request is required under Rule 26.3<sup>ter</sup>(c), rectifications referred to in Rule 91.1(e)(i) need only be filed in the language of that translation.

(c) Any correction under Rule 26 of a defect in the international application shall be in the language in which the international application is filed. Any correction under Rule 26 of a defect in a translation of the international application furnished under Rule 12.3 or 55.2(a), or in a translation of the request furnished under Rule 26.3<sup>ter</sup>(c), shall be in the language of the translation.

#### 12.3 *Translation for the Purposes of International Search*

(a) Where the language in which the international application is filed is not accepted by the International Searching Authority that is to carry out the international search, the applicant shall, within one month from the date of receipt of the international application by the receiving Office, furnish to that Office a translation of the international application into a language which is all of the following:

(i) a language accepted by that Authority, and

(ii) a language of publication, and

(iii) a language accepted by the receiving Office under Rule 12.1(a), unless the international application is filed in a language of publication.

(b) Paragraph (a) shall not apply to the request nor to any sequence listing part of the description.

(c) Where, by the time the receiving Office sends to the applicant the notification under Rule 20.5(c), the applicant has not furnished a translation required under paragraph (a), the receiving Office shall, preferably together with that notification, invite the applicant:

(i) to furnish the required translation within the time limit under paragraph (a);

(ii) in the event that the required translation is not furnished within the time limit under paragraph (a), to furnish it and to pay, where applicable, the late furnishing fee referred to in paragraph (e), within one month from the date of the invitation or two months from the date of receipt of the international application by the receiving Office, whichever expires later.

(d) Where the receiving Office has sent to the applicant an invitation under paragraph (c) and the applicant has not, within the applicable time limit under paragraph (c)(ii), furnished the required translation and paid any required late furnishing fee, the international application shall be considered withdrawn and the receiving Office shall so declare. Any translation and any payment received by the receiving Office before that Office makes the declaration under the previous sentence and before the expiration of 15 months from the priority date shall be considered to have been received before the expiration of that time limit.

(e) The furnishing of a translation after the expiration of the time limit under paragraph (a) may

be subjected by the receiving Office to the payment to it, for its own benefit, of a late furnishing fee equal to 25% of the international filing fee referred to in item 1 of the Schedule of Fees, not taking into account any fee for each sheet of the international application in excess of 30 sheets.

#### 12.4 *Translation for the Purposes of International Publication*

(a) Where the language in which the international application is filed is not a language of publication and no translation is required under Rule 12.3(a), the applicant shall, within 14 months from the priority date, furnish to the receiving Office a translation of the international application into any language of publication which the receiving Office accepts for the purposes of this paragraph.

(b) Paragraph (a) shall not apply to the request nor to any sequence listing part of the description.

(c) Where the applicant has not, within the time limit referred to in paragraph (a), furnished a translation required under that paragraph, the receiving Office shall invite the applicant to furnish the required translation, and to pay, where applicable, the late furnishing fee required under paragraph (e), within 16 months from the priority date. Any translation received by the receiving Office before that Office sends the invitation under the previous sentence shall be considered to have been received before the expiration of the time limit under paragraph (a).

(d) Where the applicant has not, within the time limit under paragraph (c), furnished the required translation and paid any required late furnishing fee, the international application shall be considered withdrawn and the receiving Office shall so declare. Any translation and any payment received by the receiving Office before that Office makes the declaration under the previous sentence and before the expiration of 17 months from the priority date shall be considered to have been received before the expiration of that time limit.

(e) The furnishing of a translation after the expiration of the time limit under paragraph (a) may be subjected by the receiving Office to the payment to it, for its own benefit, of a late furnishing fee equal to 25% of the international filing fee referred to in item 1 of the Schedule of Fees, not taking into account any fee for each sheet of the international application in excess of 30 sheets.

## Rule 13

### Unity of Invention

#### 13.1 *Requirement*

The international application shall relate to one invention only or to a group of inventions so linked as to form a single general inventive concept (“requirement of unity of invention”).

#### 13.2 *Circumstances in Which the Requirement of Unity of Invention Is to Be Considered Fulfilled*

Where a group of inventions is claimed in one and the same international application, the requirement of unity of invention referred to in Rule 13.1 shall be fulfilled only when there is a technical relationship among those inventions involving one or more of the same or corresponding special technical features. The expression “special technical features” shall mean those technical features that define a contribution which each of the claimed inventions, considered as a whole, makes over the prior art.

#### 13.3 *Determination of Unity of Invention Not Affected Manner of Claiming*

The determination whether a group of inventions is so linked as to form a single general inventive concept shall be made without regard to whether the inventions are claimed in separate claims or as alternatives within a single claim.

#### 13.4 *Dependent Claims*

Subject to Rule 13.1, it shall be permitted to include in the same international application a reasonable number of dependent claims, claiming specific forms of the invention claimed in an independent claim, even where the features of any dependent claim could be considered as constituting in themselves an invention.

#### 13.5 *Utility Models*

Any designated State in which the grant of a utility model is sought on the basis of an international application may, instead of Rules 13.1 to 13.4, apply in respect of the matters regulated in those Rules the provisions of its national law concerning utility models once the processing of the international application has started in that State, provided that the applicant shall be allowed at least two months from the expiration of the time limit applicable under Arti-

cle 22 to adapt his application to the requirements of the said provisions of the national law.

### Rule 13<sup>bis</sup>

#### Inventions Relating to Biological Material

##### 13<sup>bis</sup>.1 Definition

For the purposes of this Rule, “reference to a deposited biological material” means particulars given in an international application with respect to the deposit of biological material with a depositary institution or to the biological material so deposited.

##### 13<sup>bis</sup>.2 References (General)

Any reference to deposited biological material shall be made in accordance with this Rule and, if so made, shall be considered as satisfying the requirements of the national law of each designated State.

##### 13<sup>bis</sup>.3 References: Contents; Failure to Include Reference or Indication

(a) A reference to deposited biological material shall indicate:

- (i) the name and address of the depositary institution with which the deposit was made;
- (ii) the date of deposit of the biological material with that institution;
- (iii) the accession number given to the deposit by that institution; and
- (iv) any additional matter of which the International Bureau has been notified pursuant to Rule 13<sup>bis</sup>.7(a)(i), provided that the requirement to indicate that matter was published in the Gazette in accordance with Rule 13<sup>bis</sup>.7(c) at least two months before the filing of the international application.

(b) Failure to include a reference to deposited biological material or failure to include, in a reference to deposited biological material, an indication in accordance with paragraph (a), shall have no consequence in any designated State whose national law does not require such reference or such indication in a national application.

##### 13<sup>bis</sup>.4 References: Time Limit for Furnishing Indications

(a) Subject to paragraphs (b) and (c), if any of the indications referred to in Rule 13<sup>bis</sup>.3(a) is not included in a reference to deposited biological mate-

rial in the international application as filed but is furnished to the International Bureau:

(i) within 16 months from the priority date, the indication shall be considered by any designated Office to have been furnished in time;

(ii) after the expiration of 16 months from the priority date, the indication shall be considered by any designated Office to have been furnished on the last day of that time limit if it reaches the International Bureau before the technical preparations for international publication have been completed.

(b) If the national law applicable by a designated Office so requires in respect of national applications, that Office may require that any of the indications referred to in Rule 13<sup>bis</sup>.3(a) be furnished earlier than 16 months from the priority date, provided that the International Bureau has been notified of such requirement pursuant to Rule 13<sup>bis</sup>.7(a)(ii) and has published such requirement in the Gazette in accordance with Rule 13<sup>bis</sup>.7(c) at least two months before the filing of the international application.

(c) Where the applicant makes a request for early publication under Article 21(2)(b), any designated Office may consider any indication not furnished before the technical preparations for international publication have been completed as not having been furnished in time.

(d) The International Bureau shall notify the applicant of the date on which it received any indication furnished under paragraph (a), and

(i) if the indication was received before the technical preparations for international publication have been completed, indicate that date, and include the relevant data from the indication, in the pamphlet published under Rule 48;

(ii) if the indication was received after the technical preparations for international publication have been completed, notify that date and the relevant data from the indication to the designated Offices.

##### 13<sup>bis</sup>.5 References and Indications for the Purposes of One or More Designated States; Different Deposits for Different Designated States; Deposits with Depositary Institutions Other Than Those Notified

(a) A reference to deposited biological material shall be considered to be made for the purposes of all designated States, unless it is expressly made for the

purposes of certain of the designated States only; the same applies to the indications included in the reference.

(b) References to different deposits of the biological material may be made for different designated States.

(c) Any designated Office may disregard a deposit made with a depositary institution other than one notified by it under Rule 13<sup>bis</sup>.7(b).

#### 13<sup>bis</sup>.6 *Furnishing of Samples*

Pursuant to Articles 23 and 40, no furnishing of samples of the deposited biological material to which a reference is made in an international application shall, except with the authorization of the applicant, take place before the expiration of the applicable time limits after which national processing may start under the said Articles. However, where the applicant performs the acts referred to in Articles 22 or 39 after international publication but before the expiration of the said time limits, the furnishing of samples of the deposited biological material may take place, once the said acts have been performed. Notwithstanding the previous provision, the furnishing of samples of the deposited biological material may take place under the national law applicable by any designated Office as soon as, under that law, the international publication has the effects of the compulsory national publication of an unexamined national application.

#### 13<sup>bis</sup>.7 *National Requirements: Notification and Publication*

(a) Any national Office may notify the International Bureau of any requirement of the national law:

(i) that any matter specified in the notification, in addition to those referred to in Rule 13<sup>bis</sup>.3(a)(i), (ii) and (iii), is required to be included in a reference to deposited biological material in a national application;

(ii) that one or more of the indications referred to in Rule 13<sup>bis</sup>.3(a) are required to be included in a national application as filed or are required to be furnished at a time specified in the notification which is earlier than 16 months after the priority date.

(b) Each national Office shall notify the International Bureau of the depositary institutions with which the national law permits deposits of biological

materials to be made for the purposes of patent procedure before that Office or, if the national law does not provide for or permit such deposits, of that fact.

(c) The International Bureau shall promptly publish in the Gazette requirements notified to it under paragraph (a) and information notified to it under paragraph (b).

### **Rule 13<sup>ter</sup>**

#### **Nucleotide and/or Amino Acid Sequence Listings**

##### 13<sup>ter</sup>.1 *Sequence Listing for International Authorities*

(a) Where the International Searching Authority finds that the international application contains disclosure of one or more nucleotide and/or amino acid sequences but:

(i) the international application does not contain a sequence listing complying with the standard provided for in the Administrative Instructions, that Authority may invite the applicant to furnish to it, within a time limit fixed in the invitation, a sequence listing complying with that standard;

(ii) the applicant has not already furnished a sequence listing in computer readable form complying with the standard provided for in the Administrative Instructions, that Authority may invite the applicant to furnish to it, within a time limit fixed in the invitation, a sequence listing in such a form complying with that standard.

(b) *[Deleted]*

(c) If the applicant does not comply with an invitation under paragraph (a) within the time limit fixed in the invitation, the International Searching Authority shall not be required to search the international application to the extent that such noncompliance has the result that a meaningful search cannot be carried out.

(d) Where the International Searching Authority finds that the description does not comply with Rule 5.2(b), it shall invite the applicant to file the required correction. Rule 26.4 shall apply *mutatis mutandis* to any correction offered by the applicant. The International Searching Authority shall transmit the correction to the receiving Office and to the International Bureau.

(e) Paragraphs (a) and (c) shall apply *mutatis mutandis* to the procedure before the International Preliminary Examining Authority.

(f) Any sequence listing not contained in the international application as filed shall not, subject to Article 34, form part of the international application.

#### 13<sup>ter</sup>.2 *Sequence Listing for Designated Office*

Once the processing of the international application has started before a designated Office, Rule 13<sup>ter</sup>.1(a) shall apply *mutatis mutandis* to the procedure before that Office. No designated Office shall require the applicant to furnish to it a sequence listing other than a sequence listing complying with the standard provided for in the Administrative Instructions.

### **Rule 14**

#### **The Transmittal Fee**

##### 14.1 *The Transmittal Fee*

(a) Any receiving Office may require that the applicant pay a fee to it, for its own benefit, for receiving the international application, transmitting copies to the International Bureau and the competent International Searching Authority, and performing all the other tasks which it must perform in connection with the international application in its capacity of receiving Office (“transmittal fee”).

(b) The amount of the transmittal fee, if any, shall be fixed by the receiving Office.

(c) The transmittal fee shall be paid within one month from the date of receipt of the international application. The amount payable shall be the amount applicable on that date of receipt.

### **Rule 15**

#### **The International Filing Fee**

##### 15.1 *The International Filing Fee*

Each international application shall be subject to the payment of a fee for the benefit of the International Bureau (“international filing fee”) to be collected by the receiving Office.

##### 15.2 *Amount*

(a) The amount of the international filing fee is as set out in the Schedule of Fees.

(b) The international filing fee shall be payable in the currency or one of the currencies prescribed by the receiving Office (“prescribed currency”), it being understood that, when transferred by the receiving Office to the International Bureau, it shall be freely

convertible into Swiss currency. The amount of the international filing fee shall be established, for each receiving Office which prescribes the payment of that fee in any currency other than Swiss currency, by the Director General after consultation with the receiving Office of, or acting under Rule 19.1(b) for, the State whose official currency is the same as the prescribed currency. The amount so established shall be the equivalent, in round figures, of the amount in Swiss currency set out in the Schedule of Fees. It shall be notified by the International Bureau to each receiving Office prescribing payment in that prescribed currency and shall be published in the Gazette.

(c) Where the amount of the international filing fee set out in the Schedule of Fees is changed, the corresponding amount in the prescribed currencies shall be applied from the same date as the amount set out in the amended Schedule of Fees.

(d) Where the exchange rate between Swiss currency and any prescribed currency becomes different from the exchange rate last applied, the Director General shall establish the new amount in the prescribed currency according to directives given by the Assembly. The newly established amount shall become applicable two months after the date of its publication in the Gazette, provided that the receiving Office referred to in the second sentence of paragraph (b) and the Director General may agree on a date falling during the said two-month period, in which case the said amount shall become applicable from that date.

##### 15.3 *[Deleted]*

##### 15.4 *Time Limit for Payment; Amount Payable*

The international filing fee shall be paid within one month from the date of receipt of the international application. The amount payable shall be the amount applicable on that date of receipt.

##### 15.5 *[Deleted]*

##### 15.6 *Refund*

The receiving Office shall refund the international filing fee to the applicant:

(i) if the determination under Article 11(1) is negative,

(ii) if, before the transmittal of the record copy to the International Bureau, the international application is withdrawn or considered withdrawn, or

(iii) if, due to prescriptions concerning national security, the international application is not treated as such.

## Rule 16

### The Search Fee

#### 16.1 *Right to Ask for a Fee*

(a) Each International Searching Authority may require that the applicant pay a fee (“search fee”) for its own benefit for carrying out the international search and for performing all other tasks entrusted to International Searching Authorities by the Treaty and these Regulations.

(b) The search fee shall be collected by the receiving Office. The said fee shall be payable in the currency or one of the currencies prescribed by that Office (“receiving Office currency”), it being understood that, if any receiving Office currency is not that, or one of those, in which the International Searching Authority has fixed the said fee (“fixed currency”), it shall, when transferred by the receiving Office to the International Searching Authority, be freely convertible into the currency of the State in which the International Searching Authority has its headquarters (“headquarters currency”). The amount of the search fee in any receiving Office currency, other than the fixed currency, shall be established by the Director General after consultation with the receiving Office of, or acting under Rule 19.1(b) for, the State whose official currency is the same as the receiving Office currency. The amounts so established shall be the equivalents, in round figures, of the amount established by the International Searching Authority in the headquarters currency. They shall be notified by the International Bureau to each receiving Office prescribing payment in that receiving Office currency and shall be published in the Gazette.

(c) Where the amount of the search fee in the headquarters currency is changed, the corresponding amounts in the receiving Office currencies, other than the fixed currency or currencies, shall be applied from the same date as the changed amount in the headquarters currency.

(d) Where the exchange rate between the headquarters currency and any receiving Office currency, other than the fixed currency or currencies, becomes different from the exchange rate last applied, the

Director General shall establish the new amount in the said receiving Office currency according to directives given by the Assembly. The newly established amount shall become applicable two months after its publication in the Gazette, provided that any receiving Office referred to in the third sentence of paragraph (b) and the Director General may agree on a date falling during the said two-month period, in which case the said amount shall become applicable for that Office from that date.

(e) Where, in respect of the payment of the search fee in a receiving Office currency, other than the fixed currency or currencies, the amount actually received by the International Searching Authority in the headquarters currency is less than that fixed by it, the difference will be paid to the International Searching Authority by the International Bureau, whereas, if the amount actually received is more, the difference will belong to the International Bureau.

(f) As to the time limit for payment of the search fee and the amount payable, the provisions of Rule 15.4 relating to the international filing fee shall apply *mutatis mutandis*.

#### 16.2 *Refund*

The receiving Office shall refund the search fee to the applicant:

(i) if the determination under Article 11(1) is negative,

(ii) if, before the transmittal of the search copy to the International Searching Authority, the international application is withdrawn or considered withdrawn, or

(iii) if, due to prescriptions concerning national security, the international application is not treated as such.

#### 16.3 *Partial Refund*

Where the international application claims the priority of an earlier international application which has been the subject of an international search by the same International Searching Authority, that Authority shall refund the search fee paid in connection with the later international application to the extent and under the conditions provided for in the agreement under Article 16(3)(b), if the international search report on the later international application could wholly or partly be based on the results of the interna-

tional search effected on the earlier international application.

**Rule 16<sup>bis</sup>**

**Extension of Time Limits for Payment of Fees**

*16<sup>bis</sup>.1 Invitation by the Receiving Office*

(a) Where, by the time they are due under Rules 14.1(c), 15.4 and 16.1(f), the receiving Office finds that no fees were paid to it, or that the amount paid to it is insufficient to cover the transmittal fee, the international filing fee and the search fee, the receiving Office shall invite the applicant to pay to it the amount required to cover those fees, together with, where applicable, the late payment fee under Rule 16<sup>bis</sup>.2, within a time limit of one month from the date of the invitation.

(b) *[Deleted]*

(c) Where the receiving Office has sent to the applicant an invitation under paragraph (a) and the applicant has not, within the time limit referred to in that paragraph, paid in full the amount due, including, where applicable, the late payment fee under Rule 16<sup>bis</sup>.2, the receiving Office shall, subject to paragraph (d):

(i) make the applicable declaration under Article 14(3), and

(ii) proceed as provided in Rule 29.

(d) Any payment received by the receiving Office before that Office sends the invitation under paragraph (a) shall be considered to have been received before the expiration of the time limit under Rule 14.1(c), 15.4 or 16.1(f), as the case may be.

(e) Any payment received by the receiving Office before that Office makes the applicable declaration under Article 14(3) shall be considered to have been received before the expiration of the time limit referred to in paragraph (a).

*16<sup>bis</sup>.2 Late Payment Fee*

(a) The payment of fees in response to an invitation under Rule 16<sup>bis</sup>.1(a) may be subjected by the receiving Office to the payment to it, for its own benefit, of a late payment fee. The amount of that fee shall be:

(i) 50% of the amount of unpaid fees which is specified in the invitation, or,

(ii) if the amount calculated under item (i) is less than the transmittal fee, an amount equal to the transmittal fee.

(b) The amount of the late payment fee shall not, however, exceed the amount of 50% of the international filing fee referred to in item 1 of the Schedule of Fees, not taking into account any fee for each sheet of the international application in excess of 30 sheets.

**Rule 17**

**The Priority Document**

*17.1 Obligation to Submit Copy of Earlier National or International Application*

(a) Where the priority of an earlier national or international application is claimed under Article 8, a copy of that earlier application, certified by the authority with which it was filed (“the priority document”), shall, unless that priority document has already been filed with the receiving Office together with the international application in which the priority claim is made, and subject to paragraphs (b) and (b<sup>bis</sup>), be submitted by the applicant to the International Bureau or to the receiving Office not later than 16 months after the priority date, provided that any copy of the said earlier application which is received by the International Bureau after the expiration of that time limit shall be considered to have been received by that Bureau on the last day of that time limit if it reaches it before the date of international publication of the international application.

(b) Where the priority document is issued by the receiving Office, the applicant may, instead of submitting the priority document, request the receiving Office to prepare and transmit the priority document to the International Bureau. Such request shall be made not later than 16 months after the priority date and may be subjected by the receiving Office to the payment of a fee.

(b<sup>bis</sup>) Where the priority document is, in accordance with the Administrative Instructions, available to the receiving Office or to the International Bureau from a digital library, the applicant may, as the case may be, instead of submitting the priority document:

(i) request the receiving Office to obtain the priority document from such digital library and transmit it to the International Bureau; or



(ii) request the International Bureau to obtain the priority document from such digital library. Such request shall be made not later than 16 months after the priority date and may be subjected by the receiving Office or the International Bureau to the payment of a fee.

(c) If the requirements of none of the three preceding paragraphs are complied with, any designated Office may, subject to paragraph (d), disregard the priority claim, provided that no designated Office shall disregard the priority claim before giving the applicant an opportunity to furnish the priority document within a time limit which shall be reasonable under the circumstances.

(d) No designated Office shall disregard the priority claim under paragraph (c) if the earlier application referred to in paragraph (a) was filed with it in its capacity as national Office or if the priority document is, in accordance with the Administrative Instructions, available to it from a digital library.

#### 17.2 *Availability of Copies*

(a) Where the applicant has complied with Rule 17.1(a), (b) or (b<sup>bis</sup>), the International Bureau shall, at the specific request of the designated Office, promptly but not prior to the international publication of the international application, furnish a copy of the priority document to that Office. No such Office shall ask the applicant himself to furnish it with a copy. The applicant shall not be required to furnish a translation to the designated Office before the expiration of the applicable time limit under Article 22. Where the applicant makes an express request to the designated Office under Article 23(2) prior to the international publication of the international application, the International Bureau shall, at the specific request of the designated Office, furnish a copy of the priority document to that Office promptly after receiving it.

(b) The International Bureau shall not make copies of the priority document available to the public prior to the international publication of the international application.

(c) Where the international application has been published under Article 21, the International Bureau shall furnish a copy of the priority document to any person upon request and subject to reimbursement of the cost unless, prior to that publication:

(i) the international application was withdrawn,

(ii) the relevant priority claim was withdrawn or considered, under Rule 26<sup>bis</sup>.2(b), not to have been made.

(iii) *[Deleted]*

(d) *[Deleted]*

### **Rule 18**

#### **The Applicant**

##### 18.1 *Residence and Nationality*

(a) Subject to the provisions of paragraphs (b) and (c), the question whether an applicant is a resident or national of the Contracting State of which he claims to be a resident or national shall depend on the national law of that State and shall be decided by the receiving Office.

(b) In any case,

(i) possession of a real and effective industrial or commercial establishment in a Contracting State shall be considered residence in that State, and

(ii) a legal entity constituted according to the national law of a Contracting State shall be considered a national of that State.

(c) Where the international application is filed with the International Bureau as receiving Office, the International Bureau shall, in the circumstances specified in the Administrative Instructions, request the national Office of, or acting for, the Contracting State concerned to decide the question referred to in paragraph (a). The International Bureau shall inform the applicant of any such request. The applicant shall have an opportunity to submit arguments directly to the national Office. The national Office shall decide the said question promptly.

##### 18.2 *[Deleted]*

##### 18.3 *Two or More Applicants*

If there are two or more applicants, the right to file an international application shall exist if at least one of them is entitled to file an international application according to Article 9.

##### 18.4 *Information on Requirements Under National Law as to Applicants*

(a) and (b) *[Deleted]*

(c) The International Bureau shall, from time to time, publish information on the various national laws in respect of the question who is qualified (inventor, successor in title of the inventor, owner of the inven-

tion, or other) to file a national application and shall accompany such information by a warning that the effect of the international application in any designated State may depend on whether the person designated in the international application as applicant for the purposes of that State is a person who, under the national law of that State, is qualified to file a national application.

## Rule 19

### The Competent Receiving Office

#### 19.1 *Where to File*

(a) Subject to the provisions of paragraph (b), the international application shall be filed, at the option of the applicant,

(i) with the national Office of or acting for the Contracting State of which the applicant is a resident,

(ii) or with the national Office of or acting for the Contracting State of which the applicant is a national, or

(iii) irrespective of the Contracting State of which the applicant is a resident or national, with the International Bureau.

(b) Any Contracting State may agree with another Contracting State or any intergovernmental organization that the national Office of the latter State or the intergovernmental organization shall, for all or some purposes, act instead of the national Office of the former State as receiving Office for applicants who are residents or nationals of that former State. Notwithstanding such agreement, the national Office of the former State shall be considered the competent receiving Office for the purposes of Article 15(5).

(c) In connection with any decision made under Article 9(2), the Assembly shall appoint the national Office or the intergovernmental organization which will act as receiving Office for applications of residents or nationals of States specified by the Assembly. Such appointment shall require the previous consent of the said national Office or intergovernmental organization.

#### 19.2 *Two or More Applicants*

If there are two or more applicants,

(i) the requirements of Rule 19.1 shall be considered to be met if the national Office with which the international application is filed is the national Office

of or acting for a Contracting State of which at least one of the applicants is a resident or national;

(ii) the international application may be filed with the International Bureau under Rule 19.1(a)(iii) if at least one of the applicants is a resident or national of a Contracting State.

#### 19.3 *Publication of Fact of Delegation of Duties of Receiving Office*

(a) Any agreement referred to in Rule 19.1(b) shall be promptly notified to the International Bureau by the Contracting State which delegates the duties of the receiving Office to the national Office of or acting for another Contracting State or an intergovernmental organization.

(b) The International Bureau shall, promptly upon receipt, publish the notification in the Gazette.

#### 19.4 *Transmittal to the International Bureau as Receiving Office*

(a) Where an international application is filed with a national Office which acts as a receiving Office under the Treaty but

(i) that national Office is not competent under Rule 19.1 or 19.2 to receive that international application, or

(ii) that international application is not in a language accepted under Rule 12.1(a) by that national Office but is in a language accepted under that Rule by the International Bureau as receiving Office, or

(iii) that national Office and the International Bureau agree, for any reason other than those specified under items (i) and (ii), and with the authorization of the applicant, that the procedure under this Rule should apply, that international application shall, subject to paragraph (b), be considered to have been received by that Office on behalf of the International Bureau as receiving Office under Rule 19.1(a)(iii).

(b) Where, pursuant to paragraph (a), an international application is received by a national Office on behalf of the International Bureau as receiving Office under Rule 19.1(a)(iii), that national Office shall, unless prescriptions concerning national security prevent the international application from being so transmitted, promptly transmit it to the International Bureau. Such transmittal may be subjected by the national Office to the payment of a fee, for its own benefit, equal to the transmittal fee charged by that Office under Rule 14. The international application so

transmitted shall be considered to have been received by the International Bureau as receiving Office under Rule 19.1(a)(iii) on the date of receipt of the international application by that national Office.

(c) For the purposes of Rules 14.1(c), 15.4 and 16.1(f), where the international application was transmitted to the International Bureau under paragraph (b), the date of receipt of the international application shall be considered to be the date on which the international application was actually received by the International Bureau. For the purposes of this paragraph, the last sentence of paragraph (b) shall not apply.

## Rule 20

### Receipt of the International Application

#### 20.1 *Date and Number*

(a) Upon receipt of papers purporting to be an international application, the receiving Office shall indelibly mark the date of actual receipt on the request of each copy received and the international application number on each sheet of each copy received.

(b) The place on each sheet where the date or number shall be marked, and other details, shall be specified in the Administrative Instructions.

#### 20.2 *Receipt on Different Days*

(a) In cases where all the sheets pertaining to the same purported international application are not received on the same day by the receiving Office, that Office shall correct the date marked on the request (still leaving legible, however, the earlier date or dates already marked) so that it indicates the day on which the papers completing the international application were received, provided that

(i) where no invitation under Article 11(2)(a) to correct was sent to the applicant, the said papers are received within 30 days from the date on which sheets were first received;

(ii) where an invitation under Article 11(2)(a) to correct was sent to the applicant, the said papers are received within the applicable time limit under Rule 20.6;

(iii) in the case of Article 14(2), the missing drawings are received within 30 days from the date on which the incomplete papers were filed;

(iv) the absence or later receipt of any sheet containing the abstract or part thereof shall not, in itself, require any correction of the date marked on the request.

(b) Any sheet received on a date later than the date on which sheets were first received shall be marked by the receiving Office with the date on which it was received.

#### 20.3 *Corrected International Application*

In the case referred to in Article 11(2)(b), the receiving Office shall correct the date marked on the request (still leaving legible, however, the earlier date or dates already marked) so that it indicates the day on which the last required correction was received.

#### 20.3<sup>bis</sup> *[Deleted]*

#### 20.4 *Determination Under Article 11(1)*

(a) Promptly after receipt of the papers purporting to be an international application, the receiving Office shall determine whether the papers comply with the requirements of Article 11(1).

(b) For the purposes of Article 11(1)(iii)(c), it shall be sufficient to indicate the name of the applicant in a way which allows his identity to be established even if the name is misspelled, the given names are not fully indicated, or, in the case of legal entities, the indication of the name is abbreviated or incomplete.

(c) For the purposes of Article 11(1)(ii), it shall be sufficient that the part which appears to be a description (other than any sequence listing part thereof) and the part which appears to be a claim or claims be in a language accepted by the receiving Office under Rule 12.1(a).

(d) If, on October 1, 1997, paragraph (c) is not compatible with the national law applied by the receiving Office, paragraph (c) shall not apply to that receiving Office for as long as it continues not to be compatible with that law, provided that the said Office informs the International Bureau accordingly by December 31, 1997. The information received shall be promptly published by the International Bureau in the Gazette.

### 20.5 *Positive Determination*

(a) If the determination under Article 11(1) is positive, the receiving Office shall stamp on the request the name of the receiving Office and the words “PCT International Application,” or “Demande internationale PCT.” If the official language of the receiving Office is neither English nor French, the words “International Application” or “Demande internationale” may be accompanied by a translation of these words in the official language of the receiving Office.

(b) The copy whose request has been so stamped shall be the record copy of the international application.

(c) The receiving Office shall promptly notify the applicant of the international application number and the international filing date. At the same time, it shall send to the International Bureau a copy of the notification sent to the applicant, except where it has already sent, or is sending at the same time, the record copy to the International Bureau under Rule 22.1(a).

### 20.6 *Invitation to Correct*

(a) The invitation to correct under Article 11(2) shall specify the requirement provided for under Article 11(1) which, in the opinion of the receiving Office, has not been fulfilled.

(b) The receiving Office shall promptly mail the invitation to the applicant and shall fix a time limit, reasonable under the circumstances of the case, for filing the correction. The time limit shall not be less than 10 days, and shall not exceed one month, from the date of the invitation. If such time limit expires after the expiration of one year from the filing date of any application whose priority is claimed, the receiving Office may call this circumstance to the attention of the applicant.

### 20.7 *Negative Determination*

If the receiving Office does not, within the prescribed time limit, receive a reply to its invitation to correct, or if the correction offered by the applicant still does not fulfill the requirements provided for under Article 11(1), it shall:

(i) promptly notify the applicant that his application is not and will not be treated as an international application and shall indicate the reasons therefor,

(ii) notify the International Bureau that the number it has marked on the papers will not be used as an international application number,

(iii) keep the papers constituting the purported international application and any correspondence relating thereto as provided in Rule 93.1, and

(iv) send a copy of the said papers to the International Bureau where, pursuant to a request by the applicant under Article 25(1), the International Bureau needs such a copy and specially asks for it.

### 20.8 *Error by the Receiving Office*

If the receiving Office later discovers, or on the basis of the applicant's reply realizes, that it has erred in issuing an invitation to correct since the requirements provided for under Article 11(1) were fulfilled when the papers were received, it shall proceed as provided in Rule 20.5.

### 20.9 *Certified Copy for the Applicant*

Against payment of a fee, the receiving Office shall furnish to the applicant, on request, certified copies of the international application as filed and of any corrections thereto.

## **Rule 21**

### **Preparation of Copies**

#### *21.1 Responsibility of the Receiving Office*

(a) Where the international application is required to be filed in one copy, the receiving Office shall be responsible for preparing the home copy and the search copy required under Article 12(1).

(b) Where the international application is required to be filed in two copies, the receiving Office shall be responsible for preparing the home copy.

(c) If the international application is filed in less than the number of copies required under Rule 11.1(b), the receiving Office shall be responsible for the prompt preparation of the number of copies required, and shall have the right to fix a fee for performing that task and to collect such fee from the applicant.

**Rule 22**

**Transmittal of the Record Copy and Translation**

*22.1 Procedure*

(a) If the determination under Article 11(1) is positive, and unless prescriptions concerning national security prevent the international application from being treated as such, the receiving Office shall transmit the record copy to the International Bureau. Such transmittal shall be effected promptly after receipt of the international application or, if a check to preserve national security must be performed, as soon as the necessary clearance has been obtained. In any case, the receiving Office shall transmit the record copy in time for it to reach the International Bureau by the expiration of the 13th month from the priority date. If the transmittal is effected by mail, the receiving Office shall mail the record copy not later than five days prior to the expiration of the 13th month from the priority date.

(b) If the International Bureau has received a copy of the notification under Rule 20.5(c) but is not, by the expiration of 13 months from the priority date, in possession of the record copy, it shall remind the receiving Office that it should transmit the record copy to the International Bureau promptly.

(c) If the International Bureau has received a copy of the notification under Rule 20.5(c) but is not, by the expiration of 14 months from the priority date, in possession of the record copy, it shall notify the applicant and the receiving Office accordingly.

(d) After the expiration of 14 months from the priority date, the applicant may request the receiving Office to certify a copy of his international application as being identical with the international application as filed and may transmit such certified copy to the International Bureau.

(e) Any certification under paragraph (d) shall be free of charge and may be refused only on any of the following grounds:

(i) the copy which the receiving Office has been requested to certify is not identical with the international application as filed;

(ii) prescriptions concerning national security prevent the international application from being treated as such;

(iii) the receiving Office has already transmitted the record copy to the International Bureau and that Bureau has informed the receiving Office that it has received the record copy.

(f) Unless the International Bureau has received the record copy, or until it receives the record copy, the copy certified under paragraph (e) and received by the International Bureau shall be considered to be the record copy.

(g) If, by the expiration of the time limit applicable under Article 22, the applicant has performed the acts referred to in that Article but the designated Office has not been informed by the International Bureau of the receipt of the record copy, the designated Office shall inform the International Bureau. If the International Bureau is not in possession of the record copy, it shall promptly notify the applicant and the receiving Office unless it has already notified them under paragraph (c).

(h) Where the international application is to be published in the language of a translation furnished under Rule 12.3 or 12.4, that translation shall be transmitted by the receiving Office to the International Bureau together with the record copy under paragraph (a) or, if the receiving Office has already transmitted the record copy to the International Bureau under that paragraph, promptly after receipt of the translation.

*22.2 [Deleted]*

*22.3 Time Limit Under Article 12(3)*

The time limit referred to in Article 12(3) shall be three months from the date of the notification sent by the International Bureau to the applicant under Rule 22.1(c) or (g).

**Rule 23**

**Transmittal of the Search Copy, Translation and Sequence Listing**

*23.1 Procedure*

(a) Where no translation of the international application is required under Rule 12.3(a), the search copy shall be transmitted by the receiving Office to the International Searching Authority at the latest on the same day as the record copy is transmitted to the International Bureau unless no search fee has been paid. In the latter case, it shall be transmitted promptly after payment of the search fee.

(b) Where a translation of the international application is furnished under Rule 12.3, a copy of that translation and of the request, which together shall be considered to be the search copy under Article 12(1), shall be transmitted by the receiving Office to the International Searching Authority, unless no search fee has been paid. In the latter case, a copy of the said translation and of the request shall be transmitted promptly after payment of the search fee.

(c) Any sequence listing in computer readable form which is furnished to the receiving Office shall be transmitted by that Office to the International Searching Authority.

#### **Rule 24**

##### **Receipt of the Record Copy by the International Bureau**

24.1 *[Deleted]*

24.2 *Notification of Receipt of the Record Copy*

(a) The International Bureau shall promptly notify:

- (i) the applicant,
- (ii) the receiving Office, and

(iii) the International Searching Authority (unless it has informed the International Bureau that it wishes not to be so notified), of the fact and the date of receipt of the record copy. The notification shall identify the international application by its number, the international filing date and the name of the applicant, and shall indicate the filing date of any earlier application whose priority is claimed. The notification sent to the applicant shall also contain a list of the designated Offices and, in the case of a designated Office which is responsible for granting regional patents, of the Contracting States designated for such regional patent.

(b) *[Deleted]*

(c) If the record copy is received after the expiration of the time limit fixed in Rule 22.3, the International Bureau shall promptly notify the applicant, the receiving Office, and the International Searching Authority, accordingly.

#### **Rule 25**

##### **Receipt of the Search Copy by the International Searching Authority**

25.1 *Notification of Receipt of the Search Copy*

The International Searching Authority shall promptly notify the International Bureau, the applicant, and - unless the International Searching Authority is the same as the receiving Office - the receiving Office, of the fact and the date of receipt of the search copy.

#### **Rule 26**

##### **Checking by, and Correcting Before, the Receiving Office of Certain Elements of the International Application**

26.1 *Time Limit for Check*

(a) The receiving Office shall issue the invitation to correct provided for in Article 14(1)(b) as soon as possible, preferably within one month from the receipt of the international application.

(b) If the receiving Office issues an invitation to correct the defect referred to in Article 14(1)(a)(iii) or (iv) (missing title or missing abstract), it shall notify the International Searching Authority accordingly.

26.2 *Time Limit for Correction*

The time limit referred to in Article 14(1)(b) shall be reasonable under the circumstances and shall be fixed in each case by the receiving Office. It shall not be less than one month from the date of the invitation to correct. It may be extended by the receiving Office at any time before a decision is taken.

26.2<sup>bis</sup> *Checking of Requirements Under Article 14(1)(a)(i) and (ii)*

(a) For the purposes of Article 14(1)(a)(i), if there is more than one applicant, it shall be sufficient that the request be signed by one of them.

(b) For the purposes of Article 14(1)(a)(ii), if there is more than one applicant, it shall be sufficient that the indications required under Rule 4.5(a)(ii) and (iii) be provided in respect of one of them who is entitled according to Rule 19.1 to file the international application with the receiving Office.

26.3 *Checking of Physical Requirements Under Article 14(1)(a)(v)*

(a) Where the international application is filed in a language of publication, the receiving Office shall check:

(i) the international application for compliance with the physical requirements referred to in Rule 11 only to the extent that compliance therewith is necessary for the purpose of reasonably uniform international publication;

(ii) any translation furnished under Rule 12.3 for compliance with the physical requirements referred to in Rule 11 to the extent that compliance therewith is necessary for the purpose of satisfactory reproduction.

(b) Where the international application is filed in a language which is not a language of publication, the receiving Office shall check:

(i) the international application for compliance with the physical requirements referred to in Rule 11 only to the extent that compliance therewith is necessary for the purpose of satisfactory reproduction;

(ii) any translation furnished under Rule 12.3 or 12.4 and the drawings for compliance with the physical requirements referred to in Rule 11 to the extent that compliance therewith is necessary for the purpose of reasonably uniform international publication.

26.3<sup>bis</sup> *Invitation Under Article 14(1)(b) to Correct Defects Under Rule 11*

The receiving Office shall not be required to issue the invitation under Article 14(1)(b) to correct a defect under Rule 11 where the physical requirements referred to in that Rule are complied with to the extent required under Rule 26.3.

26.3<sup>ter</sup> *Invitation to Correct Defects Under Article 3(4)(i)*

(a) Where the abstract or any text matter of the drawings is filed in a language which is different from the language of the description and the claims, the receiving Office shall, unless

(i) a translation of the international application is required under Rule 12.3(a), or

(ii) the abstract or the text matter of the drawings is in the language in which the international application is to be published, invite the applicant to

furnish a translation of the abstract or the text matter of the drawings into the language in which the international application is to be published. Rules 26.1(a), 26.2, 26.3, 26.3<sup>bis</sup>, 26.5 and 29.1 shall apply *mutatis mutandis*.

(b) If, on October 1, 1997, paragraph (a) is not compatible with the national law applied by the receiving Office, paragraph (a) shall not apply to that receiving Office for as long as it continues not to be compatible with that law, provided that the said Office informs the International Bureau accordingly by December 31, 1997. The information received shall be promptly published by the International Bureau in the Gazette.

(c) Where the request does not comply with Rule 12.1(c), the receiving Office shall invite the applicant to file a translation so as to comply with that Rule. Rules 3, 26.1(a), 26.2, 26.5 and 29.1 shall apply *mutatis mutandis*.

(d) If, on October 1, 1997, paragraph (c) is not compatible with the national law applied by the receiving Office, paragraph (c) shall not apply to that receiving Office for as long as it continues not to be compatible with that law, provided that the said Office informs the International Bureau accordingly by December 31, 1997. The information received shall be promptly published by the International Bureau in the Gazette.

26.4 *Procedure*

Any correction offered to the receiving Office may be stated in a letter addressed to that Office if the correction is of such a nature that it can be transferred from the letter to the record copy without adversely affecting the clarity and the direct reproducibility of the sheet on to which the correction is to be transferred; otherwise, the applicant shall be required to submit a replacement sheet embodying the correction and the letter accompanying the replacement sheet shall draw attention to the differences between the replaced sheet and the replacement sheet.

26.5 *Decision of the Receiving Office*

The receiving Office shall decide whether the applicant has submitted the correction within the time limit under Rule 26.2 and, if the correction has been submitted within that time limit, whether the international application so corrected is or is not to be considered withdrawn, provided that no international

application shall be considered withdrawn for lack of compliance with the physical requirements referred to in Rule 11 if it complies with those requirements to the extent necessary for the purpose of reasonably uniform international publication.

#### 26.6 *Missing Drawings*

(a) If, as provided in Article 14(2), the international application refers to drawings which in fact are not included in that application, the receiving Office shall so indicate in the said application.

(b) The date on which the applicant receives the notification provided for in Article 14(2) shall have no effect on the time limit fixed under Rule 20.2(a)(iii).

### **Rule 26<sup>bis</sup>**

#### **Correction or Addition of Priority Claim**

##### 26<sup>bis</sup>.1 *Correction or Addition of Priority Claim*

(a) The applicant may correct or add a priority claim by a notice submitted to the receiving Office or the International Bureau within a time limit of 16 months from the priority date or, where the correction or addition would cause a change in the priority date, 16 months from the priority date as so changed, whichever 16-month period expires first, provided that such a notice may be submitted until the expiration of four months from the international filing date. The correction of a priority claim may include the addition of any indication referred to in Rule 4.10.

(b) Any notice referred to in paragraph (a) received by the receiving Office or the International Bureau after the applicant has made a request for early publication under Article 21(2)(b) shall be considered not to have been submitted, unless that request is withdrawn before the technical preparations for international publication have been completed.

(c) Where the correction or addition of a priority claim causes a change in the priority date, any time limit which is computed from the previously applicable priority date and which has not already expired shall be computed from the priority date as so changed.

##### 26<sup>bis</sup>.2 *Invitation to Correct Defects in Priority Claims*

(a) Where the receiving Office or, if the receiving Office fails to do so, the International Bureau,

finds that a priority claim does not comply with the requirements of Rule 4.10 or that any indication in a priority claim is not the same as the corresponding indication appearing in the priority document, the receiving Office or the International Bureau, as the case may be, shall invite the applicant to correct the priority claim.

(b) If, in response to an invitation under paragraph (a), the applicant does not, before the expiration of the time limit under Rule 26<sup>bis</sup>.1(a), submit a notice correcting the priority claim so as to comply with the requirements of Rule 4.10, that priority claim shall, for the purposes of the procedure under the Treaty, be considered not to have been made and the receiving Office or the International Bureau, as the case may be, shall so declare and shall inform the applicant accordingly, provided that a priority claim shall not be considered not to have been made only because the indication of the number of the earlier application referred to in Rule 4.10(a)(ii) is missing or because an indication in the priority claim is not the same as the corresponding indication appearing in the priority document.

(c) Where the receiving Office or the International Bureau has made a declaration under paragraph (b), the International Bureau shall, upon request made by the applicant and received by the International Bureau prior to the completion of the technical preparations for international publication, and subject to the payment of a special fee whose amount shall be fixed in the Administrative Instructions, publish, together with the international application, information concerning the priority claim which was considered not to have been made. A copy of that request shall be included in the communication under Article 20 where a copy of the pamphlet is not used for that communication or where the international application is not published by virtue of Article 64(3).

### **Rule 26<sup>ter</sup>**

#### **Correction or Addition of Declarations Under Rule 4.17**

##### 26<sup>ter</sup>.1 *Correction or Addition of Declarations*

The applicant may correct or add to the request any declaration referred to in Rule 4.17 by a notice submitted to the International Bureau within a time limit of 16 months from the priority date, provided that any



notice which is received by the International Bureau after the expiration of that time limit shall be considered to have been received on the last day of that time limit if it reaches it before the technical preparations for international publication have been completed.

### *26<sup>ter</sup>.2 Processing of Declarations*

(a) Where the receiving Office or the International Bureau finds that any declaration referred to in Rule 4.17 is not worded as required or, in the case of the declaration of inventorship referred to in Rule 4.17(iv), is not signed as required, the receiving Office or the International Bureau, as the case may be, may invite the applicant to correct the declaration within a time limit of 16 months from the priority date.

(b) Where the International Bureau receives any declaration or correction under Rule 26<sup>ter</sup>.1 after the expiration of the time limit under Rule 26<sup>ter</sup>.1, the International Bureau shall notify the applicant accordingly and shall proceed as provided for in the Administrative Instructions.

## **Rule 27**

### **Lack of Payment of Fees**

#### *27.1 Fees*

(a) For the purposes of Article 14(3)(a), “fees prescribed under Article 3(4)(iv)” means: the transmittal fee (Rule 14), the international filing fee (Rule 15.1), the search fee (Rule 16), and, where required, the late payment fee (Rule 16<sup>bis</sup>.2).

(b) For the purposes of Article 14(3)(a) and (b), “the fee prescribed under Article 4(2)” means the international filing fee (Rule 15.1) and, where required, the late payment fee (Rule 16<sup>bis</sup>.2).

## **Rule 28**

### **Defects Noted by the International Bureau**

#### *28.1 Note on Certain Defects*

(a) If, in the opinion of the International Bureau, the international application contains any of the defects referred to in Article 14(1)(a)(i), (ii), or (v), the International Bureau shall bring such defects to the attention of the receiving Office.

(b) The receiving Office shall, unless it disagrees with the said opinion, proceed as provided in Article 14(1)(b) and Rule 26.

## **Rule 29**

### **International Applications Considered Withdrawn**

#### *29.1 Finding by Receiving Office*

If the receiving Office declares, under Article 14(1)(b) and Rule 26.5 (failure to correct certain defects), or under Article 14(3)(a) (failure to pay the prescribed fees under Rule 27.1(a)), or under Article 14(4) (later finding of non-compliance with the requirements listed in items (i) to (iii) of Article 11(1)), or under Rule 12.3(d) or 12.4(d) (failure to furnish a required translation or, where applicable, to pay a late furnishing fee), or under Rule 92.4(g)(i) (failure to furnish the original of a document), that the international application is considered withdrawn:

(i) the receiving Office shall transmit the record copy (unless already transmitted), and any correction offered by the applicant, to the International Bureau;

(ii) the receiving Office shall promptly notify both the applicant and the International Bureau of the said declaration, and the International Bureau shall in turn notify each designated Office which has already been notified of its designation;

(iii) the receiving Office shall not transmit the search copy as provided in Rule 23, or, if such copy has already been transmitted, it shall notify the International Searching Authority of the said declaration;

(iv) the International Bureau shall not be required to notify the applicant of the receipt of the record copy.

(b) *[Deleted]*

#### *29.2 [Deleted]*

#### *29.3 Calling Certain Facts to the Attention of the Receiving Office*

If the International Bureau or the International Searching Authority considers that the receiving Office should make a finding under Article 14(4), it shall call the relevant facts to the attention of the receiving Office.

29.4 *Notification of Intent to Make Declaration Under Article 14(4)*

Before the receiving Office issues any declaration under Article 14(4), it shall notify the applicant of its intent to issue such declaration and the reasons therefor. The applicant may, if he disagrees with the tentative finding of the receiving Office, submit arguments to that effect within one month from the notification.

**Rule 30**

**Time Limit Under Article 14(4)**

30.1 *Time Limit*

The time limit referred to in Article 14(4) shall be four months from the international filing date.

**Rule 31**

**Copies Required Under Article 13**

31.1 *Request for Copies*

(a) Requests under Article 13(1) may relate to all, some kinds of, or individual international applications in which the national Office making the request is designated. Requests for all or some kinds of such international applications must be renewed for each year by means of a notification addressed by that Office before November 30 of the preceding year to the International Bureau.

(b) Requests under Article 13(2)(b) shall be subject to the payment of a fee covering the cost of preparing and mailing the copy.

31.2 *Preparation of Copies*

The preparation of copies required under Article 13 shall be the responsibility of the International Bureau.

**Rule 32**

**Extension of Effects of International Application to Certain Successor States**

32.1 *Extension of International Application to Successor State*

(a) The effects of any international application whose international filing date falls in the period defined in paragraph (b) are extended to a State (“the successor State”) whose territory was, before the

independence of that State, part of the territory of a Contracting State designated in the international application which subsequently ceased to exist (“the predecessor State”), provided that the successor State has become a Contracting State through the deposit, with the Director General, of a declaration of continuation the effect of which is that the Treaty is applied by the successor State.

(b) The period referred to in paragraph (a) starts on the day following the last day of the existence of the predecessor State and ends two months after the date on which the declaration referred to in paragraph (a) was notified by the Director General to the Governments of the States party to the Paris Convention for the Protection of Industrial Property. However, where the date of independence of the successor State is earlier than the date of the day following the last day of the existence of the predecessor State, the successor State may declare that the said period starts on the date of its independence; such a declaration shall be made together with the declaration referred to in paragraph (a) and shall specify the date of independence.

(c) Information on any international application whose filing date falls within the applicable period under paragraph (b) and whose effect is extended to the successor State shall be published by the International Bureau in the Gazette.

(d) *[Deleted]*

32.2 *Effects of Extension to Successor State*

(a) Where the effects of the international application are extended to the successor State in accordance with Rule 32.1,

(i) the successor State shall be considered as having been designated in the international application, and

(ii) the applicable time limit under Article 22 or 39(1) in relation to that State shall be extended until the expiration of at least six months from the date of the publication of the information under Rule 32.1(c).

(b) The successor State may fix a time limit which expires later than that provided in paragraph (a)(ii). The International Bureau shall publish information on such time limits in the Gazette.

**Rule 32<sup>bis</sup>**

**[Deleted]**

**Rule 33**

**Relevant Prior Art for the International Search**

33.1 *Relevant Prior Art for the International Search*

(a) For the purposes of Article 15(2), relevant prior art shall consist of everything which has been made available to the public anywhere in the world by means of written disclosure (including drawings and other illustrations) and which is capable of being of assistance in determining that the claimed invention is or is not new and that it does or does not involve an inventive step (i.e., that it is or is not obvious), provided that the making available to the public occurred prior to the international filing date.

(b) When any written disclosure refers to an oral disclosure, use, exhibition, or other means whereby the contents of the written disclosure were made available to the public, and such making available to the public occurred on a date prior to the international filing date, the international search report shall separately mention that fact and the date on which it occurred if the making available to the public of the written disclosure occurred on a date which is the same as, or later than, the international filing date.

(c) Any published application or any patent whose publication date is the same as, or later than, but whose filing date, or, where applicable, claimed priority date, is earlier than the international filing date of the international application searched, and which would constitute relevant prior art for the purposes of Article 15(2) had it been published prior to the international filing date, shall be specially mentioned in the international search report.

33.2 *Fields to Be Covered by the International Search*

(a) The international search shall cover all those technical fields, and shall be carried out on the basis of all those search files, which may contain material pertinent to the invention.

(b) Consequently, not only shall the art in which the invention is classifiable be searched but also analogous arts regardless of where classified.

(c) The question what arts are, in any given case, to be regarded as analogous shall be considered

in the light of what appears to be the necessary essential function or use of the invention and not only the specific functions expressly indicated in the international application.

(d) The international search shall embrace all subject matter that is generally recognized as equivalent to the subject matter of the claimed invention for all or certain of its features, even though, in its specifics, the invention as described in the international application is different.

33.3 *Orientation of the International Search*

(a) International search shall be made on the basis of the claims, with due regard to the description and the drawings (if any) and with particular emphasis on the inventive concept towards which the claims are directed.

(b) In so far as possible and reasonable, the international search shall cover the entire subject matter to which the claims are directed or to which they might reasonably be expected to be directed after they have been amended.

**Rule 34**

**Minimum Documentation**

34.1 *Definition*

(a) The definitions contained in Article 2(i) and (ii) shall not apply for the purposes of this Rule.

(b) The documentation referred to in Article 15(4) (“minimum documentation”) shall consist of:

(i) the “national patent documents” as specified in paragraph (c),

(ii) the published international (PCT) applications, the published regional applications for patents and inventors' certificates, and the published regional patents and inventors' certificates,

(iii) such other published items of nonpatent literature as the International Searching Authorities shall agree upon and which shall be published in a list by the International Bureau when agreed upon for the first time and whenever changed.

(c) Subject to paragraphs (d) and (e), the “national patent documents” shall be the following:

(i) the patents issued in and after 1920 by France, the former *Reichspatentamt* of Germany, Japan, the former Soviet Union, Switzerland (in French and German languages only), the United Kingdom, and the United States of America,

(ii) the patents issued by the Federal Republic of Germany and the Russian Federation,

(iii) the patent applications, if any, published in and after 1920 in the countries referred to in items (i) and (ii),

(iv) the inventors' certificates issued by the former Soviet Union,

(v) the utility certificates issued by, and the published applications for utility certificates of, France,

(vi) such patents issued by, and such patent applications published in, any other country after 1920 as are in the English, French, German, or Spanish language and in which no priority is claimed, provided that the national Office of the interested country sorts out these documents and places them at the disposal of each International Searching Authority.

(d) Where an application is republished once (for example, an *Offenlegungsschrift* as an *Auslegeschrift*) or more than once, no International Searching Authority shall be obliged to keep all versions in its documentation; consequently, each such Authority shall be entitled not to keep more than one version. Furthermore, where an application is granted and is issued in the form of a patent or a utility certificate (France), no International Searching Authority shall be obliged to keep both the application and the patent or utility certificate (France) in its documentation; consequently, each such Authority shall be entitled to keep either the application only or the patent or utility certificate (France) only.

(e) Any International Searching Authority whose official language, or one of whose official languages, is not Japanese, Russian or Spanish is entitled not to include in its documentation those patent documents of Japan, the Russian Federation and the former Soviet Union as well as those patent documents in the Spanish language, respectively, for which no abstracts in the English language are generally available. English abstracts becoming generally available after the date of entry into force of these Regulations shall require the inclusion of the patent documents to which the abstracts refer no later than six months after such abstracts become generally available. In case of the interruption of abstracting services in English in technical fields in which English abstracts were formerly generally available, the Assembly shall take appropri-

ate measures to provide for the prompt restoration of such services in the said fields.

(f) For the purposes of this Rule, applications which have only been laid open for public inspection are not considered published applications.

### Rule 35

#### The Competent International Searching Authority

##### 35.1 *When Only One International Searching Authority Is Competent*

Each receiving Office shall, in accordance with the terms of the applicable agreement referred to in Article 16(3)(b), inform the International Bureau which International Searching Authority is competent for the searching of the international applications filed with it, and the International Bureau shall promptly publish such information.

##### 35.2 *When Several International Searching Authorities Are Competent*

(a) Any receiving Office may, in accordance with the terms of the applicable agreement referred to in Article 16(3)(b), specify several International Searching Authorities:

(i) by declaring all of them competent for any international application filed with it, and leaving the choice to the applicant, or

(ii) by declaring one or more competent for certain kinds of international applications filed with it, and declaring one or more others competent for other kinds of international applications filed with it, provided that, for those kinds of international applications for which several International Searching Authorities are declared to be competent, the choice shall be left to the applicant.

(b) Any receiving Office availing itself of the faculty provided in paragraph (a) shall promptly inform the International Bureau, and the International Bureau shall promptly publish such information.

##### 35.3 *When the International Bureau Is Receiving Office Under Rule 19.1 (a)(iii)*

(a) Where the international application is filed with the International Bureau as receiving Office under Rule 19.1(a)(iii), an International Searching Authority shall be competent for the searching of that international application if it would have been competent had that international application been filed with

a receiving Office competent under Rule 19.1(a)(i) or (ii), (b) or (c), or Rule 19.2(i).

(b) Where two or more International Searching Authorities are competent under paragraph (a), the choice shall be left to the applicant.

(c) Rules 35.1 and 35.2 shall not apply to the International Bureau as receiving Office under Rule 19.1(a)(iii).

### **Rule 36**

#### **Minimum Requirements for International Searching Authorities**

##### *36.1 Definition of Minimum Requirements*

The minimum requirements referred to in Article 16(3)(c) shall be the following:

(i) the national Office or intergovernmental organization must have at least 100 full-time employees with sufficient technical qualifications to carry out searches;

(ii) that Office or organization must have in its possession, or have access to, at least the minimum documentation referred to in Rule 34, properly arranged for search purposes, on paper, in microform or stored on electronic media;

(iii) that Office or organization must have a staff which is capable of searching the required technical fields and which has the language facilities to understand at least those languages in which the minimum documentation referred to in Rule 34 is written or is translated;

(iv) that Office or organization must hold an appointment as an International Preliminary Examining Authority.

### **Rule 37**

#### **Missing or Defective Title**

##### *37.1 Lack of Title*

If the international application does not contain a title and the receiving Office has notified the International Searching Authority that it has invited the applicant to correct such defect, the International Searching Authority shall proceed with the international search unless and until it receives notification that the said application is considered withdrawn.

##### *37.2 Establishment of Title*

If the international application does not contain a title and the International Searching Authority has not received a notification from the receiving Office to the effect that the applicant has been invited to furnish a title, or if the said Authority finds that the title does not comply with Rule 4.3, it shall itself establish a title. Such title shall be established in the language in which the international application is to be published or, if a translation into another language was transmitted under Rule 23.1(b) and the International Searching Authority so wishes, in the language of that translation.

### **Rule 38**

#### **Missing or Defective Abstract**

##### *38.1 Lack of Abstract*

If the international application does not contain an abstract and the receiving Office has notified the International Searching Authority that it has invited the applicant to correct such defect, the International Searching Authority shall proceed with the international search unless and until it receives notification that the said application is considered withdrawn.

##### *38.2 Establishment of Abstract*

(a) If the international application does not contain an abstract and the International Searching Authority has not received a notification from the receiving Office to the effect that the applicant has been invited to furnish an abstract, or if the said Authority finds that the abstract does not comply with Rule 8, it shall itself establish an abstract. Such abstract shall be established in the language in which the international application is to be published or, if a translation into another language was transmitted under Rule 23.1(b) and the International Searching Authority so wishes, in the language of that translation.

(b) The applicant may, within one month from the date of mailing of the international search report, submit comments on the abstract established by the International Searching Authority. Where that Authority amends the abstract established by it, it shall notify the amendment to the International Bureau.

**Rule 39****Subject Matter Under Article 17(2)(a)(i)**39.1 *Definition*

No International Searching Authority shall be required to search an international application if, and to the extent to which, its subject matter is any of the following:

- (i) scientific and mathematical theories,
- (ii) plant or animal varieties or essentially biological processes for the production of plants and animals, other than microbiological processes and the products of such processes,
- (iii) schemes, rules, or methods of doing business, performing purely mental acts or playing games,
- (iv) methods for treatment of the human or animal body by surgery or therapy, as well as diagnostic methods,
- (v) mere presentations of information,
- (vi) computer programs to the extent that the International Searching Authority is not equipped to search prior art concerning such programs.

**Rule 40****Lack of Unity of Invention (International Search)**40.1 *Invitation to Pay*

The invitation to pay additional fees provided for in Article 17(3)(a) shall specify the reasons for which the international application is not considered as complying with the requirement of unity of invention and shall indicate the amount to be paid.

40.2 *Additional Fees*

(a) The amount of the additional fee due for searching under Article 17(3)(a) shall be determined by the competent International Searching Authority.

(b) The additional fee due for searching under Article 17(3)(a) shall be payable direct to the International Searching Authority.

(c) Any applicant may pay the additional fee under protest, that is, accompanied by a reasoned statement to the effect that the international application complies with the requirement of unity of invention or that the amount of the required additional fee is excessive. Such protest shall be examined by a three-member board or other special instance of the International Searching Authority or any competent higher authority, which, to the extent that it finds the

protest justified, shall order the total or partial reimbursement to the applicant of the additional fee. On the request of the applicant, the text of both the protest and the decision thereon shall be notified to the designated Offices together with the international search report. The applicant shall submit any translation thereof with the furnishing of the translation of the international application required under Article 22.

(d) The three-member board, special instance or competent higher authority, referred to in paragraph (c), shall not comprise any person who made the decision which is the subject of the protest.

(e) Where the applicant has, under paragraph (c), paid an additional fee under protest, the International Searching Authority may, after a prior review of the justification for the invitation to pay an additional fee, require that the applicant pay a fee for the examination of the protest (“protest fee”). The protest fee shall be paid within one month from the date of the notification to the applicant of the result of the review. If the protest fee is not so paid, the protest shall be considered withdrawn. The protest fee shall be refunded to the applicant where the three-member board, special instance or higher authority referred to in paragraph (c) finds that the protest was entirely justified.

40.3 *Time Limit*

The time limit provided for in Article 17(3)(a) shall be fixed, in each case, according to the circumstances of the case, by the International Searching Authority; it shall not be shorter than 15 or 30 days, respectively, depending on whether the applicant's address is in the same country as or in a different country from that in which the International Searching Authority is located, and it shall not be longer than 45 days, from the date of the invitation.

**Rule 41****Earlier Search Other Than International Search**41.1 *Obligation to Use Results; Refund of Fee*

If reference has been made in the request, in the form provided for in Rule 4.11, to an international-type search carried out under the conditions set out in Article 15(5) or to a search other than an international or international-type search, the International Searching Authority shall, to the extent possible, use the results of the said search in establishing the

international search report on the international application. The International Searching Authority shall refund the search fee, to the extent and under the conditions provided for in the agreement under Article 16(3)(b) or in a communication addressed to and published in the Gazette by the International Bureau, if the international search report could wholly or partly be based on the results of the said search.

#### **Rule 42**

##### **Time Limit for International Search**

###### *42.1 Time Limit for International Search*

The time limit for establishing the international search report or the declaration referred to in Article 17(2)(a) shall be three months from the receipt of the search copy by the International Searching Authority, or nine months from the priority date, whichever time limit expires later.

#### **Rule 43**

##### **The International Search Report**

###### *43.1 Identifications*

The international search report shall identify the International Searching Authority which established it by indicating the name of such Authority, and the international application by indicating the international application number, the name of the applicant, and the international filing date.

###### *43.2 Dates*

The international search report shall be dated and shall indicate the date on which the international search was actually completed. It shall also indicate the filing date of any earlier application whose priority is claimed or, if the priority of more than one earlier application is claimed, the filing date of the earliest among them.

###### *43.3 Classification*

(a) The international search report shall contain the classification of the subject matter at least according to the International Patent Classification.

(b) Such classification shall be effected by the International Searching Authority.

###### *43.4 Language*

Every international search report and any declaration made under Article 17(2)(a) shall be in the lan-

guage in which the international application to which it relates is to be published or, if a translation into another language was transmitted under Rule 23.1(b) and the International Searching Authority so wishes, in the language of that translation.

###### *43.5 Citations*

(a) The international search report shall contain the citations of the documents considered to be relevant.

(b) The method of identifying any cited document shall be regulated by the Administrative Instructions.

(c) Citations of particular relevance shall be specially indicated.

(d) Citations which are not relevant to all the claims shall be cited in relation to the claim or claims to which they are relevant.

(e) If only certain passages of the cited document are relevant or particularly relevant, they shall be identified, for example, by indicating the page, the column, or the lines, where the passage appears. If the entire document is relevant but some passages are of particular relevance, such passages shall be identified unless such identification is not practicable.

###### *43.6 Fields Searched*

(a) The international search report shall list the classification identification of the fields searched. If that identification is effected on the basis of a classification other than the International Patent Classification, the International Searching Authority shall publish the classification used.

(b) If the international search extended to patents, inventors' certificates, utility certificates, utility models, patents or certificates of addition, inventors' certificates of addition, utility certificates of addition, or published applications for any of those kinds of protection, of States, periods, or languages, not included in the minimum documentation as defined in Rule 34, the international search report shall, when practicable, identify the kinds of documents, the States, the periods, and the languages to which it extended. For the purposes of this paragraph, Article 2(ii) shall not apply.

(c) If the international search was based on, or was extended to, any electronic data base, the international search report may indicate the name of the data

base and, where considered useful to others and practicable, the search terms used.

#### 43.7 *Remarks Concerning Unity of Invention*

If the applicant paid additional fees for the international search, the international search report shall so indicate. Furthermore, where the international search was made on the main invention only or on less than all the inventions (Article 17(3)(a)), the international search report shall indicate what parts of the international application were and what parts were not searched.

#### 43.8 *Authorized Officer*

The international search report shall indicate the name of the officer of the International Searching Authority responsible for that report.

#### 43.9 *Additional Matter*

The international search report shall contain no matter other than that specified in Rules 33.1(b) and (c), 43.1 to 43.3, 43.5 to 43.8, and 44.2, and the indication referred to in Article 17(2)(b), provided that the Administrative Instructions may permit the inclusion in the international search report of any additional matter specified in the Administrative Instructions. The international search report shall not contain, and the Administrative Instructions shall not permit the inclusion of, any expressions of opinion, reasoning, arguments, or explanations.

#### 43.10 *Form*

The physical requirements as to the form of the international search report shall be prescribed by the Administrative Instructions.

### **Rule 43<sup>bis</sup>**

#### **Written Opinion of the International Searching Authority**

##### 43<sup>bis</sup>.1 *Written Opinion*

(a) Subject to Rule 69.1(b<sup>bis</sup>), the International Searching Authority shall, at the same time as it establishes the international search report, establish a written opinion as to:

(i) whether the claimed invention appears to be novel, to involve an inventive step (to be non-obvious), and to be industrially applicable;

(ii) whether the international application complies with the requirements of the Treaty and

these Regulations in so far as checked by the International Searching Authority.

The written opinion shall also be accompanied by such other observations as these Regulations provide for.

(b) For the purposes of establishing the written opinion, Articles 33(2) to (6), 35(2) and 35(3) and Rules 43.4, 64, 65, 66.1(e), 66.7, 67, 70.2(b) and (d), 70.3, 70.4(ii), 70.5(a), 70.6 to 70.10, 70.12, 70.14 and 70.15(a) shall apply *mutatis mutandis*.

(c) The written opinion shall contain a notification informing the applicant that, if a demand for international preliminary examination is made, the written opinion shall, under Rule 66.1<sup>bis</sup>(a) but subject to Rule 66.1<sup>bis</sup>(b), be considered to be a written opinion of the International Preliminary Examining Authority for the purposes of Rule 66.2(a), in which case the applicant is invited to submit to that Authority, before the expiration of the time limit under Rule 54<sup>bis</sup>.1(a), a written reply together, where appropriate, with amendments.

### **Rule 44**

#### **Transmittal of the International Search Report, Written Opinion, Etc.**

##### 44.1 *Copies of Report or Declaration and Written Opinion*

The International Searching Authority shall, on the same day, transmit one copy of the international search report and the written opinion established under Rule 43<sup>bis</sup>.1, or of the declaration referred to in Article 17(2)(a), to the International Bureau and one copy to the applicant.

##### 44.2 *Title or Abstract*

The international search report shall either state that the International Searching Authority approves the title and the abstract as submitted by the applicant or be accompanied by the text of the title and/or abstract as established by the International Searching Authority under Rules 37 and 38.

##### 44.3 *Copies of Cited Documents*

(a) The request referred to in Article 20(3) may be presented any time during seven years from the international filing date of the international application to which the international search report relates.



(b) The International Searching Authority may require that the party (applicant or designated Office) presenting the request pay to it the cost of preparing and mailing the copies. The level of the cost of preparing copies shall be provided for in the agreements referred to in Article 16(3)(b) between the International Searching Authorities and the International Bureau.

(c) *[Deleted]*

(d) Any International Searching Authority may perform the obligations referred to in paragraphs (a) and (b) through another agency responsible to it.

### Rule 44<sup>bis</sup>

#### International Preliminary Report on Patentability by the International Searching Authority

##### 44<sup>bis</sup>.1 *Issuance of Report; Transmittal to the Applicant*

(a) Unless an international preliminary examination report has been or is to be established, the International Bureau shall issue a report on behalf of the International Searching Authority (in this Rule referred to as “the report”) as to the matters referred to in Rule 43<sup>bis</sup>.1(a). The report shall have the same contents as the written opinion established under Rule 43<sup>bis</sup>.1.

(b) The report shall bear the title “international preliminary report on patentability (Chapter I of the Patent Cooperation Treaty)” together with an indication that it is issued under this Rule by the International Bureau on behalf of the International Searching Authority.

(c) The International Bureau shall promptly transmit one copy of the report issued under paragraph (a) to the applicant.

##### 44<sup>bis</sup>.2 *Communication to Designated Offices*

(a) Where a report has been issued under Rule 44<sup>bis</sup>.1, the International Bureau shall communicate it to each designated Office in accordance with Rule 93<sup>bis</sup>.1 but not before the expiration of 30 months from the priority date.

(b) Where the applicant makes an express request to a designated Office under Article 23(2), the International Bureau shall communicate a copy of the written opinion established by the International

Searching Authority under Rule 43<sup>bis</sup>.1 to that Office promptly upon the request of that Office or of the applicant.

##### 44<sup>bis</sup>.3 *Translation for Designated Offices*

(a) Any designated State may, where a report has been issued under Rule 44<sup>bis</sup>.1 in a language other than the official language, or one of the official languages, of its national Office, require a translation of the report into English. Any such requirement shall be notified to the International Bureau, which shall promptly publish it in the Gazette.

(b) If a translation is required under paragraph (a), it shall be prepared by or under the responsibility of the International Bureau.

(c) The International Bureau shall transmit a copy of the translation to any interested designated Office and to the applicant at the same time as it communicates the report to that Office.

(d) In the case referred to in Rule 44<sup>bis</sup>.2(b), the written opinion established under Rule 43<sup>bis</sup>.1 shall, upon request of the designated Office concerned, be translated into English by or under the responsibility of the International Bureau. The International Bureau shall transmit a copy of the translation to the designated Office concerned within two months from the date of receipt of the request for translation, and shall at the same time transmit a copy to the applicant.

##### 44<sup>bis</sup>.4 *Observations on the Translation*

The applicant may make written observations as to the correctness of the translation referred to in Rule 44<sup>bis</sup>.3(b) or (d) and shall send a copy of the observations to each of the interested designated Offices and to the International Bureau.

### Rule 44<sup>ter</sup>

#### Confidential Nature of Written Opinion, Report, Translation and Observations

##### 44<sup>ter</sup>.1 *Confidential Nature*

(a) The International Bureau and the International Searching Authority shall not, unless requested or authorized by the applicant, allow access by any person or authority before the expiration of 30 months from the priority date:

(i) to the written opinion established under Rule 43<sup>bis</sup>.1, to any translation thereof prepared under Rule 44<sup>bis</sup>.3(d) or to any written observations on such translation sent by the applicant under Rule 44<sup>bis</sup>.4;

(ii) if a report is issued under Rule 44<sup>bis</sup>.1, to that report, to any translation of it prepared under Rule 44<sup>bis</sup>.3(b) or to any written observations on that translation sent by the applicant under Rule 44<sup>bis</sup>.4.

(b) For the purposes of paragraph (a), the term “access” covers any means by which third parties may acquire cognizance, including individual communication and general publication.

#### **Rule 45**

##### **Translation of the International Search Report**

###### *45.1 Languages*

International search reports and declarations referred to in Article 17(2)(a) shall, when not in English, be translated into English.

#### **Rule 46**

##### **Amendment of Claims Before the International Bureau**

###### *46.1 Time Limit*

The time limit referred to in Article 19 shall be two months from the date of transmittal of the international search report to the International Bureau and to the applicant by the International Searching Authority or 16 months from the priority date, whichever time limit expires later, provided that any amendment made under Article 19 which is received by the International Bureau after the expiration of the applicable time limit shall be considered to have been received by that Bureau on the last day of that time limit if it reaches it before the technical preparations for international publication have been completed.

###### *46.2 Where to File*

Amendments made under Article 19 shall be filed directly with the International Bureau.

###### *46.3 Language of Amendments*

If the international application has been filed in a language other than the language in which it is published, any amendment made under Article 19 shall be in the language of publication.

###### *46.4 Statement*

(a) The statement referred to in Article 19(1) shall be in the language in which the international application is published and shall not exceed 500 words if in the English language or if translated into that language. The statement shall be identified as such by a heading, preferably by using the words “Statement under Article 19(1)” or their equivalent in the language of the statement.

(b) The statement shall contain no disparaging comments on the international search report or the relevance of citations contained in that report. Reference to citations, relevant to a given claim, contained in the international search report may be made only in connection with an amendment of that claim.

###### *46.5 Form of Amendments*

The applicant shall be required to submit a replacement sheet for every sheet of the claims which, on account of an amendment or amendments under Article 19, differs from the sheet originally filed. The letter accompanying the replacement sheets shall draw attention to the differences between the replaced sheets and the replacement sheets. To the extent that any amendment results in the cancellation of an entire sheet, that amendment shall be communicated in a letter.

#### **Rule 47**

##### **Communication to Designated Offices**

###### *47.1 Procedure*

(a) The communication provided for in Article 20 shall be effected by the International Bureau to each designated Office in accordance with Rule 93<sup>bis</sup>.1 but, subject to Rule 47.4, not prior to the international publication of the international application.

(a<sup>bis</sup>) The International Bureau shall notify each designated Office, in accordance with Rule 93<sup>bis</sup>.1, of the fact and date of receipt of the record copy and of the fact and date of receipt of any priority document.

(a<sup>ter</sup>) The notification under paragraph (a<sup>bis</sup>) shall include any declaration referred to in Rule 4.17(i) to (iv), and any correction thereof under Rule 26<sup>ter</sup>.1, which was received by the International Bureau before the expiration of the time limit under Rule 26<sup>ter</sup>.1, provided that the designated Office has informed the International Bureau that the applicable

national law requires the furnishing of documents or evidence relating to the matter to which the declaration relates.

(b) Any amendment received by the International Bureau within the time limit under Rule 46.1 which was not included in the communication provided for in Article 20 shall be communicated promptly to the designated Offices by the International Bureau, and the latter shall notify the applicant accordingly.

(c) The International Bureau shall, promptly after the expiration of 28 months from the priority date, send a notice to the applicant indicating:

(i) the designated Offices which have requested that the communication provided for in Article 20 be effected under Rule 93<sup>bis</sup>.1 and the date of such communication to those Offices; and

(ii) the designated Offices which have not requested that the communication provided for in Article 20 be effected under Rule 93<sup>bis</sup>.1.

(c<sup>bis</sup>) The notice referred to in paragraph (c) shall be accepted by designated Offices:

(i) in the case of a designated Office referred to in paragraph (c)(i), as conclusive evidence that the communication provided for in Article 20 was effected on the date specified in the notice;

(ii) in the case of a designated Office referred to in paragraph (c)(ii), as conclusive evidence that the Contracting State for which that Office acts as designated Office does not require the furnishing, under Article 22, by the applicant of a copy of the international application.

(d) Each designated Office shall, when it so requires, receive the international search reports and the declarations referred to in Article 17(2)(a) also in the translation referred to in Rule 45.1.

(e) Where any designated Office has not, before the expiration of 28 months from the priority date, requested the International Bureau to effect the communication provided for in Article 20 in accordance with Rule 93<sup>bis</sup>.1, the Contracting State for which that Office acts as designated Office shall be considered to have notified the International Bureau, under Rule 49.1(a<sup>bis</sup>), that it does not require the furnishing, under Article 22, by the applicant of a copy of the international application.

#### 47.2 *Copies*

The copies required for communication shall be prepared by the International Bureau. Further details concerning the copies required for communication may be provided for in the Administrative Instructions.

(b) *[Deleted]*

(c) *[Deleted]*

#### 47.3 *Languages*

(a) The international application communicated under Article 20 shall be in the language in which it is published.

(b) Where the language in which the international application is published is different from the language in which it was filed, the International Bureau shall furnish to any designated Office, upon the request of that Office, a copy of that application in the language in which it was filed.

#### 47.4 *Express Request Under Article 23(2) Prior to International Publication*

Where the applicant makes an express request to a designated Office under Article 23(2) prior to the international publication of the international application, the International Bureau shall, upon request of the applicant or the designated Office, promptly effect the communication provided for in Article 20 to that Office.

### **Rule 48**

#### **International Publication**

##### 48.1 *Form*

(a) The international application shall be published in the form of a pamphlet.

(b) The particulars regarding the form of the pamphlet and the method of reproduction shall be governed by the Administrative Instructions.

##### 48.2 *Contents*

(a) The pamphlet shall contain:

(i) a standardized front page,

(ii) the description,

(iii) the claims,

(iv) the drawings, if any,

(v) subject to paragraph (g), the international search report or the declaration under Article 17(2)(a); the publication of the international search report in the pamphlet shall, however, not be required to include

the part of the international search report which contains only matter referred to in Rule 43 already appearing on the front page of the pamphlet,

(vi) any statement filed under Article 19(1), unless the International Bureau finds that the statement does not comply with the provisions of Rule 46.4,

(vii) any request for rectification referred to in the third sentence of Rule 91.1(f),

(viii) the relevant data from any indications in relation to deposited biological material furnished under Rule 13<sup>bis</sup> separately from the description, together with an indication of the date on which the International Bureau received such indications,

(ix) any information concerning a priority claim considered not to have been made under Rule 26<sup>bis</sup>.2(b), the publication of which is requested under Rule 26<sup>bis</sup>.2(c),

(x) any declaration referred to in Rule 4.17(v), and any correction thereof under Rule 26<sup>ter</sup>.1, which was received by the International Bureau before the expiration of the time limit under Rule 26<sup>ter</sup>.1.

(b) Subject to paragraph (c), the front page shall include:

(i) data taken from the request sheet and such other data as are prescribed by the Administrative Instructions,

(ii) a figure or figures where the international application contains drawings, unless Rule 8.2(b) applies,

(iii) the abstract; if the abstract is both in English and in another language, the English text shall appear first,

(iv) an indication that the request contains any declaration referred to in Rule 4.17 which was received by the International Bureau before the expiration of the time limit under Rule 26<sup>ter</sup>.1.

(c) Where a declaration under Article 17(2)(a) has issued, the front page shall conspicuously refer to that fact and need include neither a drawing nor an abstract.

(d) The figure or figures referred to in paragraph (b)(ii) shall be selected as provided in Rule 8.2. Reproduction of such figure or figures on the front page may be in a reduced form.

(e) If there is not enough room on the front page for the totality of the abstract referred to in paragraph (b)(iii), the said abstract shall appear on the back of the front page. The same shall apply to the translation of the abstract when such translation is required to be published under Rule 48.3(c).

(f) If the claims have been amended under Article 19, the publication shall contain either the full text of the claims both as filed and as amended or the full text of the claims as filed and specify the amendments. Any statement referred to in Article 19(1) shall be included as well, unless the International Bureau finds that the statement does not comply with the provisions of Rule 46.4. The date of receipt of the amended claims by the International Bureau shall be indicated.

(g) If, at the time of the completion of the technical preparations for international publication, the international search report is not yet available (for example, because of publication on the request of the applicant as provided in Articles 21(2)(b) and 64(3)(c)(i)), the pamphlet shall contain, in place of the international search report, an indication to the effect that that report was not available and that either the pamphlet (then also including the international search report) will be republished or the international search report (when it becomes available) will be separately published.

(h) If, at the time of the completion of the technical preparations for international publication, the time limit for amending the claims under Article 19 has not expired, the pamphlet shall refer to that fact and indicate that, should the claims be amended under Article 19, then, promptly after such amendments, either the pamphlet (containing the claims as amended) will be republished or a statement reflecting all the amendments will be published. In the latter case, at least the front page and the claims shall be republished and, if a statement under Article 19(1) has been filed, that statement shall be published as well, unless the International Bureau finds that the statement does not comply with the provisions of Rule 46.4.

(i) The Administrative Instructions shall determine the cases in which the various alternatives referred to in paragraphs (g) and (h) shall apply. Such determination shall depend on the volume and com-

plexity of the amendments and/or the volume of the international application and the cost factors.

#### 48.3 *Languages of Publication*

(a) If the international application is filed in Chinese, English, French, German, Japanese, Russian or Spanish (“languages of publication”), that application shall be published in the language in which it was filed.

(b) If the international application is not filed in a language of publication and a translation into a language of publication has been furnished under Rule 12.3 or 12.4, that application shall be published in the language of that translation.

(c) If the international application is published in a language other than English, the international search report to the extent that it is published under Rule 48.2(a)(v), or the declaration referred to in Article 17(2)(a), the title of the invention, the abstract and any text matter pertaining to the figure or figures accompanying the abstract shall be published both in that language and in English. The translations shall be prepared under the responsibility of the International Bureau.

#### 48.4 *Earlier Publication on the Applicant’s Request*

(a) Where the applicant asks for publication under Articles 21(2)(b) and 64(3)(c)(i) and the international search report, or the declaration referred to in Article 17(2)(a), is not yet available for publication together with the international application, the International Bureau shall collect a special publication fee whose amount shall be fixed in the Administrative Instructions.

(b) Publication under Articles 21(2)(b) and 64(3)(c)(i) shall be effected by the International Bureau promptly after the applicant has asked for it and, where a special fee is due under paragraph (a), after receipt of such fee.

#### 48.5 *Notification of National Publication*

Where the publication of the international application by the International Bureau is governed by Article 64(3)(c)(ii), the national Office concerned shall, promptly after effecting the national publication referred to in the said provision, notify the International Bureau of the fact of such national publication.

#### 48.6 *Announcing of Certain Facts*

(a) If any notification under Rule 29.1(ii) reaches the International Bureau at a time later than that at which it was able to prevent the international publication of the international application, the International Bureau shall promptly publish a notice in the Gazette reproducing the essence of such notification.

(b) *[Deleted]*

(c) If the international application, the designation of any designated State or the priority claim is withdrawn under Rule 90<sup>bis</sup> after the technical preparations for international publication have been completed, notice of the withdrawal shall be published in the *Gazette*.

### **Rule 49**

#### **Copy, Translation and Fee Under Article 22**

##### 49.1 *Notification*

(a) Any Contracting State requiring the furnishing of a translation or the payment of a national fee, or both, under Article 22, shall notify the International Bureau of:

- (i) the languages from which and the language into which it requires translation,
- (ii) the amount of the national fee.

(a<sup>bis</sup>) Any Contracting State not requiring the furnishing, under Article 22, by the applicant of a copy of the international application (even though the communication of the copy of the international application by the International Bureau under Rule 47 has not taken place by the expiration of the time limit applicable under Article 22) shall notify the International Bureau accordingly.

(a<sup>ter</sup>) Any Contracting State which, pursuant to Article 24(2), maintains, if it is a designated State, the effect provided for in Article 11(3) even though a copy of the international application is not furnished by the applicant by the expiration of the time limit applicable under Article 22 shall notify the International Bureau accordingly.

(b) Any notification received by the International Bureau under paragraphs (a), (a<sup>bis</sup>) or (a<sup>ter</sup>) shall be promptly published by the International Bureau in the *Gazette*.

(c) If the requirements under paragraph (a) change later, such changes shall be notified by the Contracting State to the International Bureau and that

Bureau shall promptly publish the notification in the Gazette. If the change means that translation is required into a language which, before the change, was not required, such change shall be effective only with respect to international applications filed later than two months after the publication of the notification in the Gazette. Otherwise, the effective date of any change shall be determined by the Contracting State.

#### 49.2 *Languages*

The language into which translation may be required must be an official language of the designated Office. If there are several of such languages, no translation may be required if the international application is in one of them. If there are several official languages and a translation must be furnished, the applicant may choose any of those languages. Notwithstanding the foregoing provisions of this paragraph, if there are several official languages but the national law prescribes the use of one such language for foreigners, a translation into that language may be required.

#### 49.3 *Statements Under Article 19; Indications Under Rule 13<sup>bis.4</sup>*

For the purposes of Article 22 and the present Rule, any statement made under Article 19(1) and any indication furnished under Rule 13<sup>bis.4</sup> shall, subject to Rule 49.5(c) and (h), be considered part of the international application.

#### 49.4 *Use of National Form*

No applicant shall be required to use a national form when performing the acts referred to in Article 22.

#### 49.5 *Contents of and Physical Requirements for the Translation*

(a) For the purposes of Article 22, the translation of the international application shall contain the description (subject to paragraph (a<sup>bis</sup>)), the claims, any text matter of the drawings, and the abstract. If required by the designated Office, the translation shall also, subject to paragraphs (b), (c<sup>bis</sup>) and (e),

- (i) contain the request,
- (ii) if the claims have been amended under Article 19, contain both the claims as filed and the claims as amended, and

(iii) be accompanied by a copy of the drawings.

(a<sup>bis</sup>) No designated Office shall require the applicant to furnish to it a translation of any text matter contained in the sequence listing part of the description if such sequence listing part complies with Rule 12.1(d) and if the description complies with Rule 5.2(b).

(b) Any designated Office requiring the furnishing of a translation of the request shall furnish copies of the request form in the language of the translation free of charge to the applicants. The form and contents of the request form in the language of the translation shall not be different from those of the request under Rules 3 and 4; in particular, the request form in the language of the translation shall not ask for any information that is not in the request as filed. The use of the request form in the language of the translation shall be optional.

(c) Where the applicant did not furnish a translation of any statement made under Article 19(1), the designated Office may disregard such statement.

(c<sup>bis</sup>) Where the applicant furnishes, to a designated Office which requires under paragraph (a)(ii) a translation of both the claims as filed and the claims as amended, only one of the required two translations, the designated Office may disregard the claims of which a translation has not been furnished or invite the applicant to furnish the missing translation within a time limit which shall be reasonable under the circumstances and shall be fixed in the invitation. Where the designated Office chooses to invite the applicant to furnish the missing translation and the latter is not furnished within the time limit fixed in the invitation, the designated Office may disregard those claims of which a translation has not been furnished or consider the international application withdrawn.

(d) If any drawing contains text matter, the translation of that text matter shall be furnished either in the form of a copy of the original drawing with the translation pasted on the original text matter or in the form of a drawing executed anew.

(e) Any designated Office requiring under paragraph (a) the furnishing of a copy of the drawings shall, where the applicant failed to furnish such copy within the time limit applicable under Article 22, invite the applicant to furnish such copy within a time

limit which shall be reasonable under the circumstances and shall be fixed in the invitation.

(f) The expression “Fig.” does not require translation into any language.

(g) Where any copy of the drawings or any drawing executed anew which has been furnished under paragraph (d) or (e) does not comply with the physical requirements referred to in Rule 11, the designated Office may invite the applicant to correct the defect within a time limit which shall be reasonable under the circumstances and shall be fixed in the invitation.

(h) Where the applicant did not furnish a translation of the abstract or of any indication furnished under Rule 13<sup>bis</sup>.4, the designated Office shall invite the applicant to furnish such translation, if it deems it to be necessary, within a time limit which shall be reasonable under the circumstances and shall be fixed in the invitation.

(i) Information on any requirement and practice of designated Offices under the second sentence of paragraph (a) shall be published by the International Bureau in the Gazette.

(j) No designated Office shall require that the translation of the international application comply with physical requirements other than those prescribed for the international application as filed.

(k) Where a title has been established by the International Searching Authority pursuant to Rule 37.2, the translation shall contain the title as established by that Authority.

(l) If, on July 12, 1991, paragraph (c<sup>bis</sup>) or paragraph (k) is not compatible with the national law applied by the designated Office, the paragraph concerned shall not apply to that designated Office for as long as it continues not to be compatible with that law, provided that the said Office informs the International Bureau accordingly by December 31, 1991. The information received shall be promptly published by the International Bureau in the Gazette.

#### 49.6 Reinstatement of Rights After Failure to Perform the Acts Referred to in Article 22

(a) Where the effect of the international application provided for in Article 11(3) has ceased because the applicant failed to perform the acts

referred to in Article 22 within the applicable time limit, the designated Office shall, upon request of the applicant, and subject to paragraphs (b) to (e) of this Rule, reinstate the rights of the applicant with respect to that international application if it finds that any delay in meeting that time limit was unintentional or, at the option of the designated Office, that the failure to meet that time limit occurred in spite of due care required by the circumstances having been taken.

(b) The request under paragraph (a) shall be submitted to the designated Office, and the acts referred to in Article 22 shall be performed, within whichever of the following periods expires first:

(i) two months from the date of removal of the cause of the failure to meet the applicable time limit under Article 22; or

(ii) 12 months from the date of the expiration of the applicable time limit under Article 22; provided that the applicant may submit the request at any later time if so permitted by the national law applicable by the designated Office.

(c) The request under paragraph (a) shall state the reasons for the failure to comply with the applicable time limit under Article 22.

(d) The national law applicable by the designated Office may require:

(i) that a fee be paid in respect of a request under paragraph (a);

(ii) that a declaration or other evidence in support of the reasons referred to in paragraph (c) be filed.

(e) The designated Office shall not refuse a request under paragraph (a) without giving the applicant the opportunity to make observations on the intended refusal within a time limit which shall be reasonable under the circumstances.

(f) If, on October 1, 2002, paragraphs (a) to (e) are not compatible with the national law applied by the designated Office, those paragraphs shall not apply in respect of that designated Office for as long as they continue not to be compatible with that law, provided that the said Office informs the International Bureau accordingly by January 1, 2003. The information received shall be promptly published by the International Bureau in the Gazette.

**Rule 49<sup>bis</sup>**

**Indications as to Protection Sought for Purposes of National Processing**

*49<sup>bis</sup>.1 Choice of Certain Kinds of Protection*

(a) If the applicant wishes the international application to be treated, in a designated State in respect of which Article 43 applies, as an application not for the grant of a patent but for the grant of another kind of protection referred to in that Article, the applicant, when performing the acts referred to in Article 22, shall so indicate to the designated Office.

(b) If the applicant wishes the international application to be treated, in a designated State in respect of which Article 44 applies, as an application for the grant of more than one kind of protection referred to in Article 43, the applicant, when performing the acts referred to in Article 22, shall so indicate to the designated Office and shall indicate, if applicable, which kind of protection is sought primarily and which kind is sought subsidiarily.

(c) In the cases referred to in paragraphs (a) and (b), if the applicant wishes the international application to be treated, in a designated State, as an application for a patent of addition, certificate of addition, inventor's certificate of addition or utility certificate of addition, the applicant, when performing the acts referred to in Article 22, shall indicate the relevant parent application, parent patent or other parent grant.

(d) If the applicant wishes the international application to be treated, in a designated State, as an application for a continuation or a continuation-in-part of an earlier application, the applicant, when performing the acts referred to in Article 22, shall so indicate to the designated Office and shall indicate the relevant parent application.

(e) Where no express indication under paragraph (a) is made by the applicant when performing the acts referred to in Article 22 but the national fee referred to in Article 22 paid by the applicant corresponds to the national fee for a particular kind of protection, the payment of that fee shall be considered to be an indication of the wish of the applicant that the international application is to be treated as an application for that kind of protection and the designated Office shall inform the applicant accordingly.

*49<sup>bis</sup>.2 Time of Furnishing Indications*

(a) No designated Office shall require the applicant to furnish, before performing the acts referred to in Article 22, any indication referred to in Rule 49<sup>bis</sup>.1 or, where applicable, any indication as to whether the applicant seeks the grant of a national patent or a regional patent.

(b) The applicant may, if so permitted by the national law applicable by the designated Office concerned, furnish such indication or, if applicable, convert from one kind of protection to another, at any later time.

**Rule 50**

**Faculty Under Article 22(3)**

*50.1 Exercise of Faculty*

(a) Any Contracting State allowing a time limit expiring later than the time limits provided for in Article 22(1) or (2) shall notify the International Bureau of the time limits so fixed.

(b) Any notification received by the International Bureau under paragraph (a) shall be promptly published by the International Bureau in the Gazette.

(c) Notifications concerning the shortening of the previously fixed time limit shall be effective in relation to international applications filed after the expiration of three months computed from the date on which the notification was published by the International Bureau.

(d) Notifications concerning the lengthening of the previously fixed time limit shall become effective upon publication by the International Bureau in the Gazette in respect of international applications pending at the time or filed after the date of such publication, or, if the Contracting State effecting the notification fixes some later date, as from the latter date.

**Rule 51**

**Review by Designated Offices**

*51.1 Time Limit for Presenting the Request to Send Copies*

The time limit referred to in Article 25(1)(c) shall be two months computed from the date of the notification sent to the applicant under Rule 20.7(i), 24.2(c) or 29.1(ii).



51.2 *Copy of the Notice*

Where the applicant, after having received a negative determination under Article 11(1), requests the International Bureau, under Article 25(1), to send copies of the file of the purported international application to any of the named Offices he has attempted to designate, he shall attach to his request a copy of the notice referred to in Rule 20.7(i).

51.3 *Time Limit for Paying National Fee and Furnishing Translation*

The time limit referred to in Article 25(2)(a) shall expire at the same time as the time limit prescribed in Rule 51.1.

**Rule 51<sup>bis</sup>**

**Certain National Requirements Allowed Under Article 27**

51<sup>bis</sup>.1 *Certain National Requirements Allowed*

(a) Subject to Rule 51<sup>bis</sup>.2, the national law applicable by the designated Office may, in accordance with Article 27, require the applicant to furnish, in particular:

- (i) any document relating to the identity of the inventor,
- (ii) any document relating to the applicant's entitlement to apply for or be granted a patent,
- (iii) any document containing any proof of the applicant's entitlement to claim priority of an earlier application where the applicant is not the applicant who filed the earlier application or where the applicant's name has changed since the date on which the earlier application was filed,
- (iv) where the international application designates a State whose national law requires that national applications be filed by the inventor, any document containing an oath or declaration of inventorship,
- (v) any evidence concerning non-prejudicial disclosures or exceptions to lack of novelty, such as disclosures resulting from abuse, disclosures at certain exhibitions and disclosures by the applicant during a certain period of time;
- (vi) the confirmation of the international application by the signature of any applicant for the designated State who has not signed the request;

(vii) any missing indication required under Rule 4.5(a)(ii) and (iii) in respect of any applicant for the designated State.

(b) The national law applicable by the designated Office may, in accordance with Article 27(7), require that

(i) the applicant be represented by an agent having the right to represent applicants before that Office and/or have an address in the designated State for the purpose of receiving notifications,

(ii) the agent, if any, representing the applicant be duly appointed by the applicant.

(c) The national law applicable by the designated Office may, in accordance with Article 27(1), require that the international application, the translation thereof or any document relating thereto be furnished in more than one copy.

(d) The national law applicable by the designated Office may, in accordance with Article 27(2)(ii), require that the translation of the international application furnished by the applicant under Article 22 be:

(i) verified by the applicant or the person having translated the international application in a statement to the effect that, to the best of his knowledge, the translation is complete and faithful;

(ii) certified by a public authority or sworn translator, but only where the designated Office may reasonably doubt the accuracy of the translation.

(e) The national law applicable by the designated Office may, in accordance with Article 27, require the applicant to furnish a translation of the priority document, provided that such a translation may only be required where the validity of the priority claim is relevant to the determination of whether the invention concerned is patentable.

(f) If, on March 17, 2000, the proviso in paragraph (e) is not compatible with the national law applied by the designated Office, that proviso shall not apply in respect of that Office for as long as that proviso continues not to be compatible with that law, provided that the said Office informs the International Bureau accordingly by November 30, 2000. The information received shall be promptly published by the International Bureau in the Gazette.

*51<sup>bis</sup>.2 Certain Circumstances in Which Documents or Evidence May Not Be Required*

(a) Where the applicable national law does not require that national applications be filed by the inventor, the designated Office shall not, unless it may reasonably doubt the veracity of the indications or declaration concerned, require any document or evidence:

(i) relating to the identity of the inventor (Rule 51<sup>bis</sup>.1(a)(i)), if indications concerning the inventor, in accordance with Rule 4.6, are contained in the request or if a declaration as to the identity of the inventor, in accordance with Rule 4.17(i), is contained in the request or is submitted directly to the designated Office;

(ii) relating to the applicant's entitlement, as at the international filing date, to apply for and be granted a patent (Rule 51<sup>bis</sup>.1(a)(ii)), if a declaration as to that matter, in accordance with Rule 4.17(ii), is contained in the request or is submitted directly to the designated Office;

(iii) relating to the applicant's entitlement, as at the international filing date, to claim priority of an earlier application (Rule 51<sup>bis</sup>.1(a)(iii)), if a declaration as to that matter, in accordance with Rule 4.17(iii), is contained in the request or is submitted directly to the designated Office.

(b) Where the applicable national law requires that national applications be filed by the inventor, the designated Office shall not, unless it may reasonably doubt the veracity of the indications or declaration concerned, require any document or evidence:

(i) relating to the identity of the inventor (Rule 51<sup>bis</sup>.1(a)(i)) (other than a document containing an oath or declaration of inventorship (Rule 51<sup>bis</sup>.1(a)(iv))), if indications concerning the inventor, in accordance with Rule 4.6, are contained in the request;

(ii) relating to the applicant's entitlement, as at the international filing date, to claim priority of an earlier application (Rule 51<sup>bis</sup>.1(a)(iii)), if a declaration as to that matter, in accordance with Rule 4.17(iii), is contained in the request or is submitted directly to the designated Office;

(iii) containing an oath or declaration of inventorship (Rule 51<sup>bis</sup>.1(a)(iv)), if a declaration of inventorship, in accordance with Rule 4.17(iv), is

contained in the request or is submitted directly to the designated Office.

(c) If, on March 17, 2000, paragraph (a) is not compatible, in relation to any item of that paragraph, with the national law applied by the designated Office, paragraph (a) shall not apply in respect of that Office in relation to that item for as long as it continues not to be compatible with that law, provided that the said Office informs the International Bureau accordingly by November 30, 2000. The information received shall be promptly published by the International Bureau in the Gazette.

*51<sup>bis</sup>.3 Opportunity to Comply with National Requirements*

(a) Where any of the requirements referred to in Rule 51<sup>bis</sup>.1(a)(i) to (iv) and (c) to (e), or any other requirement of the national law applicable by the designated Office which that Office may apply in accordance with Article 27(1) or (2), is not already fulfilled during the same period within which the requirements under Article 22 must be complied with, the designated Office shall invite the applicant to comply with the requirement within a time limit which shall not be less than two months from the date of the invitation. Each designated Office may require that the applicant pay a fee for complying with national requirements in response to the invitation.

(b) Where any requirement of the national law applicable by the designated Office which that Office may apply in accordance with Article 27(6) or (7) is not already fulfilled during the same period within which the requirements under Article 22 must be complied with, the applicant shall have an opportunity to comply with the requirement after the expiration of that period.

(c) If, on March 17, 2000, paragraph (a) is not compatible with the national law applied by the designated Office in relation to the time limit referred to in that paragraph, the said paragraph shall not apply in respect of that Office in relation to that time limit for as long as the said paragraph continues not to be compatible with that law, provided that the said Office informs the International Bureau accordingly by November 30, 2000. The information received shall be promptly published by the International Bureau in the Gazette.

**Rule 52**

**Amendment of the Claims, the Description, and the Drawings, Before Designated Offices**

*52.1 Time Limit*

(a) In any designated State in which processing or examination starts without special request, the applicant shall, if he so wishes, exercise the right under Article 28 within one month from the fulfillment of the requirements under Article 22, provided that, if the communication under Rule 47.1 has not been effected by the expiration of the time limit applicable under Article 22, he shall exercise the said right not later than four months after such expiration date. In either case, the applicant may exercise the said right at any later time if so permitted by the national law of the said State.

(b) In any designated State in which the national law provides that examination starts only on special request, the time limit within or the time at which the applicant may exercise the right under Article 28 shall be the same as that provided by the national law for the filing of amendments in the case of the examination, on special request, of national applications, provided that such time limit shall not expire prior to, or such time shall not come before, the expiration of the time limit applicable under paragraph (a).

**PART C**

**Rules Concerning Chapter II of the Treaty**

**Rule 53**

**The Demand**

*53.1 Form*

(a) The demand shall be made on a printed form or be presented as a computer printout. The particulars of the printed form and of a demand presented as a computer printout shall be prescribed by the Administrative Instructions.

(b) Copies of printed demand forms shall be furnished free of charge by the receiving Office or by the International Preliminary Examining Authority.

(c) *[Deleted]*

*53.2 Contents*

(a) The demand shall contain:

- (i) a petition,
  - (ii) indications concerning the applicant and the agent if there is an agent,
  - (iii) indications concerning the international application to which it relates,
  - (iv) where applicable, a statement concerning amendments.
- (b) The demand shall be signed.

*53.3 The Petition*

The petition shall be to the following effect and shall preferably be worded as follows: “Demand under Article 31 of the Patent Cooperation Treaty: The undersigned requests that the international application specified below be the subject of international preliminary examination according to the Patent Cooperation Treaty.”

*53.4 The Applicant*

As to the indications concerning the applicant, Rules 4.4 and 4.16 shall apply, and Rule 4.5 shall apply *mutatis mutandis*.

*53.5 Agent or Common Representative*

If an agent or common representative is appointed, the demand shall so indicate. Rules 4.4 and 4.16 shall apply, and Rule 4.7 shall apply *mutatis mutandis*.

*53.6 Identification of the International Application*

The international application shall be identified by the name and address of the applicant, the title of the invention, the international filing date (if known to the applicant) and the international application number or, where such number is not known to the applicant, the name of the receiving Office with which the international application was filed.

*53.7 Election of States*

The filing of a demand shall constitute the election of all Contracting States which are designated and are bound by Chapter II of the Treaty.

*53.8 Signature*

(a) Subject to paragraph (b), the demand shall be signed by the applicant or, if there is more than one applicant, by all applicants making the demand.

(b) Where two or more applicants file a demand which elects a State whose national law requires that national applications be filed by the inventor and where an applicant for that elected State who is an inventor refused to sign the demand or could not be

found or reached after diligent effort, the demand need not be signed by that applicant (“the applicant concerned”) if it is signed by at least one applicant and

(i) a statement is furnished explaining, to the satisfaction of the International Preliminary Examining Authority, the lack of signature of the applicant concerned, or

(ii) the applicant concerned did not sign the request but the requirements of Rule 4.15(b) were complied with.

### 53.9 *Statement Concerning Amendments*

(a) If amendments under Article 19 have been made, the statement concerning amendments shall indicate whether, for the purposes of the international preliminary examination, the applicant wishes those amendments

(i) to be taken into account, in which case a copy of the amendments shall preferably be submitted with the demand, or

(ii) to be considered as reversed by an amendment under Article 34.

(b) If no amendments under Article 19 have been made and the time limit for filing such amendments has not expired, the statement may indicate that the applicant wishes the start of the international preliminary examination to be postponed in accordance with Rule 69.1(d).

(c) If any amendments under Article 34 are submitted with the demand, the statement shall so indicate.

## **Rule 54**

### **The Applicant Entitled to Make a Demand**

#### 54.1 *Residence and Nationality*

(a) Subject to the provisions of paragraph (b), the residence or nationality of the applicant shall, for the purposes of Article 31(2), be determined according to Rule 18.1(a) and (b).

(b) The International Preliminary Examining Authority shall, in the circumstances specified in the Administrative Instructions, request the receiving Office or, where the international application was filed with the International Bureau as receiving Office, the national Office of, or acting for, the Contracting State concerned to decide the question whether the applicant is a resident or national of the

Contracting State of which he claims to be a resident or national. The International Preliminary Examining Authority shall inform the applicant of any such request. The applicant shall have an opportunity to submit arguments directly to the Office concerned. The Office concerned shall decide the said question promptly.

#### 54.2 *Right to Make a Demand*

The right to make a demand under Article 31(2) shall exist if the applicant making the demand or, if there are two or more applicants, at least one of them is a resident or national of a Contracting State bound by Chapter II and the international application has been filed with a receiving Office of or acting for a Contracting State bound by Chapter II.

(i) *[Deleted]*

(ii) *[Deleted]*

#### 54.3 *International Applications Filed with the International Bureau as Receiving Office*

Where the international application is filed with the International Bureau as receiving Office under Rule 19.1(a)(iii), the International Bureau shall, for the purposes of Article 31(2)(a), be considered to be acting for the Contracting State of which the applicant is a resident or national.

#### 54.4 *Applicant Not Entitled to Make a Demand*

If the applicant does not have the right to make a demand or, in the case of two or more applicants, if none of them has the right to make a demand under Rule 54.2, the demand shall be considered not to have been submitted.

## **Rule 54<sup>bis</sup>**

### **Time Limit for Making a Demand**

#### 54<sup>bis</sup>.1 *Time Limit for Making a Demand*

(a) A demand may be made at any time prior to the expiration of whichever of the following periods expires later:

(i) three months from the date of transmittal to the applicant of the international search report and the written opinion established under Rule 43<sup>bis</sup>.1, or of the declaration referred to in Article 17(2)(a); or

(ii) 22 months from the priority date.

(b) Any demand made after the expiration of the time limit applicable under paragraph (a) shall be

considered as if it had not been submitted and the International Preliminary Examining Authority shall so declare.

**Rule 55**

**Languages (International Preliminary Examination)**

*55.1 Language of Demand*

The demand shall be in the language of the international application or, if the international application has been filed in a language other than the language in which it is published, in the language of publication. However, if a translation of the international application is required under Rule 55.2, the demand shall be in the language of that translation.

*55.2 Translation of International Application*

(a) Where neither the language in which the international application is filed nor the language in which the international application is published is accepted by the International Preliminary Examining Authority that is to carry out the international preliminary examination, the applicant shall, subject to paragraph (b), furnish with the demand a translation of the international application into a language which is both:

- (i) a language accepted by that Authority, and
- (ii) a language of publication.

(b) Where a translation of the international application into a language referred to in paragraph (a) was transmitted to the International Searching Authority under Rule 23.1(b) and the International Preliminary Examining Authority is part of the same national Office or intergovernmental organization as the International Searching Authority, the applicant need not furnish a translation under paragraph (a). In such a case, unless the applicant furnishes a translation under paragraph (a), the international preliminary examination shall be carried out on the basis of the translation transmitted under Rule 23.1(b).

(c) If the requirement of paragraph (a) is not complied with and paragraph (b) does not apply, the International Preliminary Examining Authority shall invite the applicant to furnish the required translation within a time limit which shall be reasonable under the circumstances. That time limit shall not be less than one month from the date of the invitation. It may

be extended by the International Preliminary Examining Authority at any time before a decision is taken.

(d) If the applicant complies with the invitation within the time limit under paragraph (c), the said requirement shall be considered to have been complied with. If the applicant fails to do so, the demand shall be considered not to have been submitted and the International Preliminary Examining Authority shall so declare.

(e) *[Deleted]*

*55.3 Translation of Amendments*

(a) Where a translation of the international application is required under Rule 55.2, any amendments which are referred to in the statement concerning amendments under Rule 53.9 and which the applicant wishes to be taken into account for the purposes of the international preliminary examination, and any amendments under Article 19 which are to be taken into account under Rule 66.1(c), shall be in the language of that translation. Where such amendments have been or are filed in another language, a translation shall also be furnished.

(b) Where the required translation of an amendment referred to in paragraph (a) is not furnished, the International Preliminary Examining Authority shall invite the applicant to furnish the missing translation within a time limit which shall be reasonable under the circumstances. That time limit shall not be less than one month from the date of the invitation. It may be extended by the International Preliminary Examining Authority at any time before a decision is taken.

(c) If the applicant fails to comply with the invention within the time limit under paragraph (b), the amendment shall not be taken into account for the purposes of the international preliminary examination.

**Rule 56**

*[Deleted]*

**Rule 57**

**The Handling Fee**

*57.1 Requirement to Pay*

Each demand for international preliminary examination shall be subject to the payment of a fee for the benefit of the International Bureau (“handling fee”) to

be collected by the International Preliminary Examining Authority to which the demand is submitted.

*57.2 Amount*

(a) The amount of the handling fee is as set out in the Schedule of Fees.

(b) *[Deleted]*

(c) The handling fee shall be payable in the currency or one of the currencies prescribed by the International Preliminary Examining Authority (“prescribed currency”), it being understood that, when transferred by that Authority to the International Bureau, it shall be freely convertible into Swiss currency. The amount of the handling fee shall be established, in each prescribed currency, for each International Preliminary Examining Authority which prescribes the payment of the handling fee in any currency other than Swiss currency, by the Director General after consultation with the Office with which consultation takes place under Rule 15.2(b) in relation to that currency, or, if there is no such Office, with the Authority which prescribes payment in that currency. The amount so established shall be the equivalent, in round figures, of the amount in Swiss currency set out in the Schedule of Fees. It shall be notified by the International Bureau to each International Preliminary Examining Authority prescribing payment in that prescribed currency and shall be published in the Gazette.

(d) Where the amount of the handling fee set out in the Schedule of Fees is changed, the corresponding amounts in the prescribed currencies shall be applied from the same date as the amount set out in the amended Schedule of Fees.

(e) Where the exchange rate between Swiss currency and any prescribed currency becomes different from the exchange rate last applied, the Director General shall establish the new amount in the prescribed currency according to directives given by the Assembly. The newly established amount shall become applicable two months after its publication in the Gazette, provided that the interested International Preliminary Examining Authority and the Director General may agree on a date falling during the said two-month period in which case the said amount shall become applicable for that Authority from that date.

*57.3 Time Limit for Payment; Amount Payable*

(a) Subject to paragraphs (b) and (c), the handling fee shall be paid within one month from the date on which the demand was submitted or 22 months from the priority date, whichever expires later.

(b) Subject to paragraph (c), where the demand was transmitted to the International Preliminary Examining Authority under Rule 59.3, the handling fee shall be paid within one month from the date of receipt by that Authority or 22 months from the priority date, whichever expires later.

(c) Where, in accordance with Rule 69.1(b), the International Preliminary Examining Authority wishes to start the international preliminary examination at the same time as the international search, that Authority shall invite the applicant to pay the handling fee within one month from the date of the invitation.

(d) The amount of the handling fee payable shall be the amount applicable on the date of payment.

*57.4 [Deleted]*

*57.5 [Deleted]*

*57.6 Refund*

The International Preliminary Examining Authority shall refund the handling fee to the applicant:

(i) if the demand is withdrawn before the demand has been sent by that Authority to the International Bureau, or

(ii) if the demand is considered, under Rule 54.4 or 54<sup>bis</sup>.1(b), not to have been submitted.

**Rule 58**

**The Preliminary Examination Fee**

*58.1 Right to Ask for a Fee*

(a) Each International Preliminary Examining Authority may require that the applicant pay a fee (“preliminary examination fee”) for its own benefit for carrying out the international preliminary examination and for performing all other tasks entrusted to International Preliminary Examining Authorities under the Treaty and these Regulations.

(b) The amount of the preliminary examination fee, if any, shall be fixed by the International Preliminary Examining Authority. As to the time limit for payment of the preliminary examination fee and the

amount payable, the provisions of Rule 57.3 relating to the handling fee shall apply *mutatis mutandis*.

(c) The preliminary examination fee shall be payable directly to the International Preliminary Examining Authority. Where that Authority is a national Office, it shall be payable in the currency prescribed by that Office, and where the Authority is an intergovernmental organization, it shall be payable in the currency of the State in which the intergovernmental organization is located or in any other currency which is freely convertible into the currency of the said State.

58.2 *[Deleted]*

58.3 *Refund*

The International Preliminary Examining Authorities shall inform the International Bureau of the extent, if any, to which, and the conditions, if any, under which, they will refund any amount paid as a preliminary examination fee where the demand is considered as if it had not been submitted, and the International Bureau shall promptly publish such information.

### **Rule 58<sup>bis</sup>**

#### **Extension of Time Limits for Payment of Fees**

58<sup>bis</sup>.1 *Invitation by the International Preliminary Examining Authority*

(a) Where the International Preliminary Examining Authority finds:

(i) that the amount paid to it is insufficient to cover the handling fee and the preliminary examination fee; or

(ii) by the time they are due under Rules 57.3 and 58.1(b), that no fees were paid to it; the Authority shall invite the applicant to pay to it the amount required to cover those fees, together with, where applicable, the late payment fee under Rule 58<sup>bis</sup>.2, within a time limit of one month from the date of the invitation.

(b) Where the International Preliminary Examining Authority has sent an invitation under paragraph (a) and the applicant has not, within the time limit referred to in that paragraph, paid in full the amount due, including, where applicable, the late payment fee under Rule 58<sup>bis</sup>.2, the demand shall, subject to para-

graph (c), be considered as if it had not been submitted and the International Preliminary Examining Authority shall so declare.

(c) Any payment received by the International Preliminary Examining Authority before that Authority sends the invitation under paragraph (a) shall be considered to have been received before the expiration of the time limit under Rule 57.3 or 58.1(b), as the case may be.

(d) Any payment received by the International Preliminary Examining Authority before that Authority proceeds under paragraph (b) shall be considered to have been received before the expiration of the time limit under paragraph (a).

58<sup>bis</sup>.2 *Late Payment Fee*

(a) The payment of fees in response to an invitation under Rule 58<sup>bis</sup>.1(a) may be subjected by the International Preliminary Examining Authority to the payment to it, for its own benefit, of a late payment fee. The amount of that fee shall be:

(i) 50% of the amount of unpaid fees which is specified in the invitation, or,

(ii) if the amount calculated under item (i) is less than the handling fee, an amount equal to the handling fee.

(b) The amount of the late payment fee shall not, however, exceed double the amount of the handling fee.

### **Rule 59**

#### **The Competent International Preliminary Examining Authority**

59.1 *Demands Under Article 31(2)(a)*

(a) For demands made under Article 31(2)(a), each receiving Office of or acting for a Contracting State bound by the provisions of Chapter II shall, in accordance with the terms of the applicable agreement referred to in Article 32(2) and (3), inform the International Bureau which International Preliminary Examining Authority is or which International Preliminary Examining Authorities are competent for the international preliminary examination of international applications filed with it. The International Bureau shall promptly publish such information. Where several International Preliminary Examining Authorities

are competent, the provisions of Rule 35.2 shall apply *mutatis mutandis*.

(b) Where the international application was filed with the International Bureau as receiving Office under Rule 19.1(a)(iii), Rule 35.3(a) and (b) shall apply *mutatis mutandis*. Paragraph (a) of this Rule shall not apply to the International Bureau as receiving Office under Rule 19.1(a)(iii).

#### 59.2 Demands Under Article 31(2)(b)

As to demands made under Article 31(2)(b), the Assembly, in specifying the International Preliminary Examining Authority competent for international applications filed with a national Office which is an International Preliminary Examining Authority, shall give preference to that Authority; if the national Office is not an International Preliminary Examining Authority, the Assembly shall give preference to the International Preliminary Examining Authority recommended by that Office.

#### 59.3 Transmittal of Demand to the Competent International Preliminary Examining Authority

(a) If the demand is submitted to a receiving Office, an International Searching Authority, or an International Preliminary Examining Authority which is not competent for the international preliminary examination of the international application, that Office or Authority shall mark the date of receipt on the demand and, unless it decides to proceed under paragraph (f), transmit the demand promptly to the International Bureau.

(b) If the demand is submitted to the International Bureau, the International Bureau shall mark the date of receipt on the demand.

(c) Where the demand is transmitted to the International Bureau under paragraph (a) or submitted to it under paragraph (b), the International Bureau shall promptly:

(i) if there is only one competent International Preliminary Examining Authority, transmit the demand to that Authority and inform the applicant accordingly, or

(ii) if two or more International Preliminary Examining Authorities are competent, invite the applicant to indicate, within the time limit applicable under Rule 54<sup>bis</sup>.1(a) or 15 days from the date of the invitation, whichever is later, the competent Interna-

tional Preliminary Examining Authority to which the demand should be transmitted.

(d) Where an indication is furnished as required under paragraph (c)(ii), the International Bureau shall promptly transmit the demand to the competent International Preliminary Examining Authority indicated by the applicant. Where no indication is so furnished, the demand shall be considered not to have been submitted and the International Bureau shall so declare.

(e) Where the demand is transmitted to a competent International Preliminary Examining Authority under paragraph (c), it shall be considered to have been received on behalf of that Authority on the date marked on it under paragraph (a) or (b), as applicable, and the demand so transmitted shall be considered to have been received by that Authority on that date.

(f) Where an Office or Authority to which the demand is submitted under paragraph (a) decides to transmit that demand directly to the competent International Preliminary Examining Authority, paragraphs (c) to (e) shall apply *mutatis mutandis*.

### Rule 60

#### Certain Defects in the Demand

##### 60.1 Defects in the Demand

(a) Subject to paragraphs (a<sup>bis</sup>) and (a<sup>ter</sup>), if the demand does not comply with the requirements specified in Rules 53.1, 53.2(a)(i) to (iii), 53.2(b), 53.3 to 53.8 and 55.1, the International Preliminary Examining Authority shall invite the applicant to correct the defects within a time limit which shall be reasonable under the circumstances. That time limit shall not be less than one month from the date of the invitation. It may be extended by the International Preliminary Examining Authority at any time before a decision is taken.

(a<sup>bis</sup>) For the purposes of Rule 53.4, if there are two or more applicants, it shall be sufficient that the indications referred to in Rule 4.5(a)(ii) and (iii) be provided in respect of one of them who has the right according to Rule 54.2 to make a demand.

(a<sup>ter</sup>) For the purposes of Rule 53.8, if there are two or more applicants, it shall be sufficient that the demand be signed by one of them.

(b) If the applicant complies with the invitation within the time limit under paragraph (a), the demand shall be considered as if it had been received on the



actual filing date, provided that the demand as submitted permitted the international application to be identified; otherwise, the demand shall be considered as if it had been received on the date on which the International Preliminary Examining Authority receives the correction.

(c) If the applicant does not comply with the invitation within the time limit under paragraph (a), the demand shall be considered as if it had not been submitted and the International Preliminary Examining Authority shall so declare.

(d) [Deleted]

(e) If the defect is noticed by the International Bureau, it shall bring the defect to the attention of the International Preliminary Examining Authority, which shall then proceed as provided in paragraphs (a) to (c).

(f) If the demand does not contain a statement concerning amendments, the International Preliminary Examining Authority shall proceed as provided for in Rules 66.1 and 69.1(a) or (b).

(g) Where the statement concerning amendments contains an indication that amendments under Article 34 are submitted with the demand (Rule 53.9(c)) but no such amendments are, in fact, submitted, the International Preliminary Examining Authority shall invite the applicant to submit the amendments within a time limit fixed in the invitation and shall proceed as provided for in Rule 69.1(e).

60.2 [Deleted]

## Rule 61

### Notification of the Demand and Elections

#### 61.1 *Notification to the International Bureau and the Applicant*

(a) The International Preliminary Examining Authority shall indicate on the demand the date of receipt or, where applicable, the date referred to in Rule 60.1(b). The International Preliminary Examining Authority shall promptly either send the demand to the International Bureau and keep a copy in its files or send a copy to the International Bureau and keep the demand in its files.

(b) The International Preliminary Examining Authority shall promptly notify the applicant of the date of receipt of the demand. Where the demand has been considered under Rules 54.4, 55.2(d), 58<sup>bis</sup>.1(b) or 60.1(c) as if it had not been submitted or where an election has been considered under Rule 60.1(d) as if it had not been made, the International Preliminary Examining Authority shall notify the applicant and the International Bureau accordingly.

(c) [Deleted]

#### 61.2 *Notification to the Elected Offices*

(a) The notification provided for in Article 31(7) shall be effected by the International Bureau.

(b) The notification shall indicate the number and filing date of the international application, the name of the applicant, the filing date of the application whose priority is claimed (where priority is claimed) and the date of receipt by the International Preliminary Examining Authority of the demand.

(c) The notification shall be sent to the elected Office together with the communication provided for in Article 20. Elections effected after such communication shall be notified promptly after they have been made.

(d) Where the applicant makes an express request to an elected Office under Article 40(2) prior to the international publication of the international application, the International Bureau shall, upon request of the applicant or the elected Office, promptly effect the communication provided for in Article 20 to that Office.

#### 61.3 *Information for the Applicant*

The International Bureau shall inform the applicant in writing of the notification referred to in Rule 61.2 and of the elected Offices notified under Article 31(7).

#### 61.4 *Publication in the Gazette*

The International Bureau shall, promptly after the filing of the demand but not before the international publication of the international application, publish in the Gazette information on the demand and the elected States concerned, as provided in the Administrative Instructions.

**Rule 62**

**Copy of the Written Opinion by the International Searching Authority and of Amendments Under Article 19 for the International Preliminary Examining Authority**

*62.1 Copy of Written Opinion by International Searching Authority and of Amendments Made Before the Demand Is Filed*

Upon receipt of a demand, or a copy thereof, from the International Preliminary Examining Authority, the International Bureau shall promptly transmit to that Authority:

(i) a copy of the written opinion established under Rule 43<sup>bis</sup>.1, unless the national Office or intergovernmental organization that acted as International Searching Authority is also acting as International Preliminary Examining Authority; and

(ii) a copy of any amendment under Article 19, and any statement referred to in that Article, unless that Authority has indicated that it has already received such a copy.

*62.2 Amendments Made After the Demand Is Filed*

If, at the time of filing any amendments under Article 19, a demand has already been submitted, the applicant shall preferably, at the same time as he files the amendments with the International Bureau, also file with the International Preliminary Examining Authority a copy of such amendments and any statement referred to in that Article. In any case, the International Bureau shall promptly transmit a copy of such amendments and statement to that Authority.

**Rule 62<sup>bis</sup>**

**Translation for the International Preliminary Examining Authority of the Written Opinion of the International Searching Authority**

*62<sup>bis</sup>.1 Translation and Observations*

(a) Upon request of the International Preliminary Examining Authority, the written opinion established under Rule 43<sup>bis</sup>.1 shall, when not in English or in a language accepted by that Authority, be translated into English by or under the responsibility of the International Bureau.

(b) The International Bureau shall transmit a copy of the translation to the International Preliminary

Examining Authority within two months from the date of receipt of the request for translation, and shall at the same time transmit a copy to the applicant.

(c) The applicant may make written observations as to the correctness of the translation and shall send a copy of the observations to the International Preliminary Examining Authority and to the International Bureau.

**Rule 63**

**Minimum Requirements for International Preliminary Examining Authorities**

*63.1 Definition of Minimum Requirements*

The minimum requirements referred to in Article 32(3) shall be the following:

(i) the national Office or intergovernmental organization must have at least 100 full-time employees with sufficient technical qualifications to carry out examinations;

(ii) that Office or organization must have at its ready disposal at least the minimum documentation referred to in Rule 34, properly arranged for examination purposes;

(iii) that Office or organization must have a staff which is capable of examining in the required technical fields and which has the language facilities to understand at least those languages in which the minimum documentation referred to in Rule 34 is written or is translated;

(iv) that Office or organization must hold an appointment as an International Searching Authority.

**Rule 64**

**Prior Art for International Preliminary Examination**

*64.1 Prior Art*

(a) For the purposes of Article 33(2) and (3), everything made available to the public anywhere in the world by means of written disclosure (including drawings and other illustrations) shall be considered prior art provided that such making available occurred prior to the relevant date.

(b) For the purposes of paragraph (a), the relevant date will be:

(i) subject to item (ii), the international filing date of the international application under international preliminary examination;

(ii) where the international application under international preliminary examination validly claims the priority of an earlier application, the filing date of such earlier application.

#### 64.2 *Non-Written Disclosures*

In cases where the making available to the public occurred by means of an oral disclosure, use, exhibition or other non-written means (“non-written disclosure”) before the relevant date as defined in Rule 64.1(b) and the date of such non-written disclosure is indicated in a written disclosure which has been made available to the public on a date which is the same as, or later than, the relevant date, the non-written disclosure shall not be considered part of the prior art for the purposes of Article 33(2) and (3). Nevertheless, the international preliminary examination report shall call attention to such non-written disclosure in the manner provided for in Rule 70.9.

#### 64.3 *Certain Published Documents*

In cases where any application or any patent which would constitute prior art for the purposes of Article 33(2) and (3) had it been published prior to the relevant date referred to in Rule 64.1 was published on a date which is the same as, or later than, the relevant date but was filed earlier than the relevant date or claimed the priority of an earlier application which had been filed prior to the relevant date, such published application or patent shall not be considered part of the prior art for the purposes of Article 33(2) and (3). Nevertheless, the international preliminary examination report shall call attention to such application or patent in the manner provided for in Rule 70.10.

### **Rule 65**

#### **Inventive Step or Non-Obviousness**

##### 65.1 *Approach to Prior Art*

For the purposes of Article 33(3), the international preliminary examination shall take into consideration the relation of any particular claim to the prior art as a whole. It shall take into consideration the claim's relation not only to individual documents or parts thereof taken separately but also its relation to combinations of such documents or parts of documents, where such combinations are obvious to a person skilled in the art.

##### 65.2 *Relevant Date*

For the purposes of Article 33(3), the relevant date for the consideration of inventive step (non-obviousness) is the date prescribed in Rule 64.1.

### **Rule 66**

#### **Procedure Before the International Preliminary Examining Authority**

##### 66.1 *Basis of the International Preliminary Examination*

(a) Subject to paragraphs (b) to (d), the international preliminary examination shall be based on the international application as filed.

(b) The applicant may submit amendments under Article 34 at the time of filing the demand or, subject to Rule 66.4<sup>bis</sup>, until the international preliminary examination report is established.

(c) Any amendments under Article 19 made before the demand was filed shall be taken into account for the purposes of the international preliminary examination unless superseded, or considered as reversed, by an amendment under Article 34.

(d) Any amendments under Article 19 made after the demand was filed and any amendments under Article 34 submitted to the International Preliminary Examining Authority shall, subject to Rule 66.4<sup>bis</sup>, be taken into account for the purposes of the international preliminary examination.

(e) Claims relating to inventions in respect of which no international search report has been established need not be the subject of international preliminary examination.

##### 66.1<sup>bis</sup> *Written Opinion of the International Searching Authority*

(a) Subject to paragraph (b), the written opinion established by the International Searching Authority under Rule 43<sup>bis</sup>.1 shall be considered to be a written opinion of the International Preliminary Examining Authority for the purposes of Rule 66.2(a).

(b) An International Preliminary Examining Authority may notify the International Bureau that paragraph (a) shall not apply to the procedure before it in respect of written opinions established under Rule 43<sup>bis</sup>.1 by the International Searching Authority or Authorities specified in the notification, provided that such a notification shall not apply to cases where

the national Office or intergovernmental organization that acted as International Searching Authority is also acting as International Preliminary Examining Authority. The International Bureau shall promptly publish any such notification in the Gazette.

(c) Where the written opinion established by the International Searching Authority under Rule 43<sup>bis</sup>.1 is not, by virtue of a notification under paragraph (b), considered to be a written opinion of the International Preliminary Examining Authority for the purposes of Rule 66.2(a), the International Preliminary Examining Authority shall notify the applicant accordingly in writing.

(d) A written opinion established by the International Searching Authority under Rule 43<sup>bis</sup>.1 which is not, by virtue of a notification under paragraph (b), considered to be a written opinion of the International Preliminary Examining Authority for the purposes of Rule 66.2(a) shall nevertheless be taken into account by the International Preliminary Examining Authority in proceeding under Rule 66.2(a).

66.2 *Written Opinion of the International Preliminary Examining Authority*

(a) If the International Preliminary Examining Authority

(i) considers that any of the situations referred to in Article 34(4) exists,

(ii) considers that the international preliminary examination report should be negative in respect of any of the claims because the invention claimed therein does not appear to be novel, does not appear to involve an inventive step (does not appear to be non-obvious), or does not appear to be industrially applicable,

(iii) notices that there is some defect in the form or contents of the international application under the Treaty or these Regulations,

(iv) considers that any amendment goes beyond the disclosure in the international application as filed,

(v) wishes to accompany the international preliminary examination report by observations on the clarity of the claims, the description, and the drawings, or the question whether the claims are fully supported by the description,

(vi) considers that a claim relates to an invention in respect of which no international search report has been established and has decided not to carry out the international preliminary examination in respect of that claim, or

(vii) considers that a nucleotide and/or amino acid sequence listing is not available to it in such a form that a meaningful international preliminary examination can be carried out, the said Authority shall notify the applicant accordingly in writing. Where the national law of the national Office acting as International Preliminary Examining Authority does not allow multiple dependent claims to be drafted in a manner different from that provided for in the second and third sentences of Rule 6.4(a), the International Preliminary Examining Authority may, in case of failure to use that manner of claiming, apply Article 34(4)(b). In such case, it shall notify the applicant accordingly in writing.

(b) The notification shall fully state the reasons for the opinion of the International Preliminary Examining Authority.

(c) The notification shall invite the applicant to submit a written reply together, where appropriate, with amendments.

(d) The notification shall fix a time limit for the reply. The time limit shall be reasonable under the circumstances. It shall normally be two months after the date of notification. In no case shall it be shorter than one month after the said date. It shall be at least two months after the said date where the international search report is transmitted at the same time as the notification. It shall, subject to paragraph (e), not be more than three months after the said date.

(e) The time limit for replying to the notification may be extended if the applicant so requests before its expiration.

66.3 *Formal Response to the International Preliminary Examining Authority*

(a) The applicant may respond to the invitation referred to in Rule 66.2(c) of the International Preliminary Examining Authority by making amendments or - if he disagrees with the opinion of that Authority - by submitting arguments, as the case may be, or do both.

(b) Any response shall be submitted directly to the International Preliminary Examining Authority.

66.4 *Additional Opportunity for Submitting Amendments or Arguments*

(a) If the International Preliminary Examining Authority wishes to issue one or more additional written opinions, it may do so, and Rules 66.2 and 66.3 shall apply.

(b) On the request of the applicant, the International Preliminary Examining Authority may give him one or more additional opportunities to submit amendments or arguments.

66.4<sup>bis</sup> *Consideration of Amendments and Arguments*

Amendments or arguments need not be taken into account by the International Preliminary Examining Authority for the purposes of a written opinion or the international preliminary examination report if they are received after that Authority has begun to draw up that opinion or report.

66.5 *Amendment*

Any change, other than the rectification of obvious errors, in the claims, the description, or the drawings, including cancellation of claims, omission of passages in the description, or omission of certain drawings, shall be considered an amendment.

66.6 *Informal Communications with the Applicant*

The International Preliminary Examining Authority may, at any time, communicate informally, over the telephone, in writing, or through personal interviews, with the applicant. The said Authority shall, at its discretion, decide whether it wishes to grant more than one personal interview if so requested by the applicant, or whether it wishes to reply to any informal written communication from the applicant.

66.7 *Copy and Translation of Earlier Application Whose Priority is Claimed*

(a) If the International Preliminary Examining Authority needs a copy of the earlier application whose priority is claimed in the international application, the International Bureau shall, on request, promptly furnish such copy. If that copy is not furnished to the International Preliminary Examining Authority because the applicant failed to comply with the requirements of Rule 17.1, and if that earlier application was not filed with that Authority in its capacity as a national Office or the priority document is not available to that Authority from a digital library in accordance with the Administrative Instructions,

the international preliminary examination report may be established as if the priority had not been claimed.

(b) If the application whose priority is claimed in the international application is in a language other than the language or one of the languages of the International Preliminary Examining Authority, that Authority may, where the validity of the priority claim is relevant for the formulation of the opinion referred to in Article 33(1), invite the applicant to furnish a translation in the said language or one of the said languages within two months from the date of the invitation. If the translation is not furnished within that time limit, the international preliminary examination report may be established as if the priority had not been claimed.

66.8 *Form of Amendments*

(a) Subject to paragraph (b), the applicant shall be required to submit a replacement sheet for every sheet of the international application which, on account of an amendment, differs from the sheet previously filed. The letter accompanying the replacement sheets shall draw attention to the differences between the replaced sheets and the replacement sheets and shall preferably also explain the reasons for the amendment.

(b) Where the amendment consists in the deletion of passages or in minor alterations or additions, the replacement sheet referred to in paragraph (a) may be a copy of the relevant sheet of the international application containing the alterations or additions, provided that the clarity and direct reproducibility of that sheet are not adversely affected. To the extent that any amendment results in the cancellation of an entire sheet, that amendment shall be communicated in a letter which shall preferably also explain the reasons for the amendment.

66.9 *Language of Amendments*

(a) Subject to paragraphs (b) and (c), if the international application has been filed in a language other than the language in which it is published, any amendment, as well as any letter referred to in Rule 66.8, shall be submitted in the language of publication.

(b) If the international preliminary examination is carried out, pursuant to Rule 55.2, on the basis of a translation of the international application, any amendment, as well as any letter referred to in para-

graph (a), shall be submitted in the language of that translation.

(c) Subject to Rule 55.3, if an amendment or letter is not submitted in a language as required under paragraph (a) or (b), the International Preliminary Examining Authority shall, if practicable, having regard to the time limit for establishing the international preliminary examination report, invite the applicant to furnish the amendment or letter in the required language within a time limit which shall be reasonable under the circumstances.

(d) If the applicant fails to comply, within the time limit under paragraph (c), with the invitation to furnish an amendment in the required language, the amendment shall not be taken into account for the purposes of the international preliminary examination. If the applicant fails to comply, within the time limit under paragraph (c), with the invitation to furnish a letter referred to in paragraph (a) in the required language, the amendment concerned need not be taken into account for the purposes of the international preliminary examination.

### **Rule 67**

#### **Subject Matter Under Article 34(4)(a)(i)**

##### *67.1 Definition*

No International Preliminary Examining Authority shall be required to carry out an international preliminary examination on an international application if, and to the extent to which, its subject matter is any of the following:

- (i) scientific and mathematical theories,
- (ii) plant or animal varieties or essentially biological processes for the production of plants and animals, other than microbiological processes and the products of such processes,
- (iii) schemes, rules, or methods of doing business, performing purely mental acts, or playing games,
- (iv) methods for treatment of the human or animal body by surgery or therapy, as well as diagnostic methods,
- (v) mere presentations of information,
- (vi) computer programs to the extent that the International Preliminary Examining Authority is not

equipped to carry out an international preliminary examination concerning such programs.

### **Rule 68**

#### **Lack of Unity of Invention (International Preliminary Examination)**

##### *68.1 No Invitation to Restrict or Pay*

Where the International Preliminary Examining Authority finds that the requirement of unity of invention is not complied with and chooses not to invite the applicant to restrict the claims or to pay additional fees, it shall proceed with the international preliminary examination, subject to Article 34(4)(b) and Rule 66.1(e), in respect of the entire international application, but shall indicate, in any written opinion and in the international preliminary examination report, that it considers that the requirement of unity of invention is not fulfilled and it shall specify the reasons therefor.

##### *68.2 Invitation to Restrict or Pay*

Where the International Preliminary Examining Authority finds that the requirement of unity of invention is not complied with and chooses to invite the applicant, at his option, to restrict the claims or to pay additional fees, it shall specify at least one possibility of restriction which, in the opinion of the International Preliminary Examining Authority, would be in compliance with the applicable requirement, and shall specify the amount of the additional fees and the reasons for which the international application is not considered as complying with the requirement of unity of invention. It shall, at the same time, fix a time limit, with regard to the circumstances of the case, for complying with the invitation; such time limit shall not be shorter than one month, and it shall not be longer than two months, from the date of the invitation.

##### *68.3 Additional Fees*

(a) The amount of the additional fee due for international preliminary examination under Article 34(3)(a) shall be determined by the competent International Preliminary Examining Authority.

(b) The additional fee due for international preliminary examination under Article 34(3)(a) shall be payable direct to the International Preliminary Examining Authority.

(c) Any applicant may pay the additional fee under protest, that is, accompanied by a reasoned statement to the effect that the international application complies with the requirement of unity of invention or that the amount of the required additional fee is excessive. Such protest shall be examined by a three-member board or other special instance of the International Preliminary Examining Authority, or any competent higher authority, which, to the extent that it finds the protest justified, shall order the total or partial reimbursement to the applicant of the additional fee. On the request of the applicant, the text of both the protest and the decision thereon shall be notified to the elected Offices as an annex to the international preliminary examination report.

(d) The three-member board, special instance or competent higher authority, referred to in paragraph (c), shall not comprise any person who made the decision which is the subject of the protest.

(e) Where the applicant has, under paragraph (c), paid an additional fee under protest, the International Preliminary Examining Authority may, after a prior review of the justification for the invitation to pay an additional fee, require that the applicant pay a fee for the examination of the protest (“protest fee”). The protest fee shall be paid within one month from the date of the notification to the applicant of the result of the review. If the protest fee is not so paid, the protest shall be considered withdrawn. The protest fee shall be refunded to the applicant where the three-member board, special instance or higher authority referred to in paragraph (c) finds that the protest was entirely justified.

#### 68.4 *Procedure in the Case of Insufficient Restriction of the Claims*

If the applicant restricts the claims but not sufficiently to comply with the requirement of unity of invention, the International Preliminary Examining Authority shall proceed as provided in Article 34(3)(c).

#### 68.5 *Main Invention*

In case of doubt which invention is the main invention for the purposes of Article 34(3)(c), the invention first mentioned in the claims shall be considered the main invention.

## Rule 69

### Start of and Time Limit for International Preliminary Examination

#### 69.1 *Start of International Preliminary Examination*

(a) Subject to paragraphs (b) to (e), the International Preliminary Examining Authority shall start the international preliminary examination when it is in possession of all of the following:

- (i) the demand;
- (ii) the amount due (in full) for the handling fee and the preliminary examination fee, including where applicable, the late payment fee under Rule 58<sup>bis</sup>.2; and
- (iii) either the international search report and the written opinion established under Rule 43<sup>bis</sup>.1 or a notice of the declaration by the International Searching Authority under Article 17(2)(a) that no international search report will be established;

provided that the International Preliminary Examining Authority shall not start the international preliminary examination before the expiration of the applicable time limit under Rule 54<sup>bis</sup>.1(a) unless the applicant expressly requests an earlier start.

(b) If the national Office or intergovernmental organization that acts as International Searching Authority also acts as International Preliminary Examining Authority, the international preliminary examination may, if that national Office or intergovernmental organization so wishes and subject to paragraphs (d) and (e), start at the same time as the international search.

(b<sup>bis</sup>) Where, in accordance with paragraph (b), the national Office or intergovernmental organization that acts as both International Searching Authority and International Preliminary Examining Authority wishes to start the international preliminary examination at the same time as the international search and considers that all of the conditions referred to in Article 34(2)(c)(i) to (iii) are fulfilled, that national Office or intergovernmental organization need not, in its capacity as International Searching Authority, establish a written opinion under Rule 43<sup>bis</sup>.1.

(c) Where the statement concerning amendments contains an indication that amendments under Article 19 are to be taken into account (Rule 53.9(a)(i)), the International Preliminary Examining

Authority shall not start the international preliminary examination before it has received a copy of the amendments concerned.

(d) Where the statement concerning amendments contains an indication that the start of the international preliminary examination is to be postponed (Rule 53.9(b)), the International Preliminary Examining Authority shall not start the international preliminary examination before whichever of the following occurs first:

(i) it has received a copy of any amendments made under Article 19;

(ii) it has received a notice from the applicant that he does not wish to make amendments under Article 19; or

(iii) the expiration of the applicable time limit under Rule 54<sup>bis</sup>.1(a).

(e) Where the statement concerning amendments contains an indication that amendments under Article 34 are submitted with the demand (Rule 53.9(c)) but no such amendments are, in fact, submitted, the International Preliminary Examining Authority shall not start the international preliminary examination before it has received the amendments or before the time limit fixed in the invitation referred to in Rule 60.1(g) has expired, whichever occurs first.

#### 69.2 *Time Limit for International Preliminary Examination*

The time limit for establishing the international preliminary examination report shall be whichever of the following periods expires last:

(i) 28 months from the priority date; or

(ii) six months from the time provided under Rule 69.1 for the start of the international preliminary examination; or

(iii) six months from the date of receipt by the International Preliminary Examining Authority of the translation furnished under Rule 55.2.

### **Rule 70**

#### **International Preliminary Report on Patentability by the International Preliminary Examining Authority (International Preliminary Examination Report)**

##### 70.1 *Definition*

For the purposes of this Rule, “report” shall mean international preliminary examination report.

##### 70.2 *Basis of the Report*

(a) If the claims have been amended, the report shall issue on the claims as amended.

(b) If, pursuant to Rule 66.7(a) or (b), the report is established as if the priority had not been claimed, the report shall so indicate.

(c) If the International Preliminary Examining Authority considers that any amendment goes beyond the disclosure in the international application as filed, the report shall be established as if such amendment had not been made, and the report shall so indicate. It shall also indicate the reasons why it considers that the amendment goes beyond the said disclosure.

(d) Where claims relate to inventions in respect of which no international search report has been established and have therefore not been the subject of international preliminary examination, the international preliminary examination report shall so indicate.

##### 70.3 *Identifications*

The report shall identify the International Preliminary Examining Authority which established it by indicating the name of such Authority, and the international application by indicating the international application number, the name of the applicant, and the international filing date.

##### 70.4 *Dates*

The report shall indicate:

(i) the date on which the demand was submitted, and

(ii) the date of the report; that date shall be the date on which the report is completed.

##### 70.5 *Classification*

(a) The report shall repeat the classification given under Rule 43.3 if the International Preliminary Examining Authority agrees with such classification.

(b) Otherwise, the International Preliminary Examining Authority shall indicate in the report the classification, at least according to the International Patent Classification, which it considers correct.

##### 70.6 *Statement Under Article 35(2)*

(a) The statement referred to in Article 35(2) shall consist of the words “YES” or “NO,” or their equivalent in the language of the report, or some appropriate sign provided for in the Administrative Instructions, and shall be accompanied by the cita-



tions, explanations, and observations, if any, referred to in the last sentence of Article 35(2).

(b) If any of the three criteria referred to in Article 35(2) (that is, novelty, inventive step (non-obviousness), industrial applicability) is not satisfied, the statement shall be negative. If, in such a case, any of the criteria, taken separately, is satisfied, the report shall specify the criterion or criteria so satisfied.

#### 70.7 Citations Under Article 35(2)

(a) The report shall cite the documents considered to be relevant for supporting the statements made under Article 35(2), whether or not such documents are cited in the international search report. Documents cited in the international search report need only be cited in the report when they are considered by the International Preliminary Examining Authority to be relevant.

(b) The provisions of Rule 43.5(b) and (e) shall apply also to the report.

#### 70.8 Explanations Under Article 35(2)

The Administrative Instructions shall contain guidelines for cases in which the explanations referred to in Article 35(2) should or should not be given and the form of such explanations. Such guidelines shall be based on the following principles:

(i) explanations shall be given whenever the statement in relation to any claim is negative;

(ii) explanations shall be given whenever the statement is positive unless the reason for citing any document is easy to imagine on the basis of consultation of the cited document;

(iii) generally, explanations shall be given if the case provided for in the last sentence of Rule 70.6(b) obtains.

#### 70.9 Non-Written Disclosures

Any non-written disclosure referred to in the report by virtue of Rule 64.2 shall be mentioned by indicating its kind, the date on which the written disclosure referring to the non-written disclosure was made available to the public, and the date on which the non-written disclosure occurred in public.

#### 70.10 Certain Published Documents

Any published application or any patent referred to in the report by virtue of Rule 64.3 shall be mentioned as such and shall be accompanied by an indication of its date of publication, of its filing date, and its

claimed priority date (if any). In respect of the priority date of any such document, the report may indicate that, in the opinion of the International Preliminary Examining Authority, such date has not been validly claimed.

#### 70.11 Mention of Amendments

If, before the International Preliminary Examining Authority, amendments have been made, this fact shall be indicated in the report. Where any amendment has resulted in the cancellation of an entire sheet, this fact shall also be specified in the report.

#### 70.12 Mention of Certain Defects and Other Matters

If the International Preliminary Examining Authority considers that, at the time it prepares the report:

(i) the international application contains any of the defects referred to in Rule 66.2(a)(iii), it shall include this opinion and the reasons therefor in the report;

(ii) the international application calls for any of the observations referred to in Rule 66.2(a)(v), it may include this opinion in the report and, if it does, it shall also indicate in the report the reasons for such opinion;

(iii) any of the situations referred to in Article 34(4) exists, it shall state this opinion and the reasons therefor in the reports;

(iv) a nucleotide and/or amino acid sequence listing is not available to it in such a form that a meaningful international preliminary examination can be carried out, it shall so state in the report.

#### 70.13 Remarks Concerning Unity of Invention

If the applicant paid additional fees for the international preliminary examination, or if the international application or the international preliminary examination was restricted under Article 34(3), the report shall so indicate. Furthermore, where the international preliminary examination was carried out on restricted claims (Article 34(3)(a)), or on the main invention only (Article 34(3)(c)), the report shall indicate what parts of the international application were and what parts were not the subject of international preliminary examination. The report shall contain the indications provided for in Rule 68.1, where the International Preliminary Examining Authority chose not to invite the applicant to restrict the claims or to pay additional fees.

**70.14 Authorized Officer**

The report shall indicate the name of the officer of the International Preliminary Examining Authority responsible for that report.

**70.15 Form; Title**

(a) The physical requirements as to the form of the report shall be prescribed by the Administrative Instructions.

(b) The report shall bear the title “international preliminary report on patentability (Chapter II of the Patent Cooperation Treaty)” together with an indication that it is the international preliminary examination report established by the International Preliminary Examining Authority.

**70.16 Annexes to the Report**

(a) Each replacement sheet under Rule 66.8(a) or (b), each replacement sheet containing amendments under Article 19 and each replacement sheet containing rectifications of obvious errors authorized under Rule 91.1(e)(iii) shall, unless superseded by later replacement sheets or amendments resulting in the cancellation of entire sheets under Rule 66.8(b), be annexed to the report. Replacement sheets containing amendments under Article 19 which have been considered as reversed by an amendment under Article 34 and letters under Rule 66.8 shall not be annexed.

(b) Notwithstanding paragraph (a), each superseded or reversed replacement sheet referred to in that paragraph shall also be annexed to the report where the International Preliminary Examining Authority considers that the relevant superseding or reversing amendment goes beyond the disclosure in the international application as filed and the report contains an indication referred to in Rule 70.2(c). In such a case, the superseded or reversed replacement sheet shall be marked as provided by the Administrative Instructions.

**70.17 Languages of the Report and the Annexes**

The report and any annex shall be in the language in which the international application to which they relate is published, or, if the international preliminary examination is carried out, pursuant to Rule 55.2, on the basis of a translation of the international application, in the language of that translation.

**Rule 71****Transmittal of the International Preliminary Examination Report****71.1 Recipients**

The International Preliminary Examining Authority shall, on the same day, transmit one copy of the international preliminary examination report and its annexes, if any, to the International Bureau, and one copy to the applicant.

**71.2 Copies of Cited Documents**

(a) The request under Article 36(4) may be presented any time during seven years from the international filing date of the international application to which the report relates.

(b) The International Preliminary Examining Authority may require that the party (applicant or elected Office) presenting the request pay to it the cost of preparing and mailing the copies. The level of the cost of preparing copies shall be provided for in the agreements referred to in Article 32(2) between the International Preliminary Examining Authorities and the International Bureau.

(c) *[Deleted]*

(d) Any International Preliminary Examining Authority may perform the obligations referred to in paragraphs (a) and (b) through another agency responsible to it.

**Rule 72****Translation of the International Preliminary Examination Report and of the Written Opinion of the International Searching Authority****72.1 Languages**

(a) Any elected State may require that the international preliminary examination report, established in any language other than the official language, or one of the official languages, of its national Office, be translated into English.

(b) Any such requirement shall be notified to the International Bureau, which shall promptly publish it in the Gazette.

**72.2 Copy of Translation for the Applicant**

The International Bureau shall transmit a copy of the translation referred to in Rule 72.1(a) of the international preliminary examination report to the appli-

cant at the same time as it communicates such translation to the interested elected Office or Offices.

*72.2<sup>bis</sup> Translation of the Written Opinion of the International Searching Authority Established Under Rule 43<sup>bis</sup>.1*

In the case referred to in Rule 73.2(b)(ii), the written opinion established by the International Searching Authority under Rule 43<sup>bis</sup>.1 shall, upon request of the elected Office concerned, be translated into English by or under the responsibility of the International Bureau. The International Bureau shall transmit a copy of the translation to the elected Office concerned within two months from the date of receipt of the request for translation, and shall at the same time transmit a copy to the applicant.

*72.3 Observations on the Translation*

The applicant may make written observations as to the correctness of the translation of the international preliminary examination report or of the written opinion established by the International Searching Authority under Rule 43<sup>bis</sup>.1 and shall send a copy of the observations to each of the interested elected Offices and to the International Bureau.

**Rule 73**

**Communication of the International Preliminary Examination Report or the Written Opinion of the International Searching Authority**

*73.1 Preparation of Copies*

The International Bureau shall prepare the copies of the documents to be communicated under Article 36(3)(a).

*73.2 Communication to Elected Offices*

(a) The International Bureau shall effect the communication provided for in Article 36(3)(a) to each elected Office in accordance with Rule 93<sup>bis</sup>.1 but not before the expiration of 30 months from the priority date.

(b) Where the applicant makes an express request to an elected Office under Article 40(2), the International Bureau shall, upon the request of that Office or of the applicant,

(i) if the international preliminary examination report has already been transmitted to the Interna-

tional Bureau under Rule 71.1, promptly effect the communication provided for in Article 36(3)(a) to that Office;

(ii) if the international preliminary examination report has not been transmitted to the International Bureau under Rule 71.1, promptly communicate a copy of the written opinion established by the International Searching Authority under Rule 43<sup>bis</sup>.1 to that Office.

(c) Where the applicant has withdrawn the demand or any or all elections, the communication provided for in paragraph (a) shall nevertheless be effected, if the International Bureau has received the international preliminary examination report, to the elected Office or Offices affected by the withdrawal.

**Rule 74**

**Translations of Annexes of the International Preliminary Examination Report and Transmittal Thereof**

*74.1 Contents of Translation and Time Limit for Transmittal Thereof*

(a) Where the furnishing of a translation of the international application is required by the elected Office under Article 39(1), the applicant shall, within the time limit applicable under Article 39(1), transmit a translation of any replacement sheet referred to in Rule 70.16 which is annexed to the international preliminary examination report unless such sheet is in the language of the required translation of the international application. The same time limit shall apply where the furnishing of a translation of the international application to the elected Office must, because of a declaration made under Article 64(2)(a)(i), be effected within the time limit applicable under Article 22.

(b) Where the furnishing under Article 39(1) of a translation of the international application is not required by the elected Office, that Office may require the applicant to furnish, within the time limit applicable under that Article, a translation into the language in which the international application was published of any replacement sheet referred to in Rule 70.16 which is annexed to the international preliminary examination report and is not in that language.

**Rule 75**

[Deleted]

**Rule 76**

**Copy, Translation and Fee Under Article 39(1);  
Translation of Priority Document**

76.1, 76.2 and 76.3 [Deleted]

76.4 *Time Limit for Translation of Priority Document*

The applicant shall not be required to furnish to any elected Office a translation of the priority document before the expiration of the applicable time limit under Article 39.

76.5 *Application of Rules 22.1(g), 47.1, 49, 49<sup>bis</sup> and 51<sup>bis</sup>*

Rules 22.1(g), 47.1, 49, 49<sup>bis</sup> and 51<sup>bis</sup> shall apply, provided that:

(i) any reference in the said Rules to the designated Office or to the designated State shall be construed as a reference to the elected Office or to the elected State, respectively;

(ii) any reference in the said Rules to Article 22 or Article 24(2) shall be construed as a reference to Article 39(1) or Article 39(3), respectively;

(iii) the words “international applications filed” in Rule 49.1(c) shall be replaced by the words “a demand submitted;”

(iv) for the purposes of Article 39(1), where an international preliminary examination report has been established, a translation of any amendment under Article 19 shall only be required if that amendment is annexed to that report;

(v) the reference in Rule 47.1(a) to Rule 47.4 shall be construed as a reference to Rule 61.2(d).

76.6 [Deleted]

**Rule 77**

**Faculty Under Article 39(1)(b)**

77.1 *Exercise of Faculty*

(a) Any Contracting State allowing a time limit expiring later than the time limit provided for in Article 39(1)(a) shall notify the International Bureau of the time limit so fixed.

(b) Any notification received by the International Bureau under paragraph (a) shall be promptly published by the International Bureau in the Gazette.

(c) Notifications concerning the shortening of the previously fixed time limit shall be effective in relation to demands submitted after the expiration of three months computed from the date on which the notification was published by the International Bureau.

(d) Notifications concerning the lengthening of the previously fixed time limit shall become effective upon publication by the International Bureau in the Gazette in respect of demands pending at the time or submitted after the date of such publication, or, if the Contracting State effecting the notification fixes some later date, as from the latter date.

**Rule 78**

**Amendment of the Claims, the Description, and the Drawings, Before Elected Offices**

78.1 *Time Limit*

(a) The applicant shall, if he so wishes, exercise the right under Article 41 to amend the claims, the description and the drawings, before the elected Office concerned within one month from the fulfillment of the requirements under Article 39(1)(a), provided that, if the transmittal of the international preliminary examination report under Article 36(1) has not taken place by the expiration of the time limit applicable under Article 39, he shall exercise the said right not later than four months after such expiration date. In either case, the applicant may exercise the said right at any later time if so permitted by the national law of the said State.

(b) In any elected State in which the national law provides that examination starts only on special request, the national law may provide that the time limit within or the time at which the applicant may exercise the right under Article 41 shall be the same as that provided by the national law for the filing of amendments in the case of the examination, on special request, of national applications, provided that such time limit shall not expire prior to, or such time shall not come before, the expiration of the time limit applicable under paragraph (a).

78.2 [Deleted]

78.3 *Utility Models*

The provisions of Rules 6.5 and 13.5 shall apply, *mutatis mutandis*, before elected Offices. If the election was made before the expiration of the 19th month from the priority date, the reference to the time limit applicable under Article 22 is replaced by a reference to the time limit applicable under Article 39.

**PART D**

**Rules Concerning Chapter III of the Treaty**

**Rule 79**

**Calendar**

79.1 *Expressing Dates*

Applicants, national Offices, receiving Offices, International Searching and Preliminary Examining Authorities, and the International Bureau, shall, for the purposes of the Treaty and the Regulations, express any date in terms of the Christian era and the Gregorian calendar, or, if they use other eras and calendars, they shall also express any date in terms of the Christian era and the Gregorian calendar.

**Rule 80**

**Computation of Time Limits**

80.1 *Periods Expressed in Years*

When a period is expressed as one year or a certain number of years, computation shall start on the day following the day on which the relevant event occurred, and the period shall expire in the relevant subsequent year in the month having the same name and on the day having the same number as the month and the day on which the said event occurred, provided that if the relevant subsequent month has no day with the same number the period shall expire on the last day of that month.

80.2 *Periods Expressed in Months*

When a period is expressed as one month or a certain number of months, computation shall start on the day following the day on which the relevant event occurred, and the period shall expire in the relevant subsequent month on the day which has the same number as the day on which the said event occurred,

provided that if the relevant subsequent month has no day with the same number the period shall expire on the last day of that month.

80.3 *Periods Expressed in Days*

When a period is expressed as a certain number of days, computation shall start on the day following the day on which the relevant event occurred, and the period shall expire on the day on which the last day of the count has been reached.

80.4 *Local Dates*

(a) The date which is taken into consideration as the starting date of the computation of any period shall be the date which prevails in the locality at the time when the relevant event occurred.

(b) The date on which any period expires shall be the date which prevails in the locality in which the required document must be filed or the required fee must be paid.

80.5 *Expiration on a Non-Working Day or Official Holiday*

If the expiration of any period during which any document or fee must reach a national Office or inter-governmental organization falls on a day:

(i) on which such Office or organization is not open to the public for the purposes of the transaction of official business;

(ii) on which ordinary mail is not delivered in the locality in which such Office or organization is situated;

(iii) which, where such Office or organization is situated in more than one locality, is an official holiday in at least one of the localities in which such Office or organization is situated, and in circumstances where the national law applicable by that Office or organization provides, in respect of national applications, that, in such a case, such period shall expire on a subsequent day; or

(iv) which, where such Office is the government authority of a Contracting State entrusted with the granting of patents, is an official holiday in part of that Contracting State, and in circumstances where the national law applicable by that Office provides, in respect of national applications, that, in such a case, such period shall expire on a subsequent day; the period shall expire on the next subsequent day on which none of the said four circumstances exists.

80.6 *Date of Documents*

Where a period starts on the day of the date of a document or letter emanating from a national Office or intergovernmental organization, any interested party may prove that the said document or letter was mailed on a day later than the date it bears, in which case the date of actual mailing shall, for the purposes of computing the period, be considered to be the date on which the period starts. Irrespective of the date on which such a document or letter was mailed, if the applicant offers to the national Office or intergovernmental organization evidence which satisfies the national Office or intergovernmental organization that the document or letter was received more than seven days after the date it bears, the national Office or intergovernmental organization shall treat the period starting from the date of the document or letter as expiring later by an additional number of days which is equal to the number of days which the document or letter was received later than seven days after the date it bears.

80.7 *End of Working Day*

(a) A period expiring on a given day shall expire at the moment the national Office or intergovernmental organization with which the document must be filed or to which the fee must be paid closes for business on that day.

(b) Any Office or organization may depart from the provisions of paragraph (a) up to midnight on the relevant day.

(c) *[Deleted]*

**Rule 81**

**Modification of Time Limits Fixed in the Treaty**

81.1 *Proposal*

(a) Any Contracting State or the Director General may propose a modification under Article 47(2).

(b) Proposals made by a Contracting State shall be presented to the Director General.

81.2 *Decision by the Assembly*

(a) When the proposal is made to the Assembly, its text shall be sent by the Director General to all Contracting States at least two months in advance of that session of the Assembly whose agenda includes the proposal.

(b) During the discussion of the proposal in the Assembly, the proposal may be amended or consequential amendments proposed.

(c) The proposal shall be considered adopted if none of the Contracting States present at the time of voting votes against the proposal.

81.3 *Voting by Correspondence*

(a) When voting by correspondence is chosen, the proposal shall be included in a written communication from the Director General to the Contracting States, inviting them to express their vote in writing.

(b) The invitation shall fix the time limit within which the reply containing the vote expressed in writing must reach the International Bureau. That time limit shall not be less than three months from the date of the invitation.

(c) Replies must be either positive or negative. Proposals for amendments or mere observations shall not be regarded as votes.

(d) The proposal shall be considered adopted if none of the Contracting States opposes the amendment and if at least one-half of the Contracting States express either approval or indifference or abstention.

**Rule 82**

**Irregularities in the Mail Service**

82.1 *Delay or Loss in Mail*

(a) Any interested party may offer evidence that he has mailed the document or letter five days prior to the expiration of the time limit. Except in cases where surface mail normally arrives at its destination within two days of mailing, or where no air-mail service is available, such evidence may be offered only if the mailing was by airmail. In any case, evidence may be offered only if the mailing was by mail registered by the postal authorities.

(b) If the mailing, in accordance with paragraph (a), of a document or letter is proven to the satisfaction of the national Office or intergovernmental organization which is the addressee, delay in arrival shall be excused, or, if the document or letter is lost in the mail, substitution for it of a new copy shall be permitted, provided that the interested party proves to the satisfaction of the said Office or organization that the document or letter offered in substitution is identical with the document or letter lost.

(c) In the cases provided for in paragraph (b), evidence of mailing within the prescribed time limit, and, where the document or letter was lost, the substitute document or letter as well as the evidence concerning its identity with the document or letter lost shall be submitted within one month after the date on which the interested party noticed - or with due diligence should have noticed - the delay or the loss, and in no case later than six months after the expiration of the time limit applicable in the given case.

(d) Any national Office or intergovernmental organization which has notified the International Bureau that it will do so shall, where a delivery service other than the postal authorities is used to mail a document or letter, apply the provisions of paragraphs (a) to (c) as if the delivery service was a postal authority. In such a case, the last sentence of paragraph (a) shall not apply but evidence may be offered only if details of the mailing were recorded by the delivery service at the time of mailing. The notification may contain an indication that it applies only to mailings using specified delivery services or delivery services which satisfy specified criteria. The International Bureau shall publish the information so notified in the Gazette.

(e) Any national Office or intergovernmental organization may proceed under paragraph (d):

(i) even if, where applicable, the delivery service used was not one of those specified, or did not satisfy the criteria specified, in the relevant notification under paragraph (d), or

(ii) even if that Office or organization has not sent to the International Bureau a notification under paragraph (d).

### 82.2 *Interruption in the Mail Service*

(a) Any interested party may offer evidence that on any of the 10 days preceding the day of expiration of the time limit the postal service was interrupted on account of war, revolution, civil disorder, strike, natural calamity, or other like reason, in the locality where the interested party resides or has his place of business or is staying.

(b) If such circumstances are proven to the satisfaction of the national Office or intergovernmental organization which is the addressee, delay in arrival shall be excused, provided that the interested party proves to the satisfaction of the said Office or organization that he effected the mailing within five days

after the mail service was resumed. The provisions of Rule 82.1(c) shall apply *mutatis mutandis*.

### **Rule 82<sup>bis</sup>**

#### **Excuse by the Designated or Elected State of Delays in Meeting Certain Time Limits**

##### 82<sup>bis</sup>.1 *Meaning of "Time Limit" in Article 48(2)*

The reference to "any time limit" in Article 48(2) shall be construed as comprising a reference:

(i) to any time limit fixed in the Treaty or these Regulations;

(ii) to any time limit fixed by the receiving Office, the International Searching Authority, the International Preliminary Examining Authority or the International Bureau or applicable by the receiving Office under its national law;

(iii) to any time limit fixed by, or in the national law applicable by, the designated or elected Office, for the performance of any act by the applicant before that Office.

##### 82<sup>bis</sup>.2 *Reinstatement of Rights and Other Provisions to Which Article 48(2) Applies*

The provisions of the national law which is referred to in Article 48(2) concerning the excusing, by the designated or elected State, of any delay in meeting any time limit are those provisions which provide for reinstatement of rights, restoration, *restitutio in integrum* or further processing in spite of noncompliance with a time limit, and any other provision providing for the extension of time limits or for excusing delays in meeting time limits.

### **Rule 82<sup>ter</sup>**

#### **Rectification of Errors Made by the Receiving Office or by the International Bureau**

##### 82<sup>ter</sup>.1 *Errors Concerning the International Filing Date and the Priority Claim*

If the applicant proves to the satisfaction of any designated or elected Office that the international filing date is incorrect due to an error made by the receiving Office or that the priority claim has been erroneously considered by the receiving Office or the International Bureau not to have been made, and if the error is an error such that, had it been made by the designated or elected Office itself, that Office would

rectify it under the national law or national practice, the said Office shall rectify the error and shall treat the international application as if it had been accorded the rectified international filing date or as if the priority claim had not been considered not to have been made.

### **Rule 83**

#### **Right to Practice Before International Authorities**

##### *83.1 Proof of Right*

The International Bureau, the competent International Searching Authority, and the competent International Preliminary Examining Authority may require the production of proof of the right to practice referred to in Article 49.

##### *83.1<sup>bis</sup> Where the International Bureau Is the Receiving Office*

(a) Any person who has the right to practice before the national Office of, or acting for, a Contracting state of which the applicant or, if there are two or more applicants, any of the applicants is a resident or national shall be entitled to practice in respect of the international application before the International Bureau in its capacity as receiving Office under Rule 19.1(a)(iii).

(b) Any person having the right to practice before the International Bureau in its capacity as receiving Office in respect of an international application shall be entitled to practice in respect of that application before the International Bureau in any other capacity and before the competent International Searching Authority and competent International Preliminary Examining Authority.

##### *83.2 Information*

(a) The national Office or the intergovernmental organization which the interested person is alleged to have a right to practice before shall, upon request, inform the International Bureau, the competent International Searching Authority, or the competent International Preliminary Examining Authority, whether such person has the right to practice before it.

(b) Such information shall be binding upon the International Bureau, the International Searching Authority, or the International Preliminary Examining Authority, as the case may be.

## **PART E**

### **Rules Concerning Chapter V of the Treaty**

#### **Rule 84**

##### **Expenses of Delegations**

##### *84.1 Expenses Borne by Governments*

The expenses of each Delegation participating in any organ established by or under the Treaty shall be borne by the Government which has appointed it.

#### **Rule 85**

##### **Absence of Quorum in the Assembly**

##### *85.1 Voting by Correspondence*

In the case provided for in Article 53(5)(b), the International Bureau shall communicate the decisions of the Assembly (other than those concerning the Assembly's own procedure) to the Contracting States which were not represented and shall invite them to express in writing their vote or abstention within a period of three months from the date of the communication. If, at the expiration of that period, the number of Contracting States having thus expressed their vote or abstention attains the number of Contracting States which was lacking for attaining the quorum in the session itself, such decisions shall take effect provided that at the same time the required majority still obtains.

#### **Rule 86**

##### **The Gazette**

##### *86.1 Contents and Form*

(a) The Gazette referred to in Article 55(4) shall contain:

(i) for each published international application, the data specified by the Administrative Instructions taken from the front page of the pamphlet published under Rule 48, the drawing (if any) appearing on the said front page, and the abstract,

(ii) the schedule of all fees payable to the receiving Offices, the International Bureau, and the International Searching and Preliminary Examining Authorities,

(iii) notices the publication of which is required under the Treaty or these Regulations,



(iv) information, if and to the extent furnished to the International Bureau by the designated or elected Offices, on the question whether the requirements provided for in Articles 22 or 39 have been complied with in respect of the international applications designating or electing the Office concerned,

(v) any other useful information prescribed by the Administrative Instructions, provided access to such information is not prohibited under the Treaty or these Regulations.

(b) The information referred to in paragraph (a) shall be made available in two forms:

(i) as a Gazette in paper form, which shall contain the data specified by the Administrative Instructions taken from the front page of the pamphlet published under Rule 48 (“bibliographic data”) and the matters referred to in paragraph (a)(ii) to (v);

(ii) as a Gazette in electronic form, which shall contain the bibliographic data, the drawing (if any) appearing on the said front page, and the abstract.

#### 86.2 *Languages; Access to the Gazette*

(a) The Gazette in paper form shall be published in a bilingual (English and French) edition. It shall also be published in editions in any other language, provided the cost of publication is assured through sales or subventions.

(b) The Assembly may order the publication of the Gazette in languages other than those referred to in paragraph (a).

(c) The Gazette in electronic form referred to in Rule 86.1(b)(ii) shall be made accessible, in English and French at the same time, by any electronic ways and means specified in the Administrative Instructions. The translations shall be ensured by the International Bureau in English and French. The International Bureau shall ensure that the making accessible of the Gazette in electronic form shall be effected on, or as soon as possible after, the date of publication of the pamphlet containing the international application.

#### 86.3 *Frequency*

The frequency of publication of the Gazette shall be determined by the Director General.

#### 86.4 *Sale*

The subscription and other sale prices of the Gazette shall be determined by the Director General.

#### 86.5 *Title*

The title of the Gazette shall be determined by the Director General.

#### 86.6 *Further Details*

Further details concerning the Gazette may be provided for in the Administrative Instructions.

### **Rule 87**

#### **Copies of Publications**

##### 87.1 *International Searching and Preliminary Examining Authorities*

Any International Searching or Preliminary Examining Authority shall have the right to receive, free of charge, two copies of every published international application, of the Gazette, and of any other publication of general interest published by the International Bureau in connection with the Treaty or these Regulations.

##### 87.2 *National Offices*

(a) Any national Office shall have the right to receive, free of charge, one copy of every published international application, of the Gazette, and of any other publication of general interest published by the International Bureau in connection with the Treaty or these Regulations.

(b) The publications referred to in paragraph (a) shall be sent on special request. If any publication is available in more than one language, the request shall specify the language or languages in which it is desired.

### **Rule 88**

#### **Amendment of the Regulations**

##### 88.1 *Requirement of Unanimity*

Amendment of the following provisions of these Regulations shall require that no State having the right to vote in the Assembly vote against the proposed amendment:

- (i) Rule 14.1 (Transmittal Fee),
- (ii) *[Deleted]*
- (iii) Rule 22.3 (Time Limit under Article 12(3)),
- (iv) Rule 33 (Relevant Prior Art for International Search),
- (v) Rule 64 (Prior Art for International Preliminary Examination),

- (vi) Rule 81 (Modification of Time Limits Fixed in the Treaty),
- (vii) the present paragraph (i.e., Rule 88.1).

88.2 *[Deleted]*

88.3 *Requirement of Absence of Opposition by Certain States*

Amendment of the following provisions of these Regulations shall require that no State referred to in Article 58(3)(a)(ii) and having the right to vote in the Assembly vote against the proposed amendment:

- (i) Rule 34 (Minimum Documentation),
- (ii) Rule 39 (Subject Matter under Article 17(2)(a)(i)),
- (iii) Rule 67 (Subject Matter under Article 34(4)(a)(i)),
- (iv) the present paragraph (i.e., Rule 88.3).

88.4 *Procedure*

Any proposal for amending a provision referred to in Rules 88.1 or 88.3 shall, if the proposal is to be decided upon in the Assembly, be communicated to all Contracting States at least two months prior to the opening of that session of the Assembly which is called upon to make a decision on the proposal.

**Rule 89**

**Administrative Instructions**

89.1 *Scope*

(a) The Administrative Instructions shall contain provisions:

- (i) concerning matters in respect of which these Regulations expressly refer to such Instructions,
- (ii) concerning any details in respect of the application of these Regulations.

(b) The Administrative Instructions shall not be in conflict with the provisions of the Treaty, these Regulations, or any agreement concluded by the International Bureau with an International Searching Authority, or an International Preliminary Examining Authority.

89.2 *Source*

(a) The Administrative Instructions shall be drawn up and promulgated by the Director General after consultation with the receiving Offices and the International Searching and Preliminary Examining Authorities.

(b) They may be modified by the Director General after consultation with the Offices or Authorities which have a direct interest in the proposed modification.

(c) The Assembly may invite the Director General to modify the Administrative Instructions, and the Director General shall proceed accordingly.

89.3 *Publication and Entry into Force*

(a) The Administrative Instructions and any modification thereof shall be published in the Gazette.

(b) Each publication shall specify the date on which the published provisions come into effect. The dates may be different for different provisions, provided that no provision may be declared effective prior to its publication in the Gazette.

**PART F**

**Rules Concerning Several Chapters of the Treaty**

**Rule 89<sup>bis</sup>**

**Filing, Processing and Communication of International Applications and Other Documents in Electronic Form or by Electronic Means**

89<sup>bis</sup>.1 *International Applications*

(a) International applications may, subject to paragraphs (b) to (e), be filed and processed in electronic form or by electronic means, in accordance with the Administrative Instructions, provided that any receiving Office shall permit the filing of international applications on paper.

(b) These Regulations shall apply *mutatis mutandis* to international applications filed in electronic form or by electronic means, subject to any special provisions of the Administrative Instructions.

(c) The Administrative Instructions shall set out the provisions and requirements in relation to the filing and processing of international applications filed, in whole or in part, in electronic form or by electronic means, including but not limited to, provisions and requirements in relation to acknowledgment of receipt, procedures relating to the according of an international filing date, physical requirements and the consequences of non-compliance with those requirements, signature of documents, means of

authentication of documents and of the identity of parties communicating with Offices and authorities, and the operation of Article 12 in relation to the home copy, the record copy and the search copy, and may contain different provisions and requirements in relation to international applications filed in different languages.

(d) No national Office or intergovernmental organization shall be obliged to receive or process international applications filed in electronic form or by electronic means unless it has notified the International Bureau that it is prepared to do so in compliance with the applicable provisions of the Administrative Instructions. The International Bureau shall publish the information so notified in the Gazette.

(e) No receiving Office which has given the International Bureau a notification under paragraph (d) may refuse to process an international application filed in electronic form or by electronic means which complies with the applicable requirements under the Administrative Instructions.

#### *89<sup>bis</sup>.2 Other Documents*

Rule 89<sup>bis</sup>.1 shall apply *mutatis mutandis* to other documents and correspondence relating to international applications.

#### *89<sup>bis</sup>.3 Communication Between Offices*

Where the Treaty, these Regulations or the Administrative Instructions provide for the communication, notification or transmittal (“communication”) of an international application, notification, communication, correspondence or other document by one national Office or intergovernmental organization to another, such communication may, where so agreed by both the sender and the receiver, be effected in electronic form or by electronic means.

### **Rule 89<sup>ter</sup>**

#### **Copies in Electronic Form of Documents Filed on Paper**

##### *89<sup>ter</sup>.1 Copies in Electronic Form of Documents Filed on Paper*

Any national Office or intergovernmental organization may provide that, where an international application or other document relating to an international

application is filed on paper, a copy thereof in electronic form, in accordance with the Administrative Instructions, may be furnished by the applicant.

### **Rule 90**

#### **Agents and Common Representatives**

##### *90.1 Appointment as Agent*

(a) A person having the right to practice before the national Office with which the international application is filed or, where the international application is filed with the International Bureau, having the right to practice in respect of the international application before the International Bureau as receiving Office may be appointed by the applicant as his agent to represent him before the receiving Office, the International Bureau, the International Searching Authority, and the International Preliminary Examining Authority.

(b) A person having the right to practice before the national Office or intergovernmental organization which acts as the International Searching Authority may be appointed by the applicant as his agent to represent him specifically before that Authority.

(c) A person having the right to practice before the national Office or intergovernmental organization which acts as the International Preliminary Examining Authority may be appointed by the applicant as his agent to represent him specifically before that Authority.

(d) An agent appointed under paragraph (a) may, unless otherwise indicated in the document appointing him, appoint one or more subagents to represent the applicant as the applicant's agent:

(i) before the receiving Office, the International Bureau, the International Searching Authority, and the International Preliminary Examining Authority, provided that any person so appointed as subagent has the right to practice before the national Office with which the international application was filed or to practice in respect of the international application before the International Bureau as receiving Office, as the case may be;

(ii) specifically before the International Searching Authority or the International Preliminary Examining Authority, provided that any person so appointed as sub-agent has the right to practice before the national Office or intergovernmental organization

which acts as the International Searching Authority or International Preliminary Examining Authority, as the case may be.

#### 90.2 *Common Representative*

(a) Where there are two or more applicants and the applicants have not appointed an agent representing all of them (a “common agent”) under Rule 90.1(a), one of the applicants who is entitled to file an international application according to Article 9 may be appointed by the other applicants as their common representative.

(b) Where there are two or more applicants and all the applicants have not appointed a common agent under Rule 90.1(a) or a common representative under paragraph (a), the applicant first named in the request who is entitled according to Rule 19.1 to file an international application with the receiving Office shall be considered to be the common representative of all the applicants.

#### 90.3 *Effects of Acts by or in Relation to Agents and Common Representatives*

(a) Any act by or in relation to an agent shall have the effect of an act by or in relation to the applicant or applicants concerned.

(b) If there are two or more agents representing the same applicant or applicants, any act by or in relation to any of those agents shall have the effect of an act by or in relation to the said applicant or applicants.

(c) Subject to Rule 90<sup>bis</sup>.5(a), second sentence, any act by or in relation to a common representative or his agent shall have the effect of an act by or in relation to all the applicants.

#### 90.4 *Manner of Appointment of Agent or Common Representative*

(a) The appointment of an agent shall be effected by the applicant signing the request, the demand, or a separate power of attorney. Where there are two or more applicants, the appointment of a common agent or common representative shall be effected by each applicant signing, at his choice, the request, the demand or a separate power of attorney.

(b) Subject to Rule 90.5, a separate power of attorney shall be submitted to either the receiving Office or the International Bureau, provided that, where a power of attorney appoints an agent under Rule 90.1(b), (c), or (d)(ii), it shall be submitted to the

International Searching Authority or the International Preliminary Examining Authority, as the case may be.

(c) If the separate power of attorney is not signed, or if the required separate power of attorney is missing, or if the indication of the name or address of the appointed person does not comply with Rule 4.4, the power of attorney shall be considered nonexistent unless the defect is corrected.

(d) Subject to paragraph (e), any receiving Office, any International Searching Authority, any International Preliminary Examining Authority and the International Bureau may waive the requirement under paragraph (b) that a separate power of attorney be submitted to it, in which case paragraph (c) shall not apply.

(e) Where the agent or the common representative submits any notice of withdrawal referred to in Rules 90<sup>bis</sup>.1 to 90<sup>bis</sup>.4, the requirement under paragraph (b) for a separate power of attorney shall not be waived under paragraph (d).

#### 90.5 *General Power of Attorney*

(a) Appointment of an agent in relation to a particular international application may be effected by referring in the request, the demand, or a separate notice to an existing separate power of attorney appointing that agent to represent the applicant in relation to any international application which may be filed by that applicant (i.e., a “general power of attorney”), provided that:

(i) the general power of attorney has been deposited in accordance with paragraph (b), and

(ii) a copy of it is attached to the request, the demand or the separate notice, as the case may be; that copy need not be signed.

(b) The general power of attorney shall be deposited with the receiving Office, provided that, where it appoints an agent under Rule 90.1(b), (c), or (d)(ii), it shall be deposited with the International Searching Authority or the International Preliminary Examining Authority, as the case may be.

(c) Any receiving Office, any International Searching Authority and any International Preliminary Examining Authority may waive the requirement under paragraph (a)(ii) that a copy of the general power of attorney is attached to the request, the demand or the separate notice, as the case may be.

(d) Notwithstanding paragraph (c), where the agent submits any notice of withdrawal referred to in

Rules 90bis.1 to 90bis.4 to the receiving Office, the International Searching Authority or the International Preliminary Examining Authority, a copy of the general power of attorney shall be submitted to that Office or Authority.

#### 90.6 *Revocation and Renunciation*

(a) Any appointment of an agent or common representative may be revoked by the persons who made the appointment or by their successors in title, in which case any appointment of a sub-agent under Rule 90.1(d) by that agent shall also be considered as revoked. Any appointment of a subagent under Rule 90.1(d) may also be revoked by the applicant concerned.

(b) The appointment of an agent under Rule 90.1(a) shall, unless otherwise indicated, have the effect of revoking any earlier appointment of an agent made under that Rule.

(c) The appointment of a common representative shall, unless otherwise indicated, have the effect of revoking any earlier appointment of a common representative.

(d) An agent or a common representative may renounce his appointment by a notification signed by him.

(e) Rule 90.4(b) and (c) shall apply, *mutatis mutandis*, to a document containing a revocation or renunciation under this Rule.

### **Rule 90<sup>bis</sup>**

#### **Withdrawals**

##### 90<sup>bis</sup>.1 *Withdrawal of the International Application*

(a) The applicant may withdraw the international application at any time prior to the expiration of 30 months from the priority date.

(b) Withdrawal shall be effective on receipt of a notice addressed by the applicant, at his option, to the International Bureau, to the receiving Office or, where Article 39(1) applies, to the International Preliminary Examining Authority.

(c) No international publication of the international application shall be effected if the notice of withdrawal sent by the applicant or transmitted by the receiving Office or the International Preliminary Examining Authority reaches the International Bureau

before the technical preparations for international publication have been completed.

##### 90<sup>bis</sup>.2 *Withdrawal of Designations*

(a) The applicant may withdraw the designation of any designated State at any time prior to the expiration of 30 months from the priority date. Withdrawal of the designation of a State which has been elected shall entail withdrawal of the corresponding election under Rule 90<sup>bis</sup>.4.

(b) Where a State has been designated for the purpose of obtaining both a national patent and a regional patent, withdrawal of the designation of that State shall be taken to mean withdrawal of only the designation for the purpose of obtaining a national patent, except where otherwise indicated.

(c) Withdrawal of the designations of all designated States shall be treated as withdrawal of the international application under Rule 90<sup>bis</sup>.1.

(d) Withdrawal shall be effective on receipt of a notice addressed by the applicant, at his option, to the International Bureau, to the receiving Office or, where Article 39(1) applies, to the International Preliminary Examining Authority.

(e) No international publication of the designation shall be effected if the notice of withdrawal sent by the applicant or transmitted by the receiving Office or the International Preliminary Examining Authority reaches the International Bureau before the technical preparations for international publication have been completed.

##### 90<sup>bis</sup>.3 *Withdrawal of Priority Claims*

(a) The applicant may withdraw a priority claim, made in the international application under Article 8(1), at any time prior to the expiration of 30 months from the priority date.

(b) Where the international application contains more than one priority claim, the applicant may exercise the right provided for in paragraph (a) in respect of one or more or all of the priority claims.

(c) Withdrawal shall be effective on receipt of a notice addressed by the applicant, at his option, to the International Bureau, to the receiving Office or, where Article 39(1) applies, to the International Preliminary Examining Authority.

(d) Where the withdrawal of a priority claim causes a change in the priority date, any time limit

which is computed from the original priority date and which has not already expired shall, subject to paragraph (e), be computed from the priority date resulting from that change.

(e) In the case of the time limit referred to in Article 21(2)(a), the International Bureau may nevertheless proceed with the international publication on the basis of the said time limit as computed from the original priority date if the notice of withdrawal sent by the applicant or transmitted by the receiving Office or the International Preliminary Examining Authority reaches the International Bureau after the completion of the technical preparations for international publication.

#### 90<sup>bis</sup>.4 *Withdrawal of the Demand, or of Elections*

(a) The applicant may withdraw the demand or any or all elections at any time prior to the expiration of 30 months from the priority date.

(b) Withdrawal shall be effective upon receipt of a notice addressed by the applicant to the International Bureau.

(c) If the notice of withdrawal is submitted by the applicant to the International Preliminary Examining Authority, that Authority shall mark the date of receipt on the notice and transmit it promptly to the International Bureau. The notice shall be considered to have been submitted to the International Bureau on the date marked.

#### 90<sup>bis</sup>.5 *Signature*

(a) Any notice of withdrawal referred to in Rules 90<sup>bis</sup>.1 to 90<sup>bis</sup>.4 shall, subject to paragraph (b), be signed by the applicant or, if there are two or more applicants, by all of them. An applicant who is considered to be the common representative under Rule 90.2(b) shall, subject to paragraph (b), not be entitled to sign such a notice on behalf of the other applicants.

(b) Where two or more applicants file an international application which designates a State whose national law requires that national applications be filed by the inventor and where an applicant for that designated State who is an inventor could not be found or reached after diligent effort, a notice of withdrawal referred to in Rules 90<sup>bis</sup>.1 to 90<sup>bis</sup>.4 need not be signed by that applicant (“the applicant concerned”) if it is signed by at least one applicant and

(i) a statement is furnished explaining, to the satisfaction of the receiving Office, the International Bureau, or the International Preliminary Examining Authority, as the case may be, the lack of signature of the applicant concerned, or

(ii) in the case of a notice of withdrawal referred to in Rule 90<sup>bis</sup>.1(b), 90<sup>bis</sup>.2(d), or 90<sup>bis</sup>.3(c), the applicant concerned did not sign the request but the requirements of Rule 4.15(b) were complied with, or

(iii) in the case of a notice of withdrawal referred to in Rule 90<sup>bis</sup>.4(b), the applicant concerned did not sign the demand but the requirements of Rule 53.8(b) were complied with.

#### 90<sup>bis</sup>.6 *Effect of Withdrawal*

(a) Withdrawal under Rule 90<sup>bis</sup> of the international application, any designation, any priority claim, the demand or any election shall have no effect in any designated or elected Office where the processing or examination of the international application has already started under Article 23(2) or Article 40(2).

(b) Where the international application is withdrawn under Rule 90<sup>bis</sup>.1, the international processing of the international application shall be discontinued.

(c) Where the demand or all elections are withdrawn under Rule 90<sup>bis</sup>.4, the processing of the international application by the International Preliminary Examining Authority shall be discontinued.

#### 90<sup>bis</sup>.7 *Faculty Under Article 37(4)(b)*

(a) Any Contracting State whose national law provides for what is described in the second part of Article 37(4)(b) shall notify the International Bureau in writing.

(b) The notification referred to in paragraph (a) shall be promptly published by the International Bureau in the Gazette, and shall have effect in respect of international applications filed more than one month after the date of such publication.

## Rule 91

### Obvious Errors in Documents

#### 91.1 *Rectification*

(a) Subject to paragraphs (b) to (g<sup>quater</sup>), obvious errors in the international application or other papers submitted by the applicant may be rectified.

(b) Errors which are due to the fact that something other than what was obviously intended was written in the international application or other paper shall be regarded as obvious errors. The rectification itself shall be obvious in the sense that anyone would immediately realize that nothing else could have been intended than what is offered as rectification.

(c) Omissions of entire elements or sheets of the international application, even if clearly resulting from inattention, at the stage, for example, of copying or assembling sheets, shall not be rectifiable.

(d) Rectification may be made on the request of the applicant. The authority having discovered what appears to be an obvious error may invite the applicant to present a request for rectification as provided in paragraphs (e) to (g)<sup>quater</sup>. Rule 26.4 shall apply *mutatis mutandis* to the manner in which rectifications shall be requested.

(e) No rectification shall be made except with the express authorization:

(i) of the receiving Office if the error is in the request,

(ii) of the International Searching Authority if the error is in any part of the international application other than the request or in any paper submitted to that Authority,

(iii) of the International Preliminary Examining Authority if the error is in any part of the international application other than the request or in any paper submitted to that Authority, and

(iv) of the International Bureau if the error is in any paper, other than the international application or amendments or corrections to that application, submitted to the International Bureau.

(f) Any authority which authorizes or refuses any rectification shall promptly notify the applicant of the authorization or refusal and, in the case of refusal, of the reasons therefor. The authority which authorizes a rectification shall promptly notify the International Bureau accordingly. Where the authorization of the rectification was refused, the International Bureau shall, upon request made by the applicant prior to the time relevant under paragraph (g)<sup>bis</sup>, (g)<sup>ter</sup>, or (g)<sup>quater</sup> and subject to the payment of a special fee whose amount shall be fixed in the Administrative Instructions, publish the request for rectification together with the international application. A copy of the

request for rectification shall be included in the communication under Article 20 where a copy of the pamphlet is not used for that communication or where the international application is not published by virtue of Article 64(3).

(g) The authorization for rectification referred to in paragraph (e) shall, subject to paragraphs (g)<sup>bis</sup>, (g)<sup>ter</sup>, and (g)<sup>quater</sup>, be effective:

(i) where it is given by the receiving Office or by the International Searching Authority, if its notification to the International Bureau reaches that Bureau before the expiration of 17 months from the priority date;

(ii) where it is given by the International Preliminary Examining Authority, if it is given before the establishment of the international preliminary examination report;

(iii) where it is given by the International Bureau, if it is given before the expiration of 17 months from the priority date.

(g)<sup>bis</sup> If the notification made under paragraph (g)(i) reaches the International Bureau, or if the rectification made under paragraph (g)(iii) is authorized by the International Bureau, after the expiration of 17 months from the priority date but before the technical preparations for international publication have been completed, the authorization shall be effective and the rectification shall be incorporated in the said publication.

(g)<sup>ter</sup> Where the applicant has asked the International Bureau to publish his international application before the expiration of 18 months from the priority date, any notification made under paragraph (g)(i) must reach, and any rectification made under paragraph (g)(iii) must be authorized by, the International Bureau, in order for the authorization to be effective, not later than at the time of the completion of the technical preparations for international publication.

(g)<sup>quater</sup> Where the international application is not published by virtue of Article 64(3), any notification made under paragraph (g)(i) must reach, and any rectification made under paragraph (g)(iii) must be authorized by, the International Bureau, in order for the authorization to be effective, not later than at the time of the communication of the international application under Article 20.

**Rule 92****Correspondence***92.1 Need for Letter and for Signature*

(a) Any paper submitted by the applicant in the course of the international procedure provided for in the Treaty and these Regulations, other than the international application itself, shall, if not itself in the form of a letter, be accompanied by a letter identifying the international application to which it relates. The letter shall be signed by the applicant.

(b) If the requirements provided for in paragraph (a) are not complied with, the applicant shall be informed as to the non-compliance and invited to remedy the omission within a time limit fixed in the invitation. The time limit so fixed shall be reasonable in the circumstances; even where the time limit so fixed expires later than the time limit applying to the furnishing of the paper (or even if the latter time limit has already expired), it shall not be less than 10 days and not more than one month from the mailing of the invitation. If the omission is remedied within the time limit fixed in the invitation, the omission shall be disregarded; otherwise, the applicant shall be informed that the paper has been disregarded.

(c) Where non-compliance with the requirements provided for in paragraph (a) has been overlooked and the paper taken into account in the international procedure, the non-compliance shall be disregarded.

*92.2 Languages*

(a) Subject to Rules 55.1 and 66.9 and to paragraph (b) of this Rule, any letter or document submitted by the applicant to the International Searching Authority or the International Preliminary Examining Authority shall be in the same language as the international application to which it relates. However, where a translation of the international application has been transmitted under Rule 23.1(b) or furnished under Rule 55.2, the language of such translation shall be used.

(b) Any letter from the applicant to the International Searching Authority or the International Preliminary Examining Authority may be in a language other than that of the international application, provided the said Authority authorizes the use of such language.

(c) *[Deleted]*

(d) Any letter from the applicant to the International Bureau shall be in English or French.

(e) Any letter or notification from the International Bureau to the applicant or to any national Office shall be in English or French.

*92.3 Mailings by National Offices and Intergovernmental Organizations*

Any document or letter emanating from or transmitted by a national Office or an intergovernmental organization and constituting an event from the date of which any time limit under the Treaty or these Regulations commences to run shall be sent by air mail, provided that surface mail may be used instead of air mail in cases where surface mail normally arrives at its destination within two days from mailing or where air mail service is not available.

*92.4 Reproductions*

(a) A document making up the international application, and any later document or correspondence relating thereto, may, notwithstanding the provisions of Rules 11.14 and 92.1(a), but subject to paragraph (h), be transmitted, to the extent feasible, by telegraph, teleprinter, facsimile machine or other like means of communication resulting in the filing of a printed or written document.

(b) A signature appearing on a document transmitted by facsimile machine shall be recognized for the purposes of the Treaty and these Regulations as a proper signature.

(c) Where the applicant has attempted to transmit a document by any of the means referred to in paragraph (a) but part or all of the received document is illegible or part of the document is not received, the document shall be treated as not having been received to the extent that the received document is illegible or that the attempted transmission failed. The national Office or intergovernmental organization shall promptly notify the applicant accordingly.

(d) Any national Office or intergovernmental organization may require that the original of any document transmitted by any of the means referred to in paragraph (a) and an accompanying letter identifying that earlier transmission be furnished within 14 days from the date of the transmission, provided that such requirement has been notified to the International Bureau and the International Bureau has published



information thereon in the Gazette. The notification shall specify whether such requirement concerns all or only certain kinds of documents.

(e) Where the applicant fails to furnish the original of a document as required under paragraph (d), the national Office or intergovernmental organization concerned may, depending on the kind of document transmitted and having regard to Rules 11 and 26.3,

(i) waive the requirement under paragraph (d), or

(ii) invite the applicant to furnish, within a time limit which shall be reasonable under the circumstances and shall be fixed in the invitation, the original of the document transmitted, provided that, where the document transmitted contains defects, or shows that the original contains defects, in respect of which the national Office or intergovernmental organization may issue an invitation to correct, that Office or organization may issue such an invitation in addition to, or instead of, proceeding under item (i) or (ii).

(f) Where the furnishing of the original of a document is not required under paragraph (d) but the national Office or intergovernmental organization considers it necessary to receive the original of the said document, it may issue an invitation as provided for under paragraph (e)(ii).

(g) If the applicant fails to comply with an invitation under paragraph (e)(ii) or (f):

(i) where the document concerned is the international application, the latter shall be considered withdrawn and the receiving Office shall so declare;

(ii) where the document concerned is a document subsequent to the international application, the document shall be considered as not having been submitted.

(h) No national Office or intergovernmental organization shall be obliged to receive any document submitted by a means referred to in paragraph (a) unless it has notified the International Bureau that it is prepared to receive such a document by that means and the International Bureau has published information thereon in the Gazette.

## **Rule 92<sup>bis</sup>**

### **Recording of Changes in Certain Indications in the Request or the Demand**

#### *92<sup>bis</sup>.1 Recording of Changes by the International Bureau*

(a) The International Bureau shall, on the request of the applicant or the receiving Office, record changes in the following indications appearing in the request or demand:

(i) person, name, residence, nationality, or address of the applicant,

(ii) person, name, or address of the agent, the common representative, or the inventor.

(b) The International Bureau shall not record the requested change if the request for recording is received by it after the expiration of 30 months from the priority date.

## **Rule 93**

### **Keeping of Records and Files**

#### *93.1 The Receiving Office*

Each receiving Office shall keep the records relating to each international application or purported international application, including the home copy, for at least 10 years from the international filing date or, where no international filing date is accorded, from the date of receipt.

#### *93.2 The International Bureau*

(a) The International Bureau shall keep the file, including the record copy, of any international application for at least 30 years from the date of receipt of the record copy.

(b) The basic records of the International Bureau shall be kept indefinitely.

#### *93.3 The International Searching and Preliminary Examining Authorities*

Each International Searching Authority and each International Preliminary Examining Authority shall keep the file of each international application it receives for at least 10 years from the international filing date.

#### *93.4 Reproductions*

For the purposes of this Rule, records, copies and files may be kept as photographic, electronic or other

reproductions, provided that the reproductions are such that the obligations to keep records, copies and files under Rules 93.1 to 93.3 are met.

### **Rule 93<sup>bis</sup>**

#### **Manner of Communication of Documents**

##### *93<sup>bis</sup>.1 Communication on Request; Communication via Digital Library*

(a) Where the Treaty, these Regulations or the Administrative Instructions provide for the communication, notification or transmittal (“communication”) of an international application, notification, communication, correspondence or other document (“document”) by the International Bureau to any designated or elected Office, such communication shall be effected only upon request by the Office concerned and at the time specified by that Office. Such request may be made in relation to individually specified documents or a specified class or classes of documents.

(b) A communication under paragraph (a) shall, where so agreed by the International Bureau and the designated or elected Office concerned, be considered to be effected at the time when the International Bureau makes the document available to that Office in electronic form in a digital library, in accordance with the Administrative Instructions, from which that Office is entitled to retrieve that document.

### **Rule 94**

#### **Access to Files**

##### *94.1 Access to the File Held by the International Bureau*

(a) At the request of the applicant or any person authorized by the applicant, the International Bureau shall furnish, subject to reimbursement of the cost of the service, copies of any document contained in its file.

(b) The International Bureau shall, at the request of any person but not before the international publication of the international application and subject to Article 38 and Rule 44<sup>ter</sup>.1, furnish, subject to the reimbursement of the cost of the service, copies of any document contained in its file.

(c) The International Bureau shall, if so requested by an elected Office, furnish copies of the international preliminary examination report under

paragraph (b) on behalf of that Office. The International Bureau shall promptly publish details of any such request in the Gazette.

##### *94.2 Access to the File Held by the International Preliminary Examining Authority*

At the request of the applicant or any person authorized by the applicant, or, once the international preliminary examination report has been established, of any elected Office, the International Preliminary Examining Authority shall furnish, subject to reimbursement of the cost of the service, copies of any document contained in its file.

##### *94.3 Access to the File Held by the Elected Office*

If the national law applicable by any elected Office allows access by third parties to the file of a national application, that Office may allow access to any documents relating to the international application, including any document relating to the international preliminary examination, contained in its file, to the same extent as provided by the national law for access to the file of a national application, but not before the international publication of the international application. The furnishing of copies of documents may be subject to reimbursement of the cost of the service.

### **Rule 95**

#### **Availability of Translations**

##### *95.1 Furnishing of Copies of Translations*

(a) At the request of the International Bureau, any designated or elected Office shall provide it with a copy of the translation of the international application furnished by the applicant to that Office.

(b) The International Bureau may, upon request and subject to reimbursement of the cost, furnish to any person copies of the translations received under paragraph (a).

### **Rule 96**

#### **The Schedule of Fees**

##### *96.1 Schedule of Fees Annexed to Regulations*

The amounts of the fees referred to in Rules 15 and 57 shall be expressed in Swiss currency. They shall be specified in the Schedule of Fees which is annexed to these Regulations and forms an integral part thereof.

## MANUAL OF PATENT EXAMINING PROCEDURE

### SCHEDULE OF FEES\*, \*\*

Fees	Amounts
1. International filing fee: (Rule 15.2)	1,400 Swiss francs plus 15 Swiss francs for each sheet of the international application in excess of 30 sheets
2. Handling Fee: (Rule 57.2)	200 Swiss francs

#### Reductions

3. The international filing fee is reduced by the following amount if the international application is, in accordance with and to the extent provided for in the Administrative Instructions, filed:

- (a) on paper together with a copy thereof in electronic form: 100 Swiss francs
- (b) in electronic form where the text of the description, claims and abstract is not in character coded format: 200 Swiss francs.
- (c) in electronic form where the text of the description, claims and abstract is in character coded format: 300 Swiss francs

4. The international filing fee (where applicable, as reduced under item 3) and the handling fee are reduced by 75% if the international application is filed by:

- (a) an applicant who is a natural person and who is a national of and resides in a State whose per capita national income is below US \$3,000 (according to the average per capita national income figures used by the United Nations for determining its scale of assessments for the contributions payable for the years 1995, 1996 and 1997); or
- (b) an applicant, whether a natural person or not, who is a national of and resides in a State that is classed as a least developed country by the United Nations; provided that, if there are several applicants, each must satisfy the criteria set out in either sub-item (a) or (b).

---

\* Shall enter into force on January 1, 2004, and shall apply to any international application whose international filing date is on or after January 1, 2004, provided that the Schedule of Fees as worded before its amendment (by either the amendments set out in document PCT/A/32/8, Annex I or by those set out in document PCT/A/31/10, Annex V) shall continue to apply to any international application which is received by the receiving Office before January 1, 2004, and is accorded an international filing date that is on or after January 1, 2004.

\*\* Shall not apply to any international application whose international filing date is before January 1, 2004, provided that the following provisions shall apply to any international application in respect of which a demand for international preliminary examination is filed on or after January 1, 2004, whether the international filing date of the international application is before, on or after January 1, 2004:

- (i) item 2 of the Schedule of Fees as amended; and
- (ii) item 4 of the Schedule of Fees as amended, insofar as it relates to the handling fee.

PATENT COOPERATION TREATY

**PCT INDEX—LEGEND**

<b>Acronym/Term</b>	<b>Meaning</b>
Art.	Patent Cooperation Treaty Article
A.I.	Patent Cooperation Treaty Administrative Instruction
CFR	U.S. Code of Federal Regulations
DO	Designated Office
EO	Elected Office
HC	Home Copy of International Application
IA	International Application
IB	International Bureau
IPE	International Preliminary Examination
IPEA	International Preliminary Examining Authority
IPER	International Preliminary Examination Report
Ipub	International Publication
IS	International Search
ISA	International Searching Authority
ISR	International Search Report
PCT	Patent Cooperation Treaty
PD	Priority Date of Earlier Filed National Application
RC	Record Copy of International Application
RO	Receiving Office
Rule	Patent Cooperation Treaty Rule
SC	Search Copy of International Application
U.S.C.	United States Code
USPTO	United States Patent and Trademark Office

MANUAL OF PATENT EXAMINING PROCEDURE



MANUAL OF PATENT EXAMINING PROCEDURE

Authorized officer. . . . . Rule 43.8, Rule 70.14,  
A.I. 514, A.I. 612  
Availability of translation of IA to IB . . . . . Rule 95

**B**

Biological material invention, . . . . . Rule 13<sup>bis</sup>  
Deposited, Indications as to . . . . . A.I. 209  
See also  
Nucleotide or amino acid sequence listing  
Sequence listing

**C**

Calendar (Gregorian to express dates). . . . . Rule 79  
See also Dates  
Changes in person, name or address of applicants  
and inventors (U.S. requirements) . . . . . 37 CFR 1.472  
National stage inventorship . . . . . 37 CFR 1.41(a),  
37 CFR 1.497(d)  
Check list (In request)  
Re documents filed with IA . . . . . Rule 3.3  
Necessary annotations by RO . . . . . A.I. 313  
Citations (proper) of documents in the ISR. . . . . A.I. 503  
Claims  
Amendment before EO . . . . . Art. 41  
Amendment before IB . . . . . Art. 19, Rule 46  
Amendment before IPEA Art. 34, Rule 66.4, Rule 66.8  
In general . . . . . Art. 6, Rule 6  
Numbering and identification upon amend-  
ment . . . . . A.I. 205  
U.S. regulation regarding. . . . . 37 CFR 1.436  
Classification of IA subject matter . . . . . A.I. 504  
Committee established by assembly of states . . . . . Art. 56  
Common representative. . . . . Rule 2.2<sup>bis</sup>, Rule 90.2  
Change of. . . . . A.I. 106  
Notice of change sent from RO to IB . . . . . A.I. 328  
Notice of change sent from IB to RO, ISA, &  
IPEA . . . . . A.I. 425  
Notice of change sent by ISA to IB . . . . . A.I. 512  
Notice of change sent by IPEA to IB. . . . . A.I. 608  
Communication  
From IB, of IA, ISR, or any Article 17(2)(a)  
determination and indication that no search  
will be established, to each DO. . . . . Art. 20, Rule 47  
Communication transmitted  
electronically . . . . . Rule 89<sup>bis</sup>, A.I. 114, A.I. 701—713,  
A.I. Annex F  
Competent IPEA . . . . . Rule 59  
Competent ISA . . . . . Art. 16, Rule 35  
Competent RO. . . . . Art. 11(1)(i), Rule 19  
Confidential nature  
Of IA . . . . . Art. 30  
Of IPE . . . . . Art. 38

Of written opinion of ISA. . . . . Rule 44<sup>ter</sup>  
Confirmation copy of facsimile transmission  
(N/A in U.S.) . . . . . Rule 92.4, A.I. 331  
Continuation or continuation-in-part, IA treated  
as in any designated state . . . . . Rule 4.11, Rule 49<sup>bis</sup>  
Copies  
In electronic form of documents filed on  
paper . . . . . Rule 89<sup>ter</sup>  
Sequence Listings and/or tables relating  
thereto . . . . . A.I. 801—A.I. 806  
Making home copy and search copy from orig-  
inal IA (record copy) by RO . . . . . Art.12, Rule 21  
Sequence Listings . . . . . A.I. 804  
Identifying RC, SC, and HC by RO . . . . . A.I. 305  
Correction of request by RO *ex officio*. . . . . A.I. 327  
Corrections and amendments during international  
processing. . . . . Rule 26.4, Rule 46,  
37 CFR 1.471  
Correspondence  
For applicant, to whom sent . . . . . A.I. 108  
In general . . . . . Rule 92

**D**

Dates (using Gregorian calendar). . . . . Rule 79  
Format of, in IA . . . . . A.I. 110  
Deadlines (See also Time limit)  
Applicable to Applicants  
(1) Before the RO  
After which applicant can request RO to  
certify copy of IA as identical with IA as  
filed and applicant can send certified  
copy to IB (14 months from PD) . . . . . Rule 22.1  
To correct Article 14(1) defects in IA Art. 14(1)b  
(e.g., IA is not properly signed, does not  
contain proper indications re applicant,  
has no title, has no abstract, does not  
comply with physical requirements in  
Rule 11) . . . . . Rule 26.2  
Extensions of time available . . . . . Rule 26.2  
Sanction: RO declares IA withdrawn  
under Rule 29.  
To correct defects under Article 11 to  
obtain an international filing date Art. 11(2), Rule  
20.6  
Sanctions: International filing date given  
IA when Article 11(1) defect is corrected  
in time set by RO; but RO declares IA  
withdrawn if not corrected within time  
set.  
To provide missing drawings  
(30 days). . . . . Art. 14(2),  
Rule 26.2, 37 CFR 1.437

PATENT COOPERATION TREATY

- Extensions of time available. . . . . Rule 26.2
- Sanction: Drawings considered nonexistent.
- To pay deficiencies in transmittal fee (Rule 14), international filing fee (Rule 15.1), search fee (Rule 16), late payment fee (Rule 16<sup>bis</sup>.2). . . . . Art. 14(3),  
  - Rule 16<sup>bis</sup>, 37 CFR 1.431
- Extension of time - One month set by RO when RO finds deficiency. . . . . Rule 16<sup>bis</sup>.1
- Sanction: RO declares IA withdrawn under Rule 29.
- To pay deficiencies in the transmittal fee, international filing fee (incl. suppl. for over 30 pages) or search fee when RO finds discrepancies before fees are due. . . . . A.I. 304(b)
- Extensions of time available. . . . . Rule 26.2
- To pay deficiencies in designation fees when RO finds discrepancies before fees are due. . . . . A.I. 304(b)
- (2) Before the ISA
  - To amend claims under Article 19 before IB within two months of date of transmittal of ISR to IB, or 16 months from priority date. . . . . Rule 46.1
  - To amend claims under Article 19 - latest of 2 months from date ISR sent to IB and Applicant or 16 months from PD or if amendment reaches IB before completion of technical preparations for Ipub Rule 46.1
  - To submit priority document, unless already filed with RO together with IA, to IB or RO not later than 16 months after PD, or where DO processes IA at any time on express request of applicant (Art. 23(2)), not later than date processing or examination is requested . . . . . Rule 17.1
  - Where lack of unity of invention is held, time limit of between 15 and 45 days set to pay additional fees to have additional inventions searched. . . . . Art. 17(3)  
    - Rule 40.3, 37 CFR 1.476
- (3) Before the IPEA
  - To amend claims, description, or drawings under Article 34 before the IPEA . . . . .Rule 66  
    - 37 CFR 1.485
  - To amend claims, description, or drawings under Article 34 before the IPEA at time of filing demand or, subject to Rule 66.4<sup>bis</sup>, until IPER is established . . . . . Rule 66.1, Rule 66.4<sup>bis</sup>
  - To correct defects in demand upon invitation within a time limit not less than 1 month and which may be extended by IPEA before a decision is made . . . . .Rule 60.1
  - To file a demand . . . . . Rule 54<sup>bis</sup>
  - To provide translation of priority document upon invitation by IPEA within 2 months of invitation date . . . . .Rule 66.7
  - To respond (including Article 34 amendments) to a written opinion within time set therein (not less than 1 month) . . . .Rule 66.2
  - Rule 66.2 permits response time set in written opinion to be from 1 month to 3 months (plus extensions) . . . . .Rule 66.2
  - Time for reply set in written opinion is non-extendable. . . . .37 CFR 1.484(d)
  - Where lack of unity of invention is held by IPEA, time limit of between 1 and 2 months set to pay additional fees to have additional inventions examined . . . . . Art. 34(3)  
    - Rule 68.2, 37 CFR 1.488
  - When filing a demand for IPE, must pay handling fee at time demand filed or within the 1 month deadline set when IPEA invites applicant to pay the fee. . . Rule 57
  - Sanction: IPEA considers IA withdrawn.
  - When seeking IPE, preliminary examination fee must be paid at time demand filed or within the 1 month deadline set when IPEA invites applicant to pay the fee. . . . . Rule 58<sup>bis</sup>
  - Sanction: IPEA considers IA withdrawn.
- (4) Before the DO/EO
  - To enter the National Stage under 35 U.S.C. 371 . . . . . 37 CFR 1.495
  - To amend claims description, or drawing under Article 28 before the DO . . . . . Rule 52
  - To amend claims, description, or drawings before EO (varies) . . . . . Rule 78
- Applicable to the RO
  - For RO to check certain elements (request is signed, has indications re applicant, has a title, an abstract, meets physical requirements of Rule 11) of IA . . . . .Rule 26.1



MANUAL OF PATENT EXAMINING PROCEDURE

For RO to hold IA withdrawn for lack of compliance with Article 11(1), items (i) to (iii) after IA has already been accorded a filing date . . . . .	Art. 14(4), Rule 30	Inventorship . . . . .	Rule 4.17(iv), Rule 51 <sup>bis</sup> .1(a)(iv), A.I. 214
For RO to transmit record copy to IB (normally 13 months or earlier, unless failure to obtain national security clearance obtained). . . . .	Rule 22	Non-prejudicial disclosures . . . . .	Rule 4.17(v), Rule 51 <sup>bis</sup> .1(a)(v), A.I. 215
For RO to transmit search copy to ISA . . .	Rule 23	Processing by IB . . . . .	Rule 26 <sup>ter</sup> .2, A.I. 419
Applicable to the IB		Defects	
For IB to notify applicant, RO, ISA (unless it declined to be notified) and DO (if it asked to be notified) of fact and date receipt of record copy of IA. . . . .	Rule 24	Correction	
International publication of IA promptly after expiration of 18 months from PD, unless earlier publication requested under Articles 21(2)(b) and 64(3)(c)(i) . . . . .	Art. 21 Rule 48	Of indications re applicant's residence or nationality . . . . .	A.I. 329
Applicable to the ISA		Of obvious defects, by RO . . . . .	A.I. 325
For ISA to establish the ISR (or declaration that the subject matter is not required to be searched or is unsearchable as per Article 17(2)) - the later of 3 months from date of receipt of SC by ISA or 9 months from PD. . . . .	Rule 42	Of request, <i>ex officio</i> , by RO . . . . .	A.I. 327
Applicable to the IPEA		Processing by IB . . . . .	A.I. 413
For IPEA to establish the IPER . . . . .	Rule 69.2	IA held withdrawn because of failure to correct certain defects. . . . .	Rule 29.1
For IPEA to start IPE . . . . .	Rule 69.1	In abstract . . . . .	Rule 38
IPEA shall promptly notify applicant of receipt of the demand. . . . .	Rule 61.1	In certain original documents submitted to national Office . . . . .	Rule 92.4
Deceased inventor (U.S. Rule) . . . . .	37 CFR 1.422	In demand . . . . .	Rule 60.1
Declarations relating to national requirements. . . . .	Rule 4.17, Rule 51 <sup>bis</sup> .1(a)	In drawings furnished to DO under Rule 49.5, possibly permitting correction by invitation. . .	Rule 49.5(g)
Correction of or addition of . . . . .	Rule 26 <sup>ter</sup> .1, A.I. 216, A.I. 317	In power of attorney - consequences . . .	Rule 90.4(c)
<i>Ex officio</i> corrections are not to be made by RO . . . . .	A.I. 327(d)	In the title . . . . .	Rule 37
by IB . . . . .	A.I. 419(c)	Invitation to correct Article 14(1)(b) defects. . . . .	Rule 26.3 <sup>bis</sup>
Invitation for, by IB . . . . .	Rule 26 <sup>ter</sup> .2(a)	Invitation to correct Article 3(4)(i) defects. . . . .	Rule 26.3 <sup>ter</sup>
Invitation for, by RO . . . . .	Rule 26 <sup>ter</sup> .2(a)	Mentioned in IPER . . . . .	Rule 90.12
Processing by IB. . . . .	Rule 26 <sup>ter</sup> .2(b), A.I. 419	Noted by IB. . . . .	Rule 28
Entitlement to apply for a patent . . . . .	Rule 4.17(ii), Rule 51 <sup>bis</sup> .1(a)(ii), A.I. 212	Definition of PCT terms. . . . .	Art. 2, 37 CFR 1.401
Entitlement to claim priority . . . . .	Rule 4.17(iii), Rule 51 <sup>bis</sup> .1(a)(iii), A.I. 213	Delays in meeting time limits, excuse of . . . . .	Rule 82 37 CFR 1.468
Exceptions to lack of novelty . . . . .	Rule 4.17(v), Rule 51 <sup>bis</sup> .1(a)(v), A.I. 215	Demand for international preliminary examination (IPE)	
Identity of inventor . . . . .	Rule 4.17(i), Rule 51 <sup>bis</sup> .1(a)(i), A.I. 211	Applicant entitled to make demand . . . . .	Rule 54
		Copy sent by IPEA to IB . . . . .	Rule 61.1
		Defects in . . . . .	Rule 60.1
		Evidence of right to file demand . . . . .	A.I. 614
		Filed with other than a competent IPEA, treatment of . . . . .	Rule 59
		In general . . . . .	Art. 31, Rule 53
		Not considered to have been made:	
		Notification by IB to EOs. . . . .	A.I. 418
		Notice sent by IPEA re filing after 19 months from PD . . . . .	A.I. 601
		Publication of notice of demand. . . . .	Rule 61.4
		Recording by IB of changes: . . . . .	Rule 92 <sup>bis</sup>
		Notifications regarding this sent by IB . . .	A.I. 422
		Time limit for making. . . . .	Rule 54 <sup>bis</sup>
		U.S. regulation regarding . . . . .	37 CFR 1.480
		Deposited microorganism	
		Indications on separate sheet . . .	Rule 13 <sup>bis</sup> , A.I. 209

PATENT COOPERATION TREATY

Description	Missing - RO procedure concerning. . . . . A.I. 310
Amendment before IPEA . . . . . Art. 34	Time set to file where not necessary to understanding of invention. . . . . Rule 7.2
Amendment before EO . . . . . Art. 41, Rule 78	Referred to, but not included in IA. . . . . Art. 14(2)
Headings for parts of . . . . . A.I. 204	U.S. regulation regarding . . . . . 37 CFR 1.437
In general. . . . . Art. 5, Rule 5	
Of nucleotide/amino acid sequence . . . . . Rule 5.2, Rule 13 <sup>ter</sup> , A.I. 801-A.I. 806, 37 CFR 1.821	
U.S. regulation regarding. . . . . 37 CFR 1.435	
Design - not mentioned as subject matter	
for IA . . . . . Art. 2(i)	
Designated Office (DO)	
Amendment of claims, description, and draw- ings before DO . . . . . Art. 28	
Communication of IA, ISR, or declaration under Article 17(2)(a) . . . . . Art. 20, Rule 47	
Not accepting sequence listings in computer readable form . . . . . A.I. 806	
Notification by DO to IB of number of IAs that did not enter the national stage timely. A.I. 112	
Opportunity to correct IA before DO . . . . . Art. 26	
Review by . . . . . Art. 25	
U.S. regulation regarding. . . . . 37 CFR 1.414	
Designated states	
Possible loss of effect in . . . . . Art. 24	
Withdrawal of/held withdrawn . . . . . Art. 24, Rule 29	
Designation of States	
Cancellation, <i>ex officio</i> , by IB . . . . . A.I. 423	
Cancellation of designations of noncontracting States by RO, <i>ex officio</i> . . . . . A.I. 318	
U.S. regulation regarding. . . . . 37 CFR 1.432	
Diagrams, considered as drawings . . . . . Rule 7.1	
Disputes . . . . . Art. 59	
Docket reference (applicant's IA file reference) . . . . . A.I. 109	
Documents cited in ISR. . . . . A.I. 503	
Documents filed with IA	
Manner of marking necessary annotations in checklist sent to IB by RO with RC of IA. . A.I. 313	
Drawing(s)	
Amendment of, before DO . . . . . Art. 34	
Amendment of, before EO. . . . . Art. 41	
Flowsheets and diagrams considered as . . . . Rule 7.1	
In general. . . . . Art. 7, Rule 7	
Invitation by RO to correct informal drawings . . . . . Rule 26	
	<b>E</b>
	Elected Office (EO)
	Notification to IB of number of applications filed after national stage deadline. . . . . A.I. 112
	U.S. as. . . . . 37 CFR 1.414
	Election(s)
	Cancellation of <i>ex officio</i> by IB . . . . . A.I. 423(b)
	Cancellation of <i>ex officio</i> by IPEA. . . . . A.I. 606
	Errors
	By RO or IB, rectification of . . . . . Rule 82 <sup>ter</sup>
	Correction of obvious
	Authorization of by IPEA
	<i>Ex officio</i> by RO . . . . . A.I. 325, A.I. 327
	Processing by IB . . . . . A.I. 413, A.I. 607
	In documents. . . . . Rule 91
	In request, <i>ex officio</i> , by RO . . . . . A.I. 327
	<i>Ex Officio</i> correction of request by RO . . . . . A.I. 327
	Expenses of delegations . . . . . Rule 84
	Expressions and language, not to be used . . . . . Rule 9
	See also Language prohibited
	Correction of. . . . . A.I. 501
	Extension of time
	Before IPEA . . . . . Rule 58 <sup>bis</sup>
	to pay international filing fee, search fee, and transmittal fee - under Rules 14, 15, and 16 . . . . . Rule 16 <sup>bis</sup>
	<b>F</b>
	Fee(s) . . . . . Rule 96.1
	Additional fees per invention where lack of unity is found by
	IPEA . . . . . Art. 34(3), Rule 68
	ISA . . . . . Art. 17(3), Rule 40
	Application of money received by RO in cer- tain cases . . . . . A.I. 321
	Associated with demand
	Handling fee . . . . . Rule 57, Rule 96.1
	Late payment fees . . . . . Rule 58 <sup>bis</sup> .2
	Time limit for payment Rule 57.3, Rule 58 <sup>bis</sup> .1
	Preliminary examination fee . . . . . Rule 58
	ISA was not U.S . . . . . 37 CFR 1.482(a)(1)
	ISA was U.S. . . . . 37 CFR 1.482(a)(1)
	Late payment fees . . . . . Rule 58 <sup>bis</sup> .2

## MANUAL OF PATENT EXAMINING PROCEDURE

<p>Time limit for payment . . . . . Rule 57.3,  Rule 58.1(b), Rule 58<sup>bis</sup>.1  (Where lack of unity of invention held by  IPEA, there is a fee for each additional  claimed invention). . . . . Art. 34(3), Rule 68,  37 CFR 1.482(a)(2)  U.S. regulation regarding . . . . . 37 CFR 1.482</p> <p>Associated with request  Extension of time to pay international filing  fee, search fee, and transmittal fee -  under Rules 14, 15, and 16. . . . . Rule 16<sup>bis</sup>  International filing fees . . . . . Rule 15  International filing fee . . . . . Rule 15, Rule 96.1  Additional component for sequence listing  part in computer readable form . . . . . A.I. 803  Basic component based on number of  sheets . . . . . A.I. 803  PCT search fee . . . . . Rule 16  No prior U.S.  application. . . . . 37 CFR 1.445(a)(2)(ii)  Prior U.S. national  application. . . . . 37 CFR 1.445(a)(2)(i)  U.S. regulation regarding. . . . . 37 CFR 1.445  (Where lack of unity of invention held by  ISA, there is a fee for each additional  claimed invention). . . . . Rule 40. Art. 17(3),  Transmittal fee . . . . . Rule 14  U.S. rule . . . . . 37 CFR 1.445(a)(1)  Invitation by RO to pay before date due . . . . A.I. 304  Invitation by RO to request search fee  refund. . . . . A.I. 322  Invitation to pay fees . . . . . A.I. 320  Invitation to request refund of fees  before IPEA. . . . . A.I. 613  Lack of payment of . . . . . Rule 27  Late payment fee re international filing fee,  search fee, and transmittal fee - under Rules  14, 15, and 16 . . . . . Rule 16<sup>bis</sup>.2  National stage fee to DO . . . . . Art. 22  U.S. statute regarding . . . . . 35 U.S.C. 376  U.S. regulation regarding . . . . . 37 CFR 1.492  National stage fee to EO . . . . . Art. 39  U.S. statute regarding. . . . . 35 U.S.C. 376  U.S. regulation regarding . . . . . 37 CFR 1.492  PCT-EASY. . . . . A.I. 102bis(c)  Preliminary examination fee . . . . . Rule 58  Refund of IA filing and processing  fees. . . . . Rule 15.6, Rule 16.2, Rule 40.2(c)  U.S. regulation regarding . . . . . 37 CFR 1.446  Schedule of fees. . . . . Rule 96</p>	<p>Special fees for publication, payable  to the IB . . . . . A.I. 113  Surcharge for filing oath or declaration later  than 30 months from PD under 37 CFR  1.495(c). . . . . 37 CFR 1.492(e)  Transmittal fee . . . . . Rule 14, 37 CFR 1.445(a)(1)  File (IA) reference (IA docket no.  of applicant) . . . . . A.I. 109  On IA sheets . . . . . Rule 11.6(f)  Filing date  Certificate of U.S. Postal Service  Express Mail . . . . . Rule 20.1, 37 CFR 1.10  Of IA. . . . . Art. 11, 35 U.S.C. 363  Finances (budget) of union of PCT states . . . . . Art. 57  Flowsheets, considered as drawings. . . . . Rule 7.1  Form(s)  Computer generated . . . . . A.I. 102(h) &amp; (i)  Request . . . . . Rule 3.2  Demand. . . . . Rule 53.1(a)  PCT. . . . . A.I. Annex A  PCT, use of . . . . . A.I. 102</p> <p style="text-align: center;"><b>G</b></p> <p>Gazette, PCT. . . . . Rule 86, A.I. 407,  A.I. Annexes D and E  Free copies of, to ISA, IPEA,  national Office. . . . . Rule 87</p> <p style="text-align: center;"><b>H</b></p> <p>Handling fee for IPE (re demand) . . . . . Rule 57  Home Copy (HC) of IA, preparation  of . . . . . Rule 21, A.I. 305</p> <p style="text-align: center;"><b>I</b></p> <p>Identification  Of DO . . . . . A.I. 107  Of EO . . . . . A.I. 107  Of IA having two or more applicants . . . . . A.I. 105  Of IA file (docket reference by applicant) . . . A.I. 109  Of international authorities. . . . . A.I. 107  Indications (two letter codes identifying countries  and other entities) . . . . . A.I. 115  Industrial applicability . . . . . Art. 34(4), Art. 35(2), (b),  Rule 70.6, Rule 66.2  Intellectual property protected under  PCT . . . . . Art. 2(i)  International application (IA)  Application no. . . . . A.I. 307  Indelibly marked on each sheet of IA . . . . A.I. 308  Arrangement of contents/elements . . . . . A.I. 207</p>
--	--

PATENT COOPERATION TREATY

Availability of, to DO . . . . .	Art. 13	Withdrawn IA, U.S. statute regarding. . . . .	35 U.S.C. 366
Certain defects in. . . . .	Art. 14	International Bureau (IB)	
Checking by RO and correcting parts of before RO . . . . .	Rule 26	In general . . . . .	Art. 55
Communicated (sent) to each DO by IB . . . . .	Art. 20, Rule 47	Patent information services provided by . . . . .	Art. 50
Confidential nature of IA. . . . .	Rule 30	U.S. regulation regarding . . . . .	37 CFR 1.415
Considered withdrawn. . . . .	Rule 29, Rule 30, Rule 49	International filing fee . . . . .	Rule 15
Copy of IA sent from IB to IPEA . . . . .	A.I. 420	International preliminary examination (IPE)	
Copy, translation and national fee to EO . . . . .	Art. 39	Conduct of, in U.S. . . . .	37 CFR 1.484
Effect of IA designation of U.S. . . . .	35 U.S.C. 363	Confidential nature of. . . . .	Art. 38
Filing date and effects of. . . . .	Art. 11	Copy, translation and fee for, furnished to EO	Art. 39
Filing in electronic form . . . . .	Rule 89 <sup>bis</sup> , A.I. 102 <sup>bis</sup> , A.I. 335, A.I. 701-A.I. 713, A.I. Annex F	Delay to enter national stage . . . . .	Art. 39(1)(a)
Sequence Listings and/or tables relating thereto . . . . .	A.I. 801 through A.I. 806	Demand for. . . . .	Art. 31
In general. . . . .	Art. 3	Withdrawal of . . . . .	Art. 37
Ipub number of . . . . .	A.I. 404	In general . . . . .	Art. 33
Language of . . . . .	Rule 12	Inventive step . . . . .	Rule 65, Art. 33(3)
Numbering - three sets: one for request, another for description, and a third for drawings . . . . .	A.I. 207	IPEA . . . . .	Art. 32
Numbering system of IA. . . . .	A.I. 307	IPER . . . . .	Art. 35, Rule 70
Copy of notification of IA number and IA filing and PD(s) sent to IB . . . . .	A.I. 324	Communication of IPER. . . . .	Rule 73
Marking each sheet of IA with. . . . .	A.I. 308	Guidelines for explanations in . . . . .	A.I. 604
Physical requirements of. . . . .	Rule 11, 37 CFR 1.433	Method of identifying documents cited in .	A.I. 611
Purported IA, notification of receipt of, by RO . . . . .	A.I. 301	Translation of . . . . .	Rule 72
Requirements, U.S. regulation regarding . . . . .	37 CFR 1.431	Translation of annexes and transmittal . . . .	Rule 74
Sheet numbering (separate sets for request, description, and drawings). . . . .	A.I. 207	Prior art for . . . . .	Rule 64
For Ipub . . . . .	A.I. 410	Start of, and time limit for . . . . .	Rule 69
Sheet(s)		Transmittal, translation, and communication of IPER to applicant and IB . . . . .	Art. 36 Rule 71
Cancellation, substitution, addition, renumbering by RO . . . . .	A.I. 311	Use of same file for ISA and IPEA . . . . .	A.I. 604
Translation of IA sent by applicant to DO . . . . .	Art. 22	Written opinion by IPEA . . . . .	Art. 34, Rule 66
Transmittal of IA to IB and ISA . . . .	Art. 12, A.I. 335	Amendment of claims, description, and drawing under Article 34 in response to. . .	Art. 34
Treated as continuation or continuation-in-part. . . . .	Rule 4.11(a)(iv); Rule 49 <sup>bis</sup>	International Preliminary Examining Authority (IPEA)	
		Competent IPEA. . . . .	Rule 59
		In general . . . . .	Art. 32
		Lack of unity determination . . . . .	Rule 68
		Minimum requirements for. . . . .	Rule 63
		Nonexaminable subject matter . . . . .	Rule 67
		Notification by IPEA of date of receipt of demand and of election to IB and applicant . . . . .	Rule 61.1
		Procedure before. . . . .	Art. 34, Rule 66
		U.S. regulation regarding . . . . .	37 CFR 1.416
		U.S. statute regarding . . . . .	35 U.S.C. 362

## MANUAL OF PATENT EXAMINING PROCEDURE

International preliminary report on patentability  
 By the IPEA . . . . . Rule 70  
 By the ISA . . . . . Rule 44<sup>bis</sup>

International publication  
 By IB of IA . . . . . Art. 21, Rule 48,  
 A.I. 406, A.I. 805

Copies of publications to ISA, IPEA,  
 national offices . . . . . Rule 87

Effect of, in United States . . . . . 35 U.S.C. 374

Number . . . . . A.I. 404

Of IA, effects of . . . . . Art. 29

Provisional Rights (in U.S.) . . . . . 35 U.S.C. 154(d)

Publication number (WO \_\_\_\_\_). . . . . A.I. 404

International search (IS) . . . . . Art. 15

Time limit for accomplishing . . . . . Rule 42

International Searching Authority (ISA) . . . . . Art. 16

Competent . . . . . Rule 35

Minimum requirements . . . . . Rule 36

Procedure before . . . . . Art. 17

U.S. statute regarding . . . . . 35 U.S.C. 362

U.S. regulation regarding . . . . . 37 CFR 1.413

International search fee . . . . . Rule 16

International search report (ISR)

Communicated (sent) from IB to

DO . . . . . Art. 20, Rule 47

Copy of IA provided by IB for ISA . . . . . A.I. 420

Indication of citations of relevance in . . . . . A.I. 505

Indications of special categories of  
 documents cited in . . . . . A.I. 507

Indication of claims to which documents  
 are relevant . . . . . A.I. 508

In general . . . . . Art. 18

Method of identifying documents cited in . . . . . A.I. 503

Subject matter not required to be searched . . . . . Rule 39

Time limit for establishing . . . . . Rule 42

Transmittal of, from ISA to IB . . . . . Rule 44

Translation of ISR . . . . . Rule 45

International-type search . . . . . Rule 41.1

Inventive step . . . . . Rule 65, Art. 33(3)

Inventions

Protection available  
 under PCT . . . . . Art. 43, Art. 44

Indications of kinds of protection . . . . . Rule 4.9

Inventor(s)

Correction of . . . . . Rule 92<sup>bis</sup>

Deceased . . . . . 37 CFR 1.422

Incapacitated or insane . . . . . 37 CFR 1.423

Joint . . . . . 37 CFR 1.421(b)

### L

Lack of unity of invention  
 Examples . . . . . A.I. Annex B

In IPE . . . . . Rule 68, 37 CFR 1.475, 37 CFR 1.488,  
 37 CFR 1.489

In IS . . . . . Rule 40, 37 CFR 1.475, 37 CFR 1.476,  
 37 CFR 1.477

In national stage . . . . . 37 CFR 1.475, 37 CFR 1.499

Unity of invention in IA, in general . . . . . Rule 13

Examples . . . . . A.I. Annex B

Language

Of correspondence by applicant to IB and ROA.I. 104

Of demand for IPE . . . . . Rule 55

Of forms used by international authorities . . . . . A.I. 103

Of IA . . . . . Art. 11(1)(ii), Rule 12

Of Ipub of IA . . . . . Rule 48.3

Of IPER . . . . . Rule 72

Of ISA . . . . . Rule 43.4

Of translation of IA . . . . . Rule 12.3, Rule 49.2

Prohibited expressions . . . . . Rule 9

Correction of . . . . . A.I. 501

Later elections (elections submitted after the  
 demand)

Later indication of priority application number by  
 RO to IB . . . . . A.I. 319

Later submitted sheets, RO procedure . . . . . A.I. 309

Loss of effect of IA in designated states . . . . . Art. 24  
 (Same consequences as withdrawal of IA)

### M

Mail service

Irregularities in . . . . . Rule 82

Microbiological inventions

See Biological material inventions Nucleotide/  
 amino acid sequence listings

Minimum documentation in ISA . . . . . Art. 15(4), Rule 34

Missing drawings, RO  
 procedure . . . . . Art. 14(2), Rule 26.6, A.I. 310

### N

National Office

Right to practice before . . . . . Art. 49, Rule 83, Rule 90.1

National stage

Amendment of claims, description, and draw-  
 ings before DOs . . . . . Art. 28, Rule 52

Before EOs . . . . . Art. 41, Rule 78

Certain national requirements allowed under  
 Article 27(1),(2),(6),(7) . . . . . Art. 27, Rule 51<sup>bis</sup>

Copy of IA, translation and fee to DO . . . . . Art. 22

Delaying of national examination and other  
 processing . . . . . Art. 23, Art. 40

DO that does not accept sequence listings in  
 computable readable form . . . . . A.I. 806

Protection available

As well as patent protection . . . . . Art. 44

PATENT COOPERATION TREATY

Other than patent protection . . . . . Art. 43  
 Requirements . . . . . Art. 27  
 Results of national examination in different  
 countries . . . . . Art. 42  
 United States  
   Commencement in . . . 35 U.S.C. 371, 37 CFR 1.491  
   Entry into U.S., requirements . . . . . 37 CFR 1.495  
   Entry into U.S., time of . . . . . 37 CFR 1.491  
   Examination in . . . . . 37 CFR 1.496  
   Improper applicant . . . . . 35 U.S.C. 373  
   National U.S. patent issued on IA,  
   effect . . . . . 35 U.S.C. 375  
 National security prescriptions . . . . . Art. 27(8)  
   Delay or prevention of transmittal of  
   RC to IB . . . . . A.I. 330  
 Nationality  
   Qualifications . . . . . Rule 18.2  
   In demand . . . . . Rule 54.1  
   Recording of changes to by the IB . . . . . Rule 92<sup>bis</sup>.1  
 Nationality or residence of applicant,  
 correction of . . . . . A.I. 329, A.I. 614  
 New (additional) matter  
   In request, deletion of *ex officio* . . . . . A.I. 303  
 Nomenclature - See also Terminology and  
 signs . . . . . Rule 10  
 Notification by IPEA of date of receipt of demand  
 to IB and applicant . . . . . Rule 61  
 Nucleotide and/or amino acid sequence  
 listings . . . . . Rule 13<sup>ter</sup>  
   Transmitted by RO to ISA . . . . . A.I. 313(c)  
 Number and numbering of claims . . . . . Rule 6.1  
 Number of (accorded to) IA . . . . . Rule 20.1  
 Number of copies of IA to be filed . . . . . Rule 11.1  
 Numbering of amendments . . . . . Rule 6.1, A.I. 205,  
   A.I. 207, A.I. 311  
 Numbering of lines on a page of IA . . . . . Rule 11.8  
 Numbering of sheets of IA . . . . . Rule 11.7  
 Numbering of sheets for Ipub . . . . . A.I. 410

**O**

Oath or declaration in U.S. national stage applica-  
 tion . . . . . 35 U.S.C. 371(c)(4), 37 CFR 1.497  
 Obvious errors in documents . . . . . Rule 91  
   Rectification of . . . . . A.I. 511  
 Obviousness/nonobviousness . . . . . Art. 33(3), Rule 65  
   See also Inventive step  
 Opportunity to correct IA before DO . . . . . Art. 26

**P**

Pamphlets (form of publishing the IA) . . . . . Rule 48  
 Patent Cooperation Treaty (PCT)  
   Administrative provisions . . . . . Arts. 53 - 58

Amendment of certain provisions . . . . . Art. 61  
 Assembly of contracting states . . . . . Art. 53  
 Becoming a party to . . . . . Art. 62  
 Committee for technical cooperation . . . . . Art. 56  
 Denunciation . . . . . Art. 66  
 Depositary functions . . . . . Art. 68  
 Disputes . . . . . Art. 59  
 Entry into force of PCT . . . . . Art. 63  
 Executive committee of assembly . . . . . Art. 54  
 Final provisions (becoming party to treaty, entry  
 into force of treaty, reservations, gradual appli-  
 cation, denunciation, signature and languages,  
 depositary functions, notifications) . . . . . Art. 62  
   Finances . . . . . Art. 57  
   Gradual application of PCT in a state . . . . . Art. 65  
   International Bureau (IB) . . . . . Art. 55  
   Notifications to states/governments re PCT  
   issues . . . . . Art. 69  
   Reservations by any state re Application of  
   PCT provisions . . . . . Art. 64  
   Revision of PCT . . . . . Art. 60  
 Patent information services furnished by IB . . . . . Art. 50  
 PCT-EASY diskettes . . . . . A.I. 102<sup>bis</sup>  
   Reduced fees payable when using . . . . . A.I. 102<sup>bis</sup>(c)  
   Transmittal of, to the IB by the RO with RC . A.I. 335  
 Physical requirements of IA . . . . . Rule 11  
 Power of attorney  
   Definition . . . . . Rule 3.3a  
   General . . . . . Rule 90.5  
 Practice before international authorities  
   Right to do so . . . . . Art. 49,  
   Rule 83, Rule 90  
 Preliminary examination fee . . . . . Rule 58  
 Prior art  
   Citation of (proper method) . . . . . A.I. 503  
   For IPE . . . . . Rule 64  
   Indications . . . . . A.I. 505  
   Of special categories of documents . . . . . A.I. 507  
   Relevant to IS . . . . . Rule 33.1  
 Priority application number . . . . . A.I. 408  
   Later indication of . . . . . A.I. 319  
 Priority claim in IA . . . . . Rule 4.10  
   Correction or cancellation  
   by RO . . . . . A.I. 314, Rule 26<sup>bis</sup>.1  
   Correction or cancellation  
   by IB . . . . . A.I. 402, Rule 26<sup>bis</sup>.1  
   Invitation to correct defects in . . . . . Rule 26<sup>bis</sup>.2  
   Not considered to have been  
   made . . . . . Rule 66.7, A.I. 302  
   Notice to that effect by IB, if not by RO . . A.I. 409  
   U.S. regulation regarding . . . . . 37 CFR 1.451  
   Withdrawal of, by applicant . . . . . Rule 90<sup>bis</sup>.3

MANUAL OF PATENT EXAMINING PROCEDURE

Priority, right of (in U.S.) . . . . .	35 U.S.C. 365	Rectification of obvious errors . . . . .	Rule 91
Benefit of filing date of a prior		Authorized by IPEA . . . . .	A.I. 607
application . . . . .	35 U.S.C. 365, 37 CFR 1.55	Authorized or not by the ISA . . . . .	A.I. 511
	37 CFR 1.78	Handling of, by RO . . . . .	A.I. 325
Priority document . . . . .	Rule 17	Limitations/restrictions	
Benefit of filing date of a prior application	35 U.S.C.	on . . . . .	Rules 91.1(b) to (g) <sup>quarter</sup>
365, 37 CFR 1.55, 37 CFR 1.78		Refund	
Copy, translation, and fee furnished to EO		If search is based in part on earlier search . . .	Rule 41
under Article 39(1) . . . . .	Rule 76	Invitation by RO to request search fee	
Fee for certified copy of, from USPTO . . . .	37 CFR	refund . . . . .	A.I. 322
1.19(b)(1)		Invitation to request refund of fees	
In proceedings before IPEA . . . . .	Rule 66.7	before IPEA . . . . .	A.I. 613
Invitation by IB to furnish . . . . .	A.I. 421	Of handling fee . . . . .	Rule 57.6
Receipt of by IB . . . . .	A.I. 411	Of international filing fee . . . . .	Rule 15.6
Translation and time limit to furnish to EO .	Rule 76	Of IPE fee . . . . .	Rule 58.3
Translation and time limit to furnish to		Of IS fee . . . . .	Rule 16
IPEA . . . . .	Rule 66.7	Regional patent treaties . . . . .	Art. 45
Transmittal by RO to IB . . . . .	A.I. 323	Regulations of the PCT . . . . .	Art. 58
U.S. regulation regarding . . . . .	37 CFR 1.451	Representation/representative	
Protection available under		See also Common representative	
PCT . . . . .	Art. 43, Art. 44, Art. 45	Appointment of . . . . .	Rule 90.4
Indications of kinds of protection in		Notice by IB to ISA and IPEA . . . . .	A.I. 425
request . . . . .	Rule 4.11(a)(iii)	Notice by IPEA to IB . . . . .	A.I. 608
Protest against payment of additional fees		Notice by ISA to IB . . . . .	A.I. 512
re holding of lack of unity . . . . .	Rule 68, Rule 40,	Notice by RO to IB . . . . .	A.I. 328
	A.I. 502, A.I. 403,	Common (definition) . . . . .	Rule 2.2 <sup>bis</sup>
Before U.S. IPEA . . . . .	37 CFR 1.489	General power of attorney . . . . .	Rule 90.5
Before U.S. ISA . . . . .	37 CFR 1.477	Limited recognition in patent	
Publication - See International publication		cases . . . . .	37 CFR 10.9
		Revocation and renunciation of representative .	Rule
		90.6	
		U.S. regulation regarding . . . . .	37 CFR 1.455
		Request (part of IA)	
		Contents . . . . .	Art. 4, Rule 4
		Declaration relating to national	
		requirements . . . . .	Rule 4.17, Rule 51 <sup>bis</sup> .1(a)
		Deletion of additional material . . . . .	A.I. 303
		Form . . . . .	Rule 3
		In general . . . . .	Art. 4
		Recording of changes in, by IB . . . . .	Rule 92 <sup>bis</sup>
		Notification of changes recorded by IB . . . .	A.I. 422
		Rectification of, including limitations on abil-	
		ity to rectify . . . . .	Rule 91.1
		U.S. regulation regarding . . . . .	37 CFR 1.434
		Residence:	
		Corrections to	
		Invitation by RO . . . . .	A.I. 329
		In demand . . . . .	Rule 54.1
		Qualifications . . . . .	Rule 18
		Recording of changes to by the IB . . . . .	Rule 92 <sup>bis</sup> .1

**Q**

Quorum, absence of	
Voting by correspondence . . . . .	Rule 85

**R**

Receipt of IA by RO . . . . .	Rule 20
Notification of by RO to IB . . . . .	Rule 20.5(b)
Notification of by RO to applicant . . . . .	A.I. 301
Receiving Office (RO)	
Competent . . . . .	Rule 19
In general . . . . .	Art. 10
U.S. RO . . . . .	35 U.S.C. 361, 37 CFR 1.412
Record copy (RC) (originally filed IA)	
Definition . . . . .	Rule 20.5(b)
Transmittal to IB by RO . . . . .	Rule 22, A.I. 335, 37 CFR
1.461	
Marking sheets of, by IB . . . . .	A.I. 401
Receipt by IB . . . . .	Rule 24

## PATENT COOPERATION TREATY

### Restriction:

See Lack of unity of invention

See Unity of invention

Results of national examination in EO . . . . . Art. 42

Revival of U.S. national stage application .37 CFR 1.137

Review of RO determinations by other international authorities re

Declaration that an IA is to be withdrawn . . . Art. 25

Review by USPTO . . . . . 35 U.S.C. 367

Designation of a state considered withdrawn. Art. 25

Review by USPTO . . . . . 35 U.S.C. 367

Failure to accord an international filing

date . . . . . Art. 25

Review by USPTO . . . . . 35 U.S.C. 367

Review by DOs of

Declaration that an IA is withdrawn . . . . . Art. 25

IB decided the IA is withdrawn under

Article 12(3) . . . . . Art. 25

Refusal to accord filing date to IA. . . . . Art. 25

Revision of PCT . . . . . Art. 60

See also Amendment of PCT provisions

Right to practice before international

authorities. . . . . Rule 83, Art. 49

### S

Search - See also international search report

Search Copy (SC) of IA

Preparation of by RO . . . . . Rule 21

Transmittal of to IB . . . . . Rule 23

Receipt of by ISA . . . . . Rule 25.1

Notification of lack of transmittal

of SC by IB. . . . . A.I. 412

Search other than IS . . . . . Rule 41

Security measures of national Office

delaying or preventing transmittal of

RC to IB. . . . . A.I. 330

U.S. statute regarding . . . . . 35 U.S.C. 368

Sequence listings in computer readable

form . . . . . Rule 13<sup>ter</sup>, A.I. 801 - A.I. 806

Considered by ISA. . . . . A.I. 513

Transmittal of. . . . . Rule 23, A.I. 804

Sheets

Deletion, addition, substitution, and

renumbering of by RO. . . . . A.I. 311

Later submitted - RO handling of . . . . . A.I. 309

Size of IA. . . . . Rule 11.5

Signature

By parties to the PCT. . . . . Art. 62

Notification by director general re. . . . . Art. 69

Defective, in IA. . . . . Art.14(1)

IA lacking prescribed signature - RO

procedure . . . . . A.I. 316

Definition (includes "seal") . . . . . Rule 2.3

Lacking, in demand . . . . . Rule 60.1(d)

National requirements. . . . . Art. 27

Of PCT in English and French . . . . . Art. 67

Requirements re correspondence . . . . . Rule 92

Requirements re demand . . . . . Rule 53.8

Requirements re request . . . . . Rule 4.15

Requirements re withdrawals . . . . . Rule 90<sup>bis</sup>.5

Signs (terminology) . . . . . Rule 10

Size of IA sheets. . . . . Rule 11.5

Subject matter that is proper in IA . . . . . Rule 67

Successor states . . . . . Rule 32

Surcharge - See also Fees: Late payment fee

### T

Technical Services

Patent information services furnished by IB . . Art. 50

Relation to other PCT provisions . . . . . Art. 52

Technical assistance committee . . . . . Art. 51

Terminology and signs . . . . . Rule 10

Time limit

Computation of. . . . . Rule 80

Delay in meeting certain. . . . . Art. 48

Delays due to mail service . . . . . Rule 82

Excuse by the designated or elected state of

delays in meeting certain time limits. . . . Rule 82<sup>bis</sup>

Extended beyond or shortened with respect to

Article 39 deadline for copy, translation, and

fee filed with EO . . . . . Rule 77

Extensions of, for payment of fees. . . . . Rule 16<sup>bis</sup>

For amendments before EO . . . . . Rule 78

For amendment of claims before the

IB . . . . . Art. 19, Rule 46.1

For amendment of claims, description, and

drawings before DO . . . . . Rule 52.1

For applicant to request IB to send files to any

DO pursuant to Article 25(1)(c) so DO can

review adverse holding by RO or IB. . . . Rule 51.1

For check by RO of certain defects in

the IA . . . . . Rule 26.1

For communication by the IB of IPER transla-

tion and annexes to each EO). . . . . Rule 73.2

For considering IA withdrawn re

Article 12(3). . . . . Rule 22.3

For considering IA withdrawn re

Article 14(4). . . . . Rule 30

For correcting priority claim. . . . . Rule 4.10

For correction by applicant of certain defects

found by and invited by RO to correct . . . Rule 26.2

For establishing the ISR . . . . . Rule 42

For establishing the IPER. . . . . Rule 69.2



## MANUAL OF PATENT EXAMINING PROCEDURE

- For paying national fee and furnishing translation before DO pursuant to Article 25(2)(a) so DO can review adverse holding by RO or IB . . . . . Rule 51.3
- For presenting request by applicant for IB to send copies of IA to DO after receiving determination that IA is withdrawn . . . . . Rule 51
- For start of, and establishment of, IPE. . . . . Rule 69
- For submitting priority document . . . . . Rule 17
- For translation of priority document before EO. . . . . Rule 76.4
- For transmittal by applicant of translation of any replacement sheet referred to in Rule 70.16 that is attached to the IPER . . . . . Rule 74.1
- In general . . . . . Art. 47
- Meaning of term “Time Limit” in Article 48(2) . . . . . Rule 82<sup>bis</sup>
- Modification of time limit fixed in PCT . . . . . Rule 81
- Of application processing based on PD . . . . . Rule 4.10  
37 CFR 1.465
- To furnish drawings which are not necessary for the understanding of the invention . . . . . Art. 7.2, Rule 7.2
- To furnish IA copy, translation, and fee to DO beyond time limit allowed by Article 22. . . . . Rule 50
- To pay fees before ISA in response to a holding of lack of unity of invention. . . . . Rule 40.3
- To request review by DO of failure to accord international filing date . . . . . Art. 25
- Utility models . . . . . Rule 6.5
- Title of invention in IA
- Content. . . . . Rule 4.3
- Missing or defective. . . . . Rule 37
- Translation
- Availability of translations. . . . . Rule 95
- By applicant, IS based on . . . . . Art. 15
- Defective/incorrect of IA. . . . . Art. 46
- Draft, of IA, prepared by ISA for publication, comments on by applicant . . . . . A.I. 506
- For purpose of international search . . . . . Rule 12.3
- Of certain words not in Latin alphabet, in request . . . . . Rule 4.16
- Of IA, availability to IB. . . . . Rule 95
- Of IA, transmittal by IB to DOs . . . . . Art. 22
- Of IA, transmittal by IB to EOs. . . . . Art. 39
- Of IA, requirement for verified or certified . . . . . Rule 51<sup>bis</sup>.1(d)
- Of IPER . . . . . Art. 36, Rule 72
- Of IPER annexes, and transmittal of to EOs by applicant . . . . . Rule 74
- Of Ipub, affecting protection of rights in any designated state. . . . . Art. 29
- Of ISR. . . . . Art. 18, Rule 45
- Of priority document before EO. . . . . Rule 76
- Of priority document before IPEA . . . . . Rule 66.7
- Transmitted to ISA . . . . . Rule 23
- Transmittal
- Fee. . . . . Rule 14
- In electronic form . . . . . Rule 89<sup>bis</sup>, Rule 89<sup>ter</sup>,  
A.I. 102<sup>bis</sup>, A.I. 335,  
A.I. 701- A.I. 703, A.I. Annex F
- Sequence Listings and/or tables relating thereto . . . . . A.I. 801 through A.I. 806
- Of RC to IB by RO. . . . . Rule 22, 37 CFR 1.461
- Of SC to ISA by RO. . . . . Rule 23
- Delayed . . . . . A.I. 306
- Treaty - See also Patent Cooperation Treaty
- ### U
- Unity of invention
- Compliance with Rule 13 . . . . . A.I. 206
- During U.S. national stage . . . . . 37 CFR 1.499
- Examples and guidelines . . . . . A.I. Annex B
- In general . . . . . Rule 13, 37 CFR 1.475
- Lack of unity before
- IPEA . . . . . Art. 34(3), Rule 68, 37 CFR 1.488,  
37 CFR 1.489
- Lack of unity before
- ISA . . . . . Art. 17(3), Rule 40, 37 CFR 1.476,  
37 CFR 1.477
- Transmittal of protest to pay fees for additional claimed inventions
- Transmittal by IB. . . . . A.I. 403
- Transmittal by IPEA . . . . . A.I. 603
- Transmittal by ISA . . . . . A.I. 502
- ### W
- WO - See also International publication number
- Withdrawals (by applicant),
- in general. . . . . Rule 90<sup>bis</sup>, A.I. 326
- Of demand or election . . . . . Art. 37, Rule 90<sup>bis</sup>.4
- Withdrawn
- Application, U.S. statute regarding. . . . . 35 U.S.C. 366
- Determination by RO re IA . . . . . Rule 29
- Decision by RO not to hold withdrawn after notifying applicant of intent to so hold . . A.I. 312
- Notification to IPEA by IB . . . . . A.I. 414
- Review of by DO. . . . . Art. 25, Rule 51

PATENT COOPERATION TREATY

Determination by IB under Article 12(3)  
Review by DO . . . . . Art. 25, Rule 51  
Written opinion by IPEA . . . . . Art. 34, Rule 66

Amendment of claims, description, and  
drawing under Article 34 in response to  
Written opinion by ISA . . . . . Art. 34, Rule 43<sup>bis</sup>

MANUAL OF PATENT EXAMINING PROCEDURE

# Appendix AI ADMINISTRATIVE INSTRUCTIONS UNDER THE PCT

---

(as in force from February 12, 2004)

## TABLE OF CONTENTS<sup>1</sup>

	TABLE OF CONTENTS		
		Section 207	Arrangement of Elements and Numbering of Sheets of the International Application
<b>Part 1:</b>	<b>Instructions Relating to General Matters</b>	Section 208	Sequence Listings
		Section 209	Indications as to Deposited Biological Material on a Separate Sheet
Section 101	Abbreviated Expressions and Interpretation	Section 210	Calculation of Designation Fee for the Purposes of National and Regional Patents
Section 102	Use of the Forms	Section 211	Declaration as to the Identity of the Inventor
Section 102 <sup>bis</sup>	Filing of Request in PCT-EASY Format Together with PCT-EASY Diskette Containing Request Data and Abstract	Section 212	Declaration as to the Applicant's Entitlement to Apply for and Be Granted a Patent
Section 103	Languages of the Forms Used by International Authorities	Section 213	Declaration as to the Applicant's Entitlement to Claim Priority of Earlier Application
Section 104	Language of Correspondence in Cases Not Covered by Rule 92.2	Section 214	Declaration of Inventorship
Section 105	Identification of International Application with Two or More Applicants	Section 215	Declaration as to Non-Prejudicial Disclosures or Exceptions to Lack of Novelty
Section 106	Change of Common Representative	Section 216	Notice of Correction or Addition of a Declaration Under Rule 26 <sup>ter</sup>
Section 107	Identification of International Authorities and of Designated and Elected Offices		
Section 108	Correspondence Intended for the Applicant		
Section 109	File Reference		
Section 110	Dates	<b>Part 3:</b>	<b>Instructions Relating to the Receiving Office</b>
Section 111	[Deleted]		
Section 112	Ceasing of Effect under Articles 24(1)(iii) and 39(2), Review under Article 25 (2) and Maintaining of Effect under Articles 24(2) and 39(3)	Section 301	Notification of Receipt of Purported International Application
Section 113	Special Fees Payable to the International Bureau	Section 302	Priority Claim Considered Not To Have Been Made
Section 114	[Deleted]	Section 303	Deletion of Additional Matter in the Request
Section 115	Indications of States, Territories, and Intergovernmental Organizations	Section 304	Invitation to Pay Fees Before Date on Which They Are Due
<b>Part 2:</b>	<b>Instructions Relating to the International Application</b>	Section 305	Identifying the Copies of the International Application
Section 201	Language of the International Application	Section 305 <sup>bis</sup>	Preparation, Identification and Transmittal of the Copies of the Translation of the International Application
Section 202	[Deleted]	Section 306	Delayed Transmittal of Search Copy
Section 203	Different Applicants for Different Designated States	Section 307	System of Numbering International Applications
Section 204	Headings of the Parts of the Description	Section 308	Marking of the Sheets of the International Application and of the Translation Thereof
Section 205	Numbering and Identification of Claims Upon Amendment	Section 309	Procedure in the Case of Later Submitted Sheets
Section 206	Unity of Invention		

<sup>1</sup> Table of Contents added for the convenience of the reader; it is not part of the Administrative Instructions.

## MANUAL OF PATENT EXAMINING PROCEDURE

Section 310	Procedure in the Case of Missing Drawings	Section 331	Receipt of Confirmation Copy
Section 311	Renumbering in the Case of Deletion, Substitution or Addition of Sheets of the International Application and of the Translation Thereof	Section 332	Notification of Languages Accepted by the receiving Office under Rules 12.1(a) and (c) and 12.4(a)
Section 312	Notification of Decision Not To Issue Declaration that the International Application Is Considered Withdrawn	Section 333	Transmittal of International Application to the International Bureau as Receiving Office
Section 313	Documents Filed with the International Application; Manner of Marking the Necessary Annotations in the Check List	Section 334	Notification to Applicant of Submission of Demand After the Expiration of 19 Months from the Priority Date
Section 314	Correction or Addition of a Priority Claim under Rule 26 <sup>bis</sup>	Section 335	Transmittal of PCT-EASY Diskette Containing Request Data and Abstract
Section 315	Notification Concerning Confirmation of Designation	Section 336	Waivers Under Rules 90.4(d) and 90.5(c)
Section 316	Procedure in the Case Where the International Application Lacks the Prescribed Signature	<b>Part 4:</b>	<b>Instructions Relating to the International Bureau</b>
Section 317	Transmittal of a Notice of Correction or Addition of a Declaration Under Rule 26 <sup>ter</sup> .1	Section 401	Marking of the Sheets of the Record Copy
Section 318	Cancellation of Designations of Non-Contracting States	Section 402	Correction or Addition of a Priority Claim Under Rule 26 <sup>bis</sup>
Section 319	[Deleted]	Section 403	Transmittal of Protest Against Payment of Additional Fee and Decision Thereon Where International Application Is Considered To Lack Unity of Invention
Section 320	Invitation to Pay Fees under Rule 16 <sup>bis</sup> .1(a)	Section 404	International Publication Number of International Application
Section 321	Application of Moneys Received by the Receiving Office in Certain Cases	Section 405	Publication of Notifications of Languages Accepted by the receiving Office under Rules 12.1(a) and (c) and 12.4(a)
Section 322	Invitation to Submit a Request for Refund of the Search Fee	Section 406	Pamphlets
Section 323	Transmittal of Priority Documents to International Bureau	Section 407	The Gazette
Section 324	Copy of Notification of the International Application Number and the International Filing Date under Rule 20.5 (c)	Section 408	Priority Application Number
Section 325	Corrections of Defects Under Rule 26.4, Rectifications of Obvious Errors Under Rule 91.1, and Corrections Under Rule 9.2	Section 409	Priority Claim Considered Not To Have Been Made
Section 326	Withdrawal by Applicant Under Rule 90 <sup>bis</sup> .1, 90 <sup>bis</sup> .2, or 90 <sup>bis</sup> .3	Section 410	Numbering of Sheets for the Purposes of International Publication; Procedure in Case of Missing Sheets or Drawings
Section 327	<i>Ex Officio</i> Correction of Request by the Receiving Office	Section 411	Receipt of Priority Document
Section 328	Notifications Concerning Representation	Section 412	Notification of Lack of Transmittal of Search Copy
Section 329	Correction of Indications Concerning the Applicant's Residence or Nationality	Section 413	Corrections of Defects under Rule 26.4, Rectifications of Obvious Errors under Rule 91.1, and Corrections under Rule 9.2
Section 330	Transmittal of Record Copy Prevented or Delayed by National Security Prescriptions	Section 414	Notification to the International Preliminary Examining Authority Where the International Application is Considered Withdrawn
		Section 415	Notification of Withdrawal under Rule 90 <sup>bis</sup> .1, 90 <sup>bis</sup> .2, 90 <sup>bis</sup> .3 or 90 <sup>bis</sup> .4
		Section 416	Correction of Request in Record Copy

## ADMINISTRATIVE INSTRUCTIONS UNDER THE PCT

Section 417	Processing of Amendments under Article 19	Section 504	Searching Authority Classification of the Subject Matter of the International Application
Section 418	Notifications to Elected Offices Where the Demand Is Considered Not To Have Been Submitted or Made	Section 505	Indication of Citations of Particular Relevance in the International Search Report
Section 419	Processing of a Declaration Under Rule 26 <sup>ter</sup>	Section 506	[Deleted]
Section 420	Copy of International Application and International Search Report for the International Preliminary Examining Authority	Section 507	Manner of Indicating Certain Special Categories of Documents Cited in the International Search Report
Section 421	Invitation To Furnish a Copy of the Priority Document	Section 508	Manner of Indicating the Claims to Which the Documents Cited in the International Search Report Are Relevant
Section 422	Notifications Concerning Changes Recorded under Rule 92 <sup>bis</sup> .1	Section 509	International Search and Written Opinion of the International Searching Authority on the Basis of a Translation of the International Application
Section 422 <sup>bis</sup>	Objections Concerning Changes in the Person of the Applicant Recorded Under Rule 92 <sup>bis</sup> .1(a)	Section 510	Refund of Search Fee in Case of Withdrawal of International Application
Section 423	Cancellation of Designations and Elections	Section 511	Rectifications of Obvious Errors Under Rule 91.1
Section 424	[Deleted]	Section 512	Notifications Concerning Representation
Section 425	Notifications Concerning Representation	Section 513	Sequence Listings
Section 426	[Deleted]	Section 514	Authorized Officer
Section 427	[Deleted]	Section 515	Amendment of Established Abstract in Response to Applicant's Comments
Section 428	[Deleted]	Section 516	Notification to Applicant of Submission of Demand After the Expiration of 19 Months from the Priority Date
Section 429	[Deleted]	Section 517	Waivers Under Rules 90.4(d) and 90.5(c)
Section 430	Notification of Designations under Rule 32	Section 518	Guidelines for Explanations Contained in the Written Opinion of the International Searching Authority
Section 431	Publication of Notice of Submission of Demand		
Section 432	Notification to Applicant of Submission of Demand After the Expiration of 19 Months from the Priority Date		
Section 433	Waivers Under Rules 90.4(d) and 90.5(c)		
Section 434	Publication of Information Concerning Waivers Under Rules 90.4(d) and 90.5(c)		
<b>Part 5:</b>	<b>Instructions Relating to the International Searching Authority</b>	<b>Part 6:</b>	<b>Instructions Relating to the International Preliminary Examining Authority</b>
Section 501	Corrections Submitted to the International Searching Authority Concerning Expressions, etc., Not To Be Used in the International Application	Section 601	Notification to Applicant of Submission of Demand After the Expiration of 19 Months From the Priority Date
Section 502	Transmittal of Protest Against Payment of Additional Fee and Decision Thereon Where International Application Is Considered To Lack Unity of Invention	Section 602	Processing of Amendments by the International Preliminary Examining Authority
Section 503	Method of Identifying Documents Cited in the International Search Report and the Written Opinion of the International	Section 603	Transmittal of Protest Against Payment of Additional Fee and Decision Thereon Where International Application Is Considered To Lack Unity of Invention

## MANUAL OF PATENT EXAMINING PROCEDURE

Section 604	Guidelines for Explanations Contained in the International Preliminary Examination Report	Section 710	Notification and Publication of Receiving Offices' Requirements and Practices
Section 605	File To Be Used for International Preliminary Examination	Section 711	Electronic Records Management
Section 606	Cancellation of Elections	Section 712	Access to Electronic Records
Section 606 <sup>bis</sup>	[Deleted]	Section 713	Provisions Relating to International Authorities and Designated Offices
Section 607	Rectifications of Obvious Errors under Rule 91.1	<b>Part 8:</b>	<b>Instructions Relating to International Applications Containing Large Nucleotide and/or Amino Acid Sequence Listings and/or Tables Relating Thereto</b>
Section 608	Notifications Concerning Representation	Section 801	Filing of International Applications Containing Sequence Listings
Section 609	Withdrawal by Applicant under Rule 90 <sup>bis</sup> .1, 90 <sup>bis</sup> .2, or 90 <sup>bis</sup> .3	Section 802	Format and Identification Requirements Relating to International Applications Containing Sequence Listings
Section 610	[Deleted]	Section 803	Calculation of International Filing Fee for International Applications Containing Sequence Listings and/or Tables
Section 611	Method of Identification of Documents in the International Preliminary Examination Report	Section 804	Preparation, Identification and Transmittal of Copies of International Applications Containing Sequence Listings
Section 612	Authorized Officer	Section 805	Publication and Communication of International Applications Containing Sequence Copies; Priority Documents
Section 613	Invitation to Submit a Request for Refund of Fees under Rule 57.6 or 58.3	Section 806	Sequence Listings for Designated Office
Section 614	Evidence of Right to File Demand		
Section 615	Invitation to Pay Fees Before Date on Which They Are Due		
Section 616	International Preliminary Examination on the Basis of a Translation of the International Application		
Section 617	Waivers Under Rules 90.4(d) and 90.5(c)		
<b>Part 7:</b>	<b>Instructions Relating to the Electronic Filing and Processing of International Applications</b>		
Section 701	Abbreviated Expressions	<b>Annex A</b>	<b>Forms</b>
Section 702	International Applications Filed in Electronic Form	Part I:	Forms Relating to the Receiving Office
Section 703	Filing Requirements; Basic Common Standard	Part II:	Forms Relating to the International Searching Authority
Section 704	Receipt; International Filing Date; Signature; Physical Requirements; Subsequent Documents and Correspondence	Part III:	Forms Relating to the International Bureau
Section 705	Home Copy, Record Copy and Search Copy	Part IV:	Forms Relating to the International Preliminary Examining Authority
Section 706	Backup Copies	Part V:	Forms for Use by the Applicant
Section 707	International filing fee; Fee Reduction	<b>Annex B</b>	<b>Unity of Invention</b>
Section 708	Special Provisions Concerning Legibility, Completeness, Infection by Viruses, Etc.	Part 1:	Instructions Concerning Unity of Invention
Section 709	Means of Communication	Part 2:	Examples Concerning Unity of Invention
		<b>Annex C</b>	<b>Standard for the Presentation of Nucleotide and Amino Acid Sequence Listings in International Patent Applications Under the PCT</b>

ADMINISTRATIVE INSTRUCTIONS UNDER THE PCT

<b>Annex C<sup>bis</sup></b>	<b>Technical Requirements for the Presentation of Tables Related to Nucleotide and Amino Acid Sequence Listings in International Patent Applications under the PCT</b>	<b>Annex F</b>	<b>Standard for the Electronic Filing and Processing of International Applications</b>
<b>Annex D</b>	<b>Information from Pamphlet Front Page to Be Included in the Gazette under Rule 86.1(a)(i)</b>	Appendix I	XML DTDs for the E-PCT Standard
<b>Annex E</b>	<b>Information to Be Published in the Gazette under Rule 86.1(a)(v)</b>	Appendix II	PKI Architecture for the E-PCT Standard
		Appendix III	Basic Common Standard for Electronic Filing
		Appendix IV	Use of Physical Media for the E-PCT Standard



**PART 1**

**INSTRUCTIONS RELATING TO GENERAL MATTERS**

**Section 101**

**Abbreviated Expressions and Interpretation**

(a) In these Administrative Instructions:

(i) “Treaty” means the Patent Cooperation Treaty;

(ii) “Regulations” means the Regulations under the Treaty;

(iii) “Article” means an Article of the Treaty;

(iv) “Rule” means a Rule of the Regulations;

(v) “International Bureau” means the International Bureau as defined in Article 2 (xix) of the Treaty;

(vi) “International Authorities” means the receiving Offices, the International Searching Authorities, the International Preliminary Examining Authorities, and the International Bureau;

(vii) “Annex” means an Annex to these Administrative Instructions, unless the contrary clearly follows from the wording or the nature of the provision, or the context in which the word is used;

(viii) “Form” means a Form contained in Annex A;<sup>2</sup>

(ix) “WIPO Standard” means a Standard established by the World Intellectual Property Organization;

(x) “Director General” means the Director General as defined in Article 2 (xx) of the Treaty.

(b) The Annexes are part of these Administrative Instructions.

**Section 102**

**Use of the Forms**

(a) Subject to paragraphs (b) to (i) and Sections 103 and 114, the International Authorities shall use, or require the use of, the mandatory Forms specified below:

(i) Forms for use by the applicant:

PCT/RO/101 (request Form)

PCT/IPEA/401 (demand Form)

(ii) Forms for use by the receiving Offices:

PCT/RO/103 PCT/RO/115 PCT/RO/150

PCT/RO/104 PCT/RO/116 PCT/RO/151

PCT/RO/105 PCT/RO/117 PCT/RO/152

PCT/RO/106 PCT/RO/118 PCT/RO/153

PCT/RO/107 PCT/RO/123 PCT/RO/154

PCT/RO/109 PCT/RO/126 PCT/RO/155

PCT/RO/110 PCT/RO/133 PCT/RO/156

PCT/RO/111 PCT/RO/136 PCT/RO/157

PCT/RO/112 PCT/RO/143

PCT/RO/113 PCT/RO/147

(iii) Forms for use by the International Searching Authorities:

PCT/ISA/201 PCT/ISA/212 PCT/ISA/233

PCT/ISA/202 PCT/ISA/217 PCT/ISA/234

PCT/ISA/203 PCT/ISA/218 PCT/ISA/235

PCT/ISA/205 PCT/ISA/219 PCT/ISA/236

PCT/ISA/206 PCT/ISA/220 PCT/ISA/237

PCT/ISA/209 PCT/ISA/225

PCT/ISA/210 PCT/ISA/228

(iv) Forms for use by the International Bureau:

PCT/IB/301 PCT/IB/325 PCT/IB/357

PCT/IB/304 PCT/IB/326 PCT/IB/358

PCT/IB/305 PCT/IB/331 PCT/IB/360

<sup>2</sup>Annex A is published separately by the World Intellectual Property Organization.

ADMINISTRATIVE INSTRUCTIONS UNDER THE PCT

PCT/IB/306	PCT/IB/332	PCT/IB/366
PCT/IB/307	PCT/IB/335	PCT/IB/367
PCT/IB/308	PCT/IB/336	PCT/IB/368
PCT/IB/310	PCT/IB/337	PCT/IB/369
PCT/IB/311	PCT/IB/338	PCT/IB/370
PCT/IB/313	PCT/IB/339	PCT/IB/371
PCT/IB/314	PCT/IB/344	PCT/IB/373
PCT/IB/315	PCT/IB/345	PCT/IB/374
PCT/IB/316	PCT/IB/346	PCT/IB/399
PCT/IB/317	PCT/IB/349	
PCT/IB/318	PCT/IB/350	
PCT/IB/319	PCT/IB/351	
PCT/IB/320	PCT/IB/353	
PCT/IB/321	PCT/IB/354	
PCT/IB/323	PCT/IB/356	

(v) Forms for use by the International Preliminary Examining Authorities:

PCT/IPEA/402	PCT/IPEA/414	PCT/IPEA/437
PCT/IPEA/404	PCT/IPEA/415	PCT/IPEA/440
PCT/IPEA/405	PCT/IPEA/416	PCT/IPEA/441
PCT/IPEA/407	PCT/IPEA/420	PCT/IPEA/442
PCT/IPEA/408	PCT/IPEA/425	PCT/IPEA/443
PCT/IPEA/409	PCT/IPEA/431	PCT/IPEA/444
PCT/IPEA/412	PCT/IPEA/436	

(b) Slight variations in layout necessary in view of the printing of the Forms referred to in paragraph (a) in various languages are permitted.

(c) Slight variations in layout in the Forms referred to in paragraph (a)(ii) to (v) are permitted to the extent necessary to meet the particular office requirements of the International Authorities, in particular in view of the production of the Forms by computer or of the use of window envelopes.

(d) Where the receiving Office, the International Searching Authority and/or the International Preliminary Examining Authority are each part of the same Office, the obligation to use the Forms referred to in paragraph (a) does not extend to communications within that same Office.

(e) The annexes to Forms PCT/RO/106, PCT/RO/118, PCT/ISA/201, PCT/ISA/205, PCT/ISA/206, PCT/ISA/210, PCT/ISA/219, PCT/IB/313, PCT/IB/336, PCT/IPEA/404, PCT/IPEA/405 and PCT/IPEA/415 may be omitted in cases where they are not used.

(f) The notes attached to Forms PCT/RO/101 (request Form) and PCT/IPEA/401 (demand Form) shall be distributed by the International Authorities concerned together with the printed versions of those Forms. The notes attached to Form PCT/ISA/220 shall accompany the Form when sent to the applicant.

(g) The use of Forms other than those referred to in paragraph (a) is optional.

(h) Where the request or the demand is presented as a computer print-out, such print-out shall be prepared as follows:

(i) the layout and contents of the request and the demand when presented as computer print-outs shall correspond to the format of Forms PCT/RO/101 (request Form) and PCT/IPEA/401 (demand Form) (“the printed Forms”), with the same information being presented on the corresponding pages;

(ii) all boxes shall be drawn by solid lines; double lines may be presented as single lines;

(iii) the box numbers and box titles shall be included even where no information is supplied therein;

(iv) the boxes for use by the International Authorities shall be at least as large as those on the printed Forms;

(v) all other boxes shall be within one cm in size of those on the printed Forms;

(vi) all text shall be 9 points or larger in size;

(vii) titles and other information shall be clearly distinguished;

(viii) explanatory notes presented in italics on the printed Forms may be omitted.

(i) Other formats permitted for the presentation of the request and the demand as computer print-outs may be determined by the Director General. Any such format shall be published in the Gazette.

### **Section 102<sup>bis</sup>**

#### **Filing of Request in PCT-EASY Format Together with PCT-EASY Diskette Containing Request Data and Abstract**

(a) Pursuant to Rule 89<sup>ter</sup>, any receiving Office may, if it is prepared to do so, accept the filing with it of any international application containing the request presented as a computer print-out prepared using the PCT-EASY software made available by the International Bureau (“request in PCT-EASY format”) together with a computer diskette, prepared using that software, containing a copy in electronic form of the data contained in the request and of the abstract (“PCT-EASY diskette”).

(b) Any receiving Office which, under paragraph (a), accepts the filing of requests in PCT-EASY format together with PCT-EASY diskettes shall notify the International Bureau accordingly. The International Bureau shall promptly publish any such information in the Gazette.

(c) Item 3(a) of the Schedule of Fees annexed to the Regulations shall apply to reduce the fees payable in respect of an international application containing the request in PCT-EASY format filed, together with a PCT-EASY diskette, with a receiving Office which, under paragraph (a), accepts the filing of such international applications.

### **Section 103**

#### **Languages of the Forms Used by International Authorities**

(a) The language of the Forms used by any receiving Office shall be the same as the language in which the international application is filed, provided that:

(i) where the international application is to be published in the language of a translation required under Rule 12.3(a) or 12.4(a), the receiving Office shall use the Forms in such language;

(ii) the receiving Office may, in its communications to the applicant, use the Forms in any other language being one of its official languages.

(b) Subject to Section 104(b), the language or languages of the Forms to be used by any International Searching Authority shall be specified in the applicable agreement referred to in Article 16(3)(b).

(c) Subject to Section 104(b), the language or languages of the Forms to be used by any International Preliminary Examining Authority shall be specified in the applicable agreement referred to in Article 32(3).

(d) The language of any Form used by the International Bureau shall be English where the language of the international application is English, and it shall be French where the language of the international application is French. Where the language of the international application is neither English nor French, the language of any Form used by the International Bureau in its communications to any other International Authority shall be English or French according to the wishes of such Authority, and in its communications to the applicant it shall be English or French according to the wishes of the applicant.

### **Section 104**

#### **Language of Correspondence in Cases Not Covered by Rule 92.2**

(a) The language of any letter from the applicant to the receiving Office shall be the same as the language of the international application to which such letter relates, provided that, where the international application is to be published in the language of a translation required under Rule 12.3(a) or 12.4(a), any letter shall be in such language. However, the receiving Office may expressly authorize the use of any other language.

(b) The language of any letter to the International Bureau shall be English where the language of the international application is English, and it shall be French where the language of the international application is French. Where the language of the international application is neither English nor French, the language of any letter to the International Bureau shall be English or French, provided that any copy, sent to the International Bureau as a notification addressed to it, of a Form sent to the applicant by the receiving Office, the International Searching Authority or the International Preliminary Examining Authority, does not require translation into English or French.

### **Section 105**

#### **Identification of International Application with Two or More Applicants**

Where any international application indicates two or more applicants, it shall be sufficient, for the purpose of identifying that application, to indicate, in any Form or correspondence relating to such application, the name of the applicant first named in the request. The provisions of the first sentence of this Section do not apply to the demand.

### **Section 106**

#### **Change of Common Representative**

Where a change is recorded under Rule 92<sup>bis</sup>.1(a) in the person of an applicant who was considered to be the common representative under Rule 90.2(b), the new applicant shall be considered to be the common representative under Rule 90.2(b) if he is entitled according to Rule 19.1 to file an international application with the receiving Office.

### **Section 107**

#### **Identification of International Authorities and of Designated and Elected Offices**

(a) Whenever the nature of any communication from or to the applicant, from or to any International Authority or, before national processing or examination has started, from or to any designated or elected Office so permits, any International Authority or any designated or elected Office may be indicated in the communication by the two-letter code referred to in Section 115.

(b) The indication of a receiving Office, an International Searching Authority, an International Preliminary Examining Authority or a designated or elected Office shall be preceded by the letters “RO,” “ISA,” “IPEA,” “DO,” or “EO,” respectively, followed by a slant (e.g., “RO/JP,” “ISA/US,” “IPEA/SE,” “DO/EP,” “EO/AU”).

### **Section 108**

#### **Correspondence Intended for the Applicant**

(a) For the purpose of this Section, where there are two or more agents whose appointments are in

force, “first mentioned agent” means the agent first mentioned in the document containing the appointments or, where the appointments are contained in two or more documents, in that which was filed first.

(b) Where a sole applicant has appointed an agent or agents under Rule 90.1(a), correspondence intended for the applicant from the International Authorities shall, subject to paragraph (d), be addressed to the agent or, where applicable, to the first mentioned agent.

(c) Where there are two or more applicants, correspondence intended for the applicants from the International Authorities shall, subject to paragraph (d), be addressed:

(i) if no common agent has been appointed under Rule 90.1—to the common representative or, where applicable, to his agent or first mentioned agent; or

(ii) if the applicants have appointed a common agent or common agents under Rule 90.1(a)—to that common agent or, where applicable, to the first mentioned common agent.

(d) Where an agent has or agents have been appointed under Rule 90.1(b), (c) or (d)(ii), paragraphs (b) and (c) shall apply to correspondence intended for the applicant relating to the procedure before the International Searching Authority or the International Preliminary Examining Authority, as the case may be, as if those paragraphs referred to the agent or agents so appointed.

(e) Where, in accordance with paragraph (c), correspondence intended for the applicants from the International Authorities is to be addressed to the common representative but the indication required under Rule 4.5(a)(ii) has not been provided for the common representative, correspondence shall be addressed:

(i) to the first applicant named in the request who is entitled according to Rule 19.1 to file an international application with the receiving Office and in respect of whom the indication required under Rule 4.5(a)(ii) has been provided; or, if there is no such applicant,

(ii) to the applicant first named in the request who is entitled according to Article 9 to file an international application and in respect of, whom the indication required under Rule 4.5(a)(ii) has been provided; or, if there is no such applicant,

(iii) to the applicant first named in the request in respect of whom the indication required under Rule 4.5(a)(ii) has been provided.

### Section 109

#### File Reference

(a) Where any document submitted by the applicant contains an indication of a file reference, that reference shall not exceed 12 characters in length and may be composed of either letters of the Latin alphabet or Arabic numerals, or both.

(b) Correspondence from International Authorities intended for the applicant shall indicate any such file reference.

### Section 110

#### Dates

Any date in the international application, or used in any correspondence emanating from International Authorities relating to the international application, shall be indicated by the Arabic number of the day, by the name of the month, and by the Arabic number of the year. The receiving Office, where the applicant has not done so, or the International Bureau, where the applicant has not done so and the receiving Office fails to do so, shall, after, above, or below any date indicated by the applicant in the request, repeat the date, in parentheses, by indicating it by two-digit Arabic numerals each for the number of the day and for the number of the month followed by the number of the year in four digits, in that order and with a period, slant or hyphen after the digit pairs of the day and of the month (for example, “20 March 2004 (20.03.2004),” “20 March 2004 (20/03/2004),” or “20 March 2004 (20-03-2004)”).

### Section 111

*[Deleted]*

### Section 112

#### Ceasing of Effect Under Articles 24(1)(iii) and 39(2), Review Under Article 25(2) and Maintaining of Effect Under Articles 24(2) and 39(3)

(a) Each national Office shall, in its capacity as designated Office, notify the International Bureau once a year of:

(i) the number of international applications in respect of which, during the preceding calendar year, the time limit applicable under Article 22 has expired;

(ii) the number of international applications in respect of which, during the preceding calendar year, the requirements provided for in Article 22 have not been complied with before the expiration of the time limit applicable under that Article, with the consequence that the effects of the international applications concerned have ceased under Article 24(1)(iii).

(b) Each national Office shall, in its capacity as elected Office, notify the International Bureau once a year of:

(i) the number of international applications in respect of which, during the preceding calendar year, the time limit applicable under Article 39(1) has expired;

(ii) the number of international applications in respect of which, during the preceding calendar year, the requirements provided for in Article 39(1) have not been complied with before the expiration of the time limit applicable under that Article, with the consequence that the effects of the international applications concerned have ceased under Article 39(3).

(c) Where, under Article 25(2), the designated Office decides that the refusal, declaration or finding referred to in Article 25(1) was not justified, it shall promptly notify the International Bureau that it will treat the international application as if the error or omission referred to in Article 25(2) had not occurred. The notification shall preferably contain the reasons for the decision of the designated Office.

(d) Where, under Article 24(2) or under Article 39(3), the designated or elected Office maintains the effect provided for in Article 11(3), it shall promptly notify the International Bureau accordingly. The notification shall preferably contain the reasons for the decision of the designated or elected Office.

### Section 113

#### Special Fees Payable to the International Bureau

(a) The special publication fee provided for in Rule 48.4 shall be 200 Swiss francs.

(b) The special fee provided for in Rule 91.1(f) shall be payable to the International Bureau and shall be 50 Swiss francs plus 12 Swiss francs for each sheet in excess of one. Where that fee has not been paid before the time of the completion of the technical preparations for international publication, the request for rectification shall not be published. Where the last sentence of Rule 91.1(f) applies and the said fee has not been paid before the time of the communication of the international application under Article 20, a copy of the request for rectification shall not be included in that communication.

(c) The special fee provided for in Rule 26<sup>bis</sup>.2(c) shall be payable to the International Bureau and shall be 50 Swiss francs plus 12 Swiss francs for each sheet in excess of one. Where that fee has not been paid before the time of the completion of the technical preparations for international publication, the information concerning the priority claim which was considered not to have been made shall not be

published. Where the last sentence of Rule 26<sup>bis</sup>.2(c) applies and the said fee has not been paid before the time of the communication of the international application under Article 20, a copy of the information concerning the priority claim which was considered not to have been made shall not be included in that communication.

### Section 114

*[Deleted]*

### Section 115

#### Indications of States, Territories, and Intergovernmental Organizations

The indication of a State, territory, or intergovernmental organization shall be made either by its full name, by a generally accepted short title which, if the indications are in English or French, shall be as appears in WIPO Standard ST.3 (Recommended Standard Two-Letter Code for the Representation of Countries, and of Other Entities and International Organizations Issuing or Registering Industrial Property Titles), or by the two-letter code as appears in that Standard.<sup>3</sup>

---

<sup>3</sup> Published in the WIPO Handbook on Industrial Property Information and Documentation.

## PART 2

### INSTRUCTIONS RELATING TO THE INTERNATIONAL APPLICATION

#### Section 201

##### Language of the International Application

The language in which the international application is filed shall preferably be indicated in the request.

#### Section 202

*[Deleted]*

#### Section 203

##### Different Applicants for Different Designated States

(a) Different applicants may be indicated for different States designated for a regional patent.

(b) Where a particular State has been designated for both a national patent and a regional patent, the same applicant or applicants shall be indicated for both designations.

#### Section 204

##### Headings of the Parts of the Description

The headings of the parts of the description should be as follows:

(i) for matter referred to in Rule 5.1(a)(i), “Technical Field”;

(ii) for matter referred to in Rule 5.1(a)(ii), “Background Art”;

(iii) for matter referred to in Rule 5.1(a)(iii), “Disclosure of Invention”;

(iv) for matter referred to in Rule 5.1(a)(iv), “Brief Description of Drawings”;

(v) for matter referred to in Rule 5.1(a)(v), “Best Mode for Carrying Out the Invention,” or, where appropriate, “Mode(s) for Carrying Out the Invention”;

(vi) for matter referred to in Rule 5.1(a)(vi), “Industrial Applicability”;

(vii) for matter referred to in Rule 5.2(a), “Sequence Listing”;

(viii) for matter referred to in Rule 5.2(b), “Sequence Listing Free Text.”

#### Section 205

##### Numbering and Identification of Claims upon Amendment

(a) Amendments to the claims under Article 19 or Article 34(2)(b) may be made either by cancelling one or more entire claims, by adding one or more new claims or by amending the text of one or more of the claims as filed. All the claims appearing on a replacement sheet shall be numbered in Arabic numerals. Where a claim is cancelled, no renumbering of the other claims shall be required. In all cases where claims are renumbered, they shall be renumbered consecutively.

(b) The applicant shall, in the letter referred to in the second and third sentences of Rule 46.5(a) or in the second and fourth sentences of Rule 66.8(a), indicate the differences between the claims as filed and the claims as amended. He shall, in particular, indicate in the said letter, in connection with each claim appearing in the international application (it being understood that identical indications concerning several claims may be grouped), whether:

(i) the claim is unchanged;

(ii) the claim is cancelled;

(iii) the claim is new;

(iv) the claim replaces one or more claims as filed;

(v) the claim is the result of the division of a claim as filed.

#### Section 206

##### Unity of Invention

The determination by the International Searching Authority, the International Preliminary Examining Authority and the designated and elected Offices whether an international application complies with the requirement of unity of invention under Rule 13 shall be made in accordance with Annex B.

## Section 207

### Arrangement of Elements and Numbering of Sheets of the International Application

(a) In effecting the sequential numbering of the sheets of the international application in accordance with Rule 11.7, the elements of the international application shall be placed in the following order: the request, the description (other than any sequence listing part thereof), the claims, the abstract, the drawings, the sequence listing part of the description (where applicable).

(b) The sequential numbering of the sheets shall be effected by using the following separate series of numbering:

(i) the first series applying to the request only and commencing with the first sheet of the request,

(ii) the second series commencing with the first sheet of the description (other than any sequence listing part thereof) and continuing through the claims until the last sheet of the abstract,

(iii) if applicable, a further series applying to the sheets of the drawings only and commencing with the first sheet of the drawings; the number of each sheet of the drawings shall consist of two Arabic numerals separated by a slant, the first being the sheet number and the second being the total number of sheets of drawings (for example, 1/3, 2/3, 3/3), and

(iv) if applicable, preferably, a further series applying to the sequence listing part of the description commencing with the first sheet of that part.

## Section 208

### Sequence Listings

Any nucleotide and/or amino acid sequence listing ("sequence listing") filed as part of the international application, or furnished together with the international application or subsequently (whether in printed form or computer readable form), shall comply with Annex C.

## Section 209

### Indications as to Deposited Biological Material on a Separate Sheet

(a) To the extent that any indication with respect to deposited biological material is not con-

tained in the description, it may be given on a separate sheet. Where any such indication is so given, it shall preferably be on Form PCT/RO/134 and, if furnished at the time of filing, the said Form shall, subject to paragraph (b), preferably be attached to the request and referred to in the check list referred to in Rule 3.3 (a)(ii).

(b) For the purposes of the Israel Patent Office, the Japan Patent Office, the Korean Intellectual Property Office, the Mexican Institute of Industrial Property, and the Turkish Patent Institute as designated Offices, paragraph (a) applies only to the extent that the said Form or sheet is included as one of the sheets of the description of the international application at the time of filing.

## Section 210

*[Deleted]*

## Section 211

### Declaration as to the Identity of the Inventor

(a) Any declaration as to the identity of the inventor, referred to in Rule 4.17(i), shall be worded as follows:

"Declaration as to the identity of the inventor (Rules 4.17(i) and 51<sup>bis</sup>.1(a)(i)):

in relation to [this] international application [No. PCT/...],

(i) ... (*name*) of ... (*address*) is the inventor of the subject matter for which protection is sought by way of [the] [this] international application

(ii) this declaration is made for the purposes of (*include as applicable*):

(a) all designations [except the designation of the United States of America]

(b) the following designations for national and/or regional patents: ..."

(b) This declaration need not be made if the name and address of the inventor are otherwise indicated in the request.

(c) This declaration may, where applicable, be combined, in accordance with Section 212(b), with the declaration referred to in Section 212(a).



**Section 212**

**Declaration as to the Applicant's Entitlement to Apply for and Be Granted a Patent**

(a) Any declaration as to the applicant's entitlement, as at the international filing date, to apply for and be granted a patent, referred to in Rule 4.17(ii), shall be worded as follows, with such inclusion, omission, repetition and re-ordering of the matters listed as items (i) to (viii) as is necessary to explain the applicant's entitlement:

"Declaration as to the applicant's entitlement, as at the international filing date, to apply for and be granted a patent (Rules 4.17(ii) and 51<sup>bis</sup>.1(a)(ii)), in a case where the declaration under Rule 4.17(iv) is not appropriate:

in relation to [this] international application [No. PCT/...],

... (*name*) is entitled to apply for and be granted a patent by virtue of the following:

(i) ... (*name*) of ... (*address*) ... is the inventor of the subject matter for which protection is sought by way of [the] [this] international application

(ii) ... (*name*) [is] [was] entitled as employer of the inventor, ... (*inventor's name*)

(iii) an agreement between ... (*name*) and ... (*name*), dated ...

(iv) an assignment from ... (*name*) to ... (*name*), dated ...

(v) consent from ... (*name*) in favor of ... (*name*), dated ...

(vi) a court order issued by ... (*name of court*), effecting a transfer from ... (*name*) to ... (*name*), dated ...

(vii) transfer of entitlement from ... (*name*) to ... (*name*) by way of ... (*specify kind of transfer*), dated ...

(viii) the applicant's name changed from ... (*name*) to ... (*name*) on ... (*date*)

(ix) this declaration is made for the purposes of (*include as applicable*):

(a) all designations [except the designation of the United States of America]

(b) the following designations for national and/or regional patents: ..."

(b) The declaration referred to in paragraph (a) may, where applicable, be combined with the declaration referred to in Section 211(a), in which case the introductory phrase shall be worded as follows and the remainder of the combined declaration shall be worded as prescribed in paragraph (a):

"Combined declaration as to the applicant's entitlement, as at the international filing date, to apply for and be granted a patent (Rules 4.17(ii) and 51<sup>bis</sup>.1(a)(ii)) and as to the identity of the inventor (Rules 4.17(i) and 51<sup>bis</sup>.1(a)(i)), in a case where the declaration under Rule 4.17(iv) is not appropriate:"

**Section 213**

**Declaration as to the Applicant's Entitlement to Claim Priority of Earlier Application**

Any declaration as to the applicant's entitlement, as at the international filing date, to claim priority of the earlier application, referred to in Rule 4.17(iii), shall be worded as follows, with such inclusion, omission, repetition and re-ordering of the matters listed as items (i) to (viii) as is necessary to explain the applicant's entitlement:

"Declaration as to the applicant's entitlement, as at the international filing date, to claim the priority of the earlier application specified below, where the applicant is not the applicant who filed the earlier application or where the applicant's name has changed since the filing of the earlier application (Rules 4.17(iii) and 51<sup>bis</sup>.1(a)(iii)):

in relation to [this] international application [No. PCT/...],

... (*name*) is entitled to claim priority of earlier application No. ... by virtue of the following:

(i) the applicant is the inventor of the subject matter for which protection was sought by way of the earlier application

(ii) ... (*name*) [is] [was] entitled as employer of the inventor, ... (*inventor's name*)

(iii) an agreement between ... (*name*) and ... (*name*), dated ...

## ADMINISTRATIVE INSTRUCTIONS UNDER THE PCT

(iv) an assignment from ... (*name*) to ... (*name*), dated ...

(v) consent from ... (*name*) in favor of ... (*name*), dated ...

(vi) a court order, issued by ... (*name of court*), effecting a transfer from ... (*name*) to ... (*name*), dated ...

(vii) transfer of entitlement from ... (*name*) to ... (*name*) by way of ... (*specify kind of transfer*), dated ...

(viii) the applicant's name changed from ... (*name*) to ... (*name*) on ... (*date*)

(ix) this declaration is made for the purposes of (*include as applicable*):

(a) all designations

(b) the following designations for national and/or regional patents: ...”

### Section 214

#### Declaration of Inventorship

(a) A declaration of inventorship, referred to in Rule 4.17(iv), that is made for the purposes of the designation of the United States of America shall be worded as follows:

“Declaration of inventorship (Rules 4.17(iv) and 51<sup>bis</sup>.1(a)(iv)) for the purposes of the designation of the United States of America:

I hereby declare that I believe I am the original, first and sole (if only one inventor is listed below) or joint (if more than one inventor is listed below) inventor of the subject matter which is claimed and for which a patent is sought.

This declaration is directed to the international application of which it forms a part (if filing declaration with application).

This declaration is directed to international application No. PCT/... (if furnishing declaration pursuant to Rule 26<sup>ter</sup>).

I hereby declare that my residence, mailing address, and citizenship are as stated next to my name.

I hereby state that I have reviewed and understand the contents of the above-identified interna-

tional application, including the claims of said application. I have identified in the request of said application, in compliance with PCT Rule 4.10, any claim to foreign priority, and I have identified below, under the heading “Prior Applications,” by application number, country or Member of the World Trade Organization, day, month and year of filing, any application for a patent or inventor's certificate filed in a country other than the United States of America, including any PCT international application designating at least one country other than the United States of America, having a filing date before that of the application on which foreign priority is claimed.

I hereby acknowledge the duty to disclose information that is known by me to be material to patentability as defined by 37 C.F.R. § 1.56, including for continuation-in-part applications, material information which became available between the filing date of the prior application and the PCT international filing date of the continuation-in-part application.

I hereby declare that all statements made herein of my own knowledge are true and that all statements made on information and belief are believed to be true; and further that these statements were made with the knowledge that willful false statements and the like so made are punishable by fine or imprisonment, or both, under Section 1001 of Title 18 of the United States Code and that such willful false statements may jeopardize the validity of the application or any patent issued thereon.

Name: ...

Residence: ... (city and either US state, if applicable, or country)

Mailing Address: ...

Citizenship: ...

Prior Applications: ...

Inventor's Signature: ... (if not contained in the request, or if declaration is corrected or added under Rule 26<sup>ter</sup> after the filing of the international application. The signature must be that of the inventor, not that of the agent)

Date: ... (of signature which is not contained in the request, or of the declaration that is corrected or added under Rule 26<sup>ter</sup> after the filing of the international application)”

(b) Where there is more than one inventor and all inventors do not sign the same declaration referred to in paragraph (a), each declaration shall indicate the names of all the inventors.

(c) Any correction or addition under Rule 26<sup>ter</sup>.1 of a declaration referred to in paragraph (a) shall take the form of a declaration referred to in that paragraph and be signed by the inventor. In addition, any such correction shall be entitled “Supplemental declaration of inventorship (Rules 4.17(iv) and 51<sup>bis</sup>.1(a)(iv))”.

### Section 215

#### Declaration as to Non-Prejudicial Disclosures or Exceptions to Lack of Novelty

Any declaration as to non-prejudicial disclosures or exceptions to lack of novelty shall be worded as follows, with such inclusion, omission, repetition and re-ordering of the matters listed as items (i) to (iv) as is necessary:

“Declaration as to non-prejudicial disclosures or exceptions to lack of novelty (Rules 4.17(v) and 51<sup>bis</sup>.1(a)(v)):

in relation to [this] international application [No. PCT/...],

... (*name*) declares that the subject matter claimed in [the] [this] international application was disclosed as follows:

(i) kind of disclosure (*include as applicable*):

(a) international exhibition

(b) publication

(c) abuse

(d) other: ...(*specify*)

(ii) date of disclosure: ...

(iii) title of disclosure (*if applicable*): ...

(iv) place of disclosure (*if applicable*): ...

(v) this declaration is made for the purposes of (*include as applicable*):

(a) all designations

(b) the following designations for national and/or regional patents: ...”

### Section 216

#### Notice of Correction or Addition of a Declaration Under Rule 26<sup>ter</sup>

Any notice referred to in Rule 26<sup>ter</sup>.1 shall consist of a replacement sheet containing a corrected declaration, or of an additional sheet containing a declaration, and an accompanying letter explaining the correction or addition.

## PART 3

### INSTRUCTIONS RELATING TO THE RECEIVING OFFICE

#### Section 301

##### Notification of Receipt of Purported International Application

Before the determination under Article 11(1), the receiving Office may notify the applicant of the receipt of the purported international application. The notification should indicate the date of actual receipt and the international application number of the purported international application referred to in Section 307 as well as, where useful for purposes of identification, the title of the invention.

#### Section 302

##### Priority Claim Considered Not To Have Been Made

Where the receiving Office declares, under Rule 26<sup>bis</sup>.2(b), that a priority claim is considered not to have been made, that Office shall enclose the priority claim concerned within square brackets, draw a line between the square brackets, while still leaving legible the indications concerned, and enter, in the margin, the words “NOT TO BE CONSIDERED FOR PCT PROCEDURE (RO)” or their equivalent in the language of publication of the international application, and shall notify the applicant accordingly. If copies of the international application have already been sent to the International Bureau and the International Searching Authority, the receiving Office shall also notify that Bureau and that Authority.

#### Section 303

##### Deletion of Additional Matter in the Request

(a) Where, under Rule 4.18(b), the receiving Office deletes *ex officio* any matter contained in the request, it shall do so by enclosing such matter within square brackets and entering, in the margin, the words “DELETED BY RO” or their equivalent in the language of publication of the international application, and shall notify the applicant accordingly. If copies of the international application have already been sent to the International Bureau and the International Search-

ing Authority, the receiving Office shall also notify that Bureau and that Authority.

(b) The receiving Office shall not delete *ex officio* any indication made in declarations referred to in Rule 4.17 which are contained in the request.

#### Section 304

##### Invitation to Pay Fees Before Date on Which They Are Due

(a) If the receiving Office finds, before the date on which they are due, that the transmittal fee, the international filing fee (including any supplement per sheet over 30) or the search fee are lacking in whole or in part, it may invite the applicant to pay the missing amounts within one month from the date of receipt of the international application.

(b) If the receiving Office finds, before the date on which they are due, that the designation fees for designations made under Rule 4.9(a) are lacking in whole or in part, it may invite the applicant to pay the missing amount within the time limit applicable under Rule 15.4(b).

(c) If the receiving Office finds that the applicant filed a written notice under Rule 4.9(c)(i), but failed to pay the designation fees and/or the confirmation fee under Rule 4.9(c)(ii) or that the amount paid is not sufficient, it may invite the applicant to pay the missing amount within the time limit under Rule 4.9(b)(ii).

#### Section 305

##### Identifying the Copies of the International Application

(a) Where, under Rule 11.1(a), the international application has been filed in one copy, the receiving Office shall, after preparing under Rule 21.1(a) the additional copies required under Article 12(1), mark,

(i) the words “RECORD COPY” in the upper left-hand corner of the first page of the original copy,

(ii) in the same space on one additional copy, the words “SEARCH COPY”, and

(iii) in the same space on the other such copy, the words “HOME COPY,” or their equivalent in the language of publication of the international application.

(b) Where, under Rule 11.1(b), the international application has been filed in more than one copy, the receiving Office shall choose the copy most suitable for reproduction purposes, and mark the words “RECORD COPY,” or their equivalent in the language of publication of the international application, in the upper left-hand corner of its first page. After verifying the identity of any additional copies and, if applicable, preparing under Rule 21.1(b) the home copy, it shall mark, in the upper left-hand corner of the first page of one such copy, the words “SEARCH COPY,” and, in the same space on the other such copy, the words “HOME COPY,” or their equivalent in the language of publication of the international application.

### **Section 305<sup>bis</sup>**

#### **Preparation, Identification and Transmittal of the Copies of the Translation of the International Application**

(a) Where a translation of the international application is furnished under Rule 12.3, the receiving Office shall:

(i) be responsible for the prompt preparation of any additional copies required where the translation is furnished in less than the number of copies required for the purposes of this paragraph, and shall have the right to fix a fee for performing that task and to collect such fee from the applicant;

(ii) mark the words “RECORD COPY-TRANSLATION (RULE 12.3)” in the upper left-hand corner of the first page of the original copy of the translation and transmit that copy to the International Bureau;

(iii) mark the words “SEARCH COPY-TRANSLATION (RULE 12.3)” in the same space on one additional copy of the translation which, together with a copy of the request marked “SEARCH COPY” under Section 305(a)(ii), is considered pursuant to Rule 23.1(b) to be the search copy, and transmit such search copy to the International Searching Authority; and

(iv) mark the words “HOME COPY-TRANSLATION (RULE 12.3)” in the same space on

the other such copy of the translation, and keep that copy in its files.

(b) The receiving Office may, when marking the copies of the translation under paragraph (a), use, instead of the words referred to in that paragraph, the equivalent of those words in the language of publication of the international application.

(c) Where a translation of the international application is furnished under Rule 12.4, the receiving Office shall:

(i) be responsible for the prompt preparation of any additional copies required where the translation is furnished in less than the number of copies required for the purposes of this paragraph, and shall have the right to fix a fee for performing that task and to collect such fee from the applicant;

(ii) mark the words “RECORD COPY – TRANSLATION (RULE 12.4)” in the upper left-hand corner of the first page of the original copy of the translation and transmit that copy to the International Bureau; and

(iii) mark the words “HOME COPY – TRANSLATION (RULE 12.4)” in the same space on the other such copy of the translation, and keep that copy in its files.

### **Section 306**

#### **Delayed Transmittal of Search Copy**

Where the search copy will be transmitted to the International Searching Authority after the date on which the record copy is transmitted to the International Bureau, the receiving Office shall notify the International Bureau. The notification may be made by marking a check-box provided for this purpose on the request.

### **Section 307**

#### **System of Numbering International Applications**

(a) Papers purporting to be an international application under Rule 20.1(a) shall be marked with the international application number, consisting of the letters “PCT,” a slant, the two-letter code referred to in Section 115, indicating the receiving Office, a four-digit indication of the year in which such papers were first received, a slant and a six-digit number, allotted in sequential order corresponding to the order in which the international applications are received (e.g.,

## ADMINISTRATIVE INSTRUCTIONS UNDER THE PCT

“PCT/SE2004/000001”). Where the International Bureau acts as receiving Office, the two-letter code “IB” shall be used.

(b) If a negative determination is made under Rule 20.7 or a declaration is made under Article 14 (4), the letters “PCT” shall be deleted by the receiving Office from the indication of the international application number on any papers marked previously with that number, and the said number shall be used without such letters in any future correspondence relating to the purported international application.

### Section 308

#### Marking of the Sheets of the International Application and of the Translation Thereof

The receiving Office shall indelibly mark the international application number referred to in Section 307 in the upper right-hand corner of each sheet of each copy of the purported international application and of any translation of the international application furnished under Rule 12.3 or 12.4.

### Section 309

#### Procedure in the Case of Later Submitted Sheets

(a) The receiving Office shall indelibly mark any sheet received on a date later than the date on which sheets were first received with the date on which it received that sheet, inserted immediately below the international application number referred to in Section 307.

(b) The receiving Office shall, in the case of later submitted sheets received within the time limits referred to in Rule 20.2(a)(i) and (ii):

(i) effect the required correction of the international filing date, or, where no international filing date has yet been accorded, of the date of receipt of the purported international application;

(ii) notify the applicant of the correction effected under item (i), above;

(iii) where transmittals under Article 12(1) have already been made, notify the International Bureau and the International Searching Authority of any correction effected under item (i), above, by transmitting a copy of the corrected first and last sheets of the request, and forward the later submitted sheets to the said Bureau and a copy thereof to the said Authority;

(iv) where transmittals under Article 12(1) have not yet been made, attach the later submitted sheets to the record copy and a copy thereof to the search copy.

(c) The receiving Office shall, in the case of later submitted sheets received after the expiration of the time limit referred to in Rule 20.2(a)(i):

(i) notify the applicant of that fact and of the date of receipt of the later submitted sheets;

(ii) where transmittals under Article 12(1) have already been made, forward the later submitted sheets to the International Bureau with the indication on the bottom of each sheet of the words: “NOT TO BE TAKEN INTO CONSIDERATION FOR THE PURPOSES OF INTERNATIONAL PROCESSING” or their equivalent in the language of publication of the international application;

(iii) where transmittals under Article 12(1) have not yet been made, attach the later submitted sheets to the record copy with the indication referred to in item (ii).

(d) The receiving Office shall, in the case of later submitted sheets received after the expiration of the time limit referred to in Rule 20.2(a)(ii), proceed as provided in Rule 20.7, unless the applicant has, within the said time limit, complied with the invitation under Article 11 (2)(a) so that an international filing date can be accorded; in the latter case, the receiving Office shall proceed as provided in paragraph (c)(i) to (iii).

### Section 310

#### Procedure in the Case of Missing Drawings

(a) Where the international application refers to drawings which in fact are not included in that application, the receiving Office shall make the indication referred to in Rule 26.6(a) by marking a check-box provided for this purpose on the request.

(b) Section 309(a) shall apply also in the case of drawings received by the receiving Office on a date later than the date on which sheets were first received by that Office.

(c) The receiving Office shall, in the case of missing drawings received within the time limit referred to in Rule 20.2(a)(iii):

(i) effect the required correction of the international filing date, or, where no international filing date has yet been accorded, of the date of receipt of

the purported international application, and delete the indication made under paragraph (a), above;

(ii) notify the applicant of the correction effected under item (i), above;

(iii) where transmittals under Article 12(1) have already been made, notify the International Bureau and the International Searching Authority of any correction effected under item (i), above, by transmitting a copy of the corrected first and last sheets of the request, and forward the later submitted drawings to the said Bureau and a copy thereof to the said Authority;

(iv) where transmittals under Article 12(1) have not yet been made, attach the later submitted drawings to the record copy and a copy thereof to the search copy.

(d) The receiving Office shall, in the case of missing drawings received after the expiration of the time limit referred to in Rule 20.2(a)(iii):

(i) notify the applicant of the fact and of the date of receipt of the later submitted drawings;

(ii) where transmittals under Article 12(1) have already been made, forward the later submitted drawings to the International Bureau with the indication on the bottom of each drawing of the words: “NOT TO BE TAKEN INTO CONSIDERATION (PCT Art. 14(2), 2nd sentence)” or their equivalent in the language of publication of the international application;

(iii) where transmittals under Article 12(1) have not yet been made, attach the later submitted drawings to the record copy with the indication referred to in item (ii).

### Section 311

#### **Renumbering in the Case of Deletion, Substitution or Addition of Sheets of the International Application and of the Translation Thereof**

(a) The receiving Office shall, subject to Section 207, sequentially renumber the sheets of the international application when necessitated by the addition of any new sheet, the deletion of entire sheets, a change in the order of the sheets or any other reason.

(b) The sheets of the international application shall be provisionally renumbered in the following manner:

(i) when a sheet is deleted, the receiving Office shall either include a blank sheet with the same number and with the word “DELETED,” or its equivalent in the language of publication of the international application, below the number, or insert, in brackets, below the number of the following sheet, the number of the deleted sheet with the word “DELETED” or its equivalent in the language of publication of the international application;

(ii) when one or more sheets are added, each sheet shall be identified by the number of the preceding sheet followed by a slant and then by another Arabic numeral such that the additional sheets are numbered consecutively, starting always with number one for the first sheet added after an unchanged sheet (e.g., 10/1, 15/1, 15/2, 15/3, etc.); when later additions of sheets to an existing series of added sheets are necessary, an extra numeral shall be used for identifying the further additions (e.g., 15/1, 15/1/1, 15/1/2, 15/2, etc.).

(c) In the cases mentioned in paragraph (b), it is recommended that the receiving Office should write, below the number of the last sheet, the total number of the sheets of the international application followed by the words “TOTAL OF SHEETS” or their equivalent in the language of publication of the international application. It is further recommended that, at the bottom of any last sheet added, the words “LAST ADDED SHEET” or their equivalent in the language of publication of the international application should be inserted.

(d) Paragraphs (a) to (c) shall apply *mutatis mutandis* to any translation of the international application furnished under Rule 12.3 or 12.4.

### Section 312

#### **Notification of Decision Not to Issue Declaration that the International Application Is Considered Withdrawn**

Where the receiving Office, after having notified the applicant under Rule 29.4 of its intent to issue a declaration under Article 14(4), decides not to issue such a declaration, it shall notify the applicant accordingly.

**Section 313**

**Documents Filed with the International Application; Manner of Marking the Necessary Annotations in the Check List**

(a) Any power of attorney, any priority document, any fee calculation sheet and any separate sheet referred to in Section 209(a) containing indications as to deposited biological material, filed with the international application shall accompany the record copy; any other document referred to in Rule 3.3(a)(ii) shall be sent only at the specific request of the International Bureau. If any document which is indicated in the check list as accompanying the international application is not, in fact, filed at the latest by the time the record copy leaves the receiving Office, that Office shall so note on the check list and the said indication shall be considered as if it had not been made.

(b) Where, under Rule 3.3(b), the receiving Office itself completes the check list, that Office shall enter, in the margin, the words “COMPLETED BY RO” or their equivalent in the language of publication of the international application. Where only some of the indications are completed by the receiving Office, the said words and each indication completed by that Office shall be identified by an asterisk.

(c) Any sequence listing in computer readable form furnished to the receiving Office, or any sequence listing in printed form furnished to the receiving Office subsequent to the filing of the international application, shall be transmitted to the International Searching Authority together with the search copy. Where such a sequence listing is received by the receiving Office after the transmittal of the search copy, that sequence listing shall be promptly transmitted to the International Searching Authority.

**Section 314**

**Correction or Addition of a Priority Claim Under Rule 26<sup>bis</sup>**

(a) Where the applicant, in a notice submitted to the receiving Office, corrects or adds a priority claim under Rule 26<sup>bis</sup>, that Office shall enter the correction or addition in the request, draw a line through, while still leaving legible, any indication deleted as a result of the correction, and enter, in the margin, the letters “RO.”

(b) The applicant and, if copies of the international application have already been sent to the International Bureau and the International Searching Authority, that Bureau and that Authority shall be promptly notified by the receiving Office of any correction or addition of a priority claim under Rule 26<sup>bis</sup> and of the date on which it received such correction or addition.

**Section 315**

[Deleted]

**Section 316**

**Procedure in the Case Where the International Application Lacks the Prescribed Signature**

Where, under Article 14(1)(a)(i), the receiving Office finds that the international application is defective in that it lacks the prescribed signature, that Office shall send to the applicant, together with the invitation to correct under Article 14(1)(b), a copy of the relevant sheet of the request part of the international application. The applicant shall, within the prescribed time limit, return said copy after affixing thereto the prescribed signature.

**Section 317**

**Transmittal of a Notice of Correction or Addition of a Declaration Under Rule 26<sup>ter</sup>.1**

If a notice under Rule 26<sup>ter</sup>.1 is submitted by the applicant to the receiving Office, that Office shall mark the date of receipt on the notice and transmit it promptly to the International Bureau. The notice shall be considered to have been received by the International Bureau on the date marked.

**Section 318**

**Cancellation of Designations of Non-Contracting States**

The receiving Office shall cancel *ex officio* the designation of any State which is not a Contracting State, shall enclose that designation within square brackets, shall draw a line between the square brackets while still leaving the designation legible, shall enter, in the margin, the words “CANCELLED EX OFFICIO BY RO” or their equivalent in the language of publication of the international application, and shall promptly



notify the applicant accordingly. If the record copy has already been sent to the International Bureau, the receiving Office shall also notify that Bureau.

**Section 319**

*[Deleted]*

**Section 320**

**Invitation to Pay Fees under Rule 16<sup>bis</sup>.1(a)**

When issuing an invitation under Rule 16<sup>bis</sup>.1(a), the receiving Office shall, if it received moneys from the applicant before the due date, inform the applicant of the fees to which those moneys have been applied.

**Section 321**

**Application of Moneys Received by the Receiving Office in Certain Cases**

(a) The receiving Office shall, to the extent that it has received instructions from the applicant as to the fees to which it shall apply moneys received by it from the applicant, apply those moneys accordingly.

(b) Where the receiving Office receives moneys from the applicant which, together with any other moneys so received, are not sufficient to cover in full the transmittal fee (if any), the international filing fee and the search fee (if any), the receiving Office shall, to the extent that it has not received instructions from the applicant as to the fees to which it shall apply the moneys which are available for the purpose, apply those moneys in payment, successively, of the fees set out below to the extent that they are due and unpaid and in the order in which they appear below:

- (i) the transmittal fee;
- (ii) the international filing fee;
- (iii) the search fee.

(c) Where, pursuant to paragraph (b), the receiving Office allocates moneys in payment of the designation fees to cover designations made under Rule 4.9(a), it shall apply them to those fees as follows:

(i) where the applicant indicates to which designation or designations the amount is to be applied, it shall be applied accordingly but, if the amount received is insufficient to cover the designations indicated, it shall be applied in the order chosen by the applicant in indicating the designations;

(ii) to the extent that the applicant has not given the indications referred to in item (i), the amount, or the balance thereof, shall be applied to the designations in the order in which they appear in the request part of the international application;

(iii) where the designation of a State is for the purposes of a regional patent, and provided that the required designation fee is, under the preceding provisions, available for that designation, the designation of any further States for which the same regional patent is sought shall be considered as covered by that fee.

(d) Where the receiving Office receives moneys from the applicant in response to an invitation under Rule 16<sup>bis</sup>.1 which are not sufficient to cover all the unpaid fees, including, where required, the late payment fee under Rule 16<sup>bis</sup>.2, the moneys shall be applied in the order referred to in paragraphs (b) and (c) to as many of the fees due, including any late payment fee, as can be covered.

(e) Where, pursuant to Rule 15.5(b), the receiving Office allocates moneys in payment of fees under Rule 15.5(a) in respect of the confirmation under Rule 4.9(c) of designations made under Rule 4.9(b), the receiving Office shall apply those moneys as follows:

(i) where the applicant indicates to which designation or designations the amount is to be applied, it shall be applied accordingly, but, if the amount is insufficient to cover the designations indicated, it shall be applied to the designations in the order chosen by the applicant in indicating the designations;

(ii) to the extent that the applicant has not given the indications referred to in item (i), the amount, or the balance thereof, shall be applied to the designations in the order in which they appear in the notice containing the confirmation;

(iii) where the designation of a State is for the purposes of a regional patent, and provided that the required designation fee is, under the preceding provisions, available for that designation, the designation of any further States for which the same regional patent is sought shall be considered as covered by that fee.

(f) When allocating moneys as provided in paragraph (e), both the designation fee and the confirmation fee must be covered in respect of each designation.

## ADMINISTRATIVE INSTRUCTIONS UNDER THE PCT

(g) Where moneys have been applied by the receiving Office in accordance with indications given by the applicant as mentioned in paragraph (c)(i) or (e)(i), the receiving Office shall inform the International Bureau as to the effect of the said indications, preferably by sending the International Bureau a copy of any relevant written communication received from the applicant.

### Section 322

#### **Invitation to Submit a Request for Refund of the Search Fee**

The receiving Office may, before making a refund of the search fee under Rule 16.2, first invite the applicant to submit a request for the refund.

### Section 323

#### **Transmittal of Priority Documents to International Bureau**

(a) Any priority document which is submitted to the receiving Office under Rule 17.1(a) shall be transmitted by that Office to the International Bureau together with the record copy or, if received after the record copy has been sent to the International Bureau, promptly after having been received by that Office.

(b) Where the priority document is issued by the receiving Office and the applicant has, not later than 16 months after the priority date, requested the receiving Office under Rule 17.1(b) to prepare and transmit it to the International Bureau, the receiving Office shall, promptly after receipt of such request (“request for priority document”) and, where applicable, the payment of the fee referred to in that Rule, transmit the priority document to the International Bureau. Where such request for priority document has been made but the required fee has not been paid, the receiving Office shall promptly notify the applicant that the request for priority document will be considered not to have been made unless the fee is paid not later than 16 months after the priority date or, in the case referred to in Article 23(2), not later than at the time the processing or examination of the international application is requested.

(c) When transmitting a priority document, the receiving Office shall notify the International Bureau of the date on which it received the priority document or the request for priority document.

(d) Where a request for priority document has, under paragraph (b), been considered not to have been made, the receiving Office shall promptly notify the International Bureau. Where the receiving Office fails to notify the International Bureau accordingly within 17 months from the priority date, the receiving Office shall prepare and transmit the priority document to the International Bureau even though the required fee has not been paid by the applicant.

(e) Where a request for priority document has been received by the receiving Office later than 16 months after the priority date, or where such request has, under paragraph (b), been considered not to have been made, the receiving Office shall promptly notify the applicant accordingly, directing attention to the requirements of Rule 17.1(a).

### Section 324

#### **Copy of Notification of the International Application Number and the International Filing Date Under Rule 20.5(c)**

The copy, sent to the International Bureau, of the notification of the international application number and the international filing date under Rule 20.5(c) shall also include, if the priority of an earlier application is claimed in the international application, the date of filing—as indicated in the international application—of that earlier application. If the priority of several earlier applications is claimed, the earliest filing date shall be indicated.

### Section 325

#### **Corrections of Defects Under Rule 26.4, Rectifications of Obvious Errors Under Rule 91.1, and Corrections Under Rule 9.2**

(a) Where the receiving Office receives a correction of defects under Rule 26.4 or authorizes a rectification of an obvious error under Rule 91.1, it shall:

(i) indelibly mark, in the upper right-hand corner of each replacement sheet, the international application number and the date on which that sheet was received;

(ii) indelibly mark, in the middle of the bottom margin of each replacement sheet, the words “SUBSTITUTE SHEET (RULE 26)” (where the replacement sheet contains a correction of defects under Rule 26) or “RECTIFIED SHEET (RULE

91.1)” (where the replacement sheet contains the rectification of an obvious error under Rule 91.1) or their equivalent in the language of publication of the international application;

(iii) indelibly mark on the letter containing the correction or rectification, or accompanying any replacement sheet, the date on which that letter was received;

(iv) keep in its files a copy of the letter containing the correction or rectification or, when the correction or rectification is contained in a replacement sheet, the replaced sheet, a copy of the letter accompanying the replacement sheet, and a copy of the replacement sheet;

(v) subject to item (vi), promptly transmit any letter and any replacement sheet to the International Bureau, and a copy thereof to the International Searching Authority;

(vi) where transmittals under Article 12(1) have not yet been made, transmit any letter and any replacement sheet to the International Bureau together with the record copy and, except where the international application is considered withdrawn and Rule 29.1 (iii) applies, a copy of the said letter or replacement sheet to the International Searching Authority together with the search copy. The record copy and the search copy shall contain any replaced sheet.

(b) Where the receiving Office refuses to authorize the rectification of an obvious error under Rule 91.1, it shall proceed as indicated under paragraph (a)(i), (iii) and (iv) and promptly transmit any letter and any proposed replacement sheet to the International Bureau. If the record copy has not yet been sent to the International Bureau, any letter and any proposed replacement sheet shall be transmitted together with the record copy.

(c) Where the receiving Office receives corrections aimed at complying with Rule 9.1, paragraphs (a) and (b) shall apply *mutatis mutandis*, provided that, where a sheet is marked as indicated in paragraph (a)(ii), the words “SUBSTITUTE SHEET (RULE 9.2)” shall be used.

## Section 326

### Withdrawal by Applicant Under Rule 90<sup>bis</sup>.1, 90<sup>bis</sup>.2 or 90<sup>bis</sup>.3

(a) The receiving Office shall promptly transmit to the International Bureau any notice from the applicant effecting withdrawal of the international application under Rule 90<sup>bis</sup>.1, of a designation under Rule 90<sup>bis</sup>.2 or of a priority claim under Rule 90<sup>bis</sup>.3 which has been filed with it together with an indication of the date of receipt of the notice. If the record copy has not yet been sent to the International Bureau, the receiving Office shall transmit the said notice together with the record copy.

(b) If the search copy has already been sent to the International Searching Authority and the international application is withdrawn under Rule 90<sup>bis</sup>.1 or a priority claim is withdrawn under Rule 90<sup>bis</sup>.3, the receiving Office shall promptly transmit a copy of the notice effecting withdrawal to the International Searching Authority.

(c) If the search copy has not yet been sent to the International Searching Authority and the international application is withdrawn under Rule 90<sup>bis</sup>.1, the receiving Office shall not send the search copy to the International Searching Authority and shall, subject to Section 322, refund the search fee to the applicant unless it has already been transferred to the International Searching Authority. If the search fee has already been transferred to the International Searching Authority, the receiving Office shall send a copy of the request and of the notice effecting withdrawal to that Authority.

(d) If the search copy has not yet been sent to the International Searching Authority and a priority claim is withdrawn under Rule 90<sup>bis</sup>.3, the receiving Office shall transmit a copy of the notice effecting withdrawal to the International Searching Authority together with the search copy.

## Section 327

### *Ex Officio* Correction of Request by the Receiving Office

(a) Subject to paragraph (d), where the record copy has not yet been sent to the International Bureau and the request requires correction because it contains

## ADMINISTRATIVE INSTRUCTIONS UNDER THE PCT

an inconsistency or a minor defect such as non-compliance with the requirement for indications under Section 115, the receiving Office may correct the request *ex officio*. If the receiving Office does so, it shall notify the applicant accordingly.

(b) When making a correction under paragraph (a), the receiving Office shall enter, in the margin, the letters "RO." Where any matter is to be deleted, the receiving Office shall enclose such matter within square brackets and shall draw a line between the square brackets while still leaving the deleted matter legible. Where any matter is to be replaced, both the first and second sentences of this paragraph shall apply.

(c) The receiving Office shall check the number of characters of the file reference, if any, and shall delete any characters beyond the number permitted by Section 109.

(d) The receiving Office shall not make any *ex officio* correction to declarations referred to in Rule 4.17 which are contained in the request.

### Section 328

#### Notifications Concerning Representation

(a) Where a power of attorney or a document containing the revocation or renunciation of an appointment is submitted to the receiving Office and the record and search copies have already been transmitted, the receiving Office shall immediately notify the International Bureau and the International Searching Authority by sending them a copy of the power of attorney or document and request the International Bureau to record a change in the indications concerning the agent or common representative under Rule 92<sup>bis</sup>.1(a)(ii).

(b) If the record copy and/or search copy have not yet been transmitted by the receiving Office, a copy of the power of attorney or document containing the revocation or renunciation of an appointment shall be transmitted by the receiving Office with the record copy and/or search copy.

### Section 329

#### Correction of Indications Concerning the Applicant's Residence or Nationality

Where, in response to an invitation to correct a defect under Article 11 (1)(i), evidence is submitted

indicating to the satisfaction of the receiving Office that, in fact, the applicant had, on the date on which the international application was actually received, the right to file an international application with that receiving Office, the invitation shall be considered to be an invitation to correct a defect under Article 14 (1)(a)(ii) and Rule 4.5 in the prescribed indications concerning the applicant's residence and/or nationality, and the applicant may correct those indications accordingly. If such correction is made, no defect shall be considered to exist under Article 11 (1)(i).

### Section 330

#### Transmittal of Record Copy Prevented or Delayed by National Security Prescriptions

(a) Where prescriptions concerning national security prevent the transmittal of the record copy by the receiving Office to the International Bureau under Rule 22.1(a), the receiving Office shall notify the applicant and the International Bureau accordingly.

(b) The notifications under paragraph (a) shall be sent before the expiration of 13 months from the priority date. Where the receiving Office believes that national security clearance is imminent, it may postpone the sending of the notifications, but shall send them before the expiration of 17 months from the priority date if no clearance has been given by that time.

### Section 331

#### Receipt of Confirmation Copy

Where, subject to Rule 92.4, the receiving Office receives an international application by facsimile machine transmission and subsequently receives the original of that international application, it shall mark such original with the words "CONFIRMATION COPY" or their equivalent in the language of publication of the international application on the bottom of the first page of the request and on the first page of the description. The marking under Section 325 is not required in such a case. The international application as received by facsimile machine transmission shall constitute the record copy. The confirmation copy shall be transmitted to the International Bureau in addition to the record copy.

**Section 332**

**Notification of Languages Accepted by the receiving Office under Rules 12.1(a) and (c) and 12.4(a)**

(a) Each receiving Office shall notify the International Bureau of the language or languages which, having regard to Rule 12.1(b), it is prepared to accept under Rule 12.1(a) for the filing of international applications.

(b) Each receiving Office shall notify the International Bureau of any change to the information notified under paragraphs (a), (d) and (e). If the change means that

(i) the receiving Office is no longer prepared to accept the filing of international applications in a language that it had previously notified the International Bureau that it was prepared to accept; or

(ii) the receiving Office is no longer prepared to accept the translation of international applications into a language of publication that it had previously notified the International Bureau that it was prepared to accept; or

(iii) the receiving Office is no longer prepared to accept the filing of requests in a language that it had previously notified the International Bureau that it was prepared to accept,

the effective date of such change shall be two months after the date of publication of the notification of the change in the Gazette pursuant to Section 405 or such later date as may be determined by the receiving Office.

(c) Nothing in paragraph (a), (b), (d) or (e) prevents any receiving Office from accepting, in a particular case,

(i) the filing of an international application in a language that it has not notified the International Bureau that it is prepared to accept; or

(ii) the translation of an international application into a language of publication that it has not notified the International Bureau that it is prepared to accept; or

(iii) the filing of a request in a language that it has not notified the International Bureau that it is prepared to accept.

(d) Each receiving Office concerned shall notify the International Bureau of the language or lan-

guages which it is prepared to accept under Rule 12.4(a) for the translation of international applications into a language of publication.

(e) Each receiving Office shall notify the International Bureau of the language or languages which it is prepared to accept under Rule 12.1(c) for the filing of requests.

**Section 333**

**Transmittal of International Application to the International Bureau as Receiving Office**

(a) Where a national Office intends to proceed under Rule 19.4(b) having regard to Rule 19.4(a)(i) or (ii), it shall, if it requires payment of the fee referred to in Rule 19.4(b) and that fee has not already been paid, promptly invite the applicant to pay that fee within a time limit of 15 days from the date of the invitation.

(b) Where a national Office intends to proceed under Rule 19.4(b) having regard to Rule 19.4(a)(iii), it shall promptly request the International Bureau as receiving Office to agree to the transmittal of the international application. The International Bureau as receiving Office shall promptly respond to that request. If the International Bureau as receiving Office agrees to the transmittal, the national Office shall promptly invite the applicant:

(i) if the transmittal has not already been authorized by the applicant, to submit to that Office, within a time limit of 15 days from the date of the invitation, an authorization of the transmittal, and,

(ii) if the Office requires payment of the fee referred to in Rule 19.4(b) and that fee has not already been paid, to pay that fee within the time limit referred to in item (i).

(c) The national Office:

(i) need not proceed under Rule 19.4(b) having regard to Rule 19.4(a)(i) to (iii) if the Office requires payment of the fee referred to in Rule 19.4(b) and the applicant does not pay that fee;

(ii) shall not proceed under Rule 19.4(b) having regard to Rule 19.4(a)(iii) if the International Bureau as receiving Office does not agree to, or if the applicant does not authorize, the transmittal of the international application under Rule 19.4(a)(iii).

**Section 334**

**Notification to Applicant of Submission of Demand After the Expiration of 19 Months from the Priority Date**

Where the demand is submitted after the expiration of 19 months from the priority date to a receiving Office and the time limit under Article 22 (1), as in force from April 1 2002, does not apply in respect of all designated Offices, the receiving Office shall:

- (i) promptly notify the applicant accordingly, directing attention to the fact that the time limit under Article 39(1)(a) does not apply, and that Article 22(1), as in force until March 31, 2002, continues to apply in respect of any such designated Office, and
- (ii) proceed under Rule 59.3.

**Section 335**

**Transmittal of PCT-EASY Diskette Containing Request Data and Abstract**

Any PCT-EASY diskette furnished to the receiving Office in accordance with Section 102<sup>bis</sup> shall be

transmitted by that Office to the International Bureau at the same time as the record copy.

**Section 336**

**Waivers Under Rules 90.4(d) and 90.5(c)**

(a) Where, in accordance with Rule 90.4(d), a receiving Office waives the requirement under Rule 90.4(b) that a separate power of attorney be submitted to it, the receiving Office shall notify the International Bureau accordingly.

(b) Where, in accordance with Rule 90.5(c), a receiving Office waives the requirement under Rule 90.5(a)(ii) that a copy of a general power of attorney be attached to the request or any separate notice, the receiving Office shall notify the International Bureau accordingly.

(c) A receiving Office may require a separate power of attorney, or a copy of a general power of attorney, in particular instances even if the receiving Office has waived the requirement in general.

(d) A receiving Office which has notified the International Bureau under paragraph (a) or (b) shall notify the International Bureau of any change to the information notified under those paragraphs.

## PART 4

### INSTRUCTIONS RELATING TO THE INTERNATIONAL BUREAU

#### Section 401

##### Marking of the Sheets of the Record Copy

(a) The International Bureau shall, upon receipt of the record copy, mark the date of receipt of the record copy in the appropriate space on the request.

(b) If the receiving Office has failed to mark any sheet as provided in Sections 311 and 325, the marking which has not been made may be inserted by the International Bureau.

#### Section 402

##### Correction or Addition of a Priority Claim Under Rule 26<sup>bis</sup>

(a) Where the applicant, in a notice submitted to the International Bureau, corrects or adds a priority claim under Rule 26<sup>bis</sup>, that Bureau shall enter the correction or addition in the request, draw a line through, while still leaving legible, any indication deleted as a result of the correction, and enter, in the margin, the letters "IB".

(b) [Deleted]

(c) The applicant, the receiving Office and the International Searching Authority shall be promptly notified by the International Bureau of any correction or addition of a priority claim under Rule 26<sup>bis</sup> and of the date on which it received such correction or addition.

(d) [Deleted]

#### Section 403

##### Transmittal of Protest Against Payment of Additional Fee and Decision Thereon Where International Application Is Considered to Lack Unity of Invention

Where, under Rules 40.2(c) or 68.3(c), the International Bureau receives a request from the applicant to forward to any designated or elected Office the texts of both the protest against payment of an additional fee as provided for in Articles 17(3)(a) and 34(3)(a) where the international application is considered to lack unity of invention and the decision thereon by the

International Searching Authority or the International Preliminary Examining Authority, as the case may be, it shall proceed according to such request.

#### Section 404

##### International Publication Number of International Application

The International Bureau shall assign to each published international application an international publication number which shall be different from the international application number. The international publication number shall be used on the pamphlet and in the Gazette entry. It shall consist of the two-letter code "WO" followed by a four-digit indication of the year of publication, a slant, and a serial number consisting of six digits (e.g., "WO 2004/123456").

#### Section 405

##### Publication of Notifications of Languages Accepted by the receiving Office under Rules 12.1(a) and (c) and 12.4(a)

The International Bureau shall promptly publish in the Gazette any notification under Section 332(a), (b), (d), or (e).

#### Section 406

##### Pamphlets

(a) Pamphlets referred to in Rule 48.1 shall be published on a given day of the week.

(b) All pamphlets shall be of A4 size and shall be reproduced recto verso, except that drawings shall be reproduced recto only.

(c) The form and particulars of the front page of each pamphlet shall be decided by the Director General.

#### Section 407

##### The Gazette

(a) The Gazette in paper form referred to in Rule 86.1(b)(i) shall be of A4 size and shall be reproduced *recto verso*.

## ADMINISTRATIVE INSTRUCTIONS UNDER THE PCT

(b) The Gazette in electronic form referred to in Rule 86.1 (b)(ii) shall be made available on the Internet, on CD-ROM and by any other electronic means as determined by the Director General. Details concerning the availability of the Gazette in electronic form shall be published in the Gazette in paper form.

(c) In addition to the contents specified in Rule 86, the Gazette shall contain, in respect of each published international application, the data indicated in Annex D.

(d) The information referred to in Rule 86.1(a)(v) shall be that which is indicated in Annex E.

### Section 408

#### Priority Application Number

(a) [Deleted]

(b) If the number of the earlier application referred to in Rule 4.10(a)(ii) (“priority application number”) is furnished after the expiration of the prescribed time limit, the International Bureau shall inform the applicant and the designated Offices of the date on which the said number was furnished. It shall indicate the said date in the international publication by including on the front page of the pamphlet next to the priority application number the words “FURNISHED LATE ON... (date),” and the equivalent of such words in the language in which the international application is published if that language is other than English.

(c) If the priority application number has not been furnished at the time of the completion of the technical preparations for international publication, the International Bureau shall indicate that fact by including on the front page of the pamphlet in the space provided for the priority application number the words “NOT FURNISHED” and the equivalent of such words in the language in which the international application is published if that language is other than English.

### Section 409

#### Priority Claim Considered Not To Have Been Made

Where the International Bureau declares, under Rule 26<sup>bis</sup>.2(b), that a priority claim is considered not to have been made, that Bureau shall enclose the priority claim concerned within square brackets, draw a

line between the square brackets, while still leaving legible the indications concerned, and enter, in the margin, the words “NOT TO BE CONSIDERED FOR PCT PROCEDURE (IB)” or their equivalent in the language of publication of the international application, and shall notify the applicant accordingly. The International Bureau shall also notify the receiving Office and the International Searching Authority.

### Section 410

#### Numbering of Sheets for the Purposes of International Publication; Procedure in Case of Missing Sheets or Drawings

(a) In the course of preparing the international application for international publication, the International Bureau shall sequentially renumber the sheets to be published only when necessitated by the addition of any new sheet, the deletion of entire sheets or a change in the order of the sheets. Otherwise, the numbering provided under Section 207 shall be maintained.

(b) Where a sheet or a drawing has not been filed or is not to be taken into consideration for the purposes of international processing under Section 309(c) or Section 310(d), the International Bureau shall include an indication to that effect in the pamphlet.

### Section 411

#### Receipt of Priority Document

(a) The International Bureau shall mark, on the first page of the priority document:

(i) the date on which the priority document has been received by it, and

(ii) the words “PRIORITY DOCUMENT—SUBMITTED OR TRANSMITTED IN COMPLIANCE WITH RULE 17.1(a) OR (b)” or the words “PRIORITY DOCUMENT — SUBMITTED OR TRANSMITTED BUT NOT IN COMPLIANCE WITH RULE 17.1(a) OR (b),” as applicable, or their equivalent in French, and shall notify the applicant and, preferably together with the notification under Rule 47.1(a<sup>bis</sup>), the designated Offices, accordingly.

(b) Where the priority document has been submitted or transmitted but not in compliance with Rule 17.1(a) or (b), the International Bureau shall, in the notification under paragraph (a) of this Section, direct



the attention of the applicant and the designated Offices to the provisions of Rule 17.1(c).

**Section 412**

**Notification of Lack of Transmittal of Search Copy**

If the International Bureau does not receive from the International Searching Authority a notification under Rule 25.1 within two months from the date of receipt of the record copy, the International Bureau shall remind the receiving Office to transmit the search copy to the International Searching Authority. A copy of the reminder shall be sent to the International Searching Authority.

**Section 413**

**Corrections of Defects Under Rule 26.4, Rectifications of Obvious Errors Under Rule 91.1, and Corrections Under Rule 9.2**

(a) Where the International Bureau receives from the receiving Office a letter containing a correction of any defects under Rule 26.4, or a replacement sheet and the letter accompanying it, the International Bureau shall transfer the correction to the record copy, together with the indication of the date on which the receiving Office received the letter, or shall insert the replacement sheet in the record copy. Any letter and any replaced sheet shall be kept in the file of the international application.

(b) Paragraph (a) shall apply *mutatis mutandis* to rectifications of obvious errors authorized by the receiving Office or by the International Searching Authority under Rule 91.1 and to corrections submitted by the applicant to the receiving Office or the International Searching Authority aimed at complying with the prescription of Rule 9.1 concerning certain expressions, drawings, statements or other matter.

**Section 414**

**Notification to the International Preliminary Examining Authority Where the International Application is Considered Withdrawn**

If a demand has been submitted and the international application is considered withdrawn under Article 14(1), (3) or (4), the International Bureau shall promptly notify the International Preliminary Exam-

ining Authority, unless the international preliminary examination report has already issued.

**Section 415**

**Notification of Withdrawal Under Rule 90<sup>bis</sup>.1, 90<sup>bis</sup>.2, 90<sup>bis</sup>.3 or 90<sup>bis</sup>.4**

(a) The fact of withdrawal by the applicant of the international application under Rule 90<sup>bis</sup>.1, of designations under Rule 90<sup>bis</sup>.2, or of a priority claim under Rule 90<sup>bis</sup>.3, together with the date on which the notice effecting withdrawal reached the International Bureau, the International Preliminary Examining Authority or the receiving Office, shall be recorded by the International Bureau and promptly notified by it to the receiving Office, the applicant, the designated Offices affected by the withdrawal and, where the withdrawal concerns the international application or a priority claim and where the international search report, or the declaration referred to in Article 17(2)(a), and the written opinion of the International Searching Authority have not yet issued, the International Searching Authority. However, where the withdrawal concerns the international application and where the notice effecting withdrawal was filed with the receiving Office before the sending of the record copy to the International Bureau, that Bureau shall send the notifications referred to in the preceding sentence and in Rule 24.2(a) to the receiving Office and the applicant only.

(b) If, at the time of the withdrawal of the international application under Rule 90<sup>bis</sup>.1, or of a priority claim under Rule 90<sup>bis</sup>.3, a demand has already been submitted and the international preliminary examination report has not yet issued, the International Bureau shall, unless the notice effecting withdrawal was submitted to the International Preliminary Examining Authority, promptly notify the fact of withdrawal to that Authority, together with the date on which the notice effecting withdrawal has reached the International Bureau or the receiving Office.

(c) The fact of withdrawal by the applicant of the demand or of one or more elections under Rule 90<sup>bis</sup>.4, together with the date on which the notice effecting withdrawal was, or was considered to have been, submitted to the International Bureau, shall be promptly notified by that Bureau:

## ADMINISTRATIVE INSTRUCTIONS UNDER THE PCT

- (i) to the applicant,
- (ii) to each elected Office affected by the withdrawal, except where it has not yet been notified of its election, and
- (iii) in the case of withdrawal of the demand or of all elections, to the International Preliminary Examining Authority, unless the notice effecting withdrawal was submitted to that Authority.

### Section 416

#### Correction of Request in Record Copy

(a) Where the request requires correction as a consequence of the withdrawal of a designation or of a change made under Rule 92<sup>bis</sup>, the International Bureau shall make the necessary correction in the record copy and shall notify the applicant and the receiving Office accordingly.

(b) When making a correction under paragraph (a), the International Bureau shall enter, in the margin, the letters “IB.” Where the correction involves the deletion or replacement of some matter, the International Bureau shall enclose such matter within square brackets and shall draw a line between the square brackets while still leaving the deleted or replaced matter legible.

### Section 417

#### Processing of Amendments Under Article 19

(a) The International Bureau shall record the date on which, under Rule 46.1, any amendment made under Article 19 was received, shall notify the applicant of that date and indicate it in any publication or copy issued by it.

(b) The International Bureau shall mark, in the upper right-hand corner of each replacement sheet submitted under Rule 46.5(a), the international application number, the date on which that sheet was received under Rule 46.1 and, in the middle of the bottom margin, the words “AMENDED SHEET (ARTICLE 19).” It shall keep in its files any replaced sheet, the letter accompanying the replacement sheet or sheets, and any letter referred to in the last sentence of Rule 46.5(a).

(c) The International Bureau shall insert any replacement sheet in the record copy and, in the case referred to in the last sentence of Rule 46.5(a), shall indicate the cancellations in the record copy.

(d) If, at the time when the demand is received by the International Bureau, the international search report and the written opinion of the International Searching Authority have been established and no amendments under Article 19 have been made, the International Bureau shall inform the International Preliminary Examining Authority accordingly, unless the Authority has informed the International Bureau that it wishes not to be so notified.

### Section 418

#### Notifications to Elected Offices Where the Demand Is Considered Not to Have Been Submitted or Made

Where, after any elected Office has been notified of its election under Article 31(7), the demand is considered not to have been submitted or made, the International Bureau shall notify the said Office accordingly.

### Section 419

#### Processing of a Declaration Under Rule 26<sup>ter</sup>

(a) Where any declaration referred to in Rule 4.17, or any correction thereof under Rule 26<sup>ter</sup>.1, is submitted to the International Bureau within the time limit under Rule 26<sup>ter</sup>.1, the International Bureau shall indicate the date on which it received the declaration or correction and insert the additional sheet or replacement sheet in the record copy.

(b) The International Bureau shall promptly notify the applicant, the receiving Office and the International Searching Authority of any declaration corrected or added under Rule 26<sup>ter</sup>.1.

(c) The International Bureau shall not make any *ex officio* correction to declarations referred to in Rule 4.17 which are contained in the request.

(d) Where any declaration referred to in Rule 4.17, or any correction thereof under Rule 26<sup>ter</sup>.1, is submitted to the International Bureau after the expiration of the time limit under Rule 26<sup>ter</sup>.1, the International Bureau shall notify the applicant accordingly and inform the applicant that such a declaration or correction should be submitted directly to the designated Office or Offices concerned. Any declaration referred to in Rule 4.17(iv), signed as prescribed in Section 214, which is submitted to the International

Bureau after the expiration of the time limit under Rule 26<sup>ter</sup>.1 shall be returned to the applicant.

### Section 420

#### Copy of International Application and International Search Report for the International Preliminary Examining Authority

Where the International Preliminary Examining Authority is not part of the same national Office or intergovernmental organization as the International Searching Authority, the International Bureau shall, promptly upon receipt of the international search report or, if the demand was received after the international search report, promptly upon receipt of the demand, send a copy of the international application and the international search report to the International Preliminary Examining Authority. In cases where, instead of the international search report, a declaration under Article 17(2)(a) was issued, references in the preceding sentence to the international search report shall be considered references to the said declaration.

### Section 421

#### Invitation to Furnish a Copy of the Priority Document

Where a request for a copy of the application whose priority is claimed in the international application is made under Rule 43<sup>bis</sup>.1(b) by the International Searching Authority or, under Rule 66.7(a), by either the International Searching Authority, or the International Preliminary Examining Authority before the International Bureau has received the priority document under Rule 17.1, the International Bureau shall, unless the applicable time limit referred to in Rule 17.1(a) has already expired, inform the applicant of such request and remind him of the requirements of Rule 17.1.

### Section 422

#### Notifications Concerning Changes Recorded Under Rule 92<sup>bis</sup>.1

(a) The International Bureau shall give notifications concerning changes recorded by it under Rule 92<sup>bis</sup>.1(a), except changes which are the subject of notifications under Section 425:

- (i) to the receiving Office;

- (ii) as long as the international search report, or the declaration referred to in Article 17(2)(a), and the written opinion of the International Searching Authority have not been established, to the International Searching Authority;

- (iii) to the designated Offices unless the change can be duly reflected in the pamphlet used for the purposes of the communication of the international application under Article 20;

- (iv) as long as the international preliminary examination report has not been established, to the International Preliminary Examining Authority;

- (v) to the elected Offices, unless the change can be duly reflected in the pamphlet used for the purposes of the communication of the international application under Article 20;

- (vi) to the applicant; where the change consists of a change in the person of the applicant, the notification shall be sent to the earlier applicant and the new applicant, provided that, where the earlier applicant and the new applicant are represented by the same agent, one notification only shall be sent to the said agent.

- (b) Where Rule 92<sup>bis</sup>.1(b) applies, the International Bureau shall notify the applicant accordingly and, if the change was requested by the receiving Office, that Office.

### Section 422<sup>bis</sup>

#### Objections Concerning Changes in the Person of the Applicant Recorded Under Rule 92<sup>bis</sup>.1(a)

(a) Where a change recorded by the International Bureau under Rule 92<sup>bis</sup>.1(a):

- (i) consists of a change in the person of the applicant, and

- (ii) the request under Rule 92<sup>bis</sup>.1(a) was not signed by or on behalf of both the earlier and the new applicant, and

- (iii) the earlier applicant objects to the change in writing,

the change under Rule 92<sup>bis</sup>.1(a) shall be considered as if it had not been recorded.

- (b) Where paragraph (a) applies, the International Bureau shall notify all those who received a notification under Section 422(a) accordingly.

**Section 423**

**Cancellation of Designations and Elections**

(a) The International Bureau shall, if the receiving Office has failed to do so, cancel *ex officio* the designation of any State which is not a Contracting State, shall enclose that designation within square brackets, draw a line between the square brackets while still leaving the designation legible, enter, in the margin, the words “CANCELLED EX OFFICIO BY IB” or their equivalent in French, and notify the applicant and the receiving Office accordingly.

(b) The International Bureau shall cancel *ex officio*:

(i) the election of any State which is not a designated State;

(ii) the election of any State not bound by Chapter II of the Treaty, if the International Preliminary Examining Authority has failed to do so.

(c) The International Bureau shall enclose the cancelled election within square brackets, draw a line between the square brackets while still leaving the election legible, enter, in the margin, the words “CANCELLED EX OFFICIO BY IB” or their equivalent in French, and notify the applicant and, if the election is in the demand, the International Preliminary Examining Authority accordingly.

**Section 424**

*[Deleted]*

**Section 425**

**Notifications Concerning Representation**

Where a power of attorney or a document containing the revocation or renunciation of an appointment is submitted to the International Bureau, the International Bureau shall immediately notify the receiving Office, the International Searching Authority and the International Preliminary Examining Authority by sending them a copy of the power of attorney or document and shall record a change in the indications concerning the agent or common representative under Rule 92<sup>bis</sup>. In the case of a renunciation of an appointment, the International Bureau shall also notify the applicant. Where the International Bureau receives a notification concerning representation under Section

328, it shall immediately notify the International Preliminary Examining Authority accordingly.

**Section 426**

*[Deleted]*

**Section 427**

*[Deleted]*

**Section 428**

*[Deleted]*

**Section 429**

*[Deleted]*

**Section 430**

**Notification of Designations under Rule 32**

Where the effects of any international application are extended to a successor State under Rule 32.1(a), the International Bureau shall promptly, but not before the international publication of the international application, effect the communication under Article 20 to the designated Office concerned, and notify that Office under Rule 47.1(a<sup>bis</sup>)

**Section 431**

**Publication of Notice of Submission of Demand**

(a) For international applications in respect of which a demand is filed before January 1, 2004, the publication in the Gazette of information on the demand and the elected States concerned, as referred to in Rule 61.4, as in force until December 31, 2003, shall consist of a notice indicating that a demand has been submitted prior to the expiration of 19 months from the priority date and, as applicable, indicating that all eligible States have been elected or, where not all eligible States have been elected, indicating those eligible States which have not been elected.

(b) For international applications in respect of which a demand is filed on or after January 1, 2004, the publication in the Gazette of information on the demand and the elected States concerned, as referred to in Rule 61.4, as in force from January 1, 2004, shall consist of a notice indicating that a demand has been submitted prior to the expiration of the applicable time limit under Rule 54<sup>bis</sup>.1(a) and that all Contract-

ing States which were designated and were bound by Chapter II of the Treaty have been elected. Where the demand is made subsequent to the expiration of 19 months from the priority date and the time limit under Article 22(1), as in force from April 1, 2002, does not apply in respect of all designated Offices, the notice shall also indicate that fact.

### **Section 432**

#### **Notification to Applicant of Submission of Demand After the Expiration of 19 Months from the Priority Date**

Where the demand is submitted after the expiration of 19 months from the priority date and subsequently transmitted to the International Bureau under Rule 59.3(a), or is submitted after the expiration of 19 months from the priority date to the International Bureau, and the time limit under Article 22(1), as in force from April 1, 2002, does not apply in respect of all designated Offices, the International Bureau shall, together with the notification sent to the applicant under Rule 59.3(c)(i) or the invitation sent to the applicant under Rule 59.3(c)(ii), as the case may be:

(i) promptly notify the applicant accordingly, directing attention to the fact that the time limit under Article 39(1)(a) does not apply, and that Article 22(1), as in force until March 31, 2002, continues to apply in respect of any such designated Office,

(ii) proceed under Rule 59.3.

### **Section 433**

#### **Waivers Under Rules 90.4(d) and 90.5(c)**

(a) Where, in accordance with Rule 90.4(d), the International Bureau waives the requirement under

Rule 90.4(b) that a separate power of attorney be submitted to it, the International Bureau shall publish a notice of this fact in the Gazette.

(b) The International Bureau may require a separate power of attorney in particular instances even if the International Bureau has waived the requirement in general.

### **Section 434**

#### **Publication of Information Concerning Waivers Under 90.4(d) and 90.5(c)**

(a) Any waivers of the requirement under Rule 90.4(b) that a separate power of attorney be submitted, or any changes to the information, notified to the International Bureau under Sections 336(a), 517(a), or 617(a) shall be promptly published in the Gazette. The effective date of any change shall be two months after the date of publication of the change in the Gazette, or such later date as may be determined by the International Bureau.

(b) Any waivers of the requirement under Rule 90.5(a)(ii) that a copy of a general power of attorney be attached to the request, the demand or any separate notice, or any changes to the information, notified to the International Bureau under Sections 336(b), 517(b), or 617(b) shall be promptly published in the Gazette. The effective date of any change shall be two months after the date of publication of the change in the Gazette, or such later date as may be determined by the International Bureau.

## PART 5

### INSTRUCTIONS RELATING TO THE INTERNATIONAL SEARCHING AUTHORITY

#### Section 501

##### **Corrections Submitted to the International Searching Authority Concerning Expressions, etc., Not To Be Used in the International Application**

Where the International Searching Authority receives corrections aimed at complying with Rule 9.1, Section 511 shall apply *mutatis mutandis*, provided that, where a sheet is marked as indicated in Section 511(a)(ii), the words “SUBSTITUTE SHEET (RULE 9.2)” shall be used.

#### Section 502

##### **Transmittal of Protest Against Payment of Additional Fee and Decision Thereon Where International Application Is Considered to Lack Unity of Invention**

The International Searching Authority shall transmit to the applicant, preferably at the latest together with the international search report, any decision which it has taken under Rule 40.2(c) on the protest of the applicant against payment of an additional fee where the international application is considered to lack unity of invention. At the same time, it shall transmit to the International Bureau a copy of both the protest and the decision thereon, as well as any request by the applicant to forward the texts of both the protest and the decision thereon to the designated Offices.

#### Section 503

##### **Method of Identifying Documents Cited in the International Search Report and the Written Opinion of the International Searching Authority**

Identification of any document cited in the international search report shall be as provided in WIPO Standard ST.14 (Recommendation for the Inclusion of References Cited in Patent Documents).<sup>4</sup> Any doc-

ument cited in the international search report may be referred to in a shortened form in the written opinion of the International Searching Authority, provided that the reference to the document is unambiguous.

#### Section 504

##### **Classification of the Subject Matter of the International Application**

(a) Where the subject matter of the international application is such that classification thereof requires more than one classification symbol according to the principles to be followed in the application of the International Patent Classification to any given patent document, the international search report shall indicate all such symbols.

(b) Where any national classification system is used, the international search report may indicate all the applicable classification symbols also according to that system.

(c) Where the subject matter of the international application is classified both according to the International Patent Classification and to any national classification system, the international search report shall, wherever possible, indicate the corresponding symbols of both classifications opposite each other.

(d) The version of the International Patent Classification applicable at the time the international application is published under Article 21 shall be used whenever feasible.

#### Section 505

##### **Indication of Citations of Particular Relevance in the International Search Report**

(a) Where any document cited in the international search report is of particular relevance, the special indication required by Rule 43.5(c) shall consist of the letter(s) “X” and/or “Y” placed next to the citation of the said document.

<sup>4</sup>Editor's Note: Published in the *WIPO Handbook on Industrial Property Information and Documentation*.

(b) Category “X” is applicable where a document is such that when taken alone, a claimed invention cannot be considered novel or cannot be considered to involve an inventive step.

(c) Category “Y” is applicable where a document is such that a claimed invention cannot be considered to involve an inventive step when the document is combined with one or more other such documents, such combination being obvious to a person skilled in the art.

### Section 506

*[Deleted]*

### Section 507

#### Manner of Indicating Certain Special Categories of Documents Cited in the International Search Report

(a) Where any document cited in the international search report refers to an oral disclosure, use, exhibition, or other means referred to in Rule 33.1(b), the separate indication required by that Rule shall consist of the letter “O” placed next to the citation of the said document.

(b) Where any document cited in the international search report is a published application or patent as defined in Rule 33.1(c), the special mention required by that Rule shall consist of the letter “E” placed next to the citation of the said document.

(c) Where any document cited in the international search report is not considered to be of particular relevance requiring the use of categories “X” and/or “Y” as provided in Section 505 but defines the general state of the art, it shall be indicated by the letter “A” placed next to the citation of the said document.<sup>5</sup>

(d) Where any document cited in the international search report is a document whose publication date occurred earlier than the international filing date of the international application, but later than the priority date claimed in that application, it shall be indi-

cated by the letter “P” next to the citation of the said document.

(e) Where any document cited in the international search report is a document whose publication date occurred after the filing date or the priority date of the international application and is not in conflict with the said application, but is cited for the principle or theory underlying the invention, which may be useful for a better understanding of the invention, or is cited to show that the reasoning or the facts underlying the invention are incorrect, it shall be indicated by the letter “T” next to the citation of the document.

(f) Where in the international search report any document is cited for reasons other than those referred to in paragraphs (a) to (e), for example:

— a document which may throw doubt on a priority claim,<sup>6</sup>

— a document cited to establish the publication date of another citation,<sup>7</sup>

such document shall be indicated by the letter “L” next to the citation of the document and the reason for citing the document shall be given.

(g) Where a document is a member of a patent family,<sup>8</sup> it shall, whenever feasible, be mentioned in the international search report in addition to the one cited belonging as well to this family and should be preceded by the sign ampersand (&). Members of a patent family may also be mentioned on a separate sheet, provided that the family to which they belong shall be clearly identified and that any text matter on that sheet, if not in the English language, shall also be furnished to the International Bureau in English translation.

(h) A document whose contents have not been verified by the search examiner but are believed to be substantially identical with those of another document which the search examiner has inspected, may be cited in the international search report in the manner indicated for patent family members in the first sentence of paragraph (g).<sup>9</sup>

<sup>5</sup>See Chapter III, paragraph 3.14 of the PCT Search Guidelines.

<sup>6</sup>See Chapter VI, paragraph 4.3 of the PCT Search Guidelines.

<sup>7</sup>See Chapter VI, paragraph 6.2 of the PCT Search Guidelines.

<sup>8</sup>See Chapter IV, paragraph 3.2 of the PCT Search Guidelines.

<sup>9</sup>See Chapter VI, paragraph 5.2 of the PCT Search Guidelines.

**Section 508**

**Manner of Indicating the Claims to Which the Documents Cited in the International Search Report Are Relevant**

(a) The claims to which cited documents are relevant shall be indicated by placing in the appropriate column of the international search report:

(i) where the cited document is relevant to one claim, the number of that claim; for example, “2” or “17”;

(ii) where the cited document is relevant to two or more claims numbered in consecutive order, the number of the first and last claims of the series connected by a hyphen; for example, “1-15” or “2-3”;

(iii) where the cited document is relevant to two or more claims that are not numbered in consecutive order, the number of each claim placed in ascending order and separated by a comma or commas; for example, “1, 6” or “1, 7, 10”;

(iv) where the cited document is relevant to more than one series of claims under (ii), above, or to claims of both categories (ii) and (iii), above, the series or individual claim numbers and series placed in ascending order using commas to separate the several series, or to separate the numbers of individual claims and each series of claims; for example, “1-6, 9-10, 12-15” or “1, 3-4, 6, 9-11.”

(b) Where different categories apply to the same document cited in an international search report in respect of different claims or groups of claims, each relevant claim or group of claims shall be listed separately opposite each indicated category of relevance. Each category and each relevant claim or group of claims may be separated by a line.

*The following example illustrates the situation where a document is of particular relevance under Section 505(b) as to claims 1 to 3 and under Section 505(c) as to claim 4, and indicates the general state of the art under Section 507(c) as to claims 11 and 12:*

<i>Category</i>	<i>Citation</i>	<i>Relevant to claim No.</i>
	GB, A 392,415 (JONES) 18 May 1933 (18.05.33)	
X	Fig.1	1-3
Y	page 3, lines 5-7	4
A	Fig.5, support 36	11-12

**Section 509**

**International Search and Written Opinion of the International Searching Authority on the Basis of a Translation of the International Application**

Where the International Searching Authority has carried out the international search and established the written opinion on the basis of a translation of the international application transmitted to that Authority under Rule 23.1(b), the international search report and the written opinion of the International Searching Authority shall so indicate.

**Section 510**

**Refund of Search Fee in Case of Withdrawal of International Application**

(a) Where the international application is withdrawn or is considered withdrawn before the International Searching Authority has started the international search, that Authority shall, subject to paragraphs (b) and (c), refund the search fee to the applicant.

(b) If the refund referred to in paragraph (a) is not compatible with the national law of the national Office acting as International Searching Authority and as long as it continues to be not compatible with that law, the International Searching Authority may abstain from refunding the search fee.

(c) The International Searching Authority may, before making a refund under paragraph (a), first invite the applicant to submit a request for the refund.



**Section 511**

**Rectifications of Obvious Errors Under Rule 91.1**

(a) Where the International Searching Authority authorizes a rectification under Rule 91.1, it shall:

(i) indelibly mark, in the upper right-hand corner of each replacement sheet, the international application number and the date on which that sheet was received;

(ii) indelibly mark, in the middle of the bottom margin of each replacement sheet, the words "RECTIFIED SHEET (RULE 91)" or their equivalent in the language of publication of the international application as well as an indication of the International Searching Authority as provided for in Section 107(b);

(iii) indelibly mark on the letter containing the rectification or accompanying any replacement sheet the date on which that letter was received;

(iv) keep in its files a copy of the letter containing the rectification or, when the rectification is contained in a replacement sheet, the replaced sheet, a copy of the letter accompanying the replacement sheet, and a copy of the replacement sheet;

(v) promptly transmit any letter and any replacement sheet to the International Bureau and a copy thereof to the receiving Office.

(b) Where the International Searching Authority refuses to authorize a rectification under Rule 91.1, it shall proceed as indicated under paragraph (a)(i), (iii), and (iv) and promptly transmit any letter and any proposed replacement sheet to the International Bureau.

**Section 512**

**Notifications Concerning Representation**

Where a power of attorney or a document containing the revocation or renunciation of an appointment is submitted to the International Searching Authority, that Authority shall immediately notify the International Bureau by sending it a copy of the power of attorney or document and request the International Bureau to record a change in the indications concerning the agent or common representative under Rule 92<sup>bis</sup>.1 (a)(ii).

**Section 513**

**Sequence Listings**

(a) Where the International Searching Authority receives a correction of a defect under Rule 13<sup>ter</sup>.1(d), it shall:

(i) indelibly mark, in the upper right-hand corner of each replacement sheet, the international application number and the date on which that sheet was received;

(ii) indelibly mark, in the middle of the bottom margin of each replacement sheet, the words "SUBSTITUTE SHEET (RULE 13<sup>ter</sup>.1(d))" or their equivalent in the language of publication of the international application;

(iii) indelibly mark on the letter containing the correction, or accompanying any replacement sheet, the date on which that letter was received;

(iv) keep in its files a copy of the letter containing the correction or, when the correction is contained in a replacement sheet, the replaced sheet, a copy of the letter accompanying the replacement sheet, and a copy of the replacement sheet;

(v) promptly transmit any letter and any replacement sheet to the International Bureau, and a copy thereof to the receiving Office.

(b) Where the international search report and the written opinion of the International Searching Authority are based on a sequence listing that was not contained in the international application as filed but was furnished subsequently to the International Searching Authority, the international search report and the written opinion of the International Searching Authority shall so indicate.

(c) Where a meaningful international search cannot be carried out and a meaningful written opinion, as to whether the claimed invention appears to be novel, to involve an inventive step (to be non-obvious) and to be industrially applicable, cannot be established because a sequence listing is not available to the International Searching Authority in the required form, that Authority shall so state in the international search report or declaration referred to in Article 17(2)(a), and in the written opinion.

(d) The International Searching Authority shall indelibly mark, in the upper right-hand corner of the first sheet of any sequence listing in printed form which was not contained in the international

## ADMINISTRATIVE INSTRUCTIONS UNDER THE PCT

application as filed but was furnished subsequently to that Authority, the words “SUBSEQUENTLY FURNISHED SEQUENCE LISTING” or their equivalent in the language of publication of the international application.

(e) The International Searching Authority shall keep in its files:

(i) any sequence listing in printed form which was not contained in the international application as filed but was furnished subsequently to that Authority; and

(ii) any sequence listing in computer readable form.

### Section 514

#### Authorized Officer

The officer of the International Searching Authority responsible for the international search report, as referred to in Rule 43.8, and for the written opinion of the International Searching Authority, as referred to in Rule 43<sup>bis</sup>.1(b), means the person who actually performed the search work and prepared the search report and the written opinion of the International Searching Authority, or another person who was responsible for supervising the search and the establishment of the written opinion.

### Section 515

#### Amendment of Established Abstract in Response to Applicant's Comments

The International Searching Authority shall inform the applicant and the International Bureau of any amendments made under Rule 38.2(b) to an abstract established by it under Rule 38.2(a).

### Section 516

#### Notification to Applicant of Submission of Demand After the Expiration of 19 Months from the Priority Date

Where the demand is submitted after the expiration of 19 months from the priority date to an International Searching Authority and the time limit under Article

22(1), as in force from April 1, 2002, does not apply in respect of all designated Offices, that Authority shall:

(i) promptly notify the applicant accordingly, directing attention to the fact that the time limit under Article 39(1)(a) does not apply, and that Article 22(1), as in force until March 31, 2002, continues to apply in respect of any such designated Office,

(ii) proceed under Rule 59.3.

### Section 517

#### Waivers Under Rule 90.4(d) and Rule 90.5(c)

(a) Where, in accordance with Rule 90.4(d), an International Searching Authority waives the requirement under Rule 90.4(b) that a separate power of attorney be submitted to it, the International Searching Authority shall notify the International Bureau accordingly.

(b) Where, in accordance with Rule 90.5(c), an International Searching Authority waives the requirement under Rule 90.5(a)(ii) that a copy of a general power of attorney be attached to any separate notice, it shall notify the International Bureau accordingly.

(c) An International Searching Authority may require a separate power of attorney, or a copy of a general power of attorney, in particular instances even if the International Searching Authority has waived the requirement in general.

(d) An International Searching Authority which has notified the International Bureau under paragraph (a) or (b) shall notify the International Bureau of any change to the information notified under those paragraphs.

### Section 518

#### Guidelines for Explanations Contained in the Written opinion of the International Searching Authority

For the purposes of establishing the written opinion of the International Searching Authority, Section 604 shall apply *mutatis mutandis*.

**PART 6**

**INSTRUCTIONS RELATING TO THE INTERNATIONAL PRELIMINARY EXAMINING AUTHORITY**

**Section 601**

**Notification to Applicant of Submission of Demand After the Expiration of 19 Months from the Priority Date**

(a) Where the demand is submitted after the expiration of 19 months from the priority date and the time limit under Article 22(1), as in force from April 1, 2002, does not apply in respect of all designated Offices, the International Preliminary Examining Authority shall promptly notify the applicant accordingly, directing attention to the fact that the time limit under Article 39(1)(a) does not apply, and that Article 22(1), as in force until March 31, 2002, continues to apply in respect of any such designated Office.

(b) Where the demand is submitted after the expiration of 19 months from the priority date to an International Preliminary Examining Authority which is not competent for the international preliminary examination of the international application, and the time limit under Article 22(1), as in force from April 1, 2002, does not apply in respect of all designated Offices, that Authority shall:

(i) promptly notify the applicant accordingly, directing attention to the fact that the time limit under Article 39(1)(a) does not apply, and that Article 22(1), as in force until March 31, 2002, continues to apply in respect of any such designated Office,

(ii) proceed under Rule 59.3.

**Section 602**

**Processing of Amendments by the International Preliminary Examining Authority**

(a) The International Preliminary Examining Authority shall:

(i) indelibly mark, in the upper right-hand corner of each replacement sheet submitted under Rule 66.8, the international application number and the date on which that sheet was received;

(ii) indelibly mark, in the middle of the bottom margin of each replacement sheet, the words "AMENDED SHEET" or their equivalent in the lan-

guage of the demand as well as an indication of the International Preliminary Examining Authority as provided for in Section 107(b);

(iii) subject to item (iv), keep in its files any replaced sheet, the letter accompanying any replacement sheet, and any superseded replacement sheet or any letter referred to in the last sentence of Rule 66.8(b) as well as a copy of any replacement sheet which is annexed to the international preliminary examination report;

(iv) where any superseded replacement sheet referred to in item (iii) is to be annexed to the international preliminary examination report under Rule 70.16(b), indelibly mark, in addition to the markings referred to in items (i) and (ii), in the middle of the bottom margin of each superseded replacement sheet, without obscuring the marking made under item (ii), the words "SUPERSEDED REPLACEMENT SHEET (RULE 70.16(b))";

(v) annex to the copy of the international preliminary examination report which is transmitted to the International Bureau any replacement sheet as provided for under Rule 70.16;

(vi) annex to the copy of the international preliminary examination report which is transmitted to the applicant a copy of each replacement sheet as provided for under Rule 70.16.

(b) Section 311(b)(ii) relating to the numbering of replacement sheets shall apply when one or more sheets are added under Rule 66.8.

(c) Where the International Preliminary Examining Authority receives from the applicant a copy of a purported amendment under Article 19 submitted after the time limit set forth in Rule 46.1, the International Preliminary Examining Authority may consider such an amendment as an amendment under Article 34 in which case it shall inform the applicant accordingly.

(d) Where the International Preliminary Examining Authority receives a copy of an amendment under Article 19, paragraphs (a) and (b) shall apply *mutatis mutandis*.

**Section 603**

**Transmittal of Protest Against Payment of Additional Fee and Decision Thereon Where International Application Is Considered To Lack Unity of Invention**

The International Preliminary Examining Authority shall transmit to the applicant, preferably at the latest together with the international preliminary examination report, any decision which it has taken under Rule 68.3(c) on the protest of the applicant against payment of an additional fee where the international application is considered to lack unity of invention. At the same time, it shall transmit to the International Bureau a copy of both the protest and the decision thereon, as well as any request by the applicant to forward the texts of both the protest and the decision thereon to the elected Offices.

**Section 604**

**Guidelines for Explanations Contained in the International Preliminary Examination Report**

(a) Explanations under Rule 70.8 shall clearly point out to which of the three criteria of novelty, inventive step (non-obviousness) and industrial applicability referred to in Article 35(2), taken separately, any cited document is applicable and shall clearly describe, with reference to the cited documents, the reasons supporting the conclusion that any of the said criteria is or is not satisfied.

(b) Explanations under Article 35(2) shall be concise and preferably in the form of short sentences.

**Section 605**

**File to Be Used for International Preliminary Examination**

Where the International Preliminary Examining Authority is part of the same national Office or inter-governmental organization as the International Searching Authority, the same file shall serve the purposes of international search and international preliminary examination.

**Section 606**

**Cancellation of Elections**

(a) The International Preliminary Examining Authority shall cancel *ex officio*:

(i) the election of any State which is not a designated State;

(ii) the election of any State not bound by Chapter II of the Treaty.

(b) The International Preliminary Examining Authority shall enclose that election within square brackets, shall draw a line between the square brackets while still leaving the election legible and shall enter, in the margin, the words "CANCELLED EX OFFICIO BY IPEA" or their equivalent in the language of the demand, and shall notify the applicant accordingly.

**Section 606<sup>bis</sup>**

[Deleted]

**Section 607**

**Rectifications of Obvious Errors Under Rule 91.1**

Where the International Preliminary Examining Authority authorizes a rectification of an obvious error under Rule 91.1, Rule 70.16 and Section 602(a) and (b) shall apply *mutatis mutandis*, provided that, where a sheet is marked as indicated in Section 602, the words "RECTIFIED SHEET (RULE 91)" shall be used.

**Section 608**

**Notifications Concerning Representation**

Where a power of attorney or a document containing the revocation or renunciation of an appointment is submitted to the International Preliminary Examining Authority, that Authority shall immediately notify the International Bureau by sending it a copy of the power of attorney or document and request the International Bureau to record a change in the indications concerning the agent or common representative under Rule 92<sup>bis</sup>.1(a)(ii).

**Section 609**

**Withdrawal by Applicant Under Rule 90<sup>bis</sup>. 1,  
90<sup>bis</sup>. 2, or 90<sup>bis</sup>. 3**

The International Preliminary Examining Authority shall promptly transmit to the International Bureau any notice from the applicant effecting withdrawal of the international application under Rule 90<sup>bis</sup>.1(b), of a designation under Rule 90<sup>bis</sup>.2(d), or of a priority claim under Rule 90<sup>bis</sup>.3(c) which has been filed with it. The International Preliminary Examining Authority shall mark the notice with the date on which it was received.

**Section 610**

*[Deleted]*

**Section 611**

**Method of Identification of Documents in the International Preliminary Examination Report**

Any document cited in the international preliminary examination report which was not cited in the international search report shall be cited in the same form as required under Section 503 for international search reports. Any document cited in the international preliminary examination report which was previously cited in the international search report may be cited in a shortened form, provided that the reference to the document is unambiguous.

**Section 612**

**Authorized Officer**

The officer of the International Preliminary Examining Authority responsible for the international preliminary examination report, as referred to in Rule 70.14, means the person who actually performed the examination work and prepared the international preliminary examination report or another person who was responsible for supervising the examination.

**Section 613**

**Invitation to Submit a Request for Refund of Fees under Rule 57.6 or 58.3**

The International Preliminary Examining Authority may, before making a refund under Rule 57.6 or 58.3,

first invite the applicant to submit a request for the refund.

**Section 614**

**Evidence of Right to File Demand**

Where a demand is considered as not having been made under Rule 61.1(b) by the International Preliminary Examining Authority because the applicant appeared, on the basis of the indication made in the demand, not to have the right to file a demand with that Authority under Rule 54 but evidence is submitted indicating to the satisfaction of the International Preliminary Examining Authority that in fact, an applicant had, on the date on which the demand was received, the right to file the demand with that Authority, the International Preliminary Examining Authority shall regard the requirements under Article 31 (2)(a) as having been fulfilled on the date of actual receipt of the demand.

**Section 615**

**Invitation to Pay Fees Before Date on Which They Are Due**

If the International Preliminary Examining Authority finds, before the date on which they are due, that the handling fee or the international preliminary examination fee are lacking in whole or in part, it may invite the applicant to pay the missing amounts within the time limit under Rule 57.3 or 58.1(b), as the case may be.

**Section 616**

**International Preliminary Examination on the Basis of a Translation of the International Application**

Where the International Preliminary Examining Authority has carried out international preliminary examination on the basis of a translation of the international application furnished to that Authority under Rule 55.2(a) or, in the case referred to in Rule 55.2 (b), transmitted, under Rule 23.1(b), to the national Office or intergovernmental organization of which that Authority is part, the international preliminary examination report shall so indicate.

ADMINISTRATIVE INSTRUCTIONS UNDER THE PCT

**Section 617**

**Waivers Under Rule 90.4(d) and 90.5(c)**

(a) Where, in accordance with Rule 90.4(d), an International Preliminary Examining Authority waives the requirement under Rule 90.4(b) that a separate power of attorney be submitted to it, the International Preliminary Examining Authority shall notify the International Bureau accordingly.

(b) Where, in accordance with Rule 90.5(c), an International Preliminary Examining Authority waives the requirement under Rule 90.5(a)(ii) that a copy of a general power of attorney be attached to the

demand or any separate notice, it shall notify the International Bureau accordingly.

(c) An International Preliminary Examining Authority may require a separate power of attorney, or a copy of a general power of attorney, in particular instances even if the International Preliminary Examining Authority has waived the requirement in general.

(d) An International Preliminary Examining Authority which has notified the International Bureau under paragraph (a) or (b) shall notify the International Bureau of any change to the information notified under those paragraphs.

## PART 7

### INSTRUCTIONS RELATING TO THE ELECTRONIC FILING AND PROCESSING OF INTERNATIONAL APPLICATIONS

#### Section 701

##### Abbreviated Expressions

For the purposes of this Part and Annex F, unless the contrary clearly follows from the wording, the nature of the provision or the context:

(i) “electronic” technology includes that having electrical, digital, magnetic, optical or electromagnetic capabilities;

(ii) “electronic document format” means the presentation or arrangement of the information in a document in electronic form;<sup>10</sup>

(iii) “means of transmittal,” in connection with a document in electronic form, means the manner in which a document is transmitted, for example, by electronic means or physical means;<sup>11</sup>

(iv) “electronic signature” means information in electronic form which is attached to, or logically associated with, an electronic document, which may be used to identify the signer and which indicates the signer’s approval of the content of the document;

(v) “basic common standard” means the basic common standard for electronic filing of international applications provided for in Annex F;<sup>12</sup>

(vi) words and expressions whose meanings are explained in Annex F have the same meanings in this Part.<sup>13</sup>

#### Section 702

##### International Applications Filed in Electronic Form

(a) The filing and processing of international applications filed in electronic form, as referred to in Rule 89<sup>bis</sup>, shall be in accordance with this Part and Annex F.<sup>14</sup>

(b) Subject to this Part, an international application in electronic form shall not be denied legal effect merely because it is in electronic form.

(c) This Part and Annex F do not apply to an international application containing a sequence listing part which is filed in computer readable form under Section 801(a).<sup>15</sup>

---

<sup>10</sup> See Annex F, section 3.

<sup>11</sup> See Annex F, section 5.

<sup>12</sup> See Annex F, Appendix III.

<sup>13</sup> For example, “electronic package” (see Section 703(b)(iii) and Annex F, section 4), “wrapped and signed package” (see Section 705(a) and (b) and Annex F, section 4.2.1), and a number of terms used in Section 710.

<sup>14</sup> The proposed modifications do not provide for the conversion of applications from paper form to electronic form or for the filing of applications partly on paper and partly in electronic form. Those matters will be dealt with in other proposed modifications of the Administrative Instructions. Although Rule 89<sup>bis</sup> also enables the Administrative Instructions to provide for the filing and processing of international applications “by electronic means,” proposed Part 7 relates in the main to applications filed “in electronic form” except where otherwise specifically mentioned (as, for example, in Section 709(a)). While applications in electronic form may, of course, be filed by electronic means, Part 7 generally focuses on the form of the application rather than the means of filing. The Regulations already provide for the filing by electronic means of applications in paper form (see Rule 92.4).

## ADMINISTRATIVE INSTRUCTIONS UNDER THE PCT

### Section 703

#### Filing Requirements; Basic Common Standard

(a) An international application may, subject to this Part, be filed in electronic form if the receiving Office has notified the International Bureau in accordance with Rule 89<sup>bis</sup>.1(d) that it is prepared to receive international applications in such form.<sup>16</sup>

(b) An international application filed in electronic form shall be:

(i) in an electronic document format that has been specified by the receiving Office<sup>17</sup> in accordance with Annex F or that complies with the basic common standard,<sup>18, 19</sup>

(ii) filed by a means of transmittal that has been specified by the receiving Office<sup>17</sup> in accordance with Annex F or that complies with the basic common standard;<sup>20, 19</sup>

(iii) in the form of an electronic package, appropriate to the means of transmittal, in accordance with Annex F or that complies with the basic common standard;<sup>21</sup>

(iv) prepared and filed using electronic filing software that has been specified by the receiving Office 17 in accordance with Annex F or that complies with the basic common standard;<sup>22, 19</sup> and

(v) free of viruses and other forms of malicious logic in accordance with Annex F or that complies with the basic common standard.<sup>23</sup>

<sup>15</sup> For example, such a sequence listing is not subject to data format and packaging requirements under Annex F, and the basic fee is calculated under Section 803 rather than Section 707. An application containing a sequence listing may, however, be filed in (fully) electronic form under Part 7 rather than partly on paper and partly in computer readable form under Section 801(a), in which case the application would be subject to Part 7 and Annex F and not Part 8. It should be remembered that Section 801 and the other provisions of Part 8 were introduced to deal with an immediate problem, namely, that of extremely large applications which cannot be dealt with practically on paper. Those provisions will need to be reviewed when electronic filing and processing systems have been more fully implemented, at which stage it is expected that such applications will be dealt with under the more general provisions of Part 7. In the meantime, however, an applicant who wishes to have the advantage of the provisions of Part 8 will have to comply with Section 801; the request will need to be filed on paper and accompanied by a sequence listing in computer readable form.

<sup>16</sup> This provision is included for the sake of clarity, although it is probably not strictly necessary in the light of Rule 89<sup>bis</sup>.1(a), (d) and (e). This provision does not, of course, affect the need for the receiving Office to be competent under Rule 19 to receive the application.

<sup>17</sup> The receiving Office must specify the electronic document format(s), means of transmittal and electronic filing software that it is prepared to accept (see Section 710(a)(i)). The specification may be of a particular format, means or software, or may be expressed in general terms.

<sup>18</sup> See Section 701(ii), Annex F, section 3, and Appendix III, section 2(a) to (c).

<sup>19</sup> Use of the basic common standard (see Section 701(v) and Annex F, Appendix III) is not mandatory for applicants, but the receiving Office must accept applications that comply with the basic common standard in addition to applications that comply with different requirements that the Office may have specified for the purposes of paragraph 703(b)(i), (ii) and (iv). The basic common standard itself does, however, provide for certain options to be exercised by receiving Offices. Note that the basic common standard provides for the use of PKI technology for packaging the international application documents (but see also footnote 21).

<sup>20</sup> See Section 701(iii), Annex F, section 5, and Appendix III, section 2(d) and (e). In the case of on-line filing, the means of transmittal encompasses the use of a transmission protocol. The use of the E-filing Interoperability Protocol is provided for in Annex F, section 5.1, and forms part of the basic common standard (see Appendix III, section 2(d)).

<sup>21</sup> See Annex F, sections 4 and 5.2. For on-line filing, the options for electronic packaging under the present text of Annex F all provide for the use of PKI, although the proposal and adoption of other solutions in the future is not precluded.

<sup>22</sup> See Annex F, section 6, and Appendix III, section 2(g). Electronic filing software to be developed by the International Bureau as an extension of the PCT-EASY software will be made available to applicants and receiving Offices. That software will support the basic common standard and certain alternatives available under Annex F. Use of that software would not be mandatory, but it will have to be accepted by any receiving Office under the basic common standard. That result is consistent with the conclusion of the Committee on Reform of the Patent Cooperation Treaty (PCT) reached at its first session in May 2001 (see document PCT/R/1/26, paragraph 66(x)). Any receiving Office will, however, also be able under Section 703(b)(iv) to specify other filing software acceptable to it.

<sup>23</sup> See Annex F, section 3.



(c) An international application filed in electronic form shall, for the purposes of Article 14(1)(a)(i), be signed by the applicant using a type of electronic signature that has been specified by the receiving Office in accordance with Annex F or, subject to Section 704(g), that complies with the basic common standard.<sup>24, 19</sup>

(d) A receiving Office which has not notified the International Bureau in accordance with Rule 89.1(d) that it is prepared to receive international applications in electronic form may nevertheless decide in a particular case to receive an international application submitted to it in such form, in which case this Part shall apply accordingly.

(e) Any receiving Office may refuse to receive an international application submitted to it in electronic form if the application does not comply with paragraph (b), or may decide to receive the application.

(f) If, on 7 January 2002, the applicable national law and the technical systems of a national Office provide for the filing with it of national applications in electronic form according to requirements which are incompatible with any of items (ii) to (iv) of paragraph (b):<sup>25</sup>

(i) the provisions concerned<sup>26</sup> shall not apply in respect of the Office in its capacity as a receiving Office for as long as the incompatibility continues; and

(ii) the Office may instead provide for the filing with it of international applications in electronic form according to that national law and those technical systems; provided that the Office informs the International Bureau accordingly by the date on which the Office sends the International Bureau a notification under Rule 89.1(d) and in any case no later than 7 April 2002. The information received shall be promptly published by the International Bureau in the Gazette.

### Section 704

#### **Receipt; International Filing Date; Signature; Physical Requirements; Subsequent Documents and Correspondence**

(a) The receiving Office shall promptly<sup>27</sup> notify the applicant of, or otherwise enable the applicant to obtain confirmation of, the receipt of any purported international application filed with it in electronic form. The notification or confirmation shall indicate or contain:

(i) the identity of the Office;

<sup>24</sup> See Section 701(iv), Annex F, section 3.3, and Appendix III, section 2(i). The receiving Office must specify the type(s) of electronic signature that it is prepared to accept (see section 710(a)(i)). While signature in compliance with the basic common standard is sufficient for the purposes of filing, compliance with the receiving Office's particular requirements may be required subsequently pursuant to Section 704(g). Note the distinction between requirements as to signature of the application for the purposes of Article 14(1)(a)(i) (which may be a basic or enhanced electronic signature by the applicant) as distinct from packaging (which requires the use of the digital signature of the sender),

<sup>25</sup> It will not be possible to make a transitional reservation in respect of the requirements of Section 703(b)(i). In addition to complying with that Section, an Office that has made a transitional reservation under Section 703(f) would have to comply with other applicable provisions of Part 7 and Annex F. For example, Section 713(b) would require compliance with Annex F as to the electronic packaging of documents transmitted from the receiving Office to the International Bureau, that is, a PKI-based "SEP" or "WASP" package type would have to be used (see Annex F, sections 4 and 5.2.2). That would be the case even if the international application itself as filed with the receiving Office did not, pursuant to a transitional reservation by the Office under Section 703(f), comply with the requirements of Section 703(b)(iii) and Annex F, section 5.2.1, as to electronic packaging. Moreover, an applicant who filed an international application with a receiving Office which has made a transitional reservation under Section 703(f) as to the application of Section 703(b)(iii) would not have to comply with Annex F as to PKI-based electronic packaging of the application. However, any subsequent communications in electronic form between the applicant and the International Bureau, the International Searching Authority or the International Preliminary Examining Authority would have to comply with Annex F (see Annex F, sections 5.2.1 and 7.1).

<sup>26</sup> A transitional reservation under Section 703(f) may be expressed to apply in relation to all or only some of the provisions mentioned.

<sup>27</sup> Numbers of provisions in the Regulations and Administrative Instructions require "prompt" official action. The question of what is "prompt" in given circumstances is not defined in absolute terms but should be explained in the PCT Receiving Office Guidelines. In the context of Section 704(a), the notification should generally issue in minutes rather than hours or days. The various indications referred to in the Section may in some cases have to be notified or confirmed at different times, for example, in the case of batch submissions of documents.

## ADMINISTRATIVE INSTRUCTIONS UNDER THE PCT

(ii) the date of receipt;<sup>28</sup>

(iii) any reference number or application number assigned to the purported application by the Office; and

(iv) a message digest, generated by the Office, of the purported application as received; and may, at the option of the Office, also indicate or contain other information such as:

(v) the names and sizes of the electronic files received;

(vi) the dates of creation of the electronic files received; and

(vii) a copy of the purported application as received.

(b) Where the receiving Office refuses in accordance with Rule 89<sup>bis</sup>.1(d) or Section 703(e) to receive a purported international application submitted to it in electronic form, it shall, if practicable having regard to the indications furnished by the applicant,<sup>29</sup> promptly notify the applicant accordingly.

(c) Promptly after receiving a purported international application in electronic form, the receiving Office shall determine whether the purported application complies with the requirements of Article 11(1) and shall proceed accordingly.<sup>30</sup>

(d) Where an international application filed in electronic form is not signed in compliance with Section 703(c), the application shall be considered not to

comply with the requirements of Article 14(1)(a)(i) and the receiving Office shall proceed accordingly.

(e) Where an international application filed in electronic form does not comply with Section 703(b) but the receiving Office decides, under Section 703(e), to receive it, that non-compliance shall be considered to be non-compliance with the physical requirements referred to in Article 14(1)(a)(v) and the receiving Office shall proceed accordingly, having regard to whether compliance is necessary for the purpose of reasonably uniform international publication (Rule 26.3) and satisfactory electronic communications.<sup>31</sup>

(f) An international application filed in electronic form may, in accordance with the provisions of Rule 19.4, be transmitted by the Office with which the application was filed to the International Bureau as receiving Office.<sup>32</sup>

(g) Where an international application filed in electronic form was signed using a type of electronic signature that complies with the basic common standard but that has not been specified by the receiving Office under Section 703(c), the Office may require that any subsequent document or correspondence submitted to it in electronic form be signed using a type of electronic signature that has been so specified.<sup>33</sup> If that requirement is not complied with, Rule 92.1(b) and (c) shall apply *mutatis mutandis*.

(h) The provisions of this Part, other than paragraph (g), shall apply *mutatis mutandis* to other docu-

<sup>28</sup> The date of receipt will be determined according to the usual principles applicable to the filing of applications on paper, including filing by electronic means (such as by facsimile transmission), that is, based on the date prevailing at the location of the Office at the time when the complete transmission of the application has been received.

<sup>29</sup> The receiving Office will, of course, be obliged to act reasonably in deciding what is “practicable” in the circumstances. While a filing date should be accorded wherever it is practicable to do so, it needs to be remembered that receiving Offices are not obliged to receive international applications which do not comply with Annex F (see Section 703(e)). Receiving Offices should not have to go to extreme lengths to find applicants who have not given adequate indications to enable them to be contacted.

<sup>30</sup> This provision, which repeats the substance of Rule 20.4(a), is included for the guidance of receiving Offices, although it is not strictly necessary in the light of Rules 89<sup>bis</sup>.1(b).

<sup>31</sup> The application of the criteria of “reasonably uniform international publication” and “satisfactory electronic communications” act as a restraint against overly strict enforcement of physical requirements by receiving Offices, similarly to Rule 26.3 which refers to “reasonably uniform international publication” and “satisfactory reproduction” in the case of applications filed on paper.

<sup>32</sup> This provision is included for the guidance of receiving Offices, although it is not strictly necessary in the light of Rule 89.1(b). A receiving Office might wish to make use of Rule 19.4, for example, where an international application in electronic form is filed in a non-accepted format or by a non-accepted means. In the case referred to in Rule 19.4(a)(iii), the agreement of the Office and the International Bureau, and the authorization of the applicant, would be necessary. Note that the consequences of any non-compliance with national security requirements are a matter for national law and are not governed by either Rule 19.4 or Section 704(f); however, consideration will be given to including mention of such requirements in the PCT Receiving Office Guidelines.

ments and correspondence relating to international applications.<sup>34</sup>

### Section 705

#### Home Copy, Record Copy and Search Copy

(a) Where an international application is filed in electronic form as a wrapped and signed package in accordance with Annex F, the home copy and the record copy<sup>35</sup> in relation to that application for the purposes of Article 12 shall each consist of a copy in electronic form of that package.<sup>36</sup>

(b) Where an international application is filed in electronic form but is not filed as a wrapped and signed package in accordance with Annex F, the home copy and the record copy in relation to that application for the purposes of Article 12 shall each consist of a copy in electronic form of the application as filed. If the application as filed was encrypted, the home copy and the record copy shall consist of the decrypted version. If the application as filed was infected by a virus or other form of malicious logic,

the home copy and the record copy shall consist of the disinfected version.<sup>37</sup>

(c) Where the international application is filed in electronic form on a physical medium,<sup>38</sup> the home copy and the record copy shall not include the physical medium, but the receiving Office shall, for the purposes of Rule 93.1, retain the application as originally filed, together with the physical medium.<sup>39</sup>

(d) Where the International Searching Authority has notified the International Bureau in accordance with Rule 89.1(d) that it is prepared to process international applications in electronic form, paragraphs (a) and (b) apply *mutatis mutandis* to the search copy; otherwise, the search copy shall consist of a copy of the application printed on paper by the receiving Office.

### Section 706

#### Backup Copies<sup>40</sup>

(a) Where an international application was filed in electronic form, the applicant may, if the receiving

<sup>33</sup> See Annex F, section 3.3. Under the basic common standard, an international application need only, for the purposes of the according of a filing date, be signed by the applicant using a basic electronic signature and packaged with the digital signature of the sender based on a low-level certificate. Under Section 704(g), the receiving Office, having accorded a filing date to such an application, would be entitled to require that subsequent documents and correspondence be signed by the applicant using a digital signature based on a high-level certificate. If that requirement is not complied with, Rule 92.1(b) and (c) shall apply *mutatis mutandis*.

<sup>34</sup> This provision makes it clear that the provisions of Part 7 relating to international applications also apply to other documents and correspondence. It appears to be necessary to include it in addition to Rule 89.2, which has the effect that Rule 89.1 applies to documents other than the international application, since Rule 89.1 is itself an enabling provision. Section 704(g) should not be covered by the provision since it makes special provisions for documents other than the international application.

<sup>35</sup> As in the case of applications filed on paper, subsequent processing of the record copy will require that it be subject to the addition of further information, in the form of markings or tags (*meta\\_data*), about the processing of the application (such as the date of receipt). That further information does not become part of the record copy in the strict sense, but rather is information associated with the record copy. In relation to that application for the purposes of Article 12 shall each consist of a copy in electronic form of that package.

<sup>36</sup> See Annex F, section 4.2.1. The wrapped and signed package (WASP) will be used for this purpose even if it is further packaged as a signed and encrypted package (SEP) (see Annex F, section 4.2.2) – that is, the SEP will be decrypted and the WASP extracted from the decrypted package. The other components of the SEP will be stored by the receiving Office as part of its records, but do not form part of the home copy or record copy. Similarly, any physical medium does not form part of the home copy or record copy (see Section 705(c)).

<sup>37</sup> The keeping of records in general by the receiving Office, including the time for which records must be kept, is governed by Rule 93.1. Where the application is encrypted or infected by a virus, the operation of this Section depends on whether the receiving Office decides to receive the application and on whether it can be decrypted or disinfected so as to enable an international filing date to be accorded.

<sup>38</sup> See Annex F, Appendix IV.

<sup>39</sup> This provision is intended to ensure that the originally filed physical medium containing the international application as filed is retained for evidentiary purposes as part of the receiving Office's records, even though it does not form part of the home copy or the record copy.

<sup>40</sup> The backup procedures provided for in Section 706 are optional for both receiving Offices and applicants. It has been included with a view particularly to addressing the concerns of those applicants and receiving Offices which are less familiar with and experienced in the filing and processing of applications in electronic form. It is noted that any applicant who wishes to make a parallel filing on paper of an application filed in electronic form is in any event at liberty to do so. The 16-month time limit corresponds to the time limit for performing certain other actions which must be completed before international publication.

## ADMINISTRATIVE INSTRUCTIONS UNDER THE PCT

Office so permits and within 16 months from the priority date, file a backup copy of the application on paper or on a physical medium in accordance with Annex F, provided that the backup copy shall be identified as such and shall be accompanied by a statement by the applicant that the content of the backup copy is identical to that of the application as filed in electronic form.<sup>41</sup>

(b) Where an international application was filed in electronic form, the receiving Office may, of its own volition or at the request of the applicant, prepare a backup copy of the application on paper or on a physical medium in accordance with Annex F, provided that the content of the backup copy shall be identical to that of the application as filed in electronic form. The Office shall, upon request by the applicant and subject to the payment of a fee, send to the applicant a copy of such a backup copy.

(c) The receiving Office shall mark any backup copy filed or prepared on paper<sup>42</sup> with the words “BACKUP COPY” or their equivalent in the language of publication of the international application on the bottom of the first page of the request and on the first page of the description.

(d) The applicant may, within 16 months from the priority date, request the receiving Office to substitute a backup copy filed in accordance with paragraph (a), or prepared in accordance with paragraph (b), for the application in electronic form, in which case the backup copy shall be considered to be replacement sheets effecting a correction under Rule 26. The replacement sheets shall be considered to have been received by the receiving Office on the date on which it received the applicant’s request.

### Section 707

#### International Filing Fee; Fee Reduction

(a) Subject to paragraph (a-bis), where an international application is filed in electronic form, the international filing fee shall be calculated on the basis of the number of sheets that the application would

contain if presented as a print-out on paper complying with the physical requirements prescribed in Rule 11.

(a-bis) Where the international application is filed in electronic form and contains a sequence listing as referred to in Rule 5.2(a), the international filing fee shall comprise the following two components:

(i) a basic component calculated on the basis of the number of sheets that the international application would contain if presented as a print-out on paper complying with the physical requirements prescribed in Rule 11, excluding the sheets containing the sequence listing and/or any tables related to that sequence listing; and

(ii) an additional component, in respect of the sheets containing the sequence listing and/or any tables related to that sequence listing, calculated on the basis of the number of sheets of the sequence listing and/or any tables if presented as a print-out on paper complying with the physical requirements prescribed in Rule 11, provided that any sheet of the sequence listing and/or any tables in excess of 400 sheets shall not require the payment of a fee per sheet as referred to in item 1 of the Schedule of Fees.

(b) Item 3(b) and (c) of the Schedule of Fees annexed to the Regulations shall apply to reduce the fees payable in respect of an international application filed in electronic form with a receiving Office which has notified the International Bureau under Section 710(a) that it is prepared to receive international applications in electronic form.

### Section 708

#### Special Provisions Concerning Legibility, Completeness, Infection by Viruses, Etc.

(a) Where an international application is transmitted<sup>43</sup> to the receiving Office in electronic form, the Office shall promptly check whether the application is legible and whether it appears to have been fully received.<sup>44</sup> Where the Office finds that all or part of the international application is illegible or that part of

<sup>41</sup> See Annex F, Appendix IV, paragraph 2(d).

<sup>42</sup> A backup copy filed on a physical medium similarly must be appropriately identified as such (see Section 706(a) and (b) and Annex F, Appendix IV, paragraph 2(d)).

<sup>43</sup> The word “transmitted” is to be understood in a general sense as including transmittal by either electronic or physical means, noting that an international application may be filed on physical media (see Annex F, Appendix IV).

the application appears not to have been received, the international application shall be treated as not having been received to the extent that it is illegible or, where transmitted by electronic means, that the attempted transmission failed, and the Office shall, if practicable<sup>45</sup> having regard to the indications furnished by the applicant, promptly notify the applicant accordingly.<sup>46, 47</sup>

(b) Where a purported international application is transmitted to the receiving Office in electronic form, the Office shall promptly check it for infection by viruses and other forms of malicious logic<sup>48</sup>. Where the Office finds that the purported application is so infected.

(i) the Office is not required to disinfect the purported application and may, under Section 703(e), refuse to receive it;

(ii) if the Office decides under Section 703(e) to receive the purported application, the Office shall use means reasonably available under the circumstances to read it, for example, by disinfecting it or preparing a backup copy under Section 706, and to store it in such a way that its contents may be ascertained if necessary;<sup>49</sup>

(iii) if the Office finds that it is able to read and store the purported application as mentioned in item (ii), it shall determine whether an international filing date should be accorded;

(iv) if the Office accords an international filing date to the application, it shall, if possible having regard to the indications furnished by the applicant, promptly notify the applicant and, if necessary, invite

the applicant to submit a substitute copy of the application free of infection;

(v) if the Office accords an international filing date to the application, it shall prepare the home copy, the record copy and the search copy on the basis of the disinfected application, the backup copy or the substitute copy referred to in items (ii) or (iv), as applicable, provided that the application shall be stored by the Office, as referred to in item (ii), for the purposes of Rule 93.1.<sup>50</sup>

## Section 709

### Means of Communication

(a) Where an international application is filed in electronic form and by electronic means of transmittal, the receiving Office shall, if practicable,<sup>51</sup> send any notifications, invitations and other correspondence to the applicant by electronic means of transmittal in accordance with Annex F, or by such other means indicated by the applicant from among those offered by the Office.

(b) Where it appears to the receiving Office that a notification, invitation or other correspondence sent to the applicant by electronic means of transmittal was not successfully transmitted, the Office shall, if practicable,<sup>52</sup> promptly retransmit the notification, invitation or other correspondence by the same or another means.<sup>52</sup>

(c) At times when the electronic systems of the receiving Office are not available for the filing of documents in electronic form or by electronic means of transmittal, the Office shall, if possible, promptly

<sup>44</sup> The receiving Office is expected, of course, to take reasonable steps to attempt to read the application. The checking may be automated to the extent possible.

<sup>45</sup> See footnote 29.

<sup>46</sup> Where the International Bureau finds that the record copy of an international application filed in electronic form as received by it is illegible, it will notify the receiving Office which will then, where applicable, proceed under Section 708(a).

<sup>47</sup> Where the international application is treated as not having been received to the extent that it is illegible or that the attempted transmission failed, the receiving Office would then determine whether a filing date should be granted on the basis of that much of the application as was received.

<sup>48</sup> Where the International Bureau finds that the record copy of an international application filed in electronic form as received by it is infected by a virus, it will notify the receiving Office which will then, where applicable, proceed under Section 708(b).

<sup>49</sup> Since the originally filed application may need to be referred to for evidentiary purposes, the receiving Office should if possible store it as filed, that is, in its infected state.

<sup>50</sup> Since the originally filed application may need to be referred to for evidentiary purposes, the receiving Office should if possible store it as filed, that is, in its infected state.

<sup>51</sup> See footnote 29.

## ADMINISTRATIVE INSTRUCTIONS UNDER THE PCT

publish information to that effect by means reasonably available to it under the circumstances, for example, by including a notice on the Office's Internet site, if any.

### **Section 710**

#### **Notification and Publication of Receiving Offices' Requirements and Practices**

(a) A notification by a receiving Office to the International Bureau under Rule 89.1(d) that it is prepared to receive international applications in electronic form shall indicate, where applicable:<sup>53</sup>

(i) the electronic document formats, means of transmittal, electronic filing software and types of electronic signature specified by it under Section 703(b)(i), (ii) and (iv), and (c), and any options specified by it under the basic common standard;

(ii) the conditions, rules and procedures relating to electronic receipt, including hours of operation, choices for processes to verify or acknowledge receipt, choices for electronic communication of invitations and notifications, any methods of online payment, details concerning any help desks, electronic and software requirements and other administrative matters related to the electronic filing of international applications and related documents;

(iii) the kinds of documents which may be transmitted to or by the Office in electronic form;

(iv) whether and under what conditions the Office accepts the filing of backup copies under Section 706(a);

(v) procedures for notification of applicants and procedures which applicants may follow as alter-

natives when the electronic systems of the Office are not available;

(vi) where applicable, certification authorities accepted by the Office, and the electronic address of a listing of the certificate policies under which the certificates are issued;

(vii) the procedures relating to access to the files of international applications filed or stored in electronic form.

(b) The receiving Office shall notify the International Bureau of any change in the matters previously indicated by it in a notification under paragraph (a).

(c) The International Bureau shall promptly publish in the Gazette any notification received by it under paragraph (a) or (b).

(d) The effective date of any change notified under paragraph (b) shall be as specified by the receiving Office in the notification, provided that any change which restricts filing options shall not be effective earlier than two months after the date of publication of the notification of the change in the Gazette.

### **Section 711**

#### **Electronic Records Management**

(a) Records, copies and files in relation to international applications in electronic form shall be maintained and stored, for the purposes of Rule 93, in accordance with the requirements of authentication, integrity, confidentiality and non-repudiation, and having due regard to the principles of electronic records management, set out in Annex F.<sup>54</sup>

<sup>52</sup> Section 709(b) as presently drafted does not impose any requirement for the receiving Office to ascertain whether an electronic communication sent by it has in fact been received by the applicant. Further consideration should be given to developing suitable systems. Those systems could then be included as Annex F requirements and suitable wording included in Section 709(b).

<sup>53</sup> A receiving Office is, of course, obliged to notify the International Bureau of the matters referred to in Section 710(a) only when it intends itself to commence receiving international applications in electronic form.

<sup>54</sup> See Annex F, section 2.2.2.1, as to the requirements of authentication, etc., and Annex F, section 8, as to the principles of electronic records management. At some future stage, Annex F could be modified to refer to the international standard for records management (ISO 15489), once that standard has been adopted, or to some other guidelines for electronic records management.

(b) Upon request by the applicant or other interested party in relation to a particular international application, the receiving Office shall, subject to any restrictions applicable under the Treaty as to access by third parties,<sup>55</sup> certify that any electronic records relating to that application are maintained and stored by it in accordance with paragraph (a).

### Section 712

#### Access to Electronic Records

Access permitted by the Treaty, the Regulations or these Administrative Instructions to documents contained in the file of an international application filed or stored in electronic form may, at the option of the national Office or intergovernmental organization concerned, be provided by electronic means or in electronic form, having due regard to the need to ensure the integrity and where applicable confidentiality of data, the principles of electronic records management set out in Annex F,<sup>56</sup> and the need to ensure security of the electronic networks, systems and applications of the Office or organization.

### Section 713

#### Provisions Relating to International Authorities and Designated Offices<sup>57</sup>

(a) The provisions of this Part shall apply *mutatis mutandis* to the International Searching Authorities

and International Preliminary Examining Authorities and to the International Bureau.<sup>58</sup>

(b) Any transmittal in electronic form of documents, notifications, communications or correspondence between receiving Offices, International Searching Authorities, International Preliminary Examining Authorities, the International Bureau and designated Offices<sup>59</sup> and Authorities concerned in accordance with Annex F.<sup>60</sup>

(c) Where any International Searching Authority, International Preliminary Examining Authority or designated Office has not notified the International Bureau in accordance with Rule 89<sup>bis</sup>.1(d) that it is prepared to process international applications in electronic form, the International Bureau shall furnish to that Office or Authority a copy on paper of any document which is stored by the International Bureau in electronic form and which that Office or Authority is entitled to receive. The International Bureau may also, upon request by the Authority or Office concerned, furnish such copy in electronic form.<sup>61</sup>

(d) Any designated Office may require that any document or correspondence submitted to it by the applicant in electronic form be signed by the applicant using a type of electronic signature specified by it in accordance with Annex F.<sup>62</sup>

---

<sup>55</sup> Articles 30 and 38 and Rule 94 restrict access.

<sup>56</sup> See Annex F, section 8.

<sup>57</sup> Provisions of Part 7 and Annex F relating to the form or contents of the international application would automatically, by virtue of Article 27(1), be applicable to designated Offices. Communications between applicants and designated Offices would not, however, be governed in general by Annex F.

<sup>58</sup> In relation to Sections 703(a) and 710, an Office acting in more than one capacity (receiving Office, International Searching Authority and/or International Preliminary Examining Authority) would give separate notices to the International Bureau, in each capacity, as to its readiness to receive and process international applications in electronic form.

<sup>59</sup> “Designated Offices” necessarily includes elected Offices.

<sup>60</sup> See Rule 89.3 and Annex F, sections 5.2.2 and 5.2.3.

<sup>61</sup> As to communications between applicants and designated Offices, see footnote 58.

<sup>62</sup> See Section 704(g) in relation to the international phase, and Annex F, section 3.3.

**PART 8**

**INSTRUCTIONS RELATING TO INTERNATIONAL APPLICATIONS  
CONTAINING LARGE NUCLEOTIDE AND/OR AMINO ACID SEQUENCE  
LISTINGS AND/OR TABLES RELATING THERETO**

**Section 801**

**Filing of International Applications Containing  
Sequence Listings and/or Tables**

(a) Pursuant to Rules 89<sup>bis</sup> and 89<sup>ter</sup>, where an international application contains disclosure of one or more nucleotide and/or amino acid sequence listings (“sequence listings”), the receiving Office may, if it is prepared to do so, accept that the sequence listing part of the description, as referred to in Rule 5.2(a) and/or any table related to the sequence listing(s) (“sequence listings and/or tables”), be filed, at the option of the applicant:

(i) only on an electronic medium in the computer readable form referred to in Section 802; or

(ii) both on an electronic medium in that computer readable form and on paper in the written form referred to in Section 802;

provided that the other elements of the international application are filed as otherwise provided for under the Regulations and these Instructions.

(b) Any receiving Office which is prepared to accept the filing in computer readable form of the sequence listings and/or tables under paragraph (a) shall notify the International Bureau accordingly. The notification shall specify the electronic media on which the receiving Office will accept such filings. The International Bureau shall promptly publish any such information in the Gazette.

(c) A receiving Office which has not made a notification under paragraph (b) may nevertheless decide in a particular case to accept an international application the sequence listings and/or tables of which are filed with it under paragraph (a).

(d) Where the sequence listings and/or tables are filed in computer readable form under paragraph (a) but not on an electronic medium specified by the receiving Office under paragraph (b), that Office shall, under Article 14(1)(a)(v), invite the applicant to furnish to it replacement sequence listings and/or tables on an electronic medium specified under paragraph (b).

(e) Where an international application containing sequence listings and/or tables in computer readable form is filed under paragraph (a) with a receiving Office which is not prepared, under paragraph (b) or (c), to accept such filings, Section 333(b) and (c) shall apply.

**Section 802**

**Format and Identification Requirements Relating  
to International Applications Containing Sequence  
Listings and/or Tables**

(a) Paragraphs 40 to 45 of Annex C shall apply *mutatis mutandis* to the sequence listing part of an international application filed in computer readable form.

(b) Tables filed in computer readable form under Section 801(a) shall comply with Annex C-*bis*.

(b-*bis*) Any International Searching Authority which requires that sequence listings be furnished in computer readable form shall select from the technical requirements contained in Annex C-*bis* those which it will apply and it shall notify the International Bureau accordingly. The International Bureau shall promptly publish any such information in the Gazette.

(b-*ter*) Where sequence listings and tables are both filed in computer readable form under Section 801(a), such listings and tables shall, respectively, be contained on separate electronic carriers which shall contain no other programs or files.

(b-*quater*) Rule 13<sup>ter</sup>.1 shall apply *mutatis mutandis* to any tables not complying with Annex C-*bis* and paragraph (b-*ter*)

(c) The label provided for in paragraph 44 of Annex C shall, in respect of the sequence listings and/or tables, also include, as the case may be, the following indications:

(i) that the sequence listings and/or tables are filed under Section 801(a);

(ii) where the sequence listings and/or tables in computer readable form are contained on more than one electronic carrier, the numbering of each such



carrier (for example, “DISK 1/3,” “DISK 2/3,” “DISK 3/3”);

(iii) where more than one copy of the sequence listings and/or tables in computer readable form has been filed, the numbering of each copy (for example, “COPY 1,” “COPY 2,” “COPY 3”).

(d) Where any correction under Rule 26.3, any rectification of an obvious error under Rule 91, or any amendment under Article 34 is submitted in respect of the sequence listings and/or tables filed, under Section 801(a)(i) or (ii), in computer readable form, replacement sequence listings and/or tables in computer readable form containing the entirety of the sequence listings and/or tables with the relevant correction, rectification or amendment shall be furnished and the label referred to in paragraph (c) shall be marked accordingly (for example, “SUBMITTED FOR CORRECTION,” “SUBMITTED FOR RECTIFICATION,” “SUBMITTED FOR AMENDMENT”). Where the sequence listings and/or tables were filed both in computer readable form and in written form under Section 801(a)(ii), replacement sheets containing the correction, rectification or amendment in question shall also be submitted in written form.

### Section 803

#### Calculation of International Filing Fee for International Applications Containing Sequence Listings and/or Tables

Where sequence listings and/or tables are filed in electronic form under Section 801(a), the international filing fee payable in respect of that application shall include the following two components:

(i) a basic component calculated as provided in the Schedule of Fees in respect of all pages filed on paper (that is, all pages of the request, description (excluding sequence listings and/or tables if also filed on paper), claims, abstract and drawings), and

(ii) an additional component, in respect of the sequence listings and/or tables, equal to 400 times the fee per sheet as referred to in item 1 of the Schedule of Fees, regardless of the actual length of the sequence listings and/or tables filed in computer readable form and regardless of the fact that sequence listings and/or tables may have been filed both in written form and in computer readable form.

### Section 804

#### Preparation, Identification and Transmittal of Copies of International Applications Containing Sequence Listings and/or Tables

(a) Where the sequence listings and/or tables are filed only in computer readable form under Section 801(a)(i), the record copy for the purposes of Article 12 shall consist of those elements of the international application filed on paper together with the sequence listings and/or tables filed in computer readable form.

(b) Where sequence listings and/or tables are filed both in computer readable form and in written form under Section 801(a)(ii), the record copy for the purposes of Article 12 shall consist of all the elements of the international application filed on paper, including the sequence listings and/or tables in written form.

(c) Where sequence listings and/or tables are filed in computer readable form under Section 801(a)(i) or (ii) in less than the number of copies required for the purposes of this Section, the receiving Office shall either:

(i) promptly prepare any additional copies required, in which case it shall have the right to fix a fee for performing that task and to collect such fee from the applicant; or

(ii) invite the applicant to promptly furnish the additional number of copies required, accompanied by a statement that the sequence listings and/or tables in computer readable form contained in those copies are identical to the sequence listings and/or tables in computer readable form as filed;

provided that, where those sequence listings and/or tables were also filed in written form under Section 801(a)(ii), the receiving Office shall not, notwithstanding Rule 11.1(b), require the applicant to file additional copies of the sequence listings and/or tables in written form.

(d) Where the sequence listings and/or tables are filed under Section 801(a)(i), the receiving Office shall, in addition to proceeding under Section 305 with respect to the parts of the international application filed on paper:

(i) mark the words “RECORD COPY—SEQUENCE LISTINGS AND/OR TABLES” on the original electronic medium containing the sequence listings and/or tables part in computer readable form

## ADMINISTRATIVE INSTRUCTIONS UNDER THE PCT

and transmit that part of the record copy to the International Bureau together with the paper part of the record copy;

(ii) mark the words “SEARCH COPY—SEQUENCE LISTINGS AND/OR TABLES” on one additional copy of the electronic medium containing the sequence listings and/or tables in computer readable form and transmit that part of the search copy to the International Searching Authority, for the purposes of Rule 13<sup>ter</sup>.1, together with the paper part of the search copy;

(iii) mark the words “HOME COPY—SEQUENCE LISTINGS AND/OR TABLES” on the other such copy of the electronic medium containing the sequence listings and/or tables in computer readable form and keep that part of the home copy in its files together with the paper part of the home copy.

(e) Where the sequence listings and/or tables are filed under Section 801(a)(ii), the receiving Office shall, in addition to proceeding under Section 305 with respect to the parts of the international application filed on paper:

(i) mark the words “RECORD COPY—SEQUENCE LISTINGS AND/OR TABLES” in the upper left-hand corner of the first page of the sequence listing and of the first page of the first table in written form and transmit that part of the record copy to the International Bureau together with the paper part of the record copy; it shall also mark the words “COPY FOR INTERNATIONAL BUREAU—SEQUENCE LISTINGS AND/OR TABLES” on one copy of the electronic medium containing the sequence listings and/or tables in computer readable form and transmit that copy with the record copy;

(ii) mark the words “SEARCH COPY—SEQUENCE LISTINGS AND/OR TABLES” on one additional copy of the electronic medium containing the sequence listings and/or tables in computer readable form and transmit that part of the search copy to the International Searching Authority, for the purposes of Rule 13<sup>ter</sup>.1, together with the paper part of the search copy;

(iii) mark the words “HOME COPY—SEQUENCE LISTINGS AND/OR TABLES” on the other such copy of the electronic medium containing the sequence listings and/or tables in computer readable form and keep that part of the home copy in its files together with the paper part of the home copy.

(f) The receiving Office may, when marking the copies referred to in paragraphs (d) and (e), use, instead of the words referred to in those paragraphs, the equivalent of those words in the language of publication of the international application.

### Section 805

#### Publication and Communication of International Applications Containing Sequence Listings and/or Tables; Copies; Priority Documents

(a) Notwithstanding Section 406, an international application containing sequence listings and/or tables may be published under Article 21, in whole or in part, in electronic form as determined by the Director General.

(b) Paragraph (a) shall apply *mutatis mutandis* in relation to:

(i) the communication of an international application under Article 20;

(ii) the furnishing of copies of an international application under Rules 87 and 94.1;

(iii) the furnishing under Rule 17.1, as a priority document, of a copy of an international application containing sequence listings and/or tables filed under Section 801(a);

(iv) the furnishing under Rules 17.2 and 66.7 of copies of a priority document.

### Section 806

#### Sequence Listings and/or Tables for Designated Office

(a) Where sequence listings and/or tables were filed only in computer readable form under Section 801(a)(i), any designated Office which does not accept the filing of sequence listings and/or tables in computer readable form may require that the applicant furnish to it, for the purposes of the national phase, a copy on paper of such sequence listings in written form complying with Annex C and a copy on paper of such tables in written form, accompanied by a statement that the sequence listings and/or tables in written form are identical to the sequence listings and/or tables in computer readable form.

(b) Rule 13<sup>ter</sup>.2 shall apply *mutatis mutandis* to any tables filed under Section 801(a).

(c) For the purposes of Rule 49.5, any designated Office may require that the applicant furnish to

MANUAL OF PATENT EXAMINING PROCEDURE

it a translation of any text matter contained in any tables filed under Section 801(a), if that text matter is not in the language-neutral vocabulary referred to in

Annex C and if it does not appear in the main part of the description in the language thereof.  
[Annexes follow]

ADMINISTRATIVE INSTRUCTIONS UNDER THE PCT

**ANNEX A**

**FORMS**

*[This Annex, which is not reproduced here, contains Forms for use by applicants and by the International Authorities, including those referred to in Section 102 of the Administrative Instructions. It consists of five Parts, which are available separately from WIPO, as follows:*

*Part I: Forms Relating to the Receiving Office;*

*Part II: Forms Relating to the International Searching Authority;*

*Part III: Forms Relating to the International Bureau;*

*Part IV: Forms Relating to the International Preliminary Examining Authority;*

*Part V: Request and Demand Forms.]*

[Annex B follows]

## ANNEX B

### UNITY OF INVENTION

#### PART 1

#### INSTRUCTIONS CONCERNING UNITY OF INVENTION

(a) **Unity of Invention.** Rule 13.1 deals with the requirement of unity of invention and states the principle that an international application should relate to only one invention or, if there is more than one invention, that the inclusion of those inventions in one international application is only permitted if all inventions are so linked as to form a single general inventive concept.

(b) **Technical Relationship.** Rule 13.2 defines the method for determining whether the requirement of unity of invention is satisfied in respect of a group of inventions claimed in an international application. Unity of invention exists only when there is a technical relationship among the claimed inventions involving one or more of the same or corresponding special technical features. The expression “special technical features” is defined in Rule 13.2 as meaning those technical features that define a contribution which each of the inventions, considered as a whole, makes over the prior art. The determination is made on the contents of the claims as interpreted in light of the description and drawings (if any).

(c) **Independent and Dependent Claims.** Unity of invention has to be considered in the first place only in relation to the independent claims in an international application and not the dependent claims. By “dependent” claim is meant a claim which contains all the features of another claim and is in the same category of claim as that other claim (the expression “category of claim” referring to the classification of claims according to the subject matter of the invention claimed for example, product, process, use or apparatus or means, etc.).

(i) If the independent claims avoid the prior art and satisfy the requirement of unity of invention, no problem of lack of unity arises in respect of any claims that depend on the independent claims. In particular, it does not matter if a dependent claim itself contains a further invention. Equally, no problem arises in the case of a genus/species situation where

the genus claim avoids the prior art. Moreover, no problem arises in the case of a combination/subcombination situation where the subcombination claim avoids the prior art and the combination claim includes all the features of the subcombination.

(ii) If, however, an independent claim does not avoid the prior art, then the question whether there is still an inventive link between all the claims dependent on that claim needs to be carefully considered. If there is no link remaining, an objection of lack of unity *a posteriori* (that is, arising only after assessment of the prior art) may be raised. Similar considerations apply in the case of a genus/species or combination/subcombination situation.

(iii) This method for determining whether unity of invention exists is intended to be applied even before the commencement of the international search. Where a search of the prior art is made, an initial determination of unity of invention, based on the assumption that the claims avoid the prior art, may be reconsidered on the basis of the results of the search of the prior art.

(d) **Illustrations of Particular Situations.** There are three particular situations for which the method for determining unity of invention contained in Rule 13.2 is explained in greater detail:

- (i) combinations of different categories of claims;
- (ii) so-called “Markush practice”; and
- (iii) intermediate and final products.

Principles for the interpretation of the method contained in Rule 13.2, in the context of each of those situations are set out below. It is understood that the principles set out below are, in all instances, interpretations of and not exceptions to the requirements of Rule 13.2.

Examples to assist in understanding the interpretation on the three areas of special concern referred to in the preceding paragraph are set out below.

(e) **Combinations of Different Categories of Claims.** The method for determining unity of invention under Rule 13 shall be construed as permitting, in particular, the inclusion of any one of the following combinations of claims of different categories in the same international application:

(i) in addition to an independent claim for a given product, an independent claim for a process specially adapted for the manufacture of the said product, and an independent claim for a use of the said product, or

(ii) in addition to an independent claim for a given process, an independent claim for an apparatus or means specifically designed for carrying out the said process, or

(iii) in addition to an independent claim for a given product, an independent claim for a process specially adapted for the manufacture of the said product and an independent claim for an apparatus or means specifically designed for carrying out the said process, it being understood that a process is specially adapted for the manufacture of a product if it inherently results in the product and that an apparatus or means is specifically designed for carrying out a process if the contribution over the prior art of the apparatus or means corresponds to the contribution the process makes over the prior art.

Thus, a process shall be considered to be specially adapted for the manufacture of a product if the claimed process inherently results in the claimed product with the technical relationship being present between the claimed product and claimed process. The words “specially adapted” are not intended to imply that the product could not also be manufactured by a different process.

Also an apparatus or means shall be considered to be “specifically designed for carrying out” a claimed process if the contribution over the prior art of the apparatus or means corresponds to the contribution the process makes over the prior art. Consequently, it would not be sufficient that the apparatus or means is merely capable of being used in carrying out the claimed process. However, the expression “specifically designed” does not imply that the apparatus or means could not be used for carrying out another process, nor that the process could not be carried out using an alternative apparatus or means.

(f) **“Markush Practice.”** The situation involving the so-called “Markush practice” wherein a single claim defines alternatives (chemical or non-chemical) is also governed by Rule 13.2. In this special situation, the requirement of a technical interrelationship and the same or corresponding special technical features as defined in Rule 13.2, shall be considered to be met when the alternatives are of a similar nature.

(i) When the Markush grouping is for alternatives of chemical compounds, they shall be regarded as being of a similar nature where the following criteria are fulfilled:

(A) all alternatives have a common property or activity, and

(B)(1) a common structure is present, i.e., a significant structural element is shared by all of the alternatives, or

(B)(2) in cases where the common structure cannot be the unifying criteria, all alternatives belong to a recognized class of chemical compounds in the art to which the invention pertains.

(ii) In paragraph (f)(i)(B)(1), above, the words “significant structural element is shared by all of the alternatives” refer to cases where the compounds share a common chemical structure which occupies a large portion of their structures, or in case the compounds have in common only a small portion of their structures, the commonly shared structure constitutes a structurally distinctive portion in view of existing prior art. The structural element may be a single component or a combination of individual components linked together.

(iii) In paragraph (f)(i)(B)(2), above, the words “recognized class of chemical compounds” mean that there is an expectation from the knowledge in the art that members of the class will behave in the same way in the context of the claimed invention. In other words, each member could be substituted one for the other, with the expectation that the same intended result would be achieved.

(iv) The fact that the alternatives of a Markush grouping can be differently classified shall not, taken alone, be considered to be justification for a finding of a lack of unity of invention.

(v) When dealing with alternatives, if it can be shown that at least one Markush alternative is not novel over the prior art, the question of unity of invention shall be reconsidered by the examiner.

Reconsideration does not necessarily imply that an objection of lack of unity shall be raised.

(g) **Intermediate and Final Products.** The situation involving intermediate and final products is also governed by Rule 13.2.

(i) The term “intermediate” is intended to mean intermediate or starting products. Such products have the ability to be used to produce final products through a physical or chemical change in which the intermediate loses its identity.

(ii) Unity of invention shall be considered to be present in the context of intermediate and final products where the following two conditions are fulfilled:

(A) the intermediate and final products have the same essential structural element, in that:

(1) the basic chemical structures of the intermediate and the final products are the same, or

(2) the chemical structures of the two products are technically closely interrelated, the intermediate incorporating an essential structural element into the final product, and

(B) the intermediate and final products are technically interrelated, this meaning that the final product is manufactured directly from the intermediate or is separated from it by a small number of intermediates all containing the same essential structural element.

(iii) Unity of invention may also be considered to be present between intermediate and final products of which the structures are not known—for example, as between an intermediate having a known structure and a final product the structure of which is not known, or as between an intermediate of unknown structure and a final product of unknown structure. In order to satisfy unity in such cases, there shall be sufficient evidence to lead one to conclude that the intermediate and final products are technically closely interrelated as, for example, when the intermediate contains the same essential element as the final product or incorporates an essential element into the final product.

(iv) It is possible to accept in a single international application different intermediate products used in different processes for the preparation of the final product, provided that they have the same essential structural element.

(v) The intermediate and final products shall not be separated, in the process leading from one to the other, by an intermediate which is not new.

(vi) If the same international application claims different intermediates for different structural parts of the final product, unity shall not be regarded as being present between the intermediates.

(vii) If the intermediate and final products are families of compounds, each intermediate compound shall correspond to a compound claimed in the family of the final products. However, some of the final products may have no corresponding compound in the family of the intermediate products so that the two families need not be absolutely congruent.

(h) As long as unity of invention can be recognized applying the above interpretations, the fact that, besides the ability to be used to produce final products, the intermediates also exhibit other possible effects or activities shall not affect the decision on unity of invention.

(i) Rule 13.3 requires that the determination of the existence of unity of invention be made without regard to whether the inventions are claimed in separate claims or as alternatives within a single claim.

(j) Rule 13.3 is not intended to constitute an encouragement to the use of alternatives within a single claim, but is intended to clarify that the criterion for the determination of unity of invention (namely, the method contained in Rule 13.2) remains the same regardless of the form of claim used.

(k) Rule 13.3 does not prevent an International Searching or Preliminary Examining Authority or an Office from objecting to alternatives being contained within a single claim on the basis of considerations such as clarity, the conciseness of claims or the claims fee system applicable in that Authority or Office.

*[ANNEX B, CONTINUED]*  
**PART 2**

**EXAMPLES CONCERNING UNITY OF INVENTION**

The application of the principles of unity of invention is illustrated by the following examples for guidance in particular cases.

**I. CLAIMS IN DIFFERENT CATEGORIES**

**Example 1**

Claim 1: A method of manufacturing chemical substance X.

Claim 2: Substance X.

Claim 3: The use of substance X as an insecticide.

Unity exists between claims 1, 2 and 3. The special technical feature common to all the claims is substance X.

**Example 2**

Claim 1: A process of manufacture comprising steps A and B.

Claim 2: Apparatus specifically designed for carrying out step A.

Claim 3: Apparatus specifically designed for carrying out step B.

Unity exists between claims 1 and 2 or between claims 1 and 3. There is no unity between claims 2 and 3 since there exists no common special technical feature between the two claims.

**Example 3**

Claim 1: A process for painting an article in which the paint contains a new rust inhibiting substance X including the steps of atomizing the paint using compressed air, electrostatically charging the atomized paint using a novel electrode arrangement A and directing the paint to the article.

Claim 2: A paint containing substance X.

Claim 3: An apparatus including electrode arrangement A.

Unity exists between claims 1 and 2 where the common special technical feature is the paint containing substance X or between claims 1 and 3 where the common special technical feature is the electrode arrangement A.

However, unity is lacking between claims 2 and 3 since there exists no common special technical feature between them.

**Example 4**

Claim 1: Use of a family of compounds X as insecticides.

Claim 2: Compound X<sub>1</sub> belonging to family X.

Provided X<sub>1</sub> has the insecticidal activity and the special technical feature in claim 1 is the insecticidal use, unity is present.



**Example 5**

- Claim 1: A process for treating textiles comprising spraying the material with a particular coating composition under special conditions (e.g., as to temperature, irradiation).
- Claim 2: A textile material coated according to the process of claim 1.
- Claim 3: A spraying machine for use in the process of claim 1 and characterized by a new nozzle arrangement providing a better distribution of the composition being sprayed.

The process according to claim 1 imparts unexpected properties to the product of claim 2.

The special technical feature in claim 1 is the use of special process conditions corresponding to what is made necessary by the choice of the particular coating. Unity exists between claims 1 and 2.

The spraying machine in claim 3 does not correspond to the above identified special technical feature. Unity does not exist between claim 3 and claims 1 and 2.

**Example 6**

- Claim 1: A fuel burner with tangential fuel inlets into a mixing chamber.
- Claim 2: A process for making a fuel burner including the step of forming tangential fuel inlets into a mixing chamber.
- Claim 3: A process for making a fuel burner including casting step A.
- Claim 4: An apparatus for carrying out a process for making a fuel burner including feature X resulting in the formation of tangential fuel inlets.
- Claim 5: An apparatus for carrying out a process for making a fuel burner including a protective housing B.
- Claim 6: A process of manufacturing carbon black including the step of tangentially introducing fuel into a mixing chamber of a fuel burner.

Unity exists between claims 1, 2, 4, and 6. The special technical feature common to all the claims is the tangential fuel inlets. Claims 3 and 5 lack unity with claims 1, 2, 4, and 6 since claims 3 and 5 do not include the same or corresponding special technical feature as set forth in claims 1, 2, 4, and 6. Claims 3 and 5 would also lack unity with one another.

**Example 7**

- Claim 1: A high corrosion resistant and high strength ferritic stainless steel strip consisting essentially of, in percent by weight: Ni=2.0-5.0; Cr=15-19; Mo=1-2; and the balance Fe having a thickness of between 0.5 and 2.0 mm and a 0.2% yield strength in excess of 50 kg/mm squared.
- Claim 2: A method of producing a high corrosion resistant and high strength ferritic stainless steel strip consisting essentially of, in percent by weight: Ni=2.0-5.0; Cr=15-19; Mo=1-2; and the balance Fe, comprising the steps of: hot rolling to a thickness between 2.0 and 5.0 mm; annealing the hot rolled strip at 800-1000 degrees C under substantially no oxidizing conditions; cold rolling the strip to a thickness of between 0.5 and 2.0 mm; and final annealing the cold rolled strip at between 1120 and 1200 degrees C for a period of 2-5 minutes.

## ADMINISTRATIVE INSTRUCTIONS UNDER THE PCT

Unity exists between product claim 1 and process claim 2. The special technical feature in the product claim is the 0.2% yield strength in excess of 50 kg/mm squared. The process steps in claim 2 inherently produce a ferritic stainless steel strip with a 0.2% yield strength in excess of 50 kg/mm squared. Even if this feature is not apparent from the wording of claim 2, it is clearly disclosed in the description. Therefore said process steps are the special technical feature which correspond to the limitation in the product claim directed to the same ferritic stainless steel with the claimed strength characteristics.

### II. CLAIMS IN THE SAME CATEGORY

#### Example 8

Claim 1: Plug characterized by feature A.

Claim 2: Socket characterized by corresponding feature A.

Feature A is a special technical feature which is included in both claims 1 and 2 and therefore unity is present.

#### Example 9

Claim 1: Transmitter provided with time axis expander for video signals.

Claim 2: Receiver provided with time axis compressor for video signals received.

Claim 3: Transmission equipment for video signals comprising a transmitter provided with time axis expander for video signals and a receiver provided with time axis compressor for video signals received.

The special technical features are in claim 1 the time axis expander, and in claim 2 the time axis compressor, which are corresponding technical features. Unity exists between claims 1 and 2. Claim 3 includes both special technical features and has unity with claims 1 and 2. The requirement for unity would still be met in the absence of the combination claim (claim 3).

#### Example 10

Claim 1: Conveyor belt with feature A.

Claim 2: Conveyor belt with feature B.

Claim 3: Conveyor belt with features A + B.

Feature A is a special technical feature and feature B is another unrelated special technical feature. Unity exists between claims 1 and 3 or between claims 2 and 3, but not between claims 1 and 2.

#### Example 11

Claim 1: Control circuit A for a d.c. motor.

Claim 2: Control circuit B for a d.c. motor.

Claim 3: An apparatus including a d.c. motor with control circuit A.

Claim 4: An apparatus including a d.c. motor with control circuit B.

Control circuit A is a special technical feature and control circuit B is another unrelated special technical feature. Unity exists between claims 1 and 3 or between claims 2 and 4, but not between claims 1 and 2 or 3 and 4.

**Example 12**

Claim 1: A display with features A + B.

Claim 2: A display according to claim 1 with additional feature C.

Claim 3: A display with features A + B with additional feature D.

Unity exists between claims 1, 2, and 3. The special technical feature common to all the claims is features A + B.

**Example 13**

Claim 1: Filament A for a lamp.

Claim 2: Lamp B having filament A.

Claim 3: Searchlight provided with lamp B having filament A and a swivel arrangement C.

Unity exists between claims 1, 2, and 3. The special technical feature common to all the claims is the filament A.

**Example 14**

Claim 1: A marking device for marking animals, comprising a disc-shaped element with a stem extending normally therefrom, the tip of which is designed to be driven through the skin of the animal to be marked, and a securing disk element to be fastened to the protruding tip of the stem on the other side of skin.

Claim 2: An apparatus for applying the marking device of claim 1, constructed as a pneumatically actuated gun for driving the stem of the disc-shaped element through the skin, and provided with a supporting surface adapted for taking up a securing disc element, to be placed at the other side of the body portion in question of the animal to be marked.

The special technical feature in claim 1 is the marking device having a disc-shaped element with a stem and a securing disc element to be fastened to the tip of the stem. The corresponding special technical feature in claim 2 is the pneumatically actuated gun for driving the marking device and having a supporting surface for the securing disc element. Unity exists between claims 1 and 2.

**Example 15**

Claim 1: Compound A.

Claim 2: An insecticide composition comprising compound A and a carrier.

Unity exists between claims 1 and 2. The special technical feature common to all the claims is compound A.

**Example 16**

Claim 1: An insecticide composition comprising compound A (consisting of  $a_1, a_2, \dots$ ) and a carrier.

Claim 2: Compound  $a_1$ .

## ADMINISTRATIVE INSTRUCTIONS UNDER THE PCT

All compounds A are not claimed in the product claim 2 for reasons of lack of novelty of some of them for instance. There is nevertheless still unity between the subject matter of claims 1 and 2 provided a 1 has the insecticidal activity which is also the special technical feature for compound A in claim 1.

### Example 17

Claim 1: Protein X

Claim 2: DNA sequence encoding protein X.

Expression of the DNA sequence in a host results in the production of a protein which is determined by the DNA sequence. The protein and the DNA sequence exhibit corresponding special technical features. Unity between claims 1 and 2 is accepted.

### III. MARKUSH PRACTICE

Example 18— common structure:

Claim 1: A compound of the formula:

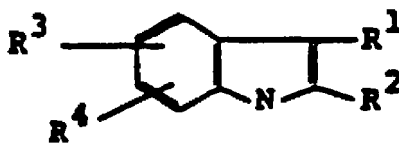

wherein R<sup>1</sup> is selected from the group consisting of phenyl, pyridyl, thiazolyl, triazinyl, alkylthio, alkoxy, and methyl; R<sup>2</sup>-R<sup>4</sup> are methyl, benzyl, or phenyl. The compounds are useful as pharmaceuticals for the purpose of enhancing the capacity of the blood to absorb oxygen.

In this case the indolyl moiety is the significant structural element which is shared by all of the alternatives. Since all the claimed compounds are alleged to possess the same utility, unity is present.

Example 19— common structure:

Claim 1: A compound of the formula:

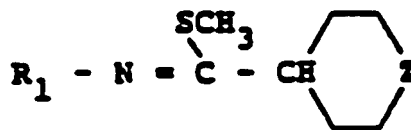

wherein R<sub>1</sub> is selected from the group consisting of phenyl, pyridyl, thiazolyl, triazinyl, alkylthio, alkoxy, and methyl; Z is selected from the group consisting of oxygen (O), sulfur (S), imino (NH), and methylene (-CH<sub>2</sub>-). The compounds are alleged to be useful as pharmaceuticals for relieving lower back pain.

MANUAL OF PATENT EXAMINING PROCEDURE

In this particular case the iminothioether group  $-N=C-SCH_3$  linked to a six atom ring is the significant structural element which is shared by all the alternatives. Thus, since all the claimed compounds are alleged to possess the same use, unity would be present. A six membered heterocyclic ring would not have been of sufficient similarity to allow a Markush grouping exhibiting unity, absent some teaching of equivalence in the prior art.

**Example 20**— common structure

Claim 1: A compound of the formula:

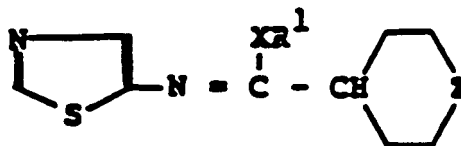

wherein  $R^1$  is methyl or phenyl, X and Z are selected from oxygen (O) and sulfur (S).

The compounds are useful as pharmaceuticals and contain the 1,3-thiazolyl substituent which provides greater penetrability of mammalian tissue which fact makes the compounds useful as relievers for headaches and as topical anti-inflammatory agents.

All compounds share a common chemical structure, the thiazole ring and the six atom heterocyclic compound bound to an imino group, which occupy a large portion of their structure. A six membered heterocyclic ring would not have been of sufficient similarity to allow a Markush grouping exhibiting unity, absent some teaching of equivalence in the prior art.

**Example 21**— common structure:

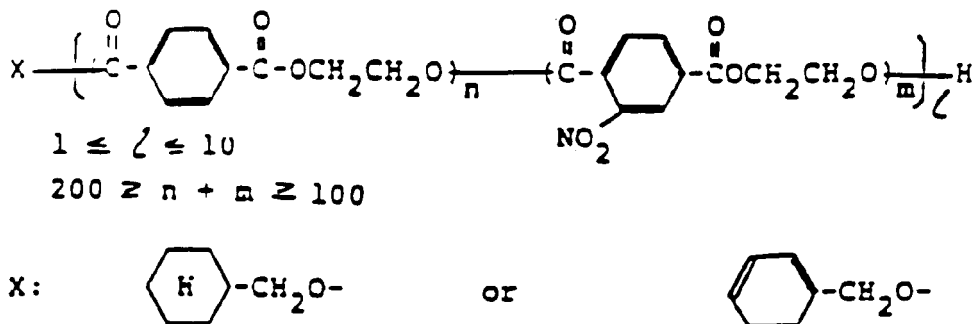

All of the above copolymers have in common a thermal degradation resistance property, due to the reduced number of free COOH radicals by esterification with X of the end COOH radicals which cause thermal degradation. The chemical structures of the alternatives are considered to be technically closely interrelated to one another. A grouping in one claim is therefore allowed.

ADMINISTRATIVE INSTRUCTIONS UNDER THE PCT

**Example 22**— common structure:

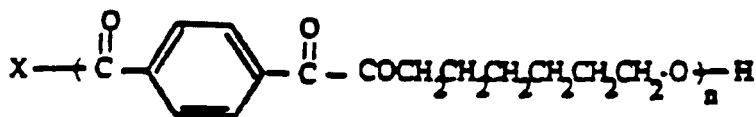

(polyhexamethyleneterephthalate)

$100 \geq n \geq 50$

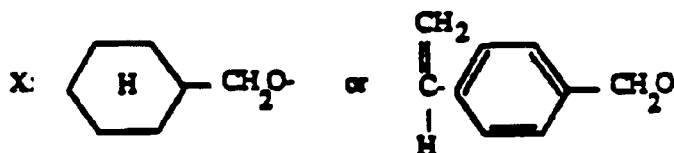

The compound obtained by esterifying the end COOH radical of known polyhexamethyleneterephthalate with  $\text{C}_6\text{H}_{11}\text{CH}_2\text{O}-$  has a thermal degradation resistant property, due to the reduced number of free COOH radicals which cause thermal degradation. In contrast, the compound obtained by esterifying the end COOH radical of known polyhexamethyleneterephthalate with a vinyl compound containing a  $\text{CH}_2 = \text{CH}-\text{C}_6\text{H}_4-\text{CH}_2\text{O}-$  moiety serves as a raw material for a setting resin when mixed with unsaturated monomer and cured (addition reaction).

All esters covered by the claim do not have a property or activity in common. For example, the product obtained through esterification with the “ $\text{CH}_2 = \text{CH}$ ” vinyl compound does not have a thermal degradation resistant property. The grouping in a single application is not allowed.

**Example 23**— No common structure:

Claim 1: A herbicidal composition consisting essentially of an effective amount of the mixture of A 2,4-D(2,4-dichlorophenoxy acetic acid) and B a second herbicide selected from the group consisting of copper sulfate, sodium chlorate, ammonium sulfamate, sodium trichloroacetate, dichloropropionic acid, 3-amino-2,5-dichlorobenzoic acid, diphenamid (an amide), ioxynil (nitrile), dinoseb (phenol), trifluralin (dinitroaniline), EPTC (thiocarbamate), and simazine (triazine) along with an inert carrier or diluent.

The different components under B must be members of a recognized class of compounds. Consequently in the present case a unity objection would be raised because the members of B are not recognized as a class of compounds, but, in fact, represent a plurality of classes which may be identified as follows:

- a) **inorganic salts:**
- copper sulfate
  - sodium chlorate
  - ammonium sulfamate

b) **organic salts and carboxylic acids:**

sodium trichloroacetate

dichloropropionic acid

3-amino-2,5-dichlorobenzoic acid

c) **amides:**

diphenamid

d) **nitriles:**

ioxynil

e) **phenols:**

dinoseb

f) **amines:**

trifluralin

g) **heterocyclic:**

simazine

**Example 24**

Claim 1: Catalyst for vapor phase oxidation of hydrocarbons, which consists of (X) or (X + a).

In this example (X) oxidizes  $RCH_3$  into  $RCH_2OH$  and (X+a) oxidizes  $RCH_3$  further into  $RCOOH$ .

Both catalysts share a common component and a common activity as oxidation catalyst for  $RCH_3$ . With (X+a) the oxidation is more complete and goes until the carboxylic acid is formed but the activity still remains the same.

A Markush grouping is acceptable.

**IV. INTERMEDIATE/FINAL PRODUCTS**

**Example 25**

Claim 1:

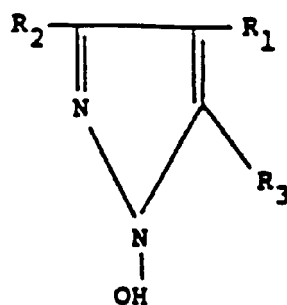

(intermediate)

ADMINISTRATIVE INSTRUCTIONS UNDER THE PCT

Claim 2:

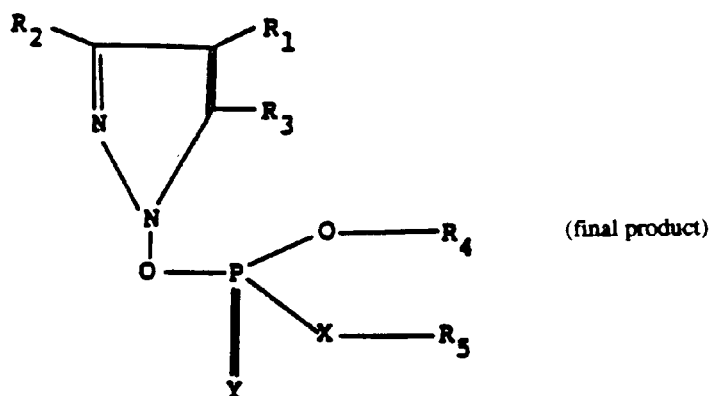

The chemical structures of the intermediate and final product are technically closely interrelated. The essential structural element incorporated into the final product is:

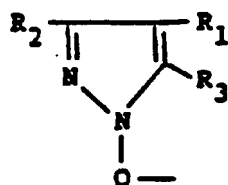

Therefore, unity exists between claims 1 and 2.

**Example 26**

Claim 1:

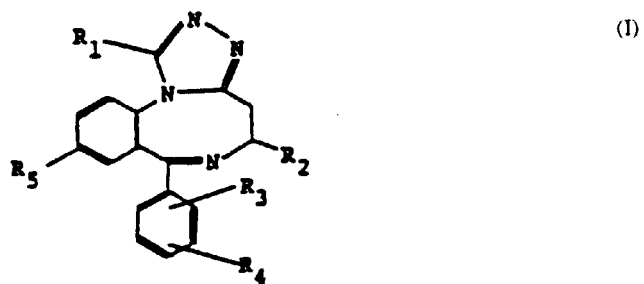



Claim 2:

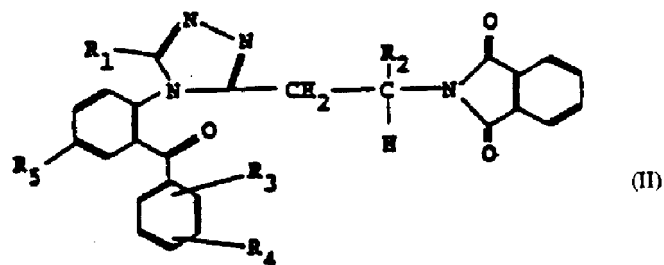

(II) is described as an intermediate to make (I). The closure mechanism is one well known in the art. Though the basic structures of compound (I) (final product) and compound (II) (intermediate) differ considerably, compound (II) is an open ring precursor to compound (I). Both compounds share a common essential structural element which is the linkage comprising the two phenyl rings and the triazole ring. The chemical structures of the two compounds are therefore considered to be technically closely interrelated.

The example therefore satisfies the requirement for unity of invention.

#### Example 27

Claim 1: Amorphous polymer A (intermediate).

Claim 2: Crystalline polymer A (final product).

In this example a film of the amorphous polymer A is stretched to make it crystalline. Here unity exists because there is an intermediate final product relation in that amorphous polymer A is used as a starting product to prepare crystalline polymer A.

For purposes of further illustration, assume that the polymer A in this example is polyisoprene. Here the intermediate, amorphous polyisoprene, and the final product, crystalline polyisoprene, have the same chemical structure.

#### Example 28

Claim 1: Polymeric compound useful as fiber material identified by the following general formula:

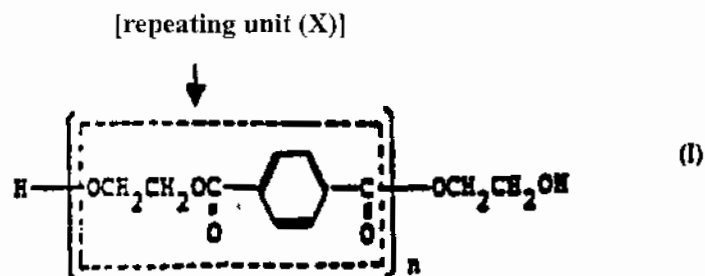

Claim 2: Compound identified by the following general formula: (useful as intermediate for polymeric compound I)

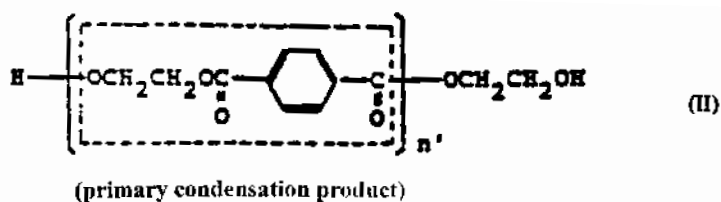

The two inventions are in an intermediate and final product relationship.

Substance (II) is a raw material for substance (I).

Meanwhile, both compounds share an essential structural element (repeating unit (X)) and are technically closely interrelated. The intermediate and final products therefore satisfy the requirements for unity.

### Example 29

Claim 1: Novel compound having structure A (Intermediate).

Claim 2: Product prepared by reacting A with a substance X (Final Product).

### Example 30

Claim 1: Reaction product of A and B (Intermediate).

Claim 2: Product prepared by reacting the reaction product of A and B with substances X and Y (Final Product).

In examples 29 and 30 the chemical structure(s) of the intermediate and/or the final product is not known. In (29) the structure of the product of claim 2 (the final product) is not known. In (30) the structures of the products of claim 1 (the intermediate) and claim 2 (the final product) are unknown. Unity exists if there is evidence which would lead one to conclude that the characteristic of the final product which is the inventive feature in the case is due to the intermediate. For example, the purpose for using the intermediates in (29) or (30) is to modify certain properties of the final product. The evidence may be in the form of test data in the specification showing the effect of the intermediate on the final product. If no such evidence exists then there is no unity on the basis of an intermediate-final product relationship.

[Annex C follows]

## ANNEX C

# STANDARD FOR THE PRESENTATION OF NUCLEOTIDE AND AMINO ACID SEQUENCE LISTINGS IN INTERNATIONAL PATENT APPLICATIONS UNDER THE PCT

### Introduction

1. This Standard has been elaborated so as to provide standardization of the presentation of nucleotide and amino acid sequence listings in international patent applications. The Standard is intended to allow the applicant to draw up a single sequence listing which is acceptable to all receiving Offices, International Searching and Preliminary Examining Authorities for the purposes of the international phase, and to all designated and elected Offices for the purposes of the national phase. It is intended to enhance the accuracy and quality of presentations of nucleotide and amino acid sequences given in international applications, to make for easier presentation and dissemination of sequences for the benefit of applicants, the public and examiners, to facilitate searching of sequence data and to allow the exchange of sequence data in electronic form and the introduction of sequence data onto computerized databases.

### Definitions

2. For the purposes of this Standard:

(i) the expression “sequence listing” means a part of the description of the application as filed or a document filed subsequently to the application, which gives a detailed disclosure of the nucleotide and/or amino acid sequences and other available information;

(ii) sequences which are included are any unbranched sequences of four or more amino acids or unbranched sequences of ten or more nucleotides. Branched sequences, sequences with fewer than four specifically defined nucleotides or amino acids as well as sequences comprising nucleotides or amino acids other than those listed in Appendix 2, Tables 1, 2, 3 and 4, are specifically excluded from this definition;

(iii) “nucleotides” embrace only those nucleotides that can be represented using the symbols set forth in Appendix 2, Table 1. Modifications, for example, methylated bases, may be described as set forth in Appendix 2, Table 2, but shall not be shown explicitly in the nucleotide sequence;

(iv) “amino acids” are those L-amino acids commonly found in naturally occurring proteins and are listed in Appendix 2, Table 3. Those amino acid sequences containing at least one D-amino acid are not intended to be embraced by this definition. Any amino acid sequence that contains post-translationally modified amino acids may be described as the amino acid sequence that is initially translated using the symbols shown in Appendix 2, Table 3, with the modified positions, for example, hydroxylations or glycosylations, being described as set forth in Appendix 2, Table 4, but these modifications shall not be shown explicitly in the amino acid sequence. Any peptide or protein that can be expressed as a sequence using the symbols in Appendix 2, Table 3, in conjunction with a description elsewhere to describe, for example, abnormal linkages, cross-links (for example, disulfide bridge) and end caps, non-peptidyl bonds, etc., is embraced by this definition;

(v) “sequence identifier” is a unique integer that corresponds to the SEQ ID NO assigned to each sequence in the listing;

(vi) “numeric identifier” is a three-digit number which represents a specific data element;

(vii) “language-neutral vocabulary” is a controlled vocabulary used in the sequence listing that represents scientific terms as prescribed by sequence database providers (including scientific names, qualifiers and their controlled-vocabulary values, the symbols appearing in Appendix 2, Tables 1, 2, 3 and 4, and the feature keys appearing in Appendix 2, Tables 5 and 6;

## ADMINISTRATIVE INSTRUCTIONS UNDER THE PCT

(viii) “competent Authority” is the International Searching Authority that is to carry out the international search and to establish the written opinion of the International Searching Authority on the international application, or the International Preliminary Examining Authority that is to carry out the international preliminary examination on the international application, or the designated/elected Office before which the processing of the international application has started.

### Sequence Listing

3. The sequence listing as defined in paragraph 2(i) shall, where it is filed together with the application, be placed at the end of the application. This part shall be entitled “Sequence Listing”, begin on a new page and preferably have independent page numbering. The sequence listing forms an integral part of the description; it is therefore unnecessary, subject to paragraph 36, to describe the sequences elsewhere in the description.

4. Where the sequence listing as defined in paragraph 2(i) is not contained in the application as filed but is a separate document furnished subsequently to the filing of the application (see paragraph 37), it shall be entitled “Sequence Listing” and shall have independent page numbering. The original numbering of the sequences (see paragraph 5) in the application as filed shall be maintained in the subsequently furnished sequence listing.

5. Each sequence shall be assigned a separate sequence identifier. The sequence identifiers shall begin with 1 and increase sequentially by integers. If no sequence is present for a sequence identifier, the code 000 should appear under numeric identifier <400>, beginning on the next line following the SEQ ID NO. The response for numeric identifier <160> shall include the total number of SEQ ID NOs, whether followed by a sequence or by the code 000.

6. In the description, claims or drawings of the application, the sequences represented in the sequence listing shall be referred to by the sequence identifier and preceded by “SEQ ID NO:”.

7. Nucleotide and amino acid sequences should be represented by at least one of the following three possibilities:

- (i) a pure nucleotide sequence;
- (ii) a pure amino acid sequence;
- (iii) a nucleotide sequence together with its corresponding amino acid sequence.

For those sequences disclosed in the format specified in option (iii), above, the amino acid sequence must be disclosed separately in the sequence listing as a pure amino acid sequence with a separate integer sequence identifier.

### Nucleotide Sequences

#### *Symbols to Be Used*

8. A nucleotide sequence shall be presented only by a single strand, in the 5'-end to 3'-end direction from left to right. The terms 3' and 5' shall not be represented in the sequence.

9. The bases of a nucleotide sequence shall be represented using the one-letter code for nucleotide sequence characters. Only lower case letters in conformity with the list given in Appendix 2, Table 1, shall be used.

10. Modified bases shall be represented as the corresponding unmodified bases or as “n” in the sequence itself if the modified base is one of those listed in Appendix 2, Table 2, and the modification shall be further described in the feature section of the sequence listing, using the codes given in Appendix 2, Table 2. These codes may be used in the description or the feature section of the sequence listing but not in the sequence itself (see also paragraph 32). The symbol “n” is the equivalent of only one unknown or modified nucleotide.

### **Format to Be Used**

11. A nucleotide sequence shall be listed with a maximum of 60 bases per line, with a space between each group of 10 bases.
12. The bases of a nucleotide sequence (including introns) shall be listed in groups of 10 bases, except in the coding parts of the sequence. Leftover bases, fewer than 10 in number at the end of non-coding parts of a sequence, should be grouped together and separated from adjacent groups by a space.
13. The bases of the coding parts of a nucleotide sequence shall be listed as triplets (codons).
14. The enumeration of the nucleotide shall start at the first base of the sequence with number 1. It shall be continuous through the whole sequence in the direction 5' to 3'. It shall be marked in the right margin, next to the line containing the one-letter codes for the bases, and giving the number of the last base of that line. The enumeration method for nucleotide sequences set forth above remains applicable to nucleotide sequences that are circular in configuration, with the exception that the designation of the first nucleotide of the sequence may be made at the option of the applicant.
15. A nucleotide sequence that is made up of one or more non-contiguous segments of a larger sequence or of segments from different sequences shall be numbered as a separate sequence, with a separate sequence identifier. A sequence with a gap or gaps shall be numbered as a plurality of separate sequences with separate sequence identifiers, with the number of separate sequences being equal in number to the number of continuous strings of sequence data.

### **Amino Acid Sequences**

#### *Symbols to Be Used*

16. The amino acids in a protein or peptide sequence shall be listed in the amino to carboxy direction from left to right. The amino and carboxy groups shall not be represented in the sequence.
17. The amino acids shall be represented using the three-letter code with the first letter as a capital and shall conform to the list given in Appendix 2, Table 3. An amino acid sequence that contains a blank or internal terminator symbols (for example, "Ter" or "\*" or ".") may not be represented as a single amino acid sequence, but shall be presented as separate amino acid sequences (see paragraph 22).
18. Modified and unusual amino acids shall be represented as the corresponding unmodified amino acids or as "Xaa" in the sequence itself if the modified amino acid is one of those listed in Appendix 2, Table 4, and the modification shall be further described in the feature section of the sequence listing, using the codes given in Appendix 2, Table 4. These codes may be used in the description or the feature section of the sequence listing but not in the sequence itself (see also paragraph 32). The symbol "Xaa" is the equivalent of only one unknown or modified amino acid.

#### *Format to Be Used*

19. A protein or peptide sequence shall be listed with a maximum of 16 amino acids per line, with a space provided between each amino acid.
20. Amino acids corresponding to the codons in the coding parts of a nucleotide sequence shall be placed immediately under the corresponding codons. Where a codon is split by an intron, the amino acid symbol should be given below the portion of the codon containing two nucleotides.
21. The enumeration of amino acids shall start at the first amino acid of the sequence, with number 1. Optionally, the amino acids preceding the mature protein, for example pre-sequences, pro-sequences, pre-pro-sequences and signal sequences, when present, may have negative numbers, counting backwards starting with the amino

## ADMINISTRATIVE INSTRUCTIONS UNDER THE PCT

acid next to number 1. Zero (0) is not used when the numbering of amino acids uses negative numbers to distinguish the mature protein. It shall be marked under the sequence every five amino acids. The enumeration method for amino acid sequences set forth above remains applicable for amino acid sequences that are circular in configuration, with the exception that the designation of the first amino acid of the sequence may be made at the option of the applicant.

22. An amino acid sequence that is made up of one or more non-contiguous segments of a larger sequence or of segments from different sequences shall be numbered as a separate sequence, with a separate sequence identifier. A sequence with a gap or gaps shall be numbered as a plurality of separate sequences with separate sequence identifiers, with the number of separate sequences being equal in number to the number of continuous strings of sequence data.

### Other Available Information in the Sequence Listing

23. The order of the items of information in the sequence listings shall follow the order in which those items are listed in the list of numeric identifiers of data elements as defined in Appendix 1.

24. Only numeric identifiers of data elements as defined in Appendix 1 shall be used for the presentation of the items of information in the sequence listing. The corresponding numeric identifier descriptions shall not be used. The provided information shall follow immediately after the numeric identifier while only those numeric identifiers for which information is given need appear on the sequence listing. Two exceptions to this requirement are numeric identifiers <220> and <300>, which serve as headers for "Feature" and "Publication Information," respectively, and are associated with information in numeric identifiers <221> to <223> and <301> to <313>, respectively. When feature and publication information is provided in the sequence listing under those numeric identifiers, numeric identifiers <220> and <300>, respectively, should be included, but left blank. Generally, a blank line shall be inserted between numeric identifiers when the digit in the first or second position of the numeric identifier changes. An exception to this general rule is that no blank line should appear preceding numeric identifier <310>. Additionally, a blank line shall precede any repeated numeric identifier.

### *Mandatory Data Elements*

25. The sequence listing shall include, in addition to and immediately preceding the actual nucleotide and/or amino acid sequence, the following items of information defined in Appendix 1 (mandatory data elements).

<110>	Applicant name
<120>	Title of invention
<160>	Number of SEQ ID NOs
<210>	SEQ ID NO: x
<211>	Length
<212>	Type
<213>	Organism
<400>	Sequence

## MANUAL OF PATENT EXAMINING PROCEDURE

Where the name of the applicant (numeric identifier <110>) is written in characters other than those of the Latin alphabet, it shall also be indicated in characters of the Latin alphabet either as a mere transliteration or through translation into English.

The data elements, except those under numeric identifiers <110>, <120> and <160>, shall be repeated for each sequence included in the sequence listing. Only the data elements under numeric identifiers <120> and <400> are mandatory if no sequence is present for a sequence identifier (see paragraph 5, above, and SEQ ID NO: 4 in the example depicted in Appendix 3 of this Standard).

26. In addition to the data elements identified in paragraph 25, above, when a sequence listing is filed at the same time as the application to which it pertains or at any time prior to the assignment of an application number, the following data element shall be included in the sequence listing.

<130>	File reference
-------	----------------

27. In addition to the data elements identified in paragraph 25, above, when a sequence listing is filed in response to a request from a competent Authority or at any time following the assignment of an application number, the following data elements shall be included in the sequence listing.

<140>	Current patent application
<141>	Current filing date

28. In addition to the data elements identified in paragraph 25, above, when a sequence listing is filed relating to an application which claims the priority of an earlier application, the following data elements shall be included in the sequence listing:

<150>	Earlier patent application
<151>	Earlier application filing date

29. If “n” or “Xaa” or a modified base or modified/unusual L-amino acid is used in the sequence, the following data elements are mandatory:

<220>	Feature
<221>	Name/key
<222>	Location
<223>	Other information

30. If the organism (numeric identifier <213>) is “Artificial Sequence” or “Unknown,” the following data elements are mandatory:

## ADMINISTRATIVE INSTRUCTIONS UNDER THE PCT

<220>	Feature
<223>	Other information

### *Optional Data Elements*

31. All data elements defined in Appendix 1, not mentioned in paragraphs 25 to 30, above, are optional (optional data elements).

### *Presentation of Features*

32. When features of sequences are presented (that is, numeric identifier <220>), they shall be described by the “feature keys” set out in Appendix 2, Tables 5 and 6.<sup>63</sup>

### *Free Text*

33. “Free text” is a wording describing characteristics of the sequence under numeric identifier <223> (Other information) which does not use language-neutral vocabulary as referred to in paragraph 2(vii).

34. The use of free text shall be limited to a few short terms indispensable for the understanding of the sequence. It shall not exceed four lines with a maximum of 65 characters per line for each given data element, when written in English. Any further information shall be included in the main part of the description in the language thereof.

35. Any free text should preferably be in the English language.

36. Where the sequence listing part of the description contains free text, any such free text shall be repeated in the main part of the description in the language thereof. It is recommended that the free text in the language of the main part of the description be put in a specific section of the description called “Sequence Listing Free Text.”

### **Subsequently Furnished Sequence Listing**

37. Any sequence listing which is not contained in the application as filed but which is furnished subsequently shall not go beyond the disclosure in the application as filed and shall be accompanied by a statement to that effect. This means that a sequence listing furnished subsequently to the filing of the application shall contain only those sequences that were disclosed in the application as filed.

38. Any sequence listing not contained in the application as filed does not form part of the application. However, the provisions of PCT Rules 13<sup>ter</sup>, 26.3, and 91 and PCT Article 34 would apply, so that it may be possible, subject to the applicable provisions, for a sequence listing contained in the application as filed to be corrected under PCT Rules 13<sup>ter</sup> or 26.3, rectified under PCT Rule 91 (in the case of an obvious error), or amended under PCT Article 34, or for a sequence listing to be submitted under PCT Article 34 as an amendment to the application.

### **Computer Readable Form of the Sequence Listing**

39. A copy of the sequence listing shall also be submitted in computer readable form, in addition to the sequence listing as contained in the application, whenever this is required by the competent Authority.

<sup>63</sup>*Editor's Note:* These tables contain extracts from the DDBJ/EMBL/GenBank Feature Table (nucleotide sequences) and the SWISS PROT Feature Table (amino acid sequences).



## MANUAL OF PATENT EXAMINING PROCEDURE

40. Any sequence listing in computer readable form submitted in addition to the written sequence listing shall be identical to the written sequence listing and shall be accompanied by a statement that “the information recorded in computer readable form is identical to the written sequence listing.”

41. The entire printable copy of the sequence listing shall be contained within one electronic file preferably on a single diskette or any other electronic medium that is acceptable to the competent Authority. The file recorded on the diskette or any other electronic medium that is acceptable to the competent Authority shall be encoded using IBM<sup>64</sup> Code Page 437, IBM Code Page 932<sup>65</sup> or a compatible code page. A compatible code page, as would be required for, for example, Japanese, Chinese, Cyrillic, Arabic, Greek or Hebrew characters, is one that assigns the Roman alphabet and numerals to the same hexadecimal positions as do the specified code pages.

42. The computer readable form shall preferably be created by dedicated software such as PatentIn or other custom computer programs; it may be created by any means, as long as the sequence listing on a submitted diskette or any other electronic medium that is acceptable to the competent Authority is readable under a Personal Computer Operating system that is acceptable to the competent Authority.

43. File compression is acceptable when using diskette media, so long as the compressed file is in a self-extracting format that will decompress on a Personal Computer Operating system that is acceptable to the competent Authority.

44. The diskette or any other electronic medium that is acceptable to the competent Authority shall have a label permanently affixed thereto on which has been hand-printed, in block capitals or typed, the name of the applicant, the title of the invention, a reference number, the date on which the data were recorded, the computer operating system and the name of the competent Authority.

45. If the diskette or any other electronic medium that is acceptable to the competent Authority is submitted after the date of filing of an application, the labels shall also include the filing date of the application and the application number.

46. Any correction of the written sequence listing which is submitted under PCT Rules 13<sup>ter</sup>.1(a)(i) or 26.3, any rectification of an obvious error in the written sequence listing which is submitted under PCT Rule 91, or any amendment which includes a written sequence listing and which is submitted under PCT Article 34, shall be accompanied by a computer readable form of the sequence listing including any such correction, rectification or amendment.

### **Appendices**

#### *Appendix 1: Numeric Identifiers*

---

<sup>64</sup>*Editor's Note:* IBM is a registered trademark of International Business Machine Corporation, United States of America.

<sup>65</sup>*Editor's Note:* The specified code pages are de facto standards for personal computers.

ADMINISTRATIVE INSTRUCTIONS UNDER THE PCT

*Appendix 2: Nucleotide and Amino Acid Symbols and Feature Table*

Table 1:	List of Nucleotides
Table 2:	List of Modified Nucleotides
Table 3:	List of Amino Acids
Table 4:	List of Modified and Unusual Amino Acids
Table 5:	List of Feature Keys Related to Nucleotide Sequences
Table 6:	List of Feature Keys Related to Protein Sequences

*Appendix 3: Specimen Sequence Listing*

[Appendices 1 to 3 to Annex C follow]

**Annex C, Appendix 1  
Numeric Identifiers**

Only numeric identifiers as defined below may be used in sequence listings submitted in applications. The text of the data element headings given below shall not be included in the sequence listings.

Numeric identifiers of mandatory data elements, that is, data elements which must be included in all sequence listings (see paragraph 25 of this Standard: items 110, 120, 160, 210, 211, 212, 213 and 400) and numeric identifiers of data elements which must be included in circumstances specified in this Standard (see paragraphs 26, 27, 28, 29 and 30 of this Standard: items 130, 140, 141, 150 and 151, and 220 to 223) are marked by the symbol "M."

Numeric identifiers of optional data elements (see paragraph 31 of this Standard) are marked by the symbol "O."

Numeric Identifier	Numeric Identifier Description	Mandatory (M) or Optional (O)	Comment
<110>	Applicant name	M	where the name of the applicant is written in characters other than those of the Latin alphabet, the same shall also be indicated in characters of the Latin alphabet either as a mere transliteration or through translation into English
<120>	Title of Invention	M	
<130>	File Reference	M, in the circumstances specified in paragraph 26 of this Standard	see paragraph 26 of this Standard
<140>	Current patent application	M, in the circumstances specified in paragraph 27 of this Standard	see paragraph 27 of this Standard; the current patent application shall be identified, in the following order, by the two-letter code indicated in accordance with WIPO Standard ST.3 and the application number (in the format used by the industrial property Office with which the current patent application is filed) or, for an international application, by the international application number
<141>	Current filing date	M, in the circumstances specified in paragraph 27 of this Standard	see paragraph 27 of this Standard; the date shall be indicated in accordance with WIPO Standard ST.2 (CCYY MM DD)

ADMINISTRATIVE INSTRUCTIONS UNDER THE PCT

Numeric Identifier	Numeric Identifier Description	Mandatory (M) or Optional (O)	Comment
<150>	Earlier patent application	M, in the circumstances specified in paragraph 28 of this Standard	see paragraph 28 of this Standard; the earlier patent application shall be identified, in the following order, by the two-letter code indicated in accordance with WIPO Standard ST.3 and the application number (in the format used by the industrial property Office with which the earlier patent application was filed) or, for an international application, by the international application number
<151>	Earlier application filing date	M, in the circumstances specified in paragraph 28 of this Standard	see paragraph 28 of this Standard; the date shall be indicated in accordance with WIPO Standard ST.2 (CCYY MM DD)
<160>	Number of SEQ ID NOs	M	
<170>	Software	O	
<210>	Information for SEQ ID NO: x	M	response shall be an integer representing the SEQ ID NO shown
<211>	Length	M	sequence length expressed in number of base pairs or amino acids
<212>	Type	M	type of molecule sequenced in SEQ ID NO: x, either DNA, RNA or PRT; if a nucleotide sequence contains both DNA and RNA fragments, the value shall be "DNA"; in addition, the combined DNA/RNA molecule shall be further described in the <220> to <223> feature section
<213>	Organism	M	Genus Species (that is, scientific name) or "Artificial Sequence" or "Unknown"
<220>	Feature	M, in the circumstances specified in paragraph 29 and 30 of this Standard	leave blank; see paragraphs 29 and 30 of this Standard; description of points of biological significance in the sequence in SEQ ID NO: x) (may be repeated depending on the number of features indicated)
<221>	Name/key	M in the circumstances specified in paragraph 29 of this Standard	see paragraph 29 of this Standard; only those keys as described in Table 5 or 6 of Appendix 2 shall be used
<222>	Location	M, in the circumstances specified in paragraph 29 of this Standard	see paragraph 29 of this Standard; - from (number of first base/amino acid in the feature) - to (number of last base/amino acid in the feature) - base pairs (numbers refer to positions of base pairs in a nucleotide sequence) - amino acids (numbers refer to positions of amino acid residues in an amino acid sequence) - whether feature is located on the complementary strand to that filed in the sequence listing

MANUAL OF PATENT EXAMINING PROCEDURE

Numeric Identifier	Numeric Identifier Description	Mandatory (M) or Optional (O)	Comment
<223>	Other information:	M, in the circumstances specified in paragraphs 29 and 30 of this Standard	see paragraphs 29 and 30 of this Standard; any other relevant information, using language neutral vocabulary, or free text (preferably in English); any free text is to be repeated in the main part of the description in the language thereof (see paragraph 36 of this Standard); where any modified base or modified/unusual L-amino acid appearing in Appendix 2, Tables 2 and 4, is in the sequence, the symbol associated with that base or amino acid from Appendix 2, Tables 2 and 4, should be used
<300>	Publication information	O	leave blank; repeat section for each relevant publication
<301>	Authors	O	
<302>	Title	O	title of publication
<303>	Journal	O	journal name in which data published
<304>	Volume	O	journal volume in which data published
<305>	Issue	O	journal issue number in which data published
<306>	Pages	O	journal page numbers on which data published
<307>	Date	O	journal date on which data published; if possible, the date shall be indicated in accordance with WIPO Standard ST.2 (CCYY MM DD)
<308>	Database accession number	O	accession number assigned by database including database name
<309>	Database entry date	O	date of entry in database; the date shall be indicated in accordance with WIPO Standard ST.2 (CCYY MM DD)
<310>	Document number	O	document number, for patent type citations only; the full document shall specify, in the following order, the two-letter code indicated in accordance with WIPO Standard ST.3, the publication number indicated in accordance with WIPO Standard ST.6, and the kind-of-document code indicated in accordance with WIPO Standard ST.16
<311>	Filing date	O	document filing date, for patent-type citations only; the date shall be indicated in accordance with WIPO Standard ST.2 (CCYY MM DD)

ADMINISTRATIVE INSTRUCTIONS UNDER THE PCT

Numeric Identifier	Numeric Identifier Description	Mandatory (M) or Optional (O)	Comment
<312>	Publication date	O	document publication date; for patent-type citations only; the date shall be indicated in accordance with WIPO Standard ST.2 (CCYY MM DD)
<313>	Relevant residues in SEQ ID NO: x: from to	O	
<400>	Sequence	M	SEQ ID NO: x should follow the numeric identifier and should appear on the line preceding the sequence (see Appendix 3)

MANUAL OF PATENT EXAMINING PROCEDURE

**Annex C, Appendix 2**  
**Nucleotide and Amino Acid Symbols and Feature Table**

**Table 1: List of Nucleotides**

Symbol	Meaning	Origin of designation
a	a	<u>a</u> denine
g	g	<u>g</u> uanine
c	c	<u>c</u> ytosine
t	t	<u>t</u> hymine
u	u	<u>u</u> racil
r	g or a	<u>p</u> urine
y	t/u or c	<u>p</u> yrimidine
m	a or c	<u>a</u> mino
k	g or t/u	<u>k</u> eto
s	g or c	<u>s</u> trong interactions 3H-bonds
w	a or t/u	<u>w</u> weak interactions 2H-bonds
b	g or c or t/u	not a
d	a or g or t/u	not c
h	a or c or t/u	not g
v	a or g or c	not t, not u
n	a or g or c or t/u, unknown, or other	<u>a</u> ny

**Table 2: List of Modified Nucleotides**

Symbol	Meaning
ac4c	4-acetylcytidine
chm5u	5-(carboxyhydroxymethyl)uridine
cm	2'-O-methylcytidine
cmnm5s2u	5-carboxymethylaminomethyl-2-thiouridine
cmnm5u	5-carboxymethylaminomethyluridine
d	dihydrouridine
fm	2'-O-methylpseudouridine
gal q	beta, D-galactosylqueuosine

ADMINISTRATIVE INSTRUCTIONS UNDER THE PCT

Symbol	Meaning
gm	2'-O-methylguanosine
i	inosine
i6a	N6-isopentenyladenosine
m1a	1-methyladenosine
m1f	1-methylpseudouridine
m1g	1-methylguanosine
m1i	1-methylinosine
m22g	2,2-dimethylguanosine
m2a	2-methyladenosine
m2g	2-methylguanosine
m3c	3-methylcytidine
m5c	5-methylcytidine
m6a	N6-methyladenosine
m7g	7-methylguanosine
mam5u	5-methylaminomethyluridine
mam5s2u	5-methoxyaminomethyl-2-thiouridine
man q	beta, D-mannosylqueuosine
mcm5s2u	5-methoxycarbonylmethyl-2-thiouridine
mcm5u	5-methoxycarbonylmethyluridine
mo5u	5-methoxyuridine
ms2i6a	2-methylthio-N6-isopentenyladenosine
ms2t6a	N-((9-beta-D-ribofuranosyl-2-methylthiopurine-6-yl)carbamoyl)threonine
mt6a	N-((9-beta-D-ribofuranosylpurine-6-yl)N-methylcarbamoyl)threonine
mv	uridine-5-oxyacetic acid-methylester
o5u	uridine-5-oxyacetic acid
osyw	wybutoxosine
p	pseudouridine
q	queuosine
s2c	2-thiocytidine
s2t	5-methyl-2-thiouridine



MANUAL OF PATENT EXAMINING PROCEDURE

Symbol	Meaning
s2u	2-thiouridine
s4u	4-thiouridine
t	5-methyluridine
t6a	N-((9-beta-D-ribofuranosylpurine-6-yl)-carbamoyl)threonine
tm	2'-O-methyl-5-methyluridine
um	2'-O-methyluridine
yw	wybutosine
x	3-(3-amino-3-carboxy-propyl)uridine, (acp3)u

**Table 3: List of Amino Acids**

Symbol	Meaning
Ala	Alanine
Cys	Cysteine
Asp	Aspartic Acid
Glu	Glutamic Acid
Phe	Phenylalanine
Gly	Glycine
His	Histidine
Ile	Isoleucine
Lys	Lysine
Leu	Leucine
Met	Methionine
Asn	Asparagine
Pro	Proline
Gln	Glutamine
Arg	Arginine
Ser	Serine
Thr	Threonine
Val	Valine
Trp	Tryptophan

ADMINISTRATIVE INSTRUCTIONS UNDER THE PCT

Symbol	Meaning
Tyr	Tyrosine
Asx	Asp or Asn
Glx	Glu or Gln
Xaa	unknown or other

**Table 4: List of Modified and Unusual Amino Acids**

Symbol	Meaning
Aad	2-Aminoadipic acid
bAad	3-Aminoadipic acid
bAla	beta-Alanine, beta-Aminopropionic acid
Abu	2-Aminobutyric acid
4Abu	4-Aminobutyric acid, piperidinic acid
Acp	6-Aminocaproic acid
Ahe	2-Aminoheptanoic acid
Aib	2-Aminoisobutyric acid
bAib	3-Aminoisobutyric acid
Apm	2-Aminopimelic acid
Dbu	2,4 Diaminobutyric acid
Des	Desmosine
Dpm	2,2'-Diaminopimelic acid
Dpr	2,3-Diaminopropionic acid
EtGly	N-Ethylglycine
EtAsn	N-Ethylasparagine
Hyl	Hydroxylysine
aHyl	allo-Hydroxylysine
3Hyp	3-Hydroxyproline
4Hyp	4-Hydroxyproline
Ide	Isodesmosine
alle	allo-Isoleucine
MeGly	N-Methylglycine, sarcosine

MANUAL OF PATENT EXAMINING PROCEDURE

Symbol	Meaning
Melle	N-Methylisoleucine
MeLys	6-N-Methyllysine
MeVal	N-Methylvaline
Nva	Norvaline
Nle	Norleucine
Orn	Ornithine

**Table 5: List of Feature Keys Related to Nucleotide Sequences**

Key	Description
allele	a related individual or strain contains stable, alternative forms of the same gene which differs from the presented sequence at this location (and perhaps others)
attenuator	(1) region of DNA at which regulation of termination of transcription occurs, which controls the expression of some bacterial operons; (2) sequence segment located between the promoter and the first structural gene that causes partial termination of transcription
C_region	constant region of immunoglobulin light and heavy chains, and T-cell receptor alpha, beta, and gamma chains; includes one or more exons depending on the particular chain
CAAT_signal	CAAT box; part of a conserved sequence located about 75 bp up-stream of the start point of eukaryotic transcription units which may be involved in RNA polymerase binding; consensus=GG (C or T) CAATCT
CDS	coding sequence; sequence of nucleotides that corresponds with the sequence of amino acids in a protein (location includes stop codon); feature includes amino acid conceptual translation
conflict	independent determinations of the “same” sequence differ at this site or region
D-loop	displacement loop; a region within mitochondrial DNA in which a short stretch of RNA is paired with one strand of DNA, displacing the original partner DNA strand in this region; also used to describe the displacement of a region of one strand of duplex DNA by a single stranded invader in the reaction catalyzed by RecA protein
D-segment	diversity segment of immunoglobulin heavy chain, and T-cell receptor beta chain
enhancer	a cis-acting sequence that increases the utilization of (some) eukaryotic promoters, and can function in either orientation and in any location (upstream or downstream) relative to the promoter
exon	region of genome that codes for portion of spliced mRNA; may contain 5'UTR all CDSs, and 3'UTR
GC_signal	GC box; a conserved GC-rich region located upstream of the start point of eukaryotic transcription units which may occur in multiple copies or in either orientation; consensus=GGGCGG

ADMINISTRATIVE INSTRUCTIONS UNDER THE PCT

Key	Description
gene	region of biological interest identified as a gene and for which a name has been assigned
iDNA	intervening DNA; DNA which is eliminated through any of several kinds of recombination
intron	a segment of DNA that is transcribed, but removed from within the transcript by splicing together the sequences (exons) on either side of it
J_segment	joining segment of immunoglobulin light and heavy chains, and T-cell receptor alpha, beta, and gamma chains
LTR	long terminal repeat, a sequence directly repeated at both ends of a defined sequence, of the sort typically found in retroviruses
mat_peptide	mature peptide or protein coding sequence; coding sequence for the mature or final peptide or protein product following post-translational modification; the location does not include the stop codon (unlike the corresponding CDS)
misc_binding	site in nucleic acid which covalently or non-covalently binds another moiety that cannot be described by any other Binding key (primer_bind or protein_bind)
misc_difference	feature sequence is different from that presented in the entry and cannot be described by any other Difference key (conflict, unsure, old_sequence, mutation, variation, allele, or modified_base)
misc_feature	region of biological interest which cannot be described by any other feature key; a new or rare feature
misc_recomb	site of any generalized, site-specific or replicative recombination event where there is a breakage and reunion of duplex DNA that cannot be described by other recombination keys (iDNA and virion) or qualifiers of source key (/insertion_seq, /transposon, /proviral)
misc_RNA	any transcript or RNA product that cannot be defined by other RNA keys (prim_transcript, precursor_RNA, mRNA, 5' clip, 3' clip, 5'UTR, 3'UTR, exon, CDS, sig_peptide, transit_peptide, mat_peptide, intron, polyA_site, rRNA, tRNA, scRNA, and snRNA)
misc_signal	any region containing a signal controlling or altering gene function or expression that cannot be described by other Signal keys (promoter, CAAT_signal, TATA_signal, -35_signal, -10_signal, GC_signal, RBS, polyA_signal, enhancer, attenuator, terminator, and rep_origin)
misc_structure	any secondary or tertiary structure or conformation that cannot be described by other Structure keys (stem_loop and D-loop)
modified_base	the indicated nucleotide is a modified nucleotide and should be substituted for by the indicated molecule (given in the mod_base qualifier value)
mRNA	messenger RNA; includes 5' untranslated region (5'UTR), coding sequences (CDS, exon) and 3' untranslated region (3'UTR)
mutation	a related strain has an abrupt, inheritable change in the sequence at this location

MANUAL OF PATENT EXAMINING PROCEDURE

Key	Description
N_region	extra nucleotides inserted between rearranged immunoglobulin segments
old_sequence	the presented sequence revises a previous version of the sequence at this location
polyA_signal	recognition region necessary for endonuclease cleavage of an RNA transcript that is followed by polyadenylation; consensus=AATAAA
polyA_site	site on an RNA transcript to which will be added adenine residues by post-transcriptional polyadenylation
precursor_RNA	any RNA species that is not yet the mature RNA product; may include 5' clipped region (5' clip), 5' untranslated region (5'UTR), coding sequences (CDS, exon), intervening sequences (intron), 3' untranslated region (3'UTR), and 3' clipped region (3'clip)
prim_transcript	primary (initial, unprocessed) transcript; includes 5' (5'clip), 5' untranslated region (5'UTR), coding sequences (CDS, exon), intervening sequences (intron), 3' untranslated region (3'UTR), and 3' clipped region (3' clip)
primer_bind	non-covalent primer binding site for initiation of replication, transcription, or reverse transcription; includes site(s) for synthetic, for example, PCR primer elements
promoter	region on a DNA molecule involved in RNA polymerase binding to initiate transcription
protein_bind	non-covalent protein binding site on nucleic acid
RBS	ribosome binding site
repeat_region	region of genome containing repeating units
repeat_unit	single repeat element
rep_origin	origin of replication; starting site for duplication of nucleic acid to give two identical copies
rRNA	mature ribosomal RNA; the RNA component of the ribonucleoprotein particle (ribosome) which assembles amino acids into proteins
S_region	switch region of immunoglobulin heavy chains; involved in the rearrangement of heavy chain DNA leading to the expression of a different immunoglobulin class from the same B-cell
satellite	many tandem repeats (identical or related) of a short basic repeating unit; many have a base composition or other property different from the genome average that allows them to be separated from the bulk (main band) genomic DNA
scRNA	small cytoplasmic RNA; any one of several small cytoplasmic RNA molecules present in the cytoplasm and (sometimes) nucleus of a eukaryote
sig_peptide	signal peptide coding sequence; coding sequence for an N-terminal domain of a secreted protein; this domain is involved in attaching nascent polypeptide to the membrane; leader sequence
snRNA	small nuclear RNA; any one of many small RNA species confined to the nucleus; several of the snRNAs are involved in splicing or other RNA processing reactions

ADMINISTRATIVE INSTRUCTIONS UNDER THE PCT

Key	Description
source	identifies the biological source of the specified span of the sequence; this key is mandatory; every entry will have, as a minimum, a single source key spanning the entire sequence; more than one source key per sequence is permissible
stem_loop	hairpin; a double-helical region formed by base-pairing between adjacent (inverted) complementary sequences in a single strand of RNA or DNA
STS	Sequence Tagged Site; short, single-copy DNA sequence that characterizes a mapping landmark on the genome and can be detected by PCR; a region of the genome can be mapped by determining the order of a series of STSs
TATA_signal	TATA box; Goldberg-Hogness box; a conserved AT-rich septamer found about 25 bp before the start point of each eukaryotic RNA polymerase II transcript unit which may be involved in positioning the enzyme for correct initiation; consensus=TATA(A or T)A(A or T)
terminator	sequence of DNA located either at the end of the transcript or adjacent to a promoter region that causes RNA polymerase to terminate transcription; may also be site of binding of repressor protein
transit_peptide	transit peptide coding sequence; coding sequence for an N-terminal domain of a nuclear-encoded organellar protein; this domain is involved in post-translational import of the protein into the organelle
tRNA	mature transfer RNA, a small RNA molecule (75-85 bases long) that mediates the translation of a nucleic acid sequence into an amino acid sequence
unsure	author is unsure of exact sequence in this region
V_region	variable region of immunoglobulin light and heavy chains, and T-cell receptor alpha, beta, and gamma chains; codes for the variable amino terminal portion; can be made up from V_segments, D_segments, N_regions, and J_segments
V_segment	variable segment of immunoglobulin light and heavy chains, and T-cell receptor alpha, beta, and gamma chains; codes for most of the variable region (V_region) and the last few amino acids of the leader peptide
variation	a related strain contains stable mutations from the same gene (for example, RFLPs, polymorphisms, etc.) which differ from the presented sequence at this location (and possibly others)
3'clip	3'-most region of a precursor transcript that is clipped off during processing
3'UTR	region at the 3' end of a mature transcript (following the stop codon) that is not translated into a protein
5'clip	5'-most region of a precursor transcript that is clipped off during processing
5'UTR	region at the 5' end of a mature transcript (preceding the initiation codon) that is not translated into a protein
-10_signal	pribnow box; a conserved region about 10 bp upstream of the start point of bacterial transcription units which may be involved in binding RNA polymerase; consensus=TAtAaT

MANUAL OF PATENT EXAMINING PROCEDURE

Key	Description
-35_signal	a conserved hexamer about 35 bp upstream of the start point of bacterial transcription units; consensus=TTGACa [ ] or TGTTGACA [ ]

**Table 6: List of Feature Keys Related to Protein Sequences**

Key	Description
CONFLICT	different papers report differing sequences
VARIANT	authors report that sequence variants exist
VARSPLIC	description of sequence variants produced by alternative splicing
MUTAGEN	site which has been experimentally altered
MOD_RES	post-translational modification of a residue
ACETYLATION	N-terminal or other
AMIDATION	generally at the C-terminal of a mature active peptide
BLOCKED	undetermined N- or C-terminal blocking group
FORMYLATION	of the N-terminal methionine
GAMMA-CARBOXYGLUTAMIC ACID HYDROXYLATION	of asparagine, aspartic acid, proline or lysine
METHYLATION	generally of lysine or arginine
PHOSPHORYLATION	of serine, threonine, tyrosine, aspartic acid or histidine
PYRROLIDONE CARBOXYLIC ACID	N-terminal glutamate which has formed an internal cyclic lactam
SULFATATION	generally of tyrosine
LIPID	covalent binding of a lipidic moiety
MYRISTATE	myristate group attached through an amide bond to the N-terminal glycine residue of the mature form of a protein or to an internal lysine residue
PALMITATE	palmitate group attached through a thioether bond to a cysteine residue or through an ester bond to a serine or threonine residue
FARNESYL	farnesyl group attached through a thioether bond to a cysteine residue
GERANYL-GERANYL	geranyl-geranyl group attached through a thioether bond to a cysteine residue

ADMINISTRATIVE INSTRUCTIONS UNDER THE PCT

Key	Description
GPI-ANCHOR	glycosyl-phosphatidylinositol (GPI) group linked to the alpha-carboxyl group of the C-terminal residue of the mature form of a protein
N-ACYL DIGLYCERIDE	N-terminal cysteine of the mature form of a prokaryotic lipoprotein with an amide-linked fatty acid and a glyceryl group to which two fatty acids are linked by ester linkages
DISULFID	disulfide bond; the 'FROM' and 'TO' endpoints represent the two residues which are linked by an intra-chain disulfide bond; if the 'FROM' and 'TO' endpoints are identical, the disulfide bond is an interchain one and the description field indicates the nature of the cross-link
THIOLEST	thiolester bond; the 'FROM' and 'TO' endpoints represent the two residues which are linked by the thiolester bond
THIOETH	thioether bond; the 'FROM' and 'TO' endpoints represent the two residues which are linked by the thioether bond
CARBOHYD	glycosylation site; the nature of the carbohydrate (if known) is given in the description field
METAL	binding site for a metal ion; the description field indicates the nature of the metal
BINDING	binding site for any chemical group (co-enzyme, prosthetic group, etc.); the chemical nature of the group is given in the description field
SIGNAL	extent of a signal sequence (prepeptide)
TRANSIT	extent of a transit peptide (mitochondrial, chloroplastic, or for a microbody)
PROPEP	extent of a propeptide
CHAIN	extent of a polypeptide chain in the mature protein
PEPTIDE	extent of a released active peptide
DOMAIN	extent of a domain of interest on the sequence; the nature of that domain is given in the description field
CA_BIND	extent of a calcium-binding region
DNA_BIND	extent of a DNA-binding region
NP_BIND	extent of a nucleotide phosphate binding region; the nature of the nucleotide phosphate is indicated in the description field
TRANSMEM	extent of a transmembrane region
ZN_FING	extent of a zinc finger region



MANUAL OF PATENT EXAMINING PROCEDURE

Key	Description
SIMILAR	extent of a similarity with another protein sequence; precise information, relative to that sequence is given in the description field
REPEAT	extent of an internal sequence repetition
HELIX	secondary structure: Helices, for example, Alpha-helix, 3(10) helix, or Pi-helix
STRAND	secondary structure: Beta-strand, for example, Hydrogen bonded beta-strand, or Residue in an isolated beta-bridge
TURN	secondary structure Turns, for example, H-bonded turn (3-turn, 4-turn or 5-turn)
ACT_SITE	amino acid(s) involved in the activity of an enzyme
SITE	any other interesting site on the sequence
INIT_MET	the sequence is known to start with an initiator methionine
NON_TER	the residue at an extremity of the sequence is not the terminal residue; if applied to position 1, this signifies that the first position is not the N-terminus of the complete molecule; if applied to the last position, it signifies that this position is not the C-terminus of the complete molecule; there is no description field for this key
NON_CONS	non consecutive residues; indicates that two residues in a sequence are not consecutive and that there are a number of unsequenced residues between them
UNSURE	uncertainties in the sequence; used to describe region(s) of a sequence for which the authors are unsure about the sequence assignment

ADMINISTRATIVE INSTRUCTIONS UNDER THE PCT

**Annex C, Appendix 3  
Specimen Sequence Listing**

```

<110> Smith, John; Smithgene Inc.
<120> Example of a Sequence Listing
<130> 01-00001
<140> PCT/EP98/00001
<141> 1998-12-31
<150> US 08/999,999
<151> 1997-10-15
<160> 4
<170> PatentIn version 2.0
<210> 1
<211> 389
<212> DNA
<213> Paramecium sp.
<220>
<221> CDS
<222> (279)...(389)
<300>
<301> Doe, Richard
<302> Isolation and Characterization of a Gene Encoding a
Protease from Paramecium sp.
<303> Journal of Genes
<304> 1
<305> 4
<306> 1-7
<307> 1988-06-31
<308> 123456
<309> 1988-06-31
<400> 1
agctgtagtc attcctgtgt cctctttctct ctgggcttct caccctgcta atcagatctc 60
agggagagtg tcttgaccct cctctgcctt tgcagcttca caggcaggca ggcaggcagc 120
tgatgtggca attgctggca gtgccacagg cttttcagcc aggcttaggg tgggttccgc 180
cgcggcgcgg cgcccctct cgcgctctc tcgcgctct ctctcgtct cctctcgtc 240
ggacctgatt aggtgagcag gaggaggggg cagtttagc atg gtt tca atg ttc agc 296
                                     Met Val Ser Met Phe Ser
                                     1 5
ttg tct ttc aaa tgg cct gga ttt tgt ttg ttt gtt tgt ttg ttc caa 344
Leu Ser Phe Lys Trp Pro Gly Phe Cys Leu Phe Val Cys Leu Phe Gln
                                     10 15 20
tgt ccc aaa gtc ctc ccc tgt cac tca tca ctg cag ccg aat ctt 389
Cys Pro Lys Val Leu Pro Cys His Ser Ser Leu Gln Pro Asn Leu
                                     25 30 35

<210> 2
<211> 37
<212> PRT
<213> Paramecium sp.

```

MANUAL OF PATENT EXAMINING PROCEDURE

```
<400> 2
Met Val Ser Met Phe Ser Leu Ser Phe Lys Trp Pro Gly Phe Cys Leu
1          5          10          15
Phe Val Cys Leu Phe Gln Cys Pro Lys Val Leu Pro Cys His Ser Ser
          20          25          30
Leu Gln Pro Asn Leu
          35
<210> 3
<211> 11
<212> PRT
<213> Artificial Sequence
<220>
<223> Designed peptide based on size and polarity to act as a
linker between the alpha and beta chains of Protein XYZ.
<400> 3
Met Val Asn Leu Glu Pro Met His Thr Glu Ile
1          5          10
<210> 4
<400> 4
000
```

[Annex C-*bis* follows]

**ANNEX C-bis**

**TECHNICAL REQUIREMENTS FOR THE PRESENTATION OF TABLES  
RELATED TO NUCLEOTIDE AND AMINO ACID SEQUENCE LISTINGS IN  
INTERNATIONAL PATENT APPLICATIONS UNDER THE PCT**

**Introduction**

1. These technical requirements have been elaborated so as to provide standardization of the presentation of tables related to nucleotide and amino acid sequence listings in international patent applications. These technical requirements are intended to allow the applicant to draw up such tables in a manner which is acceptable to all receiving Offices, International Searching Authorities, International Preliminary Examining Authorities and to the International Bureau for the purposes of the international phase and to all designated and elected Offices for the purposes of the national phase.

**Definition**

2. For the purposes of these technical requirements, “competent Authority” is the International Searching Authority that is to carry out the international search on the international application, or the International Preliminary Examining Authority that is to carry out the international preliminary examination on the international application, or the designated/elected Office before which the processing of the international application has started.

**Tables related to sequence listings**

3. Tables filed in computer readable form under Section 801(a) shall comply with one of the following character formats:
  - (i) UTF-8-encoded Unicode 3.0; or
  - (ii) XML format conforming to the “Application-Body” Document Type Definition referred to in Appendix I of Annex F;

at the option of the competent Authority.

4. The spatial relationships (e.g., columns and rows) of the table elements shall be maintained.
5. At the option of the competent Authority, file compression is acceptable, so long as the compressed file is in a self-extracting format that will decompress on a Personal Computer Operating system that is acceptable to the competent Authority and to the International Bureau.
6. Each table shall be contained within a separate electronic file on any electronic medium that is acceptable to the competent Authority. The file recorded on the electronic medium that is acceptable to the competent Authority shall be encoded using IBM Code Page 437, IBM Code Page 932 or a compatible code page. A compatible code page, as would be required for, for example, Japanese, Chinese, Cyrillic, Arabic, Greek or Hebrew characters, is one that assigns the Roman alphabet and numerals to the same hexadecimal positions as do the specified code pages.
7. Tables filed in computer readable form may be created by any means, as long as the table on an electronic medium that is acceptable to the competent Authority is readable under a Personal Computer Operating system that is acceptable to the competent Authority and to the International Bureau.
8. If the electronic medium that is acceptable to the competent Authority is submitted after the date of filing of an application, the labels shall also include the filing date of the application and the application number.

[Annex D follows]

**ANNEX D**

**INFORMATION FROM PAMPHLET FRONT PAGE TO BE INCLUDED IN THE  
GAZETTE UNDER RULE 86.1(a)(i)**

The following information shall be extracted from the front page of the pamphlet of each published international application and shall, in accordance with Rule 86.1(a)(i), appear in the corresponding entry of the Gazette:

1. as to the international publication:
  - 1.1 the international publication number
  - 1.2 the date of the international publication
  - 1.3 an indication whether the following items were published in the pamphlet:
    - 1.31 international search report
    - 1.32 declaration under Article 17(2)
    - 1.33 claims amended under Article 19(1)
    - 1.34 statement under Article 19(1)
    - 1.35 [*Deleted*]
    - 1.36 request for rectification under the third sentence of Rule 91.1(f)
    - 1.37 information concerning a priority claim which was considered not to have been made, published upon request made under Rule 26<sup>bis</sup>.2(c)
  - 1.4 the language in which the international application was filed
  - 1.5 the language of publication of the international application
2. as to the international application:
  - 2.1 the title of the invention
  - 2.2 the symbol(s) of the International Patent Classification (IPC)
  - 2.3 the international application number
  - 2.4 the international filing date
3. as to any priority claim:
  - 3.1 the application number of the earlier application
  - 3.2 the date on which the earlier application was filed
  - 3.3 where the earlier application is:
    - 3.31 a national application: the country in which the earlier application was filed
    - 3.32 a regional application: the authority entrusted with the granting of regional patents under the applicable regional patent treaty and, in the case referred to in Rule 4.1 0(b)(ii), a country party to the Paris Convention for the Protection of Industrial Property for which that earlier application was filed
    - 3.33 an international application: the receiving Office with which it was filed
4. as to the applicant, inventor and agent:
  - 4.1 their name(s)
  - 4.2 their mailing address(es)
5. as to the designated States:
  - 5.1 their names
  - 5.2 the indication of any wish for a regional patent
  - 5.3 the indication that every kind of protection available is sought, unless otherwise indicated
6. as to a statement concerning non-prejudicial disclosure or exception to lack of novelty:

## ADMINISTRATIVE INSTRUCTIONS UNDER THE PCT

- 6.1 the date of the disclosure
  - 6.2 the place of the disclosure
  - 6.3 the kind of the disclosure (e.g., exhibition, scientific publication, conference reports, etc.)
  - 6.4 the title of the exhibition, publication or conference
7. as to any indication in relation to deposited biological material furnished under Rule 13<sup>bis</sup> separately from the description:
    - 7.1 the fact that such indication is published
    - 7.2 the date on which the International Bureau received such indication
  8. as to any declaration referred to in Rule 4.17 which was received by the International Bureau before the expiration of the time limit under Rule 26<sup>ter</sup>.1:
    - 8.1 the fact that such a declaration was made and a reference to the applicable item in Rule 4.17 under which it was made
    - 8.2 an indication of those designations for the purposes of which such declaration was made.

[Annex E follows]

**ANNEX E**

**INFORMATION TO BE PUBLISHED IN THE GAZETTE UNDER RULE 86.1(a)(v)**

1. The time limits applicable under Articles 22 and 39 in respect of each Contracting State.
2. The list of the non-patent literature agreed upon by the International Searching Authorities for inclusion in the minimum documentation.
3. The names of the national Offices which do not wish to receive copies under Article 13(2)(c).
4. The provisions of the national laws of Contracting States concerning international-type search.
5. The text of the agreements entered into between the International Bureau and the International Searching Authorities or the International Preliminary Examining Authorities.
6. The names of the national Offices which entirely or in part waived their rights to any communication under Article 20.
7. The names of the Contracting States which are bound by Chapter II of the PCT.
8. Index of concordance of international application numbers and international publication numbers, listed according to international application numbers.
9. Index of applicants' names giving, for each name, the corresponding international publication number(s).
10. Index of international publication numbers, grouped according to the International Patent Classification symbols.
11. Indication of any subject matter that will not be searched or examined by the various International Searching and Preliminary Examining Authorities under Rules 39 and 67.
12. Requirements of designated and elected Offices under Rules 49.5 and 76.5 in relation to the furnishing of translations.
13. The dates defining the period referred to in Rule 32.1(b) during which the international application, whose effects may be extended to a successor State under Rule 32.1, must have been filed.

[Annex F follows]

**ANNEX F**

**STANDARD FOR THE ELECTRONIC FILING AND PROCESSING OF  
INTERNATIONAL APPLICATIONS**

*[The text of Annex F, which is not reproduced here, is available from WIPO's website at <http://www.wipo.org/pct/en/index.html>. To view Annex F, click on "PCT Gazette" and see PCT Gazette Special Issue S-04/2001 (27 December 2001). To see the complete text of the Administrative Instructions under the PCT, click on "PCT Legal Texts." Annex F consists of nine main sections and four appendices, the titles of which are reproduced below.]*

1. *Introduction*
2. *The E-PCT standard: Overview and vision*
3. *E-PCT submission structure and format*
4. *IA documents packaging*
5. *Transmission*
6. *Electronic filing software*
7. *PCT workflow transactions*
8. *Principles of electronic records management*
9. *Abbreviated expressions, interpretation and glossary*

*Appendix I XML DTDs for the E-PCT Standard*

*Appendix II PKI Architecture for the E-PCT Standard*

*Appendix III Basic Common Standard for Electronic Filing*

*Appendix IV Use of Physical Media for the E-PCT Standard]*

[End of Appendix, Annex and document]



MANUAL OF PATENT EXAMINING PROCEDURE

# Appendix P Paris Convention

---

## Paris Convention for the Protection of Industrial Property

of March 20, 1883

as revised

at Brussels on December 14, 1900, at Washington on June 2, 1911, at The Hague on November 6, 1925, at London on June 2, 1934, at Lisbon on October 31, 1958, and at Stockholm on July 14, 1967, and as amended on October 2, 1979. [Articles have been given titles to facilitate their identification. There are no titles in the signed (French) text.]

### Article 1

[Establishment of the Union; Scope of Industrial Property]

(1) The countries to which this Convention applies constitute a Union for the protection of industrial property.

(2) The protection of industrial property has as its object patents, utility models, industrial designs, trademarks, service marks, trade names, indications of source or appellations of origin, and the repression of unfair competition.

(3) Industrial property shall be understood in the broadest sense and shall apply not only to industry and commerce proper, but likewise to agricultural and extractive industries and to all manufactured or natural products, for example, wines, grain, tobacco leaf, fruit, cattle, minerals, mineral waters, beer, flowers, and flour.

(4) Patents shall include the various kinds of industrial patents recognized by the laws of the countries of the Union, such as patents of importation, patents of improvement, patents and certificates of addition, etc.

### Article 2

[National Treatment for Nationals of Countries of the Union]

(1) Nationals of any country of the Union shall, as regards the protection of industrial property, enjoy

in all the other countries of the Union the advantages that their respective laws now grant, or may hereafter grant, to nationals; all without prejudice to the rights specially provided for by this Convention. Consequently, they shall have the same protection as the latter, and the same legal remedy against any infringement of their rights, provided that the conditions and formalities imposed upon nationals are complied with.

(2) However, no requirement as to domicile or establishment in the country where protection is claimed may be imposed upon nationals of countries of the Union for the enjoyment of any industrial property rights.

(3) The provisions of the laws of each of the countries of the Union relating to judicial and administrative procedure and to jurisdiction, and to the designation of an address for service or the appointment of an agent, which may be required by the laws on industrial property are expressly reserved.

### Article 3

[Same Treatment for Certain Categories of Persons as for Nationals of Countries of the Union]

Nationals of countries outside the Union who are domiciled or who have real and effective industrial or commercial establishments in the territory of one of the countries of the Union shall be treated in the same manner as nationals of the countries of the Union.

### Article 4

[A. to I. Patents, Utility Models, Industrial Designs, Marks, Inventors Certificates; Right of Priority. — G. Patents: Division of the Application]

A. — (1) Any person who has duly filed an application for a patent, or for the registration of a utility model, or of an industrial design, or of a trademark, in one of the countries of the Union, or his successor in title, shall enjoy, for the purpose of filing in the other countries, a right of priority during the periods hereinafter fixed.

(2) Any filing that is equivalent to a regular national filing under the domestic legislation of any country of the Union or under bilateral or multilateral treaties concluded between countries of the Union shall be recognized as giving rise to the right of priority.

(3) By a regular national filing is meant any filing that is adequate to establish the date on which

the application was filed in the country concerned, whatever may be the subsequent fate of the application.

B. —Consequently, any subsequent filing in any of the other countries of the Union before the expiration of the periods referred to above shall not be invalidated by reason of any acts accomplished in the interval, in particular, another filing, the publication or exploitation of the invention, the putting on sale of copies of the design, or the use of the mark, and such acts cannot give rise to any third-party right or any right of personal possession. Rights acquired by third parties before the date of the first application that serves as the basis for the right of priority are reserved in accordance with the domestic legislation of each country of the Union.

C. — (1)The periods of priority referred to above shall be twelve months for patents and utility models, and six months for industrial designs and trademarks.

(2) These periods shall start from the date of filing of the first application; the day of filing shall not be included in the period.

(3) If the last day of the period is an official holiday, or a day when the Office is not open for the filing of applications in the country where protection is claimed, the period shall be extended until the first following working day.

(4) A subsequent application concerning the same subject as a previous first application within the meaning of paragraph (2), above, filed in the same country of the Union, shall be considered as the first application, of which the filing date shall be the starting point of the period of priority, if, at the time of filing the subsequent application, the said previous application has been withdrawn, abandoned, or refused, without having been laid open to public inspection and without leaving any rights outstanding, and if it has not yet served as a basis for claiming a right of priority. The previous application may not thereafter serve as a basis for claiming a right of priority.

D. — (1)Any person desiring to take advantage of the priority of a previous filing shall be required to make a declaration indicating the date of such filing and the country in which it was made. Each country shall determine the latest date on which such declaration must be made.

(2) These particulars shall be mentioned in the publications issued by the competent authority, and in particular in the patents and the specifications relating thereto.

(3) The countries of the Union may require any person making a declaration of priority to produce a copy of the application (description, drawings, etc.) previously filed. The copy, certified as correct by the authority which received such application, shall not require any authentication, and may in any case be filed, without fee, at any time within three months of the filing of the subsequent application. They may require it to be accompanied by a certificate from the same authority showing the date of filing, and by a translation.

(4) No other formalities may be required for the declaration of priority at the time of filing the application. Each country of the Union shall determine the consequences of failure to comply with the formalities prescribed by this Article, but such consequences shall in no case go beyond the loss of the right of priority.

(5) Subsequently, further proof may be required.

Any person who avails himself of the priority of a previous application shall be required to specify the number of that application; this number shall be published as provided for by paragraph (2), above.

E. — (1)Where an industrial design is filed in a country by virtue of a right of priority based on the filing of a utility model, the period of priority shall be the same as that fixed for industrial designs.

(2) Furthermore, it is permissible to file a utility model in a country by virtue of a right of priority based on the filing of a patent application, and vice versa.

F. — No country of the Union may refuse a priority or a patent application on the ground that the applicant claims multiple priorities, even if they originate in different countries, or on the ground that an application claiming one or more priorities contains one or more elements that were not included in the application or applications whose priority is claimed, provided that, in both cases, there is unity of invention within the meaning of the law of the country.

With respect to the elements not included in the application or applications whose priority is claimed,

## PARIS CONVENTION

the filing of the subsequent application shall give rise to a right of priority under ordinary conditions.

G. — (1) If the examination reveals that an application for a patent contains more than one invention, the applicant may divide the application into a certain number of divisional applications and preserve as the date of each the date of the initial application and the benefit of the right of priority, if any.

(2) The applicant may also, on his own initiative, divide a patent application and preserve as the date of each divisional application the date of the initial application and the benefit of the right of priority, if any. Each country of the Union shall have the right to determine the conditions under which such division shall be authorized.

H. — Priority may not be refused on the ground that certain elements of the invention for which priority is claimed do not appear among the claims formulated in the application in the country of origin, provided that the application documents as a whole specifically disclose such elements.

I. — (1) Applications for inventors' certificates filed in a country in which applicants have the right to apply at their own option either for a patent or for an inventor's certificate shall give rise to the right of priority provided for by this Article, under the same conditions and with the same effects as applications for patents.

(2) In a country in which applicants have the right to apply at their own option either for a patent or for an inventor's certificate, an applicant for an inventor's certificate shall, in accordance with the provisions of this Article relating to patent applications, enjoy a right of priority based on an application for a patent, a utility model, or an inventor's certificate.

### **Article 4<sup>bis</sup>**

[Patents: Independence of Patents Obtained for the Same Invention in Different Countries]

(1) Patents applied for in the various countries of the Union by nationals of countries of the Union shall be independent of patents obtained for the same invention in other countries, whether members of the Union or not.

(2) The foregoing provision is to be understood in an unrestricted sense, in particular, in the sense that patents applied for during the period of priority are

independent, both as regards the grounds for nullity and forfeiture, and as regards their normal duration.

(3) The provision shall apply to all patents existing at the time when it comes into effect.

(4) Similarly, it shall apply, in the case of the accession of new countries, to patents in existence on either side at the time of accession.

(5) Patents obtained with the benefit of priority shall, in the various countries of the Union, have a duration equal to that which they would have, had they been applied for or granted without the benefit of priority.

### **Article 4<sup>ter</sup>**

[Patents: Mention of the Inventor in the Patent]

The inventor shall have the right to be mentioned as such in the patent.

### **Article 4<sup>quater</sup>**

[Patents: Patentability in Case of Restrictions of Sale by Law]

The grant of a patent shall not be refused and a patent shall not be invalidated on the ground that the sale of the patented product or of a product obtained by means of a patented process is subject to restrictions or limitations resulting from the domestic law.

### **Article 5**

[A. Patents: Importation of Articles; Failure to Work or Insufficient Working; Compulsory Licenses. — B. Industrial Designs: Failure to Work; Importation of Articles. — C. Marks: Failure to Use; Different Forms; Use by Co-proprietors. — D. Patents, Utility Models, Marks, Industrial Designs: Marking]

A. — (1) Importation by the patentee into the country where the patent has been granted of articles manufactured in any of the countries of the Union shall not entail forfeiture of the patent.

(2) Each country of the Union shall have the right to take legislative measures providing for the grant of compulsory licenses to prevent the abuses which might result from the exercise of the exclusive rights conferred by the patent, for example, failure to work.

(3) Forfeiture of the patent shall not be provided for except in cases where the grant of compulsory licenses would not have been sufficient to prevent the said abuses. No proceedings for the forfei-

ture or revocation of a patent may be instituted before the expiration of two years from the grant of the first compulsory license.

(4) A compulsory license may not be applied for on the ground of failure to work or insufficient working before the expiration of a period of four years from the date of filing of the patent application or three years from the date of the grant of the patent, whichever period expires last; it shall be refused if the patentee justifies his inaction by legitimate reasons. Such a compulsory license shall be non-exclusive and shall not be transferable, even in the form of the grant of a sub-license, except with that part of the enterprise or goodwill which exploits such license.

(5) The foregoing provisions shall be applicable, *mutatis mutandis*, to utility models.

B. — The protection of industrial design shall not, under any circumstance, be subject to any forfeiture, either by reason of failure to work or by reason of the importation of articles corresponding to those which are protected.

C. — (1) If, in any country, use of the registered mark is compulsory, the registration may be cancelled only after a reasonable period, and then only if the person concerned does not justify his inaction.

(2) Use of a trademark by the proprietor in a form differing in elements which do not alter the distinctive character of the mark in the form in which it was registered in one of the countries of the Union shall not entail invalidation of the registration and shall not diminish the protection granted to the mark.

(3) Concurrent use of the same mark on identical or similar goods by industrial or commercial establishments considered as co-proprietors of the mark according to the provisions of the domestic law of the country where protection is claimed shall not prevent registration or diminish in any way the protection granted to the said mark in any country of the Union, provided that such use does not result in misleading the public and is not contrary to the public interest.

D. — No indication or mention of the patent, of the utility model, of the registration of the trademark, or of the deposit of the industrial design, shall be required upon the goods as a condition of recognition of the right to protection.

### **Article 5<sup>bis</sup>**

[All Industrial Property Rights: Period of Grace for the Payment of Fees for the Maintenance of Rights; Patents: Restoration]

(1) A period of grace of not less than six months shall be allowed for the payment of the fees prescribed for the maintenance of industrial property rights, subject, if the domestic legislation so provides, to the payment of a surcharge.

(2) The countries of the Union shall have the right to provide for the restoration of patents which have lapsed by reason of non-payment of fees.

### **Article 5<sup>ter</sup>**

[Patents: Patented Devices Forming Part of Vessels, Aircraft, or Land Vehicles]

In any country of the Union the following shall not be considered as infringements of the rights of a patentee:

(1) the use on board vessels of other countries of the Union of devices forming the subject of his patent in the body of the vessel, in the machinery, tackle, gear and other accessories, when such vessels temporarily or accidentally enter the waters of the said country, provided that such devices are used there exclusively for the needs of the vessel;

(2) the use of devices forming the subject of the patent in the construction or operation of aircraft or land vehicles of other countries of the Union, or of accessories of such aircraft or land vehicles, when those aircraft or land vehicles temporarily or accidentally enter the said country.

### **Article 5<sup>quater</sup>**

[Patents: Importation of Products Manufactured by a Process Patented in the Importing Country]

When a product is imported into a country of the Union where there exists a patent protecting a process of manufacture of the said product, the patentee shall have all the rights, with regard to the imported product, that are accorded to him by the legislation of the country of importation, on the basis of the process patent, with respect to products manufactured in that country.

PARIS CONVENTION

**Article 5<sup>quinquies</sup>**

[Industrial Designs]

Industrial designs shall be protected in all the countries of the Union.

**Article 6**

[Marks: Conditions of Registration; Independence of Protection of Same Mark in Different Countries]

(1) The conditions for the filing and registration of trademarks shall be determined in each country of the Union by its domestic legislation.

(2) However, an application for the registration of a mark filed by a national of a country of the Union in any country of the Union may not be refused, nor may a registration be invalidated, on the ground that filing, registration, or renewal, has not been effected in the country of origin.

(3) A mark duly registered in a country of the Union shall be regarded as independent of marks registered in the other countries of the Union, including the country of origin.

**Article 6<sup>bis</sup>**

[Marks: Well Known Marks]

(1) The countries of the Union undertake, *ex officio* if their legislation so permits, or at the request of an interested party, to refuse or to cancel the registration, and to prohibit the use, of a trademark which constitutes a reproduction, an imitation, or a translation, liable to create confusion, of a mark considered by the competent authority of the country of registration or use to be well known in that country as being already the mark of a person entitled to the benefits of this Convention and used for identical or similar goods.

These provisions shall also apply when the essential part of the mark constitutes a reproduction of any such well-known mark or an imitation liable to create confusion therewith.

(2) A period of at least five years from the date of registration shall be allowed for requesting the cancellation of such a mark. The countries of the Union may provide for a period within which the prohibition of use must be requested.

(3) No time limit shall be fixed for requesting the cancellation or the prohibition of the use of marks registered or used in bad faith.

**Article 6<sup>ter</sup>**

[Marks: Prohibitions concerning State Emblems, Official Hallmarks, and Emblems of Intergovernmental Organizations]

(1)(a) The countries of the Union agree to refuse or to invalidate the registration, and to prohibit by appropriate measures the use, without authorization by the competent authorities, either as trademarks or as elements of trademarks, of armorial bearings, flags, and other State emblems, of the countries of the Union, official signs and hallmarks indicating control and warranty adopted by them, and any imitation from a heraldic point of view.

(b) The provisions of subparagraph (a), above, shall apply equally to armorial bearings, flags, other emblems, abbreviations, and names, of international intergovernmental organizations of which one or more countries of the Union are members, with the exception of armorial bearings, flags, other emblems, abbreviations, and names, that are already the subject of international agreements in force, intended to ensure their protection.

(c) No country of the Union shall be required to apply the provisions of subparagraph (b), above, to the prejudice of the owners of rights acquired in good faith before the entry into force, in that country, of this Convention. The countries of the Union shall not be required to apply the said provisions when the use or registration referred to in subparagraph (a), above, is not of such a nature as to suggest to the public that a connection exists between the organization concerned and the armorial bearings, flags, emblems, abbreviations, and names, or if such use or registration is probably not of such a nature as to mislead the public as to the existence of a connection between the user and the organization.

(2) Prohibition of the use of official signs and hallmarks indicating control and warranty shall apply solely in cases where the marks in which they are incorporated are intended to be used on goods of the same or a similar kind.

(3)(a) For the application of these provisions, the countries of the Union agree to communicate reciprocally, through the intermediary of the International Bureau, the list of State emblems, and official signs and hallmarks indicating control and warranty, which they desire, or may hereafter desire, to place wholly or within certain limits under the protection of this

Article, and all subsequent modifications of such list. Each country of the Union shall in due course make available to the public the lists so communicated.

Nevertheless such communication is not obligatory in respect of flags of States.

(b) The provisions of subparagraph (b) of paragraph (1) of this Article shall apply only to such armorial bearings, flags, other emblems, abbreviations, and names, of international intergovernmental organizations as the latter have communicated to the countries of the Union through the intermediary of the International Bureau.

(4) Any country of the Union may, within a period of twelve months from the receipt of the notification, transmit its objections, if any, through the intermediary of the International Bureau, to the country or international intergovernmental organization concerned.

(5) In the case of State flags, the measures prescribed by paragraph (1), above, shall apply solely to marks registered after November 6, 1925.

(6) In the case of State emblems other than flags, and of official signs and hallmarks of the countries of the Union, and in the case of armorial bearings, flags, other emblems, abbreviations, and names, of international intergovernmental organizations, these provisions shall apply only to marks registered more than two months after receipt of the communication provided for in paragraph (3), above.

(7) In cases of bad faith, the countries shall have the right to cancel even those marks incorporating State emblems, signs, and hallmarks, which were registered before November 6, 1925.

(8) Nationals of any country who are authorized to make use of the State emblems, signs, and hallmarks, of their country may use them even if they are similar to those of another country.

(9) The countries of the Union undertake to prohibit the unauthorized use in trade of the State armorial bearings of the other countries of the Union, when the use is of such a nature as to be misleading as to the origin of the goods.

(10) The above provisions shall not prevent the countries from exercising the right given in paragraph (3) of Article 6<sup>quinquies</sup>, Section B, to refuse or to invalidate the registration of marks incorporating, without authorization, armorial bearings, flags, other State emblems, or official signs and hallmarks

adopted by a country of the Union, as well as the distinctive signs of international intergovernmental organizations referred to in paragraph (1), above.

#### **Article 6<sup>quater</sup>**

[Marks: Assignment of Marks]

(1) When, in accordance with the law of a country of the Union, the assignment of a mark is valid only if it takes place at the same time as the transfer of the business or goodwill to which the mark belongs, it shall suffice for the recognition of such validity that the portion of the business or goodwill located in that country be transferred to the assignee, together with the exclusive right to manufacture in the said country, or to sell therein, the goods bearing the mark assigned.

(2) The foregoing provision does not impose upon the countries of the Union any obligation to regard as valid the assignment of any mark the use of which by the assignee would, in fact, be of such a nature as to mislead the public, particularly as regards the origin, nature, or essential qualities, of the goods to which the mark is applied.

#### **Article 6<sup>quinquies</sup>**

[Marks: Protection of Marks Registered in One Country of the Union in the Other Countries of the Union]

A. — (1) Every trademark duly registered in the country of origin shall be accepted for filing and protected as is in the other countries of the Union, subject to the reservations indicated in this Article. Such countries may, before proceeding to final registration, require the production of a certificate of registration in the country of origin, issued by the competent authority. No authentication shall be required for this certificate.

(2) Shall be considered the country of origin the country of the Union where the applicant has a real and effective industrial or commercial establishment, or, if he has no such establishment within the Union, the country of the Union where he has his domicile, or, if he has no domicile within the Union but is a national of a country of the Union, the country of which he is a national.

B. — Trademarks covered by this Article may be neither denied registration nor invalidated except in the following cases:

## PARIS CONVENTION

1. when they are of such a nature as to infringe rights acquired by third parties in the country where protection is claimed;

2. when they are devoid of any distinctive character, or consist exclusively of signs or indications which may serve, in trade, to designate the kind, quality, quantity, intended purpose, value, place of origin, of the goods, or the time of production, or have become customary in the current language or in the bona fide and established practices of the trade of the country where protection is claimed;

3. when they are contrary to morality or public order and, in particular, of such a nature as to deceive the public. It is understood that a mark may not be considered contrary to public order for the sole reason that it does not conform to a provision of the legislation on marks, except if such provision itself relates to public order.

This provision is subject, however, to the application of Article 10<sup>bis</sup>.

C. — (1) In determining whether a mark is eligible for protection, all the factual circumstances must be taken into consideration, particularly the length of time the mark has been in use.

(2) No trademark shall be refused in the other countries of the Union for the sole reason that it differs from the mark protected in the country of origin only in respect of elements that do not alter its distinctive character and do not affect its identity in the form in which it has been registered in the said country of origin.

D. — No person may benefit from the provisions of this Article if the mark for which he claims protection is not registered in the country of origin.

E. — However, in no case shall the renewal of the registration of the mark in the country of origin involve an obligation to renew the registration in the other countries of the Union in which the mark has been registered.

F. — The benefit of priority shall remain unaffected for applications for the registration of marks filed within the period fixed by Article 4, even if registration in the country of origin is effected after the expiration of such period.

### **Article 6<sup>sexies</sup>**

[Marks: Service Marks]

The countries of the Union undertake to protect service marks. They shall not be required to provide for the registration of such marks.

### **Article 6<sup>septies</sup>**

[Marks: Registration in the Name of the Agent or Representative of the Proprietor Without the Latter's Authorization]

(1) If the agent or representative of the person who is the proprietor of a mark in one of the countries of the Union applies, without such proprietor's authorization, for the registration of the mark in his own name, in one or more countries of the Union, the proprietor shall be entitled to oppose the registration applied for or demand its cancellation or, if the law of the country so allows, the assignment in his favor of the said registration, unless such agent or representative justifies his action.

(2) The proprietor of the mark shall, subject to the provisions of paragraph (1), above, be entitled to oppose the use of his mark by his agent or representative if he has not authorized such use.

(3) Domestic legislation may provide an equitable time limit within which the proprietor of a mark must exercise the rights provided for in this Article.

### **Article 7**

[Marks: Nature of the Goods to which the Mark is Applied]

The nature of the goods to which a trademark is to be applied shall in no case form an obstacle to the registration of the mark.

### **Article 7<sup>bis</sup>**

[Marks: Collective Marks]

(1) The countries of the Union undertake to accept for filing and to protect collective marks belonging to associations the existence of which is not contrary to the law of the country of origin even if such associations do not possess an industrial or commercial establishment.

(2) Each country shall be the judge of the particular conditions under which a collective mark shall be protected and may refuse protection if the mark is contrary to the public interest.



(3) Nevertheless, the protection of these marks shall not be refused to any association the existence of which is not contrary to the law of the country of origin, on the ground that such association is not established in the country where protection is sought or is not constituted according to the law of the latter country.

### **Article 8**

[Trade Names]

A trade name shall be protected in all the countries of the Union without the obligation of filing or registration, whether or not it forms part of a trademark.

### **Article 9**

[Marks, Trade Names: Seizure, on Importation, etc., of Goods Unlawfully Bearing a Mark or Trade Name]

(1) All goods unlawfully bearing a trademark or trade name shall be seized on importation into those countries of the Union where such mark or trade name is entitled to legal protection.

(2) Seizure shall likewise be effected in the country where the unlawful affixation occurred or in the country in to which the goods were imported.

(3) Seizure shall take place at the request of the public prosecutor, or any other competent authority, or any interested party, whether a natural person or a legal entity, in conformity with the domestic legislation of each country.

(4) The authorities shall not be bound to effect seizure of goods in transit.

(5) If the legislation of a country does not permit seizure on importation, seizure shall be replaced by prohibition of importation or by seizure inside the country.

(6) If the legislation of a country permits neither seizure on importation nor prohibition of importation nor seizure inside the country, then, until such time as the legislation is modified accordingly, these measures shall be replaced by the actions and remedies available in such cases to nationals under the law of such country.

### **Article 10**

[False Indications: Seizure, on Importation, etc., of Goods Bearing False Indications as to their Source or the Identity of the Producer]

(1) The provisions of the preceding Article shall apply in cases of direct or indirect use of a false indication of the source of the goods or the identity of the producer, manufacturer, or merchant.

(2) Any producer, manufacturer, or merchant, whether a natural person or a legal entity, engaged in the production or manufacture of or trade in such goods and established either in the locality falsely indicated as the source, or in the region where such locality is situated, or in the country falsely indicated, or in the country where the false indication of source is used, shall in any case be deemed an interested party.

### **Article 10<sup>bis</sup>**

[Unfair Competition]

(1) The countries of the Union are bound to assure to nationals of such countries effective protection against unfair competition.

(2) Any act of competition contrary to honest practices in industrial or commercial matters constitutes an act of unfair competition.

(3) The following in particular shall be prohibited:

1. all acts of such a nature as to create confusion by any means whatever with the establishment, the goods, or the industrial or commercial activities, of a competitor;

2. false allegations in the course of trade of such a nature as to discredit the establishment, the goods, or the industrial or commercial activities, of a competitor;

3. indications or allegations the use of which in the course of trade is liable to mislead the public as to the nature, the manufacturing process, the characteristics, the suitability for their purpose, or the quantity, of the goods.

### **Article 10<sup>ter</sup>**

[Marks, Trade Names, False Indications, Unfair Competition: Remedies, Right to Sue]

(1) The countries of the Union undertake to assure to nationals of the other countries of the Union

## PARIS CONVENTION

appropriate legal remedies effectively to repress all the acts referred to in Articles 9, 10, and 10<sup>bis</sup>.

(2) They undertake, further, to provide measures to permit federations and associations representing interested industrialists, producers, or merchants, provided that the existence of such federations and associations is not contrary to the laws of their countries, to take action in the courts or before the administrative authorities, with a view to the repression of the acts referred to in Articles 9, 10, and 10<sup>bis</sup>, in so far as the law of the country in which protection is claimed allows such action by federations and associations of that country.

### Article 11

[Inventions, Utility Models, Industrial Designs, Marks: Temporary Protection at Certain International Exhibitions]

(1) The countries of the Union shall, in conformity with their domestic legislation, grant temporary protection to patentable inventions, utility models, industrial designs, and trademarks, in respect of goods exhibited at official or officially recognized international exhibitions held in the territory of any of them.

(2) Such temporary protection shall not extend the periods provided by Article 4. If, later, the right of priority is invoked, the authorities of any country may provide that the period shall start from the date of introduction of the goods into the exhibition.

(3) Each country may require, as proof of the identity of the article exhibited and of the date of its introduction, such documentary evidence as it considers necessary.

### Article 12

[Special National Industrial Property Services]

(1) Each country of the Union undertakes to establish a special industrial property service and a central office for the communication to the public of patents, utility models, industrial designs, and trademarks.

(2) This service shall publish an official periodical journal. It shall publish regularly:

(a) the names of the proprietors of patents granted, with a brief designation of the inventions patented;

(b) the reproductions of registered trademarks.

### Article 13

[Assembly of the Union]

(1)(a) The Union shall have an Assembly consisting of those countries of the Union which are bound by Articles 13 to 17.

(b) The Government of each country shall be represented by one delegate, who may be assisted by alternate delegates, advisors, and experts.

(c) The expenses of each delegation shall be borne by the Government which has appointed it.

(2)(a) The Assembly shall:

(i) deal with all matters concerning the maintenance and development of the Union and the implementation of this Convention;

(ii) give directions concerning the preparation for conferences of revision to the International Bureau of Intellectual Property (hereinafter designated as the International Bureau) referred to in the Convention establishing the World Intellectual Property Organization (hereinafter designated as the Organization), due account being taken of any comments made by those countries of the Union which are not bound by Articles 13 to 17;

(iii) review and approve the reports and activities of the Director General of the Organization concerning the Union, and give him all necessary instructions concerning matters within the competence of the Union;

(iv) elect the members of the Executive Committee of the Assembly;

(v) review and approve the reports and activities of its Executive Committee, and give instructions to such Committee;

(vi) determine the program and adopt the biennial budget of the Union, and approve its final accounts;

(vii) adopt the financial regulations of the Union;

(viii) establish such committees of experts and working groups as it deems appropriate to achieve the objectives of the Union;

(ix) determine which countries not members of the Union and which intergovernmental and international nongovernmental organizations shall be admitted to its meetings as observers;

(x) adopt amendments to Articles 13 to 17;

(xi) take any other appropriate action designed to further the objectives of the Union;

## MANUAL OF PATENT EXAMINING PROCEDURE

(xii) perform such other functions as are appropriate under this Convention;

(xiii) subject to its acceptance, exercise such rights as are given to it in the Convention establishing the Organization.

(b) With respect to matters which are of interest also to other Unions administered by the Organization, the Assembly shall make its decisions after having heard the advice of the Coordination Committee of the Organization.

(3)(a) Subject to the provisions of subparagraph (b), a delegate may represent one country only.

(b) Countries of the Union grouped under the terms of a special agreement in a common office possessing for each of them the character of a special national service of industrial property as referred to in Article 12 may be jointly represented during discussions by one of their number.

(4)(a) Each country member of the Assembly shall have one vote.

(b) One-half of the countries members of the Assembly shall constitute a quorum.

(c) Notwithstanding the provisions of subparagraph (b), if, in any session, the number of countries represented is less than one-half but equal to or more than one-third of the countries members of the Assembly, the Assembly may make decisions but, with the exception of decisions concerning its own procedure, all such decisions shall take effect only if the conditions set forth hereinafter are fulfilled. The International Bureau shall communicate the said decisions to the countries members of the Assembly which were not represented and shall invite them to express in writing their vote or abstention within a period of three months from the date of the communication. If, at the expiration of this period, the number of countries having thus expressed their vote or abstention attains the number of countries which was lacking for attaining the quorum in the session itself, such decisions shall take effect provided that at the same time the required majority still obtains.

(d) Subject to the provisions of Article 17(2), the decisions of the Assembly shall require two-thirds of the votes cast.

(e) Abstentions shall not be considered as votes.

(5)(a) Subject to the provisions of subparagraph (b), a delegate may vote in the name of one country only.

(b) The countries of the Union referred to in paragraph (3)(b) shall, as a general rule, endeavor to send their own delegations to the sessions of the Assembly. If, however, for exceptional reasons, any such country cannot send its own delegation, it may give to the delegation of another such country the power to vote in its name, provided that each delegation may vote by proxy for one country only. Such power to vote shall be granted in a document signed by the Head of State or the competent Minister.

(6) Countries of the Union not members of the Assembly shall be admitted to the meetings of the latter as observers.

(7)(a) The Assembly shall meet once in every second calendar year in ordinary session upon convocation by the Director General and, in the absence of exceptional circumstances, during the same period and at the same place as the General Assembly of the Organization.

(b) The Assembly shall meet in extraordinary session upon convocation by the Director General, at the request of the Executive Committee or at the request of one-fourth of the countries members of the Assembly.

(8) The Assembly shall adopt its own rules of procedure.

### Article 14

[Executive Committee]

(1) The Assembly shall have an Executive Committee.

(2)(a) The Executive Committee shall consist of countries elected by the Assembly from among countries members of the Assembly. Furthermore, the country on whose territory the Organization has its headquarters shall, subject to the provisions of Article 16 (7)(b), have an *ex officio* seat on the Committee.

(b) The Government of each country member of the Executive Committee shall be represented by one delegate, who may be assisted by alternate delegates, advisors, and experts.

(c) The expenses of each delegation shall be borne by the Government which has appointed it.

(3) The number of countries members of the Executive Committee shall correspond to one-fourth

## PARIS CONVENTION

of the number of countries members of the Assembly. In establishing the number of seats to be filled, remainders after division by four shall be disregarded.

(4) In electing the members of the Executive Committee, the Assembly shall have due regard to an equitable geographical distribution and to the need for countries party to the Special Agreements established in relation with the Union to be among the countries constituting the Executive Committee.

(5)(a) Each member of the Executive Committee shall serve from the close of the session of the Assembly which elected it to the close of the next ordinary session of the Assembly.

(b) Members of the Executive Committee may be reelected but only up to a maximum of two-thirds of such members.

(c) The Assembly shall establish the details of the rules governing the election and possible reelection of the members of the Executive Committee.

(6)(a) The Executive Committee shall:

(i) prepare the draft agenda of the Assembly;

(ii) submit proposals to the Assembly in respect of the draft program and biennial budget of the Union prepared by the Director General;

(iii) [deleted]

(iv) submit, with appropriate comments, to the Assembly the periodical reports of the Director General and the yearly audit reports on the accounts;

(v) take all necessary measures to ensure the execution of the program of the Union by the Director General, in accordance with the decisions of the Assembly and having regard to circumstances arising between two ordinary sessions of the Assembly;

(vi) perform such other functions as are allocated to it under this Convention.

(b) With respect to matters which are of interest also to other Unions administered by the Organization, the Executive Committee shall make its decisions after having heard the advice of the Coordination Committee of the Organization.

(7)(a) The Executive Committee shall meet once a year in ordinary session upon convocation by the Director General, preferably during the same period and at the same place as the Coordination Committee of the Organization.

(b) The Executive Committee shall meet in extraordinary session upon convocation by the Director General, either on his own initiative, or at the request of its Chairman or one-fourth of its members.

(8)(a) Each country member of the Executive Committee shall have one vote.

(b) One-half of the members of the Executive Committee shall constitute a quorum.

(c) Decisions shall be made by a simple majority of the votes cast.

(d) Abstentions shall not be considered as votes.

(e) A delegate may represent, and vote in the name of, one country only.

(9) Countries of the Union not members of the Executive Committee shall be admitted to its meetings as observers.

(10) The Executive Committee shall adopt its own rules of procedure.

### Article 15

[International Bureau]

(1)(a) Administrative tasks concerning the Union shall be performed by the International Bureau, which is a continuation of the Bureau of the Union united with the Bureau of the Union established by the International Convention for the Protection of Literary and Artistic Works.

(b) In particular, the International Bureau shall provide the secretariat of the various organs of the Union.

(c) The Director General of the Organization shall be the chief executive of the Union and shall represent the Union.

(2) The International Bureau shall assemble and publish information concerning the protection of industrial property. Each country of the Union shall promptly communicate to the International Bureau all new laws and official texts concerning the protection of industrial property. Furthermore, it shall furnish the International Bureau with all the publications of its industrial property service of direct concern to the protection of industrial property which the International Bureau may find useful in its work.

(3) The International Bureau shall publish a monthly periodical.

(4) The International Bureau shall, on request, furnish any country of the Union with information on

MANUAL OF PATENT EXAMINING PROCEDURE

matters concerning the protection of industrial property.

(5) The International Bureau shall conduct studies, and shall provide services, designed to facilitate the protection of industrial property.

(6) The Director General and any staff member designated by him shall participate, without the right to vote, in all meetings of the Assembly, the Executive Committee, and any other committee of experts or working group. The Director General, or a staff member designated by him, shall be *ex officio* secretary of these bodies.

(7)(a) The International Bureau shall, in accordance with the directions of the Assembly and in cooperation with the Executive Committee, make the preparations for the conferences of revision of the provisions of the Convention other than Articles 13 to 17.

(b) The International Bureau may consult with intergovernmental and international non-governmental organizations concerning preparations for conferences of revision.

(c) The Director General and persons designated by him shall take part, without the right to vote, in the discussions at these conferences.

(8) The International Bureau shall carry out any other tasks assigned to it.

**Article 16**

[Finances]

(1)(a) The Union shall have a budget.

(b) The budget of the Union shall include the income and expenses proper to the Union, its contribution to the budget of expenses common to the Unions, and, where applicable, the sum made available to the budget of the Conference of the Organization.

(c) Expenses not attributable exclusively to the Union but also to one or more other Unions administered by the Organization shall be considered as expenses common to the Unions. The share of the Union in such common expenses shall be in proportion to the interest the Union has in them.

(2) The budget of the Union shall be established with due regard to the requirements of coordination with the budgets of the other Unions administered by the Organization.

(3) The budget of the Union shall be financed from the following sources:

(i) contributions of the countries of the Union;

(ii) fees and charges due for services rendered by the International Bureau in relation to the Union;

(iii) sale of, or royalties on, the publications of the International Bureau concerning the Union;

(iv) gifts, bequests, and subventions;

(v) rents, interests, and other miscellaneous income.

(4)(a) For the purpose of establishing its contribution towards the budget, each country of the Union shall belong to a class, and shall pay its annual contributions on the basis of a number of units fixed as follows:

Class I	25
Class II	15
Class III	15
Class IV	10
Class V	5
Class VI	3
Class VII	1

(b) Unless it has already done so, each country shall indicate, concurrently with depositing its instrument of ratification or accession, the class to which it wishes to belong. Any country may change class. If it chooses a lower class, the country must announce such change to the Assembly at one of its ordinary sessions. Any such change shall take effect at the beginning of the calendar year following the said session.

(c) The annual contribution of each country shall be an amount in the same proportion to the total sum to be contributed to the budget of the Union by all countries as the number of its units is to the total of the units of all contributing countries.

(d) Contributions shall become due on the first of January of each year.

(e) A country which is in arrears in the payment of its contributions may not exercise its right to

## PARIS CONVENTION

vote in any of the organs of the Union of which it is a member if the amount of its arrears equals or exceeds the amount of the contributions due from it for the preceding two full years. However, any organ of the Union may allow such a country to continue to exercise its right to vote in that organ if, and as long as, it is satisfied that the delay in payment is due to exceptional and unavoidable circumstances.

(f) If the budget is not adopted before the beginning of a new financial period, it shall be at the same level as the budget of the previous year, as provided in the financial regulations.

(5) The amount of the fees and charges due for services rendered by the International Bureau in relation to the Union shall be established, and shall be reported to the Assembly and the Executive Committee, by the Director General.

(6)(a) The Union shall have a working capital fund which shall be constituted by a single payment made by each country of the Union. If the fund becomes insufficient, the Assembly shall decide to increase it.

(b) The amount of the initial payment of each country to the said fund or of its participation in the increase thereof shall be a proportion of the contribution of that country for the year in which the fund is established or the decision to increase it is made.

(c) The proportion and the terms of payment shall be fixed by the Assembly on the proposal of the Director General and after it has heard the advice of the Coordination Committee of the organization.

(7)(a) In the headquarters agreement concluded with the country on the territory of which the Organization has its headquarters, it shall be provided that, whenever the working capital fund is insufficient, such country shall grant advances. The amount of these advances and the conditions on which they are granted shall be the subject of separate agreements, in each case, between such country and the Organization. As long as it remains under the obligation to grant advances, such country shall have an *ex officio* seat on the Executive Committee.

(b) The country referred to in subparagraph (a) and the Organization shall each have the right to denounce the obligation to grant advances, by written notification. Denunciation shall take effect three years after the end of the year in which it has been notified.

(8) The auditing of the accounts shall be effected by one or more of the countries of the Union or by external auditors, as provided in the financial regulations. They shall be designated, with their agreement, by the Assembly.

### Article 17

[Amendment of Articles 13 to 17]

(1) Proposals for the amendment of Articles 13, 14, 15, 16, and the present Article, may be initiated by any country member of the Assembly, by the Executive Committee, or by the Director General. Such proposals shall be communicated by the Director General to the member countries of the Assembly at least six months in advance of their consideration by the Assembly.

(2) Amendments to the Articles referred to in paragraph (1) shall be adopted by the Assembly. Adoption shall require three-fourths of the votes cast, provided that any amendment to Article 13, and to the present paragraph, shall require four-fifths of the votes cast.

(3) Any amendment to the Articles referred to in paragraph (1) shall enter into force one month after written notifications of acceptance, effected in accordance with their respective constitutional processes, have been received by the Director General from three-fourths of the countries members of the Assembly at the time it adopted the amendment. Any amendment to the said Articles thus accepted shall bind all the countries which are members of the Assembly at the time the amendment enters into force, or which become members thereof at a subsequent date, provided that any amendment increasing the financial obligations of countries of the Union shall bind only those countries which have notified their acceptance of such amendment.

### Article 18

[Revision of Articles 1 to 12 and 18 to 30]

(1) This Convention shall be submitted to revision with a view to the introduction of amendments designed to improve the system of the Union.

(2) For that purpose, conferences shall be held successively in one of the countries of the Union among the delegates of the said countries.

(3) Amendments to Articles 13 to 17 are governed by the provisions of Article 17.

**Article 19**

[Special Agreements]

It is understood that the countries of the Union reserve the right to make separately between themselves special agreements for the protection of industrial property, in so far as these agreements do not contravene the provisions of this Convention.

**Article 20**

[Ratification or Accession by Countries of the Union; Entry Into Force]

(1)(a) Any country of the Union which has signed this Act may ratify it, and, if it has not signed it, may accede to it. Instruments of ratification and accession shall be deposited with the Director General.

(b) Any country of the Union may declare in its instrument of ratification or accession that its ratification or accession shall not apply:

- (i) to Articles 1 to 12, or
- (ii) to Articles 13 to 17.

(c) Any country of the Union which, in accordance with subparagraph (b), has excluded from the effects of its ratification or accession one of the two groups of Articles referred to in that subparagraph may at any later time declare that it extends the effects of its ratification or accession to that group of Articles. Such declaration shall be deposited with the Director General.

(2)(a) Articles 1 to 12 shall enter into force, with respect to the first ten countries of the Union which have deposited instruments of ratification or accession without making the declaration permitted under paragraph (1)(b)(i), three months after the deposit of the tenth such instrument of ratification or accession.

(b) Articles 13 to 17 shall enter into force, with respect to the first ten countries of the Union which have deposited instruments of ratification or accession without making the declaration permitted under paragraph (1)(b)(ii), three months after the deposit of the tenth such instrument of ratification or accession.

(c) Subject to the initial entry into force, pursuant to the provisions of subparagraphs (a) and (b), of each of the two groups of Articles referred to in paragraph (1)(b)(i) and (ii), and subject to the provisions of paragraph (1)(b), Articles 1 to 17 shall, with respect to any country of the Union, other than those referred to in subparagraphs (a) and (b), which depos-

its an instrument of ratification or accession or any country of the Union which deposits a declaration pursuant to paragraph (1)(c), enter into force three months after the date of notification by the Director General of such deposit, unless a subsequent date has been indicated in the instrument or declaration deposited. In the latter case, this Act shall enter into force with respect to that country on the date thus indicated.

(3) With respect to any country of the Union which deposits an instrument of ratification or accession, Articles 18 to 30 shall enter into force on the earlier of the dates on which any of the groups of Articles referred to in paragraph (1)(b) enters into force with respect to that country pursuant to paragraph (2)(a), (b), or (c).

**Article 21**

[Accession by Countries Outside the Union; Entry Into Force]

(1) Any country outside the Union may accede to this Act and thereby become a member of the Union. Instruments of accession shall be deposited with the Director General.

(2)(a) With respect to any country outside the Union which deposits its instrument of accession one month or more before the date of entry into force of any provisions of the present Act, this Act shall enter into force, unless a subsequent date has been indicated in the instrument of accession, on the date upon which provisions first enter into force pursuant to Article 20(2)(a) or (b); provided that:

(i) if Articles 1 to 12 do not enter into force on that date, such country shall, during the interim period before the entry into force of such provisions, and in substitution therefor, be bound by Articles 1 to 12 of the Lisbon Act,

(ii) if Articles 13 to 17 do not enter into force on that date, such country shall, during the interim period before the entry into force of such provisions, and in substitution therefor, be bound by Articles 13 and 14 (3), (4), and (5), of the Lisbon Act.

If a country indicates a subsequent date in its instrument of accession, this Act shall enter into force with respect to that country on the date thus indicated.

(b) With respect to any country outside the Union which deposits its instrument of accession on a date which is subsequent to, or precedes by less than one month, the entry into force of one group of Arti-

## PARIS CONVENTION

cles of the present Act, this Act shall, subject to the proviso of subparagraph (a), enter into force three months after the date on which its accession has been notified by the Director General, unless a subsequent date has been indicated in the instrument of accession. In the latter case, this Act shall enter into force with respect to that country on the date thus indicated.

(3) With respect to any country outside the Union which deposits its instrument of accession after the date of entry into force of the present Act in its entirety, or less than one month before such date, this Act shall enter into force three months after the date on which its accession has been notified by the Director General, unless a subsequent date has been indicated in the instrument of accession. In the latter case, this Act shall enter into force with respect to that country on the date thus indicated.

### **Article 22**

[Consequences of Ratification or Accession]

Subject to the possibilities of exceptions provided for in Articles 20(1) (b) and 28(2), ratification or accession shall automatically entail acceptance of all the clauses and admission to all the advantages of this Act.

### **Article 23**

[Accession to Earlier Acts]

After the entry into force of this Act in its entirety, a country may not accede to earlier Acts of this Convention.

### **Article 24**

[Territories]

(1) Any country may declare in its instrument of ratification or accession, or may inform the Director General by written notification any time thereafter, that this Convention shall be applicable to all or part of those territories, designated in the declaration or notification, for the external relations of which it is responsible.

(2) Any country which has made such a declaration or given such a notification may, at any time, notify the Director General that this Convention shall cease to be applicable to all or part of such territories.

(3)(a) Any declaration made under paragraph (1) shall take effect on the same date as the ratification or accession in the instrument of which it was included,

and any notification given under such paragraph shall take effect three months after its notification by the Director General.

(b) Any notification given under paragraph (2) shall take effect twelve months after its receipt by the Director General.

### **Article 25**

[Implementation of the Convention  
on the Domestic Level]

(1) Any country party to this Convention undertakes to adopt, in accordance with its constitution, the measures necessary to ensure the application of this Convention.

(2) It is understood that, at the time a country deposits its instrument of ratification or accession, it will be in a position under its domestic law to give effect to the provisions of this Convention.

### **Article 26**

[Denunciation]

(1) This Convention shall remain in force without limitation as to time.

(2) Any country may denounce this Act by notification addressed to the Director General. Such denunciation shall constitute also denunciation of all earlier Acts and shall affect only the country making it, the Convention remaining in full force and effect as regards the other countries of the Union.

(3) Denunciation shall take effect one year after the day on which the Director General has received the notification.

(4) The right of denunciation provided by this Article shall not be exercised by any country before the expiration of five years from the date upon which it becomes a member of the Union.

### **Article 27**

[Application of Earlier Acts]

(1) The present Act shall, as regards the relations between the countries to which it applies, and to the extent that it applies, replace the Convention of Paris of March 20, 1883, and the subsequent Acts of revision.

(2)(a) As regards the countries to which the present Act does not apply, or does not apply in its entirety, but to which the Lisbon Act of October 31, 1958, applies, the latter shall remain in force in its



entirety or to the extent that the present Act does not replace it by virtue of paragraph (1).

(b) Similarly, as regards the countries to which neither the present Act, nor portions thereof, nor the Lisbon Act applies, the London Act of June 2, 1934, shall remain in force in its entirety or to the extent that the present Act does not replace it by virtue of paragraph (1).

(c) Similarly, as regards the countries to which neither the present Act, nor portions thereof, nor the Lisbon Act, nor the London Act applies, The Hague Act of November 6, 1925, shall remain in force in its entirety or to the extent that the present Act does not replace it by virtue of paragraph (1).

(3) Countries outside the Union which become party to this Act shall apply it with respect to any country of the Union not party to this Act or which, although party to this Act, has made a declaration pursuant to Article 20(1)(b)(i). Such countries recognize that the said country of the Union may apply, in its relations with them, the provisions of the most recent Act to which it is party.

### **Article 28**

[Disputes]

(1) Any dispute between two or more countries of the Union concerning the interpretation or application of this Convention, not settled by negotiation, may, by any one of the countries concerned, be brought before the International Court of Justice by application in conformity with the Statute of the Court, unless the countries concerned agree on some other method of settlement. The country bringing the dispute before the Court shall inform the International Bureau; the International Bureau shall bring the matter to the attention of the other countries of the Union.

(2) Each country may, at the time it signs this Act or deposits its instrument of ratification or accession, declare that it does not consider itself bound by the provisions of paragraph (1). With regard to any dispute between such country and any other country of the Union, the provisions of paragraph (1) shall not apply.

(3) Any country having made a declaration in accordance with the provisions of paragraph (2) may, at any time, withdraw its declaration by notification addressed to the Director General.

### **Article 29**

[Signature, Languages, Depositary Functions]

(1)(a) This Act shall be signed in a single copy in the French language and shall be deposited with the Government of Sweden.

(b) Official texts shall be established by the Director General, after consultation with the interested Governments, in the English, German, Italian, Portuguese, Russian and Spanish languages, and such other languages as the Assembly may designate.

(c) In case of differences of opinion on the interpretation of the various texts, the French text shall prevail.

(2) This Act shall remain open for signature at Stockholm until January 13, 1968.

(3) The Director General shall transmit two copies, certified by the Government of Sweden, of the signed text of this Act to the Governments of all countries of the Union and, on request, to the government of any other country.

(4) The Director General shall register this Act with the Secretariat of the United Nations.

(5) The Director General shall notify the Governments of all countries of the Union of signatures, deposits of instruments of ratification or accession and any declarations included in such instruments or made pursuant to Article 20(1)(c), entry into force of any provisions of this Act, notifications of denunciation, and notifications pursuant to Article 24.

### **Article 30**

[Transitional Provisions]

(1) Until the first Director General assumes office, references in this Act to the International Bureau of the Organization or to the Director General shall be deemed to be references to the Bureau of the Union or its Director, respectively.

(2) Countries of the Union not bound by Articles 13 to 17 may, until five years after the entry into force of the Convention establishing the Organization, exercise, if they so desire, the rights provided under Articles 13 to 17 of this Act as if they were bound by those Articles. Any country desiring to exercise such rights shall give written notification to that effect to the Director General; such notification shall be effective from the date of its receipt. Such countries shall be deemed to be members of the Assembly until the expiration of the said period.

## PARIS CONVENTION

(3) As long as all the countries of the Union have not become Members of the Organization, the International Bureau of the Organization shall also function as the Bureau of the Union, and the Director General as the Director of the said Bureau.

(4) Once all the countries of the Union have become Members of the Organization, the rights, obligations, and property, of the Bureau of the Union shall devolve on the International Bureau of the Organization.

MANUAL OF PATENT EXAMINING PROCEDURE

# INDEX

A4 size paper-- Access

	Sec. No.	Sec. No.
<b>A</b>		
A4 size paper (See also Paper size).....	608.01	
.....	608.02, 1825, 1826	
A.I. series of patents (See also Patent) .....	901.04	
Abandoned application (See also Abandonment)		
Accessibility to public.....	103, 711.04	
Counting, when processed.....	711.04(a)	
Definition .....	203.05	
Failure to provide timely notice of foreign filing when nonpublication requested.....	1124	150
Fee on petition to revive.....	711.03(c)	711.03(c)
Issue fee, failure to pay .....	203.07, 711.03(c)	711.02
Listed.....	1302.04	Failure to provide timely notice of foreign filing after non-publication request .....
Matter reproduced in substitute.....	201.09	1124
Ordering .....	711.04(b), 905.03	Formal .....
Papers received, handling.....	508.02	711, 711.01
Provisional application.....	201.04(b), 201.11	Forwarding .....
Reference use .....	901.02, 2127	711.04(a)
Referred to in issued patent.....	103, 1302.04	Incomplete reply.....
Retention fee .....	601.01(a)	711.03(a)
Retention label .....	1302.07	Invention abandoned.....
Revival .....	711.03(c), 1893.02	706.02(d), 2134, 2138.03
Provisional application .....	711.03(c)	No reply .....
Storage .....	711.04(b)	711, 711.02
When open to the public .....	103	Notification of .....
Abandoned file (See Abandoned application; Abandonment)		711.02, 711.04(c)
Abandoned files repository .....	608.02(c), 707.13, 711.01	Of appeal .....
.....	711.04(a), 711.04(b), 905.03	1210
Abandonment (See also Abandoned application) .....	711	Of invention.....
After allowance .....	711.05	706.02(d), 2134, 2138.03
Amendment late .....	711.02, 714.17, 2305.03	Papers received after.....
Appeal dismissal .....	1215.04	508.02
Appeal withdrawal .....	1215.01 to 1215.03	Petition to revive.....
Assignee must consent .....	711	711.03(c), 711.04(c)
Change of address .....	711.03(c)	.....
Counted as a disposal.....	1705	1002.02(c), 1002.02(q), 1002.02(r)
Court case.....	1216	Petition to withdraw holding of examiner's statement .....
Date of.....	711.04(a)	711.03(c), 711.03(d)
Destroys continuity .....	201.11	Prior application .....
Express .....	711, 711.01	201.06(c)
Continued prosecution application (CPA).....	201.06(d)	Provisional application .....
Issue fee not paid .....	711.03(c)	201.04(b), 201.11
Issue fee paid .....	711.05	Pulling .....
		711.04(a)
		Reconsideration .....
		711.03, 711.03(c)
		Failure to respond .....
		711.03(b)
		Insufficiency of response .....
		711.03(a)
		Reissue
		Return of surrendered patent.....
		1416
		Revival.....
		711.03, 711.03(c)
		Shortened statutory period expired .....
		710.02(d)
		.....
		711.04(a)
		Special situations.....
		711.02(b)
		Termination of proceedings.....
		201.11, 711.02(c)
		Unavoidable (See also Petition).....
		711.03(c), 711.04(c)
		Undelivered action.....
		707.13
		Unintentional (See also Petition) .....
		711.03(c)
		.....
		711.04(c), 1124
		Withdrawal of holding.....
		711.03(c), 711.04(c)
		Abbreviation, periodical citation .....
		707.05(e)
		Abbreviature and abstract publication .....
		711.06
		Citation .....
		711.06(a)
		Abstract for defensive publication.....
		711.06
		Abstract of international application.....
		1826
		Abstract of the disclosure .....
		608.01(b)
		.....
		1302.01, 1302.04
		Abstract publication.....
		711.06
		Accelerated examination .....
		708.02

MANUAL OF PATENT EXAMINING PROCEDURE  
Access--Administrator or executor

	Sec. No.		Sec. No.
Access (See also Inspection; Power of attorney)		Formal matter .....	707.07(a), 707.07(e)
Attorney not of record .....	402, 405	.....	707.07(j), 714.02
Authorized by Director .....	104	Forms used.....	707
Continued Prosecution Application (CPA) .....	103	Incorrect citation of references .....	710.06
<i>Ex parte</i> reexamination file .....	2232	Informal application .....	702.01
Excluded attorney or agent.....	105	Mailing .....	707.12
<i>Inter partes</i> reexamination file .....	2609, 2632	Original in file wrapper .....	707.10, 707.12
International application.....	110	Patentability report .....	705, 705.01(c)
Pending application.....	101, 103, 104, 106, 724.04	Piecemeal examination.....	707.07(a), 707.07(g)
.....	724.04(a), 1128, 1132	Primary examiner's personal attention .....	707.01, 1004
Petition .....	103	Priority determination, foreign .....	201.13 to 201.16
Protested application .....	1901.05, 1901.07	Reissue application file.....	1430
Provisional application.....	103, 104	Reply time computation.....	710.01(a), 710.05
Published application .....	1128, 1130	Restriction requirement .....	Chapter 800
Reissue application.....	724.04(b)	Returned .....	707.13
Suspended attorney or agent .....	105	Review .....	Introduction
Accounts, Deposit (See Deposit account)		Shortened statutory period.....	710.02, 710.02(b)
Acknowledgment of protest .....	1901.05	SPE's personal attention.....	707.02
Act (See Statutes)		Supplemental.....	710.06, 714.05
Action (See also Letter, Examiner's)		Suspension (See also Suspension).....	709
Advisory action .....	706.07(f), 714.13	Suspension, primary examiner's attention.....	1004
After another examiner's action.....	706.04	Suspension, TC Director's attention.....	1003
After Board decision .....	1214.01, 1214.03 to 1214.07	Third, SPE reviews.....	707.02
After Board decision reversing examiner.....	1214.04	Time limit .....	710.02, 710.02(c)
After Board decision sustaining examiner .....	1214.06	Address, Change of correspondence.....	601.03, 711.03(c)
After interference .....	2363	After Allowance .....	2501
Amendment after final rejection .....	706.07(f)	Address, Correspondence (See also Mail Stop)	
.....	714.12, 714.13	.....	403, 2540, 2542
Citation of references .....	707.05, 710.06	Address, Fee .....	2540
Claim summary .....	707.07(i)	Address of applicant .....	605.03
Claims in excess of filing fee .....	714.10	Address of Patent and Trademark Office .....	501, 502
Closing prosecution in <i>inter partes</i> reexamination (See		Address of patent owner .....	2222, 2622
Reexamination, <i>Inter partes</i> : Action closing		Address of unavailable inventor .....	409.03(e)
prosecution)		Administration, Letters of.....	409.01(b)
Completeness .....	707.07, 707.07(a)	.....	409.01(c), 409.01(e)
Copy to applicant .....	707.12	Administration of oath.....	604
Copies of references.....	707.05(a)	Administrative instructions, PCT .....	App. AI
Correctness, Period for reply.....	710.06	Administrative Patent Judges (See Board of Patent Appeals	
Counted .....	1705	and Interferences (BPAI))	
Crosses amendment.....	714.05	Administrator or executor.....	409.01
Date .....	707.11	Allowance and issue .....	409.01(f)
Examiner's .....	707	Application by, After discharge .....	409.01(c)
File wrapper endorsement .....	707.10, 719.01	Assigned application, Inventor dies.....	409.01(e)
File wrapper entry .....	707.10	Authority.....	409.01(b)
Final rejection .....	706.07 to 706.07(f), 713.09	Consular certificate.....	409.01(d)
In reissue applications .....	1443	Foreign country .....	409.01(d)
Foreign priority determination .....	201.13 to 201.16	Heir.....	409.01, 409.01(a), 409.01(d)

INDEX

Admissions by applicant--Affidavits, traversing rejections (37 CFR 1.132)

	Sec. No.		Sec. No.
Prosecution by .....	409.01(a)	Reexamination, <i>ex parte</i> .....	2258
Intervention not required .....	409.01(f)	Reexamination, <i>inter partes</i> .....	2658
Refuses to sign .....	409.03(c)	Reference date to be overcome .....	715
Specification form .....	605.05	Reference is	
Admissions by applicant .....	706.02(c), 2129, 2133.03(c)	Common assignee .....	715.01(b), 718
Jepson claim .....	2129	Joint patent or published application to applicant and another .....	715.01(a)
Admissions in reexamination		Patent or application publication claiming same invention .....	715.05, 2138.01
<i>Ex Parte</i> .....	2217, 2258	Publication of applicant's own invention .....	715.01(c)
<i>Inter partes</i> .....	2617	Sufficiency of .....	715.08
Advantages over prior art .....	707.07(f)	When used .....	706.02(b), 706.02(l)(3), 715, 2132.01
Adverse recommendation under 37 CFR 1.312 .....	714.16(d)	Who may make affidavit .....	706.02(b)
.....	714.16(e), 714.19	.....	706.02(l)(3), 715.04
Advisory action .....	706.07(f), 714.13	Withdrawn rejection .....	715
Affidavit (See Oath; Declaration)		Affidavits, traversing rejections (37 CFR 1.132) .....	716
Affidavit, disqualifying commonly owned patent or patent application publication as prior art .....	718	Attorney arguments .....	716.01(c)
Affidavit, swearing back of reference (37 CFR 1.131) .....	706.02(l)(3), 715, 2133.01	Inoperability of references .....	716.07, 2145
.....	2133.02, 2133.03(c)	Reference attributed to applicant .....	716.10
Acts relied upon, NAFTA/WTO/U.S. ....	706.02(c)	Attribution, of reference to applicant .....	716.10
.....	715.07(c)	Commercial success, evidence .....	716.03
Best mode, failure to disclose .....	715.10	Commensurate in scope with claimed invention .....	716.03(a)
Co-authorship .....	715.01(c)	Derived from claimed invention .....	716.03(b)
Common assignee, reference and application .....	715.01(b), 718	Design applications .....	716.03(b), 1504.03
Compared to Rule 1.132 affidavit .....	715.01	Sales figures .....	716.03(b)
Completion of invention .....	715, 2133.03(c)	Commonly owned patent .....	718
Conception (See Conception)		Commonly owned patent application publication .....	718
Continuing application .....	201.06(c), 201.06(d)	Comparison with closest prior art .....	716.02(e)
Copies from prior applications .....	201.06(c)	Computer programming cases .....	2106.02
Dedication to public .....	715	Continuing application .....	201.06(c), 201.06(d)
Derivation .....	715.07(c)	Copying, evidence .....	716.06, 1504.03
Diligence (See Diligence)		Disclosure, sufficiency .....	716.09
Effective filing date .....	715	Disclosure, utility and operability .....	716.08
Exhibit, Disposition .....	715.07(d)	Evidence	
Formal requirements .....	715.04	Consideration of .....	716.01
Facts and documentary evidence .....	715.07	Publications .....	716.02(g)
Timely presented .....	715.09	Objective .....	716.01(a)
Genus-species .....	715.03	Compared to opinion evidence .....	716.01(c)
Generic claim .....	715.02	Probative value .....	716.01(c)
Interference testimony used .....	715.07(b)	Weighing against <i>prima facie</i> case .....	716.01(d)
Overcome patent or publication .....	715	.....	716.05
Petition regarding sufficiency .....	1002.02(c)	Secondary .....	716.01(b)
Prior public use/sale .....	715.10	Timeliness .....	716.01
Priority time charts .....	2138.01	Long-felt need .....	716.04
Proper use of .....	715	Petition regarding sufficiency .....	1002.02(c)
Reduction to practice (See Reduction to practice)		Reexamination, <i>ex parte</i> .....	2258

MANUAL OF PATENT EXAMINING PROCEDURE

Affidavits submitted with prior art under 35 U.S.C. 301 in patented files--Allowance and issue

Sec. No.	Sec. No.
Reexamination, <i>inter partes</i> .....	2658
Reference attributed to applicant.....	716.10
Sufficiency of.....	716.09
Synergism.....	716.02(a)
Skepticism of experts .....	716.05
Timeliness .....	716.01
Unexpected results, allegations .....	716.02
Unexpected results, evidence .....	716.02(a)
Advantages not disclosed or inherent .....	716.02(f)
Burden on applicant.....	716.02(b)
Commensurate in scope with claimed invention	
.....	716.02(d)
Genus or species .....	716.02(d)
Range, claimed .....	716.02(d)
Weighing evidence of.....	716.02(c)
Affidavits submitted with prior art under 35 U.S.C. 301 in	
patented files.....	2205
Affirmation (See Oath; Declaration)	
After final practice .....	706.07(f)
In transitional application.....	706.07(g)
In <i>ex parte</i> reexamination.....	2272
Agent (See Attorney or agent; Power of attorney)	
Agent for international application.....	1807, 1864.04
Aggregation.....	2173.05(k)
Agriculture, Department of, Plant patents.....	1608, 1609
Agricultural Research Service.....	1608, 1609
AIDS/HIV, petition to make special .....	708.02
Algorithms .....	706.03(a), 2106, 2106.02
Alien Property Custodian (A.P.C.) publications	
(See also Citation of prior art).....	901.06(c)
Allowance and issue (See also Allowed application)	
.....	Chapter 1300
Abandonment after.....	711.05
All claims allowed, shortened statutory period	
.....	710.02(b)
Amendment, Examiner's.....	1302.04
Amendment, Examiner's, Rule 1.312 .....	1305
Amendment after (See Amendment: After allowance)	
Amendment after allowance of all claims .....	714.14
.....	1303.01
Amendment after D-10 notice.....	130
Amendment at time of.....	714.15
Amendment crossing in mail.....	714.15
Assigned application .....	307
Assignment Division.....	409.01(b), 1302.11
Cancellation of claims after appeal .....	1214.06
.....	1215.03, 1214.04
Cancellation of claim lost in interference.....	2363.03
Cancellation on nonelected claim by examiner's	
amendment .....	821.01, 821.02
Cancellation of nonstatutory claim .....	1302.04(b)
Citation of prior art.....	1302.12
Claim for <i>Official Gazette</i> .....	1302.09
Claim renumbering.....	608.01(j), 1302.01, 1302.04(g)
Claim renumbering, dependent claim.....	608.01(n)
.....	1302.01
Classification .....	903.07, 903.07(b)
Classification change after allowance.....	903.07
Classification in another Technology Center... ..	903.07(b)
Classification slip notation .....	1302.10
Companion application referred to .....	1302.04, 1302.07
Copending application	
File wrapper/history notations.....	202.02, 1302.09
Parent application data.....	1302.04, 1302.04(f)
Retention label .....	1302.07
Correction of error after allowance.....	714.16
Cross-reference.....	903.07(a)
D-10 notice .....	130
Deceased inventor, notice of allowance .....	1303.03
Drawing, drafting stamp no longer required.....	608.02(o)
Drawing correction .....	608.02(z), 1302.04
Drawing in patented file .....	608.02(i), 905.03
Erasure of markings.....	1302.01
Examiner's amendment (See Examiner's amendment)	
File wrapper notation.....	1302.09
Final review .....	1302
Formal matters.....	714.16, 1302.01
Formal matters, examiner's amendment and changes	
.....	714.16, 1302.04
Formal matters, specification rewritten .....	1302.02
General review.....	1302.01
Interference.....	2305.04, 2307.03
Interference, Notation of.....	2301.01(b), 2305.04
Interference search.....	1302.08, 2301.01(b)
International classification.....	903.09
Intervention by executor.....	409.01(f)
Issue classification slip (PTO-270).....	903.07, 903.07(b)
.....	903.09, 1302.10, 1455
Issue in another TC without transfer.....	903.07(b)
Jurisdiction of application.....	1305
Listing of references .....	1302.12
Locarno classification designations .....	903.09(a)
Nonelected claims canceled by examiner's amendment	
.....	821.01, 821.02

INDEX  
Allowance, Reasons for--Amendment

	Sec. No.		Sec. No.
Notice of Allowability.....	1302.03	Rejection.....	1308.01
Notice of allowance (See Form letters and forms: Notice of allowance)		Suggesting claim for interference.....	1003, 2305.04
Ordering allowed application.....	1306.03	Allowed claim, rejection.....	706.04
Patentability report, print disposal.....	608.02(n)	By Board of Patent Appeals and Interferences....	1213.02
.....	705.01(d)	Alpha subclass.....	903.02(c)
Plant application.....	1611	Alteration of application after execution.....	605.04(a)
Printer waiting.....	1309.02	Alteration of application before execution.....	506
<i>Pro se</i> .....	707.07(j)	.....	601.01(a), 602, 608.01
Protest against issue.....	1901	Alteration of patent application.....	506
Reasons for allowance (See Reasons for allowance)		Alternative phrase in claim (See also Indefinite claim)	
Record room.....	905.03	.....	2173.05(h)
Reference listing.....	1302.12	Amended application.....	203.03
Reissue application.....	1455	Amended application, inspection for transfer.....	903.08(c)
Rejection after allowance.....	706.04, 706.05, 1308.01	Amendment (See also Reply).....	714
Related applications, file wrapper/history notations		Accidental entry.....	714.21
.....	202.02, 1302.09	Adding excess claims.....	714.10
Related applications, parent application data..	1302.04(f)	After abandonment.....	711.02, 714.17
Related applications, retention label.....	1302.07	After all claims allowed.....	714.14
Reopening prosecution.....	1308.01	After allowance	
Retention labels.....	1302.07	Approval.....	714.16, 1002.02(d)
Review by examiner.....	1302.01	Canceling claim.....	714.16
Review by primary examiner.....	903.07	Claim copied from patent.....	714.16(a), 2307.03
Rewritten specification requirement.....	1302.02	Entry in part.....	714.16(e)
Secret application.....	130, 1304.01	Examiner's action.....	714.16, 714.16(d), 714.16(e)
Signing file wrapper.....	1302.13	Excess claims.....	714.16(c)
Special.....	708.01, 710.02(b), 1301	Formal matters.....	714.16, 714.16(d)
Specification, clean copy required.....	1302.02	Handling.....	714.16(d)
Statement of invention.....	1302.01	Mailed before allowance.....	714.15
Suggestion of claims.....	2305.04	Motion under Rule 1.633(c)(2).....	714.16(b)
Supplemental oath after.....	603.01	.....	2363.03
Terminology correspondence of specification and claims		Patentability pointed out.....	714.16
.....	1302.01	Reason for adverse action.....	714.16, 714.16(d)
Title of invention.....	1302.01	Renumbering claims.....	714.16(e)
Title change by examiner.....	606.01	Secrecy order application.....	130, 1304.01
Title search, continuing application.....	306	After examiner's answer.....	1210
Transfer.....	903.08	After appeal, before examiner's answer.....	1207
Undelivered notice of allowance.....	1303.02	After Board decision.....	1002.02(d), 1214.01
Withdrawal from issue (See Withdrawal from issue)		.....	1214.06, 1214.07
Withholding from issue, secrecy order application		After death of attorney or agent.....	406
.....	130, 1304.01	After final rejection.....	706.07(f), 714.12, 714.13
Examiner determines compliance with 1.121....		.....	714.18
Allowance, Reasons for (See Reasons for allowance)		After final rejection, entered in part.....	714.20
Allowed application (See also Allowance and issue)		Amendment of.....	714.24
Definition.....	203.04	Applicants must sign.....	714.01(a)
Express abandonment of.....	711.01	At allowance.....	714.15
File wrapper data.....	1302.09	Attorney not of record.....	405, 714.01(c)
Ordering.....	1306.03		



MANUAL OF PATENT EXAMINING PROCEDURE  
Amendment--Amendment

Sec. No.	Sec. No.
Basis in disclosure ..... 608, 706.03(c) ..... 2163.03, 2163.07	Entered in part, after allowance, 37 CFR 1.312 ..... 714.16(e)
Before first action..... 608.04(b), 714.01(e), 714.03(a)	Entry ..... 714.18, 719.01(a)
Board rejection avoided ..... 1214.01	Entry denied..... 714.17, 714.19, 714.21
Brackets required ..... 714.22	Appeal case ..... 1207, 1214.07
By replacement paragraph or section ..... 714 ..... 714.22, 714.23	Defective directions ..... 714.23
By substitute specification ..... 714	Drawing correction ..... 608.02(x)
Canceled matter restored..... 608.01(s)	Drawing new matter ..... 608.04
Canceling all claims ..... 706.07(h), 711.01, 714.19	List ..... 714.19
Canceling appealed claims ..... 1215.01 to 1215.03	Paper number ..... 714.21
Claim added, terminology basis ..... 608.01(o) ..... 2163.03, 2163.07	Period for reply expired ..... 714.17
Claim numbering..... 608.01(j), 1302.01, 1302.04(g)	Preliminary amendment ..... 714.01(e), 714.03(a)
Claims	Second (or subsequent) supplemental reply.. 714.03(a)
Added in excess of filing fee .... 607, 714.10, 714.16(c)	Substitute specification unnecessary ..... 714.19, 714.20
Clean version ..... 714, 714.13, 714.16, 714.22(a)	Unduly interferes with preparation of Office action ..... 714.03(a)
Marked-up version..... 714	Entry directions ..... 714, 714.22, 714.23
Complete reply required..... 714.02, 714.04	Entry inadvertent ..... 714.21
Consolidating pending claims ..... 714, 714.13 ..... 714.16, 714.22(a)	Entry in <i>ex parte</i> reexamination ..... 2234
Copier copies..... 714.07	Entry in <i>inter partes</i> reexamination ..... 2670
Copying patent claim (See Claim presented corresponding to claim of patent)	Entry of amendment filed in connection with motions in interference ..... 2364
Crossing mailing of allowance ..... 714.15	Examiner's (See Examiner's amendment)
D-10 notice preceding ..... 130	Excess claims added ..... 714.10, 714.16(c)
Date of receipt..... 505, 710.01(a), 714.18	Facsimile..... 502.01
Date stamp	Fees, additional..... 710.02(c)
Office date ..... 505, 710.01(a), 714.18	File wrapper endorsement ..... 714.18, 719.01
TC receipt date ..... 714.18	Filed with application ..... 601.01(a)
Declaration ..... 602.01	Formal matters, compliance with ..... 714.02
Defective, directions for entry..... 714.20, 714.23	Fully responsive..... 714.02
Delivered to wrong Technology Center ..... 508.01	Heading ..... 502
Directions for entry ..... 714.22, 714.23	Immediate inspection..... 714.05
Discharged attorney or agent..... 714.19	Improper signature..... 714.01(a) ..... 714.01(c), 714.01(d)
Disapproval of preliminary amendment..... 714.03(a) ..... 1002.02(d)	Ratification..... 714.01(a), 714.08
Disapproval of second or subsequent reply..... 714.03(a)	Inaccurate ..... 707.07(h), 714.23
Discourteous..... 714.19, 714.25	Incomplete reply ..... 711.02(a), 711.03(a) ..... 714.02 to 714.04, 2266.01 ..... 2666.30, 2671
Drawing..... 608.02(p), 608.02(q), 1302.05	Time for completing..... 710.02(c), 714.03 ..... 2266.01, 2666.30
In reissue application ..... 1413	Increasing claims in excess of fee under 37 CFR 1.312 ..... 714.10, 714.16(c)
Drawing, disposition ..... 608.02(x)	Ink, not permanent..... 714.07
Drawing, new matter ..... 608.04, 714.19	Inspection by examiner..... 714.05
Duplicate ..... 719.01(a)	Interference ..... 2364.01
Easily erasable paper forbidden ..... 714.07, 714.19	Inventorship (See Correction of inventorship)
Entered in part..... 714.20	

INDEX  
American Inventors Protection Act (AIPA)--Anticipation rejection

Sec. No.	Sec. No.
Jurisdiction of application not with examiner ..... 714.16	Reissue..... 714, 1453
..... 714.19, 1305	Requirements of..... 714.02
Late ..... 710.02(d), 711, 714.17	Residence change ..... 719.02(b)
Literature citation in specification..... 608.01(p)	Responsive..... 714.02, 714.04
Manner of making ..... 714	Return, after entry on file wrapper..... 719.01
Motion under 37 CFR 1.633(c)(2), Application in issue	Ribbon copy..... 719.01(a)
..... 714.16(b)	Rule 1.312 (See Amendment: After allowance)
Name change on file wrapper..... 605.04(c), 719.02(b)	Second (or subsequent) supplemental reply ..... 714.03(a)
New matter..... 608.04, 706.03(o), 2163.06	Several filed on same day ..... 714.18
Non-compliant amendment, treatment of ..... 714.01(e)	Signature improper ..... 714.01(a), 714.01(c)
..... 714.03, 714.22	..... 714.01(d)
Nonentry (See also Amendment: Entry denied).... 714.19	Signature missing ..... 714.01(a)
Not entered..... 714.19, 714.21	Signature required..... 714.01(a)
Not fully responsive ..... 714.02 to 714.04	Signed by applicant, not by attorney or agent of record
..... 2266.01, 2666.30, 2671	..... 714.01(d)
Not fully responsive, time to perfect reply ..... 710.02(c)	Signed by attorney or agent not of record. 405, 714.01(c)
..... 714.03, 2266.01, 2666.30	Statement of allowability by Board ..... 1213.01
Oath, Original..... 602.01	Supervisory primary examiner .... 714.13, 714.16, 714.18
Objectionable remarks ..... 714.19, 714.25	Supplemental ..... 714.03(a)
Of claims ..... 714	Support by original claim ..... 608.01(l)
Of specification ..... 714	Telegram..... 714.08
Office date stamp ..... 505, 710.01(a), 714.18	Telephone number ..... 713.01, 714.01
Paper number ..... 714.18	Unduly interferes with preparation of Office action
Patentability pointed out..... 714.02, 714.04	..... 714.03(a)
Period for reply ends Sunday or holiday ..... 505, 513	Unmatched with application file..... 508.03
..... 710.01(a), 710.05	Unsigned..... 714.01(a)
Permanent ink required ..... 714.07, 714.19	Ratification of ..... 710.02(c), 714.01(a)
Petition non-entry ..... 1002.02(c)	American Inventors Protection Act (AIPA) (See Statutes:
Plant application..... 1610	Public Law 106-113)
Post Office address, Applicant..... 605.03	American National Standards Institute (ANSI) ..... 608.02
Preliminary..... 506, 714.01(e), 714.03(a)	Amino acid sequence (See Biotechnology; Nucleotide
Canceling all claims..... 601.01(e), 711.01	sequences)
Denial of entry..... 714.01(e), 714.03(a)	Analogous Art ..... 904.01(c), 1302.14, 1504.02
Excess claims..... 506, 714.10	..... 1504.03, 2131.05, 2141.01(a)
Filed with application ..... 714.01(e)	Analysis of claims ..... 904.01
Manner of making ..... 714.01(e)	Answer, Examiner's (See Examiner's answer)
New matter added..... 601.01(a), 608.04(b), 702.01	Answer all matters traversed ..... 707.07(f)
PG-Pub application..... 1121	Answer on remand..... 1211, 1211.01, 1211.02
Referred to in oath/declaration ..... 601.01(a), 602	Antecedent lacking (See also Indefinite claim) ..... 706.03
To lessen filing fee ..... 607	..... 1302.01, 2173.05(e)
Ratification	Anticipation rejection ..... 706.02(a), 707.07(d), 1504.02
Signature defective ..... 714.01(a)	..... 2131, 2132, 2133, 2136
Telegram..... 714.08	Affidavit to overcome..... 2132.01
Receipt ..... 501 to 505, 511, 512	Analogous art..... 1504.02, 2131.05
Received after allowance ..... 714.15, 1303.01	Definition of ..... 2131
Reexamination ..... 2250, 2666.01, 2672	Genus-species ..... 2131.02
Reinstatement of canceled matter..... 714.24	Generic chemical formula..... 2131.02

MANUAL OF PATENT EXAMINING PROCEDURE  
A.P.C. publications--Appeal

	Sec. No.		Sec. No.
Meaning of		Court, Federal Circuit .....	1216.01
“By others” .....	2132	Of an <i>inter partes</i> reexamination .....	2682, 2683
“In this country” .....	2132	Decision by Board .....	1213
“Known or used” .....	2132, 2133.03(a)	Of an <i>inter partes</i> reexamination .....	2681, 2682
“Patented in this or a foreign country” .....	2132	Dismissal .....	1215.04
Multiple references, when permitted .....	2131.01	Examiner reversed .....	1214.04
One year grace period .....	2133	Examiner sustained .....	1214.06
On sale (See On sale)		Examiner’s answer .....	1208
Ranges claimed .....	2131.03	Failure to prosecute appeal .....	1215.04
Rejections based on publications and		Fee (See also Fee) .....	1205, 1208.02
patents .....	2133.02	From Board decision .....	1216 to 1216.02
<i>Prima facie</i> case .....	2132.01	Hearing .....	1209
Public use (See Public use)		<i>Inter partes</i> Reexamination .....	2674 to 2680
Secondary considerations, evidence of .....	2131.04	Flowcharts .....	2601.01
A.P.C. publications (See Alien Property Custodian (A.P.C.)		Introduction .....	1201
publications)		Jurisdiction .....	1210
Apostille (See also Oath; Declaration) .....	301, 409.01(b)	Matter subject to .....	Introduction, 706.01
.....	602, 602.04, 602.04(a), 604, 604.04(a)	Multiplicity rejection .....	2173.05(n)
Apparatus, Process or product and ....	806.05(e) to 806.05(g)	New ground of rejection by Board .....	1214.01
Appeal .....	Chapter 1200	New ground of rejection by examiner prohibited in	
Abandonment .....	1210	examiner’s answer .....	1207, 1208.01
Actions subsequent to examiner’s answer .....	1210	New matter affecting claim .....	608.04(c)
Administrative handling .....	1204	Notice of .....	1205
Affidavit after appeal .....	1207, 1208.03, 1211.02	Order for compliance .....	1210.01
Affidavit after Board decision .....	1214.01, 1214.07	Oral hearing .....	1209
Amendment after examiner’s answer .....	1210	Reexamination, <i>ex parte</i> .....	2276
.....	1211.01	Reexamination, <i>inter partes</i> .....	2680
Amendment before examiner’s answer .....	1207	Patentability report case .....	705.01(a)
Amendment for purpose of .....	714.12, 714.13	Primary examiner’s attention .....	1004
Amendment makes application allowable .....	1207	Procedure after Board decision .....	1214, 1214.01
Answer, Examiner’s (See Examiner’s answer)		.....	1214.03 to 1214.07
Brief .....	1206	Protestor participation .....	1901.07
In <i>ex parte</i> reexamination .....	2274	Publication of Board decision .....	1213.03
In <i>inter partes</i> reexamination .....	2675, 2675.01	Real party in interest .....	1206, 1208
In reissue .....	1454	Rehearing by Board .....	1214.01, 1214.03
By patent owner .....	1205	Reexamination, <i>ex parte</i> .....	2273
Cancellation of withdrawn claims .....	1214.05	Reexamination, <i>inter partes</i> .....	2674 to 2680
Civil litigation .....	1216.02	Remand by Board .....	1204, 1208.03, 1210, 1211
Claims copied from patent, time limit .....	710.02(c)	.....	1211.01, 1211.02, 1211.03
Claims included .....	1205, 1206	.....	1212, 1213, 1213.02, 1214.01
Composition of the Board .....	1203	.....	1302.14, 2143.03, 2274, 2275
Concurrently with interference .....	1210, 2315	.....	2314, 2358, 2681, 2682
Concurrently with prosecution before examiner .....	1210	Remand by Federal Circuit .....	1216.01
Conference .....	1208, 1302.14	Remanded application made special .....	708.01
In <i>inter partes</i> reexamination .....	2676, 2677	Reopening of prosecution after appeal .....	1208.01
Correspondence address for litigation .....	501, 1216.01	.....	1208.02
Court .....	1216	Reopening of prosecution .....	1214.07

INDEX  
Appealable matter not petitionable--Application

	Sec. No.		Sec. No.
Reply brief to examiner's answer.....	1208.03	Acceptance of 37 CFR 1.47.....	409.03(h)
Requirement by board to address matter.....	1212	Acknowledgment.....	503
Secrecy order application.....	130, 1304.01	Address missing.....	403
SIR application.....	1105	Allowable except as to form.....	706, 710.02(b)
Statement of allowability by Board.....	1213.01	Allowed	
Supplemental appeal brief.....	1208.02	Definition.....	203.04
Supplemental examiner's answer....	1208, 1211, 1211.02	File wrapper data.....	1302.09
Suspension pending civil action or federal circuit appeal in related case.....	1213	Ordering.....	1306.03
Suspension pursuant to 37 CFR 1.56(d).....	1213	Rejection.....	706.05, 1308.01
Time for filing brief.....	1206	Suggesting claim for interference.....	2305.04
Withdrawal.....	711.02(b), 1215.01, 1215.02	Amended definition.....	203.03
Withdrawal of final rejection.....	1208.02	APS.....	902.03(e)
Withdrawal, partial.....	1214.05, 1215.03	Arrangement.....	601, 608.01(a)
Appealable matter not petitionable.....	1002, 1201	Design application.....	1503, 1503.01, 1503.02
Appendix, computer program listing.....	608.05, 1121	Assigned (See also Assignee; Assignment)	
Appendix, multiple claim sets.....	1121	Access.....	106
Applicant (See also Inventor; <i>Pro se</i> applicant).....	605	Allowance.....	307
Abandonment notification.....	711.04(c)	Conflicting subject matter.....	706.02(f)(2), 706.02(k) .. 706.02(l) to 706.02(l)(3), 706.03(k), 822, 2302
Administrator or executor.....	409 to 409.01(f), 605.05	Inventor deceased.....	409.01(e)
Age, special status.....	708.02	Assignment for examination	
Citizenship.....	605.01	Office of Initial Patent Examination.....	504
Common, at least one.....	201.03, 201.11, 706.02(f)(2) ..... 706.02(k) to 706.02(l)(3)	Assignment to examiner for examination.....	903.08(b)
Comments on statement of reasons for allowance .....	1302.14	Assignment to Technology Center	
Discourtesy.....	714.19, 714.25	for examination.....	504, 903.08, 903.08(e)
Health, special status.....	708.02	Background of the invention.....	608.01(c)
Heir.....	409.01(a), 409.01(d)	Best mode.....	608.01(h), 706.03(c)
International application.....	1805, 1810 ..... 1817.01, 1820, 1821	Brief description of the drawings.....	608.01(f)
Joint.....	201.02, 201.03, 2137.01	Brief summary of the invention.....	608.01(d)
Mailing address.....	605.03	British English spellings.....	608.01
Name change.....	605.04(c), 719.02(b)	Certified copy.....	608.01
Other than inventor.....	409 to 409.01(f), 409.03(b)	Claim omitted.....	601.01(e)
Post Office address.....	605.03	Claim terminology.....	608.01(o)
Power to inspect.....	104, 106	Claims.....	608.01(i) to 608.01(n), 706.03(k)
Reply (See Amendment; Reply)		Clarity and completeness, examiner's action.....	707.07
Requirements.....	2137.01	Classification in Technology Center.....	903.08(b)
Residence.....	605.02	Common ownership.....	324, 706.02(f)(2), 706.02(k) ..... 706.02(l) to 706.02(l)(3) ..... 709.01, 822, 2302
Self prosecuted application.....	707.07(j), 713.01	Completeness.....	201.03, 201.06(c), 506, 601.01 ..... 601.01(g), 608.01(p)
Signature.....	605.04(a), 605.04(e), 605.04(f)	Conflicting, same applicant.....	709.01, 804 ..... 822, 822.01
Small entity status.....	509.02	Content.....	Chapter 600
Sole.....	201.01	Continuation (See also Continuation).....	201.07
Application		Continuation-in-part	
Abandoned (See Abandoned application)		(See also Continuation-in-part).....	201.08
Abstract of the disclosure.....	608.01(b)		

MANUAL OF PATENT EXAMINING PROCEDURE  
Application--Application

	Sec. No.		Sec. No.
Design.....	1504.20	Search.....	702.01, 704.01
Continued prosecution (CPA) (See also Continued prosecution application (CPA))		Special.....	708.01
Design.....	201.06(d), 1502.01	Inspection .....	103
Continuity between applications .....	201.11	International (See International application)	
Control of access .....	101, 103, 106	International Convention (35 U.S.C. 119).....	201.13
Copendency.....	201.11	Invalid oath.....	604.06
Copending, Design.....	1504.20	Issue fee not paid (abandoned) .....	203.07, 711.03(c)
Correction of inventorship .....	201.03	Issue simultaneously with another application ....	1306.02
Cross-noting		Jurisdiction .....	1305
Data of parent application in file wrapper or PALM bib-data sheet ...	202.02, 719.02, 719.07, 1302.09	Mode of operation .....	608.01(h)
Data of related application, updating.....	201.11	National application.....	201
.....	202.01, 1302.04(f)	National stage application.....	201
Foreign application, file wrapper/history notation .....	202.03	New, definition .....	203.01
Foreign application, oath .....	201.14, 202.04	Nonprovisional .....	201.04(a), 506, 601
Description of the related art.....	608.01(c)	Number.....	502, 503, 506
Design (See Design application)		Status of application using .....	101, 102
Detailed description .....	608.01(g)	Omitted items .....	601.01(d), 601.01(f), 601.01(g)
Distribution .....	508	Ordered examination .....	707.02, 708, 708.01
Divisional (See also Divisional application).....	201.06	Overlapping	
Design.....	1504.20	Common ownership .....	706.02(f)(2), 706.02(k)
Drawings, necessary.....	601.01(f)	.....	706.02(l) to 706.02(l)(3)
Missing figures .....	601.01(g)	.....	709.01, 715.01(b), 804.03
Effective filing date.....	706.02, 706.02(a)	.....	822, 2302, 2315.01
English language .....	608.01	Same applicant.....	709.01, 804, 822
Examination .....	Chapter 700	.....	822.01, 2315.01
Examples .....	707.07(l)	Pages missing .....	601.01(d)
Facsimile transmission .....	608.01	Papers, arrangement.....	719.01(a)
Fee, filing (See also Fee).....	607	Parent.....	904
Field of the invention .....	608.01(c)	Parts.....	Chapter 600
File wrapper continuing (FWC) .....	201.06(b)	Pending five years .....	707.02
Filing date .....	201.11, 503, 505, 511	Plant (See also Plant patent) .....	Chapter 1600
Filing receipt (See also Postcard, self-addressed) .....	503	Prior art.....	2121 to 2129
Five year pendency .....	707.02, 708.01	Prior art effect of international publication.....	706.02(a)
Font .....	608.01	.....	1857.01, 1896, 2136.03
Foreign (See also Foreign application) .	201.13 to 201.16	Priority	
Form.....	Chapter 600	Foreign application .....	201.13, 706.02, 1402
Government-owned		.....	1504.02, 1504.10
Special .....	708.01	U.S. application.....	201.11, 706.02
Incomplete.....	203.06, 506, 601.01(d)	Protest.....	1901
.....	601.01(e), 601.01(f), 608.01(u)	Provisional (See also Provisional application)	
Definition.....	203.06, 506	.....	201.04(b), 601, 601.01
Informal.....	506, 702.01	.....	601.01(b), 602, 706.02
Definition.....	506	Public inspection .....	103
Primary examiner's attention required .....	1004	Publication (See Pre-Grant Publication (PG-Pub))	
		Publication of abstract .....	711.06, 711.06(a)
		Receipt and handling .....	Chapter 500
		Reconstruction .....	508.04

INDEX  
Application Data Sheet (ADS)--Assignment

Sec. No.	Sec. No.
Recording and tracking in Technology Center.....	1704
Referred to in patent, status information .....	102
Refile .....	201.10
Reissue (See also Reissue application) .....	1401 to 1470
Rejected definition .....	203.02
Relating to atomic energy .....	115, 150, 151
Requisites .....	702
Review .....	506
Right to inspect .....	103
Right of priority, foreign application .....	201.13
Rule 1.60 .....	201.06(a)
Rule 1.62 .....	201.06(b)
Secrecy order.....	120, 121, 130
Serial number .....	502, 503
Special (See also Special application).....	707.02
.....	708 to 708.03
List .....	708.01
Priority in patent printing .....	1308
Status.....	102, 203
Inquiries.....	203.08
Substitute .....	201.09, 201.10
Definition.....	201.09
Does not carry ownership from parent .....	306
File wrapper/history notation.....	202.02
Reference to parent application .....	201.09
Table submitted on compact disc .....	608.05(b)
Terminology, Claim .....	608.01(o)
Title of invention.....	606
Title of invention, change .....	606.01, 1302.01, 1302.04
Transfer procedure .....	903.08(d)
Transitional (See also Transitional application)	
.....	706.07(g), 803.03
Types (See also Patent) .....	201
Utility (See also Patent) .....	201
Application Data Sheet (ADS).....	201.11, 601
.....	601.01(b), 601.05, 602.01, 605.04(b)
.....	605.04(c), 605.04(f), 706.02(b), 1130
Supplemental ADS.....	601.05
Application Division (See Office of Initial Patent Examination (OIPE))	
Application publication .....	901.03
Citation of.....	707.05(e)
Disqualifying as prior art, commonly owned.....	718
Prior art effect.....	706.02(a), 901.03, 2163, 2136.03
Arbitration awards notice .....	311
Argument for allowability lacking in amendment.....	714.04
Arrangement of application .....	608.01(a)
Arrangement of art in Technology Centers .....	901.07
Arrangement, papers in file wrapper .....	719.01(a)
Art unit number on papers .....	502
Artifacts in IFW application .....	608.02
Asexual plants (See also Plant patent).....	Chapter 1600
Assigned application	
Allowance.....	307
Conflicting subject matter.....	706.03(k), 822
.....	2302, 2315.01
Inventor deceased .....	409.01(e)
Nonprovisional application claiming benefit of provisional application .....	306.01
Provisional application .....	302.03
Title report.....	320
Assignee (See also Assigned application; Assignment)	
Access to an application .....	104, 106
Address.....	302.05
Affidavits under 37 CFR 1.131 .....	715.04
Certificate of correction.....	307, 1480 to 1485
Change of inventorship, consent.....	201.03, 1412.04
Common .....	706.02(f)(2), 706.02(k), 706.02(l) to
.....	706.02(l)(3), 709.01, 822, 2302, 2315.01
Consent in reissue.....	1410.01, 1443, 1451
Double patenting, same assignee.....	706.03(k), 804, 822
Duty of disclosure.....	2001.01
Entire interest, control .....	106, 301, 324, 402.07
Foreign.....	302.04
Interfering applications, same assignee .....	709.01
.....	2302, 2315.01
Intervention.....	106, 324, 402.07
Multiple Assignees .....	324
Part interest.....	106.01
Patent issues to .....	307
Permitted to take action under 37 CFR 3.73(b) .....	324
Power to inspect .....	104
Printed on PG-Pub .....	1121
Revocation of power of attorney .....	324, 402.07
Small entity.....	509.02
Assignment.....	Chapter 300
Access.....	301.01
Allowance of application.....	307
Assignment identification requirements .....	302.03
Automated Patent and Trademark Assignment System .....	502.01
Change of name .....	314

MANUAL OF PATENT EXAMINING PROCEDURE  
Assignment Division--Attorney or agent

Sec. No.	Sec. No.
Conflicting statements of ownership under 37 CFR 3.73(b).....	1730
Continuing application.....	324
Copy.....	201.12, 306
Corrections in recorded assignment.....	301.01, 302.01
Cover sheet.....	323
Corrections.....	302.07
Date of recording.....	317.02, 323.01
Effect of recording.....	317.01
Facsimile submission.....	317.03
Foreign language translation.....	302.09, 502.01, 1730
Indexing.....	302.02
International application.....	315
Licenses.....	301
Mailing address.....	301, 313
Mergers.....	302.08, 501
Multiple assignees.....	314
Nonprovisional claiming benefit of provisional ...	314
Not endorsed on pending applications.....	324
One of several overlapping applications.....	306.01
Parent application.....	303
Part interest.....	709.01, 715.01(b)
Patent.....	201.12, 306
Patent and trademark assignment system.....	106.01, 301, 706.02(1)(2)
Pending applications.....	301, 302.03
.....	301, 302.03, 706.02(1)(2)
.....	706.02(1)(3)
Plural items.....	301.01
Printing on patent.....	307, 1309
Proof of.....	706.02(1)(2)
Provisional application.....	301, 302.03
Recording.....	301, 302, 313, 314
.....	706.02(1)(2), 706.02(1)(3)
Recording fee.....	302.06
Records not kept in application file.....	303, 320
Search room.....	1730
Security interests.....	302.07, 313
Title reports.....	303, 320
Transfer of rights from/to small entity.....	509.02
Translation.....	302.02
Assignment Division.....	320, 605.04(c), 719.02, 1121, 1730
Administrator and executor authority checked.....	409.01(b)
Allowance and issue.....	1302.11
Certified Abstract of Title.....	320
Contact information.....	1730
Information available from PALM.....	320
Mailing address.....	501
Title report.....	320
Assignment of application for examination.....	504
Assignment of reexamination to examiner <i>Ex parte</i> .....	2236, 2285, 2648
<i>Inter partes</i> .....	2636, 2648, 2655
Assignment to examiner for examination.....	903.08(b)
Assistant Commissioner for Patents (See Commissioner for Patents)	
Assistant Commissioner for Trademarks (See Commissioner for Trademarks)	
Assistant examiner (See Examiner)	
Associate attorney.....	402.02, 406
Associate attorney, correspondence with.....	403.01
Associate of unregistered attorney.....	402
Atomic Energy Act of 1954.....	120, 706.03(a), 706.03(b)
Atomic energy application.....	150
Attorney or agent Appointment by assignee of entire interest.....	106
Associate.....	402, 402.02, 406
Associate of unregistered.....	402
Compliance with duty of disclosure.....	2004
Conflicting parties having same.....	404
Continuing application.....	201.06(c)
Change of correspondence address.....	601.03
Correspondence with.....	402, 403
Correspondence with associate.....	403.01
Death.....	406
Discourtesy.....	714.25
Duty of disclosure.....	2001.01, 2002.01
Duty to inform patent owner of <i>inter partes</i> reexamination.....	2622
Excluded from practice.....	105
Inspection.....	104
Interfering applications.....	402.08, 2305, 2309.02
International application.....	402.09, 1807, 1808, 1820
Interview.....	408, 713 to 713.10, 1302.14
Limited recognition.....	402.01
More than one for same applicant.....	403.02
Name on patent.....	1309
Name on reexamination certificate.....	2287
Not of record.....	402, 405
Notarizing oath.....	604.06
Office cannot aid in selection of.....	401
Petition to reinstate.....	1002.02(m)





MANUAL OF PATENT EXAMINING PROCEDURE  
Books in library--Certificate of correction

	Sec. No.		Sec. No.
Appeal from .....	1216 to 1216.02	Burden of proof .....	2112, 2112.01, 2113
In <i>inter partes</i> reexamination.....	2682, 2683	Business hours of USPTO .....	510
Constitution and duties.....	1203		
Decision			
Dissemination of .....	1720		
Generally .....	1213		
Publication of .....	1213.03, 2681		
Treatment of.....	1721		
Duty of disclosure to .....	2001.03		
Hearing.....	1209		
Interference			
Declaration of .....	2311		
Final Decision .....	2358		
Jurisdiction.....	706.01, 706.07(c), 1210, 2300.01		
May require appellant to address matter .....	1212		
New ground of rejection by.....	1214.01		
In <i>inter partes</i> reexamination.....	2681, 2682		
Non-final decision in <i>inter partes</i> reexamination.....	2681		
Petitions.....	1002.02(g), 1002.02(j)		
Recommendation by.....	2359		
Reconsideration by.....	2358		
Rehearing by .....	1002.02(f), 1214.01, 1214.03		
<i>Inter partes</i> reexamination.....	2682, 2683		
Service Branch.....	104		
Statement of allowability by .....	1213.01		
Books in library.....	901.06(a)		
Borrowed publications .....	901.06(a), 901.06(b)		
Borrowing references from examiner's search files...	901.08		
Box, Mail (See Correspondence; Mail Stop)			
Breadth, Undue (See Undue breadth rejection)			
Brief, filed on appeal.....	1206		
<i>Ex parte</i> reexamination .....	2274		
<i>Inter partes</i> reexamination .....	2662, 2665, 2675		
Defective.....	2675, 2675.02		
Brief description of the drawings (See also Specification)			
.....	608.01(f)		
Brief summary of invention .....	608.01(d), 1302.01		
British English spelling .....	608.01		
British specification, provisional.....	201.15		
Broadening claims in reissue.....	1412.03		
Browser executable code in specification .....	608.01		
.....	608.01(p)		
Budapest Treaty (See also Microorganisms; Treaties)			
.....	901.05(b), 2402, 2404.01, 2405, 2408		
.....	2409, 2410.01, 2410.02, 2411.01		
Depositories .....	2405		
Bulletin, Classification (See Classification; Orders)			

**C**

CAFC (See Court of Appeals for the Federal Circuit (CAFC))	
Canadian patent agent.....	402
Canceled matter, before papers executed .....	608.01
Canceled matter, cannot be recaptured in reissue .....	1412.02
Canceled matter, Restoring.....	608.01(s), 714.24
Canceled matter in patented file .....	901.01
Canceling claim after issue.....	714.16, 1302.04(b)
Canceling claim withdrawn after appeal .....	1214.05
Canceling drawing.....	608.02(t)
Cancellation of drawing figures.....	608.02(t)
Cancer, petition to make special.....	708.02
Candor, Duty of (See also Duty of candor and good faith)	
.....	2001, 2001.03
Carbon copy, application papers.....	608.01
Carbon copy of amendment.....	714.07
Card catalog in library .....	901.06(a)
Caricatures, Offensive .....	608, 1504.01(e)
Case action record worksheets (PTO-1472) .....	1705
Cassis CD-ROM (See also Electronic databases)..	902.03(d)
Catalog and circulars .....	901.06(a)
Central Facsimile Number.....	502
Central Reexamination Unit (CRU) (See also Office of Patent Legal Administration (OPLA)).....	103, 2224, 2226
.....	2228, 2229, 2232, 2624, 2626
.....	2627, 2628, 2631 to 2638, 2641
.....	2647, 2647.02, 2660, 2664, 2666.06, 2667
.....	2670, 2671, 2675 to 2678, 2682
.....	2686.01 to 2687, 2689, 2694
Certificate effect of signature .....	401, 402, 410
Certificate, <i>Ex Parte</i> Reexamination .....	2288
Format .....	2290
Certificate, <i>Inter Partes</i> Reexamination ....	2688, 2690, 2694
Distribution.....	2692
Format .....	2690
Reissue patent as.....	2688, 2694
Certificate of correction.....	1480 to 1485
Applicant's mistake .....	1481

INDEX

Certificate of mailing or transmission (37 CFR 1.8)--Citation of prior art

Sec. No.	Sec. No.
Assignee's name.....	307, 1481
Branch.....	1002.02(l)
Copy required in reexamination	
<i>Ex parte</i> .....	2214
<i>Inter partes</i> .....	2614
Date of issuance .....	1485
Domestic priority .....	201.11, 1003, 1481
Electronic publication .....	1485
Expedited issuance.....	1480.01
Foreign priority .....	201.16, 1481
Form PTO-1050 .....	1480, 1480.01, 1485
Form PTO/SB/44 .....	1480, 1480.01, 1485
Handling of request for .....	1485
International application priority.....	1481
Inventorship .....	1412.04, 1481
Matter's requiring TC Director's attention.....	1003
Office's mistake .....	1480, 1480.01
<i>Official Gazette</i> listing .....	1480, 1485
Patent in litigation .....	1003
Patent involved in interference.....	1002.02(g)
Petition of refusal to issue .....	1002.02(c)
Reissue application.....	1411.01, 1443
Report by examiner .....	1485
Third party standing .....	1480
Certificate of mailing or transmission (37 CFR 1.8)	
.....	502.01, 511, 512, 513
<i>Ex parte</i> reexamination .....	2224, 2265, 2266
Information disclosure statement .....	609
<i>Inter partes</i> reexamination .....	2624, 2666, 2666.05
International application .....	1805, 1834
.....	1865, 1893.01(a)(1)
Maintenance fee .....	2510
Overcoming abandonment .....	711.03(c), 711.04(c)
Period for reply .....	714.17
Certificate of service	
<i>Ex parte</i> reexamination .....	2220
<i>Inter partes</i> reexamination .....	2620, 2666.06
Certification as to statutory estoppel in <i>inter partes</i>	
reexamination .....	2612, 2614
Certification Division.....	103
Certified copies	
Abstract of Title .....	320
Administrator or executor .....	409.01(b)
Appeal to federal circuit.....	1216.01
Application as filed .....	608.01, 1730
Civil litigation .....	1216
Facsimile submission not permitted.....	502.02
Facsimile requests for .....	1730
Foreign application .....	201.13, 201.13(b), 201.14
.....	201.14(a), 201.14(b), 201.14(c)
.....	502.02, 1417, 1504.10
.....	1893.03(c), 2138.06
MPEP.....	Title page, 1730
Orders for.....	1730
Patent copies.....	1730
Patent related file wrappers .....	1730
PCT application .....	1801, 1828, 1893.03(c)
.....	1895.01, 1896
Philippines search exchange.....	1711
Photocopies not permitted .....	502.02
Provisional application .....	103, 104
Reexamination file	
<i>Ex parte</i> .....	2232
<i>Inter partes</i> .....	2632
Change from small entity status (See also Small entity	
status).....	509.03
Change of correspondence address.....	601.03, 711.03(c)
Characteristic feature in design applications	
.....	1503.01, 1504.01(a)
Charge for pending applications	
(PALM).....	905.05
Chemical abstracts.....	708.02
Chemical compound.....	608.01(p)
Chemical practice	
Enablement .....	2164.06(b)
Generic chemical formula.....	2131.02, 2144.08
Markush.....	2173.05(h), 2173.05(o)
Chief Administrative Patent Judge .....	1002.02(f)
Circulars (See also Publication).....	Introduction
Citation of prior art	
A.P.C. publications .....	901.06(c)
Abbreviations .....	711.06, 711.06(a)
Abstract .....	706.02, 711.06, 711.06(a)
Allowance, Listing at.....	1302.12
Applicant's .....	707.05(b), 707.05(d), 1302.12
Complete data .....	707.05(e)
Copies furnished .....	707.05(a)
Correction .....	707.05(g)
Correction, period for reply .....	710.06
Cross references.....	707.05(e)
Data used .....	706.02(a), 707.05(e)
Decisions, orders, notices, memoranda .....	707.06
Defensive publications .....	711.06, 711.06(a)
Electronic Resources .....	707.05(e)

MANUAL OF PATENT EXAMINING PROCEDURE  
Citizenship of applicant--Claim

Sec. No.	Sec. No.
Examiner's answer .....	1208
Foreign language documents .....	706.02
Foreign patent data .....	707.05(e), 901.05(a)
Foreign printed applications .....	901.05(b)
Form PTO-892 reproduced .....	707.05
Incorrect .....	707.05(g), 710.06
Literature, in specification .....	608.01(p)
Mailing copy to patent owner .....	2206, 2208
Memorandum .....	707.06
Notices .....	707.06
Order of listing .....	707.05(c)
Orders .....	707.06
Patents series, U.S. (See also Patent) .....	901.04
Periodical .....	707.05(e), 901.06
Prior art effect of international application .....	706.02(a), 1857.01, 1896, 2136.03
Prior art in application .....	707.05(b), 1302.12
Prior art in patent .....	1920, Chapter 2200
Confidentiality .....	2202, 2203
Content .....	2205
Court decision .....	2207
Handling .....	2206
Parties who may cite .....	2203
Service on patent owner .....	2208
Time for filing .....	2204
Publications .....	707.05(e)
References .....	707.05
Allowance in first action .....	1302.12
From applicant .....	707.05(b), 1302.12
Citizenship of applicant .....	605.01
Civil action under 35 U.S.C. 145 .....	1214.01
.....	1214.07, 1216, 1216.02
Civil action under 35 U.S.C. 146 .....	1216, 2358
.....	2360, 2361
Claim .....	608.01(i), 608.01(k)
Added by amendment .....	608.01(o)
Results in change of inventorship .....	201.03
Added in excess of filing fee .....	714.10
After prosecution closed .....	714.16, 714.19
After prosecution closed, near end of time period .....	714.20
Aggregation .....	2173.05(k)
All allowed .....	710.02(b)
All canceled .....	711.01
Allowable except as to form .....	706, 707.07(a)
.....	707.07(j)
Allowed, Rejection of .....	706.04, 706.05
Allowed, Withdrawn appeal .....	1215.02
Alternative phrase (See also Indefinite claim) .....	2173.01, 2173.05(h)
Amendment of (See also Amendment) .....	714
Analysis .....	904.01
Antecedent basis (See also Indefinite claim) ..	2173.05(e)
Basis in description .....	608.01(o), 2171
Basis in disclosure .....	608, 2163.03
Breadth .....	2163.05, 2164.08, 2173.04
Broadening in reissue application .....	1412.02, 1412.03
Dependent claim .....	1412.03
Cancellation by examiner after appeal .....	1214.05
Cancellation results in change of inventorship .....	201.03
Change after Board statement of allowability .....	1213.01
Combination, old .....	2173.05(j)
Combination and subcombination ..	806.04(c), 806.05(a)
Comprising .....	2111.03, 2173.05(h)
Considered in deciding reexamination request .....	2243, 2643
Consisting essentially of .....	2111.03
Consisting of .....	2111.03, 2173.05(h)
Construed in light of specification .....	608.01(o)
.....	707.07, 804, 1206, 2106, 2111.01, 2111.03
.....	2129, 2145, 2164.08, 2173.05(a), 2184
Copied from patent (See Claim presented corresponding to claim of patent)	
Correspondence with disclosure .....	1302.01, 2173.03
Defined by specification, term .....	2111.01
Dependent .....	608.01(n)
Dependent, objected to when improper .....	608.01(n)
.....	706.01
Dependent on canceled or rejected claim .....	608.01(n)
.....	706.01, 707.07(j), 1214.06
Design application .....	1503, 1503.01
Differing only by functional statement .....	2173.05
Diminishing scope .....	2173.05(h)
Disclaimer .....	706.03(u), 710.02(d)
Double inclusion .....	2173.05(o)
Duplicate .....	706.03(k), 2173.05(o)
Each mentioned in letter .....	707.07(i)
Equivalence .....	2183
Excess over fee added by preliminary amendment .....	714.10
Excess over fee after notice of allowance .....	714.16(c)
Fees, dependent .....	608.01(n)
File wrapper notation .....	1302.09

INDEX

Claim presented corresponding to claim of patent--Claim presented corresponding to claim of patent

Sec. No.	Sec. No.
Foreign priority (See also Foreign application)..... 201.13	Plant application ..... 1605, 1610
..... 201.14	Plural ..... 706.03(k)
Form.....608.01(m)	Priority (See also Foreign application) ..... 201.13, 201.14
Function of machine.....2173.05(v)	Product, Functional..... 2114
Functional.....2114, 2173.05(g)	Product by process..... 2113, 2173.05(p)
Generic (See also Generic claim).....806.04(d)	Prolix (See also Indefinite claim) ..... 2173.05(m)
.....2173.05(h)	Ranges ..... 2131.03, 2145.05
Illustrated by drawing .....608.02(d), 2173.05(s)	Reference numerals included..... 608.01(m), 2173.05(s)
Improvement (i.e., Jepson claim) ..... 2129	Reissue application
Inaccurate ..... 2173.03	Numbering ..... 1453, 1455
Incomplete.....707.07(j), 2172.01	Original claim subject to reexamination ..... 1440
Indefinite ..... 706.03(d), 2173	Printed in <i>Official Gazette</i> ..... 1455
Independent.....608.01(n)	Same invention as original patent ..... 1412.01
Index ..... 719.04	Underlining and bracketing..... 1453, 1455
Indirect limitation.....706.03(d), 2173.05(f)	Rejection.....706, 2121 to 2186
Informal..... 702.01	Relative terminology ..... 2173.05(b)
International application..... 1824	Renumbering at issue..... 608.01(j), 1302.01
Interpretation .....2111, 2111.01, 2111.02, 2111.03	Renumbering dependent ..... 608.01(n), 1302.01
Jepson..... 2129	Single means.....2164.08(a), 2181
Linking.....809, 809.02, 809.03, 809.04	Single sentence ..... 608.01(m)
Linking, Generic ..... 809.02	Species, how recognized..... 806.04(e), 806.04(f)
Linking, Traverse of rejection.....818.03(d)	Species (plural) added ..... 809.02(d), 818.02(b)
Markush ..... 2173.05(h), 2173.05(o)	Statutory requirement ..... 608.01(k)
Generic ..... 803.02	Subgenus (Markush type)..... 2173.05(h)
Subgenus.....2173.05(h)	Subject matter eligibility ..... 706.03(a)
Support .....608.01(p)	Suggested for interference..... 2305 to 2305.04
Means (See also Means)..... 2181	Failure to make ..... 706.03(u)
Missing.....601.01(e)	Time limit..... 710.02(c)
Multiple dependent.....608.01(n)	Summary of invention, consistent ..... 608.01(d)
Multiplicity..... 2173.05(h), 2173.05(n)	Terminology basis in description..... 608.01(o)
Negative limitation.....2173.05(i)	.....2173.01, 2173.05(a)
New matter.....608.04, 706.03(o), 2163.06	Unsupported ..... 2163.01, 2173.03
Reissue application ..... 1411.02	Use claims ..... 2173.05(q)
Nonelected invention ..... 706.03(m), 809.02(c)	Vague (See also Indefinite claim)... 706.03, 2171 to 2173
..... 809.04, 821.01, 821.02	Varying scope..... 608.01(m)
Nonelected invention, Added ..... 821.03	With motion granted in part..... 714.20
Nonstatutory ..... 706.03(a)	Withdrawal of appealed claim ..... 1214.05, 1215.03
..... 2105 to 2107	Claim presented corresponding to claim of patent (See also
Nonstatutory, Cancellation.....1302.04(b)	Interference).....710.04(a), 2306 to 2308.02
Numbering .....608.01(j)	After allowance ..... 2307.03
Objection contrasted with rejection..... 706.01	Appeal of rejection ..... 1205, 1210
<i>Official Gazette</i> (O.G.)..... 1302.09	Disclaimer rejection..... 706.03(u)
Omnibus claim ..... 2173.05(r)	Interference pending ..... 2364.01
Ordinary and customary meaning ..... 2106, 2111.01	Late amendment ..... 714.19
Original .....608.01(l)	Not a reply to Office action ..... 711.02(b), 2307.01
Patentably distinct .....706.03(k)	Origin must be stated..... 2307.05
Plain meaning of claim term ..... 2111.01	Patent filing date later than that of application .... 2306.01

MANUAL OF PATENT EXAMINING PROCEDURE  
 Claiming same invention--Commercial exploitation as on sale

	Sec. No.		Sec. No.
Patent in different Technology Center .....	2306	Classification examiner	
Period for reply .....	710.02(c), 710.04(a)	Decision on classification .....	903.08(d) to 903.08(f)
Prosecution closed.....	714.19, 2307.03	Patentability report .....	705.01(a)
Rejection .....	2307.02	Classification of application .....	Chapter 900
TC Director's attention .....	1003	Allowed application.....	903.07 to 903.07(b)
Rejection, Failure to reply to.....	706.03(u)	.....	1004, 1302.10
Special.....	708.01	Amendment affecting .....	903.08(c)
TC Director's attention required .....	1003	Borderline .....	903.08(a)
Time limit for reply .....	710.02(c)	By applicant.....	601
Claiming same invention.....	706.02(f)(2), 706.02(k)	Cross-referencing.....	903.07(a)
.....	706.02(l) to 706.02(l)(3), 715	Decision of classification examiner.....	903.08(f)
Class, scope.....	903.02(b)	Disputed.....	903.08(a), 903.08(d), 903.08(f), 903.08(g)
Class, transfer.....	903.05	File wrapper data .....	719.03
Class definitions .....	902.02	Improperly classified .....	903.08(a)
Classification (See also Patent classification) ....	Chapter 900	In another Technology Center at allowance	
Application (See Classification of application)		.....	903.07(b), 903.08(a)
Basis .....	903.02	New application, by Office of Initial Patent	
Bulletin.....	902.04	Examination.....	903.08(a), 903.08(e)
Definitions.....	902.02, 902.02(a)	New application, by SPE.....	903.08(b)
Design .....	903.09(a), 1503.01	Post classifier.....	903.08(e), 903.08(f), 903.10
Examiner (See Classification examiner)		Preliminary .....	601
Foreign patents .....	903.03	Rules governing.....	903.08(e)
Index to U.S. Patent Classification.....	902.01(a)	Transfer to another Technology Center .....	903.08(a)
Classification, International.....	903.09	.....	903.08(d), 903.08(g)
Indices .....	902.03	Classifier, Post.....	903.08(e), 903.08(f), 903.10
Information.....	902.03(a)	Clean copy of specification .....	608.01(q), 1302.02
Insight on USPTO Local Area Network .....	902.03(c)	Clearance for new law interpretation.....	1208
International .....	903.09	Closed prosecution except for formal matters .....	707.07(j)
Issue classification slip, PTO-270 (See also Form letters		.....	710.02(b), 714.14
and forms) .....	903.07, 1302.10	Prosecution not closed .....	707.07(j)
Locarno International .....	903.09(a)	Closing of Patent and Trademark Office .....	201.13, 510
Mandatory .....	903.07	Code of Federal Regulations (CFR) (See Rules, Patent	
Manual .....	902.01	(Code of Federal Regulations))	
Patent classification Home Page on the Internet		Coinventor, Power of attorney.....	402.01
.....	902.03(a), 903.06	Collateral estoppel (See also Estoppel) .....	2012.01
Nonpatent literature.....	901.06	<i>Ex parte</i> reexamination.....	2259
Numerical index .....	902.03(c)	<i>Inter partes</i> reexamination.....	2659
Orders.....	902.04	Combination, Old (See also Restriction)..	806.05(b), 820.01
Patent, Change of.....	903.05	Combination and aggregation.....	2173.05(j), 2173.05(k)
Patent Classification Home Page on the USPTO Intranet		Combination and subcombination .....	806.04(c), 806.05(a)
.....	902.03(b)	.....	806.05(b), 806.05(c), 903.02(b)
Principles.....	903.02	Comments on tests or examples .....	707.07(l)
Revision .....	903.02(a), 903.02(b)	Commercial activity as on sale (See also On sale)	
Rules governing applications .....	903.08(e)	.....	706.02(c), 2133.03 to 2133.03(e)
Statutory authority.....	903.01	Commercial exploitation as on sale	
Subclass lists .....	902.03(c)	(See also On sale) .....	706.02(c), 2133.03(e)(1)

INDEX

Commercial success of invention, affidavit alleging--Consular certificate

Sec. No.	Sec. No.
Commercial success of invention, affidavit alleging (See also Affidavits, traversing rejections (37 CFR 1.132)) ..... 716.03, 1504.03	Computer programs or software
Commissioner for Patents (See also Director of the USPTO; Office of the Commissioner for Patents) ..... 409.01(b), 409.03 ..... 409.03(h), 409.03(i), 409.03(j), 708.01 ..... 720.01, 720.02, 720.03	Adequate disclosure..... 2106.02
Action requiring attention of	Affidavit practice..... 2106.02
Failure to identify claim as copied from a patent ..... 2307.05	Best mode ..... 2106.01
Duty of Disclosure to ..... 2001.03	Deposit of listings..... 608.05, 608.05(a)
Mailing address ..... 501	Enablement ..... 2106.01
Statutory basis ..... 1001	Patentable subject matter ..... 2106
Commissioner initiated reexamination (See Director initiated Reexamination)	Printed in PG-Pub ..... 1121
Commissioner for Trademarks	Undue experimentation..... 2106.02
Petitions decided by ..... 1002.02(i)	Written description ..... 2106.01
Commodity Control List (CCL)..... 120	Concealment ..... 608.01(h), 2138.03
Common applicants..... 715.01(a), 706.02(f)(2), 706.02(k) ..... 706.02(l) to 706.02(l)(3), 709.01, 2137	Conception..... 715.07, 2138, 2138.01, 2138.04
Common knowledge, use in rejections..... 2144.03	Concordance, International and United States classification ..... 903.09
Common ownership ..... 706.02(k), 706.02(l) to 706.02(l)(3) ..... 2137	Concurrent Office proceedings ..... 2282
Conflicting claims ..... 303, 706.02(f)(2) ..... 706.03(k), 709.01, 804, 822, 2302	Conduct of <i>ex parte</i> reexamination proceedings ..... 2254
Common representative for international application ... 1807	Conduct of <i>inter partes</i> reexamination proceedings ..... 2654
Communication with suspended or excluded attorney or agent ..... 105	Confidential citation of prior art ..... 2202, 2203
Communications, official mailing address for ..... 501	Confidential material ..... 121, 724 to 724.05
Communication via Internet..... 502.03	Confidential material submission ..... 121, 724.02
Companion case, retention label ..... 1302.07	Confidential party of interest ..... 2202, 2203
Comparative tests (See also Affidavits, traversing rejections (37 CFR 1.132)) ..... 716.02(b)	Confidential status of application ..... 101, 706.02(f)(2) Same applicant..... 706.02, 706.02(c), 706.03(k) ..... 709.01, 804, 822, 822.01 Rule 1.53(d)..... 201.06(d)
Complete application ..... 201.03, 506, 601.01 to 601.01(g)	Confidentiality, pending applications ..... Chapter 100
Complete British specification ..... 201.15	Confidentiality of international applications ..... 110
“Comprising” as transitional phrase..... 2111.03	Confirmation number ..... 503
“Comprising” in Markush claim ..... 2173.05(h)	Conflicting applications, same assignee ..... 303 ..... 706.02(f)(2), 706.02(k), 709.01 ..... 715.01(b), 804.03, 822, 2302
Compact disc submissions ..... 608.05, 2421.04, 2425	Conflicting applications, same attorney..... 2309.02, 2305
Amendments to ..... 608.05, 2426	Conflicting oaths or declarations ..... 201.03
Computer programs..... 608.05(a), 2425	Congress, Inquiry on status of application by member of ..... 203.08(a)
Requirements ..... 608.05	Conservator, Authority recorded ..... 409.02
Sequence Listings..... 1823.02 ..... 2420, 2422.03, 2424.01	Conservator, Legally incapacitated inventor ..... 409.02
Tables ..... 608.05(b), 1823.02, 2424.01	“Consisting essentially of” as transitional phrase ..... 2111.03
Computer generated icons ..... 1504.01(a)	“Consisting of” as transitional phrase ..... 2111.03
	“Consisting of” in Markush claim ..... 2173.05(h)
	Constitutional basis for patents..... Introduction
	Constructive election (See also Election of species) ..... 818.02(a), 818.02(c)
	Constructive notice to patent owner of request for reexamination ..... 2230, 2630, 2654
	Constructive reduction to practice ..... 715.07
	Consular certificate ..... 604.04

MANUAL OF PATENT EXAMINING PROCEDURE

Consular certificate, Foreign executor or administrator--Continued Prosecution Application (CPA)

Sec. No.	Sec. No.
Consular certificate, Foreign executor or administrator ..... 409.01(b), 409.01(d)	Definition..... 201.08
Consular certificate, Omission of..... 604.04(a)	Design application ..... 1504.20
Consular officer..... 604.04	Effective date..... 201.11, 706.02, 2133.01
Content of <i>ex parte</i> reexamination request ..... 2214	File wrapper continuing procedure ..... 201.06(b)
Content of <i>inter partes</i> reexamination request ..... 2614	File wrapper/history notation..... 202.02
Continuation..... 201.06(c), 201.07, 601.01(a)	Filed by assignee ..... 324
Assignment carried from parent..... 201.12, 306	Identification on letter of transmittal ..... 506
Continued prosecution application (CPA)..... 201.06(d)	Inspection of parent ..... 103
Cependency..... 201.11	<i>Inter partes</i> reexamination of ..... 2611
Cross-reference to prior application ..... 201.11	International application ..... 1817.02
Definition ..... 201.07	International application as parent..... 201.11(a)
Design ..... 1504.20	Inventor, at least one in common..... 201.11
Effective filing date..... 201.11	Ownership..... 306
File wrapper continuing (FWC) ..... 201.06(b)	Reference to parent application ..... 201.11
File wrapper/history notation ..... 202.02	Rejection over published priority document..... 2133.01
Final rejection on first action ..... 706.07(b)	Rule 1.53(b)..... 201.06(c)
Identification on letter of transmittal..... 506	Rule 1.62, Former..... 201.06(b)
Inspection of parent..... 103	Time for filing ..... 201.11
<i>Inter partes</i> reexamination of..... 2611	When patented, opens parent application to public inspection..... 103
International application..... 1817.02	Continued Prosecution Application (CPA)..... 201, 201.06
International application as parent ..... 201.11(a), 1895	..... 201.06(d)
Inventor, at least one in common ..... 201.11	Amendments before first Office action ..... 714.01(e)
New matter..... 201.07, 608.04(b)	Application number ..... 503
Oath..... 602.05(a)	Assignee right to take action..... 324
Ownership ..... 201.12	Certificate of mailing or transmission ..... 512
Parent application data in specification.... 201.11, 202.01	Complete non-provisional application..... 601.01
Parent application data noted in file history/wrapper ..... 202.02, 1302.04	..... 601.01(a)
Reference to parent application..... 201.11	Continuation-in-part not permitted ..... 201.08
Reference to parent application inadvertently omitted ..... 1302.04	Continuity with parent ..... 201.11
Reissue ..... 1414, 1441, 1451	Correspondence ..... 502, 502.01
Restriction ..... 819	Cross reference to previous application.... 202.01, 202.02
Rule 1.53(b) ..... 201.06(c)	Design application ..... 201.06(d), 1502.01
Rule 1.53(d) ..... 201.06(d)	Eliminated for utility and plant applications.... 201.06(d)
Rule 1.60 application, Former..... 201.06(a)	Express abandonment of prior application ..... 711.01
Rule 1.62 application, Former..... 201.06(b)	..... 711.02(b)
Terminal disclaimer, effect in ..... 1490	Fees
Time for filing..... 201.11	As of the filing date..... 2164.05(a)
When patented, opens parent application to public inspection ..... 103	Reissue application ..... 1415
Written description requirement..... 201.11	Foreign priority..... 201.14
Continuation-in-part..... 201.08, 601.01(a)	Improper CPA treated as RCE ..... 201.6(d), 706.07(h)
Assignment from parent does not apply..... 306	Information disclosure statement in parent.... 609, 707.05
Cependency..... 201.11	<i>Inter partes</i> reexamination of ..... 2611
Cross reference to parent application ..... 201.11	Patent term..... 1303, 2701
	Plant application, no longer available..... 201.06(d)
	Priority ..... 1302.04
	Published as PG-Pub ..... 1120

INDEX  
Continuing application--Correspondence

	Sec. No.		Sec. No.
Reissue .....	1430	Required by drafting .....	707.07(c)
Restriction requirement in prior application.....	819	Correction of inventorship	
Suspension of action .....	709	Application .....	201.03, 605.04(g)
Terminal disclaimer, effect in .....	1490	Consent of assignee .....	201.03
Utility application, no longer available .....	201.06(d)	Continuing application .....	201.03
Continuing application .....	201.11, 1302.12, 1302.04	During <i>ex parte</i> reexamination .....	2250.02
Specific reference .....	201.11	During <i>inter partes</i> reexamination.....	2658, 2666.03
Continuing data (See also Cross-noting).....	202.02	In a patent	
Continuity between applications .....	201.11	By a certificate of correction .....	1412.04, 1481
Control of inspection by assignee .....	106	By filing a reissue application .....	1402, 1412.04
Convention, International (See also Treaties) .....	201.13	Misjoinder.....	1412.04
Converting nonprovisional and provisional applications		PTO procedure.....	605.04(g)
.....	201.04(b), 601.01(c)	Correction of name .....	201.03, 605.04(b), 605.04(c)
Copendency.....	201.11	Correction of patent.....	Chapter 1400
Copending application, reference brought up to date		By reexamination (See Reexamination, <i>Ex parte</i> ;	
.....	1302.04(f)	Reexamination, <i>Inter partes</i> )	
Copending U.S. application		By reissue (See also Reissue application)....	1401 to 1470
Common ownership .....	706.02(1)(2)	Certificate of correction.....	1480 to 1485
Design application.....	1504.20	Statutory disclaimer (See also Disclaimer; Terminal	
Different inventive entities.....	706.02(f)(2)	disclaimer) .....	1490
.....	706.02(k), 706.02(1)(3)	Correction of PG-Pub. ....	1130
Duty of disclosure in .....	2001.06(b)	Correction of reference citation .....	707.05(g), 710.06
Terminal disclaimer practice .....	1490	Correspondence (See also Mail stop)	
Copied patent claim (See Claim presented corresponding to		Address of PTO .....	501, 502
claim of patent)		Address in secrecy order applications .....	120
Copier copies.....	714.07	Address of patent owner .....	2622
Copies of prior art with reexamination request		Address, official mailing .....	501
<i>Ex parte</i> .....	2218	Address, when power is to a law firm .....	403
<i>Inter partes</i> .....	2618	Associate attorney.....	403.01
Copies of published applications.....	1128	Boxes (See Mail stop)	
Copy of foreign application, certified .....	201.14	Continuing application .....	201.06(c)
Copy of printed patent in reexamination		Crossing in mail.....	714.05
<i>Ex parte</i> .....	2219	Duplicate filings .....	403, 502.04, 714.01(a)
<i>Inter partes</i> .....	2619	Electronic mail.....	502.03, 713, 713.01, 713.04, 713.05
Copying <i>ex parte</i> reexamination file by public .....	2232	Facsimile transmission .....	502.01
Copying <i>inter partes</i> reexamination file by public.....	2632	Identifying with issue batch number (no longer required)	
Copyrights.....	608.01(v)	.....	1303.01
Relationship to design patents.....	1512	Maintenance fee.....	2542
Correction of drawing .....	608.02(p), 1302.05	Plural attorneys.....	403.02
Annotated sheets .....	608.02(v)	Post Allowance.....	502, 1306
Approval by examiner.....	608.02(x)	Published application.....	1134
Corrected stamp no longer required .....	608.02(o)	Receipt and handling .....	Chapter 500
Deferrable.....	608.02(b), 608.02(p)	Reexamination, <i>ex parte</i> .....	2224
Marked-up copy .....	608.02(v)	Reexamination, <i>inter partes</i> .....	2624
New matter .....	608.04	Signature requirements .....	502.02
Not approved.....	608.02(x)	Third party, application published.....	1134
Order for.....	608.02(x)	With whom held .....	403



MANUAL OF PATENT EXAMINING PROCEDURE  
Counter-terrorism inventions, special status--Death of attorney

	Sec. No.		Sec. No.
Counter-terrorism inventions, special status .....	708.02	Cross-reference	
Counting actions.....	1705	Addition of patent.....	905.02
Countries for foreign priority .....	201.13	Another application (See also Cross-noting).....	202.01
Country codes .....	1851	.....	608.01(p), 1302.04
Coupons .....	Introduction	Art collection .....	903.02(c)
Court decision		At allowance.....	903.07, 1302.04
Certificate of .....	1216.01	Citing.....	707.05(e)
Citation of .....	707.06	Establishing new.....	903.06
Dissemination of .....	1720	Noted during examination .....	903.07(a)
Entry in patent file.....	2207	Ordering.....	903.06
Treatment of.....	1721	Required for all claimed disclosure .....	903.07(a)
Unpublished decisions .....	2677	Crossed mailings .....	714.05
Court of Appeals for the Federal Circuit (CAFC)		Customary meaning of claim term.....	2106, 2111.01
.....	711.02(b), 1002.02(k)(1), 1002.02(k)(3)	Customer numbers.....	403, 711.04(c), 2515, 2540
.....	1214.06, 1216, 1216.01, 2358	Change of address.....	601.03
Appeal to, from an <i>ex parte</i> reexamination .....	2279	Customer Service Center .....	104, 508.04, 608.02(z)
Appeal to, in an <i>inter partes</i> reexamination		.....	714.13, 1430, 1470, 1730
.....	2682, 2683	Customer Window .....	103, 501, 502, 505, 714.13
Court ordered <i>inter partes</i> reexamination .....	2686.04	.....	905.02, 1430, 1470, 2422.09
Court papers, service on Director.....	1216		
Cover sheet — provisional application .....	201.04(b)	<b>D</b>	
Credit Card Payment Form PTO-2038 reproduced.....	509	D-10 notice .....	130, 1304.01
Criteria for deciding <i>ex parte</i> reexamination request ....	2242	D-11 notice .....	1103
Criteria for deciding <i>inter partes</i> reexamination request		Damage, Proof of irreparable .....	409.03(g)
.....	2642	Databases (See Electronic databases)	
Cross appeal to the Board of Patent Appeals in <i>inter partes</i>		Date	
reexamination.....	2674	Amendment .....	505, 511, 512
Cross appeal to the Federal Circuit in <i>inter partes</i>		.....	710.01(a), 710.05, 714.18
reexamination.....	2683	Citation of foreign patent.....	901.05(a), 901.05(b)
Cross-noting		Convention .....	201.13
Data of parent application on file wrapper/history		Filing .....	201.11, 502, 503, 505, 506
.....	202.02, 1302.09	.....	506.02, 1002.02(b)
Data of provisional application in specification..	1302.04	Filing, Refusal to accord.....	506.02, 2133
Data of provisional application on file wrapper/history		Foreign application (priority) .....	201.13, 201.14, 201.15
.....	202.02	Invention.....	2137, 2138
Data of related application brought up to date		Maintenance fees due .....	2506
.....	1302.04(f)	Office action .....	707.11
Data of related application in specification.....	201.11	Office stamp .....	502, 505, 506, 714.18
.....	202.01, 1302.04	Reference.....	706.02, 707.05(e), 707.05(f)
Foreign application cited in an application oath		.....	715, 715.01, 715.01(c)
.....	201.14, 202.04	Technology Center stamp.....	714.18
Foreign application, file wrapper/history .....	202.03	Date no longer entered on drawing.....	608.02(o)
In original patent file of reissue application.....	202.05	Date of execution of oath.....	602.05
Reissue applications .....	1451, 1455	Date stamp, Technology Center .....	714.18
Specific reference.....	201.11	Death of attorney .....	406

INDEX  
Death of inventor--Deposit account

	Sec. No.		Sec. No.
Death of inventor (See also Administrator or executor)		International application .....	1820, 1893.01, 1893.01(a)
.....	409 to 409.01(f)	.....	1893.01(a)(1), 1893.01(a)(2)
Deceased inventor		.....	1893.01(a)(3), 1893.01(e)
Allowance not withdrawn .....	1303.03	.....	1893.03(a), 1893.03(b)
Legal representative as applicant .....	409.01(a), 1820	.....	1893.03(g), 1895, 1896
Proof of authority of .....	409.01(b)	Inventor refuses to sign or cannot be found.....	603
Legal representative refuses to sign .....	409.03(c)	Minor, by .....	409
Deceptive intent (See also Fraud; Inequitable conduct)		Non-English.....	602.06
Biotechnology process .....	706.02(n)	Plant patent application .....	1604
Foreign filing licenses .....	140, 706.03(s)	Refers to preliminary amendment.....	601.01(a), 602
Inventorship .....	201.03	Reissue application .....	706.03(x), 1414
Reissue .....	1402, 1414, 2012	.....	1414.01, 1444, 1455
Decision		Signed before alteration .....	605.04(a)
By Board of Patent Appeals and Interferences.....	1213	Substitute .....	602.02
.....	1302.14	Declarations, conflicting.....	201.03
Dissemination of.....	1720	Declassified matter .....	707.05(f)
<i>Ex parte</i> reexamination.....	2277	Dedication to the public.....	715, 1490
<i>Inter partes</i> reexamination.....	2681, 2682	Defective oath.....	602.03
Reconsideration of.....	1214.03	In reissue application .....	1414
Treatment of .....	1721	Defects, correction of, in request for <i>ex parte</i> reexamination	
By classification examiner .....	903.08(f)	.....	2231
Citation.....	707.06	Defects, correction of in request for <i>inter partes</i>	
<i>Ex parte</i> reexamination rehearing request.....	2240	reexamination .....	2231
Governs examiner's action.....	Introduction	Defense, applications affecting.....	115, 120, 130, 140
Listed.....	Appendix II	Defensive publication citation .....	711.06(a)
On interference motion .....	2340	Defensive publication program.....	711.06
Ordering <i>ex parte</i> reexamination.....	2246	Deferral of examination.....	709
Ordering <i>inter partes</i> reexamination (See		Definition of class.....	902.02
Reexamination, <i>Inter partes</i> : Decision on the request		Delegation of Director's authority .....	1001.01
for reexamination)		.....	1002, 1002.02
Public availability.....	103	Demonstration at interview.....	713.08
Publication of .....	707.06	Denial of request for reexamination .....	2247, 2247.01
Declaration (See also Oath).....	602	.....	2647, 2647.01
After appeal.....	1211.02	Department of Energy (DOE).....	115, 140
Amendment.....	602.01	.....	150, 151, 706.03(b)
Attached to specification.....	605.04(a)	Department of Commerce, Organization Orders	
Change of inventorship .....	201.03	30-3A cited .....	510
Copies, filing of.....	602	30-3B cited .....	510
Copies from prior application .....	201.06(c)	Dependent claim .....	608.01(n)
Date of execution .....	602.05	Objected to when base claim is canceled.....	608.01(n)
Defective .....	602.03	.....	707.07(j)
Delayed filing.....	506	Reissue.....	1455
Executed before alterations made.....	605.04(a)	Treatment in <i>inter partes</i> reexamination .....	2660.03
Facsimile transmission .....	502.01, 602	Dependent claim, objected to when improper .....	608.01(n)
Foreign priority applications listed.....	201.14	.....	706.01
.....	201.14(c), 202.04		

MANUAL OF PATENT EXAMINING PROCEDURE  
Deposit account--Description

	Sec. No.		Sec. No.
Deposit account.....	509.01	Budapest Treaty deposit.....	2404.01
Authorizations.....	509.01, 1302.04	Continuity of access.....	2404.01
Extensions of time.....	706.07(f)	Deposits certified as available.....	2404.01
International applications.....	1847, 1850, 1875.01	Health, safety restrictions.....	2404.01
Issue fee.....	1303, 1306, 1308.01	Indicia of "known and readily available".....	2404.01
Maintenance fee.....	2510, 2515, 2522	Material capable of self-replication.....	2403.01
Overdrawn.....	509.01	Direct self-replication.....	2403.01
Petition fee.....	711.03(c)	Indirect self-replication.....	2403.01
Refunds.....	509, 607.02	Need for a deposit.....	2402, 2404
Replenishment.....	509.01	Plant material.....	2403.02
Mailing address.....	501	Plant Patent Act, Relation to.....	2403.02
Deposit Account Division.....	509.01	Reference to deposit in application.....	2404, 2404.03
Deposit of microorganisms (See also Biotechnology)		Implication, presumption.....	2404, 2404.03
.....	1605, 1823.01, 2402 to 2411.05	Requirements of 35 U.S.C. 112.....	2164.06, 2404
Deposit of correspondence.....	502	.....	2404.03
Depositions		Replacement or supplement of deposit.....	2407
Evidence.....	1901.02, 2013	After a patent has issued.....	2407.02
Of examiner.....	1701.01	Exemption from replacement.....	2407.05
Deposit rules (See also Biotechnology).....	Chapter 2400	Failure to replace.....	2407.03
Acceptable depository.....	2405	In a pending application/reexamination proceeding	
Background information.....	2401	.....	2407.01
Biological material, definition.....	2403	Reason for replacement.....	2407.04
Biological material, made or isolated without undue		Replacement not recognized.....	2407.06
experimentation.....	2404.02	Treatment of replacement, presumption of identity	
Budapest Treaty (See also Treaties).....	2402	.....	2407.04
Budapest Treaty depositories.....	2405	Seeds.....	2403.02
Depositories, Current list of Budapest Treaty.....	2405	Term of deposit.....	2408
Effective date.....	2401, 2402	Budapest Treaty term.....	2408
Examination procedures.....	2411	Enforceable life of patent.....	2408
After grant.....	2411.04	Time for making original deposit.....	2406
Application in condition for allowance except for		Assurance regarding deposit before payment of issue	
deposit.....	2411.03	fee.....	2406, 2411.03
Certificate of correction.....	2411.04	Corroboration.....	2406.02
Content of application regarding deposited material		Description in application specification.....	2406.01
.....	2411.05	During application pendency.....	2406
Need for 37 CFR 1.312 amendment.....	2411.03	Loss of U.S. filing date in other countries.....	2406.03
Reissue.....	2411.04	New matter.....	2406.01
Rejections based on deposit issue.....	2411.01	Patent Cooperation Treaty applications . 1823.01, 2406	
Responses from applicant.....	2411.02	Post-issuance deposits.....	2406
Furnishing of samples.....	2410	Viability of deposit.....	2409
Access to deposits.....	2410.01	Viability statement.....	2409
Certification of accessibility of deposit.....	2410.02	35 U.S.C. 112 requirements.....	2402, 2403, 2404
Conditions of deposit.....	2410.01	Deputy Director of Patents and Trademarks	
Exception to removal of restrictions.....	2410.01	.....	1002.02(o), 1203
Restrictions removed upon grant.....	2410.01	Derogatory remark regarding prior art.....	608.01(r)
Known and readily available biological material		Description	
.....	2404.01	Basis for claim.....	608.01(o), 706.03(c), 2161, 2163

INDEX

Design application--Design application

	Sec. No.		Sec. No.
Computer programming	2106.01	Foreign priority	201.13, 1504.02, 1504.10
Detailed	608.01(g)	German application	201.14(b)
International application	1823	More than six months before U.S. filing	1504.02
Design application	Chapter 1500	Functionality	1504.01(c)
Analogous art	1504.02, 1504.03	Obviousness and	1504.03
Anticipation	1504.02	Hague Agreement (See also Treaties)	201.13, 1504.10
Application, elements of	1503	Hidden end use	1504.01(c)
Articles, design comprising multiple	1504.01(b)	Hidden feature	1504.02, 1504.03, 1504.04
“Average observer” test	1504.02	Icon, computer generated	1504.01(a)
Benelux Designs Convention (See also Treaties)	201.13, 1504.10	Indefiniteness	1503.01, 1503.02, 1504.04
Characteristic feature	1503.01, 1504.01(a)	Library collections relating to	901.06(a)
Claim	1503, 1503.01	Modification, description	1503.01
Combining references	1504.03	Multiple embodiments	1504.05
Commercial success	1504.03	Multiple parts of article	1504.01(b)
Computer generated icons	1504.01(a)	New matter	1503.01, 1503.02, 1504.01(a), 1504.04
Continuation application	1504.20	Object, Design for	1502
Continuation-in-part (CIP) application	1504.20	Obviousness	1504.03
Continued Prosecution Application (CPA)	1502.01	Obviousness-type double patenting	1504.06
Convention, International	201.13, 1504.10	Offensive subject matter	1504.01(e)
Copending applications	1504.06, 1504.20	Ornamentality lacking	1504.01(c)
Copying, evidence of, to rebut obviousness	1504.03	Patent Cooperation Treaty	1501, 1502.01
Copyright, Relationship to	1512	Patentability	1504.01, 1504.01(a) to 1504.01(e)
Definition	1502		1504.02, 1504.03, 1504.04
Description	1503, 1503.01	Petition, Special Status	708.02, 1504.30
Disclaimer	1503.01, 1503.02, 1504.04	Petition to accept color drawings	
Disclosure	1503.01, 1503.02, 1504.04	or photographs	608.02, 1503.02
Divisional application	201.06, 1504.20	Photographs	1503.02, 1504.04
Double patenting	804, 1504.06	Preamble	1503.01
Drawing	1503, 1503.01, 1503.02, 1504.04	Priority under 35 U.S.C. 119	201.13, 201.14(b)
Broken lines	1503.01, 1503.02, 1504.04		1504.02, 1504.10
Color	1503.02	Priority under 35 U.S.C. 120	201.11, 1504.20
Trademarks	1512	References supplied	707.05(a), 1513
Embodiments, alternate or multiple	1503.01	Quayle action	1504
	1504.01(b), 1504.05	Registration abroad	1504.02, 1504.10
Enablement	1503.02, 1504.04	Reexamination, <i>inter partes</i>	2611
European Community Design treaty	1504.10	Reissue	1457, 1512
Examination	1504, 1504.01, 1504.02	Request for Continued Examination (RCE)	1502.01
	1504.03, 1504.04	Request for Expedited Examination	1504.30
Expedited Examination	502, 1002.02(c)(3), 1504.30	Restriction	1504.05
Reissue	1457	Reissue	1457
Expert testimony	1504.03	Rules applicable	1501
Feature emphasized	1503.01	Scope of claim	1503.01, 1504.04
Fee, filing	607		1504.05, 1504.06
Reissue	1457	Search	1504, 1504.02, 1504.03
Fee, issue	1306	Secondary considerations	1504.03
Font, type	1504.01(a)	Simulation	1504.01(d)
		Specification	1503.01

MANUAL OF PATENT EXAMINING PROCEDURE  
Design patent series--Disclosure

Sec. No.	Sec. No.
Use of Copyrights in..... 1512	TC 3640..... 710, 1002.02(c)(1)
Use of Trademarks in ..... 1512	Director of the USPTO
Statutory bar, foreign application..... 201.13, 1504.02	Action requiring attention of
Statutory subject matter..... 1502, 1504.01	Failure to identify claim as copied from a patent
Surface ornamentation .....1502, 1502.01, 1503.02	..... 2307.05
..... 1504.01, 1504.01(a)	Authority and functions ..... 706.03(b), 708.01, 709
..... 1504.01(c), 1504.03	..... 711.02, 714, 719.01, 1001, 1002, 2203
Surface treatment or indicia ..... 1503.02	..... 2242, 2284
Term of..... 1457, 1502.01, 1505	Publication of confidential decisions ..... 103
Title ..... 1503.01, 1504.01(a)	Withdrawal from issue ..... 1308
Amendment of ..... 1503.01	Decisions ..... Introduction
Use of Trademarks in ..... 1512	Mailing address ..... 501
Trademark, relationship to ..... 1512	Notices (See also Publication) ..... Introduction, 707.06
Type fonts ..... 1504.01(a)	Orders (See also Publication) ..... Introduction, 707.06
Utility patent, relationship to ..... 1502.01	Director initiated reexamination ..... 2212, 2239
Visual characteristics ..... 1502	Disbarred attorney (See Attorney or agent: Suspended or
Written description lacking ..... 1503.01, 1503.02	excluded)
..... 1504.01(a), 1504.04	Disciplinary proceedings ..... 402
Design patent series (See also Patent)..... 901.04	Mailing address ..... 501
Designated office ..... 1801, 1893.01(a)	Disclaimer (See also Terminal disclaimer)
Designation fee - PCT..... 1817.01(a)	Co-author of publication..... 715.01(c)
Designation of states ..... 1817.01, 1817.01(a)	Copy required in reexamination
Detailed description (See Specification)	<i>Ex parte</i> ..... 2214
Determination of public use or on sale.... 706.02(c), 2133.03	<i>Inter partes</i> ..... 2614
Digest (See Cross-reference: Art collection)	Defensive publication ..... 711.06
Dictionary as a source for the ordinary and customary	Design application ..... 1503.01, 1503.02, 1504.04
meaning of a claim term..... 2111.01, 2173.05(a)	Forms..... 1490
Diligence	Interference..... 2305, 2305.04, 2307.02
Charts for priority..... 2138.01	Processing..... 1490
Filing application ..... 2138.06	Rejection..... 706.02(k), 710.02(d)
Filing reissue ..... 1403	Statutory ..... 1490
Interference practice..... 2138.01	Terminal ..... 706.02(k), 804.02, 1490
Of actions during regulatory review..... 2757.01	Disclosure (See also Duty of disclosure; Specification)
Reasonable ..... 2138.06	Abstract ..... 608.01(b)
Shown in 37 CFR 1.131 affidavit..... 715.07, 715.07(a)	Amendment ..... 608.04, 1302.02
To overcome a rejection..... 2136.05	Amendment, Preliminary..... 608.04(b)
Director of Technology Center ..... 402.06, 708.02	Best Mode (See also Best Mode)..... 608.01(h), 2165
..... 714.01(a), 714.13, 714.25, 715.08	Chemical compound..... 608.01(p)
..... 720.01, 804.04, 1002.02, 1002.02(c)	Claimed ..... 901.03
..... 1206, 1207, 1208.01, 1214.04, 1308	Common, parent and continuing applications ..... 201.11
..... 1308.01, 1901.06, 2248, 2249, 2265	Completeness..... 608.01(p), 2164
..... 2274, 2283 to 2286, 2301.01(b), 2303	Computer programming cases ..... 2106.02
..... 2303.01, 2305.04, 2306, 2307.02, 2307.03	Correspondence with claims..... 2163.05, 2173.03
..... 2309.02, 2648, 2667, 2682, 2686.01	Design application ..... 1503, 1503.01
Functions ..... 1002.02(c), 1003	Detailed description..... 608.01(g)
TC 1600..... 1002.02(c)(2)	Document ..... 1706
TC 2900..... 502, 1002.02(c)(3)	Duty of ..... Chapter 2000

INDEX  
Disclosure document program--Double patenting

	Sec. No.		Sec. No.
Enablement (See also Enablement).....	2164	<i>Inter partes</i> reexamination of.....	2611
Foreign application.....	201.15	Inventor, at least one in common.....	201.11
Implicit.....	2144.01	New matter.....	201.06
Incomplete.....	608.01(p), 706.03(c), 2161 to 2165	Oath.....	201.06(c), 602.05(a)
Incomprehensible.....	702.01	Ownership carried from parent application.....	201.12
Incorporation by reference (See also Incorporation by reference).....	608.01(p)	Parent application data notation in specification ...	202.01
Insufficient.....	608.01(p), 702.01, 706.03(c)	Patented, Opens parent application to inspection.....	103
Later filed application.....	608.01(p)	Reference to parent application.....	201.11, 1302.04
Operability.....	716.07, 2164.08(b)	Reissue.....	1414, 1440, 1450, 1451
Original claim.....	608.01(l), 2163.06	Rule 1.53(b).....	201.06(c)
Preliminary amendment.....	608.04(b)	Rule 1.53(d).....	201.06(d)
Related applications.....	608.01(p), 1302.04	Rule 1.60, Former.....	201.06(a)
Requirements for.....	2161	Rule 1.62, Former.....	201.06(b)
Reservation clause.....	608.01(e)	Signature.....	201.06(d)
Restricted to claimed subject matter.....	1302.01	Time for filing.....	201.11
Secrecy order, Material subject to.....	120	Written description requirement.....	201.11
Specification (See also Specification).....	608.01	DNA (See also Biotechnology; Nucleotide sequences) .....	Chapter 2400
Sufficiency for continuity.....	201.11	Enablement.....	2164.08
Sufficiency of.....	716	Searching.....	901.06(a)
Support for claims.....	2163.01	Sequence listing.....	2422, 2424, 2431
Trade name.....	608.01(v)	Special status for recombinant.....	708.02
Trademark.....	608.01(v)	Docket report.....	1704
Utility.....	608.01(p), 706.03(a)	Doctrine of collateral estoppel (See Estoppel)	
Written (See also Written description).....	2163	Doctrine of dedication to the public.....	715
Disclosure document program.....	1706	Doctrine of equivalents.....	2138.05, 2173.05(b), 2186
Evidence under 37 CFR 1.131.....	715.07	Doctrine of segregable parts.....	1504.05
Discourtesy.....	714.19, 714.25	Doctrine of unclean hands.....	2010
Dismissal of appeal.....	1215.04	Document, Disclosure.....	1706
Disposals counted.....	1705	Electronic (See also Electronic publications) ...	707.05(e)
Distinct, definition.....	802.01	DoD Directive 5230.25.....	120
Distinct inventions.....	802, 802.01, 803, 806.05	DoD Security Agreement.....	120
Apparatus and product made.....	806.05(g)	Domestic representative.....	302.04
Process and apparatus for its practice.....	806.05(e)	Double correspondence.....	403, 714.01(a)
Process and product made.....	806.05(f)	Double inclusion in claim.....	2173.05(o)
Divisional application.....	201.06, 601.01(a)	Double patenting.....	Chapter 800
Assignment carried from parent application.....	201.12	Avoiding rejection.....	706.02(k), 706.02(l)(3), 804.02
.....	306	Basis.....	804
Continued prosecution application (CPA).....	201.06(d)	Between one or more applications and a published application.....	804
Copendency.....	201.11	Claimed subject matter.....	806.01
Design application.....	201.06, 1504.20	Commonly owned cases, treatment.....	804.03
Drawing, Transfer of.....	608.02(i)	Copending applications.....	706.02(k), 804
Effective date.....	201.11	Definition.....	804
Filed by assignee.....	324	Design applications/patents.....	804, 1504.06
File wrapper continuation (FWC).....	201.06(b)	Different inventive entities.....	706.02(k), 804.03
File wrapper/history notation.....	202.02, 1302.04	Distinct and independent inventions.....	804.01
Inspection of parent application.....	103		

MANUAL OF PATENT EXAMINING PROCEDURE  
Drafting notation--Drawings

	Sec. No.		Sec. No.
Domination.....	804	Consistency.....	608.02(e)
International applications.....	804	Content of.....	608.02(d)
Obviousness type.....	804	Correction (See also Correction of drawing)....	608.02(p)
Design application.....	1504.06	.....	1302.05
Plant applications.....	1601	Incorporated into PG-Pub.....	1120, 1121
Reexamination.....	804, 2217, 2258	Reversed figure numbers.....	1302.04
Rejection.....	804	Date no longer entered on back.....	608.02(o)
Nonstatutory.....	804	Delivered to wrong Technology Center.....	508.01
Obvious.....	804	Design application.....	1503, 1503.01
Prohibition, 35 U.S.C. 121.....	804.01	.....	1503.02, 1504.04
Provisional.....	706.02(k), 706.02(l)(3), 804	Disclosure.....	608
Specification, use of.....	804	Divisional application.....	608.02, 608.02(i)
Statutory.....	804, 804.03	Drafting criticism included in first Office action	
Rejection nullification.....	804.01	.....	707.07(a), 707.07(c)
Restriction previously required.....	804.04, 1003	Drafting notation.....	608.02
Same assignee.....	706.02(k)	Drafting stamp no longer required.....	608.02(o)
.....	804.03, 822	Examiner determines completeness.....	608.02(e)
Same inventor.....	806.04(h), 806.04(i), 806.05	Illustrates claim.....	608.02(e)
.....	822, 822.01	Informal (no longer used).....	507, 608.02(b)
Species and genus.....	806.04(h), 806.04(i)	Interference prints.....	608.02(m)
Subject matter not patentably distinct.....	804	International application.....	1825
Submissions to TC director.....	804.04	Kept in application.....	608.02(c)
Terminal disclaimer effect.....	706.02(k)	Lost.....	1302.05(a)
.....	804.02, 1451, 1490	Mail section stamp no longer used.....	608.02(o)
In a reissue application.....	1451	Modification illustrated.....	608.02(f)
Drafting notation.....	608.02, 707.07(a), 707.07(c)	Marked-up copy.....	608.02(v), 608.02(w)
Drafting stamp (no longer required).....	608.02(o)	Necessary for filing date.....	506, 608.02
Drawings.....	507, 608.02	New drawings required.....	608.02(a)
Amendment.....	608.02(p), 1302.04	New, handling.....	608.02(a)
In <i>ex parte</i> reexamination.....	2250.01	New matter.....	608.04, 706.03(o)
In <i>inter partes</i> reexamination.....	2666.02	New, when required.....	608.02(a)
In reissue application.....	1413	Not received.....	608.02(h), 1825
Prior to publication of PG-Pub.....	1121	Not required.....	608.02
Amendment, Direction for.....	608.02(q)	Not returned.....	608.02(y)
Amendment, Disposition of orders for.....	608.02(x)	Objection.....	608, 608.01
Amendment support by original claim.....	608.04(a)	.....	608.02, 608.02(b)
Annotated sheets.....	608.02(v), 608.02(w)	.....	706.03(o), 1503.02, 1504.04
Brief description.....	608.01(f)	<i>Official Gazette</i> figure.....	1302.09
Canceled figure.....	608.02(t)	Omitted drawings.....	601.01(g)
Canceled sheet.....	608.02(t)	Patented file.....	905.03
Canceled sheet, patent.....	608.02(i)	Petition to transfer from another application....	608.02(i)
Canceled sheet, transfer.....	608.02(i)	Photographs.....	608.02, 1503.02
Color.....	608.02, 1503.02	Placement in file wrapper.....	719.01(b)
Colored plant.....	1606	Plant application.....	1603, 1606
Complete illustration.....	608.02(d)	Print (See also Print of drawing)....	608.02(m), 608.02(n)
Completeness.....	608.02(e)	Prior art.....	608.02(g), 2125
Computer lists.....	608.05	Provisional application.....	608.02

INDEX

Drawing correction--Election

	Sec. No.		Sec. No.
Reference characters .....	608.02(e)	Compliance with.....	2004
Reference characters, change .....	608.02(w)	Continuing applications .....	2001.04, 2004
Reissue application.....	1411, 1413	Copending applications .....	2001.06(b), 2004
No longer transferred from original patent.....	1413	Copied claims .....	2001.06(d)
Removal from Technology Center .....	608.02(c)	Duration of.....	2001.04, 2003.01
Replacement drawings for publication in PG-Pub ...	1121	Foreign applications .....	2001.06(a)
Replacement.....	608.02(h)	Information material to patentability ....	2001.04, 2001.05
Reversed figure numbers.....	1302.04	Litigation information.....	2001.06(c)
Review by Office of Initial Patent Examination (OIPE)		Questionnaire.....	2004
.....	507	Reexamination	
Required by examiner .....	608.02	<i>Ex parte</i> .....	2014, 2280
Requirements .....	608.02	<i>Inter partes</i> .....	2003.01, 2684
Return.....	608.02(y)	Reissue application .....	1406, 1414, 1418, 1448
Section lines .....	608.02(f)	.....	2001.06(c), 2003
Security markings.....	121	Sources of information .....	2001.06
Substitute.....	502, 608.02(h)	To whom owed .....	2001.03
Sufficiency, determined by examiner.....	608.02(e)	Violation of.....	2010
Symbols.....	608.02	Claims invalidated .....	2016
Trademarks.....	1512	Protest .....	2013
Unacceptable .....	608.02(b)	Reexamination .....	2014
Drawing correction.....	507, 608.02(p)	Reissue .....	2012
Annotated sheets .....	608.02(v), 608.02(w)	Rejection of claims in reissue application.....	1448
Approval by examiner.....	608.02(x)	Who has .....	2001.01
Marked-up copy .....	608.02(v), 608.02(w)		
New matter .....	608.04		
Order for.....	608.02(x)		
PG-Pub.....	1120, 1121		
Replacement sheets .....	502, 608.02(h)		
Required.....	507, 707.07(a), 707.07(c)		
Dual correspondence.....	403, 714.01(d)		
Due Care Showing .....	2734		
Duplicate amendments (See also Amendment).....	719.01(a)		
Duplicate claims .....	706.03(k)		
Duplicate foreign patents .....	903.03		
Duplicate papers for plant applications .....	1603, 1605		
.....	1606, 1609		
Duty of candor and good faith.....	2001, 2001.03, 2733, 2762		
Compared to duty to disclose material information			
.....	2001.04		
Information disclosure .....	609		
Reexamination .....	2280		
Duty of disclosure .....	Chapter 2000		
After patent grant .....	2003.01		
Aids to compliance.....	2004		
Checklist.....	2004		
Compared to requirement for information .....	704.12(a)		
.....	2005		

**E**

Easily erasable paper .....	608.01, 714.05, 714.07, 714.19
Effective date	
Declassified matter .....	707.05(f)
Reference patent .....	706.02, 706.02(a), 707.05(e)
.....	707.05(f), 715, 901.05(b)
Effective filing date	
Continuing application .....	201.11, 706.02, 708
Continuation-in-part .....	2133.01
Foreign priority effect.....	201.15, 706.02
International convention (See also Foreign application;	
Treaties).....	201.13
Provisional application .....	706.02
Publication.....	715.01(c)
Eighteen-month publication (See Pre-Grant Publication	
(PG-Pub))	
Election (See also Restriction;	
Election of species).....	Chapter 800
Action on nonelected claims.....	819
After multiplicity rejection .....	2173.05(n)
After restriction .....	818



MANUAL OF PATENT EXAMINING PROCEDURE  
Election of species--Entry of "Contents" of file wrapper

	Sec. No.		Sec. No.
Applicant must make.....	818.03(e)	WEST .....	719.05, 902.03(e)
Between applications, Conflicting claims .....	804	Electronic Business Center (EBC).....	1730
.....	822, 822.01	Electronic document.....	707.05(e)
Constructive .....	818.02(a), 818.02(c)	Electronic filing system (EFS).....	503, 507, 511, 608.01
In reissue application .....	1450	.....	609, 1121, 1132, 1133, 1730
Fixed by action on merits .....	818.01, 818.02(a)	Computer Readable Format (CRF) Sequence Listing	
Implied .....	818.02(a), 818.02(c)	.....	511, 1730, 2422.03
Interference .....	820.02	Electronic funds transfer to replenish deposit account	
Old combination.....	820.01	.....	509.01
Optional cancellation .....	818.02(c)	Electronic Information Disclosure Statement (e-IDS)....	609
Original presentation.....	818.02(a)	Electronic mail.....	502.03, 713, 713.01, 713.04, 713.05
Shift.....	819.01, 820	Electronic publications	
Treatment of nonelected claims		Availability as prior art.....	2128
.....	706.03(m), 821 to 821.03	Citation of.....	608.01, 707.05(e)
In reissue application .....	1450	Hyperlinks to .....	608.01, 608.01(p)
With traverse .....	818, 818.03	Search for.....	904.02(c)
.....	818.03(b), 818.03(c), 821.01	Employee number.....	711.04(b), 905.03, 905.05
Without traverse.....	821.02	Employees of Patent and Trademark Office,	
Election of species		property interest in patent .....	309
Action after .....	809.02(c)	Enablement .....	706.03(c), 2164
Allowable generic claim lacking.....	809.02(a)	Burden on the examiner.....	2164.04
Basis.....	808.01(a), 809.02	Commensurate in scope with claims .....	2164.08
Canceling species claims.....	818.02(c), 821.01, 821.02	Critical feature not claimed.....	2164.08(c)
Design application.....	1504.05	Inoperative subject matter .....	2164.08(b)
Implied .....	818.02(a), 818.02(c)	Single means claim .....	2164.08(a)
Reissue application.....	1450	Compared to utility .....	2164.07
Requirement.....	809.02(a), 809.02(b)	Design patent application .....	1503.02, 1504.04
Requirement, prior to search .....	808.01(a)	Duty or disclosure of information relevant to.....	2001.04
Species claims lacking .....	809.02(d), 818.02(b)	Evidence of.....	2164.05
Withdrawal of nonelected species.....	809.02(c)	Examples of enablement issues .....	2164.06
Electronic access to published applications .....	1128	Form paragraphs used to reject.....	706.03(c)
Electronic databases (See also PALM; PAIR)		Reduction to practice .....	2164.02
.....	706.02(e), 719.05, 901.06(a), 902.03(e), 1730	Relationship of predictability .....	2164.03
Cassis CD-ROM.....	902.03(d)	Specification must be enabling	
Chemical abstracts services.....	905.06	As of the filing date.....	2164.05(a)
Derwent's World Patents Index (WPI) .....	905.06	To persons of ordinary skill .....	2164.05(b)
Dialog.....	905.06	Test of enablement.....	2164.01
e-Official Gazette – Patents (eOG:P).....	1703	35 U.S.C. 112, sixth paragraph limitations.....	2181, 2185
EAST.....	719.05, 902.03(e)	Energy, Department of .....	115, 706.03(b)
Full-text patent database.....	1730	Energy, related applications, special status.....	708.02
INPADOC.....	905.06	English language faulty, new specification .....	608.01(q)
Lexus-Nexus .....	719.05	English language required .....	302.02, 608.01
Official Gazette Notices .....	1703	Enrollment and Discipline, Office of (See Office of	
Patent Grants Database .....	1703, 1730	Enrollment and Discipline)	
Questel-Orbit.....	719.05, 905.06	Entity, small, claiming status as (See Small entity status)	
TESS (Trademark Electronic Search System)		Entry of amendment (See also Amendment).....	714.18
.....	1703, 1730	Entry of "Contents" of file wrapper.....	719.01

INDEX  
Entry on face of file wrapper--Examiner

	Sec. No.		Sec. No.
Entry on face of file wrapper.....	719.02, 719.02(b), 1302.09	Examination of application.....	Chapter 700
Environmental Quality Program .....	708.02	Confidentiality during.....	101
Equity (civil action)		Deferral of .....	709, 1002.02(d)
Under 35 U.S.C. 145 .....	1216, 1216.02	Order of .....	707.02, 708 to 708.03
Under 35 U.S.C. 146 .....	1216, 2358	Piecemeal.....	707.07(a), 707.07(g)
Equivalents in art.....	904.01(b), 2144.06	Purpose .....	701
Erasable (specially coated) paper .....	608.01	Reissue.....	1440, 1443, 1445
Erasure in specification, before allowance.....	1302.01	Request for SIR .....	1103
Erasure in specification, before execution.....	608.01	Secrecy order application .....	130
Errors (See also Correction of patent)		Statutory authority .....	701
Correction of patents .....	Chapter 1400	Suspension of.....	709
Deceptive intent .....	140, 2022.05	Examiner	
Reissue .....	1401 to 1470	Action .....	707
Title documents.....	323	Action counted.....	1705
Withdrawal from issue .....	1308	Affidavit .....	2144.03
Essential material .....	608.01(p)	Assignment of application for examination.....	903.08(b)
Establishing subclasses .....	903.02(c)	Assignment of <i>ex parte</i> reexamination .....	2236
Estoppel		Assignment of <i>inter partes</i> reexamination.....	2636
Abandonment .....	711.03(c)	Assistant .....	707.01, 707.02
Collateral.....	2012.01	Citing prior art in an issued patent inappropriate.....	2203
In <i>ex parte</i> reexamination .....	2259	Classification (See also Classification examiner).....	903
In <i>inter partes</i> reexamination.....	2659	Consultation with Reexamination Legal Advisor (RLA) .....	2633, 2671, 2676, 2679, 2686.01
Defensive publications .....	711.06	Disposals.....	1705
Different inventive entities and commonly owned applications .....	804.03	Duty of candor and good faith to .....	2001.03
Interference .....	715, 2138.01, 2358, 2363.03	Employee number.....	711.04(b), 905.03, 905.05
Reasons for allowance.....	1302.14	Expressing opinion of validity.....	1701
Reissue proceedings .....	2012.01	Name .....	502, 707.09, 1302.13
Statutory, <i>inter partes</i> reexamination.....	2601	New action indicated by primary.....	707.01
.....	2612, 2614	Previous action by another examiner	
Terminal disclaimer .....	804.02	Allowed claims .....	706.04
European Community Design treaty (See Treaties)		Interview .....	713.01
European Patent Convention (See Treaties)		Search.....	704.10
European Patent Office (EPO) .....	120, 609, 901.05, 905.06	Primary	
.....	1801, 1819, 1823.02, 1840, 1840.01	Actions requiring personal attention ....	707.01, 714.16
.....	1843.02, 1847, 1850, 1851, 1857, 1860	.....	715.08, 1004
.....	1865, 1865.01, 1893.03(g), 2422.04	Name on file wrapper .....	1302.13
Address.....	1865	Pursuit of bounties prohibited .....	1701
As a PCT Chapter I international searching authority .....	1840.01	Reasons for allowance .....	1302.14
As a PCT Chapter II International Preliminary Examining Authority.....	1865.01	Resigns .....	708.03, 1702
Evidence, of public use or on sale.....	2133.03 to 2133.03(b)	Resigns, old cases special.....	708.03
Evidence submitted with protest .....	1901.02	Suggestion of allowable claims .....	707.07(j)
Examination guidelines for applying reference under 35 U.S.C. 102(e).....	706.02(f)(1)	Supervisory (See Supervisory patent examiner)	
		Telephoning attorney .....	408, 1302.14
		Testimony as patent expert .....	1701.01
		Time and Activity Report .....	1704, 1705
		Time reporting for <i>ex parte</i> reexamination.....	2238

MANUAL OF PATENT EXAMINING PROCEDURE  
 Examiner docket, time, and activity recording--Examiner's letter

	Sec. No.		Sec. No.
Time reporting for <i>inter partes</i> reexamination.....	2638	Reply brief.....	1208.03
Treatment of protest.....	1901.06	Special status.....	708.01
Examiner docket, time, and activity recording....	1704, 1705	Examiner's letter (See also Action) .....	707
Examiner Reissue Guide and Checklist .....	1443	Abandonment .....	711.02
Examiner's action (See also Action; Letter, Examiner's) .....	707	Advisory action .....	706.07(f), 714.13
Examiner's amendment.....	1302.04	Amendment after final rejection.....	714.13
Abstract changed by.....	608.01(b), 1302.01, 1302.04	Arguments answered .....	707.07(f)
By initialing.....	1302.04	Cancellation of nonelected claim.....	821.01, 821.02
Claim, antecedent basis in description .....	608.01(o)	Claim allowable except as to form .....	707.07(a)
Claim lost in interference, canceled .....	2363.03	.....	707.07(j), 710.02(b), 714.15
Claim, nonstatutory, canceled .....	1302.04(b)	Claim summary .....	707.07(i)
Claim, numbers identifying.....	1302.01, 1302.04(g)	Complete and clear .....	707.07
Claims, nonelected invention, canceled ...	821.01, 821.02	Copies of references .....	707.05(a)
Coping application data brought up to date .....	201.11, 1302.01	Copy to applicant.....	707.12
Defensive publication.....	711.06	Correction, period for reply .....	707.05(g), 710.06
Deposit account charge .....	1302.04	Correction of citation.....	707.05(g)
Drawing correction.....	608.02(w), 1302.04	Date stamped .....	707.11
Extension of time required for .....	706.07(f)	Decisions, cited.....	707.06
Formal matters .....	1302.01, 1302.04	Drafting criticism in first Office action .....	608.02(a)
IFW applications .....	1302.01, 1302.04, 1302.04(f)	.....	707.07(c)
Informalities corrected .....	1302.04	Election of species required, concluding paragraph .....	809.02(a), 809.02(b)
No new matter.....	608.01(o)	Examiner signature at end of letter .....	707.09
Patented coping application data .....	1302.04(f)	Examiner's amendments.....	706.07(f), 1302.04
Plant patent application practice.....	1610	File wrapper entry.....	707.10, 719.01
Reexamination		Final rejection, clearly stated.....	706.07
<i>Ex parte</i> .....	2287	Final rejection, concluding statement .....	706.07
<i>Inter partes</i>		Final rejection, patentability report.....	705.01(a)
Canceling rejected claims .....	2671, 2687	First action, includes drafting comments .....	608.02(a)
Correcting formal matters.....	2687, 2687.01	.....	707.07(c)
In merged reissue/reexamination .....	2686.03	Formal matters....	707.07(a), 707.07(e), 707.07(j), 714.02
Not permitted if approval required .....	2687.01	Full anticipation, expressions used ..	706.02(c), 706.07(d)
To the Title .....	2660.02, 2686.03, 2687	Informal application .....	702.01
Reference citation corrected.....	707.05(g)	Initialed by examiner .....	707.08
Title of application .....	606.01	Interference notice to patentee.....	2307.06
Examiner's Answer		Language in rejecting .....	707.07(d)
Appeal brief.....	1208	Mailing .....	707.12
Appeal conference not held.....	1003, 1208	Memorandum cited.....	707.06
Counted as a disposal .....	1705	New drawing required .....	608.02(b)
New ground of rejection prohibited .....	1208.01	New examiner, primary examiner indicates .....	707.01
New interpretation of law.....	1208	Notices cited .....	707.06
TV Director's attention required .....	1003	Numbering of paragraphs .....	707.07(k)
Print of drawing.....	1204	Omnibus rejection.....	707.07(d)
Reexamination		Orders cited .....	707.06
<i>Ex parte</i> .....	2275	Outstanding requirements.....	707.07(e)
<i>Inter partes</i> .....	2677	Personal matter excluded.....	707.07(d)
		Piecemeal prosecution .....	707.07(g)

INDEX

Examiner's search facilities, use regulations--Extension of time

	Sec. No.		Sec. No.
Power of attorney invalid or lacking .....	402	Heir .....	409.01, 409.01(a), 409.01(b), 409.01(d)
Preliminary amendment in new case .....	709, 714.01(e)	Intervention not required .....	409.01(f)
.....	714.03(a)	Joint inventors, inventor dies .....	409.01(f)
Primary examiner signs .....	706.07, 707.01, 707.09	Specification form .....	605.05
Primary examiner's attention required, list .....	1004	Exhibit .....	608.03
References, citation .....	707.05 to 707.05(g)	Exhibit, Affidavit under 37 CFR 1.131 ....	715.07, 715.07(d)
.....	901.04, 901.05(a)	Exhibit at interview .....	713.08
Refusing entry of amendment after Board decision		Exhibit, handling .....	608.03(a)
.....	1214.07	<i>Ex parte</i> questions .....	713.06
Rejection of claim corresponding to claim of patent		Expedited Right of Appeal Notice .....	2671, 2673.02
.....	2307.02	Experimental use (See also Public use) .....	2133.03
Remailing .....	707.13, 710.06	.....	2133.03(e)
Requirement for information .....	706.02(c)	Commercial exploitation .....	2133.03(e)(1)
Restriction requirement .....	803, 817	Completeness of the invention .....	2133.03(e)(3)
Returned .....	707.13	Factors indicative of .....	2133.03(e)(4), 2133.03(e)(5)
Reviewed by examiner .....	707.08	Intent to experiment .....	2133.03(e)(2)
Shortened time for reply .....	710.02	Reduction to practice .....	2133.03(e)(3)
Signature .....	707.09, 707.10, 1302.13	Testing by third party .....	2133.03(e)(5), 2133.03(e)(7)
Statement of rejection .....	707.07(d)	Testing, developmental .....	2133.03(e)(6)
Status letter reply .....	203.08	When experimental use ends .....	2133.03(e)(3)
Statutory basis .....	707.07(d)	Expert testimony .....	1504.03
Summary .....	707.07(i)	Expiration date of patent (See also Term, Patent)	
Supplemental .....	710.06	Adjustment under 35 U.S.C. 154 .....	2710, 2720, 2730
Undelivered .....	707.13	Design .....	1502.01, 1505
Examiner's search facilities, use regulations .....	510	Extension under 35 U.S.C. 156 .....	2750 to 2764
Example, Comments on .....	707.07(l)	Plant .....	2701
Example, Operative .....	608.01(p), 2164.02	Utility .....	2701
Example, Prophetic, simulated or predicted .....	608.01(p)	Export control of patent applications .....	120
Excess number of claims for fee, after notice of allowance		Exposure of papers during interviews .....	101, 713.07
.....	714.16(c)	Expounding patent law .....	713.02
Excess number of claims for filing fee .....	714.10	Express abandonment .....	711, 711.01
Excluded attorney or agent .....	105, 407, 713.05, 714.19	To avoid publication of application .....	711.01, 1125
Execution of oath .....	604, 605.04(a)	Express Mail deposit .....	513
Executive Order		Express Mail Procedure in <i>ex parte</i> reexamination .....	2224
No. 5464 .....	1608	Express Mail Procedure in <i>inter partes</i> reexamination	
No. 9424 .....	302, 302.06, 302.08	.....	2624, 2665, 2666, 2666.05
No. 10,096 .....	509.02	Express Mail service .....	502, 506.02, 511, 513, 711.03(c)
No. 10,358 .....	710.05	.....	1216.01, 2510
No. 12,598 .....	115, 120, 121	Expunge information in application file .....	724.05
No. 13,292 .....	115, 121	.....	724.06, 1002.02(b), 1002.02(c)
Executor or administrator .....	409.01, 605.05	Extension of shortened reply period .....	710.02(e)
Allowance and issue .....	409.01(f)	Extension of time .....	706.07(f), 710.02(e)
Application by, after discharge .....	409.01(c)	.....	1002.02(c)
Assigned application, inventor dies .....	409.01(e)	For filing brief .....	1206, 1208.01, 1215.04
Authority .....	409.01(b)	For filing continuing application .....	201.06(c)
Consular certificate .....	409.01(b)	General fee authorization .....	710.02(e)
Foreign country .....	409.01(b), 409.01(d)		

MANUAL OF PATENT EXAMINING PROCEDURE  
Extension, patent term--Fee

	Sec. No.		Sec. No.
Reexamination		Prior art effective date .....	706.02(a)
<i>Ex parte</i> .....	1002.02(c), 2265	Provisional application copendency .....	201.04(b)
<i>Inter partes</i> .....	2648, 2665, 2672, 2682	PTO business hours .....	510
Request .....	710.02(e), 1002.02(c)	Reply period .....	710.05
Extension, patent term (See Term, Patent)		Statutory bar .....	2133
Extraordinary situations		Statutory period .....	710.01(a)
Abandonment, revival .....	711.03(c)	Unscheduled closings .....	201.13
Deferring issue .....	1306.01	Federal license rights .....	310
Interview after issue .....	713.10	Federal Rules of Civil Procedure	
Reexamination, <i>ex parte</i> .....	2274	Rule 8(b) cited .....	410
Reply period reset .....	710.06	Rule 11(b)	
Suspension of rules .....	1002	Cited .....	402
Time to file .....	1206	Reproduced .....	410
Withdrawal from issue .....	711.01	Federal Rules of Evidence .....	2301.02, 2308
		Federal Telecommunications System .....	408, 713.01
		Fee (See also Refunds)	
<b>F</b>		Address .....	2540
Facsimile transmission		Appeal .....	1205, 1208.02
Assignment documents .....	302.09, 502.01	Assignment recording .....	302.06
Central Number .....	502, 502.01	Credit card payment of .....	509, 706.07(f)
Correspondence .....	502.01	Current amounts available on USPTO web site .....	509
Declaration or oath .....	502.01	.....	1730
PCT international application .....	1805, 1834.01	Examiner's amendment .....	706.07(f)
.....	1865, 1893.01(a)(1)	Extensions of time .....	706.07(f)
Maintenance fees .....	2510	Filing .....	509, 607
Permitted types of correspondence .....	502.01	Claims in excess of .....	607, 714.10
Prohibited types of correspondence .....	502.01	Dependent claims .....	608.01(n)
Reexamination		Deposit account .....	509.01
<i>Ex parte</i> .....	2224	Disclosure Document .....	1706
<i>Inter partes</i> .....	2624	Inadequate .....	506
Secrecy order application, not permitted .....	120, 502.01	International application .....	1810, 1827
Federal Circuit (See Court of Appeals for the Federal Circuit (CAFC))		Nonprovisional application .....	601.01(a)
Federal holiday		Provisional application .....	601.01(b)
Abandonment date .....	711.03(c)	Reduction for small entities .....	509.02
Appeal brief .....	1206, 2274	Reexamination	
Civil action .....	1216	<i>Ex parte</i> .....	2215
Continuity between applications .....	201.11	<i>Inter partes</i> .....	2615
Effect on reference .....	706.02(a)	Reissue .....	1415
Effect on Express Mail service .....	513	Return .....	503, 607.02
Filing date .....	502, 502.01, 505, 512, 513	Small entity .....	509.03
Foreign application copendency .....	201.13	Issue (See Issue fee)	
Foreign patent .....	2135, 2135.01	Maintenance (See Maintenance fees)	
Maintenance fees .....	2504, 2506	Payment .....	509
Papers not received .....	502	Petition to revive .....	711.03(c)
Period for reply ending on .....	505, 710.05	Publication fee .....	1126, 1133, 1303, 1306, 1306.03

INDEX  
Field of search--Final rejection

Sec. No.	Sec. No.
Reduction of basic fee for international applications containing large sequence listings and/or tables ..... 1823.02	Signing and dating by primary examiner..... 1302.13
Reduction for small entities..... 509.02	Statutory period ends on nonworking day ..... 710.05
Field of search..... 708.03, 904, 904.02, 904.02(a), 1701	Files Repository..... 711.04(b)
Notation in file..... 719.05, 904	Filing date..... 201.06(c), 502, 503, 505, 506, 506.02
Field of search, notation by examiner ..... 705.01(a)	Continued prosecution application (CPA)..... 201.06(d)
..... 719.05, 904, 904.02(a)	Effective, prior application ..... 201.11, 706.02, 2133.01
Figures (See Drawings)	Express Mailing date ..... 506.02, 513
File Information Unit (Record Room)..... 102, 103	Foreign application, Convention date (See also Foreign application) ..... 201.13, 201.15
..... 508.03, 711.04, 711.06	International application ..... 1810
File wrapper/history (See also Image File Wrapper (IFW))	Later filed application as disclosure ..... 608.01(p)
..... 719	Patent Cooperation Treaty (PCT) ..... 1810
Action entered..... 707.10	Petition..... 506.02, 513, 601.01(b), 601.01(c)
Allowed case data entered..... 1302.09	..... 601.01(f), 601.01(g)
Amendment endorsed..... 710.05, 714.18	Refusal to accord ..... 506.02
Arrangement of papers ..... 719.01(a)	Review of refusal to accord ..... 506.02
Assignment endorsement ..... 303	Subsequent publication as disclosure ..... 608.01(p)
Civil action..... 1216.02	Filing date of reexamination request
Classification data ..... 719.03	<i>Ex parte</i> ..... 2215
Classification history..... 719.03	<i>Inter partes</i> ..... 2627, 2628
Completeness ..... 724.01	Filing fee (See also Fee; Refunds)..... 607
“Contents”, Entry in ..... 719.01	Claims in excess of ..... 714.10
Continuation, Former Rule 1.62 (FWC)	Continued prosecution application (CPA)..... 201.06(d)
Public access ..... 103	Of a reissue application..... 1415
Restriction ..... 819	Deposit account ..... 509.01
Correction of error..... 719.02	Inadequate..... 506
Data entered on ..... 710.05, 719.02, 1302.09	Reduction for small entities..... 509.02
Field of search..... 719.05	Reexamination
Field of search, patentability report..... 705.01(a)	<i>Ex parte</i> ..... 2215
Foreign application cross-noting..... 202.03	<i>Inter partes</i> ..... 2615
..... 1893.03(c), 1895.01	Reissue application ..... 1415
Foreign filing date entered on ..... 719.06, 1302.06	Return ..... 503, 607.02
Index of claims..... 719.04	Filing receipt (See also Postcard, self-addressed)..... 201.03
Interference notation ..... 2301.01(b)	..... 503
Licensing and Review stamp..... 140	Final action (See Final rejection)
Name of applicant changed ..... 719.02(b)	Final Board decision in <i>inter partes</i> reexamination ..... 2681, 2682
Notes to application of another party ..... 101	Final data capture..... 1309
Papers in ..... 719.01	Final rejection..... 706.07
Parent application notation on..... 202.02, 1302.09	Amendment after ..... 714.12, 714.13
Print of drawing..... 719.01(b)	Amendment after, entered in part ..... 714.20
Printout of search history ..... 719.05	First action ..... 706.07(b)
Relation of application noted on ..... 202.02, 719.07	Interview..... 713.09
Residence changed ..... 719.02(b)	Letter ..... 706.07
Return of paper entered on..... 719.01	Patentability report ..... 705.01(a)
“Searched” box entries ..... 719.05	Petition to vacate ..... 1002.02(c)
“Searched notes” box entries..... 719.05	Premature..... 706.07(c)

MANUAL OF PATENT EXAMINING PROCEDURE  
Final restriction requirement--Foreign language

	Sec. No.		Sec. No.
Premature, Withdrawal of .....	706.07(d)	English language translation for benefit of date .....	201.15, 706.02
Primary examiner's attention required .....	1004	<i>Ex parte</i> reexamination to perfect priority .....	2258
Request for continued examination (RCE).....	706.07(h)	Filed more than a year before U.S. application .....	201.14(c)
Reexamination, <i>ex parte</i> .....	2271	Filing in foreign country .....	140
Reexamination, <i>inter partes</i> (See Action: Closing Prosecution in <i>inter partes</i> reexamination)		First.....	201.13
Secrecy order application .....	130	German design applications.....	201.14(b)
Special.....	708.01	Great Britain .....	201.15
Time for reply .....	706.07(f)	Identification.....	201.14(d)
Transitional procedure .....	706.07(g)	Incorporation by reference in U.S. application.....	201.13
When proper.....	706.07, 706.07(a), 706.07(b)	<i>Inter partes</i> reexamination to perfect priority.....	2658
Withdrawal.....	706.07(e)	License to file .....	140, 706.03(s)
Withdrawal, Primary examiner's attention.....	1004, 1005	Listed on oath/declaration.....	201.14, 602
Withdrawal of premature .....	706.07(d)	No claim for priority.....	201.14(c)
Withdrawal prior to hearing on appeal.....	1208.02	No reference made in declaration .....	201.14(c)
Final restriction requirement .....	818.03	Notice to Office after nonpublication request.....	1124
First action final rejection .....	706.07(b)	Noting earliest date in file history/wrapper .....	202.03
First Office action form.....	707	Ordering copies .....	901.05(c)
First action on the merits (FAOM) (See Letter, Examiner's)		Overcoming reference which is .....	201.15, 715
Fissionable material .....	706.03(b)	Prior art cited in related .....	2001.06(a)
Five year pendency .....	707.02, 708.01	Priority .....	102, 201.13, 706.02
Flowchart for		Papers not filed .....	201.14(c)
Effective date under 35 U.S.C. 102(e) .....	706.02(f)(1)	Petition for unintentionally delayed claim for priority .....	201.14, 201.14(a), 201.16
Examination of computer-related inventions .....	2106	.....	1002.02(b), 1402, 2258, 2658
Genus-Species guidelines.....	2144.08	Priority document in parent application.....	201.14(b)
Prior art citation in a patent.....	2206	Reissue application claiming foreign priority .....	1402, 1417
Reexamination provisions, <i>ex parte</i> .....	2201	Ribboned.....	602.04(a)
Reexamination provisions, <i>inter partes</i> .....	2601.01	Same invention .....	201.15
Transitional after-final procedures (37 CFR 1.129(a) .....	706.07(g)	Seal .....	602.04(a)
Treatment of applications having conflicting claims .	804	Statutory bar .....	201.13, 706.02(e), 2135.01
Flow sheet .....	608.02	Time limits to submission.....	201.14, 201.14(a)
FOIA (See Freedom of Information Act (FOIA))		Certificate of correction .....	201.16
Font, type .....	608.01, 1504.01(a)	Reissue .....	201.14, 201.14(b), 201.16
Foreclosure (See Assignment: Security interests)		Translation required.....	706.02, 201.15
Foreign application (See also International application)		Foreign countries recognized for priority .....	201.13
As prior art .....	706.02, 2127	Foreign executed oath.....	602.04
Certificate of correction to perfect priority .....	201.16, 1481	Foreign filing, Proving priority.....	201.14, 706.02
Certified copy to avoid reference .....	201.14, 706.02	Foreign filing date	
Certified copy not filed .....	201.14(c)	Entitled to .....	201.13, 719.06
Cross-noting on file wrapper/history.....	202.03	On file wrapper/history.....	202.03
Date entitled to .....	201.13 to 201.15	Foreign filing license .....	115, 140
Design patents.....	1504.02, 1504.10	For PCT .....	115, 1832
Determination of priority .....	201.14, 201.15	Foreign language	
Disclosure.....	201.15	Application .....	608.01
Duty of disclosure of information cited .....	2001.06(a)		

INDEX  
Foreign patent--Form letters and forms

	Sec. No.		Sec. No.
Names for months .....	901.05(a)	Form letters and forms	
Names for United States .....	901.05(a)	Abandonment .....	711.04(c)
Oath or declaration .....	602.06	Action Closing Prosecution PTOL-2065 .....	2671.02, 2696
Foreign patent		Advisory Action .....	706.07(f), 714.13
Art collection .....	901.07	Advisory Action – <i>Ex Parte</i> Reexamination PTOL-467 .....	2265, 2296
Citation .....	707.05(e), 901.05(a)	Allowability .....	1302.03
Citation dates and information .....	901.05(a)	Amendment received after allowance .....	608.02(z)
.....	901.05(b), 1851	.....	714.16(d), 714.16(e), 2307.03
Classification .....	903, 903.03	Amendment after Board decision, refused entry .....	1214.07
Country codes .....	1851	Amendment not entered .....	714.22
Database search .....	706.02(e)	Amendment not fully responsive .....	714.03
Document citation, in PCT .....	1851	Amendment unsigned .....	714.01(a)
Duplicates .....	903.03	Certificate of Correction form PTO/SB/44 or PTO 1050 .....	1480, 1480.01, 1485
Effective date .....	901.05(b)	Certificate under 37 CFR 3.73(b) PTO/SB/96 .....	324
Family of (INPADOC) .....	901.06(a)	Change of Correspondence Address, Application .....	
In prior art statement .....	609	PTO/SB/122 .....	403, 2542
Individual country overview .....	901.05	Change of Correspondence Address, Patent PTO/SB/123 .....	403, 2542
Journals .....	901.06(a)	Compact disc transmittal sheet for submission of .....	
Law overview .....	901.05	sequence listing and/or tables to the United States .....	
Library .....	901.06(a)	Receiving Office under PCT Administrative .....	
Listing at allowance .....	1302.12	Instructions-Part 8 .....	1823.02
Oppositions .....	901.05	Correspondence Address Indication PTO/SB/121 .....	403
Ordering copies .....	901.05(c)	Cover sheet, assignment document .....	302.07
Print of, where obtained .....	901.05(c)	Cover sheet, provisional application .....	
Reference .....	706.02, 901.05	Cited .....	201.04(b), 601
Statutory bar .....	201.13, 706.03(s)	Reproduced .....	201.04(b)
Transfer .....	903.05	Credit Card Payment Form PTO-2038 .....	
Translation of .....	706.02, 901.05(d)	Cited .....	509, 1302.04, 1306, 2510
Unlicensed, same applicant .....	706.03(s)	Reproduced .....	509
Foreign priority (See also Foreign application)		D-10 .....	130, 1304.01
.....	201.13 to 201.16	D-11 .....	1103
Design patent applications .....	201.14(b)	DD Form 441 .....	120
.....	1504.02, 1504.10	Death of Attorney, Application ready for allowance .....	406
U.S. filing date computed .....	201.13, 706.02, 2136.03	Declaration for Plant Patent Application PTO/SB/03 .....	1604
Formal matter		Declaration for Utility or Design Patent Application .....	
Allowance and issue .....	1302.01, 1302.02, 1302.04	PTO/SB/01 .....	602
Amendment of application in issue .....	714.16	Disclaimer in Patent PTO/SB/43 .....	1490
Claim allowable except for .....	706, 707.07(j)	Disclosure Document Request PTO/SB/95 .....	1706
Review of action involving .....	Introduction	Election of species .....	809.02(a)
Right of priority		Examiner Checklist – Reexamination .....	
Prior foreign application .....	201.13 to 201.16	PTOL-1516 .....	2296, 2687, 2696
.....	1402, 1417	Examiner’s action PTOL-326 .....	707
Prior U.S. application .....	201.11, 1405	Examiner’s answer .....	1208
Specification format .....	608.01		
When taken up .....	707.07(a), 707.07(e)		
.....	707.07(j), 714.02		
Former examiner restrictions .....	1702		



MANUAL OF PATENT EXAMINING PROCEDURE  
Form letters and forms--Form letters and forms

Sec. No.	Sec. No.
Examiner's Biweekly Time Worksheet PTO-690E ..... 1704, 2238, 2638	Issue Classification (Blue slip) PTO-270 Cited..... 903.07, 903.07(b), 903.09 ..... 1107, 1302.10, 1455, 1611
Examiner's Case Action Worksheet PTO-1472..... 1705	Digests ..... 903.07
Examiner's Order - Cross References for Search Files PTO-14B ..... 903.06	Initialing..... 903.07(b)
Examiner's Order for Replacement Copy PTO-14C ..... 901.09	Reproduced ..... 903.09
Fee Address Indication PTO/SB/47	Issue Classification, Designs PTO-328 ..... 903.07 ..... 903.09(a), 1107, 2287
Cited ..... 2540, 2595	Issue Classification Sheet ..... 1302.09, 1302.10, 1302.13
Reproduced ..... 2595	Issue Fee Transmittal PTOL-85B ..... 307, 324 ..... 512, 1306.01 ..... 1306.02, 1309, 1481
Final rejection ..... 706.07	Maintenance Fee Transmittal PTO/SB/45 Cited..... 2515, 2595 Reproduced..... 2595
For Design Applications Only: Continued Prosecution Application (CPA) Request Transmittal PTO/SB/29 ..... 201.06(d)	Nonpublication Request Under 35 USC 122(b)(2)(B)(i) PTO/SB/35 Cited..... 1121, 1122, 1135 Reproduced ..... 1135
For Design Applications Only: Receipt For Facsimile Transmitted CPA PTO/SB/29A ..... 201.06(d)	Note to SPRE/Examiner/TC Personnel of <i>Inter Partes</i> Reexamination Deadlines PTOL-2061 ..... 2696
45-day Letter ..... 150	Notice of Abandonment PTOL-1432..... 711.04(c)
General Office Action, <i>Ex Parte</i> Reexamination PTOL-466 ..... 2262, 2296	Notice of Abandonment under 37CFR 1.53(f) (CPA) For Design Applications PTO-2019 ..... 201.06(d)
General ( <i>Ex Parte</i> ) Reexam Communication PTOL-473 (with SSP) ..... 2250, 2266.03, 2296	Notice of Allowability PTOL-37..... 602.03, 608.02(b) ..... 608.02(z), 609, 710.02(e), 714.13 ..... 714.16(d), 812.01, 1205, 1207 ..... 1302.03, 1302.04, 1455
Incorrect citation of references, Correction..... 707.05(g)	Notice of Allowance and Issue Fee Due PTOL-85 ..... 115, 203.07, 203.08, 406, 509.03, 602.03 ..... 608.02(b), 609, 708.02, 710.02(e) ..... 711.01, 711.02, 711.03(c), 711.06 ..... 714.15, 714.16, 714.16(a), 714.16(d) ..... 804, 1126, 1303, 1303.03, 1304.01 ..... 1305, 1306, 1306.02, 1306.03, 1308 ..... 1308.01, 1308.03, 1309, 1512, 2001.04 ..... 2307.03, 2364, 2406, 2411, 2411.03, 2575
Information disclosure statement (IDS) PTO/SB/08 Cited ..... 609, 1893.03(g), 1901.03, 2001.04 ..... 2003, 2004, 2214, 2258.01, 2280 ..... 2287, 2614, 2687, 2690	Undelivered..... 1303.02
Reproduced..... 609	Notice of allowance, Secrecy order applications D-10..... 130, 1304, 1304.01
Interference Initial Memorandum ..... 2309.02	Notice of Appeal from the Examiner to the Board of Patent Appeals and Interferences PTO/SB/31 ..... 1205, 2273
Interfering Subject Matter, Secrecy order applications ..... 2309.06	Notice of Assignment of <i>Inter Partes</i> Reexamination PTOL-2060..... 2696
International application transmittal (PTO-1382) ..... 1830, 1832	
<i>Inter Partes</i> Reexamination Communication (With SSP) PTOL-2071 ..... 2696	
<i>Inter Partes</i> Reexamination Communication (Without SSP) PTOL-2072 ..... 2696	
<i>Inter Partes</i> Reexamination Notification Re Appeal PTOL-2067 ..... 2662, 2674, 2696	
<i>Inter Partes</i> Reexamination Transmittal PTOL-2070 ..... 2664, 2670, 2677, 2686.01, 2696	
Interview Request, Applicant Initiated PTOL-413A ..... 713.01	
Interview Summary, Examiner Initiated PTOL-413B ..... 713.04, 714.13	
Interview Summary PTOL-474, Reexamination ..... 2281, 2296	

INDEX  
Form letters and forms--Form letters and forms

Sec. No.	Sec. No.
Notice of Concurrent Proceedings – <i>Inter Partes</i> Reexamination PTOL-2062 ..... 2696	Notice of Omitted Items in a Nonprovisional Application PTO-1669 ..... 201.06(c), 601.01(d) ..... 601.01(g), 2731, 2732
Notice of Defective Paper – <i>Ex Parte</i> Reexamination PTOL-475 ..... 2250, 2266.02, 2266.03 ..... 2272, 2273, 2295, 2296	Notice of Overpayment of Patent Maintenance Fee, PTO-211 ..... 2550
Notice of Defective Paper – <i>Inter Partes</i> Reexamination PTOL-2069 ..... 2666, 2666.06, 2666.50 ..... 2666.60, 2671, 2696	Notice of Recordation ..... 302.09
Notice of Draftsperson’s Patent Drawing Review PTO-948 ..... 608.02(b), 608.02(h) ..... 707, 707.07(a)	Notice of References Cited PTO-892 ..... 707, 707.05(a) ..... 707.05(c), 707.05(d), 707.05(e) ..... 2687, 2690
Notice of Failure to Comply with <i>Inter Partes</i> Reexamination Request Fee Requirements PTOL-2057 ..... 2696	Notice of Special Acceptance of Patent Maintenance Fee, PTO-2143 ..... 2530
Notice of Improper CPA (or FWC) Filing For Utility or Plant Applications Filed Before June 8, 1995 PTO- 2011 Reproduced ..... 201.06(d)	Notice of Statutory Invention Registration (SIR) Acceptance, SIR-N (Form D-11) ..... 1103
Notice of Improper CPA For Design Applications PTO- 2012 Reproduced ..... 201.06(d)	Notice of Withdrawal from Issue under 37 CFR 1.313(b) ..... 1308
Notice of Improper Request for Continued Examination (RCE) PTO-2051 ..... 706.07(h)	Notice re Appeal and re Defective Brief – <i>Ex Parte</i> Reexamination PTOL-468 ..... 2273, 2274, 2296
Notice of Incomplete Nonprovisional Application PTO-1123 ..... 506, 601.01(d), 601.01(e), 601.01(f) ..... 601.01(g), 2731, 2732	Notice to Comply With Requirements Applications For Patent Containing Nucleotide Sequence and/or Amino Acid Sequence Disclosures PTO-1661 ..... 2427.01, 2427.02, 2731, 2732
Notice of Incomplete Reply (CPA) for Design Applications PTO-2018 Reproduced ..... 201.06(d)	Notice To File Missing Parts of Application ..... 201.03 ..... 601.01(a), 607, 710.02(d), 2731, 2732
Notice of Incomplete Request for <i>Inter Partes</i> Reexamination PTO-2059 ..... 2696	CPA for Design Applications PTO-2021 Reproduced ..... 201.06(d)
Notice of Intent to Issue <i>Ex Parte</i> Reexamination Certificate (NIRC) PTOL-469 ..... 2235, 2250 ..... 2250.01, 2271, 2271.01 ..... 2273, 2287, 2288, 2296	Notification of Non-Compliance with 37 CFR 1.192(c) PTO-462 ..... 1206
Notice of Intent to Issue <i>Inter Partes</i> Reexamination Certificate (NIRC) PTOL-2068 ..... 2666.10, 2666.20 ..... 2671, 2671.01, 2673.01 ..... 2674, 2675, 2682, 2686.01, 2687, 2696	Notification of Non-Compliance with 37 CFR 1.192(c) – PTOL-462 ..... 1206, 2296
Notice of Intent to Publish Statutory Invention Registration SIR-L ..... 1107	Office Action – <i>Ex Parte</i> Reexamination PTOL-466 ..... 2262, 2296
Notice of <i>Inter Partes</i> Reexamination Request Filing Date PTOL-2058 ..... 2696	Office Action - <i>Inter Partes</i> Reexamination PTOL-2064 Cited ..... 2647.02, 2660, 2696 Reproduced ..... 2660
Notice of Non-Acceptance of Patent Maintenance Fee, PTO-2142 ..... 2531	Office Action Summary PTOL-326 ..... 608.02(h)
Notice of Non-Acceptance of Small Entity Patent Maintenance Fee, PTO-2140 ..... 2531, 2550	Order Granting/Denying Request for <i>Ex Parte</i> Reexamination PTOL-471 ..... 2296
Notice of Non-Compliant Amendment ..... 714.01(e) ..... 714.03, 714.22	Order Granting/Denying Request for <i>Inter Partes</i> Reexamination PTOL 2063 Cited ..... 2646, 2647.01, 2647.02, 2696 Reproduced ..... 2647.01
Notice of Non-Recordation ..... 302.09	PCT forms (See Patent Cooperation Treaty (PCT)) Petition for express abandonment to Avoid Publication under 37 CFR 1.138(c) Reproduced ..... 1135



INDEX  
Form letters and forms--Form letters and forms

	Sec. No.		Sec. No.
PTOL-303 .....	706.07(f), 708.02	PTOL-2068 .....	2666.10, 2666.20, 2671, 2671.01
.....	711.03(c), 714.13	.....	2673.01, 2674, 2675, 2682, 2686.01, 2687, 2696
PTOL-319 .....	714.03	PTOL-2069	
PTOL-326		Cited .....	2666, 2666.06, 2666.50
Cited .....	201.14(b), 201.14(c)	.....	2666.60, 2671, 2696
.....	608.02(h), 609, 706.07	Reproduced .....	2666.50
.....	707, 710.02(b), 812.01	PTOL 2070 .....	2664, 2670, 2677, 2686.01, 2696
Reproduced .....	707	PTOL-2071 .....	2666.06, 2696
PTOL-404 .....	1485	PTOL-2072 .....	2696
PTOL-413 .....	713.04, 714.13, 1902	PTO/SB/01 Reproduced .....	602
PTOL-461 .....	1215.04	PTO/SB/03 .....	1604
PTOL-462 .....	1206, 2296	PTO/SB/06 .....	608.01(n)
PTOL-462R .....	2274	PTO/SB/07 .....	608.01(n)
PTOL-465 .....	2262, 2264, 2283, 2296	PTO/SB/08 (See also Form letters and forms: PTO-	
PTOL-466 .....	2262, 2296	1449) .....	608.01, 609, 707.05(d), 1302.12
PTOL-467 .....	2250, 2266.02, 2272, 2296	PTO/SB/08A	
PTOL-468 .....	2273, 2274, 2296	Cited .....	609, 2257, 2657, 2687
PTOL-469 .....	2235, 2250	Reproduced .....	609
.....	2250.01, 2271, 2271.01	PTO/SB/08B	
.....	2273, 2287, 2288, 2296	Cited .....	609, 2257, 2657, 2687
PTOL-471 .....	2296	Reproduced .....	609
PTOL-473 .....	2250, 2266.03, 2296	PTO/SB/16 .....	201.04(b)
PTOL-474 .....	2281, 2296	PTO/SB/24 .....	711.01
PTOL-475 .....	2250, 2266.02, 2266.03, 2272	PTO/SB/24A	
.....	2273, 2295, 2296	Cited .....	711.01, 1125, 1135
PTOL-476 .....	2687, 2696	Reproduced .....	711.01, 1135
PTOL-501 .....	2633, 2647.02	PTO/SB/25 .....	1490
PTOL-1432 .....	711.01, 711.02	PTO/SB/26 .....	1490
.....	711.04(c)	PTO/SB/27 .....	1504.30
PTOL-1516 .....	2296, 2687, 2696	PTO/SB/29	
PTOL-1517 .....	2296, 2687, 2696	Cited .....	201.06(d), 709
PTOL-2057 .....	2696	Reproduced .....	201.06(d)
PTOL-2058 .....	2696	PTO/SB/29A Reproduced .....	201.06(d)
PTOL-2059 .....	2696	PTO/SB/30 Reproduced .....	706.07(h)
PTOL-2060 .....	2696	PTO/SB/31 .....	1205
PTOL-2061 .....	2696	PTO/SB/35	
PTOL-2062 .....	2696	Cited .....	1121, 1122, 1135
PTOL-2063		Reproduced .....	1135
Cited .....	2646, 2647.01, 2647.02	PTO/SB/36	
Reproduced .....	2647.01	Cited .....	1123, 1124, 1135
PTOL-2064		Reproduced .....	1135
Cited .....	2647.02, 2660	PTO/SB/37 .....	709
Reproduced .....	2660	PTO/SB/42 .....	2257, 2262, 2657, 2687
PTOL-2065 .....	2671.02, 2696	PTO/SB/43 Reproduced .....	1490
PTOL-2066 .....	2673.02, 2696		
PTOL-2067 .....	2662, 2674, 2696		

MANUAL OF PATENT EXAMINING PROCEDURE  
Form letters and forms--Form letters and forms

	Sec. No.		Sec. No.
PTO/SB/44		PTO/SB/125	
Cited .....	1480, 1480.01, 1485	Cited .....	403, 2540
Reproduced .....	1485	Reproduced .....	403
PTO/SB/45		Reasons for Patentability and/or Confirmation	
Cited .....	2515, 2595	PTOL 476 .....	2687, 2696
Reproduced .....	2595	Recordation Form Cover Sheet PTO-1595 .....	302.07
PTO/SB/47		Reexamination and processing forms listed ...	2296, 2696
Cited .....	2540, 2595	Reexamination Clerk Checklist	
Reproduced .....	2595	PTOL-1517 .....	2296, 2687, 2696
PTO/SB/50 Reproduced .....	1410	Reissue Application	
PTO/SB/51		Declaration by the Assignee (See Form letters and	
Cited .....	1410.01, 1414	forms: PTO/SB/52) .....	1410.01
Reproduced .....	1414	Declaration by the Inventor (See Form letters and	
PTO/SB/51S Reproduced .....	1414.01	forms: PTO/SB/51) .....	1410.01
PTO/SB/52		Fee Transmittal Form (See Form letters and forms:	
Cited .....	1410.01, 1414	PTO/SB/56) .....	1415
Reproduced .....	1414	Statement As To Loss of Original Patent (See Form	
PTO/SB/55 Reproduced .....	1416	letters and forms: PTO/SB/55) .....	1416
PTO/SB/56 Reproduced .....	1415	Supplemental Declaration for Reissue Patent	
PTO/SB/57		Application PTO/SB/51S .....	1414.01
Cited .....	2204, 2214, 2296	Transmittal (See Form letters and forms: PTO/SB/50)	
Reproduced .....	2214	.....	1410
PTO/SB/58		Request for Customer Number PTO/SB/125 .....	403, 2540
Cited .....	2614, 2696	Request for Customer Number Data Change	
Reproduced .....	2614	PTO/SB/124 .....	403
PTO/SB/61 .....	711.03(c)	Request for Deferral of Examination 37 CFR 1.103(d)	
PTO/SB/62 .....	711.03(c)	PTO/SB/37 .....	709
PTO/SB/63 .....	711.03(c)	Request for <i>Ex Parte</i> Reexamination Transmittal	
PTO/SB/64 .....	711.03(c)	PTO/SB/57 .....	2214, 2296
PRO/SB/64a Reproduced .....	1135	Request for <i>Inter Partes</i> Reexamination Transmittal	
PTO/SB/64 PCT .....	711.03(c)	PTO/SB/58	
PTO/SB/67 Cited .....	104	Cited .....	2614, 2696
PTO/SB/68		Reproduced .....	2614
Cited .....	103, 711.04	Request for Statutory Invention Registration PTO/SB/94	
Reproduced .....	103	.....	1101
PTO/SB/81		Request for Withdrawal as Attorney or Agent	
Cited .....	402, 601.02, 1604	PTO/SB/83 .....	402.06, 2623
Reproduced .....	601.02	Rescission of Previous Nonpublication Request (35	
PTO/SB/82 Reproduced .....	2222, 2622	U.S.C. 122(b)(2)(B)(ii) and if Applicable, Notice of	
PTO/SB/83 Reproduced .....	402.06, 2223, 2623	Foreign Filing (35 U.S.C. (b)(B)(iii)) PTO/SB/36	
PTO/SB/94 .....	1101	Cited .....	1123, 1124, 1135
PTO/SB/95 .....	1706	Reproduced .....	1135
PTO/SB/96 .....	324	Response to Rule 1.312 Communication	
PTO/SB/121 .....	403	PTOL-271 .....	714.16(d), 714.16(e), 2307.03
PTO/SB/122 .....	403, 2542	Restriction requirement .....	817
PTO/SB/123 .....	403, 2542	Revocation/Appointment of Power of Attorney or	
PTO/SB/124 .....	403	Authorization of Agent PTO/SB/82 .....	2222, 2622

INDEX  
Form paragraphs (Reproduced)--Form paragraphs (Reproduced)

	Sec. No.			Sec. No.
Right of Appeal Notice PTOL-2066 .....	2673.02, 2696		2.14.01 .....	201.03
SIR-C .....	1103		2.15 .....	201.11
SIR-E .....	1103		2.16 .....	201.11
SIR-F .....	1103		2.17 .....	201.11
SIR-G .....	1103		2.18 .....	201.13
SIR-H .....	1109		2.19 .....	201.15
SIR-I .....	1103		2.20 .....	201.14(b)
SIR J .....	1103		2.21 .....	201.14(c)
SIR-K .....	1109		2.21.01 .....	201.14(a)
SIR-L .....	1107		2.22 .....	201.14(c)
SIR-M .....	1107		2.23 .....	201.14(c)
SIR-N (Form D-11) .....	1103		2.24 .....	201.14(c)
Statements to DOE or NASA .....	151		2.25 .....	201.14(c)
Subject matter admits of illustration .....	608.02(a)		2.26 .....	201.14(c)
Terminal Disclaimer to Accompany Petition			2.27 .....	201.14(c)
PTO/SB/63 .....	711.03(c)		2.28 .....	201.11
Terminal Disclaimer to Obviate a Double Patenting			2.29 .....	201.11
Rejection over a Prior Patent, PTO/SB/25 .....	1490		2.30 .....	201.06(d)
Terminal Disclaimer to Obviate a Provisional Double			2.31 .....	201.06(d)
Patenting Rejection over a Pending Second			2.32 .....	201.06(d)
Application, PTO/SB/25 .....	1490		2.33 .....	201.06(d)
Transmittal of Communication to Third Party Requester			2.34 .....	201.06(d)
– <i>Ex Parte</i> Reexamination – PTOL – 465			2.35 .....	201.06(d)
.....	2262, 2264, 2283, 2296		2.38 .....	201.11
Form paragraphs (Reproduced)			2.39 .....	201.11
2.01 .....	201.06		4.01 .....	403
2.03 .....	201.06(c)		4.02 .....	406
2.05 .....	201.07		4.03 .....	406
2.06 .....	201.08		4.04 .....	406
2.07 .....	201.09		4.06 .....	407
2.08 .....	201.10		4.07 .....	407
2.09 .....	201.11		4.08 .....	407
2.10 .....	201.11		4.09 .....	402
2.11 .....	201.11		4.10 .....	401
2.11.01 .....	201.11		5.01 .....	502
2.12 .....	201.11		5.01.01 .....	501
2.13 .....	201.03		5.02 .....	512
2.13a .....	201.03		5.03 .....	903.08
2.13b .....	201.03		5.04 .....	512
2.13c .....	201.03		6.01 .....	608.01(a)
2.13d .....	201.03		6.02 .....	608.01(a)
2.13e .....	201.03		6.02.01 .....	605.04(a)
2.13f .....	201.03		6.03 .....	602.01
2.13g .....	201.03		6.05 .....	602, 602.03, 605.01
2.13h .....	201.03		6.05.01 .....	602
2.13.01 .....	201.03		6.05.02 .....	605.02
2.14 .....	201.03		6.05.03 .....	605.01

MANUAL OF PATENT EXAMINING PROCEDURE  
Form paragraphs (Reproduced)--Form paragraphs (Reproduced)

	Sec. No.		Sec. No.
6.05.05.....	602.03	6.28.02.....	608.01(q)
6.05.06.....	602.03	6.29.....	608.01
6.05.07.....	602.03	6.30.....	608.01
6.05.08.....	602	6.31.....	608.01
6.05.11.....	604.01	6.32.....	608.01
6.05.12.....	604.01	6.33.....	608.01(m)
6.05.13.....	602.04	6.36.....	608.02(d)
6.05.14.....	602.04(a)	6.36.01.....	608.02(g)
6.05.15.....	602.03	6.37.....	608.02(h)
6.05.16.....	602.01	6.39.....	608.02(p)
6.05.17.....	602	6.40.....	608.02(p)
6.05.18.....	605.04(b)	6.41.....	608.02(p)
6.05.19.....	605.03	6.42.....	608.02(p)
6.05.20.....	602	6.43.....	608.02(p)
6.06.....	604.01	6.46.....	602.03
6.07.....	604.02	6.47.....	608.02(p)
6.08.....	604.04(a)	6.48.....	714.16(d)
6.09.01.....	605.03	6.49.....	609
6.11.....	606.01	6.49.01.....	609
6.11.01.....	606.01	6.49.02.....	609
6.12.....	608.01(b)	6.49.03.....	609
6.13.....	608.01(b)	6.49.05.....	609
6.14.....	608.01(b)	6.49.06.....	609
6.15.....	608.01(b)	6.49.07.....	609
6.16.....	608.01(b)	6.49.08.....	609
6.16.01.....	608.01(b)	6.49.09.....	609
6.17.....	608.01(j)	6.51.....	609
6.18.....	608.01(n)	6.52.....	609
6.18.01.....	608.01(m)	6.53.....	609
6.19.....	608.01(p)	6.54.....	609
6.19.01.....	608.01(p)	6.55.....	609
6.20.....	608.01(v)	6.56.....	610, 1134
6.21.....	608.02(b)	6.57.....	610, 1134
6.22.....	608.02(b)	6.60.01.....	608.05
6.22.01.....	608.02(d)	6.60.02.....	608.05
6.22.02.....	608.02(e)	6.61.01.....	608.05
6.22.03.....	608.02(e)	6.61.02.....	608.05
6.22.04.....	608.02(d)	6.62.....	608.05
6.22.05.....	608.02(f)	6.63.01.....	608.05(b)
6.22.06.....	608.02(e)	6.63.02.....	608.05(b)
6.22.07.....	608.02(e)	6.64.01.....	608.05(a)
6.23.....	608.02	6.64.02.....	608.05(a)
6.23.01.....	608.02	6.64.03.....	608.05(a)
6.24.01.....	608.02	6.70.01.....	608.05
6.26.....	608.02(b)	6.70.02.....	608.05
6.28.....	608.01(q)	6.71.01.....	608.05
6.28.01.....	608.01(q)	6.71.02.....	608.05

INDEX  
Form paragraphs (Reproduced)--Form paragraphs (Reproduced)

	Sec. No.		Sec. No.
6.72.01.....	608.05	7.29.04.....	608.01
6.72.02.....	608.05	7.30.01.....	706.03(c)
6.72.03.....	608.05	7.30.02.....	706.03(d)
6.72.04.....	608.05	7.31.01.....	706.03(c)
6.72.05.....	608.05	7.31.02.....	706.03(c)
7.01.....	702.01	7.31.03.....	706.03(c)
7.02.....	702.01	7.31.04.....	706.03(c)
7.04.....	706.03(a)	7.33.01.....	706.03(c)
7.05.....	706.03(a)	7.34.....	706.03(d)
7.05.01.....	706.03(a)	7.34.01.....	706.03(d)
7.05.02.....	706.03(a)	7.34.02.....	706.03(d)
7.05.03.....	706.03(a)	7.34.03.....	706.03(d)
7.05.04.....	706.03(a)	7.34.04.....	706.03(d)
7.05.05.....	706.03(k)	7.34.05.....	706.03(d)
7.05.06.....	706.03(k)	7.34.06.....	706.03(d)
7.07.....	706.02(i)	7.34.07.....	706.03(d)
7.08.....	706.02(i)	7.34.08.....	706.03(d)
7.09.....	706.02(i)	7.34.09.....	706.03(d)
7.10.....	706.02(i)	7.34.10.....	706.03(d)
7.11.....	706.02(i)	7.34.11.....	706.03(d)
7.12.....	706.02(i)	7.34.12.....	706.03(d)
7.12.01.....	706.02(i)	7.34.13.....	706.03(d)
7.13.....	706.02(i)	7.34.14.....	706.03(d)
7.14.....	706.02(i)	7.34.15.....	706.03(d)
7.15.....	706.02(i), 804.03	7.35.....	706.03(d)
7.15.01.....	706.02(f)(2), 706.02(i), 804.03	7.35.01.....	706.03(d)
7.15.02.....	706.02(i), 804.03	7.36.....	608.01(n)
7.15.03.....	706.02(i)	7.37.....	707.07(f)
7.16.....	706.02(i)	7.37.01.....	707.07(f)
7.17.....	706.02(i)	7.37.02.....	707.07(f)
7.18.....	706.02(i)	7.37.03.....	707.07(f)
7.19.....	706.02(i), 804.03	7.37.04.....	707.07(f)
7.20.....	706.02(m)	7.37.05.....	707.07(f)
7.20.01.....	706.02(m)	7.37.06.....	707.07(f)
7.20.02.....	706.02(m)	7.37.07.....	707.07(f)
7.20.03.....	706.02(m)	7.37.08.....	707.07(f)
7.21.....	706.02(m), 804.03	7.37.09.....	707.07(f)
7.21.01.....	706.02(m), 804.03	7.37.10.....	707.07(f)
7.21.02.....	706.02(m), 804.03	7.37.11.....	707.07(f)
7.22.....	706.02(m)	7.37.12.....	707.07(f)
7.23.....	706.02(m)	7.37.13.....	707.07(f)
7.27.....	706.02(m)	7.38.....	707.07(f)
7.28.....	706.03(o)	7.38.01.....	707.07(f)
7.29.....	608.01	7.38.02.....	707.07(f)
7.29.01.....	608.01(m)	7.39.....	706.07
7.29.02.....	608.01(m)	7.39.01.....	706.07
7.29.03.....	608.01(m)	7.40.....	706.07(a)



MANUAL OF PATENT EXAMINING PROCEDURE  
Form paragraphs (Reproduced)--Form paragraphs (Reproduced)

	Sec. No.		Sec. No.
7.40.01.....	706.07(a)	7.61.....	715
7.41.....	706.07(b)	7.62.....	715
7.41.01.....	706.07(g)	7.63.....	715
7.41.02.....	706.07(g)	7.64.....	715
7.41.03.....	706.07(b)	7.65.....	716
7.42.....	706.07(d)	7.66.....	716
7.42.01.....	706.07(g)	7.66.01.....	716
7.42.02.....	706.07(g)	7.66.02.....	716
7.42.03.....	706.07(g)	7.66.03.....	716
7.42.04.....	706.07(h)	7.66.04.....	716
7.42.05.....	706.07(h)	7.66.05.....	716
7.42.06.....	706.07(h)	7.67.....	714.13
7.42.07.....	706.07(h)	7.67.01.....	706.07(f), 714.13
7.42.08.....	706.07(h)	7.67.02.....	706.07(f)
7.42.09.....	706.07(b), 706.07(h)	7.68.....	714.13
7.42.10.....	706.07(h)	7.69.....	714.13
7.42.11.....	706.07(h)	7.69.01.....	714.13
7.42.12.....	706.07(h)	7.70.....	714.13
7.42.13.....	706.07(h)	7.70.01.....	714.13
7.42.14.....	706.07(h)	7.71.....	714.13
7.42.15.....	706.07(h)	7.72.....	714.13
7.42.16.....	706.07(h)	7.73.....	714.13
7.43.....	608.01(n), 707.07(j)	7.75.....	714.13
7.43.01.....	707.07(j)	7.76.....	714.13
7.43.02.....	707.07(j)	7.78.....	714.13
7.43.03.....	707.07(a)	7.79.....	714.13
7.43.04.....	707.07(j)	7.80.....	714.13
7.44.....	608.01(o)	7.81.....	707.05(g)
7.45.....	608.01(n)	7.82.....	707.05(g)
7.46.....	714.03(a)	7.82.01.....	707.05(g)
7.47.....	714.03(a)	7.82.02.....	707.05(g)
7.48.....	706.03(u)	7.83.....	707.05(g)
7.49.....	706.03(u)	7.84.....	713.04
7.50.....	706.04	7.84.01.....	714.01(a)
7.51.....	714.14	7.85.....	714.16(d)
7.52.....	709	7.86.....	714.16(e)
7.53.....	709	7.87.....	714.16(d)
7.54.....	709	7.88.....	711.01
7.54.01.....	709	7.89.....	711.01
7.54.02.....	709	7.90.....	711.02
7.56.....	709	7.91.....	711.02(a)
7.56.01.....	709	7.95.....	704.12(c), 714.03
7.56.02.....	709	7.95.01.....	714.03
7.57.....	715	7.96.....	707.05
7.58.....	715	7.97.....	707.07(j)
7.59.....	715	7.98.....	710.02(e)
7.60.....	715	7.98.01.....	710.02(e)

INDEX  
Form paragraphs (Reproduced)--Form paragraphs (Reproduced)

	Sec. No.		Sec. No.
7.98.02.....	711.02	8.08.....	817
7.100.....	707, 707.08	8.09.....	817
7.101.....	707, 707.08	8.10.....	817
7.102.....	707, 707.08	8.11.....	817
7.103.....	707	8.12.....	809.03
7.104.....	706.02(c)	8.13.....	816
7.105.....	704.14(a)	8.14.....	806.04(b)
7.106.....	704.14(a)	8.15.....	806.05(c)
7.107.....	704.14(a)	8.16.....	806.05(d)
7.108.....	704.14(a)	8.17.....	806.05(e)
7.109.....	704.14(a)	8.18.....	806.05(f)
7.110.....	704.14(a)	8.19.....	806.05(g)
7.111.....	704.14(a)	8.20.....	806.05(h)
7.112.....	704.14(a)	8.20.01.....	806.05(i)
7.113.....	704.14(a)	8.20.02.....	808.01
7.114.....	704.14(a)	8.21.01.....	817
7.115.....	704.14(a)	8.21.02.....	817
7.116.....	704.14(a)	8.21.03.....	817
7.117.....	704.14(a)	8.21.04.....	817
7.118.....	704.14(a)	8.22.....	818.03(b)
7.119.....	704.14(a)	8.23.....	812.01
7.120.....	704.14(a)	8.23.01.....	812.01
7.121.....	704.14(a)	8.23.02.....	817
7.122.....	704.14(a)	8.24.....	821.01
7.123.....	704.14(a)	8.25.....	821.01
7.124.....	704.14(a)	8.25.01.....	821.02
7.125.....	704.14(a)	8.25.02.....	818.03(c), 821.02
7.126.....	704.14(a)	8.26.....	821.03
7.127.....	704.14(a)	8.27.....	804.03
7.204.....	724.06	8.28.....	804.03
7.205.....	724.06	8.28.01.....	804.03
7.206.....	724.06	8.29.....	822
7.207.....	724.06	8.30.....	804
7.208.....	724.06	8.31.....	804
7.209.....	724.06	8.32.....	804
7.210.....	724.06	8.33.....	804
7.211.....	724.06	8.34.....	804
7.212.....	724.06	8.35.....	804
7.213.....	724.06	8.36.....	804
7.214.....	719.01	8.37.....	804
8.01.....	809.02(a)	8.38.....	804
8.02.....	809.02(a)	8.39.....	804
8.03.....	809.02(c)	8.41.....	803.03
8.04.....	821.03	8.42.....	821.04
8.05.....	809.02(c), 821.01	8.43.....	821.04
8.06.....	809.02(c), 821.02	8.44.....	821.04
8.07.....	821.02	8.45.....	809.04

MANUAL OF PATENT EXAMINING PROCEDURE  
Form paragraphs (Reproduced)--Form paragraphs (Reproduced)

	Sec. No.		Sec. No.
8.46.....	809.04	12.51.10.....	1208
8.47.....	809.04	12.52.....	1208
8.48.....	809.02(b)	12.52.01.....	1208
8.49.....	809.02(c)	12.52.02.....	1208
8.50.....	809.02(c)	12.52.03.....	1208
10.01.....	1308	12.52.04.....	1208
10.13.....	1481	12.52.05.....	1208
10.14.....	1481	12.53.....	1208
10.15.....	1481	12.53.01.....	1208
10.16.....	1481	12.53.02.....	1208
10.17.....	1481	12.54.....	1208
10.18.....	1481	12.54.01.....	1208
10.19.....	1451	12.54.02.....	1208
10.20.....	1002	12.54.03.....	1208
12.01.....	1205	12.55.....	1208
12.02.....	1205	12.55.01.....	1208
12.03.....	1205	12.55.02.....	1208
12.04.....	1205	12.55.04.....	1208
12.08.....	1206	12.56.....	1208
12.09.....	1206	12.56.01.....	1208
12.09.01.....	1206	12.56.02.....	1208
12.10.....	1206	12.56.03.....	1208
12.11.....	1206	12.57.....	1208
12.12.....	1206	12.57.01.....	1208
12.13.....	1206	12.57.02.....	1208
12.16.....	1206	12.59.....	1208
12.17.....	1206	12.59.01.....	1208
12.19.....	1214.07	12.61.....	1208
12.20.....	1214.06	12.63.....	1208
12.47.....	1208.03	12.69.....	1206
12.49.....	1208	12.69.01.....	1206
12.50.....	1208	12.70.....	1206
12.50.01.....	1208	12.70.01.....	1206
12.50.02.....	1208	12.70.02.....	1206
12.50.03.....	1208	12.71.....	1206
12.50.04.....	1208	12.72.....	1206
12.50.05.....	1208	12.73.....	1206
12.50.06.....	1208	12.74.....	1206
12.51.....	1208	12.76.....	1206
12.51.01.....	1208	12.76.01.....	1206
12.51.02.....	1208	12.76.02.....	1206
12.51.03.....	1208	12.76.03.....	1206
12.51.04.....	1208	12.76.04.....	1206
12.51.05.....	1208	12.76.05.....	1206
12.51.07.....	1208	12.76.06.....	1206
12.51.08.....	1208	12.77.....	1206
12.51.09.....	1208	12.78.....	1206

INDEX  
Form paragraphs (Reproduced)--Form paragraphs (Reproduced)

	Sec. No.		Sec. No.
12.79.....	1208	14.23.....	1490
12.80.....	1211	14.23.01.....	1490
12.81.....	1208.02	14.24.....	1490
13.01.....	1302.02	14.25.....	1490
13.02.....	1302.04	14.26.....	1490
13.02.01.....	1302.04	14.26.01.....	1490
13.02.02.....	706.07(f), 1302.04	14.26.02.....	1490
13.03.....	1302.14	14.26.03.....	1490
13.03.01.....	1302.14	14.26.04.....	1490
13.04.....	1308.03	14.26.05.....	1490
13.05.....	1308.03	14.26.06.....	1490
13.06.....	1302.04	14.26.07.....	1490
13.07.....	1302.01	14.27.01.....	1490
13.08.....	1302.01	14.27.02.....	1490
13.09.....	609	14.27.03.....	1490
13.10.....	714.16	14.27.04.....	1490
14.01.....	1414	14.27.06.....	1490
14.01.01.....	1414	14.28.....	1490
14.01.02.....	1414	14.29.....	1490
14.01.03.....	1414	14.29.01.....	1490
14.01.04.....	1414	14.29.02.....	1490
14.01.05.....	1414	14.30.....	1490
14.05.01.....	1416	14.30.01.....	1490
14.05.02.....	1444	14.30.02.....	1490
14.06.....	1442.01	14.32.....	1490
14.07.....	1442.03	14.33.....	1490
14.08.....	1442.02	14.34.....	1490
14.09.....	1442.02	14.35.....	1490
14.10.....	1442.02	14.35.01.....	1490
14.11.....	1442.02	14.36.....	1490
14.11.01.....	1418	14.36.01.....	1490
14.12.....	1412.03	14.37.....	1490
14.13.....	1412.03	14.38.....	1490
14.14.....	1444	14.39.....	1490
14.15.....	1410.01	15.01.....	1504.10
14.16.....	1410.01	15.01.01.....	1504.10
14.16.01.....	1410.01	15.02.....	1504.10
14.16.02.....	1410.01	15.03.....	1504.10
14.16.03.....	1410.01	15.03.01.....	1504.02
14.16.04.....	1410.01	15.04.....	1504.10
14.16.06.....	1410.01	15.05.....	1503.01
14.17.....	1412.02	15.05.01.....	1503.01
14.20.01.....	1453	15.05.03.....	1503.02
14.21.01.....	1453	15.05.04.....	1503.02
14.21.09.....	1448	15.05.041.....	1503.02
14.22.....	1448	15.05.05.....	1503.02
14.22.01.....	1411.02	15.07.....	1503.02

MANUAL OF PATENT EXAMINING PROCEDURE  
Form paragraphs (Reproduced)--Form paragraphs (Reproduced)

	Sec. No.		Sec. No.
15.07.01.....	1504.01	15.27.02.....	1504.05
15.08.....	1504.01(c)	15.27.03.....	1504.05
15.08.01.....	1504.01(c)	15.27.04.....	1504.05
15.08.02.....	1504.01(d)	15.27.05.....	1504.05
15.08.03.....	1504.01(d)	15.27.06.....	1504.05
15.09.....	1504.01	15.27.07.....	1504.05
15.10.....	1504.01(e)	15.27.08.....	1504.05
15.11.....	1504.02	15.28.....	1504.05
15.12.....	1504.02	15.28.01.....	1504.05
15.13.....	1504.02	15.28.02.....	1504.05
15.14.....	1504.02	15.29.....	1504.05
15.15.....	1504.02	15.30.....	1504.05
15.15.01.....	1504.02	15.31.....	1504.05
15.15.02.....	1504.02	15.33.....	1504.05
15.15.03.....	1504.02	15.34.....	1504.05
15.15.04.....	1504.02	15.35.....	1504.05
15.16.....	1504.02	15.36.....	1504.05
15.17.....	1504.02	15.37.....	1504.05
15.18.....	1504.03	15.38.....	1504.02, 1504.03
15.19.....	1504.03	15.39.....	1504.03
15.19.01.....	1504	15.39.01.....	1504.03
15.19.02.....	1504.03	15.39.02.....	1504.03
15.19.03.....	1504.03	15.40.....	1504.03
15.19.04.....	1504.03	15.40.01.....	1504.02, 1504.03
15.19.05.....	1504.03	15.41.....	1503.01
15.19.06.....	1504.03	15.42.....	1502
15.19.07.....	1504.03	15.43.....	1502
15.20.02.....	1504.04	15.44.....	1502, 1504.01
15.21.....	1504.04	15.45.....	1503.02
15.21.01.....	1504.04	15.46.01.....	1503.01
15.22.....	1504.04	15.47.....	1503.01
15.22.02.....	1504.04	15.47.01.....	1503.01
15.22.03.....	1504.04	15.48.....	1503.02
15.23.....	1504.06	15.49.....	1503.02
15.23.01.....	1504.06	15.50.....	1503.02
15.23.02.....	1504.06	15.50.01.....	1503.02
15.24.....	1504.06	15.50.02.....	1503.02
15.24.03.....	1504.06	15.50.03.....	1503.02
15.24.04.....	1504.06	15.50.04.....	1503.02
15.24.05.....	1504.02	15.50.05.....	1503.02
15.24.06.....	1504.06	15.51.....	1504.04
15.24.07.....	1504.06	15.51.01.....	1504.04
15.24.08.....	1504.06	15.52.....	1504.10
15.25.....	1504.06	15.55.....	1512
15.26.....	1504.20	15.55.01.....	1512
15.27.....	1504.05	15.58.....	1504
15.27.01.....	1504.05	15.58.01.....	1504.04

INDEX  
Form paragraphs (Reproduced)--Form paragraphs (Reproduced)

	Sec. No.		Sec. No.
15.59.....	1503.01	18.08.....	1845.01, 1878.01
15.60.....	1503.01	18.08.01.....	1845.01, 1878.01
15.61.....	1503.01	18.09.....	1845.01, 1878.01
15.62.....	1503.01	18.10.....	1845.01, 1878.01
15.63.....	1503.01	18.11.....	1845.01, 1878.01
15.64.....	1503.01	18.12.01.....	1845.01, 1878.01
15.65.....	1504.04	18.13.01.....	1845.01, 1878.01
15.66.....	1504	18.14.01.....	1845.01, 1878.01
15.66.01.....	1504	18.15.....	1845.01, 1878.01
15.67.....	1504.03, 1504.06	18.16.....	1850
15.68.....	1504.03, 1504.06	18.17.....	1850
15.69.01.....	1504.04	18.18.....	1850
15.70.....	1504.03	18.19.....	1893.03(d)
15.72.....	1504	18.20.....	1893.03(d)
15.73.....	1504.04	18.21.....	1893.03(d)
15.74.....	1504.20	19.01.....	1901.06
15.75.....	1504.20	19.02.....	1901.06
15.75.01.....	1504.20	22.01.....	2246
15.76.....	1512	22.01.01.....	2642, 2258.01
15.85.....	1504.04	22.02.....	2247
15.90.....	1504	22.03.....	2258
16.01.....	1605	22.04.....	2260
16.02.....	1605	22.04.01.....	2265
16.03.....	1605	22.05.....	2285, 2686.03
16.04.....	1610	22.06.....	2287
16.05.....	1612	22.07.....	2282
16.05.01.....	1612	22.08.....	2282
16.06.....	1606	22.09.....	2271
16.07.....	1606	22.10.....	2271
16.08.....	1610	22.11.....	2258
16.09.....	1605	22.12.....	2250, 2666.01
16.10.....	1605	22.13.....	2250
16.11.....	1606	22.14.....	2266.01
16.12.....	1610	22.15.....	2266.03
16.13.....	1607	22.16.....	2287
18.01.....	1845.01, 1878.01	22.20.....	2286
18.02.....	1845.01, 1878.01	23.01.....	2307.03
18.02.01.....	1845.01, 1878.01	23.02.....	2363
18.02.02.....	1845.01, 1878.01	23.03.....	2363.02
18.03.....	1845.01, 1878.01	23.04.....	2305
18.04.....	1845.01, 1878.01	23.05.....	2305
18.04.01.....	1845.01, 1878.01	23.06.....	2305
18.05.....	1850	23.07.....	2305
18.06.....	1850	23.08.....	2305.04
18.06.01.....	1850	23.09.....	2306.01
18.06.02.....	1850	23.10.....	2306.01
18.07.....	1850	23.11.....	2307.05

MANUAL OF PATENT EXAMINING PROCEDURE  
 Fraud--Fraud

	Sec. No.		Sec. No.
23.12.....	2307	26.53.01.....	2677
23.13.....	2307.02	26.54.....	2677
23.14.....	715.05, 2307.02	26.54.01.....	2677
23.14.01.....	715.05, 2307.02	26.54.02.....	2677
23.15.....	2307.02	26.54.03.....	2677
23.16.....	2307.04	26.55.....	2677
23.17.....	2315.01	26.55.01.....	2677
23.18.....	2315.01	26.55.02.....	2677
23.19.....	2305.04	26.55.03.....	2677
23.20.....	2307.06	26.55.04.....	2677
23.21.....	2307.06	26.55.05.....	2677
24.01.....	2427.01	26.56.....	2677
24.02.....	2427.01	26.56.01.....	2677
24.03.....	2427.01	26.56.02.....	2677
24.04.....	2427.01	26.56.03.....	2677
24.05.....	2427.01	26.57.....	2677
24.05.01.....	2427.01	26.57.01.....	2677
26.01.....	2646	26.57.02.....	2677
26.02.....	2647	26.57.03.....	2677
26.03.....	2658, 2671.01	26.57.04.....	2677
26.03.01.....	2658	26.59.....	2677
26.04.....	2660	26.59.01.....	2677
26.05.....	2660, 2671.01	26.60.....	2677
26.05.01.....	2666.01	26.61.....	2677
26.06.....	2666.30	26.62.....	2677
26.07.....	2671.02	26.63.....	2677
26.08.....	2673.02	26.64.....	2677
26.09.....	2675.02	26.65.....	2679
26.10.....	2675.02	26.65.01.....	2679
26.11.....	2675.02	26.66.....	2679
26.50.....	2677	26.66.01.....	2679
26.50.01.....	2677	26.66.02.....	2679
26.50.02.....	2677	26.67.....	2678
26.50.03.....	2677	26.67.01.....	2682
26.50.04.....	2677	26.68.....	2666.06
26.50.05.....	2677	26.69.....	2687
26.50.06.....	2677	26.70.....	2687
26.51.....	2677	26.73.....	2660, 2671.01
26.51.01.....	2677	26.80.....	2686.04
26.51.02.....	2677		
26.52.....	2677	Fraud (See also Duty of disclosure; Inequitable conduct; Deceptive intent)	
26.52.01.....	2677	Avoiding charge of.....	2004
26.52.02.....	2677	Civil litigation.....	1216.02, 2001.06(c)
26.52.03.....	2677	Claims invalidated.....	2016
26.52.04.....	2677	Inventorship.....	201.03
26.53.....	2677	On the Patent and Trademark Office.....	509.03, 1448
26.53.01.....	2677	Protest.....	1901, 1901.02, 1901.06, 2013

INDEX  
Fraudulent--Hatch-Waxman Act

	Sec. No.		Sec. No.
Reexamination		Genetic sequence (See Biotechnology; Nucleotide sequences; and Sequence rules)	
<i>Ex parte</i> .....	2014, 2216, 2217, 2258, 2280	Genus and species.....	806.04(a) to 806.04(f), 806.04(h)
<i>Inter partes</i> .....	2014, 2658, 2684	.....	806.04(i), 808.01(a), 809.02
Reissue .....	1448, 2012	Anticipation of.....	2131.02
Small entity status .....	509.03	Obviousness of .....	2144.08
Fraudulent .....	706.03(a)	German priority document.....	901.05
Freedom of Information Act (FOIA).....	103, 1002.02(k)(2)	Geschmacksmuster .....	201.14(b)
Frivolous invention .....	706.03(a)	Good faith (See Duty of candor and good faith)	
Full faith and credit in prior Examiner's action		Government registers.....	302, 302.07
Allowed claims .....	706.04	Government license clause .....	310
Interview .....	713.01	Government-owned application, special.....	708.01
Search.....	704.10	Graphic symbols .....	608.02
Full name of applicant.....	605.04(b)	Great Britain, complete specification .....	201.15
Full signatory authority .....	1004	Great Britain, provisional specification .....	201.15
Function of machine rejection .....	2173.05(v)	Greek letter Phi usage.....	608.01(g)
Functional claim, rejection.....	2114, 2173.05(g)	Group director (See Director of Technology Center)	
Functional equivalents .....	2144.06	Group, International classification.....	903.09
Functionality in design patent applications .....	1504.01(c)	Guardian, Authority recorded.....	409.02
		Guardian of legally incapacitated inventor .....	409.02
		Guidelines	
<b>G</b>		Drafting an application .....	601
Gazette, Official (See <i>Official Gazette</i> (O.G.))		Drug disclosures .....	2107.01, 2107.03
Gazette, PCT .....	1801, 1823.01, 1857	Effective date under 35 U.S.C. 102(e).....	706.02(f)(1)
Gebrauchsmuster .....	201.13, 201.14(d), 901.05(b)	Electronic mail.....	502.03
General Counsel .....	502, 1002.02(k)(1)	Examination of computer-related inventions.....	2106
Mailing address .....	501	Inventorship.....	605.07
General information .....	1730	Genus-species .....	2144.08
“General Information Concerning Patents” booklet		Grant of reexamination request .....	2242
.....	Introduction, 703	Handling of citation in patent .....	1920
General Information Services Division (GISD).....	1730	Internet Usage.....	502.03, 904.02(c)
General power of attorney for international application		Means/step plus function.....	2181
.....	1807	Utility.....	2107
Generic claim		Legal precedent.....	2107 to 2107.03
Allowable .....	808.01(a), 809.02(b), 809.02(e)	Written Description.....	2163
Transitional application .....	803.03(b)		
Definition .....	806.04(d)	<b>H</b>	
Informal.....	809.02(e)	Hague Agreement (See also Treaties) .....	201.13, 1504.10
Markush group .....	803.02, 2173.05(h)	Hand delivery of papers.....	501, 502, 710.02(e), 714.13
Patentably distinct over other species .....	806.04(h)	Handling of citation of prior art.....	2206
Presented after issue of patent.....	806.04(i)	Handling of mail and papers.....	Chapter 500
Rejection .....	809.02(a)	In <i>ex parte</i> reexamination .....	2270
Species claims lacking .....	809.02(d), 818.02(b)	In <i>inter partes</i> reexamination.....	2670
Subcombination.....	806.04(c)	Handling of protest.....	1901.05
Support for scope of.....	706.03(c), 2164.08	Hatch-Waxman Act.....	2750
Traverse of rejection in lieu of election.....	818.03(b)		
.....	818.03(d)		



MANUAL OF PATENT EXAMINING PROCEDURE  
Hearing on appeal--Inequitable conduct

	Sec. No.		Sec. No.
Hearing on appeal .....	1209	Drawing .....	506, 601.01(f)
Heir as applicant (See also Administrator or executor)		Invalid oath .....	604.06
.....409.01, 409.01(a), 409.01(d), 1303.03		Return of filing fee .....	506
Help line (telephone number).....	1730	Using again.....	608.01(u)
Hidden end use in design applications .....	1504.01(c)	Incomplete claim, rejection ...	706.03(c), 706.03(d), 2172.01
Hidden feature in design applications		Incomplete protest .....	1901.03
Anticipation.....	1504.02	Incomplete requests for <i>ex parte</i> reexamination.....	2227
Enablement.....	1504.04	Incomplete requests for <i>ex parte</i> reexamination.....	2627
Obviousness .....	1504.03	Incomplete response .....	711.03(a), 714.03
HIV/AIDS, Petitions .....	708.02	Time for completing .....	710.02(c), 711, 714.03
Hours of operation.....	510	Incorporation by reference.....	103, 201.06(c), 201.11
Holiday, federal (See Federal Holiday)		.....608.01(p), 2163.07, 2163.07(b), 2173.05(s)	
Hyperlinks in specification.....	608.01, 608.01(p)	Foreign priority application .....	201.13
		In an Examiner's Answer during <i>inter partes</i>	
		reexamination .....	2677
		Public access to incorporated application .....	103
		Incorrect citation of reference.....	707.05(g), 710.06
		Indefinite claim.....	706.03(d), 2171 to 2174
		Alternative phrase.....	2173.01, 2173.05(h)
		Antecedent basis .....	2173.05(e)
		Breadth compared.....	2173.04
		Design applications.....	1503.01, 1503.02, 1504.04
		International application .....	1845, 1874
		Multiplicity .....	2173.05(n)
		Must be considered .....	2143.03
		Nonelected claims.....	821
		Numerical ranges.....	2173.05(c)
		Prolix .....	2173.05(m)
		Rejections .....	706.03(d)
		35 U.S.C. 112, first and second paragraph compared	
		.....	2174, 2185
		35 U.S.C. 112, sixth paragraph limitations.....	2181, 2185
		Independent claim.....	608.01(n)
		Independent, definition.....	802.01
		Independent inventions.....	802, 802.01, 803, 803.02, 806
		.....	806.04, 808.01, 808.01(a)
		Independent inventor (See also Applicant; Inventor; <i>Pro se</i>	
		applicant)	
		Independent Inventor programs .....	1730
		Small entity status.....	509.02
		Index of claims .....	707.07(i), 719.04
		Index of patents, Classification, Numerical.....	902.03(a)
		Index to the U.S. Patent Classification .....	902.01(a)
		Industrial Security Manual (ISM).....	120
		Inequitable conduct (See also Duty of disclosure, Fraud)	
		.....	2001.06(c), 2010
		Best mode .....	2165

**I**

ICIREPAT country codes.....	201.14(d)
ICIREPAT identification numbers.....	201.14(d)
Icon, computer generated .....	1504.01(a)
Identification of papers .....	502, 503
Identification of priority application .....	201.14(d)
Identity of inventors under 35 U.S.C. 119.....	201.13
Idiomatic English .....	608.01(q)
Illustration (See Drawings)	
Image File Wrapper (IFW)	
Artifact.....	608.02
Paper scanning .....	508
Power to inspect not accepted .....	104
Public access .....	103
Image File Wrapper (IFW) forms	
Issue Classification Sheet, reproduced.....	1302.09
Cited .....	1302.10, 1302.13
Implied election.....	818.02, 818.02(a), 818.02(c)
Improper comments, <i>inter partes</i> reexamination .....	2667
Improper joinder, effect on patent.....	805
Improper multiple dependent claim .....	608.01(n)
Improvement (Jepson claim).....	2129
Inaccurate claim .....	2173.03
Inappropriate papers in <i>inter partes</i> reexamination.....	2667
Incoming-Mail Section (See also Office of Initial Patent	
Examination (OIPE)).....	501
Incomplete amendments, time for completing	
.....	710.02(c), 714.03
Incomplete application .....	506, 601.01(d), 601.01(e)
Claims omitted .....	601.01(e)
Definition .....	203.06

INDEX  
Informal application--Interference

	Sec. No.		Sec. No.
Claims invalidated.....	2016	Insanity .....	409, 409.02
Finding affects all claims .....	2016	Inspection	
Protest .....	1901, 1901.06, 2013	Amendment .....	714.05
Reexamination .....	2014	Application .....	103, 104
Reissue .....	1448, 2012	Approval of power.....	104
Informal application .....	506, 702.01	Assignment.....	301.01
Primary examiner's attention required .....	1004	Authorization.....	402
Search.....	702.01, 704.01	By assignee.....	104, 106, 106.01
Informal drawing (no longer applies).....	507, 608.02(b)	By excluded or suspended attorney or agent .....	105
Informal requests for <i>ex parte</i> reexamination .....	2228	By inventor .....	106
Informal requests for <i>inter partes</i> reexamination.....	2628	By licensee.....	106.01
Informality, Action calling attention to .....	707.07(a)	Control of, By assignee .....	106
.....	707.07(j), 710.02(b), 714.14	File Information Unit (Record room) .....	103
Information Center (See Scientific and Technical Information Center (STIC))		International application .....	110
Information Disclosure Statements (See also Prior art .....)	201.06(d), 609, 1406	Patent file.....	103
Relationship to requirement for information.....	704.14(d)	Petition.....	103
Information material to patentability (See also Duty of disclosure).....	2001.04, 2001.05	Record room .....	103
Coping application .....	2001.06(b)	Reissue application .....	103
Copied claims.....	2001.06(d)	Right of.....	103, 104, 106
Foreign application.....	2001.06(a)	Insufficient disclosure.....	608.01(p), 706.03(c), 2161
Litigation.....	2001.06(c)	Insufficient reply .....	710.02(c), 711.02(a)
Information on status of application referred to in patent .....	102	.....	711.03(a), 714.03, 2266.01, 2666.30, 2671
Information reasonably necessary for finding prior art .....	704.11	Int. Cl. (International Patent Classification) .....	903.09
Information sent to applicant for guidance.....	703	Intellectual property compared.....	1512
Information submitted with protest .....	1901.02	Intellectual Property and High Technology Technical Amendments Act of 2002 (Pub. L. 107-273) .....	706.02(a)
Infringement action		Intent to claim.....	706
Statute of limitations .....	2204	Inter-American Convention (See also Treaties) .....	201.13
INID codes or numbers .....	901.04, 901.05(b), 2290	Interference.....	Chapter 2300
Initial data capture for printing.....	1309	Abandonment, suppression or concealment, notice..	2138
Initial examiner review of reissue .....	1443	Access to files.....	2312
Ink color		Action after.....	2363
Black .....	707.10, 719.02, 719.05	Action after <i>ex parte</i> reexamination .....	2284
Red .....	714.18, 719.02	Action after <i>inter partes</i> reexamination.....	2686.02
Permanent.....	608.01, 714.07, 714.19	Action made when suggesting claims.....	2305.01
Inoperativeness.....	2164.07, 2164.08(b)	Action suggesting claims.....	2305, 2305.04
Affidavit.....	716.07	Addition of new party.....	2342
INPADOC.....	901.06(a), 905.06	Administrative patent judge handles.....	2300.01, 2314
Inquiries, Official and Congressional.....	203.08(a)	After notice of allowance .....	2307.03
Inquiries regarding patent search, examination, or validity .....	1701	Allowance of losing party's application .....	2363.03
Inquiry as to status of application.....	102, 203.08	Amendment filed during.....	2364.01
Application published .....	1128, 1134	Applicant requests interference with patent.....	2307
		Application already in interference.....	2305.04
		Application and patent in different Technology Centers .....	2306
		Applications in different Technology Centers.....	2301.01(a)

MANUAL OF PATENT EXAMINING PROCEDURE  
Interference--Interference

Sec. No.	Sec. No.
Attorney, parties have same .....	2305, 2309.02
Basis of practice .....	2138.01, 2300.01
Between application and patent.....	2306 to 2308.02
Between applications .....	2303, 2304
Cancellation of losing party's claims .....	2363.03
Claim of foreign priority by patentee not considered .....	2308.01
Claim interpretation .....	2301.01
Claim presented corresponding to patent claim.....	2306 to 2308.02
Claims, need not be identical .....	2303
Claims, overlapping in two applications of same party .....	2315.01
Claims, suggesting .....	1003, 2305 to 2305.04
Claims, unpatentable over suggested claim.....	2305.01
Claims corresponding to count support in specification .....	2163.03
Claims corresponding to patent claims, rejection .....	2307.02
Common ownership .....	2302
Conception .....	2138.01, 2138.04
Concurrent with appeal .....	2315
Consultation with examiner .....	2340
Consultation of examiner with administrative patent judge .....	2314, 2360, 2363, 2363.03
Consultation of examiner with interference practice specialist.....	2300.01, 2301.01(b), 2305.04, 2309
Copending <i>ex parte</i> reexamination.....	2284
Copending <i>inter partes</i> reexamination .....	2686, 2686.02
Copied patent claim not identified .....	2305, 2307.05
Count, defined.....	2301.02
Counts, formulation of.....	2138.05, 2163.03 2301.01, 2306
Dates, difference in effective filing .....	2303
TC Director's attention required.....	1003
Decision on motion .....	2340
Declaration .....	2311
Definitions.....	2301.02
Determining priority.....	2138.01
Diligence, reasonable .....	2138.01, 2138.06
Director of TC must approve of.....	1003, 2303, 2303.01 2305.04, 2306, 2307.02, 2309.02
Disclaimer, statutory .....	706.03(u), 710.02(d)
Disposal count.....	1705
Drawing, losing party's obtaining copy of.....	2363.03
Drawing prints.....	608.02(m)
Election of invention not affected .....	820.02
Entry of amendment filed in connection with motion .....	2364
Estoppel .....	715, 2138.01, 2358, 2363.03
Evidence .....	2138.04
Failure to identify patent when claims presented .....	2305 2307.05
Failure to present suggested claim.....	2305.01
Federal Rules of Evidence .....	2301.02, 2308
File wrapper notation.....	2301.01(b)
Final decision.....	2358
Foreign application, benefit.....	2309.02
Fraud.....	2010
Generic claims .....	2303
Identification of patent, corresponding claims presented .....	2307.05
Inequitable conduct.....	2010
Initial memorandum .....	2309.02
Inspection of affidavits and declarations .....	2309.03
Inter partes questions not to be discussed <i>ex parte</i> .....	2314
Interference Practice Specialist.....	2300.01, 2301.01(b) 2305.04, 2309
Interpretation of claims.....	2301.01
Interview prohibited .....	2314
Judicial review .....	1216, 1216.01
Jurisdiction over interference .....	2300.01, 2314
Litigation, notice of .....	2360
Losing party, may obtain copy of opponent's application.....	2363.03
Losing party, treatment of.....	2363.03
Lost counts.....	715, 2138.01
Memorandum, proposing.....	2309.02
Motions Applications not involved in interference .....	2333
Decision .....	2340
Hearing.....	2340
Preliminary.....	2333, 2340
Stay .....	2686.02
Suspend .....	2686.02
Multiple dependent claims.....	2309.02
Multiple patents involved .....	2306
New reference found .....	2341
No interference in fact .....	2301.02, 2363.01
Nonelected claims.....	2303.01
Notation on file wrapper, allowed application.....	2305.04
Notation on file wrapper, possible interference .....	2301.01(b)

INDEX

Interference practice specialist(s)--International application

Sec. No.	Sec. No.
Notification of patentee, attempt to provoke interference ..... 2307.06	Showing under 37 CFR 1.608(b)..... 2308.02
Office of Patent Publication notified..... 2305.04	Special dispatch..... 708.01, 2307, 2307.02
Order to show cause..... 2340	Statutory basis..... 708.01, 2300.01
Overlapping applications..... 2315.01	Subsidiary of corporation, common ownership..... 2302
Patent filing date earlier than application date .... 2308.01 ..... 2308.02	Suggestion of claims..... 2305 to 2305.04
Patent filing date later than application date ..... 2306.01	Suggestion of claims, time limit ..... 710.02(c), 2305.02
Patent in different Technology Center ..... 2306	Suspension of action pending outcome of reexamination ..... 2284, 2686.02
Petition refusal to initiate ..... 1002.02(c)	Suspension of <i>ex parte</i> prosecution ..... 709, 709.01, 2315 ..... 2315.01
Power of attorney filed..... 402.08	Terminated open to public..... 103
Preliminary motions..... 2333, 2340	Termination..... 2361
Preparation of papers by examiner..... 2309, 2309.02	Testimony..... 715.07(b)
Priority time charts..... 2138.01	Time limit for reply..... 2305.02, 2307.02
Protest, notice of..... 2360	Transfer of application..... 2301.01(a), 2306
Provoking..... 2300.02	Two periods for reply running..... 2307.02
In <i>ex parte</i> reexamination..... 2284	Winning party..... 710.02(b), 2363.02
In <i>inter partes</i> reexamination..... 2686.02	Withdrawal of application from issue ..... 2305.04, 2307.03
Public use proceeding ..... 706.03(v)	Withdrawal of outstanding action..... 2315
Reconsideration of decision on motion..... 2340	Interference practice specialist(s) ..... 2300.01(a), 2301.01(b) ..... 2305.04, 2309, 2309.02(d)
Reduction to practice..... 2138.01, 2138.05	Interlibrary loans..... 901.06(a)
Reexamination	Interlineation in specification before execution..... 608.01
<i>Ex parte</i> , copending with interference..... 2284	International application (See also Foreign application; Patent Cooperation Treaty (PCT))
<i>Inter partes</i> , copending with interference ..... 2686, 2686.02	Abstract..... 1826
Reexamination, notice of..... 2360	Access..... 101, 110
Reexamination, presentation of claims for interference with patent under..... 2307.04	Agent..... 1807, 1864.04
Reference found during interference..... 2341	Amendment before the designated office ... 1893.01(a)(2) ..... 1893.01(a)(3)
References pertinent to motions, made of record..... 1302.12	Amendment of claims before International Bureau.. 1853
Reinstatement of action..... 2315, 2363.02, 2363.03	Amino acid sequence..... 1823.02
Reissue application..... 1449.02, 2301.01, 2360	Applicant..... 1810
Reissue application copending with interference on original patent..... 1449.01	Applicants different for different designated states ..... 1817.01, 1817.01(a)
Reissue application, notice of..... 2360	Assignment document..... 301
Rejection of claims corresponding to patent claims ..... 2307.02	Attorney..... 1807
Rejection of claims unpatentable over suggested claim ..... 2305.01, 2305.02	Attorney file reference number..... 1821
Requirements for interference..... 2303, 2306	Claims..... 1824
Response to suggestion for claims ..... 710.02(c), 2305 ..... 2305.03	Common representative..... 1807
Revocation of power of attorney..... 402.08	Confidential status..... 101, 110
Search..... 1302.08, 2301.01(b)	Content..... 1812
Second interference..... 2365	Continuation..... 1817.02
Secrecy order application..... 130, 2309.06	Continuation of..... 201.11(a), 1895
	Continuation-in-part..... 1817.02
	Correspondence..... 1834

MANUAL OF PATENT EXAMINING PROCEDURE  
International classification--Interviews

Sec. No.	Sec. No.		
Definition .....	201	Time limits.....	1836, 1842, 1843.05
Deposit accounts .....	509.01	.....	1879.01, 1879.01(a)
Description .....	1823	Title .....	1821
Designation fee .....	1817.01(a)	Translation for U.S. national stage .....	1893.01(d)
Designation of states .....	1817.01, 1817.01(a)	Transmittal fee .....	1827
Drawings .....	1825, 1893.03(f)	Transmittal letter.....	1830
Drawings missing.....	1825	Unity of invention.....	823, 1850, 1875, 1893.03(d)
Early national stage entry under 35 U.S.C. 371(f)		Withdrawal .....	1859, 1880
.....	1893.01, 1893.01(a)(2), 1893.03(b)	International classification.....	903.09
Elements.....	1812	International patent classification .....	719.05
Errors, rectification of.....	1836	International searching authority .....	1840
Fees .....	1827, 1893.01(c), 1896	International Trade Commission .....	724
Filing date .....	1810	International-type search .....	707, 1852
Foreign filing license.....	1832	Internet.....	502.03, 1730
Formal requirements .....	1810	Address.....	1730
Forms (See Patent Cooperation Treaty (PCT): Forms)		Database collections .....	1730
Home copy .....	1801, 1848, 1879.04, 1895.01	Disclosure document program.....	1706
International preliminary examination .....	1860	Electronic mail.....	502.03, 713, 713.01
International search.....	1843	.....	713.04, 713.05
International searching authority.....	1840	General Information Concerning Patents .....	703
Inventor .....	1817.01, 1817.01(a), 1820, 1893.01(e)	Kids Pages .....	1730
Kinds of protection.....	1817.02	“PatentIn” computer software (See also Sequence rules)	
Mail service.....	1834, 1834.02	.....	2430
Member states .....	1817	Payment of maintenance fees by .....	2522
Microorganism deposit.....	1823.01	PCT Legal Office.....	1730
National stage.....	1893 to 1896	Publication of Board Decisions .....	1213.03
Numbering of sheets .....	1812	Publication of the <i>Official Gazette</i> .....	1703
Oath.....	1893.01(e)	Searching .....	904.02(c)
Parent to national application.....	201.11(a), 1817.02	Usage Policy.....	502.03, 904.02(c)
Power of attorney .....	1807	World Intellectual Property Office (WIPO)	
Precautionary designations.....	1817.01(a)	.....	Introduction, 1801, 1851
Prior art effect .....	1857.01, 1896, 2127, 2136.03	<i>Inter partes</i> questions .....	713.06
Priority .....	201.13(b), 1828	Interpretation of law, new.....	1208
Priority document.....	201.13(b), 1828	Intervening rights	
Publication .....	1857	In reexamination	
Record copy .....	1801, 1828, 1832, 1848	<i>Ex parte</i> .....	2293
Rectification of obvious errors.....	1836	<i>Inter partes</i> .....	2693
Refund of fees .....	1847, 1850, 1852	In reinstated patents.....	2591
.....	1865.01, 1875.02	In reissue.....	1460
Representation.....	402.09	Intervention by assignee .....	106
Request.....	1821	Interviews .....	713
Search copy .....	1801, 1840, 1840.01, 1847	Advance indication of issues to be discussed .....	713.01
Search fee.....	1827	Allowed application.....	713.05, 713.10
Search report .....	707.05, 1844	Appointment in advance .....	713.01
Secrecy order.....	115, 120, 1832	Attorney not of record .....	101, 402
Signature of applicant .....	1820	Authority to conduct.....	713.05
		Before filing.....	713.02

INDEX  
Invention--Inventor's certificate

	Sec. No.		Sec. No.
Before filing amendment under 37 CFR 1.312 .....	713.10	Inventive entity, Same(overlapping subject matter) .....	804
Before first action.....	706.07(b), 713.01, 713.02	.....	804.03, 822, 822.01
Demonstration.....	713.08	Inventor (See also Applicant; <i>Pro se</i> applicant) .....	605
During working days only.....	713.01	Common, at least one .....	201.03, 201.11
Electronic mail .....	502.03, 713, 713.01, 713.04, 713.05	.....	706.02(k), 2137.01
Excluded or suspended attorney or agent.....	105, 713.05	Continuing application .....	201.06(c)
Exhibit.....	713.08	Correction (See Correction of inventorship)	
Exposure of other cases during .....	101, 713.07	Deceased.....	409 to 409.01(f), 1820
Field of search.....	713.02	Execution of oath/declaration by	
Finally rejected application .....	706.07(f), 713.09	legal representative.....	605.04(a)
How conducted.....	713.01	Government property rights statement.....	151
<i>Inter partes</i> questions.....	713.06, 2314	Duty of disclosure by.....	2001.01, 2002.01
Interview summary form.....	713.04, 2281	Foreign priority.....	201.13, 2133.01
Local attorney .....	713.03, 713.05	Full first or middle name required .....	605.04(b)
Made of record .....	713.01, 713.04	Heirs .....	409.01(a), 409.01(d)
Merged reissue/ <i>inter partes</i> reexamination .....	2686.03	Initials as a given name .....	605.04(b)
Model.....	713.08	Insane.....	409, 409.02
Oral agreement not binding.....	713.04	International application .....	1812, 1817.01, 1817.01(a)
Patentability report cases.....	713.01	Legally incapacitated .....	409, 409.02
Prior to first Office action .....	706.07(b), 713.02	Minor .....	409
Prohibited.....	713.05	Name change .....	605.04(c), 719.02(b)
Protestor participation .....	1901.07	Correction .....	201.03, 201.05
Question of patent validity .....	1701	Order .....	605.04(f)
Record of substance required .....	713.01, 713.04	Petition.....	605.04(c)
Reexamination		Typographical, translation error.....	201.03, 601.05
<i>Ex parte</i> .....	2281	None available .....	409, 409.03(b), 603
<i>Inter partes</i> .....	2666.30, 2685, 2686.03, 2687	Proof.....	409.03(d)
Refused.....	713.01, 713.02, 713.05	Proof of irreparable damage.....	409.03(g)
.....	713.10, 2314	Proof of proprietary interest.....	409.03(f)
Requested in continuing application .....	706.07(b)	Order of .....	605.04(f)
Requested in Office action.....	707	<i>Pro se</i> .....	707.07(j), 713.01
Sounding out .....	713.03	Refuses to sign.....	409, 409.03(d), 603
Special situations.....	713.05	Execution of oath .....	605.04(b)
Substance made of record .....	713.04, 714.13, 1302.03	Representative of.....	Chapter 400, 1706
Telephone.....	101, 408, 713.01, 713.05, 812.01	Requirements.....	2137.01
Time allowed.....	713.01	Residence.....	605.02
Video conference .....	713.01, 713.04	Rule 1.53(b).....	201.06(c)
Videotape showing.....	713.01	Rule 1.53(d).....	201.06(d)
Where held .....	713.01	Self-prosecuted case .....	707.07(j), 713.01
Invention (See Patent; Rejection)		Small entity status.....	509.02
Brief summary.....	608.01(d)	Unavailable.....	409, 409.03, 603
Detailed description .....	608.01(g)	At least one joint inventor available.....	409.03(a)
Made in this country.....	2138.02	Last known address.....	409.03(e)
Mode of operation .....	608.01(h)	Proof.....	409.03(d)
Inventive entity, Different.....	706.02(k)	Proof of irreparable damage.....	409.03(g)
.....	706.02(l) to 706.02(l)(3)	Proof of proprietary interest.....	409.03(f)

MANUAL OF PATENT EXAMINING PROCEDURE  
Inventor's certificate--Library, Scientific

	Sec. No.		Sec. No.
Inventor's certificate		Correction .....	201.03
Priority benefit .....	201.13(a), 202.04	Provisional application .....	605.07
Rejection based on .....	706.02(e)	Joint owners .....	301
Inventor's Assistance Center .....	1730	Joint venture .....	706.02(l)(2)
IPC (International Patent Classification) .....	903.09	Journal, Patent Office Society .....	707.06
IPS (Interference Practice Specialist) .....	2301.01	Judicial notice .....	2144.03
Irreparable damage, Proof of .....	409.03(g)	Judicial review	
Issue (See Allowance and issue)		<i>Ex parte</i> reexamination proceedings .....	1216
Issue batch number (no longer used) .....	1303.01	Patent applications .....	1216
Issue Classification Sheet .....	1302.13	Standards of review by the Federal Circuit .....	1216.01
Issue fee .....	1306	Jurisdiction	
After payment .....	1306.03	Allowed application .....	714.16, 1305
Credit card payment .....	1306	Appealed application .....	1210
Deposit account .....	1303, 1306	Application before court .....	1216
Failure to pay .....	203.07, 711.03(c), 1306	Interference .....	2314
Interfering case, not applied .....	2305.04		
Late payment .....	711.03(c)	<b>K</b>	
Petition to accept late fee .....	203.07, 711.03(c)	Kind Codes .....	901.04(a)
Reissue application .....	1415	Kinds of patent documents .....	1851
Who may file .....	1306		
Issue of patent .....	1309	<b>L</b>	
Deferred .....	1306.01	Laches .....	2190
Request for simultaneous issuance .....	1306.02	Lack of unity of invention .....	803, 823
Issue of patent to assignee .....	307	Lack of utility .....	608.01(p), 706.03(a)
Issue slip (See also Form letters and forms) .....	903.07	Language, Offensive .....	608, 1504.01(e)
Issuing in another TC without transfer .....	903.07(b)	Language of papers .....	608.01
		Late payment of issue fee .....	711.03(c)
<b>J</b>		Law, new interpretation of .....	1208
Jacket (See File wrapper/history)		Laws, Patent (See Statutes)	
Japanese year system .....	901.05(a)	Legal representative refuses to sign .....	409.03(c)
Jepson claim .....	2129	Letter (See also Action; Form letters and forms; Letter, Examiner's)	
Joinder, Improper .....	805	Abandoned after allowance .....	711.05
Joinder, linking claim allowed .....	809.04	Congressional inquiry .....	203.08(a)
Joinder of inventors .....	409.03(j)	Drawing transfer .....	608.02(i)
Joint application, definition .....	201.02	Official inquiry .....	203.08(a)
Joint application, original oath .....	602	Status .....	203.08
Joint inventor		Letter, Examiner's (See Examiner's Letter)	
Oath .....	602	Letters, receipt and handling .....	Chapter 500
Power of attorney to .....	402.01	Letters of administration .....	409.01(b), 409.01(c), 409.01(e)
Refuses to sign application .....	409.03, 409.03(a)	Letters testamentary .....	409.01(b)
Rights of nonsigning .....	409.03(i)	Library, Scientific (See Scientific and Technical Information Center (STIC))	
Joint inventors .....	201.02, 201.03, 605, 605.07, 2137.01		
Change in order of names .....	605.04(f)		

INDEX  
Library services--Maintenance fees

	Sec. No.		Sec. No.
Library services.....	901.06(a)	Mail Stop 16 (Refunds) .....	509.03
Libreville Agreement (See also Treaties).....	201.13	Mail Stop AF .....	714.13
License agreements under patent .....	301	Mail Stop Assignment Recordation.....	501, 302.08
Recording of .....	310, 313	Mail Stop Conversion.....	601.01(c)
License rights clause .....	310	Mail Stop DD .....	1706
License to file foreign application.....	115, 140, 706.03(s)	Mail Stop Document Services .....	103, 501, 1430, 1470
License to file international application .....	140, 1832	.....	2222, 2232, 2501, 2622, 2632
Licensee, access .....	106.01	Mail Stop <i>Ex Parte</i> Reexam .....	501, 2222, 2224
Licensing and Review section.....	115, 120	.....	2226, 2231
.....	140, 150, 502, 502.01, 706.03(b), 706.03(s)	Mail Stop Expedited Design.....	1504.30
Linking claim .....	809, 809.02, 809.03, 809.04	Mail Stop Express Abandonment .....	1002.02(r), 1125
Transitional application.....	803.03(a)	Mail Stop INTERFERENCE.....	501
Traverse of rejection .....	818.03(d)	Mail Stop <i>Inter Partes</i> Reexam ....	501, 2622, 2624, 2631
List of countries giving right of priority.....	201.13	Mail Stop Issue Fee .....	502, 1306, 1306.02
List of decisions .....	Appendix II	Mail Stop L&R .....	120
List of prior art in reexamination .....	2257, 2657	Mail Stop M Correspondence.....	501, 2510
Literature citation in specification.....	608.01(p)	Mail Stop MPEP.....	Foreword
Litigation information, Duty to disclose .....	2001.06(c)	Mail Stop OED .....	402, 407
Litigation not stayed in reissue.....	1442.02	Mail Stop Patent Ext.....	501, 1002.02(b), 2754, 2754
Litigation, reexamination copending		Mail Stop PCT .....	501, 1805, 1808, 1821, 1823.02, 1865
<i>Ex parte</i> .....	2286	Mail Stop Petitions .....	720, 1002.02(b), 1308
<i>Inter partes</i> .....	2640, 2681, 2686, 2686.04	.....	1901.03, 2580, 2590, 2720
Litigation related reissue .....	1404, 1442.01 to 1442.05	Mail Stop PGPUB .....	1126
Litigation, stays.....	1442.03, 1442.05, 2686.04	Mail Stop PGPUB DRAWINGS.....	507
Living matter (See also Biotechnology).....	2105	Mail Stop Reissue.....	1410
Local representative of attorneys .....	408	Mail Stop Sequence.....	2422.09, 2429
Locarno international classification designation ....	903.09(a)	Mailing action.....	707.12
		In <i>ex parte</i> reexamination .....	2264
		In <i>inter parte</i> reexamination .....	2664
		Mailing, Certificate of (See Certificate of mailing or transmission)	
		Maintenance Fee Branch .....	1501
		Contact information.....	1730
		Maintenance fees (See also Fee; Refunds) .....	1730
		.....	Chapter 2500
		Attorney or agent	
		Handling of requests to withdraw .....	2560
		Revocation of power of attorney.....	2501, 2560
		Change of correspondence address.....	2501, 2542
		Credit card used for payment of .....	2510, 2522
		Due dates for payment.....	2506
		Duplicate Payment.....	2532
		Facsimile submission.....	2510
		Fee address .....	2540
		Fee amounts.....	2501, 2520
		Forms.....	2595

**M**

Machine, process or product .....	806.05(e)
.....	806.05(f), 806.05(g)
Mail (See also Mail Stop and Correspondence)	
Address.....	501
Depositing correspondence .....	502
Distribution .....	501
Express .....	502, 513, 711.03(c)
Identification .....	502, 503
Receipt and handling.....	Chapter 500
Undelivered.....	707.13, 1303.02
Zip code.....	502
Mail date as filing date .....	513
Mail room date stamp.....	608.02(o)
Mail stop .....	501
Mail Stop 8 (Solicitor) .....	501, 1216, 1216.01
Mail Stop 10.....	1232



MANUAL OF PATENT EXAMINING PROCEDURE  
Mandatory Classification--Multiple dependent claims

Sec. No.	Sec. No.
Information available from Maintenance Fee Branch ..... 1730	Mathematical algorithms ..... 706.03(a), 2106
Information required with payment..... 2515, 2530	Matter not in original disclosure..... 608.04(a)
Insufficient ..... 2531	Means ..... 2181
Internet submission ..... 2510	Broadest reasonable interpretation..... 2181
Intervening rights in reinstated patents ..... 2591	Equivalent compared to Doctrine of
Late ..... 2531	Equivalents ..... 2186
Mailing address for maintenance fee documents ..... 501, 2510	Obviousness..... 2183
Mailing address for payments ..... 501	<i>Prima facie</i> case of equivalence ..... 2183, 2184
Maintenance Fee Branch ..... 2501	Related issues under 35 U.S.C. 112, first
Method of payment ..... 2522	or second paragraphs ..... 2181, 2185
Notices – Expiration, Receipt, Reminder..... 2575	Scope of the identification of prior art..... 2182
Obligation to pay while reissue is pending..... 1415.01	Single means claim ..... 2164.08(a), 2181
Overpayment ..... 2550	Means plus function limitations..... 706.02(m), 2106
Patents subject to payment of..... 2504	..... 2111.01, 2114, 2181 to 2186
Payment informalities ..... 2530	Mechanical search ..... 719.05
Petition to accept ..... 2515, 2531, 2590	Memorandum, citation..... 707.06
Reexamination ..... 2506	Merger of <i>ex parte</i> reexamination and reissue..... 2285
Refusal to accept and record payments,	Merger of <i>inter partes</i> reexamination and reissue .... 2686.03
Review of..... 2580	Merits, Appeal to Board of Patent Appeals
Reinstatement, delayed payment..... 2590	and Interferences..... Introduction
Unavoidable delay basis ..... 2590	Method of making and apparatus or product ..... 806.05(e)
Unintentional delay basis..... 2590	..... 806.05(f), 820
Reissue patents ..... 1415.01, 1443, 2504, 2506, 2520	Metric (S.I.) system usage ..... 608.01
Saturday, Sunday or Federal holiday, due on ..... 2504, 2506	Microorganisms (See Biotechnology)
Small entity status requirements ..... 2550	Microorganisms, deposit of ..... 1823.01, 2402 to 2411.05
Special Acceptance ..... 2530	Microorganisms, patentability of..... 706.03(a)
Status requests..... 1730, 2570	..... 2105, 2164.06
Mandatory Classification ..... 903.07	Militarily Critical Technology List (MCTL) ..... 120
Manual, authority of..... foreword	Military officer notary ..... 604.03(a)
Manual, subscription address ..... title page	Minor, inventor..... 409
Manual of Classification ..... Introduction, 902.01	Misjoinder, Effect on patent ..... 805
Manuscript decision ..... 707.06	Misjoinder of inventors ..... 201.03, 1402, 1412.04, 1481
Margin, application papers..... 608.01	Missing patent copy, Replacement ..... 901.09
Mark of applicant ..... 605.04(d)	Mistake (See Correction of patent; Errors)
Marking in application, erasing at allowance..... 1302.01	Mistake by Office in Pre-Grant Publication ..... 1130
Marking patent copy ..... 905.04	Mode, Best (See Best Mode)
Marking, Security..... 121	Mode of operation ..... 608.01(h)
Markush claim..... 803.02, 2173.05(h), 2173.05(o)	Model..... 608.03
Antedating reference for..... 715.03	Model, return ..... 608.03(a)
Supporting disclosure..... 608.01(p), 2163.05, 2164.03	Model at interview..... 713.08
Master classification file (MCF) ..... 902.03(a), 903.06	Model filed in priority country ..... 201.14(b)
Material mistake by Office in published PG-Pub..... 1130	Months, foreign language names ..... 901.05(a)
Materiality of information regarding patentability (See Duty of disclosure)	Months, foreign language names ..... 901.05(a)
	Motions in interferences (See Interference: Motions)
	Multiple dependent claims
	Fee calculation..... 607, 608.01(n)
	Handling ..... 608.01(n)



MANUAL OF PATENT EXAMINING PROCEDURE  
Nonelected species--Numbering paragraphs of letter

	Sec. No.		Sec. No.
Canceled .....	821.01, 821.02	<i>Ex parte</i> reexamination.....	2273
Withdrawn .....	821.01, 821.02	<i>Inter partes</i> reexamination.....	2662, 2667, 2674
Interference .....	2303.01	Notice of cross appeal.....	2662, 2674, 2674.01
Nonelected species		Notice of <i>Ex Parte</i> Reexamination Certificate Issuance in the <i>Official Gazette</i> .....	2291
Claims to		Notice of <i>Ex Parte</i> Request for Reexamination in the <i>Official Gazette</i> .....	2227
Canceled .....	821.01, 821.02	Notice of foreign filing after nonpublication request.....	1124
Withdrawn .....	809.02(c), 821.01, 821.02	Notice of informal patent application form (PTO-152) .....	707.07(a)
Non-English oath or declaration .....	602.06	Notice of Intent to Issue <i>Ex Parte</i> Reexamination Certificate (NIRC) PTOL-469.....	2235, 2250
Nonnaturally occurring manufacture or composition of matter.....	2105	.....	2250.01, 2271, 2271.01
Nonpatent literature.....	901.06	.....	2273, 2287, 2288, 2296
Nonprofit organization, claiming status as.....	509.03	Notice of Intent to Issue <i>Inter Partes</i> Reexamination Certificate (NIRC) PTOL-2068 .....	2666.10, 2666.20
Nonprofit organizations .....	509.02	.....	2671, 2671.01, 2673.01
Nonprovisional application (See also Application) .....	201.04(a), 506, 601	.....	2674, 2675, 2682, 2686.01
Nonpublication request, Application.....	1122	.....	2687, 2696
Nonpublication Request Under 35 USC 122(b)(2)(B)(i), form PTO/SB/35		Notice of Intent to Publish Statutory Invention Registration, SIR-L .....	1107
Cited.....	1121, 1122	Notice of <i>Inter Partes</i> Reexamination Certificate Issuance in the <i>Official Gazette</i> .....	2688, 2691
Reproduced .....	1135	Notice of <i>Inter Partes</i> Request for Reexamination in the <i>Official Gazette</i> .....	2627, 2629
Nonreceipt of Office letter .....	711.03(c)	Notice of New or Revised Pre-Grant Publication.....	1127
Nonsigning inventor's rights.....	409.03(i)	Notice of non-compliant amendment .....	714.01(e), 714.03
Nonstatutory claim.....	706.03(a), 2107.01	.....	714.22
Nonstatutory claim, canceled .....	1302.04(b)	Notice of Pre-Grant Publication .....	1127
Nonstatutory subject matter .....	706.03(a)	Notice of references cited form (PTO-892).....	609, 707.05
.....	2105 to 2107.01	.....	707.05(a) to 707.05(e), 2687
Not fully responsive amendment.....	714.02, 2266.01	Notices (See also Publication).....	Introduction, 707.06
.....	2666.30, 2671	Notices, maintenance fees .....	2575
Notary jurisdiction .....	604.02	Nuclear material application.....	706.03(b)
Notary jurisdiction, military officer .....	604.03(a)	Nucleotide sequences (See also Biotechnology; Sequence rules).....	803.04, 1823.02, 1848
Notary jurisdiction, venue agreement .....	604.02	.....	1850, 1877, Chapter 2400
Notary seal .....	604.01	Publication on web for PG-Pubs.....	1121
Notation of possible interference .....	2301.01(b)	Restriction practice .....	803.04, 1850, 2434
Notation on file wrapper/history		Nullification of double patenting rejection.....	804.01
Foreign application.....	202.03	Number, Application .....	503, 506
Parent application.....	201.11, 202.02	Number, Drawing reference character.....	608.01(g)
Notice, citation .....	707.06	Number, Serial.....	503, 506
Notice of allowability.....	1302.03	Numbering of papers in file wrapper.....	719.01(a)
Notice of allowance (See also Allowance and issue; Form letters and forms: Notice of Allowance and Issue Fee Due PTOL-85) .....	1303	Numbering paragraphs of letter.....	707.07(k)
Assigned application .....	308		
Deceased inventor .....	1303.03		
Reissue application.....	1444		
Secrecy order application .....	115, 130		
Undelivered.....	1303.02		
Notice of appeal .....	1205		

INDEX  
Oath--Obviousness

	Sec. No.		Sec. No.
<b>O</b>			
Oath (See also Declaration)		Notary certificate .....	602.01
After appeal .....	1212.02	Notary jurisdiction .....	604.02, 604.03(a)
Antedating patent for interference (Rule 1.608) .....	2308 to 2308.02	Refers to preliminary amendment .....	601.01(a), 602
Antedating reference (See Affidavit, swearing back of reference (37 CFR 1.131))		Seal .....	604.01
Inspection during interference (Rules 1.131, and 1.608(b) .....	2312	Seal, Foreign application .....	602.04(a)
Minor, by .....	409	Seal, Not required .....	604.01, 604.03(a)
Non-English .....	602.06	Signed before alteration of specification .....	605.04(a)
Original (See also Oath, Original, Rule 1.63) .....	602	Substitute .....	602.02
Plant application (Rule 1.162) .....	1604	Venue .....	604.02
Reissue (Rule 1.175) .....	706.03(x), 1414, 1444	Oath, Supplemental, Rule 1.67 .....	603
Supplemental .....	1414.01	After allowance .....	603.01, 714.16
Supplemental .....	602.02, 603	Change of inventorship .....	201.03
Supplemental and allowance .....	603.01	Oaths, Conflicting .....	201.03
Traversing rejection (Rule 1.132) .....	716	Object of invention .....	608.01(d)
Oath, Antedating reference (See also Affidavit, swearing back of reference (37 CFR 1.131)) .....	715	Objection contrasted with rejection .....	706.01
Oath, International application .....	1893.01(e)	Objection, Dependent claims .....	608.01(n)
Oath, Original, Rule 1.63 .....	602	Objection to formal matters, When made .....	707.07(a)
Administering .....	604	.....	707.07(j), 710.02(b), 714.14
Amendment .....	602.01	Obvious error, correction .....	1302.04, 1305
Attorney administers .....	604.06	Obviously informal application .....	702.01, 704.10
Consular certificate .....	604.04	Obviousness .....	706.02, 706.02(j), 2141 to 2146
Continuing application .....	201.06(c)	Age of reference .....	2145
Copies, filing of .....	602	Analogous prior art .....	1504.03, 2141.01(a), 2145
Date of execution .....	602.05	Design applications .....	1504.03
Declaration in lieu of, Rule 1.68 .....	602	Form paragraphs used for rejection .....	706.02(m)
Defective .....	602.01, 602.02, 602.03	Number of references .....	2145
Delayed filing .....	506	Ordinary skill, level of .....	2141.03
Divisional application .....	602.05(a)	<i>Prima facie</i> case .....	2142 to 2143.03, 2144.02
Executed before alteration of specification .....	605.04(a)	Predictability .....	2143.02
Execution .....	604	Rebuttal against .....	2145
Facsimile .....	602	Process claims, nonobvious product .....	2116.01
Foreign execution .....	602.04	Provisional rejection .....	706.02(k)
Foreign-filed applications listed .....	201.14, 201.14(c)	Ranges .....	2144.05
.....	202.04	Rationale for .....	2144 to 2144.09
Invalid, By attorney in case .....	604.06	Adjustable, making .....	2144.04
Jurisdiction of notary .....	604.02, 604.03(a)	Aesthetic design changes .....	2144.04
New required .....	602.01, 602.02	Automating manual activity .....	2144.04
Notary .....	602, 602.01, 602.04(a), 604.01	Duplication of parts .....	2144.04
.....	604.02, 604.03(a), 604.06	Elimination of element or step .....	2144.04
		Equivalence, art-recognized .....	2144.06
		Genus-species .....	2144.08
		Integral, making .....	2144.04
		Omission of element or step .....	2144.04
		Portable, making .....	2144.04
		Proportion changes .....	2144.04
		Purifying old product .....	2144.04

MANUAL OF PATENT EXAMINING PROCEDURE  
 Offenlegungsschriften--Office of the Deputy Commissioner for Patent

	Sec. No.		Sec. No.
Ranges .....	2144.05	Office of Initial Patent Examination (OIPE)(See also	
Rearrangement of parts .....	2144.04	Incoming-Mail Section).....	201.03, 201.06(c), 201.06(d)
Reversal of parts .....	2144.04	.....	202.02, 202.03, 203.08, 501, 502, 503
Separable, making .....	2144.04	.....	506, 508.03, 601, 601.01(d), 601.01(f)
Sequence, change in .....	2144.04	.....	601.01(g), 601.01(h), 602.05(a), 605.04(c)
Shape changes .....	2144.04	.....	605.04(f), 605.04(g), 607, 608.01, 608.02(a)
Size changes .....	2144.04	.....	608.02(z), 609, 707.07(a), 714.16(d)
Species-genus .....	2144.08	.....	719.01(b), 719.02, 719.02(b), 903.08(a)
Rebuttal arguments by applicant .....	2145	.....	1306, 1414, 1706
Teaching away in prior art .....	2141.02, 2145	Contact information.....	1730
Offenlegungsschriften.....	901.05(b)	Customer Service Center.....	1730
Offensive language.....	608, 1504.01(e)	Petitions handled.....	1002.02(q)
Redacted in Pre-Grant Publication.....	1120	Office of International Relations .....	201.13, 203.08(a)
Offensive subject matter .....	1003, 1504.01(e)	Office of Patent Classification..	903, 903.05, 903.09, 905.02
Offer to sell .....	706.02(c), 2133.03(b)	Office of Patent Legal Administration (OPLA) (See also	
Offer to surrender original patent.....	1416	Central Reexamination Unit (CRU)) .....	103, 409.03
Office action (See Action)		.....	409.03(h), 409.03(j), 506.02, 706.02(l)(2)
Office action in <i>ex parte</i> reexamination.....	2260, 2262	.....	720, 720.01, 720.03, 720.04
Office action in <i>inter partes</i> reexamination.....	2660, 2671	.....	1002.02(b), 1430, 1449, 1449.01
Not closing prosecution.....	2671.01	.....	1451, 1456, 1457, 2226, 2232, 2235,
Reopening prosecution after ACP.....	2673, 2673.01	.....	2281, 2284, 2285, 2287, 2288, 2294
Reopening prosecution after Examiner's Answer		.....	2626, 2642, 2666.50, 2667, 2668
.....	2679	.....	2686.01 to 2687, 2694
Reopening prosecution after RAN .....	2676, 2677	Office of Patent Publications (a.k.a. Publishing Division)	
Office date stamp .....	505, 506, 710.01(a), 714.18	.....	104, 201.14(c), 203.04
Office hours.....	510	.....	502, 502.01, 508.03, 603.01, 608.01(m)
Office of the Commissioner for Patents.....	409.01(b)	.....	608.02(z), 711.01, 711.05, 714.16(d)
.....	409.03, 409.03(h), 409.03(i), 409.03(j)	.....	724.05, 903.07, 1302.05, 1302.05(a)
.....	1721, 1901.03, 1902.01	.....	1302.09, 1302.12, 1308, 1309, 1309.02, 1611
Duty of disclosure to .....	2001.03	.....	2235, 2283, 2287, 2289, 2635, 2686.01, 2687
Office of the Deputy Assistant		Petitions decided.....	1002.02(r)
Commissioner for Patents .....	1721	Pre-Grant Publications Division.....	502, 502.01, 1120
Office of Congressional Relations .....	203.08(a)	.....	1122, 1125, 1126, 1730
Office of Electronic Information Products and Services		Telephone number .....	1730
.....	Title Page, 1730	Office of Patent Quality Review.....	1302.04, 1308.03
Office of Enrollment and Discipline .....	406, 407, 410, 502	Office of PCT Legal Administration .....	103, 1730
.....	510, 601.03, 604.06, 714.01(a)	Office of Petitions.....	106, 201.03, 502, 605.04(c)
.....	714.13, 1002.02(k)(1), 1002.02(m)	.....	605.04(f), 605.04(g), 609, 1002.02(b), 1308
.....	2205, 2220, 2620	Location and phone number.....	1730
Mailing address .....	501	Office of Public Records .....	103, 104, 711.04, 1128, 1309
Office of General Law .....	1002.02(k)(2)	Office of Solicitor.....	302.04, 311, 1002.02(k)(3)
		.....	1216.01, 1216.02, 1701.01, 1720
		.....	1721, 2207, 2681
		Mailing address .....	501

INDEX  
Office of the Deputy Commissioner for Patent--Operative

	Sec. No.	Sec. No.
Office of the Deputy Commissioner for Patent		
Examination Policy .....	502.03, 720, 720.01	
.....	720.03, 1002.02(b), 1721	
.....	2307.04, 2307.05, 2677	
Petitions decided by .....	1002.02(b)	
Official action .....	707	
Official cross-reference, order of .....	903.06	
<i>Official Gazette</i> (O.G.).....	Introduction, 409.03, 1703	
As prior art reference .....	903.06	
Claim published .....	1302.09	
Reissue application.....	1455	
From <i>ex parte</i> reexamination certificate.....	2287	
From <i>inter partes</i> reexamination certificate .....	2691	
Copies and Subscriptions .....	1703	
Defensive publications .....	711.06(a)	
Designating classification .....	1302.09	
Drawing figure .....	1302.09	
eOG:P.....	1703	
Issuing as U.S. patent.....	901.05	
Notice of Board title changes .....	1203	
Notice of <i>ex parte</i> reexamination certificate ..	2288, 2291	
Notice of <i>inter partes</i> reexamination certificate		
.....	2688, 2691	
Notice of Certificate of Correction.....	1480, 1485	
<i>Notices</i> .....	1703	
Notices of maintenance fees due .....	2501, 2575	
Notice of <i>ex parte</i> reexamination request.....	2229	
Notice of <i>inter partes</i> reexamination request		
.....	2627, 2629 to 2631	
Online.....	1703	
<i>Patents</i> .....	1703	
Published electronically .....	1703	
Publishing disclaimers .....	1490	
Reissue application filing notice .....	1430, 1441	
.....	1441.01, 1443, 1453, 1457, 1470, 1703	
Statutory Invention Registration (SIR).....	1111	
<i>Trademarks</i> .....	1703	
Official inquiries .....	203.08(a)	
Official Notice.....	2144.03	
OIPE (See Office of Initial Patent Examination (OIPE))		
“Old art” use in deciding request for reexamination		
.....	2242, 2642	
Old combination.....	2173.05(j)	
Old combination, restriction.....	806.05(b), 820.01	
Omission in reply, inadvertent .....	710.02(c)	
.....	2266.01, 2666.30	
Omnibus claim.....	706.03(d), 2173.05(r)	
Cancellation.....	1302.04(b)	
On-line search (See also Electronic databases)		
.....	706.02(e), 901.06(a), 902.03(e)	
On sale (See also Public Use).....	706.02(c)	
.....	2133.03, 2133.03(b)	
Affidavit or declaration .....	715.10	
Anticipation rejection .....	2133.03(b)	
Buyer .....	2133.03(b)	
Commercial activities .....	2133.03, 2133.03(c)	
.....	2133.03(e), 2133.03(e)(1)	
Completion of the invention .....	2133.03, 2133.03(b)	
.....	2133.03(c), 2133.03(e)(1), 2133.03(e)(3)	
Admission of completion by 37 CFR 1.131		
affidavit .....	2133.03(c)	
Definition of .....	2133.03(b)	
Conditional sale .....	2133.03(b)	
Nonprofit sale.....	2133.03(b)	
Sale of rights .....	2133.03(b)	
Single sale .....	2133.03(b)	
Delivery of offered goods.....	2133.03(b)	
Device embodying process .....	2111.03(c)	
Evidence of (prior art publications).....	2133.03(b)	
Experimental use (See also Experimental use)		
.....	2133.03, 2133.03(e)	
Goods “on hand” .....	2133.03(b)	
“In this country” .....	2133.03(d)	
Invention.....	2133.03(c)	
Intent to sell.....	2133.03(b), 2133.03(e)(2)	
Offer for sale.....	2133.03(b)	
Policy considerations.....	2133.03	
“Ready for patenting” .....	2111.03(c)	
Reduction to practice .....	2133.03(c), 2133.03(e)	
Sale by inventor or associate .....	2133.03(b)	
Sale by third party.....	2133.03(b)	
Testing by third party.....	2133.03(e)(5)	
.....	2133.03(e)(7)	
Sale of a process .....	2133.03(c)	
Sale of “rights” .....	2133.03(b)	
Secrecy .....	2133.03, 2133.03(b)	
Supervision and control over invention .....	2133.03(e)(5)	
.....	2133.03(e)(7)	
Test for determining if impermissible sale occurred		
.....	2133.03(b)	
Operating hours (See Hours of operation)		
Operative .....	2164.07, 2164.08(b)	

MANUAL OF PATENT EXAMINING PROCEDURE  
Operative example--Parent application data, Cross-noting

	Sec. No.		Sec. No.
Operative example .....	608.01(p)	Oversight of <i>inter partes</i> reexamination .....	2689
Operative, Showing .....	608.03, 716	Owner's representative .....	Chapter 400
Opposition to issue of patent (See Protest)		Ownership and assignment .....	Chapter 300, 706.02(l)(2)
Oral hearing in reexamination		.....	706.02(l)(3)
<i>Ex parte</i> .....	2276	Ownership at time invention made .....	706.02(k)
<i>Inter partes</i> .....	2662, 2675, 2677, 2680	.....	706.02(l) to 706.02(l)(3)
Open to public .....	2680	Ownership of applications filed subsequent to recording of	
Oral hearing on appeal .....	1209	assignment .....	201.12, 306
Order, citation of .....	707.06		
Order, Classification .....	902.04		
Order granting <i>ex parte</i> reexamination .....	2246		
Order granting <i>inter partes</i> reexamination .....	2646, 2660		
Returned as undelivered .....	2654		
Order of examination .....	707.02, 708 to 708.03		
Patentability report .....	705.01(b)		
Order of papers in file wrapper .....	719.01(a)		
Order for compliance .....	1210.01		
Ordering			
Abandoned file .....	711.04(b), 905.03		
Allowed applications .....	1306.03		
Cross-references .....	903.06		
Foreign patent .....	901.05(c)		
Patented file .....	711.04(b), 905.03		
Publication .....	901.06(b)		
Reexamination, decision			
<i>Ex parte</i> .....	2246, 2247, 2247.01		
<i>Inter partes</i> .....	2646		
Soft copy .....	905.02		
Subclass list .....	902.03(c)		
Orders (See also Publication) .....	Introduction, 707.06		
Ordinary and customary meaning of claim term			
.....	2106, 2111.01		
Evidence of .....	2111.01		
Original application (See Nonprovisional application)			
Original carries title to some continuing applications	201.12		
Original disclosure, inherent characteristics .....	608.04(a)		
Ornamentality lacking in design applications .....	1504.01(c)		
Outstanding requirements .....	707.07(e)		
Overcoming a reference, Right of priority .....	201.15		
.....	706.02(b)		
Overlapping applications			
Same applicant .....	709.01, 715.01(a), 804		
.....	804.02, 822, 822.01, 2315.01		
Same assignee .....	706.02(f)(2), 706.02(k)		
.....	706.02(l) to 706.02(l)(3), 709.01		
.....	715.01(b), 822, 2315.01, 2302		
Overlapping claims .....	804.02		

**P**

P.O. Box (See Mail stop)	
PAIR .....	102, 104, 203.08, 1121, 1128, 1730, 2232, 2632
PALM .....	101, 102, 508.01, 508.03, 711.04(b)
.....	1845.02, 1893, 1893.03(a), 1893.03(b)
.....	1895.01, 2232, 2233, 2235, 2237
.....	2289, 2629, 2632, 2633, 2635, 2647.02
.....	2648, 2660, 2664, 2670, 2687, 2689
Application location .....	905.05, 2635
Application records and reports .....	1704
Application status .....	102
Examiner Docket, Time, and Activity Reports .....	1705
“Flag” in reissue application .....	1456
Paper Correlating Office .....	508.03
Paper, easily erasable .....	608.01, 714.05, 714.07, 714.19
Paper number .....	714.18, 714.21
Paper number of print .....	719.01(b)
Paper size (See also A4 size paper)	
Application papers .....	608.01
Drawings .....	608.02
Photographs .....	608.02
Substitute drawings .....	608.02(h)
Papers (See also Return of Papers)	
Delivered to wrong Technology Center .....	508.01
Depositing .....	502
Distribution .....	508
File wrapper .....	719.01, 719.01(a)
Identification .....	502, 503
Receipt and handling .....	Chapter 500
Received after patenting or abandonment .....	508.02
Signature required .....	402
Submitted in reissue litigation .....	1404
Unmatched .....	508.03
Parent application .....	201.04

INDEX

Parent application data, Cross-noting--Patent and Trademark Office (PTO or USPTO)

Sec. No.	Sec. No.
Parent application data, Cross-noting..... 201.11	Interference..... 2306 to 2308.02
..... 202.01, 202.02	Inventorship..... 2137.01
Parent application carries assignment	Jurisdiction ..... 1305
to some continuing applications ..... 201.12	Law, opinions not given ..... 713.02
Parent application review ..... 707.05, 719.05	Laws (See Statutes)
..... 904, 2001.06(b)	Licensing ..... 301
Paris Convention (See also Treaties)..... 201.13, App. P	Litigation relating to reissue ..... 1442.04
Article 4 Cited..... 201.13, 201.14(b)	Marking examiner's copy ..... 905.04
Partial signatory authority ..... 1005	Missing copy ..... 901.09
Patent	Ordering soft copy ..... 905.02
1836 (present) series ..... 901.04	Owner, appeal by..... 1205
A.I. series ..... 901.04	Owner, service of citation on..... 2208
Allowance and issue..... Chapter 1300	Owner's address in reexamination..... 2222, 2622
Application publication..... 1120 to 1135	Ownership..... 301
Arrangement in Examiner's Search Files..... 901.07	Plant series..... 901.04, Chapter 1600
Assignment..... 301	Post-issuance information updating..... 2501
Borrowing from Examiner's Search Files..... 901.08	Prior art citation in..... 2003.01
Citation handling..... 1920	Printing priority ..... 1309
Citation of prior art in ..... 1920, 2202	Publication of application..... 1120 to 1135
Claim copied (See Claim presented corresponding to	Reconstruction of file ..... 508.04
claim of patent)	Reference (See Reference)
Classification change ..... 903.05	Reissue series..... 901.04
Classification indices ..... 902.03, 902.03(a)	Reissued, effect of ..... 1460
Classification Home Page on the Internet ..... 902.03(a)	Right to exclude others ..... 509.02, 1111
Classification Home Page on the USPTO Intranet	..... 1601, 2162
..... 902.03(b)	Rules (See Rules, Patent (Code of Federal Regulations))
Classification Insight on USPTO LAN..... 902.03(c)	Simultaneous issue ..... 1306.02
Copy in <i>ex parte</i> reexamination request..... 2219	Soft copy..... 905.02
Double column format..... 2214, 2219	Statutory subject matter ..... 706.03(a), 2107,1601
Copy in <i>inter partes</i> reexamination request ..... 2619	Surrender of original in reissue..... 1416, 1443
Double column format..... 2614	Statutes (See Statutes)
Copy Orders ..... 1730	System, Constitutional basis for ..... Introduction
Correction of ..... Chapter 1400	Term adjustment..... 2710 to 2736
Cost of copy ..... 905.02	Terms (See Term, Patent)
Definition ..... Introduction, 2135.01	Transfer..... 903.05
Design ..... Chapter 1500	Transfer of rights in ..... 509.02
Design series ..... 901.04	Type, Design vs. utility..... 1502.01
Design vs. Utility ..... 1502.01	Utility series..... 901.04, 1502.01
Effective date ..... 706.02(a), 715, 715.01, 2133.01	Utility vs. design..... 1502.01
Extension (See Term, Patent)	X series ..... 901.04
File reconstruction..... 508.04	Patent Academy..... Title page, 713.01
Files..... 905.03	Patent and Trademark Assignment System ..... 302.09
Foreign (See Foreign patent)	Patent and Trademark Copy Sales ..... 707.05(a)
General Information About, booklet ..... 703	Patent and Trademark Office (PTO or USPTO)
Issue ..... Chapter 1300	Address..... 501, 502
Issue Notification form ..... 1306.03	Business hours ..... 510
Index ..... 902.03(b)	Employees, property interest in patent ..... 309



MANUAL OF PATENT EXAMINING PROCEDURE  
Patent application publication--Patent Cooperation Treaty (PCT)

Sec. No.	Sec. No.
Matters decided by various officials .....Chapter 1000	Concepts, major ..... 1801
Publications .....Introduction	Country codes ..... 1851
Attorneys and Agents Registered to Practice Before the United States Patent and Trademark Office .....401, 902.03(d), 1706	Definitions ..... 1802
Development and Use of Patent Classification Systems ..... 903.02	Design patents ..... 1501.01, 1503.01
Official Gazette of the United States Patent and Trademark Office (See <i>Official Gazette</i> (O.G.))	Designated office ..... 1893.01(a)
Receipt and handling of mail .....Chapter 500	Designation of states.....1817.01, 1817.01(a)
Telephone numbers ..... 1730	Fees.....1827, 1893.01(c)
Web site..... 1730	Reduced basic fee by filing sequence listing and/or tables on compact disc..... 1823.02
Patent application publication (See Pre-Grant Publication (PG-Pub))	Filing date requirements ..... 1810
Patent Assistance Center (See Inventors Assistance Center)	Foreign filing license ..... 1832
Patent attorney or agent (See Attorney or agent)	Foreign patent citation codes ..... 1851
Patent classification (See also Classification; Prior Art) .....Chapter 900	Forms
Classes..... 707.05(e), 902.01	Compact Disc Transmittal Sheet For Submission of Sequence Listing and/or Tables To The United States Receiving Office Under Pct Administrative Instructions-Part 8 ..... 1823.02
..... 902.02, 903.02(a), 903.02(b)	IB/307 ..... 1893.03(e)
Cross references ..... 903.06, 903.07, 903.07(a)	IB/308 ..... 1893.01(a)(1)
Digests..... 903.06, 903.07	PCT/DO/EO/903 ..... 1893.01(a)(3), 1893.03(a)
Issue slip..... 903.07	..... 1893.03(b), 1893.03(e)
Manual of Classification .....Introduction, 902.01	..... 1893.03(g), 1895.01
Master classification file (MCF) ..... 902.03(a), 903.06	PCT/DO/EO/905 ..... 1893.01(a)(1), 1893.01(d)
Orders..... 902.04	..... 1893.01(e), 1893.03(b)
Post classifier (See Post classifier)	PCT/DO/EO/1390 ..... 1893.03(a)
Shoes .....510, 901.05(c), 901.07, 902.02(b), 905.04	PCT/ISA/201..... 1852
Statutory authority..... 903.01	PCT/ISA/203..... 1843.04
Subclasses ..... 707.05(e), 902.01	PCT/ISA/206..... 1850
.....902.02, 903.02(a), 903.02(c)	PCT/ISA/210..... 1843.04, 1844, 1844.01
Patent classifier's decision ..... 903.08(f)	.....1845.02, 1893.03(e)
Patent Cooperation Treaty (PCT) (See also International application; Treaties)..... Chapter 1800, App. T	PCT/ISA/217..... 1836
Administrative Instructions ..... App. AI	PCT/ISA/220..... 1844, 1845.02
Agent..... 1807	PCT/IPEA/401 ..... 1864, 1865, 1866
Amendment before the designated office... 1893.01(a)(2)	PCT/IPEA/405 ..... 1875, 1875.01
..... 1893.01(a)(3)	PCT/IPEA/408 ..... 1860, 1860.01, 1874,
Amendment of claims before the International Bureau ..... 1853	..... 1876, 1878, 1878.01, 1879
Applicant..... 1810, 1817.01, 1817.01(a)	PCT/IPEA/409 ..... 1871, 1871.01, 1874, 1878
Applicant for United States Receiving Office..... 1805	..... 1878.01, 1878.01(a), 1879, 1893.03(e)
..... 1810, 1820	PCT/IPEA/410 ..... 1864.04
Basic flow timeline ..... 1842	PCT/IPEA/411 ..... 1876
Classification of application.....903.08(b)	PCT/IPEA/412 ..... 1836, 1876.01
Classification of subject matter ..... 1844.01, 1879	PCT/IPEA/416 ..... 1879.02
Common representative..... 1807	PCT/IPEA/420 ..... 1875.02
	PCT/IPEA/428 ..... 1878.02
	PCT/RO/101 ..... 1801, 1812, 1817.01(a)
	..... 1821, 1844, 1844.01
	PCT/RO/117 ..... 1893.03(e)

INDEX

Patent Cooperation Treaty Administrative Instructions--Patent Cooperation Treaty Rules

Sec. No.	Sec. No.
PCT/RO/136 .....	1893.03(e)
PTO-1382 .....	1830, 1832
USPTO/299 .....	1850
USPTO/499 .....	1850, 1875, 1875.01
Gazette .....	1801, 1823.01, 1857
Guidelines on qualifying for reduced basic fee by filing sequence listing on compact disc .....	1823.02
Help Desk.....	1730
Information sources.....	1730
International Bureau.....	1801
International preliminary examination .....	1860, 1860.01
International preliminary examination report.....	1879
International preliminary report on patentability .....	1801
.....	1845, 1879.03, 1893.03(e)
International publication .....	1857
Prior art effect.....	1857.01, 1896, 2136.03
International search report.....	1844
International searching authority.....	1840
Member countries.....	1817
National procedure .....	1893
National stage (See National stage application (35 U.S.C. 371))	
Numbering of sheets .....	1812
Office of PCT Legal Administration.....	103, 1730
Priority .....	201.13(b), 1828, 1893.03(c), 1895
Priority document.....	201.13(b), 1828
Publication .....	1857
Receiving office .....	1801
Receiving office procedure .....	1801
Record copy transmittal .....	1801
Regular filing in each designated state.....	1893.01(b)
Reply to invitation concerning lack of unity of invention .....	1850, 1875.02, 1893.03(d)
Reply to written opinion.....	1878.02
Representation before the designated office.....	402
Revocation of agent.....	1808
Schedule of fees .....	1827
Search report .....	707.05, 1302.14, 1844
Secrecy order.....	120
Sequence listings.....	1823.02, 1848
On electronic media .....	1823.02
Signature missing.....	1820
Unity of invention .....	823, 1850, 1875, 1893.03(d)
Written opinion, preparation .....	1845, 1878, 1878.01
Written opinion, time to reply to.....	1845.01, 1878, 1878.01
	Patent Cooperation Treaty Administrative Instructions
	..... App. AI
	105 Reproduced .....
	1834
	204 Reproduced .....
	1823
	205 Reproduced .....
	1824
	208 Reproduced .....
	1823.02
	209 Reproduced .....
	1823
	404 Reproduced .....
	1857
	502 Reproduced .....
	1850
	513 Reproduced .....
	1848
	603 Reproduced .....
	1875.02
	604 Reproduced .....
	1879
	605 Reproduced .....
	1872
	606 Reproduced .....
	1880
	607 Reproduced .....
	1876
	801 Reproduced .....
	1823.02
	803 Reproduced .....
	1823.02
	Patent Cooperation Treaty Articles..... App. T
	3 Reproduced .....
	1812
	5 Reproduced .....
	1823
	6 Reproduced.....
	1824
	7 Reproduced .....
	1825
	11 Reproduced .....
	1810, 1896
	17 Reproduced .....
	1843
	18 Reproduced .....
	1844
	19 Reproduced .....
	1853
	21 Reproduced .....
	1857
	29 Reproduced .....
	1857
	30 Reproduced .....
	110
	31 Reproduced .....
	1864.02, 1864.03, 1865, 1869
	32 Reproduced .....
	1862
	33 Reproduced .....
	1878.01(a)
	..... 1878.01(a)(1), 1878.01(a)(3)
	34 Reproduced .....
	1862, 1864.01, 1874
	..... 1875, 1878, 1878.01, 1878.02
	35 Reproduced .....
	1879
	36 Reproduced .....
	1879.02, 1879.03
	37 Reproduced .....
	1880
	38 Reproduced .....
	1879.04
	Patent Cooperation Treaty Rules
	4.3. Reproduced .....
	1844.01
	4.11. Reproduced .....
	1817.02, 1819
	4.15. Reproduced .....
	1820
	5.1. Reproduced .....
	1823
	5.2. Reproduced .....
	1823.02
	6 Reproduced .....
	1824
	6.1. Reproduced .....
	1824

MANUAL OF PATENT EXAMINING PROCEDURE  
Patent Cooperation Treaty Rules--Patent Cooperation Treaty Rules

	Sec. No.		Sec. No.
6.2. Reproduced .....	1824	40 Reproduced .....	1850
6.3. Reproduced .....	1824	40.1. Reproduced .....	1850
6.4. Reproduced .....	1824	40.2. Reproduced .....	1850
6.5. Reproduced .....	1824	40.3. Reproduced .....	1850
7 Reproduced .....	1825	41 Reproduced .....	1852
7.1. Reproduced .....	1825	41.1. Reproduced .....	1852
7.2. Reproduced .....	1825	43bis Reproduced .....	1845
8 Reproduced .....	402.09, 1826	43bis.1. Reproduced .....	1845
8.1. Reproduced .....	1826, 1844.01	44ter. Reproduced .....	1879.04
8.2. Reproduced .....	1826, 1844.01	46 Reproduced .....	1853
8.3. Reproduced .....	1826, 1844.01	46.1. Reproduced .....	1853
11 Reproduced .....	1825	46.2. Reproduced .....	1853
11.5. Reproduced .....	1825	46.3. Reproduced .....	1853
11.6. Reproduced .....	1825	46.4. Reproduced .....	1853
11.11. Reproduced .....	1825	46.5. Reproduced .....	1853
11.13. Reproduced .....	1825	54 Reproduced .....	1864.02
13 Reproduced .....	1850	54.1. Reproduced .....	1864.02
13.1 Reproduced .....	1850	54.2. Reproduced .....	1864.02
13.2 Reproduced .....	1850	54.3 Reproduced .....	1864.02
13.3 Reproduced .....	1850	54.4. Reproduced .....	1864.02
13.4 Reproduced .....	1850	60 Reproduced .....	1868
13.5 Reproduced .....	1850	60.1. Reproduced .....	1868
13 <sup>bis</sup> Reproduced .....	1823.01	61 Reproduced .....	1881
13 <sup>bis</sup> .1. Reproduced .....	1823.01	61.2. Reproduced .....	1881
13 <sup>bis</sup> .2. Reproduced .....	1823.01	61.3. Reproduced .....	1881
13 <sup>bis</sup> .3. Reproduced .....	1823.01	62 Reproduced .....	1871, 1871.01
13 <sup>bis</sup> .4. Reproduced .....	1823.01	62.1. Reproduced .....	1871, 1871.01
13 <sup>bis</sup> .5. Reproduced .....	1823.01	62.2. Reproduced .....	1871, 1871.01
13 <sup>bis</sup> .6. Reproduced .....	1823.01	62bis Reproduced .....	1871
13 <sup>bis</sup> .7. Reproduced .....	1823.01	62bis.1 Reproduced .....	1871
13 <sup>ter</sup> Reproduced .....	1823.02	64 Reproduced .....	1878.01(a)
13 <sup>ter</sup> .1 Reproduced .....	1823.02, 1848	64.1. Reproduced .....	1878.01(a)
13 <sup>ter</sup> .2 Reproduced .....	1823.02	64.2. Reproduced .....	1878.01(a)
17 Reproduced .....	201.13(b)	64.3. Reproduced .....	1878.01(a)
17.1. Reproduced .....	201.13(b)	65 Reproduced .....	1878.01(a)(2)
17.2 Reproduced .....	201.13(b)	65.1. Reproduced .....	1878.01(a)(2)
33 Reproduced .....	1843	65.2. Reproduced .....	1878.01(a)(2)
33.1. Reproduced .....	1843	66 Reproduced ..	1843.02, 1864.01, 1870, 1878, 1878.02
33.2. Reproduced .....	1843	66.1. Reproduced .....	1843.02
33.3. Reproduced .....	1843	66.1bis. Reproduced .....	1878
37.1 Reproduced .....	1844.01	66.3. Reproduced .....	1878.02
37.2 Reproduced .....	1844.01	66.4. Reproduced .....	1878
38 Reproduced .....	110, 1844.01	66.5. Reproduced .....	1878.02
38.1 Reproduced .....	1844.01	66.6. Reproduced .....	1878.02
38.2 Reproduced .....	1844.01	66.7. Reproduced .....	1870
39 Reproduced .....	1843.02	66.8. Reproduced .....	1864.01, 1878.02
39.1. Reproduced .....	1843.02	66.9. Reproduced .....	1878.02

INDEX  
Patent and Trademark Depository Libraries (PTDLs)--

Sec. No.	Sec. No.
69 Reproduced .....	Count .....
69.1. Reproduced .....	Date status .....
69.2. Reproduced .....	Dispute between examiners .....
70 Reproduced .....	Drawing .....
70.17 Reproduced .....	Final action .....
71 Reproduced .....	Improper .....
71.1. Reproduced .....	Initiate .....
71.2. Reproduced .....	Interviews .....
72 Reproduced .....	Limitation as to use .....
72.1. Reproduced .....	Practice used only in extraordinary situations .....
72.2. Reproduced .....	Primary decides propriety .....
72.2bis. Reproduced .....	Print of drawing .....
72.3. Reproduced .....	Purpose .....
82 Reproduced .....	Request for .....
82.1. Reproduced .....	Recording .....
82.2. Reproduced .....	Restriction, Effect on .....
90.4. Reproduced .....	Search .....
90.5. Reproduced .....	Sequence of examination .....
90.6. Reproduced .....	Transfer of appeal .....
90 <sup>bis</sup> Reproduced .....	Patentability review conference in <i>ex parte</i> reexamination
90 <sup>bis</sup> .1 Reproduced .....	..... 2271, 2271.01, 2287
90 <sup>bis</sup> .2 Reproduced .....	Patentability review conference in <i>inter partes</i>
90 <sup>bis</sup> .3 Reproduced .....	reexamination .....
90 <sup>bis</sup> .4 Reproduced .....	..... 2671.03
90 <sup>bis</sup> .5 Reproduced .....	Patentability statement .....
90 <sup>bis</sup> .6 Reproduced .....	..... 609, 1302.14
90 <sup>bis</sup> .7 Reproduced .....	Patentable novelty, pointed out .....
91 Reproduced .....	..... 714.04
91.1. Reproduced .....	Patentable subject matter
92 Reproduced .....	Computer programs .....
92.1. Reproduced .....	Disclosed but not claimed .....
92.2. Reproduced .....	Living subject matter .....
Patent and Trademark Depository Libraries (PTDLs)	Mathematical algorithms .....
Accepting documents under the Disclosure Document	Plants .....
Program .....	..... 1601, 2105
..... 1706	Patented file .....
Patent application publication (See Pre-Grant Publication	..... 905.03
(PG-Pub))	Patented file, ordering .....
Patent pending (See Statutes: 35 U.S.C. 292)	..... 711.04(b)
Patent search room .....	“Patent In” computer program (See also Sequence rules)
Hours .....	..... 1730, 2430
Regulations for public use .....	Patents of addition, foreign .....
..... 510	..... 901.05(b)
Patent term extension/adjustments .....	Payment of fees .....
..... 1303, 2211, 2250	..... 509
..... 2611, 2666.01	Payor number (See Customer numbers)
Patentability (See also Reasons for Allowance; Rejection)	PCT (See Patent Cooperation Treaty (PCT))
..... Chapter 2100	Pencil notations, erased at allowance .....
Patentability report .....	..... 1302.01
Appeal .....	Pending application as prior art (See also Application
..... 705.01(a), 1208	publication) .....
	..... 706.02(f)(2), 706.02(k), 901.03
	Pending application charge location .....
	..... 905.05
	Pending application preserved in confidence .....
	..... 101
	Pending applications as references (See also Application
	Publication) .....
	..... 706.02(f)(1), 706.02(f)(2)
	..... 706.02(k), 901.03

MANUAL OF PATENT EXAMINING PROCEDURE  
Period for reply--Petition

	Sec. No.		Sec. No.
Period for reply .....	710	Time limit action .....	710.02
After Board decision .....	1214.01	Time limit action, When used.....	710.02(c)
After final.....	706.07(f)	Two periods running.....	710.04, 710.04(a)
In transitional application.....	706.07(g)	Withdrawal of attorney or agent during.....	402.06
After interference .....	710.02(b), 2363.02	Periodicals .....	901.06, 901.06(a)
Amendment after.....	714.17	Period of enforceability ....	2204, 2211, 2610, 2611, 2686.02
Claim copied from patent.....	710.04(a)	Permanent ink.....	608.01, 714.07, 714.19
Claims all allowed.....	707.07(a), 710.02(b), 714.14	Perpetual motion.....	506, 608.03, 706.03(a)
Computed.....	710.01(a), 710.05	.....	707.07(g), 2107.01
Copying claim from patent does not extend statutory period .....	710.04(a)	Persons who may cite prior art relating to an issued patent .....	2203
Correction of citation .....	707.05(g), 710.06	Pertinent prior art.....	904.02
Date of receipt of amendment .....	710.01(a), 710.05	Petition	
Defective Office action .....	707.05(g), 710.06	Abandonment holding .....	711.02, 711.03(c), 711.03(d)
Difference between shortened statutory period and time limit.....	710.02(d)	.....	1002.02(c), 1002.02(p), 1002.02(q), 1002.02(r)
Extension.....	710.02(d), 710.02(e)	Abandonment holding, examiner's statement..	711.03(d)
Extension of time to commence civil action .....	1002.02(k)(1)	Abandonment holding for failure to provide timely notice of foreign filing.....	1124
Extension of time to file notice of appeal at CAFC .....	1002.02(k)(1)	Accept color drawings or photographs .....	507
Full statutory period for reply .....	130	.....	1002.02(d), 1503.02
Holiday, Saturday, or Sunday expiration of time .....	505, 513, 710.05, 710.01(a)	Accepting late issue fee .....	203.07, 711.03(c)
Incomplete reply.....	710.02(c), 711.02(a)	Accept omitted pages.....	1002.02(p)
.....	714.03, 2266.01, 2666.30	Access to application.....	103, 1002.02(b), 1002.02(p)
Less than six months .....	710.02, 710.02(b), 710.02(c)	Access to interference agreement .....	1002.02(f)
.....	710.02(d), 710.02(e)	Access to interference application .....	1002.02(f)
Miscellaneous factors.....	710.06	Access to unopened preliminary statements...	1002.02(g)
Petition .....	1002	Add inventor in provisional application .....	1002.02(q)
Property rights under AEC and NASA Acts.....	150	Admit model.....	1002.02(c)
Remailing.....	707.13, 710.06	Attorney withdrawal .....	1002.02(b), 1002.02(c)
Restarting .....	710.06	.....	1002.02(p)
Saturday, Expiration of time .....	505, 710.01(a), 710.05	Biotechnology processes under 35 U.S.C. 103(b) .....	706.02(n)
Secrecy order application .....	130	Board decision in <i>inter partes</i> reexamination.....	2681
Shortened, Extension.....	710.02(d), 710.02(e)	Board of Patent Appeals and Interferences involved .....	1002.02(f), 1002.02(g), 1002.02(j)
Shortened statutory period .....	710.02, 710.02(b)	Certificate of Correction.....	1002.02(d), 1002.02(g)
.....	710.02(e)	.....	1002.02(l)
Shortened statutory period, Distinguished from time limit.....	710.02(d)	Change in inventorship .....	1002.02(d), 1002.02(e)
Shortened statutory period, When used.....	710.02(b)	.....	1002.02(l), 1002.02(p), 1002.02(q), 1481
Statutory period.....	710.01	Change inventor's name .....	605.04(c)
How computed.....	710.01(a)	Change in order of inventors names .....	605.04(f)
Suggesting claims.....	710.02(c), 2305.02	Color drawings or photographs .....	507
Sunday, Expiration of time.....	505, 710.01(a), 710.05	.....	1002.02(d), 1503.02
Supplemental action .....	710.06	Common ownership situation .....	706.02(k)
Time computation .....	710.01(a), 710.05	Concurrent <i>ex parte</i> and <i>inter partes</i> prosecution .....	1002.02(g)

INDEX  
Petition--Petition

	Sec. No.		Sec. No.
Consideration of submission after NIRC in <i>inter partes</i> reexamination .....	2687.01	Filing date .....	506.02, 513
Converting a 111(a) application to a 371 application .....	1002.02(p)	.....	601.01(b), 601.01(c), 601.01(f)
Converting a 371 application to 111(a) application .....	1002.02(p)	.....	601.01(g), 1002.02(b)
Converting a nonprovisional to provisional ....	1002.02(b)	Final rejection .....	1002.02(c)
.....	1002.02(c), 1002.02(p), 1002.02(q)	SIR application .....	1105
Correct filing date .....	506.02, 513	Foreign filing license .....	140, 1002.02(c)(1)
.....	601.01(b), 1002.02(b)	Facsimile submission .....	502.01
Correction of inventorship .....	201.03, 1002.02(d)	Inspection .....	103
.....	1002.02(e), 1002.02(l)	Interference .....	1002.02(c), 1002.02(f), 1002.02(g)
.....	1002.02(p), 1002.02(q)	Interview in merged reissue/ <i>inter partes</i> reexamination .....	2686.03
In <i>ex parte</i> reexamination .....	2250.02	Late foreign priority claim .....	1002.02(b)
In <i>inter partes</i> reexamination .....	2658, 2666.03	Maintenance fees, accept and record .....	1002.02(b)
Counter-terrorism inventions .....	708.02, 1002.02(s)	.....	2580
Defer issuance .....	1002.02(b), 1306.01	Maintenance fees, delayed payment/reinstatement .....	1002.02(b), 2515, 2531, 2590
Delegation of Director's authority .....	1001.01	Make special (See also Special application) .....	708.02, 1002.02(s), 1504.30
Denial .....	1002.02	Matter subject to .....	Introduction, 706.01, 1002
Denial of request for reexamination .....	1002.02(c)	Merge reexaminations .....	1002.02(b), 2283
<i>Ex parte</i> .....	2246, 2248, 2265	Merge reissue and <i>ex parte</i> reexamination .....	1002.02(b), 2285
<i>Inter partes</i> .....	2647, 2648	Merge reissue and <i>inter partes</i> reexamination .....	1002.02(b), 2667, 2686.03
Director's duties .....	Introduction, 1002	Modification of secrecy order .....	120
Dismissed .....	1002.02	New matter .....	608.04(c), 1002.02(c)
Dismissed without prejudice .....	1002.02	Nonsigning inventor .....	409.03, 1002.02(b)
Divisional reissue .....	1002.02(b)	.....	1002.02(p)
Entry of amendment .....	1002.02(d), 1207	Objection by examiner .....	1002.02(c)
Entry of amendment after RAN in <i>inter partes</i> reexamination .....	2672, 2673.02, 2675	Patent term extension .....	1002.02(b)
Entry of late paper for revival of <i>ex parte</i> reexamination .....	1002.02(b), 2268	Period for filing .....	1002
Entry of late papers for revival of <i>inter partes</i> reexamination proceeding .....	1002.02(b), 2668	Premature Action Closing Prosecution (ACP) in <i>inter partes</i> reexamination .....	2672
Expedited examination of design applications .....	502, 1002.02(c)(3)	Premature final rejection .....	706.07(c), 1002.02(c)
Express abandonment after payment of issue fee .....	1002.02(b)	Preliminary amendment as part of original disclosure .....	608.04(b)
.....	1002.02(b)	Procedure .....	1002.01
Express abandonment to avoid pre-grant publication .....	502, 1125, 1135	Public use proceedings .....	1002.02(b)
Facsimile submission .....	502.01	Publication Division .....	1002.02(r)
Expunge papers from file .....	1002.02(b), 1002.02(c)	Reconsideration of denied petition ( <i>ex parte</i> reexamination) .....	2268
Expunge information .....	724.05, 1002.02(c)	Rescission of secrecy order .....	1002.02(c)(1)
Extension of time .....	710.02(e), 714.17, 1002.02(q)	Refused assignment .....	313, 317
Application before Office of Patent Legal Administration .....	1002.02(b)	Refusal to enter amendment .....	1002.02(c)
Application before Office of Petition .....	1002.02(b)	Refusal to initiate interference .....	1002.02(c)
		Refusal to issue Certificate of Correction .....	1002.02(c)
		Registration to practice .....	1002.02(m)

MANUAL OF PATENT EXAMINING PROCEDURE

Petition for Express Abandonment to Avoid Publication Under 37 CFR 1.138(a) PTO/SB/24A--Plant patent

Sec. No.	Sec. No.
Reinstate rejection after Board decision..... 1002.02(c)	Vacate an order granting <i>inter partes</i>
Reinstatement.....1002.02(m)	reexamination .....2646
Relating to PCT international application and/or	Waive rules..... 1002.02(b)
national stage application..... 1002.02(p)	Waive time provisions in <i>ex parte</i> reexamination .... 2265
Relating to reexamination or reissue..... 1002.02(b)	Waive time provisions in <i>inter partes</i> reexamination
Reopen prosecution after Board decision..... 1002.02(c)	..... 2648, 2668, 2672
Reopen prosecution after Board decision in <i>inter partes</i>	Withdrawal of lapsed patent..... 1002.02(r)
reexamination..... 2682	Withdrawal from issue, after issue fee paid
Requirement for information..... 1002.02(c)	..... 502, 1002.02(b), 1308
Rescission of secrecy order..... 120	Withdrawal from issue, issue fee not paid
Resetting period for reply..... 1002.02(c)	.....1002.02(c), 1308
Restriction requirement holding..... 821.01, 1002.02(c)	Withdrawal of a terminal disclaimer ..... 1490
Retroactive foreign filing license ..... 140	Withdrawal of abandonment..... 1002.02(b)
Return model..... 1002.02(c)	Withdrawal of attorney ..... 1002.02(s)
Return original oath..... 1002.02(c)	In interference ..... 1002.02(g)
Revival..... 711.03(c), 1002.02(b), 1124	Withhold from issue, before issue fee paid.... 1002.02(c)
Revive PCT application ..... 1002.02(p)	Petition for Express Abandonment to Avoid Publication
Rule 1.48 (inventorship)..... 201.03	Under 37 CFR 1.138(a) PTO/SB/24A
Secrecy order..... 1002.02(c)(1)	Cited ..... 1125
Sequence rules..... 1002.02(c)(2)	Reproduced..... 1135
Special status..... 708.02, 1002.02(s), 1504.30	Petition for Revival of an Application For Patent
Stay <i>ex parte</i> reexamination proceedings..... 2284, 2285	Abandoned for Failure to Notify the Office of a Foreign or
Stay <i>inter partes</i> reexamination proceedings ..... 2667	International Filing PTO/SB/64a
..... 2686.02, 2686.03	Cited ..... 1124
Sufficiency of an affidavit..... 1002.02(c)	Reproduced..... 1135
Supervisory authority of Director of the USPTO	Petitionable matter..... 706.01
..... 1002.02(b), 1002.02(c)	PG-Pub (See Pre-Grant Publication (PG-Pub))
Suspend action – public safety or defense.. 1002.02(c)(1)	Pharmaceutical subject matter
Suspend rules ..... 1002.02(b)	Safety review by FDA ..... 2107.03
Suspension of second or subsequent <i>inter partes</i>	Statute (See Statutes: 35 U.S.C. 155)
reexamination requests..... 2640	Utility..... 2107.01
Time for filing..... 1002	Phi, Greek letter usage..... 608.01(g)
Trademark related ..... 1002.02(i)	Philippines-United States search exchange ..... 1711
Transfer from another application.....608.02(i)	Photograph as drawing ..... 507, 608.02, 1503.02
Unavoidable delay, withdraw abandonment .... 711.03(c)	Piecemeal prosecution ..... 707.07(g)
..... 1002.02(b), 1002.02(c)(3), 1306	Plant Breeder’s Rights ..... 1613
Unintentional delay, withdraw abandonment.... 711.03(c)	Plant Convention, UPOV ..... 1612
..... 1002.02(b), 1002.02(c)(3), 1306	Plant patent..... Chapter 1600
Failure to provide timely notice of foreign filing . 1124	Action ..... 1610
Unintentionally delayed claim for foreign priority	Advertising ..... 1610
..... 201.14, 201.14(a), 201.16	Affidavit ..... 1610
..... 1002.02(b), 1402, 2258, 2658	Agricultural Research Service (ARS)..... 1608, 1609
Unintentionally delayed claim for priority to a U.S.	Allowance..... 1611
application.....201.06(c), 201.11, 201.11(a)	Application publication ..... 1120 to 1135
..... 1002.02(b), 2258, 2658	Asexual reproduction..... 1601, 1605
Vacate order granting request for <i>ex parte</i> reexamination	Bacteria..... 1601
..... 2246	Claim ..... 1605, 1610

INDEX  
Plant patent series--Pre-Grant Publication (PG-Pub)

	Sec. No.		Sec. No.
Color drawing .....	1603, 1606	Attorney not of record .....	714.01(c)
Color identified .....	1605	Canadian patent agent.....	402
Declaration.....	1604	Change in plurality of applications or patents .....	402
Definitions.....	1601	Coinventor .....	402.01, 402.10
Department of Agriculture .....	1608	Death of applicant.....	409 to 409.01(f)
Deposit .....	1605	Death of principal attorney .....	406
Duplicate papers.....	1603, 1605, 1609	Exception as to registration .....	402.01
Elements of application.....	1603	General, for international application .....	1807
Examination .....	1608	Invalid.....	402
Examiner's amendment.....	1610	Joint applicant.....	402.01
Executive Order .....	1608	Limited recognition .....	402.01
Issue .....	1611	Notice of revocation .....	402.05
Laudatory expressions.....	1610	Post Office address .....	601.02
Method claim improper.....	1605	Provisional application .....	103
Oath.....	1604	Reexamination, <i>inter partes</i> .....	2613, 2622
Parts.....	1603	Revocation.....	402.05, 402.07, 402.08, 402.10
Plant varieties excluded.....	1601	After Allowance .....	2501
Priority claim.....	1613	Secrecy order applications.....	120
Publication of application.....	1120 to 1135	Unregistered attorney or agent.....	402, 402.01
Report of Agricultural Research Service.....	1608, 1609	Withdrawal of attorney or agent.....	402.06, 2501
Rules applicable .....	1602	Withdrawn in patent .....	2223, 2501
Signature .....	1603	Power to inspect .....	103, 104, 324, 402, 713.05
Specification.....	1605, 1610	Power to inspect, approval.....	104
Specimens .....	1607	Power to inspect, suspended attorney.....	105
Statutory basis .....	1601	Practitioner (See Attorney or agent)	
Term .....	2701	Practitioner's names on patents .....	1309
Tubers .....	1601	Pre-Grant Publication (PG-Pub).....	1120 to 1135
UPOV Convention .....	1612	Amendments prior to publication .....	1121
Plant patent series.....	901.04	Appendices not published.....	1121
PO Box (See Mail stop)		Application in a foreign language.....	608.01
Post classifier .....	902.04, 903.02(c), 903.07(b)	Assignee information published .....	1121
.....	903.08(d), 903.08(e), 903.08(f)	Certification as to intent to file counterpart applications	
.....	903.09, 903.10	.....	1122
Requesting consideration by .....	903.08(d)	Claim sets, multiple .....	1121
Post Office, Depositing papers in.....	502	Computer programs .....	1121
Post Office address (See also Correspondence; Mail Stop)		Content .....	1120, 1121
Applicant.....	409.03(e), 605.03, 719.02(b)	Conversion to provisional to	
Attorney .....	601.02	avoid publication .....	601.01(c)
Postal Service interruptions and emergencies .....	511	Complete application required.....	1120
Postcard, self-addressed .....	203.08, 503	Copies of published application files.....	1128
.....	601.01(d), 601.01(f), 601.01(g)	Correction of errors in the PG-Pub.....	1130
.....	719.01(a), 1205, 1901, 1901.05	Correspondence address .....	1121
Power of attorney .....	402	Correspondence regarding published application.....	1134
Application in interference.....	402.08	Disparaging remarks not published .....	1120
Application oath or declaration includes.....	601.02	Drawings.....	507, 1120, 1121
Assignee revokes.....	402.07	Early publication .....	1129
Associate attorney .....	402, 402.02, 406		



MANUAL OF PATENT EXAMINING PROCEDURE  
Pre-Grant Publication Division--Prior art

Sec. No.	Sec. No.
Express abandonment to avoid publication..... 502	Premature response in <i>inter partes</i> reexamination.....2667
..... 1125, 1135	<i>Prima facie</i> showing, public use proceeding..... 720.02
Facsimile submission..... 502.01	Primary examiner ..... 705.01(a), 706.04, 706.07(c)
Fee, publication..... 1126, 1133, 1303, 1306, 1306.03	..... 706.07(d), 707.01, 710.02(b), 710.02(e)
Forms ..... 1135	..... 711.03(a), 713.01, 713.02, 713.10, 714.16
Inappropriate nonpublication request..... 1122	..... 714.16(d), 714.19, 715.08, 716, 2271
Material mistake by the Office..... 1130	..... 2633, 2636, 2648, 2660, 2671.01 to 2671.03
Nonpublication request ..... 1122	Actions requiring personal attention..... 705.01(a)
Notice of foreign filing..... 1124	..... 707.01, 707.09, 710.02(b)
Notice of Publication..... 1127	..... 713.02, 714.16(d), 1004
Notice of New or Revised Publication ..... 1127	Name on file wrapper ..... 1302.13
Offensive language not published ..... 1120	Print of drawing (See also Drawings)..... 608.02(m)
Public access to published application ..... 1128, 1132	Additional ..... 608.02(m)
Publication date, projected ..... 1120, 1122	Alteration..... 608.02(m)
Publication fee..... 1126, 1133, 1303	Colored ..... 608.02(m)
RCE's not published ..... 1120	Examiner's notation on..... 608.02(m)
Redacted publication..... 1132	File wrapper..... 719.01(b)
Refund of publication fee..... 1126	Kept in Technology Center..... 608.02(c)
Replacement drawings prior to publication..... 507	Marked-up ..... 608.02(v)
..... 1120, 1121	Marking ..... 608.02(m)
Republication ..... 1130	Patentability report ..... 608.02(n), 705.01(d)
Request for early publication ..... 1129	Returned drawing ..... 608.02(y)
Request for nonpublication ..... 1122	Printed matter nonstatutory..... 706.03(a)
Request for redacted publication..... 1132	Printer waiting ..... 708.01, 1305, 1309.02
Rescission of nonpublication request..... 1123, 1124	Printing date, declassified material..... 707.05(f)
Residence changed..... 719.02(b)	Printing practitioners names on patents ..... 1309
Sequences published on Internet..... 1121	Printing priority ..... 1309
Status information of published application..... 1128	Prior art (See also Reference)..... Chapter 900
Substitute specification required ..... 1120	Admissions as ..... 2129
Tables, large ..... 608.05(b)	Analogous..... 2141.01(a)
Third party inquiries..... 1134	Duty of disclosure of ..... 2001.04
Voluntary publication..... 1133	Effects of international application publication..... 1857
When published..... 1120	..... 1857.01, 1895.01
Which applications..... 1120	Equivalents ..... 2144.06
Pre-Grant Publication Division ..... 502, 1120	Electronic Information Disclosure Statement..... 609
..... 1122, 1125, 1126	Filed on Saturday Sunday or a Federal holiday ..... 609
Preamble, design application..... 1503.01	Foreign application as..... 2135.01
Preamble, effect of..... 2111.02	Information reasonably necessary for finding ..... 704.11
Preamble, Jepson claim..... 2129	International application publication ..... 706.02(a)
Predicted tests in specification ..... 608.01(p)	..... 1857.01, 2163, 2163.03
Preliminary amendment ..... 506, 714.01(e)	Kind codes ..... 901.04(a)
Preliminary amendment	Level of ordinary skill ..... 2141.03
Excess claims ..... 506, 714.10	Patents as ..... 706.02(a), 2126, 2132, 2136
New matter..... 608.04(b)	Publications under 35 U.S.C. 122(b) ..... 1895.01, 1896
Preliminary handling of public use or on sale ..... 2122	..... 2136, 2136.03
Preliminary hearing, public use proceeding ..... 720.03	Scope and content of..... 2141.01
Premature final rejection ..... 706.07(c)	Means limitations ..... 2182

INDEX

Prior art citations in reexamination proceedings--Proof of irreparable damage

Sec. No.	Sec. No.
Search (See also Search) ..... Chapter 900	Claiming in reissue application ..... 1402, 1405, 1417
Statutory Invention Registrations as..... 901.02, 2136	Foreign application (See also Foreign application)
Suitability of..... 2144.07	..... 201.13
Third party submissions ..... 609, 1134.01	Corrected by Certificate of Correction..... 1481
Used in deciding request for reexamination... 2242, 2642	Design applications ..... 1504.02, 1504.10
Well-known in the art..... 2144.03	<i>Ex parte</i> reexamination ..... 2258
Prior art citations in reexamination proceedings	Incorporation by reference ..... 201.13, 608.01(p)
<i>Ex parte</i> ..... 2202	<i>Inter partes</i> reexamination ..... 2658
Content ..... 2205	Proper identification..... 201.14(d)
Copies of prior art..... 2205	Formal requirements..... 201.11, 201.14, 706.02(f)(1)
English translations..... 2205	Incorporation by reference to earlier application
Explanation of pertinence..... 2205	..... 608.01(p)
Flowcharts ..... 2206	International application ..... 201.11(a), 1828, 1893.03(c)
Handling ..... 2206	Corrected by Certificate of Correction..... 1481
Sample letter ..... 2205	Inventor's certificate ..... 201.13(a)
Service on patent owner ..... 2208	Overcoming reference ..... 201.15
Time for filing ..... 2204	Patent printing ..... 1309
<i>Inter partes</i> ..... 2602, 2646	Petition for unintentionally delayed claim to benefit of
..... 2654, 2656, 2657	prior U.S. application..... 201.11, 201.11(a)
After the order to reexamine ..... 2602, 2667	Prior U.S. application ..... 201.11
After a Notice of Intent to Issue <i>Inter Partes</i>	Corrected by Certificate of Correction..... 201.11, 1481
reexamination Certificate issues ..... 2687.01	Design application..... 1504.20
Before the first Office action ..... 2625	In <i>ex parte</i> reexamination ..... 2258
Before the order to reexamine ..... 2602, 2654	In <i>inter partes</i> reexamination ..... 2658
By another requestor..... 2656	Provisional application..... 706.02
By the patent owner..... 2656	Time charts ..... 2138.01
Storage area ..... 2667	Time for filing ..... 201.13
With the Request ..... 2656	Priority document (See Foreign application)
With third party's comments ..... 2666.05, 2667	Priority practice (See Foreign application)
Prior art copies in reexamination	Private use (See also Public use) ..... 2133.03(a)
<i>Ex parte</i> ..... 2218	Proceedings, Termination of..... 201.11, 711.02(c)
<i>Inter partes</i> ..... 2618	Process of making and product made ..... 806.05(f)
Prior art filed by protestor ..... 1901.02, 1901.03	Processing and retention fee ..... 601.01(a)
Prior art on drawing ..... 608.02(g), 2125	Processing of reexamination in Technology Center
Prior art statement ..... 609, 1893.03(g)	<i>Ex parte</i> ..... 2233
Provisional application ..... 609	<i>Inter partes</i> ..... 2633
Reissue application ..... 1418	Product and process of using ..... 806.05(h), 2173.05(p)
Prior art, statement applying (reexamination)..... 2217, 2617	Product by process..... 2113, 2173.05(p)
Prior art used in determining reexamination request	Product of human ingenuity..... 2105
<i>Ex parte</i> ..... 2244	Product of nature ..... 706.03(a)
<i>Inter partes</i> ..... 2644	Program Management System (PMS) ..... 2238, 2638
Prior examiner's action ..... 704.01, 706.04, 713.01	Programs, Computer (See Computer programs or software)
Priority	Prolix claim ..... 2173.05(m)
Claiming in continued prosecution	Proof, burden of..... 2112, 2112.01, 2113
application ..... 201.06(d), 1302.04	Proof of authority of administrator or executor ..... 409.01(b)
Claiming in <i>ex parte</i> reexamination ..... 2258	Proof of foreign filing..... 201.14
Claiming in <i>inter partes</i> reexamination..... 2658	Proof of irreparable damage ..... 409.03(g)

MANUAL OF PATENT EXAMINING PROCEDURE

Proof of ownership, reissue application--Public access to ex parte reexamination file

Sec. No.	Sec. No.
Proof of ownership, reissue application .....	Improper protest .....
1410.01	1134, 1901.03
Proof of unavailability or refusal to sign .....	Information which can be relied on .....
409.03(d)	1901.02
Proofreading of action .....	Involving fraud, lack of good faith or candor, or
707.08	violation of duty of disclosure .....
Proper multiple dependent claim .....	1901.06, 2013
608.01(n)	Multiple papers on same issue .....
Property rights statement .....	1901.07(a)
150	Reissue application .....
Contents of .....	1441.01, 1901.04
151	Reissue litigation .....
Property rights under AEC and NASA Acts ...	1901.03, 1901.04
115, 150, 151	Requirement for information .....
Prophetic examples in the specification .....	1901
608.01(p)	Review of adverse decision .....
Proprietary interest, Proof of .....	1906
409.03(f)	Service on patentee or applicant .....
Proprietary materials (See Protective order material; Trade	1901.03
secret material)	TC Director's attention required .....
	1003
<i>Pro se</i> applicant (See also Applicant; Inventor)	Timeliness of protest .....
	1901.04
Appeal brief .....	Trade secret information .....
1206	724, 1901.02
Certificate of mailing .....	Treatment by examiner .....
512	1901.06
Change of address .....	Under Rule 1.291 .....
601.03, 719.02(b)	1901
Death .....	Who can file .....
409.01(f)	1901.01
Duty of disclosure .....	Protestor participation .....
2002.01	1901.07
Examination of application .....	Provisional application .....
707.07(j)	201.04(b), 1706
Examiner's action .....	Abandonment .....
707	201.04(b), 201.11, 711.03(c)
Interview .....	Access .....
713.01	103, 104
Legal representation .....	Assignment of .....
401	302.03
Telephone restriction practice .....	Assignment of application claiming benefits of ...
812.01	306.01
Prosecution	Completeness .....
	506, 601.01(b)
Closed, application allowable except for formal matters	Conversion to .....
.....	201.04(b), 601.01(c)
707.07(j), 710.02(b), 714.14	Correction of inventorship .....
	201.03
Closed, secrecy order cases .....	Cover sheet for .....
130	201.04(b)
Prosecution after appeal .....	Data, on file wrapper/history of .....
1208.02	202.02, 1302.09
Piecemeal .....	Data, in specification of .....
707.07(g)	1302.04
Reopening after allowance .....	Drawing .....
1308.01	608.02
Reopening after Board decision .....	Effective filing date .....
1214.07	601.01(b), 706.02
Prosecution laches .....	English language translation for benefit of date ...
2190	201.11
Prosecution of Secrecy Order application .....	Filing receipt .....
130	503
Prosecution reopened after court decision .....	Guidelines for drafting .....
1216.01	601
Protective order material (See also Trade secret material)	Information disclosure statement .....
.....	609
724 to 724.06	Joint inventors in .....
	605.07
Submission .....	Last day of pendency .....
724.02	201.04(b)
Protest .....	Ordering of abandoned .....
Chapter 1900	905.03
Access by protestor .....	Priority .....
1901.05, 1901.07	201.04(b), 201.11
Acknowledgment of protest .....	Error in, as reissue grounds .....
1901.05	1402
Certificate of service .....	Request to convert to nonprovisional .....
1901.03	1002.02(b)
Comments of applicant .....	.....
1901.06	1002.02(q)
Complete .....	Revival .....
1901.03	711.03(c)
Copies of documents .....	Statutory Invention Registration .....
1901.03	1101
Express consent of applicant required .....	Small entity status .....
1134	509.03
Filed in reissue where patent is in	Specification .....
interference .....	601.01
1449, 1901.06	PTO employee restrictions, assignment .....
	309
Handling .....	Public access to <i>ex parte</i> reexamination file .....
1901.05	2232

INDEX

Public access to inter partes reexamination file--Quayle practice

	Sec. No.		Sec. No.
Public access to <i>inter partes</i> reexamination file.....	2632	Oral argument.....	720.04
Public domain (See also Public use; On sale; and Disclaimer).....	2121.03, 2133.03 .....2133.03(a), 2145	Petitions.....	1134, 1002.02(b)
Dedication to public.....	715, 1490	Preliminary handling.....	720.01
Public inspection, Application file.....	103, 1128	Preliminary hearing.....	720.03
<i>Ex parte</i> reexamination.....	103, 2232	<i>Prima facie</i> showing.....	720.02
<i>Inter partes</i> reexamination.....	103, 2609, 2632	Rejections after.....	706.03(v)
Redacted application publication.....	103, 1132	Rejections on.....	706.03(v), 720.05
Reissue.....	103, 1430, 1470	Testimony.....	720.04
Public inspection of assignments.....	301.01	Publication, Defensive.....	711.06, 711.06(a), 1111
Public Law (See Statutes)		Publication of Statutory Invention Registration.....	1111
Public policy.....	706.03(a)	Publication date.....	706.02(a), 707.05(f)
Public right to inspect files.....	103, 1128	Publication fee.....	1126, 1133, 1303, 1306, 1306.03
In <i>ex parte</i> reexamination.....	103, 2232	Publication of abstracts.....	711.06, 711.06(a)
In <i>inter partes</i> reexamination.....	103, 2609, 2632	Publication	
Public sale (See also On sale; Public use).....	2133.03	Board decisions.....	1213.03
Public search room (See Patent search room)		Citing.....	706.02, 707.05(e), 901.06
Public searchers.....	101	Date of.....	706.02(a)
Public use (See also On sale).....	706.02(c) .....2133.03, 2133.03(a)	Declassified.....	707.05(f)
Affidavit or declaration.....	715.10	Notices.....	Introduction, 707.06, 1703
Anticipation.....	2133.03(a)	<i>Official Gazette</i> (O.G.).....	1703
Commercial exploitation.....	2133.03(e)(1)	Orders.....	Introduction, 707.06, 1703
Commercial use.....	2133.03(a)	Own, as reference.....	715.01(c), 2132.01
Completion of the invention.....	2133.03 .....2133.03(c), 2133.03(e)(1)	Patent and Trademark Office.....	Introduction
Definition of.....	2133.03(a)	Pre-Grant (See Pre-Grant Publication (PG-Pub))	
Evidence.....	706.02(c)	Prior art effect of international.....	706.02(a), 1857.01 .....2136.03
Experimental use (See also Experimental use) .....	2133.03, 2133.03(e)	Rules changes.....	1703
In this country.....	706.02(c), 2133.03(d)	Under 35 U.S.C. 122(b) as references .....	1857.01, 1896, 2136, 2136.03
Intent to experiment.....	2133.03(e)(2), 2133.03(e)(3)	Voluntary.....	1133
Invention.....	2133.03(c)	Publishing Division (See Office of Patent Publications)	
Policy considerations.....	2133.03	Pulling abandonments.....	711.04(a)
Public knowledge or on display.....	2133.03(a)		
Secrecy.....	2133.03(a)	<b>Q</b>	
Single use.....	2133.03(a)	Quality Assurance.....	1302.04, 1308.03, 1720
Control over invention.....	2133.03(a) .....2133.03(e)(5), 2133.03(e)(7)	In reexamination.....	2289, 2689
Testing by third party.....	2133.03(e)(5), 2133.03(e)(7)	Quality Assurance Specialist (QAS).....	2289, 2689
Use with expectation of privacy.....	2133.03(a)	Quality control program.....	1308.03
Use by inventor or associates.....	2133.03(a)	Quayle practice.....	710.02(b), 714.14
Use by independent third parties.....	2133.03(a)	Action recording.....	1705
Public use proceedings.....	720	After final rejection.....	706.07(f)
Affidavits.....	720.01	Allowance action.....	707.05(a), 714.14, 714.15
Final decision.....	720.05	Claims later added.....	714.20
		Copies of references.....	707.05(a)
		Design application.....	1504
		Examiner's amendment used instead of.....	608.01(b)

MANUAL OF PATENT EXAMINING PROCEDURE  
Query Printer Waiting--Reexamination, Ex parte

	Sec. No.		Sec. No.
Formal matters corrected.....	706.07(f), 812.01	Depositing correspondence.....	502
Information disclosure statement.....	609	Entry of amendments.....	714.18
Primary examiner signature required.....	1005	Filing receipt.....	503
Reexamination, <i>ex parte</i> .....	2250.01, 2266.01	Office date stamp.....	505
Reissue.....	1444	Period for reply.....	710.01(a)
Shortened statutory period.....	710.02(b), 2250.01	Receiving Office PCT procedure.....	1801
Query Printer Waiting.....	1306.03	International Bureau.....	1805
		Reciprocal privileges, foreign priority.....	201.13
		Reciprocal security agreements.....	120
		Reclassification	
		Classes.....	903.02(a)
		Patents.....	903.05
		Subclasses.....	903.02(c)
		Recombinant DNA (See also DNA; Biotechnology)	
		Special status.....	708.02
		Reconsideration in <i>ex parte</i> reexamination.....	2269
		Reconsideration in <i>inter partes</i> reexamination.....	2669
		Reconsideration of abandonment.....	711.03, 711.03(c)
		Based on insufficient reply.....	711.03(a)
		Based on failure to reply within period.....	711.03(b)
		Record of interview.....	713.01, 713.04
		Record room (See File Information Unit (Record Room))	
		Record system for reexamination	
		<i>Ex parte</i> .....	2235
		<i>Inter partes</i> .....	2635
		Recording assignment.....	301, 302, 317
		Recording change of business name.....	314
		Recording government interests.....	302, 302.07
		Recording license agreement.....	313
		Recording of other documents.....	313 to 317
		Recording security interest.....	313
		Redacted publication of an application.....	1132
		Reduction to practice.....	715.07, 2133.03(c)
		.....	2138.01, 2138.05
		Reexamination, <i>Ex parte</i> .....	Chapter 2200
		Access to file.....	103, 724.04(c), 2209, 2232
		Action following Board decision.....	2278
		Address of patent owner.....	2222
		Admissions.....	2217, 2258
		Affidavits.....	2216, 2217, 2258, 2265
		After final practice.....	2272
		Amendment.....	714, 2234, 2250, 2295
		Abstract.....	2287
		After final rejection.....	2272
		Examiner's.....	2287
		Filed with request.....	2221
		Improper.....	2250

**R**

Ranges

Anticipation of.....	2131.03
Obviousness of.....	2144.05

Ratification of papers filed

Death of attorney.....	406
Death of inventor.....	409.01
Signature improper or lacking.....	714.01(a)
Telegram amendment.....	714.08

Real party in interest.....	1206, 1208
In <i>inter partes</i> reexamination.....	2612, 2614, 2677

Reasons for allowance..... 1302.14

Amendments after final rejection.....	714.13
Appeal record.....	1213.02
Applicant's comments on.....	1302.14
Claim narrowing.....	1302.14
Comments on, <i>ex parte</i> reexamination.....	2287
Comments on, <i>inter partes</i> reexamination.....	2687.01
Estoppel effect.....	1302.14
Failure of applicant to comment on.....	1302.14
Patent Cooperation Treaty application.....	1845.01, 1878.01
Presumption of acquiescence by applicant.....	1302.14
Public use proceedings.....	720.05

Reexamination	
<i>Ex parte</i> .....	2262, 2287
<i>Inter partes</i> .....	2687

Rebuttal brief in <i>inter partes</i> reexamination appeal	
.....	2678, 2679

Refused entry.....	2679
--------------------	------

Recapture

Claimed subject matter.....	706.02(l)(1), 1412.02
Matter in reissue.....	1412.02
Of patent rights	
Disclaimed by filing a disclaimer.....	1490
Waived when SIR published.....	1111

Receipt of mail and papers..... Chapter 500

Arrangement of papers in file wrapper.....	719.01(a)
--	-----------

INDEX

Reexamination, Ex parte--Reexamination, Ex parte

Sec. No.	Sec. No.
In a merged reissue/ <i>ex parte</i> reexamination .....	2285
Prior reexamination certificate issued.....	2250, 2295
Provisions of Rule 1.312 do not apply.....	2287
Reissue patent issued.....	2250
Ancillary issues .....	2217, 2258
Appeal.....	2273
Appeal brief.....	2274
Appeals to courts.....	1216, 1216.01, 2279
Application file location.....	2635
Assignment.....	301
To an examiner.....	2236, 2248, 2255, 2285
Attorney or agent.....	2213
Name on certificate.....	2287
Basic characteristics .....	2209
Certificate of .....	2288, 2294
Reissue patent as.....	2290, 2294
Certificate attached to patent copy .....	2292
Certificate distribution .....	2292
Certificate format .....	2290
Certificate of mailing or transmission .....	2224
Certificate of prior reexamination in later request .....	2214, 2219, 2619
Certificate of service .....	2220
Certified copy.....	2232
Citation of prior art.....	2202
After first office action .....	2271
Claim for <i>Official Gazette</i> .....	2287
Claim, multiple dependent, preparation for publishing .....	2287
Claim numbering.....	2250
Claims considered.....	2243, 2258
Claims invalid/unenforceable.....	2286
Claims presented for interference.....	2283, 2307.04
Clerical handling .....	2270
Collateral estoppel.....	2259
Comments on “Statement of Reasons for Patentability and/or Confirmation” .....	2287
Conclusion .....	2287
Concurrent proceedings .....	2282 to 2686
Conduct of proceedings.....	2254
Consideration of responses.....	2252, 2253
Consolidated proceedings .....	2283
Constructive notice to patent owner.....	2230
Content of request .....	2214
Copending proceedings.....	2283 to 2686
Copy of patent in request .....	2219
Double column format.....	2214, 2219
Copying of file.....	2232
Correction of inventorship.....	2250.02, 2258
Correction of request .....	2231
Correspondence .....	2224
Criteria for deciding request .....	2242
Decision of Board of Patent Appeals and Interferences .....	2277
Decision on request .....	2240
Decision ordering reexamination.....	2246
Decision processing.....	2245
Defective submission.....	2266.02
Denied .....	2240, 2247, 2247.01
Dependent claim treatment .....	2260.01
Director’s initiative.....	2239
Domestic priority .....	2258
Double correspondence .....	2224
Double patenting .....	804, 2258
Drawing correction .....	2250.01
Duty of disclosure.....	2003.01, 2280
Electronic copy .....	2209, 2232
Entry of amendments.....	2234, 2270
Entry of court decisions in patent file.....	2207
Examiner.....	2236, 2248, 2255
Deposition.....	1701.01
Examiner’s amendment .....	2287
Examiner’s answer .....	2275
Expiration of patent .....	2211, 2250
Explanation of prior art.....	2217
Extension of time.....	2265
Failure to timely reply to Office action .....	2266
Fees.....	2215, 2233, 2283, 2285
Final action .....	706.07(a), 2265, 2271
Flowchart.....	2201
Foreign priority.....	2258
Forms.....	2296
Granted .....	2246, 2247.01
Grounds of rejection .....	2217
Identity of requester.....	2212
Inappropriate papers .....	2267
Return of papers .....	2267
Incomplete request.....	2227
Informal request.....	2228
Informal submission .....	2266.02
Initial processing .....	2226
Interference copending .....	2284
Intervening rights.....	2293
Interviews in .....	2281

MANUAL OF PATENT EXAMINING PROCEDURE  
Reexamination, Ex parte--Reexamination, Ex parte

	Sec. No.		Sec. No.
Introduction.....	2201	Prior art considered.....	2244, 2256
Listing of prior art.....	2257	Prior art previously cited/considered.....	2242, 2258.01
Litigation copending.....	2286	Proceedings.....	2209
Litigation review.....	2240, 2287	Processing in Technology Center.....	2233, 2245
Mailing of Office actions.....	2264	Clerical handling.....	2270
Merger.....	2283, 2686.01	Project code.....	2238
Merger with reissue proceedings.....	1449.01	Public access.....	103, 2232
Multiple dependent claim handling, preparation for publishing.....	2287	Quality Assurance Specialist (QAS).....	2289
New matter.....	2270	Quality review.....	2289
NIRC (See Form letters and forms: Notice of Intent to Issue <i>Ex Parte</i> Reexamination Certificate (NIRC) PTOL-469))		Reasons for patentability and/or confirmation .....	2262, 2287
Notification of Concurrent Proceedings.....	2285	Reconsideration of Office action.....	2269
Of a reexamination.....	2295	Record system.....	2235
Office action.....	2260, 2262	Refund if request denied.....	2247, 2248
<i>Official Gazette</i>		Reissue copending.....	1449.01, 2285
Notice of certificate.....	2291	Rejections.....	2242, 2258
Notice of request.....	2229	Using “old art”.....	2258.01
“Old art” (i.e., previously considered/cited) .....	2242, 2258.01	Reminders.....	2287
Oral hearing.....	2276	Reply by third party requester.....	2251, 2253
Orders for copies of.....	2232	Period for reply cannot be extended.....	2265
Patent copy in request.....	2219	Reports.....	2235
Double column format.....	2214, 2219	Representative of requester.....	2213
Patent owner’s address.....	2222	Request.....	2210
Patent owner’s statement.....	2249	After reissue patent issues.....	2240, 2258, 2285
Patent owner’s statement of interview.....	2281	After first reexamination certificate issues.....	2294
Patentability review conference.....	2271, 2271.01, 2287	Content.....	2214
Petition.....	1002.02(b)	Correction processing.....	2231
Correct inventorship.....	2250.02	Decision.....	2240, 2244
Denial of request.....	1002.02(c), 2246, 2265	Decision criteria.....	2242
For entry of late papers (revival of terminated proceedings).....	2268	Denied.....	2247, 2247.01
Merge proceedings.....	2283, 2285	After reissue patent issues.....	2240
Reconsideration.....	2268	During interference.....	2284
Stay proceedings pending interference.....	2284	Facsimile submission not permitted.....	502.01
Stay proceedings pending reissue.....	2285	Filing address.....	2224
Unavoidable delay.....	2268	Granted.....	2246, 2247.01
Unintentional delay.....	2268	Guidelines.....	2242
Vacate order granting request.....	2246	“Old art” (previously considered art) involved .....	2242, 2258.01
Waive time provisions.....	2265	Response to Office action.....	2266
Power of attorney, withdrawal.....	2223	Restriction improper.....	2258
Preprocessing staff.....	2226, 2228	Review.....	2289
.....	2229, 2232, 2239	Sample letter requesting reexamination.....	2214
Printing of certificate.....	2288	Scope.....	2258
Prior art.....	2218	Search.....	2244, 2258.01
		Second or subsequent request.....	2240, 2283
		Prior art considered.....	2240, 2242

INDEX

Reexamination, Inter partes--Reexamination, Inter partes

Sec. No.	Sec. No.
Service by patent owner on requestor of patent owner statement ..... 2249	Admissions ..... 2617
Service of papers ..... 2220, 2266, 2266.02, 2266.03	Affidavits ..... 2616, 2617, 2658, 2666, 2675, 2677
Special status for action ..... 2261	Amendment by patent owner
Statement applying prior art ..... 2217	After a new ground of rejection is issued by the Board ..... 2682
Statement by owner ..... 2249	After Action Closing Prosecution (ACP) ..... 2671 ..... 2672, 2673
Statement of Reasons for Patentability and/or Confirmation ..... 2287	After expiration of the patent ..... 2666.01
Statutory basis ..... 2201	After Notice of Intent to Issue <i>Inter Partes</i> Reexamination Certificate (NIRC) ..... 2687.01
Stay ..... 2283	After Right of Appeal Notice (RAN) ..... 2673 ..... 2673.02, 2675
Submission defective or informal ..... 2266.02	Claims ..... 2666.01
After final ..... 2272	Defective ..... 2666.50, 2666.60, 2667
Submission not fully responsive ..... 2266.01	Dependent claim ..... 2660.03
After final ..... 2272	Drawings ..... 2666.02
Substantial new question of patentability ..... 2201, 2216 ..... 2240, 2242, 2244, 2246	Entry ..... 2670
Using "old art" ..... 2242, 2258.01	In a merged reexamination proceedings ..... 2670, 2686.01, 2686.03
"Sufficient cause" for extension of time ..... 2265	Of a reissued patent ..... 2686.03
Suspension ..... 2283	Title ..... 2660.02
Terminated ..... 2294	To provoke an interference ..... 2686.02
Terminated files ..... 2294	Unsigned ..... 2666.50
Tickler reports ..... 2235	Appeal (i.e., Appellant) Brief ..... 2675
Time for request decision ..... 2241	Defective ..... 2675, 2675.02
Time for requesting ..... 2211	Appeal Conference ..... 2676, 2677
Time for response to actions ..... 2263	Appeal to the Board of Patent Appeals and Interferences ..... 2674 to 2680
Time reporting ..... 2238	Flowchart ..... 2601.01
Title report ..... 320, 2287	Appeal to the Court of Appeals for the Federal Circuit ..... 2682, 2683
Transfer ..... 2237	Appeal to the U.S. District Court for the District of Columbia not available ..... 2683
Translation required ..... 2218	Appellant defined ..... 2674
Untimely filed paper prior to order ..... 2225	Assignment to examiner ..... 2636, 2648, 2655
Untimely filed papers ..... 2267	Certificate of <i>inter partes</i> reexamination ..... 2688 ..... 2690, 2694
Untimely responses ..... 2252	Distribution ..... 2692
Use of transmittal form (PTOL-465) ..... 2264	Format ..... 2690
Vacated ..... 2294	Reissue patent as ..... 2688, 2694
Vacated, claims invalid/unenforceable ..... 2286	Certificate of service ..... 2620, 2666.06
Who may file request for ..... 2212	Certificate of mailing or transmission ..... 2624 ..... 2665, 2666, 2666.05
Withdrawal of attorney during ..... 402.06, 2223	Certificate of prior reexamination in later request ..... 2214, 2219, 2619
Withdrawal of power of attorney ..... 2223	Certification as to statutory estoppel ..... 2612, 2614
Reexamination, <i>Inter partes</i> (See also Reexamination, <i>Ex Parte</i> ) ..... Chapter 2600	Clerical handling ..... 2670
Access by public ..... 103, 724.04(c), 2609, 2632	
Action closing prosecution (ACP) ..... 2660, 2666.05 ..... 2666.10, 2667, 2660, 2666.05 ..... 2671.03, 2673.02, 2682	
Content ..... 2671.02	
Premature ..... 2672	
Response to ..... 2672	



MANUAL OF PATENT EXAMINING PROCEDURE  
Reexamination, Inter partes--Reexamination, Inter partes

	Sec. No.		Sec. No.
Collateral estoppel.....	2659	Before the decision on the Request.....	2633
Comments on Statement of Reasons for Patentability and/or Confirmation.....	2687.01	In merged reexamination proceedings .....	2686.01
Comments by third party (See Reexamination, <i>Inter partes</i> : Response by third party)		Regarding multiple reexamination requests.....	2686.01
Concurrent proceedings .....	2282, 2686	Review of Rebuttal Briefs.....	2679
Constructive notice of.....	2630, 2654	Examiner's Amendment	
Copending proceedings.....	2282, 2686	Canceling rejected claims .....	2671, 2687
Copies of the prior art with request.....	2618	Correcting formal matters .....	2687, 2687.01
Copy of printed patent with request .....	2619	In merged reissue/reexamination .....	2686.03
Double column format.....	2614	Not permitted if approval required.....	2687.01
Copying of the file by the public.....	2632	To the Title.....	2660.02, 2686.03, 2687
Correction of inventorship .....	2658, 2666.03	Examiner's Answer .....	2677
Correspondence.....	2624	Expedited Right of Appeal Notice.....	2671, 2673.02
Court of Appeals for the Federal Circuit.....	2682, 2683	“Express Mail” procedure.....	2624, 2665
Court ordered .....	2686.04	.....	2666, 2666.05
Cross appeal to the Board of Patent Appeals .....	2674	Extensions of time .....	2665
Cross appeal to the Federal Circuit .....	2683	After Action Closing Prosecution .....	2672
Decision by the Board of Patent Appeals and		To amend the claims after a Board decision containing a new ground of rejection .....	2682
Interferences.....	2681, 2682	To appeal to the Court of Appeals for the Federal Circuit.....	2682
Decision on the request for <i>inter partes</i> reexamination		To complete a reply held non-responsive .....	2660.30
.....	2640, 2641	To petition denial of the Request .....	2648, 2665
After Court decision .....	2686.04	Facsimile transmission, correspondence by.....	2624
Content .....	2646	Fees.....	2634
Criteria for deciding.....	2642	For a copy of the file on CD.....	2632
Deadline for mailing.....	2641	Refund.....	2615, 2647, 2648
Denial .....	2640, 2647, 2647.01	Final Board decision.....	2681, 2682
.....	2648, 2694	Filing date.....	2627, 2628
Grant.....	2640	Flowcharts .....	2601.01
“Old art” (previously considered art) used .....	2642	Foreign priority.....	2658
Processing.....	2647, 2647.01, 2648	Forms listed .....	2696
Prior art available.....	2644	Fraud.....	2684
Reissue about to issue.....	2686.03	Improper comments.....	2667
Dependent claim treatment.....	2660.03	Inappropriate papers .....	2667
Design applications .....	2611	Incorporation by reference in Examiner's Answer ...	2677
Domestic priority .....	2658	Interference copending .....	2686, 2686.02
Drawings .....	2666.02	Intervening rights.....	2693
Duty of disclosure .....	2003.01, 2684	Interviews in a merged reexamination/reissue.....	2686.03
Electronic copy.....	2609, 2632	Interviews not permitted .....	2666.30, 2685, 2687
Enlarging claim scope prohibited.....	2658, 2666.01	Litigation concurrent .....	2640, 2681, 2686, 2686.04
Estoppel, Collateral.....	2659	Litigation search .....	2686.04
Estoppel, Statutory.....	2601, 2612, 2614	Litigation stayed .....	2686.04
Examination scope .....	2658, 2671.01, 2671.02	Merger of multiple requests for reexamination ...	2686.01
Examiner consultation with a Reexamination Legal		Merger of reissue and <i>inter partes</i> reexamination	
Advisor (RLA)		.....	2686.03
After response by parties .....	2671	Multiple requests for reexamination filed	
Before appeal.....	2676	.....	2640, 2686, 2686.01, 2695

INDEX

Reexamination, Inter partes--Reexamination, Inter partes

Sec. No.	Sec. No.
New grounds for rejection..... 2671.01	Unavoidable delay .....2668
By the Board of Appeals ..... 2681, 2682	Unintentional delay .....2668
New matter..... 2671.01, 2671.02	Vacate order granting <i>inter partes</i> reexamination ..... 2646
NIRC (See Form letters and forms: Notice of Intent to Issue <i>Inter Partes</i> Reexamination Certificate (NIRC) PTOL 2068)	Waive time provisions ..... 2648, 2668, 2672
Non-final Board decision ..... 2681	Premature response/comments ..... 2625, 2667
Non-responsive reply by patent owner/third party ..... 2666.30, 2666.50	Prior art citation..... 2602, 2646, 2654, 2656, 2657
Notice of appeal ..... 2662, 2674, 2674.01	After the order to reexamine ..... 2602, 2667
Premature..... 2667	After a Notice of Intent to Issue <i>Inter Partes</i> Reexamination Certificate issues..... 2687.01
Notice of cross appeal ..... 2662, 2674, 2674.01	Before the first Office action..... 2625
Notice of <i>Inter Partes</i> Request for Reexamination in the <i>Official Gazette</i> ..... 2627, 2629	Before the order to reexamine..... 2602, 2654
Notice of <i>Inter Partes</i> Reexamination Certificate	By another requestor ..... 2656
Issuance in the <i>Official Gazette</i> ..... 2688, 2691	By the patent owner ..... 2656
Office action..... 2660, 2671	Storage area..... 2667
Not closing prosecution ..... 2671.01	With the Request..... 2656
Reopening prosecution after ACP ..... 2673, 2673.01	With third party's comments..... 2666.05, 2667
Reopening prosecution after Examiner's Answer ..... 2679	Prior art copies with request ..... 2618
Reopening prosecution after RAN..... 2676, 2677	Processing..... 2670
Oral hearing..... 2662, 2675, 2677, 2680	After a decision by the Board..... 2682
Open to public ..... 2680	Amendment..... 2666.01, 2670, 2687
Order granting <i>inter partes</i> reexamination..... 2646, 2660	Clerical..... 2670
Returned as undelivered ..... 2654	Examiner's Answer..... 2677
Oversight..... 2689	Inappropriate papers..... 2667
Patent copy with request ..... 2619	Merger of multiple reexamination requests ..... 2686.01
Double column format..... 2614	Merger of reissue and <i>inter partes</i> reexamination ..... 2686.03
Patentability Review Conference ..... 2671.03	Terminated <i>inter partes</i> reexamination..... 2694
Petition ..... 1002.02(b)	Proof of service (See Reexamination, <i>Inter partes</i> : Service of papers)
Board decision ..... 2681	Public access..... 103, 2609, 2632
Consideration of submissions after NIRC ..... 2687.01	Publication..... 2687
Correct inventorship ..... 2658, 2666.03	Publication of Board decision..... 2681
Denial of request for <i>inter partes</i> reexamination ..... 1002.02(c), 2647, 2648	RAN (See Reexamination, <i>Inter partes</i> : Right of Appeal Notice (RAN))
Entry of late papers for revival of reexamination proceeding..... 2668	Real party in interest identification..... 2612, 2614, 2677
Enter an amendment after RAN .. 2672, 2673.02, 2675	Reasons for Patentability and/or Confirmation..... 2687
For an interview in a merged reexamination/reissue ..... 2686.03	Rebuttal Brief ..... 2678, 2679
Merge <i>inter partes</i> reexamination and reissue ..... 1002.02(b), 2667, 2686.03	Refused entry ..... 2679
Premature Action Closing Prosecution..... 2672	Records..... 2635
Reopen prosecution after Board decision ..... 2682	Reissue copending ..... 1449.01, 2643, 2686 ..... 2686.03
Suspend second or subsequent requests..... 2640	Reissue previously issued..... 2640, 2686
Stay reexamination ..... 2667, 2686.02, 2686.03	Remand by the Board of Appeals..... 2681, 2682
	Reopening prosecution after an Action Closing Prosecution (ACP)..... 2673, 2673.01
	Reopening prosecution after a Board decision ..... 2682

MANUAL OF PATENT EXAMINING PROCEDURE  
Reexamination, Inter partes--Reexamination, Inter partes

	Sec. No.		Sec. No.
Representative of requestor.....	2613	Late (See also Reexamination, <i>Inter partes</i> : Time periods for response) .....	2667, 2668
Request for extension of time.....	2665	No proof of service .....	2667
Request for reconsideration by patent owner .....	2666	No response filed .....	2666.20, 2671
Request for <i>inter partes</i> reexamination		Other than third party requester .....	2667
Claims considered.....	2643	Period for response.....	2666.05, 2666.20
Content .....	2614	Person not of record .....	2666.50
Denied .....	2640, 2647	Premature comments.....	2625, 2667
Facsimile transmission not permitted .....	502.01, 2624	Premature appeal.....	2667
Filed after reissue issued.....	2658	Prior art submission with .....	2666.05, 2667
Filed while interference pending .....	2686.02	Too long.....	2667
Filing address.....	2624	Unsigned .....	2666.50, 2667
Granted .....	2640	Review .....	2689
Incomplete .....	2627	Right of Appeal Notice (RAN).....	2666.05, 2666.10
Informal .....	2628	.....	2667, 2671 to 2674, 2677
Prior art cited with .....	2618	Content.....	2673.02
Second or subsequent filed .....	2640, 2686.01	Scanning .....	2632
Statement applying the prior art .....	2617	Scope of examination .....	2658, 2671.01, 2671.02
Time for filing .....	2611	Service of papers .....	2666.06
Vacated.....	2628	Certificate of .....	2620, 2666.06
Request for Rehearing by the Board .....	2682, 2683	Proof of service .....	2666.06, 2666.50, 2667
<i>Res judicata</i> .....	2659	To patent owner .....	2620, 2654, 2666.05
Respondent Brief.....	2675.01	To third party requestor.....	2654, 2666, 2666.05
Defective.....	2675.01, 2675.02	Special Status.....	2661
Respondent defined.....	2674	Statement applying the prior art .....	2617
Response by patent owner.....	2666	Statutory estoppel .....	2601, 2612, 2614
After Action Closing Prosecution.....	2671, 2672	Stayed pending litigation outcome .....	2686.04
Defective.....	2666.30, 2666.40, 2667	Stayed pending reissue outcome.....	2686.03
Improper comments .....	2667	Submissions prior to the first Office action .....	2625
Late (See also Reexamination, <i>Inter partes</i> : Time periods for response).....	2667, 2668	Substantial new question of patentability .....	2614, 2616, 2617, 2640, 2246
No proof of service .....	2667	.....	2642 to 2647, 2648, 2658, 2686.01, 2686.04
No response filed.....	2666.10, 2671	‘Sufficient cause’ for extension of time.....	2665
.....	2671.01, 2671.02	Suspension of requests for <i>inter partes</i> reexamination .....	2640, 2686.01
Not fully responsive.....	2666.30, 2671	Terminated.....	2694
Person not of record.....	2666.50	Third party requestor (See Reexamination, <i>Inter partes</i> : Response by third party)	
Premature.....	2625, 2667	Time for requesting <i>inter partes</i> reexamination .....	2611
To Notice of Defective Paper .....	2666.40, 2666.60	Time periods after appeal for filing:	
To Office action.....	2666, 2666.30	Amendment after Board decision containing a new ground for rejection .....	2682
Too long.....	2667	Notice of Appeal in the Federal Circuit .....	2682
Unsigned.....	2666.50, 2667	Notice of Cross Appeal in the Federal Circuit .....	2683
Response by third party		Request for Rehearing.....	2682
After Action Closing Prosecution.....	2671, 2672	Time periods during appeal for filing:	
After patent owner corrects defect.....	2666.40	Appeal (i.e., Appellant) Brief.....	2675
Comments regarding response by patent owner .....	2666.05, 2666.20, 2666.30		
Defective.....	2666.50, 2667		
Improper comments.....	2666.05, 2667, 2671		

INDEX  
Reexamination Legal Advisor (RLA)--Reference

Sec. No.	Sec. No.
Corrected/Supplemental Appellant Brief ..... 2675, 2675.02	Between applicant's priority date and U.S. filing date..... 201.15, 706.02(b)
Corrected/Supplemental Respondent Brief ..... 2675.01, 2675.02	Borrowing from Technology Center..... 901.08
Corrected/Supplemental Rebuttal Brief..... 2679	Citation ..... 707.05 to 707.05(g), 901.04, 901.05(a)
Notice of Appeal..... 2674	After allowance ..... 1302.12, 1308.01
Notice of Cross Appeal..... 2674, 2674.01	After appeal..... 1208.01
Rebuttal Brief ..... 2678	By applicant ..... 707.05(b), 707.05(c), 1302.12
Request for Oral Hearing..... 2680	Correction ..... 707.05(g)
Respondent Brief..... 2675.01	Period for reply ..... 710.06
Time periods for response ..... 2662	Claims foreign date..... 715.01
After Action Closing Prosecution..... 2672	Combination of references..... 706.02(j)
After defective submission ..... 2666.30	Copending..... 706.02(f)(2), 706.02(k)
..... 2666.50, 2666.60	..... 706.02(l) to 706.02(l)(3), 709.01
After Office action..... 2662, 2665, 2667	Copies ..... 707.05(a)
To make claims the same in each concurrent reexamination..... 2686.01	Cross, how cited ..... 707.05(e)
Time reporting by Office personnel ..... 2638	Cross reference addition ..... 905.02
For a Patentability Review Conference ..... 2671.03	Date, determination of ..... 707.05(f), 2124
Title ..... 2660.02	..... 2126, 2128 to 2128.02
Transfer ..... 2637	Date, exception to the rule ..... 2124
Unpublished legal opinions..... 2677	Declassified printed matter ..... 707.05(f)
Reexamination Legal Advisor (RLA) ..... 2632, 2633	Defensive publications ..... 901.06(d)
..... 2640, 2641, 2647.02, 2664, 2670	Design application ..... 707.05(a)
..... 2675, 2679, 2686.01, 2686.04, 2689	Disclosure, broad ..... 2123
Reexamination Processing System (REPS)..... 103, 2632	Drawings as prior art ..... 2125
Reference (See also Prior art)	Effects of international application publication ..... 1857
A.I. Series patent ..... 901.04	..... 1857.01
A.P.C. publication ..... 901.06(c)	Effective date
Abandoned application..... 901.02, 2127	Patent ..... 706.02, 706.02(a), 707.05(e), 707.05(f), 715
Abbreviations ..... 901.06(d)	Publication ..... 706.02(a), 715.01(c),
Abstracts ..... 706.02, 901.06(d)	..... 1857.01, 2128.02
Additional..... 707.05(d)	Electronic publications ..... 707.05(e), 904.02(c), 2128
Admissions..... 2129	Enabled disclosure..... 2131.01
Analogous art ..... 904.01(c), 2141.01(a)	Enabling, plant genetics..... 2121.03
..... 2143.01, 2145	Enabling, compounds and compositions ..... 2121.02
Antedating (See Affidavit, swearing back of reference (37 CFR1.131))	Enabling, apparatus and articles ..... 2121.04
Applications, domestic and foreign..... 2127	Equivalents ..... 904.01(b)
Applying reference under 35 U.S.C. 102(e).. 706.02(f)(1)	Every element rule for anticipation ..... 2131
Arrangement in Examiner's Search files..... 901.07	Evidencing the meaning of a term
As evidence of inherency ..... 2131.01	used in the primary reference ..... 2131.01
As evidence in multiple reference,	Foreign patent ... 706.02, 707.05(e), 901.05(a), 901.05(b)
35 U.S.C. 102 rejection ..... 2131.01	Forfeited application..... 901.02
Assigned application as..... 804.03	From interference ..... 1302.12
Availability..... 2128	Incorrect citation..... 707.05(g), 710.06, 1302.12
	Inoperability ..... 716
	Internal documents, confidential ..... 2128.01
	Intervening..... 201.15, 706.02(b)

MANUAL OF PATENT EXAMINING PROCEDURE  
Reference characters--Reissue application

	Sec. No.		Sec. No.
Joint patent to applicant and another .....	715.01(a)	Swearing back (See also Affidavit, swearing back of reference (37 CFR 1.131)).....	706.02(k)
.....	715.01(c)	.....	715, 2132.01, 2133.02
Listing at allowance .....	1302.12, 1455	Thesis.....	2128.01
Lost counts in interference .....	2138.01	Utility.....	2122
Multiple reference rejections under		“Well known in the art,” supported by .....	2144.03
35 USC 102.....	2131.01	Reference characters.....	608.01(g)
Newly discovered after allowance .....	1308.01	Reference to foreign application.....	202.03, 202.04, 901.03
Nonanalogous art		Reference to prior patent .....	608.01(p)
(See also Reference: Analogous art).....	2131.05	.....	608.01(r), 901.03
.....	2141.01(a)	Reference to related application (See Cross-noting)	
None cited by examiner .....	707.05, 707.05(a)	Reference to related application	
Operability .....	2121	for disclosure .....	608.01(p)
Ordering official cross.....	903.06	Refile application (See also Application; Substitute application) .....	201.10
Overcome		Refunds (See also Fee; Deposit accounts).....	509, 607.02
Under Rule 1.130.....	718	Additional invention or species .....	803.03(a), 803.03(b)
Under Rule 1.131 (See also Affidavit, swearing back of reference (37 CRR 1.131)).....	706.02(a)	Canceled claims .....	506
.....	706.02(f)(2), 706.02(k), 715	Correspondence address .....	509.03, 2540, 2542
.....	1302.14, 2132.01, 2133.02	Filing fee.....	201.04(b), 503, 506, 601.01(a)
Under Rule 1.132.....	706.02(f)(2), 706.02(k)	International applications.....	1002.02(p), 1819, 1847
.....	716, 2132.01	.....	1850, 1864
Overcoming under 35 U.S.C. 119 .....	201.15	International search fee.....	707, 1819, 1847
Paper, orally presented .....	2128.01	.....	1852, 1859
Patent.....	901.04, 2126	Issue fee .....	1308.01, 1308.03
Patent, date available.....	2126.01	Maintenance fee.....	2520, 2540, 2542, 2550, 2590
Patent, Foreign (See Foreign patent)		Oral hearing.....	1209
Patent, official number lacking .....	901.04	Publication fee .....	1126
Patent claiming same invention.....	715.05, 2306	Reexamination	
.....	2308.01	<i>Ex parte</i> .....	2215, 2247, 2248
Pending application (See also Application) .....	901.03	<i>Inter partes</i> .....	2615, 2647, 2648
Publication of applicant’s invention.....	715.01(a)	Refund Section, Office of Finance .....	509.03, 607.02
.....	715.01(c), 2132.01, 2133.01	Petition fee.....	506.02
Publication, date available.....	2128.02	Small entity fee.....	509.03, 2550
Publication, printed .....	2128	Statutory Invention Registration (SIR).....	1109
Publications.....	706.02, 707.05(e), 901.06	Refusal to publish SIR.....	1105
.....	2131.01, 2132.01, 2133.01	Registration, Attorney or agent.....	402, 1702
Published abstracts of application .....	706.02, 711.06(a)	Regulations, examiner’s search facilities.....	510
.....	2131.01, 2133.01	Regulations, public search room.....	510
Rejection over broad disclosure instead		Rehearing by Board of Patent Appeals and Interferences	
of preferred embodiments .....	2123	.....	1002.02(j), 1214.01, 1214.03, 1214.04
Replacement of missing .....	901.09	Rehearing by C.A.F.C. ....	1216.01
Same assignee .....	706.02(f)(2), 706.02(k)	Reissue application .....	1401 to 1470
.....	706.02(l) to 706.02(l)(3), 709.01, 715.01(b)	Absolute intervening rights.....	1460
Selection of pertinent .....	904.02	Access to.....	103, 724.04(b), 1430, 1470
Statutory bar .....	706.02(a), 201.13, 2133.02	Acknowledgment of protest.....	1901.05
Statutory section to use .....	706.02(a)	Additional information required .....	1442.01, 1442.04
Supply procedure .....	707.05(a), 707.05(g), 710.06		

INDEX  
Reissue application--Reissue application

	Sec. No.		Sec. No.
Adjudication of original patent .....	1442.01	Divisional .....	1002.02(b), 1410.01
Allowance .....	1455	.....	1412.01, 1414, 1450, 1451, 1457
Amendment.....	714, 1411, 1453	Domestic priority, delayed claim.....	201.11
Examiner's.....	1455	Double patenting .....	1451
Of drawings .....	1413, 1453	Drawings.....	1413, 1414, 1453
So that reissue can be merged with <i>ex parte</i>		Duty of disclosure.....	1406, 1418, 1448
reexamination.....	2285	.....	2001.06(c), 2003
So that reissue can be merged with <i>inter partes</i>		Election of species.....	1450
reexamination.....	2686.03	Equitable intervening rights.....	1460
Amends or corrects original patent .....	1400.01, 1402	Error correction after allowance	
Appeal brief.....	1454	.....	1414.01, 1444
Assignee consent.....	1410.01, 1443, 1451	Error in original patent .....	1401, 1402, 1414, 1414.01
Broadened .....	706.03(x), 1412.03	Examination.....	1440, 1443, 1445
Cannot be used to remove terminal disclaimer .....	1490	Review of Oath/Declaration.....	1444
Certificate of correction .....	1411.01, 1412.04, 1443	Examiner Reissue Guide and Checklist.....	1443
.....	1480 to 1485	Expedited examination .....	708.01, 1441, 1442, 1442.03
Claim		Design .....	1457
Broadening .....	1412.02, 1412.03	Expired patent.....	1415.01
Dependent.....	1412.03	Filed during interference .....	2358, 2360
Format .....	1411, 1453	Filing fee.....	1415
Numbering.....	1451, 1455, 1455	Final Office action.....	1443
Oath requirement.....	1414	Foreign priority claim.....	201.14, 201.16, 201.14(b)
Printed in <i>Official Gazette</i> .....	1455	.....	1402, 1417
Same invention as original patent.....	1412.01	Format .....	1410, 1411, 1411.01
Too narrow .....	1402	Fraud.....	1448, 2012
Collateral estoppel.....	2112.01	Grounds for filing.....	1402
Consent by assignee .....	1410.01, 1443, 1451	Inequitable conduct.....	1448, 2010
Content .....	1410	Information disclosure statement.....	2003
Continuation.....	1410.01, 1414, 1451	Initial examiner review .....	1443
Copending application reference.....	1402	Inoperative or invalid, Oath requirement.....	1414
Copending <i>ex parte</i> reexamination proceedings .....	2285	Inspection .....	103
Copending <i>inter partes</i> reexamination proceedings		Interference.....	1449.02, 2360
.....	2686.03	Interference on original patent concurrent with...	1449.01
Correct inadequacies .....	1402	Intervening rights.....	1460
Court decision involving original patent.....	1442.01	Inventorship error .....	1402, 1412.04
Court ordered .....	1442.05	List of references .....	1455
Cross noting .....	1451, 1455	Litigation involved .....	1404, 1442.01 to 1442.05, 1443
Deceptive intention .....	1414	Marking envelope .....	1404
Declaration.....	1410.01, 1414, 1414.01, 1444	Litigation protest.....	1901.03
Supplemental .....	1414.01, 1444, 1455	Maintenance fees on original patent .....	1415.01
Defective oath, ground for rejection.....	706.03(x)	Merger of reissue applications after restriction .....	1450
.....	1414	Merger of reissue application with <i>ex parte</i>	
Dependent claim.....	1455	reexamination .....	2285
Design .....	1457	Merger of reissue application with <i>inter partes</i>	
Diligence .....	1403	reexamination .....	2686.03
Disclaimer .....	1411.01, 1450	Multiple filings .....	1451
		New matter .....	1411.02

MANUAL OF PATENT EXAMINING PROCEDURE  
Rejected application--Rejection

	Sec. No.		Sec. No.
Numbering of claims .....	1451, 1453	Specification .....	1410, 1411, 1411.01, 1453, 1455
Notice in original file .....	202.05	Statement, patent not available .....	1416
Oath .....	1414, 1414.01, 1444	Statutory basis .....	1401
Primary examiner's decision .....	1004	Statutory disclaimer .....	1490
Supplemental .....	1414.01, 1444, 1455	Stayed pending <i>ex parte</i> reexamination .....	2686.03
Offer to surrender patent .....	1416, 1443	Stayed pending <i>inter partes</i> reexamination .....	2686.03
<i>Official Gazette</i>		Submission of papers in .....	1404
Claim to be printed in .....	1455	Suit on original patent .....	1442.01
Filing notice in .....	1430, 1441, 1441.01	Surrendered patent returned to applicant .....	1416
.....	1443, 1452, 1457, 1470	Suspension .....	1450
Omission of feature .....	1411.02	Terminal disclaimer .....	1410.01, 1411, 1451, 1490
Open to public .....	103, 1430, 1470	Transfer of original drawing	
Ordering copies of papers in file .....	1430	(prior practice) .....	608.02(i), 1413
Ownership .....	201.12, 1410.01, 1443	Treatment of protest .....	1901.06
Patent series .....	901.04	Twice reissued .....	1411
Patent term, affect on .....	1405	Two month delay period .....	1441, 1441.01
Petition to merge reissue and <i>ex parte</i> reexamination		Rejected application .....	203.02
.....	1002.02(b), 2285	Rejection (See also Anticipation rejection; Indefinite claim; Obviousness) .....	706
Petition to merge reissue and <i>inter partes</i> reexamination		Abandonment of invention .....	706.02(d), 706.03(s)
.....	1002.02(b), 2686.03	Admission by applicant .....	706.02(c), 2133.03(c)
Petition to stay reissue pending <i>ex parte</i> reexamination		After allowance of application .....	706.04, 706.05
.....	2285	.....	1308.01
Petition to stay reissue pending <i>inter partes</i>		After allowance of claim .....	706.04
reexamination .....	2686.03	After allowance, primary examiner review of .....	1004
Print of drawing .....	608.02, 608.02(m)	After appeal, New rejection .....	1208.01
Prior art consideration .....	1402	After termination of interference .....	2363.03
Prior art statement .....	1418	Against public policy .....	706.03(a)
Priority correction .....	201.14(b), 201.16	Aggregation .....	2173.05(k)
.....	1402, 1405, 1417	All valid grounds .....	707.07(g)
Protest .....	1441.01, 1443, 1901	Allowed claim by Board of Patent Appeals and	
Protest filed in reissue where patent		Interferences .....	1213.02
is in interference .....	1443, 1449	Alternative phrases .....	2173.05(h)
Public access .....	103, 1430, 1470	Anticipation (See also Anticipation rejection)..	706.02(a)
Recapture of matter .....	706.02(l)(1), 1412.02	.....	707.07(d), 2131, 2132, 2133, 2136
Reexamination proceedings copending .....	1449.01	Art (See also Prior art) .....	706.02
<i>Ex parte</i> .....	2285	Assigned applications, Same applicant .....	804.03
<i>Inter partes</i> .....	2643, 2686, 2686.03, 2695	Atomic Energy Act .....	706.03(b)
Rejection .....	706.03(x)	Authorship .....	2137
Request for Continued Examination (RCE) .....	1451	Backup rejections .....	706.02
Requirement for information .....	1442.04	Bar, Statutory .....	706.02(a), 2133 to 2133.03(e)(7)
Restriction .....	1450, 1451	Overcoming .....	706.02(b)
Design .....	1457	Board of Patent Appeals and Interferences introduces	
Return of original patent .....	1416	.....	1214.01
Review .....	1456	Board of Patent Appeals and Interferences statement on	
Same invention as original patent .....	1412.01	allowed claim .....	1213.02
Special for examination .....	708.01, 1441, 1442, 1442.03	Breadth .....	2173.04
Design .....	1557		





MANUAL OF PATENT EXAMINING PROCEDURE  
Rejoinder--Representatives of out-of-town attorneys

Sec. No.	Sec. No.
Product of nature .....	706.03(a)
Prolix .....	2173.05(m)
Provisional rejection.....	706.02(f)(2), 706.02(k)
.....	706.02(l)(3)
Public sale (See also On sale and Public use) ...	706.02(c)
Public use (See also Public use).....	706.02(c)
Public use proceeding .....	706.03(v), 720.05
Ranges.....	706.03(c), 2131.03, 2144.05
Recapture in reissue application.....	1412.02
Reissue application	
Broadened claims .....	706.03(x), 1412.03, 2163.05
Defective oath.....	706.03(x), 1444
Recapture .....	1412.02
Repeated .....	707.07(f)
<i>Res judicata</i> .....	706.03(w)
Scientific principle .....	706.03(a)
Secondary considerations .....	2131.04
Single means claim .....	2164.08(a)
Species and genus .....	806.04(h), 806.04(i)
.....	2131.02, 2144.08
Statement of .....	707.07(d)
Statutory bar.....	706.02(a), 2133 to 2133.03(e)(7)
Suggested claims not made .....	706.03(u)
Technical.....	706.03
Trademark or trade name .....	608.01(v)
Undue breadth .....	2163.05, 2173.04
Utility .....	706.03(a), 2107
Vague .....	706.03(d)
Well known in the art.....	2144.03
Rejoinder.....	806.05(c), 806.05(e), 809, 821.04
Related inventions.....	802.01, 806.04(b), 806.05
.....	808.02, 809.03
Related inventions, species .....	806.04(b)
Remailing Office action .....	707.13, 710.06
Remand by Board	
Affidavit.....	1211.02
Amendment.....	1211.01
Further search.....	1211.03
In general.....	1211
<i>Ex parte</i> reexamination .....	2274, 2275
<i>Inter partes</i> reexamination .....	2675, 2675.01
.....	2677, 2681, 2682
Special.....	708.01
Removal of application from Office .....	101
Renumbering claims.....	1302.01
Reopening after allowance.....	1308.01
Reopening after court decision.....	1216.01
	Reopening prosecution after Action Closing Prosecution in <i>inter partes</i> reexamination.....
	2673, 2673.01
	Reopening prosecution after Board decision in <i>inter partes</i> reexamination .....
	2682
	Replenishment of deposit accounts (See Deposit account: Replenishment)
	Reply (See also Amendment; Period for reply)
	After abandonment .....
	714.17
	After Board decision.....
	1214.01, 1214.06
	After final rejection .....
	714.12, 714.13
	By filing RCE .....
	706.07(h)
	Within 2 months.....
	706.07(f)
	Attorney arguments .....
	716.01(c), 2145
	By patent owner in <i>inter partes</i> reexamination (See Reexamination, <i>Inter partes</i> : Response by patent owner)
	By third party in <i>inter partes</i> reexamination (See Reexamination, <i>Inter partes</i> : Response by third party)
	Complete.....
	714.02 to 714.04
	Copying claim from patent not a reply .....
	711.02(b)
	Election requirement.....
	809.02(a), 809.02(b)
	.....
	818.03(a), 818.03(b), 818.03(c)
	Formal matters.....
	714.02
	Incomplete .....
	710.02(c), 711.02, 711.02(a)
	.....
	711.03(a), 714.02 to 714.05, 2266.01
	In <i>ex parte</i> reexamination .....
	2266
	Incomplete, election of species lacking .....
	809.02(a)
	.....
	818.03(b)
	Incomplete, proceedings not stayed by petition.....
	1002
	Incomplete, time for completing.....
	710.02(c), 711
	.....
	714.03, 2266.01
	Late .....
	711, 711.02
	Late, excused.....
	710.02(d)
	Patentability pointed out.....
	706.02(b), 714.02, 714.04
	Restart period for .....
	710.06
	Restoration of canceled matter .....
	608.01(s), 714.24
	Restriction requirement .....
	818 to 820.02
	Signed by all applicants.....
	714.01(a)
	Statutory period .....
	710.01
	Unmatched with application file.....
	508.03
	Reply brief.....
	1208, 1208.03
	Representative capacity .....
	402, 405, 714.01(c)
	Cannot expressly abandon .....
	711, 711.01
	Representative of foreign assignee .....
	302.04
	Representative of inventor or owner.....
	Chapter 400
	Representative of requester.....
	2213
	Representatives of out-of-town attorneys.....
	408

INDEX  
 Republication of PG-Pub--Restriction

	Sec. No.		Sec. No.
Replication of PG-Pub .....	1130	Relationship to information disclosure statements .....	704.14(d)
Request for Continued Examination (RCE).....	706.07(h)	Reply to .....	704.12
After allowance.....	1308	Elements of a complete reply.....	704.12(b)
Comparison with CPA.....	706.07(h)	Time periods for .....	704.13
Conditions for filing.....	706.07(h)	Treatment of an incomplete reply.....	704.12(c)
Design application .....	1502.01	Scope of requirement .....	704.11, 704.11(a)
Improper CPA treated as.....	201.06(d)	What information may be required .....	704.11, 704.11(a)
<i>Inter partes</i> reexamination of.....	2611	When requirement may be made.....	704.11(b)
Reissue application .....	1452	Requirements must be repeated .....	707.07(e)
Submission requirement .....	706.07(h)	Requisites of the application.....	702
Suspension of action in .....	709	<i>Res judicata</i> .....	706.03(w), 707.07(g), 2259, 2659
Terminal disclaimer, effect in .....	1490	Rescission of nonpublication request .....	1123, 1124
Request for <i>ex parte</i> reexamination		Rescission of Previous Nonpublication Request (35 U.S.C. 122(b)(2)(B)(ii) and if Applicable, Notice of Foreign Filing (35 U.S.C. (b)(B)(iii) form PTO/SB/36 Cited .....	1123, 1124
Decision criteria .....	2242	Reproduced.....	1135
Facsimile submission not permitted .....	502.01	Reservation clause in application .....	608.01(e), 608.01(t)
Notice of request in <i>Official Gazette</i> .....	2229	Residence, Applicant's .....	605.02, 719.02(b)
Requester's representative.....	2213	Resignation of examiner .....	1702
Time for filing.....	2210, 2211	Old cases special.....	708.03
Time to decide.....	2241	Respondent Brief in appeal of <i>inter partes</i> reexamination .....	2675.01, 2675.02
Request for <i>inter partes</i> reexamination (See Reexamination, <i>Inter partes</i> : Request; Reexamination, <i>Inter partes</i> : Decision on the request for reexamination)		Response (See Reply)	
Request form (PCT/RO/101) .....	1812, 1821, 1844, 1844.01	Restriction (See also Election; Election of species) .....	Chapter 800
Request for patentability report.....	705.01(e), 1003	Action, examiner's.....	814 to 817
Request for reconsideration of patent term adjustment .....	1002.02(b)	Action after, special.....	708.01
Request for rehearing of Board decision .....	1002.02(b)	Action on the merits .....	810 to 810.03
.....	1214.01, 1214.03, 1214.04	Apparatus and process or product.....	806.05(e) to 806.05(g)
<i>Inter partes</i> reexamination .....	2682, 2683	Application referred to second examiner.....	815
Request for reinstatement of period of patent term adjustment .....	1002.02(b)	Basis .....	802
Request for Statutory Invention Registration (PTO/SB/94) reproduced.....	1101	Burden, without serious .....	803
Request to convert provisional application to nonprovisional application .....	1002.02(b)	Claimed subject matter .....	806.01
Request to issue patent in name of assignee after issue fee paid.....	1002.02(r)	Claims to divisible inventions added before action .....	818.02(a)
Requirement for information.....	704.10 to 704.14(d)	Combination and subcombination .....	806.05(a) to 806.05(c)
.....	706.02(c), 710.02(d)	Continuation .....	819
.....	1901.06, 2122, 2123, 2307.05	Design application .....	1504.05
After the first action on the merits .....	704.11(b)	Definition.....	802.02
Authority for requirement .....	704.10	Distinct invention .....	802.01, 806, 806.05
Consideration of information submitted .....	704.14(b)	Election other than express .....	818.02
.....	707.05(b)	Election fixed by action on claim .....	818.01
Format of requirement .....	704.14	Final requirement.....	821.01
Relation to duty of disclosure .....	704.12(a), 2005		

MANUAL OF PATENT EXAMINING PROCEDURE  
Restrictions on former examiners--Right of priority

Sec. No.	Sec. No.
Grouped in parent application.....	811.04
Improper.....	803, 806, 808.02
Independent embodiments.....	806.04, 806.05
Independent inventions.....	802.01, 803, 806
.....	806.04, 808.01, 808.01(a), 818.03
Introduction.....	801
Linking claim.....	809, 809.02, 809.03, 809.04
Linking claim, traverse of rejection.....	818.03(d)
Markush type claims.....	803, 803.02
Nonelected claims, treatment of.....	821 to 821.03
Reissue application.....	1450
Nonelected invention.....	706.03(m), 809.04
Nucleotide sequences.....	803.04, 2434
Old combination and subcombination.....	806.05(b)
.....	820.01
Patentability over prior art.....	806.02, 809, 809.03
Patentability report, effect.....	807
Petition from requirement.....	809.04, 818.03(c)
Process and product or apparatus.....	806.05(e)
.....	806.05(g), 820
Product and process of using.....	806.05(h)
Product, process of making and using.....	806.05(i)
Reissue application.....	1450, 1451
Rejection of nonelected claims.....	821 to 821.03
Rejoinder.....	806.05(c), 806.05(e), 809, 821.04
Related inventions.....	802.01, 803, 806, 806.04(b)
.....	808.02, 809.03
Requirement.....	812, 814 to 817
Additional.....	811.02
After election.....	818
Shift of invention/species.....	819.01
With traverse.....	818.03(b), 821.01
Without traverse.....	821.02
By group where examinable.....	812
Completeness.....	815
Concluding paragraph.....	817, 818.03(b)
Consult other group.....	812.01, 815
Final.....	810.03, 818.03
First action.....	811
Patentability.....	810 to 810.03
Petition from.....	809.04, 818.03(c)
Reasons for insisting upon.....	808
Rejection on double patenting following.....	804.01
Repeated after withdrawal.....	811.03
Reply to.....	818 to 818.03(e)
Review by examiner with at least partial signatory authority.....	803.01
Submission to TC director.....	804.04
Second requirement.....	811.02
Sequences.....	803.04, 2434
Single claim.....	803
Single embodiment.....	806.03
Species-Genus.....	806.04(a)
Species may be related inventions.....	806.04(b)
Species of unclaimed genus.....	808.01(a)
Subcombination, Combination..	806.05(a) to 806.05(c)
When made.....	811, 811.02
Withdrawal.....	819
Telephone.....	812.01
Transitional application.....	803.03
Traverse of requirement.....	818, 818.03(c), 821.01
Restrictions on former examiners.....	1702
Restrictions upon employees of Office.....	309
Retention label.....	1302.07
Retroactive foreign filing license.....	140
Return of Papers	
Discourteous matter.....	714.19, 714.25, 1003
Entered in the file.....	201.14(c), 719.01, 1003
Return of drawing.....	608.02(y)
Return of filing fee.....	607.02
Return of oath.....	604.04(a)
Return of patent.....	1416
Return of post card.....	503, 1901.05
Returned Office action.....	707.13
Review at allowance.....	1302.01
Review for national security.....	115
Review for Government property rights.....	115
Revised statutes (See Statutes)	
Revival of abandoned application.....	203.07, 711.03
.....	711.03(c), 1002.02(b)
Revocation of agent under PCT.....	1808
Revocation/Appointment of Power of Attorney or Authorization of Agent PTO/SB/82.....	2222, 2622
Revocation of power of attorney.....	402.05, 402.07
After Allowance.....	2501
Rewritten specification.....	608.01(q)
Right of Appeal Notice (RAN).....	2666.05, 2666.10, 2667
.....	2671 to 2674, 2677
Content.....	2673.02
Right of priority (See also Foreign application)	
Foreign application.....	201.13
Form paragraphs.....	201.14(c)
Formal requirements.....	201.14
Overcoming a reference.....	201.15, 706.02(b)

INDEX  
Right to exclude others--Rules, Patent (Code of Federal Regulations)

	Sec. No.		Sec. No.
Papers required.....	201.14(b)	1.53 Reproduced .....	201.04(b), 201.06(c), 201.06(d)
Time for filing papers.....	201.14(a)	.....	506, 601.01, 601.01(c)
U.S. application.....	201.11	1.54 Reproduced .....	503
Right to exclude others.....	509.02, 1111	1.55 Reproduced .....	201.13, 201.13(a)
.....	1601, 2162	1.56 Reproduced .....	2001, 2001.01
Rights, Transfer of patent or application.....	509.02	.....	2001.04, 2001.05, 2002
RNA (See Biotechnology; Nucleotide sequences)		1.58 Reproduced .....	608.01, 608.05(b)
Roster of attorneys or agents.....	601.03, 1730, 2205, 2220	1.59 Reproduced .....	724.06
Rules, 21 CFR 60.3(b) .....	2751	1.63 Reproduced .....	201.06(c), 602
Rules, Patent (Code of Federal Regulations)		1.64 Reproduced .....	605.04(a)
.....	Introduction, App. R	1.66 Reproduced .....	602.04(a), 604
10 CFR 810 Cited .....	140	1.67 Reproduced .....	603
21 CFR 312.80-312.88 Cited .....	2107.03	1.68 Reproduced .....	602
37 CFR:		1.69 Reproduced .....	602.06, 2004
1.1 Reproduced .....	501	1.71 Reproduced .....	608.01, 608.01(v)
1.2 Reproduced .....	713.04, 2002.02	1.72 Reproduced .....	606, 608.01(b)
1.3 Reproduced .....	714.25	1.73 Reproduced .....	608.01(d)
1.4 Reproduced .....	501, 502.02, 502.04, 509.03, 2002.02	1.74 Reproduced .....	608.01(f)
1.5 Reproduced .....	502	1.75 Reproduced .....	608.01(i), 608.01(n), 2173.05(n)
1.6 Reproduced .....	502, 502.01, 505, 511, 513	1.76 Reproduced .....	601.05
1.7 Reproduced .....	710.05	1.77 Reproduced .....	608.01(a), 608.05
1.9 Reproduced .....	201, 201.04(b), 1893	1.78 in effect on November 29, 2000, Reproduced ..	1481
1.10 Reproduced .....	513	1.78 Reproduced .....	202.01, 804.03
1.11 Reproduced .....	103, 1430, 1879.04, 2229, 2312, 2629	.....	822.01, 1481
1.12 Reproduced .....	301.01	1.79 Reproduced .....	608.01(e)
1.14 Reproduced .....	101, 102, 103, 104	1.81 Reproduced .....	608.02
.....	110, 150, 1128, 1879.04	1.83 Reproduced .....	608.02(d)
1.22 Reproduced .....	509	1.84 Reproduced .....	608.01(f), 608.01(v), 608.02, 1606
1.23 Reproduced .....	509	1.85 Reproduced .....	608.02(b), 608.02(p)
1.25 Reproduced .....	509.01	1.91 Reproduced .....	608.03
1.26 Reproduced .....	509, 607.02	1.93 Reproduced .....	608.03
1.27 Reproduced .....	509.02, 509.03	1.94 Reproduced .....	608.03(a)
1.28 Reproduced .....	509.03	1.95 Reproduced .....	608.03(a)
1.31 Reproduced .....	401	1.96 Reproduced .....	608.05(a)
1.33 Reproduced .....	403, 601.03	1.97 Reproduced .....	609
.....	714.01(a), 2222, 2622	1.98 Reproduced .....	609
1.34 Reproduced .....	402	1.99 Reproduced .....	610, 1134.01
1.36 Reproduced .....	402.05	1.102 Reproduced .....	708.01, 708.02
1.41 Reproduced .....	605	1.103 Reproduced .....	709
1.42 Reproduced .....	409.01(a)	1.104 Reproduced .....	706, 707, 707.05
1.43 Reproduced .....	409.02	.....	707.07, 1302.14, 1852, 2260, 2660
1.45 Reproduced .....	605, 605.07	1.105 Reproduced .....	704.10
1.47 Reproduced .....	409.03	1.111 Reproduced .....	714.02, 714.03(a), 2266, 2666
1.48 Reproduced .....	201.03	1.112 Reproduced .....	706
1.51 Reproduced .....	601	1.113 Reproduced .....	706.07
1.52 Reproduced .....	608.01, 608.05, 2250	1.114 Reproduced .....	706.07(h)
		1.115 Reproduced .....	714.03(a)

MANUAL OF PATENT EXAMINING PROCEDURE  
Rules, Patent (Code of Federal Regulations)--Rules, Patent (Code of Federal Regulations)

	Sec. No.		Sec. No.
1.116 Reproduced .....	714.12	1.194 Reproduced .....	1209
1.121 Reproduced .....	608.02(p), 608.04, 714, 714.22	1.195 Reproduced .....	1211.02
.....	714.22(a), 1453, 2234, 2250, 2666.01	1.196 Reproduced .....	1212, 1213.02
1.125 Reproduced .....	608.01(q)	.....	1213, 1213.01, 1213.02
1.126 Reproduced .....	608.01(j)	1.197 Reproduced .....	1214, 1214.03, 1214.06
1.129 Reproduced .....	706.07(g), 803.03	1.198 Reproduced .....	1214.07
1.130 Reproduced .....	718, 804.02	1.211 Reproduced.....	1120, 1126
.....	804.03, 822.01	1.213 Reproduced.....	1122, 1123, 1124
1.131 Reproduced .....	715	1.215 Reproduced.....	1121
1.132 Reproduced .....	716	1.217 Reproduced.....	1132
1.133 Reproduced .....	713.01, 713.04	1.219 Reproduced.....	1129
1.135 Reproduced .....	710.01	1.221 Reproduced.....	1130, 1133
.....	711, 711.03(c), 714.03	1.248 Reproduced .....	1901
1.136 Reproduced .....	710.02, 710.02(e)	1.251 Reproduced .....	508.04
1.137 Reproduced .....	1124, 2268, 2668	1.291 Reproduced .....	1901
1.138 Reproduced .....	711, 1125	1.292 Reproduced .....	720
1.141 Reproduced .....	802, 806.05(i)	1.293 Reproduced .....	1101
1.142 Reproduced .....	802	1.294 Reproduced .....	1103
1.143 Reproduced .....	818.03	1.295 Reproduced .....	1105
1.144 Reproduced .....	818.03(c)	1.296 Reproduced .....	1109
1.145 Reproduced .....	821.03	1.297 Reproduced .....	1111
1.146 Reproduced .....	809.02	1.301 Reproduced .....	1216
1.151 Reproduced .....	1501	1.302 Reproduced .....	1216.01
1.152 Reproduced .....	1503.02	1.303 Reproduced .....	1216
1.153 Reproduced .....	1503.01	1.304 Reproduced .....	1216
1.154 Reproduced .....	1503.01	1.311 Reproduced .....	1303
1.155 Reproduced .....	1504.30	1.312 Reproduced .....	714.16
1.161 Reproduced .....	1602	1.313 Reproduced .....	1308
1.162 Reproduced .....	1604, 1605	1.314 Reproduced .....	1306.01
1.163 Reproduced .....	1603, 1605	1.321 Reproduced .....	1490
1.164 Reproduced .....	1605	1.322 Reproduced .....	1480
1.165 Reproduced .....	1606	1.323 Reproduced .....	1481
1.166 Reproduced .....	1607	1.324 Reproduced .....	1481
1.167 Reproduced .....	1608	1.335 Reproduced .....	311
1.171 Reproduced .....	1410	1.362 Reproduced .....	2504
1.172 Reproduced .....	1410.01	1.363 Reproduced .....	2540
1.173 Reproduced .....	1410, 1411, 1413, 1453	1.366 Reproduced .....	2515
1.175 Reproduced .....	1414	1.377 Reproduced .....	2580
1.176 Reproduced .....	1440, 1450, 2686.03	1.378 Reproduced .....	2590
1.177 Reproduced .....	1451	1.413 Reproduced .....	1840
1.178 Reproduced .....	1416, 1418, 1442.04	1.414 Reproduced .....	1893.01(a)
1.181 Reproduced .....	711.03(c), 1002	1.415 Reproduced .....	1853
1.182 Reproduced .....	1002	1.416 Reproduced .....	1862
1.183 Reproduced .....	1002	1.422 Reproduced .....	1820
1.191 Reproduced .....	1205	1.431 Reproduced .....	1810
1.192 Reproduced .....	1206	1.432 Reproduced .....	1817.01, 1817.01(a)
1.193 Reproduced .....	1208, 1208.03, 2275	1.434 Reproduced .....	1821

INDEX

Rules, Patent (Code of Federal Regulations)--Rules, Patent (Code of Federal Regulations)

	Sec. No.		Sec. No.
1.435 Reproduced .....	1823	1.615 Reproduced .....	2315
1.436 Reproduced .....	1824	1.640 Reproduced .....	2340
1.437 Reproduced .....	1825	1.641 Reproduced .....	2341
1.438 Reproduced .....	1826	1.642 Reproduced .....	2342
1.446 Reproduced .....	1847	1.658 Reproduced .....	2358
1.451 Reproduced .....	201.13(b)	1.659 Reproduced .....	2359
1.455 Reproduced .....	402.09, 1807, 1808	1.660 Reproduced .....	2284, 2360, 2686.02
1.475 Reproduced .....	1850	1.661 Reproduced .....	2361
1.477 Reproduced .....	1850	1.663 Reproduced .....	2363.03
1.480 Reproduced .....	1864	1.664 Reproduced .....	2363
1.481 Reproduced .....	1867	1.665 Reproduced .....	2365
1.484 Reproduced .....	1878, 1878.01	1.701 Reproduced .....	2720
1.485 Reproduced .....	1864.01, 1878.02	1.702 Reproduced .....	2730
1.488 Reproduced .....	1875	1.703 Reproduced .....	2730, 2731
1.489 Reproduced .....	1875.02	1.704 Reproduced .....	2730, 2732
1.491 Reproduced .....	1893.01	1.705 Reproduced .....	2730, 2733, 2734, 2735, 2736
1.495 Reproduced .....	709, 1893.01(a)	1.710 Reproduced .....	2751
1.496 Reproduced .....	1893.03	1.720 Reproduced .....	2751
1.497 Reproduced .....	1893.01(e)	1.730 Reproduced .....	2752
1.499 Reproduced .....	1893.03(d)	1.740 Reproduced .....	2753, 2754
1.501 Reproduced .....	2202, 2602	1.741 Reproduced .....	2754
1.502 Reproduced .....	2202	1.750 Reproduced .....	2755
1.510 Reproduced .....	2210, 2212, 2213, 2214	1.760 Reproduced .....	2755.01
.....	2215, 2227, 2266.03	1.765 Reproduced .....	2762, 2763
1.515 Reproduced .....	2240, 2248	1.770 Reproduced .....	2764
1.520 Reproduced .....	2239	1.780 Reproduced .....	2759
1.525 Reproduced .....	2246	1.785 Reproduced .....	2761
1.530 Reproduced .....	2234, 2249, 2250, 2250.01	1.790 Reproduced .....	2755.02
.....	2250.02, 2666.01, 2666.02	1.791 Reproduced .....	2755.02
1.535 Reproduced .....	2251	1.801 Reproduced .....	2403
1.540 Reproduced .....	2252	1.802 Reproduced .....	2404
1.550 Reproduced .....	2254, 2265, 2266, 2266.03	1.803 Reproduced .....	2405
1.552 Reproduced .....	2258	1.804 Reproduced .....	2406
1.555 Reproduced .....	2280	1.805 Reproduced .....	2407
1.560 Reproduced .....	2281	1.806 Reproduced .....	2408
1.565 Reproduced .....	2282, 2283, 2284, 2285, 2286	1.807 Reproduced .....	2409
1.570 Reproduced .....	2288	1.808 Reproduced .....	2410
1.601 Reproduced .....	2301.02	1.809 Reproduced .....	2411
1.602 Reproduced .....	2302	1.821 Reproduced .....	2422
1.603 Reproduced .....	2303	1.822 Reproduced .....	2423
1.604 Reproduced .....	2304	1.823 Reproduced .....	2424
1.605 Reproduced .....	2305	1.824 Reproduced .....	2425
1.606 Reproduced .....	2306	1.825 Reproduced .....	2426
1.607 Reproduced .....	2307	1.902 Reproduced .....	2202, 2602, 2625
1.608 Reproduced .....	2308	1.903 Reproduced .....	2666.06
1.611 Reproduced .....	2311	1.907 Reproduced .....	2612, 2686.04
1.614 Reproduced .....	2314	1.913 Reproduced .....	2610, 2612

MANUAL OF PATENT EXAMINING PROCEDURE  
 Sale, On--Scientific and Technical Information  
 Center (STIC)

	Sec. No.
1.915 Reproduced ..2610, 2613, 2614, 2615, 2627, 2628	
1.919 Reproduced .....	2615, 2627
1.923 Reproduced .....	2640
1.925 Reproduced .....	2640
1.927 Reproduced .....	2640, 2648
1.931 Reproduced .....	2646
1.933 Reproduced .....	2684
1.935 Reproduced .....	2660
1.937 Reproduced .....	2654, 2686.03
1.939 Reproduced .....	2625, 2667
1.941 Reproduced .....	2666.01, 2666.02
1.945 Reproduced .....	2666
1.947 Reproduced .....	2666.05
1.948 Reproduced .....	2666.05
1.949 Reproduced .....	2671.01, 2671.02
1.951 Reproduced .....	2672
1.953 Reproduced .....	2673.02
1.955 Reproduced .....	2685
1.959 Reproduced .....	2674, 2674.01
1.963 Reproduced .....	2675, 2675.01, 2678
1.965 Reproduced .....	2675, 2675.02
1.967 Reproduced .....	2675.01, 2675.02
1.969 Reproduced .....	2677
1.971 Reproduced .....	2677
1.973 Reproduced .....	2680
1.977 Reproduced .....	2681
1.979 Reproduced .....	2682
1.981 Reproduced .....	2682
1.985 Reproduced .....	2686
1.987 Reproduced .....	2686.04
1.989 Reproduced .....	2686.01
1.991 Reproduced .....	2686.03
1.993 Reproduced .....	2686.02
1.995 Reproduced .....	2686.03
1.997 Reproduced .....	2686.03, 2688
3.1 Reproduced .....	301
3.11 Reproduced .....	302
3.21 Reproduced .....	302.03
3.24 Reproduced .....	302.01
3.26 Reproduced .....	302.02
3.27 Reproduced .....	302.08
3.28 Reproduced .....	302.07
3.31 Reproduced .....	302.07
3.34 Reproduced .....	323.01
3.41 Reproduced .....	302.06
3.51 Reproduced .....	317.01
3.54 Reproduced .....	317.03

	Sec. No.
3.56 Reproduced .....	317.03
3.58 Reproduced .....	302
3.61 Reproduced .....	302.04
3.71 Reproduced .....	324, 402.07
3.73 Reproduced .....	324, 1410.01
3.81 Reproduced .....	307
5.1 Reproduced .....	120
5.2 Reproduced .....	120
5.3 Reproduced .....	120, 2309.06
5.4 Reproduced .....	120
5.5 Reproduced .....	120
5.11 Reproduced .....	140
5.12 Reproduced .....	140
5.13 Reproduced .....	140
5.14 Reproduced .....	140
5.15 Reproduced .....	140
5.18 Reproduced .....	140
5.19 Reproduced .....	140
5.20 Reproduced .....	140
5.25 Reproduced .....	140
10.9 Reproduced .....	402.01
10.10 Reproduced .....	1702
10.11 Reproduced .....	402
10.18 Reproduced .....	402, 410, 509.03
102.4 Reproduced .....	103

**S**

Sale, On (See On sale)	
Same attorney, interfering applications .....	2305, 2309.02
Sample letter on citation of prior art in patent .....	2205
Sanctions.....	410
Saturday, effect on time for reply .....	502, 505, 513
.....	710.05, 2504, 2506
Scanning <i>inter partes</i> reexamination papers.....	2632
Scientific and Technical Information	
Center (STIC) .....	901.06(a)
Biotechnology sequence listings.....	2421.03, 2427.01
.....	2427.02, 2429
Foreign patents .....	706.02(e), 901.05, 901.05(c)
.....	903.03, 905.06
Hours .....	1730
Litigation search .....	2240, 2286, 2640, 2686.04
Literature collection.....	719.05
Location and telephone number.....	1730

INDEX

Scientific principle not patentable--Sequence rules

	Sec. No.		Sec. No.
Translation assistance.....	901.05(d), 901.06(a)	Scope .....	2112
Scientific principle not patentable.....	706.03(a)	Selecting pertinent references.....	904.03
Scope of claims .....	904.01(a), 2163.05, 2164.08	Title .....	306
Design application.....	1503.01, 1504.04	Unduly extensive and burdensome .....	808.01(a)
.....	1504.05, 1504.06	.....	809.02(d), 818.02(b)
Scope of class.....	903.02(b)	Search exchange, United States-Philippines.....	1711
Scope of reexamination		Search notes box entries .....	719.05
<i>Ex parte</i> .....	2258	Search room, examiner's use.....	510
<i>Inter partes</i> .....	2658	Search room hours.....	510, 1730
Screening new application for security review .....	115	Search tools, automated.....	902.03(e)
.....	706.03(b)	Searched box entries.....	719.05
Seal.....	604.01	Secrecy, in general.....	101
Not required .....	604.01, 604.03(a)	Secrecy of international applications.....	120
Venue .....	604.02	“Secrecy Order” application.....	115, 120, 130
Search.....	Chapter 900	After declassification.....	130
After reversal by Board of Patent Appeals and		Allowance.....	130
Interferences.....	1214.04	Commodity Control List.....	120
Aids in Scientific and Technical Information Center		Correspondence .....	120
(STIC) .....	901.06(a)	Facsimile transmission of correspondence not permitted	120
Analogous art areas.....	904.01(c)	.....	120
APS .....	902.03(e)	Final rejection.....	130
Cards, subclass definitions .....	902.02(b)	Interference.....	130, 2309.06
Claim analysis.....	904.01	Petition for rescission or modification.....	120
Computer.....	719.05	Prosecution .....	130
Databases (See Electronic databases)		Review .....	115, 140
Electronic documents.....	707.05(e), 904.02(c)	Security, Application affecting.....	120, 121, 130, 140
Fee, PCT.....	1827	Secret sale (See On sale)	
Field of.....	904.02, 904.02(a)	Security interest in patent, recording (See also Assignment)	
Not to be given for patented inventions .....	1701	.....	313
File wrapper notation .....	705.01(a), 719.05, 904	Security markings.....	121, 130, 140, 724
Incomprehensible disclosure.....	702.01	Security screening of new applications .....	115, 140
In Technology Center, by member of public.....	713.02	Security Working Group 3640, applications submitted	
Informal application.....	702.01, 704.01	.....	121, 130, 706.03(b), 1002.02(c)(1)
INPADOC.....	901.06(a)	Self-addressed postcard (See also Postcard, self-addressed)	
Interference .....	2301.01(b)	.....	503
Internet.....	707.05(e), 904.02(c)	Sequence listing (See also Sequence rules).....	2422.03
Mechanized.....	719.05	Database (See Sequence rules)	
Notes in classification definitions .....	902.02(a)	Hand delivery .....	2422.09
Notes in file wrapper.....	705.01(a), 719.05, 903.07(a)	Mail Stop (See also Mail Stop).....	2422.09
Online database (See also Electronic databases)		Pre-Grant Publications (PG-Pub) .....	1121
.....	901.06(a), 902.03(e)	Statements.....	2422.06, 2422.07
Outlining .....	904.02(a)	Sequence rules (See also Biotechnology).....	Chapter 2400
Patentability report.....	705.01(a), 705.01(b)	Amendments to sequence listing and computer	
Prior examiner's.....	704.01	readable form.....	2426
Procedure .....	704.01, 904	Amino acid definition.....	2422.01
Requirements for information.....	704.11, 704.11(a)	Applications affected, new applications .....	2421.01
Restriction requirement.....	808.02	AuthorIn .....	2430



MANUAL OF PATENT EXAMINING PROCEDURE  
Sequences, restriction--Signature

Sec. No.	Sec. No.
Background information ..... 2401, 2420	Summary of requirements ..... 2421.02
Bona fide reply ..... 2421.03	Variants of a presented sequence ..... 2422.03
Changes to rules ..... 2421.04	Voluntary compliance ..... 2421.01
Coding regions, depiction of ..... 2423.02	WIPO Standard ST. 25, Appendix 2 Tables
Compliance requirement ..... 2422.07, 2429	Reproduced ..... 2422
Computer readable form requirement ..... 2422.04, 2425	Cited ..... 2422.01, 2423, 2423.01
Database ..... 2421.01, 2421.02, 2421.04, 2422.01	Sequences, restriction ..... 803.04, 2434
..... 2422.03, 2422.04, 2423.02, 2424.02	Series codes ..... 503
..... 2424.02, 2425, 2429, 2430	Series of dependent claims ..... 608.01(n)
Definitions for nucleotides/amino acids ..... 2422.01	Series, Patent (See Patent)
Effective date ..... 2401, 2420	Service, proof of, in a petition for access ..... 103
Exclusive conformance requirement ..... 2422.02	Service of citation in patent ..... 1901
Extensions of time ..... 2421.03	Service of court papers on Director ..... 1216
Format and symbols ..... 2423, 2423.01	Service of patent owner statement on requestor in <i>ex parte</i>
Form paragraphs ..... 2427.01	reexamination ..... 2242, 2266.03
Hand-delivery of sequence listings and	Service of papers in <i>inter partes</i> reexamination ..... 2666.06
computer readable forms ..... 2422.09	Certificate of ..... 2620, 2666.06
Helpful hints for compliance ..... 2429	Proof of service ..... 2666.06, 2666.50, 2667
Informational requirements for	To patent owner ..... 2620, 2654, 2666.05
sequence listings ..... 2424, 2424.01, 2424.02	To third party requestor ..... 2654, 2666, 2666.05
Mandatory information items ..... 2424, 2424.02	Shift of election ..... 819
Miscellaneous requirements, information ..... 2424.03	Shoes (See also Search) ..... 901.07
New applications ..... 2421.01	Shortened statutory period (See also Period for reply;
Notice to comply ..... 2421.03, 2427.02	Statutory period) ..... 710.02, 710.02(b)
Nucleotide definition ..... 2422.01	Appeal ..... 1206, 1214.06, 1215.04
Numbering of sequences ..... 2423.02	Date of abandonment ..... 711.04(a)
Numeric identifiers ..... 2424, 2424.02	Drawings ..... 608.02(b)
Official copy of sequence listing ..... 2422.04	Extension of time ..... 710.02(e), 1002.02(c)
Patent information ..... 1730, 2430	Final rejection ..... 706.07, 706.07(b)
Presumptions regarding compliance ..... 2422.08	..... 706.07(f), 706.07(g), 714.13
Previously filed identical computer readable	Informal application ..... 702.01
form, reference to ..... 2422.05	Information disclosure statement ..... 609
Replacement of sequence listing and	Interference ..... 2307.02, 2363.02
computer readable form ..... 2426	Oath ..... 602.03
Sample sequence listing ..... 2431	Quayle ..... 714.14
Sample statements ..... 2428	Reexamination, <i>ex parte</i> ..... 2250.01, 2263
Sanctions for failure to comply ..... 2422.07	..... 2265, 2273, 2285, 2286
Sequence identifier requirement ..... 2422.03	Statutory Invention Registration (SIR) ..... 1103, 1107
Sequence listing requirement ..... 2422.03	Time limits compared ..... 710.02(d)
Patent Cooperation Treaty (PCT) ..... 1823.02, 1848	Signatory Authority, Full ..... 1004
..... 2430	Signatory Authority, Partial ..... 1005
Sequence presentation ..... 2423.03	Signature
Sequences embedded in application text ..... 2422.03	Alteration in specification signed ..... 608.01
Sequences in drawings ..... 2422.02	Amendment ..... 714.01
Statement regarding content of paper and computer	Signature improper ..... 714.01(a), 714.01(c)
readable copies ..... 2422.06, 2428	..... 714.01(d)
Statement regarding new matter ..... 2422.07, 2428	Signature missing ..... 714.01(a)

INDEX

Signing, continued prosecution application--Species

Sec. No.	Sec. No.
Signed by applicant, not by attorney of record.....	714.01(d)
Signed by attorney not of record .....	405
Applicant.....	605.04(a), 605.04(d), 605.04(e)
Applicant changes name.....	201.03, 605.04(c), 719.02(b)
Applicant, international application .....	1820
Applicant unable to write .....	605.04(d)
Application papers .....	605.04(a)
Attorney or agent not of record.....	405
Certification, effect of.....	401, 410
Continued prosecution application.....	201.06(d)
Correction of name.....	605.04(c)
Express abandonment.....	711, 711.01
Facsimile .....	502.01, 502.02
Full, first or middle name.....	605.04(b)
Required on every paper .....	402
Title with.....	605.04(e)
Uniformity with name .....	605.04(b)
Signing, continued prosecution application .....	201.06(d)
Signing examiner's letter .....	706.07, 707.08, 707.09
Signing file wrapper .....	1302.13
Simulated tests in the specification .....	608.01(p)
Simultaneous issue of patents .....	1306.02
Single means claim .....	2164.08(a), 2181
Size of paper (See A4 size paper; Paper size)	
Sketch of subject matter of claims .....	904.01(a)
Small Business Act .....	509.02
Small Business Administration .....	509.02
Small entity status (See also Fee)	
Change of status .....	509.03
Claiming status.....	509.03
Correcting status.....	509.03
Definition .....	509.02
Established in parent application.....	201.06(c)
Fees .....	509.02
Government organizations .....	509.02
Improper payment .....	509.03
Independent inventor.....	509.02
Maintenance fees.....	509.03, 2515, 2550
Nonprofit organization.....	509.02, 509.03
Refund.....	509.03, 607.02
Small business concern .....	509.02
Statement verified .....	509.03
Transfer of invention rights.....	509.02
Soft copy, Ordering.....	905.02
Solicitor's Office (See Office of Solicitor)	
Sources of information to disclose .....	2001.06
Special application.....	708 to 708.03
Accelerated examination .....	708.02
Allowable application, except for form .....	707.07(j)
.....	710.02(b), 714.14, 1301
Appealed application .....	1204
Applicant's age, health .....	708.02, 1002.02(s)
Biotechnology case, small entity .....	708.02
Cancer.....	708.02, 1002.02(s)
Counter-terrorism inventions.....	708.02, 1002.02(s)
DNA .....	708.02
Energy .....	708.02
Environmental Quality Program.....	1002.02(s)
Five year pendency .....	707.02
HIV/AIDS.....	708.02, 1002.02(s)
Infringement .....	708.02, 1002.02(s)
Interference with a patent .....	2307.02
List.....	708.01
Manufacture.....	708.02, 1002.02(s)
Patent printing priority.....	1309
Petition to make .....	708.02, 1002.02(s)
Reexamination	
<i>Ex parte</i> .....	2261
<i>Inter partes</i> .....	2661
Reissue application .....	706.03(x), 1442
Remanded by Board .....	708.01
Revived applications.....	711.03(c)
Superconductivity.....	708.02
Special examining procedure.....	708.02
Special Program Examiner (SPRE).....	103, 706.02(l)(1)
.....	1456, 1825, 1845.01, 1851, 2238
.....	1896, 2233, 2237, 2246, 2283, 2286
.....	2287, 2289, 2294, 2295, 2633, 2638
.....	2647.02, 2664, 2670, 2671, 2686.01
.....	2687, 2687.01, 2689
Petitions decided.....	1002.02(s)
Species.....	802.01, 806.04(a) to 806.04(f)
.....	806.04(h), 806.04(i)
Anticipation by a generic chemical formula.....	2131.02
Anticipation of a genus by the species.....	2131.02
Cancellation of species claims.....	821.01, 821.02
Claims restricted to .....	806.04(e)
Election of (See Election of species)	
How recognized.....	806.04(f)
Independent inventions.....	802.01, 808.01(a)
Mutually exclusive characteristics.....	806.04(f)
Obviousness of .....	2144.08
Patentably distinct.....	806.04(h)

MANUAL OF PATENT EXAMINING PROCEDURE  
Specification--Status letter database

Sec. No.	Sec. No.
Patentability over genus.....	806.04(h)
Plural.....	706.03(k), 808.01(a), 809.02
Reissue.....	1450
Rejection.....	806.04(h), 2131.02
Related.....	806.04(b)
With allowable generic claim.....	809.02(b)
Withdrawal of species claims.....	809.02(c)
.....	821.01, 821.02
Specification (See also Disclosure).....	608.01, 2161
Amendment, instructions for entry of.....	714.22, 714.23
Amendment, manner of making.....	714
Arrangement.....	608.01(a)
Background of the invention.....	608.01(c)
Best mode (See also Best mode).....	2165
Brief description of drawings.....	608.01(f)
Brief summary of invention.....	608.01(d)
British English spellings in.....	608.01
British provisional and complete.....	201.15
Changes prior to filing.....	601.01(a), 608.01
Completeness.....	608.01(p), 2161, 2163 to 2165
Computer lists.....	608.05
Confused by amendments.....	608.01(q), 1302.02
Content of.....	608.01(a)
Continued prosecution application.....	201.06(d)
Copyrights in.....	1512
Correction by examiner's amendment.....	1302.04 to 1302.04(g)
Correction by initialing.....	1302.04
Cross-noting of related applications.....	202.01, 1302.04
Defines claim term.....	2111.01
Derogatory remarks prohibited.....	608.01(r)
Description.....	608.01(g), 2163, 2163.02
Design application.....	1503.01
Detailed description of invention.....	608.01(g)
Enablement (See also Enablement).....	2164
English language.....	608.01
Facsimile transmission.....	608.01
Font.....	608.01
Format.....	608.01
Illustrations in.....	608.01
Incorporation by reference.....	2163.07
Interlineation prior to filing.....	608.01
Language faulty.....	608.01
Missing pages.....	601.01(d)
New matter.....	608.04, 706.03(o), 2163.06
Omitted pages.....	601.01(d)
Paragraph numbering.....	608.01, 714
Parts.....	608.01(a)
Provisional application.....	601.01(b)
Reference characters corrected.....	1302.04
Reference to copending application updated .....	202.01, 1302.04(f)
Reissue application.....	1411
Requirements for.....	2161
Return.....	608.01
Rewritten.....	608.01(q), 1302.02
Signature.....	605.04(a)
Substitute, amendment including.....	714.19, 714.20
Substitute specification.....	608.01(q), 714.19, 714.20
Pre-Grant Publication.....	1120
Summary of invention.....	608.01(d)
Table submission on compact disc.....	608.05(b)
Terminology basis for claims.....	608.01(o), 2163.07
Title of invention.....	606
Title of invention changed.....	606.01
Trademarks in.....	1512
Transfer to another application.....	608.01(t)
Written description (See also Written description).....	2163
Specimen, Composition of matter.....	608.03
Specimen, Handling.....	608.03(a)
Specimen, Plant application.....	1607
Stamp	
Drafting, no longer required.....	608.02(o)
Technology Center date.....	714.18
Office date.....	502, 505, 506, 710.01(a), 714.18
Standards of review by the Federal Circuit.....	1216.01
Statement applying the prior art in an <i>ex parte</i> reexamination.....	2217
Statement applying the prior art in an <i>inter partes</i> reexamination.....	2617
Statement, Examiner's (See also Action)	
Statement by inventors when changing inventorship.....	201.03
Statement by owner in <i>ex parte</i> reexamination.....	2249
Statement of allowability by Board.....	1213.01
Statement of invention, coextensive with claims.....	608.01(d)
Statement of invention, reviewed on allowance.....	1302.01
Statement, Prior art (See also Prior art).....	201.06(d), 609
Status inquiries.....	102, 203.08
Congressional.....	203.08(a)
Maintenance fees.....	2570
White House.....	203.08(a)
Status letter.....	203.08
Status letter database.....	203.08

INDEX  
Status of application--Statutes

	Sec. No.		Sec. No.
Status of application .....	102, 203	10 U.S.C. 140(c) Cited .....	120
Abandoned .....	203.05	15 U.S.C. 15(b) Cited .....	101
Abandoned for failure to pay issue fee .....	203.07	15 U.S.C. 1062 Cited .....	513
Allowed or in issue .....	203.04	17 U.S.C. 401 Cited .....	1512
Amended .....	203.03	17 U.S.C. 909 Cited .....	608.01, 608.01(v)
Incomplete .....	203.06	18 U.S.C. 1001	
New .....	203.01	Cited .....	402, 711.03(c)
Parent patent application .....	102, 201.11	.....	715.04, 716.02(g), 2428
Priority claims .....	102	Reproduced .....	602
Published application .....	1128	18 U.S.C. 1905 Cited .....	101
Referred to in foreign patent .....	102	18 U.S.C. 2071 Reproduced .....	101
Rejected .....	203.02	18 U.S.C. 2331 .....	708.02
Statute, citation .....	Introduction	20 U.S.C. 1000 Cited .....	509.02
Statute of limitations		26 U.S.C. 501 Cited .....	509.02
Citation of prior art .....	2204	28 U.S.C. 1745 Cited .....	901.05
Term of biological material deposit .....	2408	28 U.S.C. 1746	
Time for requesting <i>ex parte</i> reexamination ..	2210, 2211	Cited .....	602.03, 2301.02
Time for requesting <i>inter partes</i> reexamination .....	2611	Reproduced .....	602
Statutes		35 U.S.C. 2 Reproduced .....	1001
Atomic Energy Act Cited .....	120, 140, 150	35 U.S.C. 3 Reproduced .....	1001
.....	706.03, 706.03(a) to 706.03(b)	35 U.S.C. 4 Reproduced .....	309
Freedom of Information Act .....	1002.02(k)(2)	35 U.S.C. 6 Reproduced .....	1203
Public Law 87-333 Cited .....	201.13	35 U.S.C. 7 Reproduced .....	901.06(a)
Public Law 94-131 .....	608.01(n)	35 U.S.C. 8 Reproduced .....	903.01
Public Law 96-517 .....	509.02, 2201, 2209, 2501	35 U.S.C. 21 Reproduced .....	511, 513, 710.05
Public Law 97-247 .....	509.02, 509.03, 511	35 U.S.C. 22 Reproduced .....	608.01
.....	711.03(c), 2501	35 U.S.C. 25 Reproduced .....	602
Public Law 98-622 .....	605.07	35 U.S.C. 26 Reproduced .....	602
.....	706.02(k), 804, 2501	35 U.S.C. 41 Reproduced .....	1205, 2268, 2501, 2668
Public Law 100-418, Section 9101(c), (d) .....	140	35 U.S.C. 42 Reproduced .....	607.02
Public Law 102-204 .....	2501	35 U.S.C. 100 Reproduced .....	701
Public Law 102-444 .....	2501	35 U.S.C. 101 Reproduced .....	701, 804, 2107.01
Public Law 103-465 .....	201.03, 201.11, 601.01(d)	35 U.S.C. 102 Reproduced ..	706.02, 706.02(a), 1504.02
.....	706.07(g), 707.05, 715, 715.07(c)	.....	1857.01, 2131, 2132, 2133
.....	803.03, 804.02, 2132, 2138.02	.....	2133.03(c), 2134, 2135, 2136
Public Law 105-358 .....	2501	.....	2137, 2138, 2217, 2258, 2617
Public Law 106-113 .....	201.04(b), 201.11, 201.14(b)	35 U.S.C. 102(e), former Reproduced .....	2136
.....	505, 510, 512, 706.02(a), 715, 1402	35 U.S.C. 103 Reproduced .....	706.02, 706.02(l)
.....	2201, 2273, 2501, 2601, 2602, 2611, 2642	.....	706.02(l)(1), 706.02(n), 804.03
Public Law 107-273 Cited .....	706.02(a), 706.07(a), 2201	.....	1504.03, 2141, 2146
.....	2258.01, 2273, 2279, 2601, 2612, 2683	35 U.S.C. 104 Reproduced .....	715.07(c)
Public Law 506 (81st Cong.) Article 136 Cited		35 U.S.C. 111 Reproduced .....	201, 201.04(b), 601
.....	604.03(a)	35 U.S.C. 112 Reproduced .....	1504.04
Revised Statute of 1874 .....	Introduction	35 U.S.C. 113 Reproduced .....	608.02
5 U.S.C. 552(a) .....	2422, 2423	35 U.S.C. 114 Reproduced .....	608.03
5 U.S.C. 6103 Cited .....	710.05	35 U.S.C. 115 Reproduced .....	602
7 U.S.C. 2321 .....	1612	35 U.S.C. 116 Reproduced .....	409.03, 605.07

MANUAL OF PATENT EXAMINING PROCEDURE  
Statutory authority of Director--Statutory Invention Registration (SIR)

Sec. No.	Sec. No.
35 U.S.C. 117 Reproduced .....	409.01(a)
35 U.S.C. 118 Reproduced .....	409.03
35 U.S.C. 119 Reproduced .....	201.11, 201.13, 201.16
35 U.S.C. 120 Reproduced .....	201.11, 1504.20
35 U.S.C. 121 Reproduced .....	802, 804
35 U.S.C. 122 Reproduced .....	101, 1120, 1122
.....	1123, 1124, 1132, 1134
35 U.S.C. 131 Reproduced .....	701
35 U.S.C. 132 Reproduced .....	706.03(o), 706.07(h)
35 U.S.C. 133 Reproduced .....	710, 2268, 2668
35 U.S.C. 134 Reproduced .....	1205
35 U.S.C. 135 Reproduced .....	2300.01
35 U.S.C. 141 Reproduced .....	1216, 2683
35 U.S.C. 142 Reproduced .....	1216.01
35 U.S.C. 143 Reproduced .....	1216.01
35 U.S.C. 144 Reproduced .....	1216.01
35 U.S.C. 145 Reproduced .....	1216
35 U.S.C. 146 Reproduced .....	1216
35 U.S.C. 152 Reproduced .....	307
35 U.S.C. 153 Reproduced .....	1309
35 U.S.C. 154 Reproduced .....	2701
35 U.S.C. 154, former, Reproduced .....	2720
35 U.S.C. 156 Reproduced .....	2751
.....	2752, 2755.01, 2758, 2759
35 U.S.C. 157 Reproduced .....	1101
35 U.S.C. 161 Reproduced .....	1601
35 U.S.C. 162 Reproduced .....	804, 1605, 2105, 2403.02
35 U.S.C. 163 Reproduced .....	1601
35 U.S.C. 164 Reproduced .....	1608
35 U.S.C. 171 Reproduced .....	1501, 1504.01
35 U.S.C. 172 Reproduced .....	1504.02, 1504.10
35 U.S.C. 173 Reproduced .....	1505
35 U.S.C. 181 Reproduced .....	115
35 U.S.C. 182 Reproduced .....	706.03(s)
35 U.S.C. 184 Reproduced .....	140, 706.03(s)
35 U.S.C. 185 Reproduced .....	140, 706.03(s)
35 U.S.C. 186 Reproduced .....	140
35 U.S.C. 187 Reproduced .....	140
35 U.S.C. 188 Reproduced .....	140
35 U.S.C. 251 Reproduced .....	1401, 1412.03
35 U.S.C. 252 Reproduced .....	1460
35 U.S.C. 253 Reproduced .....	1490
35 U.S.C. 254 Reproduced .....	1480
35 U.S.C. 255 Reproduced .....	1481
35 U.S.C. 256 Reproduced .....	1481
35 U.S.C. 261 Reproduced .....	301
35 U.S.C. 262 Reproduced .....	301
35 U.S.C. 267 Reproduced .....	710
35 U.S.C. 293 Reproduced .....	302.04
35 U.S.C. 294 Reproduced .....	311
35 U.S.C. 301 Reproduced .....	2602
35 U.S.C. 302 Reproduced .....	2210
35 U.S.C. 303 Reproduced .....	2240
35 U.S.C. 304 Reproduced .....	2246
35 U.S.C. 305 Reproduced .....	2254, 2261
35 U.S.C. 306 Reproduced .....	1216, 2273
35 U.S.C. 307 Reproduced .....	2288, 2293
35 U.S.C. 311 Reproduced .....	2610
35 U.S.C. 312 Reproduced .....	2640
35 U.S.C. 313 Reproduced .....	2646
35 U.S.C. 314 Reproduced .....	2654, 2661, 2686.04
35 U.S.C. 315 Reproduced .....	2674
35 U.S.C. 316 Reproduced .....	2688, 2693
35 U.S.C. 317 Reproduced .....	2686.04
35 U.S.C. 318 Reproduced .....	2686.04
35 U.S.C. 361 Reproduced .....	1805
35 U.S.C. 362 Reproduced .....	1840
35 U.S.C. 363 Reproduced .....	1810
35 U.S.C. 365 Reproduced .....	201.13(b)
35 U.S.C. 371 Reproduced .....	1893.01
35 U.S.C. 373 Reproduced .....	1810
35 U.S.C. 374 Reproduced .....	1857, 1857.01
42 U.S.C. 141 Cited.....	120
42 U.S.C. 181 Cited.....	120
42 U.S.C. 2182 Reproduced .....	150
42 U.S.C. 2457 Reproduced .....	150
Statutory authority of Director.....	1001
Statutory bar .....	706.02(a), 2133 to 2133.03(e)(7)
Foreign application .....	201.13, 1504.02
Overcoming .....	706.02(b)
Rule 1.130 not available .....	718
Rule 1.131 not available .....	715
Statutory classes of invention, utility.....	706.03(a)
Statutory disclaimer (See Disclaimer; Terminal disclaimer)	
Statutory estoppel in <i>inter partes</i> reexamination.....	2601
.....	2612, 2614
Statutory Invention Registration (SIR).....	409.03(j)
.....	Chapter 1100
Defensive publication compared .....	711.06
Effect of.....	1111
Examination.....	1101, 1103
Provisional application .....	1101
Publication of.....	1111
Refund of fee .....	1109

INDEX  
Statutory period--Supervisory patent examiner

	Sec. No.		Sec. No.
Rejections using .....	706.02(a), 901.02, 2136	Submission of prior art by applicant.....	707.05(b)
Request for .....	1101	Submission of information by applicant.....	704.12(b)
Secrecy order application .....	1103	.....	704.14(b), 707.05(b)
Statutory period (See also Period for reply: Shortened statutory period) .....	710.01, 710.01(a)	Subpoena by court, Application file .....	1216.02
Abandonment for failure to reply .....	711.02, 711.02(a)	Subpoena of examiner .....	1701.01
Appeal .....	1205	Subscription correspondence address .....	title page
Broadening claims in a reissue application .....	1412.03	Substantial new question of patentability	
Computed .....	710.01(a)	In <i>ex parte</i> reexamination .....	2216, 2242, 2258.01
Date from which period runs .....	710.06	In <i>inter partes</i> reexamination.....	2614, 2616
Date of abandonment .....	711.04(a)	.....	2617, 2640, 2642
Full statutory period .....	130	Substitute application (See also Application)	
Interference .....	2315, 2363	.....	201.09, 201.10
Not extendible .....	710.02(e)	Assignment .....	306
Postal service emergency .....	511	Copendency lacking .....	201.11
Property rights statement.....	150	Definition.....	201.09
Reexamination, <i>ex parte</i> .....	2265, 2272	Does not carry ownership from parent .....	306
Reexamination, <i>inter partes</i> .....	2662, 2665	File wrapper/history notation.....	202.02
Secrecy order application .....	130	Reference to parent application .....	201.09, 201.11
Shortened statutory period (See Shortened statutory period)		Substitute attorney or agent .....	406
Two periods for reply set .....	710.04, 710.04(a)	Substitute for missing hard copy .....	901.09
Stay of reexamination		Substitute oath .....	602.02
<i>Ex parte</i> .....	2284, 2285	Substitute page.....	714.20
<i>Inter partes</i> .....	2686.03, 2686.04	Substitute specification.....	608.01, 608.01(q), 714.19, 714.20
Stay of reissue .....	1442.02, 2285	Amendment incorporating .....	714, 714.19, 714.20
Stockholm Revision, Paris Convention (See also Treaties)		New matter .....	608.01(q)
.....	201.13	Sufficiency of disclosure affidavit.....	716
Strasbourg Agreement (See also Treaties) .....	903.09	‘Sufficient cause’ for extension of time in <i>ex parte</i> reexamination .....	2265
STIC (See Scientific and Technical Information Center (STIC))		‘Sufficient cause’ for extension of time in <i>inter partes</i> reexamination .....	2665
Subclass, list of patent numbers .....	902.03(c)	Suggested claims, Failure to make .....	706.03(u)
Subcombination		Suggested claim made after end of statutory period.....	2305.03
Aggregation and .....	806.05(a)	Suggestion of allowable claims	
Combination and .....	802.01, 806.04(c), 806.05(b)	by examiner .....	707.07(j), 713.01
Not generic .....	806.04(c)	Suggestion of claims for interference .....	2305 to 2305.04
Species .....	806.04(b)	Suggestion of claims for interference, time limit.....	710.02(c)
Subgeneric Markush claims .....	2173.05(h)	Summary of action PTOL-326 .....	707
Subject matter, design patent .....	1502, 1504.01	Summary of interview .....	713.01, 713.04
Subject matter, nonstatutory.....	706.03(a)	Summary of invention .....	608.01(d)
Subject matter combinations .....	903.02(b)	Sunday or holiday, effect on time for reply .....	502
Submission of amendment or showing of facts after Board decision.....	1214.01	.....	505, 513, 710.05
Submission of patents or publications, third party .....	610	Sunday or holiday, effect on reference .....	706.02(a)
Submission to classification unit		Supervisory applications examiner.....	714.13
Classification of application.....	903.08(d), 903.08(e)		
Patentability report.....	705.01(a)		

MANUAL OF PATENT EXAMINING PROCEDURE  
Supervisory patent examiner--Term, Patent

	Sec. No.		Sec. No.
Supervisory patent examiner .....	705.01, 707, 707.02	Technical rejections .....	706.03
.....	708.03, 713.01, 713.08, 714.05	Technical support staff duties (See Manual of Clerical Procedure)	
.....	714.13, 714.16, 714.16(d), 714.18	Technology Center Director (See Director of Technology Center)	
.....	812.01, 903.08(b), 1208.02, 1214.07	Technology Center, papers sent to wrong .....	508.01
.....	2233, 2236, 2237, 2238, 2248	Technology Center Working Group 3640 (security group) .....	121, 130, 1002.02(c)(1)
.....	2271.01, 2287	Telegraphic amendment .....	714.08
.....	2633, 2636, 2637, 2638, 2641, 2648	Telephone call, multiplicity rejection .....	2173.05(n)
.....	2671, 2671.03, 2676	Telephone numbers.....	1730
Petitions decided by .....	1002.02(d)	Attorney.....	408, 713.01, 714.01
Supervisory review, Rule 1.817 .....	711.03(d)	Examiner.....	707.08
Supplemental action .....	710.06, 714.05	General information.....	1730
Supplemental Application Data Sheet (ADS) .....	601.05	Telephoning of attorney to examiner.....	408, 713.01
Supplemental examiner's answer .....	1208.03, 1211	Term, Patent .....	707.05, 2701
Supplemental oath or declaration .....	603	Adjustment of.....	2701, 2710, 2730
After allowance .....	603.01, 714.16	.....	2731, 2732, 2733, 2734, 2735, 2736
Reissue .....	1414.01	Determination of .....	2733
Surcharge for late payment of fees		Due care showing.....	2734
in international application .....	1827	Grounds for.....	2730
Surface ornamentation .....	1502, 1502.01, 1503.02	Period of .....	2731
.....	1504.01, 1504.01(a)	Reductions to .....	2732
.....	1504.01(c), 1504.03	Request for reconsideration .....	2735
Surrender of patent.....	1416	Third party papers.....	2736
Suspension		Continued prosecution application .....	2701
Applicant's request for .....	709	Deposit of biological material .....	2408
Decided by .....	709, 1002.02(c), 1004	Design.....	1502.01, 1505
Deferral of examination .....	709	Divisional .....	201.06
<i>Ex parte</i> prosecution during interference .....	2315	Extension under 35 U.S.C. 156	
Not permitted if outstanding Office action.....	709	FDA regulatory review and .....	2750 to 2758
Of action, because of litigation .....	1213	Deadline .....	2754.01 to 2754.03
Of action, by Office.....	709	Duty of disclosure and.....	2762
Overlapping application .....	709.01, 2315.01	Interim extension.....	2755.01, 2755.02
Reexamination		Specific Products	
<i>Ex parte</i> .....	2283, 2284, 2307.04	Animal drugs .....	2750, 2751, 2758
<i>Inter partes</i> .....	2640, 2686.01	Antibiotic drugs .....	2751, 2758
Request for, in CPA .....	709	Color additives.....	2750, 2751, 2754.01, 2758
Request for, in RCE .....	709	Food additives.....	2750, 2751, 2754.01, 2758
Rules .....	1002	Medical devices .....	2750, 2751, 2753, 2758
Secrecy order application .....	2309.06	Veterinary Biological Products.....	2750
Swearing back of reference (See Affidavit, swearing back of reference (37 CFR 1.131))		.....	2751, 2756, 2758
Symbols, Drawing.....	608.02	Third party papers .....	2736
		Withdrawal.....	2761, 2764
		USPTO delays and.....	2710
		Foreign.....	901.05
		Transitional practice .....	706.07(g), 803.03

**T**

Tables submitted on compact disc.....	608.05(b)
Technical documents.....	901.06(a)

INDEX  
Terminal disclaimer--Trade secret material

Sec. No.	Sec. No.
Utility .....	2701
Terminal disclaimer (See also Disclaimer) .....	1490
Avoiding double patenting rejection .....	706.02(k)
.....	706.02(l)(3), 804.02, 806.04(i)
Certificate of correction and.....	2701, 2720
Continued Prosecution Application (CPA) .....	1490
Continuing applications .....	1490
Copending applications procedure .....	1490
Informal memo.....	1490
Request for Continued Examination (RCE).....	1490
Reissue .....	1410.01, 1451, 1490
Required for revival .....	711.03(c)
Routing.....	1490
Situations where not applicable.....	804.03
Withdrawal of .....	1490
Terminology in application .....	608.01(g), 608.01(o)
.....	706.03(d), 1302.01
Termination of proceedings .....	201.11, 711.02(c)
<i>Ex parte</i> reexamination .....	2294
<i>Inter partes</i> reexamination .....	2694
TESS (Trademark Electronic Search System) .....	1703
Test comments .....	707.07(l)
Testamentary, Letters (See also Administrator or executor)	
.....	409.01(b)
Testimony, examiner.....	1701.01
Testimony, public use proceeding.....	720.04
Tests, comparative (See Affidavits, traversing rejections (37 CFR 1.132))	
Third action cases.....	707.02
Third party reply in <i>inter partes</i> reexamination (See Reexamination, <i>Inter partes</i> : Response by third party)	
Third party requestor (See Reexamination, <i>Inter partes</i> : Response by third party)	
Third party submissions/inquiries/correspondence in published applications .....	1134, 1134.01
Time and Activity Report.....	1704, 1705
Time for claiming benefit of earlier application.....	201.11
Time for deciding Director initiated reexamination .....	2211, 2239
Time for deciding reexamination request.....	2241
Time for filing papers, right of priority .....	201.14(a)
Time for filing petitions .....	1002
Time for requesting reexamination	
<i>Ex parte</i> .....	2210, 2211
<i>Inter partes</i> .....	2611
Time for reply (See also Period for reply).....	702.01, 710
Time for reply to action in reexamination	
<i>Ex parte</i> .....	2263
<i>Inter partes</i> .....	2662
Time limit .....	710.02, 710.02(c)
For making suggested claims.....	710.02(c)
Interference.....	2305.01, 2305.02, 2321
International preliminary examination report (IPER) .....	1879.01, 1879.01(a)
International search report (ISR) .....	1843.05
Period for reply .....	710
Permanent ink copy .....	714.07
Prior art filing .....	2204
Reply to final rejection .....	706.07(f)
Restriction requirement .....	811
Rewrite claims following Board decision.....	1214.06
Shortened statutory period compared to .....	710.02
.....	710.02(b), 710.02(d)
Statutory period .....	710.01, 710.01(a)
Transfer of application.....	903.08(d)
Two periods running.....	710.04
Time period for owner's statement.....	2249
Time reporting.....	2238, 2638, 2671.03
Time to pay maintenance fees .....	2506
Timely submission of protest.....	1901.04
Title conveyed by assignment .....	201.12, Chapter 300
Title documents, handling .....	317
Title of invention .....	606
Change by examiner .....	2660.02, 2686.03
Design application .....	1503.01, 1504.01(a)
Amendment of .....	1503.01
Use of Trademarks in.....	1512
International application .....	1821
Plant patent application .....	1610
Reviewed at issue .....	606.01, 1302.01
Title report.....	303, 320, 2287
Titles of USPTO Officials .....	Title Page (reverse side)
Title with signature .....	605.04(e)
Trade secret material .....	724 to 724.05
Completeness of file wrapper .....	724.01
Materials submitted covered	
by 35 U.S.C. 122 .....	724.04(a)
Method of submitting .....	724.02
Office treatment and handling .....	724.04, 724.06
After publication.....	724.04(a)
Petition to expunge materials.....	724.05
Reexamination under 37 CFR 1.11(d).....	724.04(c)
Reissue under 37 CFR 1.11(b).....	724.04(b)



MANUAL OF PATENT EXAMINING PROCEDURE  
Trade secret submission label--Unclaimed disclosure, reservation

Sec. No.	Sec. No.
Types of.....	724.03
Trade secret submission label .....	724.02
Trademark and trade name.....	608.01(v), 706.03(d)
.....	2173.05(u), App. I
Design patent, relationship to .....	1512
Misuse in patent specification .....	608.01(v)
Trademark Manual of Examining Procedure .....	Foreword
Trademarks, Partial list of .....	Appendix I
Transfer of application	
After amendment.....	903.08(c)
After classification decision .....	903.08(g)
Allowable application .....	903.07(b), 1305
Decision of classification examiner .....	903.08(f)
Divisible inventions .....	812
Interference .....	2306
New .....	903.08(a)
Notification of applicant.....	903.08
Outside Technology Center.....	903.08(d)
Primary examiner's authority.....	903.08
Procedure .....	903.08(a), 903.08(d), 903.08(g)
Secrecy order application .....	130
Submitted to classification examiner .....	903.08(d)
Within Technology Center.....	903.08(d)
Transfer of class or subclass.....	903.05
Transfer of drawing.....	608.02(i)
Transfer of reexamination	
<i>Ex parte</i> .....	2237
<i>Inter partes</i> .....	2637
Transfer of rights to patent or application .....	509.02
Transfer of specification prohibited .....	608.01(t)
Transfer of U.S. patent.....	903.05
Transitional application (See also Application)	
After final practice .....	706.07(g)
Generic claim allowable.....	803.03(b)
Linking claim allowable.....	803.03(a)
Patent term .....	2701
Restriction practice.....	803.03
Transitional phrases .....	2111.03
"Characterized by" .....	2111.03
"Composed of" .....	2111.03
"Comprising" .....	2111.03, 2173.05(h)
"Consisting essentially of" .....	2111.03
"Consisting of" .....	2111.03, 2173.05(h)
"Containing" .....	2111.03
Translation, foreign application or foreign priority document .....	201.15
Translations index in STIC .....	901.06(a)
Translator, Patent and Trademark Office .....	901.05(d)
.....	901.06(a)
Transmission, certificate of (See Certificate of mailing or transmission)	
Transmittal Fee, PCT.....	1827
Traverse, answer all matters .....	707.07(f)
Traverse, division or species requirement .....	818
.....	818.03 to 818.03(d), 821.01, 821.02
Traverse, rejection of linking claim.....	818.03(d)
Treaties	
Benelux Designs Convention (See also Design application).....	201.13, 1504.10
Budapest Treaty (See also Biotechnology; Microorganisms).....	901.05(b)
.....	2402, 2404.01, 2405, 2408
.....	2409, 2410.01, 2410.02, 2411.01
European Community Design.....	1504.10
European Patent Convention .....	901.05, 1817
.....	1840.01, 1865.01
GATT .....	2138.02
Hague Agreement (See also Design application) .....	201.13, 1504.10
Hague Convention .....	409.01(b), 602.04(a), 604.04
Inter-American Convention.....	201.13
Libreville Agreement.....	201.13
NAFTA.....	201.04(b), 715, 715.07(c), 2138.02
Paris Convention .....	201.13, App. P
Patent Cooperation Treaty (PCT) .....	Chapter 1800
.....	App. AI, App. T
Strasbourg Agreement .....	903.09
UPOV Convention (See also Plant patent) .....	1612, 1613
Uruguay Round Agreements Act (URAA).....	201.04(b)
.....	715, 715.07(c), 2701, 2132
TRIPS Agreement (Trade-Related Aspects of Intellectual Property).....	1801
Tubers .....	1601
Twenty year term (See Term, Patent)	
Two month delay period in reissues .....	1441
Two periods for reply running.....	710.04
Type font .....	608.01, 1504.01(a)
 <b>U</b>  	
Unavailable inventor.....	409, 409.03
Unavoidable abandonment (See Abandonment)	
Unclaimed disclosure, reservation .....	608.01(e)

INDEX  
Undelivered mail--Withdrawal from issue

	Sec. No.		Sec. No.
Undelivered mail .....	707.13, 1303.02	Maintenance fees .....	2506
Undue breadth rejection .....	706.03, 707.07(g)	Period of enforceability .....	2204, 2211, 2611
.....	2164.08(a), 2173.04, 2173.05(h)	Specification .....	608.01
Unexpected results (See also Affidavits, traversing rejections (37 CFR 1.132)) .....	716.02 to 716.02(g)	Utility required .....	608.01(p), 706.03(a), 2107, 2164.07
Unintentional abandonment (See Abandonment)			
United Kingdom priority document .....	201.15		
United States Code (See also Statutes)			
United States of America, Foreign language names for .....	901.05(a)		
Unity of invention .....	803, 823, 1850, 1875, 1893.03(d)		
University or other institution of higher learning .....	509.02		
Unlocatable Patent or Application Files .....	508.04		
Unmatched papers .....	508.03		
Unofficial subclasses and digests .....	903.02(c)		
Unscheduled closing .....	201.13		
Unsigned amendment .....	711, 714.01(a)		
Untimely filed (premature) paper prior to order for <i>ex parte</i> reexamination .....	2225		
Untimely filed (premature) paper prior to order for <i>inter partes</i> reexamination .....	2625		
Untimely response to <i>ex parte</i> reexamination .....	2267		
Untimely response to <i>inter partes</i> reexamination .....	2667		
UPOV Convention (See also Plant patent; Treaties).....	1612		
.....	1613		
Uruguay Round Agreements Act (See also Treaties) .....	201.04(b), 715, 715.07(c), 2701, 2132		
Use claims .....	2173.05(q)		
Use, Public (See Public use)			
User pass .....	510		
Utility classes .....	902.02		
Utility, disclosure in drug cases .....	2164.06, 2164.07		
Utility requirement guidelines .....	2107		
Legal precedent for .....	2107 to 2107.03		
Relationship of enablement to .....	2164.07		
Utility lacking, rejection .....	706.03(a), 2107		
Utility model .....	901.05(b)		
Utility patent (See also Design application; Patent; Plant patent).....	901.04, 1502.01		
Application publication .....	1120 to 1135		
Copies of .....	707.05(a)		
Copyrighted material in .....	608.01(v)		
Design patent compared to .....	1502.01		
Double patenting .....	804		
Drawings / Photographs .....	608.01(f), 608.02		
Elements of .....	Chapter 600		
Expiration date or term .....	2211, 2250, 2611		
		<b>V</b>	
		Vague and indefinite rejection (See Indefinite claim)	
		Validity of patent, examiner comments .....	1701
		Venue .....	604.02
		Video conference center .....	713.01
		Video tapes .....	713.01
		Violation of duty of disclosure (See Duty of disclosure)	
		Argued in protest .....	1901.02, 1901.06
		Visitors to Office .....	510
		Voluntary publication .....	1133
		<b>W</b>	
		Waiver	
		Of confidentiality .....	103
		.....	201.06(d), 1002.02(k)(1)
		Of deficiencies in oath or declaration .....	602.03
		Of patent rights .....	706, 711.06, 1101, 1111
		Of rules .....	201.03, 307
		.....	602, 711.03(c)
		.....	724.06, 803.04, 1002, 1002.02(b), 1481
		.....	1850, 2248, 2265, 2421.01, 2425, 2434
		Walk-up customer window .....	502
		Washington D.C. representatives of attorneys .....	408
		When disclosure is made .....	2003
		White House inquiry .....	203.08(a)
		Who has duty to disclose .....	2001.01
		WIPO .....	201.13, 901.04, 1801
		WIPO Standards	
		ST. 3 .....	901.05(b), 1851
		ST. 10 .....	901.05(b)
		ST. 14 .....	707.05(e), 901.05(b)
		ST. 16 .....	901.05(b), 1851, 2424.03
		ST. 25, Appendix 2	
		Tables reproduced .....	2422
		Cited .....	2422.01, 2423, 2423.01
		ST. 34 .....	901.05(b)
		Withdrawal from appeal after remand by Board .	1002.02(d)
		Withdrawal from issue .....	1303.01, 1308

MANUAL OF PATENT EXAMINING PROCEDURE  
Withdrawal of abandonment--X series of patents

	Sec. No.		Sec. No.
Amendment crossing allowance.....	714.15	New matter .....	2163.06
Claim presented corresponding to claim of patent.....	2307.03	Requirements for compliance .....	2163.02
Director's approval.....	1003, 1308	Support for claimed subject matter .....	201.11, 2163.01
Interference purposes .....	2305.04, 2307.03	Corresponding to count in interference .....	2163.03
Petition for.....	1002.02(b), 1002.02(c), 1308		
Quality Review.....	1308.03	<b>X</b>	
Refund of fee.....	1308.01	X series of patents (See also Patent).....	901.04
Rejection .....	706.04, 1308.01		
Suggesting claims for interference .....	2305.04		
Withdrawal of abandonment (See Abandonment; Petition)			
Withdrawal of appeal .....	1215.01		
Withdrawal of appeal claim .....	1214.05, 1215.03		
Withdrawal of attorney (See also Attorney or agent; Power of attorney).....	402.06, 1002.02(s), 2223, 2560		
Withdrawal of claims			
To nonelected invention.....	821.01, 821.02, 821.03		
To nonelected species .....	809.02(c), 821.01, 821.02		
Withdrawal of final rejection .....	706.07(e)		
After appeal.....	1208.02		
Premature final .....	706.07(d)		
Primary decides.....	1004		
Withdrawal of holding of abandonment (See also Abandonment; Petition) .....	711.03(c), 711.04(c)		
Withdrawal of power of attorney in patent.....	2223, 2623		
Withdrawal of SIR request.....	1109		
Withdrawal of terminal disclaimer.....	1490		
Withhold from issue petition.....	1002.02(c)		
Witness, Examiner as .....	1701.01		
World Trade Organization member countries .....	201.13		
World Wide Web address .....	1730		
Wrapper (See File wrapper/history)			
Writing, Disclosures must be in .....	2002.02		
Written description (See also Specification) .....	706.03(c), 2163		
Amendments supported by original description .....	2163.07		
Inherent function, theory or advantage .....	2163.07(a)		
Incorporation by reference.....	608.01(p), 2163.07(b)		
Burden on the examiner .....	2163.04		
Changes to scope of claims .....	2163.05		
Circumstances when issues arise.....	2163.03		
Design application.....	1503.01, 1503.02		
.....	1504.01(a), 1504.04		
Form paragraphs used to reject .....	706.03(c)		
Guidelines for compliance .....	2163		